

EMC TEST REPORT

For

Wireless ADSL 2/2+ Router

Model Number: Gaw9.2Z18-4, Gaw9B.2Z18-4

FCC ID: V4VGaw92Z18-4

Report Number : WT088000373

Test Laboratory	:	Shenzhen Academy of Metrology and Quality Inspection EMC Laboratory Guangdong EMC Compliance Test Center
Site Location	:	Bldg. of Metrology & Quality Inspection, Longzhu Road, Shenzhen, Guangdong, China
Tel	:	0086-755-26941637, 26941529, 26941531
Fax	:	0086-755-26941545
Email	:	emclab@sohu.com

TABLE OF CONTENTS

TEST REPORT DECLARATION	4
1. TEST RESULTS SUMMARY	5
2. GENERAL INFORMATION	6
2.1. Report information	6
2.2. Laboratory Accreditation and Relationship to Customer	6
2.3. Measurement Uncertainty	6
3. PRODUCT DESCRIPTION	7
3.1. EUT Description	7
3.2. Related Submittal(s) / Grant (s)	7
3.3. Block Diagram of EUT Configuration.....	8
3.4. Operating Condition of EUT	8
3.5. Special Accessories.....	8
3.6. Equipment Modifications.....	8
3.7. Support Equipment List	9
3.8. Test Conditions	9
4. TEST EQUIPMENT USED	10
5. CONDUCTED DISTURBANCE TEST	11
5.1. Test Standard and Limit.....	11
5.2. Test Procedure	11
5.3. Test Arrangement.....	11
5.4. Test Data	11
6. RADIATED DISTURBANCE TEST	15
6.1. Test Standard and Limit.....	15
6.2. Test Procedure	15
6.3. Test Arrangement.....	15
6.4. Test Data	16
7. 6DB BANDWIDTH MEASUREMENT	21
7.1. LIMITS OF 6dB BANDWIDTH MEASUREMENT.....	21
7.2. TEST PROCEDURE	21
7.3. TEST SETUP.....	21
7.4. EUT OPERATING CONDITIONS.....	21
7.5. Test Data	21
8. MAXIMUM PEAK OUTPUT POWER	25
8.1. LIMITS OF MAXIMUM PEAK OUTPUT POWER MEASUREMENT.....	25
8.2. TEST PROCEDURES	25
8.3. TEST SETUP	25
8.4. EUT OPERATING CONDITIONS.....	25
8.5. Test Data	25
9. POWER SPECTRAL DENSITY MEASUREMENT	26
9.1. LIMITS OF POWER SPECTRAL DENSITY MEASUREMENT.....	26
9.2. TEST PROCEDURE	26
9.3. 4.5.5 TEST SETUP.....	26
9.4. 4.5.6 EUT OPERATING CONDITION	26

9.5.	Test Data	26
10.	BAND EDGES MEASUREMENT	30
10.1.	LIMITS OF BAND EDGES MEASUREMENT.....	30
10.2.	TEST PROCEDURE	30
10.3.	EUT OPERATING CONDITION	30
10.4.	TEST RESULTS.....	30
11.	ANTENNA REQUIREMENT	32
11.1.	STANDARD APPLICABLE.....	32
11.2.	ANTENNA CONNECTED CONSTRUCTION	32
	APPENDIX I TEST PHOTO.....	33
	APPENDIX II EUT PHOTO	35

TEST REPORT DECLARATION

Applicant : Shenzhen Gongjin Electronics Co., Ltd
Address : A211-A213, B201-B210, 2F Baiying Building, 1019# Nanhai RD,
Shekou, Shenzhen, Guangdong, China.
Manufacturer : Shenzhen Gongjin Electronics Co., Ltd
Address : A211-A213, B201-B210, 2F Baiying Building, 1019# Nanhai RD,
Shekou, Shenzhen, Guangdong, China.
Factory : Shenzhen Gongjin Electronics Co., Ltd
Address : A211-A213, B201-B210, 2F Baiying Building, 1019# Nanhai RD,
Shekou, Shenzhen, Guangdong, China.
EUT Description : Wireless ADSL 2/2+ Router
Model Number : Gaw9.2Z18-4, Gaw9B.2Z18-4
FCC ID : V4VGaw92Z18-4
Test Standards:

FCC Part 15 15.207, 15.209, 15.247

The EUT described above is tested by Shenzhen Academy of Metrology and Quality Inspection EMC Laboratory to determine the maximum emissions from the EUT. Shenzhen Academy of Metrology and Quality Inspection EMC Laboratory is assumed full responsibility for the accuracy of the test results. The test data, data evaluation, test procedures, and equipment configurations shown in this report were made in accordance with the procedures given in ANSI C63.4 (2003) and the energy emitted by the sample EUT tested as described in this report is in compliance with FCC Rules Part 15.207, 15.209 and 15.247.

The test report is valid for above tested sample only and shall not be reproduced in part without written approval of the laboratory.

Tested by:	 _____ (Louis Lin)	Date:	<u>Apr. 14, 2008</u>
Checked by:	 _____ (Dewelly Yang)	Date:	<u>Apr. 14, 2008</u>
Approved by:	 _____ (Peter Lin)	Date:	<u>Apr. 14, 2008</u>

1. TEST RESULTS SUMMARY

Table 1 Test Results Summary

Test Items	FCC Rules	Test Results
Conducted Disturbance	15.207	Pass
Radiated disturbance	15.209	Pass
6dB Bandwidth	15.247(a)(2)	Pass
Maximum Peak Output Power	15.247(b)	Pass
Band Edge Measurement	15.247(d)	Pass
Power Spectral Density	15.247(e)	Pass
Antenna Requirement	15.203	Pass

2. GENERAL INFORMATION

2.1. Report information

- 2.1.1. This report is not a certificate of quality; it only applies to the sample of the specific product/equipment given at the time of its testing. The results are not used to indicate or imply that they are application to the similar items. In addition, such results must not be used to indicate or imply that SMQ approves recommends or endorses the manufacture, supplier or use of such product/equipment, or that SMQ in any way guarantees the later performance of the product/equipment.
- 2.1.2. The sample/s mentioned in this report is/are supplied by Applicant, SMQ therefore assumes no responsibility for the accuracy of information on the brand name, model number, origin of manufacture or any information supplied.
- 2.1.3. Additional copies of the report are available to the Applicant at an additional fee. No third part can obtain a copy of this report through SMQ, unless the applicant has authorized SMQ in writing to do so.

2.2. Laboratory Accreditation and Relationship to Customer

The testing report were performed by the Shenzhen Academy of Metrology and quality Inspection EMC Laboratory (Guangdong EMC compliance testing center), in their facilities located at Bldg. of Metrology & Quality Inspection, Longzhu Road, Nanshan District, Shenzhen, Guangdong, China. At the time of testing, Laboratory is accredited by the following organizations:

China National Accreditation Committee for Laboratories (**CNAL**) accredits the Laboratory for conformance to FCC standards, EMC international standards and EN standards. The Registration Number is L0579.

The Laboratory is listed in the United States of American Federal Communications Commission (**FCC**), and the registration number are **97379**(open area test site) and **274801**(semi anechoic chamber).

The Laboratory is listed in Voluntary Control Council for Interference by Information Technology Equipment (**VCCI**), and the registration number are **R-1974**(open area test site), **R-1966**(semi anechoic chamber), **C-2117**(mains ports conducted interference measurement) and **T-180**(telecommunication ports conducted interference measurement).

The Laboratory is registered to perform emission tests with Industry Canada (**IC**), and the registration number is **IC4174**.

TUV Rhineland accredits the Laboratory for conformance to IEC and EN standards, the registration number is **E2024086Z02**.

Measurement Uncertainty

2.3. Measurement Uncertainty

Conducted Disturbance: 9kHz~30MHz 3.5dB

Radiated Disturbance: 30MHz~1000MHz 4.5dB
1GHz~18GHz 4.6dB

3. PRODUCT DESCRIPTION

3.1. EUT Description

Description : Wireless ADSL 2/2+ Router

Manufacturer : Shenzhen Gongjin Electronics Co., Ltd

Model Number : Gaw9. 2Z18-4, Gaw9B. 2Z18-4

Adaptor : Model: ADS-18E-12 1212GPCU
Input : 100-240V~, 50/60Hz, Max. 0.60A
Output: 12VDC, 1.0A

Operate Frequency : 2.412GHz~2.462GHz

Antenna Designation : Replaceable antenna with Non-standard jack

Antenna Gain : 2.0 ± 0.7 dBi

Remark: Gaw9. 2Z18-4 and Gaw9B. 2Z18-4 are series products, they are identical in schematic, construction and critical components but different software. So, all tests are performed on Gaw9. 2Z18-4 only.

Table 2 The working Frequency List

Channel	Frequency	Channel	Frequency
1	2412 MHz	7	2442 MHz
2	2417 MHz	8	2447 MHz
3	2422 MHz	9	2452 MHz
4	2427 MHz	10	2457 MHz
5	2432 MHz	11	2462 MHz
6	2437 MHz		

3.2. Related Submittal(s) / Grant (s)

This submittal(s) (test report) is intended for FCC ID: V4VGaw92Z18-4 filing to comply with Section 15.207, 15.209, 15.247 of the FCC Part 15, Subpart C Rules.

3.3. Block Diagram of EUT Configuration

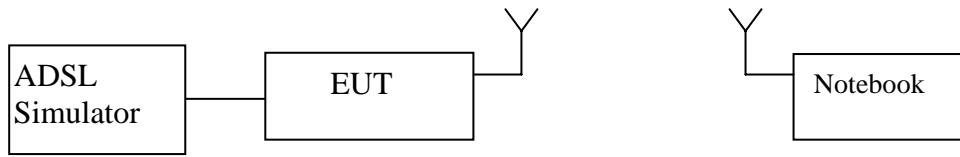

Figure 1 EUT setup 1

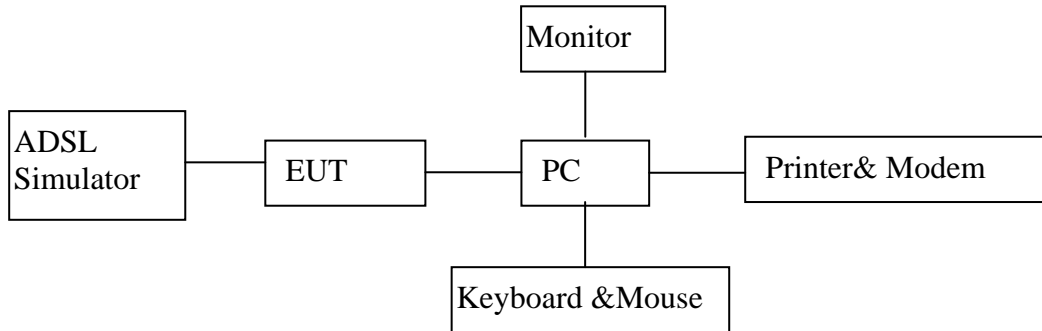

Figure 2 EUT setup 2

3.4. Operating Condition of EUT

- Mode1: Transmitting at 2412MHz
- Mode2: Transmitting at 2442MHz
- Mode3: Transmitting at 2462MHz
- Mode4: Communication (wire network)

3.5. Special Accessories

Not available for this EUT intended for grant.

3.6. Equipment Modifications

Not available for this EUT intended for grant.

3.7. Support Equipment List

Table 3 Support Equipment

Name	Model Number	S/N	Manufacture
Notebook	R51	--	IBM
Adaptor for notebook	02K6654	--	IBM
PC	P9111A #AB2	CN31104346	COMPAQ
Monitor	P4825	CN3087A02 6	COMPAQ
Adaptor of monitor	PA-1400-02	3101571101 LN	LITEON
Keyboard (PS/2)	KB-0133	CT:B55930DGANN3NU	COMPAQ
Mouse (PS/2)	M-S69	CT:F466BOMMSNS05J2	COMPAQ
Printer	BJC-265SP	EVX81604	CANON
Adaptor for printer	AD-300	--	CANON
Modem (COM)	56000BPS	200060057	KPT
Adaptor for modem	AM-1280AV	--	KPT
ADSL Simulator	IES-1000	3912A165-100	ZyXEL

3.8. Test Conditions

Date of test: Feb 28, 2008-Mar 3, 2008

Date of EUT Receive: Feb 27, 200

Temperature: 0-35 °C

Relative Humidity: 50-70%

4. TEST EQUIPMENT USED

Table 4 Test Equipment

No.	Equipment	Manufacturer	Model No.	Last Cal.	Cal. Interval
SB2603	EMI Test Receiver	Rohde & Schwarz	ESCS30	Jan.25, 2008	1 Year
SB3321	AMN	Rohde & Schwarz	ESH2-Z5	Jan.25, 2008	1 Year
SB2604	AMN	Rohde & Schwarz	ESH3-Z5	Jan.25, 2008	1 Year
SB3436	EMI Test Receiver	Rohde & Schwarz	ESI26	Jan.25, 2008	1 Year
SB3440	Bilog Antenna	Chase	CBL6112B	Jan.25, 2008	1 Year
SB3435	Horn Antenna	Rohde & Schwarz	HF906	Jan.25, 2008	1 Year
SB3435/01	Amplifier(1-18GHz)	Rohde & Schwarz	---	Jan.25, 2008	1 Year
SB3435/02	Amplifier(18-40GHz)	Rohde & Schwarz	---	May.05, 2007	1 Year
SB3435/03	Horn Antenna	Rohde & Schwarz	AT4560	May.05, 2007	1 Year
SB3450/01	3m Semi-anechoic chamber	Albatross Projects	9X6X6	Jan.25, 2008	1 Year

5. CONDUCTED DISTURBANCE TEST

5.1. Test Standard and Limit

5.1.1. Test Standard

FCC Part 15 15.207

5.1.2. Test Limit

Table 5 Conducted Disturbance Test Limit (Class B)

Frequency	Maximum RF Line Voltage (dB μ V)	
	Quasi-peak Level	Average Level
150kHz~500kHz	66 ~ 56 *	56 ~ 46 *
500kHz~5MHz	56	46
5MHz~30MHz	60	50

- Decreasing linearly with logarithm of the frequency
- The lower limit shall apply at the transition frequency.

5.2. Test Procedure

The EUT is put on a table of non-conducting material that is 80cm high. The vertical conducting wall of shielding is located 40cm to the rear of the EUT. The power line of the EUT is connected to the AC mains through a Artificial Mains Network (A.M.N.). A EMI test receiver (R&S Test Receiver ESCS30) is used to test the emissions form both sides of AC line. According to the requirements in Section 7 and 13 of ANSI C63.4-2003. Conducted emissions from the EUT measured in the frequency range between 0.15 MHz and 30MHz using CISPR Quasi-Peak and average detector mode.

The bandwidth of EMI test receiver is set at 9kHz.

5.3. Test Arrangement

The arrangement of the equipment is installed to meet the standards and operating in a manner, which tends to maximize its emission characteristics in a normal application. The detailed information refers to test picture.

5.4. Test Data

The emissions don't show in below are too low against the limits. Refer to the test curves.

Test mode: Communication (wire network) (the worst case)

Table 6 Conducted Disturbance Test Data

Model: Gaw9.2Z18-4							
Mode: 4							
Line							
Frequency (MHz)	Correction Factor (dB)	Quasi-Peak			Average		
		Reading (dB μ V)	Emission Level (dB μ V)	Limits (dB μ V)	Reading (dB μ V)	Emission Level (dB μ V)	Limits (dB μ V)
0.190	9.8	37.7	47.5	64.0	26.4	36.2	54.0
0.250	9.8	32.2	42.0	61.8	22.0	31.8	51.8
0.314	9.8	27.1	36.9	59.9	22.8	32.6	49.9

REMARKS: 1. Emission level(dBuV)=Read Value(dBuV) + Correction Factor(dB)
 2. Correction Factor(dB) =LISN Factor (dB) + Cable Factor (dB)+Limiter Factor(dB)
 3. The other emission levels were very low against the limit.

Table 7 Conducted Disturbance Test Data

Model: Gaw9.2Z18-4							
Mode: 4							
Neutral							
Frequency (MHz)	Correction Factor (dB)	Quasi-Peak			Average		
		Reading (dB μ V)	Emission Level (dB μ V)	Limits (dB μ V)	Reading (dB μ V)	Emission Level (dB μ V)	Limits (dB μ V)
0.190	9.8	38.4	48.2	64.0	28.1	37.9	54.0
0.250	9.8	34.4	44.2	61.8	31.5	41.3	51.8
0.314	9.8	29.4	39.2	59.9	26.7	36.5	49.9

REMARKS: 1. Emission level(dBuV)=Read Value(dBuV) + Correction Factor(dB)
 2. Correction Factor(dB) =LISN Factor (dB) + Cable Factor (dB)+Limiter Factor(dB)
 3. The other emission levels were very low against the limit.

Conducted Disturbance

EUT: M/N:Gaw9.2Z18-4
Op Cond: Communication
Test Spec: L
Comment: AC 120V/60Hz

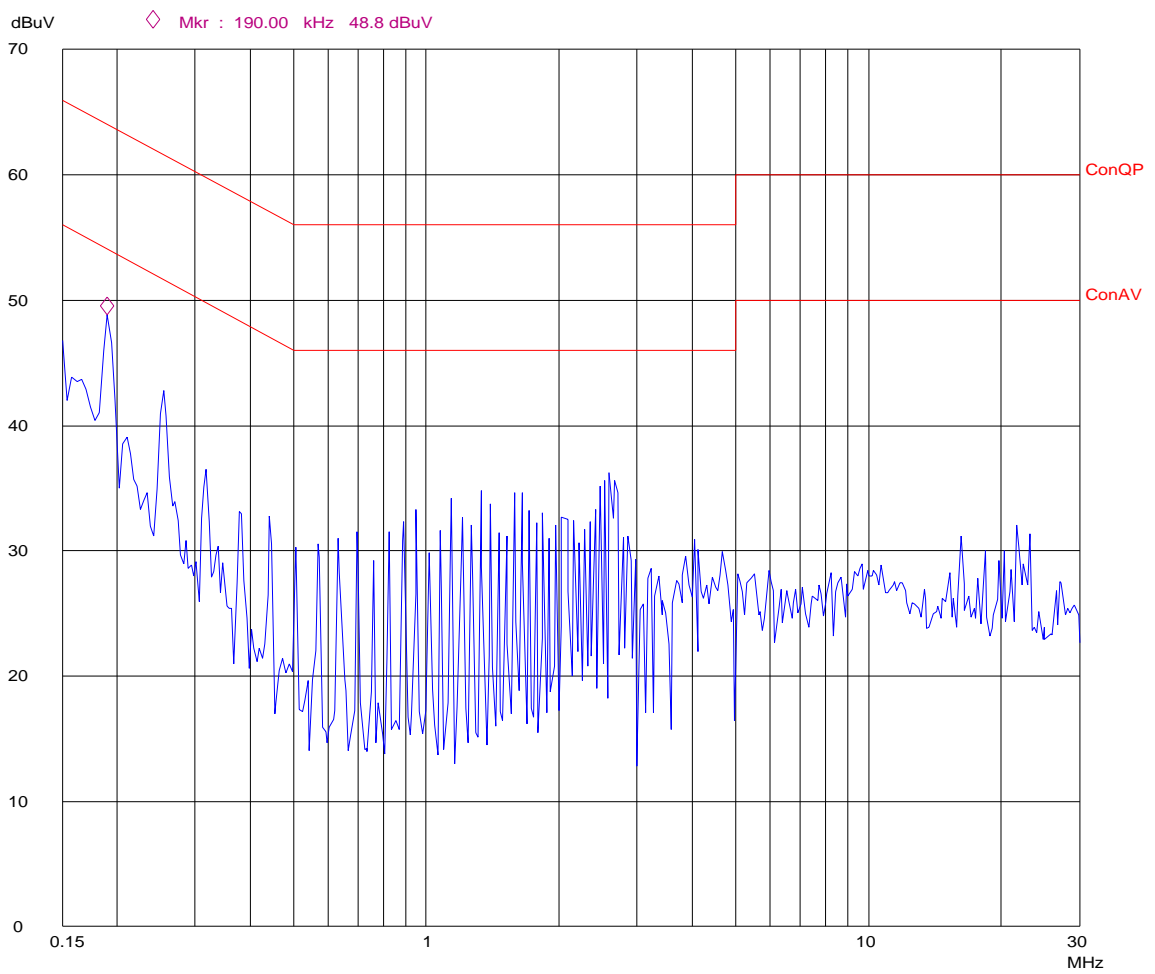

Conducted Disturbance

EUT: M/N:Gaw9.2Z18-4
Op Cond: Communication
Test Spec: N
Comment: AC 120V/60Hz

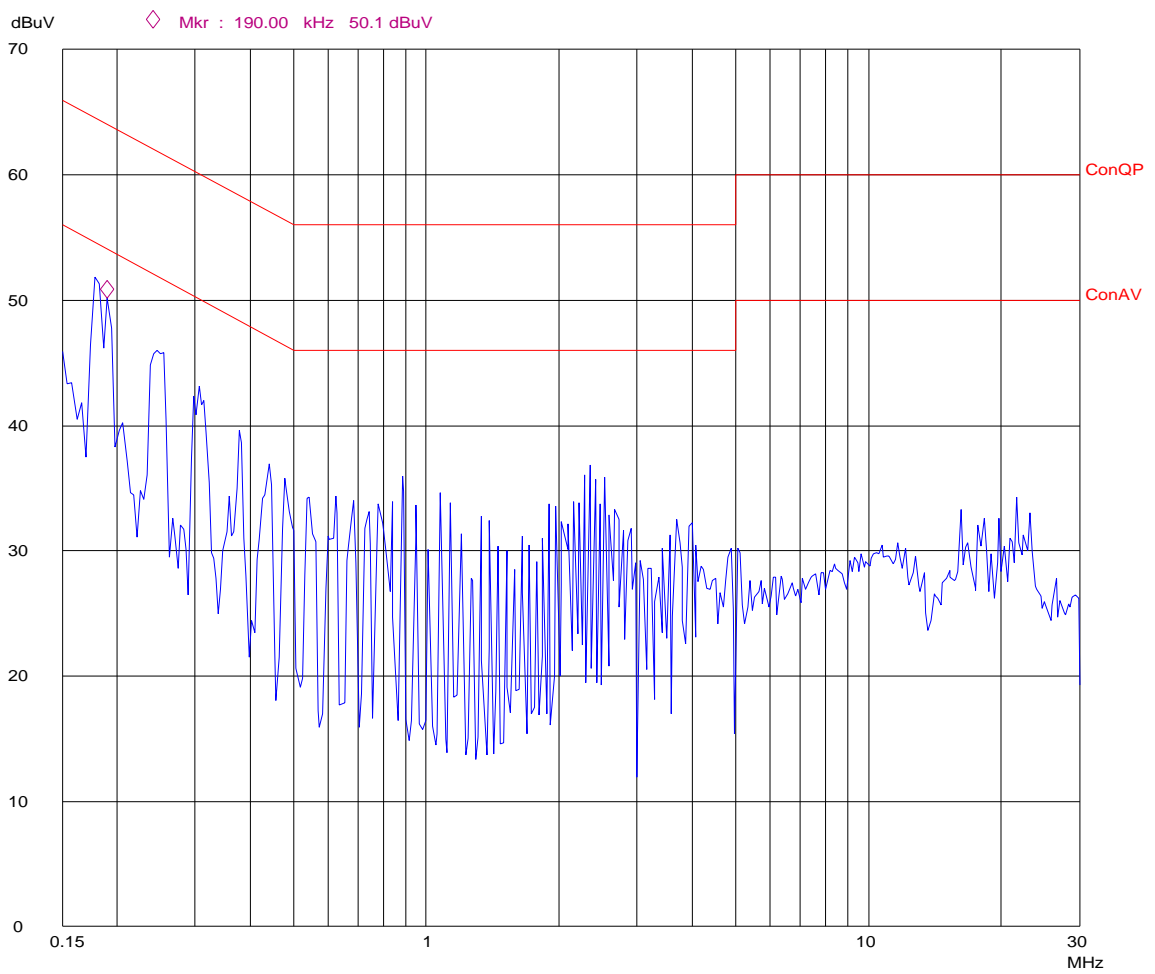

6. RADIATED DISTURBANCE TEST

6.1. Test Standard and Limit

6.1.1. Test Standard

FCC Part 15 15.209

6.1.2. Test Limit

Table 8 Radiated Disturbance Test Limit

FREQUENCY MHz	FIELD STRENGTHS LIMITS ($\mu\text{V/m}$)	FIELD STRENGTHS LIMITS dB ($\mu\text{V/m}$)
Fundamental	50000	94.0
Harmonics	500	54.0
30 ~ 88	100	40.0
88 ~ 216	150	43.5
216 ~ 960	200	46.0
960 ~	500	54.0

* The lower limit shall apply at the transition frequency.

* The test distance is 3m.

6.2. Test Procedure

The EUT is placed on a turntable, which is 0.8 meter above ground. The turntable can rotate 360 degrees to determine the position of the maximum emission level. EUT is set 3 meters away from the receiving antenna, which is mounted on an antenna tower. The antenna can move up and down between 1 to 4 meters to find out the maximum emission level. Broadband antenna is used as a receiving antenna. Both horizontal and vertical polarization of the antenna is set on test. In order to find out the max. emission, the relative positions of this hand-held transmitter(EUT) was rotated through three orthogonal axes according to the requirements in Section 8 and 13 of ANSI C63.4-2003.

Radiated measurements were performed on the frequency range from 30MHz to 25GHz. All readings from 30 MHz to 1 GHz are quasi-peak values with a resolution bandwidth of 120 kHz, $\text{VBW} \geq \text{RBW}$. All readings above 1 GHz are AV and PK values. $\text{RBW}=1\text{MHz}$ and $\text{VBW}=10\text{Hz}$ for AV value, $\text{RBW}=1\text{MHz}$ and $\text{VBW} \geq \text{RBW}$ for peak value.

Measurements were made at 3 meters

6.3. Test Arrangement

The arrangement of the equipment is installed to meet the standards and operating in a manner, which tends to maximize its emission characteristics in a normal application. The detailed information refers to test picture.

6.4. Test Data

The emissions don't show in below are too low against the limits.

Table 9 General Radiated Emission Data

Model: Gaw9.2Z18-4						
mode: 1						
Frequency MHz	Emission (dBuV/m)	Read Value (dBuV)	Correction Factor (dB/m)	Polarization	Limits (dBuV/m)	Note
53.030	33.8	25.7	8.1	Vertical	40.0	QP Value
156.771	34.1	21.0	13.1	Vertical	43.5	QP Value
750.008	41.5	16.7	24.8	Vertical	46.0	QP Value
250.032	39.2	23.3	15.9	Horizontal	46.0	QP Value
4824.642	43.7	41.4	2.3	Horizontal	54.0	AV Value
4824.521	40.8	38.5	2.3	Vertical	54.0	AV Value
4824.642	49.8	47.5	2.3	Horizontal	74.0	PK Value
4824.521	46.6	44.3	2.3	Vertical	74.0	PK Value
2400.208	34.8	38.5	-3.7	Horizontal	54.0	AV Value
2400.208	40.4	44.1	-3.7	Horizontal	74.0	PK Value
2400.208	33.1	36.8	-3.7	Vertical	54.0	AV Value
2400.208	37.6	41.3	-3.7	Vertical	74.0	PK Value
2483.597	31.3	35	-3.7	Horizontal	54.0	AV Value
2483.597	35.1	38.8	-3.7	Horizontal	74.0	PK Value
2483.597	26.5	30.2	-3.7	Vertical	54.0	AV Value
2483.597	33.9	37.6	-3.7	Vertical	74.0	PK Value

- REMARKS: 1. Emission level(dBuV/m)=Read Value(dBuV) + Correction Factor(dB/m)
 2. Correction Factor(dB/m) = Antenna Factor (dB/m) + Cable Factor (dB)
 3. The other emission levels were very low against the limit.

Table 10 General Radiated Emission Data

Model: Gaw9.2Z18-4						
mode: 2						
Frequency MHz	Emission (dBuV/m)	Read Value (dBuV)	Correction Factor (dB/m)	Polarization	Limits (dBuV/m)	Note
750.008	40.8	16.0	24.8	Horizontal	46.0	QP Value
125.010	36.3	21.9	14.5	Vertical	43.5	QP Value
750.008	41.6	16.8	24.8	Vertical	46.0	QP Value
4885.018	49.0	46.7	2.3	Horizontal	54.0	AV Value
4885.215	44.6	42.3	2.3	Vertical	54.0	AV Value
4885.018	50.1	48.0	2.3	Horizontal	54.0	PK Value
4885.215	51.1	48.8	2.3	Vertical	54.0	PK Value
2400.010	33.6	37.3	-3.7	Horizontal	54.0	AV Value
2400.010	39.3	43	-3.7	Horizontal	74.0	PK Value
2400.010	30.7	34.4	-3.7	Vertical	54.0	AV Value
2400.010	36.9	40.6	-3.7	Vertical	74.0	PK Value
2483.567	33.1	36.8	-3.7	Horizontal	54.0	AV Value
2483.567	37.8	41.5	-3.7	Horizontal	74.0	PK Value
2483.567	31.8	35.5	-3.7	Vertical	54.0	AV Value
2483.567	35.6	39.3	-3.7	Vertical	74.0	PK Value

- REMARKS: 1. Emission level(dBuV/m)=Read Value(dBuV) + Correction Factor(dB/m)
2. Correction Factor(dB/m) = Antenna Factor (dB/m) + Cable Factor (dB)
3. The other emission levels were very low against the limit.

Table 11 General Radiated Emission Data

Model: Gaw9.2Z18-4						
mode: 3						
Frequency MHz	Emission (dBuV/m)	Read Value (dBuV)	Correction Factor (dB/m)	Polarization	Limits (dBuV/m)	Note
750.008	40.3	15.5	24.8	Horizontal	46.0	QP Value
114.473	35.8	21.1	14.7	Vertical	43.5	QP Value
750.008	41.6	16.8	24.8	Vertical	46.0	QP Value
4923.918	47.3	45	2.3	Horizontal	54.0	AV Value
4924.001	43.5	41.2	2.3	Vertical	54.0	AV Value
4923.918	52.7	50.4	2.3	Horizontal	54.0	PK Value
4924.001	50.9	48.6	2.3	Vertical	54.0	PK Value
2400.010	37.5	41.2	-3.7	Horizontal	54.0	AV Value
2400.010	45.0	48.7	-3.7	Horizontal	74.0	PK Value
2400.010	35.9	39.6	-3.7	Vertical	54.0	AV Value
2400.010	42.4	46.1	-3.7	Vertical	74.0	PK Value
2483.567	35.8	39.5	-3.7	Horizontal	54.0	AV Value
2483.567	42.1	45.8	-3.7	Horizontal	74.0	PK Value
2483.567	34.1	37.8	-3.7	Vertical	54.0	AV Value
2483.567	39.5	43.2	-3.7	Vertical	74.0	PK Value

- REMARKS: 1. Emission level(dBuV/m)=Read Value(dBuV) + Correction Factor(dB/m)
2. Correction Factor(dB/m) = Antenna Factor (dB/m) + Cable Factor (dB)
3. The other emission levels were very low against the limit.

Table 12 General Radiated Emission Data

Model: Gaw9.2Z18-4						
mode: 4						
Frequency MHz	Emission (dBuV/m)	Read Value (dBuV)	Correction Factor (dB/m)	Polarization	Limits (dBuV/m)	Note
500.030	40.6	19.3	21.3	Horizontal	46.0	QP Value
750.028	43.7	18.9	24.8	Horizontal	46.0	QP Value
875.010	44.6	18.9	25.7	Horizontal	46.0	QP Value
30.431	33.9	14.2	19.7	Vertical	40.0	QP Value
125.01	38.9	24.5	14.5	Vertical	43.5	QP Value
500.03	43.9	22.6	21.3	Vertical	46.0	QP Value
750.008	43.4	18.6	24.8	Vertical	46.0	QP Value
881.19	40.9	15.1	25.8	Vertical	46.0	QP Value

- REMARKS: 1. Emission level(dBuV/m)=Read Value(dBuV) + Correction Factor(dB/m)
2. Correction Factor(dB/m) = Antenna Factor (dB/m) + Cable Factor (dB)
3. The other emission levels were very low against the limit.

Table 13 Restricted Band Radiated Emission Data

MHz	MHz	MHz	GHz
0.090 - 0.110	16.42 - 16.423	399.9 - 410	4.5 - 5.15
0.495 - 0.505	16.69475 - 16.69525	608 - 614	5.35 - 5.46
2.1735 - 2.1905	16.80425 - 16.80475	960 - 1240	7.25 - 7.75
4.125 - 4.128	25.5 - 25.67	1300 - 1427	8.025 - 8.5
4.17725 - 4.17775	37.5 - 38.25	1435 - 1626.5	9.0 - 9.2
4.20725 - 4.20775	73 - 74.6	1645.5 - 1646.5	9.3 - 9.5
6.215 - 6.218	74.8 - 75.2	1660 - 1710	
6.26775 - 6.26825	108 - 121.94	1718.8 - 1722.2	
6.31175 - 6.31225	123 - 138	2200 - 2300	
8.291 - 8.294	149.9 - 150.05	2310 - 2390	
8.362 - 8.366	156.52475 - 156.52525	2483.5 - 2500	
8.37625 - 8.38675	156.7 - 156.9	2655 - 2900	
8.41425 - 8.41475	162.0125 - 167.17	3260 - 3267	
12.29 - 12.293	167.72 - 173.2	3332 - 3339	
12.51975 -	240 - 285	3345.8 - 3358	
12.52025	322 - 335.4	3600 - 4400	
12.57675 -			
12.57725			
13.36 - 13.41			

All the emission of the above band were less than the limit 20dB.

7. 6DB BANDWIDTH MEASUREMENT

7.1. LIMITS OF 6dB BANDWIDTH MEASUREMENT

The minimum of 6dB Bandwidth Measurement is 0.5 MHz.

7.2. TEST PROCEDURE

The transmitter output was connected to the spectrum analyzer through an attenuator. The bandwidth of the fundamental frequency was measured by spectrum analyzer with 100kHz RBW and $VBW \geq RBW$. The 6dB bandwidth is defined as the total spectrum the power of which is higher than peak power minus 6dB.

7.3. TEST SETUP



7.4. EUT OPERATING CONDITIONS

mode 1
mode 2
mode 3

7.5. Test Data

Table 14 6dB Bandwidth Test Data

CHANNEL	6dB BANDWIDTH (MHz)	MINIMUM LIMIT (MHz)	results
Ch1	15.8	0.5	Pass
Ch7	16.0	0.5	Pass
Ch11	15.9	0.5	Pass

mode 1



*RBW 100 kHz Delta 3 [T1]
VBW 300 kHz -6.53 dB
*SWT 50 ms 5.680000000 MHz

Ref 20 dBm

*Att 30 dB

1 PK
VIEW

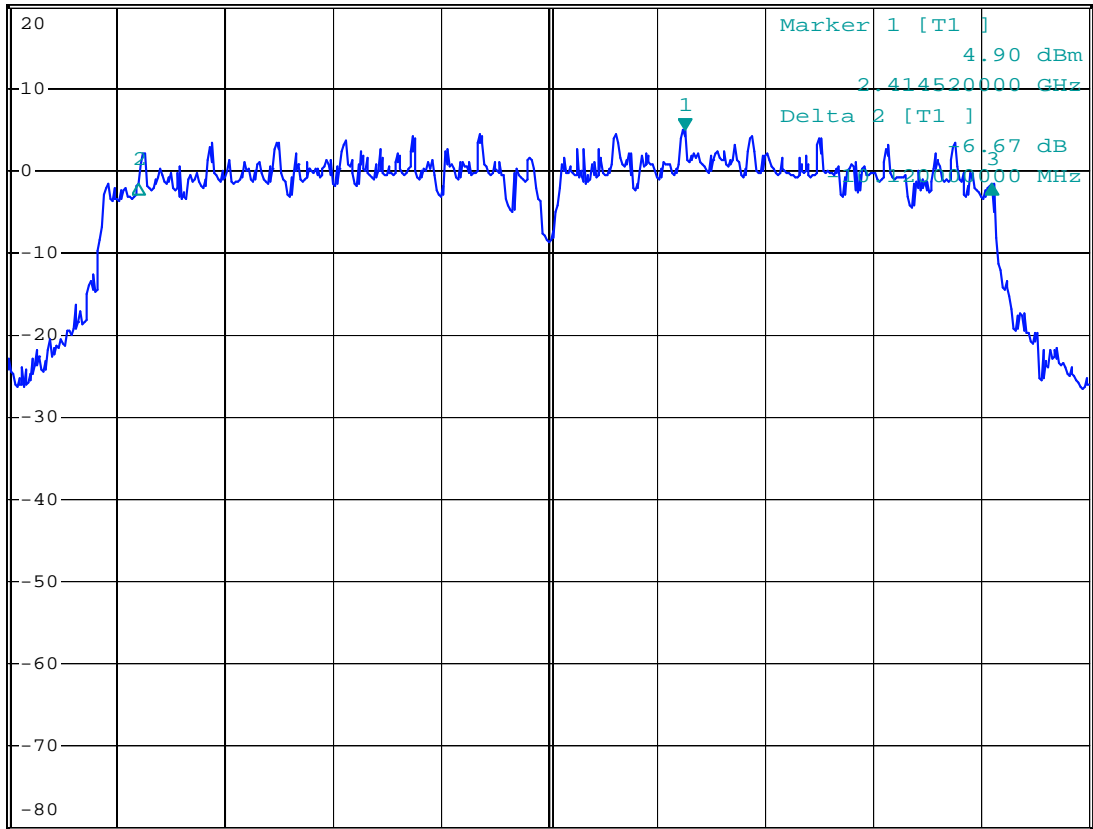

Center 2.412 GHz

2 MHz/

Span 20 MHz

Date: 4.MAR.2008 04:03:50

mode 2



*RBW 100 kHz Delta 3 [T1]
*VBW 100 kHz -5.88 dB
Ref 20 dBm *Att 30 dB SWT 5 ms 7.200000000 MHz

1 PK
VIEW

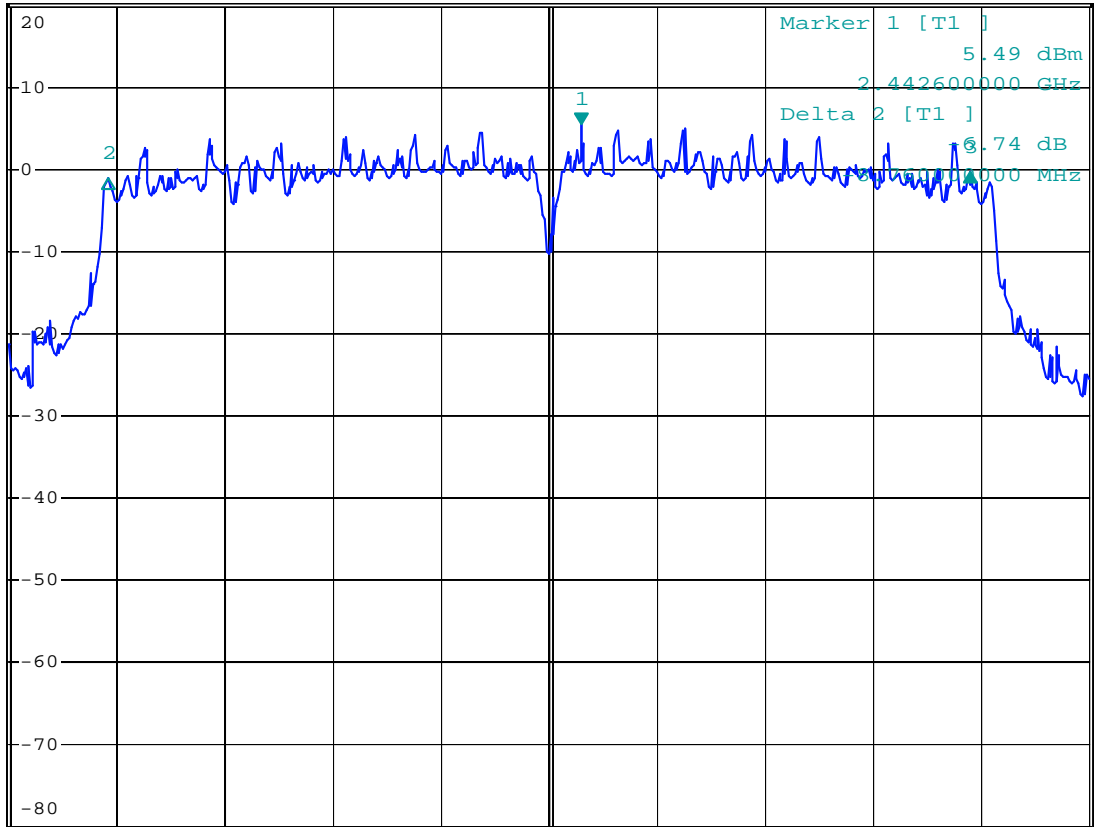

Center 2.442 GHz 2 MHz/ Span 20 MHz

Date: 4.MAR.2008 04:32:19

mode 3



*RBW 100 kHz Delta 3 [T1]
*VBW 100 kHz -6.84 dB
SWT 5 ms 5.280000000 MHz

Ref 20 dBm

*Att 30 dB

SWT 5 ms

5.280000000 MHz

1 PK
VIEW

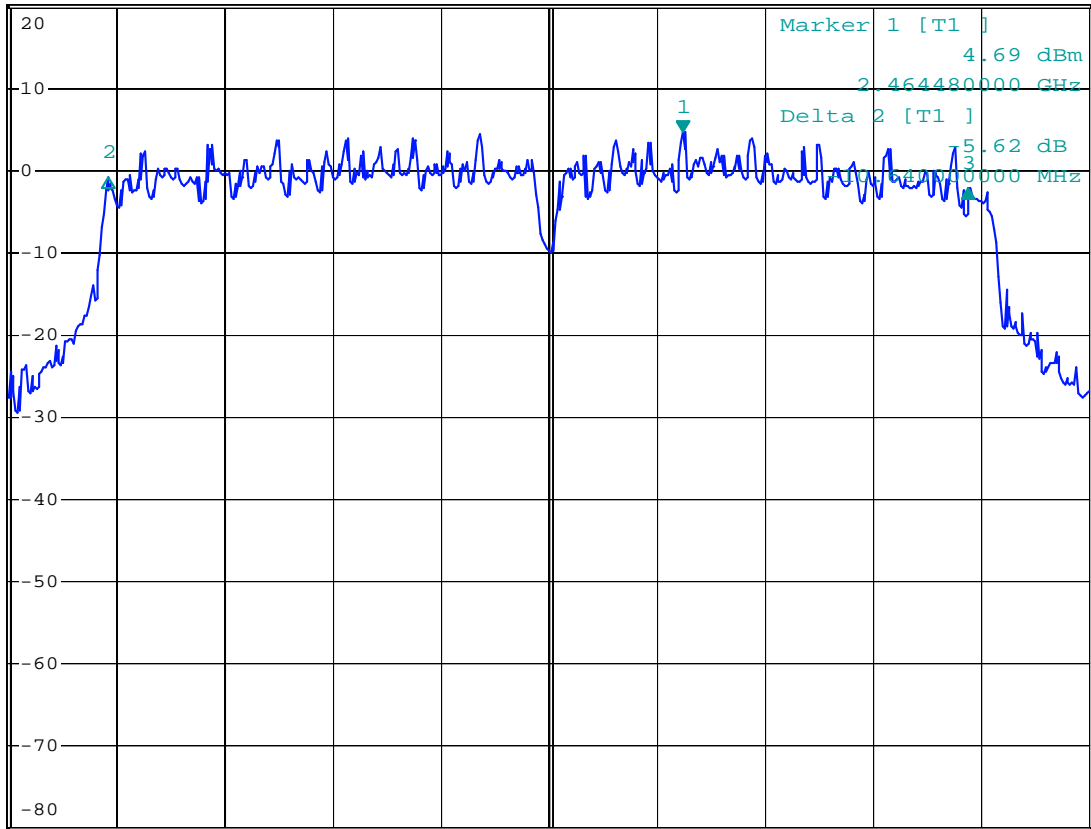

Marker 1 [T1]
4.69 dBm
2.464480000 GHz

Delta 2 [T1]
5.62 dB
2.464480000 MHz

Center 2.462 GHz

2 MHz/

Span 20 MHz

Date: 4.MAR.2008 04:34:57

8. MAXIMUM PEAK OUTPUT POWER

8.1. LIMITS OF MAXIMUM PEAK OUTPUT POWER MEASUREMENT

The Maximum Peak Output Power Measurement is 30dBm.

8.2. TEST PROCEDURES

1. A detector was used on the output port of the EUT. An oscilloscope was used to read the response of the detector.
2. Replaced the EUT by the signal generator. The center frequency of the S.G was adjusted to the center frequency of the measured channel.
3. Adjusted the power to have the same reading on oscilloscope. Record the power level.

8.3. TEST SETUP



8.4. EUT OPERATING CONDITIONS

mode 1
mode 2
mode 3

8.5. Test Data

Table 15 Maximum Peak Output Power Test Data

Supply voltage	Peak Power Output (dBm)			LIMIT (dBm)	results
	Ch1	Ch7	Ch11		
				30dBm	Pass
AC 230V	19.6	18.9	19.2	30dBm	Pass
AC 195V	19.3	18.8	18.8	30dBm	Pass
AC 265V	19.2	18.8	19.0	30dBm	Pass

9. POWER SPECTRAL DENSITY MEASUREMENT

9.1. LIMITS OF POWER SPECTRAL DENSITY MEASUREMENT

The Maximum of Power Spectral Density Measurement is 8dBm.

9.2. TEST PROCEDURE

The transmitter output was connected to the spectrum analyzer through an attenuator(10.0dB), the bandwidth of the fundamental frequency was measured with the spectrum analyzer using 3kHz RBW and $VBW \geq RBW$, set sweep time = span/3kHz. The power spectral density was measured and recorded. The sweep time is allowed to be longer than span/3kHz for a full response of the mixer in the spectrum analyzer.

9.3. 4.5.5 TEST SETUP

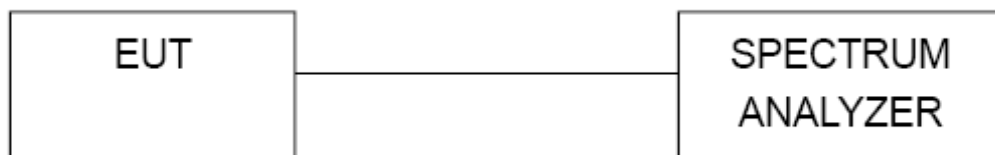

9.4. 4.5.6 EUT OPERATING CONDITION

mode 1
mode 2
mode 3

9.5. Test Data

Table 16 Test Data

CHANNEL	RF POWER LEVEL IN 3kHz BW (dBm)	MAXIMUM LIMIT (dBm)	results
Ch1	-7.4	8	Pass
Ch7	-4.1	8	Pass
Ch11	-8.4	8	Pass

mode 1



✓ REW 3 kHz Maskes 1 [T1]
✓ VEW 30 kHz -7.40 dBm
✓ SWI 680 a 2.412376000 GHz

Ref 0 dBm

✓ Att 10 dB

1 PK
VIEW

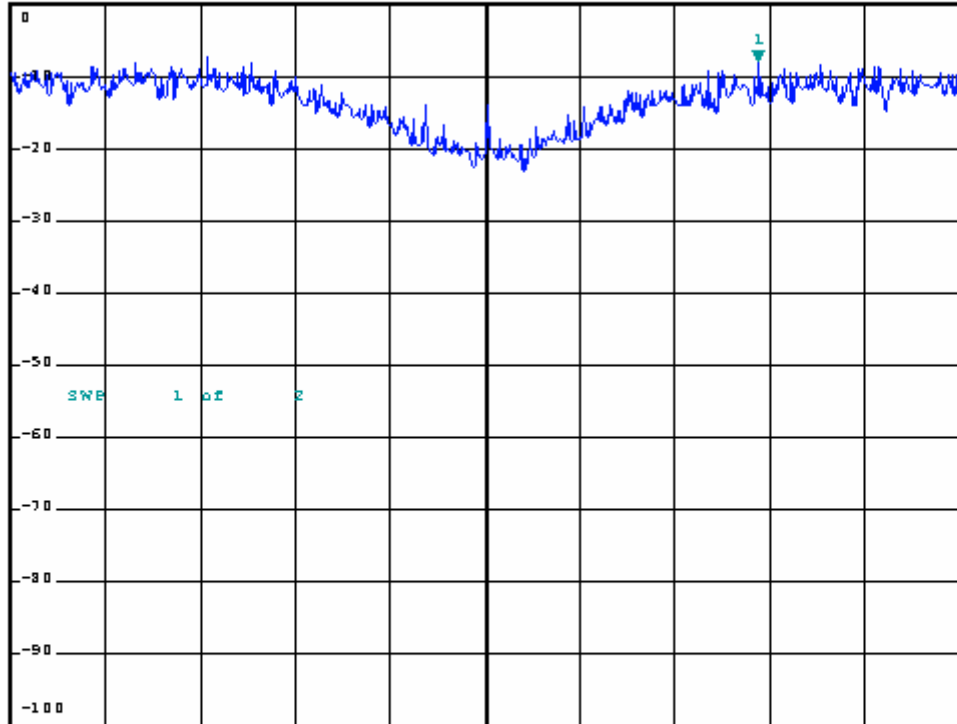

Center 2.412 GHz

200 kHz/

Span 2 MHz

mode 2



*RBW 3 kHz Marker 1 [T1]
*VBW 30 kHz -4.10 dBm
*SWT 680 s 2.442320000 GHz

Ref 0 dBm

*Att 10 dB

1 PK
VIEW

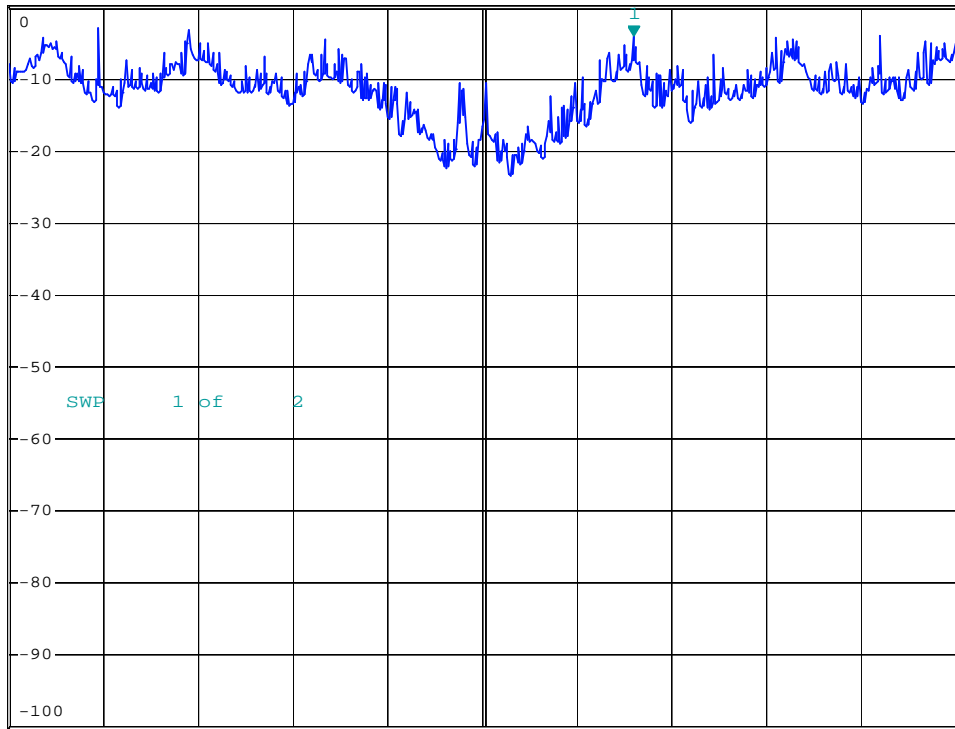

Center 2.442 GHz

200 kHz/

Span 2 MHz

mode 3



*RBW 3 kHz Marker 1 [T1]
*VBW 10 kHz -8.40 dBm
*SWT 500 s 2.461277000 GHz

Ref 20 dBm

*Att 30 dB

1 PK
VIEW

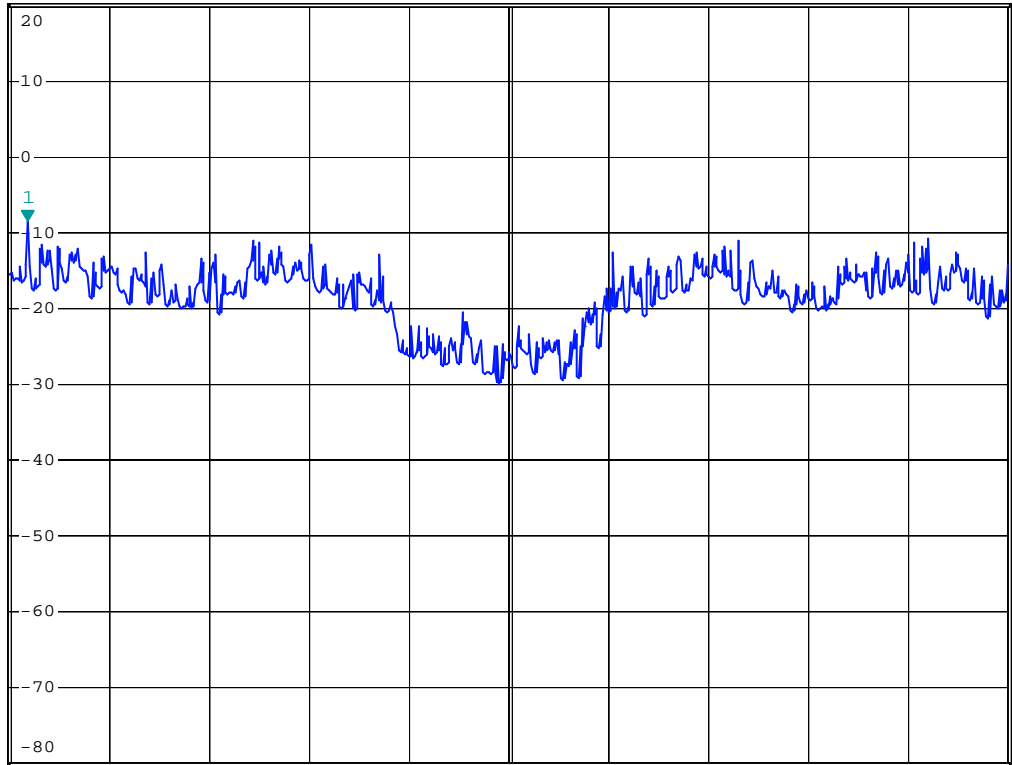

Center 2.462 GHz

150 kHz/

Span 1.5 MHz

Date: 4.MAR.2008 04:47:52

10. BAND EDGES MEASUREMENT

10.1. LIMITS OF BAND EDGES MEASUREMENT

Below -20dB of the highest emission level of operating band (in 100kHz Resolution Bandwidth).

10.2. TEST PROCEDURE

The transmitter output was connected to the spectrum analyzer through an attenuator. Set both RBW and VBW of spectrum analyzer to 100kHz with suitable frequency span including 100 MHz bandwidth from band edge. The band edges was measured and recorded.

10.3. EUT OPERATING CONDITION

mode 1
mode 2
mode 3

10.4. TEST RESULTS

The spectrum plots are attached on the following. Test data shows compliance with the band edge requirement in part 15.247(d).

Marker: 2.40003006 GHz 42.94 dBuV
Delta Mk: 83.567134 MHz -17.85 dB

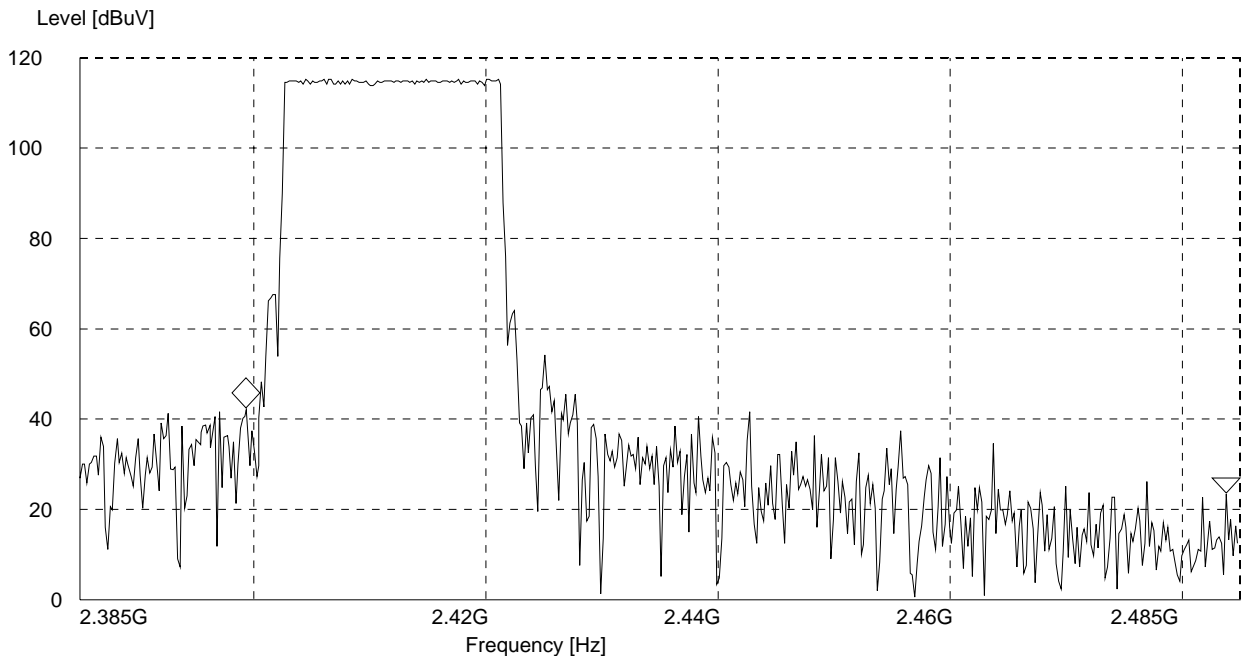

Marker: 2.4003006 GHz 42.23 dBuV
Delta Mk: 83.567134 MHz 2.27 dB

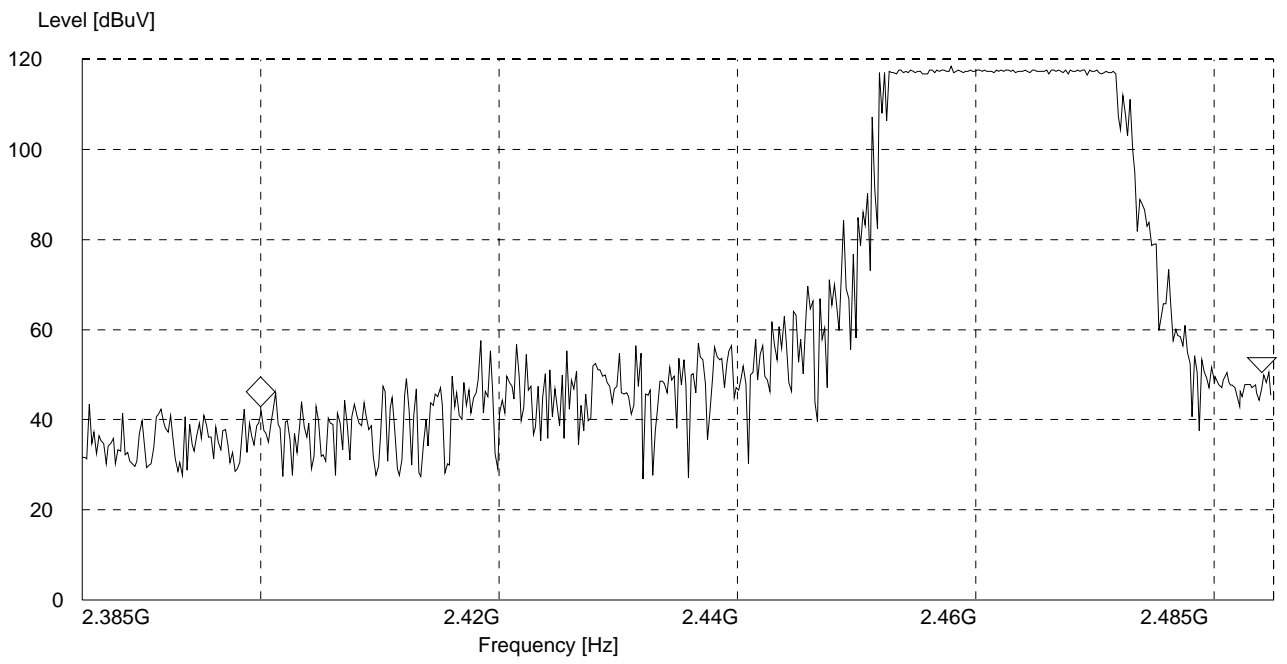

11. ANTENNA REQUIREMENT

11.1. STANDARD APPLICABLE

For intentional device, according to FCC 47 CFR Section 15.203, an intentional radiator shall be designed to ensure that no antenna other than that furnished by the responsible party shall be used with the device. And according to FCC 47 CFR Section 15.247 (b), if transmitting antennas of directional gain greater than 6dBi are used, the power shall be reduced by the amount in dB that the directional gain of the antenna exceeds 6dBi.

11.2. ANTENNA CONNECTED CONSTRUCTION

The EUT has a replaceable antenna with a non-standard antenna jack, the antenna gain is 2.0 ± 0.7 dBi which is less than 6dBi. Therefore it complies with the antenna requirement.

APPENDIX I TEST PHOTO

Photo 1 Conducted Emission Test







Photo 2 Radiated Emission Test



APPENDIX II EUT PHOTO

Photo 1 Label of EUT

Model:Gaw9B.2Z18-4
Wireless ADSL 2/2+ Router
Power:  12V 1A 
  1588 
FCC ID: V4VGaw92Z18-4
This device complies with Part 15 of the FCC Rules.
Operation is subject to the following two conditions:
(1) this device may not cause harmful interference, and
(2) this device must accept any interference received,
including interference that may cause undesired operation.
Shenzhen Gongjin Electronics Co.,Ltd.





Model:Gaw9.2Z18-4
Wireless ADSL 2/2+ Router
Power:  12V 1A 
  1588 
FCC ID: V4VGaw92Z18-4
This device complies with Part 15 of the FCC Rules.
Operation is subject to the following two conditions:
(1) this device may not cause harmful interference, and
(2) this device must accept any interference received,
including interference that may cause undesired operation.
Shenzhen Gongjin Electronics Co.,Ltd.

Photo 2 Appearance of EUT



Photo 3 Appearance of EUT



Photo 5 Inside of EUT

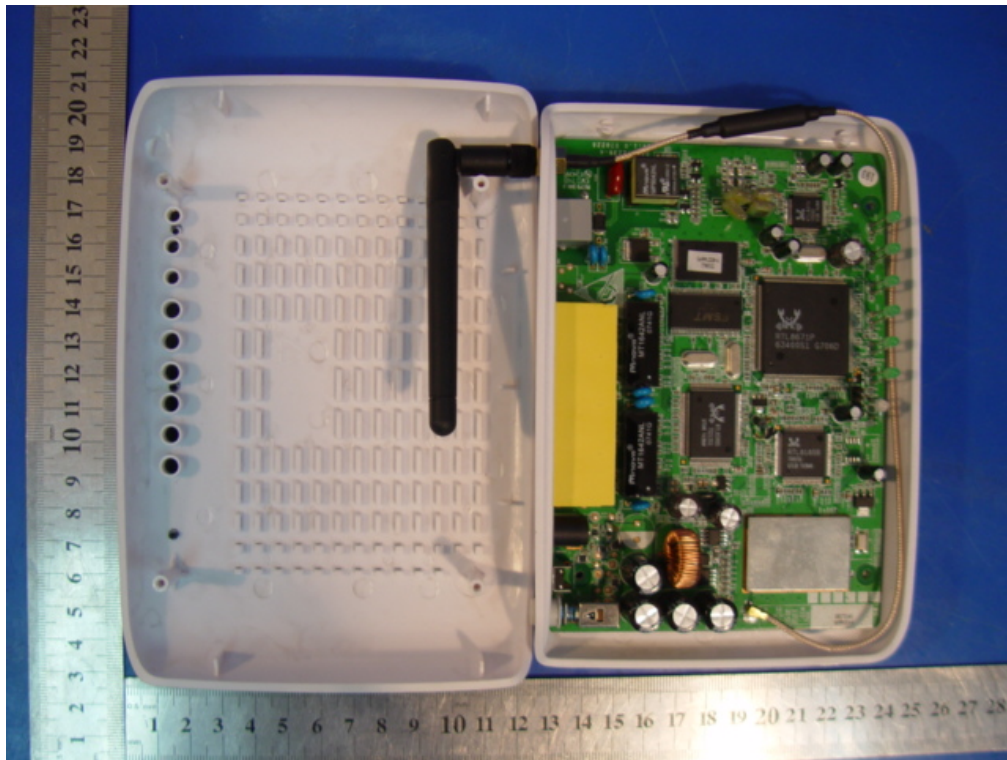

Photo 6 Inside of EUT

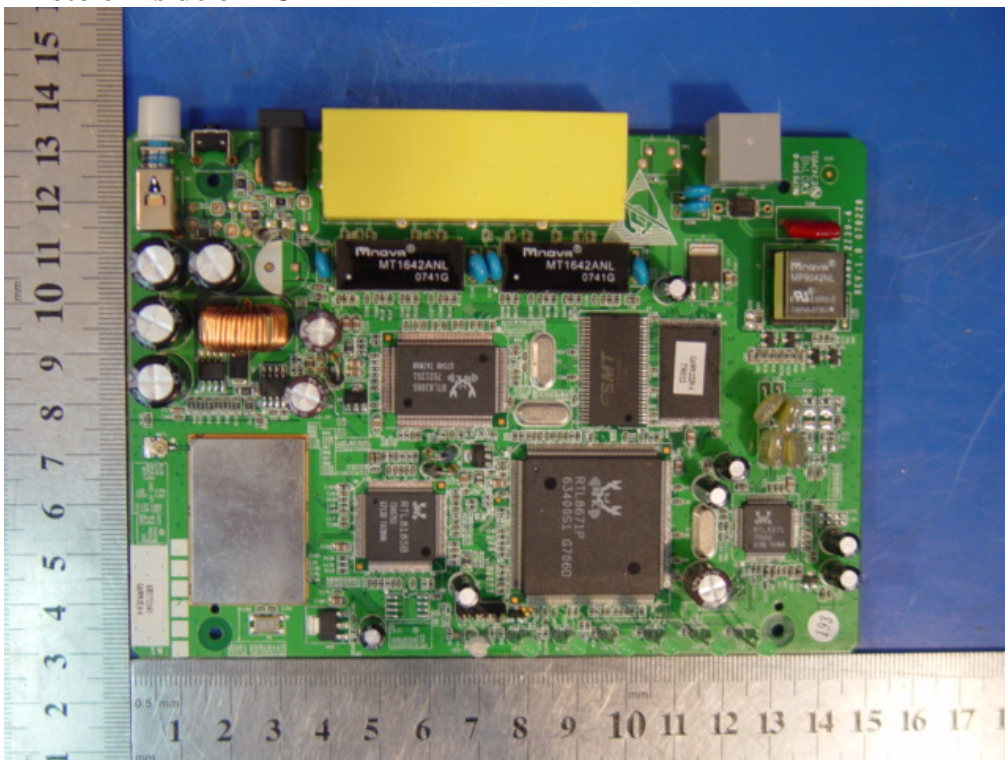

Photo 7 Inside of EUT

