



Personal Touch Tablet  
Preliminary Spec  
2012-08-22

---

## Table of content

### I - GETTING STARTED

Important Safety Precautions	3
Cleaning the Panel	3
Cleaning the Personal Touch Tablet	3
Introduction	4
Buttons Overview	5
Accessories	5
What's in the Box	6
Charging the Battery	6
Power On/Off and Unlock Personal Touch Tablet	6

### II - FUNCTIONING OF THE TABLET

Navigation	7
Home Screen	7
Application Launcher Screen	7
Status Bar	8
Onscreen Keyboard	9

### III - SETTINGS

Set Up Wi-Fi Connection	10
Set up 3G Function (optional)	10
Set Date and Time	11
Set Up Email	12
Set Up Calendar	13
Widgets	14
Change Wallpapers	14
Use folders	14
Install Third-Part Applications from micro SD	15

### IV - CONNECTIONS

Browser	16
Wi-Fi	17
Bluetooth	17
PC Connection	18
Connect to TV set (optional)	19

### V - APPLICATIONS

Camera	20
Clock	21
Calculator	22
Downloads	23
Gallery	24
Music	25
MoviePlayer	26
File Browser	27

### VI - PRODUCT SPECIFICATION 28

### VII FCC Statement

---

## I - GETTING STARTED

### Important Safety Precautions

Always follow these basic safety precautions when using your Personal Touch Tablet. This will reduce the risk of fire, electric shock and injury.

**Warning:** To reduce the risk of fire or shock hazard, do not expose this product to rain or water.

**Warning:** To prevent the risk of electric shock, do not remove the cover. There are no user-serviceable parts inside. Opening will void your warranty.

- Unplug the Personal Touch Tablet before performing maintenance.
- Keep your Personal Touch Tablet out of direct sunlight and heat sources.
- Protect the power cord. Route power cords so that they are not likely to be walked on or pinched by items placed on or against them. Pay particular attention to the point where the power cord is attached to the Personal Touch Tablet.
- Only use the AC adapter included with the Personal Touch Tablet. Using any other power adapter will void your warranty.
- Unplug the power cord from the outlet when the unit is not in charging condition.

### Cleaning the Panel

Treat the screen gently. The screen is made of glass and can be scratched or broken.

To clean fingerprints or dust from the screen, it is recommended to use a soft, non-abrasive cloth such as a camera lens cloth to clean the screen.

If you use a commercial Cleaning Kit, do not apply the cleaning liquid directly to the screen. Clean the screen with cleaning cloth moistened with the liquid.

### Cleaning the Personal Touch Tablet

Clean the outer surface of the Personal Touch Tablet (excluding the screen) with a soft cloth dampened with water.

---

## **Introduction**

Welcome to the Personal Touch Tablet! The Personal Touch Tablet includes these key features:

- Displays Alarm, AppInstaller, Browser, Calculator, Calendar, Camera, Clock, Email, File Browser, Gallery, HDMI Switch, Music, Setting, Video Player and etc
- Displays digital photos, Play Music and Video
- Wi-Fi function to connect with your AP router for internet browsing
- Micro Secure Digital™ (micro SD) slot for external storage
- Capacitive touch screen for all user operations
- 4GB Internal Memory
- USB2.0 OTG for connection to the PC or USB flash drive

## Buttons Overview

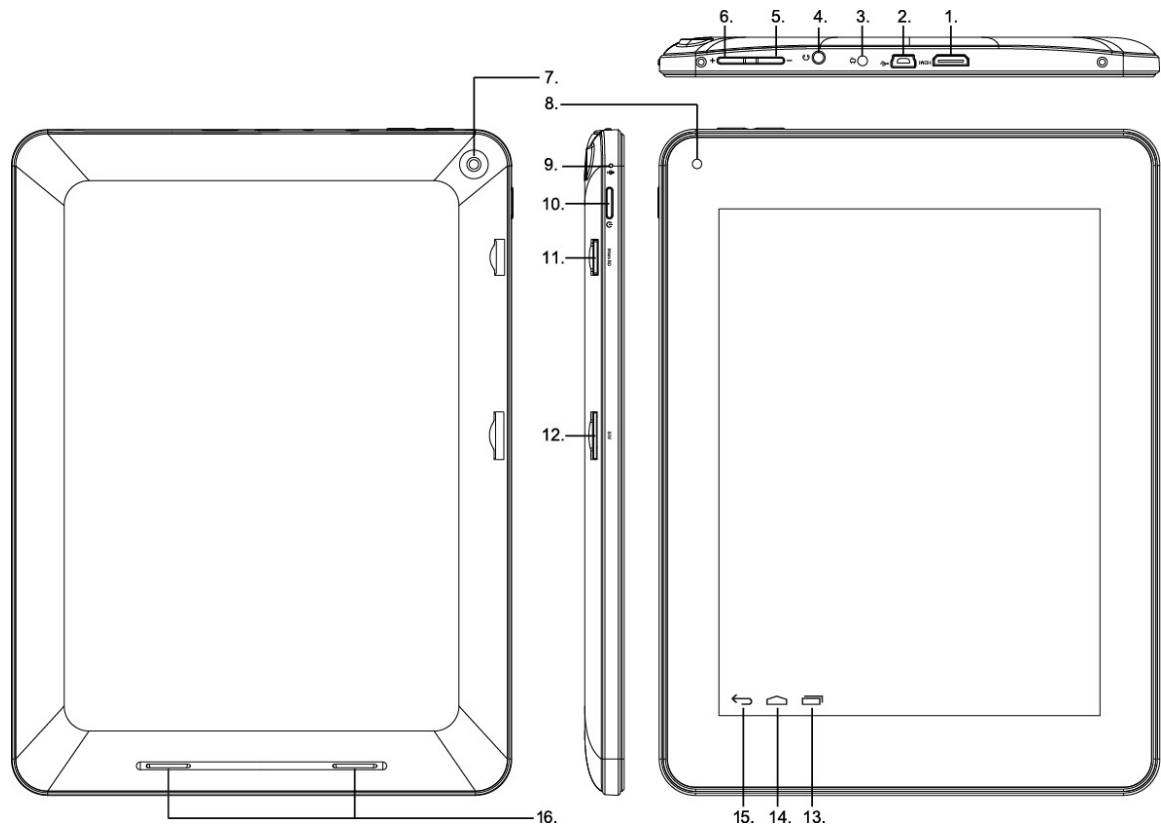

## Accessories

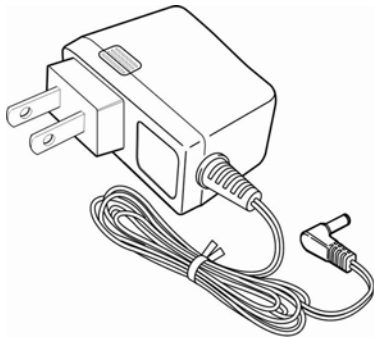

Power Adapter (depending on the regional requirement, the plug may look different)

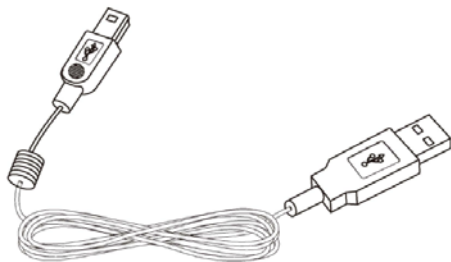

USB Cable

---

## What's in the Box

Personal Touch Tablet  
AC Power Adapter (5V/2A)  
USB Cable  
Quick Start Guide

## Charging the Battery

Plug the AC power adapter into the Personal Touch Tablet and into a wall outlet.

Icon  will turn to icon  while the battery is charging.

When charging is completed, the battery icon will turn into a steady blue.

- \* It is strongly recommended you fully charge the device for about 4-6 hours before use.
- \* When charging battery, the better indicator for a fully charged battery is a steady blue

battery icon on the notification bar.  icon means the battery is still being charged, even when 100% has been displayed for battery level on the Settings → About tablet → Status screen.

## Power on/off and Unlock Personal Touch Tablet

The Personal Touch Tablet is easy to set up. Just follow these steps:

1. To power on: Press and hold Power button for 2 seconds.
2. To unlock: Wait until a screen with a lock icon shows up, gently tap the “Lock” icon and slide it toward the unlock icon.
3. To power off: Press and hold the Power button for 2 seconds until “Power off” window pops up on screen where you can choose OK option to power off the device.
4. To reset: Press the power button for 6 to 8 seconds.

**Note:** The screen with the lock icon will time out in 10 seconds if you do not unlock it. In case it happens, the Power button can be pressed briefly to make it show up again.

---

## II - FUNCTIONING OF THE TABLET

### Navigation

Tablet has five home screens by default. The first time you turn on the tablet or after having factory data reset, you will see a navigation screen.

- \* To see all you applications, touch  inside the circle.
- \* You can put your favorite applications on Home screen.

### Home Screen



A typical Home screen with wallpaper, status bar, and few applications on the screen.

\* The background wallpaper may be different from model to model

- ◆  A shortcut to Google search
- ◆  A shortcut to application Launcher screen.

### Application Launcher Screen

A typical application Launcher screen is shown below. One icon represents one application which can be run by tapping on the icon.



\*The screen icon may be different from model to model

## Status Bar

At the bottom of the screen, the status bar mainly indicates Back icon, Home icon, Recent viewed applications icon, Current time, Wi-Fi status, 3G status, Bluetooth status and battery level, etc.



Icon	Action
	On any functional screen, tap this icon to go back one screen or exit application.
	On any functional screen, tap this icon to go to Home screen
	Shows a list of thumbnail images of applications you've work with recently. To open an application, touch it. To remove a thumbnail from the list, swipe it left or right.
	Current time
	Wi-Fi connection and signal strength
	Shows 3G signal status (optional)
	Shows Bluetooth status
	Battery level. Will turn orange when battery is low and turn red when battery is very low.

## Onscreen Keyboard

The onscreen keyboard appears automatically anytime you tap on a text line for input. While entering text with the onscreen keyboard, each character will be entered into the position pointed by a vertical cursor. You can change the cursor position by tapping with your finger on the position you want to enter the next character. To select different language keyboard, touch and hold icon . A pop menu will show up to let you select the "Input Options"





---

## Input options

Input languages

Android keyboard settings

\*Setting up an International keyboard: see “Install Third-Part Applications from micro SD” section.

---

### III- SETTINGS

#### Set Up Wi-Fi Connection



Make Wi-Fi Connection in Settings → Wireless & networks → Wi-Fi, slide the Wi-Fi switch to the **ON** position.

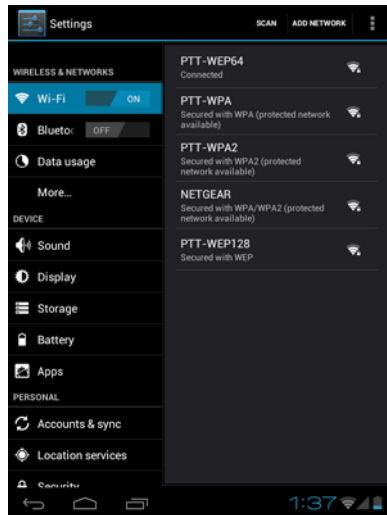

Normally, the device will automatically scan the available Wi-Fi Access Point (AP). If this does not happen, select icon **Scan** (upper right corner) to scan for the available Wi-Fi APs. Then, tap on the desired AP to make the connection. If it is a secured AP, system will prompt you for the password. Enter it by tapping on the password entry line, and use the onscreen keyboard to enter the password. Then, tap on the **Connect** to start connecting to that AP.

When connection is established, the Wi-Fi connected icon  will show up on the status bar.

#### Set up 3G Function (Optional)

1. In **More** option of Wireless & network settings, tap in **Mobile networks**, make sure the **Data enabled** is checked on before you connect to the mobile network.
  2. To enable 3G function of your Personal Touch Tablet, insert a SIM card or a 3G Dongle to it first. Power on the device, it will search for 3G signal automatically.
  3. When connection is established, the 3G connected icon  will show up on the status bar.
  4. In Access Point Names, select your favor APN.
- \*Turn off Wi-Fi signal before setting up 3G function.  
\*Roaming date may incur significant roaming charge.  
\*3G Dongle is not available if built-in 3G Module was inserted.

## Set Date and Time



Use Settings → Date & Time to open up the date/time setting screen as shown below. Select the correct time zone. If the Wi-Fi is connected to Internet, check on the **Automatic date & time** to have time set up automatically. If Wi-Fi is not connected to Internet, uncheck **Automatic date & time** to temporarily set date and time. Then, check Automatic again before leaving the screen. In the future, when the Wi-Fi is connected to internet, date and time will be automatically adjusted.

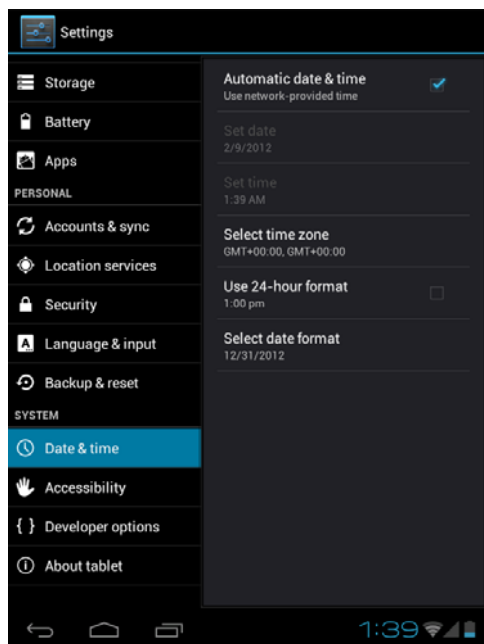





## Set Up Email



You can configure Email for most accounts in just a few steps. For many popular email services, tablet automatically enters most of the settings for you.

1. Make sure the Wi-Fi is connected.
2. Open the Email application and enter your Email address and password, then tap “Next”
3. Give a name to your account then tap “Next”. Mail messages will be downloaded automatically.

Icons on the screen:

Icon	Action
	Tap to enter E-mail compose interface
	Tap to enter search interface of Inbox
	Refresh
	Tap to enter Account settings. To remove your account record in tablet, tap <b>Remove account</b>

## Set Up Calendar







Calendar makes you easy to stay on schedule. You can view your schedule in day/week/month and agenda mode by touching icons at upper left corner. Swipe to scroll vertically or horizontally.

When using calendar for the first time, there are some steps you shall follow:

1. Tap Calendar icon into Gmail entering interface, then enter your Gmail account and password and tap **Next**.
2. Change the Serve “gmail.com” for “m.google.com”, then tap **Next** step.
3. You can tap on the specific date to start using your personal calendar now.

Icons across the top:

Icon	Action
	Tap to see the viewing type: day/week/month/and agenda
	Tap to view today's schedule
	Tap to show the creating events interface
	Tap to show more options: Refresh/Search/Settings

## Widgets

Widget is a small application. After being installed, it shows up in the main **Widgets** screen.

**To add widgets:** Touch and hold a widget, drag it to an empty space on Home screen and release your finger.

**To remove:** Tap and hold any icon on Home screen, then drag it into the **Remove** icon.

\* If there is not enough room to drop it, the widget won't get added to the Home screen.

## Change Wallpapers

Tap any blank space on Home screen and hold until a **Choose wallpaper from** menu pops out. Then, you can select wallpaper from your Gallery/ Live wallpapers/ Wallpapers.

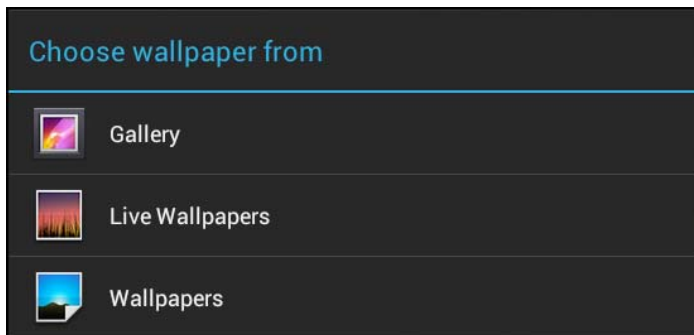

## Use Folders



You can combine several applications' icon in a folder by dropping one icon over another on a Home screen.

From any Home screen, you can:

**Open a folder** by a slight touch.

**Rename a folder** by touching its name.

**Move icons** around your Home screens: Touch, hold, and then slide.

## Install Third-Part Applications from micro SD



AppInstaller can be used to install the application file (with extension apk)

into the system.

1. Change the Settings to allow third-party application installation. In Settings → Security → Unknown sources, check the box to the right.
2. Prepare application files in the route of sdcard or NAND flash.
3. Launch the AppInstaller application on the application launcher screen. The system will scan for the installation files. Find the application you want to install from the list and tap on it. The installation process will start. Follow the screen instruction to complete the installation.

## IV- CONNECTIONS

### Browser



Browser is used for browsing the World Wide Web. With the web browser plug-ins, you could browse websites to watch videos, download contents, and listen to music etc.

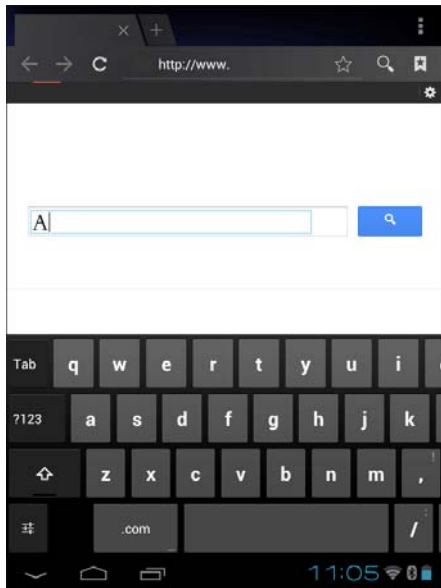

1. Tap the address field (in the title bar) to bring up the onscreen keyboard, enter website address, then tap Enter.
2. Similar website previously browsed or key word previous searched will appear beneath the address field. You can tap them to go to the website listed or search the key word.
3. Double tap on screen to zoom in and zoom out. Moving fingers across the screen will pan the screen up, down, left or right.

Tap Menu button  at the right-upper corner to display additional functions at the bottom of the screen.



## Wi-Fi

This tablet uses the 802.11b/g/n wireless specification to transmit and receive data. For more information, refer to “Set up Wi-Fi Connection” on page 10.

## Bluetooth

Bluetooth is a short-range communications technology that enables you to link to other devices for exchanging information without a physical connection.

Make Bluetooth Connection In Settings → Wireless & networks → Slide the Bluetooth

switch **ON**. Icon  will display in the status bar when Bluetooth is active.

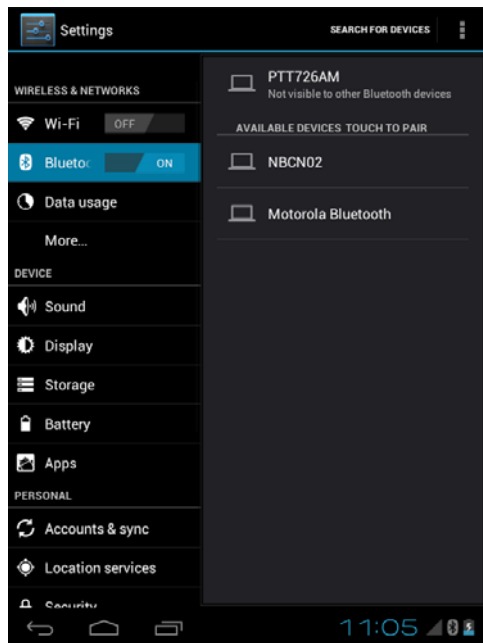

Setting up Bluetooth is similar to setting up Wi-Fi. Normally, the device will automatically scan the available Bluetooth devices. If this does not happen, tap Scan for devices for the available Bluetooth device. Then, tap on the desired device for a while to show Pair & connect, and enter a PIN to pair with this Bluetooth to make the connection. Tap on the **OK** to start connecting to that Bluetooth.

When connection is established, you may start exchanging information now.

\*Insert a TF card before storing information.

## PC Connection

Connect your tablet to a PC via USB cable. By connecting tablet to a PC, you can synchronise files or transfer data directly.

1. Plug one end of a USB cable to a tablet and plug the other end to a PC, then you will see a screen as below. Tap **Turn on USB storage** to connect to PC.
2. For a better use of your tablet, tap Turn off USB storage every time you unmount USB storage.

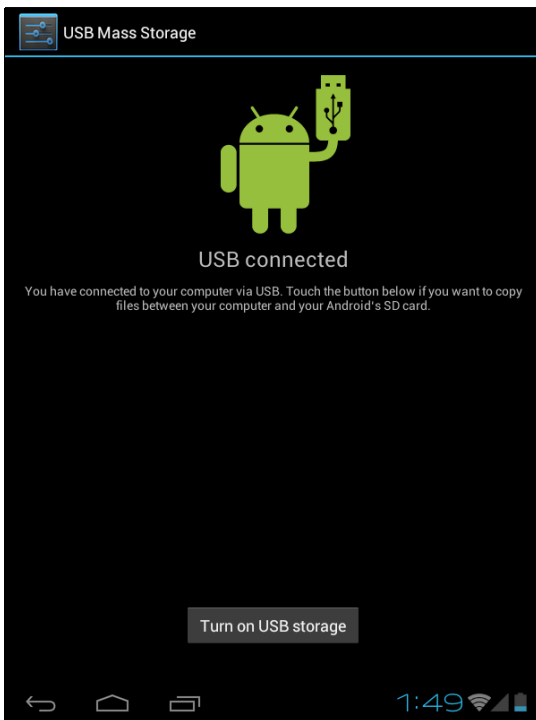

## Connect to TV set (Optional)



HDMI switch can switch your video display from tablet to a TV or monitor with HDMI input. With dual display feature, while the tablet screen is shown on TV or monitor, tablet will become a touch pad for all operations, including switching video display back to the tablet screen. LCD will display user interface and system remains operational on the tablet.

To switch the video display from the tablet screen to a TV or Monitor equipped with HDMI input

1. Plug one end (larger end) of the HDMI cable into one of the TV/monitor HDMI inputs, and plug the other end to tablet HDMI output.
2. Choose the correct input source setting on TV/monitor. Wait until the HDMI icon  shows up on the status bar, and indicates “HDMI connected”.
3. Open the HDMI Switch application. Tap on a compatible video format the TV/monitor can accept. If you don’t know which one to use, the best guess is to tap on the 1080p (or 720p for older HD Ready TV).
4. Wait for a few seconds, the tablet video will show up on the TV/monitor screen.
5. Slide your finger on the tablet screen to move an arrow to the OK button, and double tap the tablet screen to apply the selection.
6. From this moment on, until your use the HDMI Switch application to switch the video back to tablet screen or disconnect the HDMI cable, you can use the following gestures to perform all the operations.
  - Finger move ---- move arrow cursor on the TV/monitor
  - Double tap ---- select/open the item pointed by the arrow
  - Double tap and quick move – slide the screen, scroll a list or move the tapped icon.
  - Double tap and hold -- equivalent to the long press of an item when video display is on the tablet screen.
7. To switch back to the normal video on the tablet screen, simply unplug the HDMI cable

## V-APPLICATIONS

### Camera



Tablet allows you to take photos and video through the front or back camera. You can take photos at resolution up to 640 x 480 pixel (0.3 megapixels), 1600 x 1200 pixel (2.0 megapixels) and videos at resolution up to 640 x 480 pixels. The picture taken and video recorded will be store in the NAND flash. To view pictures or videos, tap a square icon at the upper right corner of the screen.

#### To take picture:



Make sure mode switch is set to , the photo mode.



Tap on the shutter button  to take a picture.

#### To record video:

Make sure mode switch is set to , the video recording mode.

Tap on the Recording button  to start video recording.

The back camera includes a Panorama mode that allows you to photograph a single image by panning across a scene. Tap on the panorama button  into panorama mode. Tap on the recording button  to start image recording

Icon	Action
	Toggles between camera on the front and back
+ —	Swipe icon  to zoom in or out
	Submenu: Flash mode/ White balance/ Exposure/AntiBanding/Camera settings/Time lapse interval

## Clock



After tapping on clock icon in Launcher screen, the following screen will be shown. Tap on icon  into alarm setting interface.

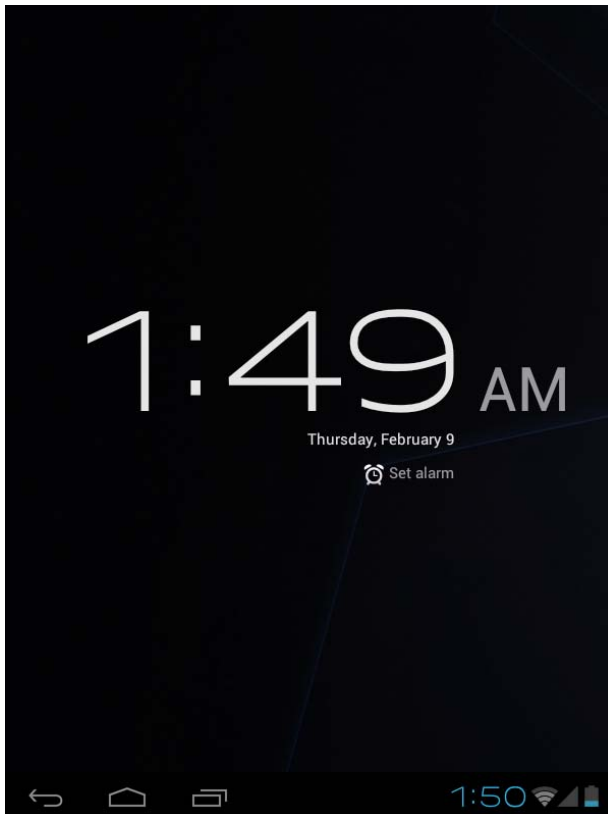

## Calculator



To perform mathematical calculation directly on tablet by tap numbers and symbols.

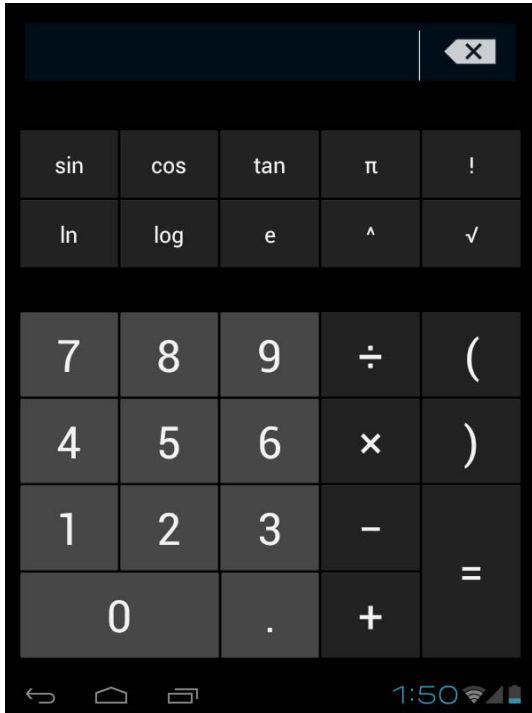

## Downloads



Files, applications and other items you download from Browser or Email will be stored in your micro SD card. Use the Downloads application to view, reopen or delete what you've downloaded.



1. Touch an item in Downloads can reopen it.
2. Check items you want to share, and then tap icon  to choose a sharing method from the list.
3. Check items you want to delete; then tap delete icon. The item will be deleted from your micro SD card.
4. In **Downloads** window → Tap **Sort by size** or **Sort by date** to switch back and forth.

## Gallery



Tap on “Gallery” in Launcher screen to open the application.

1. The first screen shows all photos and subfolders located in the Pictures folder.
2. Tap Pictures folder into photo thumbnail mode. (Default view)
3. Tap a thumbnail into photo single view mode.
4. When in photo single view mode, tap anywhere on screen to show function bar on screen.

Icon	Action
	Share photos by Google/Bluetooth/Email
	Delete
	Go to more options: Delete/Slideshow/Rotate left/ Rotate right/ Crop photo/ Details/Set picture as



## Music



Tap “Music” in the application launcher screen to get to the song screen

as below:

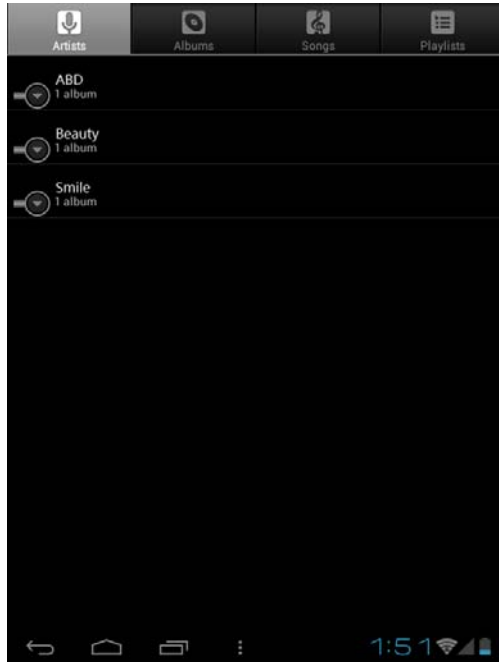

Select the **Artists/Albums/songs** or **playlists** mode to play music. Use the onscreen icons to configure how you want to play the songs.

Icon	Action
	Show playing list
	Turn shuffle on/off function
	Repeating all songs, current song or Off
	Previous song
	Pause/ Stop
	Next song

**Note:** Song will keep playing as background music while you leave the music playback screen. This function allows you to browse files, view photos and surf Internet while listening to music. To stop playing songs, tap on Pause on the music playing screen followed by the Back button

Tap on status bar to select other functions to play the song.

## Movie Player



1. Tap “MoviePlayer” in the application launcher screen.
2. Browse the micro SD or internal memory to find the video file to play.
3. Tap video file to start playing video.
4. While playing video file, tap anywhere on screen to display the control bar as below.  
 Drag the blue bar to fast forward or backward view video.

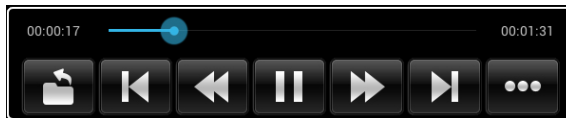

Icon	Action
	Back to previous menu
	Move to previous video
	Fast reverse
	Play/Pause
	Fast forward
	Move to next video
	Show more options

Additional options in the control bar are:

Icon	Action
	Back icon
	Resume Mode
	Play Mode: Repeat all or Repeat one
	Audio Track
	Subtitle option
	Adjust the size of screen display mode: Normal/ Full Screen/ 4:3 / 16:9
	Adjust screen brightness: 1/2/3/4/5/6
	File information: Name/Format/Size/Resolution/Duration







## File Browser



In Launcher screen, tap FileBrowser to choose your options first:

Internal Memory / SD Card.

### Icons on FileBrowser

	Back to Device List interface
	Multiple select: Enable a file list with multiple selection capability
	Edit file: File operations (Cut/Copy/ Paste/Delete) on the selected files
	Sort file: Sort by name/ Sort by date/ Sort by size
	Back icon
	Thumbnail: Toggle between thumbnail view and list view of the files.
	Help mode

## VI- PRODUCT SPECIFICATION

Specifications:	
<b>General</b>	
Panel Size/Type	8" TFT capacitive touch panel
Aspect Ratio:	4:3
Resolution:	1024 x 768
CPU	Dual Core ARM Cortex-A9, CPU 1.5GHz
OS	Android 4.0
<b>Storage</b>	
Internal memory	1GB DDR3
NAND Flash	4GB(default)
External SD card	Micro SD up to 32GB
<b>Support Format</b>	
Video	MPEG 1/2/4, H.264/VC-1 @1080P RealVideo 8/9/10 @720P
Audio	MP3, WMA, AAC, AC-3 (Optional)
Images	JPEG, BMP, GIF, PNG
<b>Connectivity</b>	
External 3G dongle(Optional)	Support
WiFi	802.11 b/g/n
Bluetooth	V3.0 of 1,2,3 Mbps
Webcam (Front)	0.3 Mega pixel
Main Camera (back)	2.0 Mega pixel
HDMI	1.4a
USB OTG	USB OTG 2.0 x 1
Stereo Speaker	0.5W x 2
Microphone	Built-in
Earphone	3.5mm Stereo Jack
<b>Sensor</b>	
G-sensor	3-axis
GPS	Optional
Gyro	Support
<b>User Interface</b>	
Hardware Keys	Power, Vol+, Vol-
Virtual	Full Touch Screen / Touch Button / Virtual keyboard
<b>Dimension/Weight/Condition</b>	

Dimension :	214 x 161 x 12.7 mm
Weight	527g (with 3G module)
Operation Condition	0°C ~ 40°C
Storage Condition	-20°C ~ 55°C
<b>Power</b>	
Battery :	Li-Polymer Rechargeable 3.7V/4000mAh
	Standby time : Up to 120 hours(TBD)
	Video Playback : Up to 5 hours
AC/DC Adapter	100Vac~240Vac, 0.5A, 50Hz-60Hz, 5V/2A

## VII FCC Statement

Rev 1.0

This device complies with part 15 of the FCC rules. Operation is subject to the following two conditions:

- (1) this device may not cause harmful interference, and
- (2) this device must accept any interference received, including interference that may cause undesired operation.

NOTE: The manufacturer is not responsible for any radio or TV interference caused by unauthorized modifications to this equipment. Such modifications could void the user's authority to operate the equipment.

NOTE: This equipment has been tested and found to comply with the limits for a Class B digital device, pursuant to part 15 of the FCC Rules. These limits are designed to provide reasonable protection against harmful interference in a residential installation. This equipment generates uses and can radiate radio frequency energy and, if not installed and used in accordance with the instructions, may cause harmful interference to radio communications. However, there is no guarantee that interference will not occur in a particular installation.

If this equipment does cause harmful interference to radio or television reception, which can be determined by turning the equipment off and on, the user is encouraged to try to correct the interference by one or more of the following measures:

- Reorient or relocate the receiving antenna.
- Increase the separation between the equipment and receiver.
- Connect the equipment into an outlet on a circuit different from that to which the receiver is connected.
- Consult the dealer or an experienced radio/TV technician for help.

Caution: Any changes or modifications not expressly approved by the party responsible for compliance could void the user's authority to operate the equipment. The highest SAR value for body is 0.523W/kg.