

### 3.2. Block Diagram of Test Setup

#### 3.2.1. Block diagram of connection between the EUT and simulators

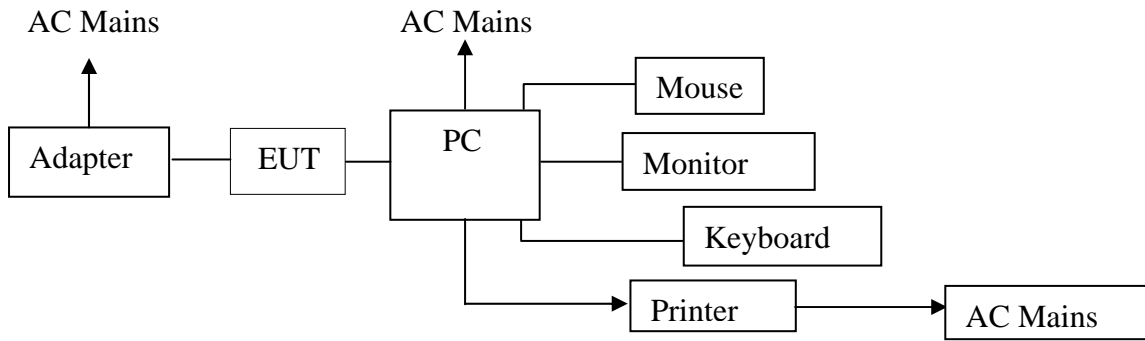

(EUT: 12'' Digital Photo Frame)

#### 3.2.2. Anechoic Chamber Test Setup Diagram

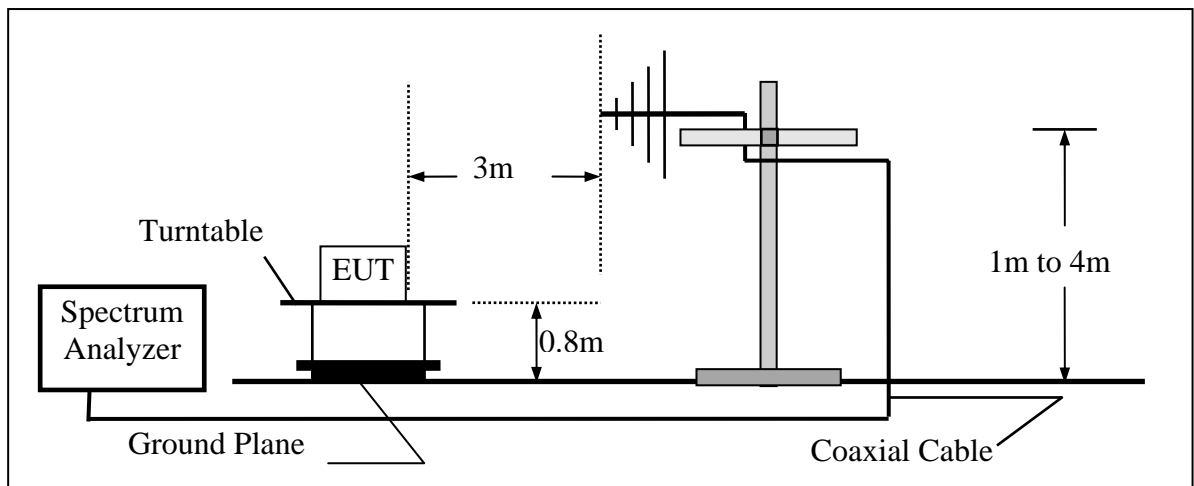

(EUT: 12'' Digital Photo Frame)

### 3.3. Radiated Emission Limit

Radiated Emission Limits is as following.

FREQUENCY MHz	DISTANCE Meters	FIELD STRENGTHS LIMIT
		dB(μV)/m
30 ~ 88	3	40.0
88 ~ 216	3	43.5
216 ~ 960	3	46.0
960 ~ 1000	3	54.0
>1000	3	74.0 dB(μV)/m (peak) 54.0 dB(μV)/m (Average)

- Remark :
- (1) Emission level (dB)μV = 20 log Emission level μV/m
  - (2) The smaller limit shall apply at the cross point between two frequency bands.
  - (3) Distance is the distance in meters between the measuring instrument, antenna and the closest point of any part of the device or system.

### 3.4.EUT Configuration on Measurement

The following equipment are installed on Radiated Emission Measurement to meet the commission requirements and operating regulations in a manner which tends to maximize its emission characteristics in normal application.

12'' Digital Photo Frame (EUT)

Model Number : PD121INCH

### 3.5.Operating Condition of EUT

3.5.1 Setup the EUT as shown in Section 3.2.

3.5.2 Turn on the power of all equipment.

3.5.3 Let the EUT work in test mode (Memorying, SD Card Playing, CF Card Playing, USB Playing, Connect to PC) and measure it.

### 3.6.Test Procedure

EUT and its simulators are placed on a turntable, which is 0.8 meter high above ground. The turn table can rotate 360 degrees to determine the position of the maximum emission level. EUT is set 3.0 meters away from the receiving antenna, which is mounted on a antenna tower. The antenna can be moved up and down between 1.0 meter and 4 meters to find out the maximum emission level. Broadband antenna (calibrated bilog antenna) is used as receiving antenna. Both horizontal and vertical polarization of the antenna is set on measurement. In order to find the maximum emission levels, all of the interface cables must be manipulated according to ANSI C63.4-2003 on radiated emission measurement.

The bandwidth of the EMI test receiver (R&S ESCI) set at 120KHz in 30MHz to 1000MHz, set at 1MHz above 1000MHz.

The frequency range from 30MHz to 1000MHz is checked.

### 3.7.Radiated Emission Noise Measurement Results

**PASS.**

Test data refer to following pages.

## Adapter ADS-18C-12N 12018GPCU used for test.

Dongguan EMTEK Co., Ltd.  
 No. 281, Guantai Road, Nancheng District, Dongguan, Guangdong 523077 P.R. China  
 www.emtek.com.cn Tel: +86-769-2280 7078 Fax: +86-769-2280 7079



### Radiated Emission Measurement

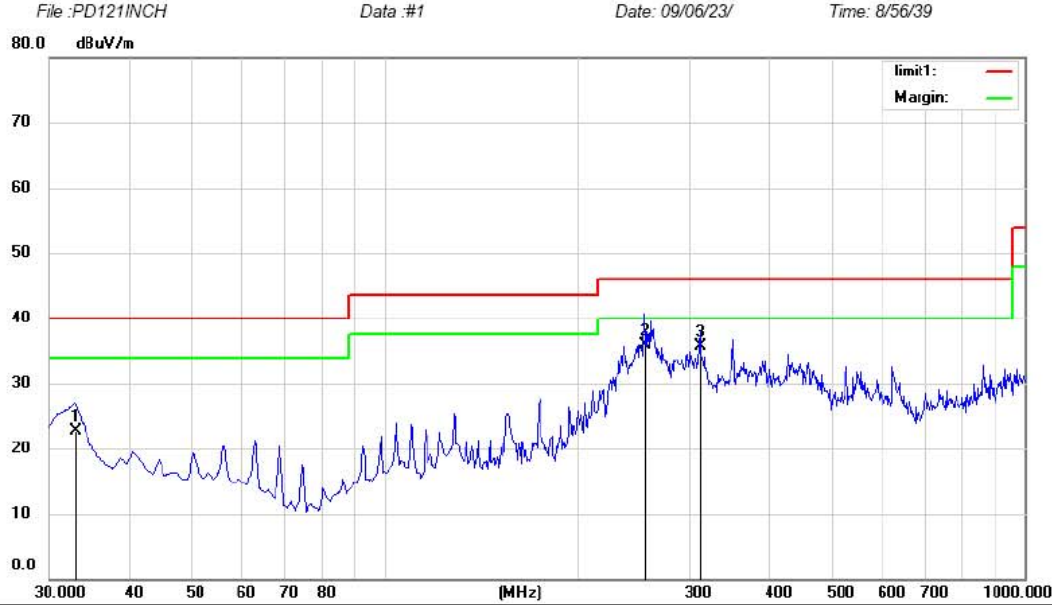

Site: Chamber #1      Polarization: **Horizontal**      Temperature: 26  
 Limit: (RE)FCC PART 15 class B 3m      Power: AC 120V/60Hz      Humidity: 55 %  
 EUT: 12.1"DIGITAL PHOTO FRAME  
 M/N: PD121INCH  
 Mode: Memorying  
 Note: Adapter Model: ADS-18C-12N 12018GPCU

No.	Mk.	Freq.	Reading Level	Correct Factor	Measurement	Limit	Over	Antenna Height	Table Degree	
		MHz	dBuV	dB	dBuV/m	dBuV/m	dB	cm	degree	Comment
1		32.9100	37.55	-14.85	22.70	40.00	-17.30			QP
2	*	255.0400	47.75	-11.94	35.81	46.00	-10.19			QP
3		312.2700	46.32	-10.65	35.67	46.00	-10.33			QP

\*:Maximum data    x:Over limit    !:over margin

Operator:

File :PD121INCH\Data :#1

Page: 1

Adapter ADS-18C-12N 12018GPCU used for test.

Dongguan EMTEK Co., Ltd.  
 No. 281, Guantai Road, Nancheng District, Dongguan, Guangdong 523077 P.R. China  
 www.emtek.com.cn Tel:+86-769-2280 7078 Fax:+86-769-2280 7079



Radiated Emission Measurement

File :PD121INCH

Data :#2

Date: 09/06/23/

Time: 9/03/26

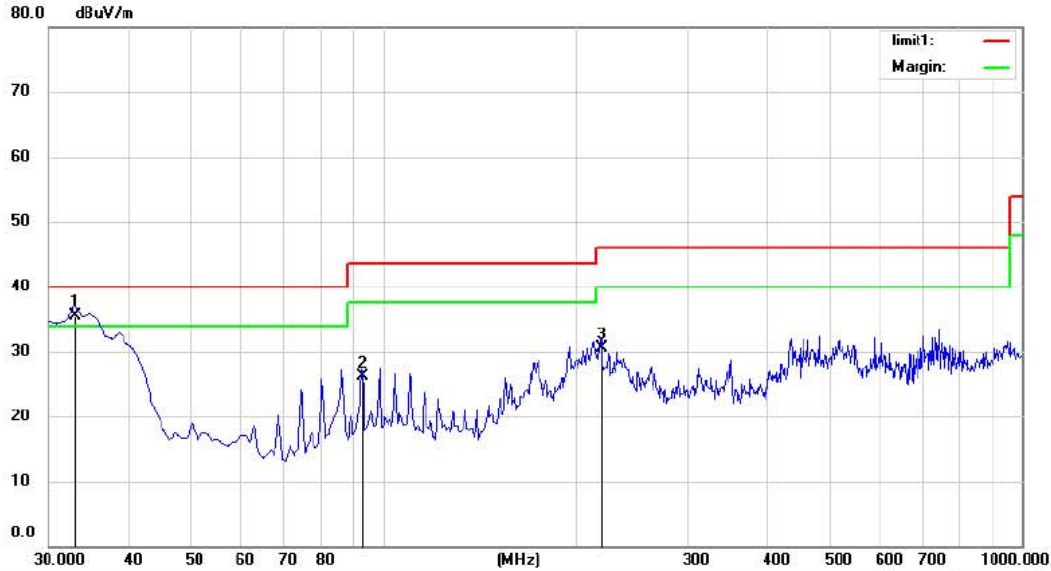

Site Chamber #1 Polarization: **Vertical** Temperature: 26  
 Limit: (RE)FCC PART 15 class B 3m Power: AC 120V/60Hz Humidity: 55 %  
 EUT: 12.1"DIGITAL PHOTO FRAME  
 M/N: PD121INCH  
 Mode:Memorying  
 Note:Adapter Model: ADS-18C-12N 12018GPCU

No.	Mk.	Freq.	Reading Level	Correct Factor	Measurement	Limit	Over	Antenna Height	Table Degree	Comment
		MHz	dBuV	dB	dBuV/m	dBuV/m	dB	cm	degree	
1	*	32.9100	50.39	-14.85	35.54	40.00	-4.46	QP		
2		93.0500	41.20	-15.02	26.18	43.50	-17.32	QP		
3		219.1500	43.65	-13.14	30.51	46.00	-15.49	QP		

\*:Maximum data x:Over limit !:over margin

Operator:

File :PD121INCH>Data :#2

Page: 1

Adapter ADS-18C-12N 12018GPCU used for test.

Dongguan EMTEK Co., Ltd.  
 No.281, Guantai Road, Nancheng District, Dongguan, Guangdong 523077 P.R. China  
 www.emtek.com.cn Tel:+86-769-2280 7078 Fax:+86-769-2280 7079



Radiated Emission Measurement

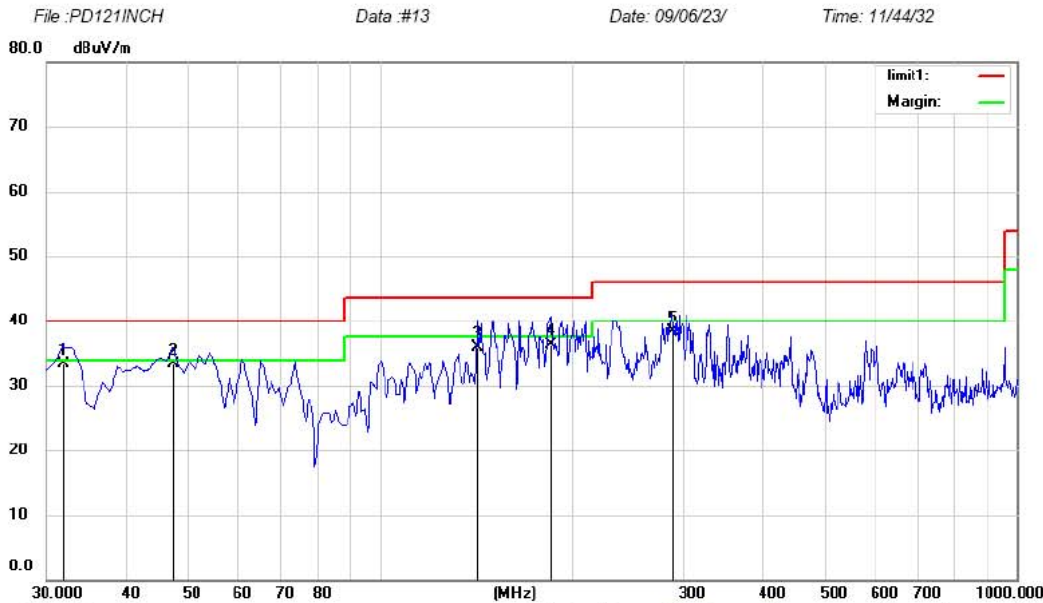

Site Chamber #1      Polarization: **Horizontal**      Temperature: 26  
 Limit: (RE)FCC PART 15 class B 3m      Power: AC 120V/60Hz      Humidity: 55 %  
 EUT: 12.1"DIGITAL PHOTO FRAME  
 M/N: PD121INCH  
 Mode:CONNECT TO PC  
 Note: Adapter Model: ADS-18C-12N 12018GPCU

No.	Mk.	Freq.	Reading Level	Correct Factor	Measurement	Limit	Over	Antenna Height	Table Degree	Comment
		MHz	dBuV	dB	dBuV/m	dBuV/m	dB	cm	degree	
1	*	31.9400	48.26	-14.95	33.31	40.00	-6.69	QP		
2		47.4600	47.52	-14.26	33.26	40.00	-6.74	QP		
3		142.5200	54.68	-18.87	35.81	43.50	-7.69	QP		
4		186.1700	51.17	-14.91	36.26	43.50	-7.24	QP		
5		288.0200	49.22	-10.96	38.26	46.00	-7.74	QP		

\*:Maximum data    x:Over limit    !:over margin

Operator:

File :PD121INCH>Data :#13

Page: 1

Adapter ADS-18C-12N 12018GPCU used for test.

Dongguan EMTEK Co., Ltd.  
 No. 281, Guantai Road, Nancheng District, Dongguan, Guangdong 523077 P.R. China  
 www.emtek.com.cn Tel:+86-769-2280 7078 Fax:+86-769-2280 7079



Radiated Emission Measurement

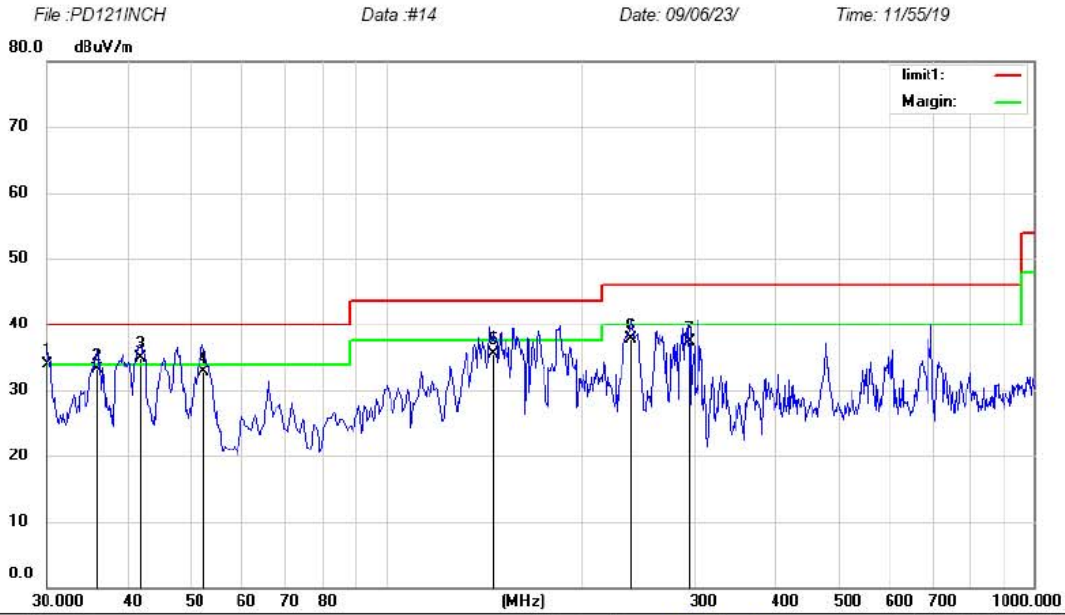

Site Chamber #1 Polarization: **Vertical** Temperature: 26  
 Limit: (RE)FCC PART 15 class B 3m Power: AC 120V/60Hz Humidity: 55 %  
 EUT: 12.1"DIGITAL PHOTO FRAME  
 M/N: PD121INCH  
 Mode: CONNECT TO PC  
 Note: Adapter Model: ADS-18C-12N 12018GPCU

No.	Mk.	Freq.	Reading Level	Correct Factor	Measurement	Limit	Over	Antenna Height	Table Degree	
		MHz	dBuV	dB	dBuV/m	dBuV/m	dB	cm	degree	Comment
1		30.1051	48.96	-15.14	33.82	40.00	-6.18	QP		
2		35.8746	47.55	-14.54	33.01	40.00	-6.99	QP		
3	*	41.8594	48.94	-14.12	34.82	40.00	-5.18	QP		
4		52.3100	47.23	-14.50	32.73	40.00	-7.27	QP		
5		146.4000	54.36	-18.79	35.57	43.50	-7.93	QP		
6		239.5200	49.78	-12.08	37.70	46.00	-8.30	QP		
7		293.8400	48.24	-10.84	37.40	46.00	-8.60	QP		

\*:Maximum data x:Over limit !:over margin

Operator:

Adapter ADS-18C-12N 12018GPCU used for test.

Dongguan EMTEK Co., Ltd.  
 No. 281, Guantai Road, Nancheng District, Dongguan, Guangdong 523077 P.R. China  
 www.emtek.com.cn Tel: +86-769-2280 7078 Fax: +86-769-2280 7079



Radiated Emission Measurement

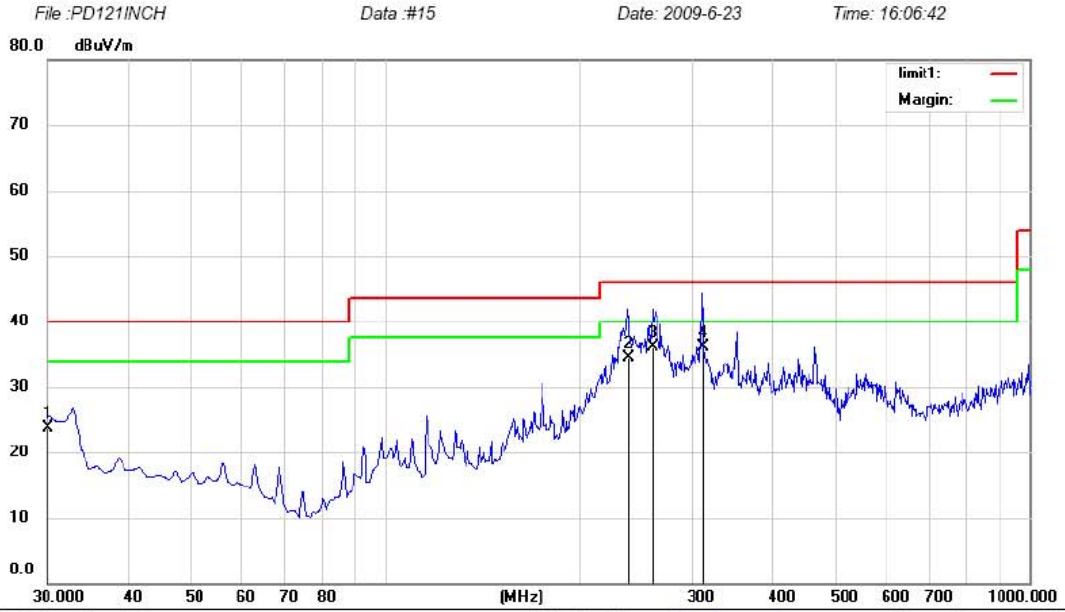

Site Chamber #1 Polarization: **Horizontal** Temperature: 26  
 Limit: (RE)FCC PART 15 class B 3m Power: AC 120V/60Hz Humidity: 55 %  
 EUT: 12.1"DIGITAL PHOTO FRAME  
 M/N: PD121INCH  
 Mode: SD CARD PLAYING  
 Note: Adapter Model: ADS-18C-12N 12018GPCU

No.	Mk.	Freq.	Reading Level	Correct Factor	Measurement	Limit	Over	Antenna Height	Table Degree	Detector	Comment
		MHz	dBuV	dB	dBuV/m	dBuV/m	dB	cm	degree		
1		30.0000	38.93	-15.15	23.78	40.00	-16.22	QP			
2		238.5500	46.65	-12.13	34.52	46.00	-11.48	QP			
3		260.8600	48.05	-11.95	36.10	46.00	-9.90	QP			
4	*	311.3000	46.85	-10.65	36.20	46.00	-9.80	QP			

\*:Maximum data x:Over limit !:over margin

Operator:

File :PD121INCHData :#15

Page: 1

Adapter ADS-18C-12N 12018GPCU used for test.

Dongguan EMTEK Co., Ltd.  
 No. 281, Guantai Road, Nancheng District, Dongguan, Guangdong 523077 P. R. China  
 www.emtek.com.cn Tel: +86-769-2280 7078 Fax: +86-769-2280 7079



Radiated Emission Measurement

File : PD121INCH      Data : #16      Date : 2009-6-23      Time : 16:16:09

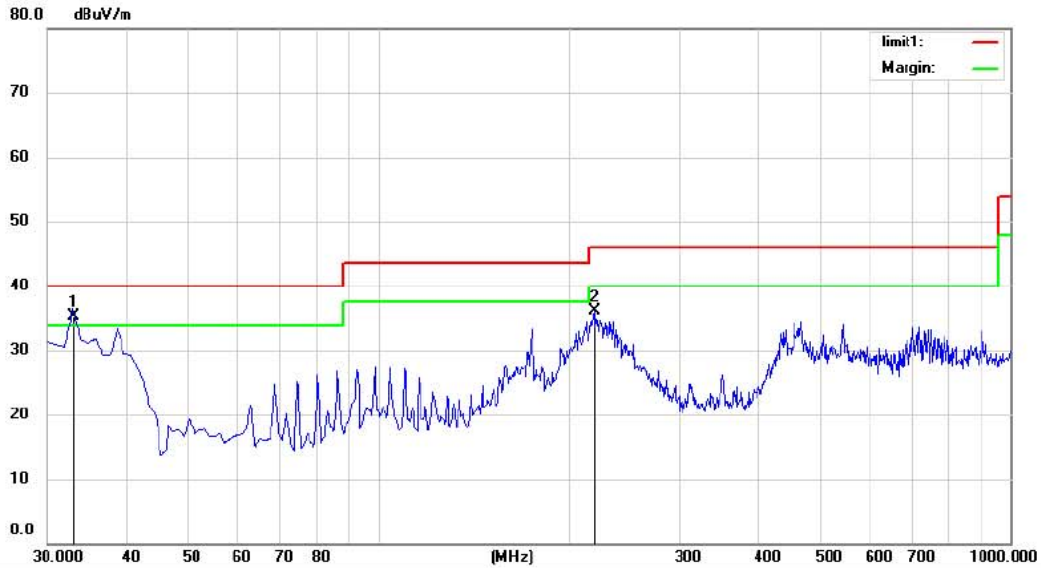

Site Chamber #1      Polarization: **Vertical**      Temperature: 26  
 Limit: (RE)FCC PART 15 class B 3m      Power: AC 120V/60Hz      Humidity: 55 %  
 EUT: 12.1"DIGITAL PHOTO FRAME  
 M/N: PD121INCH  
 Mode: SD CARD PLAYING  
 Note: Adapter Model: ADS-18C-12N 12018GPCU

No.	Mk.	Freq.	Reading Level	Correct Factor	Measurement	Limit	Over	Antenna Height	Table Degree	
		MHz	dBuV	dB	dBuV/m	dBuV/m	dB	cm	degree	Comment
1	*	32.9100	50.15	-14.85	35.30	40.00	-4.70	QP		
2		220.1200	49.20	-13.08	36.12	46.00	-9.88	QP		

\*:Maximum data    x:Over limit    !:over margin

Operator:

File :PD121INCH>Data :#16

Page: 1



### Adapter ADS-18C-12N 12018GPCU used for test.

Dongguan EMTEK Co., Ltd.  
 No.281, Guantai Road, Nancheng District, Dongguan, Guangdong 523077 P.R. China  
 www.emtek.com.cn Tel:+86-769-2280 7078 Fax:+86-769-2280 7079



#### Radiated Emission Measurement

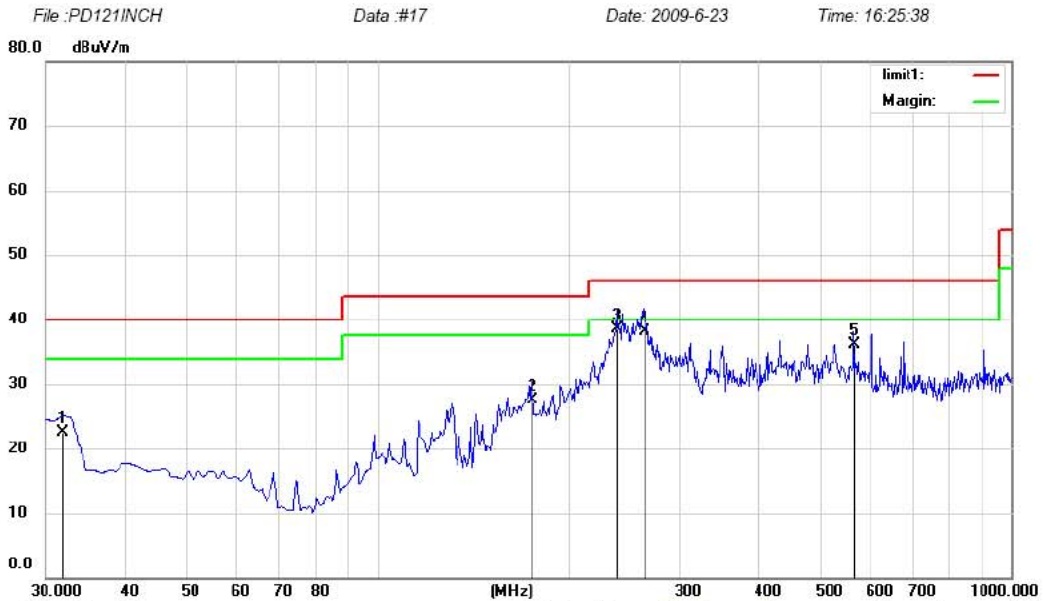

Site Chamber #1      Polarization: **Horizontal**      Temperature: 26  
 Limit: (RE)FCC PART 15 class B 3m      Power: AC 120V/60Hz      Humidity: 55 %  
 EUT: 12.1"DIGITAL PHOTO FRAME  
 M/N: PD121INCH  
 Mode: USB PLAYING  
 Note: Adapter Model: ADS-18C-12N 12018GPCU

No.	Mk.	Freq.	Reading Level	Correct Factor	Measurement	Limit	Over	Antenna Height	Table Degree	Detector	Comment
		MHz	dBuV	dB	dBuV/m	dBuV/m	dB	cm	degree		
1		31.9544	37.55	-14.95	22.60	40.00	-17.40			QP	
2		175.5000	43.73	-16.29	27.44	43.50	-16.06			QP	
3	*	239.5200	50.51	-12.08	38.43	46.00	-7.57			QP	
4		263.7700	50.05	-11.87	38.18	46.00	-7.82			QP	
5		565.4400	42.73	-6.67	36.06	46.00	-9.94			QP	

\*:Maximum data    x:Over limit    !:over margin

Operator:

File :PD121INCH\Data :#17

Page: 1

Adapter ADS-18C-12N 12018GPCU used for test.

Dongguan EMTEK Co., Ltd.  
 No. 281, Guantai Road, Nancheng District, Dongguan, Guangdong 523077 P. R. China  
 www.emtek.com.cn Tel: +86-769-2280 7078 Fax: +86-769-2280 7079



Radiated Emission Measurement

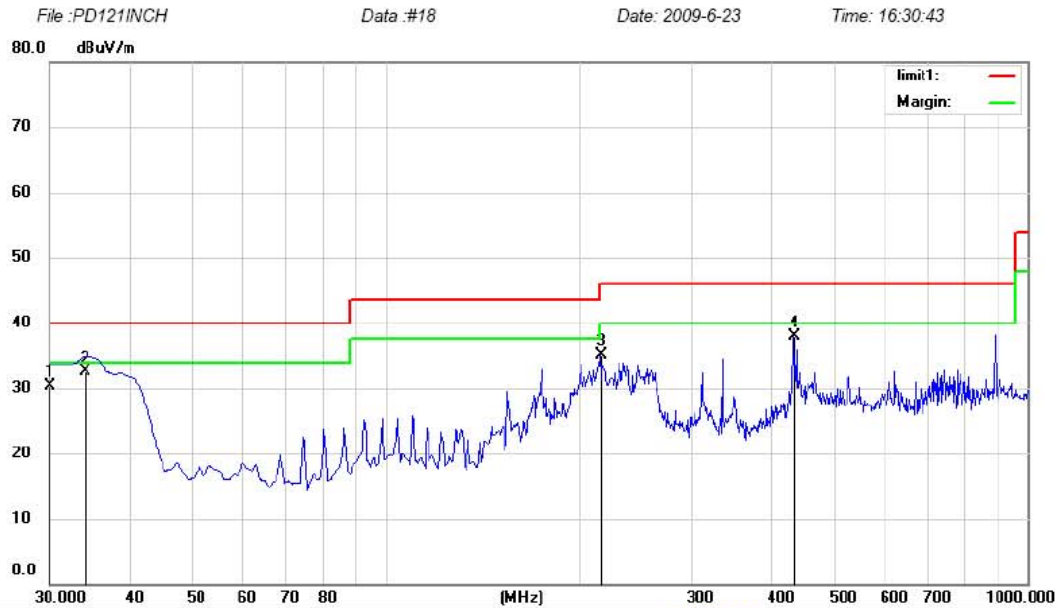

Site Chamber #1 Polarization: **Vertical** Temperature: 26  
 Limit: (RE)FCC PART 15 class B 3m Power: AC 120V/60Hz Humidity: 55 %  
 EUT: 12.1"DIGITAL PHOTO FRAME  
 M/N: PD121INCH  
 Mode: USB PLAYING  
 Note: Adapter Model: ADS-18C-12N 12018GPCU

No.	Mk.	Freq.	Reading Level	Correct Factor	Measurement	Limit	Over	Antenna Height	Table Degree	Comment
		MHz	dBuV	dB	dBuV/m	dBuV/m	dB	cm	degree	
1		30.0000	45.55	-15.15	30.40	40.00	-9.60	QP		
2	*	34.1560	47.27	-14.72	32.55	40.00	-7.45	QP		
3		216.2400	48.45	-13.32	35.13	46.00	-10.87	QP		
4		432.5500	46.26	-8.31	37.95	46.00	-8.05	QP		

\*:Maximum data x:Over limit !:over margin

Operator:

File :PD121INCH\Data :#18

Page: 1

Adapter ADS-18C-12N 12018GPCU used for test.

Dongguan EMTEK Co., Ltd.  
 No. 281, Guantai Road, Nancheng District, Dongguan, Guangdong 523077 P.R. China  
 www.emtek.com.cn Tel:+86-769-2280 7078 Fax:+86-769-2280 7079



Radiated Emission Measurement

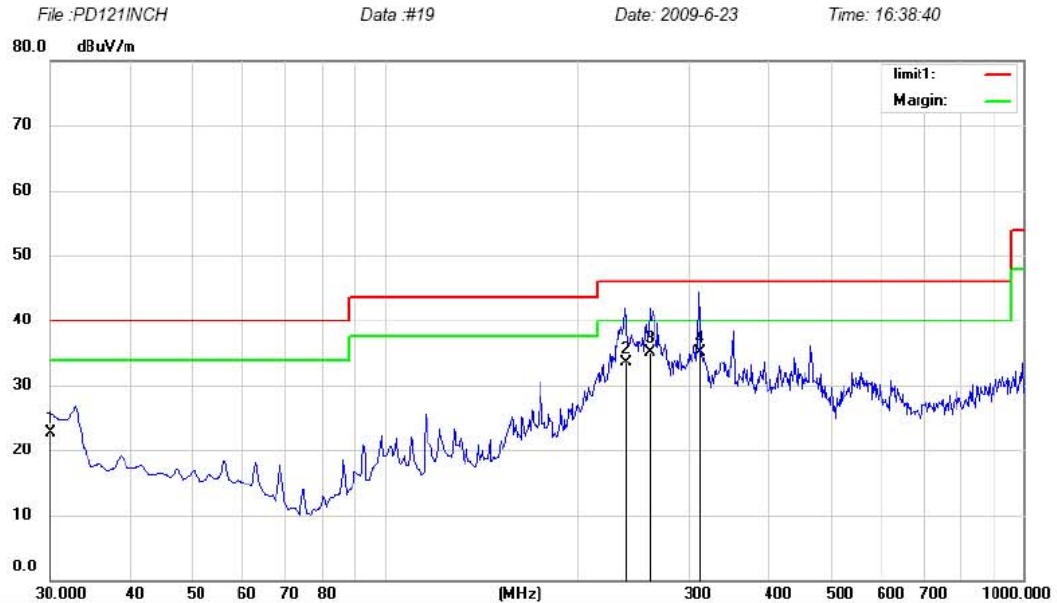

Site Chamber #1 Polarization: **Horizontal** Temperature: 26  
 Limit: (RE)FCC PART 15 class B 3m Power: AC 120V/60Hz Humidity: 55 %  
 EUT: 12.1"DIGITAL PHOTO FRAME  
 M/N: PD121INCH  
 Mode:CF CARD PLAYING  
 Note: Adapter Model: ADS-18C-12N 12018GPCU

No.	Mk.	Freq.	Reading Level	Correct Factor	Measurement	Limit	Over	Antenna Height	Table Degree	Comment
		MHz	dBuV	dB	dBuV/m	dBuV/m	dB	cm	degree	
1		30.0000	37.93	-15.15	22.78	40.00	-17.22	QP		
2		238.5500	45.65	-12.13	33.52	46.00	-12.48	QP		
3		260.8600	47.05	-11.95	35.10	46.00	-10.90	QP		
4	*	311.3000	45.85	-10.65	35.20	46.00	-10.80	QP		

\*:Maximum data x:Over limit !:over margin

Operator:

File :PD121INCHData :#19

Page: 1

Adapter ADS-18C-12N 12018GPCU used for test.

Dongguan EMTEK Co., Ltd.  
 No. 281, Guantai Road, Nancheng District, Dongguan, Guangdong 523077 P.R. China  
 www.emtek.com.cn Tel: +86-769-2280 7078 Fax: +86-769-2280 7079



Radiated Emission Measurement

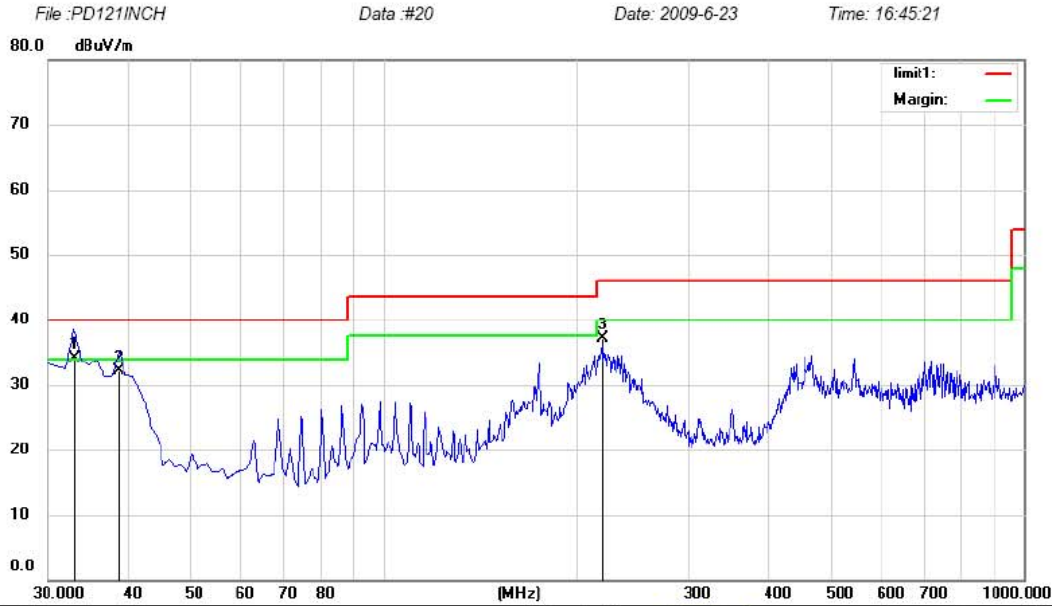

Site Chamber #1      Polarization: **Vertical**      Temperature: 26  
 Limit: (RE)FCC PART 15 class B 3m      Power: AC 120V/60Hz      Humidity: 55 %  
 EUT: 12.1"DIGITAL PHOTO FRAME  
 M/N: PD121INCH  
 Mode: CF CARD PLAYING  
 Note: Adapter Model: ADS-18C-12N 12018GPCU

No.	Mk.	Freq.	Reading Level	Correct Factor	Measurement	Limit	Over	Antenna Height	Table Degree	Comment
		MHz	dBuV	dB	dBuV/m	dBuV/m	dB	cm	degree	
1	*	32.9100	48.95	-14.85	34.10	40.00	-5.90	QP		
2		38.7300	46.26	-14.25	32.01	40.00	-7.99	QP		
3		220.1200	50.20	-13.08	37.12	46.00	-8.88	QP		

\*:Maximum data    x:Over limit    !:over margin

Operator:

File :PD121INCHData :#20

Page: 1

## Adapter ZDA120150US used for test.

Dongguan EMTEK Co., Ltd.  
 No. 281, Guantai Road, Nancheng District, Dongguan, Guangdong 523077 P.R. China  
 www.emtek.com.cn Tel: +86-769-2280 7078 Fax: +86-769-2280 7079



### Radiated Emission Measurement

File : PD121INCH

Data : #53

Date : 2009-6-23

Time : 22:52:07

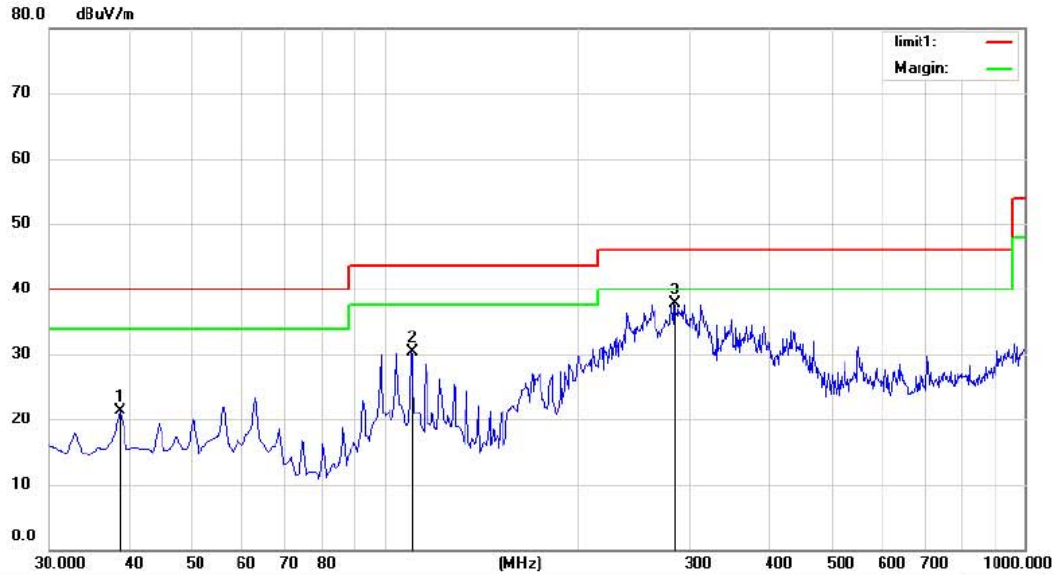

Site: Chamber #1      Polarization: **Horizontal**      Temperature: 26  
 Limit: (RE)FCC PART 15 class B 3m      Power: AC 120V/60Hz      Humidity: 55 %  
 EUT: 12.1"DIGITAL PHOTO FRAME  
 M/N: PD121INCH  
 Mode: CONNECT TO PC  
 Note: Adapter Model: ZDA120150US

No.	Mk.	Freq. MHz	Reading Level dBuV	Correct Factor dB	Measure- ment dBuV/m	Limit dBuV/m	Over dB	Detector	Antenna Height cm	Table Degree	Comment
1		38.7300	35.53	-14.25	21.28	40.00	-18.72	QP			
2		110.5100	45.66	-15.29	30.37	43.50	-13.13	QP			
3	*	284.1400	48.77	-11.11	37.66	46.00	-8.34	QP			

\*:Maximum data    x:Over limit    !:over margin

Operator:

File :PD121INCH\Data :#53

Page: 1

## Adapter ZDA120150US used for test.

Dongguan EMTEK Co., Ltd.  
 No. 281, Guantai Road, Nancheng District, Dongguan, Guangdong 523077 P.R. China  
 www.emtek.com.cn Tel: +86-769-2280 7078 Fax: +86-769-2280 7079



### Radiated Emission Measurement

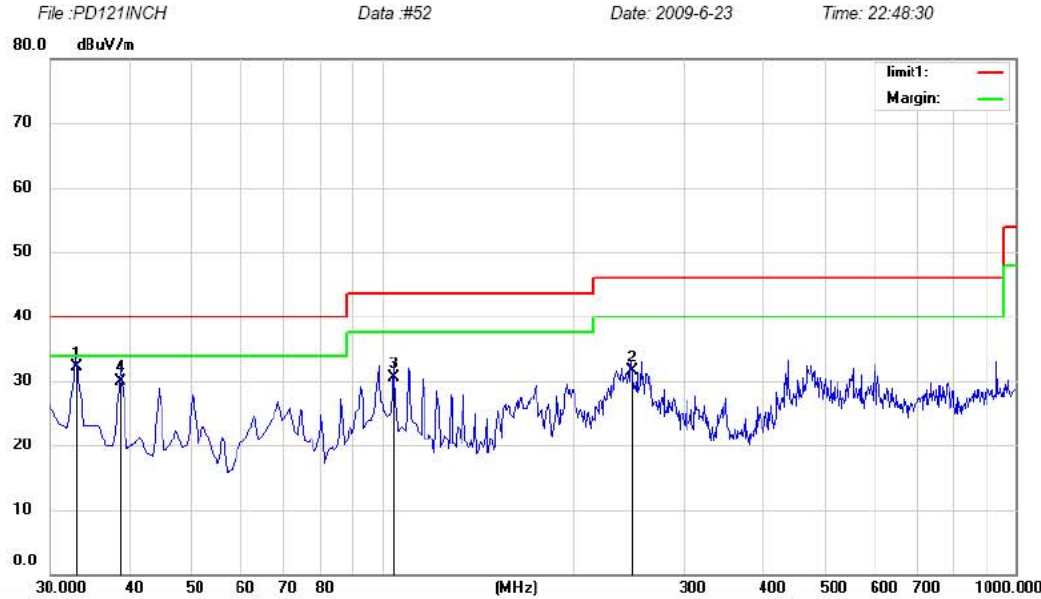

Site Chamber #1      Polarization: **Vertical**      Temperature: 26  
 Limit: (RE)FCC PART 15 class B 3m      Power: AC 120V/60Hz      Humidity: 55 %  
 EUT: 12.1"DIGITAL PHOTO FRAME  
 M/N: PD121INCH  
 Mode: CONNECT TO PC  
 Note: Adapter Model: ZDA120150US

No.	Mk.	Freq.	Reading Level	Correct Factor	Measurement	Limit	Over	Antenna Height	Table Degree	
		MHz	dBuV	dB	dBuV/m	dBuV/m	dB	cm	degree	Comment
1	*	32.9100	46.95	-14.85	32.10	40.00	-7.90	QP		
2		248.2500	43.51	-11.94	31.57	46.00	-14.43	QP		
3		104.6900	45.22	-14.72	30.50	43.50	-13.00	QP		
4		38.7300	44.19	-14.25	29.94	40.00	-10.06	QP		

\*:Maximum data    x:Over limit    !:over margin

Operator:

File: PD121INCH\Data: #52

Page: 1

### Adapter ZDA120150US used for test.

Dongguan EMTEK Co., Ltd.  
 No. 281, Guantai Road, Nancheng District, Dongguan, Guangdong 523077 P. R. China  
 www.emtek.com.cn Tel: +86-769-2280 7078 Fax: +86-769-2280 7079



#### Radiated Emission Measurement

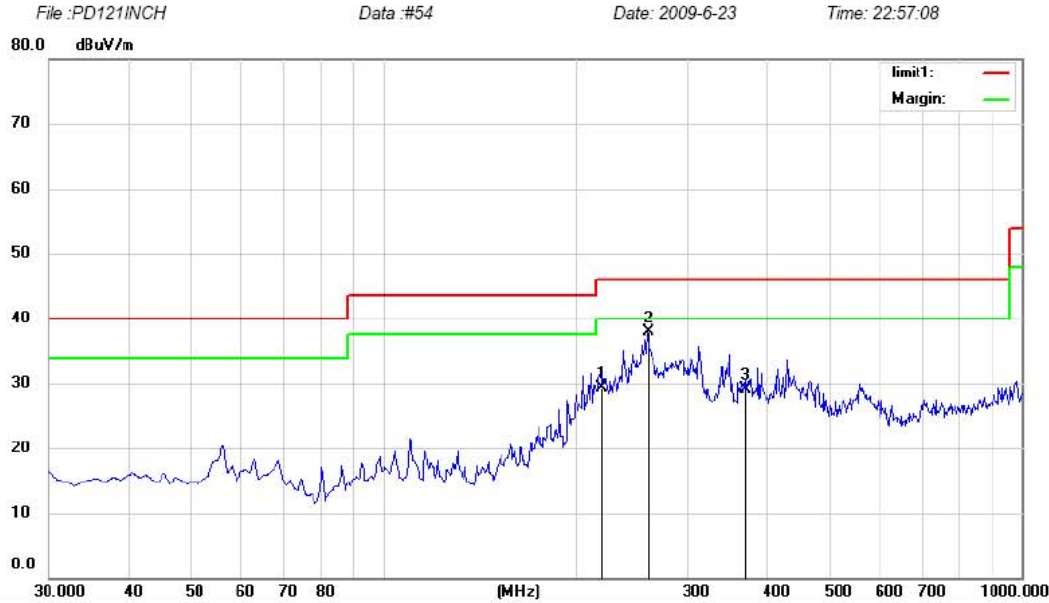

Site: Chamber #1      Polarization: **Horizontal**      Temperature: 26  
 Limit: (RE)FCC PART 15 class B 3m      Power: AC 120V/60Hz      Humidity: 55 %  
 EUT: 12.1"DIGITAL PHOTO FRAME  
 M/N: PD121INCH  
 Mode: SD CARD PLAYING  
 Note: Adapter Model: ZDA120150US

No.	Mk.	Freq.	Reading Level	Correct Factor	Measurement	Limit	Over	Antenna Height	Table Degree	Comment
		MHz	dBuV	dB	dBuV/m	dBuV/m	dB	cm	degree	
1		219.1500	42.36	-13.14	29.22	46.00	-16.78	QP		
2	*	259.8900	49.92	-11.97	37.95	46.00	-8.05	QP		
3		369.5000	38.57	-9.54	29.03	46.00	-16.97	QP		

\*:Maximum data    x:Over limit    !:over margin

Operator:

File: PD121INCH>Data: #54

Page: 1

### Adapter ZDA120150US used for test.

Dongguan EMTEK Co., Ltd.  
 No 281, Guantai Road, Nancheng District, Dongguan, Guangdong 523077 P.R. China  
 www.emtek.com.cn Tel:+86-769-2280 7078 Fax:+86-769-2280 7079



#### Radiated Emission Measurement

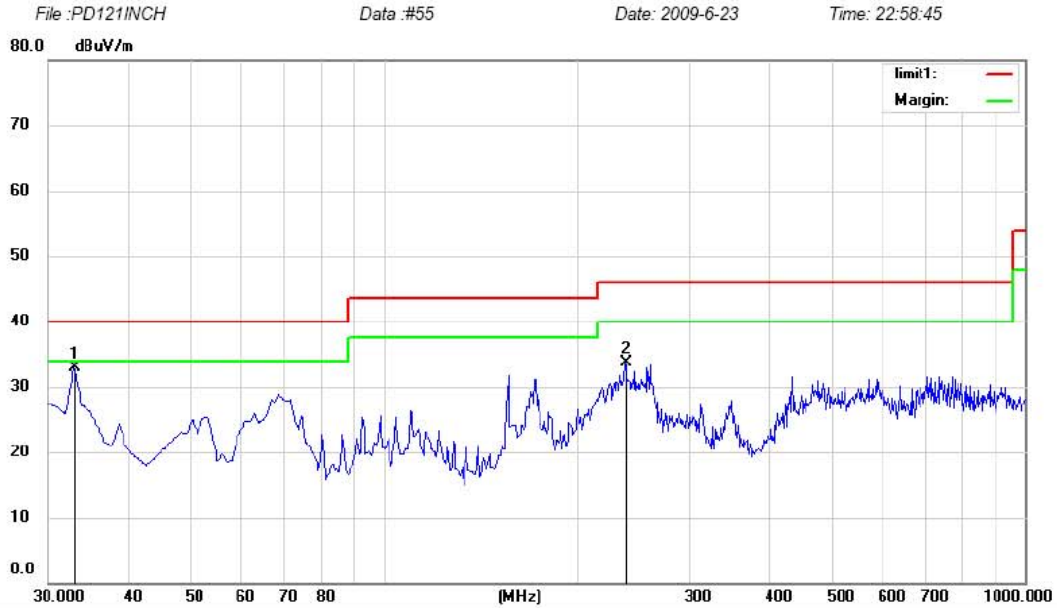

Site Chamber #1      Polarization: **Vertical**      Temperature: 26  
 Limit: (RE)FCC PART 15 class B 3m      Power: AC 120V/60Hz      Humidity: 55 %  
 EUT: 12.1"DIGITAL PHOTO FRAME  
 M/N: PD121INCH  
 Mode:SD CARD PLAYING  
 Note: Adapter Model: ZDA120150US

No.	Mk.	Freq.	Reading Level	Correct Factor	Measure-ment	Limit	Over	Antenna Height	Table Degree	
		MHz	dBuV	dB	dBuV/m	dBuV/m	dB	cm	degree	Comment
1	*	32.9100	47.71	-14.85	32.86	40.00	-7.14	QP		
2		238.5500	45.74	-12.13	33.61	46.00	-12.39	QP		

\*:Maximum data    x:Over limit    !:over margin

Operator:

File :PD121INCH>Data :#55

Page: 1



### Adapter ZDA120150US used for test.

Dongguan EMTEK Co., Ltd.  
 No. 281, Guantai Road, Nancheng District, Dongguan, Guangdong 523077 P. R. China  
 www.emtek.com.cn Tel: +86-769-2280 7078 Fax: +86-769-2280 7079



#### Radiated Emission Measurement

File : PD121INCH      Data : #57      Date : 2009-6-23      Time : 23:04:29

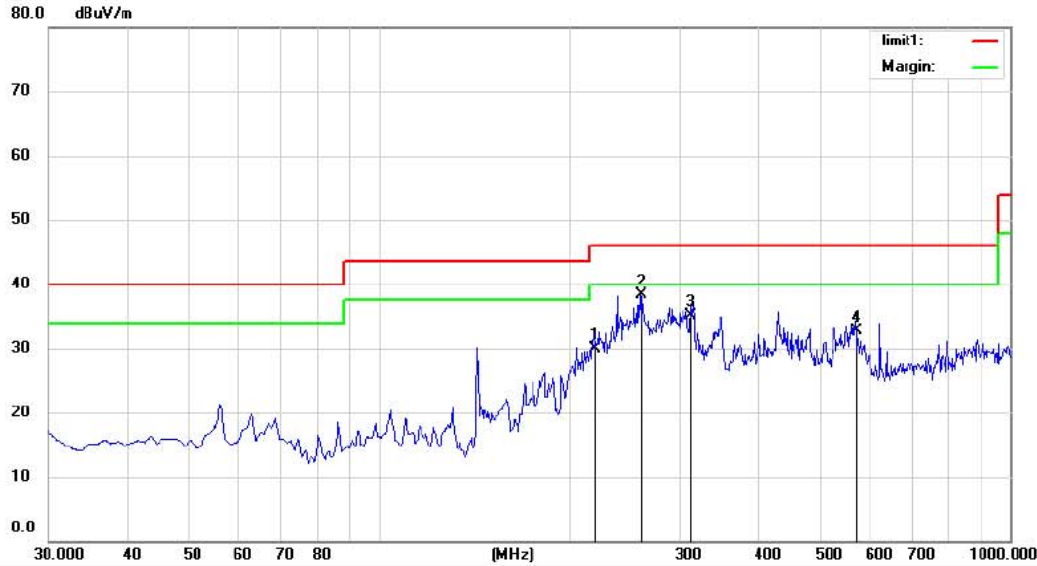

Site Chamber #1      Polarization: **Horizontal**      Temperature: 26  
 Limit: (RE)FCC PART 15 class B 3m      Power: AC 120V/60Hz      Humidity: 55 %  
 EUT: 12.1"DIGITAL PHOTO FRAME  
 M/N: PD121INCH  
 Mode: USB PLAYING  
 Note: Adapter Model: ZDA120150US

No.	Mk.	Freq.	Reading Level	Correct Factor	Measurement	Limit	Over	Antenna Height	Table Degree
		MHz	dBuV	dB	dBuV/m	dBuV/m	dB	cm	degree
1		219.1500	43.01	-13.14	29.87	46.00	-16.13	QP	
2	*	259.8900	50.25	-11.97	38.28	46.00	-7.72	QP	
3		313.2400	45.68	-10.63	35.05	46.00	-10.95	QP	
4		570.2900	39.21	-6.52	32.69	46.00	-13.31	QP	

\*:Maximum data    x:Over limit    !:over margin

Operator:

File :PD121INCH>Data :#57

Page: 1

## Adapter ZDA120150US used for test.

Dongguan EMTEK Co., Ltd.  
 No. 281, Guantai Road, Nancheng District, Dongguan, Guangdong 523077 P. R. China  
 www.emtek.com.cn Tel: +86-769-2280 7078 Fax: +86-769-2280 7079



### Radiated Emission Measurement

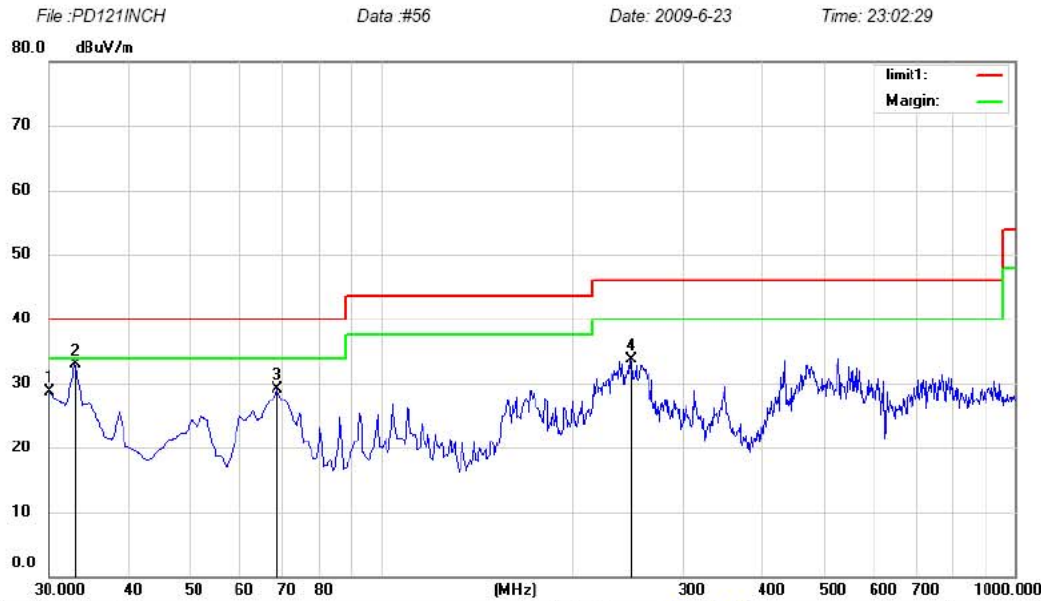

Site Chamber #1      Polarization: **Vertical**      Temperature: 26  
 Limit: (RE)FCC PART 15 class B 3m      Power: AC 120V/60Hz      Humidity: 55 %  
 EUT: 12.1" DIGITAL PHOTO FRAME  
 M/N: PD121INCH  
 Mode: USB PLAYING  
 Note: Adapter Model: ZDA120150US

No.	Mk.	Freq.	Reading Level	Correct Factor	Measurement	Limit	Over	Antenna Height	Table Degree	
		MHz	dBuV	dB	dBuV/m	dBuV/m	dB	Detector	cm	degree
1		30.0000	43.88	-15.15	28.73	40.00	-11.27	QP		
2	*	32.9100	47.84	-14.85	32.99	40.00	-7.01	QP		
3		68.8000	47.45	-18.44	29.01	40.00	-10.99	QP		
4		248.2500	45.57	-11.94	33.63	46.00	-12.37	QP		

\*:Maximum data    x:Over limit    !:over margin

Operator:

File :PD121INCH Data :#56

Page: 1

## Adapter ZDA120150US used for test.

Dongguan EMTEK Co., Ltd.  
 No.281, Guantai Road, Nancheng District, Dongguan, Guangdong 523077 P.R. China  
 www.emtek.com.cn Tel:+86-769-2280 7078 Fax:+86-769-2280 7079



### Radiated Emission Measurement

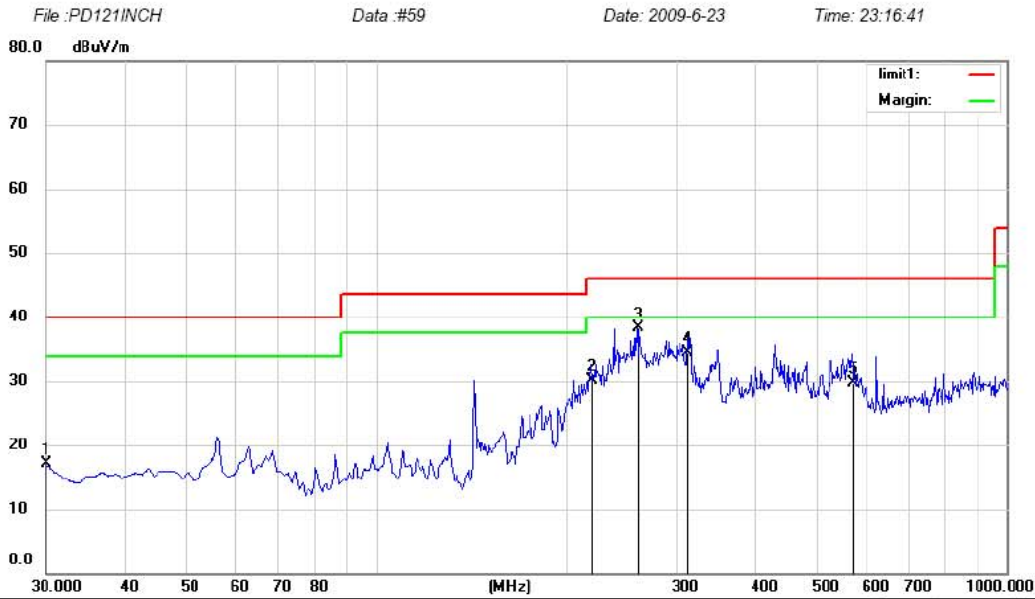

Site Chamber #1      Polarization: **Horizontal**      Temperature: 26  
 Limit: (RE)FCC PART 15 class B 3m      Power: AC 120V/60Hz      Humidity: 55 %  
 EUT: 12.1"DIGITAL PHOTO FRAME  
 M/N: PD121INCH  
 Mode: CF CARD PLAYING  
 Note: Adapter Model: ZDA120150US

No.	Mk.	Freq.	Reading Level	Correct Factor	Measurement	Limit	Over	Antenna Height	Table Degree	Comment
		MHz	dBuV	dB	dBuV/m	dBuV/m	dB	cm	degree	
1		30.0000	32.22	-15.15	17.07	40.00	-22.93	QP		
2		219.1500	43.24	-13.14	30.10	46.00	-15.90	QP		
3	*	259.8900	50.25	-11.97	38.28	46.00	-7.72	QP		
4		313.2400	45.19	-10.63	34.56	46.00	-11.44	QP		
5		570.2900	36.20	-6.52	29.68	46.00	-16.32	QP		

\*:Maximum data    x:Over limit    !:over margin

Operator:

File : PD121INCH>Data : #59

Page: 1

## Adapter ZDA120150US used for test.

Dongguan EMTEK Co., Ltd.  
 No.281,Guantai Road, Nancheng District,Dongguan,Guangdong 523077 P.R. China  
 www.emtek.com.cn Tel:+86-769-2280 7078 Fax:+86-769-2280 7079



### Radiated Emission Measurement

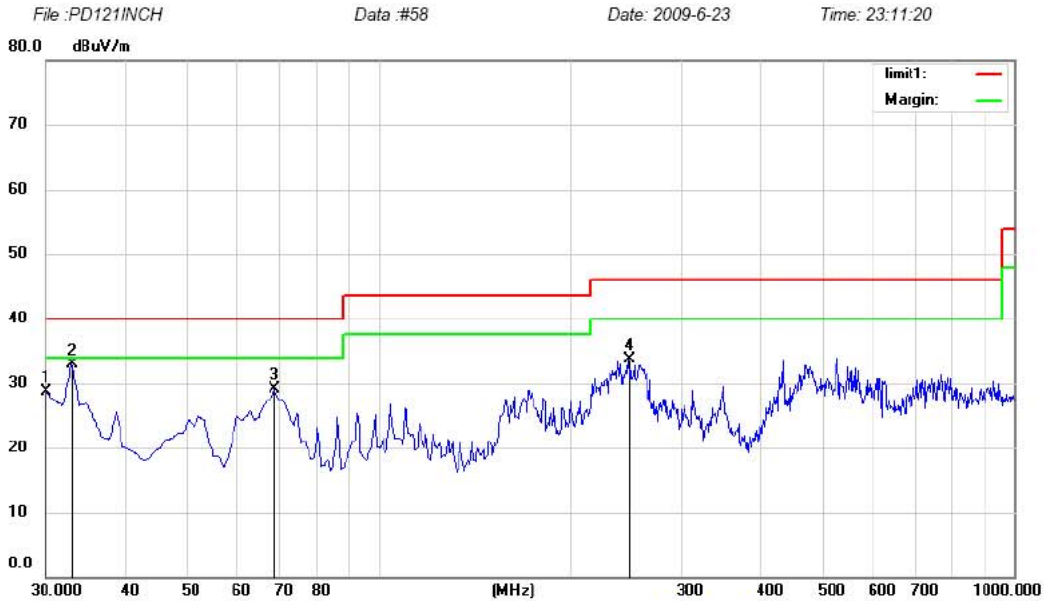

Site Chamber #1      Polarization: **Vertical**      Temperature: 26  
 Limit: (RE)FCC PART 15 class B 3m      Power: AC 120V/60Hz      Humidity: 55 %  
 EUT: 12.1"DIGITAL PHOTO FRAME  
 MN: PD121INCH  
 Mode:CF CARD PLAYING  
 Note: Adapter Model: ZDA120150US

No.	Mk.	Freq.	Reading Level	Correct Factor	Measurement	Limit	Over	Antenna Height	Table Degree	
		MHz	dBuV	dB	dBuV/m	dBuV/m	dB	Detector	cm	degree
1		30.0000	43.88	-15.15	28.73	40.00	-11.27	QP		
2	*	32.9100	47.84	-14.85	32.99	40.00	-7.01	QP		
3		68.8000	47.45	-18.44	29.01	40.00	-10.99	QP		
4		248.2500	45.57	-11.94	33.63	46.00	-12.37	QP		

\*:Maximum data    x:Over limit    !:over margin

Operator:

File :PD121INCH/Data :#58

Page: 1

### Adapter ZDA120150US used for test.

Dongguan EMTEK Co., Ltd.  
 No. 281, Guantai Road, Nancheng District, Dongguan, Guangdong 523077 P.R. China  
 www.emtek.com.cn Tel:+86-769-2280 7078 Fax:+86-769-2280 7079



#### Radiated Emission Measurement

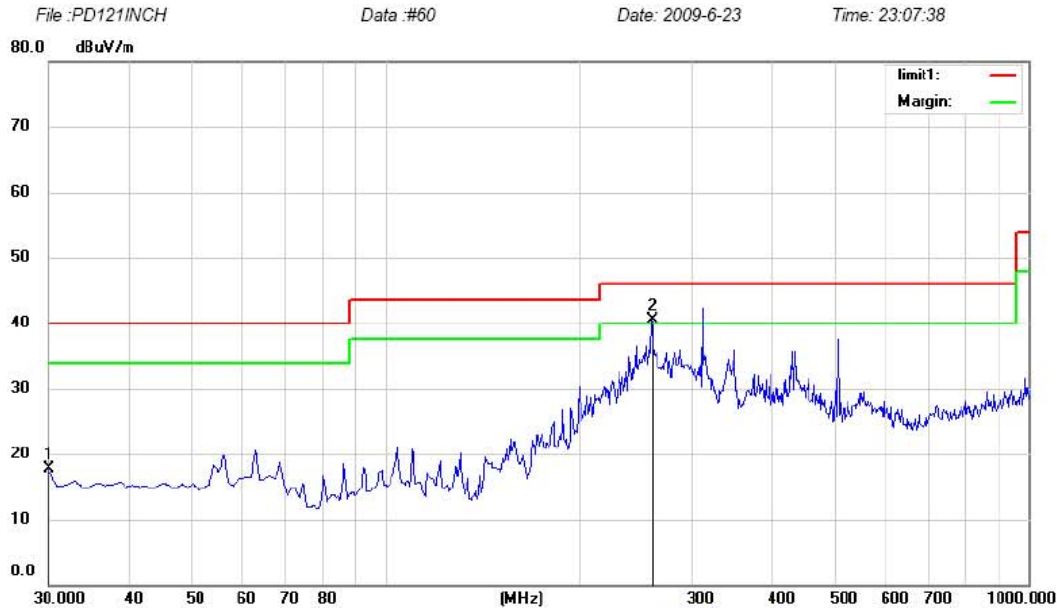

Site Chamber #1      Polarization: **Horizontal**      Temperature: 26  
 Limit: (RE)FCC PART 15 class B 3m      Power: AC 120V/60Hz      Humidity: 55 %  
 EUT: 12.1"DIGITAL PHOTO FRAME  
 M/N: PD121INCH  
 Mode:Memorying  
 Note: Adapter Model: ZDA120150US

No.	Mk.	Freq.	Reading Level	Correct Factor	Measurement	Limit	Over	Antenna Height	Table Degree	
		MHz	dBuV	dB	dBuV/m	dBuV/m	dB	cm	degree	Comment
1		30.0000	32.93	-15.15	17.78	40.00	-22.22	QP		
2	*	259.8900	52.41	-11.97	40.44	46.00	-5.56	QP		

\*:Maximum data    x:Over limit    !:over margin

Operator:

File :PD121INCHData :#60

Page: 1

## Adapter ZDA120150US used for test.

Dongguan EMTEK Co., Ltd.  
 No. 281, Guantai Road, Nancheng District, Dongguan, Guangdong 523077 P.R. China  
 www.emtek.com.cn Tel:+86-769-2280 7078 Fax:+86-769-2280 7079



### Radiated Emission Measurement

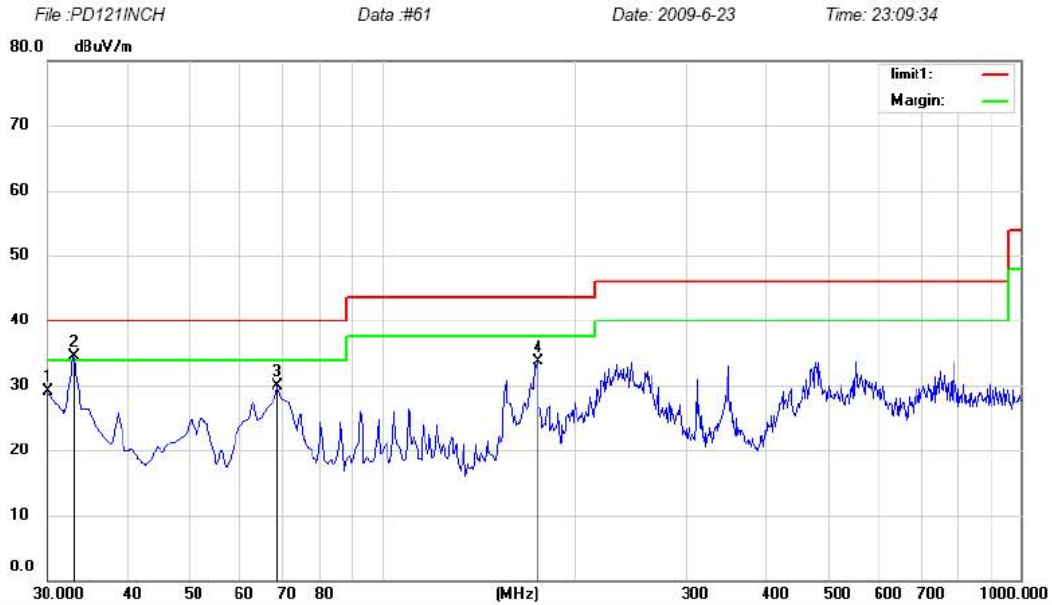

Site Chamber #1      Polarization: **Vertical**      Temperature: 26  
 Limit: (RE)FCC PART 15 class B 3m      Power: AC 120V/60Hz      Humidity: 55 %  
 EUT: 12.1"DIGITAL PHOTO FRAME  
 M/N: PD121INCH  
 Mode: Memorying  
 Note: Adapter Model: ZDA120150US

No.	Mk.	Freq.	Reading Level	Correct Factor	Measurement	Limit	Over	Antenna Height	Table Degree	Comment
		MHz	dBuV	dB	dBuV/m	dBuV/m	dB	cm	degree	
1		30.0000	44.20	-15.15	29.05	40.00	-10.95	QP		
2	*	32.9100	49.28	-14.85	34.43	40.00	-5.57	QP		
3		68.8000	48.28	-18.44	29.84	40.00	-10.16	QP		
4		175.5000	50.09	-16.29	33.80	43.50	-9.70	QP		

\*:Maximum data    x:Over limit    !:over margin

Operator:

File :PD121INCHData :#61

Page: 1

Adapter XKD-C1500IC12.0-18C-US used for test.

Dongguan EMTEK Co., Ltd.  
 No. 281, Guantai Road, Nancheng District, Dongguan, Guangdong 523077 P.R. China  
 www.emtek.com.cn Tel: +86-769-2280 7078 Fax: +86-769-2280 7079



Radiated Emission Measurement

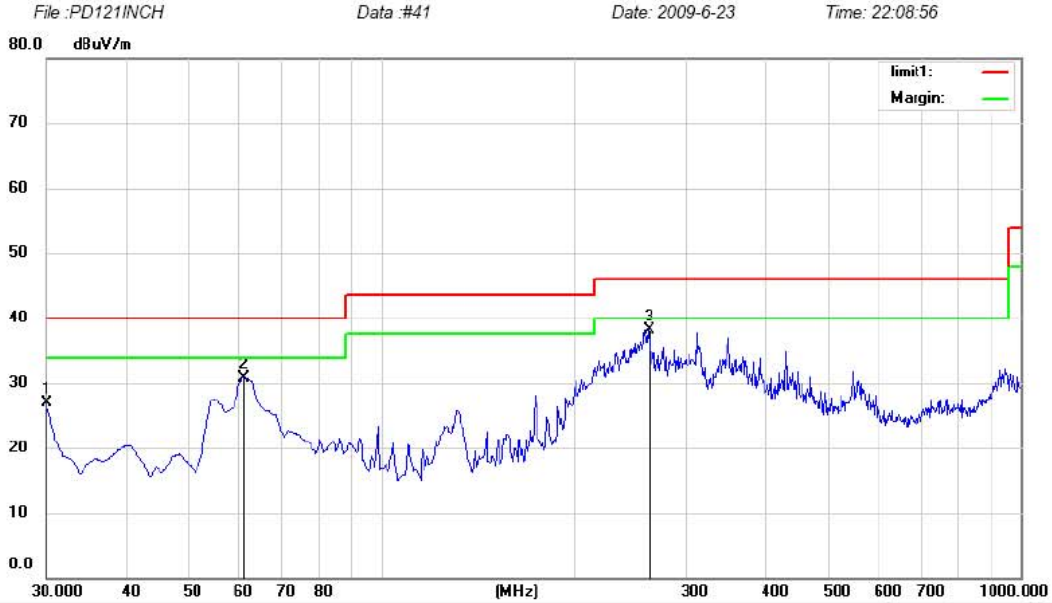

Site Chamber #1      Polarization: **Horizontal**      Temperature: 26  
 Limit: (RE)FCC PART 15 class B 3m      Power: AC 120V/60Hz      Humidity: 55 %  
 EUT: 12.1"DIGITAL PHOTO FRAME  
 M/N: PD121INCH  
 Mode: Memorying  
 Note: Adapter Model: XKD-C1500IC12.0-18C-US

No.	Mk.	Freq.	Reading Level	Correct Factor	Measurement	Limit	Over	Antenna Height	Table Degree	Comment
		MHz	dBuV	dB	dBuV/m	dBuV/m	dB	cm	degree	
1		30.0000	42.09	-15.15	26.94	40.00	-13.06	QP		
2		61.0400	46.13	-15.33	30.80	40.00	-9.20	QP		
3	*	262.8000	50.09	-11.89	38.20	46.00	-7.80	QP		

\*:Maximum data    x:Over limit    !:over margin

Operator:

File :PD121INCH>Data :#41

Page: 1

Adapter XKD-C1500IC12.0-18C-US used for test.

Dongguan EMTEK Co., Ltd.  
 No. 281, Guantai Road, Nancheng District, Dongguan, Guangdong 523077 P.R. China  
 www.emtek.com.cn Tel: +86-769-2280 7078 Fax: +86-769-2280 7079



Radiated Emission Measurement

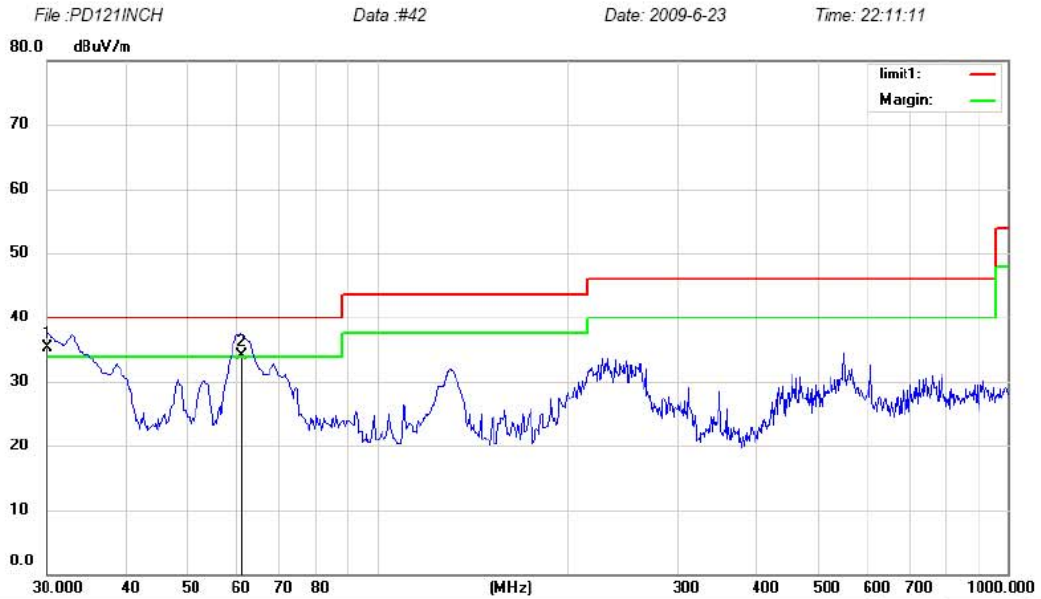

Site: Chamber #1      Polarization: **Vertical**      Temperature: 26  
 Limit: (RE)FCC PART 15 class B 3m      Power: AC 120V/60Hz      Humidity: 55 %  
 EUT: 12.1"DIGITAL PHOTO FRAME  
 M/N: PD121INCH  
 Mode: Memorying  
 Note: Adapter Model: XKD-C1500IC12.0-18C-US

No.	Mk.	Freq.	Reading Level	Correct Factor	Measurement	Limit	Over	Antenna Height	Table Degree		
		MHz	dBuV	dB	dBuV/m	dBuV/m	dB	Detector	cm	degree	Comment
1	*	30.0000	50.55	-15.15	35.40	40.00	-4.60	QP			
2	!	61.0400	49.35	-15.33	34.02	40.00	-5.98	QP			

\*:Maximum data    x:Over limit    !:over margin

Operator:

File :PD121INCH>Data :#42

Page: 1



Adapter XKD-C1500IC12.0-18C-US used for test.

Dongguan EMTEK Co., Ltd.  
 No.281, Guantai Road, Nancheng District, Dongguan, Guangdong 523077 P.R. China  
 www.emtek.com.cn Tel:+86-769-2280 7078 Fax:+86-769-2280 7079



Radiated Emission Measurement

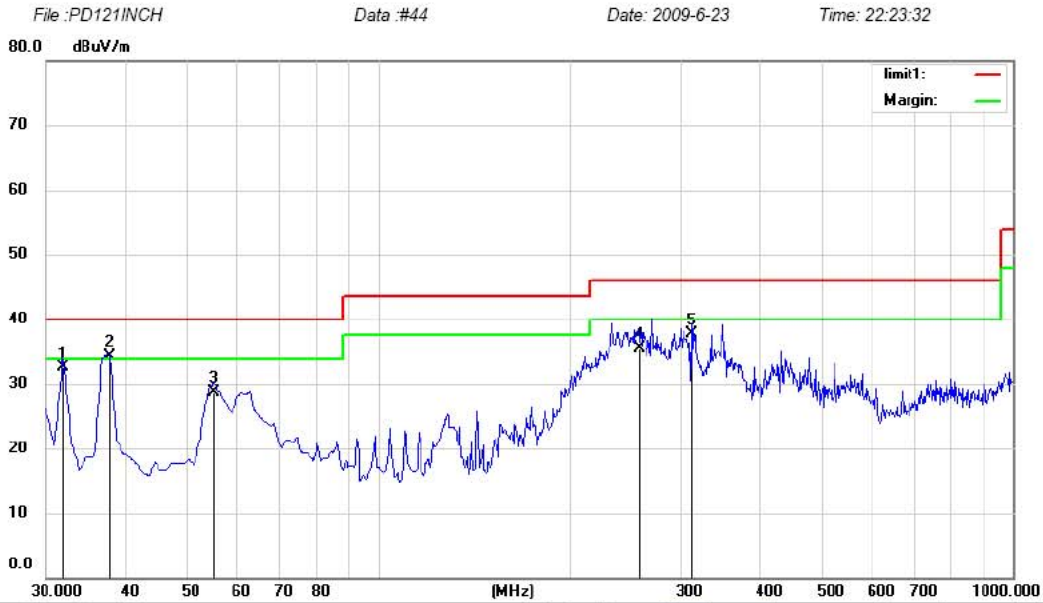

Site Chamber #1      Polarization: **Horizontal**      Temperature: 26  
 Limit: (RE)FCC PART 15 class B 3m      Power: AC 120V/60Hz      Humidity: 55 %  
 EUT: 12.1"DIGITAL PHOTO FRAME  
 M/N: PD121INCH  
 Mode: USB PLAYING  
 Note: Adapter Model: XKD-C1500IC12.0-18C-US

No.	Mk.	Freq.	Reading Level	Correct Factor	Measurement	Limit	Over	Antenna Height	Table Degree	
		MHz	dBuV	dB	dBuV/m	dBuV/m	dB	cm	degree	Comment
1		31.9400	47.52	-14.95	32.57	40.00	-7.43	QP		
2	*	37.7600	48.67	-14.35	34.32	40.00	-5.68	QP		
3		55.2200	43.25	-14.63	28.62	40.00	-11.38	QP		
4		257.9500	47.52	-11.96	35.56	46.00	-10.44	QP		
5		313.2400	48.34	-10.63	37.71	46.00	-8.29	QP		

\*:Maximum data    x:Over limit    !:over margin

Operator:

File :PD121INCH\Data :#44

Page: 1

Adapter XKD-C1500IC12.0-18C-US used for test.

Dongguan EMTEK Co., Ltd.  
 No.281,Guantai Road, Nancheng District,Dongguan,Guangdong 523077 P.R. China  
 www.emtek.com.cn Tel:+86-769-2280 7078 Fax:+86-769-2280 7079



Radiated Emission Measurement

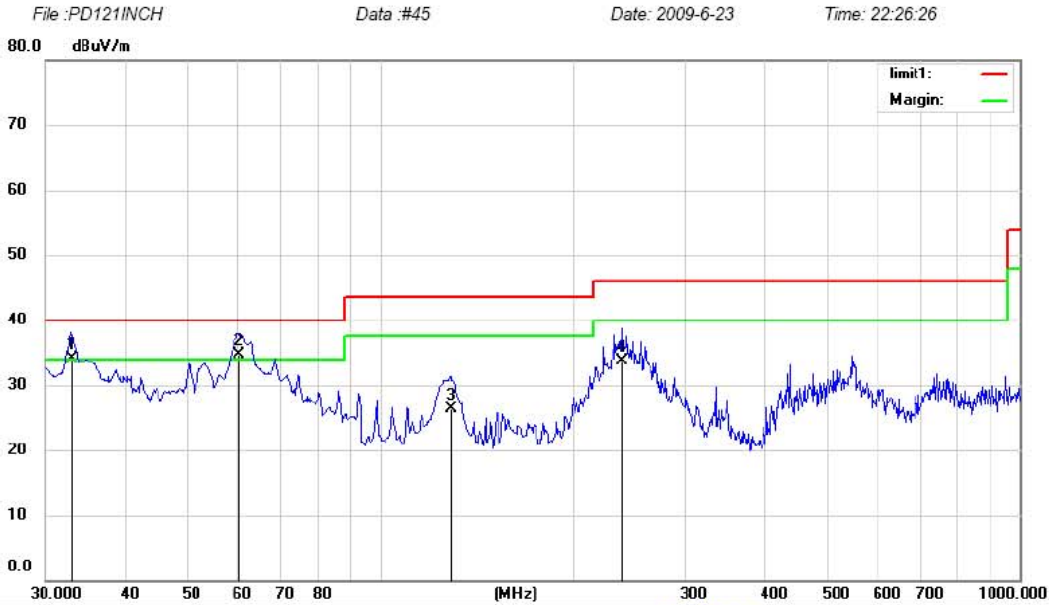

Site Chamber #1 Polarization: **Vertical** Temperature: 26  
 Limit: (RE)FCC PART 15 class B 3m Power: AC 120V/60Hz Humidity: 55 %  
 EUT: 12.1"DIGITAL PHOTO FRAME  
 MN: PD121INCH  
 Mode:USB PLAYING  
 Note: Adapter Model: XKD-C1500IC12.0-18C-US

No.	Mk.	Freq.	Reading Level	Correct Factor	Measurement	Limit	Over	Antenna Height	Table Degree	Comment
		MHz	dBuV	dB	dBuV/m	dBuV/m	dB	cm	degree	
1	!	32.9100	48.89	-14.85	34.04	40.00	-5.96	QP		
2	*	60.0700	49.76	-14.96	34.80	40.00	-5.20	QP		
3		128.9400	44.49	-18.19	26.30	43.50	-17.20	QP		
4		239.5200	45.81	-12.08	33.73	46.00	-12.27	QP		

\*:Maximum data x:Over limit !:over margin

Operator:

File :PD121INCH\Data :#45

Page: 1

Adapter XKD-C1500IC12.0-18C-US used for test.

Dongguan EMTEK Co., Ltd.  
 No. 281, Guantai Road, Nancheng District, Dongguan, Guangdong 523077 P.R. China  
 www.emtek.com.cn Tel:+86-769-2280 7078 Fax:+86-769-2280 7079



Radiated Emission Measurement

File :PD121INCH

Data :#46

Date: 2009-6-23

Time: 22:30:24

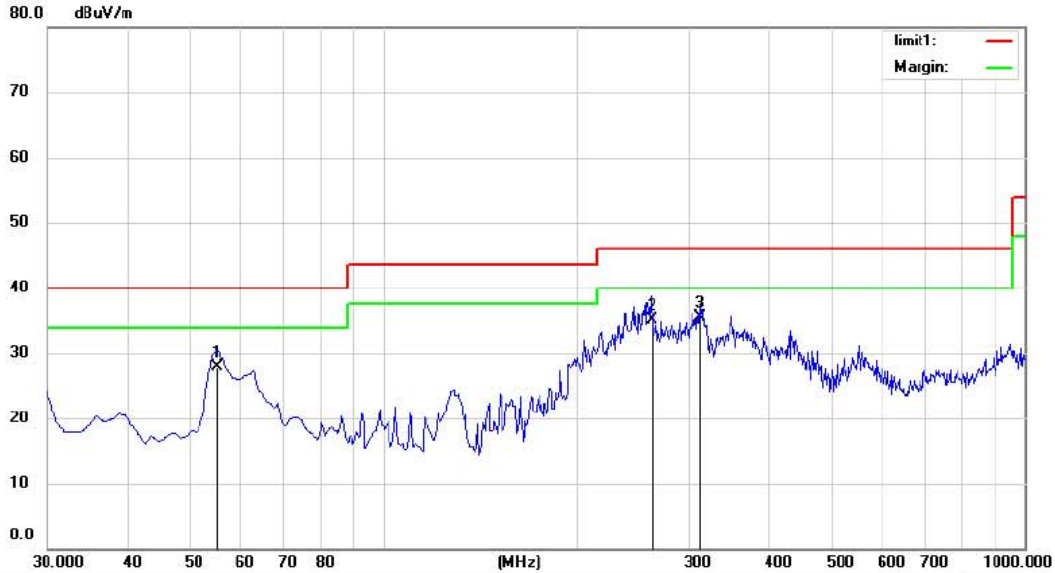

Site Chamber #1 Polarization: **Horizontal** Temperature: 26  
 Limit: (RE)FCC PART 15 class B 3m Power: AC 120V/60Hz Humidity: 55 %  
 EUT: 12.1"DIGITAL PHOTO FRAME  
 M/N: PD121INCH  
 Mode:SD CARD PLAYING  
 Note: Adapter Model: XKD-C1500IC12.0-18C-US

No.	Mk.	Freq.	Reading Level	Correct Factor	Measurement	Limit	Over	Antenna Height	Table Degree	Comment
		MHz	dBuV	dB	dBuV/m	dBuV/m	dB	Detector	cm	degree
1		55.2200	42.58	-14.63	27.95	40.00	-12.05	QP		
2		262.8000	47.01	-11.89	35.12	46.00	-10.88	QP		
3	*	313.2400	46.23	-10.63	35.60	46.00	-10.40	QP		

\*:Maximum data x:Over limit !:over margin

Operator:

File :PD121INCH\Data :#46

Page: 1

Adapter XKD-C1500IC12.0-18C-US used for test.

Dongguan EMTEK Co., Ltd.  
 No. 281, Guantai Road, Nancheng District, Dongguan, Guangdong 523077 P.R. China  
 www.emtek.com.cn Tel:+86-769-2280 7078 Fax:+86-769-2280 7079



Radiated Emission Measurement

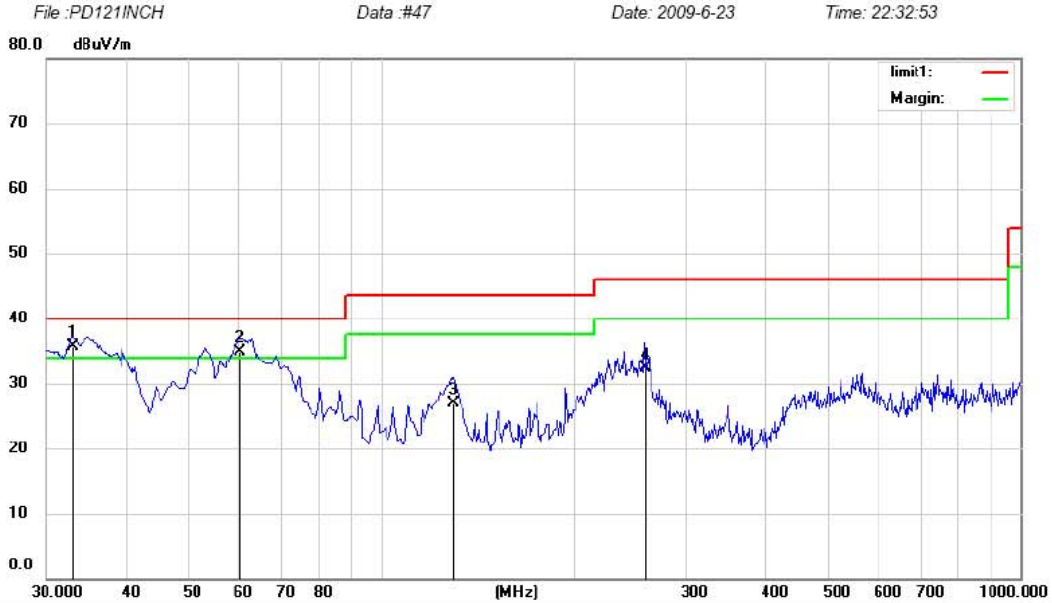

Site Chamber #1      Polarization: **Vertical**      Temperature: 26  
 Limit: (RE)FCC PART 15 class B 3m      Power: AC 120V/60Hz      Humidity: 55 %  
 EUT: 12.1"DIGITAL PHOTO FRAME  
 M/N: PD121INCH  
 Mode: SD CARD PLAYING  
 Note: Adapter Model: XKD-C1500IC12.0-18C-US

No.	Mk.	Freq. MHz	Reading Level dBuV	Correct Factor dB	Measure- ment dBuV/m	Limit dBuV/m	Over dB	Antenna Height cm	Table Degree	Comment
1	*	32.9100	50.61	-14.85	35.76	40.00	-4.24	QP		
2	!	60.0700	49.86	-14.96	34.90	40.00	-5.10	QP		
3		129.9100	45.21	-18.33	26.88	43.50	-16.62	QP		
4		258.9200	44.34	-11.96	32.38	46.00	-13.62	QP		

\*:Maximum data    x:Over limit    !:over margin

Operator:

File :PD121INCH>Data :#47

Page: 1

Adapter XKD-C1500IC12.0-18C-US used for test.

Dongguan EMTEK Co., Ltd.  
 No.281, Guantai Road, Nancheng District, Dongguan, Guangdong 523077 P.R. China  
 www.emtek.com.cn Tel:+86-769-2280 7078 Fax:+86-769-2280 7079



Radiated Emission Measurement

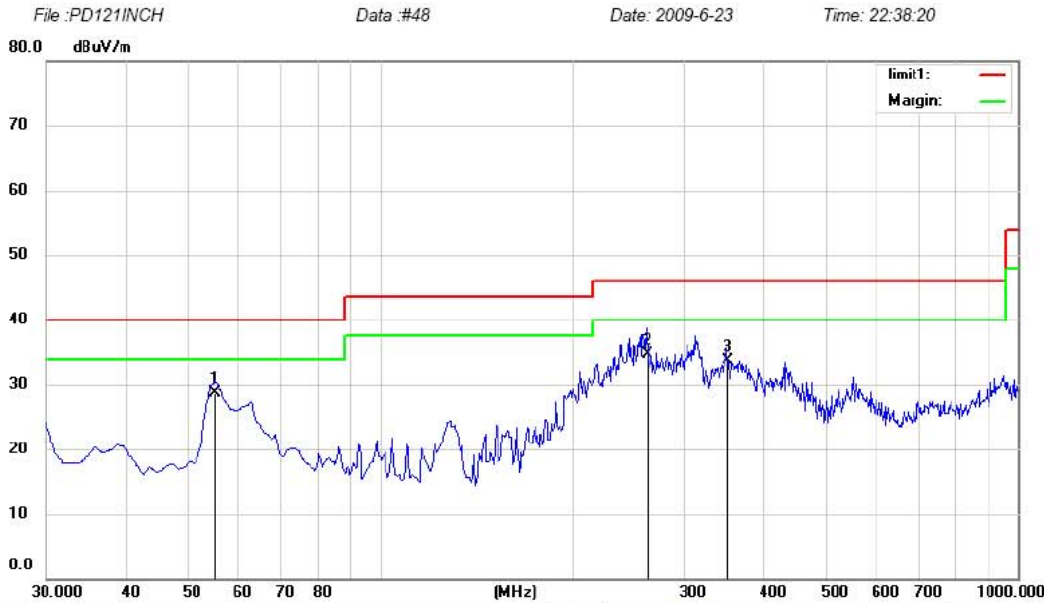

Site Chamber #1      Polarization: **Horizontal**      Temperature: 26  
 Limit: (RE)FCC PART 15 class B 3m      Power: AC 120V/60Hz      Humidity: 55 %  
 EUT: 12.1"DIGITAL PHOTO FRAME  
 M/N: PD121INCH  
 Mode: CF CARD PLAYING  
 Note: Adapter Model: XKD-C1500IC12.0-18C-US

No.	Mk.	Freq.	Reading Level	Correct Factor	Measurement	Limit	Over	Antenna Height	Table Degree	
		MHz	dBuV	dB	dBuV/m	dBuV/m	dB	cm	degree	Comment
1		55.2200	43.28	-14.63	28.65	40.00	-11.35	QP		
2	*	262.8000	46.57	-11.89	34.68	46.00	-11.32	QP		
3		351.0700	43.55	-9.76	33.79	46.00	-12.21	QP		

\*:Maximum data    x:Over limit    !:over margin

Operator:

File :PD121INCH>Data :#48

Page: 1

Adapter XKD-C1500IC12.0-18C-US used for test.

Dongguan EMTEK Co., Ltd.  
 No.281,Guantai Road, Nancheng District,Dongguan,Guangdong 523077 P.R. China  
 www.emtek.com.cn Tel:+86-769-2280 7078 Fax:+86-769-2280 7079



Radiated Emission Measurement

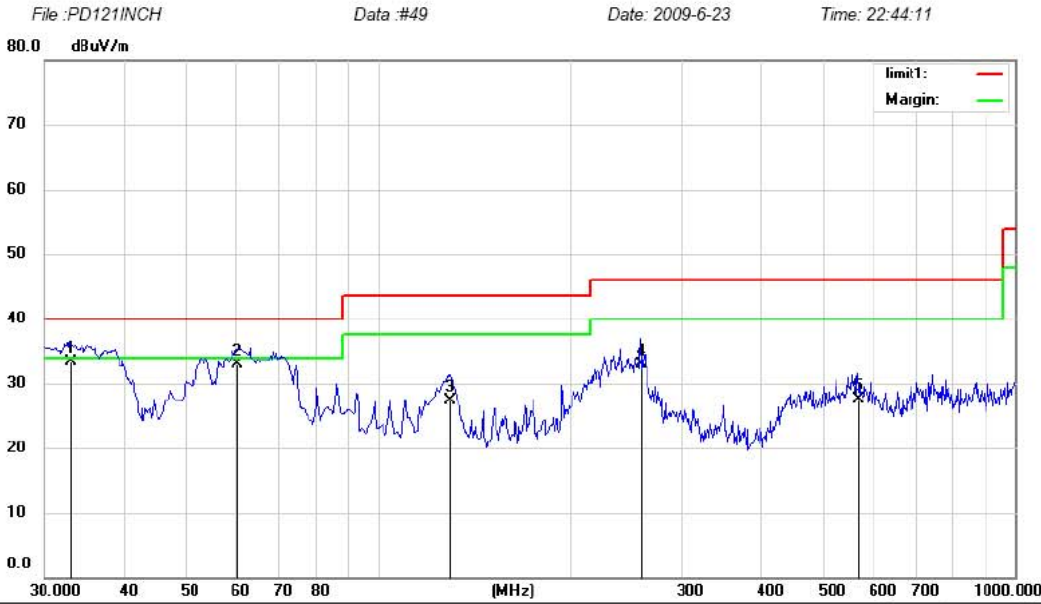

Site Chamber #1 Polarization: **Vertical** Temperature: 26  
 Limit: (RE)FCC PART 15 class B 3m Power: AC 120V/60Hz Humidity: 55 %  
 EUT: 12.1"DIGITAL PHOTO FRAME  
 M/N: PD121INCH  
 Mode:CF CARD PLAYING  
 Note: Adapter Model: XKD-C1500IC12.0-18C-US

No.	Mk.	Freq.	Reading Level	Correct Factor	Measurement	Limit	Over	Antenna Height	Table Degree	
		MHz	dBuV	dB	dBuV/m	dBuV/m	dB	cm	degree	Comment
1	*	32.9100	48.25	-14.85	33.40	40.00	-6.60	QP		
2		60.0700	47.86	-14.96	32.90	40.00	-7.10	QP		
3		129.9100	45.71	-18.33	27.38	43.50	-16.12	QP		
4		258.9200	44.84	-11.96	32.88	46.00	-13.12	QP		
5		568.3500	34.02	-6.58	27.44	46.00	-18.56	QP		

\*:Maximum data x:Over limit !:over margin

Operator:

File :PD121INCH>Data :#49

Page: 1

Adapter XKD-C1500IC12.0-18C-US used for test.

Dongguan EMTEK Co., Ltd.  
 No.281,Guantai Road, Nancheng District,Dongguan,Guangdong 523077 P. R. China  
 www.emtek.com.cn Tel:+86-769-2280 7078 Fax:+86-769-2280 7079



Radiated Emission Measurement

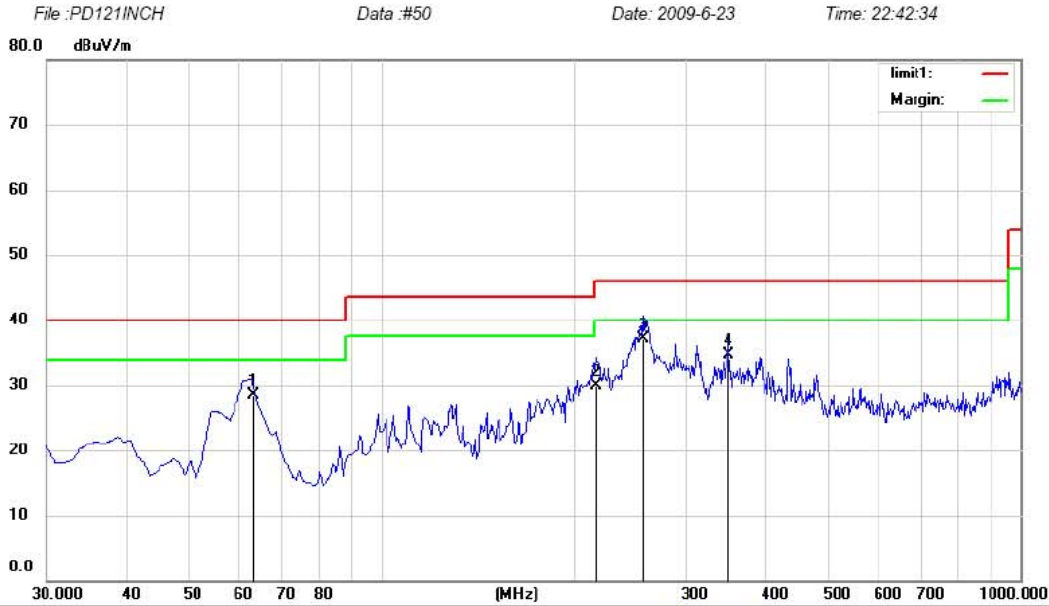

Site Chamber #1 Polarization: **Horizontal** Temperature: 26  
 Limit: (RE)FCC PART 15 class B 3m Power: AC 120V/60Hz Humidity: 55 %  
 EUT: 12.1"DIGITAL PHOTO FRAME  
 M/N: PD121INCH  
 Mode:CONNECT TO PC  
 Note: Adapter Model: XKD-C1500IC12.0-18C-US

No.	Mk.	Freq.	Reading Level	Correct Factor	Measurement	Limit	Over	Antenna Height	Table Degree	Comment
		MHz	dBuV	dB	dBuV/m	dBuV/m	dB	cm	degree	
1		62.9800	44.53	-16.10	28.43	40.00	-11.57	QP		
2		217.2100	43.19	-13.26	29.93	46.00	-16.07	QP		
3	*	256.9800	49.08	-11.95	37.13	46.00	-8.87	QP		
4		350.1000	44.50	-9.77	34.73	46.00	-11.27	QP		

\*:Maximum data x:Over limit !:over margin

Operator:

File :PD121INCH>Data :#50

Page: 1

Adapter XKD-C1500IC12.0-18C-US used for test.

Dongguan EMTEK Co., Ltd.  
 No. 281, Guantai Road, Nancheng District, Dongguan, Guangdong 523077 P. R. China  
 www.emtek.com.cn Tel:+86-769-2280 7078 Fax:+86-769-2280 7079



Radiated Emission Measurement

File :PD121INCH

Data :#51

Date: 2009-6-23

Time: 22:44:32



Site Chamber #1 Polarization: **Vertical** Temperature: 26  
 Limit: (RE)FCC PART 15 class B 3m Power: AC 120V/60Hz Humidity: 55 %  
 EUT: 12.1"DIGITAL PHOTO FRAME  
 M/N: PD121INCH  
 Mode:CONNECT TO PC  
 Note: Adapter Model: XKD-C1500IC12.0-18C-US

No.	Mk.	Freq.	Reading Level	Correct Factor	Measurement	Limit	Over	Antenna Height	Table Degree	
		MHz	dBuV	dB	dBuV/m	dBuV/m	dB	cm	degree	Comment
1		30.0000	47.20	-15.15	32.05	40.00	-7.95	QP		
2	*	34.8500	49.12	-14.65	34.47	40.00	-5.53	QP		
3		130.8800	51.84	-18.39	33.45	43.50	-10.05	QP		

\*:Maximum data x:Over limit !:over margin

Operator:

File :PD121INCH\Data :#51

Page: 1