

Brookstone[®]

A WORLD OF INNOVATION

Since 1965, people have come to Brookstone to see what's new, discover smart solutions to everyday problems—and have some fun. At Brookstone, we believe there's always a better way to do things. And we created a world of innovation to prove it.

Brookstone[®]

MY LIFE

10" Digital Picture Show

DIGITAL PICTURES—PLUS MUSIC AND VIDEOS



Merrimack, New Hampshire USA 03054 • 800-846-3000 • www.Brookstone.com

634592

TABLE OF CONTENTS

Warnings and Cautions	2-3
Accessories	3
Location of Parts and Controls	4
Frame Operation	5
Frame Features	6
Optimizing Photo Storage Capacity	7
Installing Software on your Computer	7
Software Control Locations	8
HOW TO Clock and Settings	9-10
HOW TO Photos	11-18
HOW TO Video	19-24
HOW TO Music	25-31
Screen Prompts	32-33
Specifications	34
Care and Maintenance	34
Compatible File Formats	34
Troubleshooting Guide	35-38
Notes	39-41
Warranty	42

ONE (1) YEAR LIMITED WARRANTY

Brookstone warrants this product against defects in materials and/or workmanship under normal use for a period of ONE (1) YEAR from the date of purchase by the original purchaser ("Warranty Period"). If a defect arises and a valid claim is received within the Warranty Period, at its option, Brookstone will either 1) repair the defect at no charge, using new or refurbished replacement parts, or 2) replace the product with a new product that is at least functionally equivalent to the original product, or 3) provide a store credit in the amount of the purchase price of the original product. A replacement product or part, including a user-installable part installed in accordance with instructions provided by Brookstone, assumes the remaining warranty of the original product. When a product or part is exchanged, any replacement item becomes your property and the replaced item becomes Brookstone's property. When a store credit is given, the original product must be returned to Brookstone and becomes Brookstone's property.

Obtaining Service: To obtain warranty service, call Brookstone Limited Warranty Service at 1-800-292-9819. Please be prepared to describe the product that needs service and the nature of the problem. A purchase receipt is required. All repairs and replacements must be authorized in advance. Service options, parts availability and response times will vary. You are responsible for delivery and the cost of delivery of the product or any parts to the authorized service center for replacement, per our instructions.

Limits and Exclusions: Coverage under this Limited Warranty is limited to the United States of America, including the District of Columbia and the U.S. Territories of Guam, Puerto Rico, and the U.S. Virgin Islands.

This Limited Warranty applies only to products manufactured for Brookstone that can be identified by the "Brookstone" trademark, trade name, or logo affixed to them or their packaging. The Limited Warranty does not apply to any non-Brookstone products. Manufacturers or suppliers other than Brookstone may provide their own warranties to the purchaser, but Brookstone, in so far as permitted by law, provides these products "as is."

This warranty does not apply to: a) damage caused by failure to follow instructions relating to product's use or the installation of components; b) damage caused by accident, abuse, misuse, fire, floods, earthquake or other external causes; c) damage caused by service performed by anyone who is not a representative of Brookstone; d) accessories used in conjunction with a covered product; e) a product or part that has been modified to alter functionality or capability; f) items intended to be periodically replaced by the purchaser during the normal life of the product including, without limitation, batteries or light bulbs; or g) any and all pre-existing conditions that occur prior to the effective date of this Limited Warranty relating to any product sold "as is" including, without limitation, floor demonstration models and refurbished items.

BROOKSTONE SHALL NOT BE LIABLE FOR INCIDENTAL OR CONSEQUENTIAL DAMAGES RESULTING FROM THE USE OF THIS PRODUCT, OR ARISING OUT OF ANY BREACH OF THIS WARRANTY. TO THE EXTENT PERMITTED BY APPLICABLE LAW, BROOKSTONE DISCLAIMS ANY AND ALL STATUTORY OR IMPLIED WARRANTIES, INCLUDING, WITHOUT LIMITATION, WARRANTIES OF MERCHANTABILITY, FITNESS FOR A PARTICULAR PURPOSE AND WARRANTIES AGAINST HIDDEN OR LATENT DEFECTS. IF BROOKSTONE CANNOT LAWFULLY DISCLAIM STATUTORY OR IMPLIED WARRANTIES, THEN TO THE EXTENT PERMITTED BY LAW, ALL SUCH WARRANTIES SHALL BE LIMITED IN DURATION TO THE DURATION OF THIS EXPRESS WARRANTY.

Some states disallow the exclusion or limitation of incidental or consequential damages or how long an implied warranty lasts, so the above exclusions or limitations may not apply to you. This warranty gives you specific legal rights and you may also have other rights, which vary from state to state.

NOTES

IMPORTANT SAFETY INFORMATION

Please read all safety and operating instructions carefully before use and keep these for future reference.

CAUTION

- TO REDUCE THE RISK OF ELECTRIC SHOCK, DO NOT REMOVE COVER. THERE ARE NO SERVICEABLE PARTS INSIDE.
- TO REDUCE THE RISK OF FIRE OR ELECTRIC SHOCK, DO NOT EXPOSE THIS UNIT TO RAIN OR MOISTURE.



The lightning flash with arrow-head symbol within an equilateral triangle is intended to alert the user to the presence of uninsulated "dangerous voltage" within the unit's enclosure that may be of sufficient magnitude to constitute a risk of electric shock.



The exclamation point within an equilateral triangle is intended to alert the user to the presence of important operating and maintenance (servicing) instructions in the literature accompanying the unit.

IMPORTANT SAFETY INSTRUCTIONS

All the safety and operating instructions should be read, adhered to and followed before the unit is operated.

DANGER

To reduce the risk of electric shock, burns, fire or injury:

1. Always unplug the unit from the electrical outlet immediately after using.
2. Do not use while bathing or in a shower.
3. Do not place or store unit where it can fall or be pulled into a tub or sink.
4. Do not place in or drop into water or other liquid.
5. Do not reach for the unit if it has fallen into water. Unplug it immediately.
6. Care should be taken so that objects do not fall and liquids are not spilled onto the unit.

WARNING

1. Close supervision is necessary when this unit is used by or near children.
2. Use this unit only for its intended use as described in this manual.
3. Unplug this unit during lightning storms or when unused for long periods of time.
4. Never drop or insert an object into any opening.
5. Protect the power cord from being walked on or pinched, particularly at plug outlets, convenience receptacles, and the point where it exits the unit.
6. Do not allow cord to touch hot surfaces. Wrap cord loosely around the unit when storing.
7. The unit should be situated away from direct sunlight or heat sources, such as radiators, electric heaters, heat registers, stoves, or other units (including amplifiers) that produce heat. Avoid placing on top of stereo equipment that radiates heat.
8. Never block the air openings of the unit with materials such as clothing, plastic bags or papers, or place it on a soft surface such as a bed or couch, where the air openings may be blocked.
9. Do not overload electrical outlet. Use the power source as indicated.
10. Do not carry this unit by the cord or use the cord as a handle.
11. Never operate this unit if it has a damaged cord or plug, if it is not working properly, if it has been dropped or damaged, or dropped into water. If the unit's power supply cord or plug is damaged, do not attempt to fix it yourself.
12. To avoid the risk of electric shock, do not disassemble or attempt to repair the unit. Incorrect repair can cause risk of electric shock or injury to persons when unit is used.
13. Do not operate in the presence of explosive and/or flammable fumes.









ACCESSORIES

1. Adapter
2. Bonus Walnut Finish Frame
3. MediaImpression™ Software CD

NOTES

NOTES

LOCATION OF PARTS AND CONTROLS

- | | |
|--|---|
| 1.  Power | 12. Speaker (2) |
| 2. Power Save Light Sensor | 13. Menu |
| 3. Volume Down | 14. Select |
| 4. Volume Up | 15. Exit |
| 5. Card Reader Slot | 16. Quick Access  Slide Show |
| 6. Flash Drive | 17. Quick Access  Video |
| 7. USB In | 18. Quick Access  Music |
| 8. DC In | 19.  Up,  Down,  Left,  Right |
| 9. Reset | 20. Copy |
| 10. Power On LED | 21. Delete |
| 11. Stand | 22. Rotate |

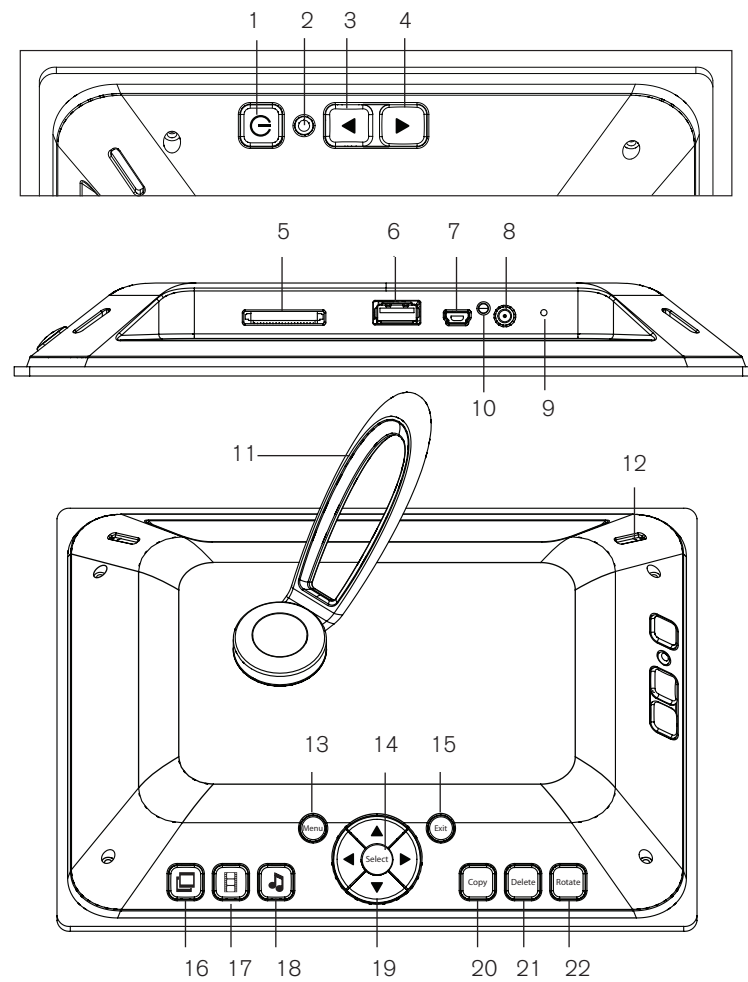

FRAME OPERATION

ATTACHING THE STAND

Line up pins on stand with holes on the frame and insert stand.

Rotate stand to first position for landscape viewing (see A). Or, rotate stand to second position (see B) and stand the frame upright for portrait viewing (see C).

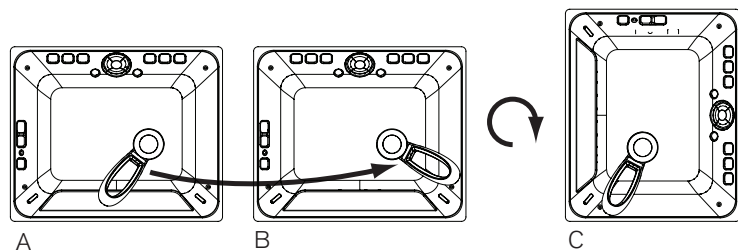

TURNING THE FRAME ON/OFF

Plug in adapter.

Press and hold the POWER BUTTON  until the Brookstone® logo appears on screen to turn on the frame (5-6 seconds). The Home Screen with memory bar appears on the display after the frame is turned on. See below.

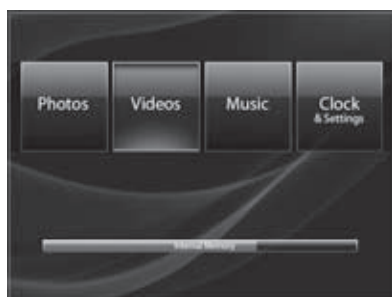

Note: A blue fill in the bar indicates used memory. When the bar is completely blue, the memory is full.



Press and hold POWER BUTTON  for 2 to 3 seconds to turn off the frame. The Brookstone® logo will appear on the screen as it is shutting down.

INSERTING A MEMORY CARD OR FLASH DRIVE

With the frame powered on, insert your memory card or flash drive into the appropriate slot. The Home Screen will show for 60 seconds if no selection is made. After 60 seconds the media will auto-play.

Note: When a memory card is inserted into the frame, the frame's internal memory (media you have copied to the frame's drive) will not be available.

USING THE VOLUME

Press VOLUME  and VOLUME  to adjust volume level. Volume graphic appears on screen to show volume level.

TROUBLESHOOTING GUIDE (continued)

PROBLEM	POSSIBLE CAUSE	ACTION
Music is not playing with my Slide Show.	Slide Show Music is not on. There are no music files on the internal memory, media card, or flash drive.	Turn Slide Show Music on (see page 23). Make sure there are music files on the internal memory, media card, or flash drive.
My rotated photo goes back to its original orientation when I exit out of Photo Full Screen.	Media card or flash drive is inserted into the frame.	Rotated photos will not be saved when viewing photos on a media card or flash drive. Only photos on the internal memory will be saved when they are rotated.
My photos are not playing in the order I want them to play.	Files are not named correctly for the frame to order them.	The frame will order files numerically, then alphabetically. A common mistake is to name the files 1, 2, 3, 4, 5, 6, 7, 8, 9,10. In this case, "10" would come after "1" and before "2" because of the "0". The best way to order them numerically is, "01", "02", etc...
	Files are in folders on the frame drive.	The frame does not recognize folders when ordering files.
	The Slide Show Order is set to "Random."	Change the Slide Show Photo Order to "Normal." See page 14.
My frame's screen is frozen and the frame will not perform functions.		Disconnect and reconnect the adapter from the frame. Press and hold the power button for 3 seconds to turn the frame on. The frame should resume normal operation.

TROUBLESHOOTING GUIDE (continued)

PROBLEM	POSSIBLE CAUSE	ACTION
The frame drive is not mounting on my computer.	Frame may not be powered on.	Make sure frame is powered on.
	USB cable connections may be loose.	Make sure USB cable connections are secure.
	Flash drive is inserted into the frame.	Remove flash drive from frame before connecting to computer.
The frame is not reading my flash drive.	Flash drive connection may be loose.	Make sure flash drive connection is secure
	USB cable is inserted into the frame but not hooked up to the computer.	Remove USB cable from frame before inserting your flash drive.
Received an error that my JPEG failed to resize while resizing with the Medialmpression™ software.	The frame's internal memory is full.	Remove files to free up internal memory.
The frame is not saving as many photos on the internal memory as I expected.	JPEG files are large.	Use included Medialmpression™ software to resize your JPEGS (see page 13) or copy your photos directly from a media card or flash drive to the frame.
	Video and music files are taking up memory space.	Remove files to free up internal memory.

FRAME FEATURES

PHOTO SMOOTH

The PHOTO SMOOTH feature modifies faces within your photos with a smoothing airbrush effect. Feature only works in Slide Show mode (normal transition).

DYNAMIC LIGHTING

The DYNAMIC LIGHTING feature improves your photo's light balance to enhance dark photos. Feature only works in Slide Show mode (normal transition).

FACE ZOOM

The FACE ZOOM feature automatically pans and zooms to faces within your photos. Feature only works in Slide Show mode (normal transition).

MULTI SHOW

The MULTI SHOW slide show transition will show multiple photos at the same time.

POWER SAVE

The POWER SAVE feature detects the room's light level and automatically puts the frame into energy saving mode by shutting down the LED display. If the frame senses that the room is dark for more than 15 minutes and no buttons have been pressed, the following graphic appears on screen.

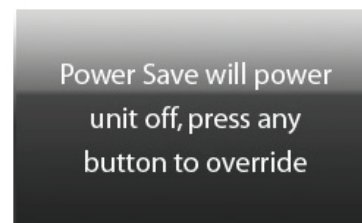

When the frame senses light, or any button on the frame is pressed, the LED display will turn on and the frame will resume current operation.

ANTI-VIRUS

When the frame is powered on, any files with the extension ".exe" or ".bat" (common extensions for possible viruses) that have been put on the frame's drive via the computer will be automatically deleted from the frame.

RESET

Press the RESET button with a thin, pointed object (such as a paper clip). Power the unit on after pressing the RESET button. The frame will default to the factory settings, however, the frame's internal memory will remain intact.

Note: Frame should not be used as a storage device.

OPTIMIZING PHOTO STORAGE CAPACITY

When the photos are downloaded to the frame with either a memory card or a flash drive, photos are automatically optimized for the frame's screen resolution.

MedialImpression™ SOFTWARE

When using your computer to download photos onto the frame it is recommended to use the included MedialImpression™ software.

The MedialImpression™ software optimizes your photos for the frame's screen resolution. (800 x 600 pixel dimensions, 72 dpi (pixels per inch)).

The MedialImpression™ software will make new files of your photos when it saves them to the frame. Your original photos will remain intact/unchanged.

Note: If your photo's dimensions are smaller than 800 x 600, there is no need to resize. To find out the dimensions of a photo, simply place your cursor over the thumbnail while using the MedialImpression™ software. This will show a pop-up box with your photo's dimensions.

An example of the MedialImpression™ screen is on the following page.

INSTALLING SOFTWARE ON YOUR COMPUTER

Photos placed on the frame using a computer and without using the MedialImpression™ software will not be optimized to your frame's specifications and could possibly use more memory than necessary.

FOR WINDOWS® 2000/XP/VISTA®:

1. Insert MedialImpression™ SOFTWARE CD into your computer's CD-ROM drive.
2. Open the CD and double click Windows folder (this software does not auto-run).
3. Double click on the Setup.exe file.
4. InstallShield® Wizard will launch on your computer. Follow the InstallShield® Wizard on-screen instructions to install the MedialImpression™ software on your computer.
5. To open MedialImpression™, locate the installed software on your computer and double click on the MedialImpression™ icon.

FOR MAC® OS X 10.4 AND LATER:

1. Insert MedialImpression™ SOFTWARE CD into your computer's CD-ROM drive.
2. Open the CD and double click on the Mac folder (this software does not auto-run).
3. Double click on "MedialImpression Installer".
4. Follow the MedialImpression™ Installer on-screen instructions to install the MedialImpression™ software on your computer.
5. To open MedialImpression™, locate the installed software on your computer and double click on the MedialImpression™ icon.

TROUBLESHOOTING GUIDE (continued)

PROBLEM	POSSIBLE CAUSE	ACTION
When selecting a photo from THUMBNAIL to show in FULL SCREEN, "File not supported" or "Photo Error" appears on screen.	Photo data cannot be viewed in this mode.	Photos not viewable in this mode may be removed by user.
Photos are taking a long time to load/slide show times are inaccurate.	Photo Smooth, Dynamic Lighting and Face Zoom features are active.	Photo Smooth, Dynamic Lighting and Face Zoom features increase load time.
	Photos are not optimized and photo size is very large.	Make sure photos are optimized for frame.
When photos, videos, or music are loading, the display shows a blank screen or screen graphics for several seconds before file is displayed.	Files are too large.	Make sure photos are optimized for frame.
Face Zoom, Photo Smooth, Dynamic Lighting features are not functioning on certain faces.	These features may not work due to photo angle, distance in photo, clothing, accessories etc.	Software limitation.
Face Zoom, Photo Smooth, Dynamic Lighting features are not working with certain slide show transitions.	These features will only run under the NORMAL slide show transition.	Software limitation.

TROUBLESHOOTING GUIDE

PROBLEM	POSSIBLE CAUSE	ACTION
Frame does not power on.	The adapter is not inserted correctly.	Ensure adapter is connected correctly.
	Power outlet does not have power.	Relocate to a power outlet that has power.
Frame does not read memory card.	Memory card is not inserted correctly.	All cards are inserted with the label-side up.
	Using a Memory Stick® Duo adapter.	Remove and reinsert card and adapter to ensure proper contact in card reader.
	Card is below 64MB.	Use a 64MB or higher card.
File does not download, the file is distorted, the unit freezes or the file will not copy to the frame.	Using a memory card that is not compatible with the frame.	Ensure the memory card is compatible with the frame. See page 30.
	File is very large.	Files above 2.0 megapixels take longer to download.
Some of my photos are not showing on the frame.	Internal memory is full.	Files will not download when memory is full. Delete files from the frame before downloading.
	Photo file is a scanned image.	Scanned images can be very large. Some may be too large for the frame to handle.
Some of my photos are not showing on the frame.	Photos are not in JPEG format.	Use Medialmpression™ software to convert your photos to JPEG. See page 17 for instructions.

SOFTWARE CONTROL LOCATIONS

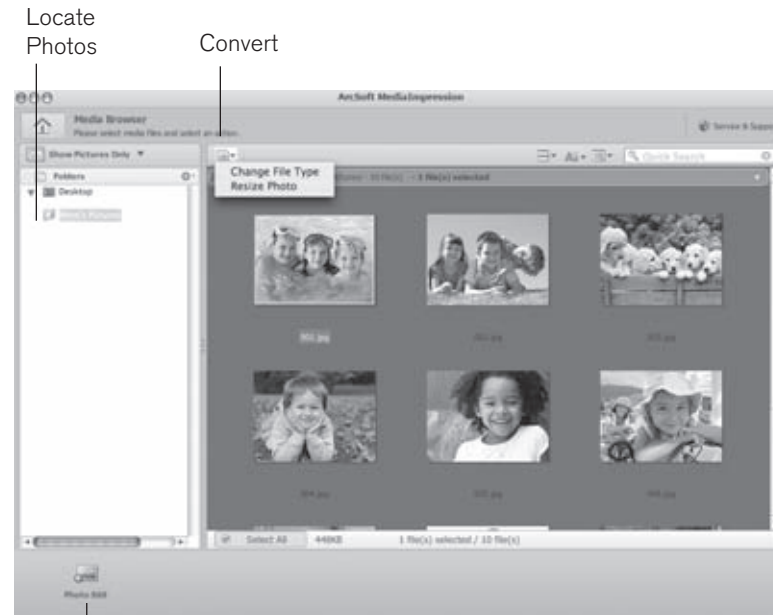
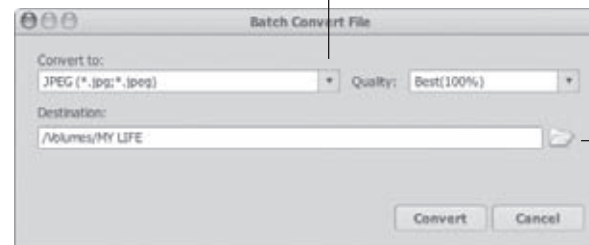
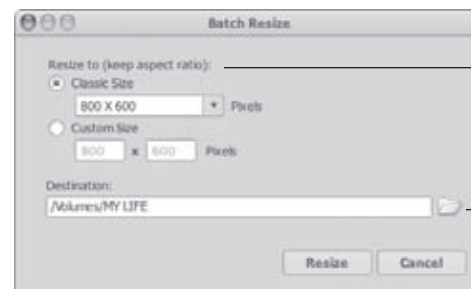

Photo Edit

Convert: To convert files to correct format for frame.



Destination (Browse):
To choose destination of converted files. Choose the frame drive to load files onto the frame.



Resize:
Choose size.

Destination (Browse):
To choose destination of resized files. Choose the frame drive to load files onto the frame.

See detailed instructions on how to use the Medialmpression™ software on page 13.

HOW TO... IT'S EASY!

CLOCK & SETTINGS

I WANT TO...

DO THIS...

Set the Time and Date.

1. Press EXIT until you get to the Home Screen.
2. Press ◀ and ▶ to highlight CLOCK & SETTINGS.
3. Press SELECT if no media is loaded on the frame, or press MENU if media is loaded on the frame.
4. "Set Time and Date" menu selection will appear.
5. Press SELECT. Clock and Calendar area becomes active and Time is highlighted.
6. Press ▲ or ▼ to select time.
7. Press ▶ to highlight AM/PM.
8. Press ▲ or ▼ to select AM or PM.
9. Press ▶ to highlight Year.
10. Press ▲ or ▼ to select Year.
11. Press ▶ to highlight Day.
12. Press ▲ or ▼ to select Day.
13. Press ▶ to highlight Month.
14. Press ▲ or ▼ to select Month.
15. Press EXIT to exit time/date set and save selections.

Select the Brightness Level.

1. When in Clock mode press MENU.
2. Press ▶ to go to the "Brightness Level" menu selection.
3. Press ▲ or ▼ to highlight choice.
4. Press SELECT to save choice. Selection will appear in blue at the top of the list.
5. Press EXIT to exit menu.

SPECIFICATIONS

Key Features: 10" TFT LCD Screen,
512MB Internal Memory,
USB Mass Storage,
800 x 600 Screen Resolution

Compatible Memory Cards*: SD® and Mini SD™ (Secure Digital™),
MMC® (MultiMedia Card), MS, MS
PRO, MS Duo (with adapter), MS PRO
Duo (with adapter) (Memory Stick®)

Power Supply: AC Adapter (included)

Compatible Software: Windows® 2000/XP/Vista®,
Mac® OS X 10.4 and later

*Cards must have a minimum of 64MB.

CARE AND MAINTENANCE

1. Clean frame with a soft, dry, clean cloth.
2. If the LCD screen needs additional cleaning, power off and unplug frame and clean LCD screen with a soft, clean cloth and an LCD screen cleaning solution.

COMPATIBLE FILE FORMATS

PHOTO

- JPEG

VIDEO

- AVI (MPEG 1/2/4, MJPEG)
- MPG (MPEG 1, MPEG 2)
- MP4 (MPEG 4)
- MOV (MJPEG)

Video audio compatibility: AAC or MP3

MUSIC

- MP3

Windows and Vista are registered trademarks of Microsoft Corporation.
Mac is a registered trademark of Apple, Inc. SD is a trademark of Toshiba Corporation.
MMC is a trademark of MultiMedia Card Associates. Memory Stick is a registered
trademark of Sony Corporation. ArcSoft MediaImpression is a trademark of ArcSoft, Inc.

SCREEN PROMPTS (continued)

IF YOU SEE...

IT MEANS...



The frame's internal memory is full. Files cannot be copied to the frame until some files are deleted.



The Quick Access Slide Show button has been pressed and there are no photo files on the frame or on the media inserted into the frame.



The Quick Access Video button has been pressed and there are no video files on the frame or on the media inserted into the frame.



The Quick Access Music button has been pressed and there are no music files on the frame or on the media inserted into the frame.

CLOCK & SETTINGS (continued)

I WANT TO...

DO THIS...

Activate the Power Save feature.

1. When in Clock mode press MENU.
2. Press **▶** to go to the "Power Save" menu selection.
3. Press **▲** or **▼** to highlight choice.
4. Press SELECT to save choice. Selection will appear in blue at the top of the list.
5. Press EXIT to exit menu.

Display Time and Date in a Full Screen Slide Show.

1. Press EXIT until you get to the Home Screen.
2. Press **◀** and **▶** to highlight CLOCK & SETTINGS.
3. Press SELECT if no media is loaded on the frame, or press MENU if media is loaded on the frame.
4. Press **▶** to go to the "Time/Date Display" menu selection.
5. Press **▲** or **▼** to highlight "With Photo."
6. Press SELECT to save choice. Selection will appear in blue at the top of the list.
7. Press EXIT to exit menu. Display will show Time and Date in a Full Screen Slide Show.

NOTE: Photos will be shown with Normal Slide Show transition when in Clock mode.

Display Time and Date in a Multi Show.

1. Press EXIT until you get to the Home Screen.
2. Press **◀** and **▶** to highlight CLOCK & SETTINGS.
3. Press SELECT if no media is loaded on the frame, or press MENU if media is loaded on the frame.
4. Press **▶** to go to the "Time/Date Display" menu selection.
5. Press **▲** or **▼** to highlight "With Multi Show."
6. Press SELECT to save choice. Selection will appear in blue at the top of the list.
7. Press EXIT to exit menu. Display will show Time and Date in a Multi Show.

Note: Photo features such as Photo Smooth, Face Zoom and Dynamic Lighting are not available in Clock mode.

PHOTOS

I WANT TO...

View my photos in Full Screen.

DO THIS...

1. Press EXIT until you get to the Home Screen.
2. Press ◀ or ▶ to highlight PHOTOS.
3. Press SELECT. Unit will be in Thumbnail mode.
4. Search for photo and highlight selection by pressing ▲, ▼, ◀ or ▶.
5. With chosen photo highlighted, press SELECT.
6. Press ◀ and ▶ to scroll through photos in Full Screen.

View my photos in Thumbnail.

1. Press EXIT until you get to the Home Screen.
2. Press ◀ and ▶ to highlight PHOTOS.
3. Press SELECT.
4. Press ▲, ▼, ◀ or ▶ to scroll though photos in thumbnail mode.

QUICK ACCESS

Copy my photos onto the frame from my memory card or flash drive.

COPY SINGLE PHOTO

1. Insert your memory card or flash drive into the frame.
2. Press ◀ or ▶ to highlight PHOTOS.
3. Press SELECT.
4. Select photo to copy in either Full Screen or Thumbnail mode.
5. Press COPY.
6. Prompt will come on screen to confirm photo to be copied.
7. Press COPY to confirm.

COPY ALL PHOTOS

1. Insert your memory card or flash drive into the frame.
2. Press ◀ or ▶ to highlight PHOTOS.
3. Press SELECT.
4. When in either Full Screen or Thumbnail mode, press and hold COPY button for 2 seconds.
5. Prompt will come on screen to confirm all photos to be copied.
6. Press COPY to confirm.

ADVANCED

Copy my photos onto the frame from my memory card or flash drive.

COPY SELECTED PHOTOS

1. Insert your memory card or flash drive into the frame.
2. Press ◀ or ▶ to highlight PHOTOS.

SCREEN PROMPTS

Screen Prompts are messages you may see on the frame's screen. The following are examples of what you might see, with a brief explanation.

IF YOU SEE...

IT MEANS...

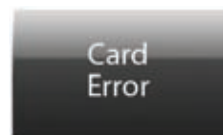

The media inserted into the frame is either incompatible with the frame or is corrupt.

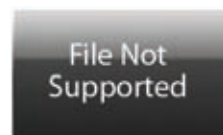

The file is incompatible with the frame.



The photo is either incompatible with the frame or is corrupt.



The media inserted into the frame contains no files or contains files that are incompatible with the frame.

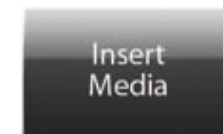

The Copy button has been pressed when there is no media inserted in the frame.



A button has been pressed for a function that is not available in the frame's current state.

MUSIC (continued)

I WANT TO...

Delete songs from the frame (ADVANCED continued).

DO THIS...

DELETE ALL SONGS

1. Remove the memory card or flash drive from the frame.
2. Press ◀ or ▶ to highlight MUSIC.
3. Press SELECT.
4. Press MENU.
5. Press ▶ to go to the "Delete" menu selection.
6. Press ▲ or ▼ to highlight "Delete All."
7. Press SELECT.
8. Prompt will come on screen to confirm all songs to be deleted. Press SELECT to confirm. After all songs are deleted the unit will go to the Home Screen.

Delete songs from the frame using my computer.

1. Insert one end of a USB cable (not included) into the USB In port on the unit and the other end of the cable into your computer's USB port. The display will show "USB Connected" and an external "MyLifeFrame" drive will appear on your computer.
2. Access the "MyLifeFrame" drive.
3. Select songs to be deleted and drag them to the trash or select and press delete.
4. Empty the trash.
5. Disconnect the "MyLifeFrame" external drive from the computer properly to avoid any loss of data.

PHOTOS (continued)

I WANT TO...

ADVANCED
Copy my photos onto the frame from my memory card or flash drive (continued).

DO THIS...

3. Press SELECT.
4. Press MENU.
5. Press ▶ to go to the "Copy" menu selection.
6. Press ▲ or ▼ to highlight "Select to Copy" and then press SELECT.
7. Search for photo by pressing ▲, ▼, ◀ or ▶.
8. With chosen photo to copy highlighted, press SELECT.
9. A + graphic will appear in the lower right corner of the photo to confirm it is to be copied.
10. Repeat steps 7 and 8 to select additional photos to be copied.
11. After all photos to be copied are selected, press MENU or EXIT. The "Copy" menu will highlight.
12. Press ▲ or ▼ to highlight "Copy Selected."
13. Press SELECT. After photos are copied, the unit is in Thumbnail mode.

HELPFUL HINTS: To deselect a photo that has been selected to be copied, highlight the photo and press SELECT. The + graphic will no longer be in the lower right corner of the photo.

To select all photos on your media card or flash drive to be copied while using the "Select to Copy" function, press and hold SELECT for 2 seconds. The + graphic will appear in lower right corner of every photo.

COPY ALL PHOTOS

1. Insert your memory card or flash drive into the frame.
2. Press ◀ or ▶ to highlight PHOTOS.
3. Press SELECT.
4. Press MENU.
5. Press ▶ to go to the "Copy" menu selection.
6. Press ▲ or ▼ to highlight "Copy All"
7. Press SELECT.
8. Prompt will come on screen to confirm all photos to be copied. Press SELECT to confirm. After all photos are copied, the unit is in Thumbnail mode.

PHOTOS (continued)

I WANT TO...



Copy my photos onto the frame using my computer. (See page 8 for Medialmpression™ controls locations.)

DO THIS...

1. Ensure Medialmpression™ software (included) is installed on your computer. See page 7 for installation instructions.
2. Insert one end of a USB cable (not included) into the USB In port on the unit and the other end of the cable into your computer's USB port. The frame display will show "USB Connected" and an external "MyLifeFrame" drive will appear on your computer.
3. Open Medialmpression™ software.
4. Use "Folders" window to select location to find photos to put on frame. Photos will appear as thumbnails.
5. Click on photos to be copied/resized or click on Select All to select all photos.
6. Click on the Convert icon and select "Resize Photo" from the drop-down menu.
7. A window will appear to choose file size and destination for copied/resized photos. Choose "Classic Size" of 800 x 600.
8. Click on the Browse icon to choose the frame's external drive as the destination for the copied/resized photos.
9. Click on "Resize." Photos will be resized and saved onto frame.
10. Disconnect the "MyLifeFrame" external drive from the computer properly to avoid any loss of data.

HELPFUL HINTS: Use the Photo Edit feature to rotate your photos.

Play Slide Show.

Press . If you are in a menu selection screen, press EXIT then .

Stop Slide Show.

While Slide Show is playing, press  and the Slide Show will stop and the unit will revert to Full Screen mode. Or, press EXIT and the Slide Show will stop and the unit will go into Thumbnail mode.













MUSIC (continued)

I WANT TO...

ADVANCED
Delete songs from the frame.

DO THIS...

DELETE SELECTED SONGS

1. Remove your memory card or flash drive from the frame.
2. Press  or  to highlight MUSIC.
3. Press SELECT.
4. Press MENU.
5. Press  to go to the "Delete" menu selection.
6. Press  or  to highlight "Select to Delete" and then press SELECT.
7. Search for song and highlight selection by pressing , ,  or .
8. With chosen song to delete highlighted, press SELECT.
9. An  graphic will appear to the right of the song name to confirm it is to be deleted. Repeat steps 7 and 8 to select additional songs to be deleted.
10. After all songs to be deleted are selected, press MENU or EXIT. The "Delete" menu will highlight.
11. Press  or  to highlight "Delete Selected."
12. Press SELECT. After songs are deleted, the unit will revert to Music List mode.

HELPFUL HINTS: To deselect a song that has been selected to be deleted, highlight the song and press SELECT. The  graphic will no longer be to the right of the song name.

To select all songs on the frame to be deleted while using the "Select to Delete" function, press and hold SELECT for 2 seconds. The  graphic will appear to the right of the song name of every song.

MUSIC (continued)

I WANT TO...

DO THIS...

Select music playback.

1. When in Music List mode, press MENU.
2. "Playback" menu selection will appear.
3. Press ▲ or ▼ to highlight choice.
4. Press SELECT to save choice. Selection will appear in blue at the top of the list.
5. Press EXIT to exit menu.

Arrange my songs in a specific order.

1. The frame automatically arranges songs by file name numerically, then alphabetically.
2. For example, a song with the file name "01.mp3" will come before a song with the file name "a.mp3."
3. Using your computer, rename your song files numerically or alphabetically and copy the songs onto the frame.

HELPFUL HINTS: If ordering songs numerically, be sure to start with "01", "02", etc... not "1", "2", as "10" will come before "2."

QUICK ACCESS

Delete songs from the frame.

DELETE SINGLE SONG

1. Remove your memory card or flash drive from the frame.
2. Press ◀ or ▶ to highlight MUSIC.
3. Press SELECT.
4. Select song to delete in Music List mode.
5. Press DELETE.
6. Prompt will come on screen to confirm song to be deleted. Press DELETE to confirm.

DELETE ALL SONGS

1. Remove your memory card or flash drive from the frame.
2. When in Music List mode, press and hold DELETE button for 2 seconds.
3. Prompt will come on screen to confirm all songs to be deleted. Press DELETE to confirm. After all songs are deleted the unit will go to the Home Screen.

PHOTOS (continued)

I WANT TO...

DO THIS...

Select Slide Show time.

1. When in either Full Screen or Thumbnail mode, press MENU.
2. "Slide Show Time" menu selection will appear.
3. Press ▲ or ▼ to highlight choice.
4. Press SELECT to save choice. Selection will appear in blue at the top of the list.
5. Press EXIT to exit menu.

Select Slide Show Transition.

1. When in either Full Screen or Thumbnail mode, press MENU.
2. Press ▶ to go to the "Slide Show Transition" menu selection.
3. Press ▲ or ▼ to highlight choice.
4. Press SELECT to save choice. Selection will appear in blue at the top of the list.
5. Press EXIT to exit menu.

Select Slide Show Photo Order.

1. When in either Full Screen or Thumbnail mode, press MENU.
2. Press ▶ to go to the "Slide Show Photo Order" menu selection.
3. Press ▲ or ▼ to highlight choice.
4. Press SELECT to save choice. Selection will appear in blue at the top of the list.
5. Press EXIT to exit menu.

Activate Face Zoom Feature.

1. When in either Full Screen or Thumbnail mode, press MENU.
2. Press ▶ to go to the "Face Zoom" menu selection.
3. Press ▲ or ▼ to highlight "On".
4. Press SELECT to save choice. Selection will appear in blue at the top of the list.
5. Press EXIT to exit menu.

PHOTOS (continued)

I WANT TO...

DO THIS...

Activate Photo Smooth Feature.

1. When in either Full Screen or Thumbnail mode, press MENU.
2. Press **▶** to go to the "Photo Smooth" menu selection.
3. Press **▲** or **▼** to highlight "On".
4. Press SELECT to save choice. Selection will appear in blue at the top of the list.
5. Press EXIT to exit menu.

Activate Dynamic Lighting Feature.

1. When in either Full Screen or Thumbnail mode, press MENU.
2. Press **▶** to go to the "Dynamic Lighting" menu selection.
3. Press **▲** or **▼** to highlight "On".
4. Press SELECT to save choice. Selection will appear in blue at the top of the list.
5. Press EXIT to exit menu.

Rotate photo.

1. When in Full Screen mode, press **◀** or **▶** to select photo to rotate.
2. Press ROTATE. Photo will rotate 90 degrees.
3. Press ROTATE again to rotate photo another 90 degrees. Photo will be saved in rotated position when on internal memory only.

Arrange my photos in a specific order.

1. The frame automatically arranges photos by file name numerically, then alphabetically.
2. For example, a photo with the file name "01.jpg" will come before a photo with the file name "a.jpg."
3. Using your computer, rename your photo files numerically or alphabetically and copy the photos onto the frame.

HELPFUL HINTS: If ordering photos numerically, be sure to start with "01", "02", etc... not "1", "2", as "10" will come before "2."

MUSIC (continued)

I WANT TO...

DO THIS...

Copy my music onto the frame from my memory card or flash drive (ADVANCED continued).

COPY ALL SONGS

1. Insert your memory card or flash drive into the frame.
2. Press **◀** or **▶** to highlight MUSIC.
3. Press SELECT.
4. Press MENU.
5. Press **▶** to go to the "Copy" menu selection.
6. Press **▲** or **▼** to highlight "Copy All."
7. Press SELECT.
8. Prompt will come on screen to confirm all songs to be copied. Press SELECT to confirm. After all songs are copied, the unit is in Music List mode.

Copy my songs onto the frame using my computer.

1. Insert one end of a USB cable (not included) into the USB In port on the unit and the other end of the cable into your computer's USB port. The frame display will show "USB Connected" and an external "MyLifeFrame" drive will appear on your computer.
2. Drag and drop music files from your computer to the "MyLifeFrame" external drive.
3. Disconnect the "MyLifeFrame" external drive from the computer properly to avoid any loss of data.

MUSIC (continued)

I WANT TO...

ADVANCED

Copy my music onto the frame from my memory card or flash drive.

DO THIS...

COPY SELECTED SONGS

1. Insert your memory card or flash drive into the frame.
2. Press ◀ or ▶ to highlight MUSIC.
3. Press SELECT.
4. Press MENU.
5. Press ▶ to go to the "Copy" menu selection.
6. Press ▲ or ▼ to highlight "Select to Copy" and then press SELECT.
7. Search for song and highlight selection by pressing ▲, ▼, ◀ or ▶.
8. With chosen song to copy highlighted, press SELECT.
9. An + graphic will appear to the right of the song name to confirm it is to be copied. Repeat steps 7 and 8 to select additional songs to be copied.
10. After all songs to be copied are selected, press MENU or EXIT. The "Copy" menu will appear.
11. Press ▲ or ▼ to highlight "Copy Selected"
12. Press SELECT. After songs are copied, the unit is in Music List mode.

HELPFUL HINTS: To deselect a song that has been selected to be copied, highlight the song and press SELECT. The + graphic will no longer be to the right of the song name.

To select all songs on your media card or flash drive to be copied while using the "Select to Copy" function, press and hold SELECT for 2 seconds. The + graphic will appear to the right of the song name of every song.

PHOTOS (continued)

I WANT TO...

QUICK ACCESS

Delete photos from the frame.

DO THIS...

DELETE SINGLE PHOTO

1. Remove your memory card or flash drive from the frame.
2. Press ◀ or ▶ to highlight PHOTOS.
3. Press SELECT.
4. Select photo to delete in either Full Screen or Thumbnail mode.
5. Press DELETE.
6. Prompt will come on screen to confirm photo to be deleted. Press DELETE to confirm.

DELETE ALL PHOTOS

1. Remove your memory card or flash drive from the frame.
2. Press ◀ or ▶ to highlight PHOTOS.
3. Press SELECT.
4. When in either Full Screen or Thumbnail mode, press and hold DELETE button for 2 seconds.
5. Prompt will come on screen to confirm all photos to be deleted. Press DELETE to confirm. After all photos are deleted the unit will go to the Home Screen.

PHOTOS (continued)

I WANT TO...

ADVANCED

Delete photos from the frame.

DO THIS...

DELETE SELECTED PHOTOS

1. Remove your memory card or flash drive from the frame.
2. Press ◀ or ▶ to highlight PHOTOS.
3. Press SELECT.
4. Press MENU.
5. Press ▶ to go to the "Delete" menu selection and then press SELECT.
6. Press ▲ or ▼ to highlight "Select to Delete."
7. Search for photo and highlight selection by pressing ▲, ▼, ◀ or ▶.
8. With chosen photo to delete highlighted, press SELECT.
9. An ✕ graphic will appear in the lower right corner of the photo to confirm it is to be deleted. Repeat steps 7 and 8 to select additional photos to be deleted.
10. After all photos to be deleted are selected, press MENU or EXIT. The "Delete" menu will highlight.
11. Press ▲ or ▼ to highlight "Delete Selected" in menu.
12. Press SELECT. After photos are deleted, the unit will revert to Thumbnail mode.

HELPFUL HINTS: To deselect a photo that has been selected to be deleted, highlight the photo and press SELECT. The ✕ graphic will no longer be in the lower right corner of the photo.

To select all photos on the frame to be deleted while using the "Select to Delete" function, press and hold SELECT for 2 seconds. The ✕ graphic will appear in the lower right corner of every photo.

DELETE ALL PHOTOS

1. Remove your memory card or flash drive from the frame.
2. Press ◀ or ▶ to highlight PHOTOS.
3. Press SELECT.
4. Press MENU.
5. Press ▶ to go to the "Delete" menu selection.
6. Press ▲ or ▼ to highlight "Delete All."
7. Press SELECT.
8. Prompt will come on screen to confirm all photos to be deleted. Press SELECT to confirm. After all photos are deleted the unit will go to the Home Screen.

MUSIC (continued)

I WANT TO...

QUICK ACCESS

Copy my music onto the frame from my memory card or flash drive.

DO THIS...

COPY SINGLE SONG

1. Insert your memory card or flash drive into the frame.
2. Press ◀ or ▶ to highlight MUSIC.
3. Press SELECT.
4. Select song to copy in Music List mode.
5. Press COPY.
6. Prompt will come on screen to confirm music to be copied. Press COPY to confirm.

COPY ALL SONGS



1. Insert your memory card or flash drive into the frame.
2. Press ◀ or ▶ to highlight MUSIC.
3. Press SELECT.
4. When in Music List mode, press and hold COPY button for 2 seconds.
5. Prompt will come on screen to confirm all songs to be copied. Press COPY to confirm.

MUSIC

I WANT TO...

DO THIS...





Play Music.

Press . If you are in a menu selection screen, press EXIT then .







Stop Music.

While music is playing, press  to stop music, or EXIT to go to the music list.

View my Music List.

1. Press EXIT until you get to the Home Screen.
2. Press  and  to highlight MUSIC.
3. Press SELECT.
4. Press  and  to scroll through songs.
5. With chosen song highlighted, press SELECT.
6. Song will start playing.

Play music with my Slide Show.

1. When in Music List mode press MENU.
2. Press  to go to the "Slide Show Music" menu selection.
3. Press  and  to highlight "On".
4. Press SELECT to save choice. Selection will appear in blue at the top of the list.
5. Press EXIT to exit Menu.
6. Press .
7. Press the  and  buttons during the Slide Show to change songs.

PHOTOS (continued)

I WANT TO...

DO THIS...

Delete photos from the frame using my computer.

1. Insert one end of a USB cable (not included) into the USB In port on the unit and the other end of the cable into your computer's USB port. The display will show "USB Connected" and an external "MyLifeFrame" will appear on your computer.
2. Access the "MyLifeFrame" drive.
3. Select photos to be deleted and drag them to the trash, or select and press delete.
4. Empty the trash.
5. Disconnect the "MyLifeFrame" external drive from the computer properly to avoid any loss of data.

Convert my photo files to JPEG.

1. Ensure Medialmpression™ software (included) is installed on your computer. See page 7 for installation instructions.
2. Open Medialmpression™ software.
3. Use "Folders" window to select photos to convert to JPEG. Photos will appear as thumbnails.
4. Click on photos to be converted or click on Select All to select all photos.
5. Click on the Convert icon and select "Change File Type" from the drop down menu.
6. A window will appear to choose the Convert To file type and destination for converted photos. Choose "JPEG" and click on the Browse icon to choose the destination for the converted photos.
7. Click on "Convert." Photos will be converted to JPEG.



Note: Converting photo files to JPEG will leave them at their original size. To optimize your photos for the frame's screen resolution, use the Medialmpression™ software to resize your photos (see page 13).

VIDEO

I WANT TO...

DO THIS...









Play Videos.

Press . If you are in a menu selection screen, press EXIT and then .







Stop Video.

While video is playing, press  to stop the video, or press EXIT to go to the Thumbnail screen.

View my videos in Full Screen.

1. Press EXIT until you get to the Home Screen.
2. Press  and  to highlight VIDEOS.
3. Press SELECT. Unit will be in Thumbnail mode.
4. Search for video and highlight selection by pressing , ,  or .
5. With chosen video highlighted, press SELECT.
6. Video will start playing.
7. Press  and  to scroll through videos in Full Screen.



View my videos in Thumbnail.

1. Press EXIT until you get to the Home Screen.
2. Press  and  to highlight VIDEOS.
3. Press SELECT.
4. Press , ,  or  to scroll through videos.



QUICK ACCESS

Copy my videos onto the frame from my memory card or flash drive.

COPY SINGLE VIDEO

1. Insert your memory card or flash drive into the frame.
2. Press  or  to highlight VIDEOS.
3. Press SELECT.
4. Select video to copy in Thumbnail mode.
5. Press COPY.
6. Prompt will come on screen to confirm video to be copied. Press COPY to confirm.

COPY ALL VIDEOS

1. Insert your memory card or flash drive into the frame.
2. Press  or  to highlight VIDEOS.
3. Press SELECT.
4. When in Thumbnail mode press and hold COPY button for 2 seconds.
5. Prompt will come on screen to confirm all videos to be copied. Press COPY to confirm.





VIDEO (continued)

I WANT TO...

DO THIS...

Delete videos from the frame (ADVANCED continued).

DELETE ALL VIDEOS

1. Remove the memory card or flash drive from the frame.
2. Press  or  to highlight VIDEOS.
3. Press SELECT.
4. Press MENU.
5. Press  to go to the "Delete" menu selection.
6. Press  or  to highlight "Delete All."
7. Press SELECT.
8. Prompt will come on screen to confirm all videos to be deleted. Press SELECT to confirm. After all videos are deleted the unit will go to the Home Screen.

Delete videos from the frame using my computer.

1. Insert one end of a USB cable (not included) into the USB In port on the unit and the other end of the cable into your computer's USB port. The display will show "USB Connected" and an external "MyLifeFrame" will appear on your computer.
2. Access the "MyLifeFrame" drive.
3. Select videos to be deleted and drag them to the trash or select and press delete.
4. Empty the trash.
5. Disconnect the "MyLifeFrame" external drive from the computer properly to avoid any loss of data.

VIDEO (continued)

I WANT TO...

ADVANCED

Delete videos from the frame.

DO THIS...

DELETE SELECTED VIDEOS

1. Remove the memory card or flash drive from the frame.
2. Press ◀ or ▶ to highlight VIDEOS.
3. Press SELECT.
4. Press MENU.
5. Press ▶ to go to the "Delete" menu selection.
6. Press ▲ or ▼ to highlight "Select to Delete" and then press SELECT.
7. Search for video and highlight selection by pressing ▲, ▼, ◀ or ▶.
8. With chosen video to delete highlighted, press SELECT.
9. An ✕ graphic will appear in the lower right corner of the video to confirm it is to be deleted. Repeat steps 7 and 8 to select additional videos to be deleted.
10. After all videos to be deleted are selected, press MENU or EXIT. The "Delete" menu will appear.
11. Press ▲ or ▼ to highlight "Delete Selected."
12. Press SELECT. After videos are deleted, the unit is in Thumbnail mode.

HELPFUL HINTS: To deselect a video that has been selected to be deleted, highlight the video and press SELECT. The ✕ graphic will no longer be in the lower right corner of the video.

To select all videos on the frame to be deleted while using the "Select to Delete" function, press and hold SELECT for 2 seconds. The ✕ graphic will appear in the lower right corner of every video.

VIDEO (continued)

I WANT TO...

ADVANCED

Copy my videos onto the frame from my memory card or flash drive (continued).

DO THIS...

COPY SELECTED VIDEOS

1. Insert your memory card or flash drive into the frame.
2. Press ◀ or ▶ to highlight VIDEOS.
3. Press SELECT.
4. Press MENU.
5. Press ▶ to go to the "Copy" menu selection.
6. Press ▲ or ▼ to highlight "Select to Copy" and then press SELECT.
7. Search for video and highlight selection by pressing ▲, ▼, ◀ or ▶.
8. With chosen video to copy highlighted, press SELECT.
9. A + graphic will appear in the lower right corner of the video to confirm it is to be copied. Repeat steps 7 and 8 to select additional videos to be copied.
10. After all videos to be copied are selected, press MENU or EXIT. The "Copy" menu will highlight.
11. Press ▲ or ▼ to highlight "Copy Selected."
12. Press SELECT. After videos are copied, the unit is in Thumbnail mode.

HELPFUL HINTS: To deselect a video that has been selected to be copied, highlight the video and press SELECT. The + graphic will no longer be in the lower right corner of the video.

To select all videos on your media card or flash drive to be copied while using the "Select to Copy" function, press and hold SELECT for 2 seconds. The + graphic will appear in lower right corner of every video.

VIDEO (continued)

I WANT TO...

DO THIS...

ADVANCED

Copy my videos onto the frame from my memory card or flash drive (continued).

COPY ALL VIDEOS

1. Insert your memory card or flash drive into the frame.
2. Press ◀ or ▶ to highlight VIDEOS.
3. Press SELECT.
4. When in either Full Screen or Thumbnail mode, press MENU.
5. Press ▶ to go to the "Copy" menu selection.
6. Press ▲ or ▼ to highlight "Copy All."
7. Press SELECT.
8. Prompt will come on screen to confirm all videos to be copied. Press SELECT to confirm. After all videos are copied, the unit is in Thumbnail mode.

Copy my videos onto the frame using my computer.

1. Insert one end of a USB cable (not included) into the USB In port on the unit and the other end of the cable into your computer's USB port. The frame display will show "USB Connected" and an external "MyLifeFrame" drive will appear on your computer.
2. Drag and drop video files from your computer to the "MyLifeFrame" external drive.
3. Disconnect the "MyLifeFrame" external drive from the computer properly to avoid any loss of data.

Select Video playback.

1. When in either Full Screen or Thumbnail mode, press MENU.
2. "Playback" menu selection will appear.
3. Press ▲ or ▼ to highlight choice.
4. Press SELECT to save choice. Selection will appear in blue at the top of the list.
5. Press EXIT to exit menu.

VIDEO (continued)

I WANT TO...

DO THIS...

Arrange my videos in a specific order.

1. The frame automatically arranges videos by file name numerically, then alphabetically.
2. For example, a video with the file name "01.mpg" will come before a video with the file name "a.mpg."
3. Using your computer, rename your video files numerically or alphabetically and copy the videos onto the frame.

HELPFUL HINTS: If ordering videos numerically, be sure to start with "01", "02", etc... not "1", "2", as "10" will come before "2."

QUICK ACCESS

Delete videos from the frame.

DELETE SINGLE VIDEO

1. Remove your memory card or flash drive from the frame.
2. Press ◀ or ▶ to highlight VIDEOS.
3. Press SELECT.
4. Select video to delete in Thumbnail mode.
5. Press DELETE.
6. Prompt will come on screen to confirm video to be deleted. Press DELETE to confirm.

DELETE ALL VIDEOS

1. Remove your memory card or flash drive from the frame.
2. Press ◀ or ▶ to highlight VIDEOS.
3. Press SELECT.
4. When in Thumbnail mode, press and hold DELETE button for 2 seconds.
5. Prompt will come on screen to confirm all videos to be deleted. Press DELETE to confirm. After all videos are deleted the unit will go to the Home Screen.

Changes or modifications not expressly approved by the party responsible for compliance could void the user's authority to operate the equipment.

This equipment has been tested and found to comply with the limits for a Class B digital device, pursuant to Part 15 of the FCC Rules. These limits are designed to provide reasonable protection against harmful interference in a residential installation. This equipment generates uses and can radiate radio frequency energy and, if not installed and used in accordance with the instructions, may cause harmful interference to radio communications. However, there is no guarantee that interference will not occur in a particular installation. If this equipment does cause harmful interference to radio or television reception, which can be determined by turning the equipment off and on, the user is encouraged to try to correct the interference by one or more of the following measures:

- Reorient or relocate the receiving antenna.
- Increase the separation between the equipment and receiver.
- Connect the equipment into an outlet on a circuit different from that to which the receiver is connected.
- Consult the dealer or an experienced radio/TV technician for help