

SAR Test Plots

- Verification SAR Plots
- SAR Test Plots

DT&C Co., Ltd.

DUT: Dipole 2450 MHz; Type: D2450V2; Serial: D2450V2 - SN:920

Communication System: UID 0, CW (0); Frequency: 2450 MHz; Duty Cycle: 1:1
Medium parameters used: $f = 2450$ MHz; $\sigma = 1.818$ S/m; $\epsilon_r = 37.825$; $\rho = 1000$ kg/m³
Phantom section: Flat Section

DASY5 Configuration:

Probe: EX3DV4 - SN3916; ConvF(7.66, 7.66, 7.66); Calibrated: 4/25/2019; Electronics: DAE4 Sn1392
Sensor-Surface: 2mm (Mechanical Surface Detection)
Phantom: SAM with CRP_2013_10_08_right; Type: QD000P40CD; Serial: TP:1785
Measurement SW: DASY52, Version 52.8 (8); SEMCAD X Version 14.6.10 (7331)

Test Date: 2019-07-29; Ambient Temp: 20.4; Tissue Temp: 21.0

2450 MHz System Verification (100 mW)

Area Scan (6x8x1): Measurement grid: dx=12mm, dy=12mm

Zoom Scan (7x7x7)/Cube 0: Measurement grid: dx=5mm, dy=5mm, dz=5mm

Power Drift = -0.09 dB

Peak SAR (extrapolated) = 10.8 W/kg

SAR(1 g) = 5.1 W/kg; SAR(10 g) = 2.33 W/kg

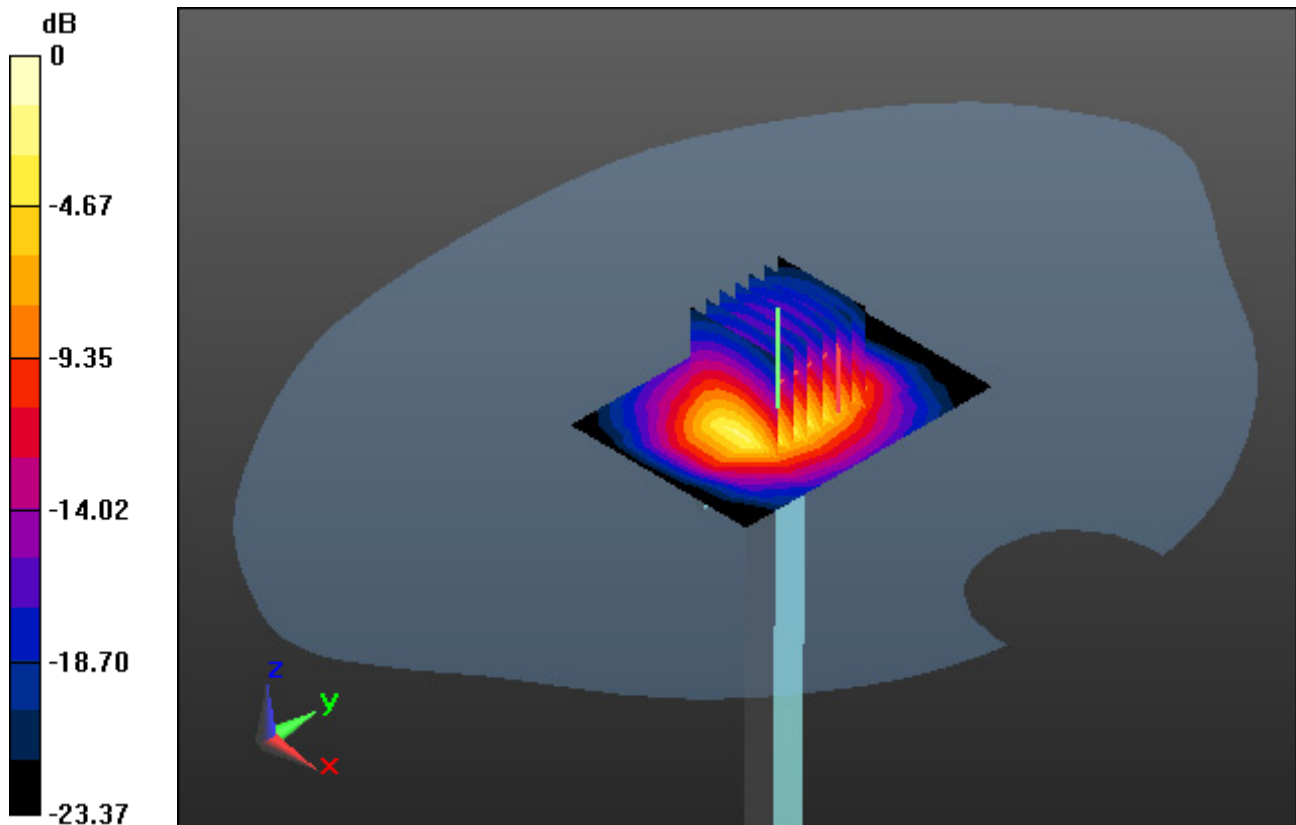

0 dB = 7.82 W/kg

DT&C Co., Ltd.

DUT: Dipole 2450 MHz; Type: D2450V2; Serial: D2450V2 - SN:920

Communication System: UID 0, CW; Frequency: 2450 MHz; Duty Cycle: 1:1
Medium parameters used: $f = 2450$ MHz; $\sigma = 1.821$ S/m; $\epsilon_r = 38.35$; $\rho = 1000$ kg/m³
Phantom section: Flat Section

DASY5 Configuration:

Probe: EX3DV4 - SN3916; ConvF(7.66, 7.66, 7.66); Calibrated: 4/25/2019; Electronics: DAE4 Sn1392
Sensor-Surface: 2mm (Mechanical Surface Detection)
Phantom: SAM with CRP_2013_10_08_right; Type: QD000P40CD; Serial: TP:1785
Measurement SW: DASY52, Version 52.8 (8); SEMCAD X Version 14.6.10 (7331)

Test Date: 2019-07-30; Ambient Temp: 20.8; Tissue Temp: 20.5

2450 MHz System Verification (100 mW)

Area Scan (7x9x1): Measurement grid: dx=12mm, dy=12mm

Zoom Scan (7x7x7)/Cube 0: Measurement grid: dx=5mm, dy=5mm, dz=5mm

Power Drift = -0.08 dB

Peak SAR (extrapolated) = 10.7 W/kg

SAR(1 g) = 4.98 W/kg; SAR(10 g) = 2.32 W/kg

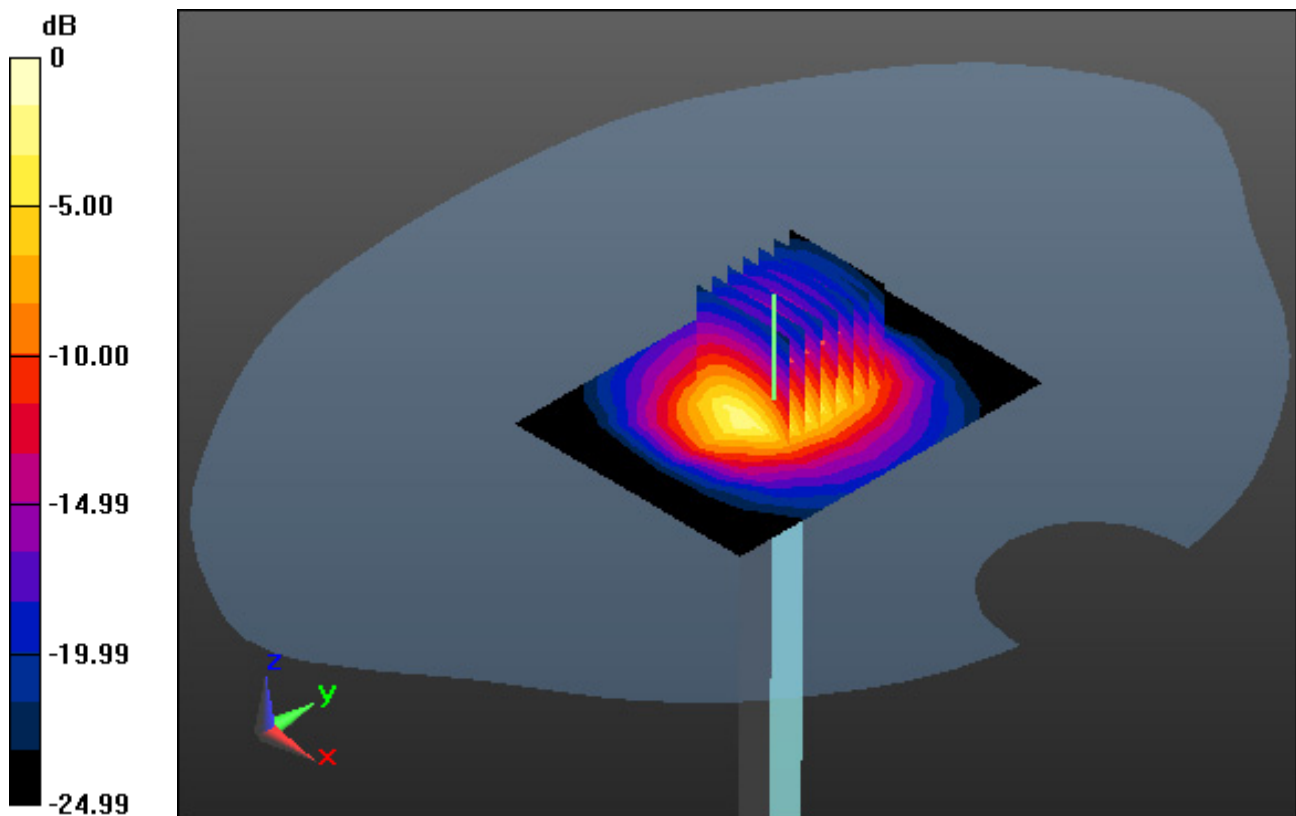

0 dB = 7.58 W/kg

DT&C Co., Ltd.

DUT: 2450 MHz Dipole; Type: D2450V2; Serial: D2450V2 - SN:920

Communication System: UID 0, CW; Frequency: 2450 MHz; Duty Cycle: 1:1
Medium parameters used: $f = 2450$ MHz; $\sigma = 1.811$ S/m; $\epsilon_r = 38.366$; $\rho = 1000$ kg/m³
Phantom section: Flat Section

DASY5 Configuration:

Probe: EX3DV4 - SN3916; ConvF(7.66, 7.66, 7.66); Calibrated: 4/25/2019; Electronics: DAE4 Sn1392
Sensor-Surface: 2mm (Mechanical Surface Detection)
Phantom: SAM with CRP_2013_10_08_right; Type: QD000P40CD; Serial: TP:1785
Measurement SW: DASY52, Version 52.8 (8); SEMCAD X Version 14.6.10 (7331)

Test Date: 2019-08-13; Ambient Temp: 20.4; Tissue Temp: 20.6

2450 MHz System Verification (100 mW)

Area Scan (7x9x1): Measurement grid: dx=12mm, dy=12mm

Zoom Scan (7x7x7)/Cube 0: Measurement grid: dx=5mm, dy=5mm, dz=5mm

Power Drift = -0.09 dB

Peak SAR (extrapolated) = 12.8 W/kg

SAR(1 g) = 5.42 W/kg; SAR(10 g) = 2.62 W/kg

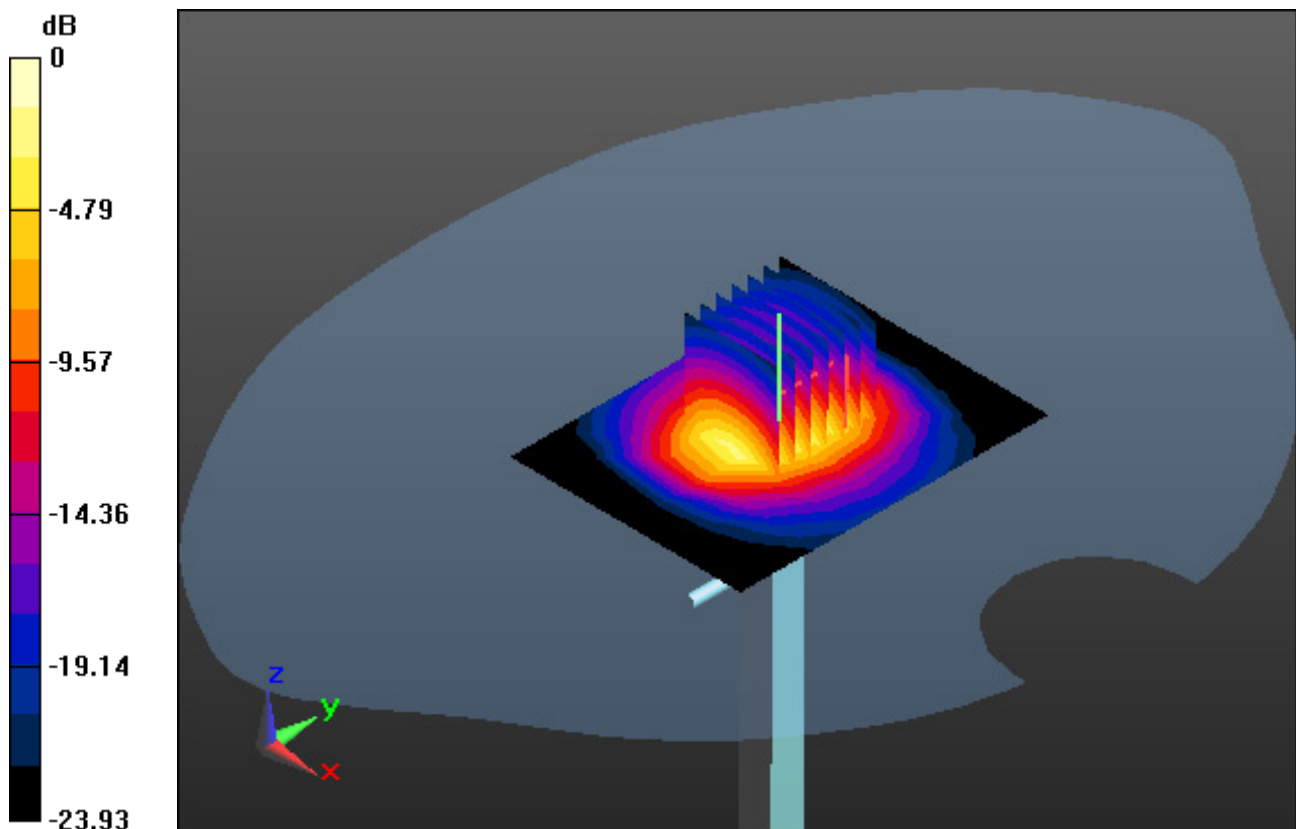

0 dB = 8.94 W/kg

DT&C Co., Ltd.

DUT: Dipole 5000 MHz; Type: D5GHzV2; Serial: D5GHzV2 - SN:1103

Communication System: UID 0, CW (0); Frequency: 5300 MHz; Duty Cycle: 1:1
Medium parameters used: $f = 5300$ MHz; $\sigma = 4.581$ S/m; $\epsilon_r = 35.133$; $\rho = 1000$ kg/m³
Phantom section: Flat Section

DASY5 Configuration:

Probe: EX3DV4 - SN3916; ConvF(4.94, 4.94, 4.94); Calibrated: 4/25/2019; Electronics: DAE4 Sn1392
Sensor-Surface: 1.4mm (Mechanical Surface Detection)
Phantom: SAM with CRP_2016_07_22_middle; Type: QD000P40CD; Serial: TP:1786
Measurement SW: DASY52, Version 52.8 (8); SEMCAD X Version 14.6.10 (7331)

Test Date: 2019-08-01; Ambient Temp: 20.5; Tissue Temp: 20.6

5300 MHz System Verification (100 mW)

Area Scan (7x10x1): Measurement grid: dx=10mm, dy=10mm

Zoom Scan (7x7x11)/Cube 0: Measurement grid: dx=4mm, dy=4mm, dz=1.4mm, Graded Ratio:1.4

Power Drift = 0.02 dB

Peak SAR (extrapolated) = 31.8 W/kg

SAR(1 g) = 8.21 W/kg; SAR(10 g) = 2.38 W/kg

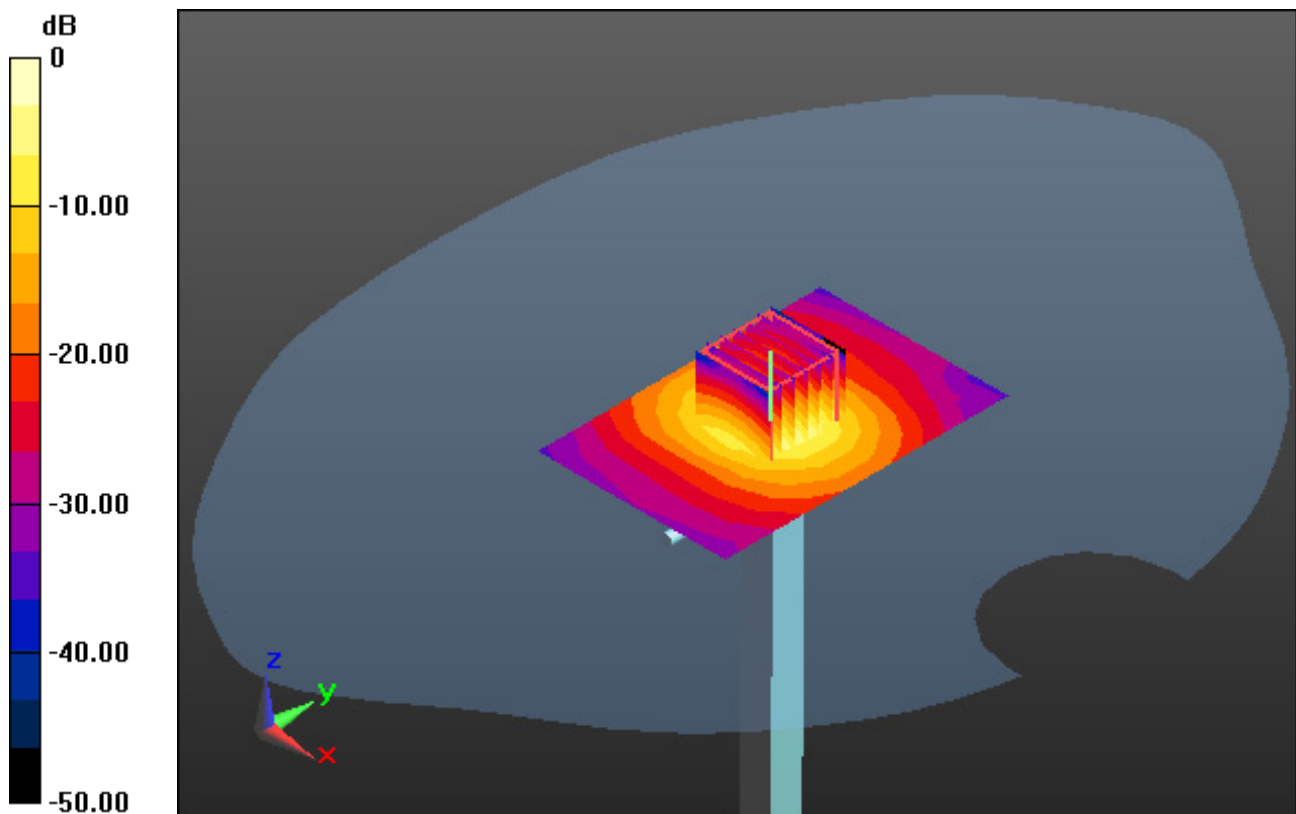

0 dB = 17.0 W/kg

DT&C Co., Ltd.

DUT: Dipole 5000 MHz; Type: D5GHzV2; Serial: D5GHzV2 - SN:1103

Communication System: UID 0, CW (0); Frequency: 5300 MHz; Duty Cycle: 1:1
Medium parameters used: $f = 5300$ MHz; $\sigma = 4.587$ S/m; $\epsilon_r = 35.437$; $\rho = 1000$ kg/m³
Phantom section: Flat Section

DASY5 Configuration:

Probe: EX3DV4 - SN3916; ConvF(4.94, 4.94, 4.94); Calibrated: 4/25/2019; Electronics: DAE4 Sn1392
Sensor-Surface: 1.4mm (Mechanical Surface Detection)
Phantom: SAM with CRP_2016_07_22_middle; Type: QD000P40CD; Serial: TP:1786
Measurement SW: DASY52, Version 52.8 (8); SEMCAD X Version 14.6.10 (7331)

Test Date: 2019-07-31; Ambient Temp: 21.0; Tissue Temp: 20.4

5300 MHz System Verification (100 mW)

Area Scan (7x7x1): Measurement grid: dx=10mm, dy=10mm

Zoom Scan (8x8x7)/Cube 0: Measurement grid: dx=4mm, dy=4mm, dz=1.4mm, Graded Ratio:1.4

Power Drift = 0.03 dB

Peak SAR (extrapolated) = 34.1 W/kg

SAR(1 g) = 8.4 W/kg; SAR(10 g) = 2.42 W/kg

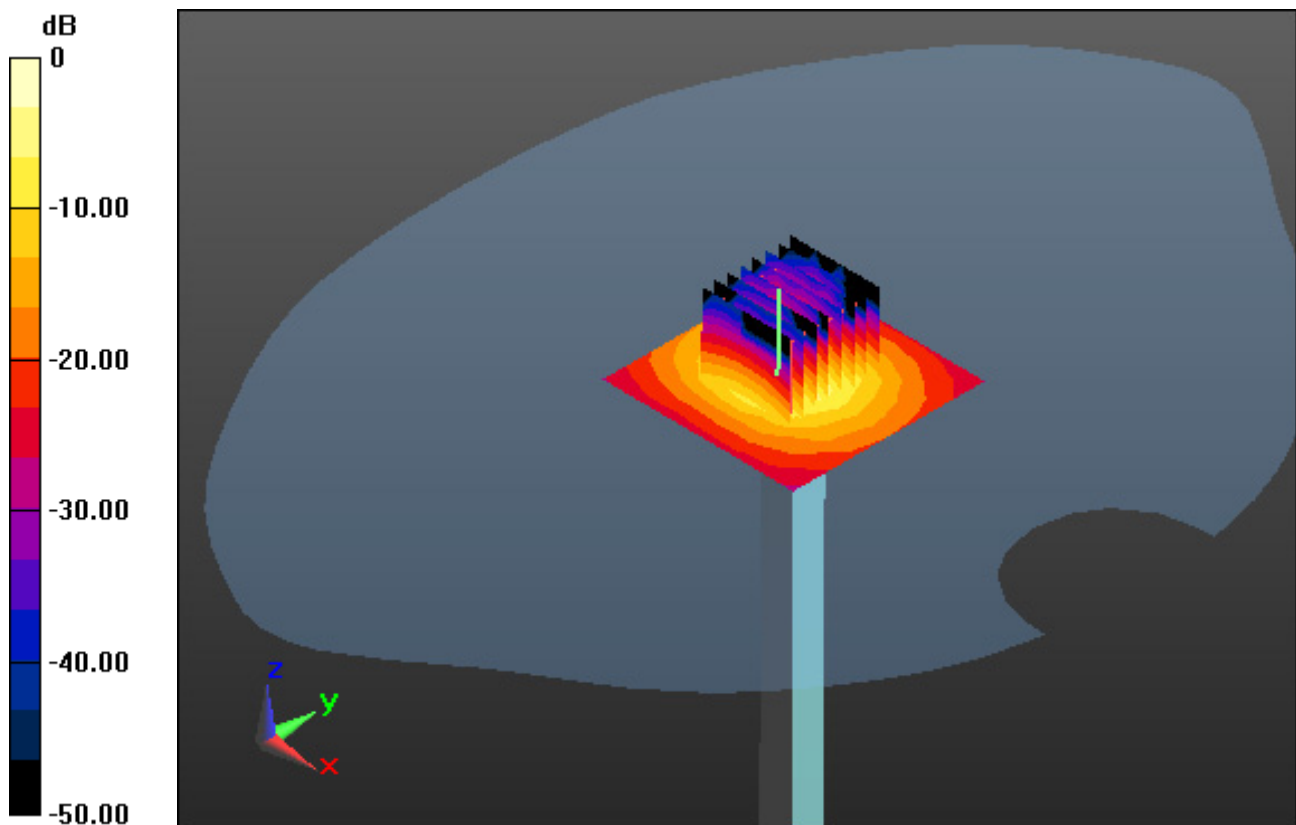

0 dB = 19.3 W/kg

DT&C Co., Ltd.

DUT: Dipole 5000 MHz; Type: D5GHzV2; Serial: D5GHzV2 - SN:1103

Communication System: UID 0, CW (0); Frequency: 5600 MHz; Duty Cycle: 1:1
Medium parameters used: $f = 5600$ MHz; $\sigma = 5.148$ S/m; $\epsilon_r = 34.855$; $\rho = 1000$ kg/m³
Phantom section: Flat Section

DASY5 Configuration:

Probe: EX3DV4 - SN3916; ConvF(4.75, 4.75, 4.75); Calibrated: 4/25/2019; Electronics: DAE4 Sn1392
Sensor-Surface: 1.4mm (Mechanical Surface Detection)
Phantom: SAM with CRP_2016_07_22_middle; Type: QD000P40CD; Serial: TP:1786
Measurement SW: DASY52, Version 52.8 (8); SEMCAD X Version 14.6.10 (7331)

Test Date: 2019-08-02; Ambient Temp: 20.6; Tissue Temp: 20.2

5600 MHz System Verification (100 mW)

Area Scan (7x10x1): Measurement grid: dx=10mm, dy=10mm

Zoom Scan (7x7x11)/Cube 0: Measurement grid: dx=4mm, dy=4mm, dz=1.4mm, Graded Ratio:1.4

Power Drift = 0.08 dB

Peak SAR (extrapolated) = 41.9 W/kg

SAR(1 g) = 8.27 W/kg; SAR(10 g) = 2.36 W/kg

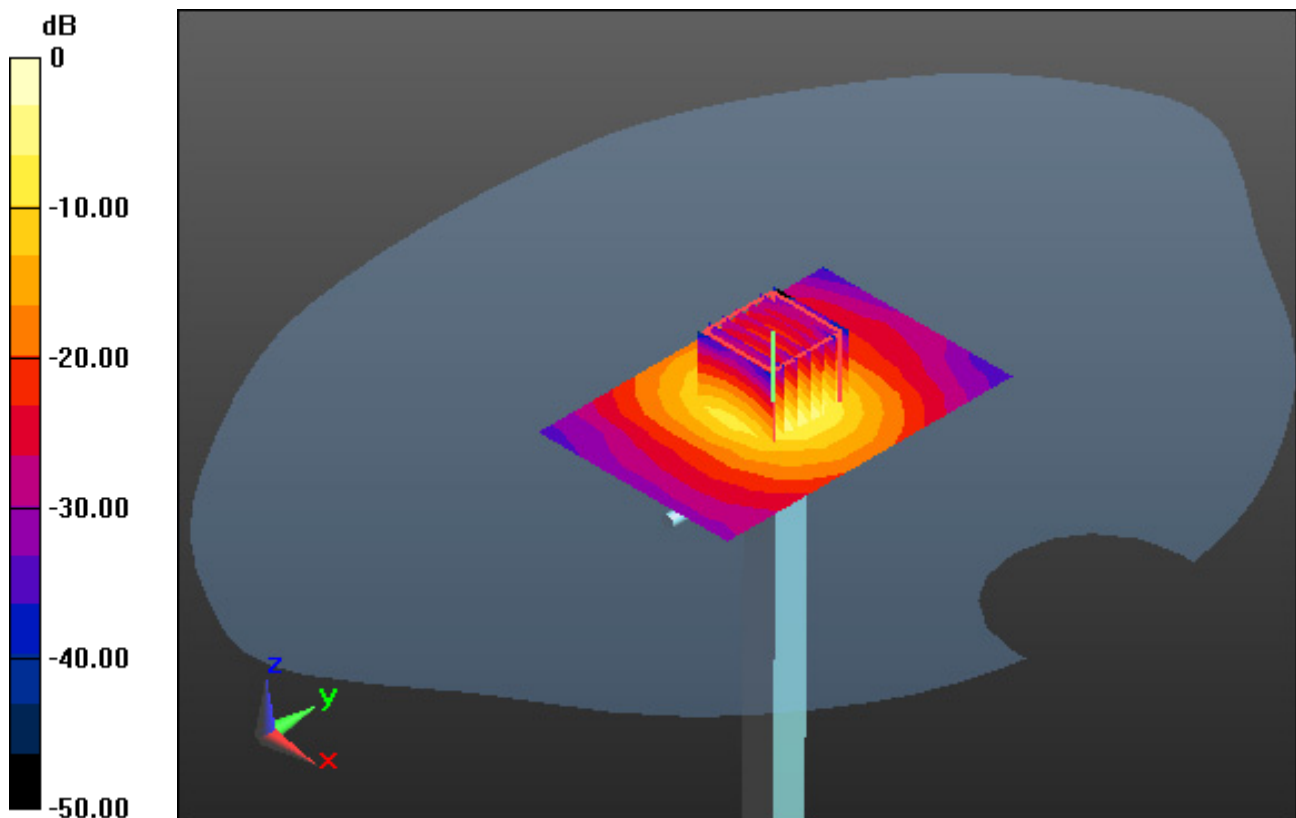

0 dB = 22.0 W/kg

DT&C Co., Ltd.

DUT: Dipole 5000 MHz; Type: D5GHzV2; Serial: D5GHzV2 - SN:1103

Communication System: UID 0, CW (0); Frequency: 5600 MHz; Duty Cycle: 1:1
Medium parameters used: $f = 5600$ MHz; $\sigma = 5.14$ S/m; $\epsilon_r = 35.032$; $\rho = 1000$ kg/m³
Phantom section: Flat Section

DASY5 Configuration:

Probe: EX3DV4 - SN3933; ConvF(4.71, 4.71, 4.71); Calibrated: 9/25/2018; Electronics: DAE4 Sn1391
Sensor-Surface: 1.4mm (Mechanical Surface Detection)
Phantom: SAM with CRP v5.0(Right); Type: QD000P40CD; Serial: 1220
Measurement SW: DASY52, Version 52.8 (8); SEMCAD X Version 14.6.10 (7331)

Test Date: 2019-07-30; Ambient Temp: 21.3; Tissue Temp: 21.5

5600 MHz System Verification (100 mW)

Area Scan (7x10x1): Measurement grid: dx=10mm, dy=10mm

Zoom Scan (7x7x11)/Cube 0: Measurement grid: dx=4mm, dy=4mm, dz=1.4mm, Graded Ratio:1.4

Power Drift = 0.01 dB

Peak SAR (extrapolated) = 40.3 W/kg

SAR(1 g) = 8.23 W/kg; SAR(10 g) = 2.33 W/kg

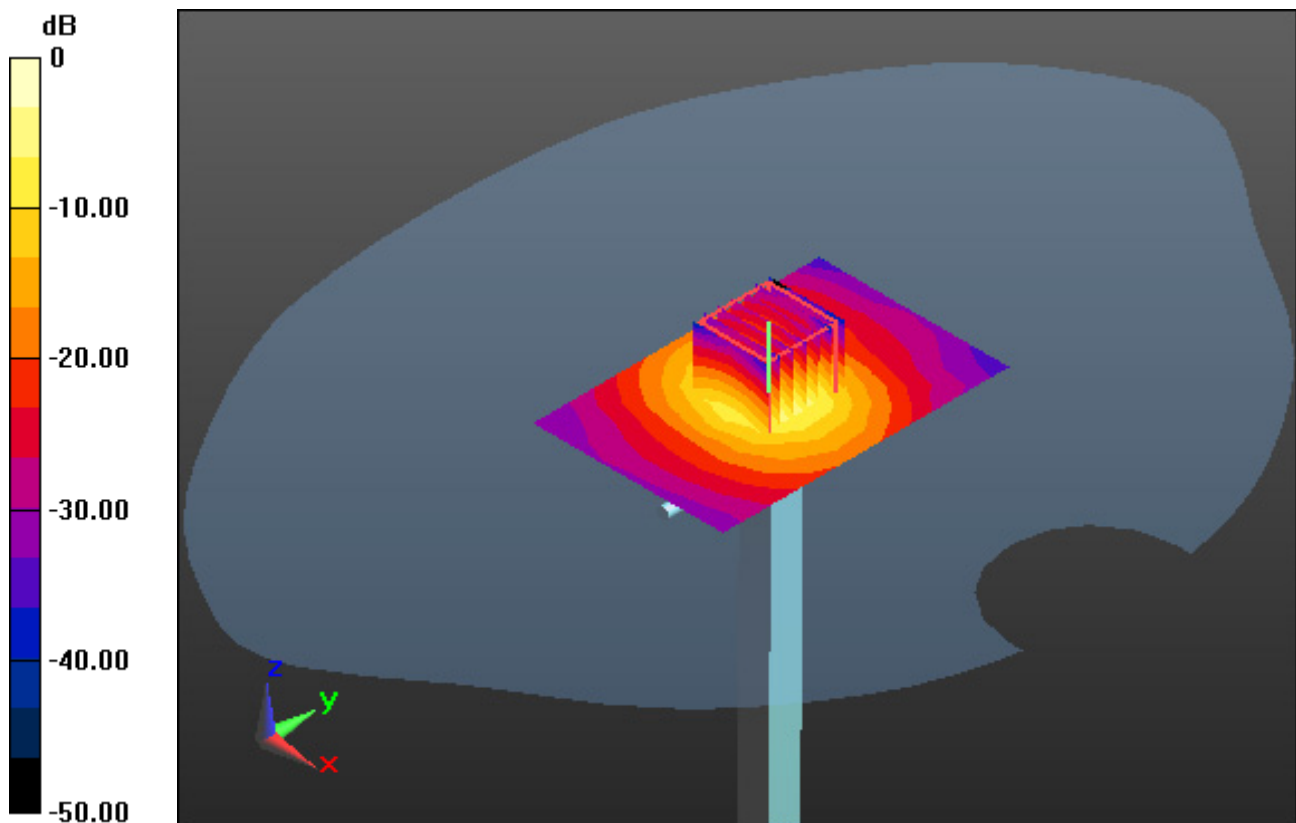

0 dB = 21.7 W/kg

DT&C Co., Ltd.

DUT: Dipole 5000 MHz; Type: D5GHzV2; Serial: D5GHzV2 - SN:1103

Communication System: UID 0, CW (0); Frequency: 5800 MHz; Duty Cycle: 1:1
Medium parameters used: $f = 5800$ MHz; $\sigma = 5.472$ S/m; $\epsilon_r = 34.64$; $\rho = 1000$ kg/m³
Phantom section: Flat Section

DASY5 Configuration:

Probe: EX3DV4 - SN3933; ConvF(4.77, 4.77, 4.77); Calibrated: 9/25/2018; Electronics: DAE4 Sn1391
Sensor-Surface: 1.4mm (Mechanical Surface Detection)
Phantom: SAM with CRP v5.0(Right); Type: QD000P40CD; Serial: 1220
Measurement SW: DASY52, Version 52.8 (8); SEMCAD X Version 14.6.10 (7331)

Test Date: 2019-08-05; Ambient Temp: 20.9; Tissue Temp: 21.5

5800 MHz System Verification (100 mW)

Area Scan (7x7x1): Measurement grid: dx=10mm, dy=10mm

Zoom Scan (8x8x7)/Cube 0: Measurement grid: dx=4mm, dy=4mm, dz=1.4mm, Graded Ratio:1.4

Power Drift = 0.03 dB

Peak SAR (extrapolated) = 37.5 W/kg

SAR(1 g) = 8.2 W/kg; SAR(10 g) = 2.27 W/kg

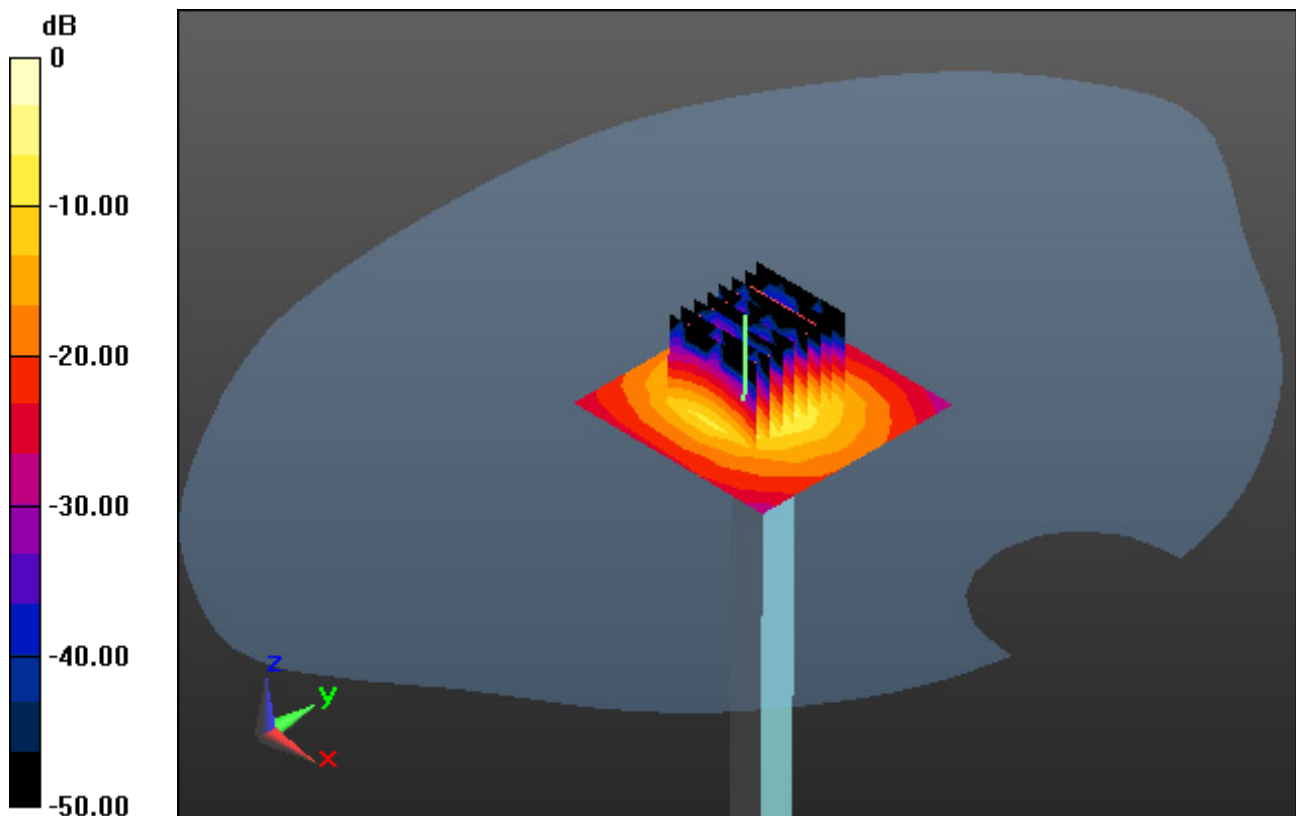

0 dB = 17.5 W/kg

DT&C Co., Ltd.

DUT: Dipole 5000 MHz; Type: D5GHzV2; Serial: D5GHzV2 - SN:1103

Communication System: UID 0, CW (0); Frequency: 5800 MHz; Duty Cycle: 1:1
Medium parameters used: $f = 5800$ MHz; $\sigma = 5.36$ S/m; $\epsilon_r = 35.001$; $\rho = 1000$ kg/m³
Phantom section: Flat Section

DASY5 Configuration:

Probe: EX3DV4 - SN3933; ConvF(4.77, 4.77, 4.77); Calibrated: 9/25/2018; Electronics: DAE4 Sn1391
Sensor-Surface: 1.4mm (Mechanical Surface Detection)
Phantom: SAM with CRP v5.0(Right); Type: QD000P40CD; Serial: 1220
Measurement SW: DASY52, Version 52.8 (8); SEMCAD X Version 14.6.10 (7331)

Test Date: 2019-08-06; Ambient Temp: 21.8; Tissue Temp: 22.0

5800 MHz System Verification (100 mW)

Area Scan (7x10x1): Measurement grid: dx=10mm, dy=10mm

Zoom Scan (7x7x11)/Cube 0: Measurement grid: dx=4mm, dy=4mm, dz=1.4mm, Graded Ratio:1.4

Power Drift = 0.09 dB

Peak SAR (extrapolated) = 38.7 W/kg

SAR(1 g) = 8.3 W/kg; SAR(10 g) = 2.41 W/kg

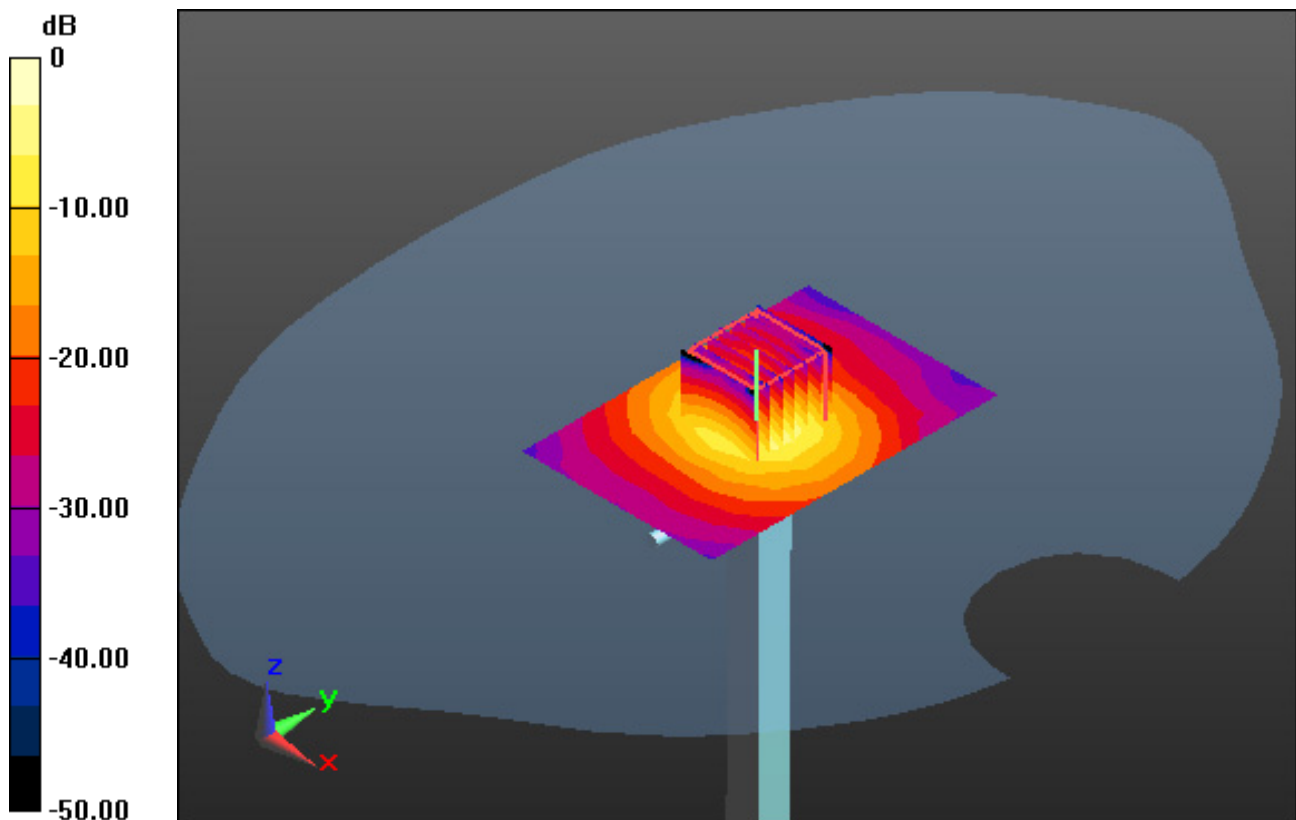

0 dB = 18.8 W/kg

DT&C Co., Ltd.

DUT: PM90W; Type: PDA

Communication System: UID 0, 2.4 GHz W-LAN (0); Frequency: 2462 MHz; Duty Cycle: 1:1
Medium parameters used: $f = 2462$ MHz; $\sigma = 1.829$ S/m; $\epsilon_r = 37.769$; $\rho = 1000$ kg/m³
Phantom section: Right Section

DASY5 Configuration:

Probe: EX3DV4 - SN3916; ConvF(7.66, 7.66, 7.66); Calibrated: 4/25/2019; Electronics: DAE4 Sn1392
Sensor-Surface: 2mm (Mechanical Surface Detection)
Phantom: SAM with CRP_2013_10_08_right; Type: QD000P40CD; Serial: TP:1785
Measurement SW: DASY52, Version 52.8 (8); SEMCAD X Version 14.6.10 (7331)

Test Date: 2019-07-29; Ambient Temp: 20.4; Tissue Temp: 21.0

Right Touch, WLAN(802.11b) Ch. 11, Ant Internal, Standard Battery, Ant.1

Area Scan (11x17x1): Measurement grid: dx=12mm, dy=12mm

Zoom Scan (7x7x7)/Cube 0: Measurement grid: dx=5mm, dy=5mm, dz=5mm

Power Drift = 0.08 dB

Peak SAR (extrapolated) = 0.281 W/kg

SAR(1 g) = 0.130 W/kg; SAR(10 g) = 0.062 W/kg

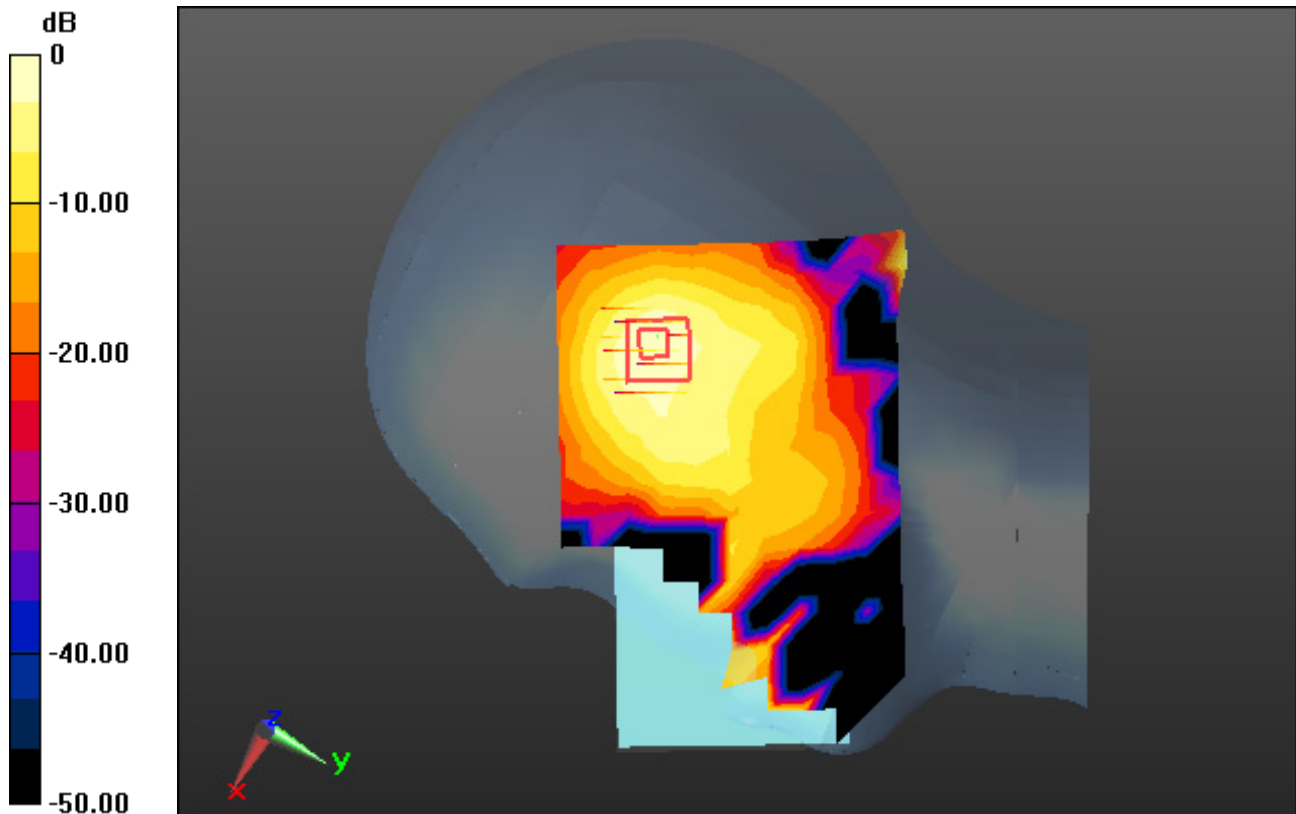

0 dB = 0.200 W/kg

DT&C Co., Ltd.

DUT: PM90W; Type: PDA

Communication System: UID 0, W-LAN (0); Frequency: 2412 MHz; Duty Cycle: 1:1
Medium parameters used: $f = 2412$ MHz; $\sigma = 1.774$ S/m; $\epsilon_r = 37.963$; $\rho = 1000$ kg/m³
Phantom section: Left Section

DASY5 Configuration:

Probe: EX3DV4 - SN3916; ConvF(7.66, 7.66, 7.66); Calibrated: 4/25/2019; Electronics: DAE4 Sn1392
Sensor-Surface: 2mm (Mechanical Surface Detection)
Phantom: SAM with CRP_2013_10_08_right; Type: QD000P40CD; Serial: TP:1785
Measurement SW: DASY52, Version 52.8 (8); SEMCAD X Version 14.6.10 (7331)

Test Date: 2019-07-29; Ambient Temp: 20.4; Tissue Temp: 21.0

Left Touch, WLAN(802.11b) Ch. 1, Ant Internal, Standard Battery, Ant.2

Area Scan (11x17x1): Measurement grid: dx=12mm, dy=12mm

Zoom Scan (7x7x7)/Cube 0: Measurement grid: dx=5mm, dy=5mm, dz=5mm

Power Drift = 0.00 dB

Peak SAR (extrapolated) = 0.0330 W/kg

SAR(1 g) = 0.016 W/kg; SAR(10 g) = 0.00482 W/kg

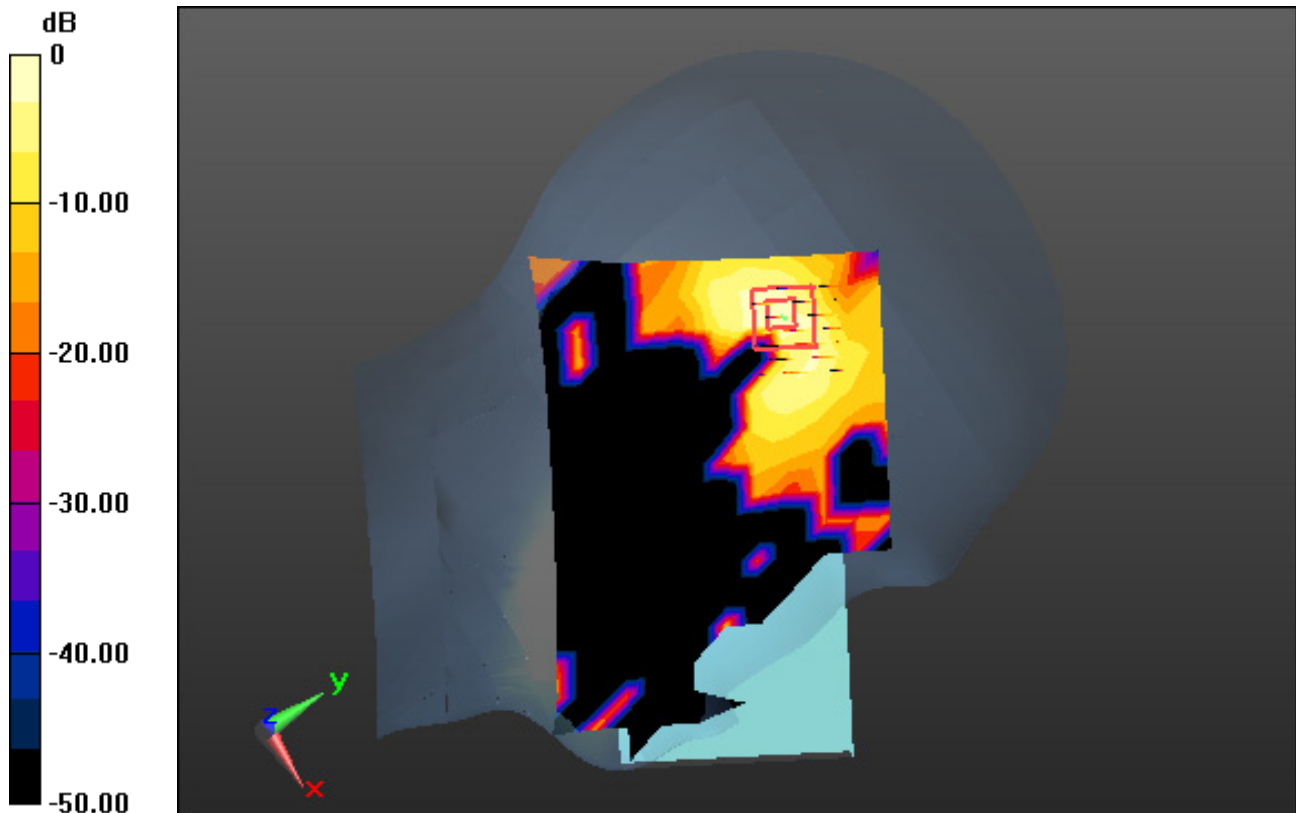

0 dB = 0.0259 W/kg

DT&C Co., Ltd.

DUT: PM90W; Type: PDA

Communication System: UID 0, W-LAN (0); Frequency: 2462 MHz; Duty Cycle: 1:1
Medium parameters used: $f = 2462$ MHz; $\sigma = 1.829$ S/m; $\epsilon_r = 37.769$; $\rho = 1000$ kg/m³
Phantom section: Right Section

DASY5 Configuration:

Probe: EX3DV4 - SN3916; ConvF(7.66, 7.66, 7.66); Calibrated: 4/25/2019; Electronics: DAE4 Sn1392
Sensor-Surface: 2mm (Mechanical Surface Detection)
Phantom: SAM with CRP_2013_10_08_right; Type: QD000P40CD; Serial: TP:1785
Measurement SW: DASY52, Version 52.8 (8); SEMCAD X Version 14.6.10 (7331)

Test Date: 2019-07-29; Ambient Temp: 20.4; Tissue Temp: 21.0

Right Touch, WLAN(802.11b) Ch. 11, Ant Internal, Standard Battery, MIMO

Area Scan (11x17x1): Measurement grid: dx=12mm, dy=12mm

Zoom Scan (7x7x7)/Cube 0: Measurement grid: dx=5mm, dy=5mm, dz=5mm

Power Drift = -0.13 dB

Peak SAR (extrapolated) = 0.205 W/kg

SAR(1 g) = 0.095 W/kg; SAR(10 g) = 0.046 W/kg

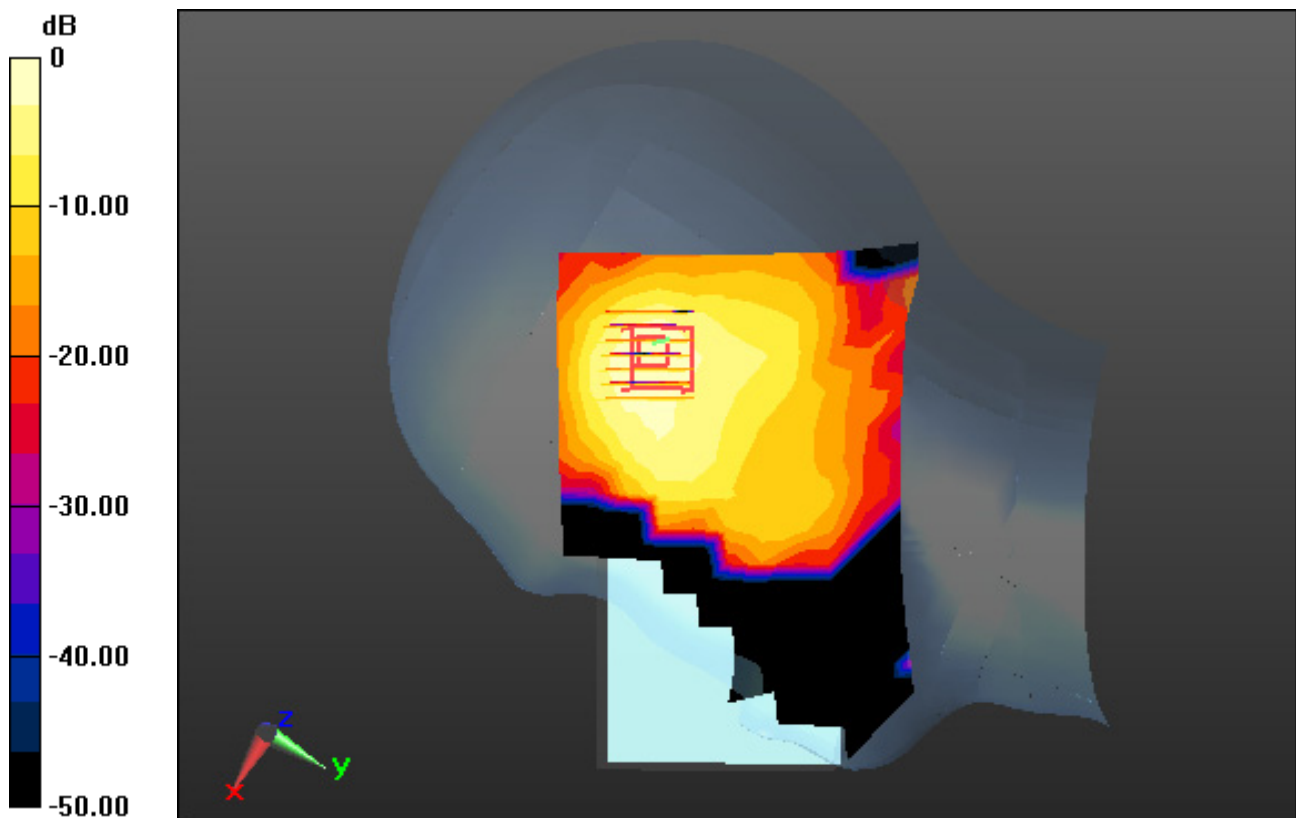

0 dB = 0.142 W/kg

DT&C Co., Ltd.

DUT: PM90W; Type: PDA

Communication System: UID 0, W-LAN_5300 (0); Frequency: 5260 MHz; Duty Cycle: 1:1
Medium parameters used: $f = 5260$ MHz; $\sigma = 4.546$ S/m; $\epsilon_r = 35.19$; $\rho = 1000$ kg/m³
Phantom section: Right Section

DASY5 Configuration:

Probe: EX3DV4 - SN3916; ConvF(4.94, 4.94, 4.94); Calibrated: 4/25/2019; Electronics: DAE4 Sn1392
Sensor-Surface: 1.4mm (Mechanical Surface Detection)
Phantom: SAM with CRP_2016_07_22_middle; Type: QD000P40CD; Serial: TP:1786
Measurement SW: DASY52, Version 52.8 (8); SEMCAD X Version 14.6.10 (7331)

Test Date: 2019-08-01; Ambient Temp: 20.5; Tissue Temp: 20.6

Right Touch, WLAN(802.11a) Ch. 52, Ant Internal, Standard Battery, Ant.1

Area Scan (13x21x1): Measurement grid: dx=10mm, dy=10mm

Zoom Scan (8x8x7)/Cube 0: Measurement grid: dx=4mm, dy=4mm, dz=1.4mm, Graded Ratio:1.4

Power Drift = 0.06 dB

Peak SAR (extrapolated) = 2.40 W/kg

SAR(1 g) = 0.644 W/kg; SAR(10 g) = 0.219 W/kg

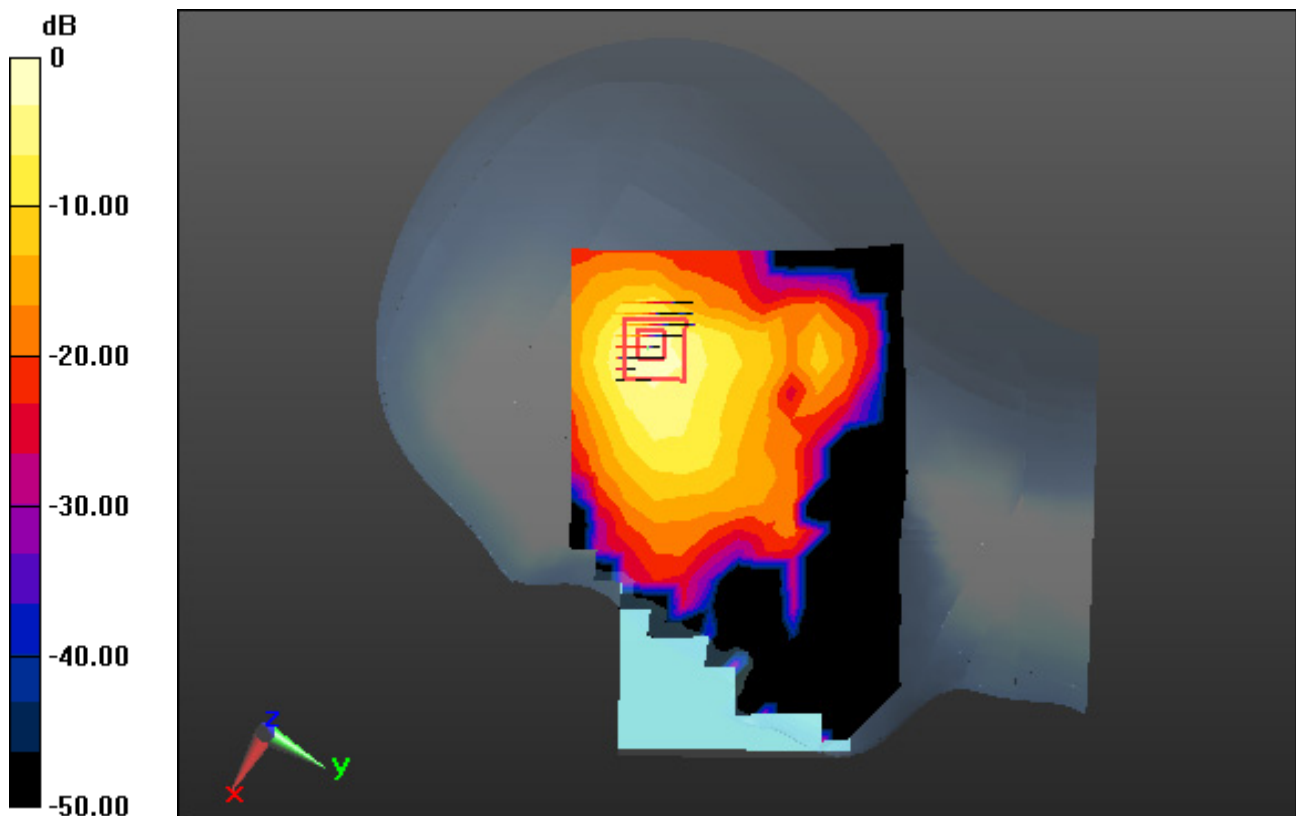

0 dB = 1.51 W/kg

DT&C Co., Ltd.

DUT: PM90W; Type: PDA

Communication System: UID 0, W-LAN_5300 (0); Frequency: 5260 MHz; Duty Cycle: 1:1
Medium parameters used: $f = 5260$ MHz; $\sigma = 4.546$ S/m; $\epsilon_r = 35.19$; $\rho = 1000$ kg/m³
Phantom section: Left Section

DASY5 Configuration:

Probe: EX3DV4 - SN3916; ConvF(4.94, 4.94, 4.94); Calibrated: 4/25/2019; Electronics: DAE4 Sn1392
Sensor-Surface: 1.4mm (Mechanical Surface Detection)
Phantom: SAM with CRP_2016_07_22_middle; Type: QD000P40CD; Serial: TP:1786
Measurement SW: DASY52, Version 52.8 (8); SEMCAD X Version 14.6.10 (7331)

Test Date: 2019-08-01; Ambient Temp: 20.5; Tissue Temp: 20.6

Left Touch, WLAN(802.11a) Ch. 52, Ant Internal, Standard Battery, Ant.2

Area Scan (13x21x1): Measurement grid: dx=10mm, dy=10mm

Zoom Scan (8x8x7)/Cube 0: Measurement grid: dx=4mm, dy=4mm, dz=1.4mm, Graded Ratio:1.4

Power Drift = -0.05 dB

Peak SAR (extrapolated) = 1.17 W/kg

SAR(1 g) = 0.330 W/kg; SAR(10 g) = 0.110 W/kg

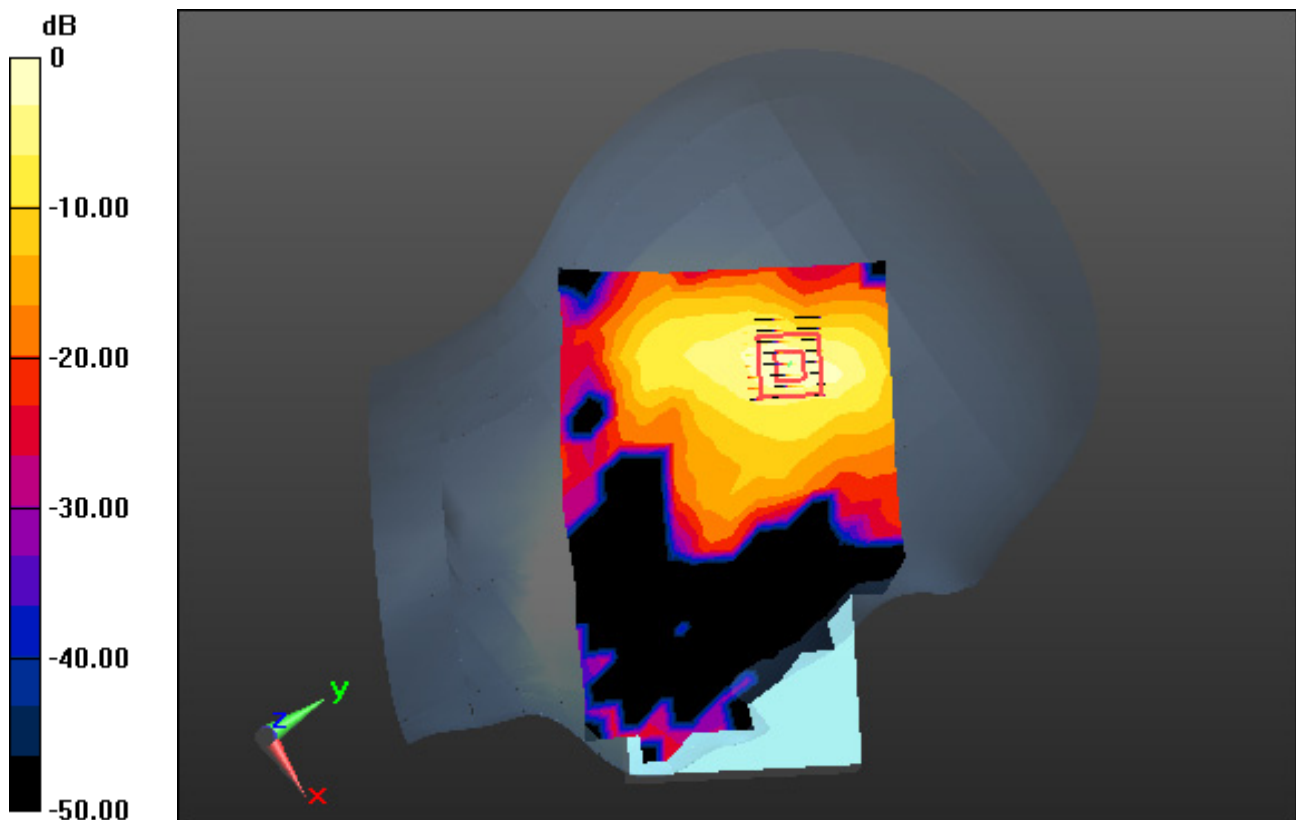

0 dB = 0.758 W/kg

DT&C Co., Ltd.

DUT: PM90W; Type: PDA; Serial

Communication System: UID 0, W-LAN_5300 (0); Frequency: 5260 MHz; Duty Cycle: 1:1
Medium parameters used: $f = 5260$ MHz; $\sigma = 4.546$ S/m; $\epsilon_r = 35.19$; $\rho = 1000$ kg/m³
Phantom section: Right Section

DASY5 Configuration:

Probe: EX3DV4 - SN3916; ConvF(4.94, 4.94, 4.94); Calibrated: 4/25/2019; Electronics: DAE4 Sn1392
Sensor-Surface: 1.4mm (Mechanical Surface Detection)
Phantom: SAM with CRP_2016_07_22_middle; Type: QD000P40CD; Serial: TP:1786
Measurement SW: DASY52, Version 52.8 (8); SEMCAD X Version 14.6.10 (7331)

Test Date: 2019-08-01; Ambient Temp: 20.5; Tissue Temp: 20.6

Right Touch, WLAN(802.11a) Ch. 52, Ant Internal, Standard Battery, MIMO

Area Scan (13x21x1): Measurement grid: dx=10mm, dy=10mm

Zoom Scan (8x8x7)/Cube 0: Measurement grid: dx=4mm, dy=4mm, dz=1.4mm, Graded Ratio:1.4

Power Drift = 0.11 dB

Peak SAR (extrapolated) = 2.45 W/kg

SAR(1 g) = 0.656 W/kg; SAR(10 g) = 0.222 W/kg

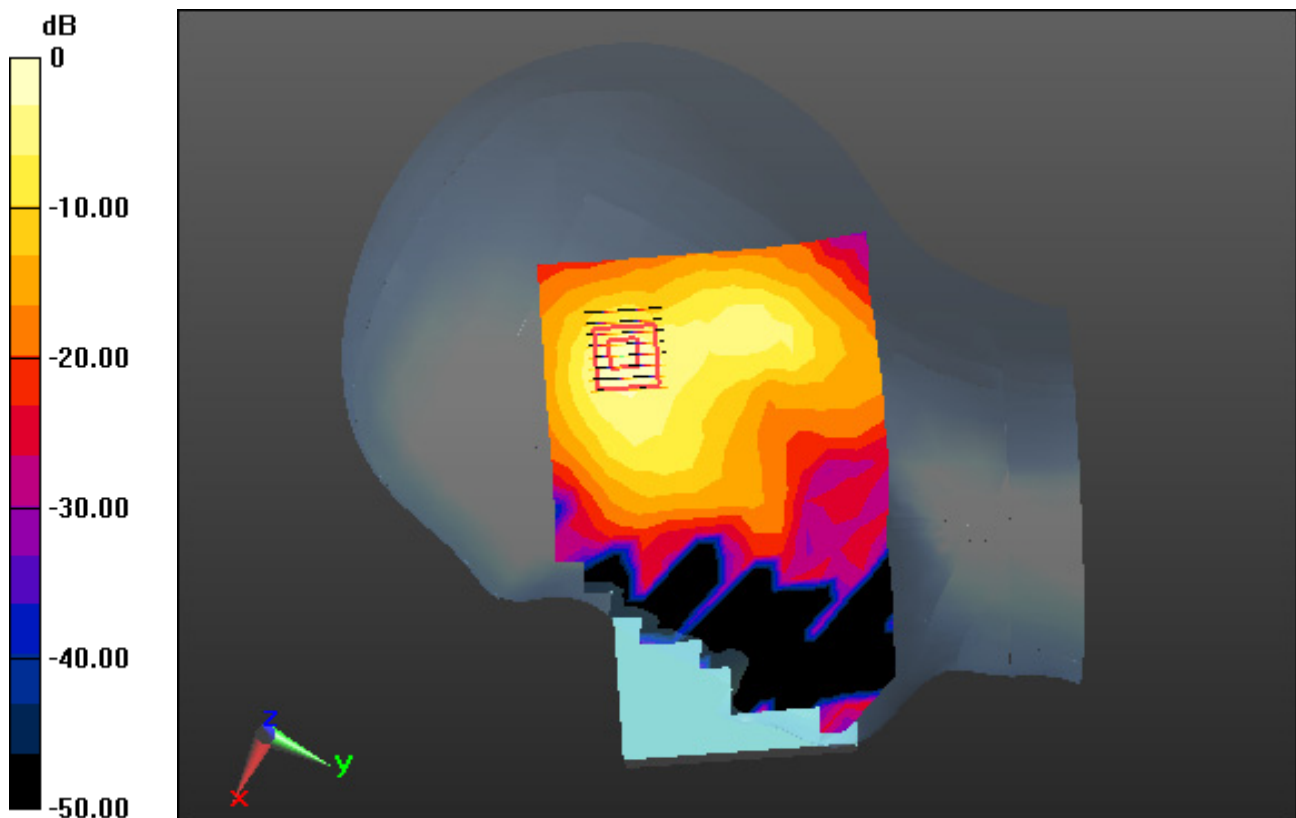

0 dB = 1.53 W/kg

DT&C Co., Ltd.

DUT: PM90W; Type: PDA

Communication System: UID 0, W-LAN_5600 (0); Frequency: 5660 MHz; Duty Cycle: 1:1
Medium parameters used: $f = 5660$ MHz; $\sigma = 5.213$ S/m; $\epsilon_r = 34.743$; $\rho = 1000$ kg/m³
Phantom section: Right Section

DASY5 Configuration:

Probe: EX3DV4 - SN3916; ConvF(4.75, 4.75, 4.75); Calibrated: 4/25/2019; Electronics: DAE4 Sn1392
Sensor-Surface: 1.4mm (Mechanical Surface Detection)
Phantom: SAM with CRP_2016_07_22_middle; Type: QD000P40CD; Serial: TP:1786
Measurement SW: DASY52, Version 52.8 (8); SEMCAD X Version 14.6.10 (7331)

Test Date: 2019-08-02; Ambient Temp: 20.6; Tissue Temp: 20.2

Right Touch, WLAN(802.11a) Ch. 132, Ant Internal, Standard Battery, Ant.1

Area Scan (13x21x1): Measurement grid: dx=10mm, dy=10mm

Zoom Scan (8x8x7)/Cube 0: Measurement grid: dx=4mm, dy=4mm, dz=1.4mm, Graded Ratio:1.4

Power Drift = 0.06 dB

Peak SAR (extrapolated) = 2.05 W/kg

SAR(1 g) = 0.496 W/kg; SAR(10 g) = 0.167 W/kg

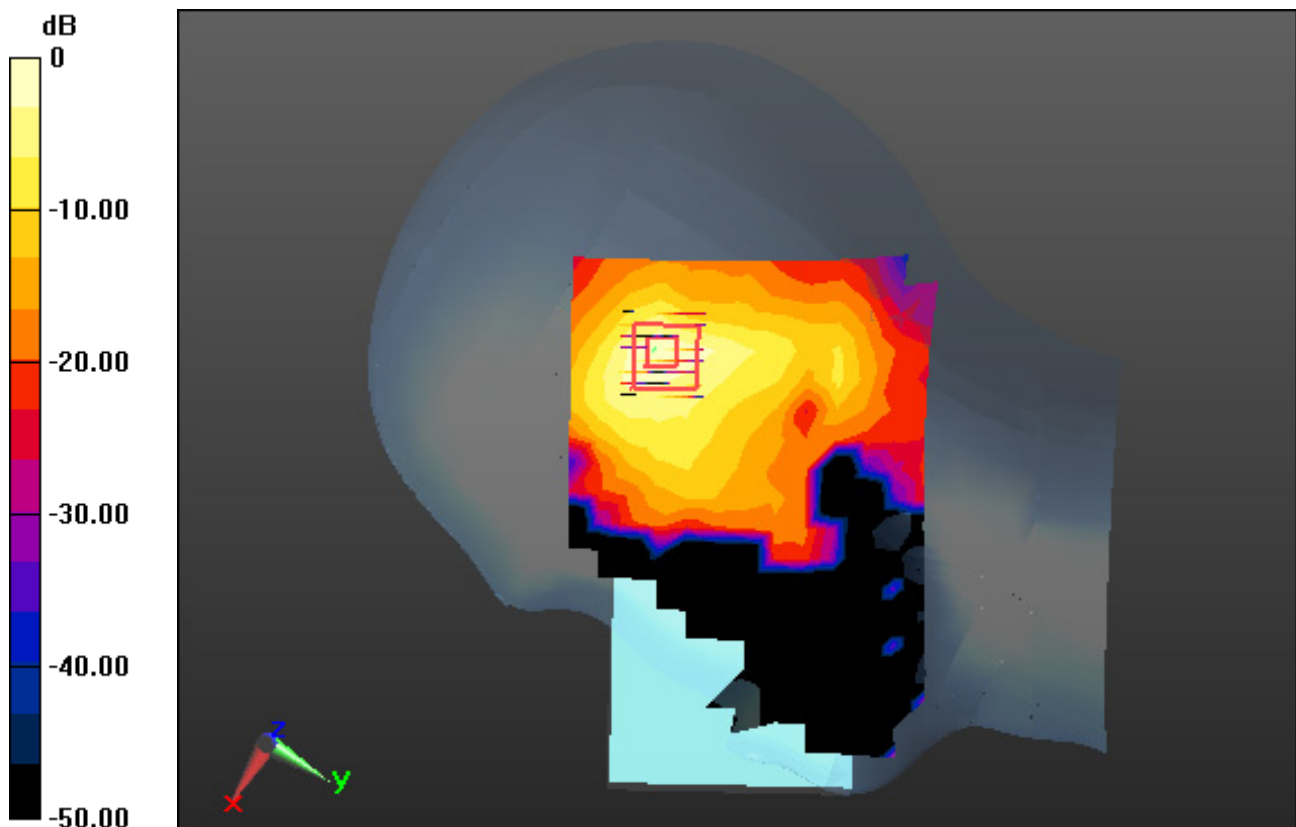

0 dB = 1.21 W/kg

DT&C Co., Ltd.

DUT: PM90W; Type: PDA

Communication System: UID 0, W-LAN_5500 (0); Frequency: 5660 MHz; Duty Cycle: 1:1
Medium parameters used: $f = 5660$ MHz; $\sigma = 5.213$ S/m; $\epsilon_r = 34.743$; $\rho = 1000$ kg/m³
Phantom section: Right Section

DASY5 Configuration:

Probe: EX3DV4 - SN3916; ConvF(4.75, 4.75, 4.75); Calibrated: 4/25/2019; Electronics: DAE4 Sn1392
Sensor-Surface: 1.4mm (Mechanical Surface Detection)
Phantom: SAM with CRP_2016_07_22_middle; Type: QD000P40CD; Serial: TP:1786
Measurement SW: DASY52, Version 52.8 (8); SEMCAD X Version 14.6.10 (7331)

Test Date: 2019-08-02; Ambient Temp: 20.6; Tissue Temp: 20.2

Right Tilt, WLAN(802.11a) Ch. 132, Ant Internal, Standard Battery, Ant.2

Area Scan (13x21x1): Measurement grid: dx=10mm, dy=10mm

Zoom Scan (8x8x7)/Cube 0: Measurement grid: dx=4mm, dy=4mm, dz=1.4mm, Graded Ratio:1.4

Power Drift = 0.00 dB

Peak SAR (extrapolated) = 1.06 W/kg

SAR(1 g) = 0.292 W/kg; SAR(10 g) = 0.104 W/kg

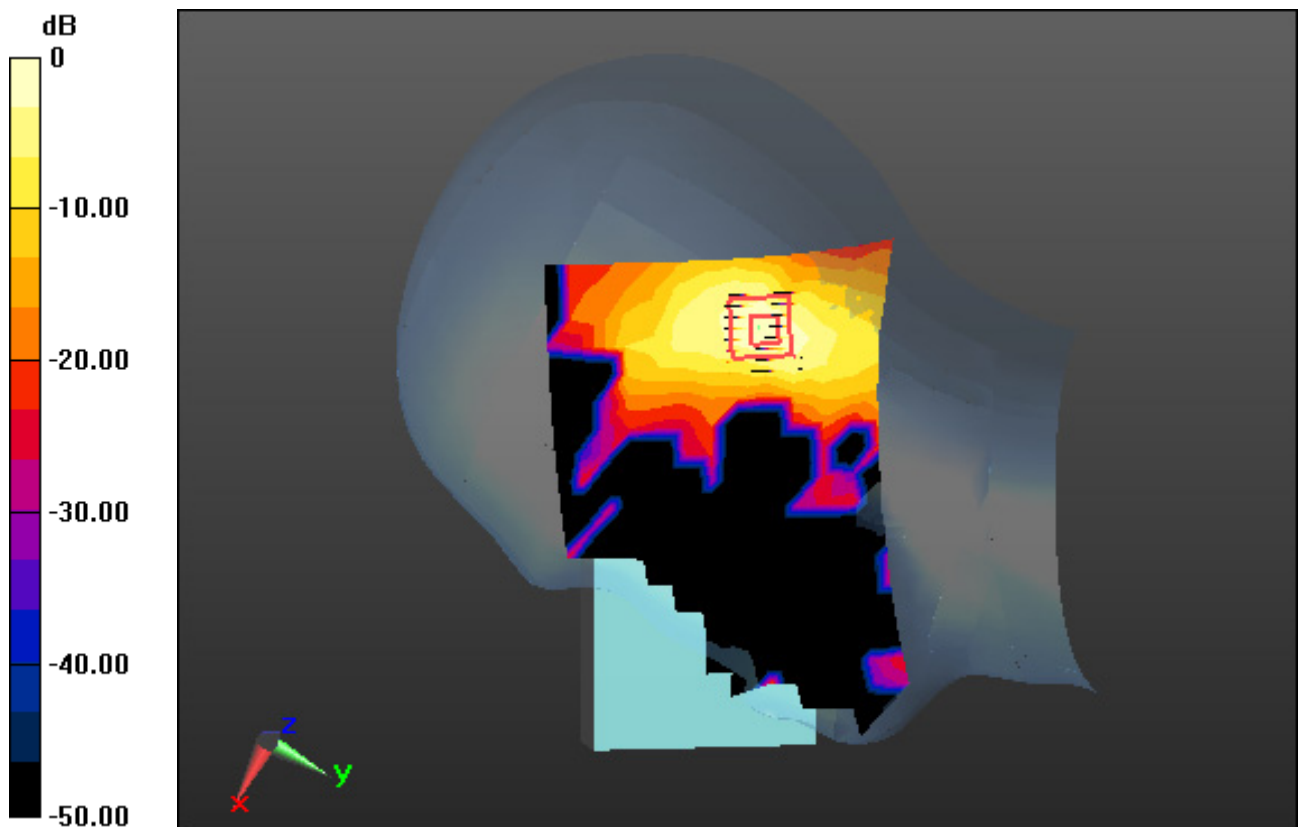

0 dB = 0.666 W/kg

DT&C Co., Ltd.

DUT: PM90W; Type: PDA

Communication System: UID 0, W-LAN_5500 (0); Frequency: 5660 MHz; Duty Cycle: 1:1
Medium parameters used: $f = 5660$ MHz; $\sigma = 5.213$ S/m; $\epsilon_r = 34.743$; $\rho = 1000$ kg/m³
Phantom section: Left Section

DASY5 Configuration:

Probe: EX3DV4 - SN3916; ConvF(4.75, 4.75, 4.75); Calibrated: 4/25/2019; Electronics: DAE4 Sn1392
Sensor-Surface: 1.4mm (Mechanical Surface Detection)
Phantom: SAM with CRP_2016_07_22_middle; Type: QD000P40CD; Serial: TP:1786
Measurement SW: DASY52, Version 52.8 (8); SEMCAD X Version 14.6.10 (7331)

Test Date: 2019-08-02; Ambient Temp: 20.6; Tissue Temp: 20.2

Left Tilt, WLAN(802.11a) Ch. 132, Ant Internal, Standard Battery, MIMO

Area Scan (13x21x1): Measurement grid: dx=10mm, dy=10mm

Zoom Scan (8x8x7)/Cube 0: Measurement grid: dx=4mm, dy=4mm, dz=1.4mm, Graded Ratio:1.4

Power Drift = -0.01 dB

Peak SAR (extrapolated) = 1.74 W/kg

SAR(1 g) = 0.467 W/kg; SAR(10 g) = 0.167 W/kg

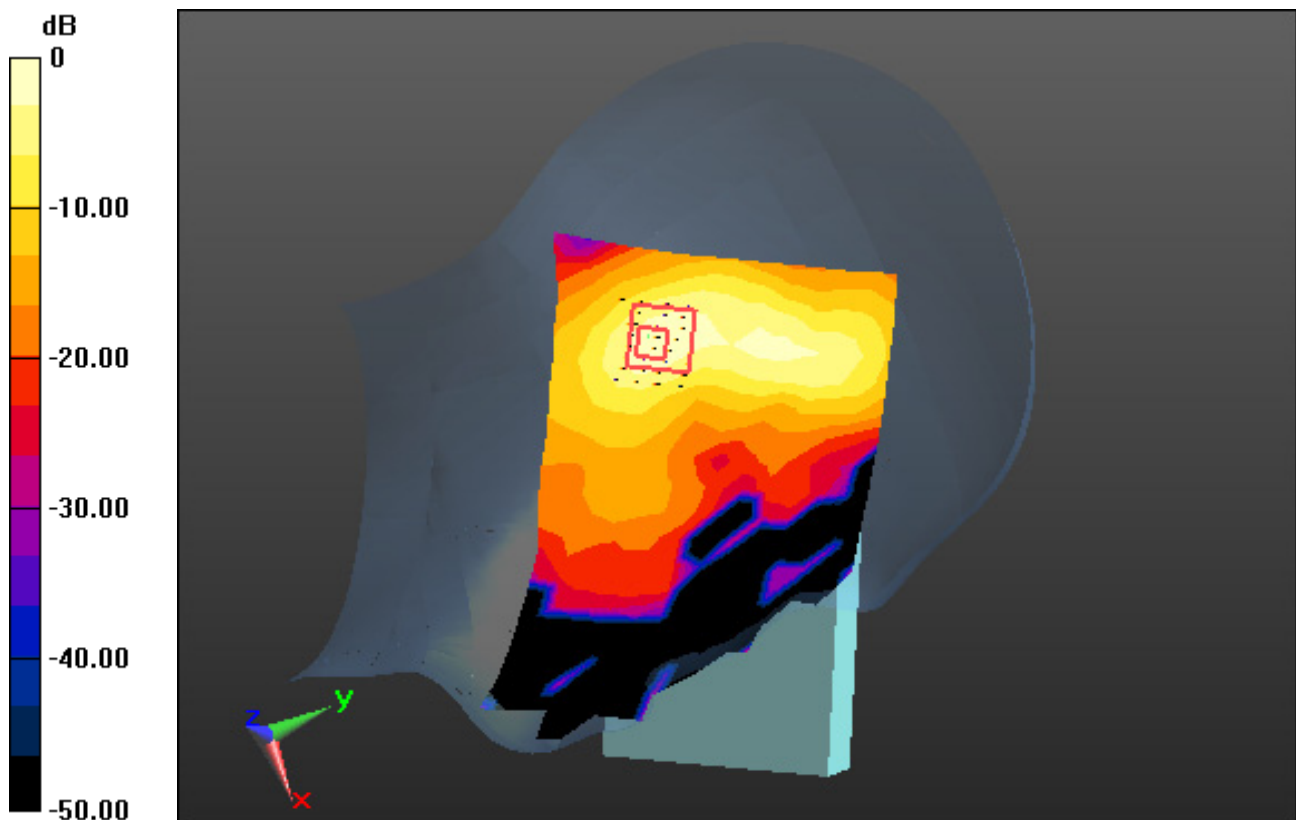

0 dB = 1.08 W/kg

DT&C Co., Ltd.

DUT: PM90W; Type: PDA

Communication System: UID 0, W-LAN_5800 (0); Frequency: 5825 MHz; Duty Cycle: 1:1
Medium parameters used: $f = 5825$ MHz; $\sigma = 5.496$ S/m; $\epsilon_r = 34.616$; $\rho = 1000$ kg/m³
Phantom section: Right Section

DASY5 Configuration:

Probe: EX3DV4 - SN3933; ConvF(4.77, 4.77, 4.77); Calibrated: 9/25/2018; Electronics: DAE4 Sn1391
Sensor-Surface: 1.4mm (Mechanical Surface Detection)
Phantom: SAM with CRP v5.0(Right); Type: QD000P40CD; Serial: 1220
Measurement SW: DASY52, Version 52.8 (8); SEMCAD X Version 14.6.10 (7331)

Test Date: 2019-08-05; Ambient Temp: 20.9; Tissue Temp: 21.5

Right Touch, WLAN(802.11a) Ch. 165, Ant Internal, Standard Battery, Ant.1

Area Scan (13x21x1): Measurement grid: dx=10mm, dy=10mm

Zoom Scan (8x8x7)/Cube 0: Measurement grid: dx=4mm, dy=4mm, dz=1.4mm, Graded Ratio:1.4

Power Drift = -0.03 dB

Peak SAR (extrapolated) = 0.853 W/kg

SAR(1 g) = 0.184 W/kg; SAR(10 g) = 0.058 W/kg

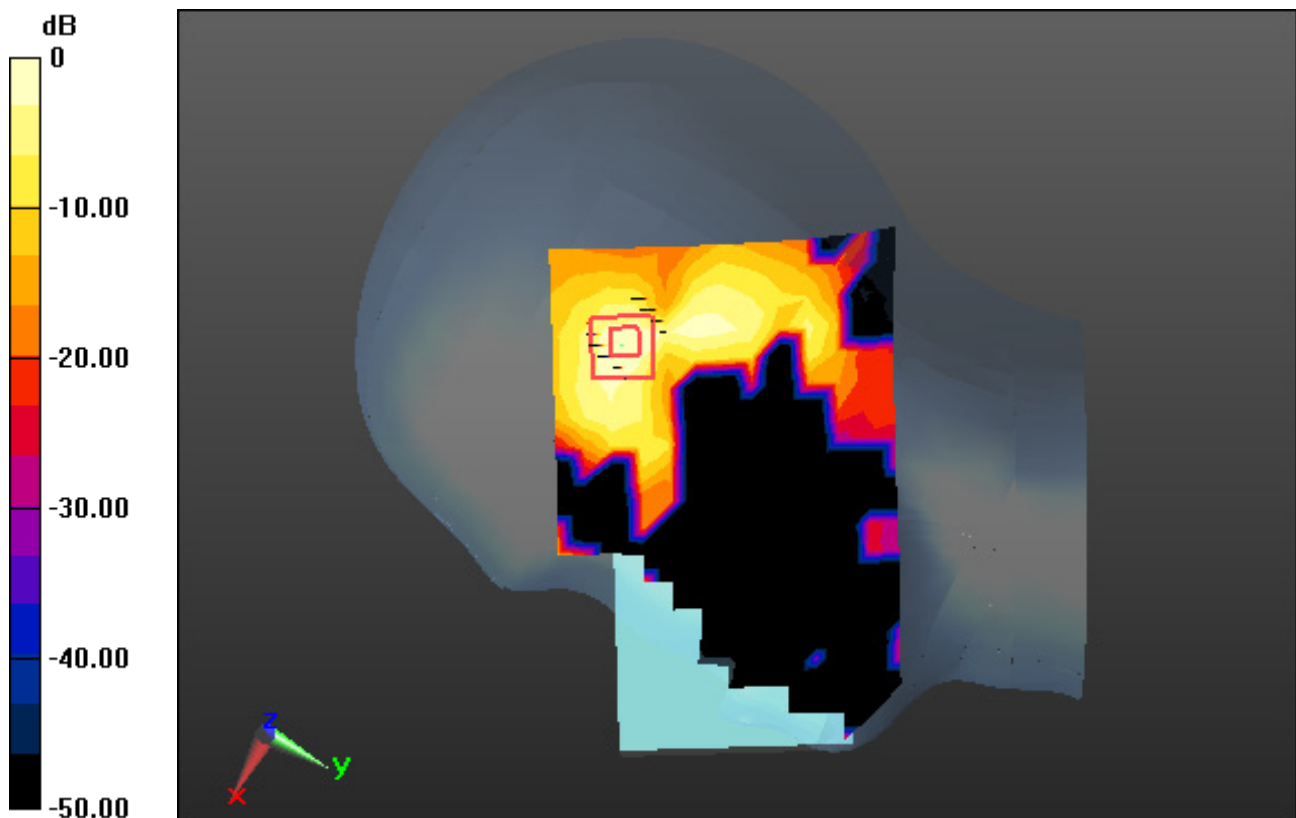

0 dB = 0.505 W/kg

DT&C Co., Ltd.

DUT: PM90W; Type: PDA

Communication System: UID 0, W-LAN 5.8G(802.11a/n/ac) (0); Frequency: 5825 MHz;Duty Cycle: 1:1
Medium parameters used: $f = 5825$ MHz; $\sigma = 5.496$ S/m; $\epsilon_r = 34.616$; $\rho = 1000$ kg/m³
Phantom section: Right Section

DASY5 Configuration:

Probe: EX3DV4 - SN3933; ConvF(4.77, 4.77, 4.77); Calibrated: 9/25/2018; Electronics: DAE4 Sn1391
Sensor-Surface: 1.4mm (Mechanical Surface Detection)
Phantom: SAM with CRP v5.0(Right); Type: QD000P40CD; Serial: 1220
Measurement SW: DASY52, Version 52.8 (8); SEMCAD X Version 14.6.10 (7331)

Test Date: 2019-08-05; Ambient Temp: 20.9; Tissue Temp: 21.5

Right Tilt, WLAN(802.11a) Ch. 165, Ant Internal, Standard Battery, Ant.2

Area Scan (13x21x1): Measurement grid: dx=10mm, dy=10mm

Zoom Scan (8x8x7)/Cube 0: Measurement grid: dx=4mm, dy=4mm, dz=1.4mm, Graded Ratio:1.4

Power Drift = 0.16 dB

Peak SAR (extrapolated) = 0.984 W/kg

SAR(1 g) = 0.272 W/kg; SAR(10 g) = 0.105 W/kg

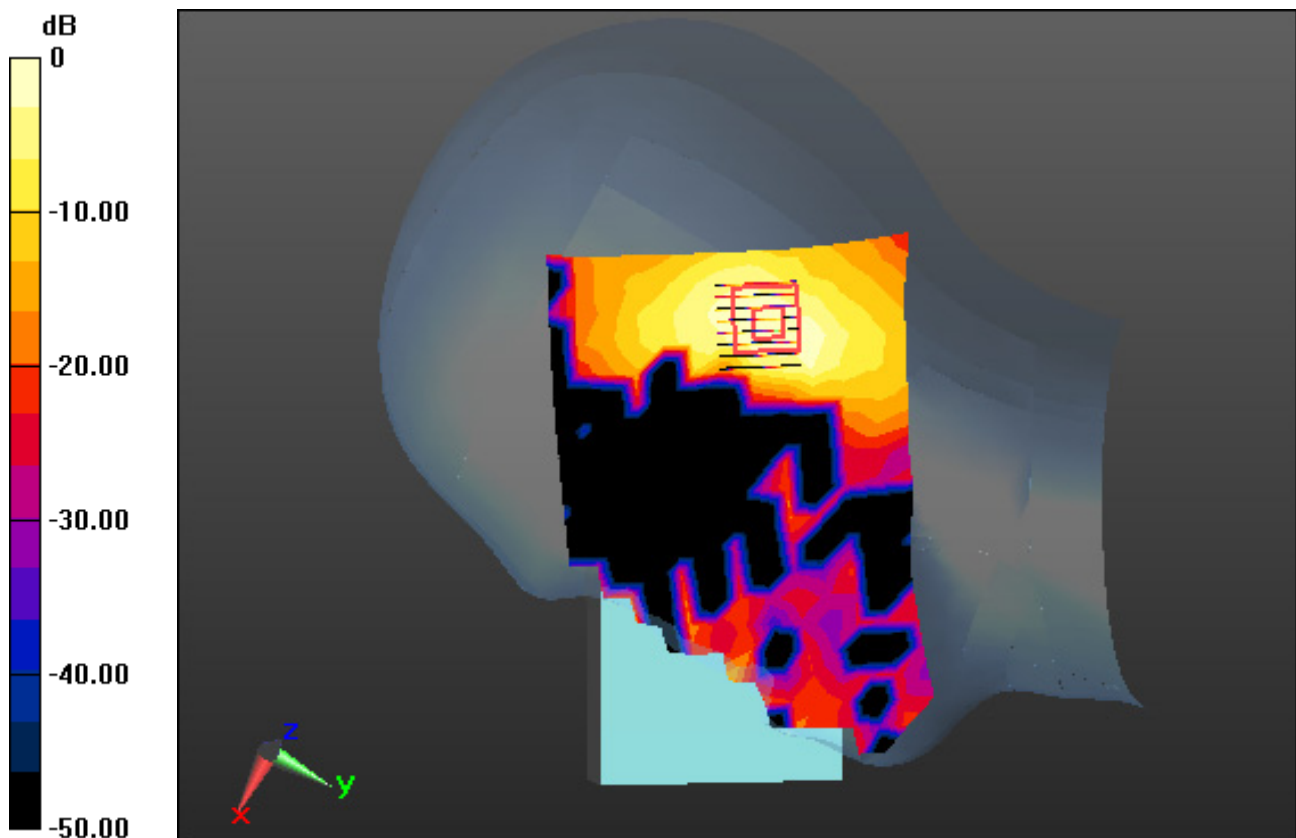

0 dB = 0.611 W/kg

DT&C Co., Ltd.

DUT: PM90W; Type: PDA

Communication System: UID 0, W-LAN 5.8G(802.11a/n/ac) (0); Frequency: 5825 MHz;Duty Cycle: 1:1
Medium parameters used: $f = 5825$ MHz; $\sigma = 5.496$ S/m; $\epsilon_r = 34.616$; $\rho = 1000$ kg/m³
Phantom section: Right Section

DASY5 Configuration:

Probe: EX3DV4 - SN3933; ConvF(4.77, 4.77, 4.77); Calibrated: 9/25/2018; Electronics: DAE4 Sn1391
Sensor-Surface: 1.4mm (Mechanical Surface Detection)
Phantom: SAM with CRP v5.0(Right); Type: QD000P40CD; Serial: 1220
Measurement SW: DASY52, Version 52.8 (8); SEMCAD X Version 14.6.10 (7331)

Test Date: 2019-08-05; Ambient Temp: 20.9; Tissue Temp: 21.5

Right Tilt, WLAN(802.11a) Ch. 165, Ant Internal, Standard Battery, MIMO

Area Scan (13x21x1): Measurement grid: dx=10mm, dy=10mm

Zoom Scan (8x8x7)/Cube 0: Measurement grid: dx=4mm, dy=4mm, dz=1.4mm, Graded Ratio:1.4

Power Drift = -0.04 dB

Peak SAR (extrapolated) = 1.23 W/kg

SAR(1 g) = 0.332 W/kg; SAR(10 g) = 0.129 W/kg

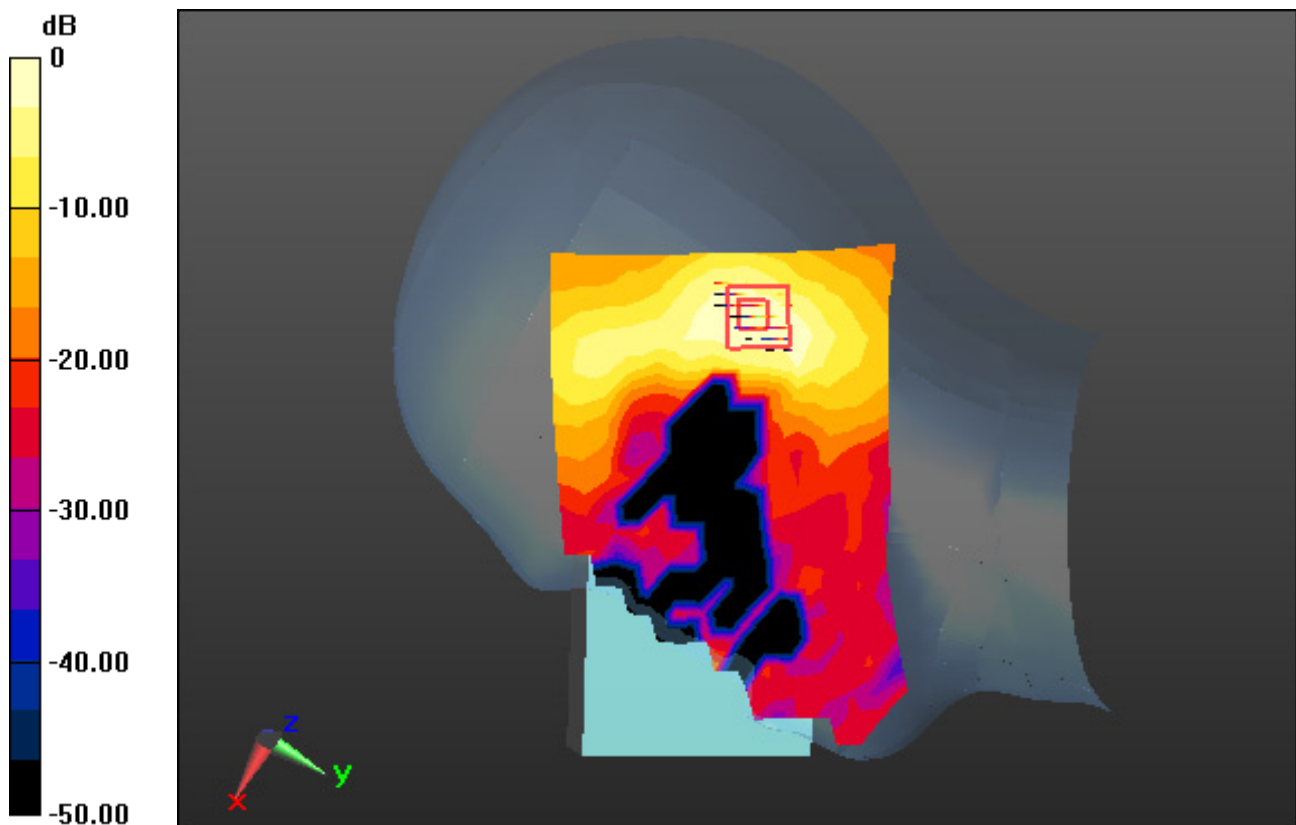

0 dB = 0.739 W/kg

DT&C Co., Ltd.

DUT: PM90W; Type: PDA

Communication System: UID 0, Bluetooth (0); Frequency: 2441 MHz; Duty Cycle: 1:1.302

Medium parameters used: $f = 2441$ MHz; $\sigma = 1.802$ S/m; $\epsilon_r = 38.404$; $\rho = 1000$ kg/m³

Phantom section: Right Section

DASY5 Configuration:

Probe: EX3DV4 - SN3916; ConvF(7.66, 7.66, 7.66); Calibrated: 4/25/2019; Electronics: DAE4 Sn1392

Sensor-Surface: 2mm (Mechanical Surface Detection)

Phantom: SAM with CRP_2013_10_08_right; Type: QD000P40CD; Serial: TP:1785

Measurement SW: DASY52, Version 52.8 (8); SEMCAD X Version 14.6.10 (7331)

Test Date: 2019-08-13; Ambient Temp: 20.4; Tissue Temp: 20.6

Right Touch, Bluetooth Ch. 39, Ant Internal, Standard Battery

Area Scan (11x17x1): Measurement grid: dx=12mm, dy=12mm

Zoom Scan (7x7x7)/Cube 0: Measurement grid: dx=5mm, dy=5mm, dz=5mm

Power Drift = 0.11 dB

Peak SAR (extrapolated) = 0.0760 W/kg

SAR(1 g) = 0.036 W/kg; SAR(10 g) = 0.017 W/kg

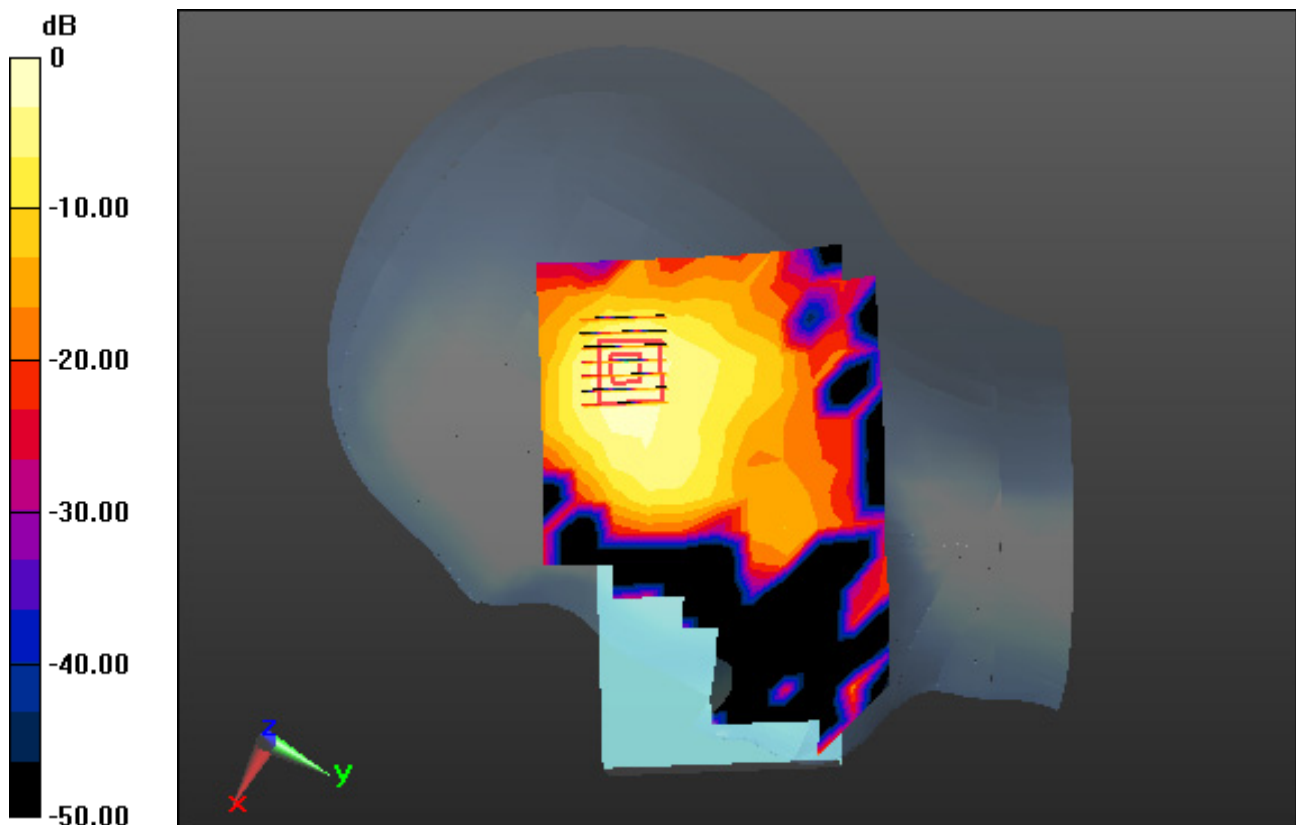

0 dB = 0.0548 W/kg

DT&C Co., Ltd.

DUT: PM90W; Type: PDA

Communication System: UID 0, W-LAN (0); Frequency: 2462 MHz; Duty Cycle: 1:1
Medium parameters used: $f = 2462$ MHz; $\sigma = 1.832$ S/m; $\epsilon_r = 38.292$; $\rho = 1000$ kg/m³
Phantom section: Flat Section

DASY5 Configuration:

Probe: EX3DV4 - SN3916; ConvF(7.66, 7.66, 7.66); Calibrated: 4/25/2019; Electronics: DAE4 Sn1392
Sensor-Surface: 2mm (Mechanical Surface Detection)
Phantom: SAM with CRP_2013_10_08_right; Type: QD000P40CD; Serial: TP:1785
Measurement SW: DASY52, Version 52.8 (8); SEMCAD X Version 14.6.10 (7331)

Test Date: 2019-07-30; Ambient Temp: 20.8; Tissue Temp: 20.5

1.5 cm space from Body, Front, WLAN(802.11b) Ch. 11, Ant Internal, Ant.1

Area Scan (11x17x1): Measurement grid: dx=12mm, dy=12mm

Zoom Scan (7x7x7)/Cube 0: Measurement grid: dx=5mm, dy=5mm, dz=5mm

Power Drift = -0.10 dB

Peak SAR (extrapolated) = 0.0300 W/kg

SAR(1 g) = 0.015 W/kg; SAR(10 g) = 0.00854 W/kg

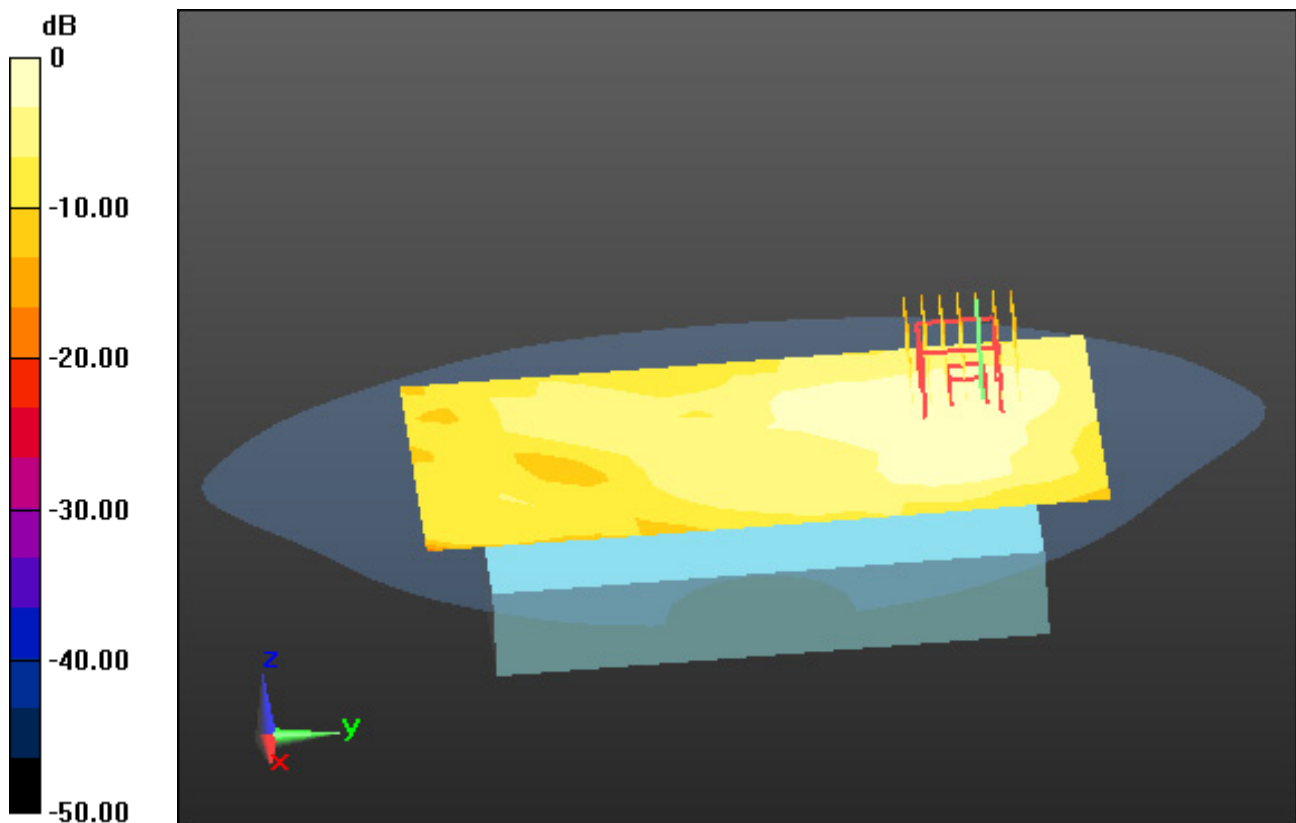

0 dB = 0.0211 W/kg

DT&C Co., Ltd.

DUT: PM90W; Type: PDA

Communication System: UID 0, W-LAN (0); Frequency: 2412 MHz; Duty Cycle: 1:1
Medium parameters used: $f = 2412$ MHz; $\sigma = 1.777$ S/m; $\epsilon_r = 38.481$; $\rho = 1000$ kg/m³
Phantom section: Flat Section

DASY5 Configuration:

Probe: EX3DV4 - SN3916; ConvF(7.66, 7.66, 7.66); Calibrated: 4/25/2019; Electronics: DAE4 Sn1392
Sensor-Surface: 2mm (Mechanical Surface Detection)
Phantom: SAM with CRP_2013_10_08_right; Type: QD000P40CD; Serial: TP:1785
Measurement SW: DASY52, Version 52.8 (8); SEMCAD X Version 14.6.10 (7331)

Test Date: 2019-07-30; Ambient Temp: 20.8; Tissue Temp: 20.5

1.5 cm space from Body, Rear, WLAN(802.11b) Ch. 1, Ant Internal, Ant.2

Area Scan (11x17x1): Measurement grid: dx=12mm, dy=12mm

Zoom Scan (7x7x7)/Cube 0: Measurement grid: dx=5mm, dy=5mm, dz=5mm

Power Drift = -0.13 dB

Peak SAR (extrapolated) = 0.0170 W/kg

SAR(1 g) = 0.0039 W/kg; SAR(10 g) = 0.00207 W/kg

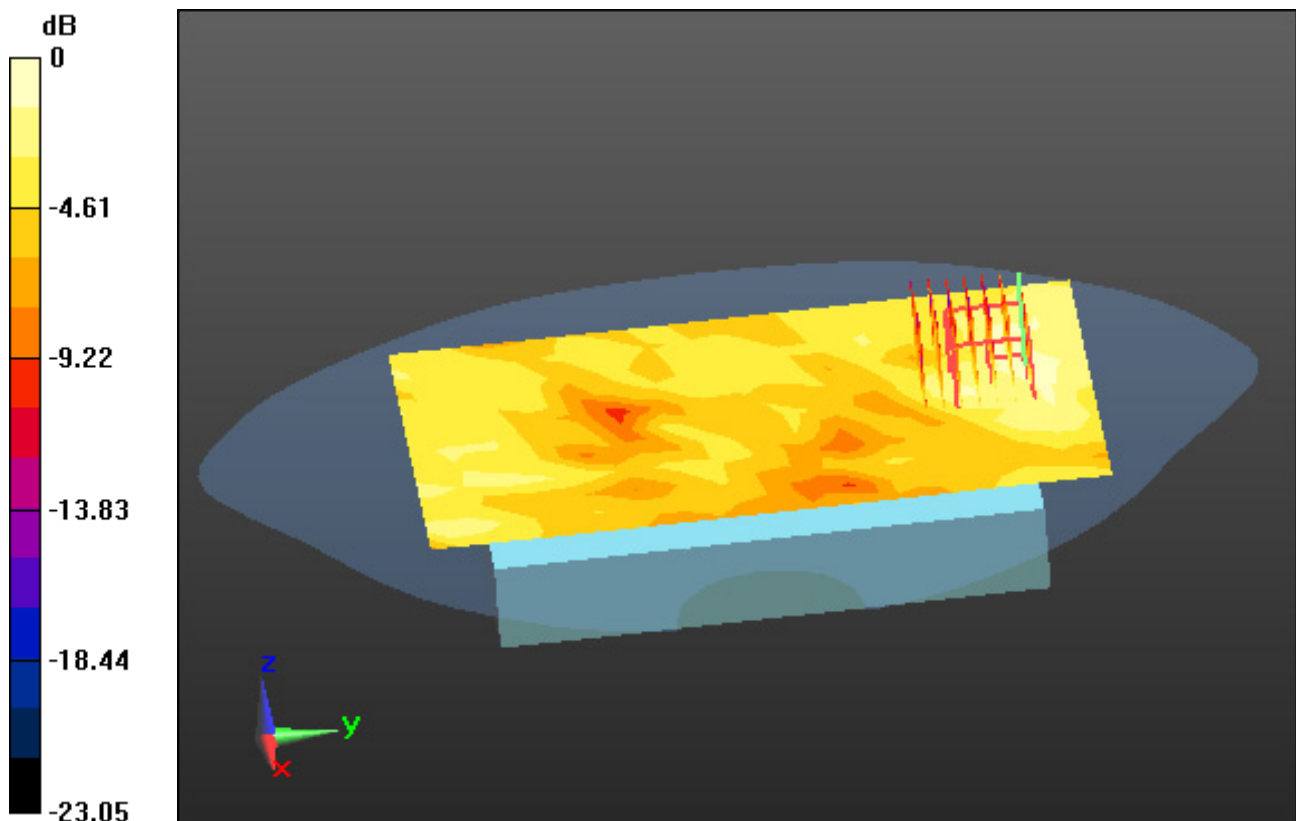

0 dB = 0.00593 W/kg

DT&C Co., Ltd.

DUT: PM90W; Type: PDA

Communication System: UID 0, W-LAN (0); Frequency: 2462 MHz; Duty Cycle: 1:1
Medium parameters used: $f = 2462$ MHz; $\sigma = 1.832$ S/m; $\epsilon_r = 38.292$; $\rho = 1000$ kg/m³
Phantom section: Flat Section

DASY5 Configuration:

Probe: EX3DV4 - SN3916; ConvF(7.66, 7.66, 7.66); Calibrated: 4/25/2019; Electronics: DAE4 Sn1392
Sensor-Surface: 2mm (Mechanical Surface Detection)
Phantom: SAM with CRP_2013_10_08_right; Type: QD000P40CD; Serial: TP:1785
Measurement SW: DASY52, Version 52.8 (8); SEMCAD X Version 14.6.10 (7331)

Test Date: 2019-07-30; Ambient Temp: 20.8; Tissue Temp: 20.5

1.5 cm space from Body, Rear, WLAN(802.11b) Ch. 11, Ant Internal, MIMO

Area Scan (11x17x1): Measurement grid: dx=12mm, dy=12mm

Zoom Scan (7x7x7)/Cube 0: Measurement grid: dx=5mm, dy=5mm, dz=5mm

Power Drift = -0.03 dB

Peak SAR (extrapolated) = 0.0720 W/kg

SAR(1 g) = 0.017 W/kg; SAR(10 g) = 0.00917 W/kg

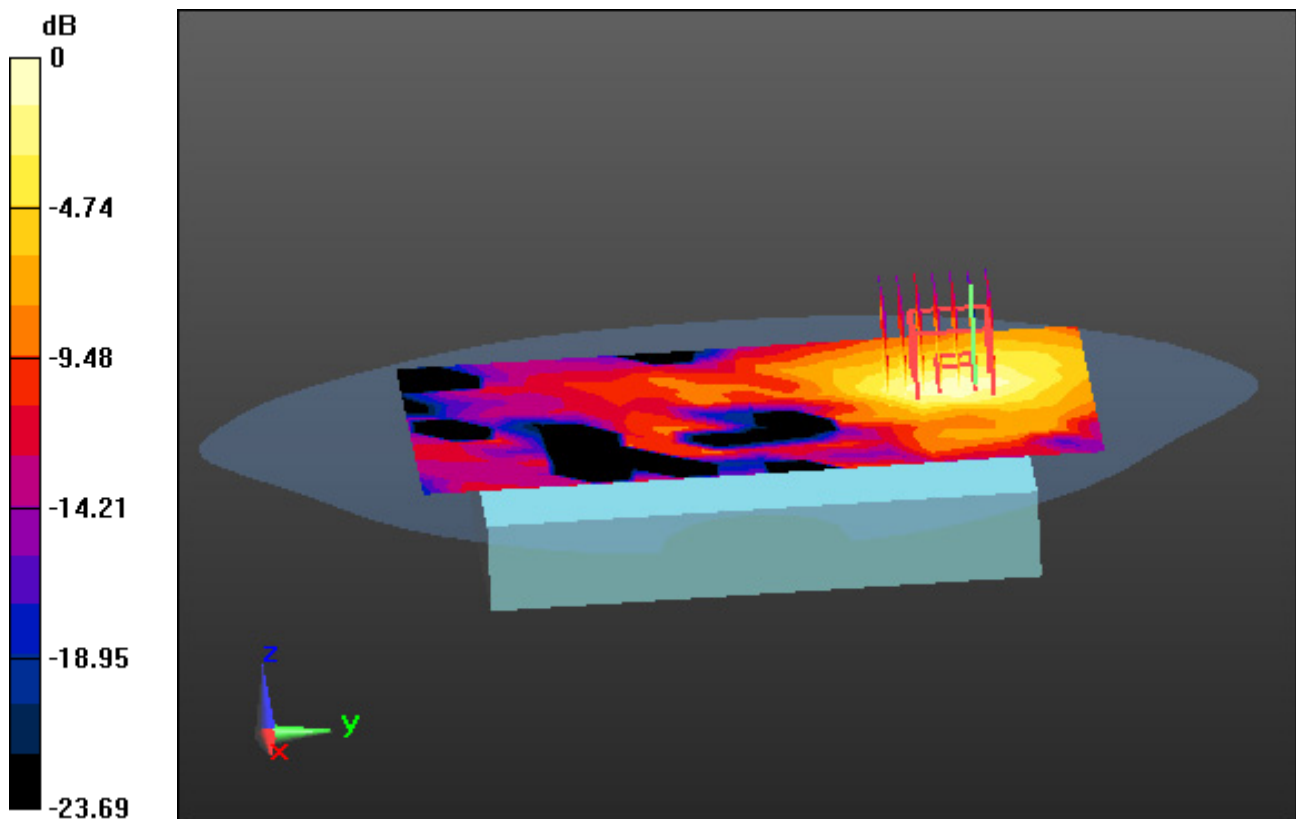

0 dB = 0.0232 W/kg

DT&C Co., Ltd.

DUT: PM90W; Type: PDA

Communication System: UID 0, W-LAN_5300 (0); Frequency: 5260 MHz; Duty Cycle: 1:1
Medium parameters used: $f = 5260$ MHz; $\sigma = 4.55$ S/m; $\epsilon_r = 35.49$; $\rho = 1000$ kg/m³
Phantom section: Flat Section

DASY5 Configuration:

Probe: EX3DV4 - SN3916; ConvF(4.94, 4.94, 4.94); Calibrated: 4/25/2019; Electronics: DAE4 Sn1392
Sensor-Surface: 1.4mm (Mechanical Surface Detection)
Phantom: SAM with CRP_2016_07_22_middle; Type: QD000P40CD; Serial: TP:1786
Measurement SW: DASY52, Version 52.8 (8); SEMCAD X Version 14.6.10 (7331)

Test Date: 2019-07-31; Ambient Temp: 21.0; Tissue Temp: 20.4

1.5 cm space from Body, Front, WLAN(802.11a) Ch. 52, Ant Internal, Ant.1

Area Scan (14x21x1): Measurement grid: dx=10mm, dy=10mm

Zoom Scan (8x8x7)/Cube 0: Measurement grid: dx=4mm, dy=4mm, dz=1.4mm, Graded Ratio:1.4

Power Drift = 0.14 dB

Peak SAR (extrapolated) = 0.250 W/kg

SAR(1 g) = 0.069 W/kg; SAR(10 g) = 0.028 W/kg

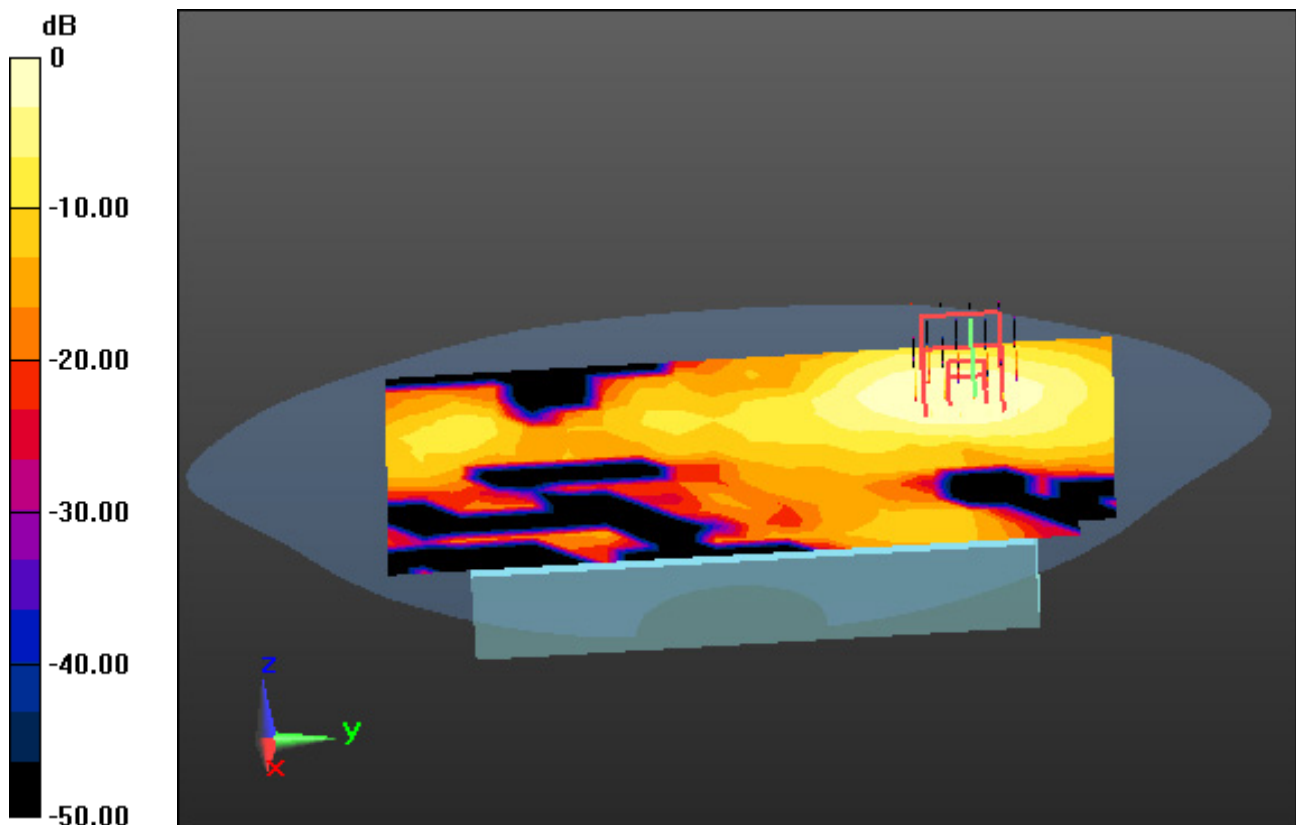

0 dB = 0.154 W/kg

DT&C Co., Ltd.

DUT: PM90W; Type: PDA

Communication System: UID 0, W-LAN_5300 (0); Frequency: 5260 MHz; Duty Cycle: 1:1
Medium parameters used: $f = 5260$ MHz; $\sigma = 4.55$ S/m; $\epsilon_r = 35.49$; $\rho = 1000$ kg/m³
Phantom section: Flat Section

DASY5 Configuration:

Probe: EX3DV4 - SN3916; ConvF(4.94, 4.94, 4.94); Calibrated: 4/25/2019; Electronics: DAE4 Sn1392
Sensor-Surface: 1.4mm (Mechanical Surface Detection)
Phantom: SAM with CRP_2016_07_22_middle; Type: QD000P40CD; Serial: TP:1786
Measurement SW: DASY52, Version 52.8 (8); SEMCAD X Version 14.6.10 (7331)

Test Date: 2019-07-31; Ambient Temp: 21.0; Tissue Temp: 20.4

1.5 cm space from Body, Rear, WLAN(802.11a) Ch. 52, Ant Internal, Ant.2

Area Scan (14x21x1): Measurement grid: dx=10mm, dy=10mm

Zoom Scan (8x8x7)/Cube 0: Measurement grid: dx=4mm, dy=4mm, dz=1.4mm, Graded Ratio:1.4

Power Drift = 0.04 dB

Peak SAR (extrapolated) = 0.358 W/kg

SAR(1 g) = 0.109 W/kg; SAR(10 g) = 0.043 W/kg

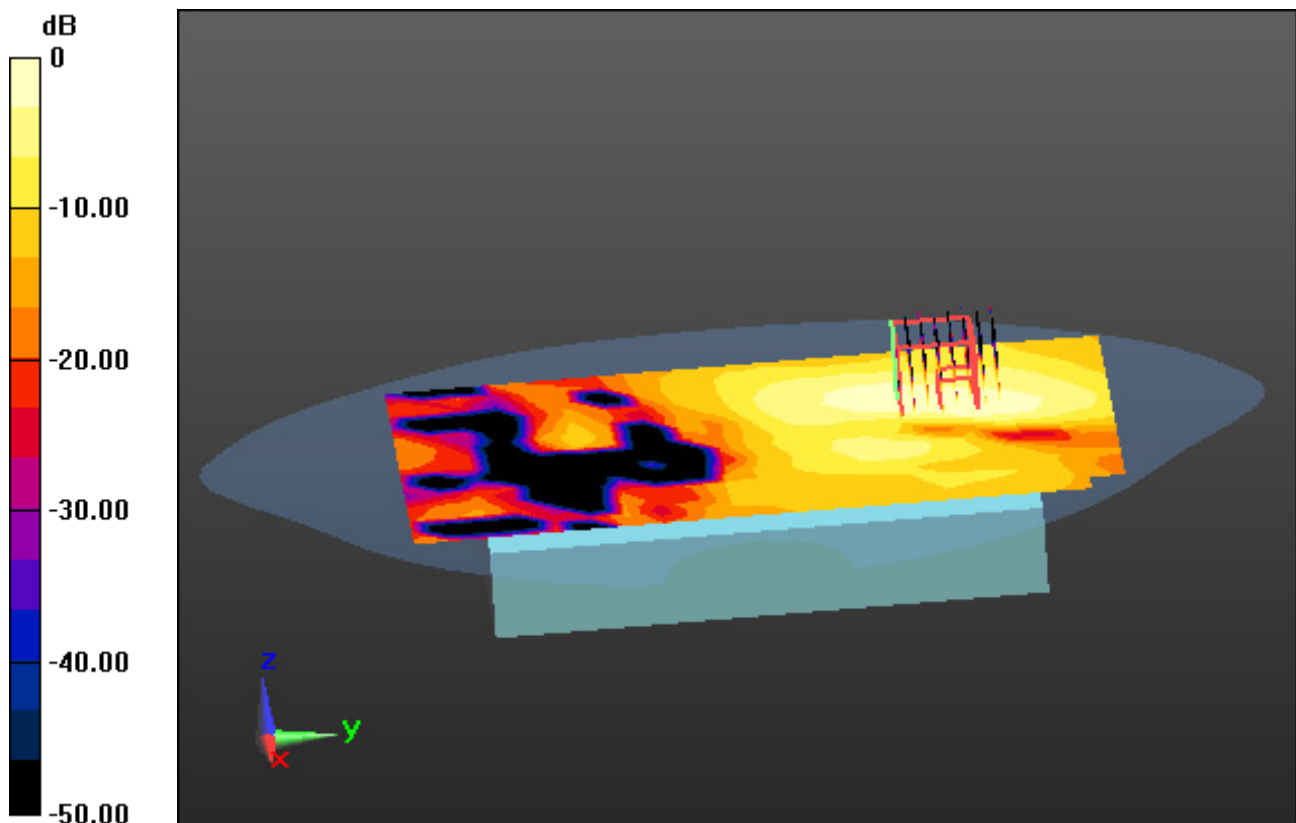

0 dB = 0.238 W/kg

DT&C Co., Ltd.

DUT: PM90W; Type: PDA

Communication System: UID 0, W-LAN_5300 (0); Frequency: 5260 MHz; Duty Cycle: 1:1
Medium parameters used: $f = 5260$ MHz; $\sigma = 4.55$ S/m; $\epsilon_r = 35.49$; $\rho = 1000$ kg/m³
Phantom section: Flat Section

DASY5 Configuration:

Probe: EX3DV4 - SN3916; ConvF(4.94, 4.94, 4.94); Calibrated: 4/25/2019; Electronics: DAE4 Sn1392
Sensor-Surface: 1.4mm (Mechanical Surface Detection)
Phantom: SAM with CRP_2016_07_22_middle; Type: QD000P40CD; Serial: TP:1786
Measurement SW: DASY52, Version 52.8 (8); SEMCAD X Version 14.6.10 (7331)

Test Date: 2019-07-31; Ambient Temp: 21.0; Tissue Temp: 20.4

1.5 cm space from Body, Rear, WLAN(802.11a) Ch. 52, Ant Internal, MIMO

Area Scan (14x21x1): Measurement grid: dx=10mm, dy=10mm

Zoom Scan (8x8x7)/Cube 0: Measurement grid: dx=4mm, dy=4mm, dz=1.4mm, Graded Ratio:1.4

Power Drift = -0.15 dB

Peak SAR (extrapolated) = 0.405 W/kg

SAR(1 g) = 0.112 W/kg; SAR(10 g) = 0.045 W/kg

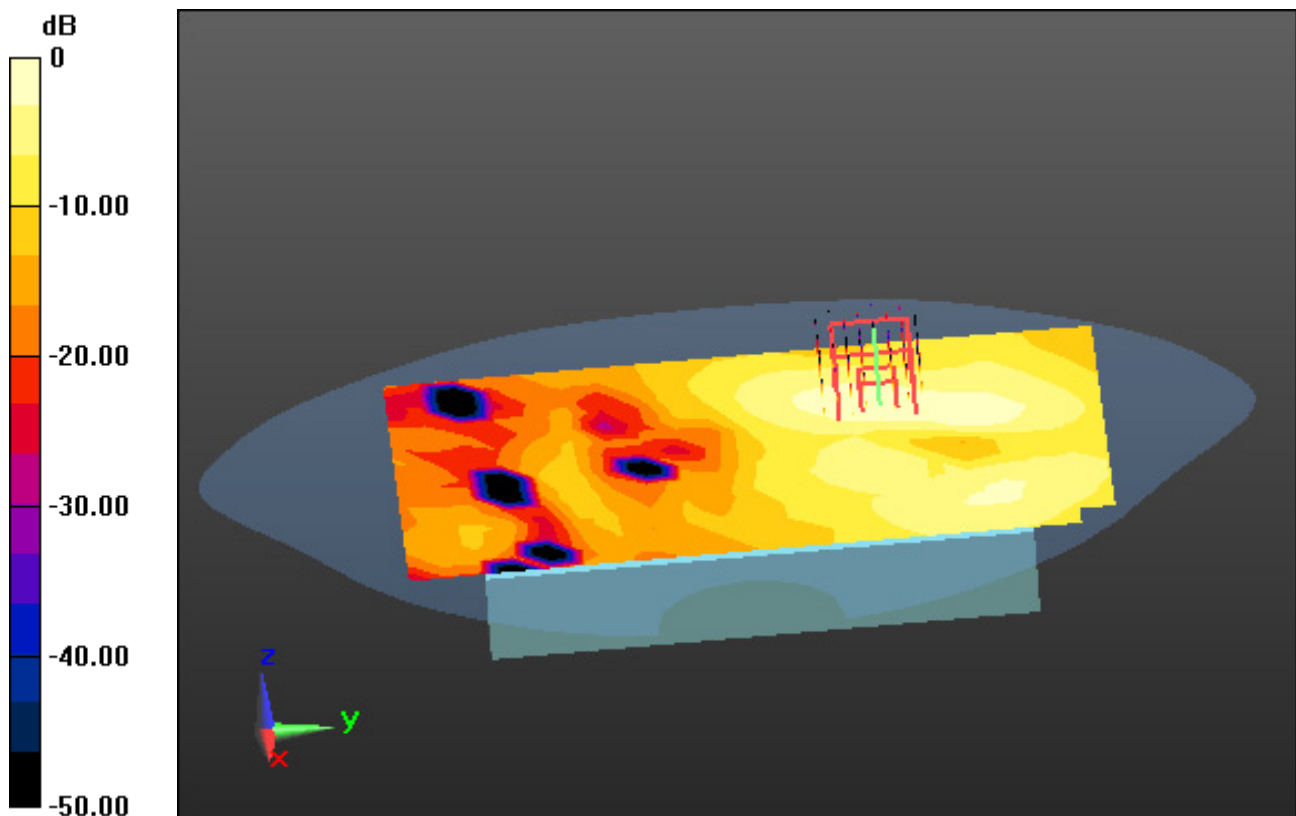

0 dB = 0.253 W/kg

DT&C Co., Ltd.

DUT: PM90W; Type: PDA

Communication System: UID 0, W-LAN_5500 (0); Frequency: 5660 MHz; Duty Cycle: 1:1
Medium parameters used: $f = 5660$ MHz; $\sigma = 5.203$ S/m; $\epsilon_r = 34.884$; $\rho = 1000$ kg/m³
Phantom section: Flat Section

DASY5 Configuration:

Probe: EX3DV4 - SN3933; ConvF(4.71, 4.71, 4.71); Calibrated: 9/25/2018; Electronics: DAE4 Sn1391
Sensor-Surface: 1.4mm (Mechanical Surface Detection)
Phantom: SAM with CRP v5.0(Right); Type: QD000P40CD; Serial: 1220
Measurement SW: DASY52, Version 52.8 (8); SEMCAD X Version 14.6.10 (7331)

Test Date: 2019-07-30; Ambient Temp: 21.3; Tissue Temp: 21.5

1.5 cm space from Body, Rear, WLAN(802.11a) Ch. 132, Ant Internal, Ant.1

Area Scan (14x21x1): Measurement grid: dx=10mm, dy=10mm

Zoom Scan (8x8x7)/Cube 0: Measurement grid: dx=4mm, dy=4mm, dz=1.4mm, Graded Ratio:1.4
Power Drift = -0.11 dB
Peak SAR (extrapolated) = 0.530 W/kg
SAR(1 g) = 0.137 W/kg; SAR(10 g) = 0.056 W/kg

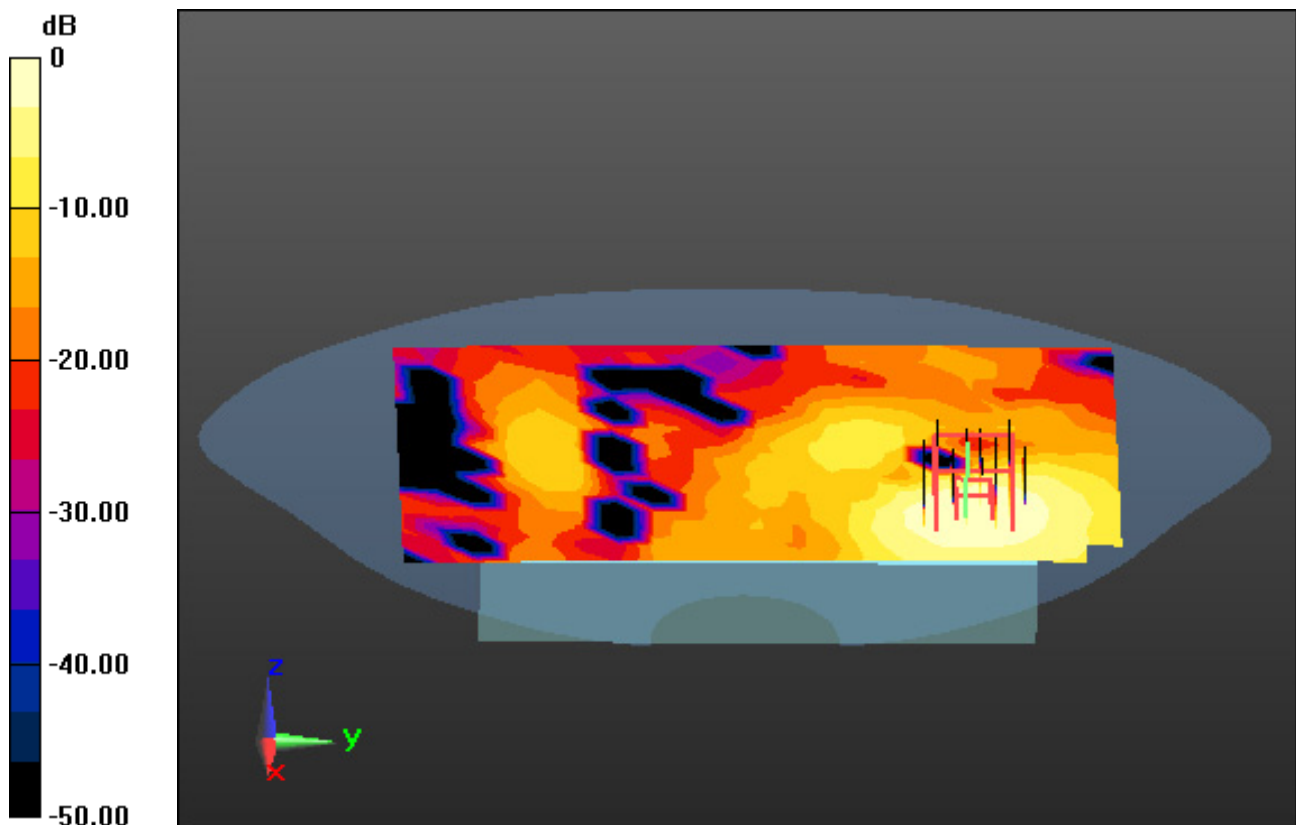

0 dB = 0.315 W/kg

DT&C Co., Ltd.

DUT: PM90W; Type: PDA

Communication System: UID 0, W-LAN_5500 (0); Frequency: 5660 MHz; Duty Cycle: 1:1
Medium parameters used: $f = 5660$ MHz; $\sigma = 5.203$ S/m; $\epsilon_r = 34.884$; $\rho = 1000$ kg/m³
Phantom section: Flat Section

DASY5 Configuration:

Probe: EX3DV4 - SN3933; ConvF(4.71, 4.71, 4.71); Calibrated: 9/25/2018; Electronics: DAE4 Sn1391
Sensor-Surface: 1.4mm (Mechanical Surface Detection)
Phantom: SAM with CRP v5.0(Right); Type: QD000P40CD; Serial: 1220
Measurement SW: DASY52, Version 52.8 (8); SEMCAD X Version 14.6.10 (7331)

Test Date: 2019-07-30; Ambient Temp: 21.3; Tissue Temp: 21.5

1.5 cm space from Body, Rear, WLAN(802.11a) Ch. 132, Ant Internal, Ant.2

Area Scan (14x21x1): Measurement grid: dx=10mm, dy=10mm

Zoom Scan (8x8x7)/Cube 0: Measurement grid: dx=4mm, dy=4mm, dz=1.4mm, Graded Ratio:1.4

Power Drift = 0.07 dB

Peak SAR (extrapolated) = 0.353 W/kg

SAR(1 g) = 0.079 W/kg; SAR(10 g) = 0.033 W/kg

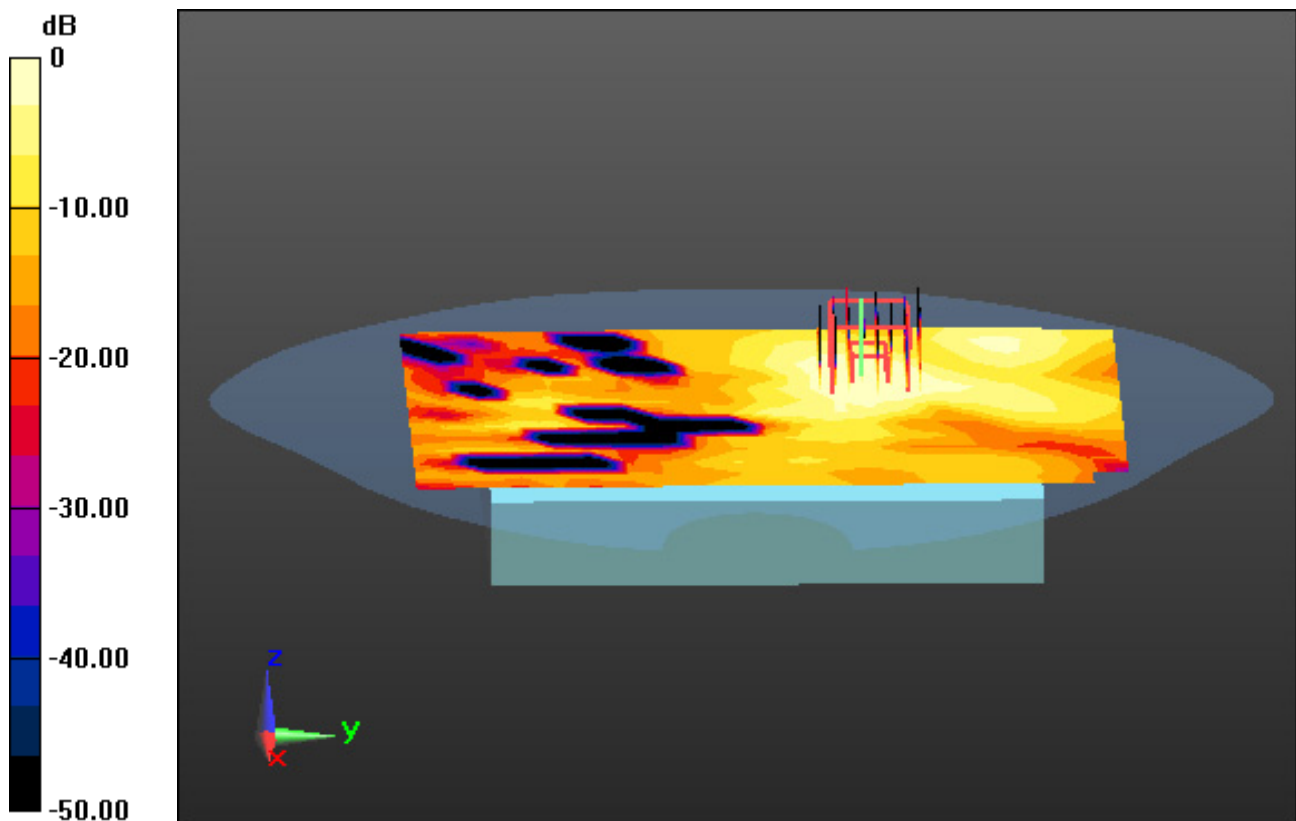

0 dB = 0.186 W/kg

DT&C Co., Ltd.

DUT: PM90W; Type: PDA

Communication System: UID 0, W-LAN 5.6G&5.8G (0); Frequency: 5660 MHz; Duty Cycle: 1:1
Medium parameters used: $f = 5660$ MHz; $\sigma = 5.203$ S/m; $\epsilon_r = 34.884$; $\rho = 1000$ kg/m³
Phantom section: Flat Section

DASY5 Configuration:

Probe: EX3DV4 - SN3933; ConvF(4.71, 4.71, 4.71); Calibrated: 9/25/2018; Electronics: DAE4 Sn1391
Sensor-Surface: 1.4mm (Mechanical Surface Detection)
Phantom: SAM with CRP v5.0(Right); Type: QD000P40CD; Serial: 1220
Measurement SW: DASY52, Version 52.8 (8); SEMCAD X Version 14.6.10 (7331)

Test Date: 2019-07-30; Ambient Temp: 21.3; Tissue Temp: 21.5

1.5 cm space from Body, Rear, WLAN(802.11a) Ch. 132, Ant Internal, MIMO

Area Scan (14x21x1): Measurement grid: dx=10mm, dy=10mm

Zoom Scan (8x8x7)/Cube 0: Measurement grid: dx=4mm, dy=4mm, dz=1.4mm, Graded Ratio:1.4

Power Drift = -0.00 dB

Peak SAR (extrapolated) = 0.608 W/kg

SAR(1 g) = 0.162 W/kg; SAR(10 g) = 0.068 W/kg

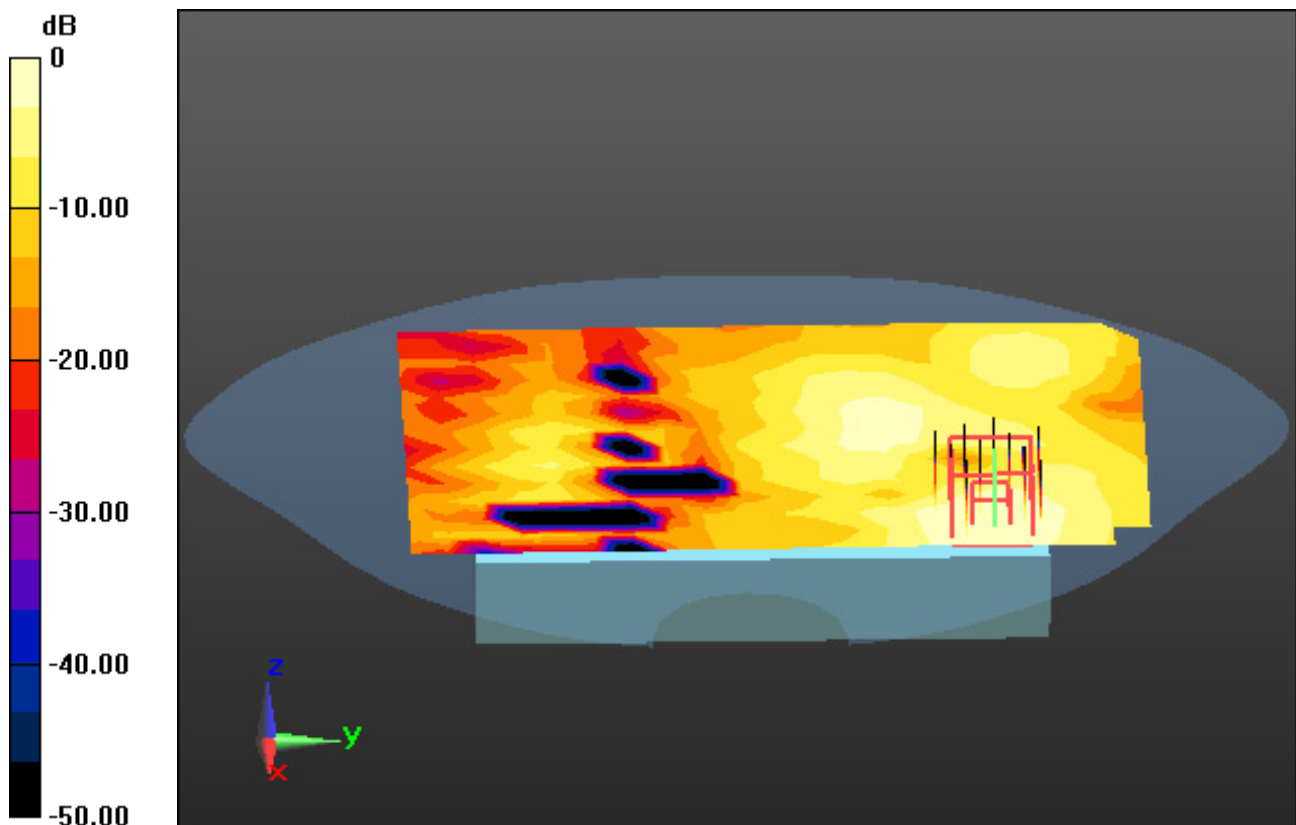

0 dB = 0.363 W/kg

DT&C Co., Ltd.

DUT: PM90W; Type: PDA

Communication System: UID 0, W-LAN_5800 (0); Frequency: 5825 MHz; Duty Cycle: 1:1
Medium parameters used: $f = 5825$ MHz; $\sigma = 5.385$ S/m; $\epsilon_r = 34.989$; $\rho = 1000$ kg/m³
Phantom section: Flat Section

DASY5 Configuration:

Probe: EX3DV4 - SN3933; ConvF(4.77, 4.77, 4.77); Calibrated: 9/25/2018; Electronics: DAE4 Sn1391
Sensor-Surface: 1.4mm (Mechanical Surface Detection)
Phantom: SAM with CRP v5.0(Right); Type: QD000P40CD; Serial: 1220
Measurement SW: DASY52, Version 52.8 (8); SEMCAD X Version 14.6.10 (7331)

Test Date: 2019-08-06; Ambient Temp: 21.8; Tissue Temp: 22.0

1.5 cm space from Body, Rear, WLAN(802.11a) Ch. 165, Ant Internal, Ant.1

Area Scan (14x21x1): Measurement grid: dx=10mm, dy=10mm

Zoom Scan (8x8x7)/Cube 0: Measurement grid: dx=4mm, dy=4mm, dz=1.4mm, Graded Ratio:1.4

Power Drift = -0.10 dB

Peak SAR (extrapolated) = 0.479 W/kg

SAR(1 g) = 0.126 W/kg; SAR(10 g) = 0.050 W/kg

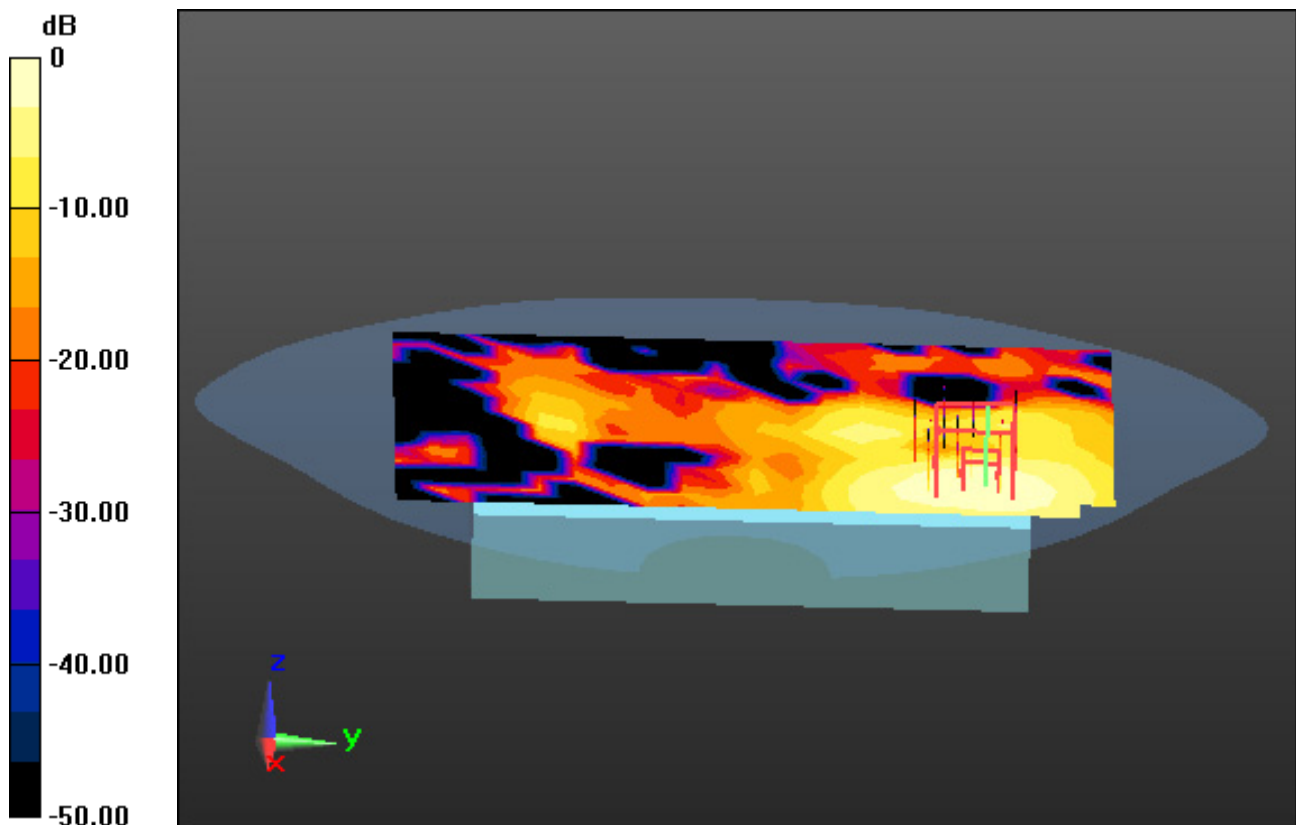

0 dB = 0.295 W/kg

DT&C Co., Ltd.

DUT: PM90W; Type: PDA

Communication System: UID 0, W-LAN_5800 (0); Frequency: 5825 MHz; Duty Cycle: 1:1
Medium parameters used: $f = 5825$ MHz; $\sigma = 5.385$ S/m; $\epsilon_r = 34.989$; $\rho = 1000$ kg/m³
Phantom section: Flat Section

DASY5 Configuration:

Probe: EX3DV4 - SN3933; ConvF(4.77, 4.77, 4.77); Calibrated: 9/25/2018; Electronics: DAE4 Sn1391
Sensor-Surface: 1.4mm (Mechanical Surface Detection)
Phantom: SAM with CRP v5.0(Right); Type: QD000P40CD; Serial: 1220
Measurement SW: DASY52, Version 52.8 (8); SEMCAD X Version 14.6.10 (7331)

Test Date: 2019-08-06; Ambient Temp: 21.8; Tissue Temp: 22.0

1.5 cm space from Body, Rear, WLAN(802.11a) Ch. 165, Ant Internal, Ant.2

Area Scan (14x21x1): Measurement grid: dx=10mm, dy=10mm

Zoom Scan (8x8x7)/Cube 0: Measurement grid: dx=4mm, dy=4mm, dz=1.4mm, Graded Ratio:1.4

Power Drift = -0.02 dB

Peak SAR (extrapolated) = 0.334 W/kg

SAR(1 g) = 0.090 W/kg; SAR(10 g) = 0.034 W/kg

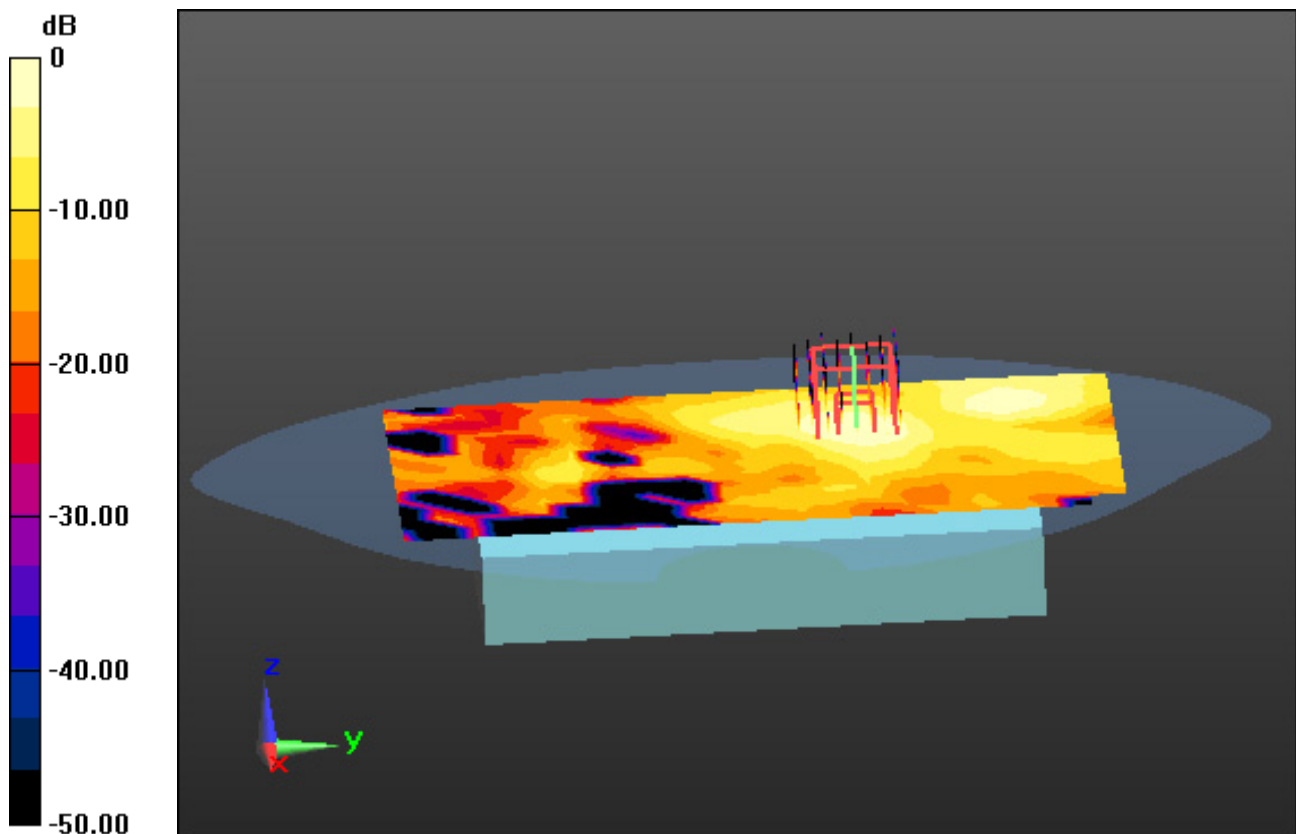

0 dB = 0.223 W/kg

DT&C Co., Ltd.

DUT: PM90W; Type: PDA

Communication System: UID 0, W-LAN 5.8G(802.11a/n/ac) (0); Frequency: 5825 MHz; Duty Cycle: 1:1
Medium parameters used: $f = 5825$ MHz; $\sigma = 5.385$ S/m; $\epsilon_r = 34.989$; $\rho = 1000$ kg/m³
Phantom section: Flat Section

DASY5 Configuration:

Probe: EX3DV4 - SN3933; ConvF(4.77, 4.77, 4.77); Calibrated: 9/25/2018; Electronics: DAE4 Sn1391
Sensor-Surface: 1.4mm (Mechanical Surface Detection)
Phantom: SAM with CRP v5.0(Right); Type: QD000P40CD; Serial: 1220
Measurement SW: DASY52, Version 52.8 (8); SEMCAD X Version 14.6.10 (7331)

Test Date: 2019-08-06; Ambient Temp: 21.8; Tissue Temp: 22.0

1.5 cm space from Body, Rear, WLAN(802.11a) Ch. 165, Ant Internal, MIMO

Area Scan (14x21x1): Measurement grid: dx=10mm, dy=10mm

Zoom Scan (8x8x7)/Cube 0: Measurement grid: dx=4mm, dy=4mm, dz=1.4mm, Graded Ratio:1.4

Power Drift = -0.18 dB

Peak SAR (extrapolated) = 0.576 W/kg

SAR(1 g) = 0.143 W/kg; SAR(10 g) = 0.060 W/kg

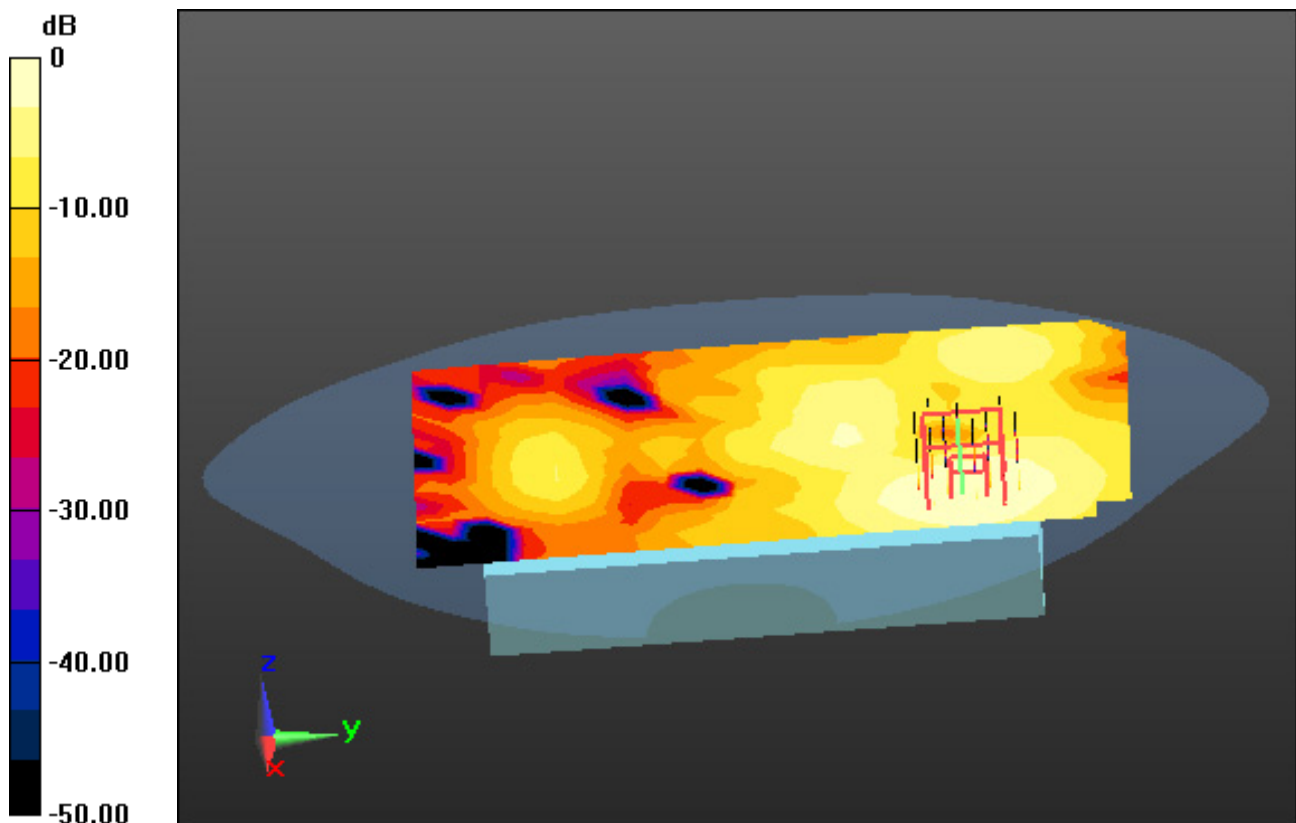

0 dB = 0.332 W/kg

DT&C Co., Ltd.

DUT: PM90W; Type: PDA

Communication System: UID 0, Bluetooth (0); Frequency: 2441 MHz; Duty Cycle: 1:1.30227
Medium parameters used: $f = 2441$ MHz; $\sigma = 1.802$ S/m; $\epsilon_r = 38.404$; $\rho = 1000$ kg/m³
Phantom section: Flat Section

DASY5 Configuration:

Probe: EX3DV4 - SN3916; ConvF(7.66, 7.66, 7.66); Calibrated: 4/25/2019; Electronics: DAE4 Sn1392
Sensor-Surface: 2mm (Mechanical Surface Detection)
Phantom: SAM with CRP_2013_10_08_right; Type: QD000P40CD; Serial: TP:1785
Measurement SW: DASY52, Version 52.8 (8); SEMCAD X Version 14.6.10 (7331)

Test Date: 2019-08-13; Ambient Temp: 20.4; Tissue Temp: 20.6

1.5 cm space from Body, Front, Bluetooth Ch. 39, Ant Internal

Area Scan (11x17x1): Measurement grid: dx=12mm, dy=12mm

Zoom Scan (7x7x7)/Cube 0: Measurement grid: dx=5mm, dy=5mm, dz=5mm

Power Drift = -0.08 dB

Peak SAR (extrapolated) = 0.0120 W/kg

SAR(1 g) = 0.00261 W/kg; SAR(10 g) = 0.000749 W/kg

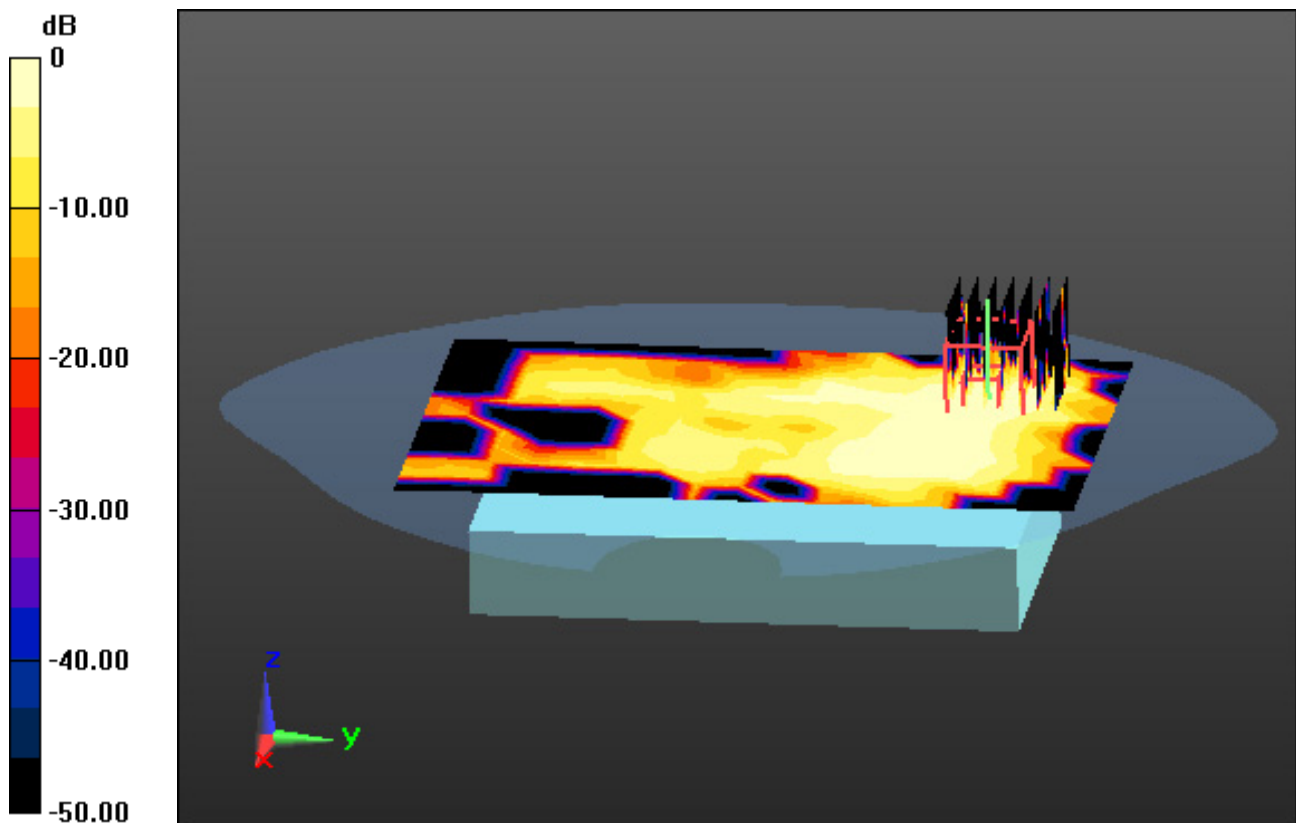

0 dB = 0.00605 W/kg

DT&C Co., Ltd.

DUT: PM90W; Type: PDA

Communication System: UID 0, W-LAN (0); Frequency: 2462 MHz; Duty Cycle: 1:1
Medium parameters used: $f = 2462$ MHz; $\sigma = 1.832$ S/m; $\epsilon_r = 38.292$; $\rho = 1000$ kg/m³
Phantom section: Flat Section

DASY5 Configuration:

Probe: EX3DV4 - SN3916; ConvF(7.66, 7.66, 7.66); Calibrated: 4/25/2019; Electronics: DAE4 Sn1392
Sensor-Surface: 2mm (Mechanical Surface Detection)
Phantom: SAM with CRP_2013_10_08_right; Type: QD000P40CD; Serial: TP:1785
Measurement SW: DASY52, Version 52.8 (8); SEMCAD X Version 14.6.10 (7331)

Test Date: 2019-07-30; Ambient Temp: 20.8; Tissue Temp: 20.5

Touch from Body, Left, WLAN(802.11b) Ch. 11, Ant Internal, Ant.1

Area Scan (7x17x1): Measurement grid: dx=12mm, dy=12mm

Zoom Scan (7x7x7)/Cube 0: Measurement grid: dx=5mm, dy=5mm, dz=5mm

Power Drift = -0.04 dB

Peak SAR (extrapolated) = 0.933 W/kg

SAR(1 g) = 0.319 W/kg; SAR(10 g) = 0.111 W/kg

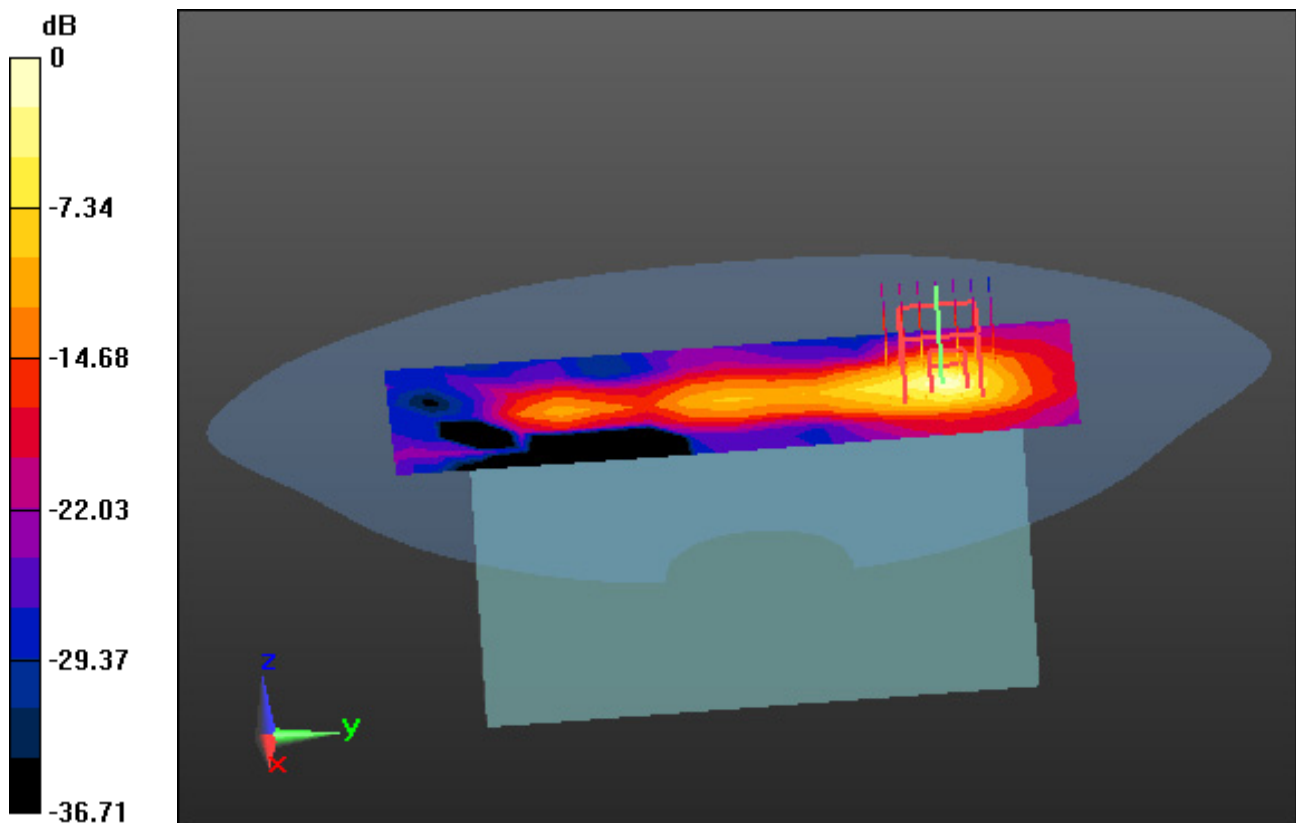

0 dB = 0.587 W/kg

DT&C Co., Ltd.

DUT: PM90W; Type: PDA

Communication System: UID 0, W-LAN (0); Frequency: 2412 MHz; Duty Cycle: 1:1
Medium parameters used: $f = 2412$ MHz; $\sigma = 1.777$ S/m; $\epsilon_r = 38.481$; $\rho = 1000$ kg/m³
Phantom section: Flat Section

DASY5 Configuration:

Probe: EX3DV4 - SN3916; ConvF(7.66, 7.66, 7.66); Calibrated: 4/25/2019; Electronics: DAE4 Sn1392
Sensor-Surface: 2mm (Mechanical Surface Detection)
Phantom: SAM with CRP_2013_10_08_right; Type: QD000P40CD; Serial: TP:1785
Measurement SW: DASY52, Version 52.8 (8); SEMCAD X Version 14.6.10 (7331)

Test Date: 2019-07-30; Ambient Temp: 20.8; Tissue Temp: 20.5

Touch from Body, Right, WLAN(802.11b) Ch. 1, Ant Internal, Ant.2

Area Scan (7x17x1): Measurement grid: dx=12mm, dy=12mm

Zoom Scan (7x7x7)/Cube 0: Measurement grid: dx=5mm, dy=5mm, dz=5mm

Power Drift = 0.09 dB

Peak SAR (extrapolated) = 0.200 W/kg

SAR(1 g) = 0.080 W/kg; SAR(10 g) = 0.032 W/kg

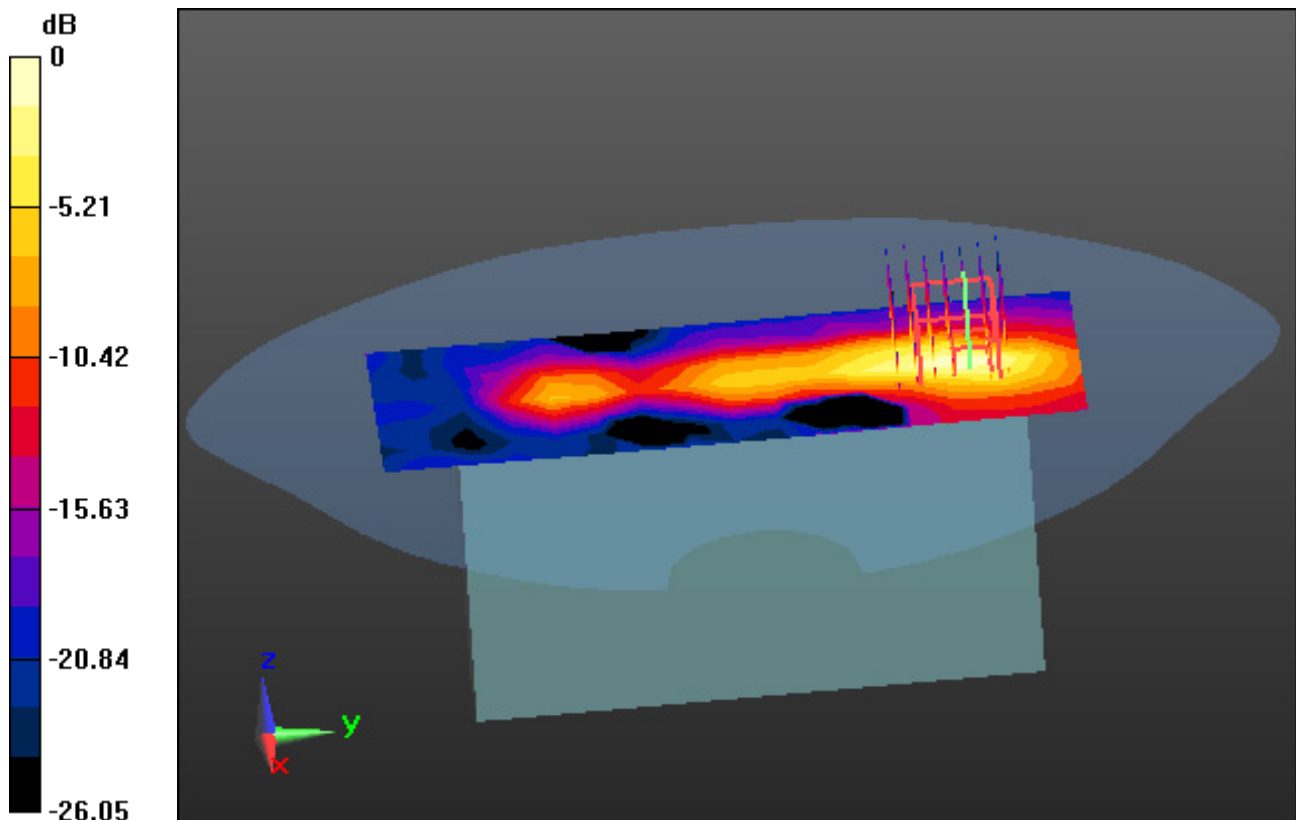

0 dB = 0.128 W/kg

DT&C Co., Ltd.

DUT: PM90W; Type: PDA

Communication System: UID 0, W-LAN (0); Frequency: 2462 MHz; Duty Cycle: 1:1
Medium parameters used: $f = 2462$ MHz; $\sigma = 1.832$ S/m; $\epsilon_r = 38.292$; $\rho = 1000$ kg/m³
Phantom section: Flat Section

DASY5 Configuration:

Probe: EX3DV4 - SN3916; ConvF(7.66, 7.66, 7.66); Calibrated: 4/25/2019; Electronics: DAE4 Sn1392
Sensor-Surface: 2mm (Mechanical Surface Detection)
Phantom: SAM with CRP_2013_10_08_right; Type: QD000P40CD; Serial: TP:1785
Measurement SW: DASY52, Version 52.8 (8); SEMCAD X Version 14.6.10 (7331)

Test Date: 2019-07-30; Ambient Temp: 20.8; Tissue Temp: 20.5

Touch from Body, Left, WLAN(802.11b) Ch. 11, Ant Internal, MIMO

Area Scan (7x17x1): Measurement grid: dx=12mm, dy=12mm

Zoom Scan (7x7x7)/Cube 0: Measurement grid: dx=5mm, dy=5mm, dz=5mm

Power Drift = -0.10 dB

Peak SAR (extrapolated) = 0.625 W/kg

SAR(1 g) = 0.235 W/kg; SAR(10 g) = 0.087 W/kg

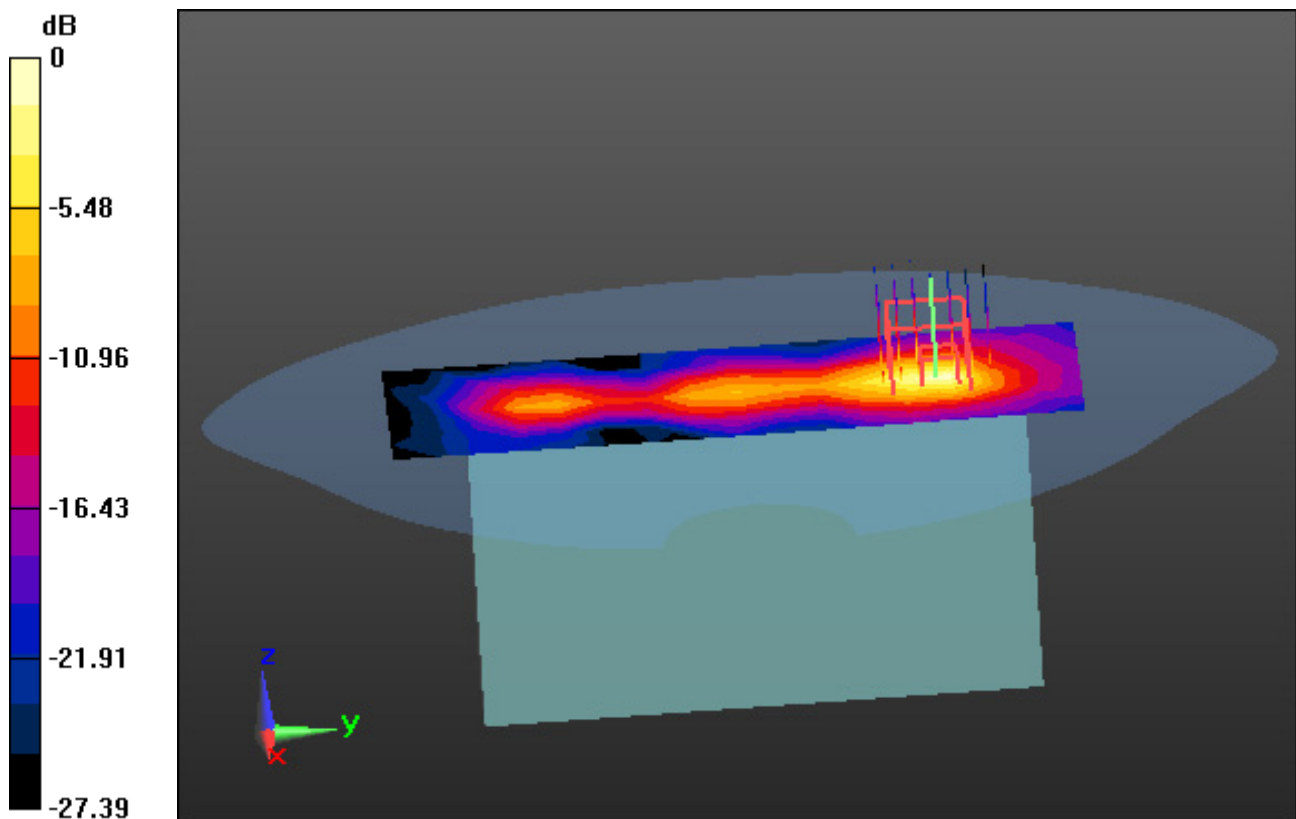

0 dB = 0.409 W/kg

DT&C Co., Ltd.

DUT: PM90W; Type: PDA

Communication System: UID 0, W-LAN_5300 (0); Frequency: 5260 MHz; Duty Cycle: 1:1
Medium parameters used: $f = 5260$ MHz; $\sigma = 4.55$ S/m; $\epsilon_r = 35.49$; $\rho = 1000$ kg/m³
Phantom section: Flat Section

DASY5 Configuration:

Probe: EX3DV4 - SN3916; ConvF(4.94, 4.94, 4.94); Calibrated: 4/25/2019; Electronics: DAE4 Sn1392
Sensor-Surface: 1.4mm (Mechanical Surface Detection)
Phantom: SAM with CRP_2016_07_22_middle; Type: QD000P40CD; Serial: TP:1786
Measurement SW: DASY52, Version 52.8 (8); SEMCAD X Version 14.6.10 (7331)

Test Date: 2019-07-31; Ambient Temp: 21.0; Tissue Temp: 20.4

Touch from Body, Left, WLAN(802.11a) Ch. 52, Ant Internal, Ant.1

Area Scan (9x21x1): Measurement grid: dx=10mm, dy=10mm

Zoom Scan (8x8x7)/Cube 0: Measurement grid: dx=4mm, dy=4mm, dz=1.4mm, Graded Ratio:1.4

Power Drift = -0.04 dB

Peak SAR (extrapolated) = 4.14 W/kg

SAR(1 g) = 0.918 W/kg; SAR(10 g) = 0.287 W/kg

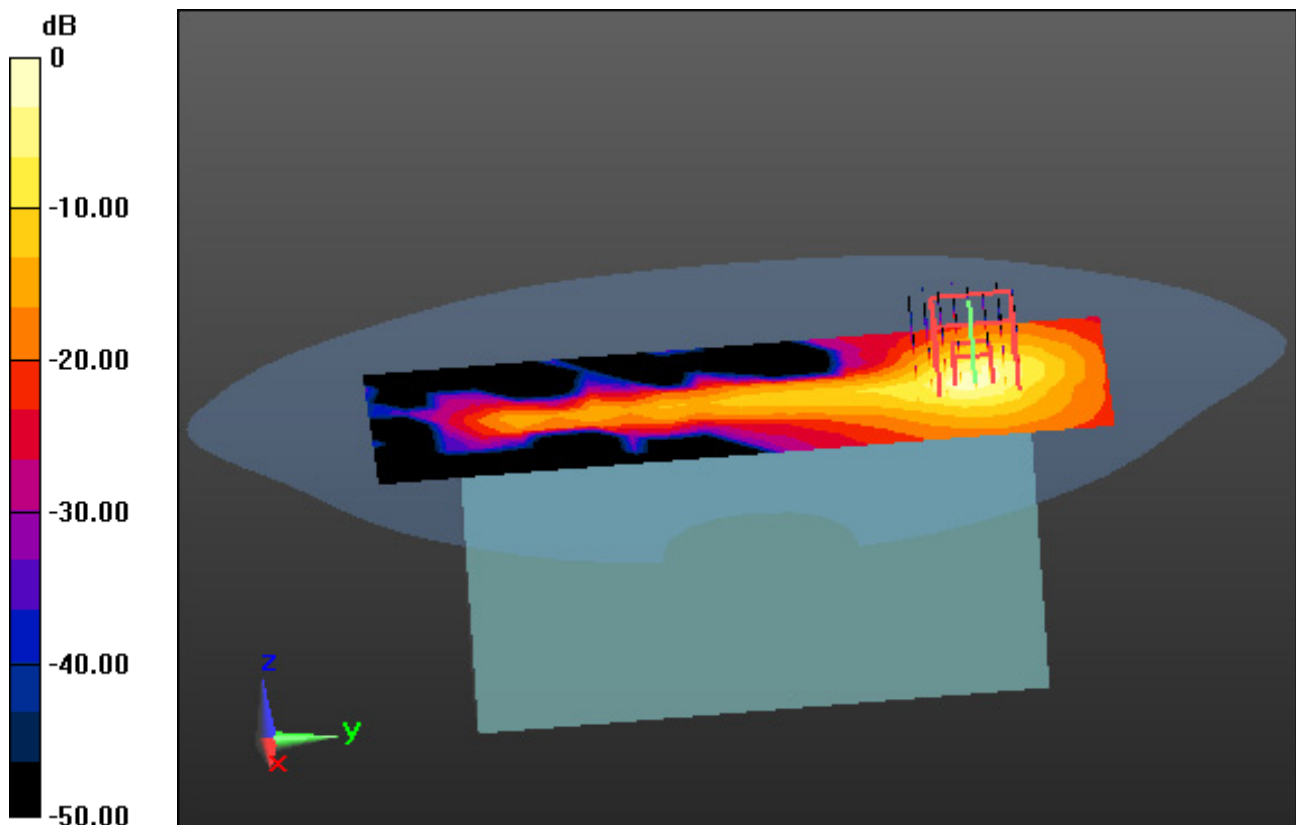

0 dB = 2.25 W/kg

DT&C Co., Ltd.

DUT: PM90W; Type: PDA

Communication System: UID 0, W-LAN_5300 (0); Frequency: 5260 MHz; Duty Cycle: 1:1
Medium parameters used: $f = 5260$ MHz; $\sigma = 4.55$ S/m; $\epsilon_r = 35.49$; $\rho = 1000$ kg/m³
Phantom section: Flat Section

DASY5 Configuration:

Probe: EX3DV4 - SN3916; ConvF(4.94, 4.94, 4.94); Calibrated: 4/25/2019; Electronics: DAE4 Sn1392
Sensor-Surface: 1.4mm (Mechanical Surface Detection)
Phantom: SAM with CRP_2016_07_22_middle; Type: QD000P40CD; Serial: TP:1786
Measurement SW: DASY52, Version 52.8 (8); SEMCAD X Version 14.6.10 (7331)

Test Date: 2019-07-31; Ambient Temp: 21.0; Tissue Temp: 20.4

Touch from Body, Right, WLAN(802.11a) Ch. 52, Ant Internal, Ant.2

Area Scan (9x21x1): Measurement grid: dx=10mm, dy=10mm

Zoom Scan (8x8x7)/Cube 0: Measurement grid: dx=4mm, dy=4mm, dz=1.4mm, Graded Ratio:1.4

Power Drift = -0.19 dB

Peak SAR (extrapolated) = 5.28 W/kg

SAR(1 g) = 1.24 W/kg; SAR(10 g) = 0.307 W/kg

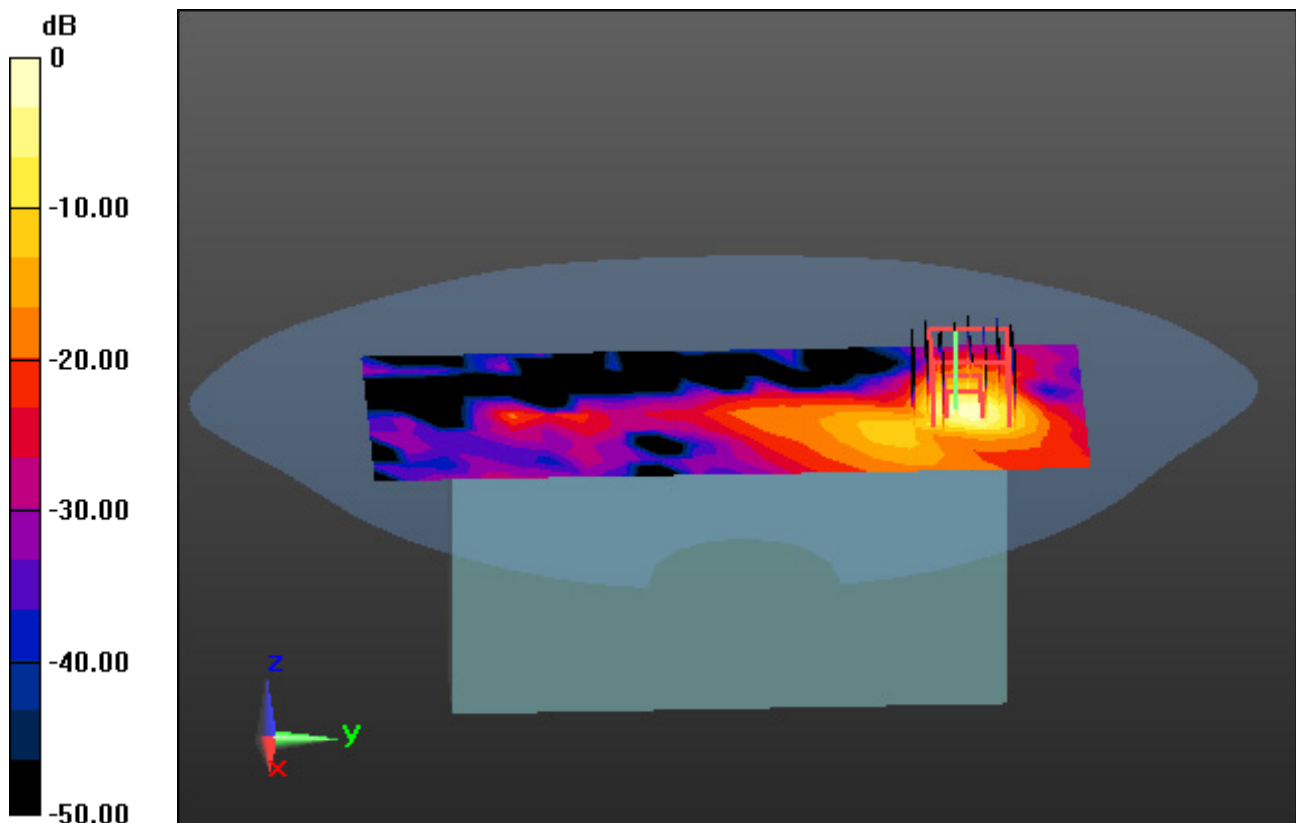

0 dB = 2.98 W/kg

DT&C Co., Ltd.

DUT: PM90W; Type: PDA

Communication System: UID 0, W-LAN_5300 (0); Frequency: 5260 MHz; Duty Cycle: 1:1
Medium parameters used: $f = 5260$ MHz; $\sigma = 4.55$ S/m; $\epsilon_r = 35.49$; $\rho = 1000$ kg/m³
Phantom section: Flat Section

DASY5 Configuration:

Probe: EX3DV4 - SN3916; ConvF(4.94, 4.94, 4.94); Calibrated: 4/25/2019; Electronics: DAE4 Sn1392
Sensor-Surface: 1.4mm (Mechanical Surface Detection)
Phantom: SAM with CRP_2016_07_22_middle; Type: QD000P40CD; Serial: TP:1786
Measurement SW: DASY52, Version 52.8 (8); SEMCAD X Version 14.6.10 (7331)

Test Date: 2019-07-31; Ambient Temp: 21.0; Tissue Temp: 20.4

Touch from Body, Left, WLAN(802.11a) Ch. 52, Ant Internal, MIMO

Area Scan (9x21x1): Measurement grid: dx=10mm, dy=10mm

Zoom Scan (8x8x7)/Cube 0: Measurement grid: dx=4mm, dy=4mm, dz=1.4mm, Graded Ratio:1.4

Power Drift = 0.19 dB

Peak SAR (extrapolated) = 8.14 W/kg

SAR(1 g) = 1.79 W/kg; SAR(10 g) = 0.469 W/kg

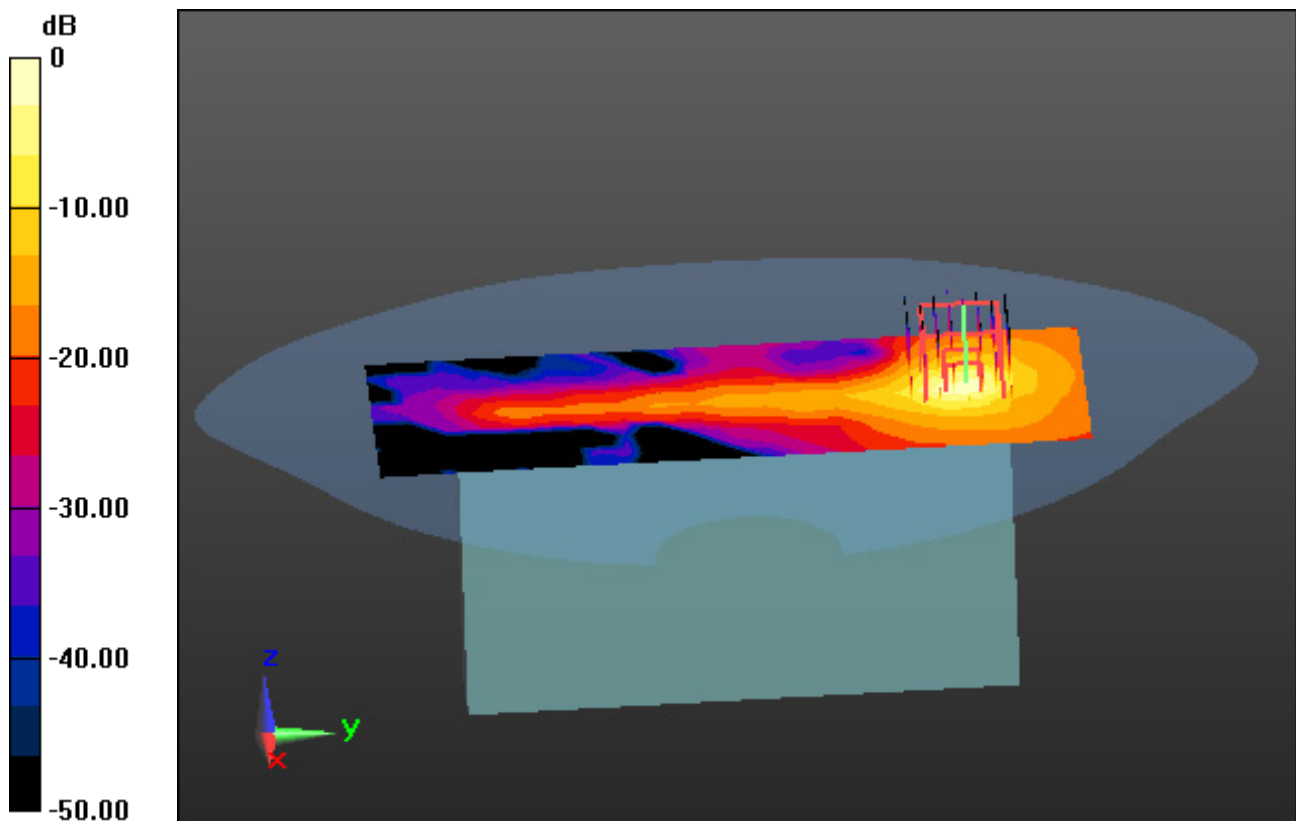

0 dB = 4.71 W/kg

DT&C Co., Ltd.

DUT: PM90W; Type: PDA

Communication System: UID 0, W-LAN_5500 (0); Frequency: 5660 MHz; Duty Cycle: 1:1
Medium parameters used: $f = 5660$ MHz; $\sigma = 5.203$ S/m; $\epsilon_r = 34.884$; $\rho = 1000$ kg/m³
Phantom section: Flat Section

DASY5 Configuration:

Probe: EX3DV4 - SN3933; ConvF(4.71, 4.71, 4.71); Calibrated: 9/25/2018; Electronics: DAE4 Sn1391
Sensor-Surface: 1.4mm (Mechanical Surface Detection)
Phantom: SAM with CRP v5.0(Right); Type: QD000P40CD; Serial: 1220
Measurement SW: DASY52, Version 52.8 (8); SEMCAD X Version 14.6.10 (7331)

Test Date: 2019-07-30; Ambient Temp: 21.3; Tissue Temp: 21.5

Touch from Body, Left, WLAN(802.11a) Ch. 132, Ant Internal, Ant.1

Area Scan (9x21x1): Measurement grid: dx=10mm, dy=10mm

Zoom Scan (8x8x7)/Cube 0: Measurement grid: dx=4mm, dy=4mm, dz=1.4mm, Graded Ratio:1.4

Power Drift = -0.06 dB

Peak SAR (extrapolated) = 14.8 W/kg

SAR(1 g) = 2.86 W/kg; SAR(10 g) = 0.697 W/kg

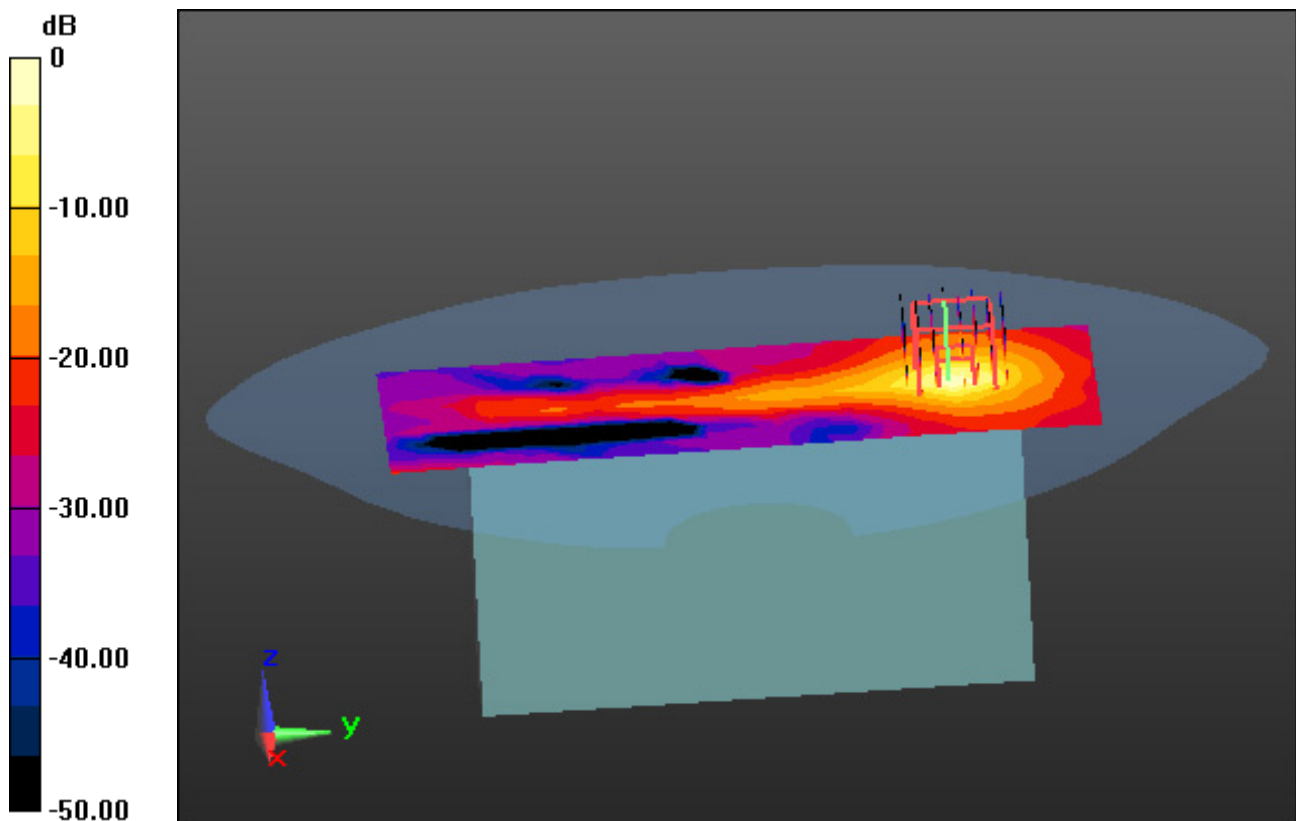

0 dB = 7.45 W/kg

DT&C Co., Ltd.

DUT: PM90W; Type: PDA

Communication System: UID 0, W-LAN_5500 (0); Frequency: 5660 MHz; Duty Cycle: 1:1
Medium parameters used: $f = 5660$ MHz; $\sigma = 5.203$ S/m; $\epsilon_r = 34.884$; $\rho = 1000$ kg/m³
Phantom section: Flat Section

DASY5 Configuration:

Probe: EX3DV4 - SN3933; ConvF(4.71, 4.71, 4.71); Calibrated: 9/25/2018; Electronics: DAE4 Sn1391
Sensor-Surface: 1.4mm (Mechanical Surface Detection)
Phantom: SAM with CRP v5.0(Right); Type: QD000P40CD; Serial: 1220
Measurement SW: DASY52, Version 52.8 (8); SEMCAD X Version 14.6.10 (7331)

Test Date: 2019-07-30; Ambient Temp: 21.3; Tissue Temp: 21.5

Touch from Body, Right, WLAN(802.11a) Ch. 132, Ant Internal, Ant.2

Area Scan (9x21x1): Measurement grid: dx=10mm, dy=10mm

Zoom Scan (8x8x7)/Cube 0: Measurement grid: dx=4mm, dy=4mm, dz=1.4mm, Graded Ratio:1.4

Power Drift = 0.02 dB

Peak SAR (extrapolated) = 5.96 W/kg

SAR(1 g) = 1.3 W/kg; SAR(10 g) = 0.346 W/kg

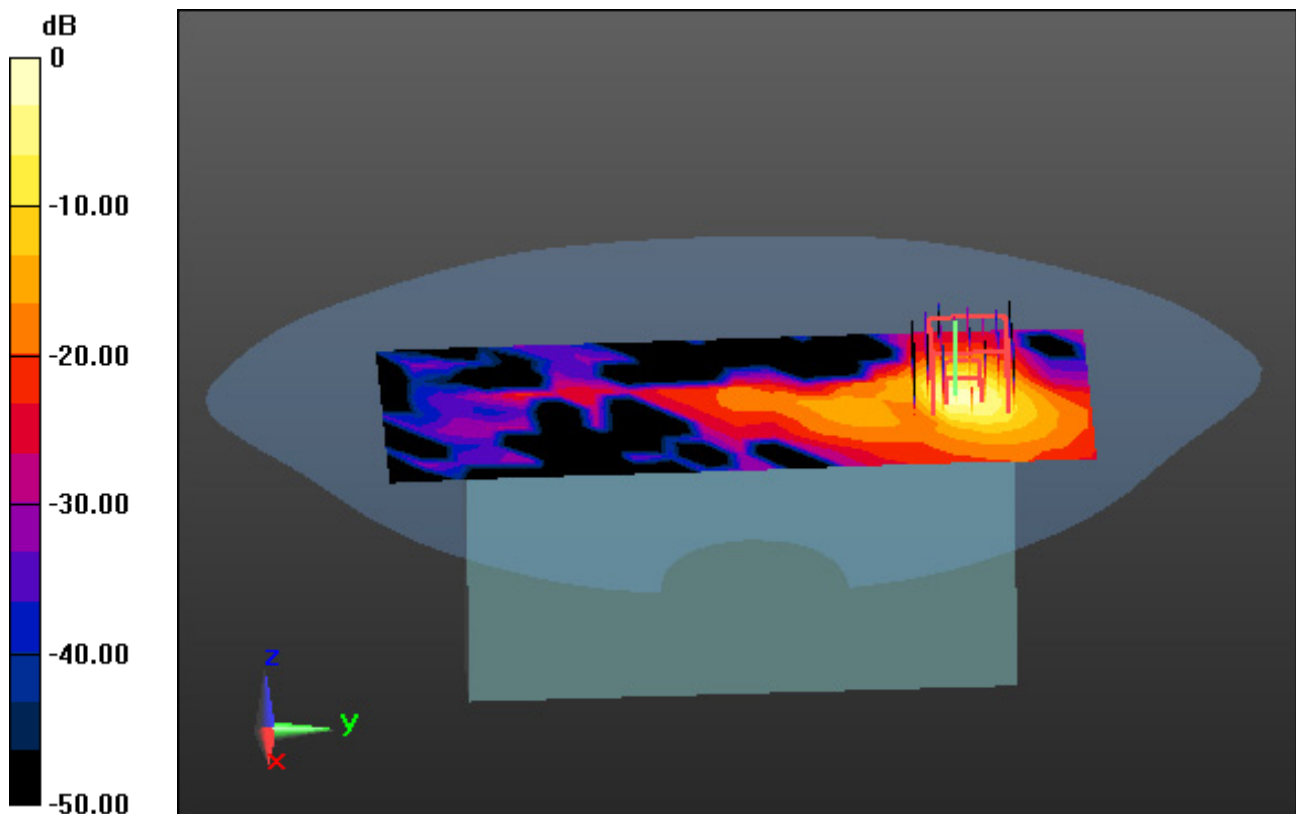

0 dB = 3.38 W/kg

DT&C Co., Ltd.

DUT: PM90W; Type: PDA

Communication System: UID 0, W-LAN 5.6G&5.8G (0); Frequency: 5660 MHz; Duty Cycle: 1:1
Medium parameters used: $f = 5660$ MHz; $\sigma = 5.203$ S/m; $\epsilon_r = 34.884$; $\rho = 1000$ kg/m³
Phantom section: Flat Section

DASY5 Configuration:

Probe: EX3DV4 - SN3933; ConvF(4.71, 4.71, 4.71); Calibrated: 9/25/2018; Electronics: DAE4 Sn1391
Sensor-Surface: 1.4mm (Mechanical Surface Detection)
Phantom: SAM with CRP v5.0(Right); Type: QD000P40CD; Serial: 1220
Measurement SW: DASY52, Version 52.8 (8); SEMCAD X Version 14.6.10 (7331)

Test Date: 2019-07-30; Ambient Temp: 21.3; Tissue Temp: 21.5

Touch from Body, Left, WLAN(802.11a) Ch. 132, Ant Internal, MIMO

Area Scan (9x21x1): Measurement grid: dx=10mm, dy=10mm

Zoom Scan (8x8x7)/Cube 0: Measurement grid: dx=4mm, dy=4mm, dz=1.4mm, Graded Ratio:1.4

Power Drift = -0.08 dB

Peak SAR (extrapolated) = 14.1 W/kg

SAR(1 g) = 2.78 W/kg; SAR(10 g) = 0.689 W/kg

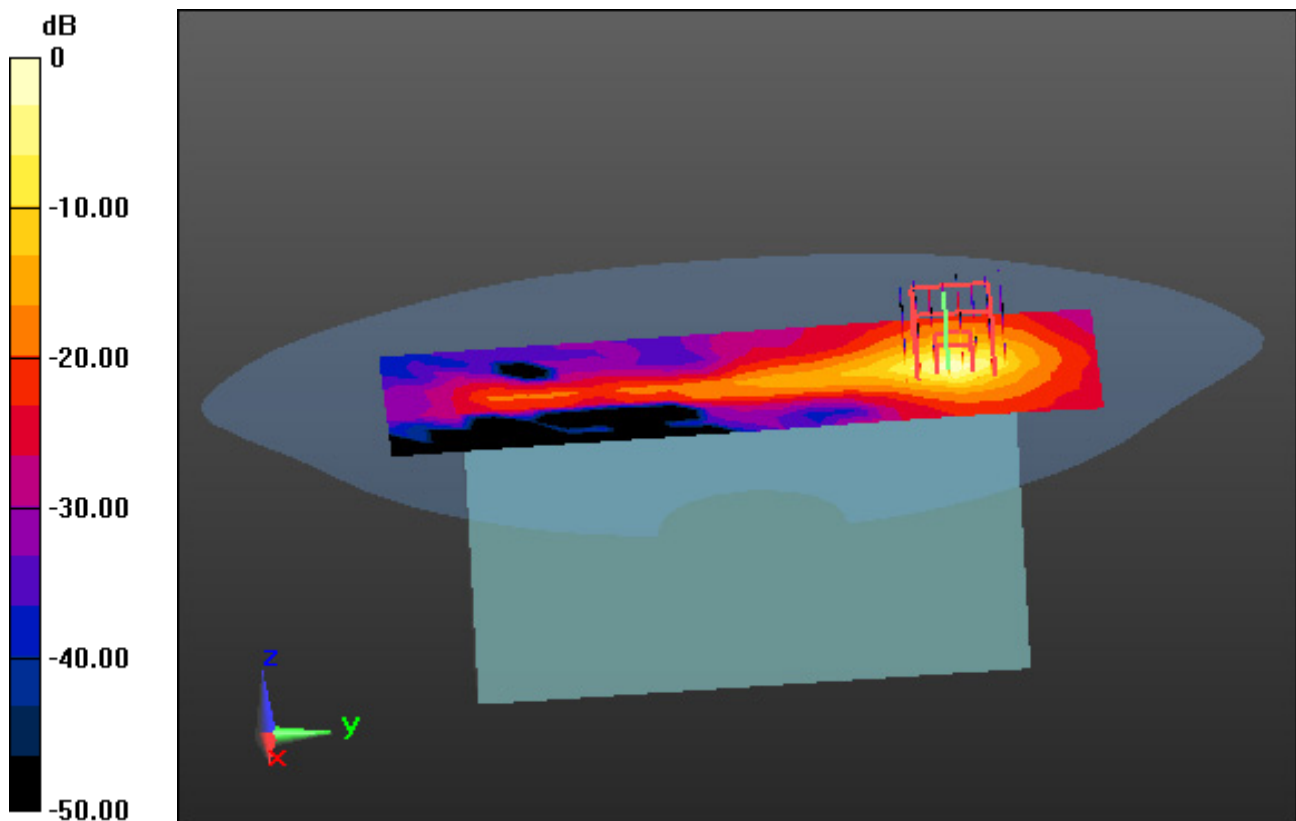

0 dB = 7.34 W/kg

DT&C Co., Ltd.

DUT: PM90W; Type: PDA

Communication System: UID 0, W-LAN_5800 (0); Frequency: 5825 MHz; Duty Cycle: 1:1
Medium parameters used: $f = 5825$ MHz; $\sigma = 5.385$ S/m; $\epsilon_r = 34.989$; $\rho = 1000$ kg/m³
Phantom section: Flat Section

DASY5 Configuration:

Probe: EX3DV4 - SN3933; ConvF(4.77, 4.77, 4.77); Calibrated: 9/25/2018; Electronics: DAE4 Sn1391
Sensor-Surface: 1.4mm (Mechanical Surface Detection)
Phantom: SAM with CRP v5.0(Right); Type: QD000P40CD; Serial: 1220
Measurement SW: DASY52, Version 52.8 (8); SEMCAD X Version 14.6.10 (7331)

Test Date: 2019-08-06; Ambient Temp: 21.8; Tissue Temp: 22.0

Touch from Body, Left, WLAN(802.11a) Ch. 165, Ant Internal, Ant.1

Area Scan (9x21x1): Measurement grid: dx=10mm, dy=10mm

Zoom Scan (8x8x7)/Cube 0: Measurement grid: dx=4mm, dy=4mm, dz=1.4mm, Graded Ratio:1.4

Power Drift = 0.13 dB

Peak SAR (extrapolated) = 11.1 W/kg

SAR(1 g) = 2.07 W/kg; SAR(10 g) = 0.552 W/kg

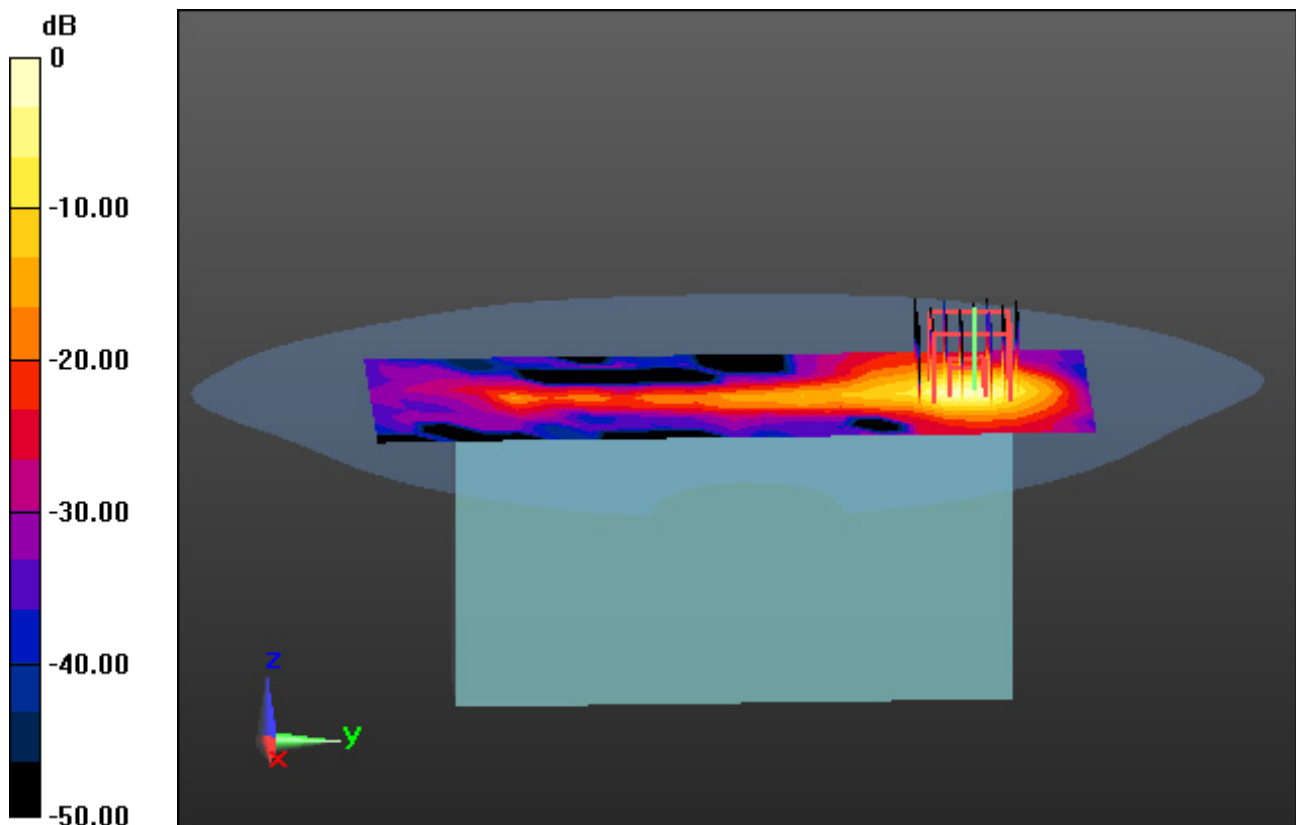

0 dB = 5.45 W/kg

DT&C Co., Ltd.

DUT: PM90W; Type: PDA

Communication System: UID 0, W-LAN_5800 (0); Frequency: 5825 MHz; Duty Cycle: 1:1
Medium parameters used: $f = 5825$ MHz; $\sigma = 5.385$ S/m; $\epsilon_r = 34.989$; $\rho = 1000$ kg/m³
Phantom section: Flat Section

DASY5 Configuration:

Probe: EX3DV4 - SN3933; ConvF(4.77, 4.77, 4.77); Calibrated: 9/25/2018; Electronics: DAE4 Sn1391
Sensor-Surface: 1.4mm (Mechanical Surface Detection)
Phantom: SAM with CRP v5.0(Right); Type: QD000P40CD; Serial: 1220
Measurement SW: DASY52, Version 52.8 (8); SEMCAD X Version 14.6.10 (7331)

Test Date: 2019-08-06; Ambient Temp: 21.8; Tissue Temp: 22.0

Touch from Body, Right, WLAN(802.11a) Ch. 165, Ant Internal, Ant.2

Area Scan (9x21x1): Measurement grid: dx=10mm, dy=10mm

Zoom Scan (8x8x7)/Cube 0: Measurement grid: dx=4mm, dy=4mm, dz=1.4mm, Graded Ratio:1.4

Power Drift = 0.01 dB

Peak SAR (extrapolated) = 8.24 W/kg

SAR(1 g) = 1.71 W/kg; SAR(10 g) = 0.449 W/kg

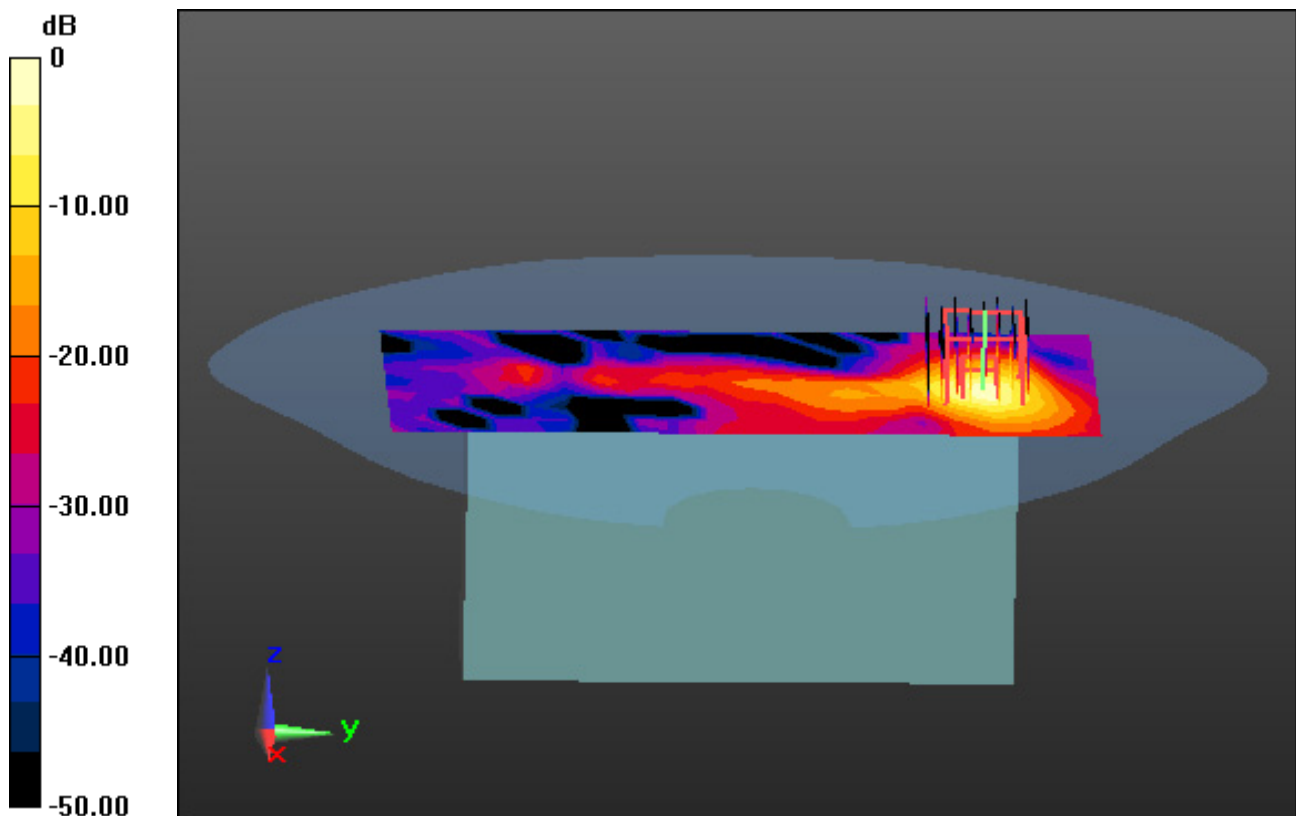

0 dB = 4.54 W/kg

DT&C Co., Ltd.

DUT: PM90W; Type: PDA

Communication System: UID 0, W-LAN 5.8G(802.11a/n/ac) (0); Frequency: 5825 MHz;Duty Cycle: 1:1
Medium parameters used: $f = 5825$ MHz; $\sigma = 5.385$ S/m; $\epsilon_r = 34.989$; $\rho = 1000$ kg/m³
Phantom section: Flat Section

DASY5 Configuration:

Probe: EX3DV4 - SN3933; ConvF(4.77, 4.77, 4.77); Calibrated: 9/25/2018; Electronics: DAE4 Sn1391
Sensor-Surface: 1.4mm (Mechanical Surface Detection)
Phantom: SAM with CRP v5.0(Right); Type: QD000P40CD; Serial: 1220
Measurement SW: DASY52, Version 52.8 (8); SEMCAD X Version 14.6.10 (7331)

Test Date: 2019-08-06; Ambient Temp: 21.8; Tissue Temp: 22.0

Touch from Body, Left, WLAN(802.11a) Ch. 165, Ant Internal, MIMO

Area Scan (9x21x1): Measurement grid: dx=10mm, dy=10mm

Zoom Scan (8x8x7)/Cube 0: Measurement grid: dx=4mm, dy=4mm, dz=1.4mm, Graded Ratio:1.4

Power Drift = -0.18 dB

Peak SAR (extrapolated) = 10.9 W/kg

SAR(1 g) = 2.1 W/kg; SAR(10 g) = 0.531 W/kg

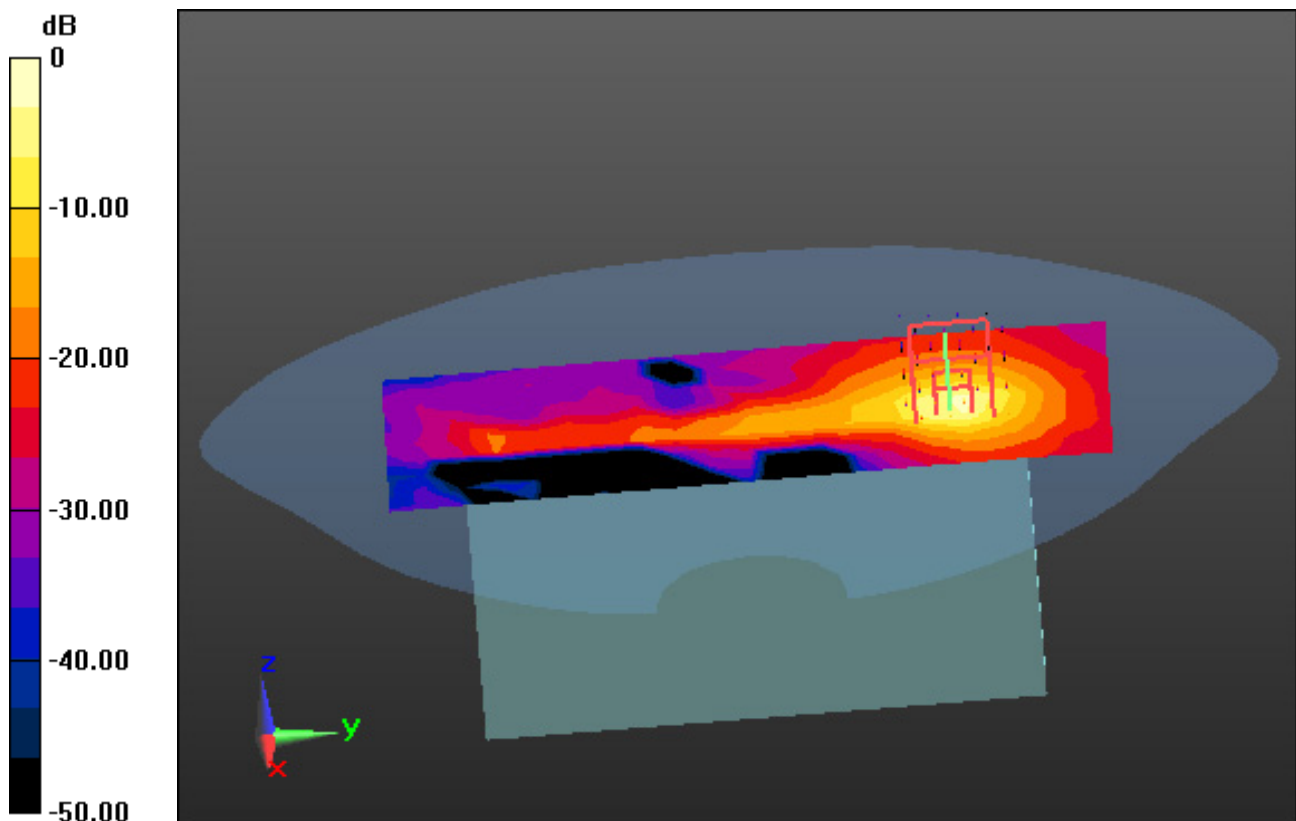

0 dB = 5.88 W/kg

DT&C Co., Ltd.

DUT: PM90W; Type: PDA

Communication System: UID 0, Bluetooth (0); Frequency: 2441 MHz; Duty Cycle: 1:1.302
Medium parameters used: $f = 2441$ MHz; $\sigma = 1.802$ S/m; $\epsilon_r = 38.404$; $\rho = 1000$ kg/m³
Phantom section: Flat Section

DASY5 Configuration:

Probe: EX3DV4 - SN3916; ConvF(7.66, 7.66, 7.66); Calibrated: 4/25/2019; Electronics: DAE4 Sn1392
Sensor-Surface: 2mm (Mechanical Surface Detection)
Phantom: SAM with CRP_2013_10_08_right; Type: QD000P40CD; Serial: TP:1785
Measurement SW: DASY52, Version 52.8 (8); SEMCAD X Version 14.6.10 (7331)

Test Date: 2019-08-13; Ambient Temp: 20.4; Tissue Temp: 20.6

Touch from Body, Left, Bluetooth Ch. 39, Ant Internal

Area Scan (7x17x1): Measurement grid: dx=12mm, dy=12mm

Zoom Scan (7x7x7)/Cube 0: Measurement grid: dx=5mm, dy=5mm, dz=5mm

Power Drift = 0.14 dB

Peak SAR (extrapolated) = 0.656 W/kg

SAR(1 g) = 0.194 W/kg; SAR(10 g) = 0.070 W/kg

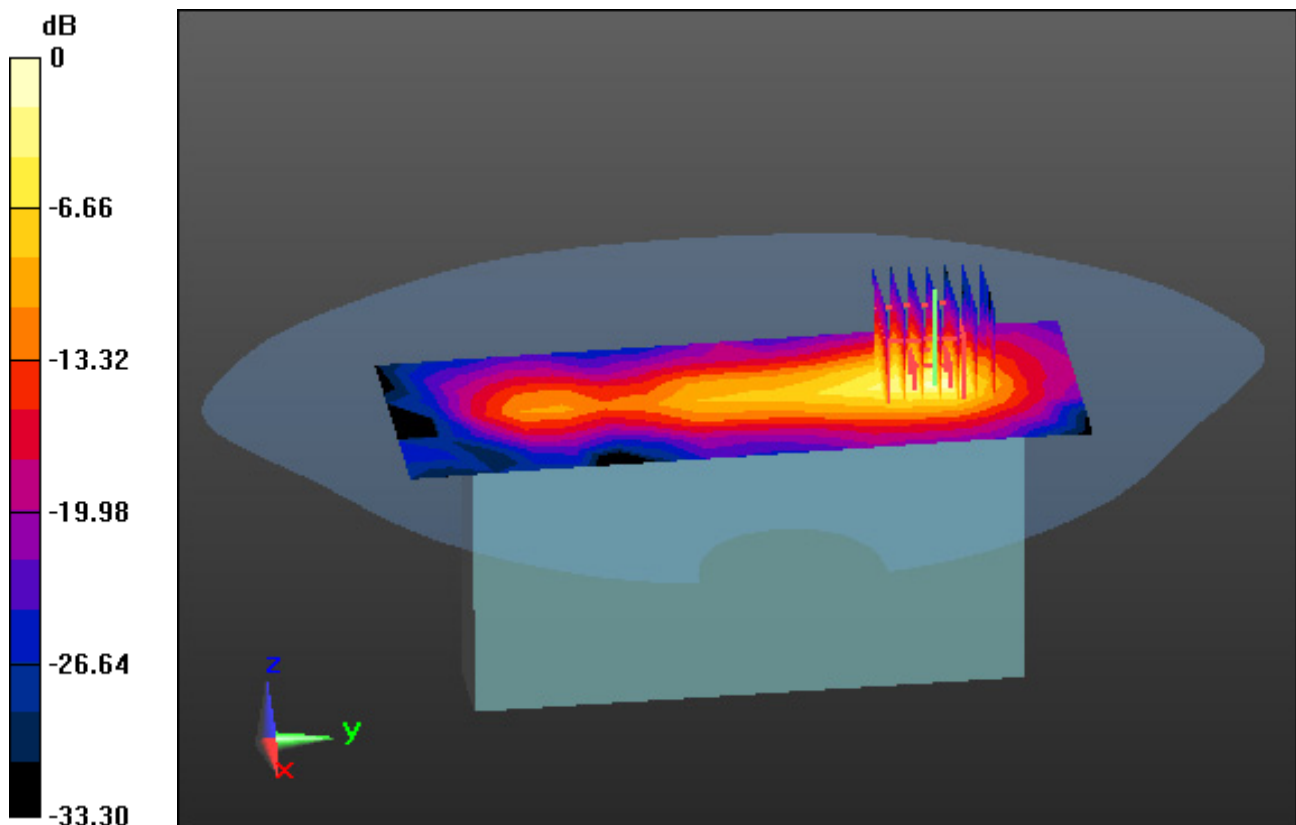

0 dB = 0.365 W/kg