

DT&C Co., Ltd.

DUT: PM90G; Type: PDA

Communication System: UID 0, GSM 850_2 Tx (0); Frequency: 836.6 MHz; Duty Cycle: 1:4.15
Medium parameters used: $f = 836.6 \text{ MHz}$; $\sigma = 0.891 \text{ S/m}$; $\epsilon_r = 42.785$; $\rho = 1000 \text{ kg/m}^3$
Phantom section: Flat Section

DASY5 Configuration:

Probe: EX3DV4 - SN3866; ConvF(9.39, 9.39, 9.39); Calibrated: 5/28/2019; Electronics: DAE4 Sn1394
Sensor-Surface: 2mm (Mechanical Surface Detection)
Phantom: SAM-twin middle_2013_09_24; Type: QD000P40CD; Serial: 1782
Measurement SW: DASY52, Version 52.8 (8); SEMCAD X Version 14.6.10 (7331)

Test Date: 2019-07-26; Ambient Temp: 22.3; Tissue Temp: 22.8

1.5 cm space from Body, Rear, GSM850 GPRS 2Tx Ch. 190, Ant Internal

Area Scan (9x14x1): Measurement grid: $dx=15\text{mm}$, $dy=15\text{mm}$

Zoom Scan (5x5x7)/Cube 0: Measurement grid: $dx=8\text{mm}$, $dy=8\text{mm}$, $dz=5\text{mm}$

Power Drift = -0.06 dB

Peak SAR (extrapolated) = 0.337 W/kg

SAR(1 g) = 0.266 W/kg; SAR(10 g) = 0.201 W/kg

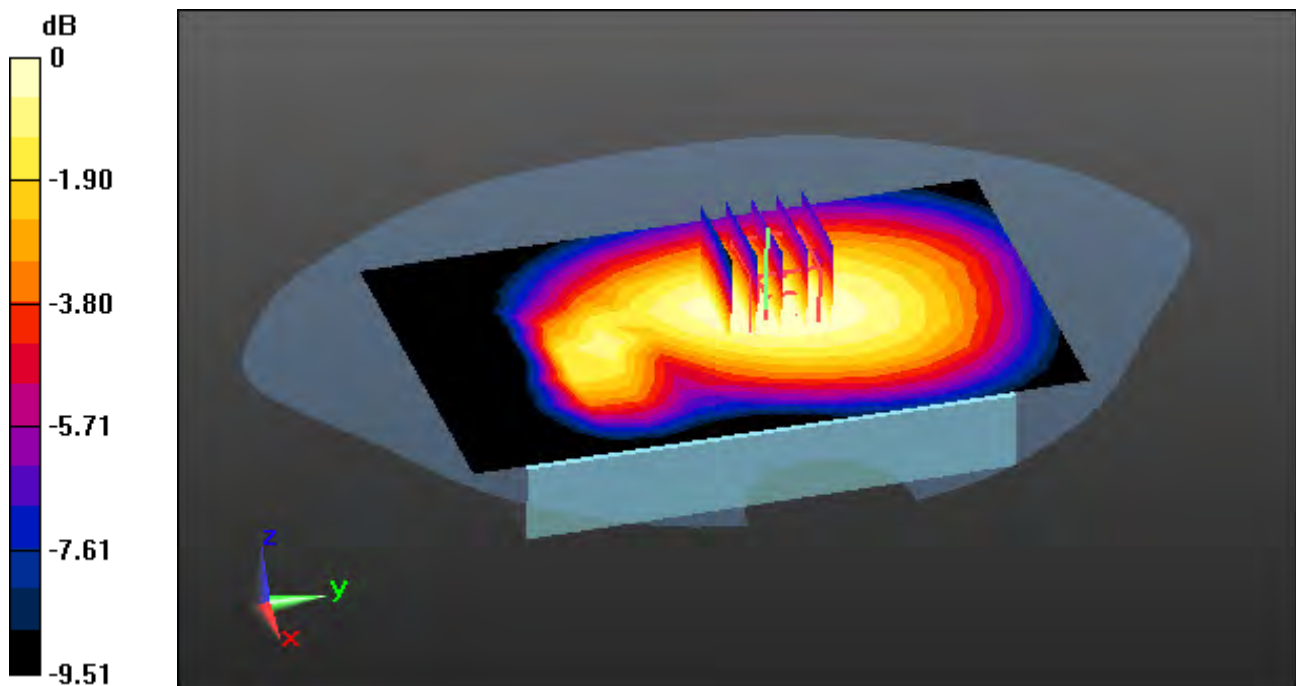

0 dB = 0.306 W/kg

DT&C Co., Ltd.

DUT: PM90G; Type: PDA

Communication System: UID 0, PCS 1900 2 Tx (0); Frequency: 1880 MHz; Duty Cycle: 1:4.15
Medium parameters used: $f = 1880$ MHz; $\sigma = 1.384$ S/m; $\epsilon_r = 40.087$; $\rho = 1000$ kg/m³
Phantom section: Flat Section

DASY5 Configuration:

Probe: EX3DV4 - SN7337; ConvF(8.49, 8.49, 8.49) @ 1880 MHz; Calibrated: 2018-11-22;
Electronics: DAE4 Sn1453

Sensor-Surface: 2mm (Mechanical Surface Detection)

Phantom: SAM_Right_20170922; Type: QD000P40CD; Serial: 1895

Measurement SW: DASY52, Version 52.10 (2); SEMCAD X Version 14.6.12 (7450)

Test Date: 2019-07-15; Ambient Temp: 21.6; Tissue Temp: 21.5

1.5 cm space from Body, Rear, PCS1900 GPRS 2 Tx Ch. 661, Ant. Internal

Area Scan (9x14x1): Measurement grid: dx=15mm, dy=15mm

Zoom Scan (5x5x7)/Cube 0: Measurement grid: dx=8mm, dy=8mm, dz=5mm

Power Drift = 0.01 dB

Peak SAR (extrapolated) = 0.411 W/kg

SAR(1 g) = 0.244 W/kg; SAR(10 g) = 0.140 W/kg

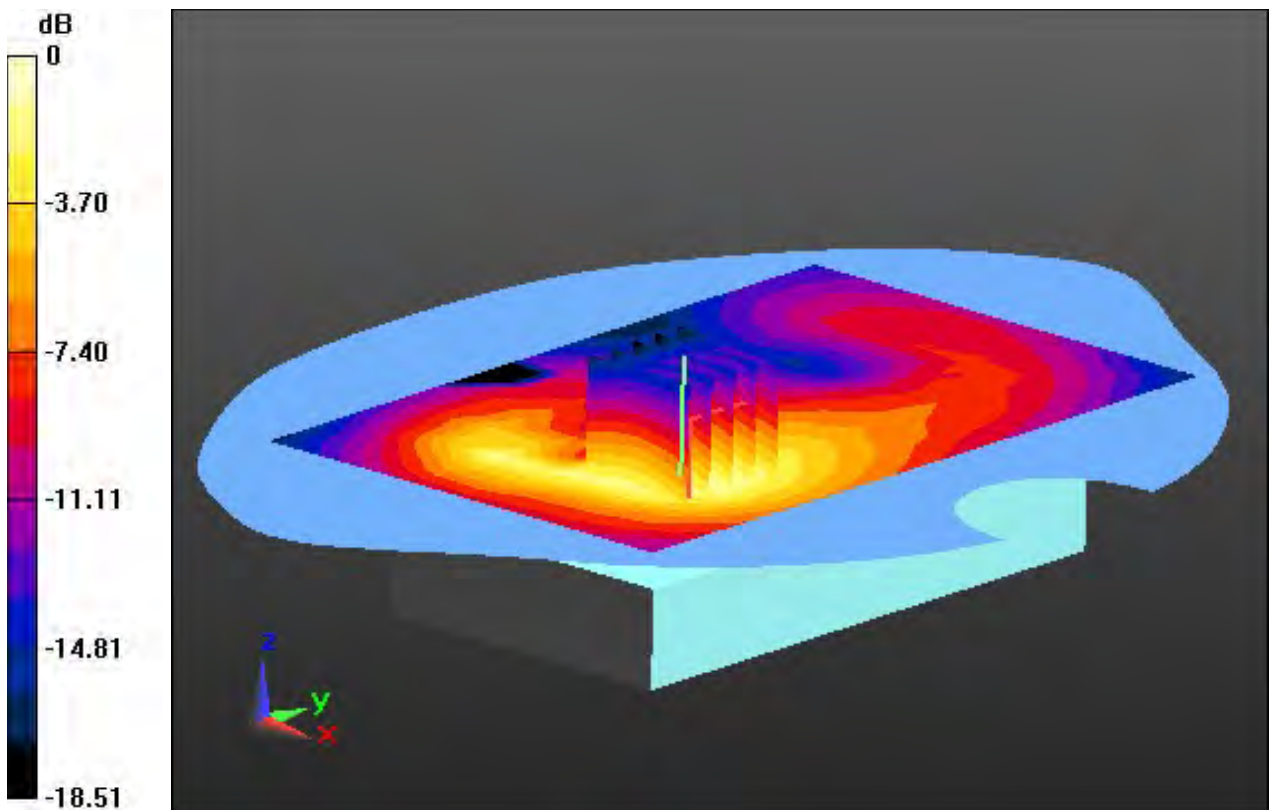

0 dB = 0.327 W/kg

DT&C Co., Ltd.

DUT: PM90G; Type: PDA

Communication System: UID 0, WCDMA 850 (0); Frequency: 836.6 MHz; Duty Cycle: 1:1
Medium parameters used: $f = 836.6$ MHz; $\sigma = 0.879$ S/m; $\epsilon_r = 42.344$; $\rho = 1000$ kg/m³
Phantom section: Flat Section

DASY5 Configuration:

Probe: EX3DV4 - SN3866; ConvF(9.39, 9.39, 9.39); Calibrated: 5/28/2019; Electronics: DAE4 Sn1394
Sensor-Surface: 2mm (Mechanical Surface Detection)
Phantom: SAM-twin middle_2013_09_24; Type: QD000P40CD; Serial: 1782
Measurement SW: DASY52, Version 52.8 (8); SEMCAD X Version 14.6.10 (7331)

Test Date: 2019-07-29; Ambient Temp: 22.5; Tissue Temp: 22.2

1.5 cm space from Body, Rear, WCDMA Band 5 Ch. 4183, Ant Internal

Area Scan (9x14x1): Measurement grid: dx=15mm, dy=15mm

Zoom Scan (5x5x7)/Cube 0: Measurement grid: dx=8mm, dy=8mm, dz=5mm

Power Drift = -0.02 dB

Peak SAR (extrapolated) = 0.350 W/kg

SAR(1 g) = 0.280 W/kg; SAR(10 g) = 0.213 W/kg

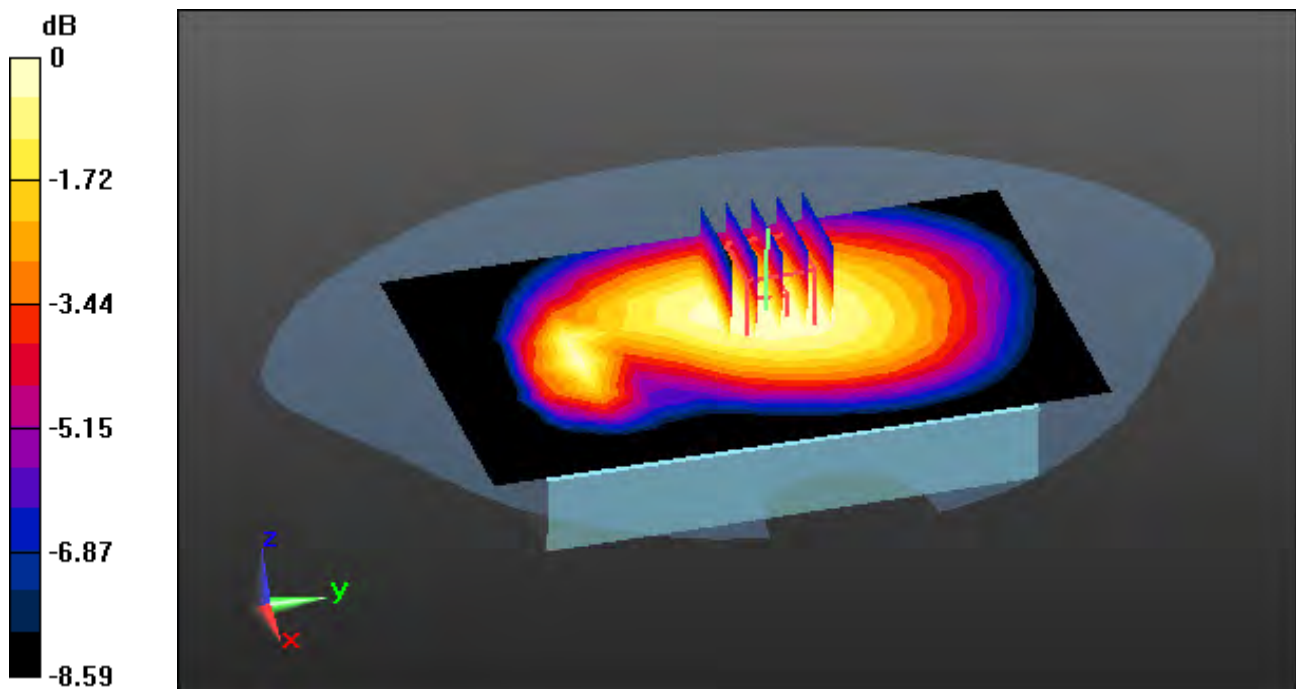

0 dB = 0.321 W/kg

DT&C Co., Ltd.

DUT: PM90G; Type: PDA

Communication System: UID 0, WCDMA (0); Frequency: 1732.4 MHz; Duty Cycle: 1:1
Medium parameters used: $f = 1732.4$ MHz; $\sigma = 1.324$ S/m; $\epsilon_r = 40.805$; $\rho = 1000$ kg/m³
Phantom section: Flat Section

DASY5 Configuration:

Probe: EX3DV4 - SN7337; ConvF(8.96, 8.96, 8.96) @ 1732.4 MHz; Calibrated: 2018-11-22;
Electronics: DAE4 Sn1453

Sensor-Surface: 2mm (Mechanical Surface Detection)

Phantom: SAM_Right_20170922; Type: QD000P40CD; Serial: 1895

Measurement SW: DASY52, Version 52.10 (2); SEMCAD X Version 14.6.12 (7450)

Test Date: 2019-08-12; Ambient Temp: 20.9; Tissue Temp: 20.8

1.5 cm space from Body, Rear, WCDMA Band 4 Ch. 1412, Ant. Internal

Area Scan (9x14x1): Measurement grid: dx=15mm, dy=15mm

Zoom Scan (5x5x7)/Cube 0: Measurement grid: dx=8mm, dy=8mm, dz=5mm

Power Drift = 0.00 dB

Peak SAR (extrapolated) = 0.594 W/kg

SAR(1 g) = 0.389 W/kg; SAR(10 g) = 0.242 W/kg

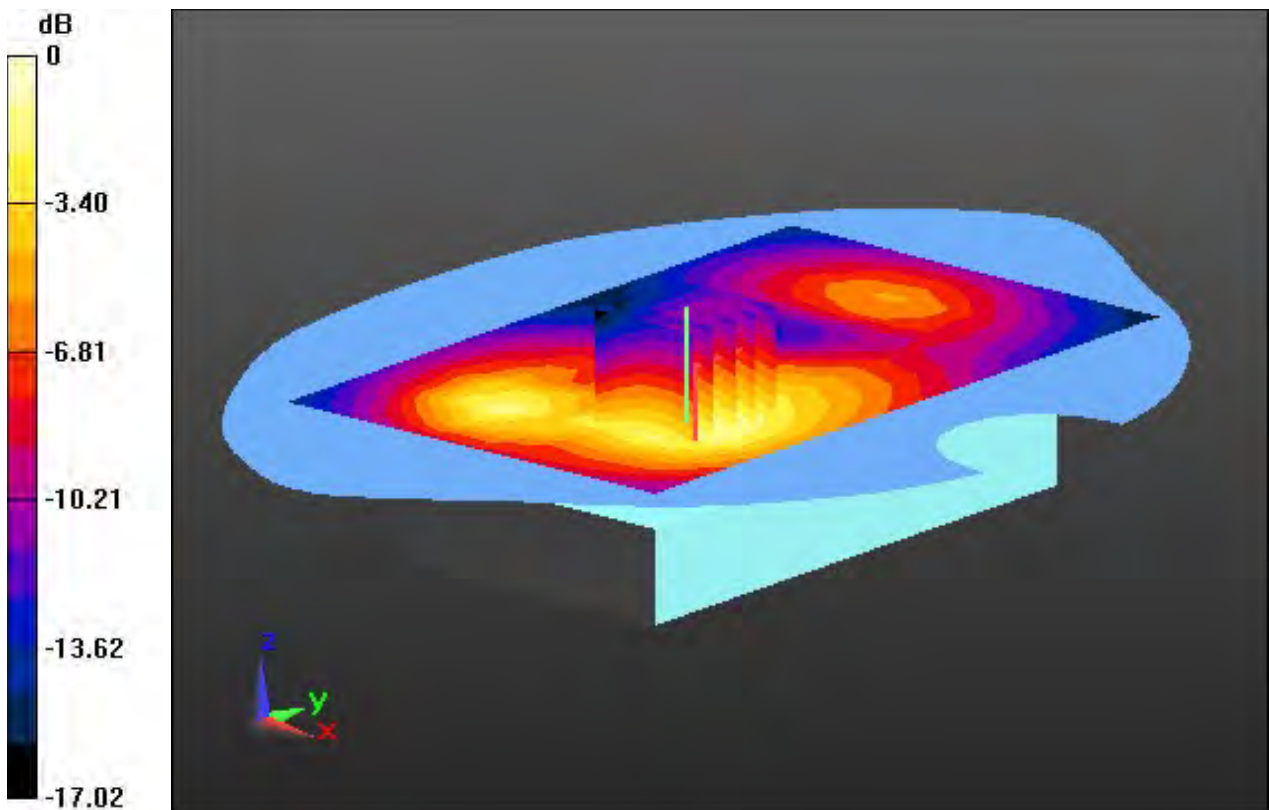

0 dB = 0.501 W/kg

DT&C Co., Ltd.

DUT: PM90G; Type: PDA

Communication System: UID 0, WCDMA (0); Frequency: 1880 MHz; Duty Cycle: 1:1
Medium parameters used: $f = 1880$ MHz; $\sigma = 1.384$ S/m; $\epsilon_r = 40.087$; $\rho = 1000$ kg/m³
Phantom section: Flat Section

DASY5 Configuration:

Probe: EX3DV4 - SN7337; ConvF(8.49, 8.49, 8.49) @ 1880 MHz; Calibrated: 2018-11-22;
Electronics: DAE4 Sn1453
Sensor-Surface: 2mm (Mechanical Surface Detection)
Phantom: SAM_Right_20170922; Type: QD000P40CD; Serial: 1895
Measurement SW: DASY52, Version 52.10 (2); SEMCAD X Version 14.6.12 (7450)

Test Date: 2019-07-15; Ambient Temp: 21.6; Tissue Temp: 21.5

1.5 cm space from Body, Rear, WCDMA Band 2 Ch. 9400, Ant. Internal

Area Scan (9x14x1): Measurement grid: dx=15mm, dy=15mm

Zoom Scan (5x5x7)/Cube 0: Measurement grid: dx=8mm, dy=8mm, dz=5mm

Power Drift = 0.03 dB

Peak SAR (extrapolated) = 0.880 W/kg

SAR(1 g) = 0.517 W/kg; SAR(10 g) = 0.292 W/kg

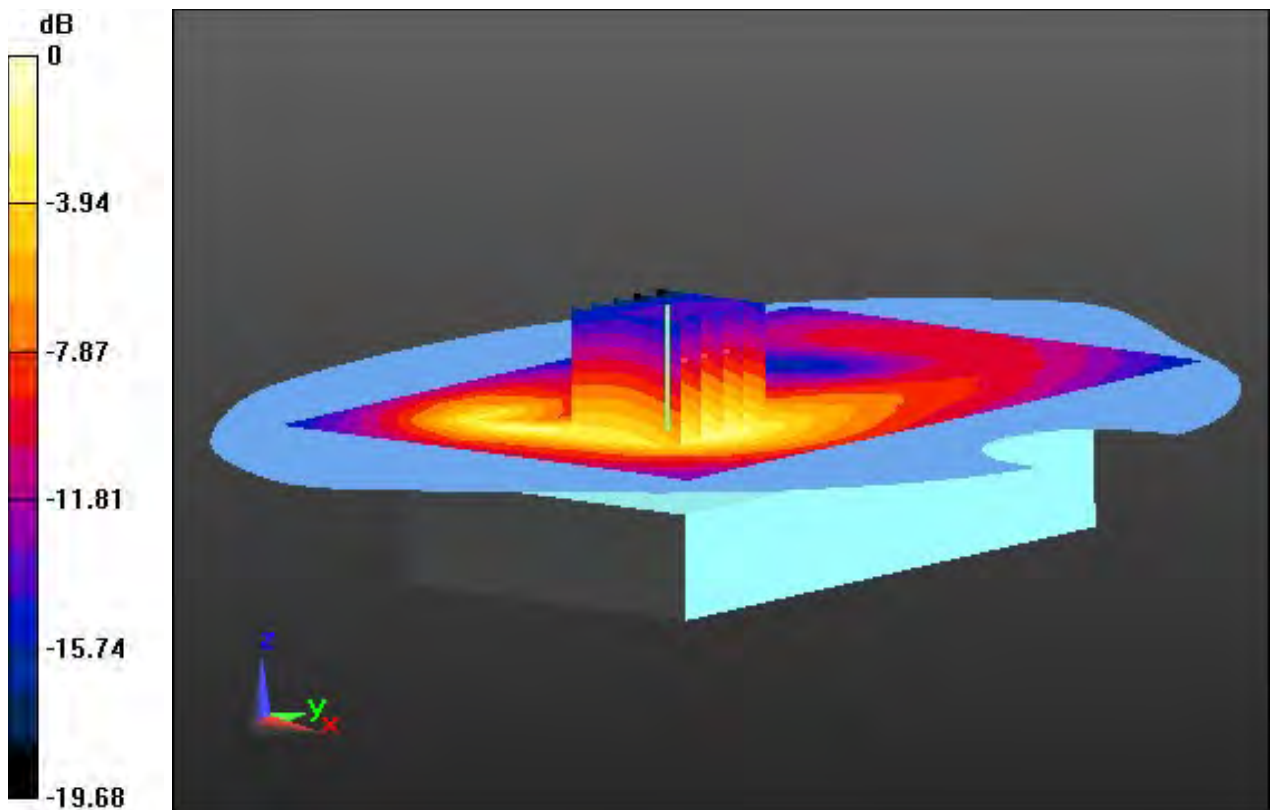

0 dB = 0.706 W/kg

DT&C Co., Ltd.

DUT: PM90G; Type: PDA

Communication System: UID 0, LTE Band 12 (FCC) (0); Frequency: 707.5 MHz; Duty Cycle: 1:1
Medium parameters used: $f = 707.5$ MHz; $\sigma = 0.866$ S/m; $\epsilon_r = 42.824$; $\rho = 1000$ kg/m³
Phantom section: Flat Section

DASY5 Configuration:

Probe: EX3DV4 - SN3866; ConvF(9.85, 9.85, 9.85); Calibrated: 5/28/2019; Electronics: DAE4 Sn1394
Sensor-Surface: 2mm (Mechanical Surface Detection)
Phantom: SAM-twin middle_2013_09_24; Type: QD000P40CD; Serial: 1782
Measurement SW: DASY52, Version 52.8 (8); SEMCAD X Version 14.6.10 (7331)

Test Date: 2019-07-30; Ambient Temp: 22.0; Tissue Temp: 21.9

1.5 cm space from Body, Rear, LTE Band 12 Ch. 23095, Ant Internal

Mode : BandWidth 10 MHz, QPSK, RB Size: 1

Area Scan (9x14x1): Measurement grid: dx=15mm, dy=15mm

Zoom Scan (5x5x7)/Cube 0: Measurement grid: dx=8mm, dy=8mm, dz=5mm

Power Drift = -0.05 dB

Peak SAR (extrapolated) = 0.290 W/kg

SAR(1 g) = 0.237 W/kg; SAR(10 g) = 0.185 W/kg

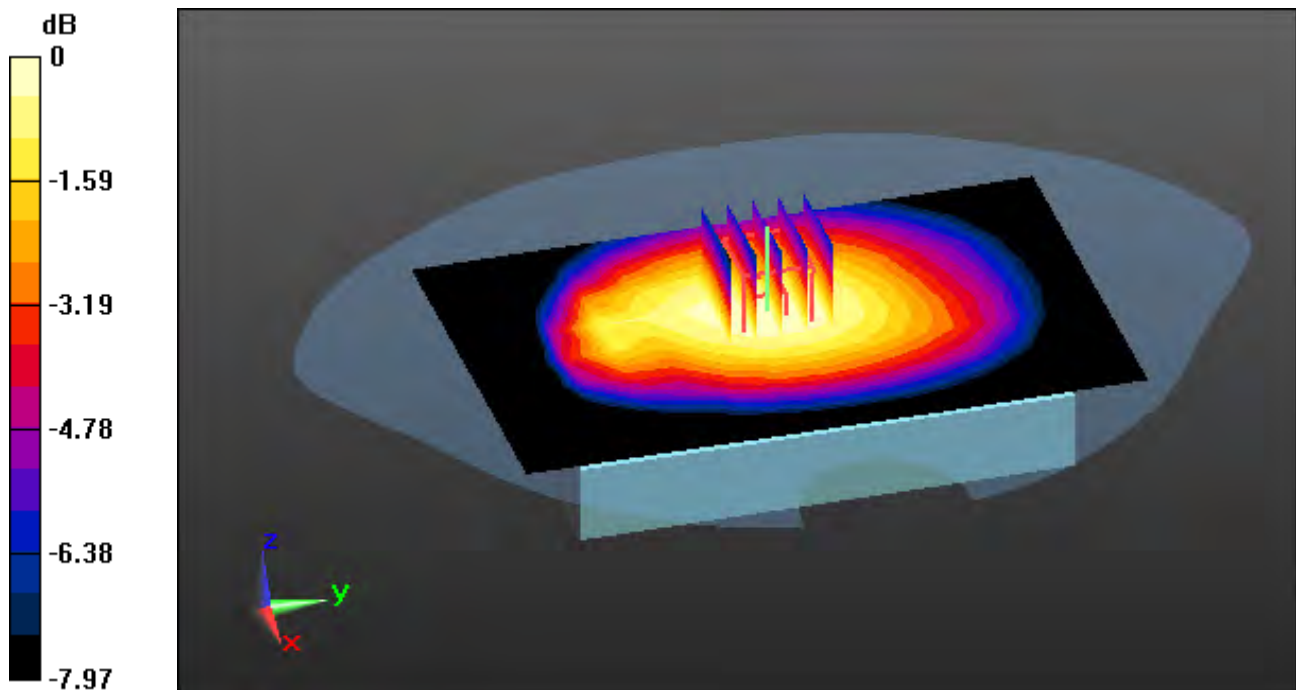

0 dB = 0.268 W/kg

DT&C Co., Ltd.

DUT: PM90G; Type: PDA

Communication System: UID 0, LTE Band 13 (0); Frequency: 782 MHz; Duty Cycle: 1:1
Medium parameters used: $f = 782 \text{ MHz}$; $\sigma = 0.91 \text{ S/m}$; $\epsilon_r = 40.984$; $\rho = 1000 \text{ kg/m}^3$
Phantom section: Flat Section

DASY5 Configuration:

Probe: EX3DV4 - SN3866; ConvF(9.85, 9.85, 9.85); Calibrated: 5/28/2019; Electronics: DAE4 Sn1394
Sensor-Surface: 2mm (Mechanical Surface Detection)
Phantom: SAM-twin middle_2013_09_24; Type: QD000P40CD; Serial: 1782
Measurement SW: DASY52, Version 52.8 (8); SEMCAD X Version 14.6.10 (7331)

Test Date: 2019-08-01; Ambient Temp: 22.1; Tissue Temp: 21.8

1.5 cm space from Body, Rear, LTE Band 13 Ch. 23230, Ant Internal

Mode : BandWidth 10 MHz, QPSK, RB Size: 1

Area Scan (9x14x1): Measurement grid: $dx=15\text{mm}$, $dy=15\text{mm}$

Zoom Scan (5x5x7)/Cube 0: Measurement grid: $dx=8\text{mm}$, $dy=8\text{mm}$, $dz=5\text{mm}$
Power Drift = -0.03 dB

Peak SAR (extrapolated) = 0.412 W/kg

SAR(1 g) = 0.331 W/kg; SAR(10 g) = 0.256 W/kg

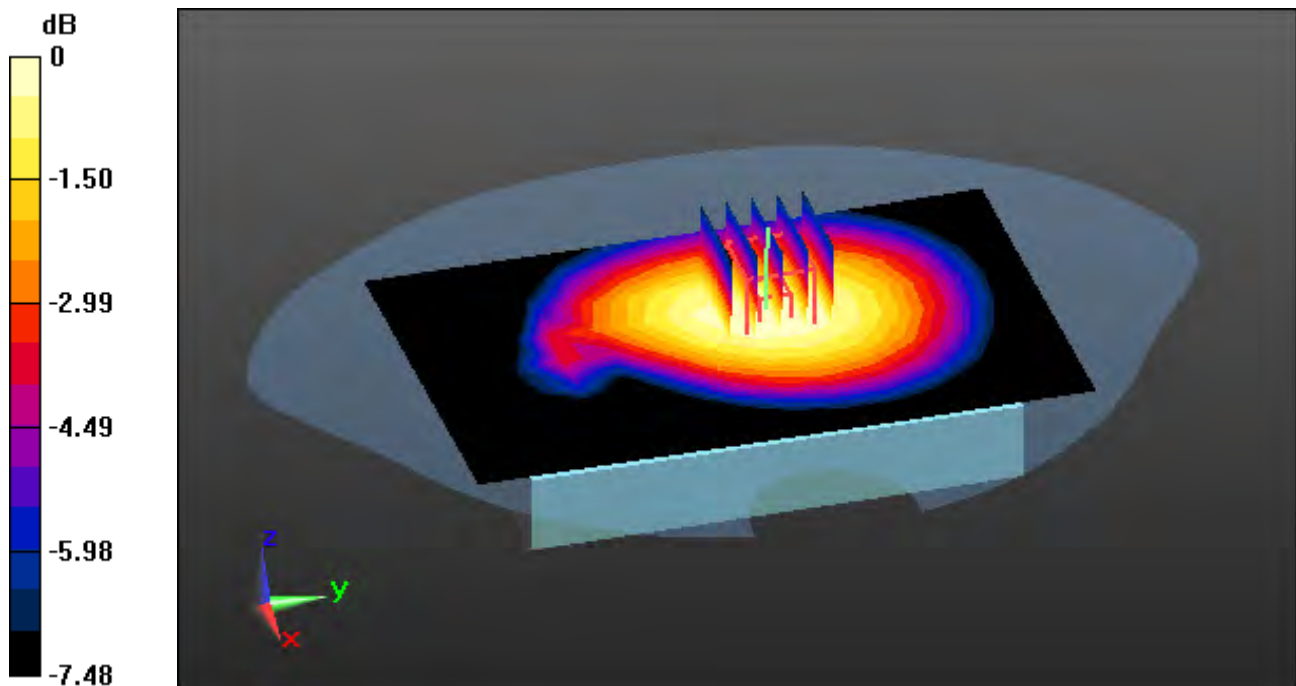

0 dB = 0.378 W/kg

DT&C Co., Ltd.

DUT: PM90G; Type: PDA

Communication System: UID 0, LTE Band 14 (0); Frequency: 793 MHz; Duty Cycle: 1:1
Medium parameters used: $f = 793$ MHz; $\sigma = 0.91$ S/m; $\epsilon_r = 40.359$; $\rho = 1000$ kg/m³
Phantom section: Flat Section

DASY5 Configuration:

Probe: EX3DV4 - SN3866; ConvF(9.85, 9.85, 9.85); Calibrated: 5/28/2019; Electronics: DAE4 Sn1394
Sensor-Surface: 2mm (Mechanical Surface Detection)
Phantom: SAM-twin middle_2013_09_24; Type: QD000P40CD; Serial: 1782
Measurement SW: DASY52, Version 52.8 (8); SEMCAD X Version 14.6.10 (7331)

Test Date: 2019-08-02; Ambient Temp: 21.7; Tissue Temp: 21.5

1.5 cm space from Body, Rear, LTE Band 14 Ch. 23330, Ant Internal

Mode : BandWidth 10 MHz, QPSK, RB Size: 1

Area Scan (9x14x1): Measurement grid: dx=15mm, dy=15mm

Zoom Scan (5x5x7)/Cube 0: Measurement grid: dx=8mm, dy=8mm, dz=5mm
Power Drift = -0.01 dB

Peak SAR (extrapolated) = 0.390 W/kg

SAR(1 g) = 0.255 W/kg; SAR(10 g) = 0.183 W/kg

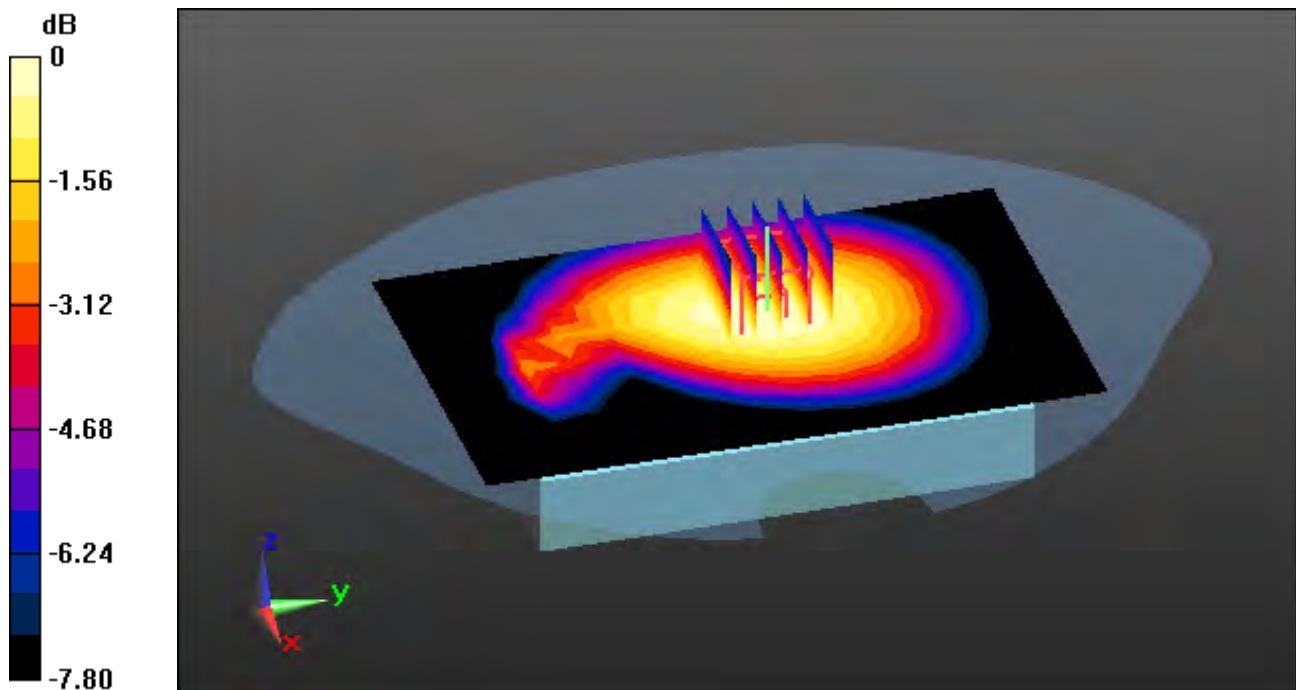

0 dB = 0.359 W/kg

DT&C Co., Ltd.

DUT: PM90G; Type: PDA

Communication System: UID 0, LTE BAND 26 (0); Frequency: 831.5 MHz; Duty Cycle: 1:1
Medium parameters used: $f = 831.5$ MHz; $\sigma = 0.895$ S/m; $\epsilon_r = 42.934$; $\rho = 1000$ kg/m³
Phantom section: Flat Section

DASY5 Configuration:

Probe: EX3DV4 - SN3866; ConvF(9.39, 9.39, 9.39); Calibrated: 5/28/2019; Electronics: DAE4 Sn1394
Sensor-Surface: 2mm (Mechanical Surface Detection)
Phantom: SAM-twin middle_2013_09_24; Type: QD000P40CD; Serial: 1782
Measurement SW: DASY52, Version 52.8 (8); SEMCAD X Version 14.6.10 (7331)

Test Date: 2019-07-31; Ambient Temp: 22.3; Tissue Temp: 22.0

1.5 cm space from Body, Rear, LTE Band 26 Ch. 26865, Ant Internal

Mode : BandWidth 15 MHz, QPSK, RB Size: 1

Area Scan (9x14x1): Measurement grid: dx=15mm, dy=15mm

Zoom Scan (5x5x7)/Cube 0: Measurement grid: dx=8mm, dy=8mm, dz=5mm

Power Drift = -0.13 dB

Peak SAR (extrapolated) = 0.373 W/kg

SAR(1 g) = 0.296 W/kg; SAR(10 g) = 0.225 W/kg

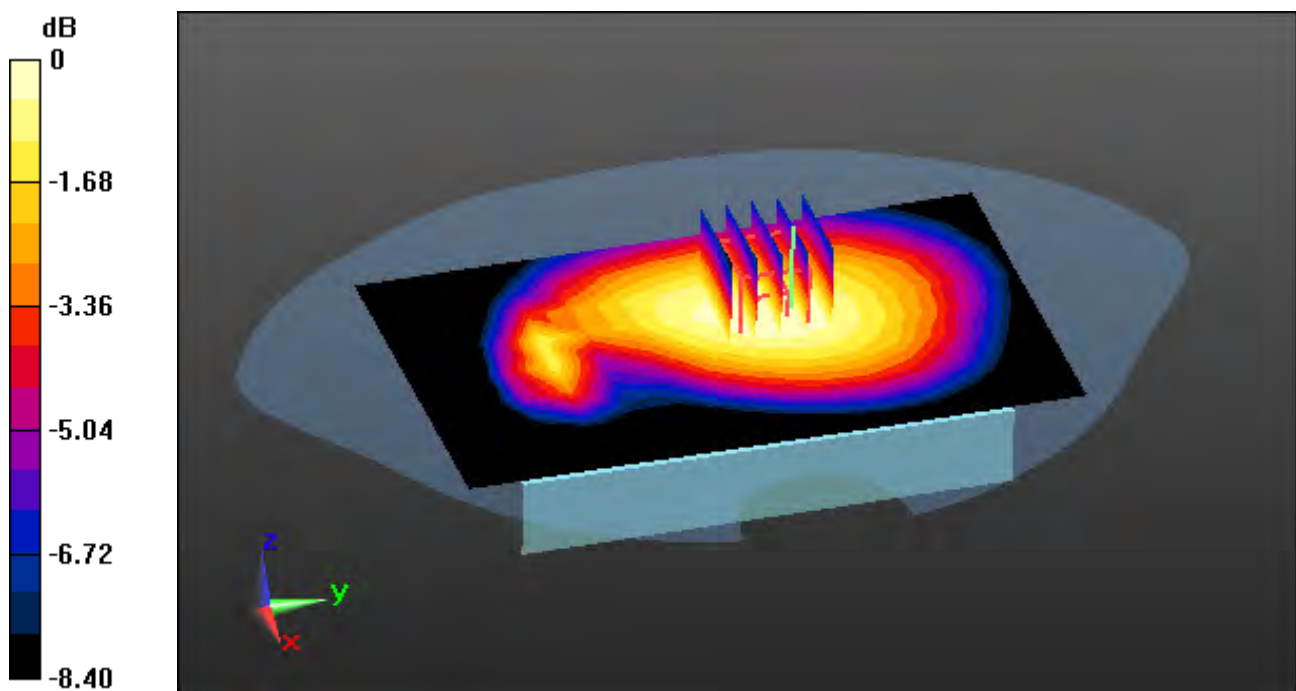

0 dB = 0.339 W/kg

DT&C Co., Ltd.

DUT: PM90G; Type: PDA

Communication System: UID 0, LTE Band 4 (0); Frequency: 1732.5 MHz; Duty Cycle: 1:1
Medium parameters used: $f = 1732.5$ MHz; $\sigma = 1.324$ S/m; $\epsilon_r = 40.805$; $\rho = 1000$ kg/m³
Phantom section: Flat Section

DASY5 Configuration:

Probe: EX3DV4 - SN7337; ConvF(8.96, 8.96, 8.96) @ 1732.5 MHz; Calibrated: 2018-11-22
Electronics: DAE4 Sn1453

Sensor-Surface: 2mm (Mechanical Surface Detection)

Phantom: SAM_Right_20170922; Type: QD000P40CD; Serial: 1895

Measurement SW: DASY52, Version 52.10 (2); SEMCAD X Version 14.6.12 (7450)

Test Date: 2019-08-12; Ambient Temp: 20.9; Tissue Temp: 20.8

1.5 cm space from Body, Rear, LTE Band 4 Ch. 20175, Ant Internal

Mode : BandWidth 20 MHz, QPSK, RB Size: 1

Area Scan (9x14x1): Measurement grid: dx=15mm, dy=15mm

Zoom Scan (5x5x7)/Cube 0: Measurement grid: dx=8mm, dy=8mm, dz=5mm

Power Drift = -0.00 dB

Peak SAR (extrapolated) = 0.444 W/kg

SAR(1 g) = 0.292 W/kg; SAR(10 g) = 0.183 W/kg

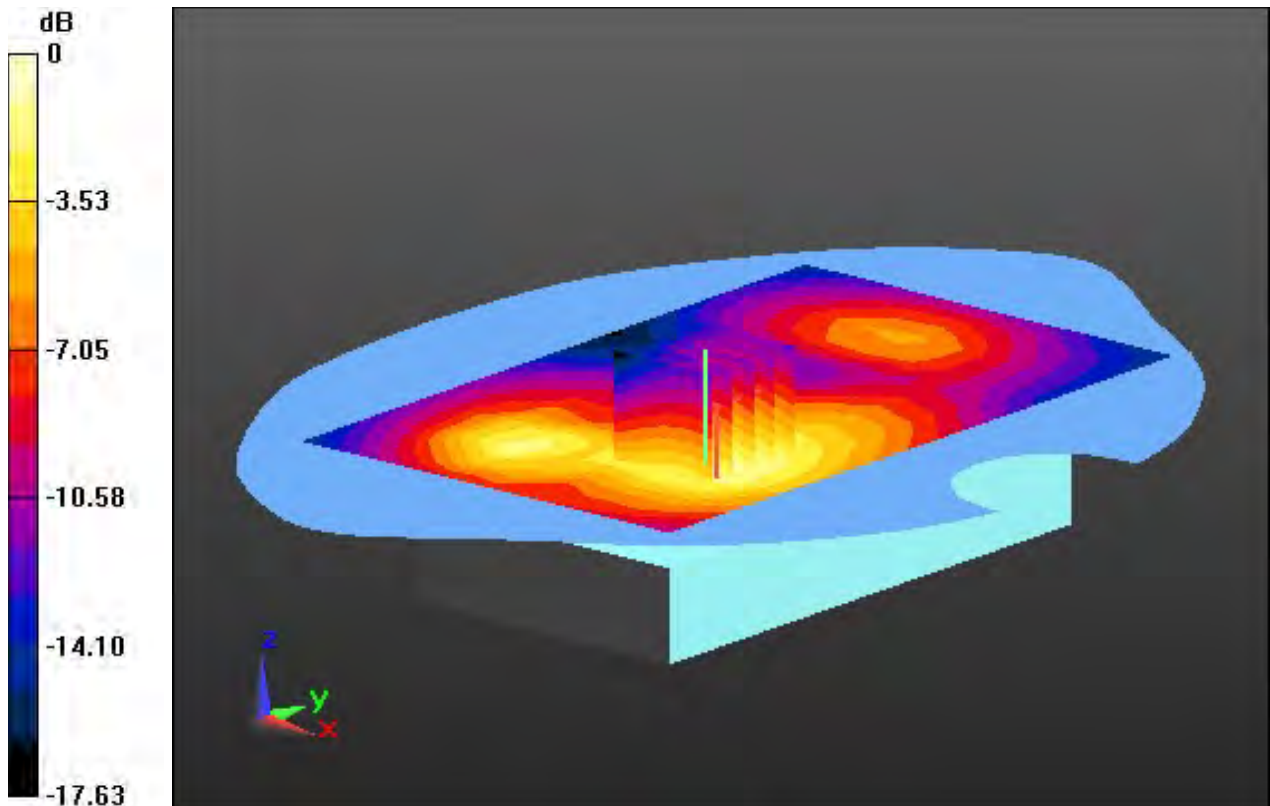

0 dB = 0.376 W/kg

DT&C Co., Ltd.

DUT: PM90G; Type: PDA

Communication System: UID 0, LTE Band 25 (0); Frequency: 1860 MHz; Duty Cycle: 1:1
Medium parameters used: $f = 1860$ MHz; $\sigma = 1.366$ S/m; $\epsilon_r = 40.201$; $\rho = 1000$ kg/m³
Phantom section: Flat Section

DASY5 Configuration:

Probe: EX3DV4 - SN7337; ConvF(8.49, 8.49, 8.49) @ 1860 MHz; Calibrated: 2018-11-22
Electronics: DAE4 Sn1453

Sensor-Surface: 2mm (Mechanical Surface Detection)

Phantom: SAM_Right_20170922; Type: QD000P40CD; Serial: 1895

Measurement SW: DASY52, Version 52.10 (2); SEMCAD X Version 14.6.12 (7450)

Test Date: 2019-07-17; Ambient Temp: 21.3; Tissue Temp: 21.2

1.5 cm space from Body, Rear, LTE Band 25 Ch. 26140, Ant Internal

Mode : BandWidth 20 MHz, QPSK, RB Size: 1

Area Scan (9x14x1): Measurement grid: dx=15mm, dy=15mm

Zoom Scan (5x5x7)/Cube 0: Measurement grid: dx=8mm, dy=8mm, dz=5mm

Power Drift = -0.00 dB

Peak SAR (extrapolated) = 0.802 W/kg

SAR(1 g) = 0.452 W/kg; SAR(10 g) = 0.243 W/kg

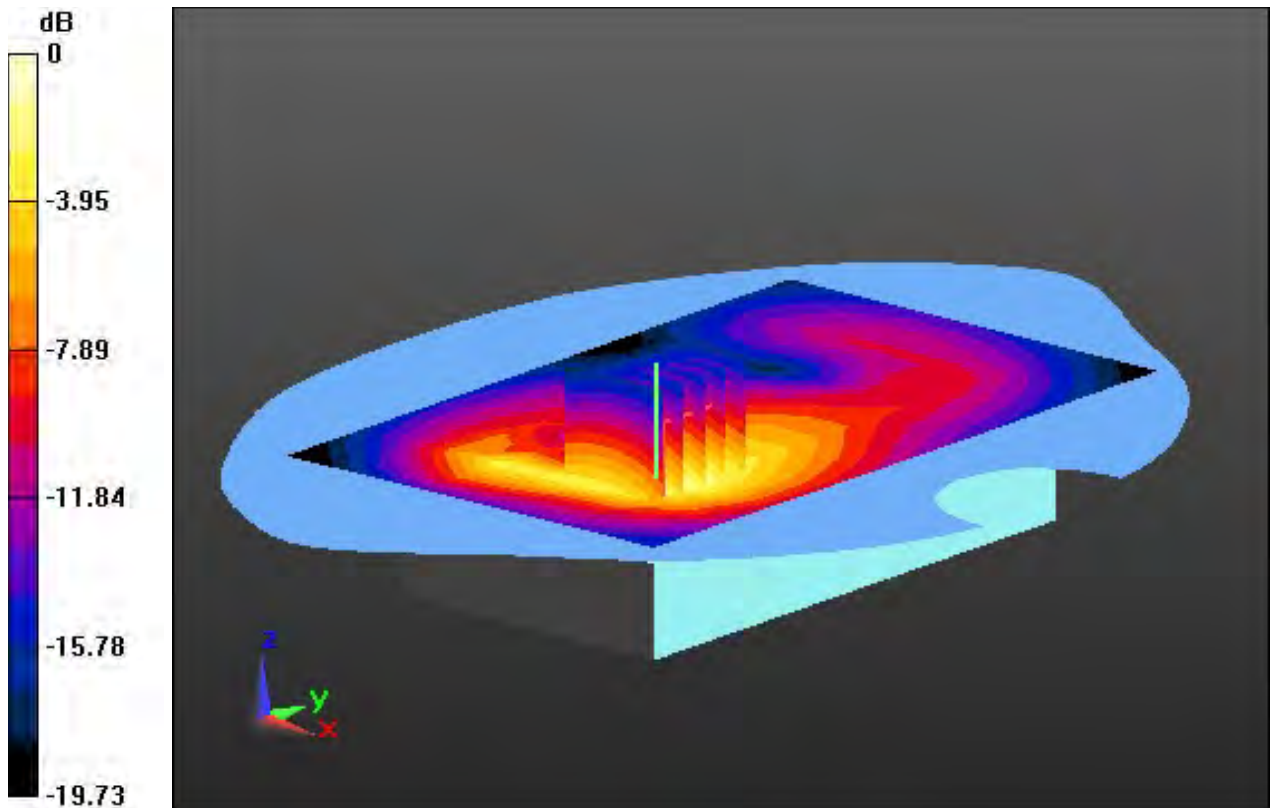

0 dB = 0.629 W/kg

DT&C Co., Ltd.

DUT: PM90G; Type: PDA

Communication System: UID 0, LTE Band 41(TDD) (0); Frequency: 2549.5 MHz;Duty Cycle: 1:1.58

Medium parameters used: $f = 2549.5$ MHz; $\sigma = 1.919$ S/m; $\epsilon_r = 37.835$; $\rho = 1000$ kg/m³
Phantom section: Flat Section

DASY5 Configuration:

Probe: EX3DV4 - SN7337; ConvF(7.43, 7.43, 7.43) @ 2549.5 MHz; Calibrated: 2018-11-22
Electronics: DAE4 Sn1453

Sensor-Surface: 2mm (Mechanical Surface Detection)

Phantom: SAM_Right_20170922; Type: QD000P40CD; Serial: 1895

Measurement SW: DASY52, Version 52.10 (2); SEMCAD X Version 14.6.12 (7450)

Test Date: 2019-07-23; Ambient Temp: 20.7; Tissue Temp: 20.6

1.5 cm space from Body, Rear, LTE Band 41 Ch. 40185, Ant Internal

Mode : BandWidth 20 MHz, QPSK, RB Size: 1

Area Scan (11x17x1): Measurement grid: dx=12mm, dy=12mm

Zoom Scan (7x7x7)/Cube 0: Measurement grid: dx=5mm, dy=5mm, dz=5mm

Power Drift = 0.03 dB

Peak SAR (extrapolated) = 1.92 W/kg

SAR(1 g) = 0.981 W/kg; SAR(10 g) = 0.490 W/kg

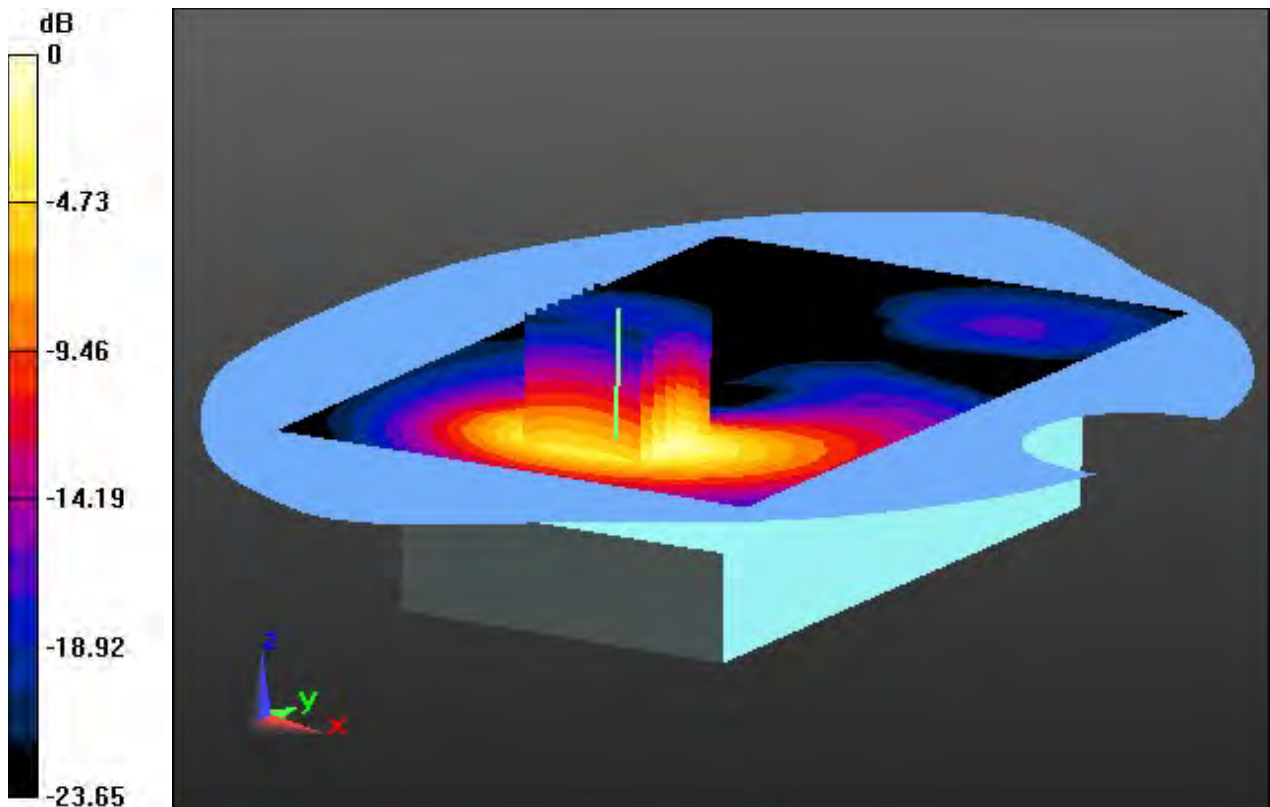

0 dB = 1.44 W/kg

DT&C Co., Ltd.

DUT: PM90G; Type: PDA

Communication System: UID 0, W-LAN (0); Frequency: 2437 MHz; Duty Cycle: 1:1
Medium parameters used: $f = 2437$ MHz; $\sigma = 1.798$ S/m; $\epsilon_r = 38.46$; $\rho = 1000$ kg/m³
Phantom section: Flat Section

DASY5 Configuration:

Probe: EX3DV4 - SN3916; ConvF(7.66, 7.66, 7.66); Calibrated: 4/25/2019; Electronics: DAE4 Sn1392
Sensor-Surface: 2mm (Mechanical Surface Detection)
Phantom: SAM with CRP_2013_10_08_right; Type: QD000P40CD; Serial: TP:1785
Measurement SW: DASY52, Version 52.8 (8); SEMCAD X Version 14.6.10 (7331)

Test Date: 2019-08-14; Ambient Temp: 20.4; Tissue Temp: 20.5

1.5 cm space from Body, Front, WLAN(802.11b) Ch. 6, Ant Internal

Area Scan (11x17x1): Measurement grid: dx=12mm, dy=12mm

Zoom Scan (7x7x7)/Cube 0: Measurement grid: dx=5mm, dy=5mm, dz=5mm

Power Drift = 0.10 dB

Peak SAR (extrapolated) = 0.0600 W/kg

SAR(1 g) = 0.033 W/kg; SAR(10 g) = 0.018 W/kg

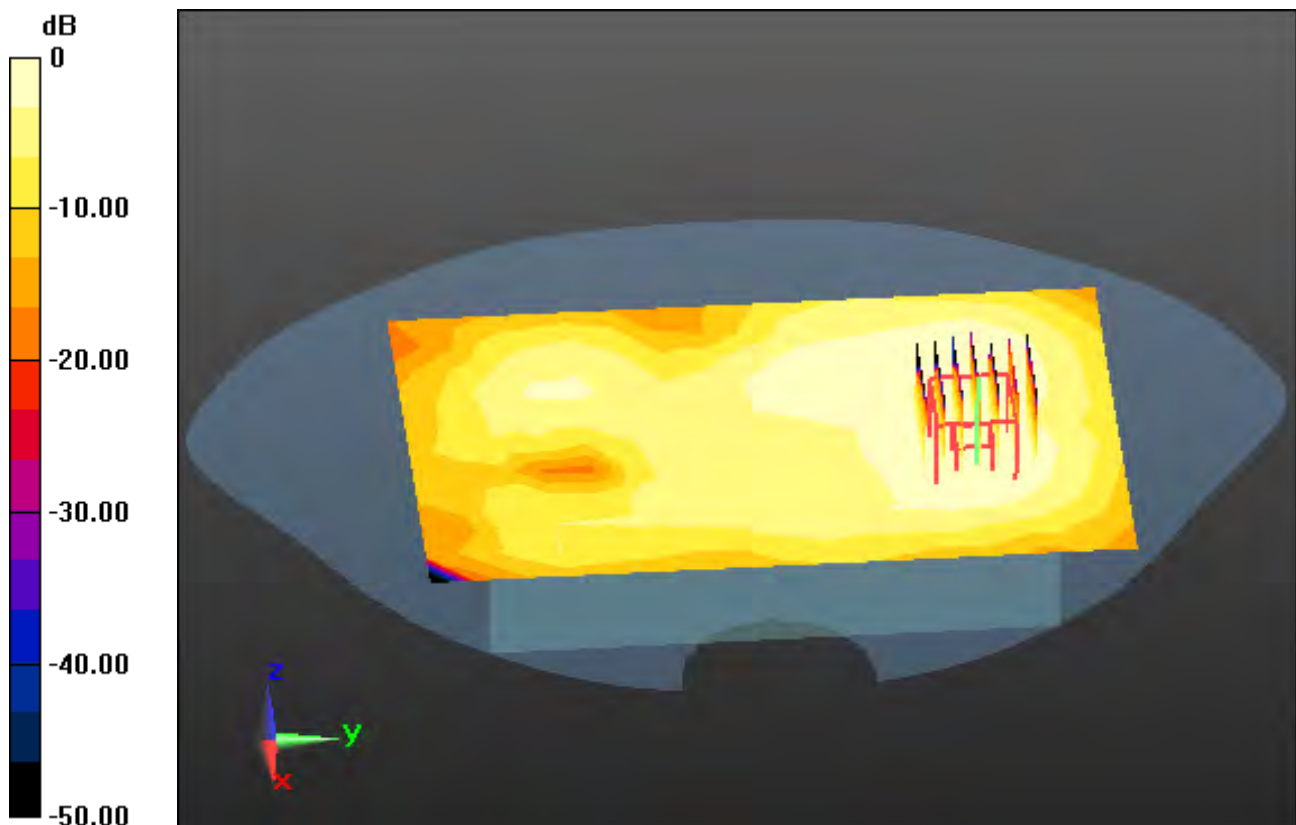

0 dB = 0.0460 W/kg

DT&C Co., Ltd.

DUT: PM90G; Type: PDA

Communication System: UID 0, W-LAN_5300 (0); Frequency: 5300 MHz; Duty Cycle: 1:1
Medium parameters used: $f = 5300$ MHz; $\sigma = 4.588$ S/m; $\epsilon_r = 35.577$; $\rho = 1000$ kg/m³
Phantom section: Flat Section

DASY5 Configuration:

Probe: EX3DV4 - SN3916; ConvF(4.94, 4.94, 4.94); Calibrated: 4/25/2019; Electronics: DAE4 Sn1392
Sensor-Surface: 1.4mm (Mechanical Surface Detection)
Phantom: SAM with CRP_2016_07_22_middle; Type: QD000P40CD; Serial: TP:1786
Measurement SW: DASY52, Version 52.8 (8); SEMCAD X Version 14.6.10 (7331)

Test Date: 2019-08-16; Ambient Temp: 21.2; Tissue Temp: 21.4

1.5 cm space from Body, Front, WLAN(802.11a) Ch. 60, Ant Internal

Area Scan (14x21x1): Measurement grid: dx=10mm, dy=10mm

Zoom Scan (8x8x7)/Cube 0: Measurement grid: dx=4mm, dy=4mm, dz=1.4mm, Graded Ratio:1.4

Power Drift = -0.00 dB

Peak SAR (extrapolated) = 0.667 W/kg

SAR(1 g) = 0.194 W/kg; SAR(10 g) = 0.081 W/kg

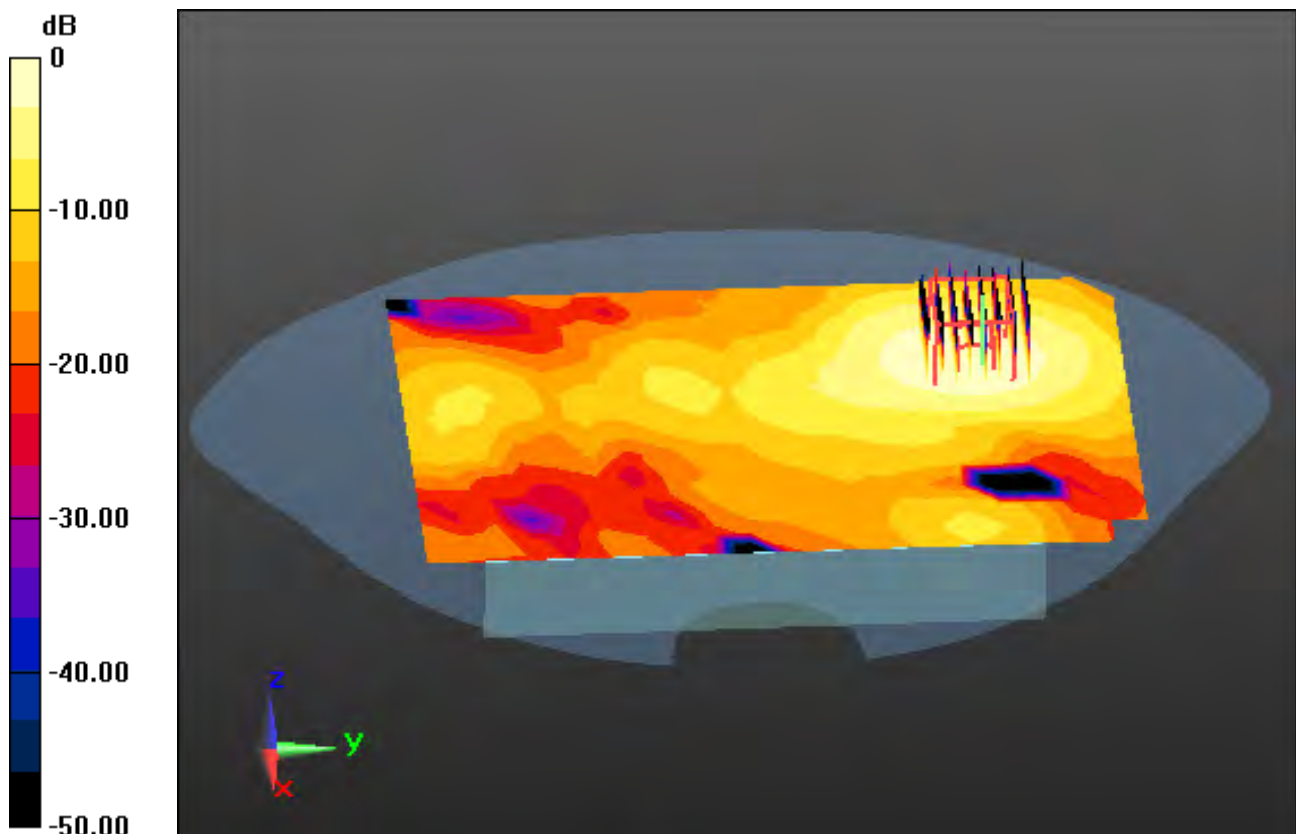

0 dB = 0.421 W/kg

DT&C Co., Ltd.

DUT: PM90G; Type: PDA

Communication System: UID 0, W-LAN_5500 (0); Frequency: 5580 MHz; Duty Cycle: 1:1
Medium parameters used: $f = 5580$ MHz; $\sigma = 5.085$ S/m; $\epsilon_r = 34.541$; $\rho = 1000$ kg/m³
Phantom section: Flat Section

DASY5 Configuration:

Probe: EX3DV4 - SN3933; ConvF(4.71, 4.71, 4.71); Calibrated: 9/25/2018; Electronics: DAE4 Sn1391
Sensor-Surface: 1.4mm (Mechanical Surface Detection)
Phantom: SAM (30deg probe tilt) with CRP v5.0(Right); Type: QD000P40CD; Serial: 1220
Measurement SW: DASY52, Version 52.8 (8); SEMCAD X Version 14.6.10 (7331)

Test Date: 2019-08-14; Ambient Temp: 22.1; Tissue Temp: 22.3

1.5 cm space from Body, Rear, WLAN(802.11a) Ch. 116, Ant Internal

Area Scan (14x21x1): Measurement grid: dx=10mm, dy=10mm

Zoom Scan (8x8x7)/Cube 0: Measurement grid: dx=4mm, dy=4mm, dz=1.4mm, Graded Ratio:1.4

Power Drift = -0.07 dB

Peak SAR (extrapolated) = 1.04 W/kg

SAR(1 g) = 0.290 W/kg; SAR(10 g) = 0.122 W/kg

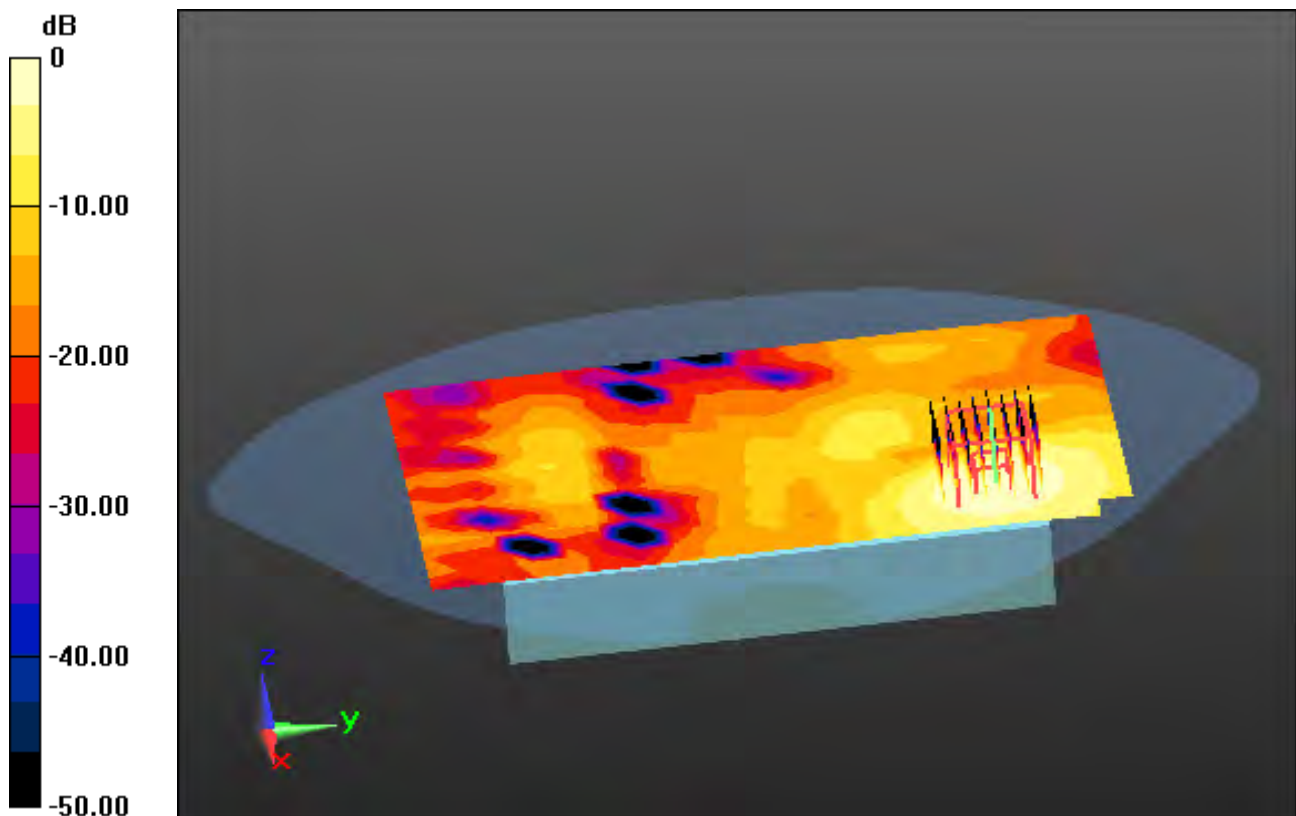

0 dB = 0.628 W/kg

DT&C Co., Ltd.

DUT: PM90G; Type: PDA

Communication System: UID 0, W-LAN 5.8G(802.11a/n/ac) (0); Frequency: 5825 MHz; Duty Cycle: 1:1
Medium parameters used: $f = 5825$ MHz; $\sigma = 5.407$ S/m; $\epsilon_r = 35.666$; $\rho = 1000$ kg/m³
Phantom section: Flat Section

DASY5 Configuration:

Probe: EX3DV4 - SN3933; ConvF(4.77, 4.77, 4.77); Calibrated: 9/25/2018; Electronics: DAE4 Sn1391
Sensor-Surface: 1.4mm (Mechanical Surface Detection)
Phantom: SAM with CRP v5.0(Right); Type: QD000P40CD; Serial: 1220
Measurement SW: DASY52, Version 52.8 (8); SEMCAD X Version 14.6.10 (7331)

Test Date: 2019-08-16; Ambient Temp: 21.8; Tissue Temp: 21.9

1.5 cm space from Body, Rear, WLAN(802.11a) Ch. 165, Ant Internal

Area Scan (14x21x1): Measurement grid: dx=10mm, dy=10mm

Zoom Scan (8x8x7)/Cube 0: Measurement grid: dx=4mm, dy=4mm, dz=1.4mm, Graded Ratio:1.4

Power Drift = -0.09 dB

Peak SAR (extrapolated) = 0.588 W/kg

SAR(1 g) = 0.140 W/kg; SAR(10 g) = 0.060 W/kg

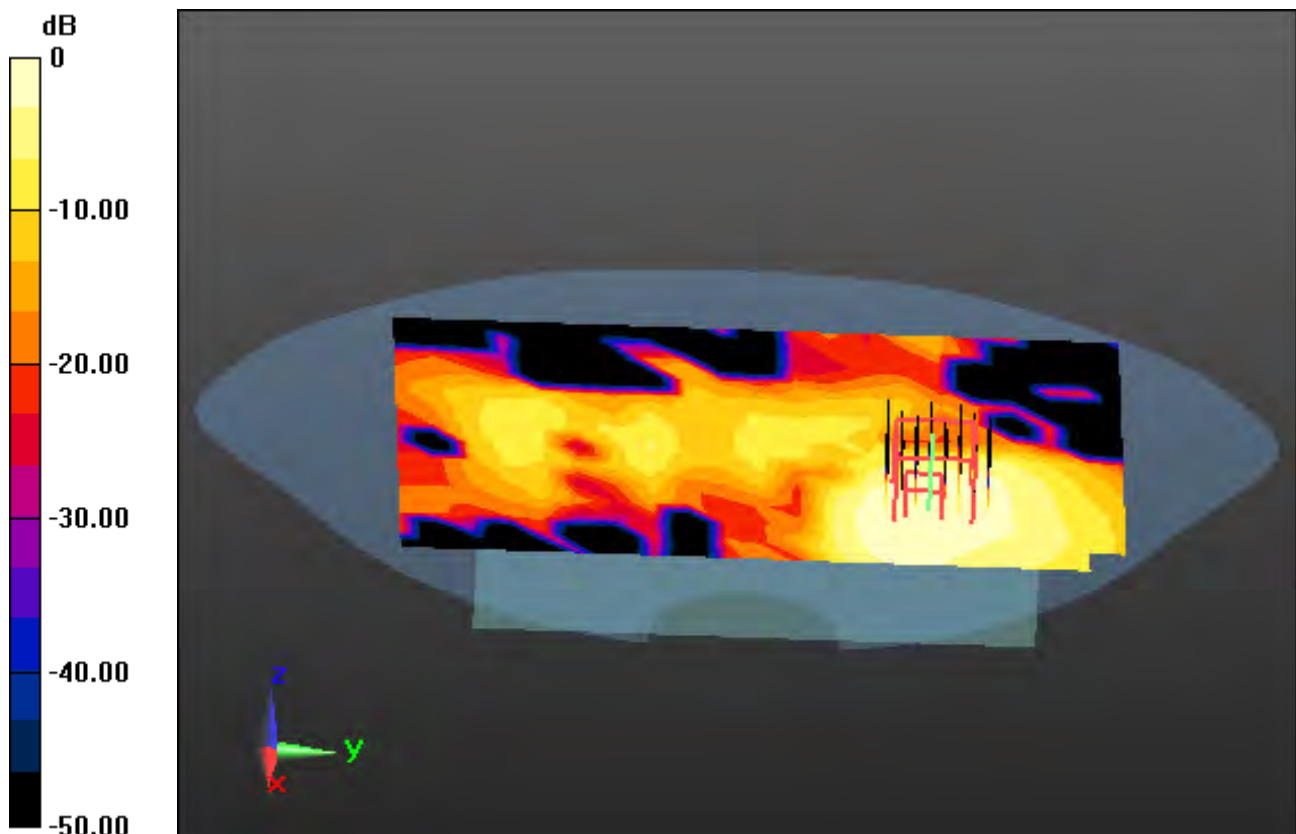

0 dB = 0.338 W/kg

DT&C Co., Ltd.

DUT: PM90W; Type: PDA

Communication System: UID 0, Bluetooth (0); Frequency: 2441 MHz; Duty Cycle: 1:1.302
Medium parameters used: $f = 2441$ MHz; $\sigma = 1.802$ S/m; $\epsilon_r = 38.404$; $\rho = 1000$ kg/m³
Phantom section: Flat Section

DASY5 Configuration:

Probe: EX3DV4 - SN3916; ConvF(7.66, 7.66, 7.66); Calibrated: 4/25/2019; Electronics: DAE4 Sn1392
Sensor-Surface: 2mm (Mechanical Surface Detection)
Phantom: SAM with CRP_2013_10_08_right; Type: QD000P40CD; Serial: TP:1785
Measurement SW: DASY52, Version 52.8 (8); SEMCAD X Version 14.6.10 (7331)

Test Date: 2019-08-13; Ambient Temp: 20.4; Tissue Temp: 20.6

1.5 cm space from Body, Front, Bluetooth Ch. 39, Ant Internal

Area Scan (11x17x1): Measurement grid: dx=12mm, dy=12mm

Zoom Scan (7x7x7)/Cube 0: Measurement grid: dx=5mm, dy=5mm, dz=5mm

Power Drift = -0.08 dB

Peak SAR (extrapolated) = 0.0120 W/kg

SAR(1 g) = 0.00261 W/kg; SAR(10 g) = 0.000749 W/kg

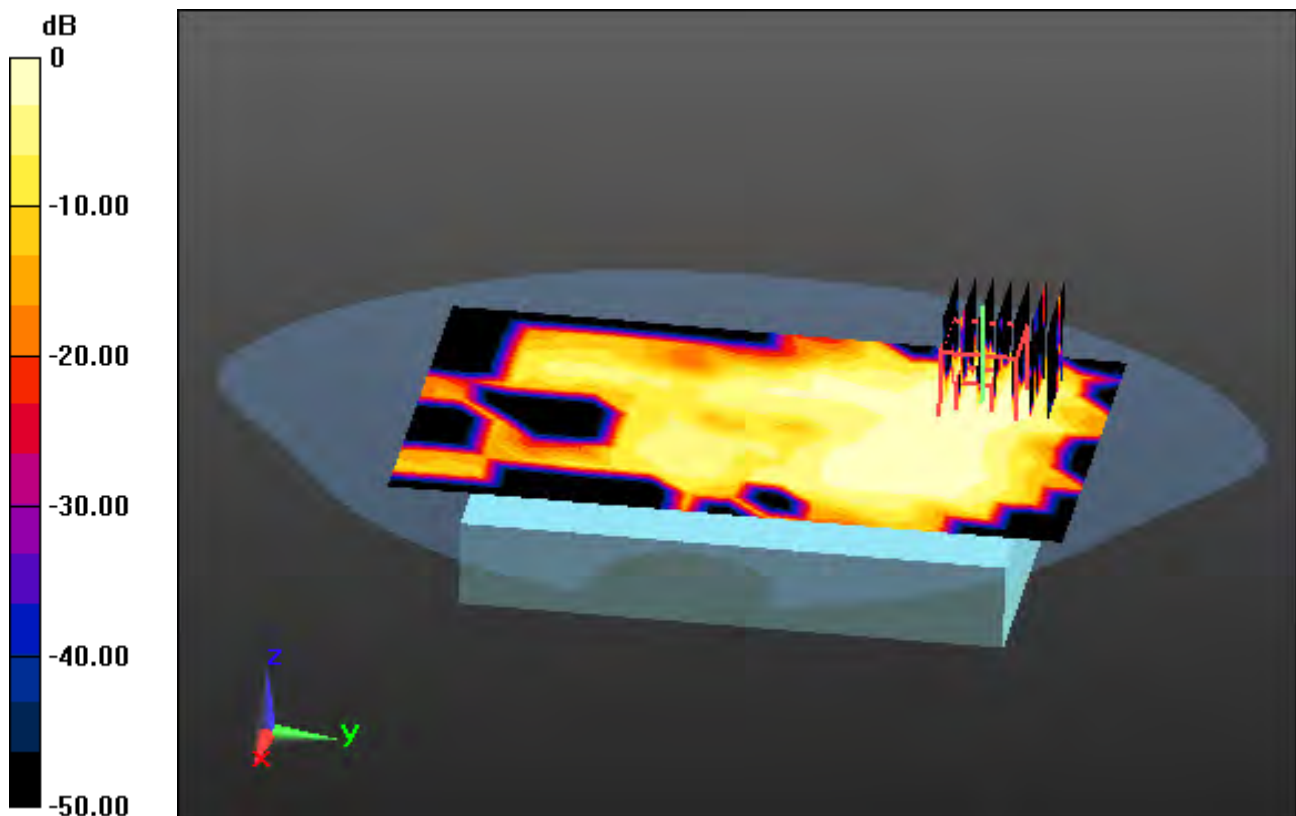

0 dB = 0.00605 W/kg

DT&C Co., Ltd.

DUT: PM90G; Type: PDA

Communication System: UID 0, GSM 850_2 Tx (0); Frequency: 836.6 MHz; Duty Cycle: 1:4.15
Medium parameters used: $f = 836.6$ MHz; $\sigma = 0.891$ S/m; $\epsilon_r = 42.785$; $\rho = 1000$ kg/m³
Phantom section: Flat Section

DASY5 Configuration:

Probe: EX3DV4 - SN3866; ConvF(9.39, 9.39, 9.39); Calibrated: 5/28/2019; Electronics: DAE4 Sn1394
Sensor-Surface: 2mm (Mechanical Surface Detection)
Phantom: SAM-twin middle_2013_09_24; Type: QD000P40CD; Serial: 1782
Measurement SW: DASY52, Version 52.8 (8); SEMCAD X Version 14.6.10 (7331)

Test Date: 2019-07-26; Ambient Temp: 22.3; Tissue Temp: 22.8

1 cm space from Body, Rear, GSM850 GPRS 2Tx Ch. 190, Ant Internal

Area Scan (9x14x1): Measurement grid: dx=15mm, dy=15mm

Zoom Scan (5x5x7)/Cube 0: Measurement grid: dx=8mm, dy=8mm, dz=5mm

Power Drift = -0.11 dB

Peak SAR (extrapolated) = 0.699 W/kg

SAR(1 g) = 0.384 W/kg; SAR(10 g) = 0.213 W/kg

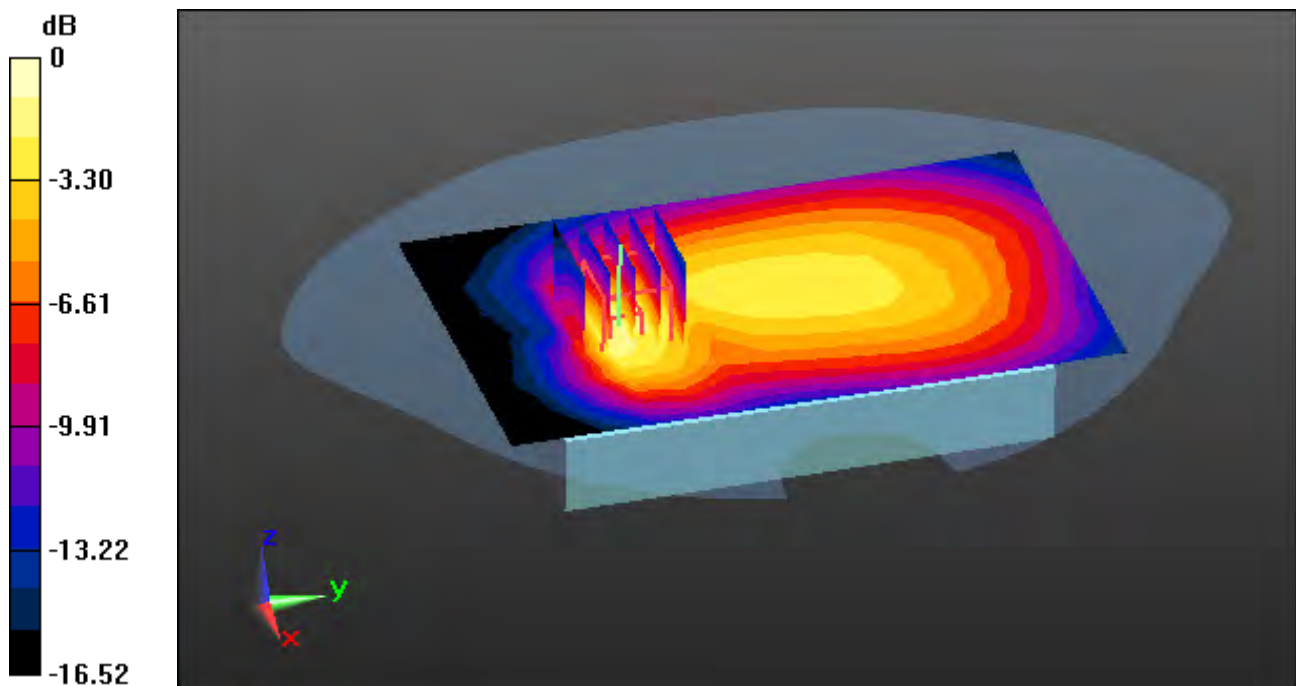

0 dB = 0.547 W/kg

DT&C Co., Ltd.

DUT: PM90G; Type: PDA

Communication System: UID 0, PCS 1900 2 Tx (0); Frequency: 1880 MHz; Duty Cycle: 1:4.15
Medium parameters used: $f = 1880$ MHz; $\sigma = 1.384$ S/m; $\epsilon_r = 40.087$; $\rho = 1000$ kg/m³
Phantom section: Flat Section

DASY5 Configuration:

Probe: EX3DV4 - SN7337; ConvF(8.49, 8.49, 8.49) @ 1880 MHz; Calibrated: 2018-11-22;
Electronics: DAE4 Sn1453

Sensor-Surface: 2mm (Mechanical Surface Detection)

Phantom: SAM_Right_20170922; Type: QD000P40CD; Serial: 1895

Measurement SW: DASY52, Version 52.10 (2); SEMCAD X Version 14.6.12 (7450)

Test Date: 2019-07-15; Ambient Temp: 21.6; Tissue Temp: 21.5

1 cm space from Body, Rear, PCS1900 GPRS 2 Tx Ch. 661, Ant. Internal

Area Scan (9x14x1): Measurement grid: dx=15mm, dy=15mm

Zoom Scan (5x5x7)/Cube 0: Measurement grid: dx=8mm, dy=8mm, dz=5mm

Power Drift = 0.03 dB

Peak SAR (extrapolated) = 0.892 W/kg

SAR(1 g) = 0.502 W/kg; SAR(10 g) = 0.273 W/kg

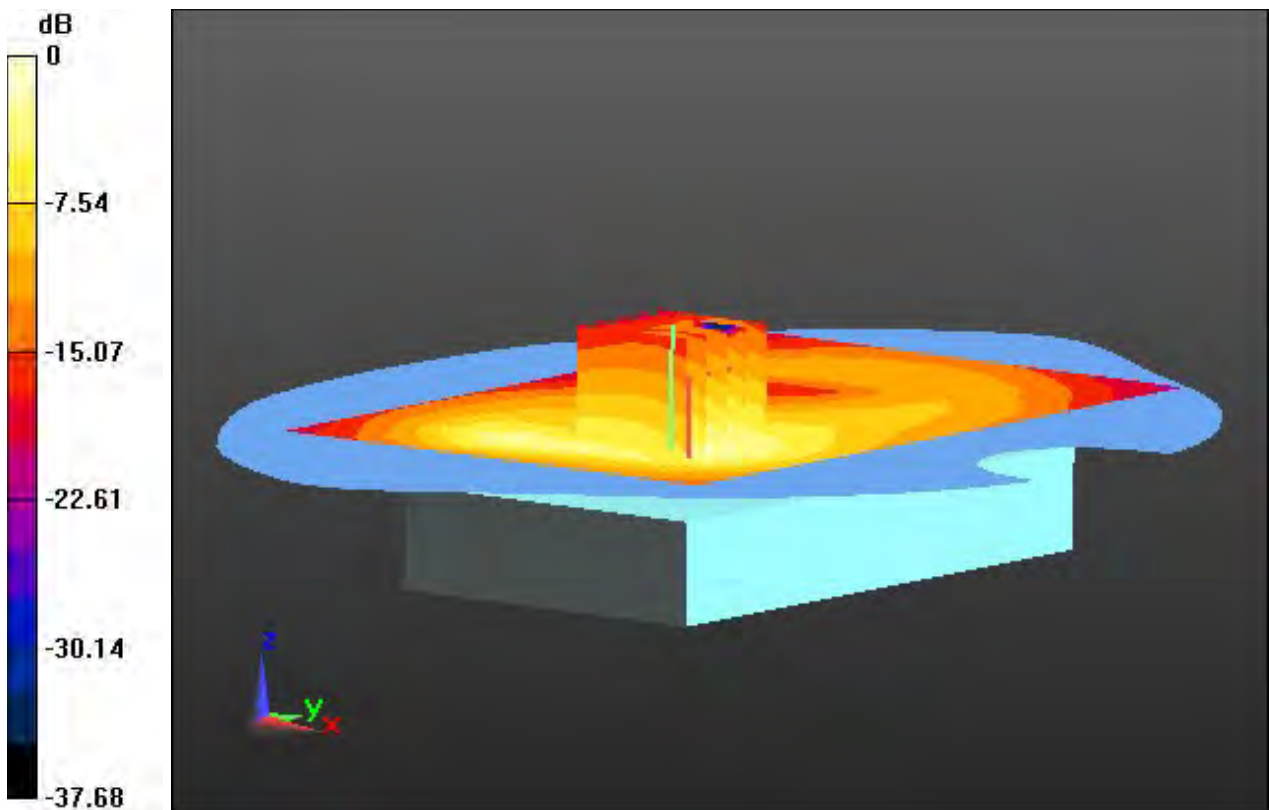

0 dB = 0.707 W/kg

DT&C Co., Ltd.

DUT: PM90G; Type: PDA

Communication System: UID 0, WCDMA 850 (0); Frequency: 836.6 MHz; Duty Cycle: 1:1
Medium parameters used: $f = 836.6$ MHz; $\sigma = 0.879$ S/m; $\epsilon_r = 42.344$; $\rho = 1000$ kg/m³
Phantom section: Flat Section

DASY5 Configuration:

Probe: EX3DV4 - SN3866; ConvF(9.39, 9.39, 9.39); Calibrated: 5/28/2019; Electronics: DAE4 Sn1394
Sensor-Surface: 2mm (Mechanical Surface Detection)
Phantom: SAM-twin middle_2013_09_24; Type: QD000P40CD; Serial: 1782
Measurement SW: DASY52, Version 52.8 (8); SEMCAD X Version 14.6.10 (7331)

Test Date: 2019-07-29; Ambient Temp: 22.5; Tissue Temp: 22.2

1 cm space from Body, Rear, WCDMA Band 5 Ch. 4183, Ant Internal

Area Scan (9x14x1): Measurement grid: dx=15mm, dy=15mm

Zoom Scan (5x5x7)/Cube 0: Measurement grid: dx=8mm, dy=8mm, dz=5mm

Power Drift = 0.02 dB

Peak SAR (extrapolated) = 0.915 W/kg

SAR(1 g) = 0.504 W/kg; SAR(10 g) = 0.277 W/kg

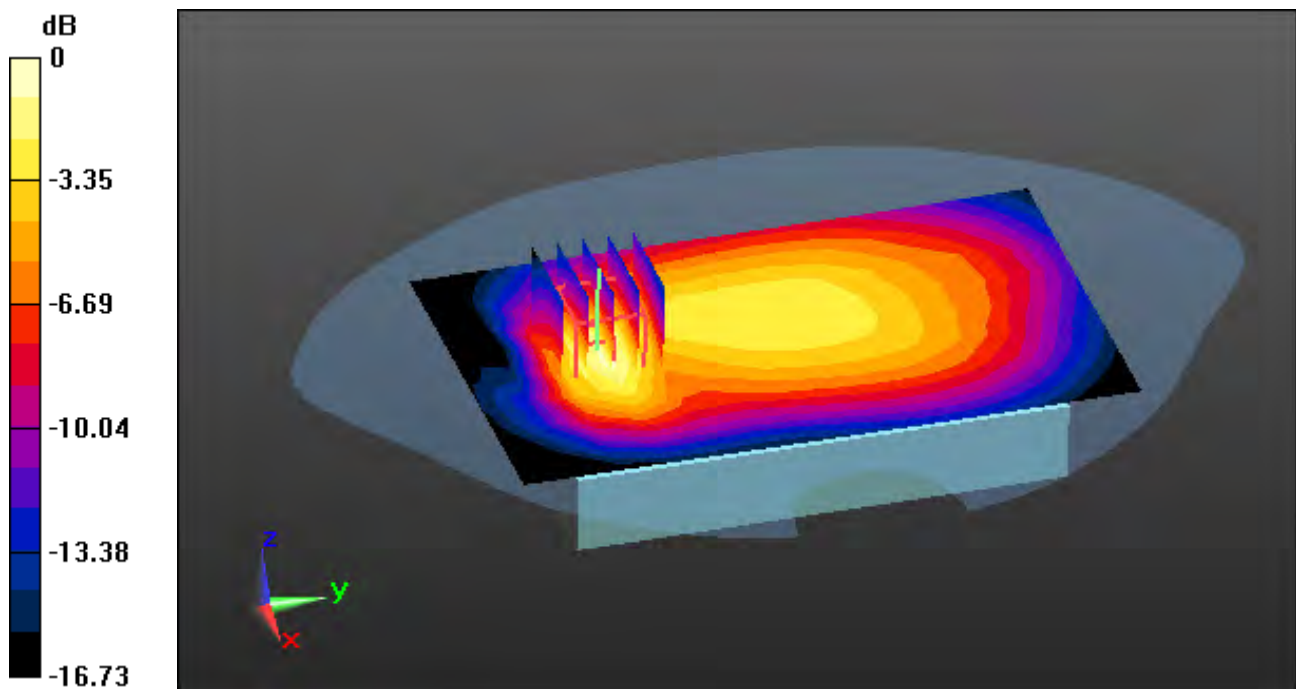

0 dB = 0.700 W/kg

DT&C Co., Ltd.

DUT: PM90G; Type: PDA

Communication System: UID 0, WCDMA (0); Frequency: 1752.6 MHz; Duty Cycle: 1:1
Medium parameters used: $f = 1752.6$ MHz; $\sigma = 1.343$ S/m; $\epsilon_r = 40.777$; $\rho = 1000$ kg/m³
Phantom section: Flat Section

DASY5 Configuration:

Probe: EX3DV4 - SN7337; ConvF(8.96, 8.96, 8.96) @ 1752.6 MHz; Calibrated: 2018-11-22;
Electronics: DAE4 Sn1453

Sensor-Surface: 2mm (Mechanical Surface Detection)

Phantom: SAM_Right_20170922; Type: QD000P40CD; Serial: 1895

Measurement SW: DASY52, Version 52.10 (2); SEMCAD X Version 14.6.12 (7450)

Test Date: 2019-08-12; Ambient Temp: 20.9; Tissue Temp: 20.8

1 cm space from Body, Rear, WCDMA Band 4 Ch. 1513, Ant. Internal

Area Scan (9x14x1): Measurement grid: dx=15mm, dy=15mm

Zoom Scan (5x5x7)/Cube 0: Measurement grid: dx=8mm, dy=8mm, dz=5mm

Power Drift = 0.03 dB

Peak SAR (extrapolated) = 1.34 W/kg

SAR(1 g) = 0.845 W/kg; SAR(10 g) = 0.503 W/kg

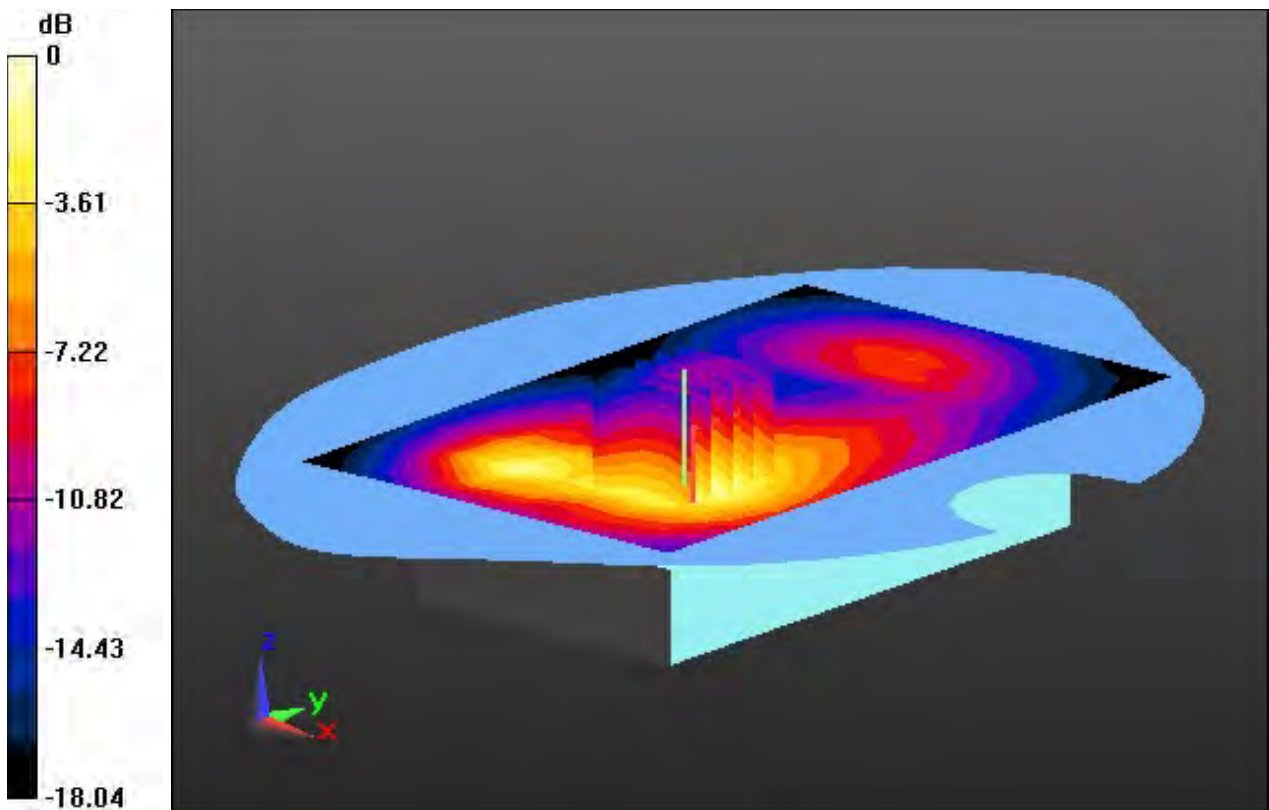

0 dB = 1.11 W/kg

DT&C Co., Ltd.

DUT: PM90G; Type: PDA

Communication System: UID 0, WCDMA (0); Frequency: 1880 MHz; Duty Cycle: 1:1
Medium parameters used: $f = 1880$ MHz; $\sigma = 1.384$ S/m; $\epsilon_r = 40.087$; $\rho = 1000$ kg/m³
Phantom section: Flat Section

DASY5 Configuration:

Probe: EX3DV4 - SN7337; ConvF(8.49, 8.49, 8.49) @ 1880 MHz; Calibrated: 2018-11-22;
Electronics: DAE4 Sn1453

Sensor-Surface: 2mm (Mechanical Surface Detection)

Phantom: SAM_Right_20170922; Type: QD000P40CD; Serial: 1895

Measurement SW: DASY52, Version 52.10 (2); SEMCAD X Version 14.6.12 (7450)

Test Date: 2019-07-15; Ambient Temp: 21.6; Tissue Temp: 21.5

1 cm space from Body, Rear, WCDMA Band 2 Ch. 9400, Ant. Internal

Area Scan (9x14x1): Measurement grid: dx=15mm, dy=15mm

Zoom Scan (5x5x7)/Cube 0: Measurement grid: dx=8mm, dy=8mm, dz=5mm

Power Drift = -0.04 dB

Peak SAR (extrapolated) = 1.59 W/kg

SAR(1 g) = 0.907 W/kg; SAR(10 g) = 0.499 W/kg

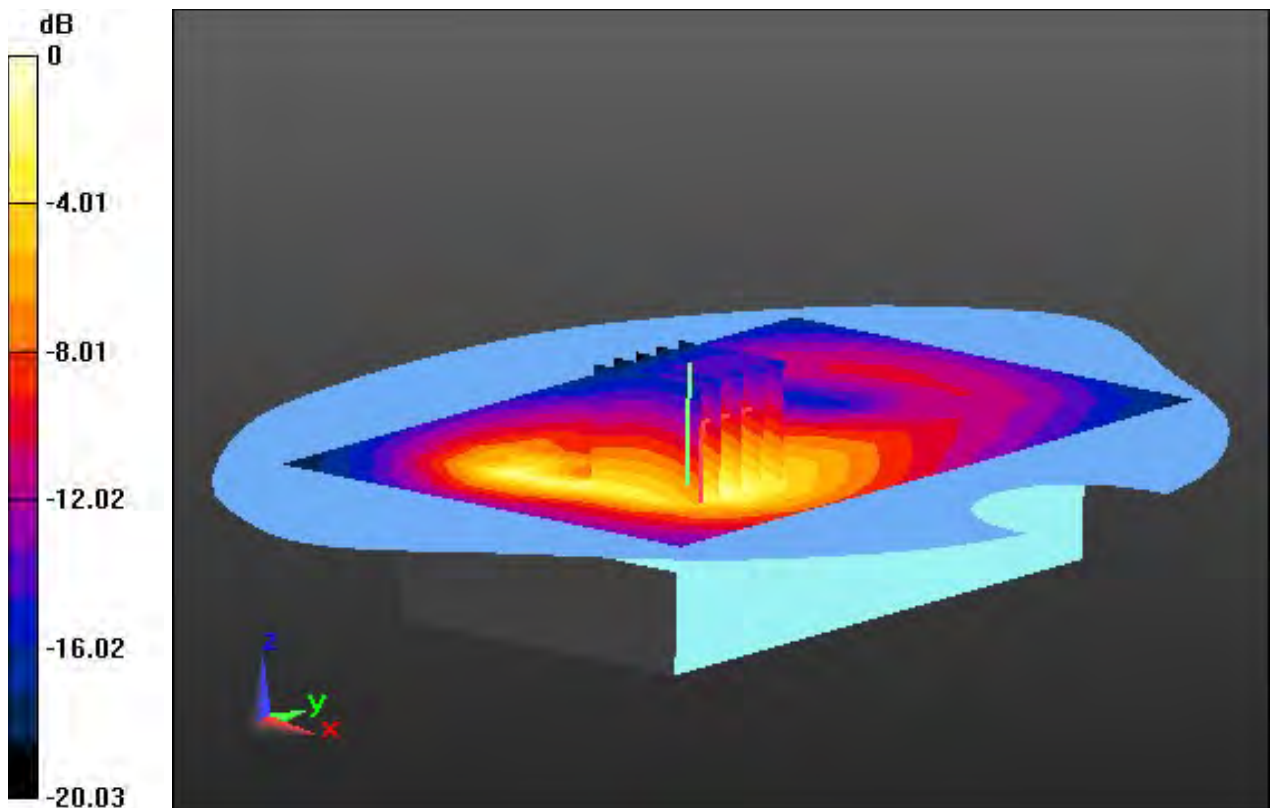

0 dB = 1.26 W/kg

DT&C Co., Ltd.

DUT: PM90G; Type: PDA

Communication System: UID 0, LTE Band 12 (FCC) (0); Frequency: 707.5 MHz; Duty Cycle: 1:1
Medium parameters used: $f = 707.5$ MHz; $\sigma = 0.866$ S/m; $\epsilon_r = 42.824$; $\rho = 1000$ kg/m³
Phantom section: Flat Section

DASY5 Configuration:

Probe: EX3DV4 - SN3866; ConvF(9.85, 9.85, 9.85); Calibrated: 5/28/2019; Electronics: DAE4 Sn1394
Sensor-Surface: 2mm (Mechanical Surface Detection)
Phantom: SAM-twin middle_2013_09_24; Type: QD000P40CD; Serial: 1782
Measurement SW: DASY52, Version 52.8 (8); SEMCAD X Version 14.6.10 (7331)

Test Date: 2019-07-30; Ambient Temp: 22.0; Tissue Temp: 21.9

1 cm space from Body, Rear, LTE Band 12 Ch. 23095, Ant Internal

Mode : BandWidth 10 MHz, QPSK, RB Size: 1

Area Scan (9x14x1): Measurement grid: dx=15mm, dy=15mm

Zoom Scan (5x5x7)/Cube 0: Measurement grid: dx=8mm, dy=8mm, dz=5mm

Power Drift = -0.07 dB

Peak SAR (extrapolated) = 0.556 W/kg

SAR(1 g) = 0.334 W/kg; SAR(10 g) = 0.214 W/kg

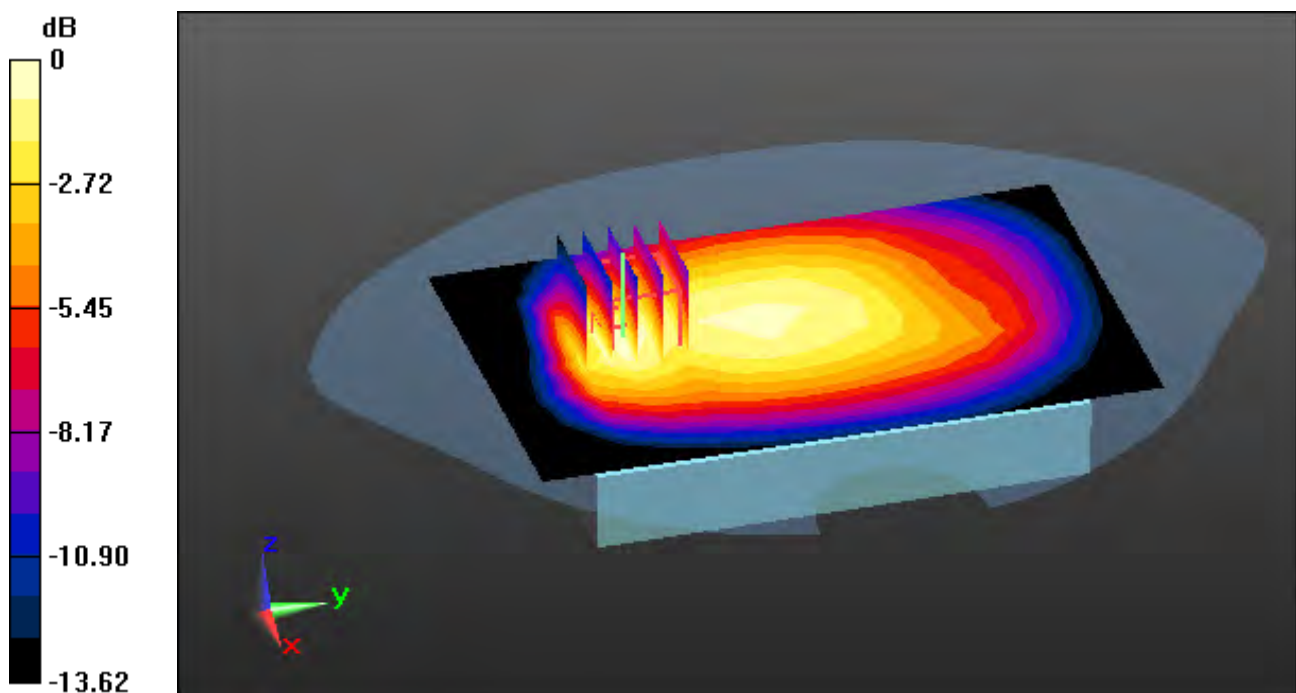

0 dB = 0.421 W/kg

DT&C Co., Ltd.

DUT: PM90G; Type: PDA

Communication System: UID 0, LTE Band 13 (0); Frequency: 782 MHz; Duty Cycle: 1:1
Medium parameters used: $f = 782 \text{ MHz}$; $\sigma = 0.91 \text{ S/m}$; $\epsilon_r = 40.984$; $\rho = 1000 \text{ kg/m}^3$
Phantom section: Flat Section

DASY5 Configuration:

Probe: EX3DV4 - SN3866; ConvF(9.85, 9.85, 9.85); Calibrated: 5/28/2019; Electronics: DAE4 Sn1394
Sensor-Surface: 2mm (Mechanical Surface Detection)
Phantom: SAM-twin middle_2013_09_24; Type: QD000P40CD; Serial: 1782
Measurement SW: DASY52, Version 52.8 (8); SEMCAD X Version 14.6.10 (7331)

Test Date: 2019-08-01; Ambient Temp: 22.1; Tissue Temp: 21.8

1 cm space from Body, Rear, LTE Band 13 Ch. 23230, Ant Internal

Mode : BandWidth 10 MHz, QPSK, RB Size: 1

Area Scan (9x14x1): Measurement grid: $dx=15\text{mm}$, $dy=15\text{mm}$

Zoom Scan (5x5x7)/Cube 0: Measurement grid: $dx=8\text{mm}$, $dy=8\text{mm}$, $dz=5\text{mm}$

Power Drift = -0.07 dB

Peak SAR (extrapolated) = 0.499 W/kg

SAR(1 g) = 0.402 W/kg; SAR(10 g) = 0.310 W/kg

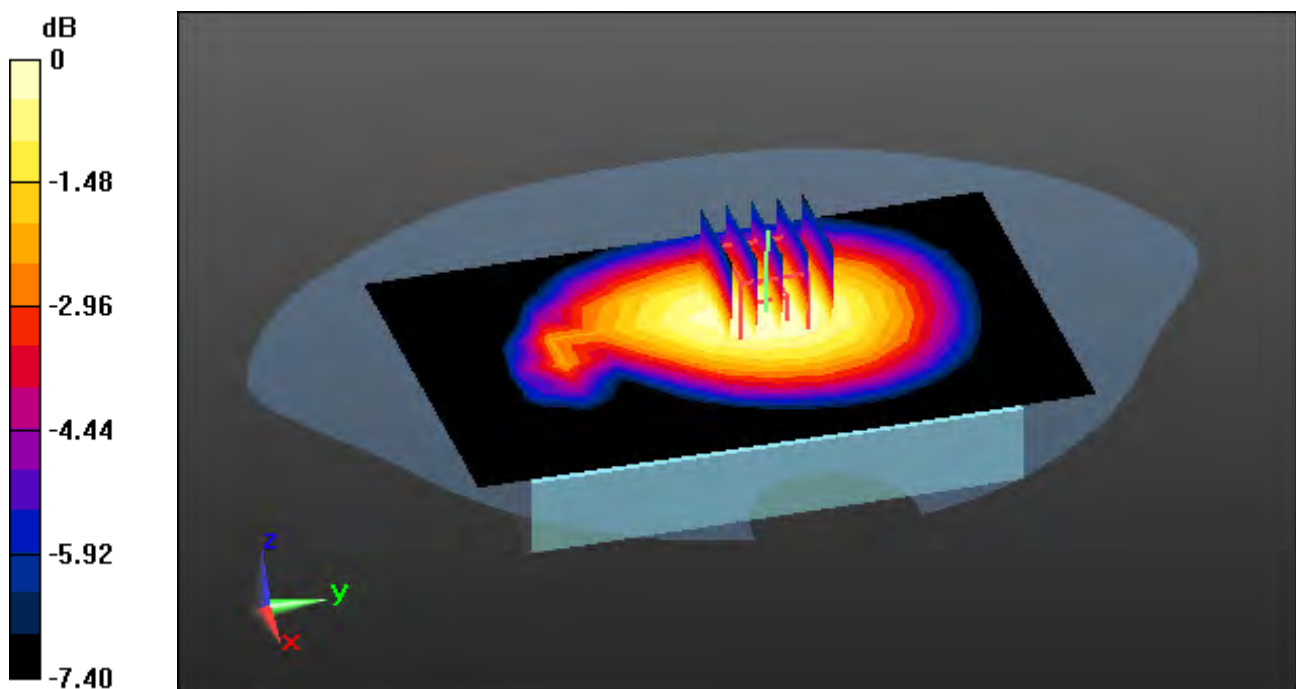

0 dB = 0.459 W/kg

DT&C Co., Ltd.

DUT: PM90G; Type: PDA

Communication System: UID 0, LTE Band 14 (0); Frequency: 793 MHz; Duty Cycle: 1:1
Medium parameters used: $f = 793 \text{ MHz}$; $\sigma = 0.91 \text{ S/m}$; $\epsilon_r = 40.359$; $\rho = 1000 \text{ kg/m}^3$
Phantom section: Flat Section

DASY5 Configuration:

Probe: EX3DV4 - SN3866; ConvF(9.85, 9.85, 9.85); Calibrated: 5/28/2019; Electronics: DAE4 Sn1394
Sensor-Surface: 2mm (Mechanical Surface Detection)
Phantom: SAM-twin middle_2013_09_24; Type: QD000P40CD; Serial: 1782
Measurement SW: DASY52, Version 52.8 (8); SEMCAD X Version 14.6.10 (7331)

Test Date: 2019-08-02; Ambient Temp: 21.7; Tissue Temp: 21.5

1 cm space from Body, Rear, LTE Band 14 Ch. 23330, Ant Internal

Mode : BandWidth 10 MHz, QPSK, RB Size: 1

Area Scan (9x14x1): Measurement grid: $dx=15\text{mm}$, $dy=15\text{mm}$

Zoom Scan (5x5x7)/Cube 0: Measurement grid: $dx=8\text{mm}$, $dy=8\text{mm}$, $dz=5\text{mm}$

Power Drift = -0.03 dB

Peak SAR (extrapolated) = 0.421 W/kg

SAR(1 g) = 0.341 W/kg; SAR(10 g) = 0.263 W/kg

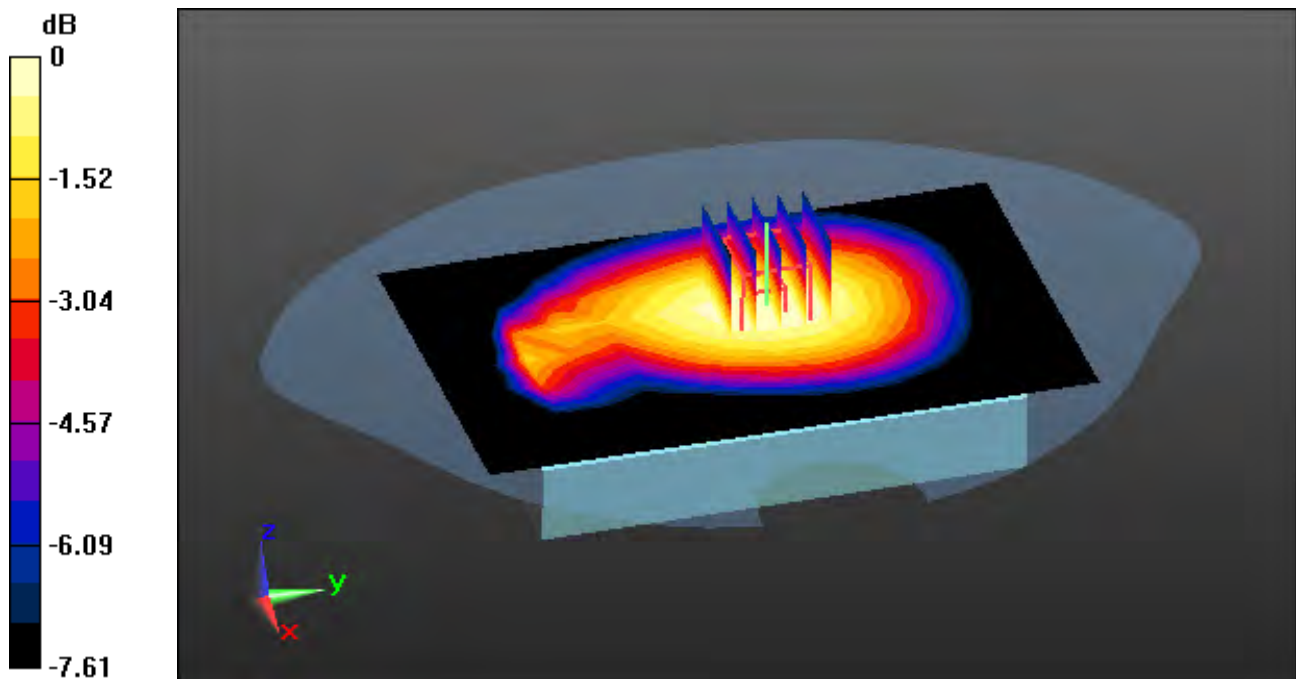

0 dB = 0.388 W/kg

DT&C Co., Ltd.

DUT: PM90G; Type: PDA

Communication System: UID 0, LTE BAND 26 (0); Frequency: 831.5 MHz; Duty Cycle: 1:1
Medium parameters used: $f = 831.5$ MHz; $\sigma = 0.895$ S/m; $\epsilon_r = 42.934$; $\rho = 1000$ kg/m³
Phantom section: Flat Section

DASY5 Configuration:

Probe: EX3DV4 - SN3866; ConvF(9.39, 9.39, 9.39); Calibrated: 5/28/2019; Electronics: DAE4 Sn1394
Sensor-Surface: 2mm (Mechanical Surface Detection)
Phantom: SAM-twin middle_2013_09_24; Type: QD000P40CD; Serial: 1782
Measurement SW: DASY52, Version 52.8 (8); SEMCAD X Version 14.6.10 (7331)

Test Date: 2019-07-31; Ambient Temp: 22.3; Tissue Temp: 22.0

1 cm space from Body, Rear, LTE Band 26 Ch. 26865, Ant Internal

Mode : BandWidth 15 MHz, QPSK, RB Size: 1

Area Scan (9x14x1): Measurement grid: dx=15mm, dy=15mm

Zoom Scan (5x5x7)/Cube 0: Measurement grid: dx=8mm, dy=8mm, dz=5mm

Power Drift = -0.02 dB

Peak SAR (extrapolated) = 0.795 W/kg

SAR(1 g) = 0.436 W/kg; SAR(10 g) = 0.238 W/kg

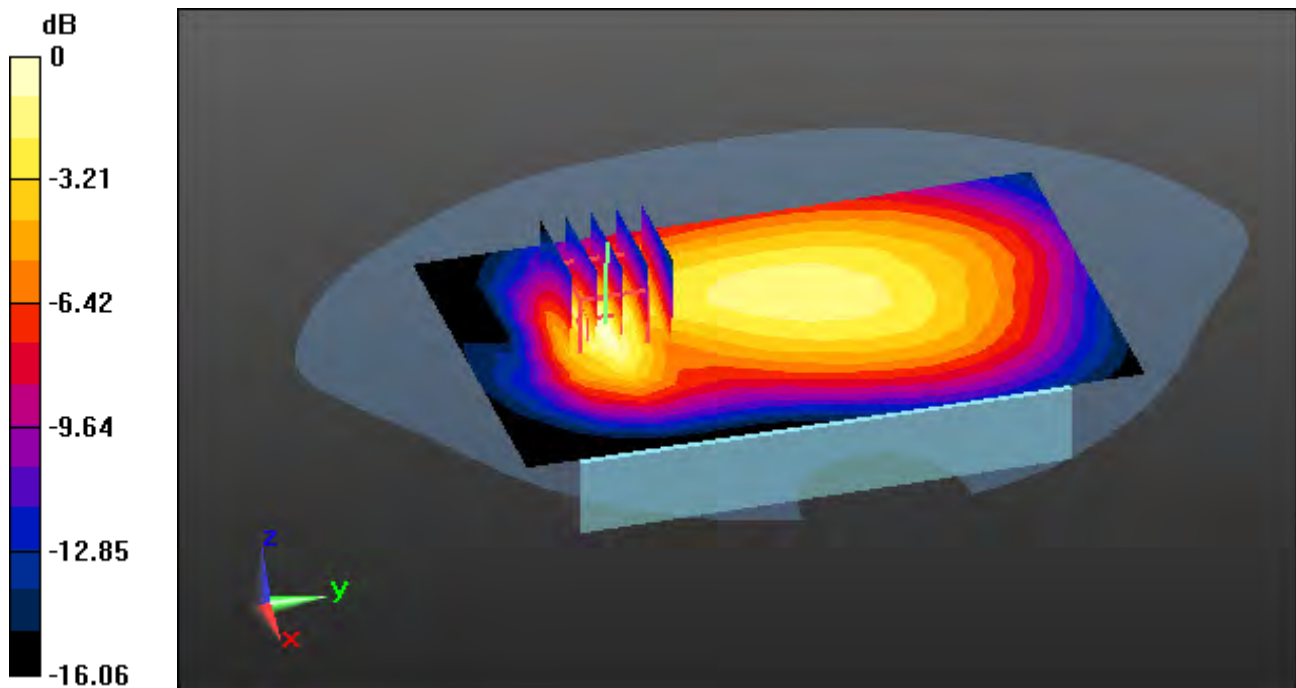

0 dB = 0.585 W/kg

DT&C Co., Ltd.

DUT: PM90G; Type: PDA

Communication System: UID 0, LTE Band 4 (0); Frequency: 1732.5 MHz; Duty Cycle: 1:1
Medium parameters used: $f = 1732.5$ MHz; $\sigma = 1.324$ S/m; $\epsilon_r = 40.805$; $\rho = 1000$ kg/m³
Phantom section: Flat Section

DASY5 Configuration:

Probe: EX3DV4 - SN7337; ConvF(8.96, 8.96, 8.96) @ 1732.5 MHz; Calibrated: 2018-11-22
Electronics: DAE4 Sn1453

Sensor-Surface: 2mm (Mechanical Surface Detection)

Phantom: SAM_Right_20170922; Type: QD000P40CD; Serial: 1895

Measurement SW: DASY52, Version 52.10 (2); SEMCAD X Version 14.6.12 (7450)

Test Date: 2019-08-12; Ambient Temp: 20.9; Tissue Temp: 20.8

1 cm space from Body, Rear, LTE Band 4 Ch. 20175, Ant Internal

Mode : BandWidth 20 MHz, QPSK, RB Size: 1

Area Scan (9x14x1): Measurement grid: dx=15mm, dy=15mm

Zoom Scan (5x5x7)/Cube 0: Measurement grid: dx=8mm, dy=8mm, dz=5mm

Power Drift = 0.03 dB

Peak SAR (extrapolated) = 0.938 W/kg

SAR(1 g) = 0.580 W/kg; SAR(10 g) = 0.341 W/kg

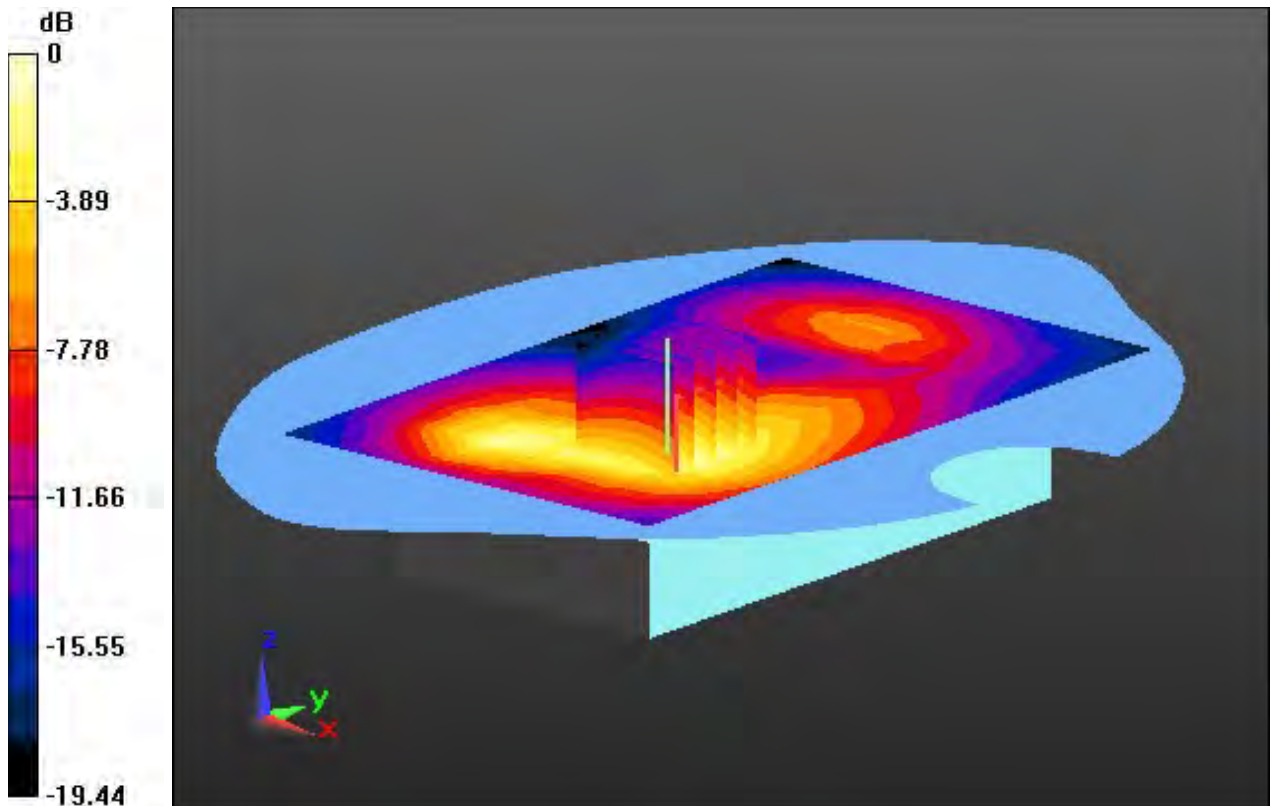

0 dB = 0.771 W/kg

DT&C Co., Ltd.

DUT: PM90G; Type: PDA

Communication System: UID 0, LTE Band 25 (0); Frequency: 1905 MHz; Duty Cycle: 1:1
Medium parameters used: $f = 1905$ MHz; $\sigma = 1.405$ S/m; $\epsilon_r = 39.923$; $\rho = 1000$ kg/m³
Phantom section: Flat Section

DASY5 Configuration:

Probe: EX3DV4 - SN7337; ConvF(8.49, 8.49, 8.49) @ 1905 MHz; Calibrated: 2018-11-22
Electronics: DAE4 Sn1453

Sensor-Surface: 2mm (Mechanical Surface Detection)

Phantom: SAM_Right_20170922; Type: QD000P40CD; Serial: 1895

Measurement SW: DASY52, Version 52.10 (2); SEMCAD X Version 14.6.12 (7450)

Test Date: 2019-07-17; Ambient Temp: 21.3; Tissue Temp: 21.2

1 cm space from Body, Rear, LTE Band 25 Ch. 26590, Ant Internal

Mode : BandWidth 20 MHz, QPSK, RB Size: 1

Area Scan (9x14x1): Measurement grid: dx=15mm, dy=15mm

Zoom Scan (5x5x7)/Cube 0: Measurement grid: dx=8mm, dy=8mm, dz=5mm

Power Drift = 0.01 dB

Peak SAR (extrapolated) = 1.43 W/kg

SAR(1 g) = 0.812 W/kg; SAR(10 g) = 0.445 W/kg

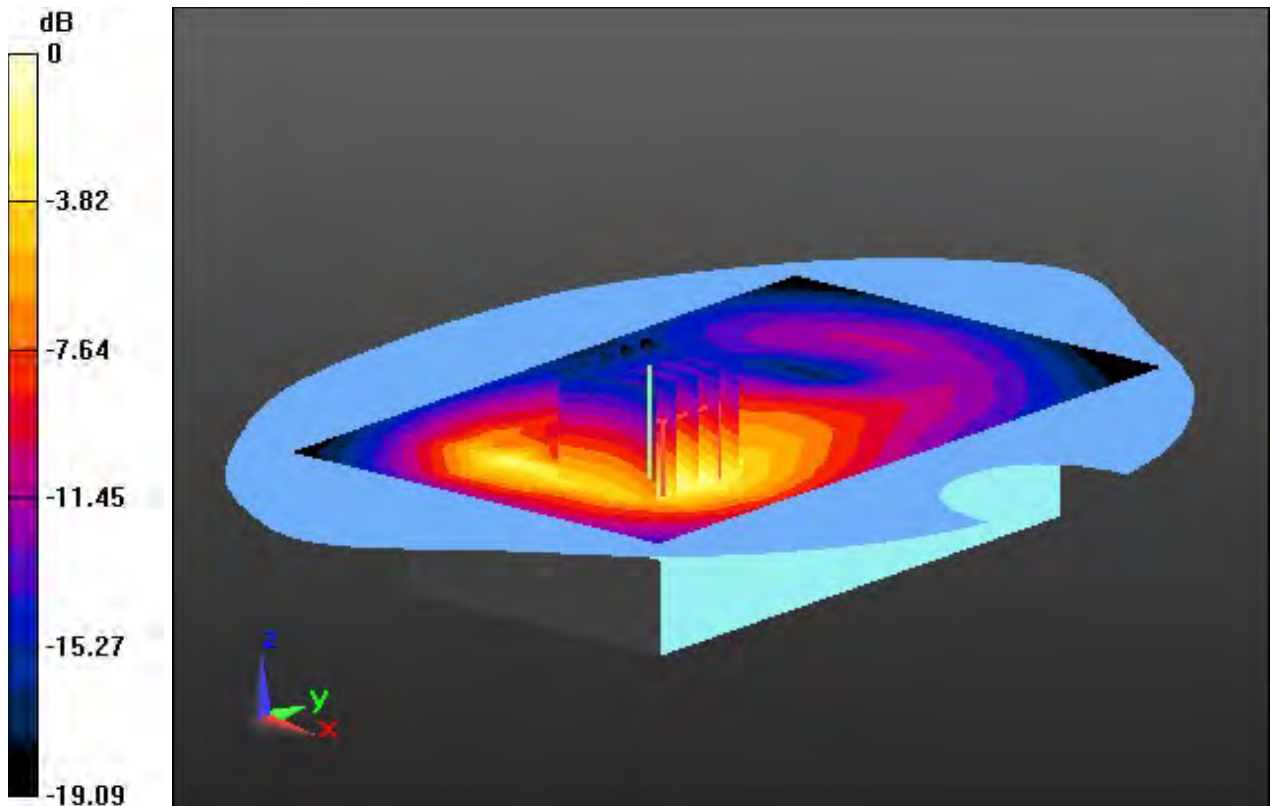

0 dB = 1.13 W/kg

DT&C Co., Ltd.

DUT: PM90G; Type: PDA

Communication System: UID 0, LTE Band 7 (0); Frequency: 2560 MHz; Duty Cycle: 1:1
Medium parameters used: $f = 2560$ MHz; $\sigma = 1.977$ S/m; $\epsilon_r = 39.44$; $\rho = 1000$ kg/m³
Phantom section: Flat Section

DASY5 Configuration:

Probe: EX3DV4 - SN7337; ConvF(7.43, 7.43, 7.43) @ 2560 MHz; Calibrated: 2018-11-22
Electronics: DAE4 Sn1453
Sensor-Surface: 2mm (Mechanical Surface Detection)
Phantom: SAM_Right_20170922; Type: QD000P40CD; Serial: 1895
Measurement SW: DASY52, Version 52.10 (2); SEMCAD X Version 14.6.12 (7450)

Test Date: 2019-08-27; Ambient Temp: 21.7; Tissue Temp: 21.6

1 cm space from Body, Rear, LTE Band 7 Ch. 21350, Ant Internal

Mode : BandWidth 20 MHz, QPSK, RB Size: 1

Area Scan (11x17x1): Measurement grid: dx=12mm, dy=12mm

Zoom Scan (7x7x7)/Cube 0: Measurement grid: dx=5mm, dy=5mm, dz=5mm

Power Drift = 0.01 dB

Peak SAR (extrapolated) = 2.60 W/kg

SAR(1 g) = 1.25 W/kg; SAR(10 g) = 0.576 W/kg

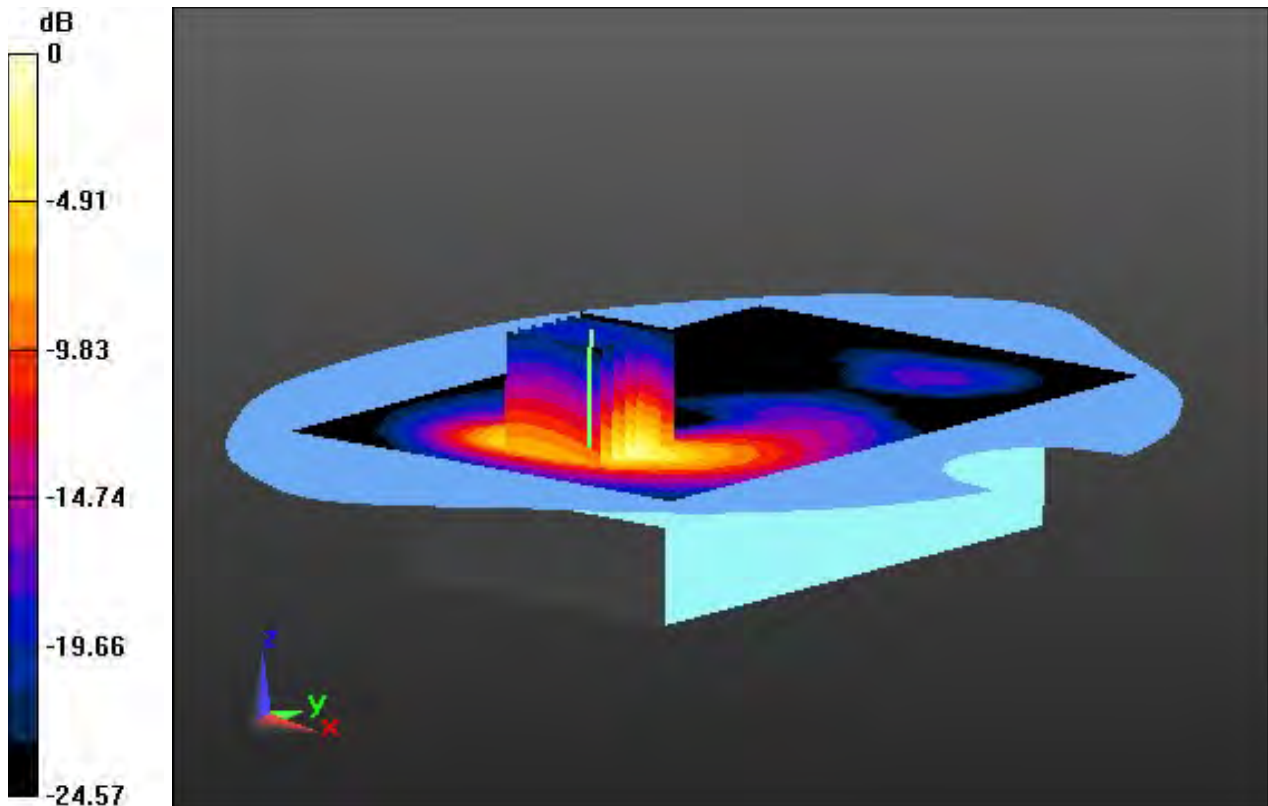

0 dB = 1.90 W/kg

DT&C Co., Ltd.

DUT: PM90G; Type: PDA

Communication System: UID 0, LTE Band 41(TDD) (0); Frequency: 2506 MHz; Duty Cycle: 1:1.58
Medium parameters used: $f = 2506$ MHz; $\sigma = 1.921$ S/m; $\epsilon_r = 39.646$; $\rho = 1000$ kg/m³
Phantom section: Flat Section

DASY5 Configuration:

Probe: EX3DV4 - SN7337; ConvF(7.43, 7.43, 7.43) @ 2506 MHz; Calibrated: 2018-11-22
Electronics: DAE4 Sn1453

Sensor-Surface: 2mm (Mechanical Surface Detection)

Phantom: SAM_Right_20170922; Type: QD000P40CD; Serial: 1895

Measurement SW: DASY52, Version 52.10 (2); SEMCAD X Version 14.6.12 (7450)

Test Date: 2019-08-27; Ambient Temp: 21.7; Tissue Temp: 21.6

1 cm space from Body, Rear, LTE Band 41 Ch. 39750, Ant Internal

Mode : BandWidth 20 MHz, QPSK, RB Size: 1

Area Scan (11x17x1): Measurement grid: dx=12mm, dy=12mm

Zoom Scan (7x7x7)/Cube 0: Measurement grid: dx=5mm, dy=5mm, dz=5mm

Power Drift = -0.00 dB

Peak SAR (extrapolated) = 1.64 W/kg

SAR(1 g) = 0.810 W/kg; SAR(10 g) = 0.382 W/kg

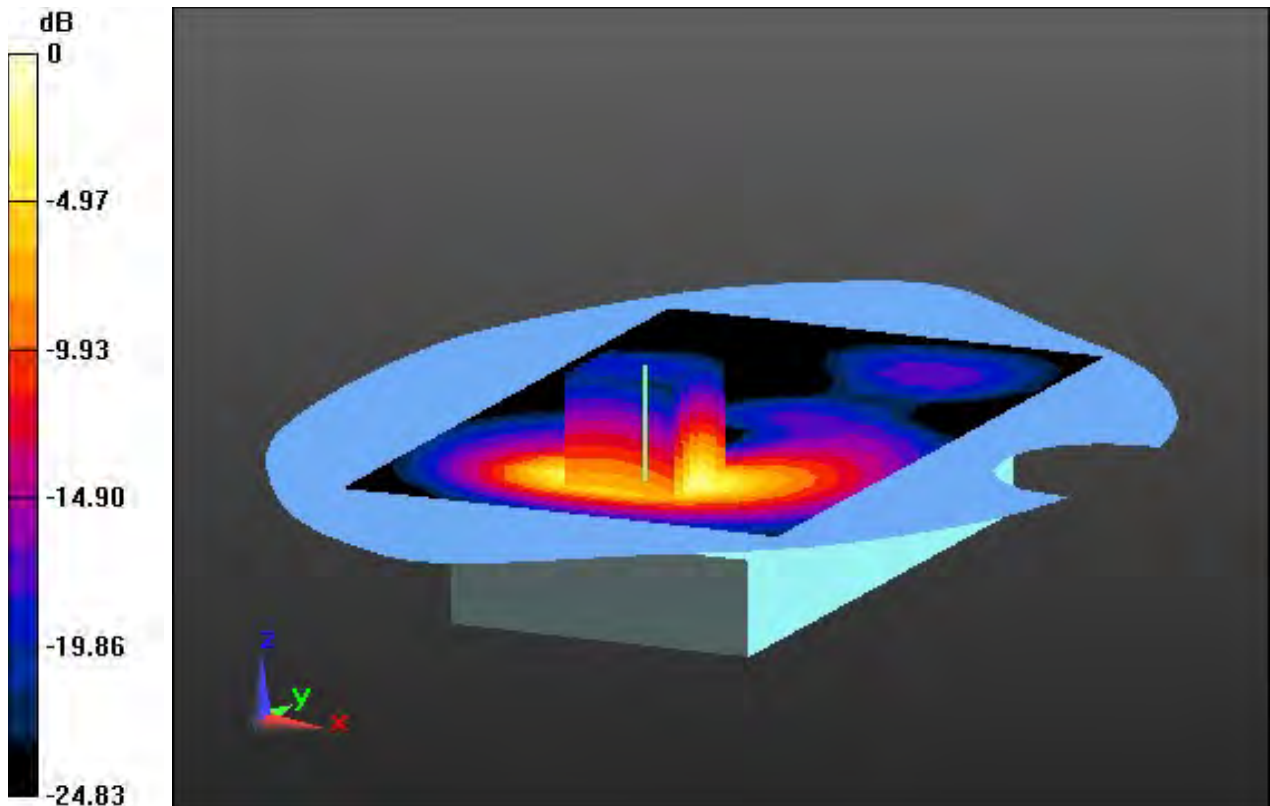

0 dB = 1.22 W/kg

DT&C Co., Ltd.

DUT: PM90G; Type: PDA

Communication System: UID 0, W-LAN (0); Frequency: 2437 MHz; Duty Cycle: 1:1
Medium parameters used: $f = 2437$ MHz; $\sigma = 1.798$ S/m; $\epsilon_r = 38.46$; $\rho = 1000$ kg/m³
Phantom section: Flat Section

DASY5 Configuration:

Probe: EX3DV4 - SN3916; ConvF(7.66, 7.66, 7.66); Calibrated: 4/25/2019; Electronics: DAE4 Sn1392
Sensor-Surface: 2mm (Mechanical Surface Detection)
Phantom: SAM with CRP_2013_10_08_right; Type: QD000P40CD; Serial: TP:1785
Measurement SW: DASY52, Version 52.8 (8); SEMCAD X Version 14.6.10 (7331)

Test Date: 2019-08-14; Ambient Temp: 20.4; Tissue Temp: 20.5

1.0 cm space from Body, Left, WLAN(802.11b) Ch. 6, Ant Internal

Area Scan (7x17x1): Measurement grid: dx=12mm, dy=12mm

Zoom Scan (7x7x7)/Cube 0: Measurement grid: dx=5mm, dy=5mm, dz=5mm

Power Drift = -0.09 dB

Peak SAR (extrapolated) = 0.243 W/kg

SAR(1 g) = 0.113 W/kg; SAR(10 g) = 0.051 W/kg

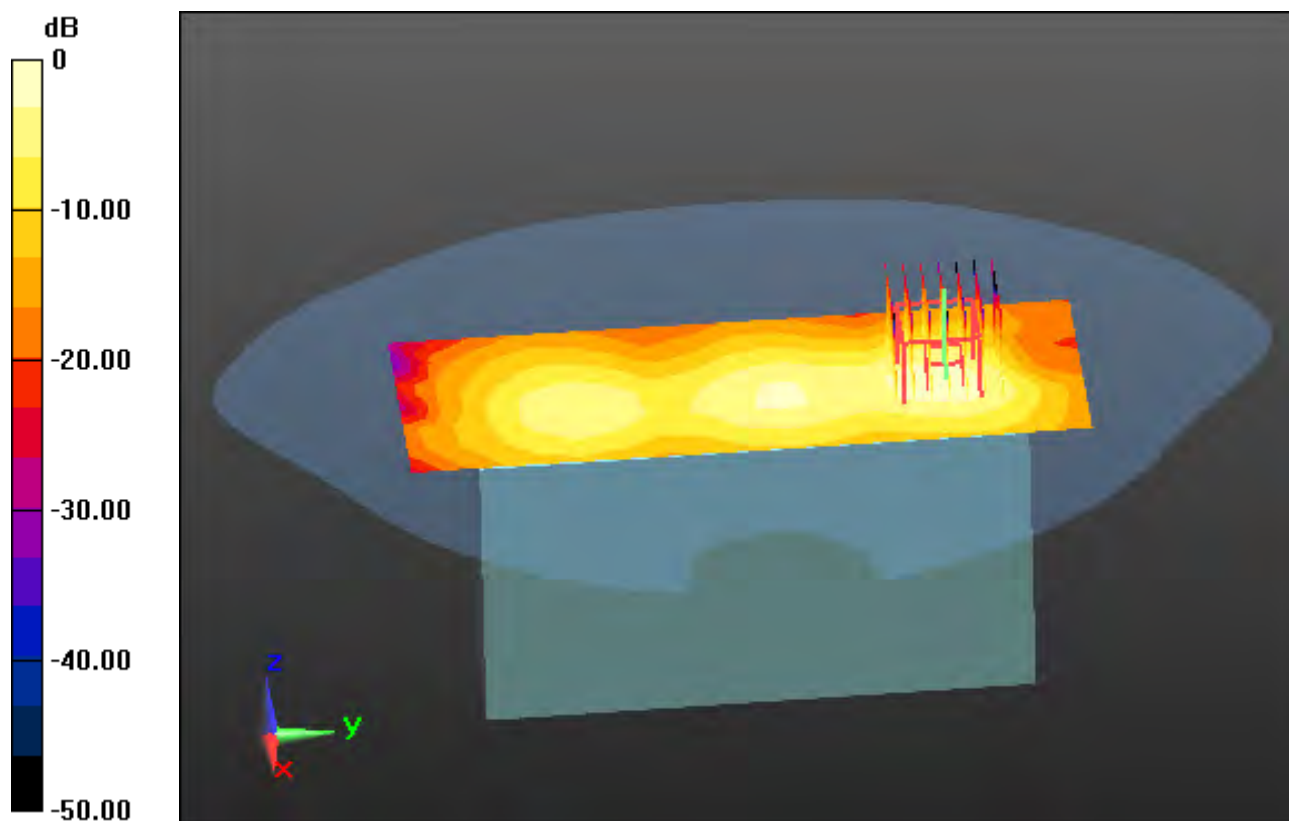

0 dB = 0.176 W/kg

DT&C Co., Ltd.

DUT: PM90G; Type: PDA

Communication System: UID 0, W-LAN_5200 (0); Frequency: 5200 MHz; Duty Cycle: 1:1
Medium parameters used: $f = 5200$ MHz; $\sigma = 4.558$ S/m; $\epsilon_r = 37.071$; $\rho = 1000$ kg/m³
Phantom section: Flat Section

DASY5 Configuration:

Probe: EX3DV4 - SN3916; ConvF(5.14, 5.14, 5.14); Calibrated: 4/25/2019; Electronics: DAE4 Sn1392
Sensor-Surface: 1.4mm (Mechanical Surface Detection)
Phantom: SAM with CRP_2016_07_22_middle; Type: QD000P40CD; Serial: TP:1786
Measurement SW: DASY52, Version 52.8 (8); SEMCAD X Version 14.6.10 (7331)

Test Date: 2019-08-15; Ambient Temp: 22.0; Tissue Temp: 21.9

1.0 cm space from Body, Left, WLAN(802.11a) Ch. 40, Ant Internal

Area Scan (9x21x1): Measurement grid: dx=10mm, dy=10mm

Zoom Scan (8x8x7)/Cube 0: Measurement grid: dx=4mm, dy=4mm, dz=1.4mm, Graded Ratio:1.4

Power Drift = 0.00 dB

Peak SAR (extrapolated) = 1.82 W/kg

SAR(1 g) = 0.518 W/kg; SAR(10 g) = 0.195 W/kg

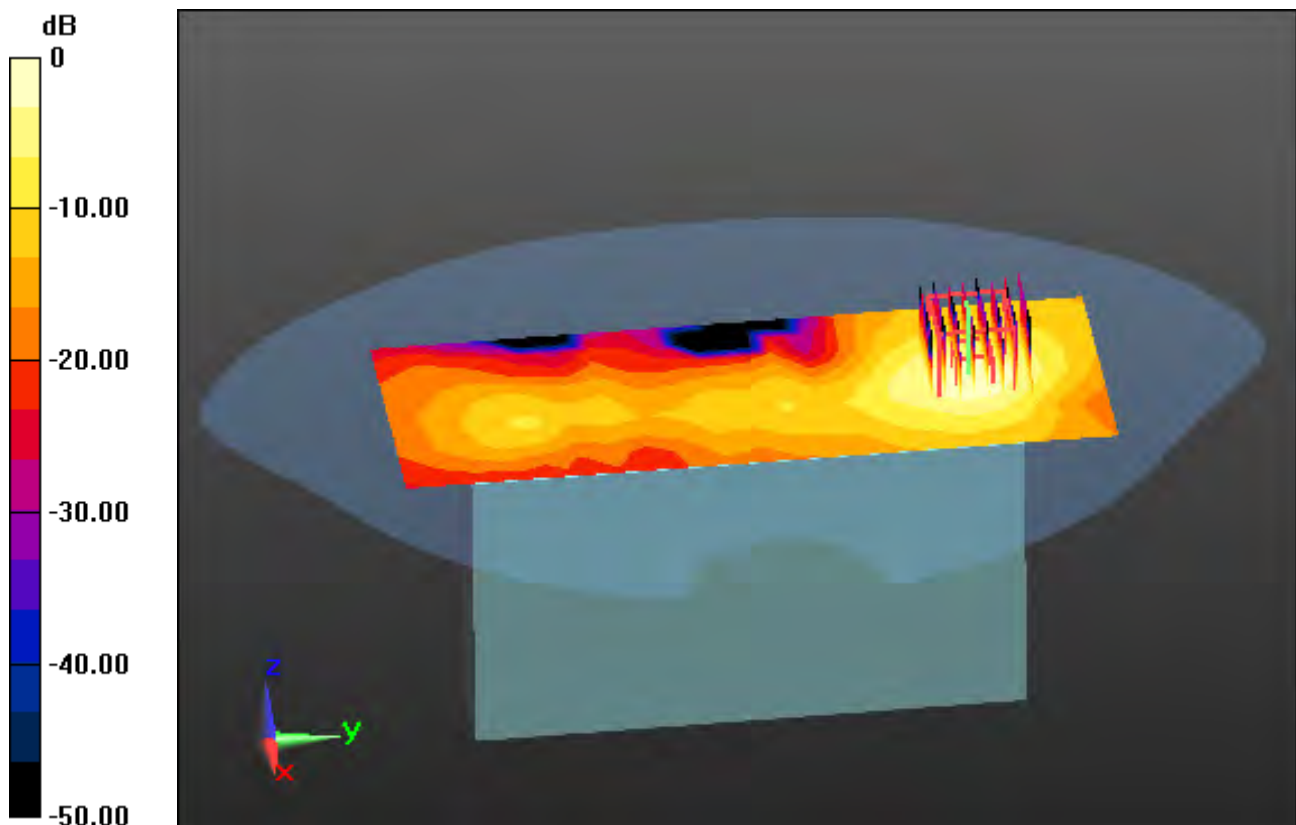

0 dB = 1.14 W/kg

DT&C Co., Ltd.

DUT: PM90G; Type: PDA

Communication System: UID 0, W-LAN 5.8G(802.11a/n/ac) (0); Frequency: 5825 MHz; Duty Cycle: 1:1
Medium parameters used: $f = 5825$ MHz; $\sigma = 5.407$ S/m; $\epsilon_r = 35.666$; $\rho = 1000$ kg/m³
Phantom section: Flat Section

DASY5 Configuration:

Probe: EX3DV4 - SN3933; ConvF(4.77, 4.77, 4.77); Calibrated: 9/25/2018; Electronics: DAE4 Sn1391
Sensor-Surface: 1.4mm (Mechanical Surface Detection)
Phantom: SAM (30deg probe tilt) with CRP v5.0(Right); Type: QD000P40CD; Serial: 1220
Measurement SW: DASY52, Version 52.8 (8); SEMCAD X Version 14.6.10 (7331)

Test Date: 2019-08-16; Ambient Temp: 21.8; Tissue Temp: 21.9

1.0 cm space from Body, Left, WLAN(802.11a) Ch. 165, Ant Internal

Area Scan (9x21x1): Measurement grid: dx=10mm, dy=10mm

Zoom Scan (8x8x7)/Cube 0: Measurement grid: dx=4mm, dy=4mm, dz=1.4mm, Graded Ratio:1.4

Power Drift = -0.17 dB

Peak SAR (extrapolated) = 2.49 W/kg

SAR(1 g) = 0.632 W/kg; SAR(10 g) = 0.248 W/kg

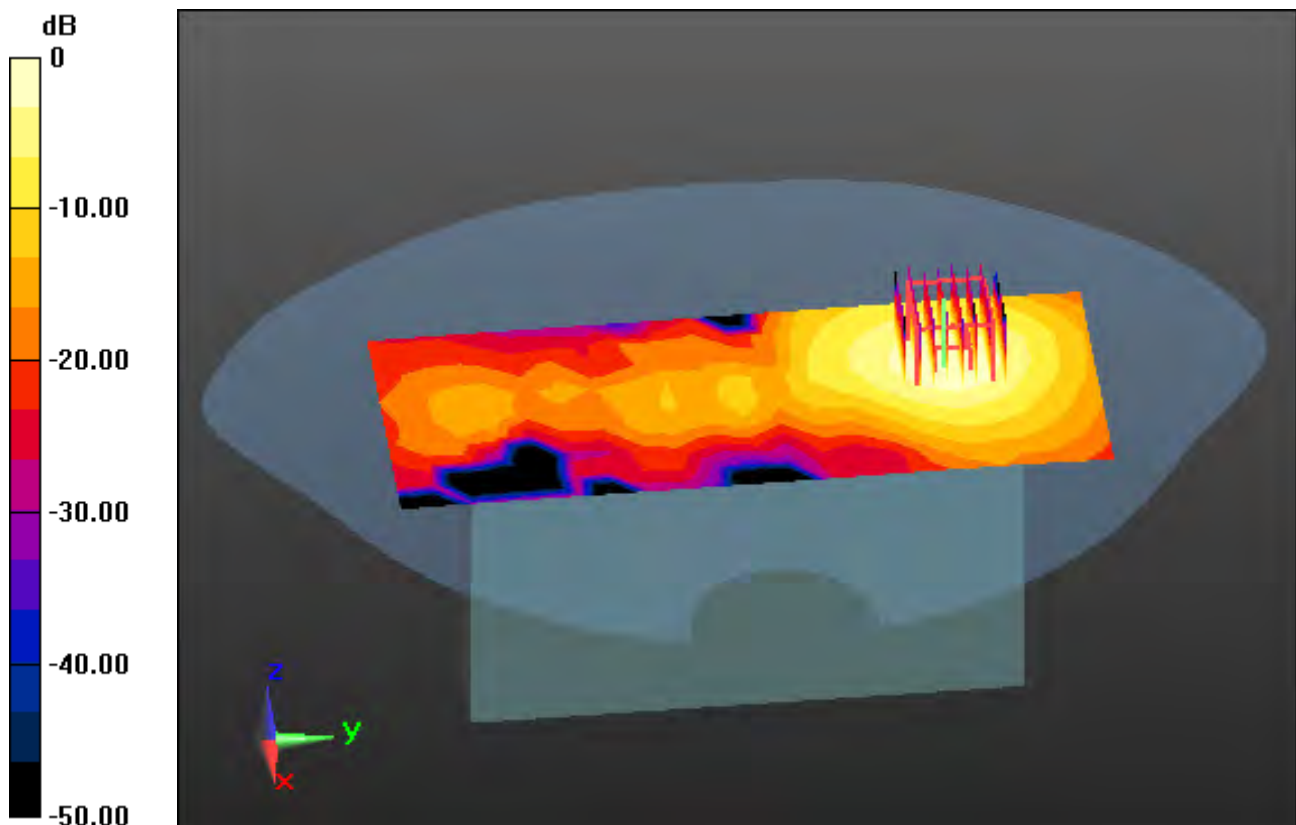

0 dB = 1.43 W/kg

DT&C Co., Ltd.

DUT: PM90W; Type: PDA

Communication System: UID 0, Bluetooth (0); Frequency: 2480 MHz; Duty Cycle: 1:1.302

Medium parameters used: $f = 2441$ MHz; $\sigma = 1.802$ S/m; $\epsilon_r = 38.404$; $\rho = 1000$ kg/m³

Phantom section: Flat Section

DASY5 Configuration:

Probe: EX3DV4 - SN3916; ConvF(7.66, 7.66, 7.66); Calibrated: 4/25/2019; Electronics: DAE4 Sn1392

Sensor-Surface: 2mm (Mechanical Surface Detection)

Phantom: SAM with CRP_2013_10_08_right; Type: QD000P40CD; Serial: TP:1785

Measurement SW: DASY52, Version 52.8 (8); SEMCAD X Version 14.6.10 (7331)

Test Date: 2019-08-13; Ambient Temp: 20.4; Tissue Temp: 20.6

1.0 cm space from Body, Left, Bluetooth Ch. 39, Ant Internal

Area Scan (7x17x1): Measurement grid: dx=12mm, dy=12mm

Zoom Scan (7x7x7)/Cube 0: Measurement grid: dx=5mm, dy=5mm, dz=5mm

Power Drift = 0.03 dB

Peak SAR (extrapolated) = 0.0610 W/kg

SAR(1 g) = 0.016 W/kg; SAR(10 g) = 0.00596 W/kg

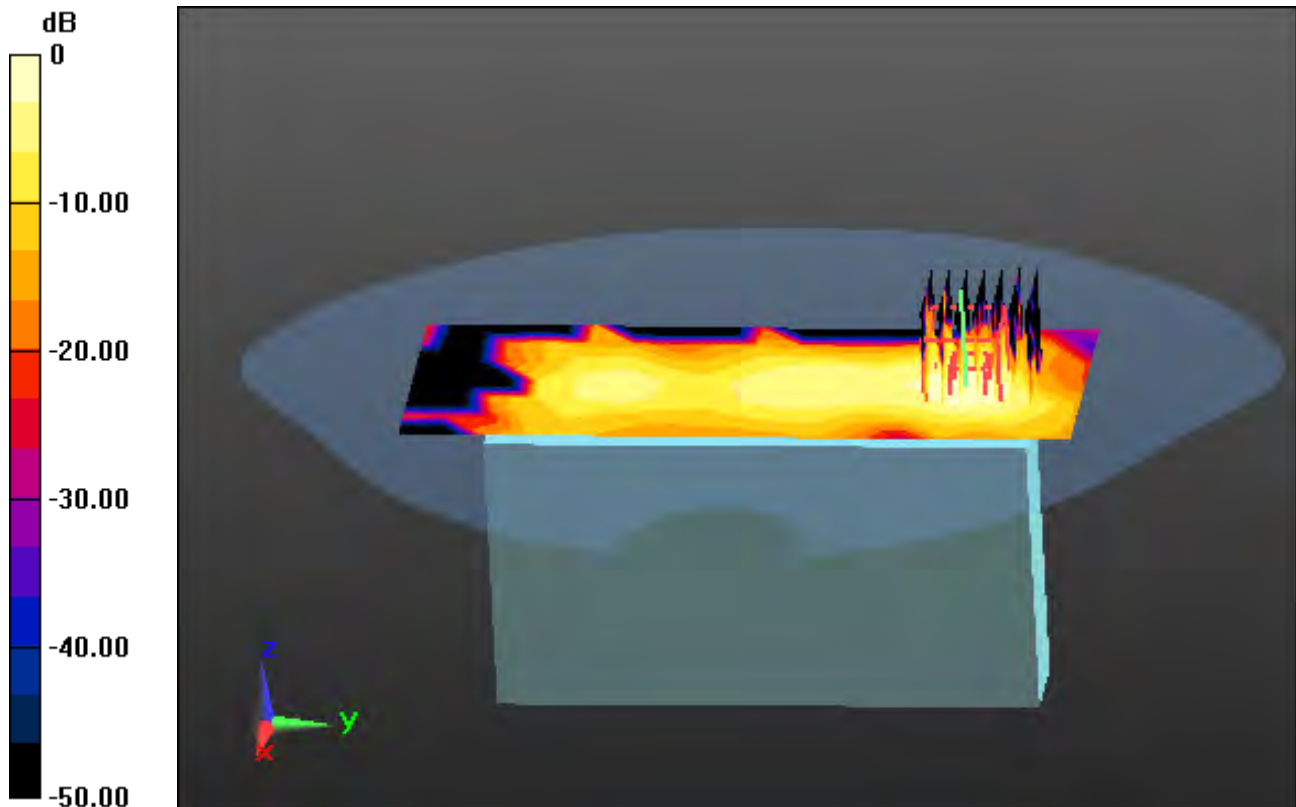

0 dB = 0.0260 W/kg

DT&C Co., Ltd.

DUT: PM90G; Type: PDA

Communication System: UID 0, LTE Band 7 (0); Frequency: 2535 MHz; Duty Cycle: 1:1
Medium parameters used: $f = 2535$ MHz; $\sigma = 1.887$ S/m; $\epsilon_r = 40.227$; $\rho = 1000$ kg/m³
Phantom section: Flat Section

DASY5 Configuration:

Probe: EX3DV4 - SN7337; ConvF(7.43, 7.43, 7.43) @ 2535 MHz; Calibrated: 2018-11-22
Electronics: DAE4 Sn1453
Sensor-Surface: 2mm (Mechanical Surface Detection)
Phantom: SAM_Right_20170922; Type: QD000P40CD; Serial: 1895
Measurement SW: DASY52, Version 52.10 (2); SEMCAD X Version 14.6.12 (7450)

Test Date: 2019-07-09; Ambient Temp: 21.4; Tissue Temp: 21.2

Touch from Body, Rear, LTE Band 7 Ch. 21100, Ant Internal

Mode : BandWidth 20 MHz, QPSK, RB Size: 1

Area Scan (11x17x1): Measurement grid: dx=12mm, dy=12mm

Zoom Scan (7x7x7)/Cube 0: Measurement grid: dx=5mm, dy=5mm, dz=5mm

Power Drift = 0.11 dB

Peak SAR (extrapolated) = 13.7 W/kg

SAR(1 g) = 5.25 W/kg; SAR(10 g) = 1.97 W/kg

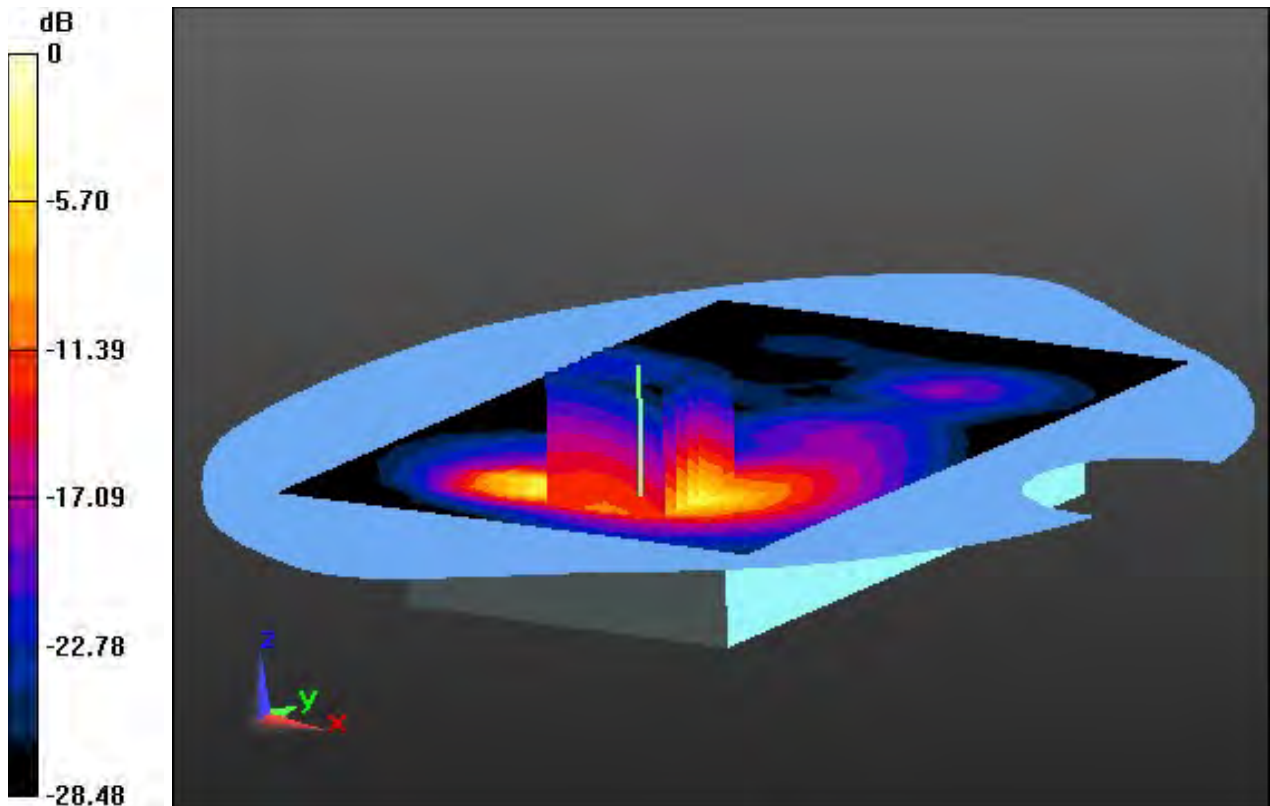

0 dB = 9.01 W/kg

DT&C Co., Ltd.

DUT: PM90G; Type: PDA

Communication System: UID 0, LTE Band 41(TDD) (0); Frequency: 2593 MHz; Duty Cycle: 1:1.58
Medium parameters used: $f = 2593$ MHz; $\sigma = 1.965$ S/m; $\epsilon_r = 37.689$; $\rho = 1000$ kg/m³
Phantom section: Flat Section

DASY5 Configuration:

Probe: EX3DV4 - SN7337; ConvF(7.43, 7.43, 7.43) @ 2593 MHz; Calibrated: 2018-11-22
Electronics: DAE4 Sn1453

Sensor-Surface: 2mm (Mechanical Surface Detection)

Phantom: SAM_Right_20170922; Type: QD000P40CD; Serial: 1895

Measurement SW: DASY52, Version 52.10 (2); SEMCAD X Version 14.6.12 (7450)

Test Date: 2019-07-23; Ambient Temp: 20.7; Tissue Temp: 20.6

Touch from Body, Rear, LTE Band 41 Ch. 40620, Ant Internal

Mode : BandWidth 20 MHz, QPSK, RB Size: 1

Area Scan (11x17x1): Measurement grid: dx=12mm, dy=12mm

Zoom Scan (7x7x7)/Cube 0: Measurement grid: dx=5mm, dy=5mm, dz=5mm

Power Drift = -0.18 dB

Peak SAR (extrapolated) = 7.18 W/kg

SAR(1 g) = 3.25 W/kg; SAR(10 g) = 1.38 W/kg

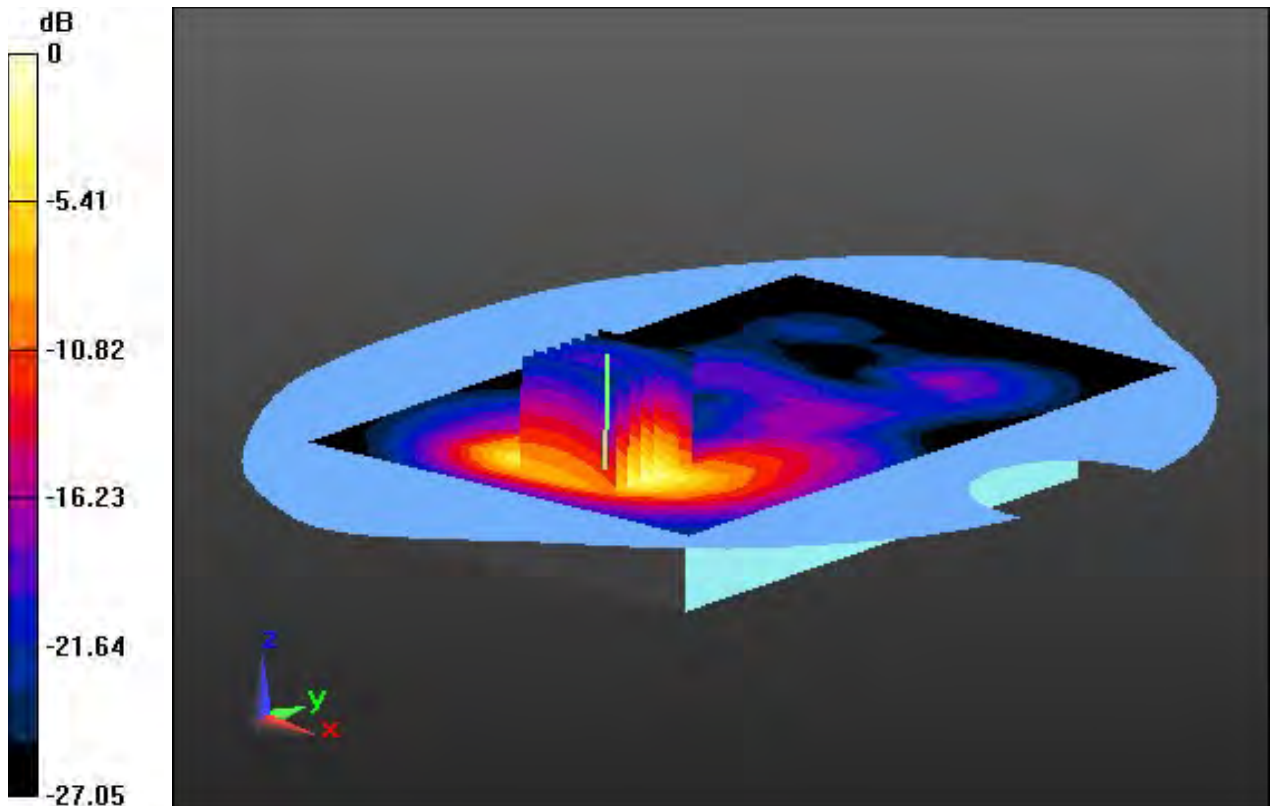

0 dB = 5.17 W/kg

DT&C Co., Ltd.

DUT: PM90G; Type: PDA

Communication System: UID 0, W-LAN_5300 (0); Frequency: 5300 MHz; Duty Cycle: 1:1
Medium parameters used: $f = 5300$ MHz; $\sigma = 4.588$ S/m; $\epsilon_r = 35.577$; $\rho = 1000$ kg/m³
Phantom section: Flat Section

DASY5 Configuration:

Probe: EX3DV4 - SN3916; ConvF(4.94, 4.94, 4.94); Calibrated: 4/25/2019; Electronics: DAE4 Sn1392
Sensor-Surface: 1.4mm (Mechanical Surface Detection)
Phantom: SAM with CRP_2016_07_22_middle; Type: QD000P40CD; Serial: TP:1786
Measurement SW: DASY52, Version 52.8 (8); SEMCAD X Version 14.6.10 (7331)

Test Date: 2019-08-16; Ambient Temp: 21.2; Tissue Temp: 21.4

Touch from Body, Left, WLAN(802.11a) Ch. 60, Ant Internal

Area Scan (9x21x1): Measurement grid: dx=10mm, dy=10mm

Zoom Scan (8x8x7)/Cube 0: Measurement grid: dx=4mm, dy=4mm, dz=1.4mm, Graded Ratio:1.4

Power Drift = -0.18 dB

Peak SAR (extrapolated) = 17.9 W/kg

SAR(1 g) = 3.83 W/kg; SAR(10 g) = 0.996 W/kg

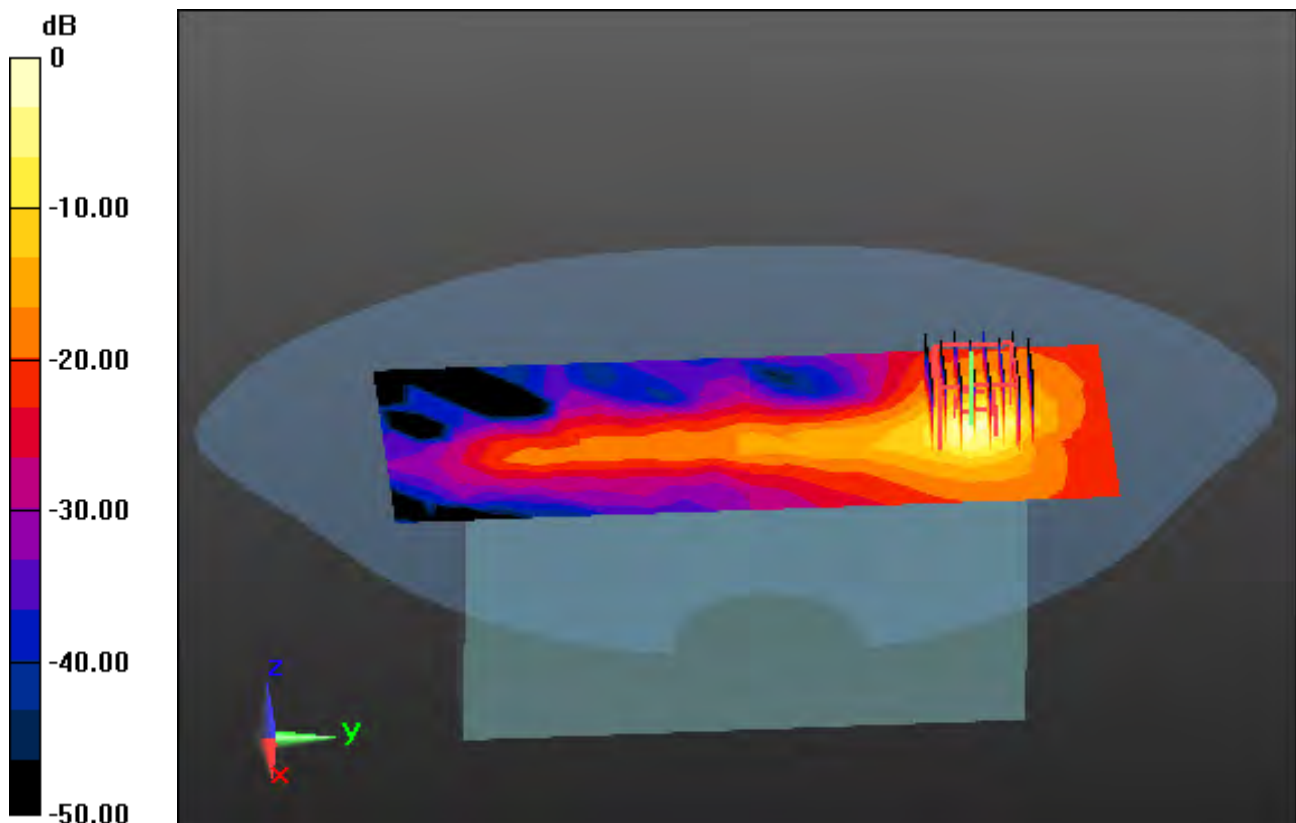

0 dB = 9.83 W/kg

DT&C Co., Ltd.

DUT: PM90G; Type: PDA

Communication System: UID 0, W-LAN_5500 (0); Frequency: 5580 MHz; Duty Cycle: 1:1
Medium parameters used: $f = 5580$ MHz; $\sigma = 5.085$ S/m; $\epsilon_r = 34.541$; $\rho = 1000$ kg/m³
Phantom section: Flat Section

DASY5 Configuration:

Probe: EX3DV4 - SN3933; ConvF(4.71, 4.71, 4.71); Calibrated: 9/25/2018; Electronics: DAE4 Sn1391
Sensor-Surface: 1.4mm (Mechanical Surface Detection)
Phantom: SAM (30deg probe tilt) with CRP v5.0(Right); Type: QD000P40CD; Serial: 1220
Measurement SW: DASY52, Version 52.8 (8); SEMCAD X Version 14.6.10 (7331)

Test Date: 2019-08-14; Ambient Temp: 22.1; Tissue Temp: 22.3

Touch from Body, Left, WLAN(802.11a) Ch. 116, Ant Internal

Area Scan (9x21x1): Measurement grid: dx=10mm, dy=10mm

Zoom Scan (8x8x7)/Cube 0: Measurement grid: dx=4mm, dy=4mm, dz=1.4mm, Graded Ratio:1.4

Power Drift = 0.02 dB

Peak SAR (extrapolated) = 23.7 W/kg

SAR(1 g) = 4.84 W/kg; SAR(10 g) = 1.24 W/kg

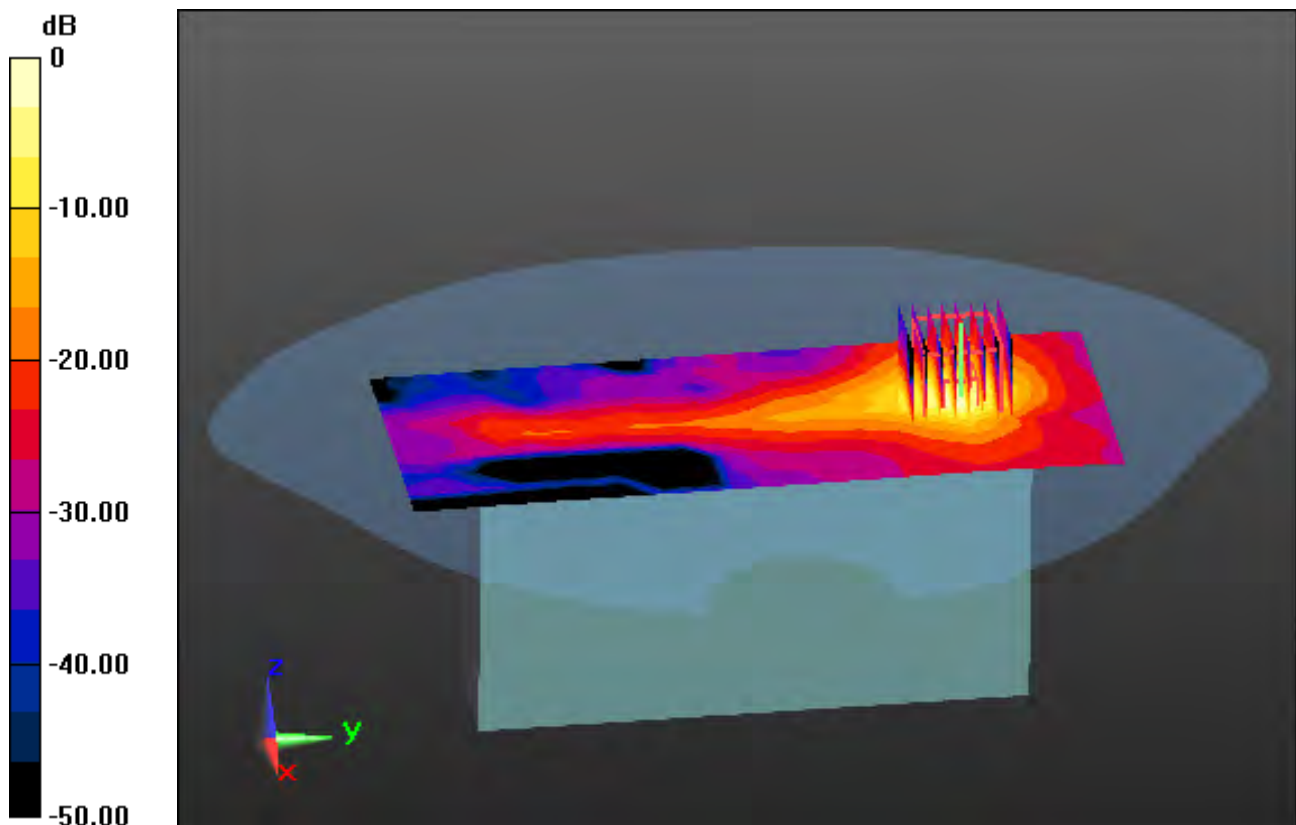

0 dB = 12.7 W/kg