

Time of Occupancy (FH)

Hopping mode : Enable & TM1 & DH5

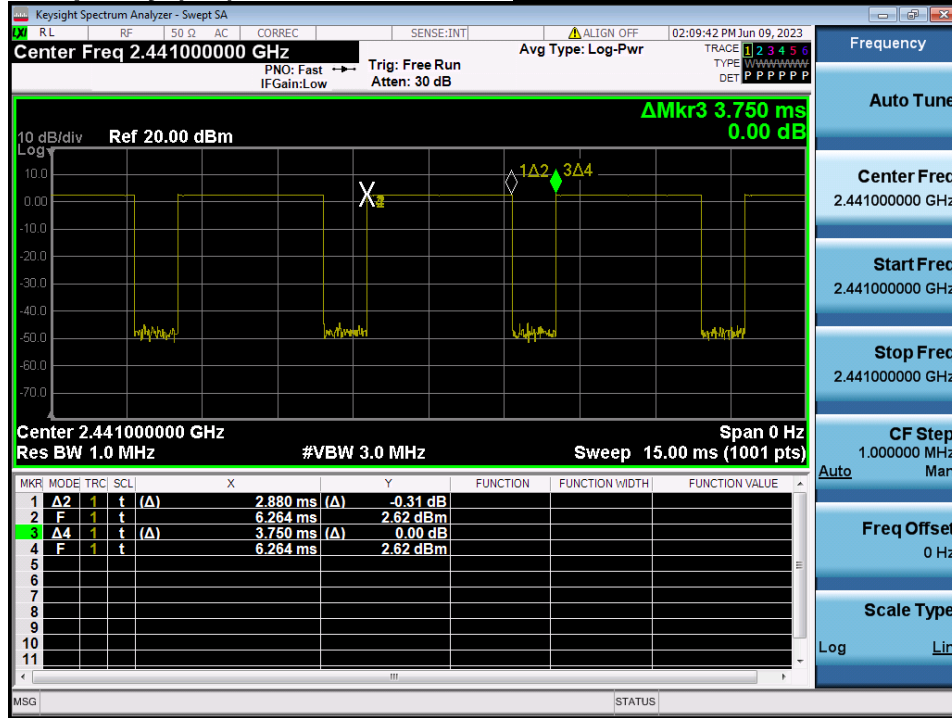

Time of Occupancy (FH)

Hopping mode : Enable & TM1 & 2-DH5

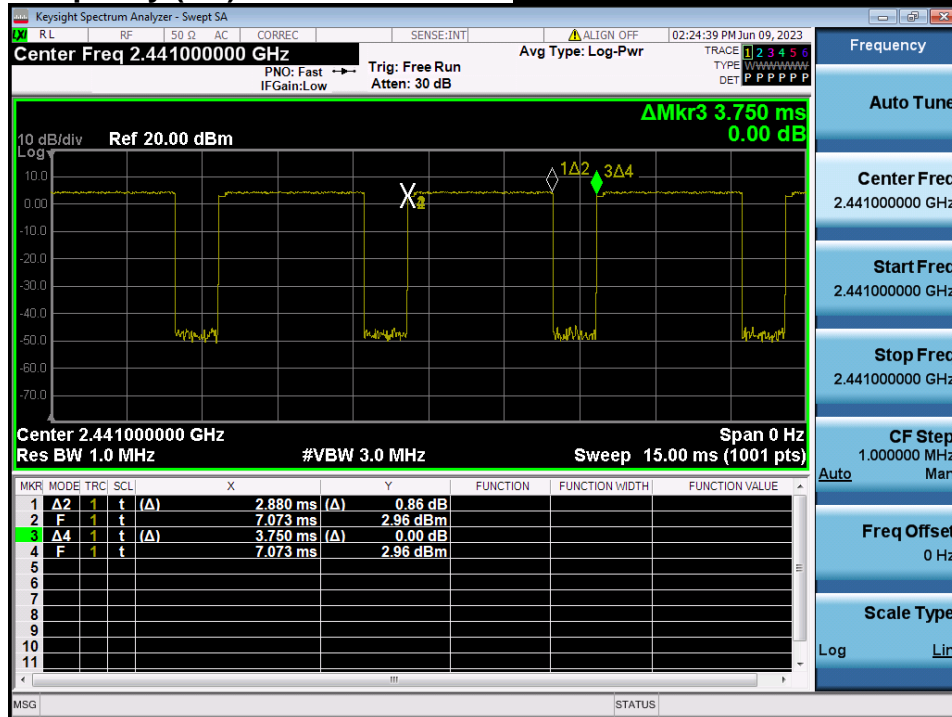

Time of Occupancy (FH)

Hopping mode : Enable & TM1 &3-DH5

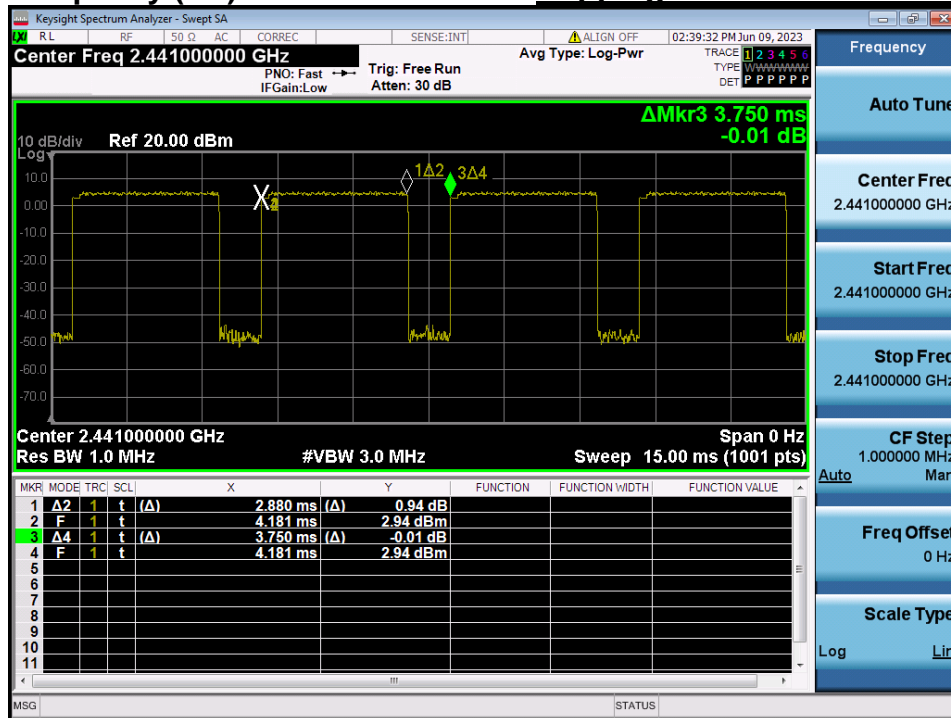

Time of Occupancy (AFH)

Hopping mode : Enable & TM1 & DH5

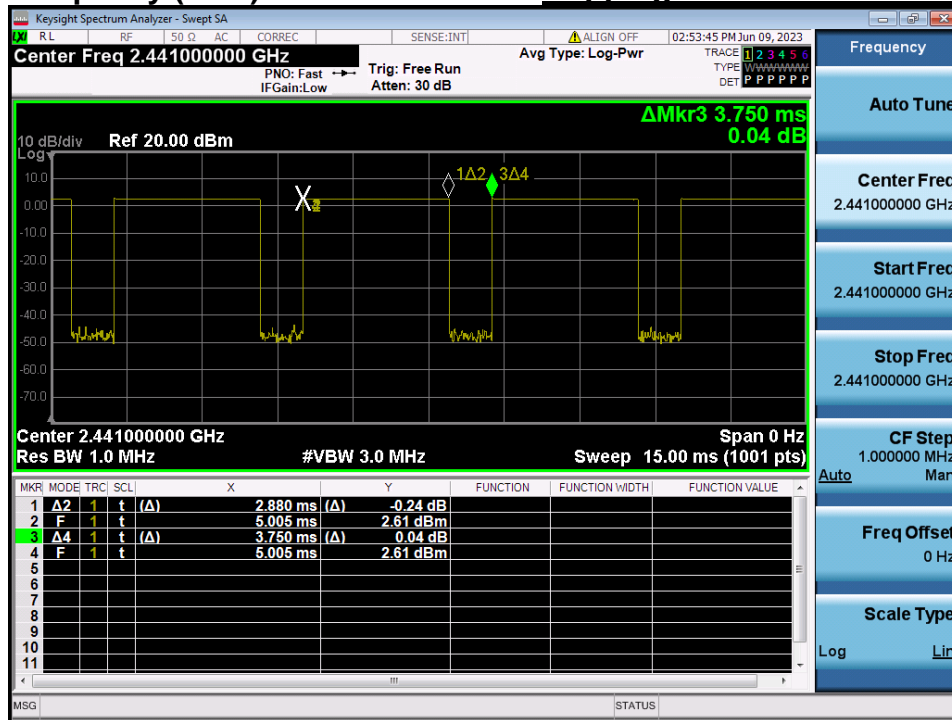

Time of Occupancy (AFH)

Hopping mode : Enable & TM1 & 2-DH5

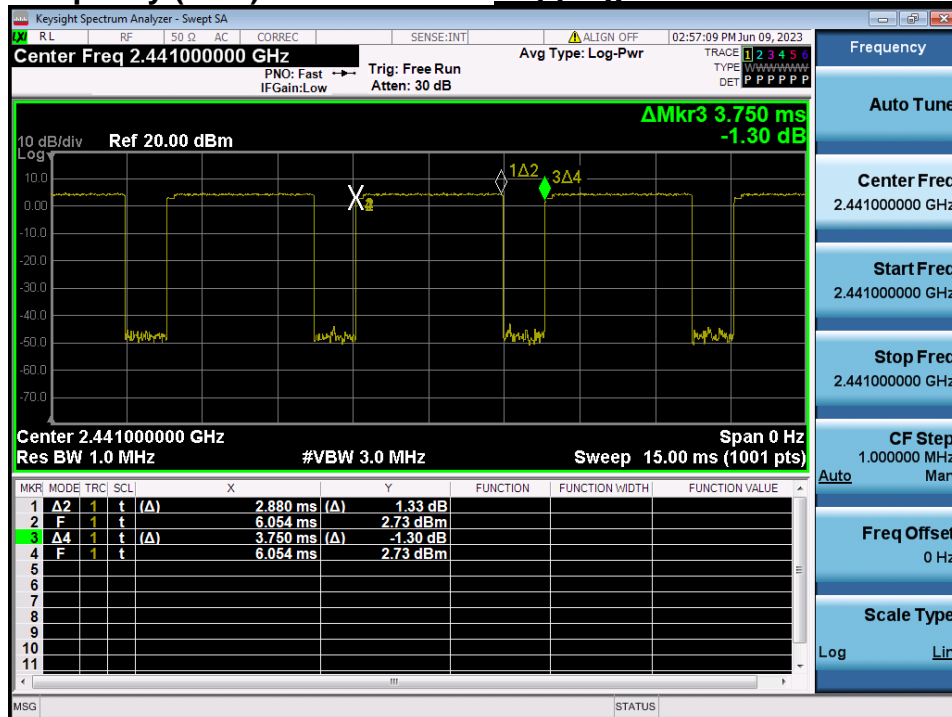

Time of Occupancy (AFH)

Hopping mode : Enable & TM1 &3-DH5

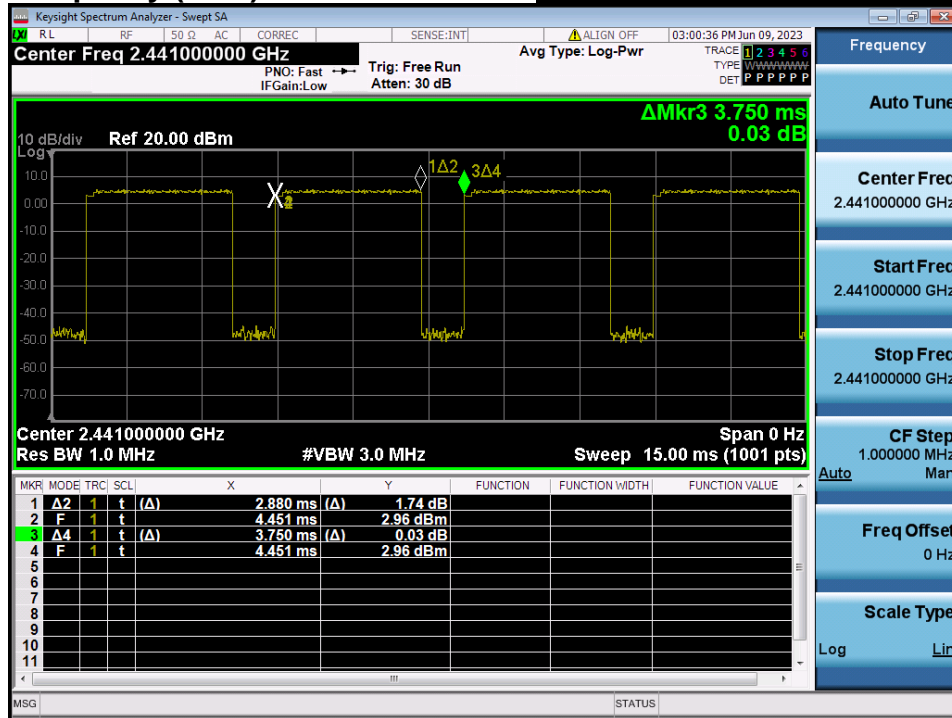

9. Unwanted Emissions

9.1. Test Setup

Refer to the APPENDIX I.

9.2. Limit

Part 15.247(d), Part 15.205, Part 15.209 & RSS-247 [5.5], RSS-Gen [8.9], RSS-Gen [8.10]

In any 100 kHz bandwidth outside the frequency band in which the spread spectrum or digitally modulated intentional radiator is operating, the radio frequency power that is produced by the intentional radiator shall be at least 20 dB below that in the 100 kHz bandwidth within the band that contains the highest level of the desired power, based on either an RF conducted or a radiated measurement, provided the transmitter demonstrates compliance with the peak conducted power limits. If the transmitter complies with the conducted power limits based on the use of RMS averaging over a time interval, as permitted under paragraph (b)(3) of Part 15.247 the attenuation required under this paragraph shall be 30 dB instead of 20 dB. Attenuation below the general limits specified in §15.209(a) is not required. In addition, radiated emissions which fall in the restricted bands, as defined in §15.205(a), must also comply with the radiated emission limits specified in §15.209(a) (see §15.205(c)).

- Part 15.209 & RSS-Gen[8.9]: General requirement

Frequency (MHz)	FCC Limit (uV/m)	IC Limit (uA/m)	Measurement Distance (m)
0.009 – 0.490	2 400 / F (kHz)	6.37/F (F in kHz)	300
0.490 – 1.705	24 000 / F (kHz)	63.7/F (F in kHz)	30
1.705 – 30.0	30	0.08	30

Frequency (MHz)	FCC Limit (uV/m)	IC Limit (uV/m)	Measurement Distance (m)
30 ~ 88	100 **	100	3
88 ~ 216	150 **	150	3
216 ~ 960	200 **	200	3
Above 960	500	500	3

**Except as provided in paragraph (g), fundamental emissions from intentional radiators operating under this section shall not be located in the frequency bands 54-72 MHz, 76-88 MHz, 174-216 MHz or 470-806 MHz. However, operation within these frequency bands is permitted under other sections of this part, e.g., §15.231 and 15.241.

- Part 15.205(a): Restricted band of operation

MHz	MHz	MHz	MHz	GHz	GHz
0.009 ~ 0.110	8.414 25 ~ 8.414 75	108 ~ 121.94	1 300 ~ 1 427	4.5 ~ 5.15	14.47 ~ 14.5
0.495 ~ 0.505	12.29 ~ 12.293	123 ~ 138	1 435 ~ 1 626.5	5.35 ~ 5.46	15.35 ~ 16.2
2.173 5 ~ 2.190 5	12.519 75 ~ 12.520 25	149.9 ~ 150.05	1 645.5 ~ 1 646.5	7.25 ~ 7.75	17.7 ~ 21.4
4.125 ~ 4.128	12.576 75 ~ 12.577 25	156.524 75 ~ 156.525 25	1 660 ~ 1 710	8.025 ~ 8.5	22.01 ~ 23.12
4.177 25 ~ 4.177 75	13.36 ~ 13.41	156.7 ~ 156.9	1 718.8 ~ 1 722.2	9.0 ~ 9.2	23.6 ~ 24.0
4.207 25 ~ 4.207 75	16.42 ~ 16.423	162.012 5 ~ 167.17	2 200 ~ 2 300	9.3 ~ 9.5	31.2 ~ 31.8
6.215 ~ 6.218	16.694 75 ~ 16.695 25	167.72 ~ 173.2	2 310 ~ 2 390	10.6 ~ 12.7	36.43 ~ 36.5
6.267 75 ~ 6.268 25	16.804 25 ~ 16.804 75	240 ~ 285	2 483.5 ~ 2 500	13.25 ~ 13.4	Above 38.6
6.311 75 ~ 6.312 25	25.5 ~ 25.67	322 ~ 335.4	2 655 ~ 2 900		
8.291 ~ 8.294	37.5 ~ 38.25	399.90 ~ 410	3 260 ~ 3 267		
8.362 ~ 8.366	73 ~ 74.6	608 ~ 614	3 332 ~ 3 339		
8.376 25 ~ 8.386 75	74.8 ~ 75.2	960 ~ 1 240	3 345.8 ~ 3 358		
			3 600 ~ 4 400		

- RSS-GEN[8.10]: Restricted frequency bands

MHz	MHz	MHz	MHz	MHz	GHz
0.090 ~ 0.110	8.362 ~ 8.366	73 ~ 74.6	608 ~ 614	3 345.8 ~ 3 358	9.0 ~ 9.2
0.495 ~ 0.505	8.376 25 ~ 8.386 75	74.8 ~ 75.2	960 ~ 1 427	3 500 ~ 4 400	9.3 ~ 9.5
2.173 5 ~ 2.190 5	8.414 25 ~ 8.414 75	108 ~ 138	1 435 ~ 1 626.5	4 500 ~ 5 150	10.6 ~ 12.7
3.020 ~ 3.026	12.29 ~ 12.293	149.9 ~ 150.05	1 645.5 ~ 1 646.5	5 350 ~ 5 460	13.25 ~ 13.4
4.125 ~ 4.128	12.519 75 ~ 12.520 25	156.524 75 ~	1 660 ~ 1 710	7 250 ~ 7 750	14.47 ~ 14.5
4.177 25 ~ 4.177 75	12.576 75 ~ 12.577 25	156.525 25	1 718.8 ~ 1 722.2	8 025 ~ 8 500	15.35 ~ 16.2
4.207 25 ~ 4.207 75	13.36 ~ 13.41	156.7 ~ 156.9	2 200 ~ 2 300		17.7 ~ 21.4
5.677 ~ 5.683	16.42 ~ 16.423	162.01 25 ~ 167.17	2 310 ~ 2 390		22.01 ~ 23.12
6.215 ~ 6.218	16.694 75 ~ 16.695 25	167.72 ~ 173.2	2 483.5 ~ 2 500		23.6 ~ 24.0
6.267 75 ~ 6.268 25	16.804 25 ~ 16.804 75	240 ~ 285	2 655 ~ 2 900		31.2 ~ 31.8
6.311 75 ~ 6.312 25	25.5 ~ 25.67	322 ~ 335.4	3 260 ~ 3 267		36.43 ~ 36.5
8.291 ~ 8.294	37.5 ~ 38.25	399.90 ~ 410	3 332 ~ 3 339		Above 38.6

9.3. Test Procedures

9.3.1. Test Procedures for Unwanted Emissions(Radiated)

1. The EUT is placed on a non-conductive table. For emission measurements at or below 1 GHz, the table height is 80 cm. For emission measurements above 1 GHz, the table height is 1.5 m. The table was rotated 360 degrees to determine the position of the highest radiation.
2. During performing radiated emission below 1 GHz, the EUT was set 3 meters away from the interference receiving antenna, which was mounted on the top of a variable-height antenna tower. During performing radiated emission above 1 GHz, the EUT was set 1 or 3 meter away from the interference-receiving antenna.
3. For measurements above 1 GHz absorbers are placed on the floor between the turn table and the antenna mast in such a way so as to maximize the reduction of reflections. For measurements below 1 GHz, the absorbers are removed.
4. The antenna is a broadband antenna, and its height is varied from one meter to four meters above the ground to determine the maximum value of the field strength. Both horizontal and vertical polarizations of the antenna are set to make the measurement.
5. For each suspected emission, the EUT was arranged to its worst case and then the antenna was tuned to heights from 1 meter to 4 meters and the table was turned from 0 degrees to 360 degrees to find the maximum reading.
6. The test-receiver system was set to Peak Detect Function and Specified Bandwidth with Maximum Hold Mode.
7. If the emission level of the EUT in peak mode was 10 dB lower than the limit specified, then testing could be stopped and the peak values of the EUT would be reported. Otherwise the emissions that did not have 10 dB margin would be re-tested one by one using peak, quasi-peak or average method as specified and then reported in a data sheet.

Measurement Instrument Setting

- Frequencies less than or equal to 1 000 MHz
The resolution bandwidth and video bandwidth of test receiver/spectrum analyzer is 120 kHz for Quasi-peak detection (QP) at frequency below 1 GHz.
- Frequencies above 1 000 MHz
The resolution bandwidth and video bandwidth of test receiver/spectrum analyzer is 1 MHz for Peak detection and frequency above 1 GHz.
The result of Average measurement is calculated using PK result and duty correction factor.

9.3.2. Test Procedures for Unwanted Emissions(Conducted)

1. The transmitter output was connected to the spectrum analyzer.
2. The **reference level** of the fundamental frequency was measured with the spectrum analyzer using RBW = 100 kHz, VBW = 300 kHz.
3. The conducted spurious emission was tested each ranges were set as below.

Frequency range : 9 kHz ~ 30 MHz

RBW = 100 kHz, VBW = 300 kHz, SWEEP TIME = AUTO, DETECTOR = PEAK, TRACE = MAX HOLD, SWEEP POINT : 40 001

Frequency range : 30 MHz ~ 10 GHz, 10 GHz ~ 25 GHz

RBW = 1 MHz, VBW = 3 MHz, SWEEP TIME = AUTO, DETECTOR = PEAK, TRACE = MAX HOLD, SWEEP POINT : 40 001

LIMIT LINE = 20 dB below of the reference level of above measurement procedure Step 2. (RBW = 100 kHz, VBW = 300 kHz)

If the emission level with above setting was close to the limit (ie, less than 3 dB margin) then zoom scan is required using RBW = 100 kHz, VBW = 300 kHz, SPAN = 100 MHz and BINS = 2 001 to get accurate emission level within 100 kHz BW.

Also the path loss for conducted measurement setup was used as described on the Appendix I of this test report.

9.4. Test Results

9.4.1. Unwanted Emissions(Radiated)

▪ Test Notes.

- The radiated emissions were investigated 9 kHz to 25 GHz. And no other spurious and harmonic emissions were found below listed frequencies.
- Information of Distance Correction Factor
 For finding emissions, measurements may be performed at a distance closer than that specified in the regulations.
 In this case, the distance correction factor is applied to the result.
 - Calculation of distance factor
 At frequencies below 30 MHz = $40 \log(\text{tested distance} / \text{specified distance})$
 At frequencies at or above 30 MHz = $20 \log(\text{tested distance} / \text{specified distance})$
 When distance factor is "N/A", the measurements were performed at the specified distance and distance factor is not applied.
- DCCF Calculation. (DCCF = Duty Cycle Correction Factor)
 - Time to cycle through all channels = $\Delta t = T [\text{ms}] \times 20$ minimum hopping channels, where T = pulse width = **2.88 ms**
 - $100 \text{ ms} / \Delta t [\text{ms}] = H \rightarrow$ Round up to next highest integer, to account for worst case, $H' = 100 / (2.88 \times 20) = 1.74 \approx 2$
 - The Worst Case Dwell Time = $T [\text{ms}] \times H' = 2.88 \text{ ms} \times 2 = 5.76 \text{ ms}$
 - DCCF = $20 \log(\text{The Worst Case Dwell Time} / 100 \text{ ms}) \text{ dB} = 20 \log(5.76 / 100) = -24.79 \text{ dB}$
- Sample Calculation.
 $\text{Margin} = \text{Limit} - \text{Result} / \text{Result} = \text{Reading} + \text{TF} + \text{DCCF} + \text{DCF} / \text{TF} = \text{AF} + \text{CL} + \text{HL} + \text{AL} - \text{AG}$
 Where, TF = Total Factor, AF = Antenna Factor, CL = Cable Loss, AG = Amplifier Gain, HL = High pass filter Loss, AL = Attenuator Loss, DCCF = Duty Cycle Correction Factor, DCF = Distance Correction Factor

9 kHz ~ 25 GHz Data (TM1 & GFSK)

▪ Lowest Channel

Frequency (MHz)	ANT Pol	EUT Position (Axis)	Detector Mode	Reading (dBuV)	TF (dB/m)	DCCF (dB)	DCF (dB)	Result (dBuV/m)	Limit (dBuV/m)	Margin (dB)
2 387.88	H	Y	PK	51.54	4.61	N/A	N/A	56.15	74.00	17.85
2 387.88	H	Y	AV	51.54	4.61	-24.79	N/A	31.36	54.00	22.64
4 803.84	H	Y	PK	49.43	2.43	N/A	N/A	51.86	74.00	22.14
4 803.84	H	Y	AV	49.43	2.43	-24.79	N/A	27.07	54.00	26.93

▪ Middle Channel

Frequency (MHz)	ANT Pol	EUT Position (Axis)	Detector Mode	Reading (dBuV)	TF (dB/m)	DCCF (dB)	DCF (dB)	Result (dBuV/m)	Limit (dBuV/m)	Margin (dB)
4 882.28	H	Y	PK	49.93	2.40	N/A	N/A	52.33	74.00	21.67
4 882.28	H	Y	AV	49.93	2.40	-24.79	N/A	27.54	54.00	26.46

▪ Highest Channel

Frequency (MHz)	ANT Pol	EUT Position (Axis)	Detector Mode	Reading (dBuV)	TF (dB/m)	DCCF (dB)	DCF (dB)	Result (dBuV/m)	Limit (dBuV/m)	Margin (dB)
2 483.54	H	Y	PK	53.33	5.62	N/A	N/A	58.95	74.00	15.05
2 483.54	H	Y	AV	53.33	5.62	-24.79	N/A	34.16	54.00	19.84
4 960.25	H	Y	PK	49.09	2.69	N/A	N/A	51.78	74.00	22.22
4 960.25	H	Y	AV	49.09	2.69	-24.79	N/A	26.99	54.00	27.01

9 kHz ~ 25 GHz Data (TM2 & GFSK)

▪ Highest Channel

Frequency (MHz)	ANT Pol	EUT Position (Axis)	Detector Mode	Reading (dBuV)	TF (dB/m)	DCCF (dB)	DCF (dB)	Result (dBuV/m)	Limit (dBuV/m)	Margin (dB)
2 485.54	H	Y	PK	52.12	5.65	N/A	N/A	57.77	74.00	16.23
2 485.54	H	Y	AV	52.12	5.65	-24.79	N/A	32.98	54.00	21.02
4 958.83	H	Y	PK	48.79	2.67	N/A	N/A	51.46	74.00	22.54
4 958.83	H	Y	AV	48.79	2.67	-24.79	N/A	26.67	54.00	27.33

9 kHz ~ 25 GHz Data (TM 1 & $\pi/4$ DQPSK)

• Lowest Channel

Frequency (MHz)	ANT Pol	EUT Position (Axis)	Detector Mode	Reading (dBuV)	TF (dB/m)	DCCF (dB)	DCF (dB)	Result (dBuV/m)	Limit (dBuV/m)	Margin (dB)
2 387.87	H	Y	PK	51.92	4.61	N/A	N/A	56.53	74.00	17.47
2 387.87	H	Y	AV	51.92	4.61	-24.79	N/A	31.74	54.00	22.26
4 805.89	H	Y	PK	49.35	2.42	N/A	N/A	51.77	74.00	22.23
4 805.89	H	Y	AV	49.35	2.42	-24.79	N/A	26.98	54.00	27.02

• Middle Channel

Frequency (MHz)	ANT Pol	EUT Position (Axis)	Detector Mode	Reading (dBuV)	TF (dB/m)	DCCF (dB)	DCF (dB)	Result (dBuV/m)	Limit (dBuV/m)	Margin (dB)
4 880.29	H	Y	PK	49.58	2.35	N/A	N/A	51.93	74.00	22.07
4 880.29	H	Y	AV	49.58	2.35	-24.79	N/A	27.14	54.00	26.86

• Highest Channel

Frequency (MHz)	ANT Pol	EUT Position (Axis)	Detector Mode	Reading (dBuV)	TF (dB/m)	DCCF (dB)	DCF (dB)	Result (dBuV/m)	Limit (dBuV/m)	Margin (dB)
2 483.61	H	Y	PK	52.84	5.62	N/A	N/A	58.46	74.00	15.54
2 483.61	H	Y	AV	52.84	5.62	-24.79	N/A	33.67	54.00	20.33
4 961.64	H	Y	PK	49.34	2.69	N/A	N/A	52.03	74.00	21.97
4 961.64	H	Y	AV	49.34	2.69	-24.79	N/A	27.24	54.00	26.76

9 kHz ~ 25 GHz Data (TM 1 & 8DPSK)

• Lowest Channel

Frequency (MHz)	ANT Pol	EUT Position (Axis)	Detector Mode	Reading (dBuV)	TF (dB/m)	DCCF (dB)	DCF (dB)	Result (dBuV/m)	Limit (dBuV/m)	Margin (dB)
2 388.87	H	Y	PK	51.99	4.60	N/A	N/A	56.59	74.00	17.41
2 388.87	H	Y	AV	51.99	4.60	-24.79	N/A	31.80	54.00	22.20
4 802.76	H	Y	PK	48.77	2.43	N/A	N/A	51.20	74.00	22.80
4 802.76	H	Y	AV	48.77	2.43	-24.79	N/A	26.41	54.00	27.59

• Middle Channel

Frequency (MHz)	ANT Pol	EUT Position (Axis)	Detector Mode	Reading (dBuV)	TF (dB/m)	DCCF (dB)	DCF (dB)	Result (dBuV/m)	Limit (dBuV/m)	Margin (dB)
4 882.66	H	Y	PK	48.84	2.40	N/A	N/A	51.24	74.00	22.76
4 882.66	H	Y	AV	48.84	2.40	-24.79	N/A	26.45	54.00	27.55

• Highest Channel

Frequency (MHz)	ANT Pol	EUT Position (Axis)	Detector Mode	Reading (dBuV)	TF (dB/m)	DCCF (dB)	DCF (dB)	Result (dBuV/m)	Limit (dBuV/m)	Margin (dB)
2 483.57	H	Y	PK	52.09	5.62	N/A	N/A	57.71	74.00	16.29
2 483.57	H	Y	AV	52.09	5.62	-24.79	N/A	32.92	54.00	21.08
4 961.20	H	Y	PK	48.68	2.69	N/A	N/A	51.37	74.00	22.63
4 961.20	H	Y	AV	48.68	2.69	-24.79	N/A	26.58	54.00	27.42

9.4.2. Unwanted Emissions(Conducted)

Low Band-edge

TM1 & Lowest Channel & GFSK

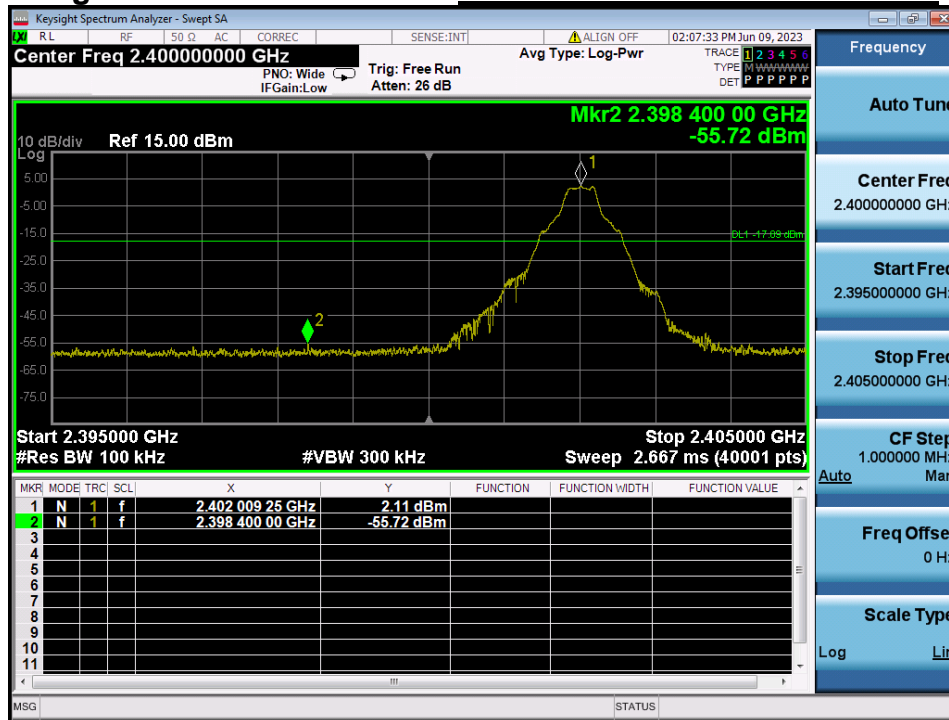

Low Band-edge

TM1 & Hopping mode & GFSK

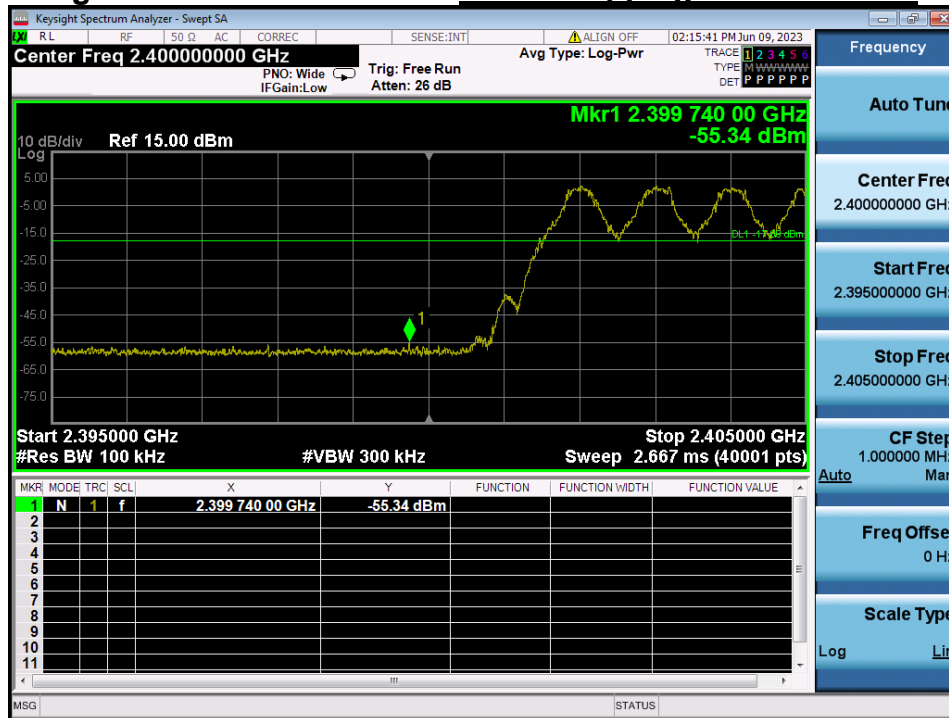

Conducted Spurious Emissions **TM1 & Lowest Channel & GFSK**

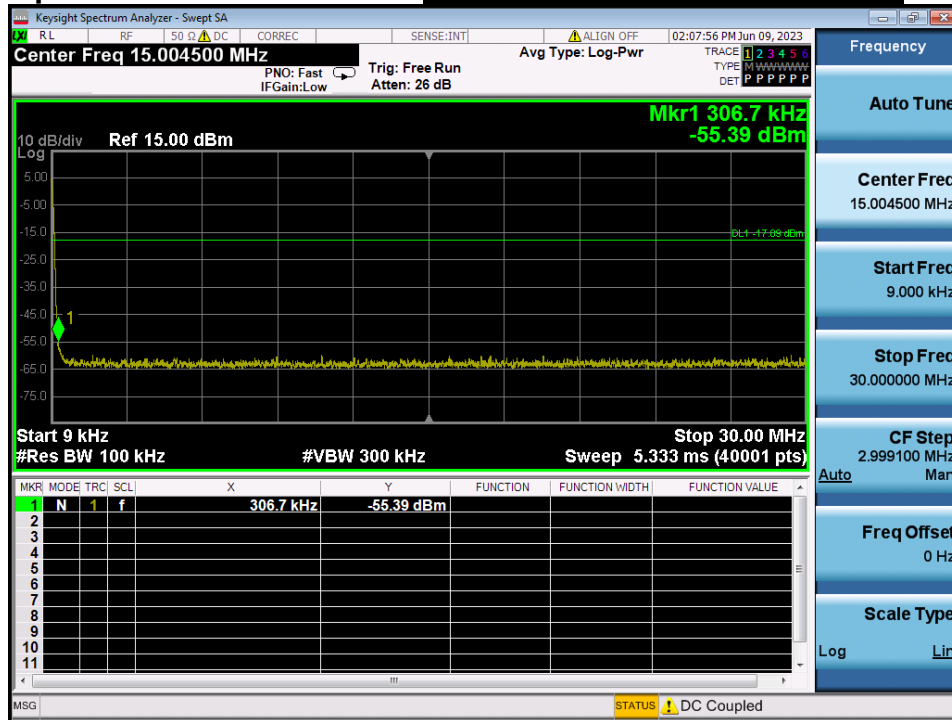

Conducted Spurious Emissions **TM1 & Lowest Channel & GFSK**

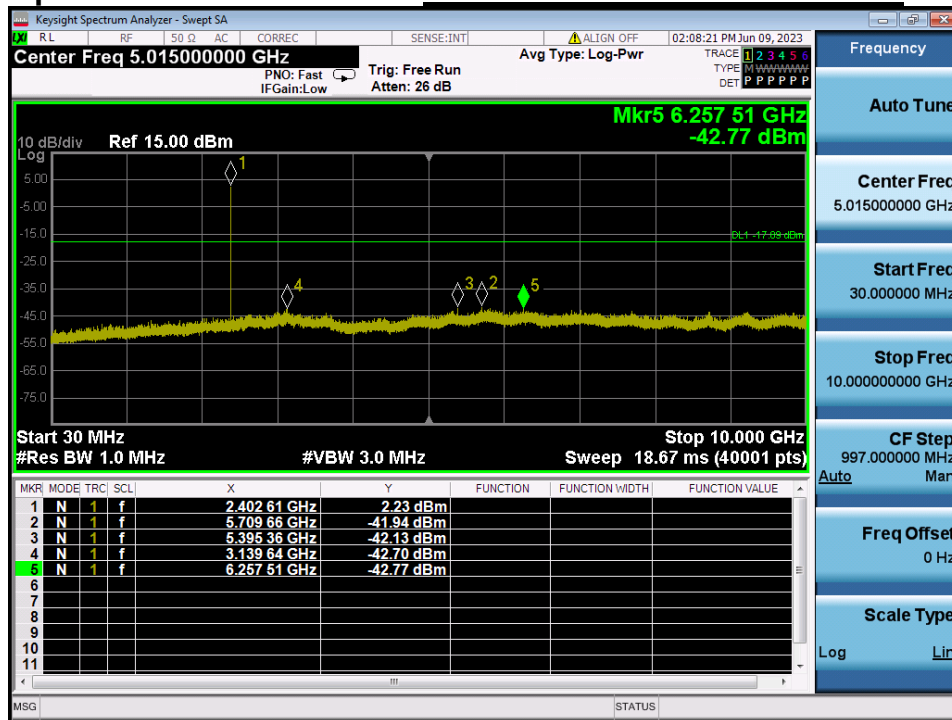

Conducted Spurious Emissions **TM1 & Lowest Channel & GFSK**

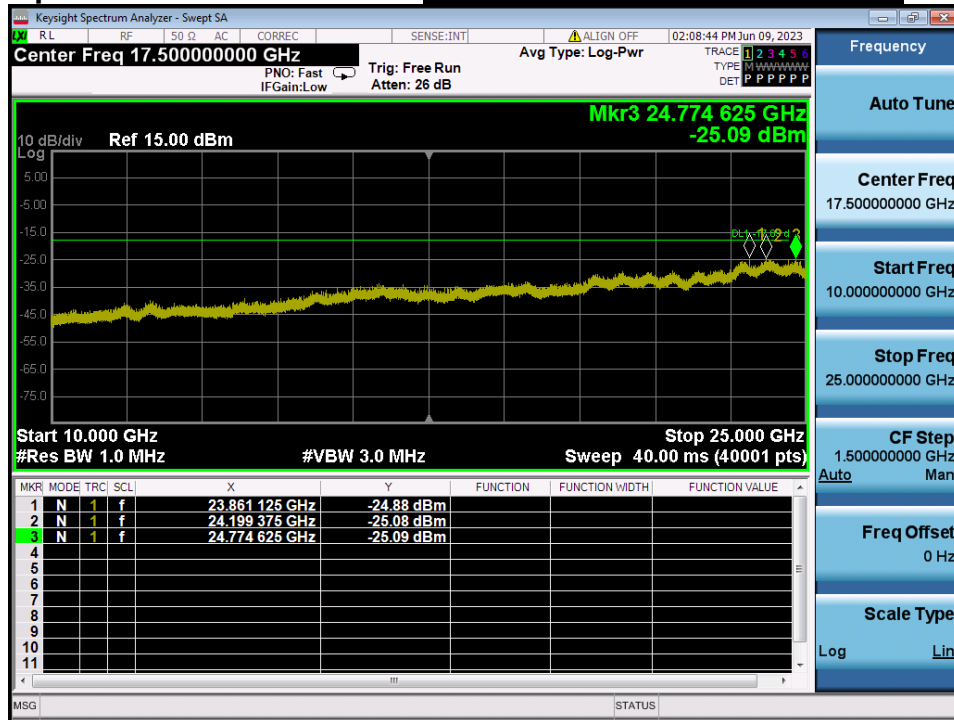

Reference for limit

TM1 & Middle Channel & GFSK

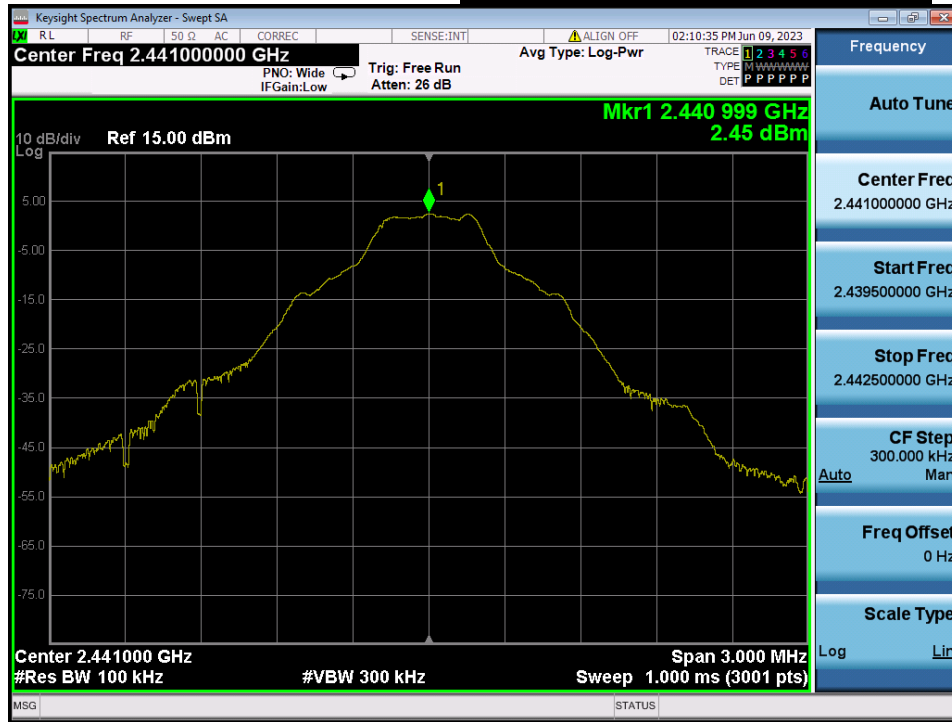

Conducted Spurious Emissions

TM1 & Middle Channel & GFSK

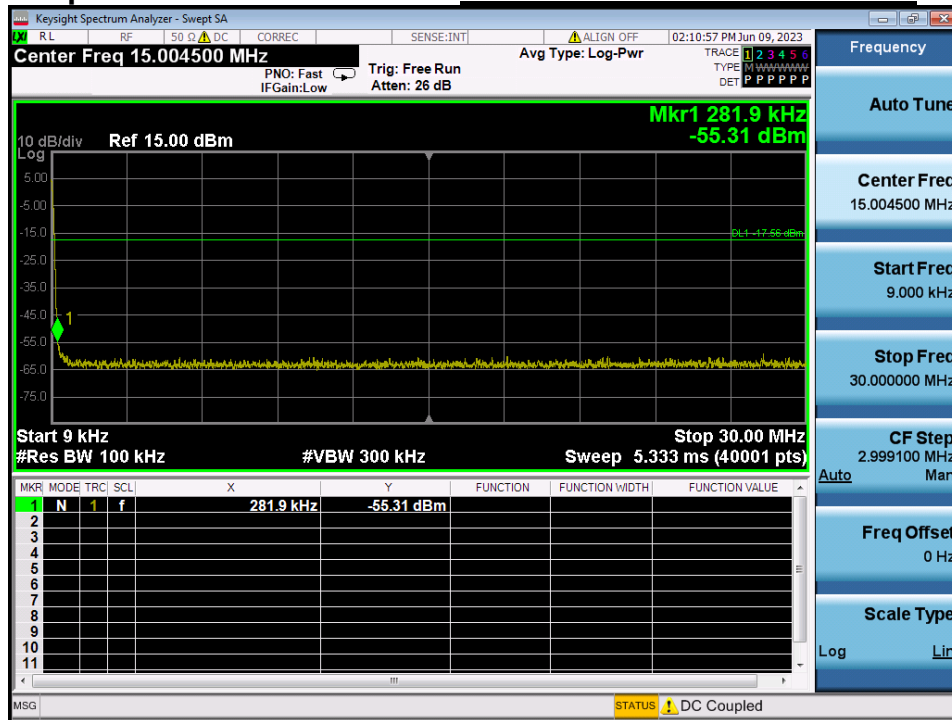

Conducted Spurious Emissions **TM1 & Middle Channel & GFSK**

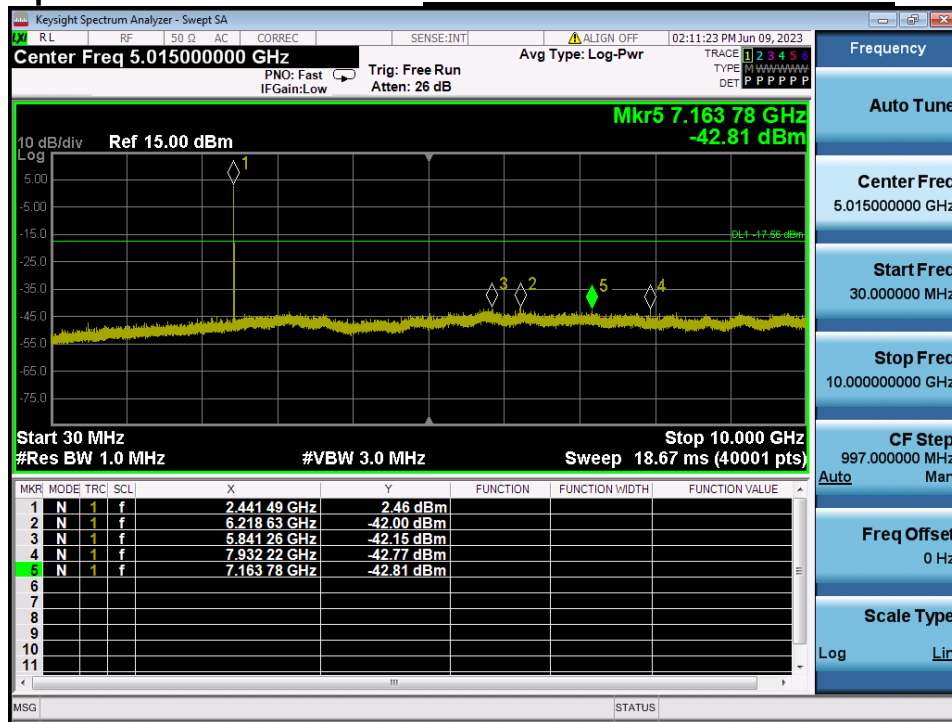

Conducted Spurious Emissions **TM1 & Middle Channel & GFSK**

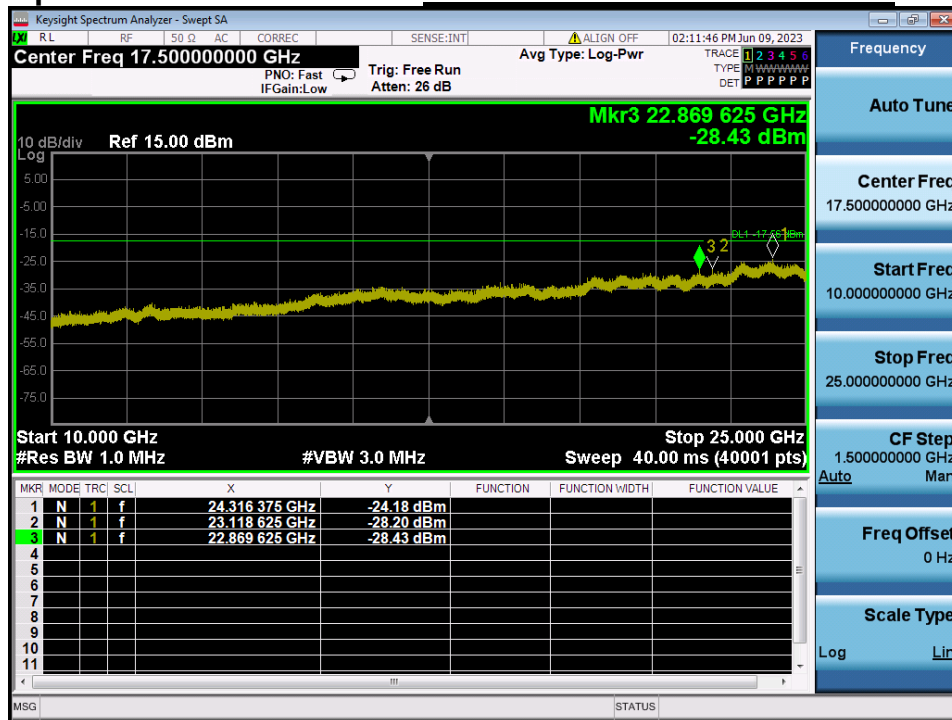

High Band-edge

TM1 & GFSK & Highest Channel

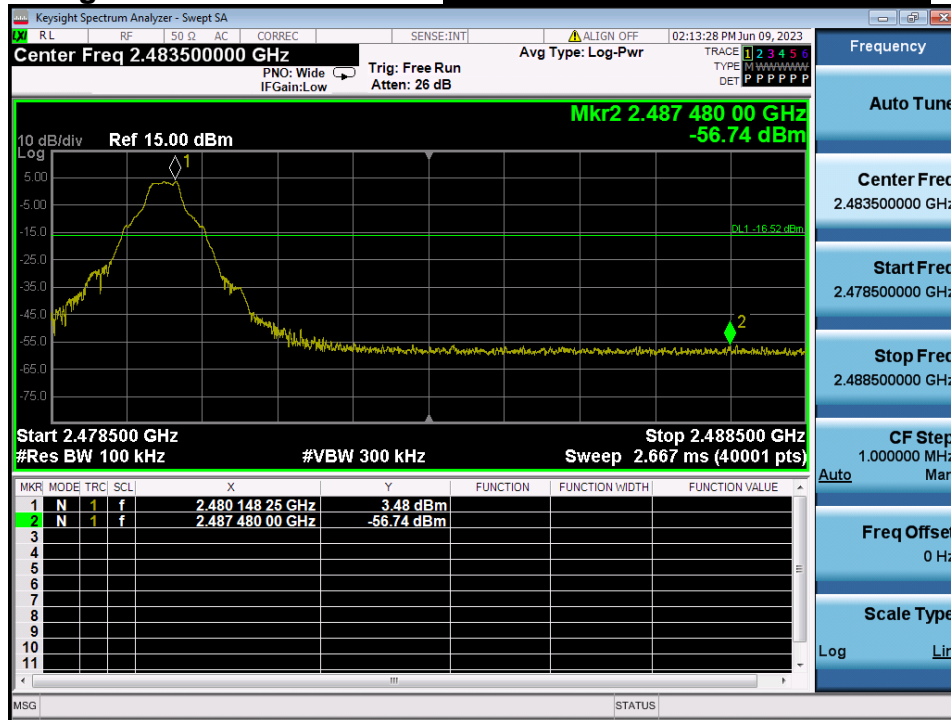

High Band-edge

TM1 & Hopping mode & GFSK

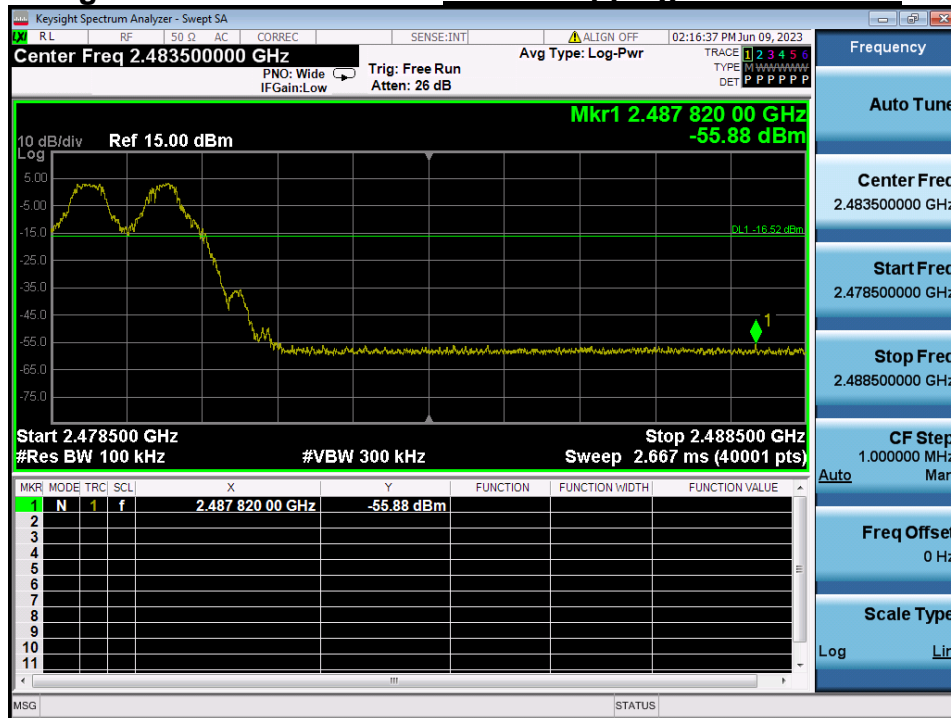

Conducted Spurious Emissions **TM1 & GFSK & Highest Channel**

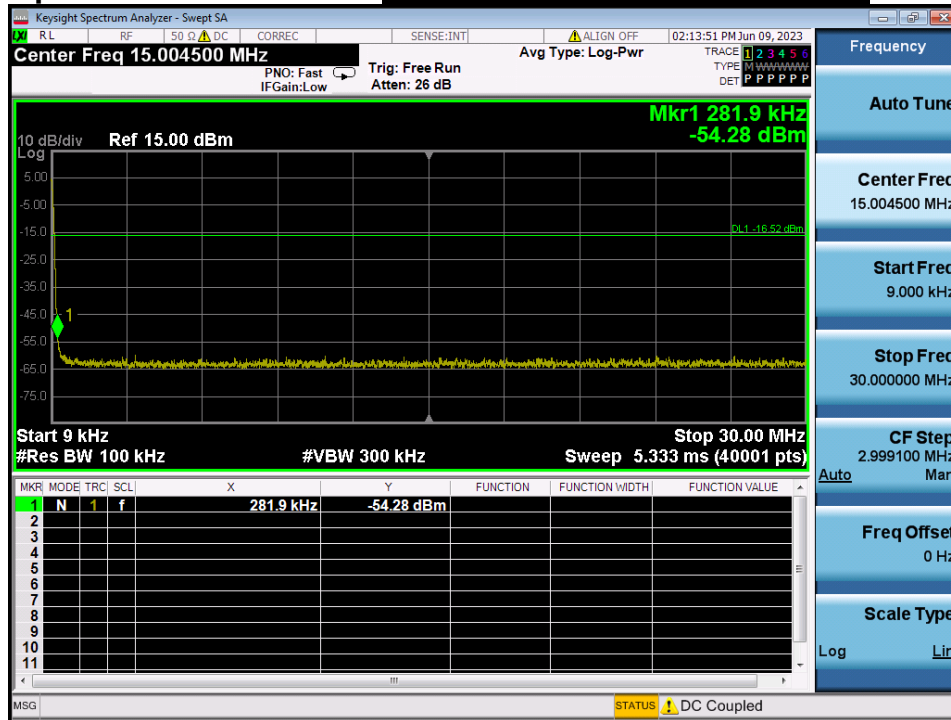

Conducted Spurious Emissions **TM1 & GFSK & Highest Channel**

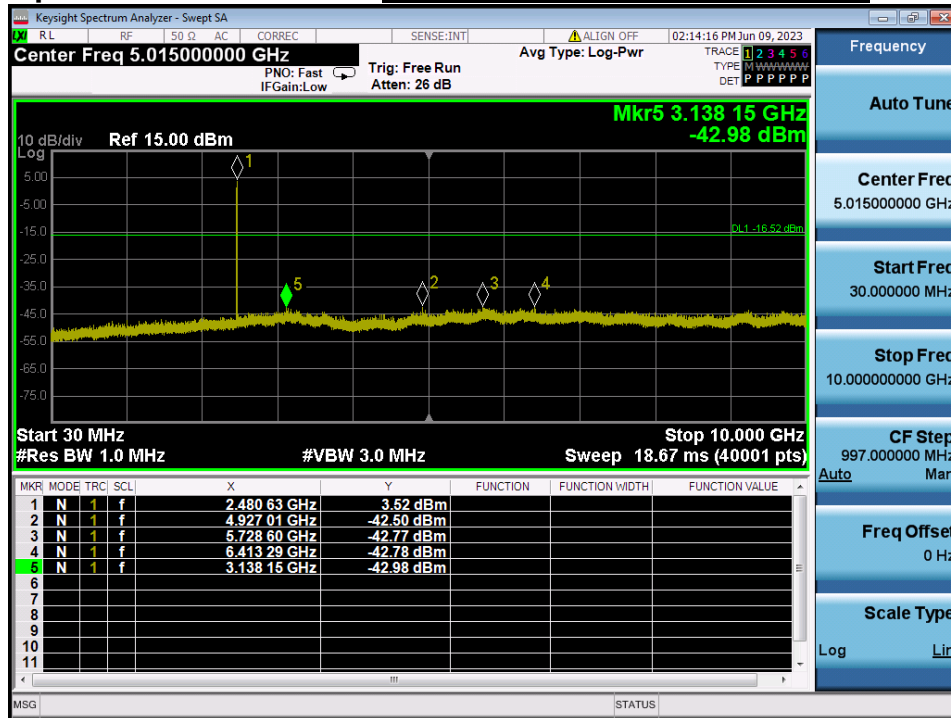

Conducted Spurious Emissions **TM1 & GFSK & Highest Channel**

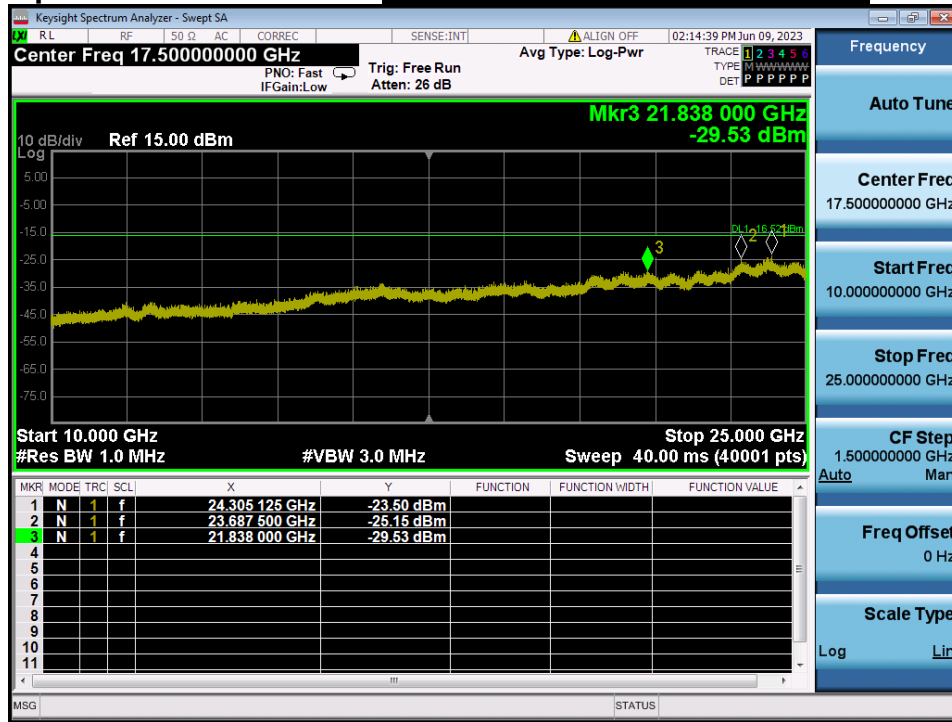

Low Band-edge

TM1 & Lowest Channel & $\pi/4$ DQPSK

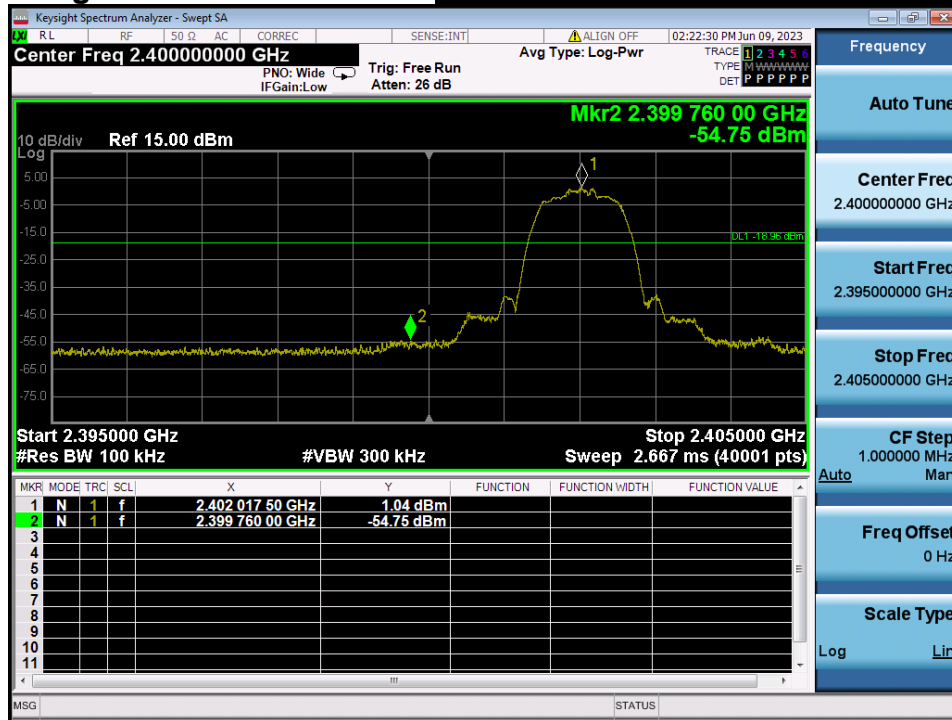

Low Band-edge

TM1 & Hopping mode & $\pi/4$ DQPSK

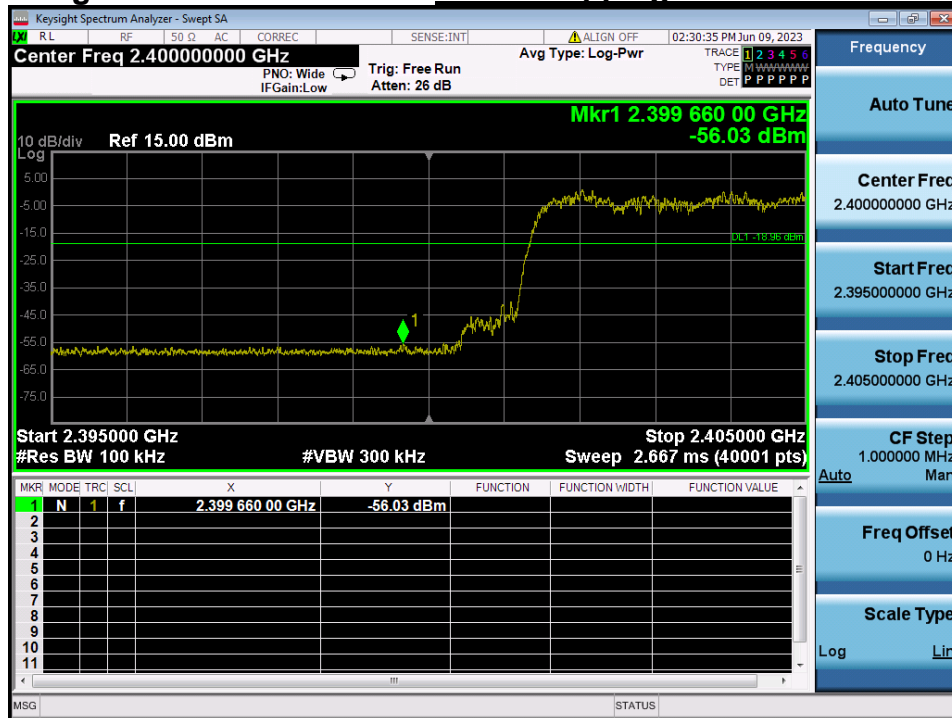

Conducted Spurious Emissions **TM1 & Lowest Channel & $\pi/4$ DQPSK**

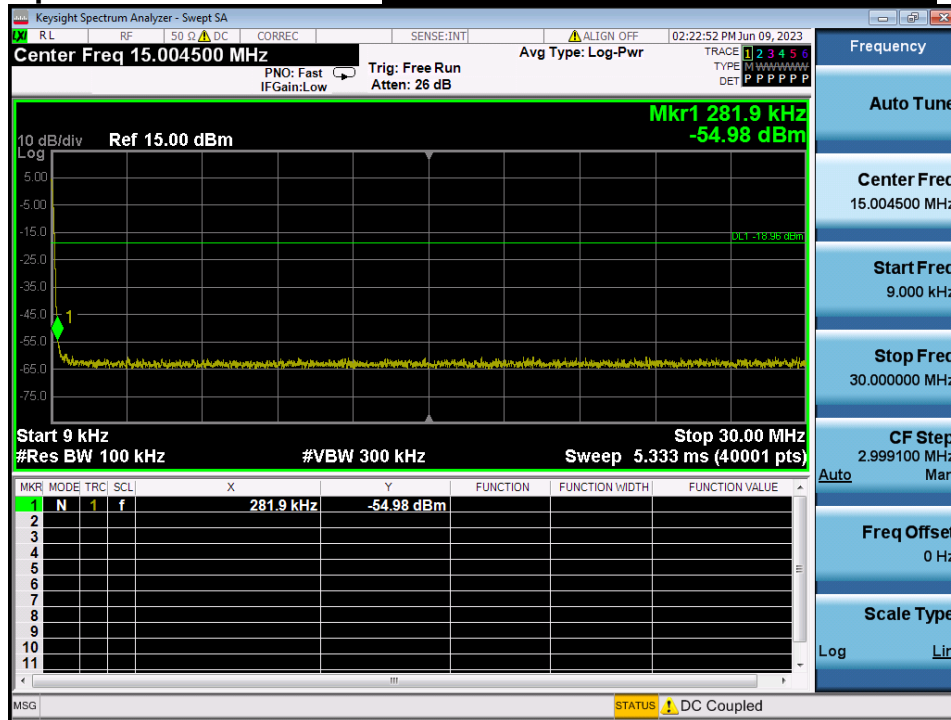

Conducted Spurious Emissions **TM1 & Lowest Channel & $\pi/4$ DQPSK**

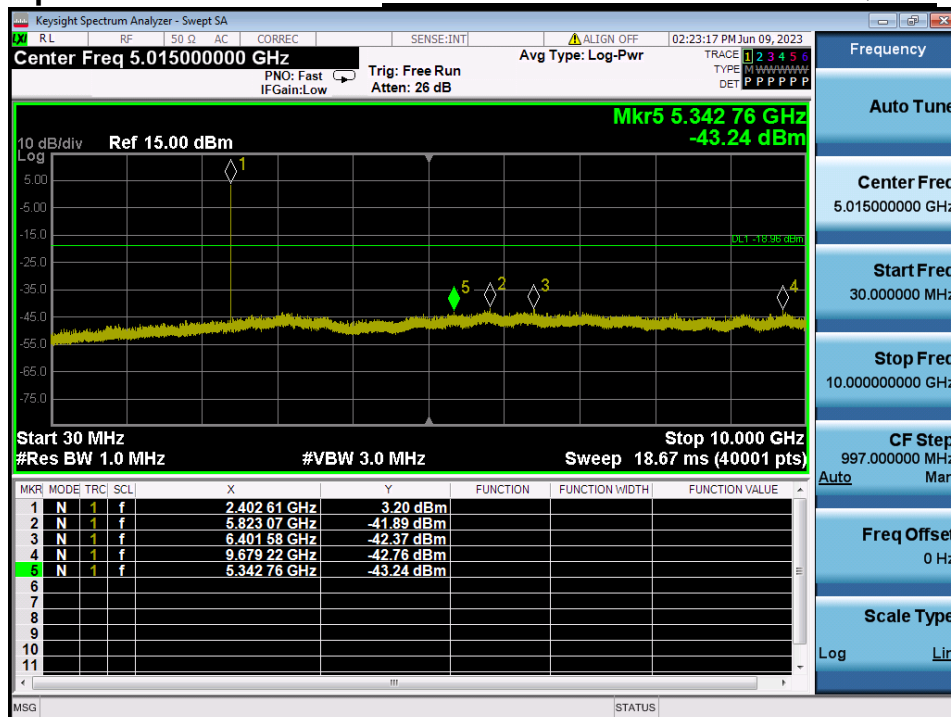

Conducted Spurious Emissions **TM1 & Lowest Channel & $\pi/4$ DQPSK**

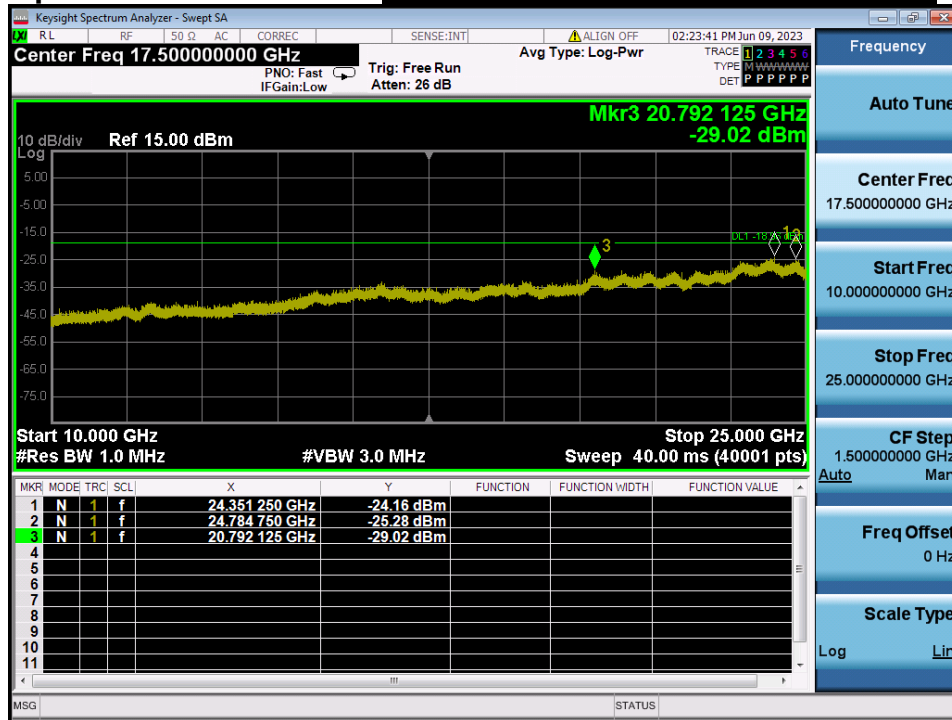

Reference for limit

TM1 & Middle Channel & $\pi/4$ DQPSK

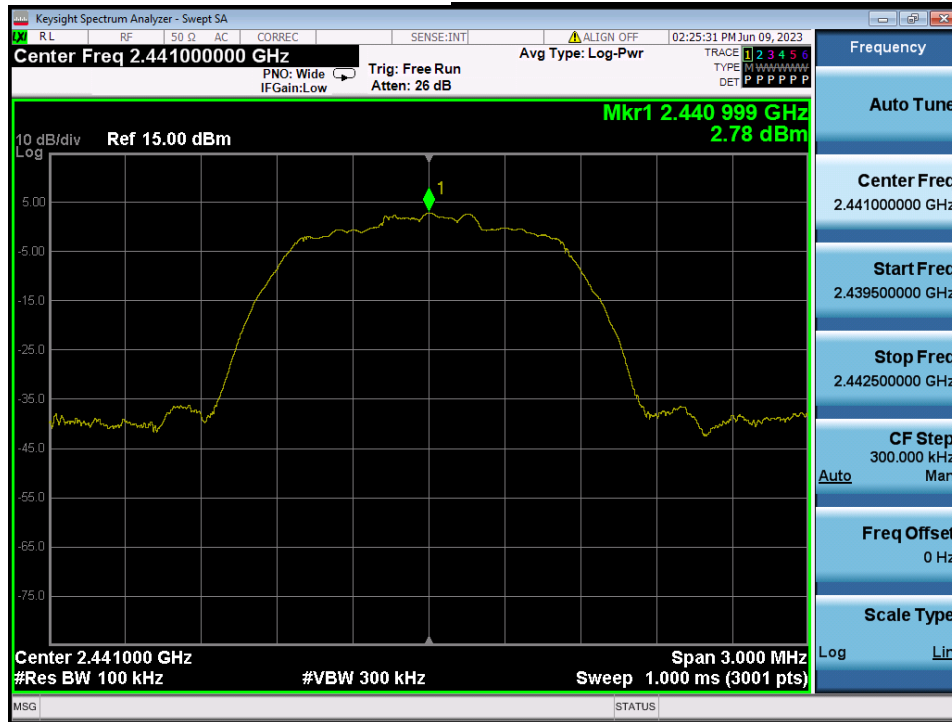

Conducted Spurious Emissions

TM1 & Middle Channel & $\pi/4$ DQPSK

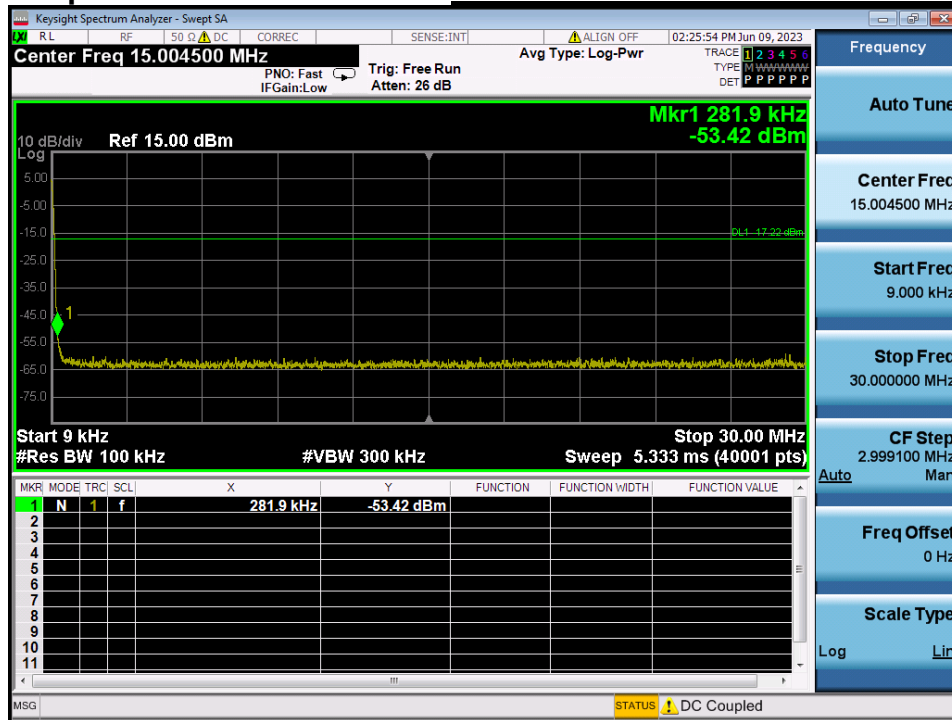

Conducted Spurious Emissions **TM1 & Middle Channel & $\pi/4$ DQPSK**

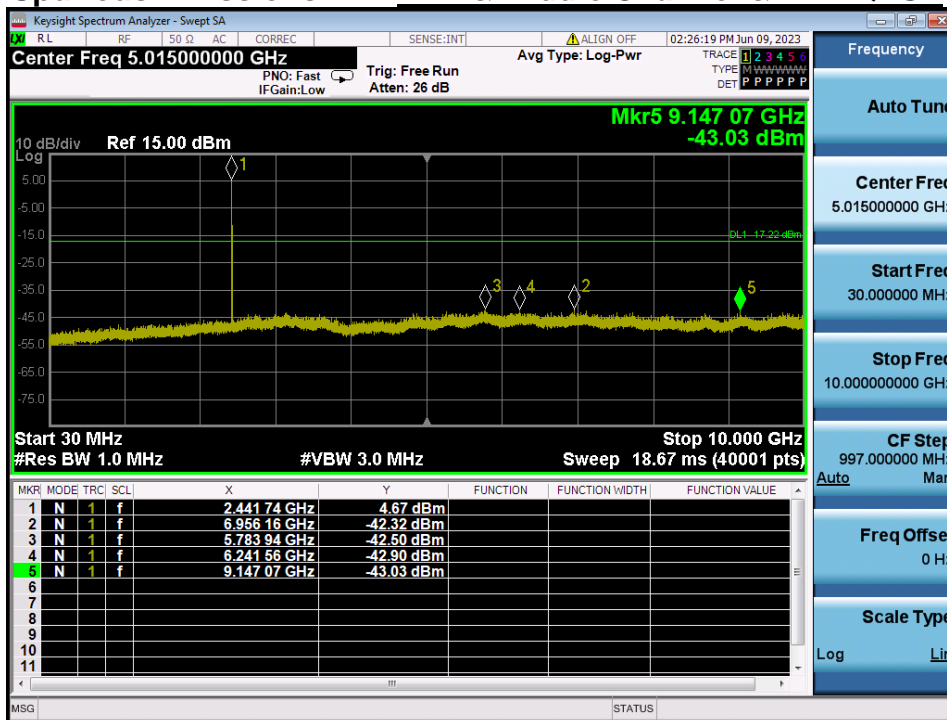

Conducted Spurious Emissions **TM1 & Middle Channel & $\pi/4$ DQPSK**

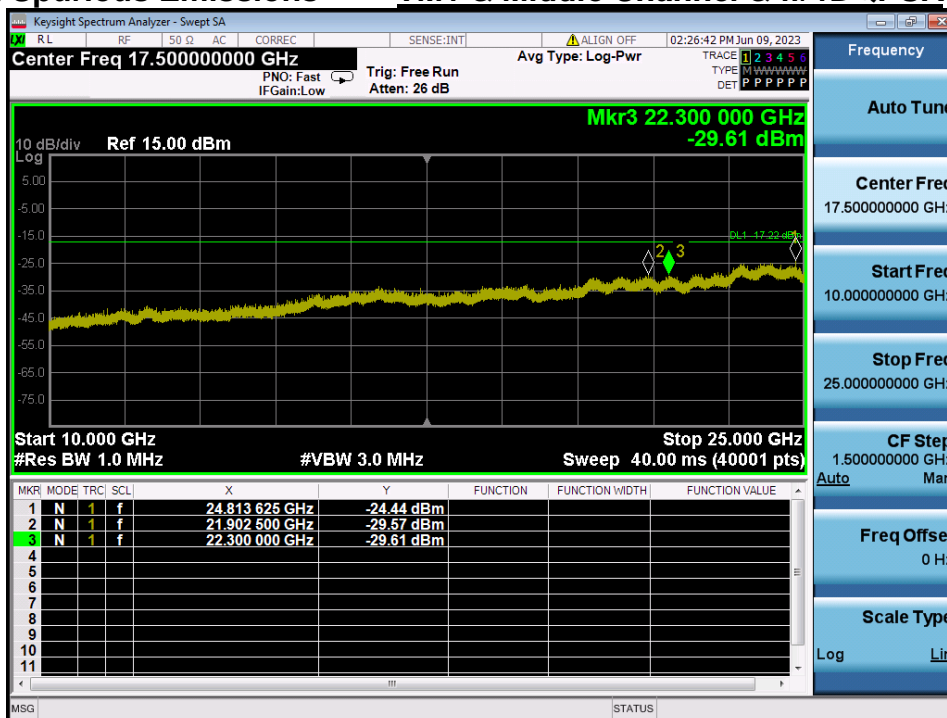

High Band-edge

TM1 & Highest Channel & $\pi/4$ DQPSK

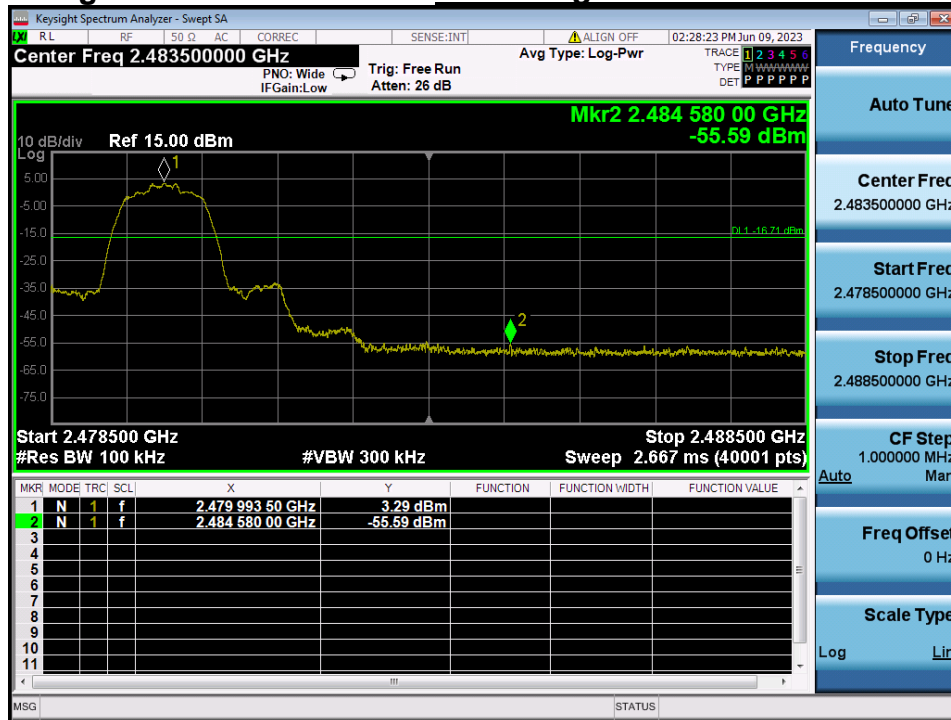

High Band-edge

TM1 & Hopping mode & $\pi/4$ DQPSK

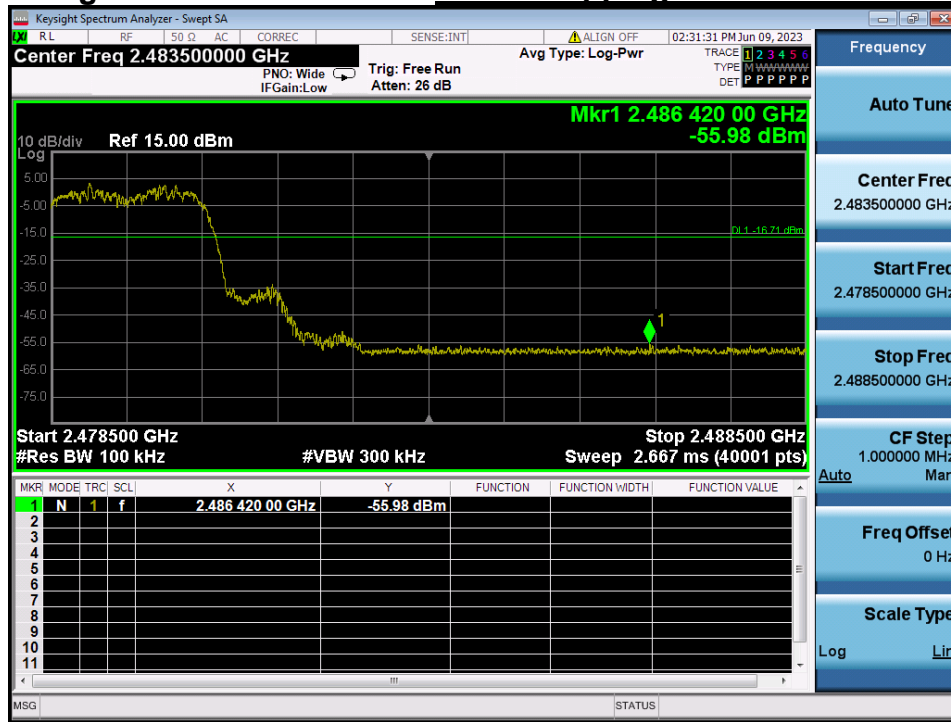

Conducted Spurious Emissions **TM1 & Highest Channel & $\pi/4$ DQPSK**

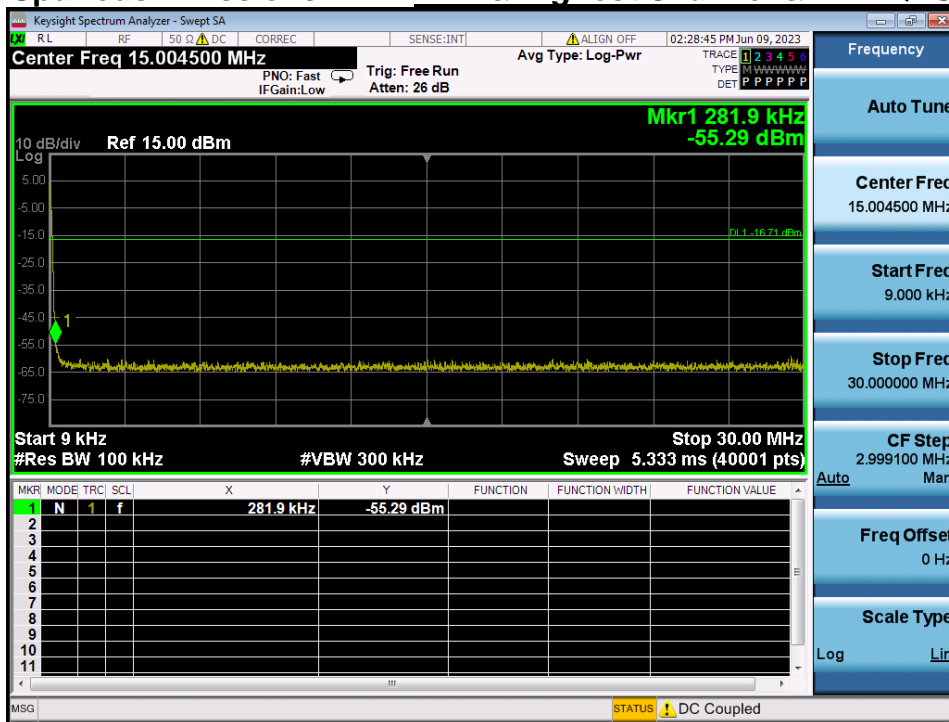

Conducted Spurious Emissions **TM1 & Highest Channel & $\pi/4$ DQPSK**

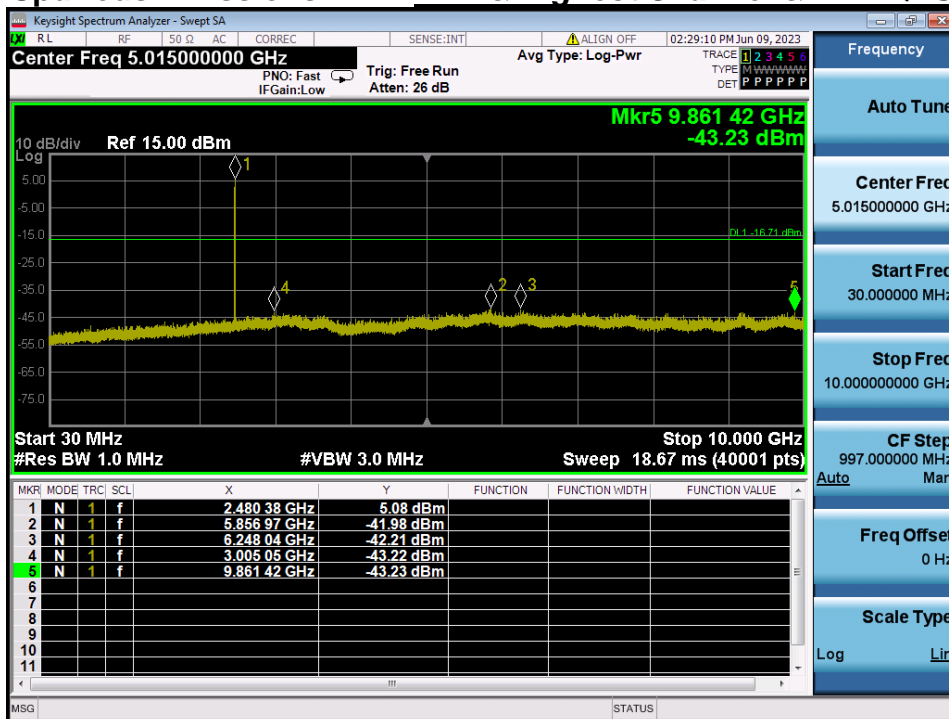

Conducted Spurious Emissions **TM1 & Highest Channel & $\pi/4$ DQPSK**

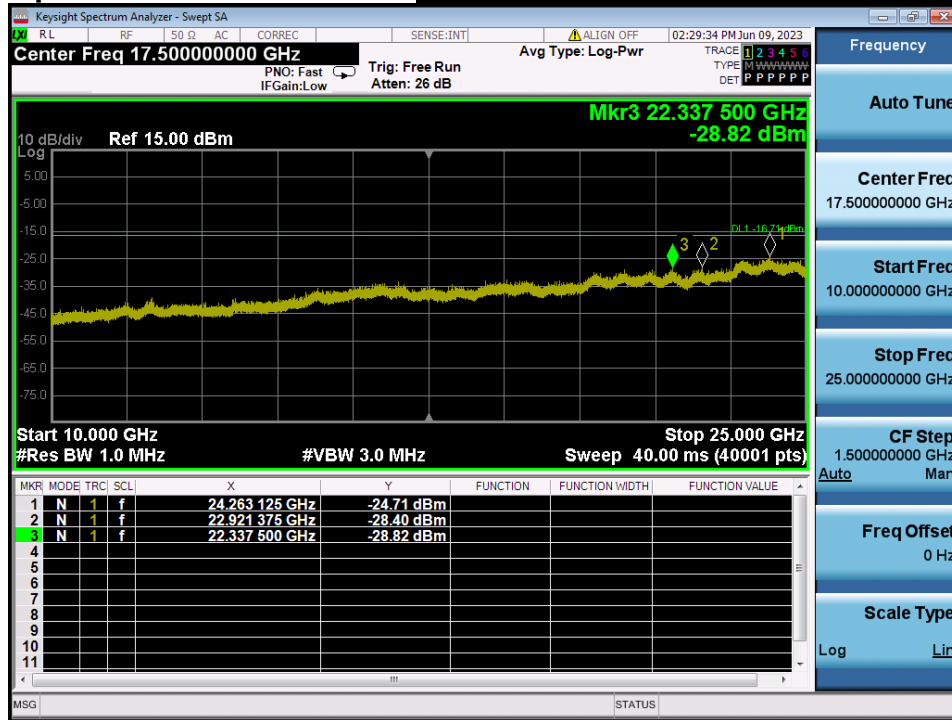

Low Band-edge

TM1 & Lowest Channel & 8DPSK

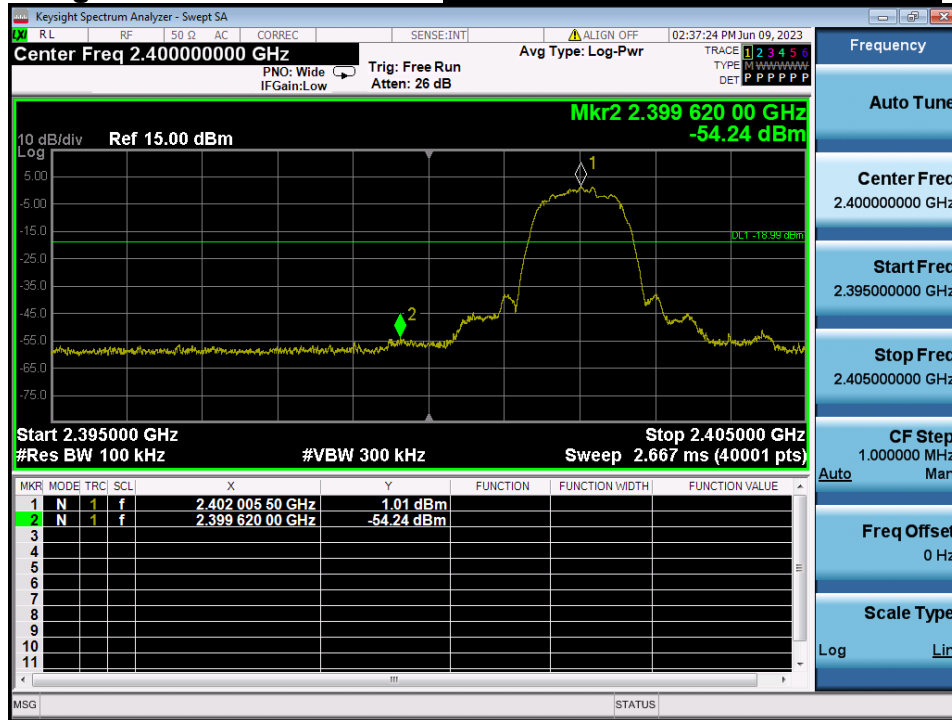

Low Band-edge

TM1 & Hopping mode & 8DPSK

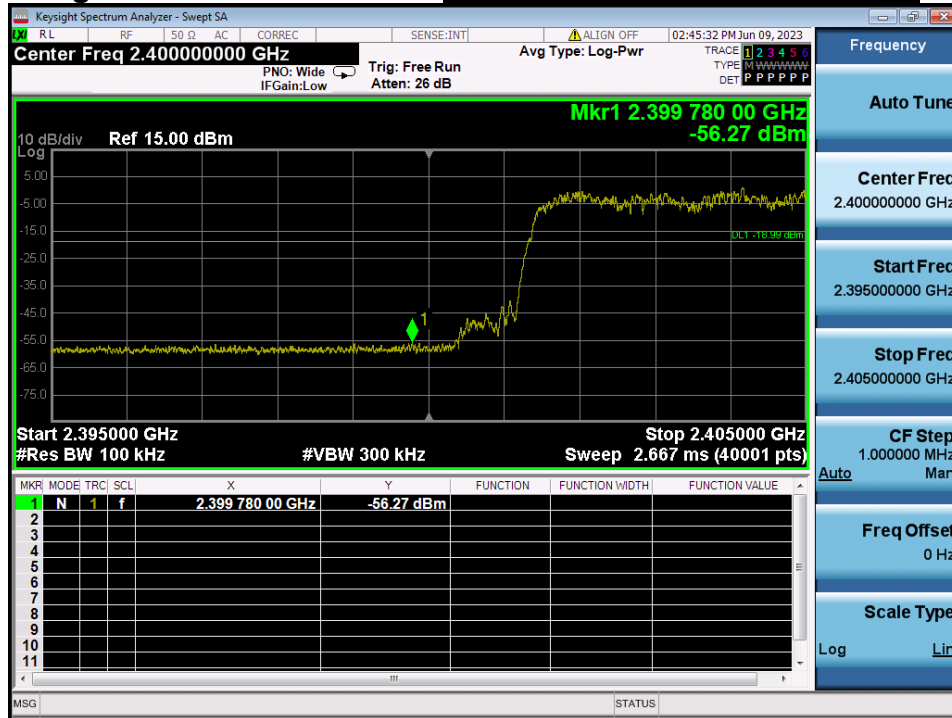

Conducted Spurious Emissions **TM1 & Lowest Channel & 8DPSK**

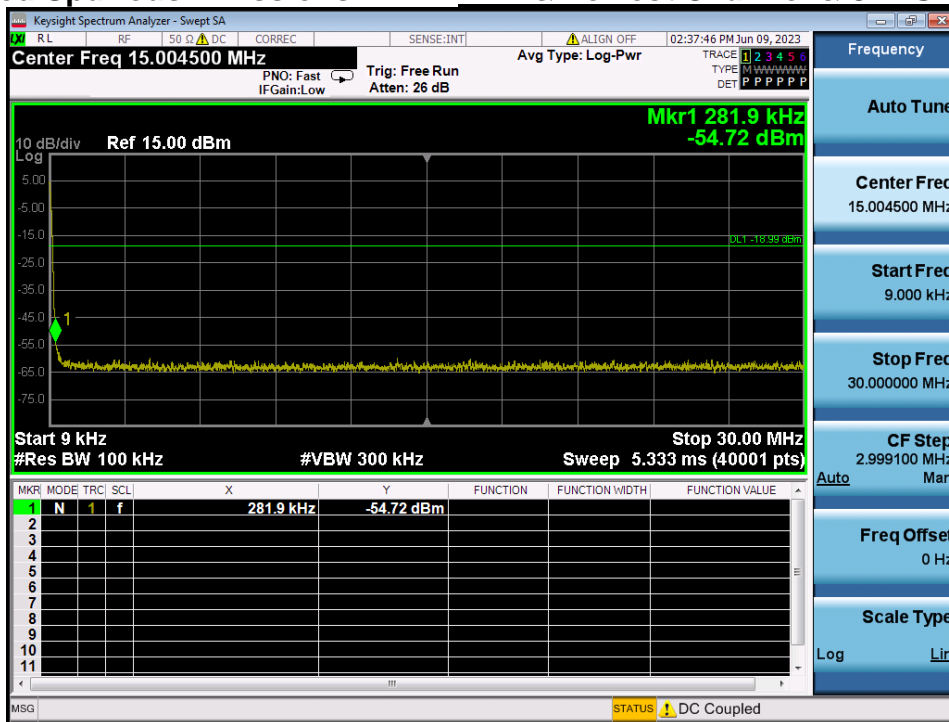

Conducted Spurious Emissions **TM1 & Lowest Channel & 8DPSK**

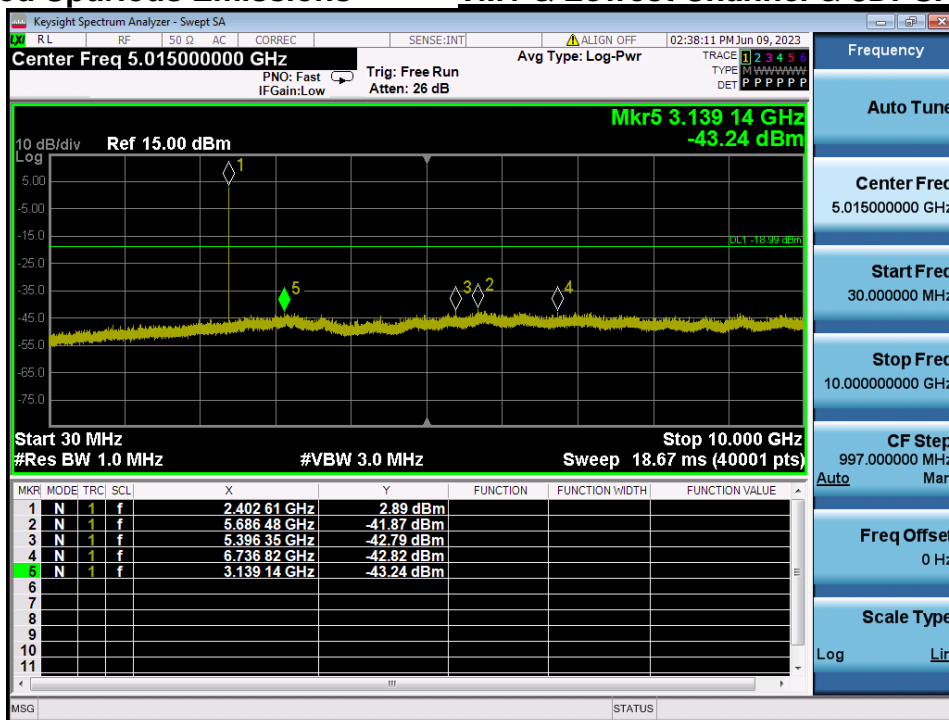

Conducted Spurious Emissions *TM1 & Lowest Channel & 8DPSK*

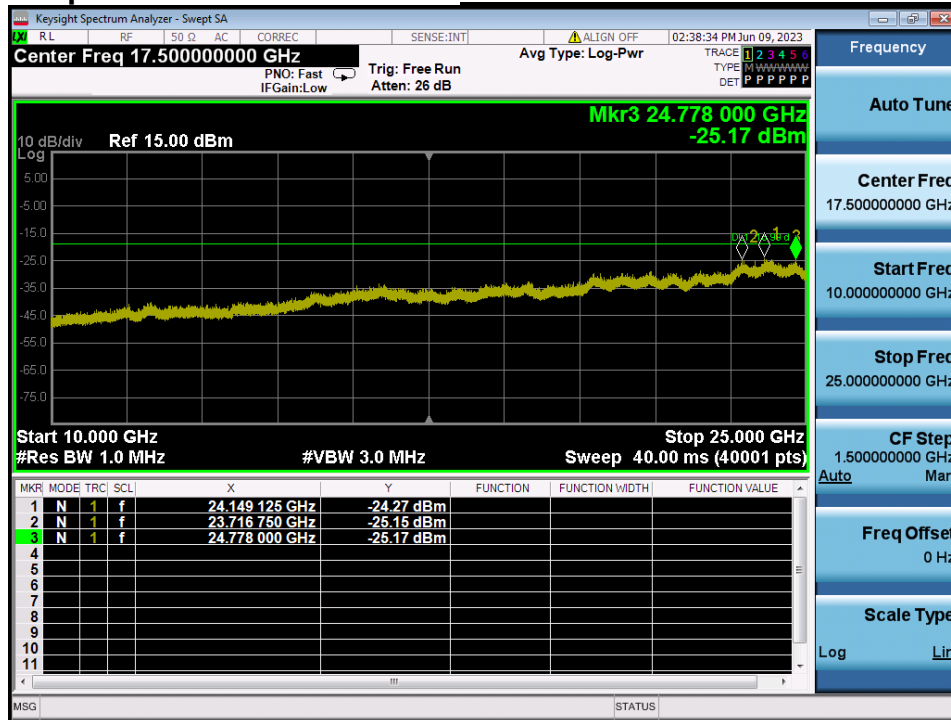

Reference for limit

TM1 & Middle Channel & 8DPSK

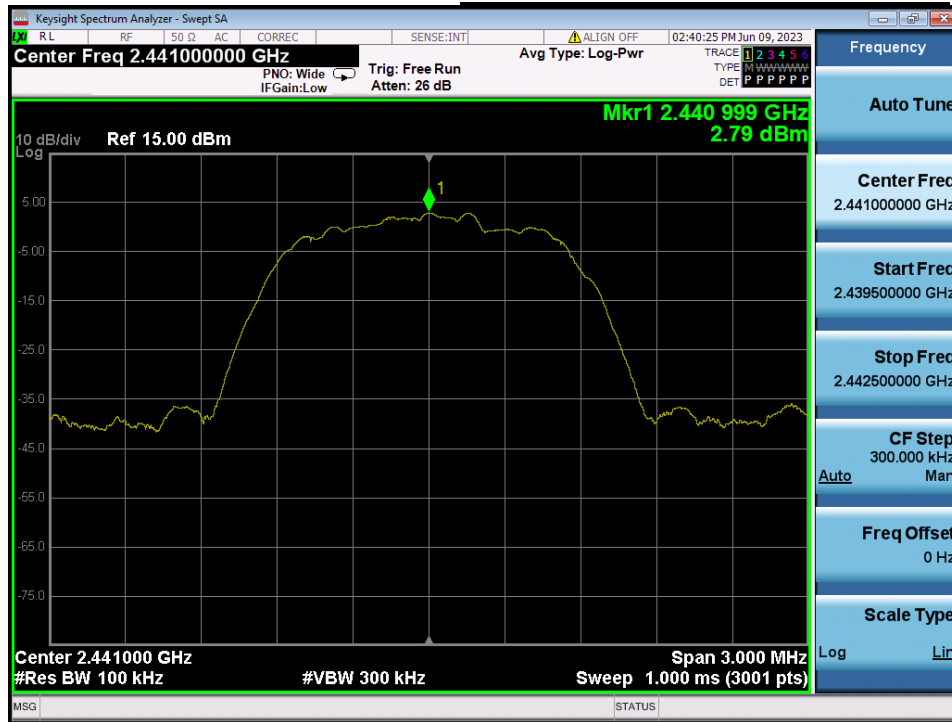

Conducted Spurious Emissions

TM1 & Middle Channel & 8DPSK

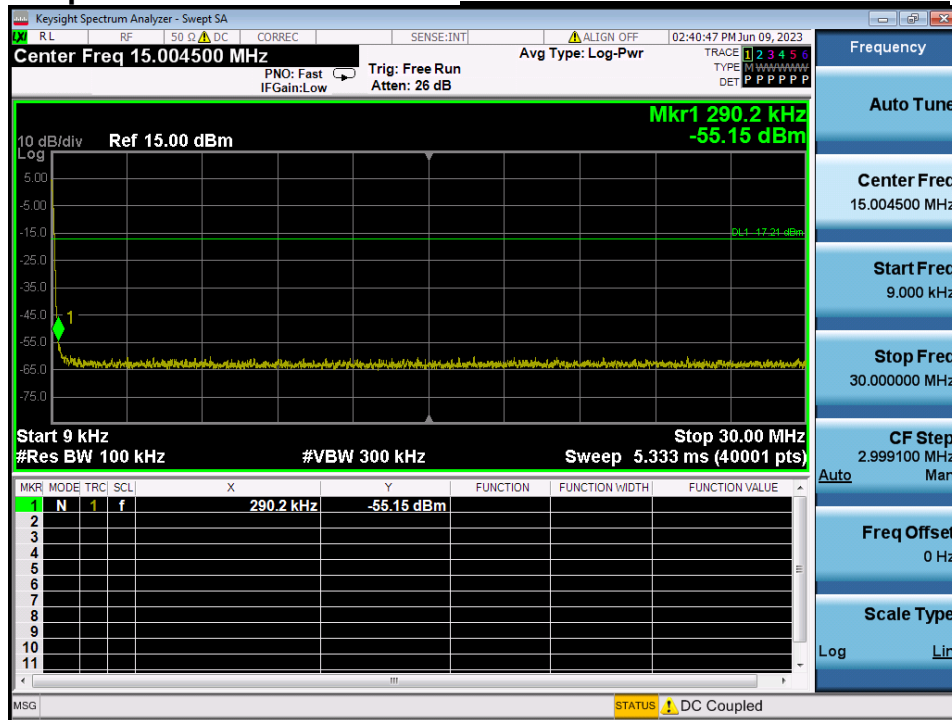

Conducted Spurious Emissions **TM1 & Middle Channel & 8DPSK**

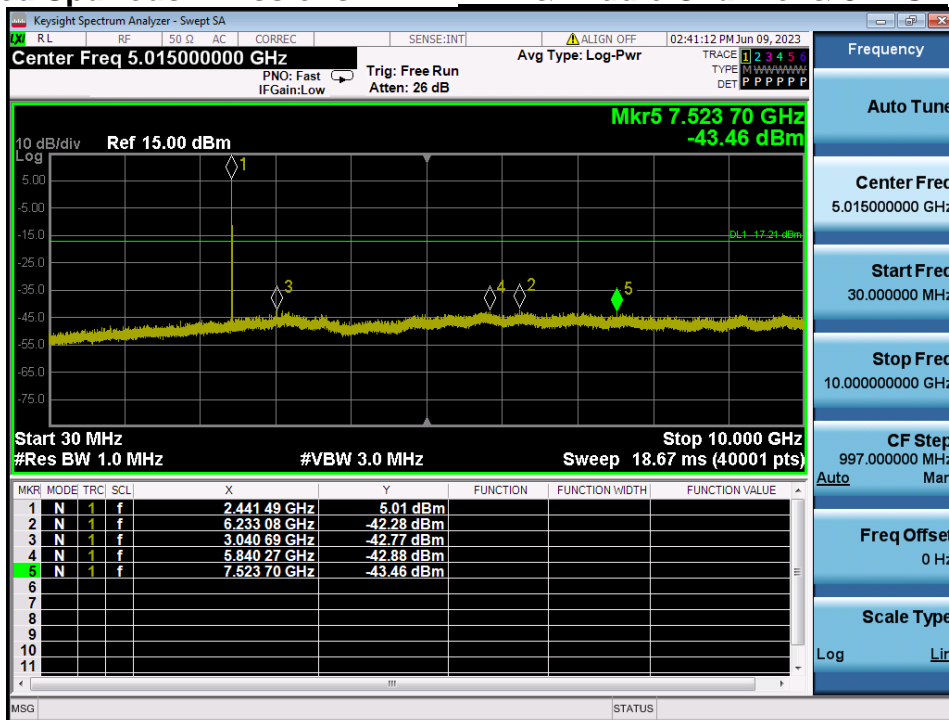

Conducted Spurious Emissions **TM1 & Middle Channel & 8DPSK**

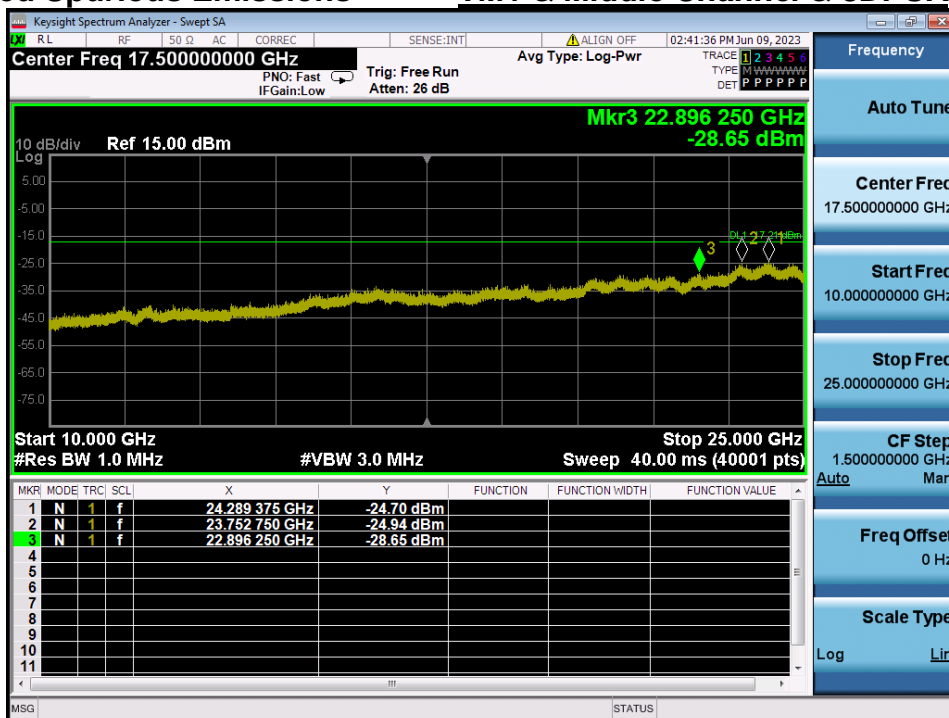

High Band-edge

TM1 & Highest Channel & 8DPSK

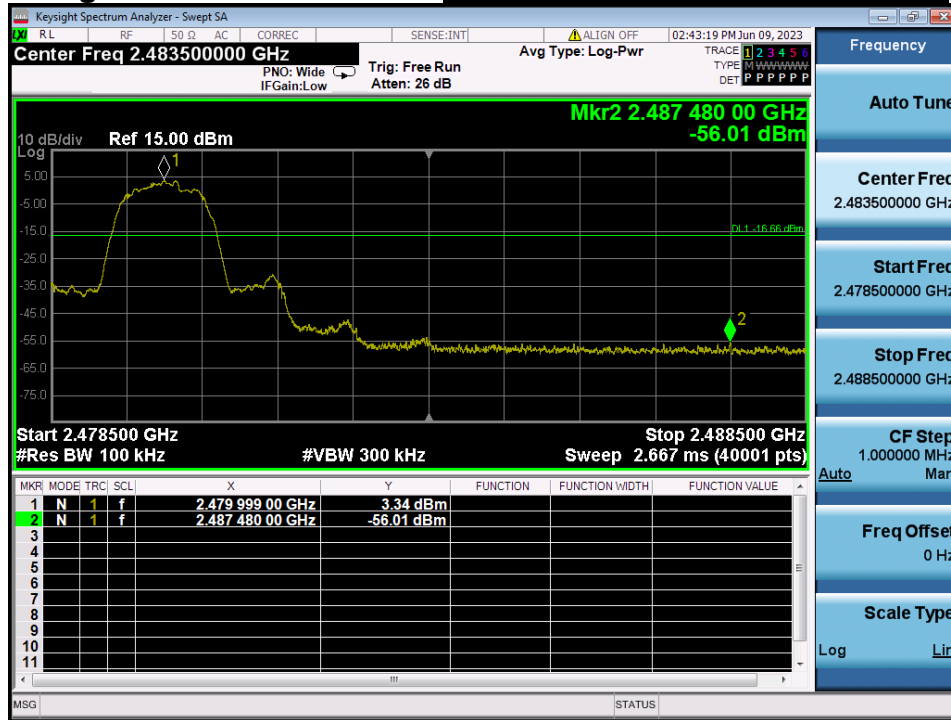

High Band-edge

TM1 & Hopping mode & 8DPSK

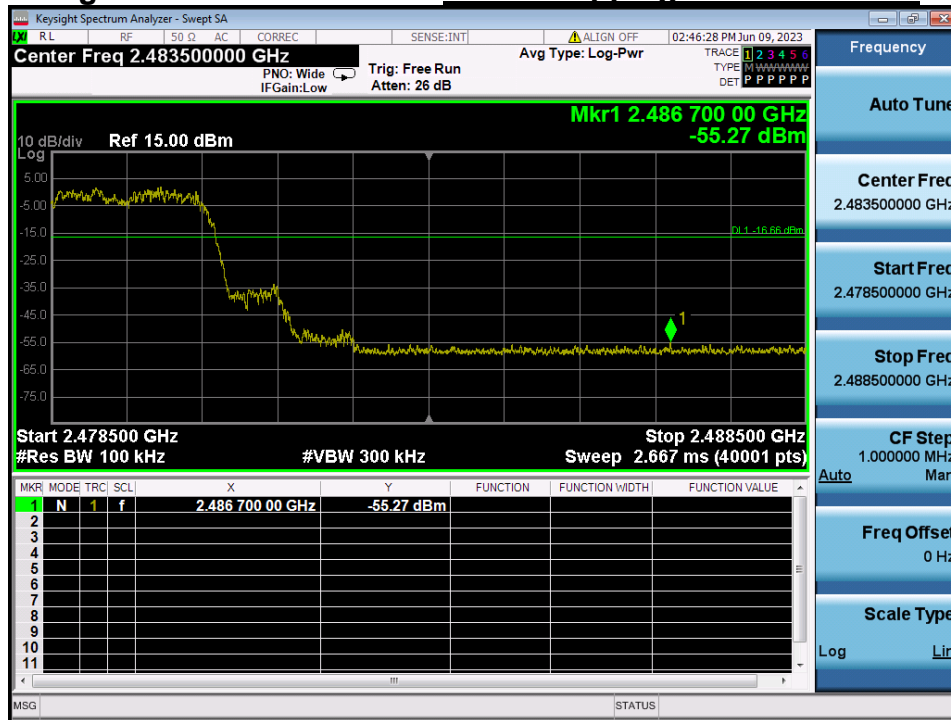

Conducted Spurious Emissions *TM1 & Highest Channel & 8DPSK*

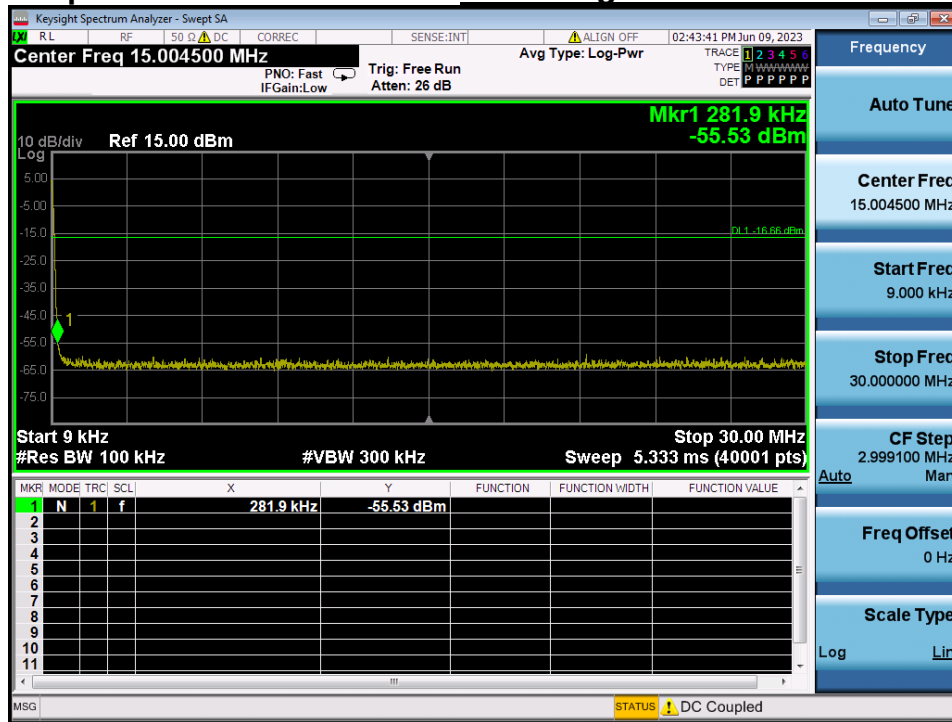

Conducted Spurious Emissions *TM1 & Highest Channel & 8DPSK*

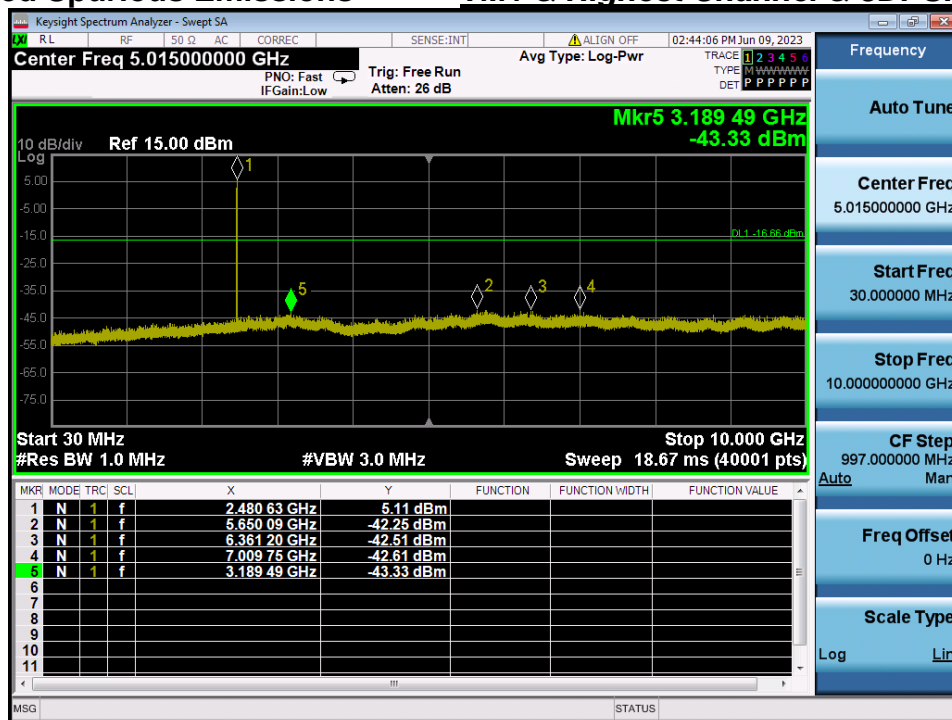

Conducted Spurious Emissions *TM1 & Highest Channel & 8DPSK*

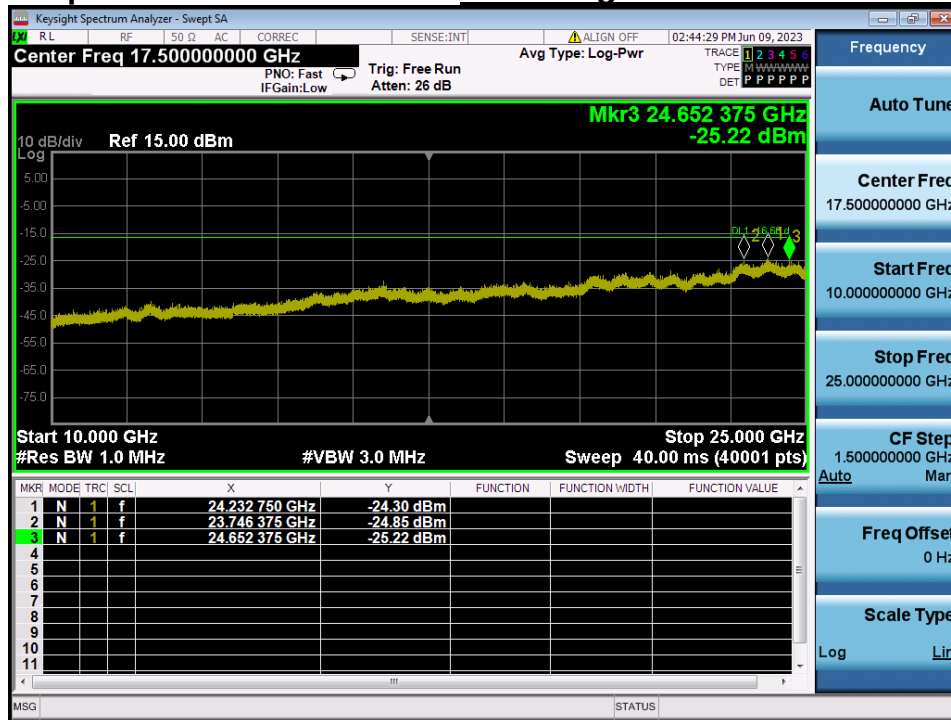

10. AC Power-Line Conducted Emissions

10.1. Test Setup

See test photographs for the actual connections between EUT and support equipment.

10.2. Limit

According to §15.207(a) for an intentional radiator that is designed to be connected to the public utility (AC) power line, the radio frequency voltage that is conducted back onto the AC power line on any frequency or frequencies, within the band 150 kHz to 30 MHz, shall not exceed the limits in the following table, as measured using a 50 uH/50 ohm line impedance stabilization network (LISN).

Compliance with the provision of this paragraph shall on the measurement of the radio frequency voltage between each power line and ground at the power terminal. The lower applies at the boundary between the frequency ranges.

Frequency Range (MHz)	Conducted Limit (dBuV)	
	Quasi-Peak	Average
0.15 ~ 0.50	66 to 56 *	56 to 46 *
0.5 ~ 5.0	56	46
5 ~ 30	60	50

* Decreases with the logarithm of the frequency

10.3. Test Procedure

Conducted emissions from the EUT were measured according to the ANSI C63.10.

1. The test procedure is performed in a 6.5 m × 3.5 m × 3.5 m (L × W × H) shielded room. The EUT along with its peripherals were placed on a 1.0 m (W) × 1.5 m (L) and 0.8 m in height wooden table and the EUT was adjusted to maintain a 0.4 meter space from a vertical reference plane.
2. The EUT was connected to power mains through a line impedance stabilization network (LISN) which provides 50 ohm coupling impedance for measuring instrument and the chassis ground was bounded to the horizontal ground plane of shielded room.
3. All peripherals were connected to the second LISN and the chassis ground also bounded to the horizontal ground plane of shielded room.
4. The excess power cable between the EUT and the LISN was bundled. The power cables of peripherals were unbundled. All connecting cables of EUT and peripherals were moved to find the maximum emission.

10.4. Test Results

AC Power-Line Conducted Emissions (Graph) = Modulation : GFSK

Results of Conducted Emission

DTNC

Date 2023-05-26

Order No.
Model No. PM86
Serial No.
Test Condition BT

Reference No.
Power Supply
Temp/Humi. 21 °C / 41 %
Operator S.M.Gil

Memo 1M_2402

LIMIT : FCC P15.207 AV
FCC P15.207 QP

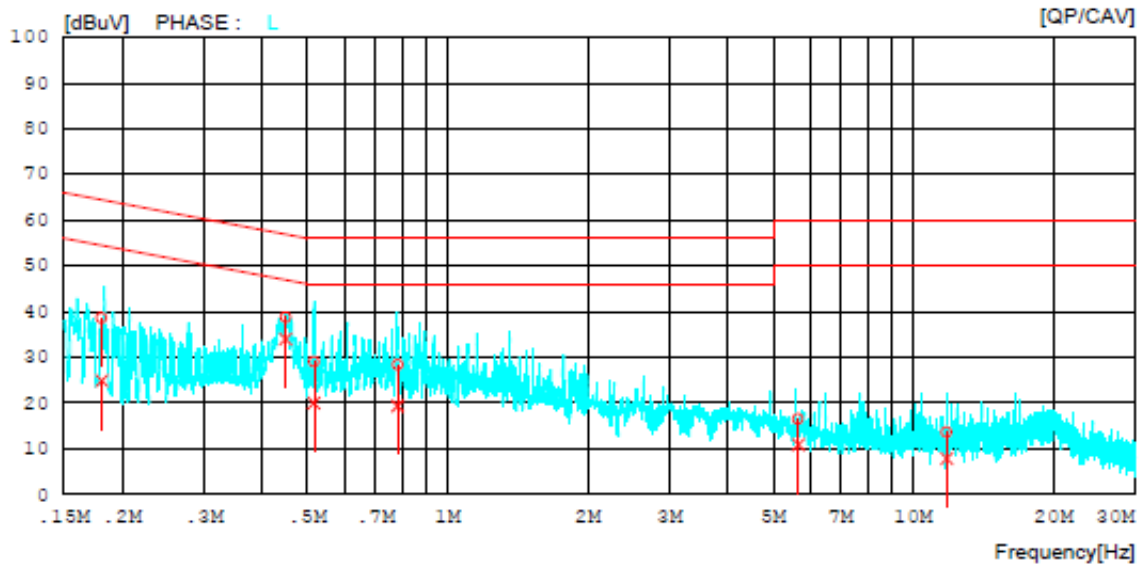
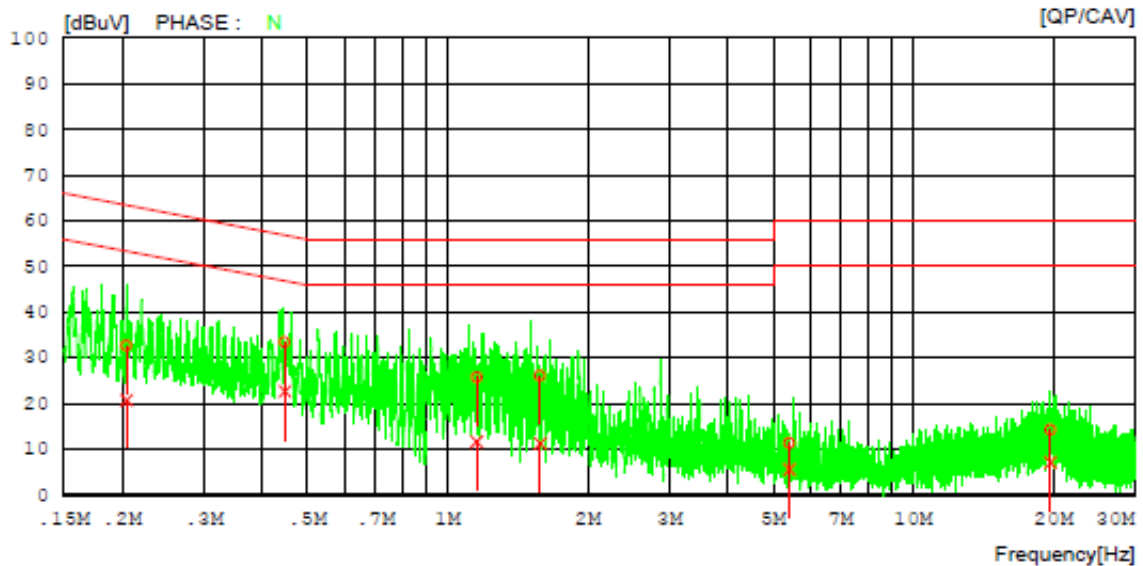

AC Power-Line Conducted Emissions (List) = Modulation : 8DPSK

Results of Conducted Emission

DTNC

Date 2023-05-26

Order No.		Reference No.	
Model No.	PM86	Power Supply	
Serial No.		Temp/Humi.	21 °C / 41 %
Test Condition	BT	Operator	S.M.Gil
Memo	1M_2402		

LIMIT : FCC P15.207 AV
FCC P15.207 QP

NO	FREQ [MHz]	READING		C.FACTOR [dB]	RESULT		LIMIT		MARGIN		PHASE
		QP [dBuV]	CAV [dBuV]		QP [dBuV]	CAV [dBuV]	QP [dBuV]	CAV [dBuV]			
1	0.20441	22.74	10.85	9.98	32.72	20.83	63.43	53.43	30.71	32.60	N
2	0.44686	23.47	12.68	10.00	33.47	22.68	56.93	46.93	23.46	24.25	N
3	1.15500	15.73	1.67	10.01	25.74	11.68	56.00	46.00	30.26	34.32	N
4	1.57920	16.08	1.32	10.03	26.11	11.35	56.00	46.00	29.89	34.65	N
5	5.42220	1.16	-4.60	10.21	11.37	5.61	60.00	50.00	48.63	44.39	N
6	19.70560	3.70	-3.49	10.56	14.26	7.07	60.00	50.00	45.74	42.93	N
7	0.18068	28.74	15.01	9.89	38.63	24.90	64.45	54.45	25.82	29.55	L
8	0.44891	28.82	24.04	9.90	38.72	33.94	56.90	46.90	18.18	12.96	L
9	0.51577	19.15	10.08	9.90	29.05	19.98	56.00	46.00	26.95	26.02	L
10	0.78068	18.49	9.39	9.90	28.39	19.29	56.00	46.00	27.61	26.71	L
11	5.66740	6.35	0.77	10.11	16.46	10.88	60.00	50.00	43.54	39.12	L
12	11.80000	3.33	-2.47	10.28	13.61	7.81	60.00	50.00	46.39	42.19	L

APPENDIX I

Test set up diagrams

▪ Radiated Measurement

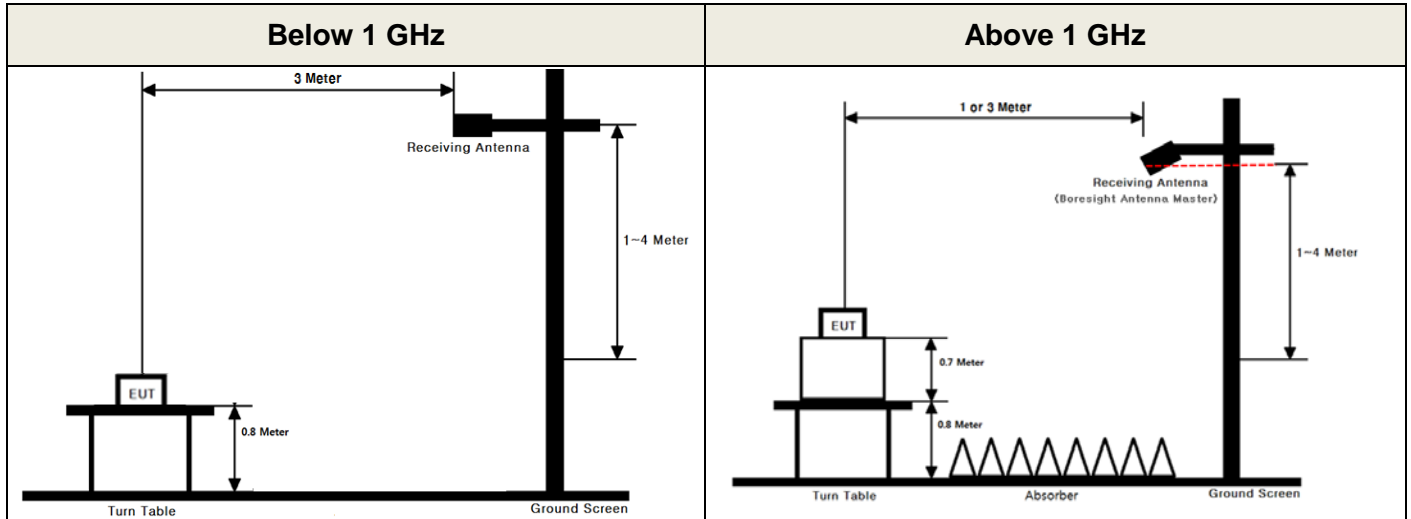

▪ Conducted Measurement

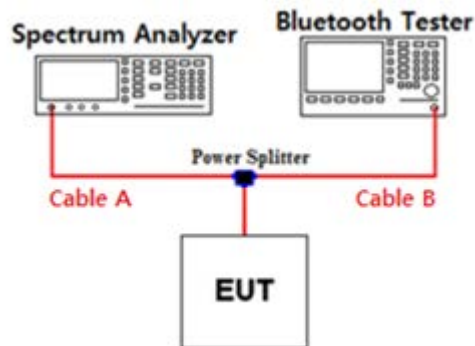

Path loss information

Frequency (GHz)	Path Loss (dB)	Frequency (GHz)	Path Loss (dB)
0.03	6.53	15	7.83
1	6.83	20	8.09
2.402 & 2.441 & 2.480	6.96	25	8.69
5	7.04	-	-
10	7.38	-	-

Note 1: The path loss from EUT to Spectrum analyzer was measured and used for test.
 Path loss (S/A's correction factor) = Cable A + Power Splitter

APPENDIX II

Unwanted Emissions (Radiated) Test Plot

TM1 & GFSK & Lowest & Y & Hor

Detector Mode : PK

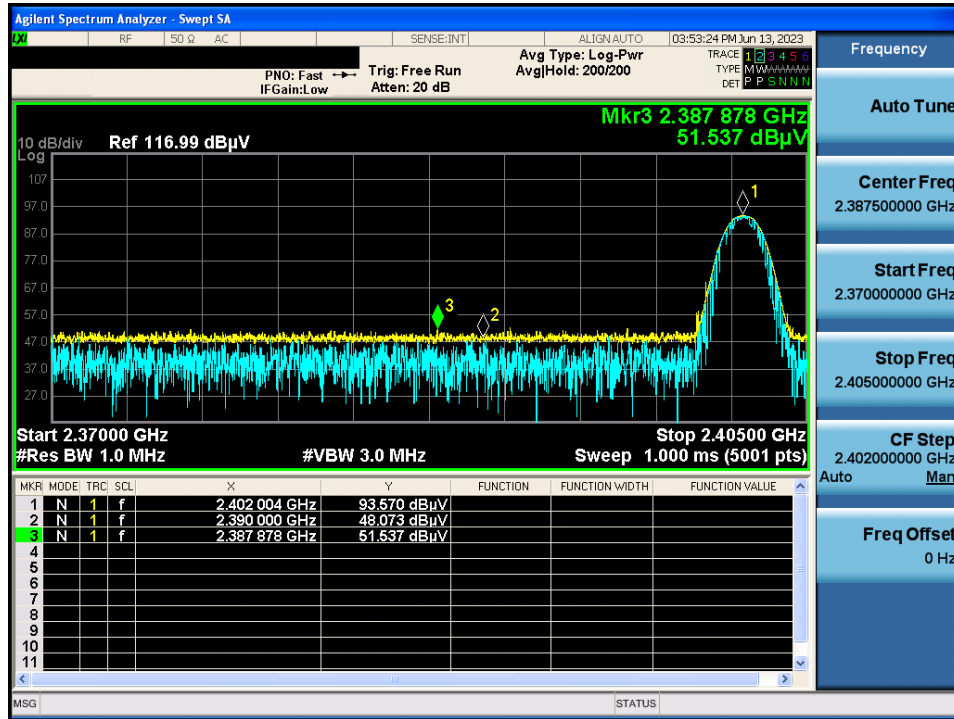

TM1 & GFSK & Highest & Y & Hor

Detector Mode : PK

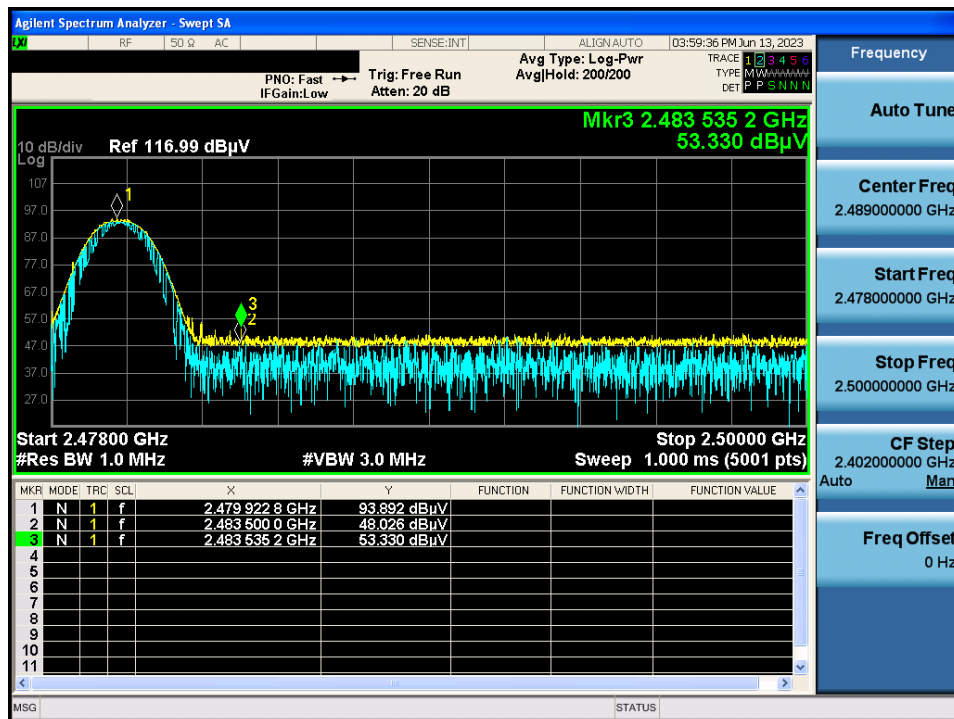

TM1 & $\pi/4$ DQPSK & Lowest & Y & Hor

Detector Mode : PK

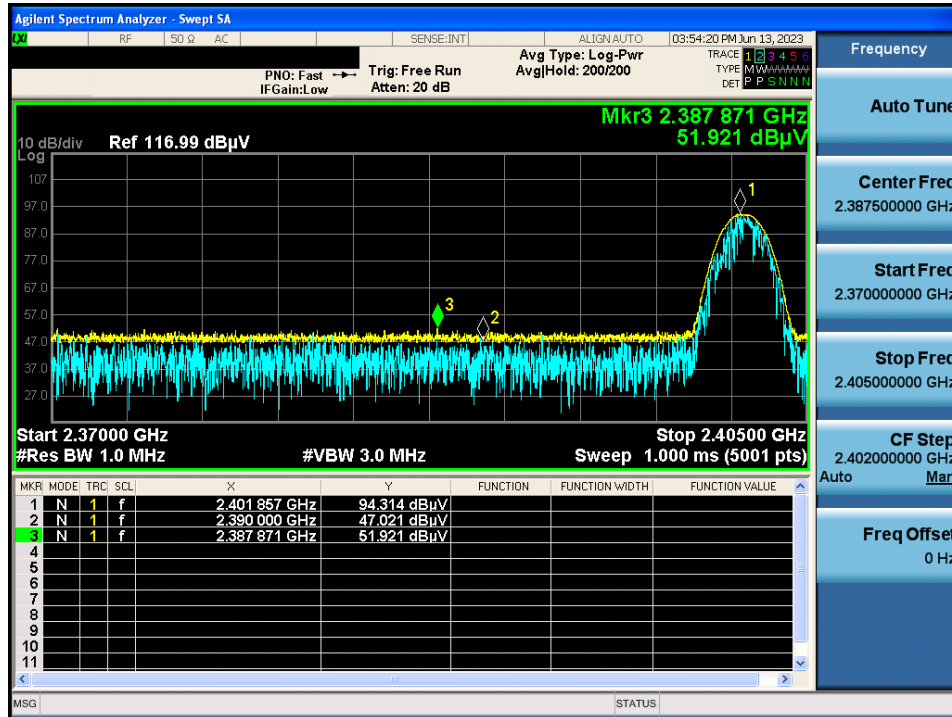

TM1 & $\pi/4$ DQPSK & Highest & Y & Hor

Detector Mode : PK

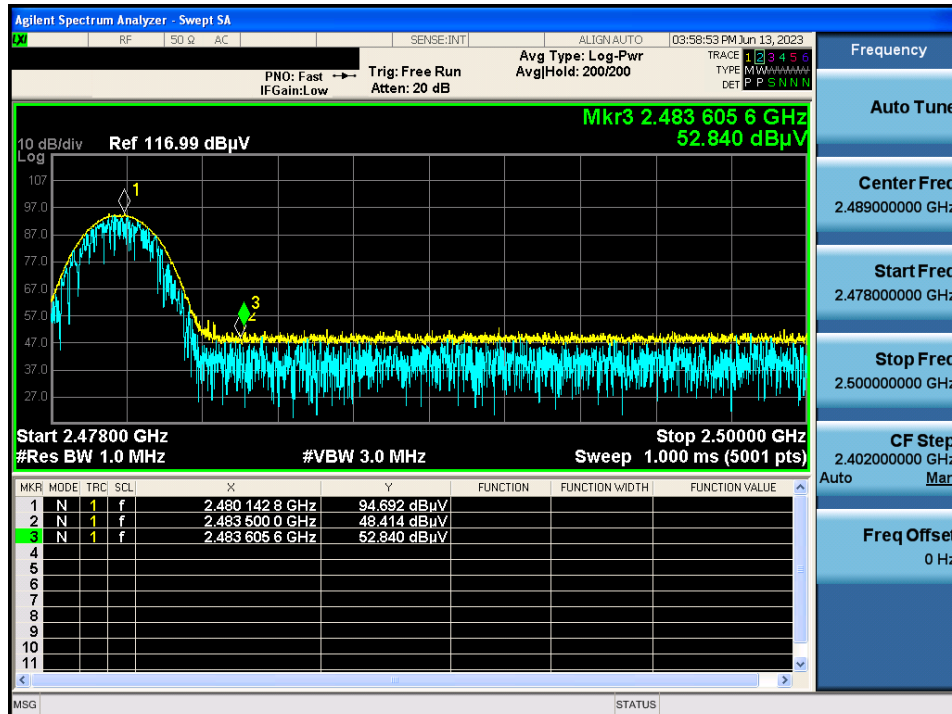

TM1 & 8DPSK & Lowest & Y & Hor

Detector Mode : PK

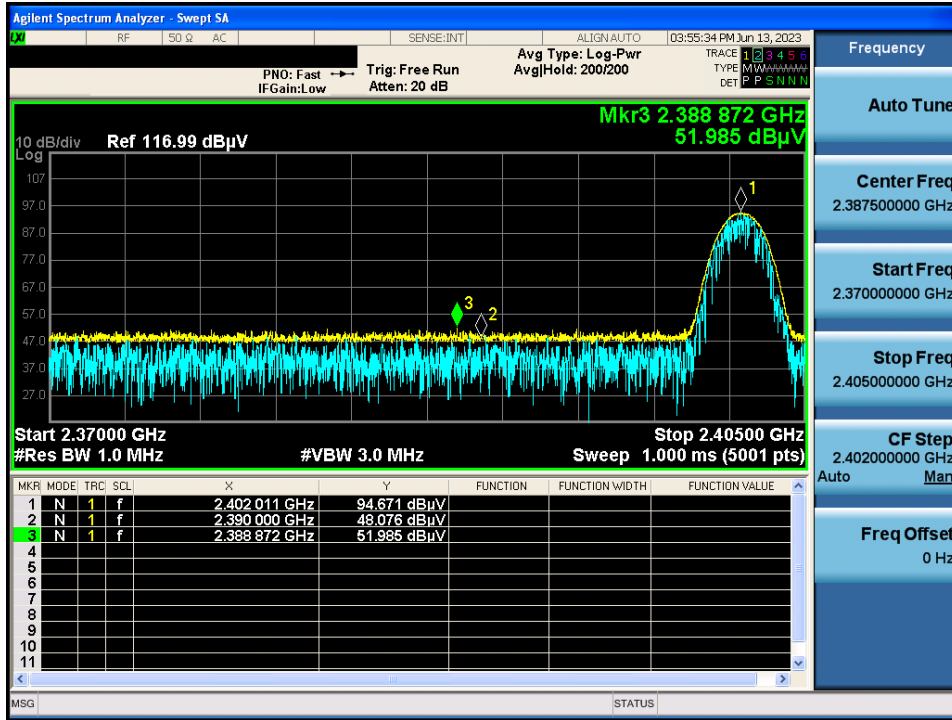

TM1 & 8DPSK & Highest & Y & Hor

Detector Mode : PK

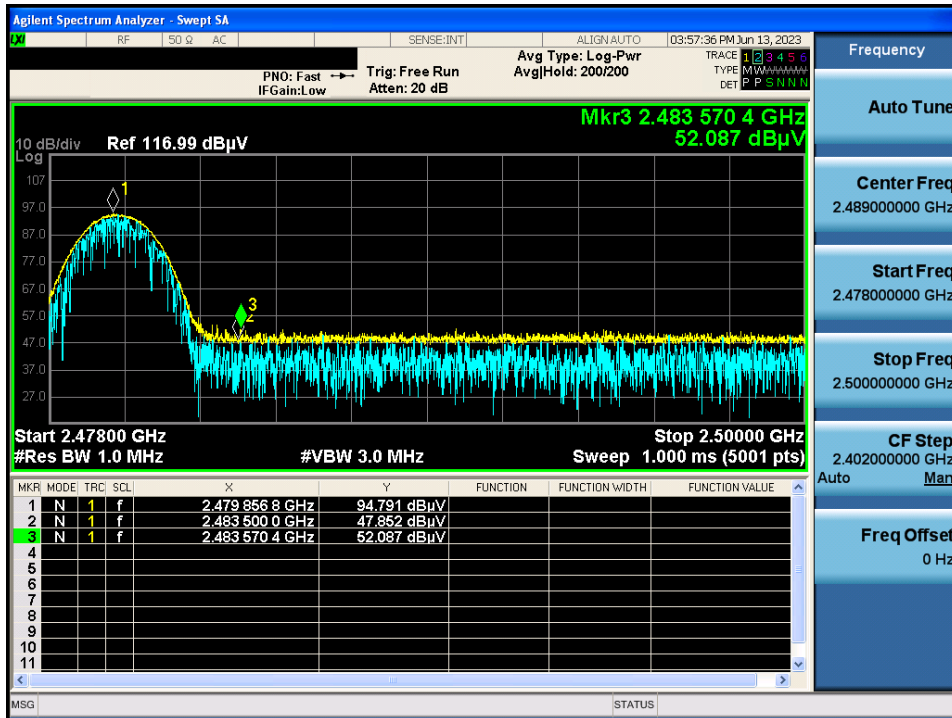

TM1 & GFSK & Middle & Y & Hor

Detector Mode : PK

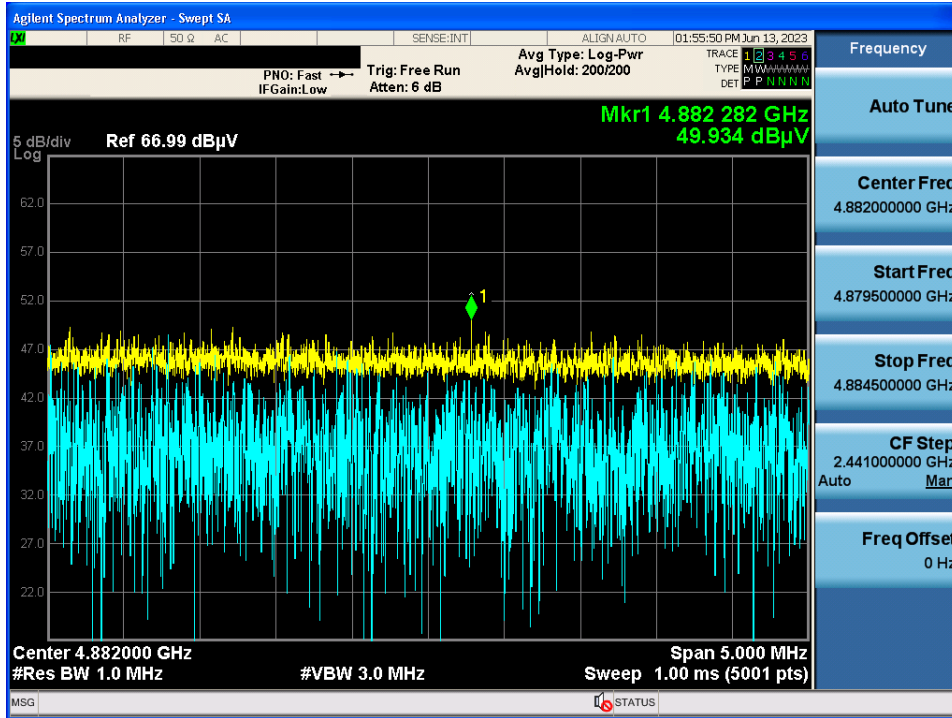

TM1 & π/4DQPSK & Highest & Y & Hor

Detector Mode : PK

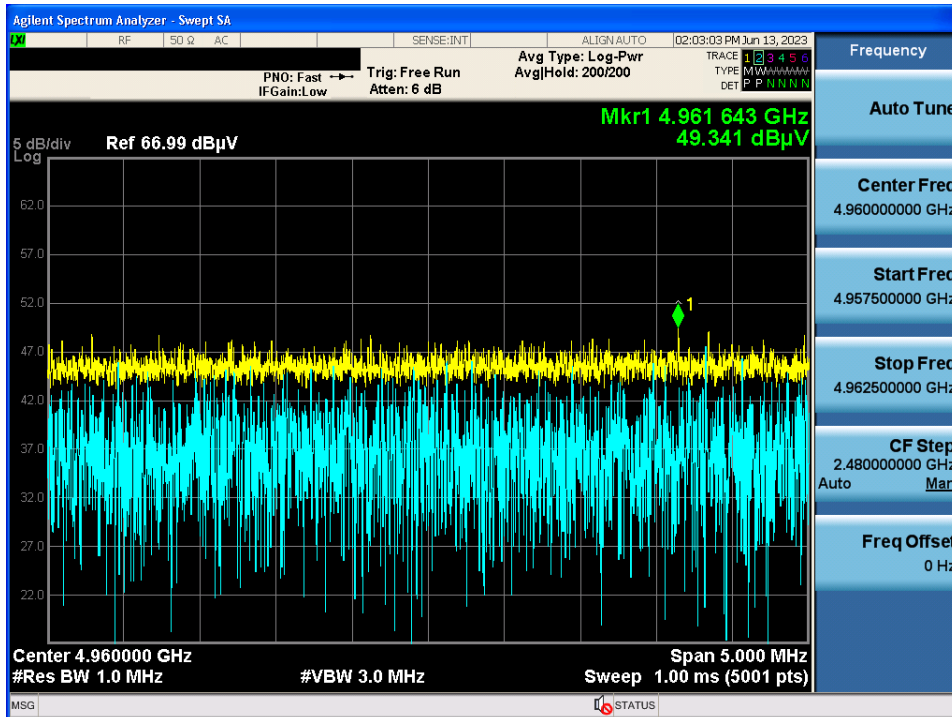

TM1 & 8DPSK & Highest & Y & Hor

Detector Mode : PK

