

TEST REPORT



Dt&C Co., Ltd.

42, Yurim-ro, 154Beon-gil, Cheoin-gu, Yongin-si, Gyeonggi-do, Korea, 17042
Tel : 031-321-2664, Fax : 031-321-1664

1. Report No : DRTFCC2402-0011

2. Customer

• Name : Point Mobile Co., LTD.

• Address : B-9F Kabul Great Valley, 32, Digital-ro 9-gil, Geumcheon-gu, Seoul, South Korea, 08512

3. Use of Report : FCC Original Grant

4. Product Name / Model Name : Mobile Computer / PM84

FCC ID : V2X-PM84

5. FCC Regulation(s): Part 2, 22, 90

Test Method Used : KDB971168 D01v03r01, ANSI C63.26-2015, ANSI/TIA-603-E-2016

6. Date of Test : 2023.11.13 ~ 2024.01.22

7. Location of Test : Permanent Testing Lab On Site Testing

8. Testing Environment : See appended test report.

9. Test Result : Refer to the attached test result.

The results shown in this test report refer only to the sample(s) tested unless otherwise stated.

This test report is not related to KOLAS accreditation.

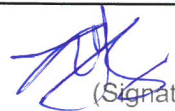
Affirmation	Tested by		Technical Manager	
	Name : SeokHo Han	 (Signature)	Name : JaeJin Lee	 (Signature)

2024 . 02 . 05 .

Dt&C Co., Ltd.

If this report is required to confirmation of authenticity, please contact to report@dtnc.net

Test Report Version

Test Report No.	Date	Description	Revised by	Reviewed by
DRTFCC2402-0011	Feb. 05, 2024	Initial issue	SeokHo Han	JaeJin Lee

Table of Contents

1. GENERAL INFORMATION	4
2. INTRODUCTION	5
2.1. EUT DESCRIPTION	5
2.2. TESTING ENVIRONMENT	5
2.3. MEASURING INSTRUMENT CALIBRATION.....	5
2.4. MEASUREMENT UNCERTAINTY	5
2.5. TEST FACILITY	5
3. DESCRIPTION OF TESTS.....	6
3.1. ERP & EIRP (Effective Radiated Power & Equivalent Isotropic Radiated Power)	6
3.2. OCCUPIED BANDWIDTH.....	8
3.3. BAND EDGE EMISSIONS AT ANTENNA TERMINAL	9
3.4. SPURIOUS AND HARMONIC EMISSIONS AT ANTENNA TERMINAL	10
3.5. EMISSION MASK.....	11
3.6. UNDESIRABLE EMISSIONS	12
3.7. FREQUENCY STABILITY	13
4. LIST OF TEST EQUIPMENT	14
5. SUMMARY OF TEST RESULTS.....	15
6. EMISSION DESIGNATOR AND SAMPLE CALCULATION	16
7. TEST DATA.....	17
7.1. CONDUCTED OUTPUT POWER	17
7.2. OCCUPIED BANDWIDTH	18
7.3. BAND EDEG EMISSIONS (Conducted).....	18
7.4. SPURIOUS AND HARMONICS EMISSIONS (Conducted)	18
7.5. ERP	19
7.6. UNDESIRABLE EMISSIONS (Radiated).....	20
7.7. FREQUENCY STABILITY	21
8. TEST PLOTS	22
8.1. OCCUPIED BANDWIDTH.....	22
8.2. PEAK TO AVERAGE RATIO	32
8.3. BAND EDGE EMISSIONS(Conducted).....	42
8.4. SPURIOUS AND HARMONICS EMISSIONS(Conducted)	47

1. GENERAL INFORMATION

FCC Classification	PCS Licensed Transmitter held to ear (PCE)
FCC ID	V2X-PM84
Product Name	Mobile Computer
Model Name	PM84
Add Model Name	-
FVIN(Firmware Version Identification Number)	84.01
EUT Serial Number	Conducted(23287A0055), Radiated(23287A0071)
Supplying power	DC 3.87 V
Antenna Information	Antenna Type: FPC Antenna Gain: -1.1 dBi (PK)

Mode	TX Frequency (MHz)	Emission Designator	Modulation	Conducted output power	
				Max power (dBm)	Max power (W)
LTE Band 26	821.5	13M4G7D	QPSK	22.75	0.188
LTE Band 26	821.5	13M4W7D	16QAM	21.87	0.154
LTE Band 26	821.5	13M4W7D	64QAM	20.75	0.119
LTE Band 26	819	8M93G7D	QPSK	22.90	0.195
LTE Band 26	819	8M92W7D	16QAM	21.87	0.154
LTE Band 26	819	8M94W7D	64QAM	20.84	0.121
LTE Band 26	816.5 ~ 821.5	4M47G7D	QPSK	22.84	0.192
LTE Band 26	816.5 ~ 821.5	4M47W7D	16QAM	21.95	0.157
LTE Band 26	816.5 ~ 821.5	4M47W7D	64QAM	20.79	0.120
LTE Band 26	815.5 ~ 822.5	2M69G7D	QPSK	22.93	0.196
LTE Band 26	815.5 ~ 822.5	2M68W7D	16QAM	22.05	0.160
LTE Band 26	815.5 ~ 822.5	2M68W7D	64QAM	20.91	0.123
LTE Band 26	814.7 ~ 823.3	1M08G7D	QPSK	22.75	0.188
LTE Band 26	814.7 ~ 823.3	1M08W7D	16QAM	21.87	0.154
LTE Band 26	814.7 ~ 823.3	1M08W7D	64QAM	20.75	0.119

2. INTRODUCTION

2.1. EUT DESCRIPTION

The Equipment Under Test (EUT) supports 850/1900 GSM, 850/1700/1900 WCDMA, Multi-band LTE, 802.11b/g/n WLAN(2.4GHz), 802.11a/n/ac WLAN(5GHz), Bluetooth(BDR, EDR, LE) and NFC.

2.2. TESTING ENVIRONMENT

Ambient Condition	
▪ Temperature	+20 °C ~ +22 °C
▪ Relative Humidity	39 % ~ 41 %

2.3. MEASURING INSTRUMENT CALIBRATION

The measuring equipment, which was utilized in performing the tests documented herein, has been calibrated in accordance with the manufacturer's recommendations for utilizing calibration equipment, which is traceable to recognized national standards.

2.4. MEASUREMENT UNCERTAINTY

The measurement uncertainties shown below were calculated in accordance with requirements of ANSI C 63.4-2014. All measurement uncertainty values are shown with a coverage factor of $k = 2$ to indicate a 95 % level of confidence.

Parameter	Measurement uncertainty
Radiated Disturbance (Below 1 GHz)	4.8 dB (The confidence level is about 95 %, $k = 2$)
Radiated Disturbance (1 GHz ~ 18 GHz)	5.0 dB (The confidence level is about 95 %, $k = 2$)
Radiated Disturbance (Above 18 GHz)	5.2 dB (The confidence level is about 95 %, $k = 2$)

2.5. TEST FACILITY

Dt&C Co., Ltd.	
The 3 m test site and conducted measurement facility used to collect the radiated data are located at the 42, Yurim-ro, 154beon-gil, Cheoin-gu, Yongin-si, Gyeonggi-do, Korea 17042.	
The test site complies with the requirements of Part 2.948 according to ANSI C63.4-2014.	
- FCC & IC MRA Designation No. : KR0034	
- ISED#: 5740A	
www.dtnc.net	
Telephone	: + 82-31-321-2664
FAX	: + 82-31-321-1664

3. DESCRIPTION OF TESTS

3.1. ERP & EIRP (Effective Radiated Power & Equivalent Isotropic Radiated Power)

Test Set-up

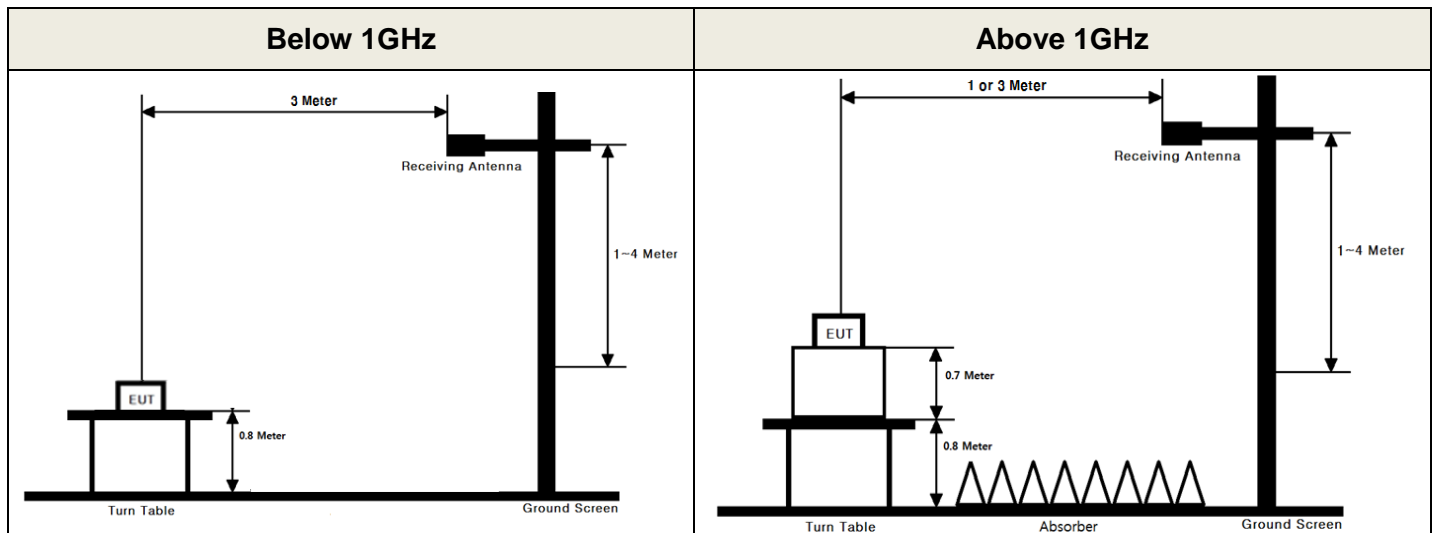

These measurements were performed at 3 m test site. The equipment under test is placed on a non-conductive table 0.8 or 1.5 meters above a turntable which is flush with the ground plane and 3 meters from the receive antenna. For measurements above 1GHz absorbers are placed on the floor between the turn table and the antenna mast in such a way so as to maximize the reduction of reflections. For measurements below 1 GHz, the absorbers are removed.

Test Procedure

- ANSI/TIA-603-E-2016 - Section 2.2.17
- KDB971168 D01v03 - Section 5.2.2
- ANSI C63.26-2015 – Section 5.2.4.4.1

Test setting

1. Set span to 2 x to 3 x the OBW.
2. Set RBW = 1 % to 5 % of the OBW.
3. Set VBW \geq 3 x RBW.
4. Set number of points in sweep \geq 2 x span / RBW.
5. Sweep time:
 - 1) Set = auto-couple, or
 - 2) Set \geq $[10 \times (\text{number of points in sweep}) \times (\text{transmission period})]$ for single sweep (automation-compatible) measurement. Transmission period is the on and off time of the transmitter.
6. Detector = power averaging (rms).
7. If the EUT can be configured to transmit continuously, then set the trigger to free run.
8. If the EUT cannot be configured to transmit continuously, then use a sweep trigger with the level set to enable triggering only on full power bursts and configure the EUT to transmit at full power for the entire duration of each sweep. Verify that the sweep time is less than or equal to the transmission burst duration. Time gating can also be used under similar constraints (i.e., configured such that measurement data is collected only during active full-power transmissions).

9. Trace average at least 100 traces in power averaging (rms) mode if sweep is set to auto-couple. To accurately determine the average power over multiple symbols, it can be necessary to increase the number of traces to be averaged above 100 or, if using a manually configured sweep time, increase the sweep time.
10. Compute the power by integrating the spectrum across the OBW of the signal using the instrument's band or channel power measurement function, with the band/channel limits set equal to the OBW band edges. If the instrument does not have a band or channel power function, then sum the spectrum levels (in linear power units) at intervals equal to the RBW extending across the entire OBW of the spectrum.

The receiver antenna height and turntable rotations were adjusted for the highest reading on the receive spectrum analyzer.

A half-wave dipole was substituted in place of the EUT. This dipole antenna was driven by a signal generator and the level of the signal generator was adjusted to obtain the same receive spectrum analyzer reading. The conducted power at the terminal of the substitute antenna is measured.

The ERP/EIRP is calculated using the following formula:

ERP/EIRP = The conducted power at the substitute antenna's terminal [dBm] + Substitute Antenna gain [dBd for ERP , dBi for EIRP]

For readings above 1 GHz, the above procedure is repeated using horn antennas and the difference between the gain of the horn antenna and an isotropic antenna are taken into consideration.

3.2. OCCUPIED BANDWIDTH

Test set-up

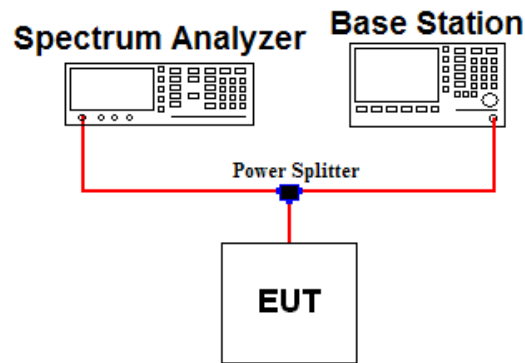

Test Procedure

- KDB971168 D01v03 - Section 4.3
- ANSI C63.26-2015 – Section 5.4.4

The occupied bandwidth, that is the frequency bandwidth such that, below its lower and above its upper frequency limits, the mean powers radiated are each equal to 0.5 percent of the total mean power of a given emission.

Test setting

1. The signal analyzer's automatic bandwidth measurement capability was used to perform the 99 % occupied bandwidth and the 26 dB bandwidth. The bandwidth measurement was not influenced by any intermediate power nulls in the fundamental emission.
2. $RBW = 1 \% \sim 5 \%$ of the expected OBW & $VBW \geq 3 \times RBW$
3. Detector = Peak
4. Trance mode = Max hold
5. Sweep = Auto couple
6. The trace was allowed to stabilize
7. If necessary, step 2 ~ 6 were repeated after changing the RBW such that it would be within 1 % ~ 5 % of the 99 % occupied bandwidth observed in step 6.

3.3. BAND EDGE EMISSIONS AT ANTENNA TERMINAL

Test set-up

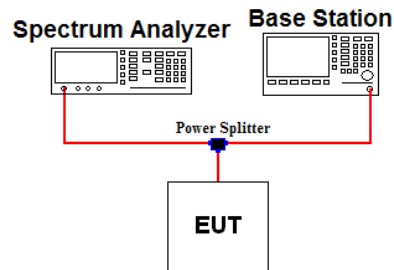

Test Procedure

- KDB971168 D01v03 - Section 6, KDB971168D02v02 - Section 8
- ANSI C63.26-2015 – Section 5.7

All out of band emissions are measured by means of a calibrated spectrum analyzer. Out-of-band emission requirement shall apply only to the “outer” channels included in an EA license and to spectrum adjacent to interior channels used by incumbent licensees. The EUT was setup to maximum output power at its lowest and highest channel with all bandwidths, modulations and RB configurations.

For any frequency removed from the EA licensee's frequency block by up to and including 37.5 kHz, the power of any emission shall be attenuated below the transmitter power (P) in watts by at least $116 \log_{10}(f/6.1)$ decibels or $50 + 10 \log_{10}(P)$ decibels or 80 decibels, whichever is the lesser attenuation, where f is the frequency removed from the center of the outer channel in the block in kilohertz and where f is greater than 12.5 kHz.

Section 90.691(a) compliance testing, use RBW = 300 Hz for offsets less than 37.5 kHz from a channel edge; RBW = 100 kHz for offsets greater than 37.5 kHz is allowed.

Test setting

1. Span was set large enough so as to capture all out of band emissions near the band edge
2. RBW = 300 Hz & VBW $\geq 3 \times$ RBW (less than 37.5 kHz from a channel edge)
RBW = 100 KHz & VBW $\geq 3 \times$ RBW (greater than 37.5 kHz from a channel edge)
3. Detector = RMS & Trace mode = Average
4. Sweep time = Auto couple
5. The trace was allowed to stabilize

3.4. SPURIOUS AND HARMONIC EMISSIONS AT ANTENNA TERMINAL

Test set-up

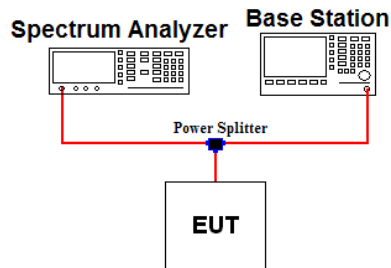

Test Procedure

- KDB971168 D01v03 - Section 6
- ANSI C63.26-2015 – Section 5.7

The level of the carrier and the various conducted spurious and harmonic frequencies is measured by means of a calibrated spectrum analyzer. The EUT was setup to maximum output power at its low, middle, high channel with all bandwidths, modulations and RB configurations. The spectrum is scanned from 9 kHz up to a frequency including its 10th harmonic.

The power of any spurious emission shall be attenuated below the transmitter power (P) by at least $43 + 10 \log(P)$ dB.

Test setting

1. RBW = 100 kHz(Below 1 GHz) or 1 MHz(Above 1 GHz) & VBW $\geq 3 \times$ RBW (Refer to Note 1)
2. Detector = RMS & Trace mode = Max hold
3. Sweep time = Auto couple
4. Number of sweep point $\geq 2 \times$ span / RBW
5. The trace was allowed to stabilize

Note 1: Compliance with these provisions is based on the use of measurement instrumentation employing a resolution bandwidth of 100 kHz or greater for frequencies less than 1GHz and 1MHz or greater for frequencies greater than 1 GHz.

3.5. EMISSION MASK

Test set-up

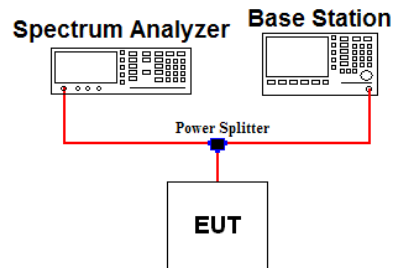

Test Procedure

- KDB971168 D01v03 - Section 6
- ANSI C63.26-2015 – Section 5.7

The level of the carrier and the various conducted spurious and harmonic frequencies is measured by means of a calibrated spectrum analyzer. The EUT was setup to maximum output power at its low, middle, high channel with all bandwidths, modulations and RB configurations.

Transmitters used in the radio services by Part 90 must comply with the emission masks.

Test setting

6. RBW = 100 kHz(Below 1 GHz) or 1 MHz(Above 1 GHz) & VBW $\geq 3 \times$ RBW (Refer to Note 1)
7. Detector = RMS & Trace mode = Max hold
8. Sweep time = Auto couple
9. Number of sweep point $\geq 2 \times$ span / RBW
10. The trace was allowed to stabilize

Note 1: Compliance with these provisions is based on the use of measurement instrumentation employing a resolution bandwidth of 100 kHz or greater for frequencies less than 1GHz and 1MHz or greater for frequencies greater than 1 GHz.

3.6. UNDESIRABLE EMISSIONS

Test Set-up

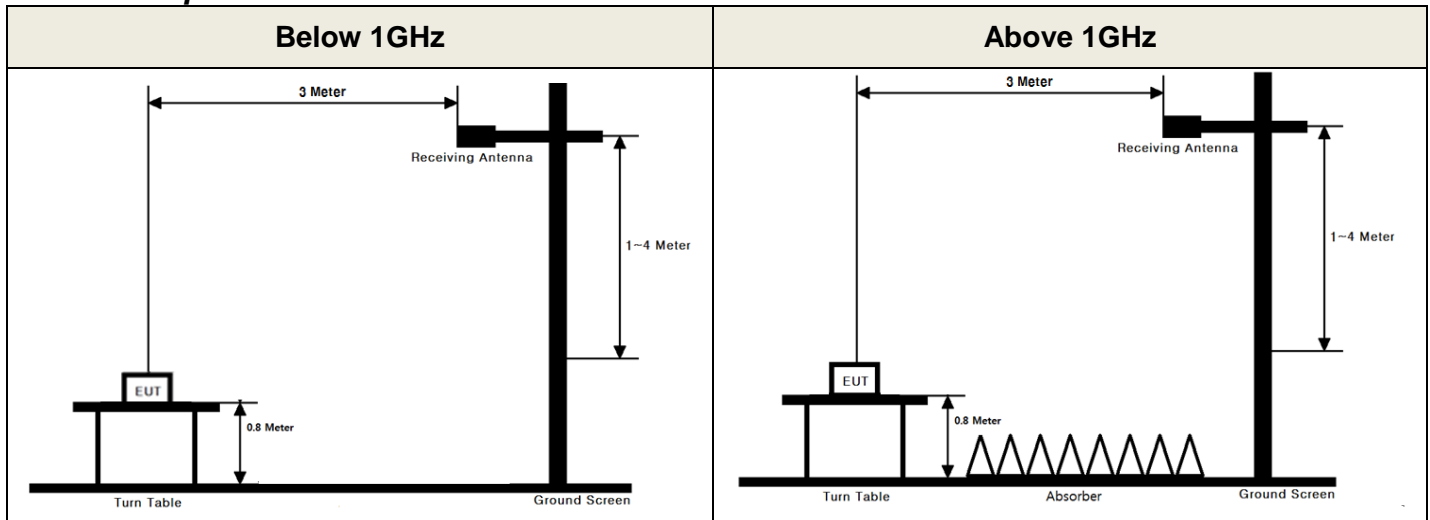

These measurements were performed at 3 test site. The equipment under test is placed on a non-conductive table 0.8 or 1.5 meters above a turntable which is flush with the ground plane and 3 meters from the receive antenna. For measurements above 1GHz absorbers are placed on the floor between the turn table and the antenna mast in such a way so as to maximize the reduction of reflections. For measurements below 1 GHz, the absorbers are removed.

Test Procedure

- ANSI/TIA-603-E-2016 - Section 2.2.12
- KDB971168 D01v03 - Section 5.8
- ANSI C63.26-2015 – Section 5.5

Test setting

1. RBW = 100 kHz for below 1 GHz and 1 MHz for above 1 GHz / VBW \geq 3 X RBW
2. Detector = RMS & Trace mode = Average
3. Sweep time = Auto couple
4. Number of sweep point \geq 2 X span / RBW
5. The trace was allowed to stabilize

The receive antenna height and turntable rotations were adjusted for the highest reading on the receive spectrum analyzer.

For radiated power measurements below 1 GHz, a half-wave dipole was substituted in place of the EUT. This dipole antenna was driven by a signal generator and the level of the signal generator was adjusted to obtain the same spectrum analyzer reading.

For radiated power measurements above 1 GHz, a Horn antenna was substituted in place of the EUT. This Horn antenna was driven by a signal generator and the level of the signal generator was adjusted to obtain the same spectrum analyzer reading. The difference between the gain of the horn and an isotropic antenna are taken into consideration.

4. LIST OF TEST EQUIPMENT

Type	Manufacturer	Model	Cal.Date (yy/mm/dd)	Next.Cal. Date (yy/mm/dd)	S/N
Spectrum Analyzer	Agilent Technologies	N9020A	23/12/15	24/12/15	MY50110097
Spectrum Analyzer	Agilent Technologies	N9020A	23/12/15	24/12/15	MY48011700
Spectrum Analyzer	Agilent Technologies	N9020A	23/12/15	24/12/15	MY50410163
DC power supply	Agilent Technologies	66332A	23/06/23	24/06/23	US37474125
Multimeter	FLUKE	17B+	23/12/15	24/12/15	36390701WS
Power Splitter	Anritsu	K241B	23/06/23	24/06/23	020611
Temp & Humi	ESPEC	SU-261	23/06/23	24/06/23	92006578
Radio Communication Analyzer	Anritsu	MT8820C	23/06/23	24/06/23	6200951873
Thermohygrometer	BODYCOM	BJ5478	23/12/15	24/12/15	120612-1
Thermohygrometer	BODYCOM	BJ5478	23/12/15	24/12/15	120612-2
Signal Generator	Rohde Schwarz	SMBV100A	23/12/15	24/12/15	255571
Signal Generator	ANRITSU	MG3695C	23/12/15	24/12/15	173501
Loop Antenna	ETS-Lindgren	6502	22/04/22	24/04/22	203480
Bilog Antenna	Schwarzbeck	VULB 9160	23/12/15	24/12/15	3362
Dipole Antenna	Schwarzbeck	UHA 9105	22/12/16	24/12/16	2262
HORN ANT	ETS	3117	23/12/15	24/12/15	00140394
HORN ANT	A.H.Systems	SAS-574	23/06/23	24/06/23	155
PreAmplifier	H.P	8447D	23/12/15	24/12/15	2944A07774
PreAmplifier	Agilent	8449B	23/12/15	24/12/15	3008A02108
PreAmplifier	A.H.Systems Inc.	PAM-1840VH	23/06/23	24/06/23	163
High-pass filter	Wainwright	WHKX12-935-1000-15000-40SS	23/12/15	24/12/15	7
High-pass filter	Wainwright	WHKX10-2838-3300-18000-60SS	23/12/15	24/12/15	2
High-pass filter	Wainwright	WHKX6-6320-8000-26500-40CC	23/12/15	24/12/15	2
Cable	HUBER+SUHNER	SUCOFLEX100	24/01/03	25/01/03	M-1
Cable	HUBER+SUHNER	SUCOFLEX100	24/01/03	25/01/03	M-2
Cable	Junkosah	MWX241/B	24/01/03	25/01/03	M-3
Cable	Junkosah	MWX221	24/01/03	25/01/03	M-4
Cable	Junkosah	MWX221	24/01/03	25/01/03	M-5
Cable	DTNC	Cable	24/01/03	25/01/03	M-6
Cable	JUNFLON	J12J101757-00	24/01/03	25/01/03	M-7
Cable	HUBER+SUHNER	SUCOFLEX104	24/01/03	25/01/03	M-8
Cable	HUBER+SUHNER	SUCOFLEX106	24/01/03	25/01/03	M-9
Cable	Junkosha	MWX342	24/01/03	25/01/03	RFC-72

Note1: The measurement antennas were calibrated in accordance to the requirements of ANSI C63.5-2017.

Note2: The cable is not a regular calibration item, so it has been calibrated by Dt&C itself.

5. SUMMARY OF TEST RESULTS

FCC Part Section(s)	Test Description	Test Limit	Test Condition	Status <small>Note 1</small>
2.1046 90.635	Conducted Output Power	< 100 Watts	Conducted	C
2.1049	Occupied Bandwidth	N/A		C
2.1051 90.691	Band Edge / Conducted Spurious Emissions	> 43 + 10log ₁₀ (P) dB for all out-of-band emissions except > 50 + 10log ₁₀ (P) dB at Band Edge and for all out-of-band emissions within 37.5kHz of Block Edge		C
2.1055 90.213	Frequency Stability	< 2.5 ppm		C
22.913(a.5)	Radiated Output Power	< 7 Watts max. ERP	Radiated	C
2.1053 90.691	Undesirable Emissions	> 43 + 10log ₁₀ (P) dB for all out-of-band emissions except > 50 + 10log ₁₀ (P) dB at Band Edge and for all out-of-band emissions within 37.5kHz of Block Edge		C

Note 1: **C**=Comply **NC**=Not Comply **NT**=Not Tested **NA**=Not Applicable

Note 2: This radiated test items were performed in three orthogonal EUT positions and the worst case data was reported.

6. EMISSION DESIGNATOR AND SAMPLE CALCULATION

A. Emission Designator

LTE Band 26(QPSK)

Emission Designator = **13M4G7D**
 LTE OBW = 13.424 MHz
 G = Phase Modulation
 7 = Quantized/Digital Info
 D = Data Transmission

LTE Band 26(16QAM)

Emission Designator = **13M4W7D**
 LTE OBW = 13.366 MHz
 W = Amplitude/Angle Modulated
 7 = Quantized/Digital Info
 D = Data Transmission

LTE Band 26(64QAM)

Emission Designator = **13M4W7D**
 LTE OBW = 13.382 MHz
 W = Amplitude/Angle Modulated
 7 = Quantized/Digital Info
 D = Data Transmission

B. For substitution method

- 1) The EUT was placed on a turntable with 0.8 meter height for frequency below 1GHz and 1.5 meter height for frequency above 1 GHz respectively above ground.
- 2) The EUT was set 3 meters from the receiving antenna mounted on the antenna tower.
- 3) During the test, the turn table is rotated until the maximum signal is found.
- 4) Record the field strength meter's level. (ex. Spectrum reading level is -8.5 dBm)
- 5) Replace the EUT with dipole/Horn antenna that is connected to a calibrated signal generator.
- 6) Increase the signal generator output till the field strength meter's level is equal to the item (4). (ex. Signal generator level is -18.04 dBm)
- 7) The gain of the cable and amplifier between the signal generator and terminals of substituted antenna is 46.92 dB at test frequency.
- 8) Record the level at substituted antenna terminal. (ex. 28.88dBm)
- 9) The result is calculated as below;

$$\underline{\text{EIRP(dBm)} = \text{LEVLE@ANTENNA TERMINAL} + \text{TX Antenna Gain (dBi)}}$$

$$\underline{\text{ERP(dBm)} = \text{LEVLE@ANTENNA TERMINAL} + \text{TX Antenna Gain (dBd)}}$$

Where, TX Antenna Gain (dBd) = TX Antenna Gain (dBi) - 2.15 dB

7. TEST DATA

7.1. CONDUCTED OUTPUT POWER

- Test Notes

- 1) This is device was tested under all bandwidths, modulations and RB configurations and the worst case data are reported in the below table.

Channel Bandwidth (MHz)	Test Frequency (MHz)	Test Mode	Conducted Output power (dBm)	Conducted Output power (W)
15	821.5	QPSK	22.75	0.188
		16QAM	21.87	0.154
		64QAM	20.75	0.119
10	819	QPSK	22.90	0.195
		16QAM	21.87	0.154
		64QAM	20.84	0.121
5	816.5	QPSK	22.79	0.190
		16QAM	21.82	0.152
		64QAM	20.78	0.120
	821.5	QPSK	22.84	0.192
		16QAM	21.95	0.157
		64QAM	20.79	0.120
3	815.5	QPSK	22.80	0.191
		16QAM	21.87	0.154
		64QAM	20.78	0.120
	819	QPSK	22.93	0.196
		16QAM	22.05	0.160
		64QAM	20.91	0.123
	822.5	QPSK	22.82	0.191
		16QAM	21.93	0.156
		64QAM	20.82	0.121
1.4	814.7	QPSK	22.87	0.194
		16QAM	21.95	0.157
		64QAM	20.97	0.125
	819	QPSK	22.98	0.199
		16QAM	22.04	0.160
		64QAM	21.09	0.129
	823.3	QPSK	22.92	0.196
		16QAM	21.94	0.156
		64QAM	21.02	0.126

7.2. OCCUPIED BANDWIDTH

- Plots of the EUT's Occupied Bandwidth are shown in Clause 8.1

7.3. BAND EDGE EMISSIONS (Conducted)

- Plots of the EUT's Band Edge Emissions are shown in Clause 8.2

7.4. SPURIOUS AND HARMONICS EMISSIONS (Conducted)

- Plots of the EUT's Spurious Emissions are shown in Clause 8.3

7.5. ERP

- Test Notes

This device was tested under all bandwidths, modulations and RB configurations and the worst case data are reported in the table above.

- Measurement data:

Channel Bandwidth (MHz)	Tx Freq. (MHz)	Test Mode	RB Size/ Offset	Ant Pol (H/V)	Level at Antenna Terminal(dBm)	Substitute Antenna Gain(dBd)	ERP (dBm)	ERP (W)
15	821.5	QPSK	1/37	H	22.17	-1.42	20.75	0.119
		16QAM	1/37	H	21.29	-1.42	19.87	0.097
		64QAM	1/37	H	20.38	-1.42	18.96	0.079
10	819	QPSK	1/25	H	21.82	-1.42	20.40	0.110
		16QAM	1/25	H	21.12	-1.42	19.70	0.093
		64QAM	1/25	H	19.99	-1.42	18.57	0.072
5	816.5	QPSK	1/24	H	21.68	-1.42	20.26	0.106
		16QAM	1/24	H	20.66	-1.42	19.24	0.084
		64QAM	1/24	H	19.97	-1.42	18.55	0.072
	821.5	QPSK	1/12	H	21.98	-1.42	20.56	0.114
		16QAM	1/12	H	21.16	-1.42	19.74	0.094
		64QAM	1/12	H	20.15	-1.42	18.73	0.075
3	815.5	QPSK	1/7	H	21.38	-1.42	19.96	0.099
		16QAM	1/7	H	20.52	-1.42	19.10	0.081
		64QAM	1/7	H	19.58	-1.42	18.16	0.065
	819	QPSK	1/7	H	21.75	-1.42	20.33	0.108
		16QAM	1/7	H	20.99	-1.42	19.57	0.091
		64QAM	1/7	H	19.91	-1.42	18.49	0.071
	822.5	QPSK	1/7	H	21.97	-1.42	20.55	0.114
		16QAM	1/7	H	21.21	-1.42	19.79	0.095
		64QAM	1/7	H	19.96	-1.42	18.54	0.071
1.4	814.7	QPSK	1/2	H	21.25	-1.41	19.84	0.096
		16QAM	1/2	H	20.41	-1.41	19.00	0.079
		64QAM	1/2	H	19.47	-1.41	18.06	0.064
	819	QPSK	1/2	H	21.88	-1.42	20.46	0.111
		16QAM	1/2	H	21.11	-1.42	19.69	0.093
		64QAM	1/2	H	20.19	-1.42	18.77	0.075
	823.3	QPSK	1/2	H	21.91	-1.42	20.49	0.112
		16QAM	1/2	H	21.14	-1.42	19.72	0.094
		64QAM	1/2	H	20.04	-1.42	18.62	0.073

7.6. UNDESIRABLE EMISSIONS (Radiated)

- Test Notes

1. Limit Calculation = $43 + 10\log_{10}(P[\text{Watts}])$
2. The frequency spectrum is examined from 9 kHz to the 10th harmonic of the fundamental frequency of the transmitter. No other spurious and harmonic emissions were reported greater than listed emissions above table.
3. All mode and RB configuration were investigated and the worst case data are reported.

- Measurement data:

Channel Bandwidth (MHz)	Test Freq. (MHz)	RB Size/ Offset	Test Mode	Freq.(MHz)	Ant Pol (H/V)	Level at Antenna Terminal(dBm)	Substitute Antenna Gain(dBd)	Result (dBm)	Limit (dBm)	Margin (dB)
15	821.5	1/37	QPSK	1 643.04	H	-61.17	4.09	-57.08	-13.00	44.08
				2 464.54	H	-64.89	3.79	-61.10	-13.00	48.10
				3 285.49	H	-67.74	5.56	-62.18	-13.00	49.18
				4 106.87	H	-69.47	7.10	-62.37	-13.00	49.37

7.7. FREQUENCY STABILITY

- Test Notes

Based on the results of the frequency stability test at the center channel the frequency deviation results measured are very small. As such it is determined that the channels at the band edge would remain in-band when the maximum measured frequency deviation noted during the frequency stability tests is applied. Therefore the device is determined to remain operating in band over the temperature and voltage range as tested.

OPERATING FREQUENCY : 819.00 MHz
 REFERENCE VOLTAGE : 3.87 V DC
 LIMIT : 2.5 ppm

VOLTAGE (%)	POWER (V DC)	TEMP (°C)	FREQ (Hz)	Deviation	
				(%)	(ppm)
100 %	3.87	+20	818,999,993	-0.0000009	-0.009
100 %		-30	818,999,989	-0.0000013	-0.013
100 %		-20	818,999,991	-0.0000011	-0.011
100 %		-10	818,999,987	-0.0000016	-0.016
100 %		0	818,999,990	-0.0000012	-0.012
100 %		+10	818,999,995	-0.0000006	-0.006
100 %		+20	818,999,993	-0.0000009	-0.009
100 %		+30	818,999,992	-0.0000010	-0.010
100 %		+40	818,999,990	-0.0000012	-0.012
100 %		+50	818,999,996	-0.0000005	-0.005
115 %		4.43	+20	818,999,988	-0.0000015
BATT.ENDPOINT	3.55	+20	818,999,994	-0.0000007	-0.007

8. TEST PLOTS

8.1. OCCUPIED BANDWIDTH

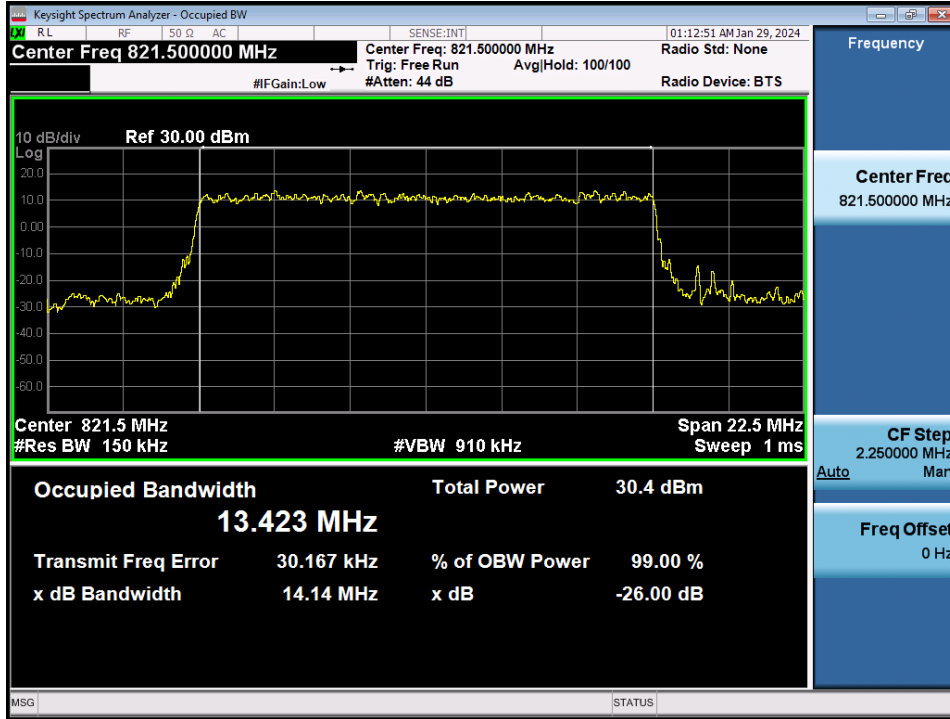

LTE Band 26 / 15 MHz / QPSK - RB Size 75

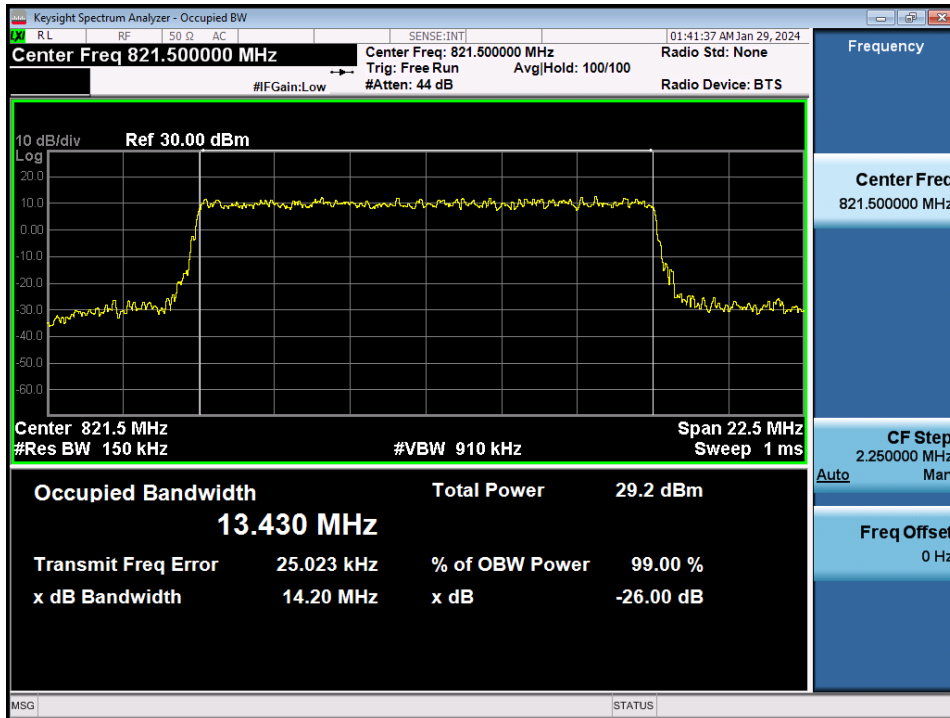

LTE Band 26 / 15 MHz / 16QAM - RB Size 75

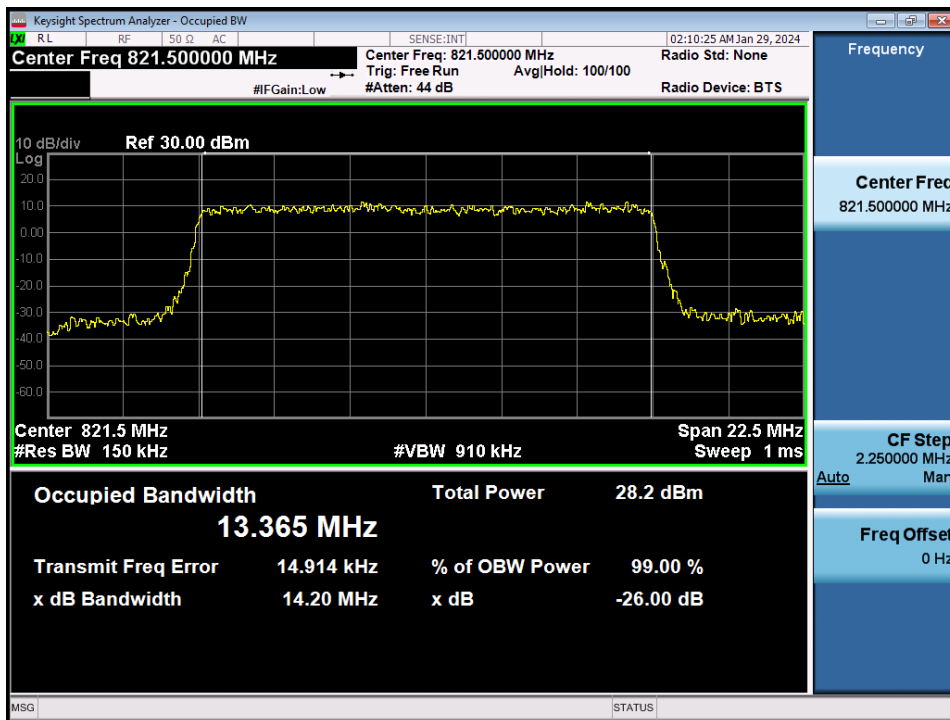

LTE Band 26 / 15 MHz / 64QAM - RB Size 75

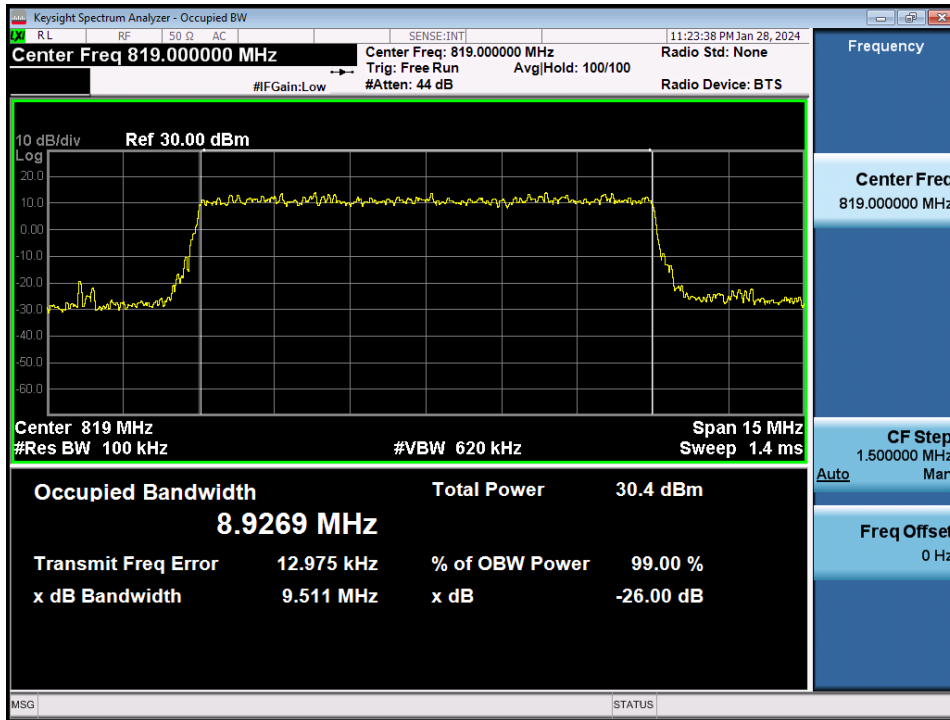

LTE Band 26 / 10 MHz / QPSK - RB Size 50

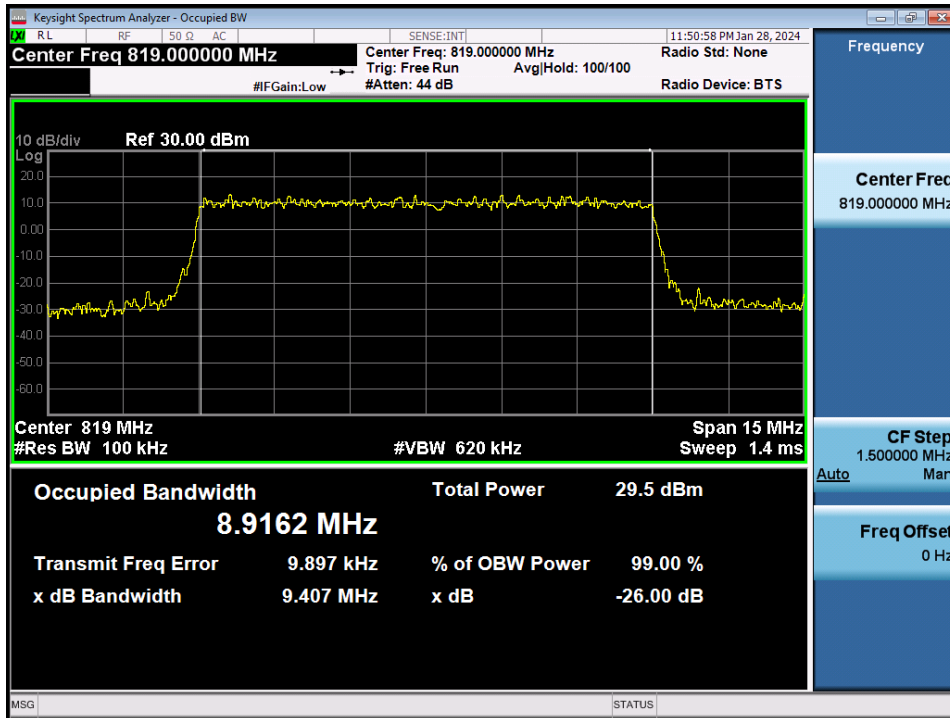

LTE Band 26 / 10 MHz / 16QAM - RB Size 50

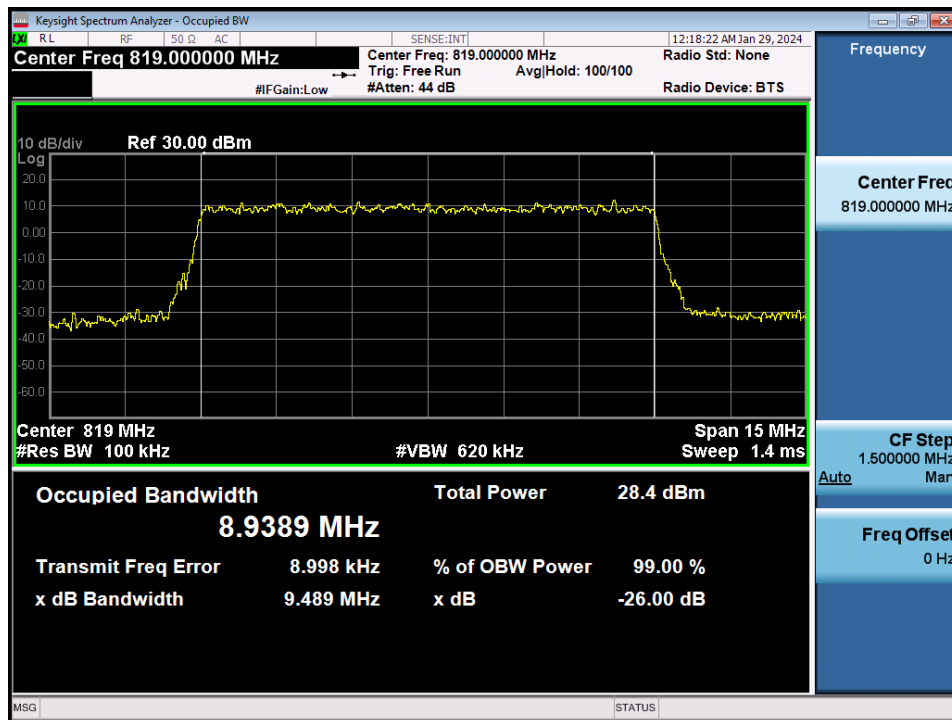

LTE Band 26 / 10 MHz / 64QAM - RB Size 50

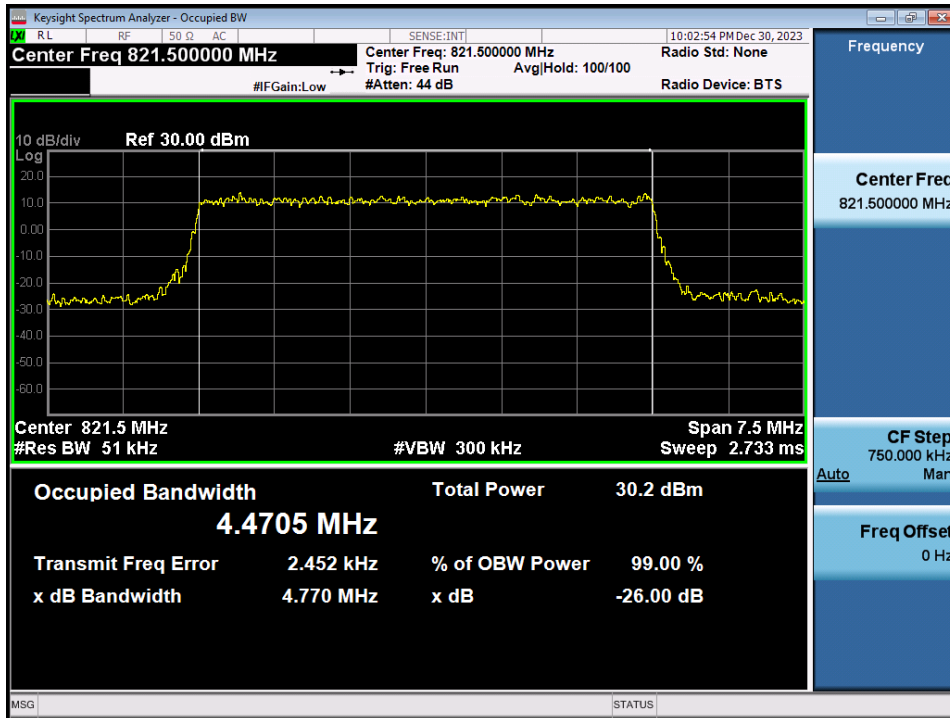

LTE Band 26 / 5 MHz / QPSK - RB Size 25

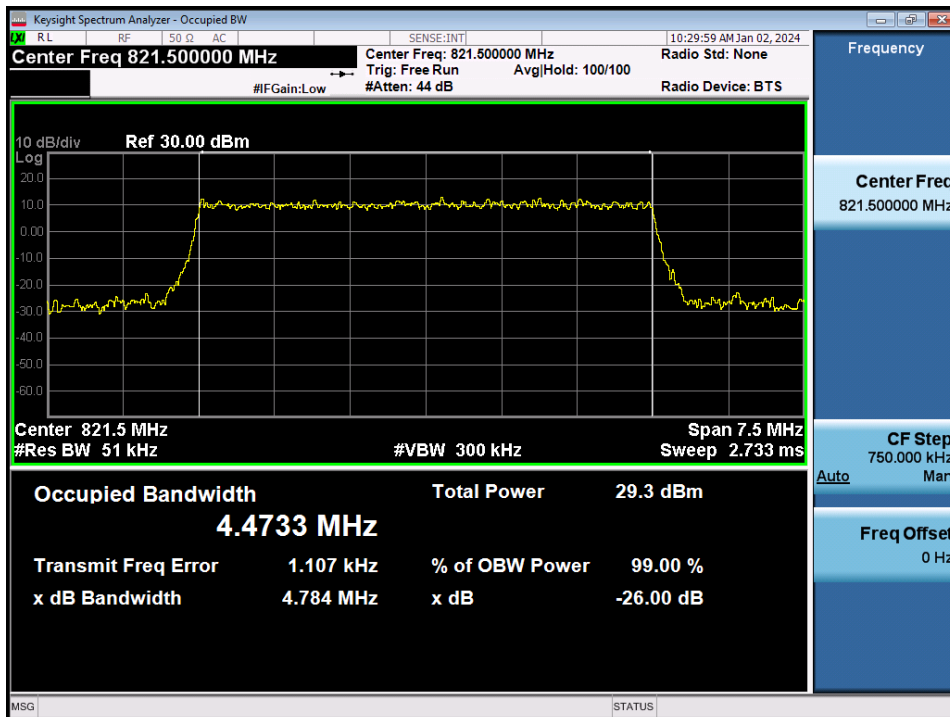

LTE Band 26 / 5 MHz / 16QAM - RB Size 25

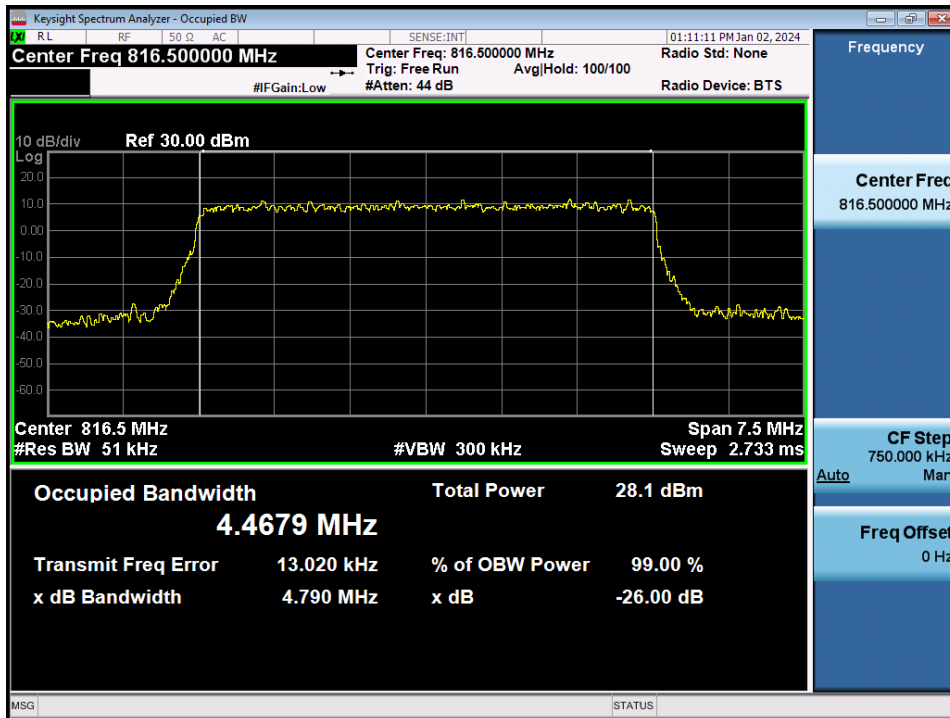

LTE Band 26 / 5 MHz / 64QAM - RB Size 25

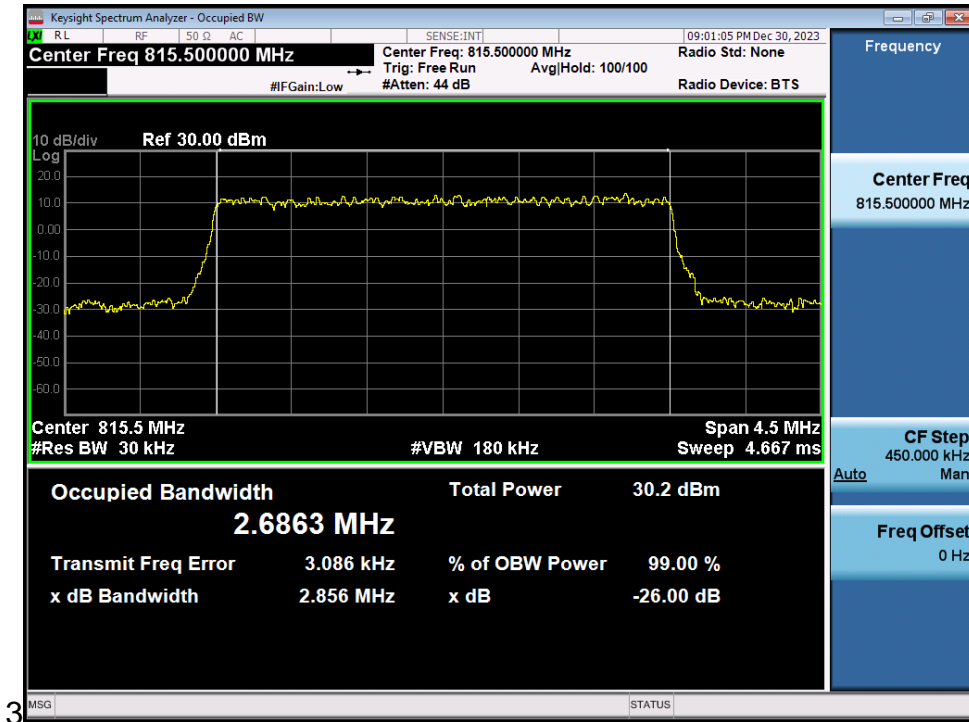

LTE Band 26 / 3 MHz / QPSK - RB Size 15

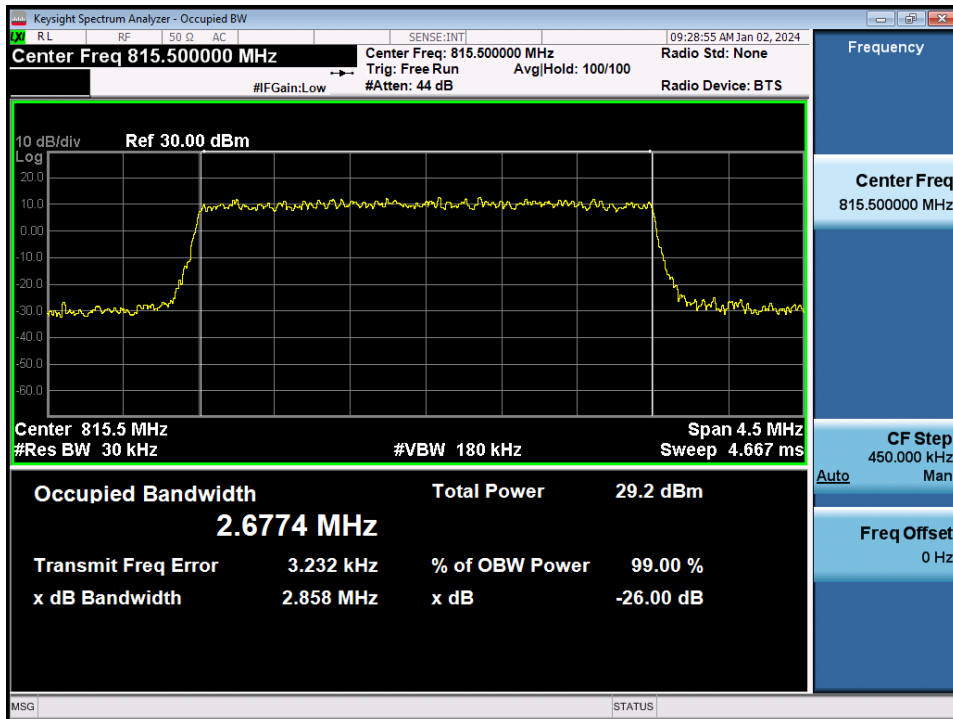

LTE Band 26 / 3 MHz / 16QAM - RB Size 15

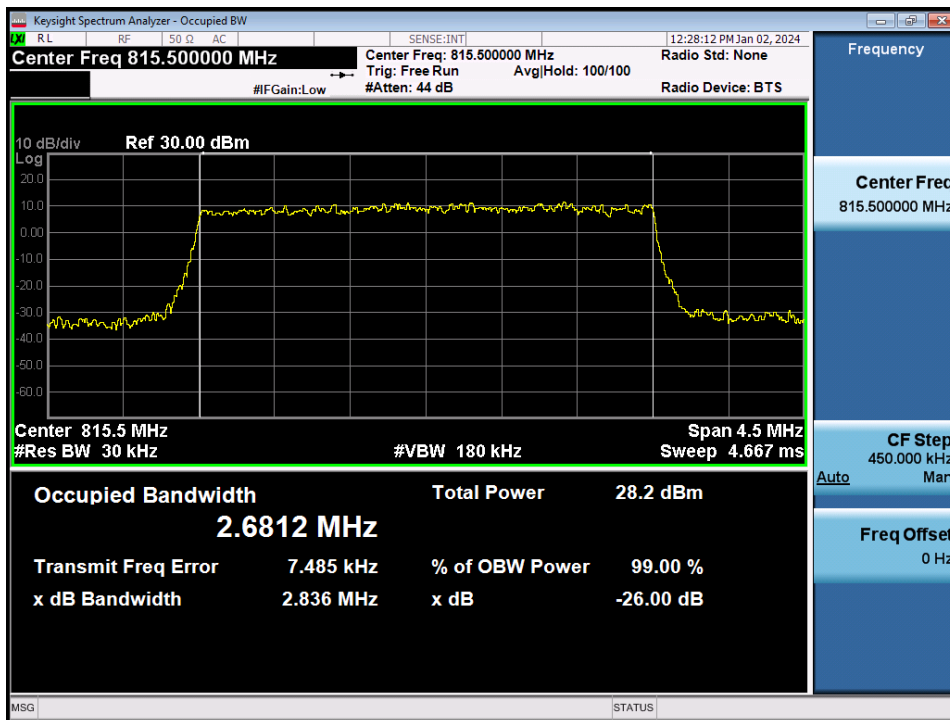

LTE Band 26 / 3 MHz / 64QAM - RB Size 15

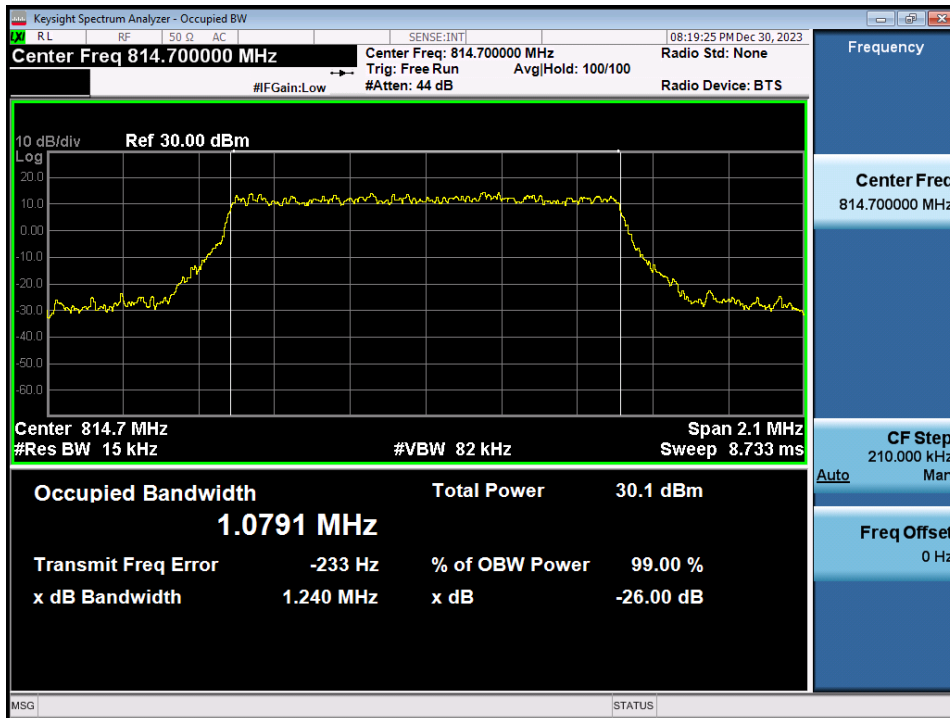

LTE Band 26 / 1.4 MHz / QPSK - RB Size 6

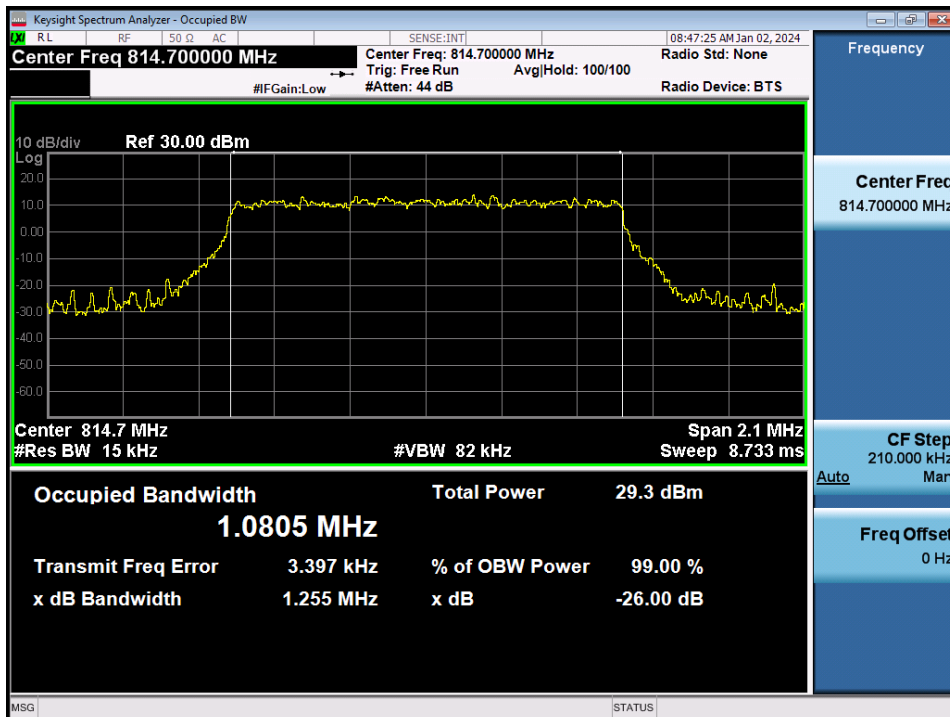

LTE Band 26 / 1.4 MHz / 16QAM - RB Size 6

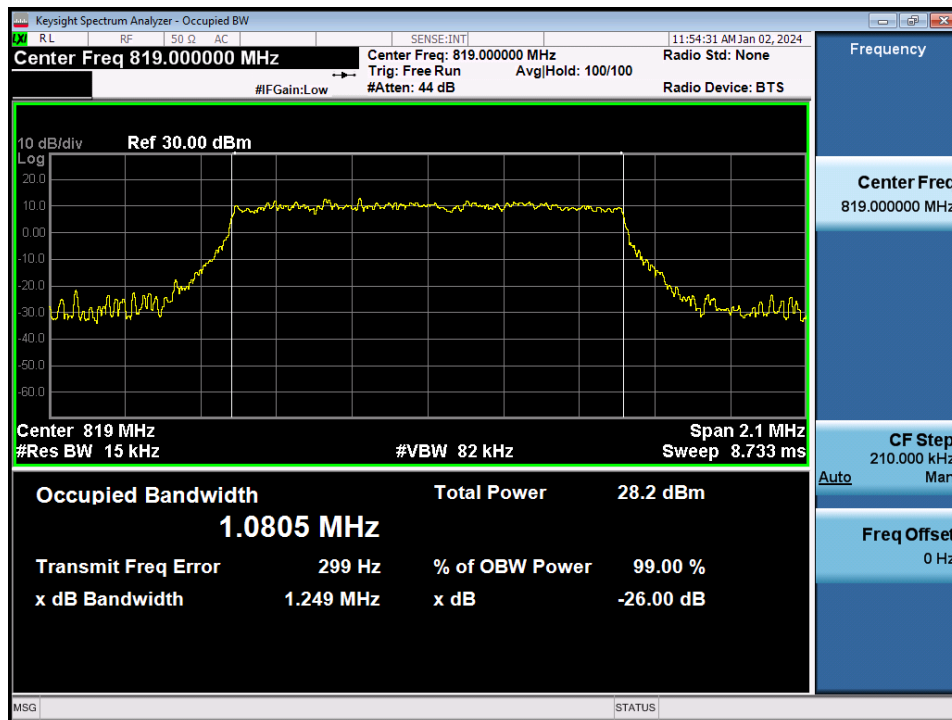

LTE Band 26 / 1.4 MHz / 64QAM - RB Size 6

8.2. PEAK TO AVERAGE RATIO

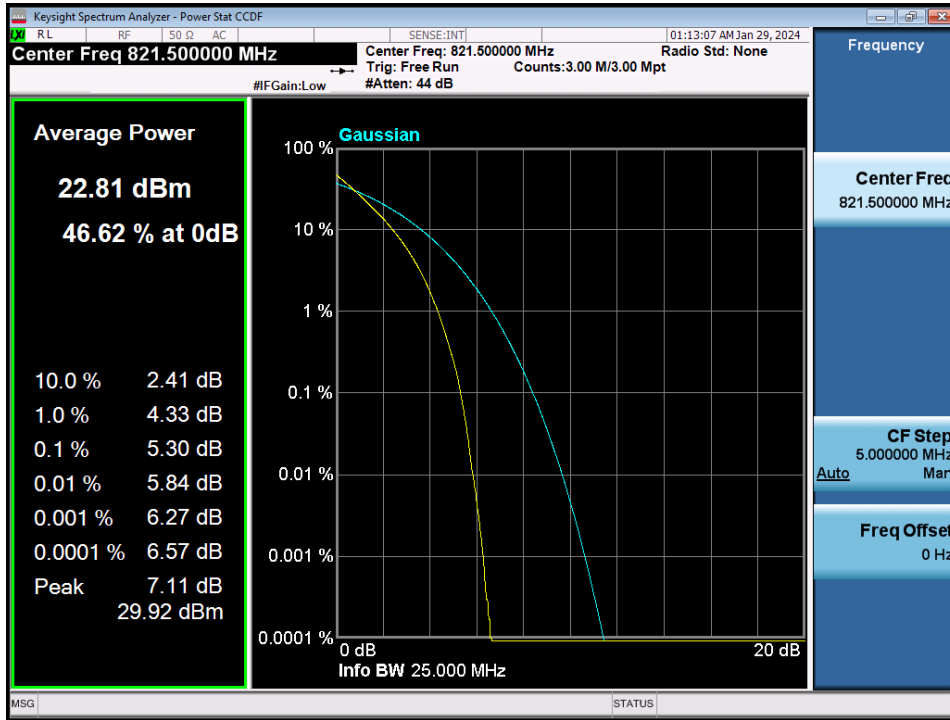

LTE Band 26 / 15 MHz / QPSK - RB Size 75

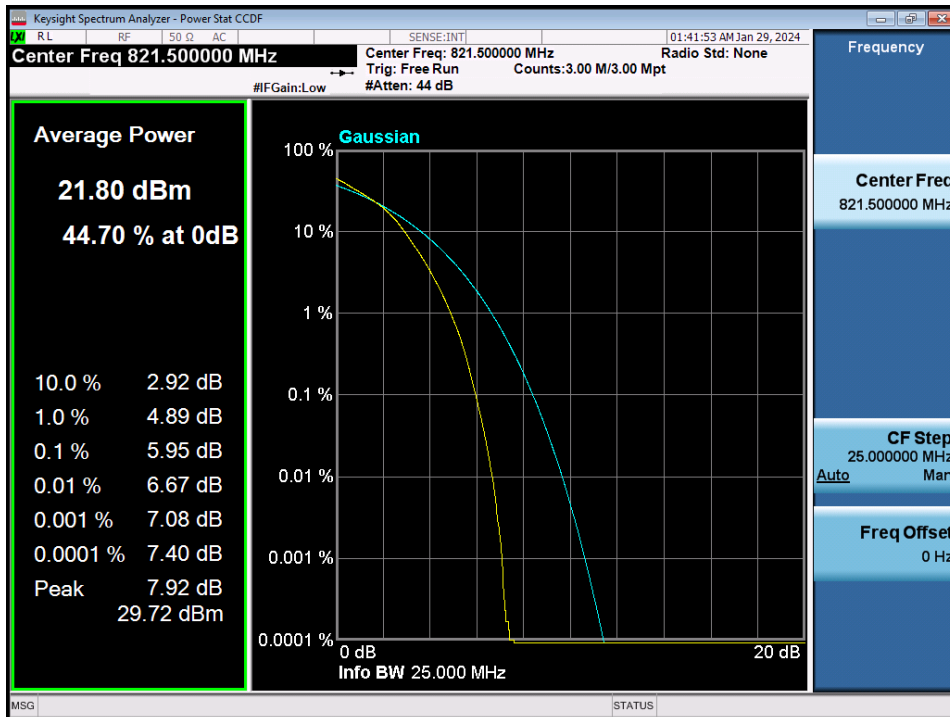

LTE Band 26 / 15 MHz / 16QAM - RB Size 75

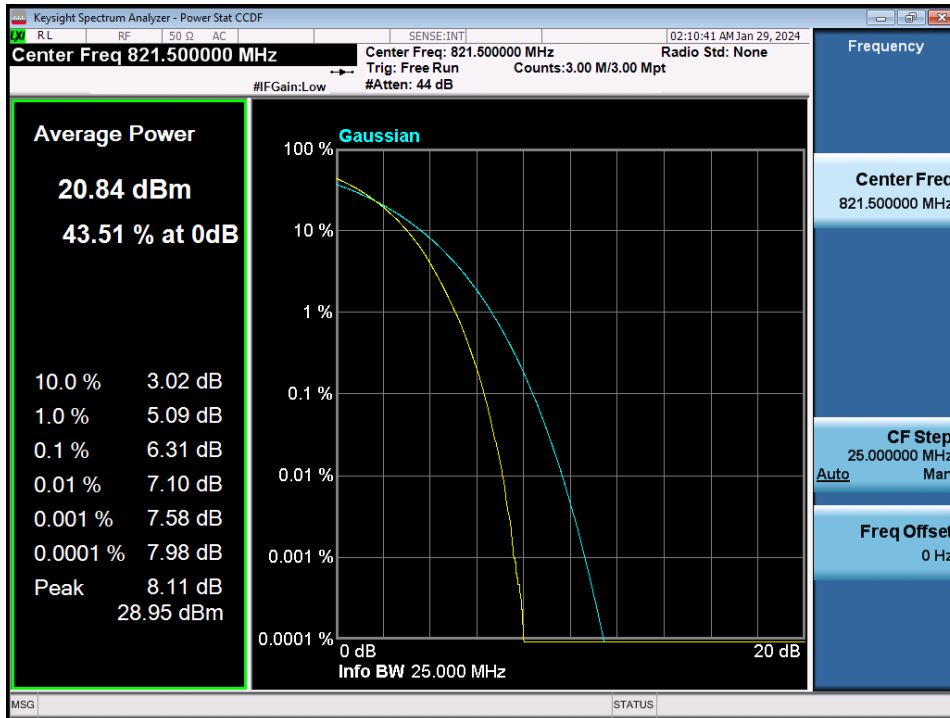

LTE Band 26 / 15 MHz / 64QAM - RB Size 75

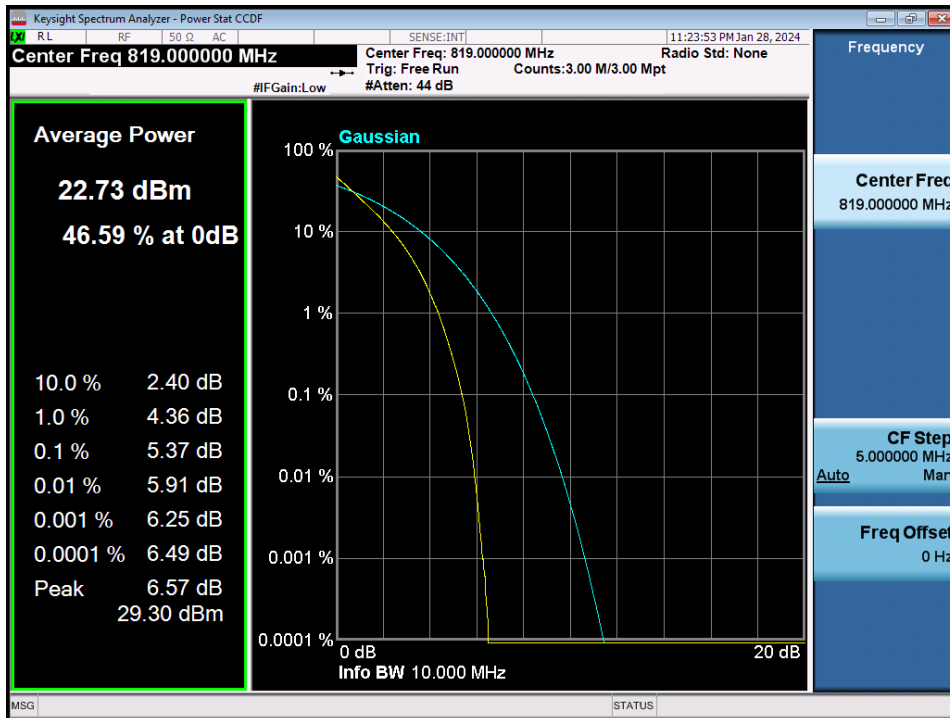

LTE Band 26 / 10 MHz / QPSK - RB Size 50

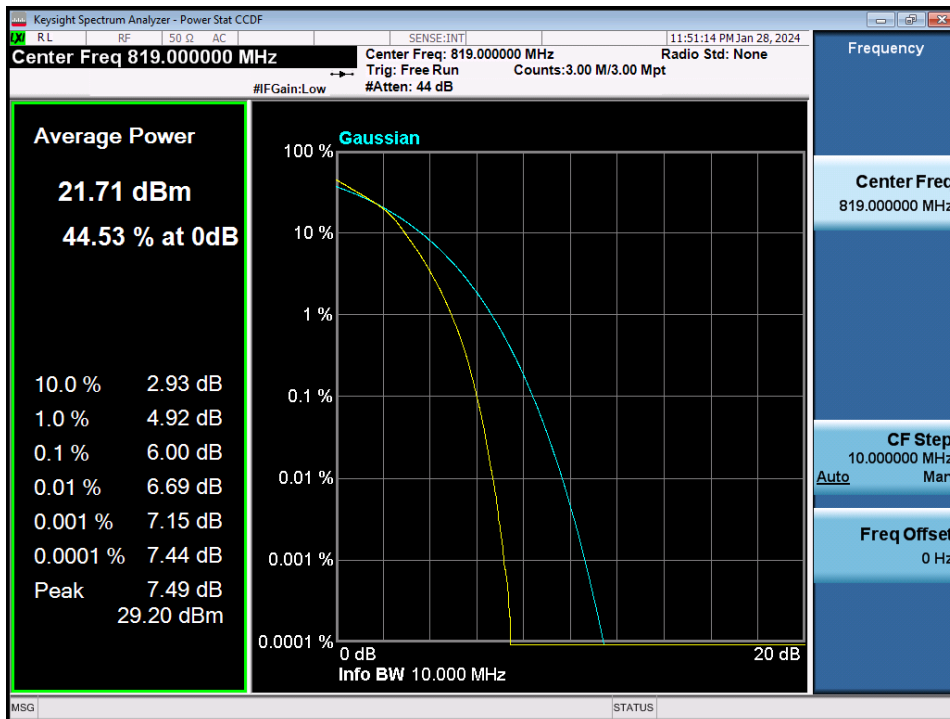

LTE Band 26 / 10 MHz / 16QAM - RB Size 50

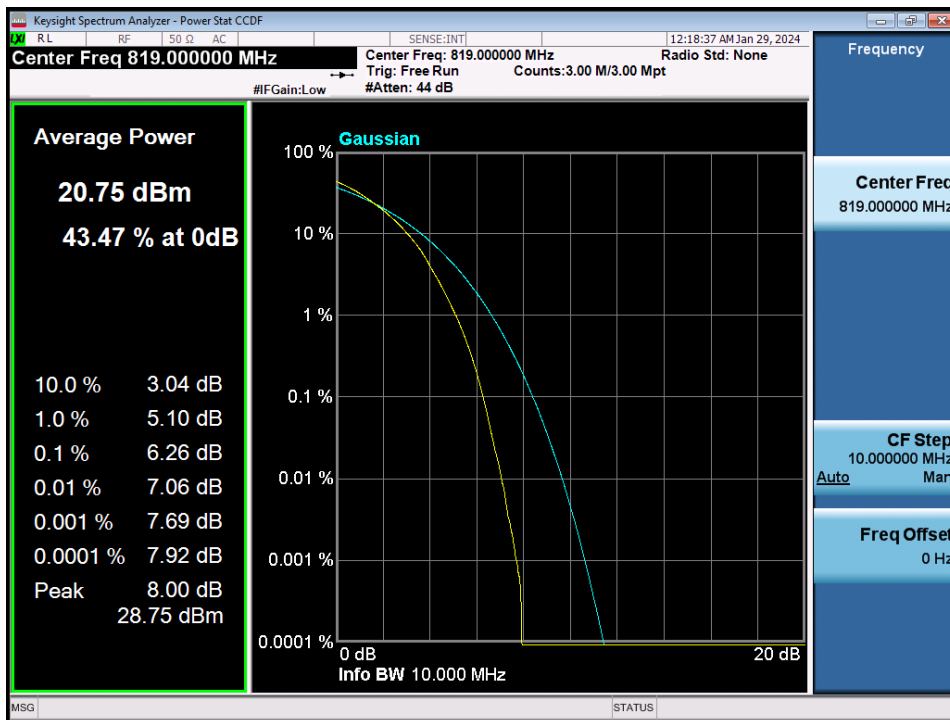

LTE Band 26 / 10 MHz / 64QAM - RB Size 50

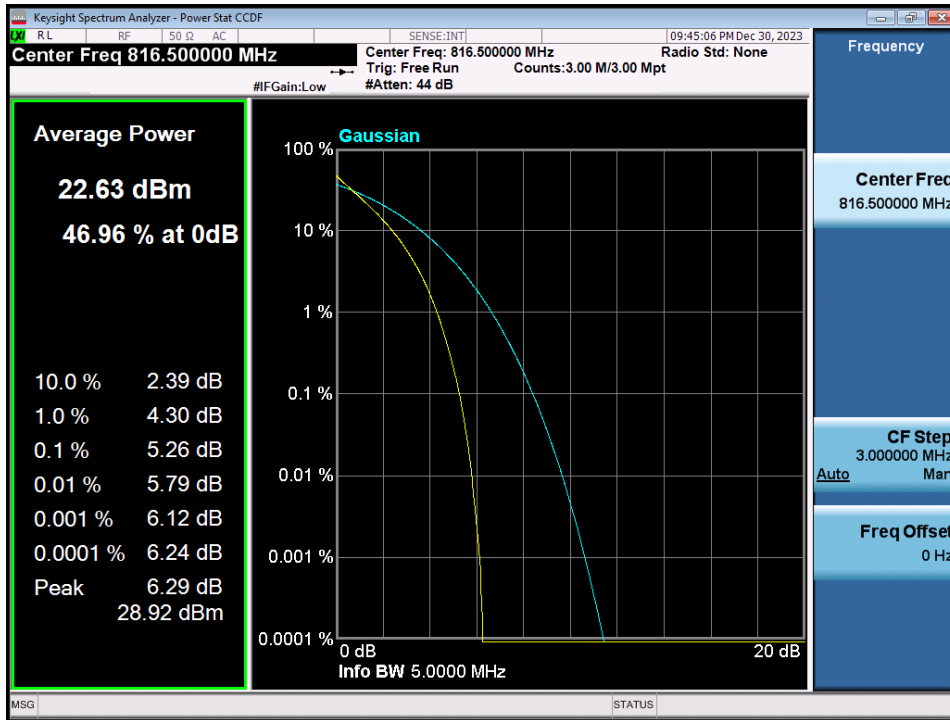

LTE Band 26 / 5 MHz / QPSK - RB Size 25

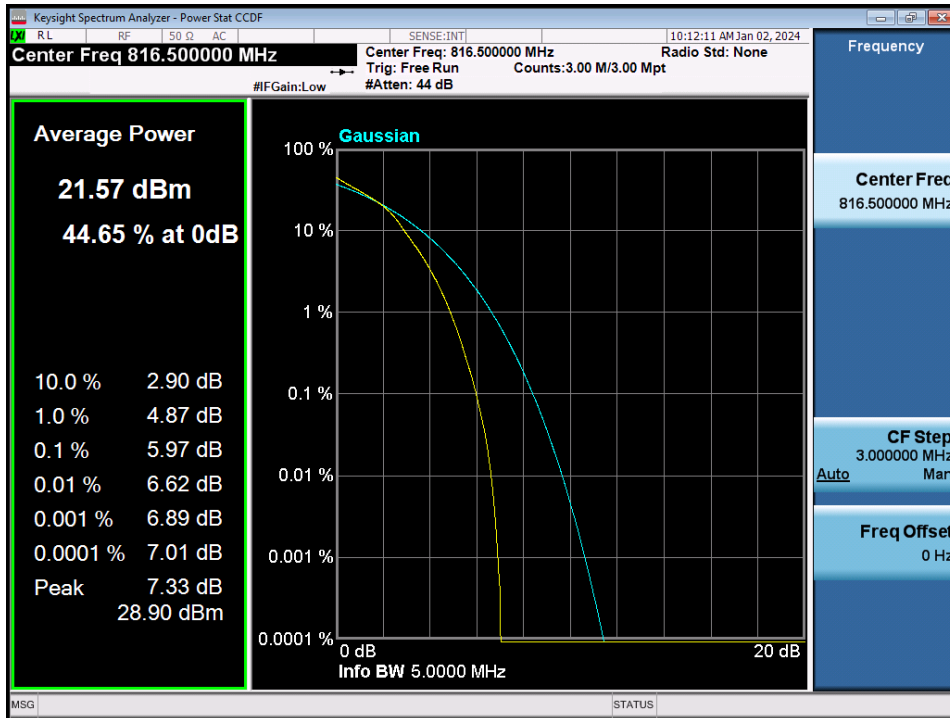

LTE Band 26 / 5 MHz / 16QAM - RB Size 25

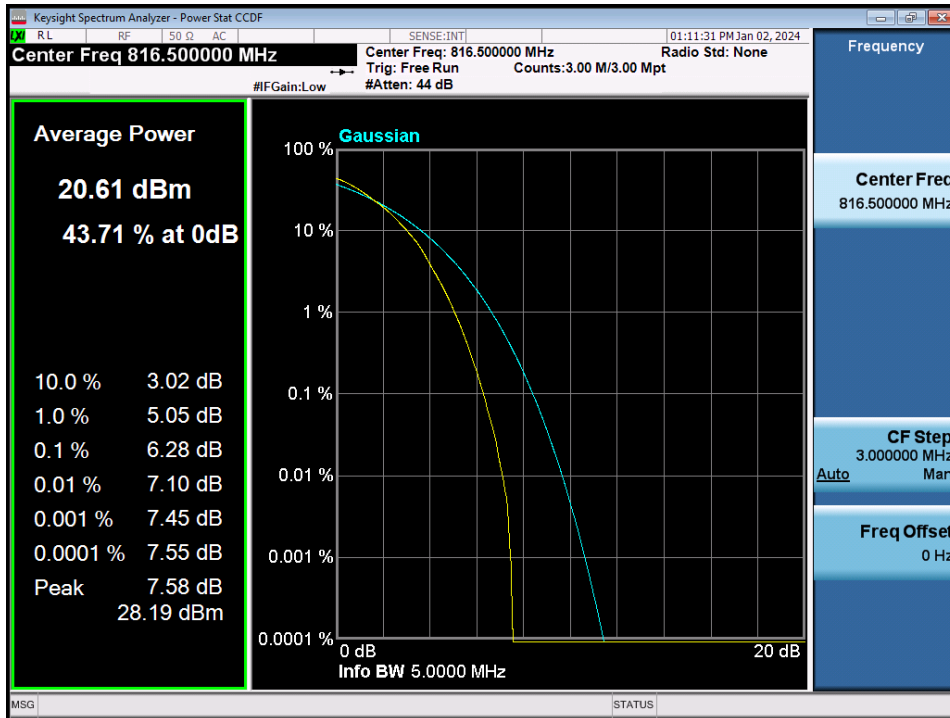

LTE Band 26 / 5 MHz / 64QAM - RB Size 25

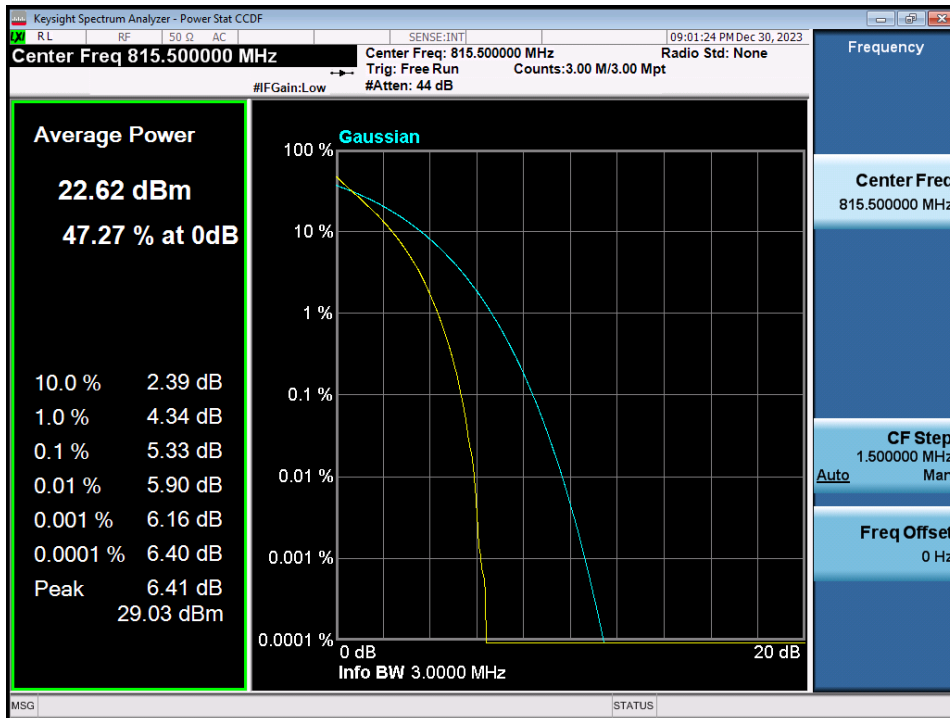

LTE Band 26 / 3 MHz / QPSK - RB Size 15

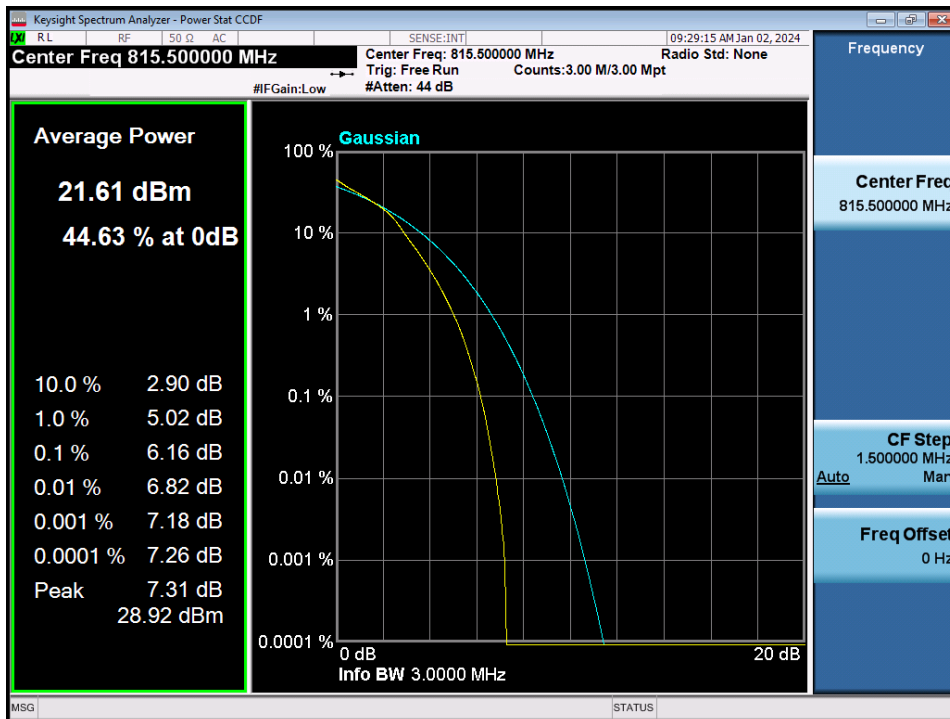

LTE Band 26 / 3 MHz / 16QAM - RB Size 15

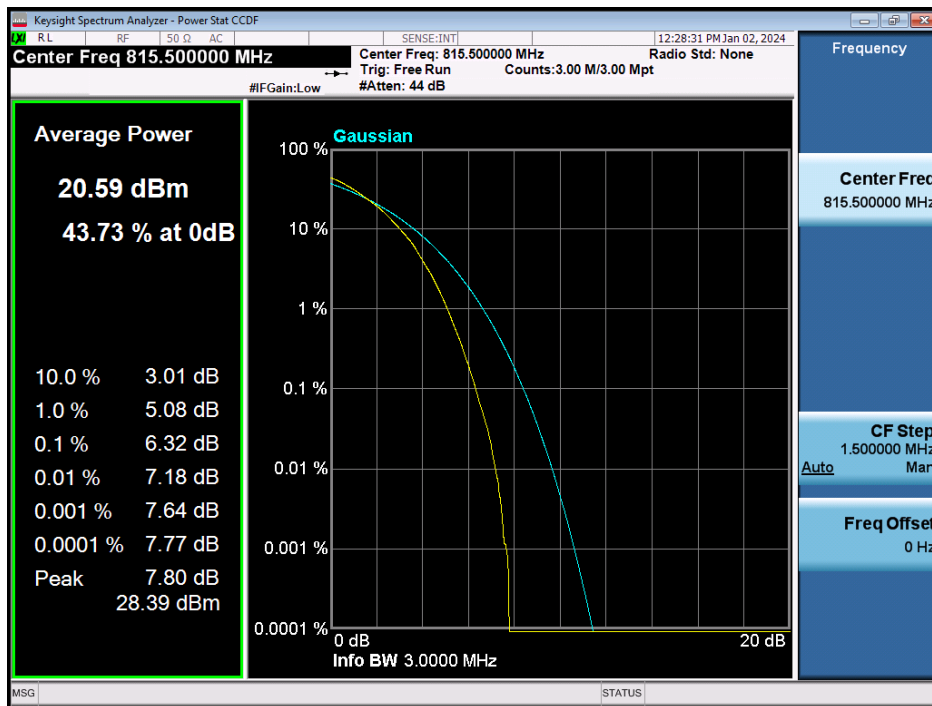

LTE Band 26 / 3 MHz / 64QAM - RB Size 15

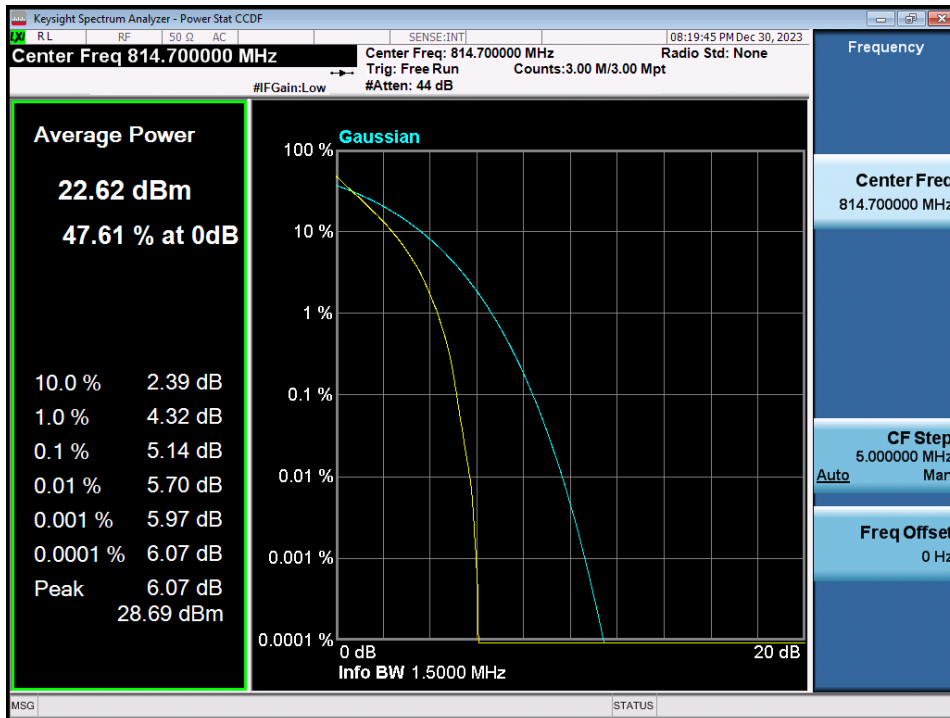

LTE Band 26 / 1.4 MHz / QPSK - RB Size 6

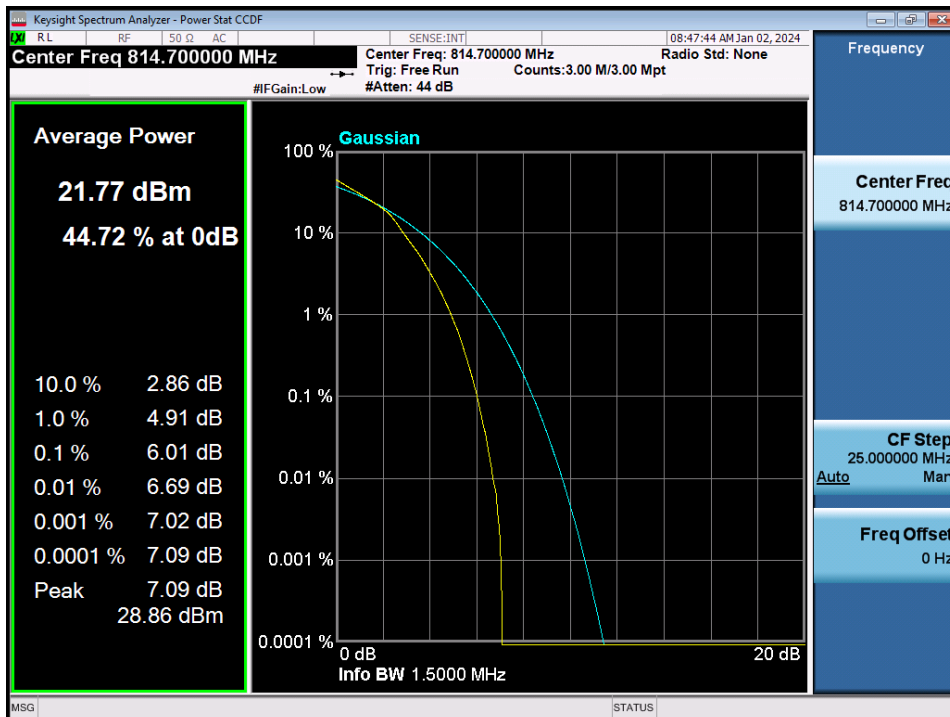

LTE Band 26 / 1.4 MHz / 16QAM - RB Size 6

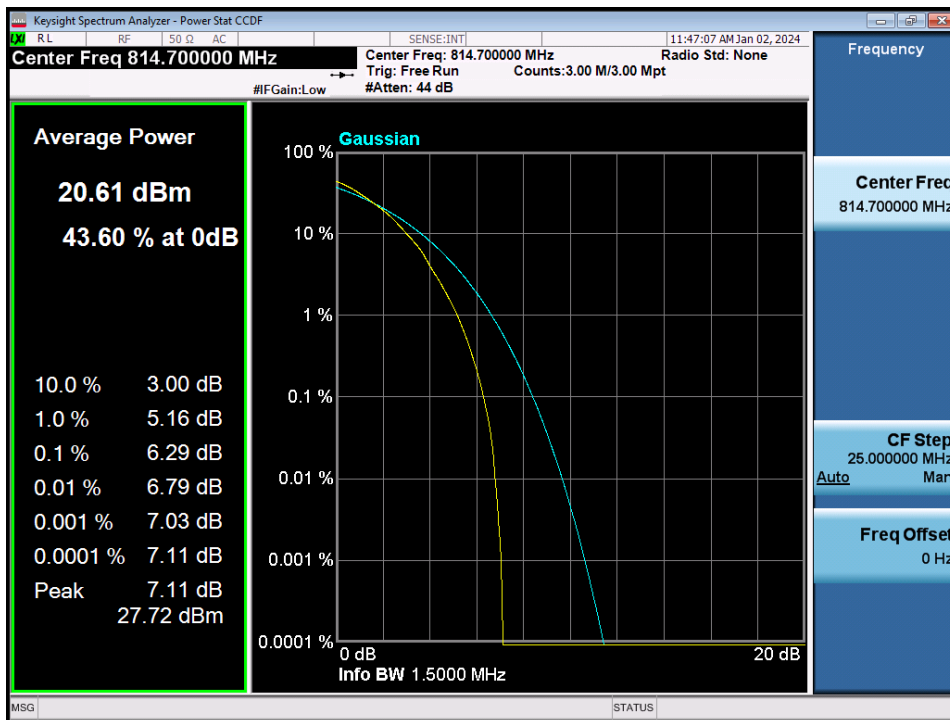

LTE Band 26 / 1.4 MHz / 64QAM - RB Size 6

8.3. BAND EDGE EMISSIONS(Conducted)

- Band Edge & Extended Band Edge

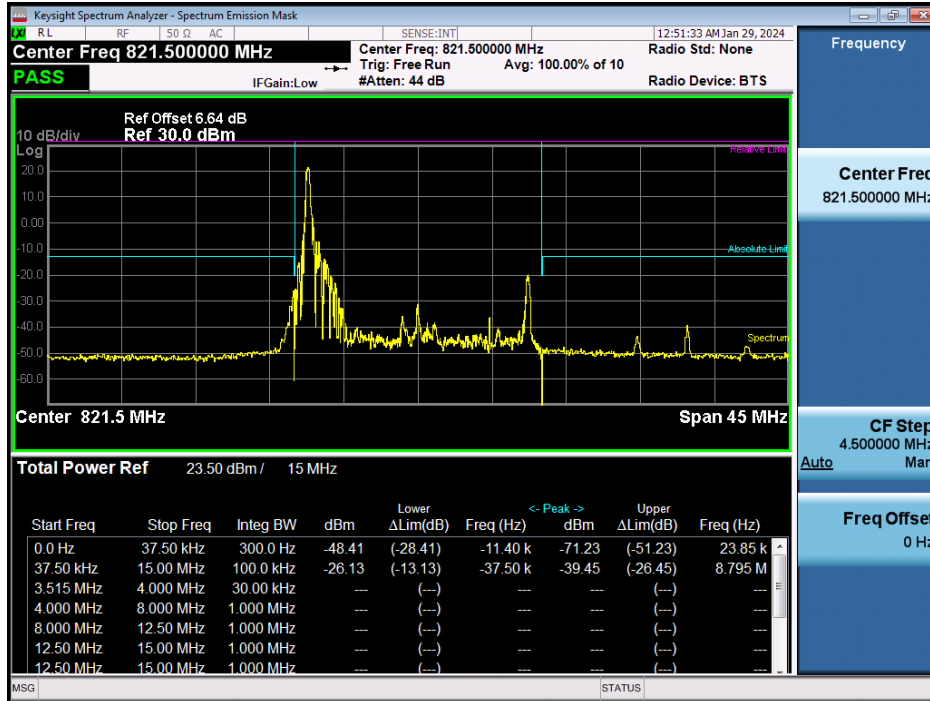

LTE Band 26 / 15 MHz / QPSK - RB Size/Offset (1/0)

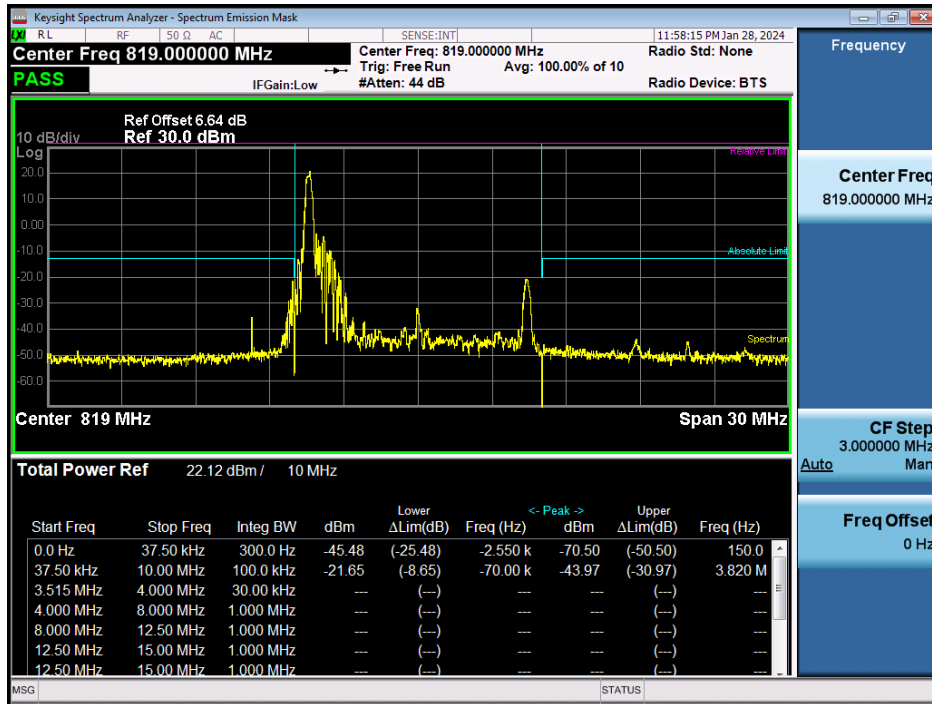

LTE Band 26 / 10 MHz / 16QAM - RB Size/Offset (1/0)

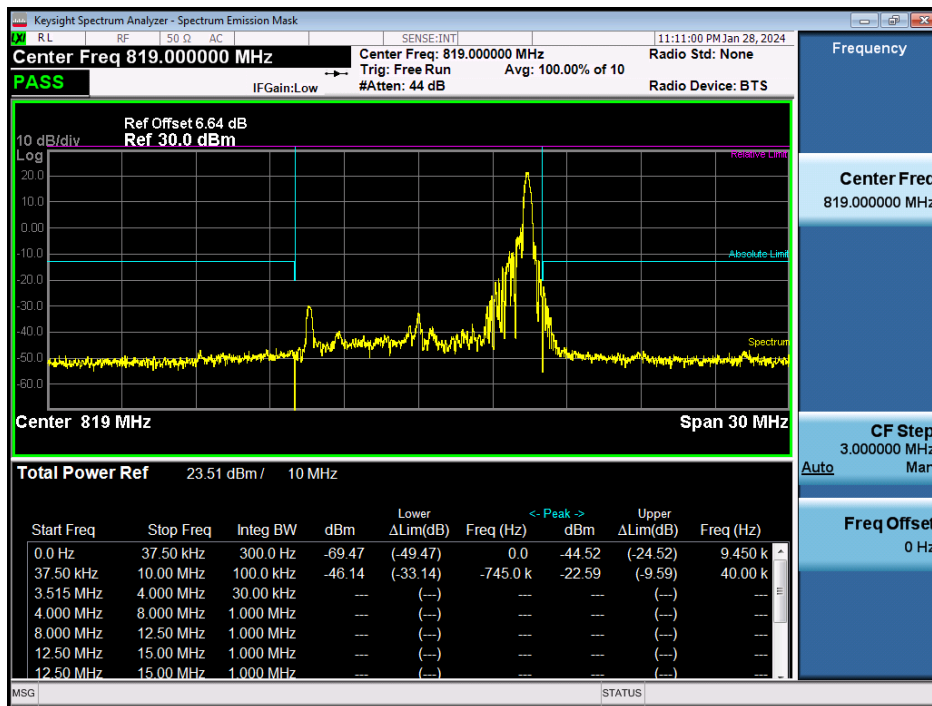

LTE Band 26 / 10 MHz / QPSK- RB Size/Offset (1/49)

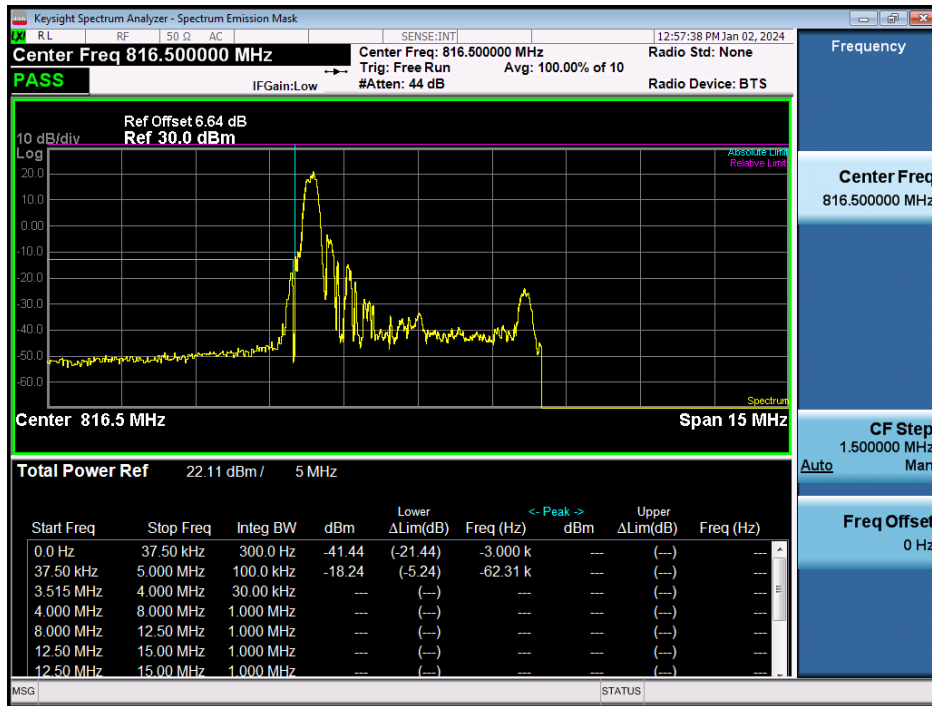

LTE Band 26 / 5 MHz / 64QAM - RB Size/Offset (1/0)

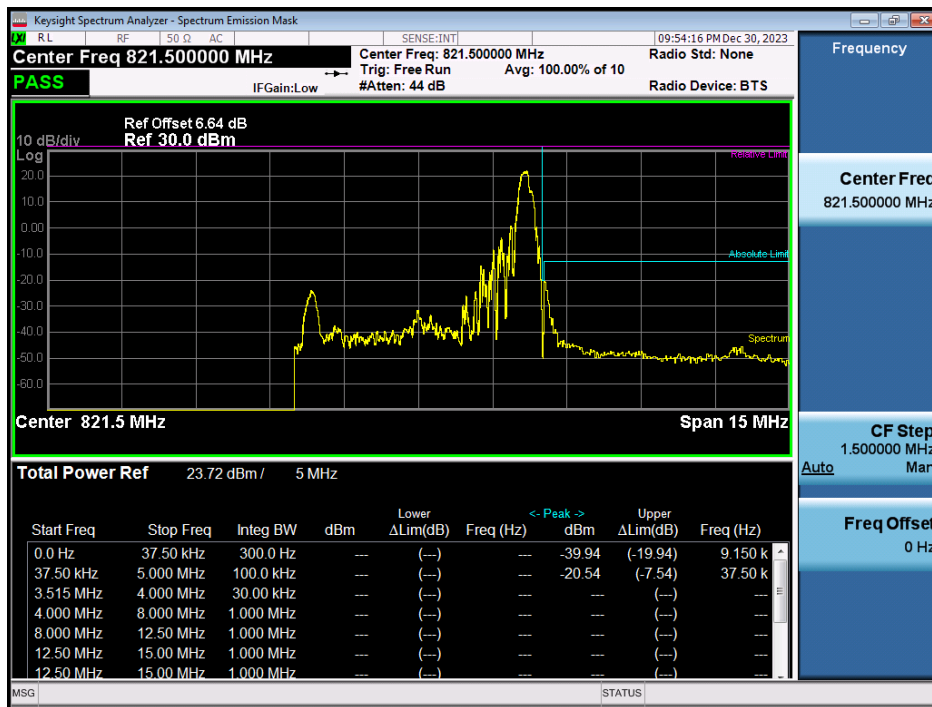

LTE Band 26 / 5 MHz / QPSK - RB Size/Offset (1/24)



LTE Band 26 / 3 MHz / 16QAM - RB Size/Offset (1/0)

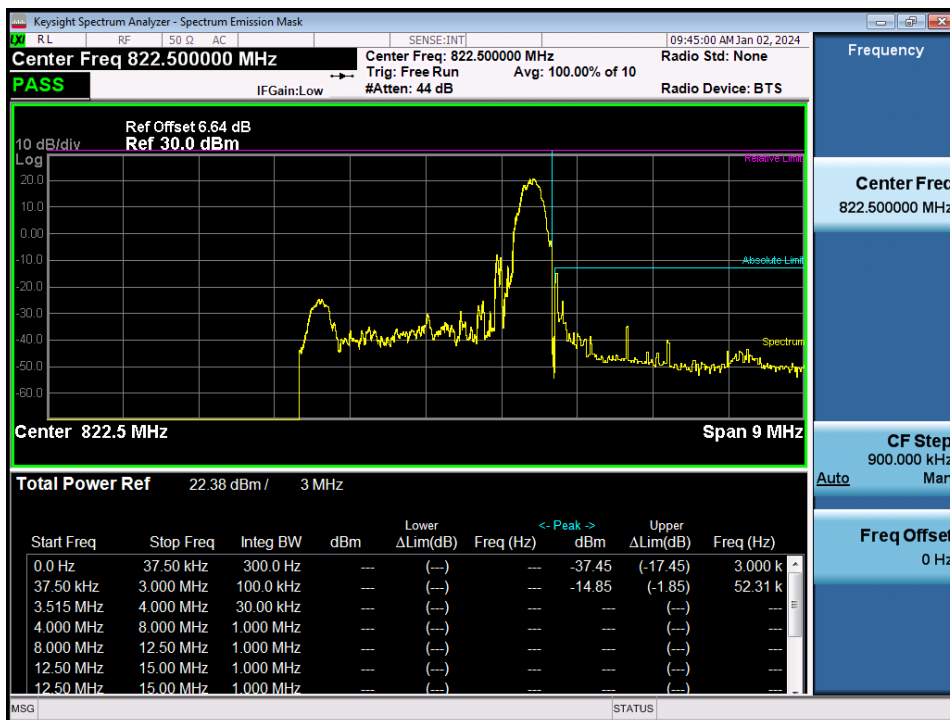

LTE Band 26 / 3 MHz / 16QAM - RB Size/Offset (1/14)

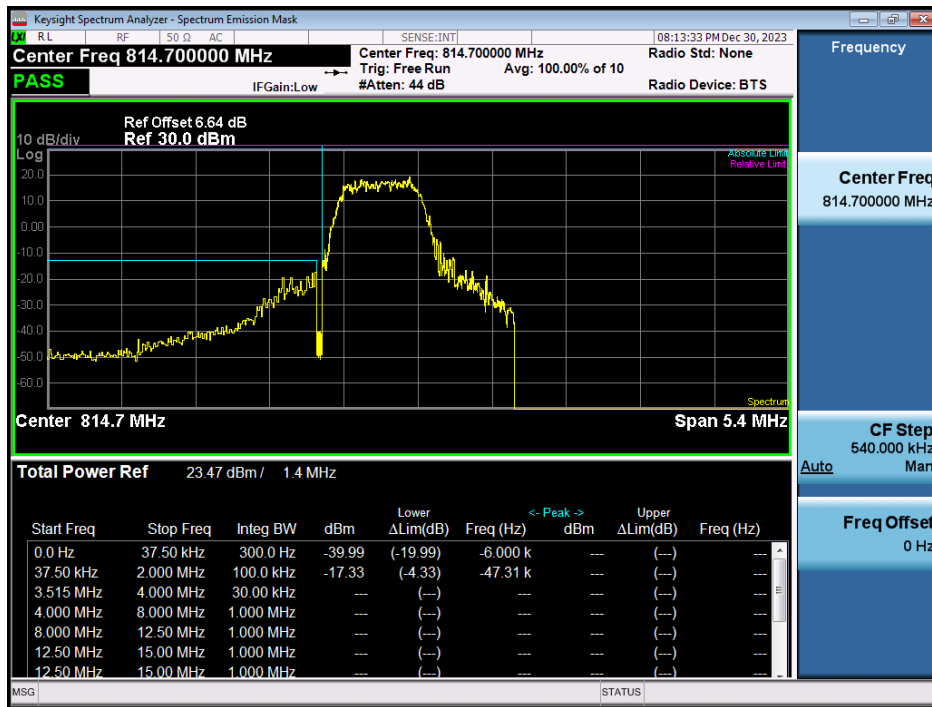

LTE Band 26 / 1.4 MHz / QPSK - RB Size/Offset (3/0)

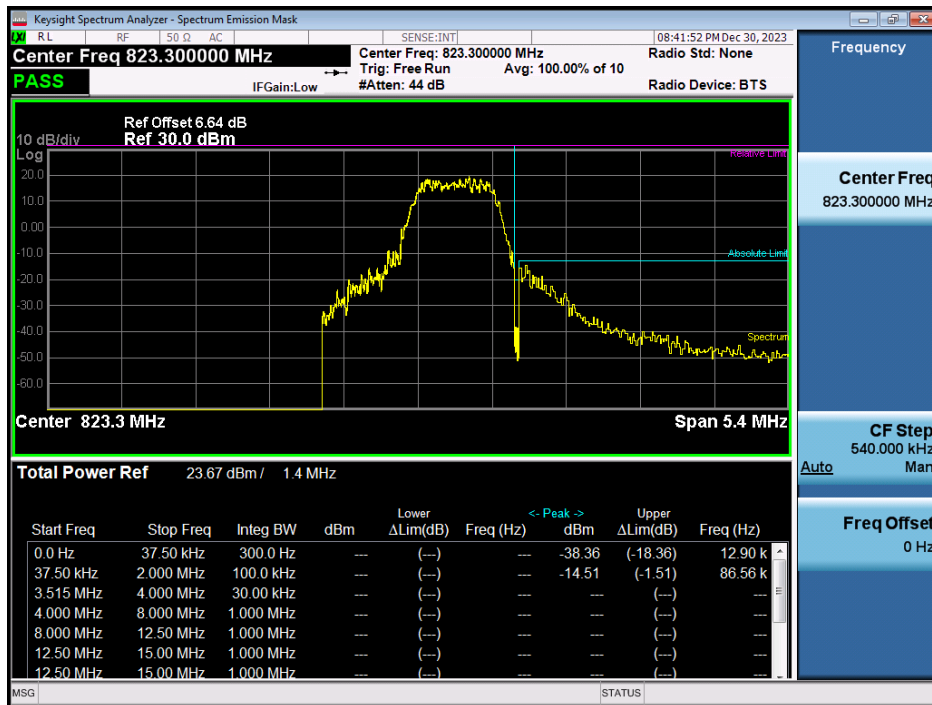

LTE Band 26 / 1.4 MHz / QPSK - RB Size/Offset (3/3)

8.4. SPURIOUS AND HARMONICS EMISSIONS(Conducted)

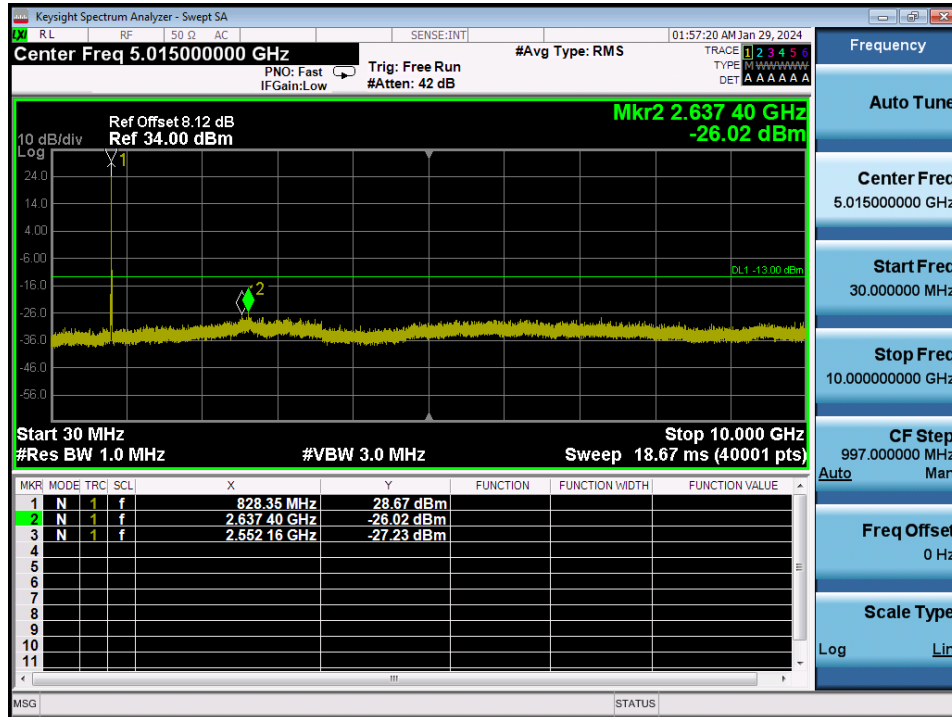

LTE Band 26 / 15 MHz / 64QAM - RB Size/Offset (1/74) - Low Channel

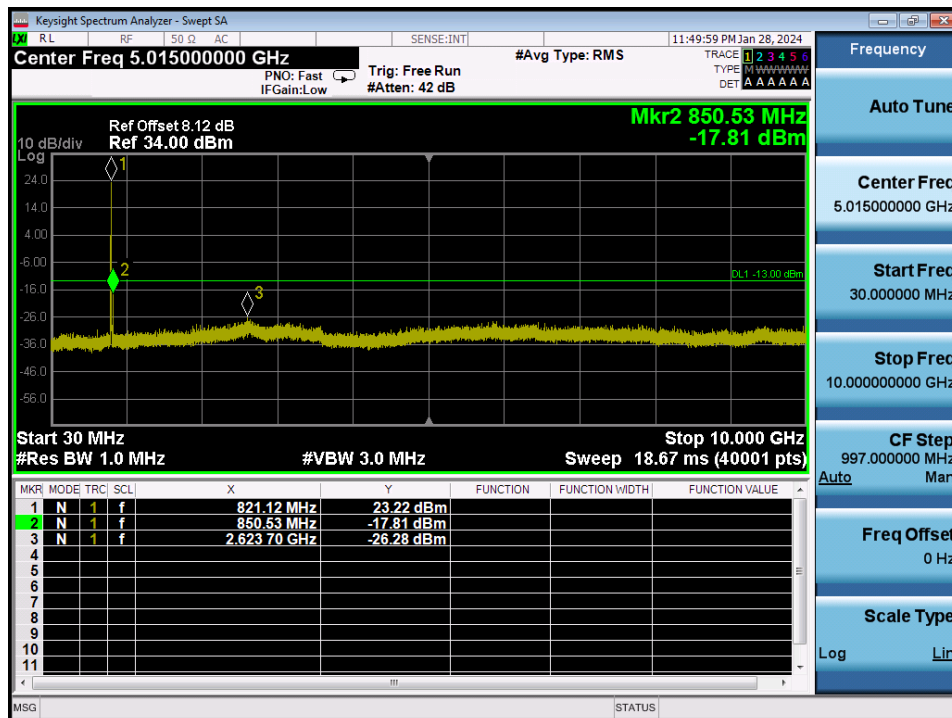

LTE Band 26 / 10 MHz / 16QAM - RB Size/Offset (25/25) - Low Channel

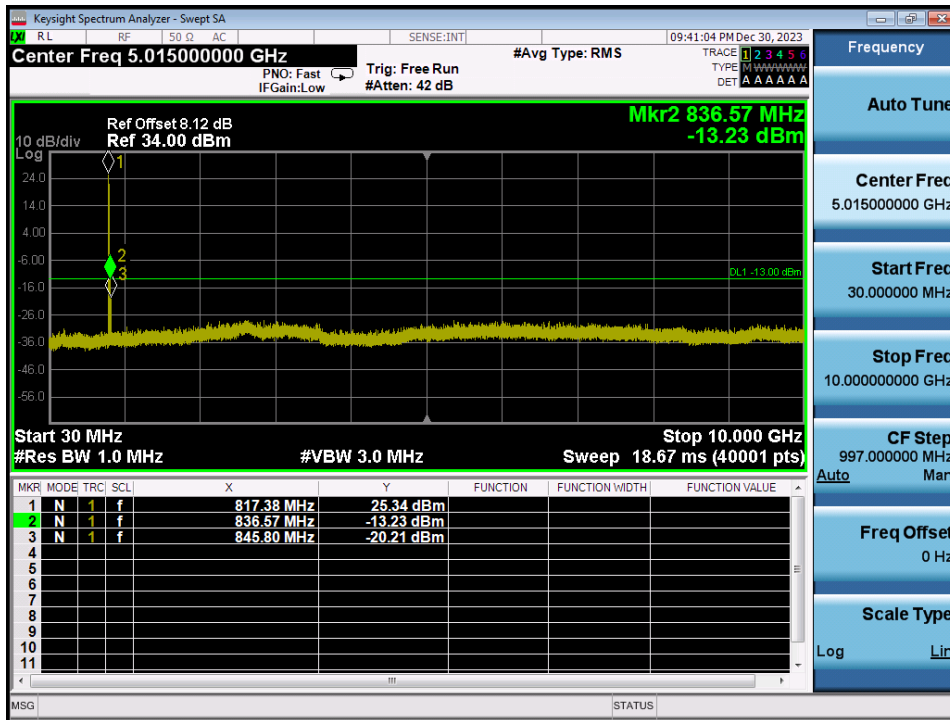

LTE Band 26 / 5 MHz / QPSK - RB Size/Offset (12/6) - Low Channel

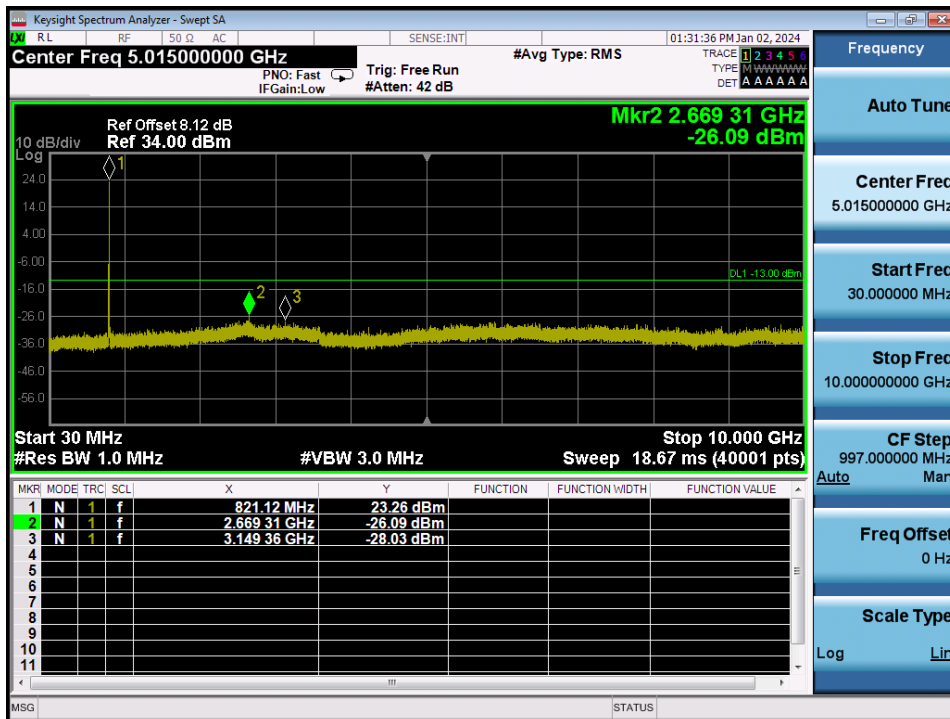

LTE Band 26 / 5 MHz / 64QAM - RB Size/Offset (25/0) - High Channel

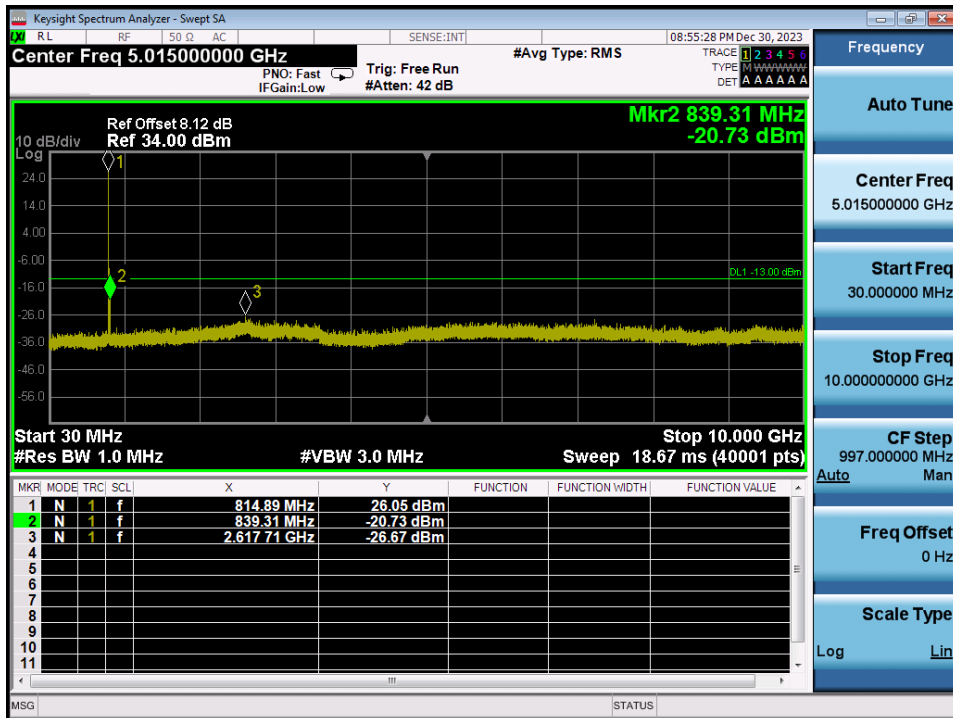

LTE Band 26 / 3 MHz / QPSK - RB Size/Offset (8/0) - Low Channel

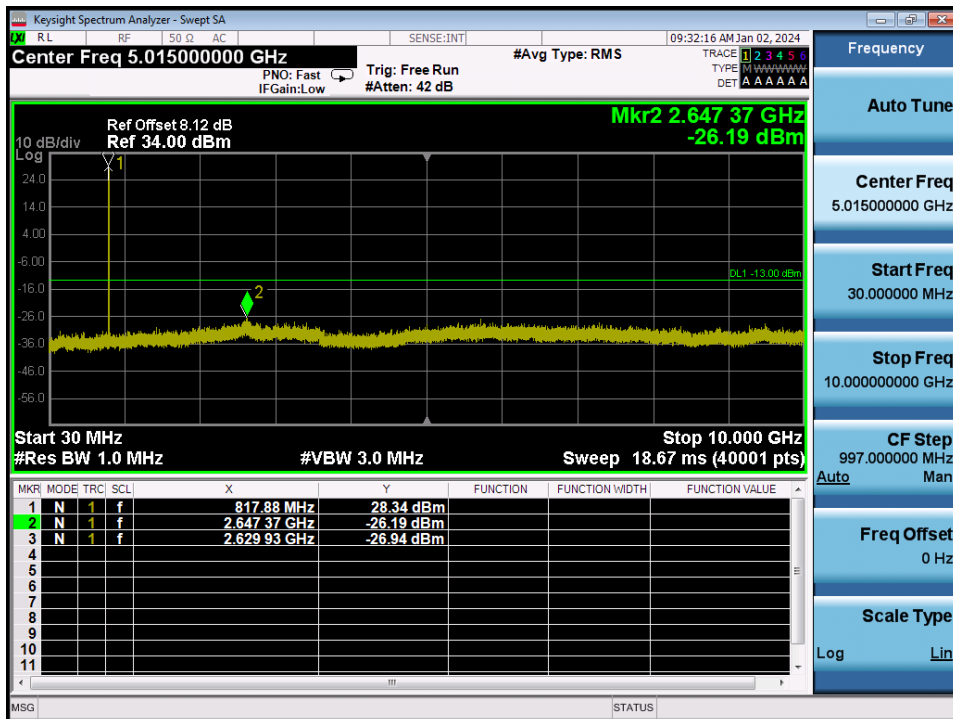

LTE Band 26 / 3 MHz / 16QAM - RB Size/Offset (1/0) - Mid Channel

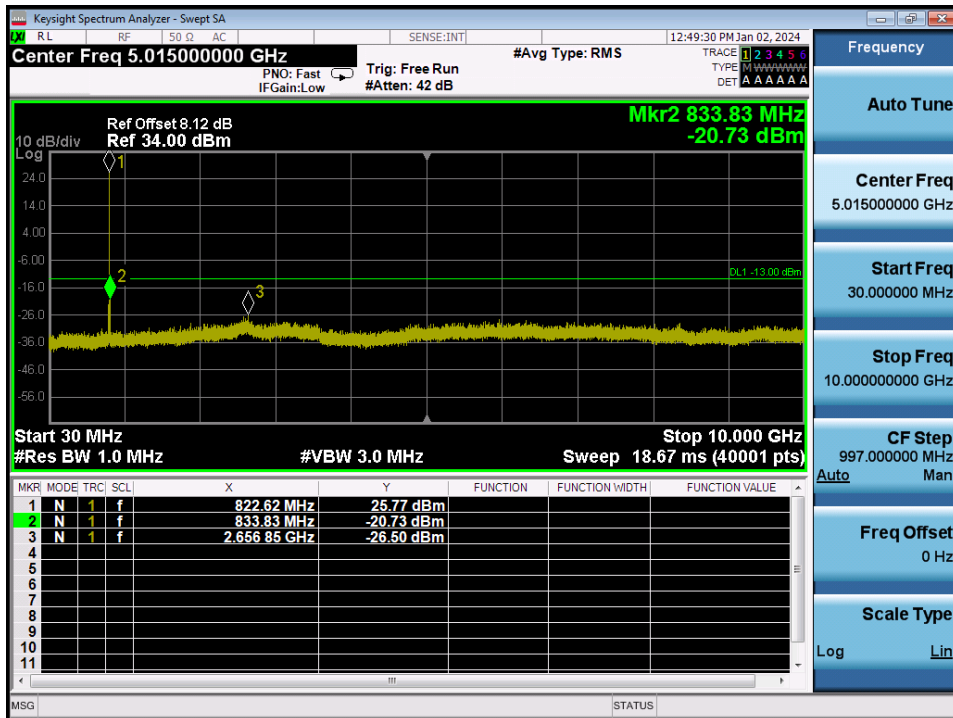

LTE Band 26 / 3 MHz / 64QAM - RB Size/Offset (8/4) - High Channel

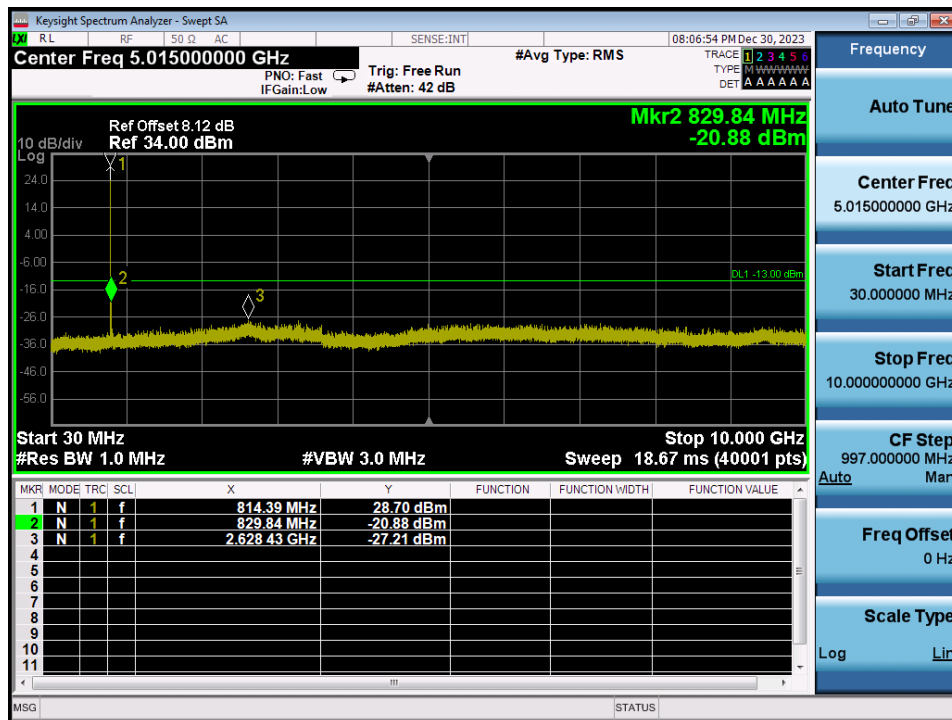

LTE Band 26 / 1.4 MHz / QPSK - RB Size/Offset (1/0) – Low Channel

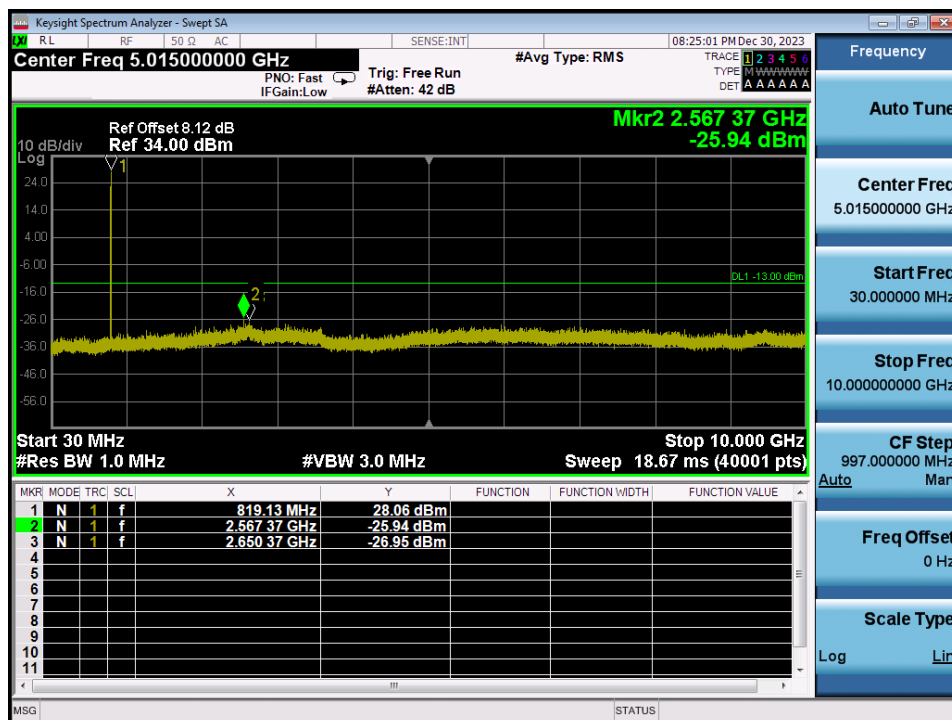

LTE Band 26 / 1.4 MHz / QPSK- RB Size/Offset (3/0) – Mid Channel

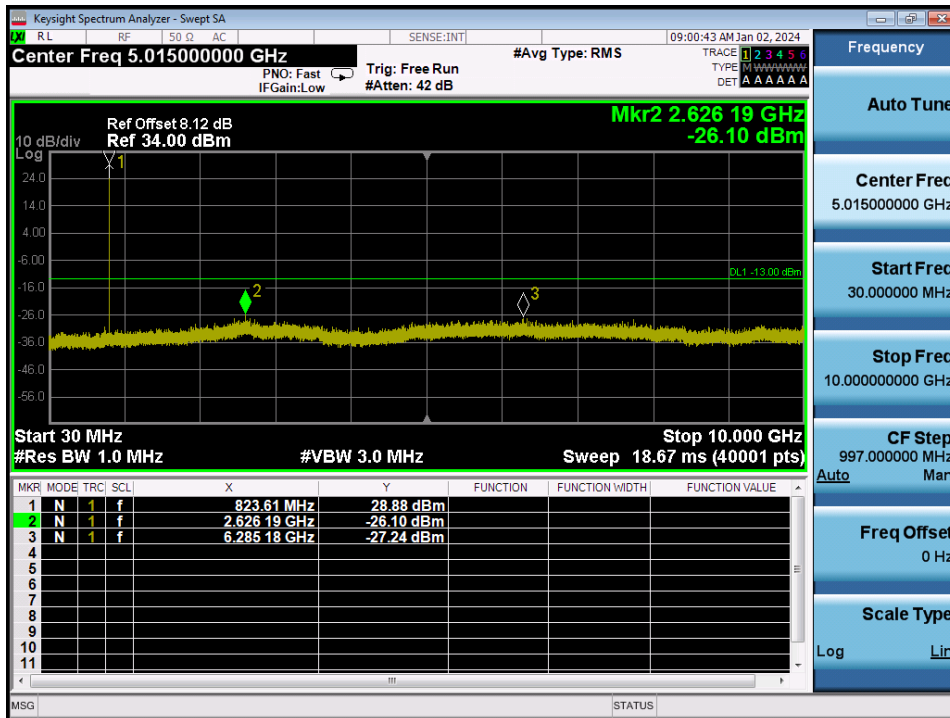

LTE Band 26 / 1.4 MHz / 16QAM - RB Size/Offset (1/2) – High Channel