

5. Number of Hopping Frequencies

5.1 Test Setup

Refer to the APPENDIX I.

5.2 Limit

Limit : ≥ 15 hops

5.3 Procedure

The number of hopping frequencies was measured with a spectrum analyzer connected to the antenna terminal, while EUT had its hopping function enabled.

To get higher resolution, two frequency ranges for FH mode within the 2400 ~ 2483.5 MHz were examined.

The spectrum analyzer is set to :

Span for FH mode = 50 MHz Start Frequency = 2391.5 MHz, Stop Frequency = 2441.5 MHz

Start Frequency = 2441.5 MHz, Stop Frequency = 2491.5 MHz

Span for AFH mode = 30 MHz Start Frequency = 2396.0 MHz, Stop Frequency = 2426.0 MHz

RBW = To identify clearly the individual channels, set the RBW to less than 30% of the channel spacing or the 20 dB bandwidth, whichever is smaller.

VBW \geq RBW Sweep = auto

Detector function = peak Trace = max hold

5.4 Test Results

FH mode

Hopping mode	Test mode	Test Result (Total Hops)
Enable	GFSK	79
	$\pi/4$ -DQPSK	79
	8DPSK	79

AFH mode

Hopping mode	Test mode	Test Result (Total Hops)
Enable	GFSK	20
	$\pi/4$ -DQPSK	20
	8DPSK	20

Note 1 : See next pages for actual measured spectrum plots.

- Minimum Standard :

At least 15 hops

Number of Hopping Frequencies 1(FH)

Hopping mode : Enable & GFSK

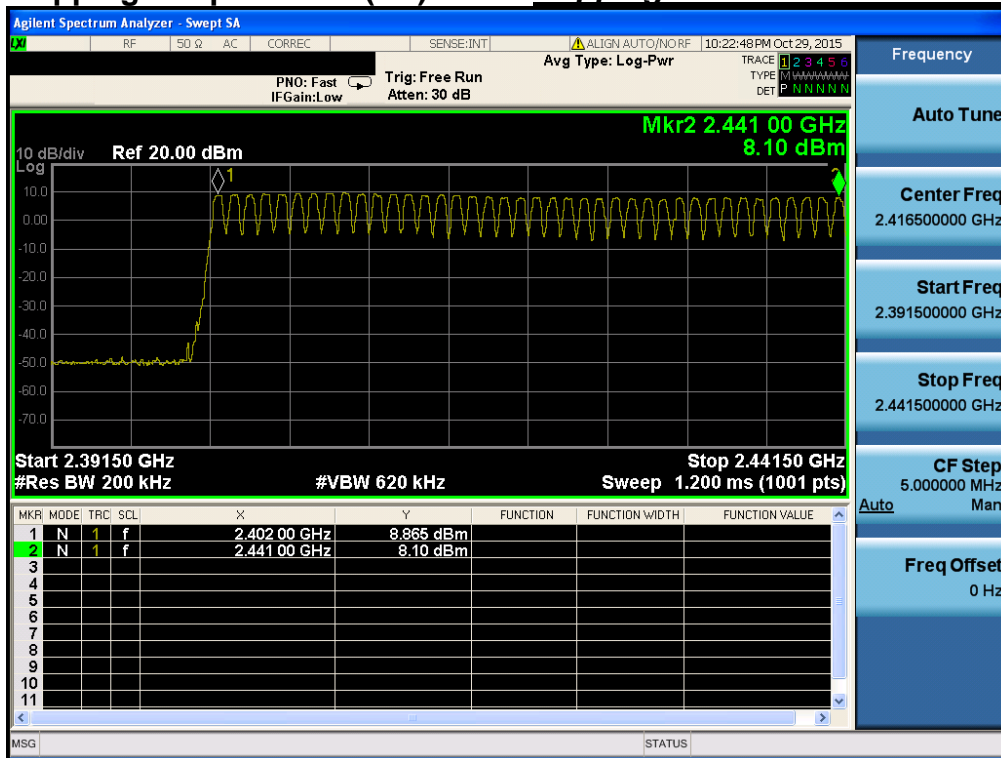

Number of Hopping Frequencies 2(FH)

Hopping mode : Enable & GFSK

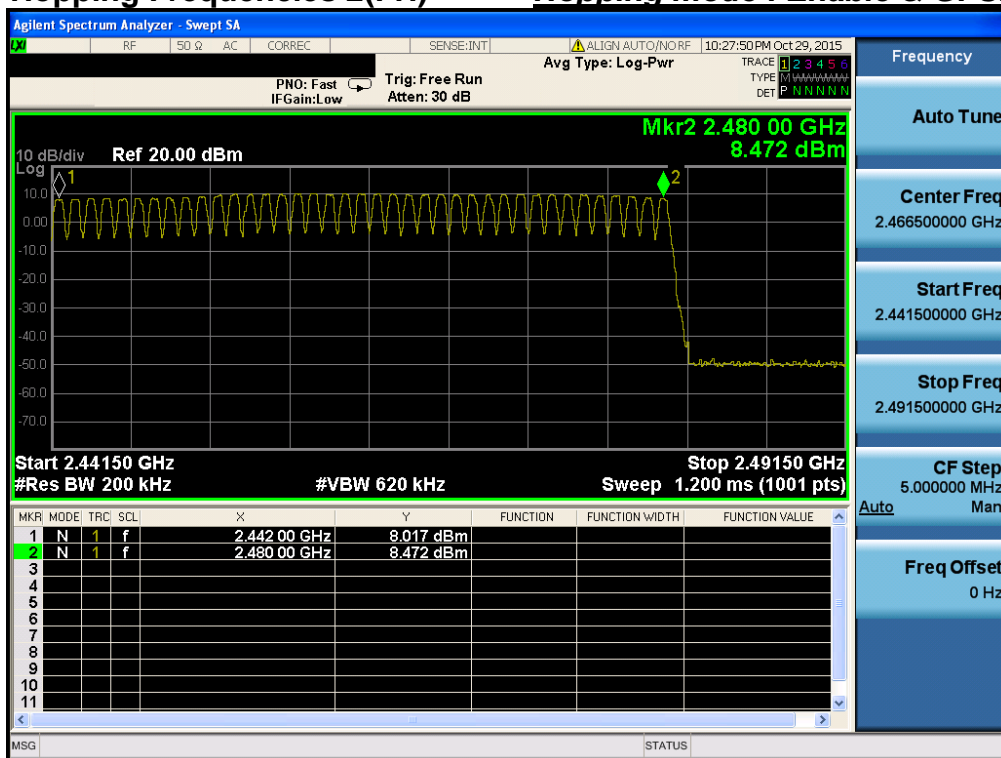

Number of Hopping Frequencies 1(FH)

Hopping mode : Enable & $\pi/4$ -DQPSK

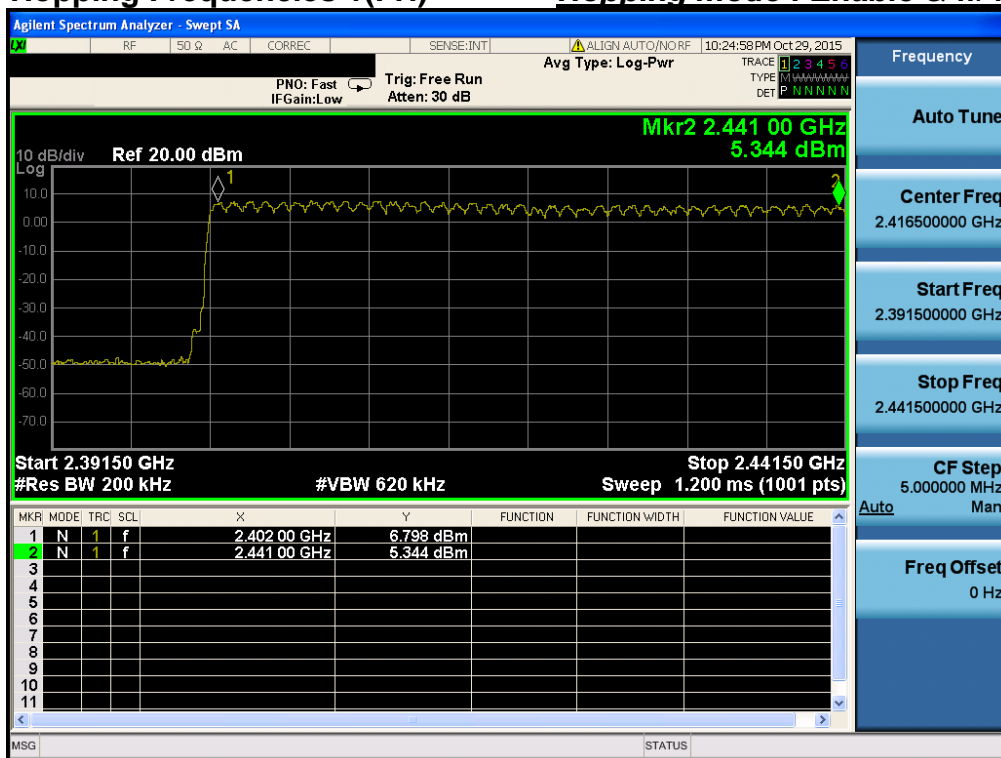

Number of Hopping Frequencies 2(FH)

Hopping mode : Enable & $\pi/4$ -DQPSK

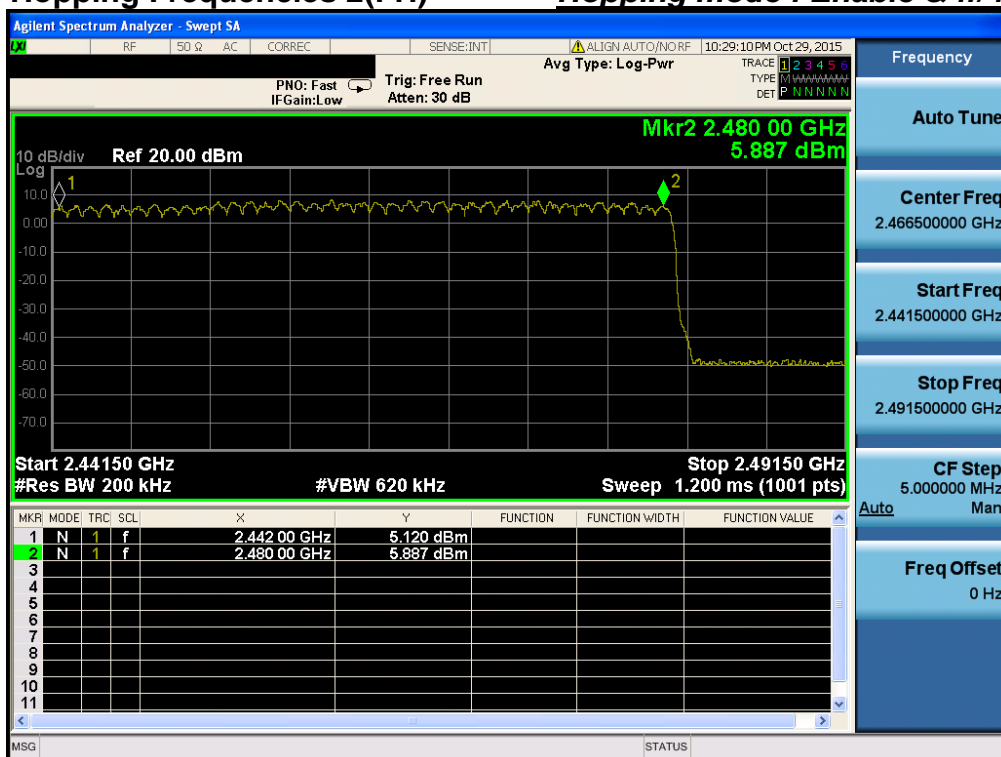

Number of Hopping Frequencies 1(FH)

Hopping mode : Enable & 8DPSK

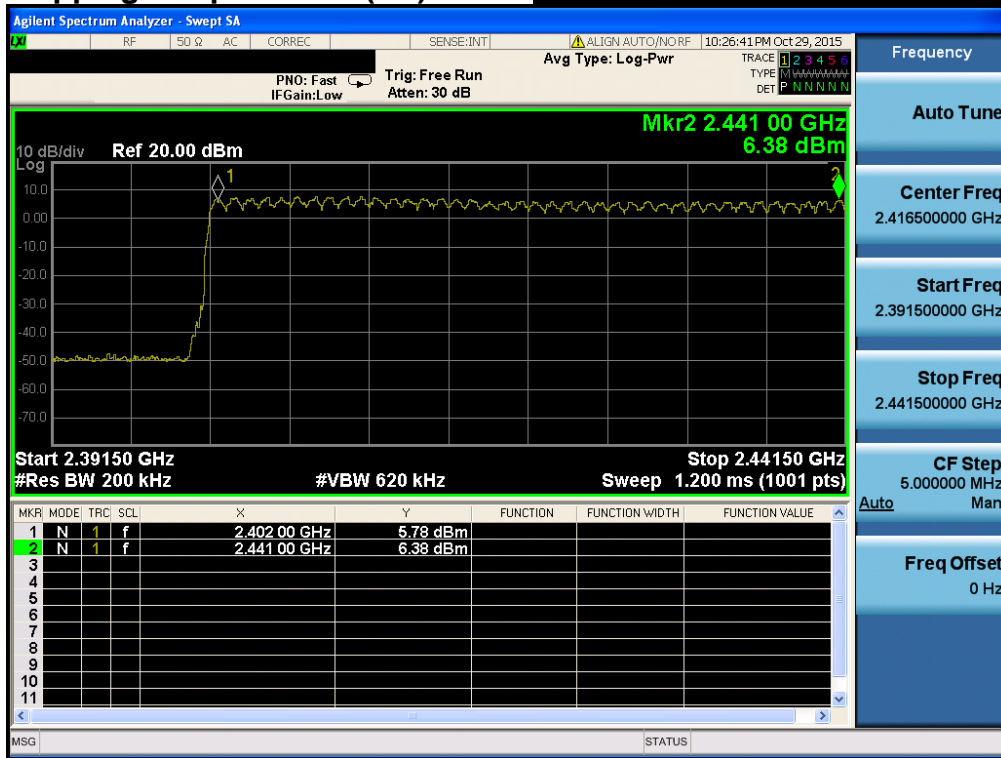

Number of Hopping Frequencies 2(FH)

Hopping mode : Enable & 8DPSK

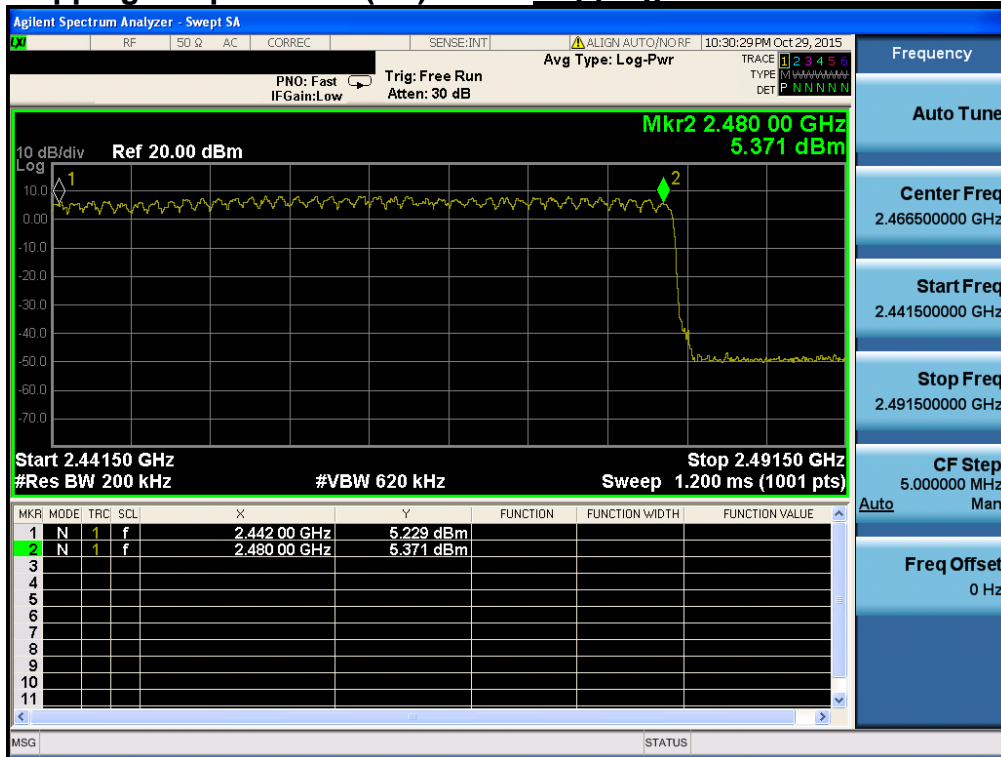

Number of Hopping Frequencies 1(AFH)

Hopping mode : Enable & GFSK

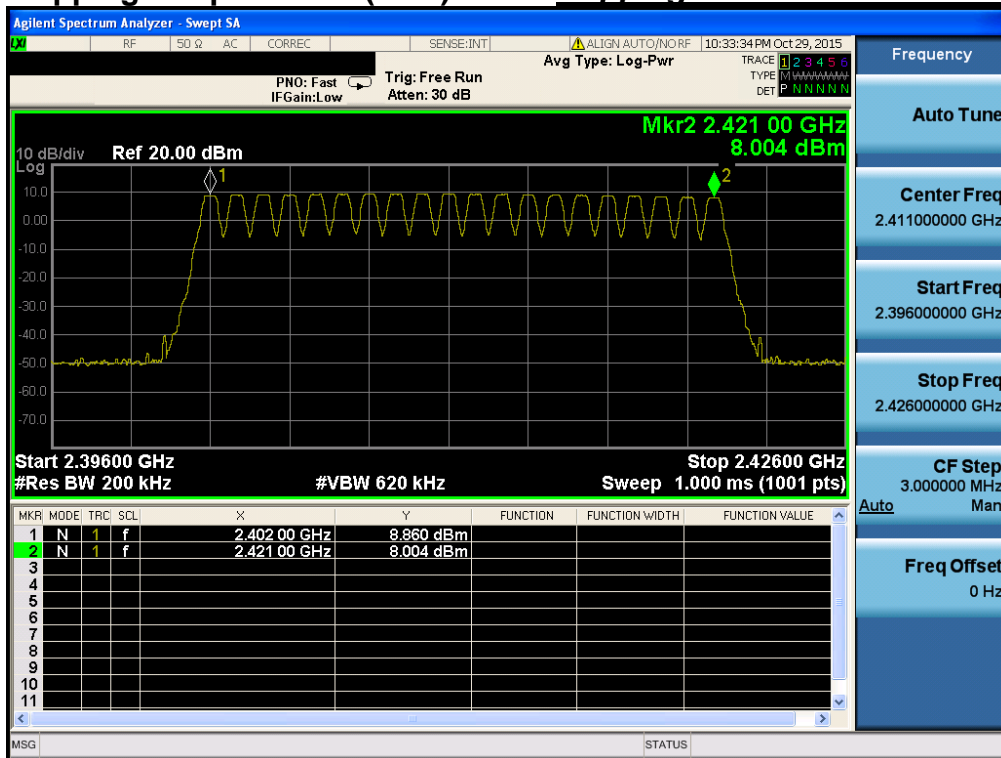

Number of Hopping Frequencies 1(AFH)

Hopping mode : Enable & $\pi/4$ -DQPSK

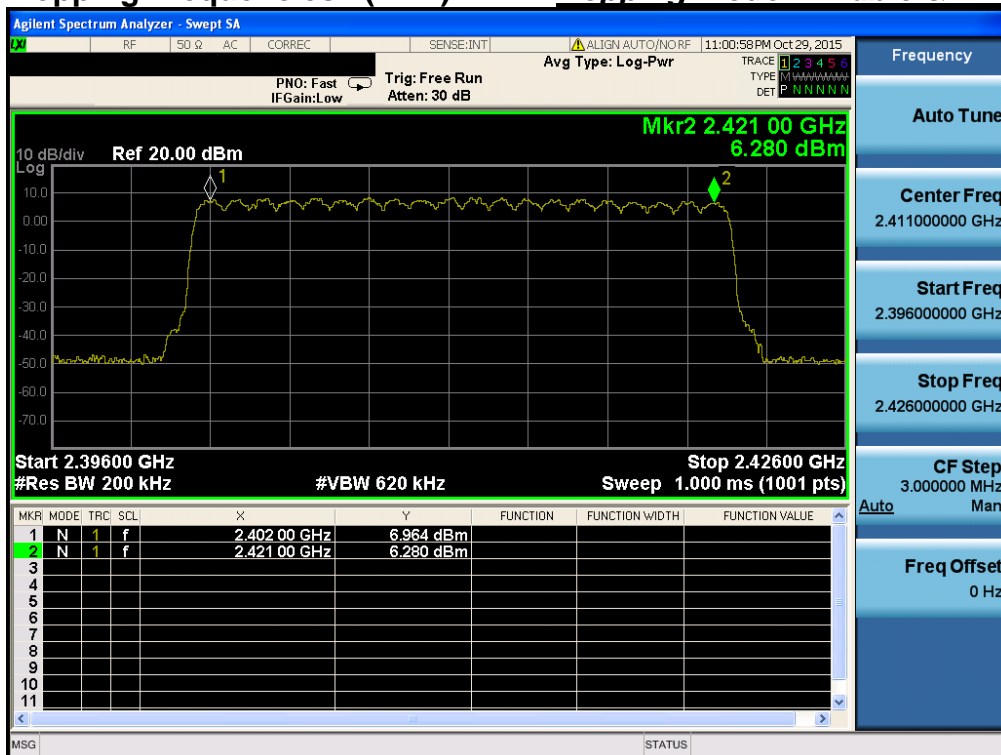

Number of Hopping Frequencies 1(AFH) *Hopping mode : Enable & 8DPSK*

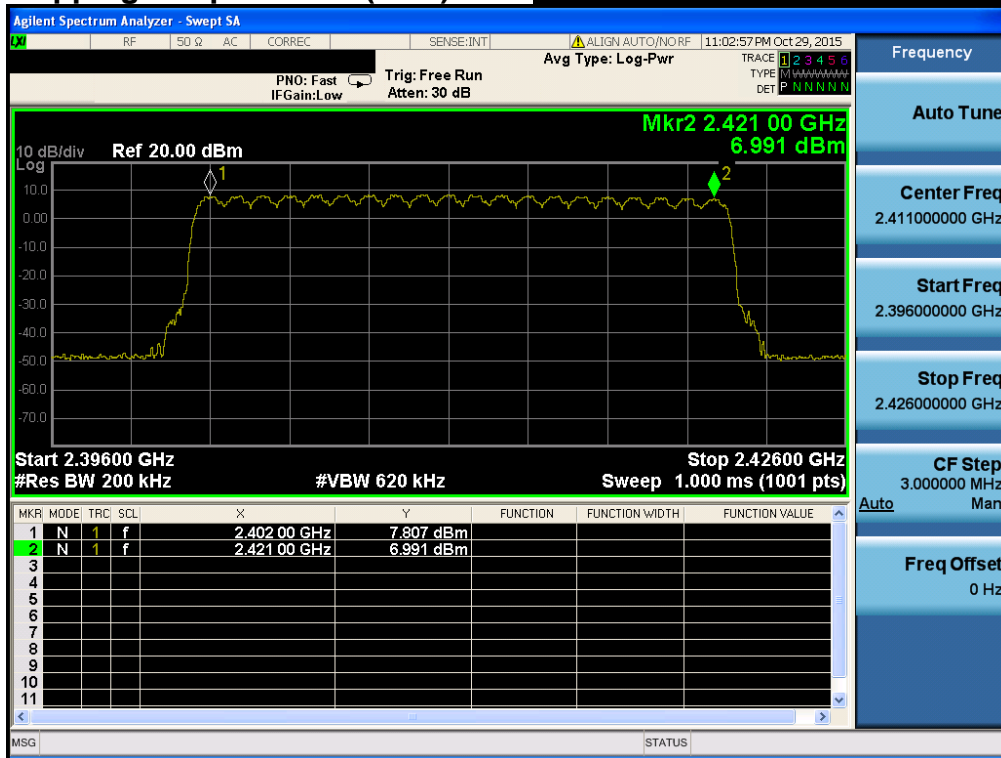

6. Time of Occupancy (Dwell Time)

6.1 Test Setup

Refer to the APPENDIX I.

6.2 Limit

The maximum permissible time of occupancy is 400 ms within a period of 400 ms multiplied by the number of hopping channels employed.

6.3 Test Procedure

The dwell time was measured with a spectrum analyzer connected to the antenna terminal, while EUT had its hopping function enabled.

The spectrum analyzer is set to :

Center frequency = 2441 MHz

Span = zero

RBW = 1 MHz (RBW shall be \leq channel spacing and where possible RBW should be set $\gg 1 / T$, where T is the expected dwell time per channel)

VBW \geq RBW

Detector function = peak

Trace = max hold

6.4 Test Results

FH mode

Hopping mode	Packet Type	Number of hopping Channels	Burst On Time (ms)	Period (ms)	Test Result (sec)
Enable	DH 5	79	2.880	3.750	0.307
	2 DH 5	79	2.880	3.750	0.307
	3 DH 5	79	2.880	3.750	0.307

AFH mode

Hopping mode	Packet Type	Number of hopping Channels	Burst On Time (ms)	Period (ms)	Test Result (sec)
Enable	DH 5	20	2.880	3.750	0.154
	2 DH 5	20	2.880	3.750	0.154
	3 DH 5	20	2.880	3.750	0.154

Note 1 : Dwell Time = $0.4 \times \text{Hopping channel} \times \text{Burst ON time} \times ((\text{Hopping rate} \div \text{Time slots}) \div \text{Hopping channel})$

- Time slots for DH5 = 6 slots (TX = 5 slot / RX = 1 slot)
- Hopping Rate = 1600 for FH mode & 800 for AFH mode

Note 2 : See next pages for actual measured spectrum plots.

Time of Occupancy (FH)

Hopping mode : Enable & GFSK

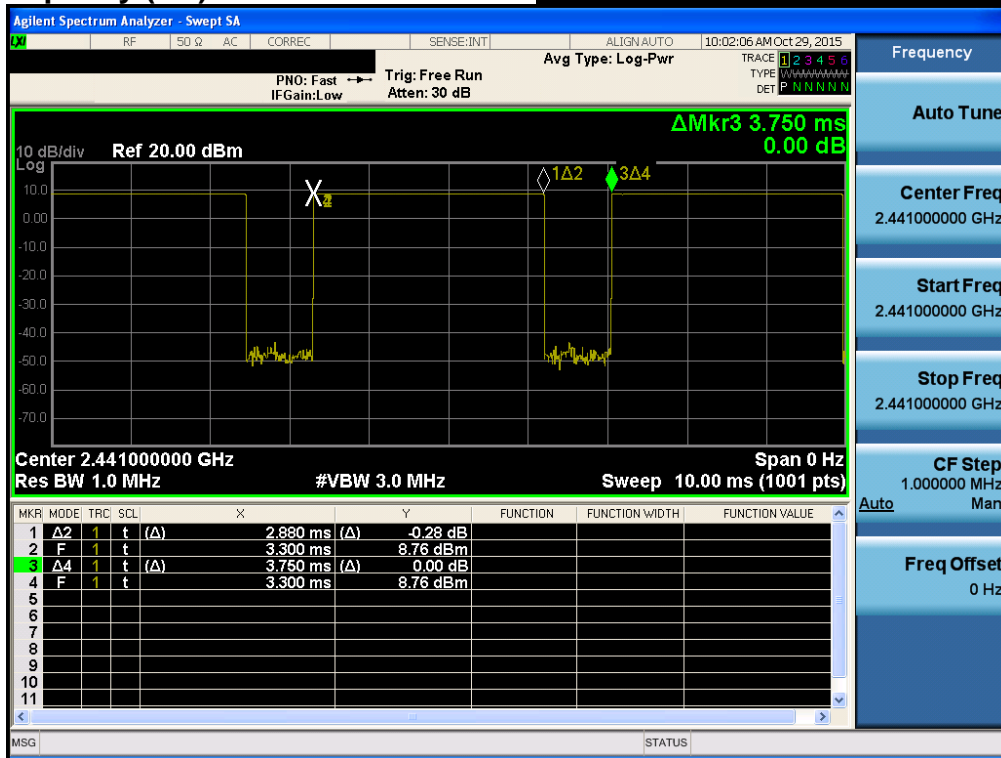

Time of Occupancy (FH)

Hopping mode : Enable & π/4-DQPSK

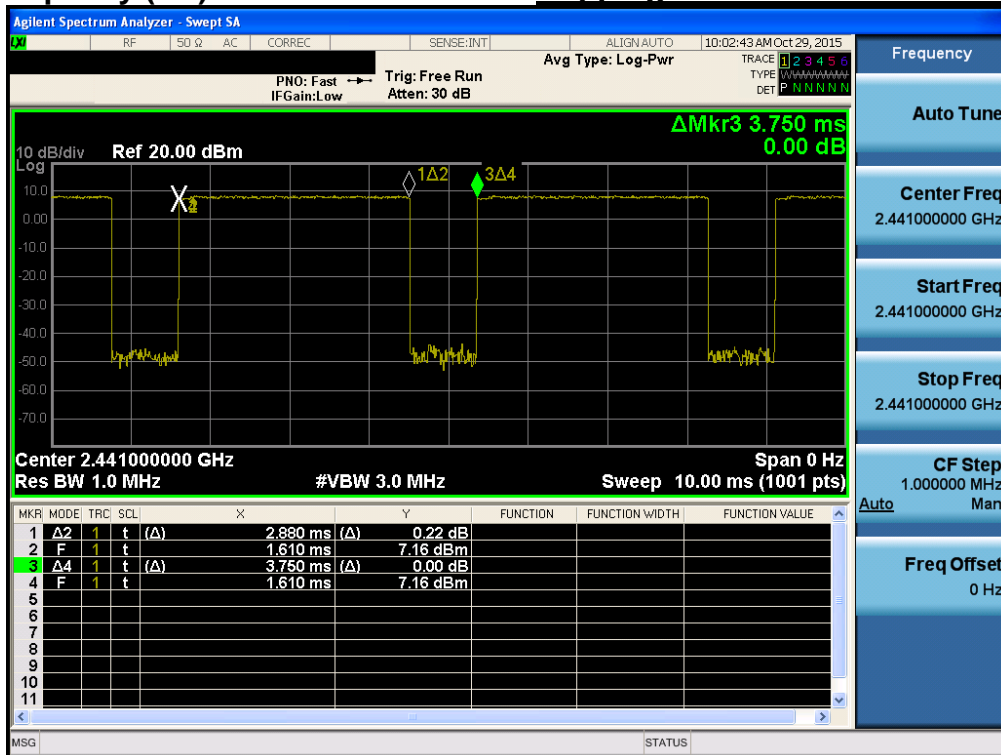

Time of Occupancy (FH)

Hopping mode : Enable & 8DPSK

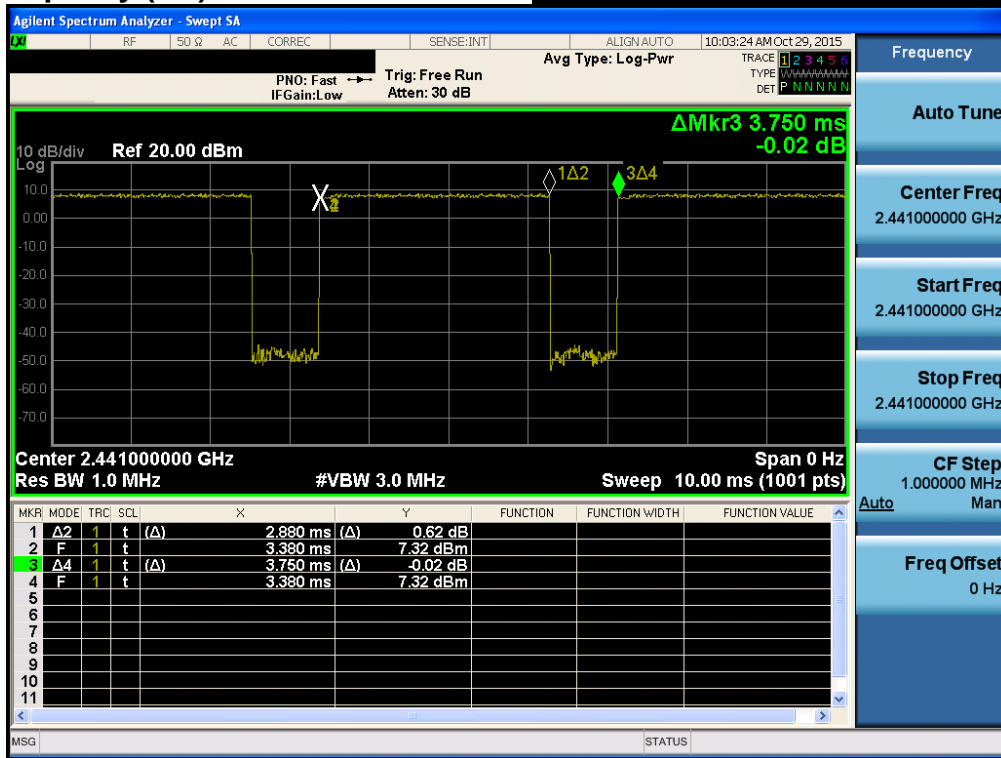

Time of Occupancy (AFH)

Hopping mode : Enable & GFSK

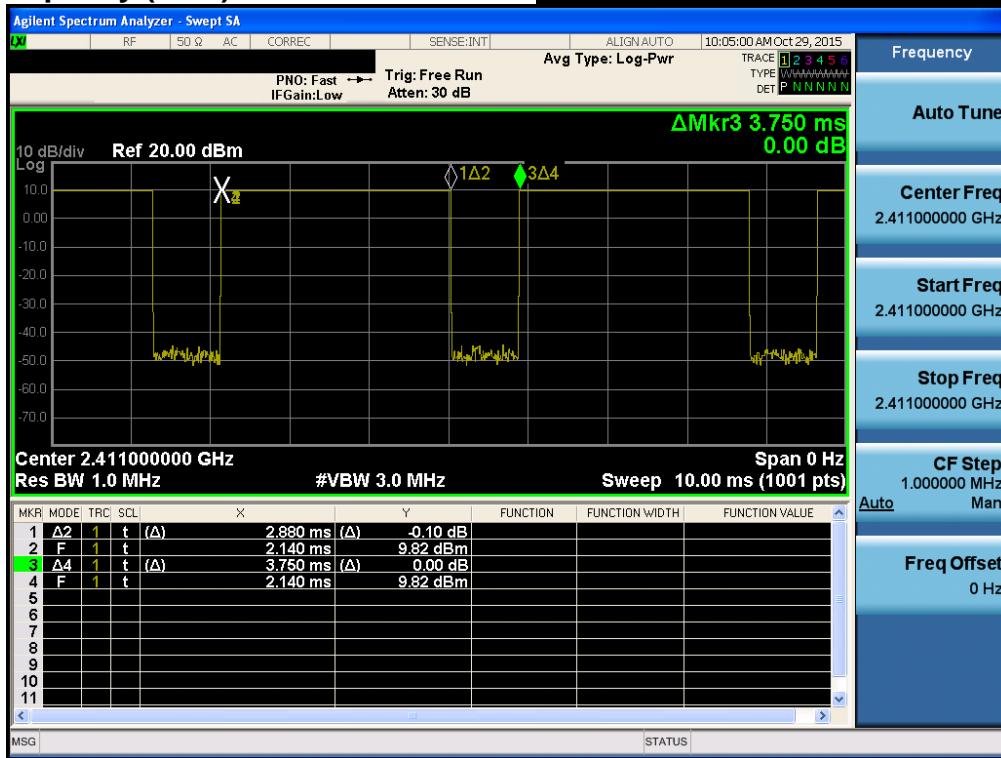

Time of Occupancy (AFH)

Hopping mode : Enable & π/4-DQPSK

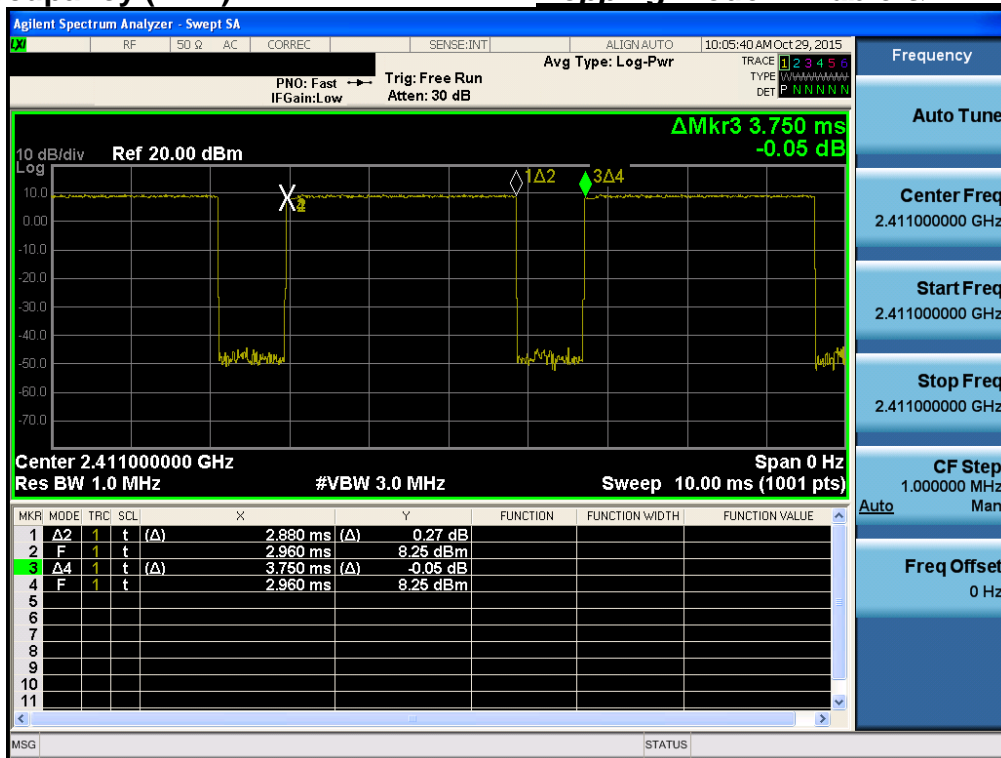

Time of Occupancy (AFH)

Hopping mode : Enable & 8DPSK

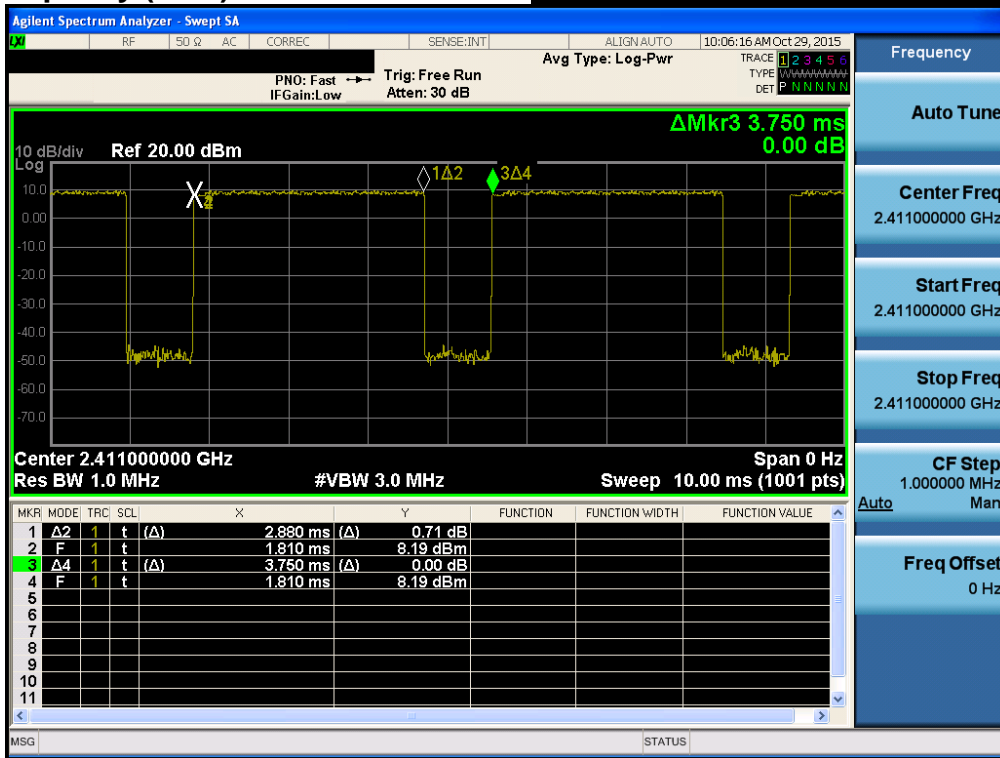

7. Transmitter Radiated Spurious Emissions and Conducted Spurious Emission

7.1 Test Setup

Refer to the APPENDIX I.

7.2 Limit

According to §15.247(d), in any 100 kHz bandwidth outside the frequency band in which the spread spectrum or digitally modulated intentional radiator is operating, the radio frequency power that is produced by the intentional radiator shall be at least 20 dB below that in the 100 kHz bandwidth within the band that contains the highest level of the desired power, based on either an RF conducted or a radiated measurement, provided the transmitter demonstrates compliance with the peak conducted power limits. If the transmitter complies with the conducted power limits based on the use of RMS averaging over a time interval, as permitted under paragraph(b)(3) of this section, the attenuation required under this paragraph shall be 30 dB instead of 20 dB. Attenuation below the general limits specified in section §15.209(a) is not required. In addition, radiated emission which in the restricted band, as define in section §15.205(a), must also comply the radiated emission limits specified in section §15.209(a) (see section §15.205(c))

According to § 15.209(a), except as provided elsewhere in this Subpart, the emissions from an intentional radiator shall not exceed the field strength levels specified in the following table

Frequency (MHz)	Limit (uV/m)	Measurement Distance (meter)
0.009 ~ 0.490	2400/F (kHz)	300
0.490 ~ 1705	24000/F (kHz)	30
1705 ~ 30.0	30	30
30 ~ 88	100 **	3
88 ~ 216	150 **	3
216 ~ 960	200 **	3
Above 960	500	3

** Except as provided in 15.209(g), fundamental emissions from intentional radiators operating under this Section shall not be located in the frequency bands 54 - 72 MHz, 76 - 88 MHz, 174 - 216 MHz or 470 - 806 MHz. However, operation within these frequency bands is permitted under other sections of this Part, e.g. 15.231 and 15.241.

According to § 15.205(a) and (b), only spurious emissions are permitted in any of the frequency bands listed below :

MHz	MHz	MHz	MHz	GHz	GHz
0.009 ~ 0.110	8.41425 ~ 8.41475	108 ~ 121.94	1300 ~ 1427	4.5 ~ 5.15	14.47 ~ 14.5
0.495 ~ 0.505	12.29 ~ 12.293	123 ~ 138	1435 ~ 1626.5	5.35 ~ 5.46	15.35 ~ 16.2
2.1735 ~ 2.1905	12.51975 ~ 12.52025	149.9 ~ 150.05	1645.5 ~ 1646.5	7.25 ~ 7.75	17.7 ~ 21.4
4.125 ~ 4.128	12.57675 ~ 12.57725	156.52475 ~	1660 ~ 1710	8.025 ~ 8.5	22.01 ~ 23.12
4.17725 ~ 4.17775	13.36 ~ 13.41	156.52525	1718.8 ~ 1722.2	9.0 ~ 9.2	23.6 ~ 24.0
4.20725 ~ 4.20775	16.42 ~ 16.423	156.7 ~ 156.9	2200 ~ 2300	9.3 ~ 9.5	31.2 ~ 31.8
6.215 ~ 6.218	16.69475 ~ 16.69525	162.0125 ~ 167.17	2310 ~ 2390	10.6 ~ 12.7	36.43 ~ 36.5
6.26775 ~ 6.26825	16.80425 ~ 16.80475	167.72 ~ 173.2	2483.5 ~ 2500	13.25 ~ 13.4	Above 38.6
6.31175 ~ 6.31225	25.5 ~ 25.67	240 ~ 285	2655 ~ 2900		
8.291 ~ 8.294	37.5 ~ 38.25	322 ~ 335.4	3260 ~ 3267		
8.362 ~ 8.366	73 ~ 74.6	399.90 ~ 410	3332 ~ 3339		
8.37625 ~ 8.38675	74.8 ~ 75.2	608 ~ 614	3345.8 ~ 3358		
		960 ~ 1240	3600 ~ 4400		

The field strength of emissions appearing within these frequency bands shall not exceed the limits shown in §15.209. At frequencies equal to or less than 1000 MHz, compliance with the limits in §15.209 shall be demonstrated using measurement instrumentation employing a CISPR quasi-peak detector. Above 1000 MHz, compliance with the emission limits in §15.209 shall be demonstrated based on the average value of the measured emissions. The provisions in §15.35 apply to these measurements.

7.3. Test Procedures

7.3.1. Test Procedures for Radiated Spurious Emissions

1. The EUT is placed on a non-conductive table. For emission measurements at or below 1 GHz, the table height is 80 cm. For emission measurements above 1 GHz, the table height is 1.5 m.
The table was rotated 360 degrees to determine the position of the highest radiation.
2. During performing radiated emission below 1 GHz, the EUT was set 3 meters away from the interference receiving antenna, which was mounted on the top of a variable-height antenna tower. During performing radiated emission above 1 GHz, the EUT was set 1 or 3 meter away from the interference-receiving antenna.
3. For measurements above 1GHz absorbers are placed on the floor between the turn table and the antenna mast in such a way so as to maximize the reduction of reflections. For measurements below 1 GHz, the absorbers are removed.
4. The antenna is a broadband antenna, and its height is varied from one meter to four meters above the ground to determine the maximum value of the field strength. Both horizontal and vertical polarizations of the antenna are set to make the measurement.
5. For each suspected emission, the EUT was arranged to its worst case and then the antenna was tuned to heights from 1 meter to 4 meters and the table was turned from 0 degrees to 360 degrees to find the maximum reading.
6. The test-receiver system was set to Peak Detect Function and Specified Bandwidth with Maximum Hold Mode.
7. If the emission level of the EUT in peak mode was 10 dB lower than the limit specified, then testing could be stopped and the peak values of the EUT would be reported. Otherwise the emissions that did not have 10 dB margin would be re-tested one by one using peak, quasi-peak or average method as specified and then reported in a data sheet.

NOTE 1. The resolution bandwidth and video bandwidth of test receiver/spectrum analyzer is 120 kHz for Quasi-peak detection (QP) at frequency below 1 GHz.

NOTE 2. The resolution bandwidth and video bandwidth of test receiver/spectrum analyzer is 1 MHz for Peak detection and frequency above 1 GHz.

NOTE 3. The resolution bandwidth of test receiver/spectrum analyzer is 1 MHz and the video bandwidth is 1 kHz for Average detection (AV) at frequency above 1 GHz.

7.3.2. Test Procedures for Conducted Spurious Emissions

1. The transmitter output was connected to the spectrum analyzer.
2. The **reference level** of the fundamental frequency was measured with the spectrum analyzer using RBW = 100 kHz, VBW = 300 kHz.
3. The conducted spurious emission was tested each ranges were set as below.

Frequency range : 9 kHz ~ 30 MHz

RBW = 100 kHz, VBW = 300 kHz, SWEEP TIME = AUTO, DETECTOR = PEAK, TRACE = MAX HOLD, SWEEP POINT : 40001

Frequency range : 30 MHz ~ 10 GHz, 10 GHz ~ 25 GHz

RBW = 1 MHz, VBW = 3 MHz, SWEEP TIME = AUTO, DETECTOR = PEAK, TRACE = MAX HOLD, SWEEP POINT : 40001

LIMIT LINE = 20 dB below of the reference level of above measurement procedure Step 2. (RBW = 100 kHz, VBW = 300 kHz)

If the emission level with above setting was close to the limit (ie, less than 3 dB margin) then zoom scan is required using RBW = 100 kHz, VBW = 300 kHz, SPAN = 100 MHz and BINS = 2001 to get accurate emission level within 100 kHz BW.

Also the path loss for conducted measurement setup was used as described on the Appendix I of this test report.

7.4. Test Results

7.4.1. Radiated Emissions

9 kHz ~ 25 GHz Data (Modulation : GFSK)

▪ Lowest Channel

Frequency (MHz)	ANT Pol	The worst case EUT Position (Axis)	Detector Mode	Reading (dBuV)	T.F (dB/m)	D.C.F (dB)	Distance Factor (dB)	Result (dBuV/m)	Limit (dBuV/m)	Margin (dB)
2484.24	H	Z	PK	46.84	2.84	N/A	N/A	49.68	74.00	24.32
2390.00	H	Z	AV	34.86	2.84	-24.79	N/A	12.91	54.00	41.09
4804.09	V	Z	PK	47.68	7.99	N/A	N/A	55.67	74.00	18.33
4803.99	V	Z	AV	37.41	7.99	-24.79	N/A	20.61	54.00	33.39

▪ Middle Channel

Frequency (MHz)	ANT Pol	The worst case EUT Position (Axis)	Detector Mode	Reading (dBuV)	T.F (dB/m)	D.C.F (dB)	Distance Factor (dB)	Result (dBuV/m)	Limit (dBuV/m)	Margin (dB)
4882.39	V	Z	PK	48.82	8.03	N/A	N/A	56.85	74.00	17.15
4882.04	V	Z	AV	42.41	8.03	-24.79	N/A	25.65	54.00	28.35

▪ Highest Channel

Frequency (MHz)	ANT Pol	The worst case EUT Position (Axis)	Detector Mode	Reading (dBuV)	T.F (dB/m)	D.C.F (dB)	Distance Factor (dB)	Result (dBuV/m)	Limit (dBuV/m)	Margin (dB)
2483.77	H	Z	PK	54.69	3.19	N/A	N/A	57.88	74.00	16.12
2483.51	H	Z	AV	40.11	3.19	-24.79	N/A	18.51	54.00	35.49
4959.65	V	Z	PK	48.86	8.19	N/A	N/A	57.05	74.00	16.95
4959.98	V	Z	AV	42.38	8.19	-24.79	N/A	25.78	54.00	28.22

▪ **Note.**

1. No other spurious and harmonic emissions were found greater than listed emissions on above table.

2. Information of Distance Factor

For finding emissions, the test distance might be reduced from 3m to 1m. In this case, the distance factor(-9.54dB) is applied to the result.

- Calculation of distance factor = $20 \log(\text{applied distance} / \text{required distance}) = 20 \log(1 \text{ m} / 3 \text{ m}) = \underline{-9.54 \text{ dB}}$

When distance factor is "N/A", the distance is 3 m and distance factor is not applied.

3. D.C.F Calculation. (D.C.F = Duty Cycle Correction Factor)

- Time to cycle through all channels = $\Delta t = T [\text{ms}] \times 20$ minimum hopping channels, where T = pulse width = **2.88 ms**

- $100 \text{ ms} / \Delta t [\text{ms}] = H \rightarrow$ Round up to next highest integer, to account for worst case, $H' = 100 / (2.88 \times 20) = 1.736 \approx 2$

- The Worst Case Dwell Time = $T [\text{ms}] \times H' = 2.88 \text{ ms} \times 2 = 5.76 \text{ ms}$

- D.C.F = $20 \log(\text{The Worst Case Dwell Time} / 100 \text{ ms}) \text{ dB} = 20 \log(5.76 / 100) = \underline{-24.79 \text{ dB}}$

4. Sample Calculation.

Margin = Limit – Result / Result = Reading + T.F + D.C.F / T.F = AF + CL – AG

Where, T.F = Total Factor, AF = Antenna Factor, CL = Cable Loss, AG = Amplifier Gain.

9 kHz ~ 25 GHz Data (Modulation : $\pi/4$ DQPSK)

▪ Lowest Channel

Frequency (MHz)	ANT Pol	The worst case EUT Position (Axis)	Detector Mode	Reading (dBuV)	T.F (dB/m)	D.C.F (dB)	Distance Factor (dB)	Result (dBuV/m)	Limit (dBuV/m)	Margin (dB)
2389.49	H	Z	PK	47.01	2.84	N/A	N/A	49.85	74.00	24.15
2389.73	H	Z	AV	34.74	2.84	-24.79	N/A	12.79	54.00	41.21
4804.21	V	Z	PK	45.54	7.99	N/A	N/A	53.53	74.00	20.47
4804.12	V	Z	AV	33.51	7.99	-24.79	N/A	16.71	54.00	37.29

▪ Middle Channel

Frequency (MHz)	ANT Pol	The worst case EUT Position (Axis)	Detector Mode	Reading (dBuV)	T.F (dB/m)	D.C.F (dB)	Distance Factor (dB)	Result (dBuV/m)	Limit (dBuV/m)	Margin (dB)
4882.49	V	Z	PK	47.76	8.03	N/A	N/A	55.79	74.00	18.21
4882.00	V	Z	AV	36.90	8.03	-24.79	N/A	20.14	54.00	33.86

▪ Highest Channel

Frequency (MHz)	ANT Pol	The worst case EUT Position (Axis)	Detector Mode	Reading (dBuV)	T.F (dB/m)	D.C.F (dB)	Distance Factor (dB)	Result (dBuV/m)	Limit (dBuV/m)	Margin (dB)
2483.74	H	Z	PK	52.69	3.19	N/A	N/A	55.88	74.00	18.12
2483.64	H	Z	AV	39.37	3.19	-24.79	N/A	17.77	54.00	36.23
4959.67	V	Z	PK	47.80	8.19	N/A	N/A	55.99	74.00	18.01
4959.93	V	Z	AV	36.85	8.19	-24.79	N/A	20.25	54.00	33.75

▪ **Note.**

1. No other spurious and harmonic emissions were found greater than listed emissions on above table.

2. Information of Distance Factor

For finding emissions, the test distance might be reduced from 3m to 1m. In this case, the distance factor(-9.54dB) is applied to the result.

- Calculation of distance factor = $20 \log(\text{applied distance} / \text{required distance}) = 20 \log(1 \text{ m} / 3 \text{ m}) = -9.54 \text{ dB}$

When distance factor is "N/A", the distance is 3 m and distance factor is not applied.

3. D.C.F Calculation. (D.C.F = Duty Cycle Correction Factor)

- Time to cycle through all channels = $\Delta t = T [\text{ms}] \times 20$ minimum hopping channels, where T = pulse width = **2.88 ms**

- $100 \text{ ms} / \Delta t [\text{ms}] = H \rightarrow$ Round up to next highest integer, to account for worst case, $H' = 100 / (2.88 \times 20) = 1.736 \approx 2$

- The Worst Case Dwell Time = $T [\text{ms}] \times H' = 2.88 \text{ ms} \times 2 = 5.76 \text{ ms}$

- D.C.F = $20 \text{ Log}(\text{The Worst Case Dwell Time} / 100 \text{ ms}) \text{ dB} = 20 \text{ log}(5.76 / 100) = -24.79 \text{ dB}$

4. Sample Calculation.

Margin = Limit – Result / Result = Reading + T.F + D.C.F / T.F = AF + CL – AG

Where, T.F = Total Factor, AF = Antenna Factor, CL = Cable Loss, AG = Amplifier Gain.

9 kHz ~ 25 GHz Data (Modulation : 8DPSK)

▪ **Lowest Channel**

Frequency (MHz)	ANT Pol	The worst case EUT Position (Axis)	Detector Mode	Reading (dBuV)	T.F (dB/m)	D.C.F (dB)	Distance Factor (dB)	Result (dBuV/m)	Limit (dBuV/m)	Margin (dB)
2389.25	H	Z	PK	47.20	2.84	N/A	N/A	50.04	74.00	23.96
2389.79	H	Z	AV	34.62	2.84	-24.79	N/A	12.67	54.00	41.33
4803.75	V	Z	PK	46.49	7.99	N/A	N/A	54.48	74.00	19.52
4803.89	V	Z	AV	33.60	7.99	-24.79	N/A	16.80	54.00	37.20

▪ **Middle Channel**

Frequency (MHz)	ANT Pol	The worst case EUT Position (Axis)	Detector Mode	Reading (dBuV)	T.F (dB/m)	D.C.F (dB)	Distance Factor (dB)	Result (dBuV/m)	Limit (dBuV/m)	Margin (dB)
4881.90	V	Z	PK	48.02	8.03	N/A	N/A	56.05	74.00	17.95
4882.04	V	Z	AV	36.80	8.03	-24.79	N/A	20.04	54.00	33.96

▪ **Highest Channel**

Frequency (MHz)	ANT Pol	The worst case EUT Position (Axis)	Detector Mode	Reading (dBuV)	T.F (dB/m)	D.C.F (dB)	Distance Factor (dB)	Result (dBuV/m)	Limit (dBuV/m)	Margin (dB)
2483.68	H	Z	PK	53.48	3.19	N/A	N/A	56.67	74.00	17.33
2483.50	H	Z	AV	39.49	3.19	-24.79	N/A	17.89	54.00	36.11
4960.13	V	Z	PK	47.73	8.19	N/A	N/A	55.92	74.00	18.08
4960.04	V	Z	AV	36.93	8.19	-24.79	N/A	20.33	54.00	33.67

▪ **Note.**

- No other spurious and harmonic emissions were found greater than listed emissions on above table.
- Information of Distance Factor
 For finding emissions, the test distance might be reduced from 3m to 1m. In this case, the distance factor(-9.54dB) is applied to the result.
 - Calculation of distance factor = $20 \log(\text{applied distance} / \text{required distance}) = 20 \log(1 \text{ m} / 3 \text{ m}) = -9.54 \text{ dB}$
 When distance factor is "N/A", the distance is 3 m and distance factor is not applied.
- D.C.F Calculation. (D.C.F = Duty Cycle Correction Factor)
 - Time to cycle through all channels = $\Delta t = T [\text{ms}] \times 20$ minimum hopping channels, where T = pulse width = **2.88 ms**
 - $100 \text{ ms} / \Delta t [\text{ms}] = H \rightarrow$ Round up to next highest integer, to account for worst case, $H' = 100 / (2.88 \times 20) = 1.736 \approx 2$
 - The Worst Case Dwell Time = $T [\text{ms}] \times H' = 2.88 \text{ ms} \times 2 = 5.76 \text{ ms}$
 - D.C.F = $20 \text{ Log}(\text{The Worst Case Dwell Time} / 100 \text{ ms}) \text{ dB} = 20 \log(5.76 / 100) = -24.79 \text{ dB}$
- Sample Calculation.
 $\text{Margin} = \text{Limit} - \text{Result} / \text{Result} = \text{Reading} + \text{T.F} + \text{D.C.F} / \text{T.F} = \text{AF} + \text{CL} - \text{AG}$
 Where, T.F = Total Factor, AF = Antenna Factor, CL = Cable Loss, AG = Amplifier Gain.

9 kHz ~ 25 GHz Data (*Hopping mode*)

▪ **GFSK**

Frequency (MHz)	ANT Pol	The worst case EUT Position (Axis)	Detector Mode	Reading (dBuV)	T.F (dB/m)	D.C.F (dB)	Distance Factor (dB)	Result (dBuV/m)	Limit (dBuV/m)	Margin (dB)
2387.33	H	Z	PK	47.60	2.84	N/A	N/A	50.44	74.00	23.56
2485.23	H	Z	AV	34.75	2.84	-24.79	N/A	12.80	54.00	41.20
2483.72	H	Z	PK	51.58	3.19	N/A	N/A	54.77	74.00	19.23
2483.51	H	Z	AV	39.87	3.19	-24.79	N/A	18.27	54.00	35.73

▪ **π/4DQPSK**

Frequency (MHz)	ANT Pol	The worst case EUT Position (Axis)	Detector Mode	Reading (dBuV)	T.F (dB/m)	D.C.F (dB)	Distance Factor (dB)	Result (dBuV/m)	Limit (dBuV/m)	Margin (dB)
2385.95	H	Z	PK	47.91	2.84	N/A	N/A	50.75	74.00	23.25
2389.23	H	Z	AV	34.67	2.84	-24.79	N/A	12.72	54.00	41.28
2483.71	H	Z	PK	53.40	3.19	N/A	N/A	56.59	74.00	17.41
2483.50	H	Z	AV	39.29	3.19	-24.79	N/A	17.69	54.00	36.31

▪ **8DPSK**

Frequency (MHz)	ANT Pol	The worst case EUT Position (Axis)	Detector Mode	Reading (dBuV)	T.F (dB/m)	D.C.F (dB)	Distance Factor (dB)	Result (dBuV/m)	Limit (dBuV/m)	Margin (dB)
2386.80	H	Z	PK	48.14	2.84	N/A	N/A	50.98	74.00	23.02
2389.52	H	Z	AV	34.69	2.84	-24.79	N/A	12.74	54.00	41.26
2484.03	H	Z	PK	51.85	3.19	N/A	N/A	55.04	74.00	18.96
2483.60	H	Z	AV	39.35	3.19	-24.79	N/A	17.75	54.00	36.25

▪ **Note.**

1. No other spurious and harmonic emissions were found greater than listed emissions on above table.

2. Information of Distance Factor

For finding emissions, the test distance might be reduced from 3m to 1m. In this case, the distance factor(-9.54dB) is applied to the result.

- Calculation of distance factor = $20 \log(\text{applied distance} / \text{required distance}) = 20 \log(1 \text{ m} / 3 \text{ m}) = \underline{\underline{-9.54 \text{ dB}}}$

When distance factor is "N/A", the distance is 3 m and distance factor is not applied.

3. D.C.F Calculation. (D.C.F = Duty Cycle Correction Factor)

- Time to cycle through all channels = $\Delta t = T [\text{ms}] \times 20$ minimum hopping channels, where T = pulse width = **2.88 ms**

- $100 \text{ ms} / \Delta t [\text{ms}] = H \rightarrow$ Round up to next highest integer, to account for worst case, $H' = 100 / (2.88 \times 20) = 1.736 \approx 2$

- The Worst Case Dwell Time = $T [\text{ms}] \times H' = 2.88 \text{ ms} \times 2 = 5.76 \text{ ms}$

- D.C.F = $20 \log(\text{The Worst Case Dwell Time} / 100 \text{ ms}) \text{ dB} = 20 \log(5.76 / 100) = \underline{\underline{-24.79 \text{ dB}}}$

4. Sample Calculation.

Margin = Limit – Result / Result = Reading + T.F + D.C.F / T.F = AF + CL – AG

Where, T.F = Total Factor, AF = Antenna Factor, CL = Cable Loss, AG = Amplifier Gain.

7.4.2. Conducted Spurious Emissions

Low Band-edge

Lowest Channel & Modulation : GFSK

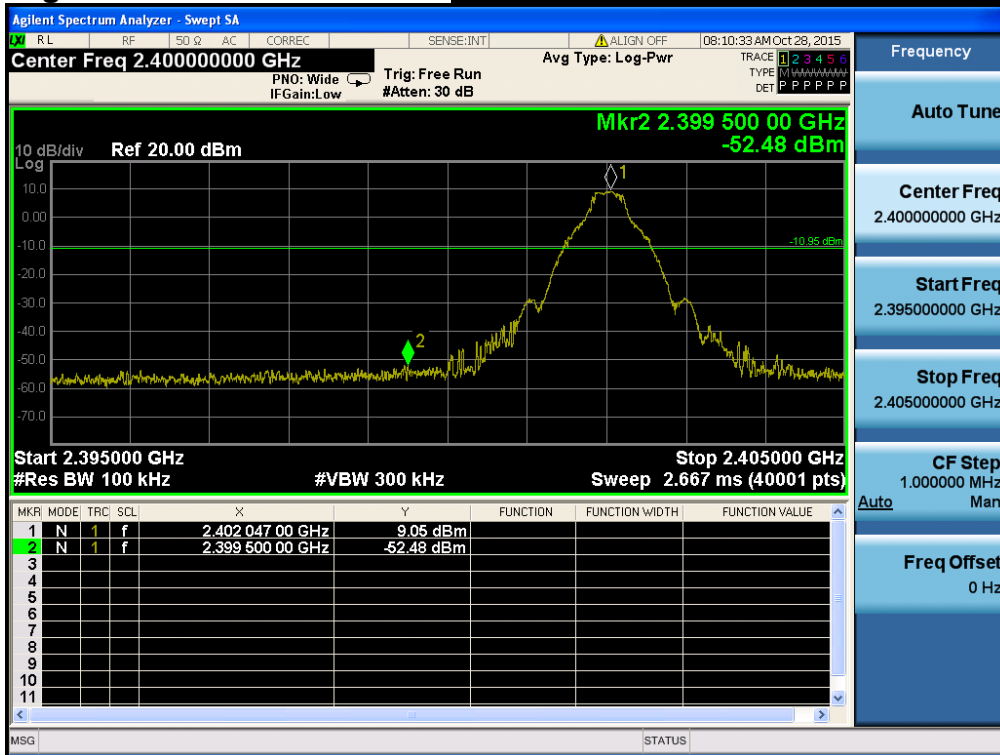

Low Band-edge

Hopping mode & Modulation : GFSK

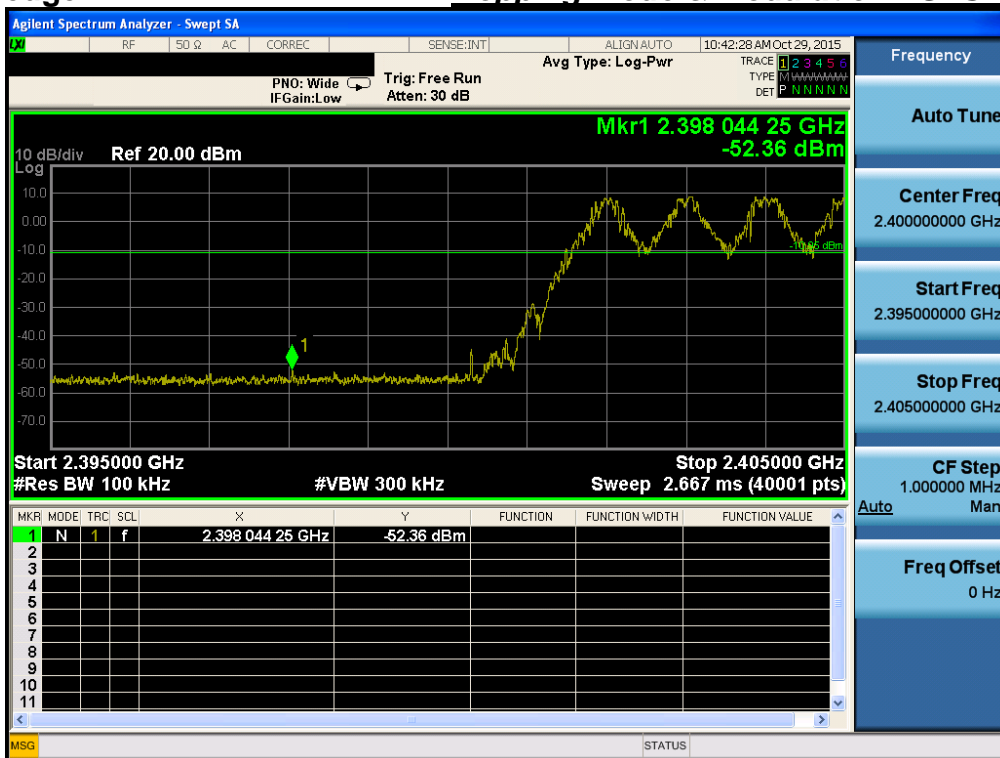

Conducted Spurious Emissions

Lowest Channel & Modulation : GFSK

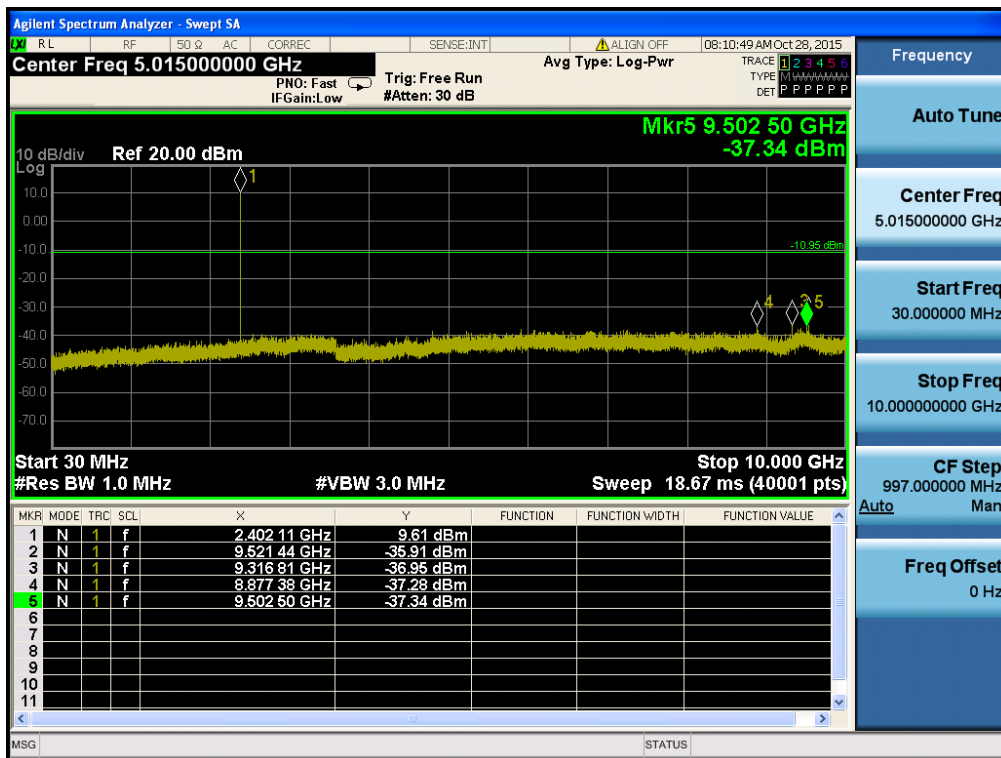
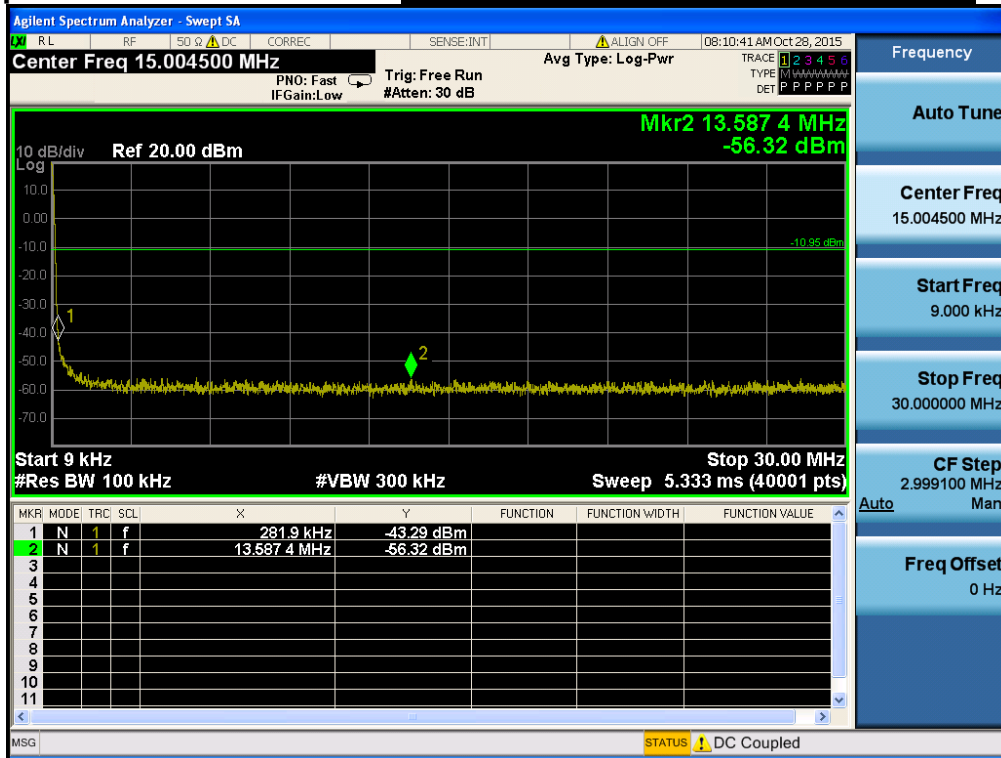

Conducted Spurious Emissions

Lowest Channel & Modulation : GFSK

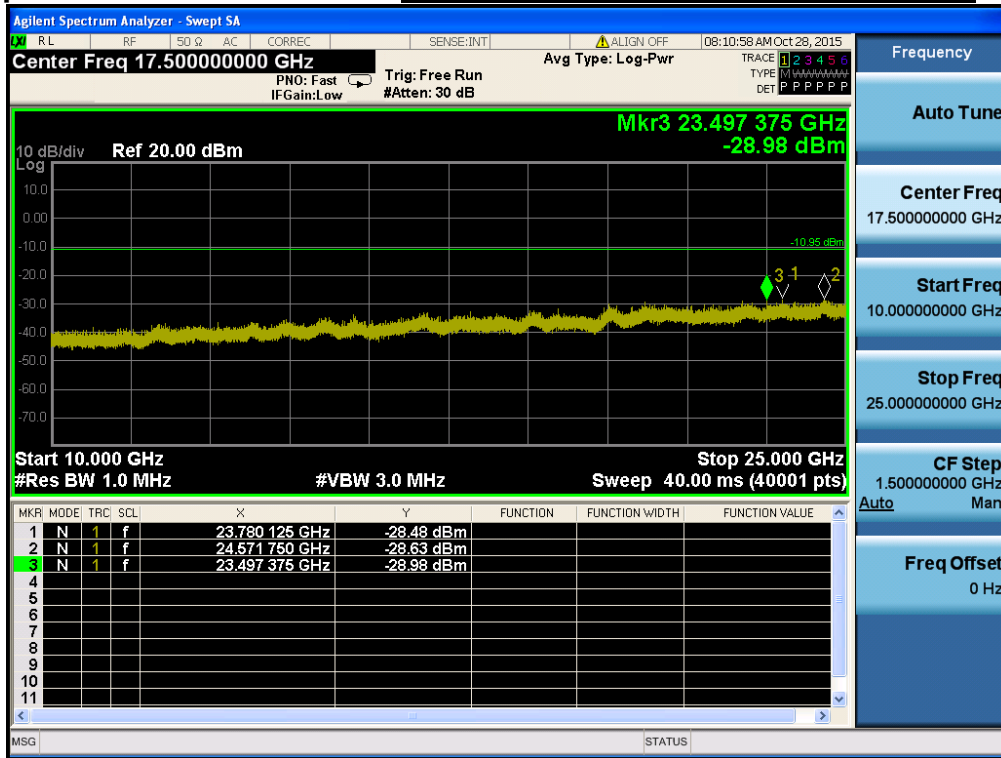

Reference for limit

Middle Channel & Modulation : GFSK

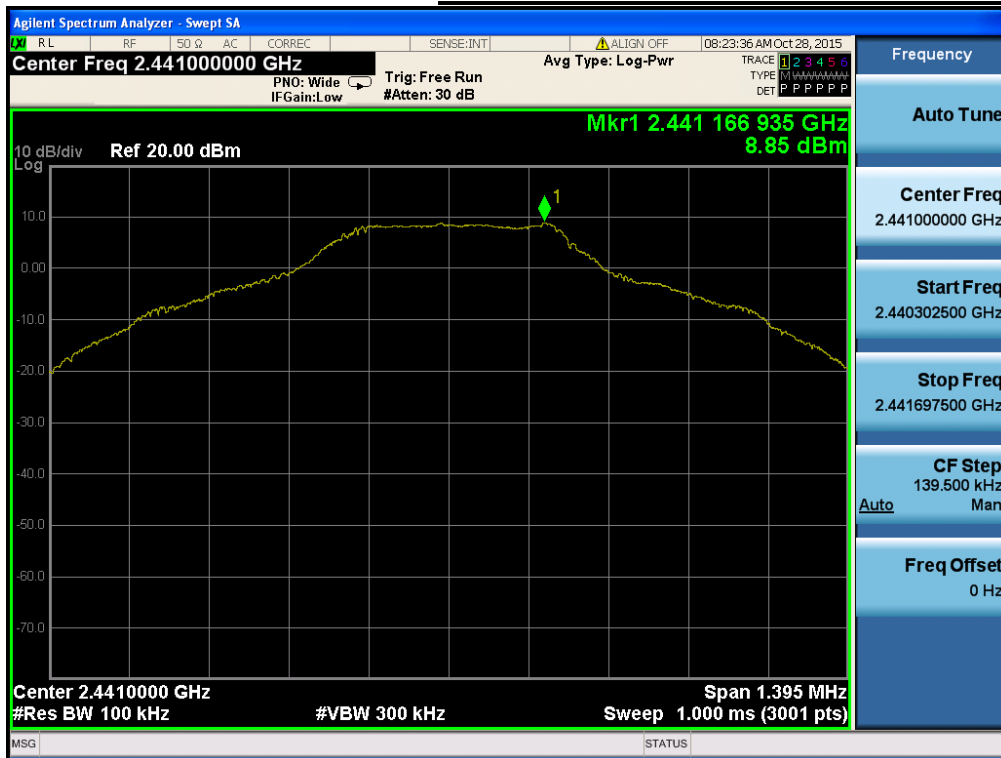

Conducted Spurious Emissions

Middle Channel & Modulation : GFSK

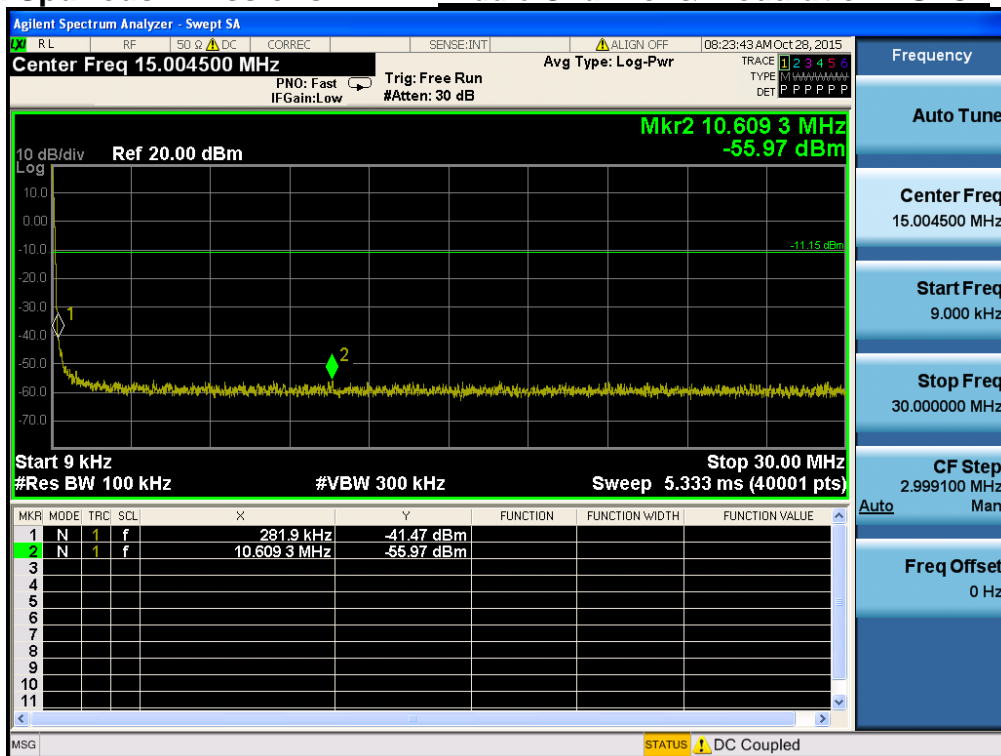

Conducted Spurious Emissions

Middle Channel & Modulation : GFSK

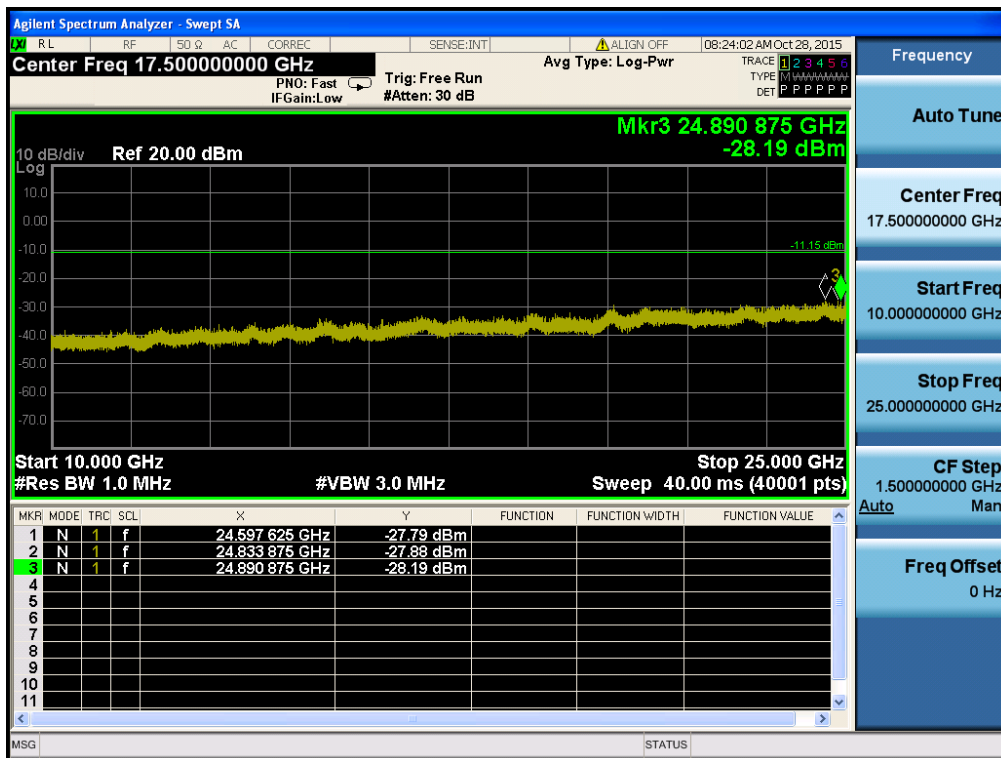
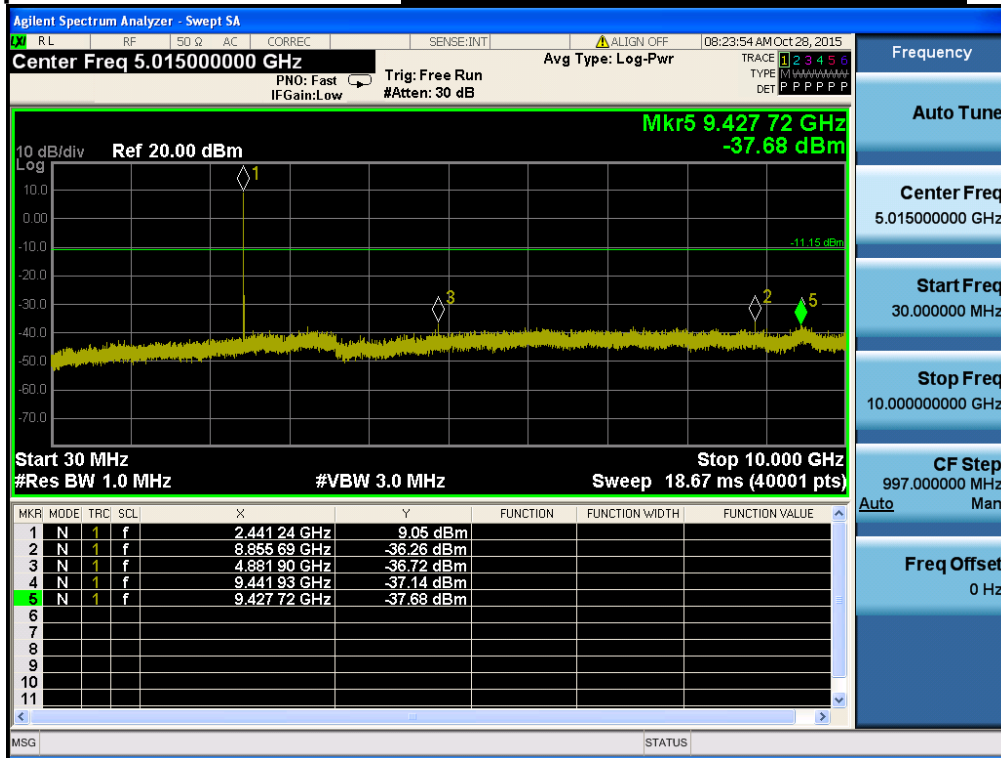

High Band-edge

Highest Channel & Modulation : GFSK

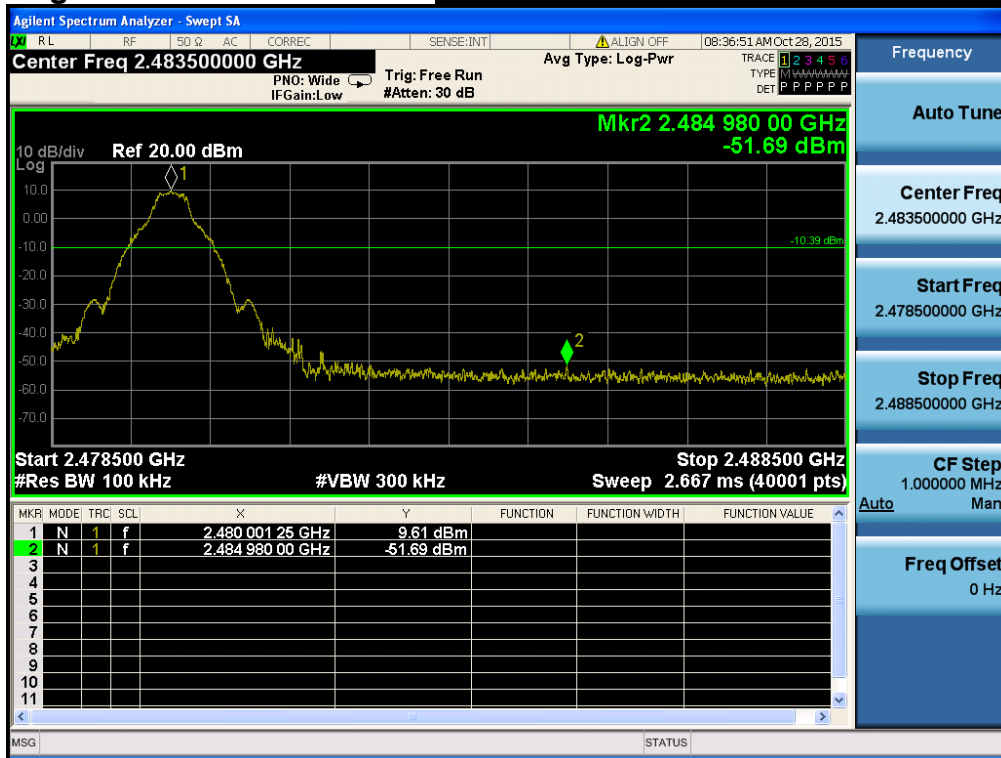

High Band-edge

Hopping mode & Modulation : GFSK



Conducted Spurious Emissions

Highest Channel & Modulation : GFSK

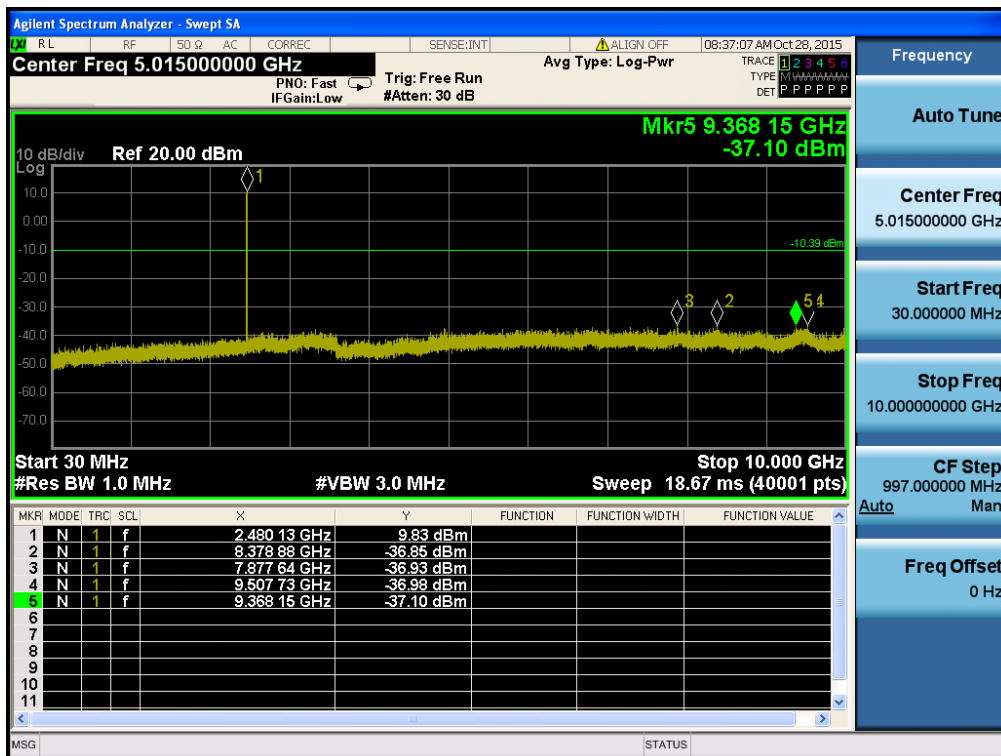
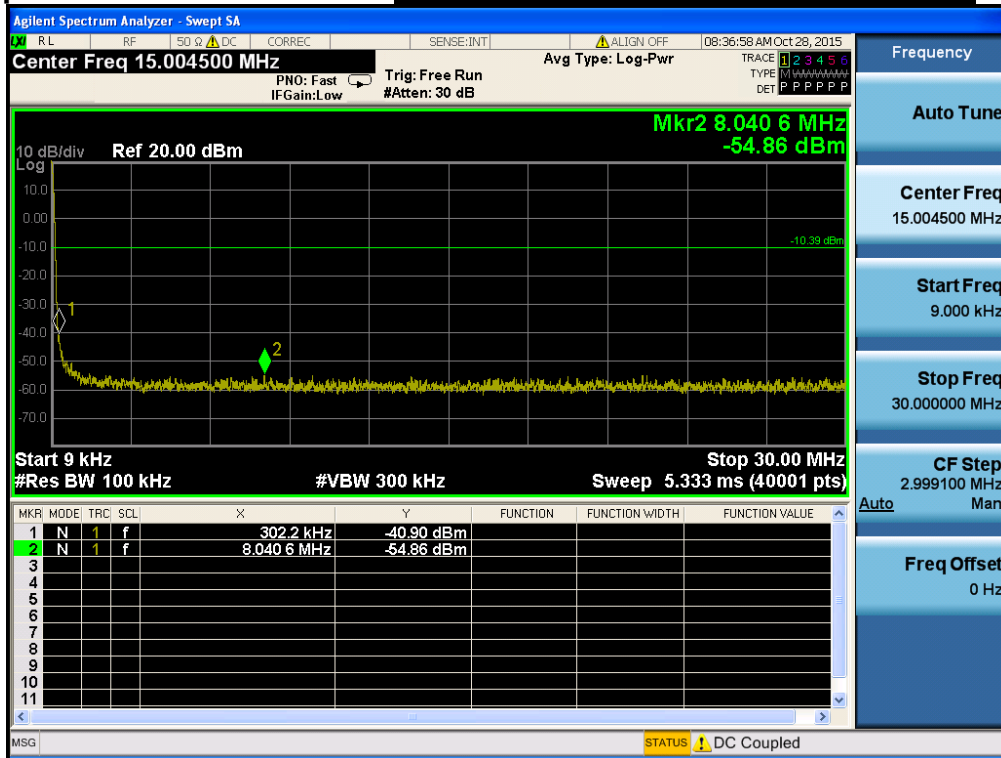



Conducted Spurious Emissions

Highest Channel & Modulation : GFSK

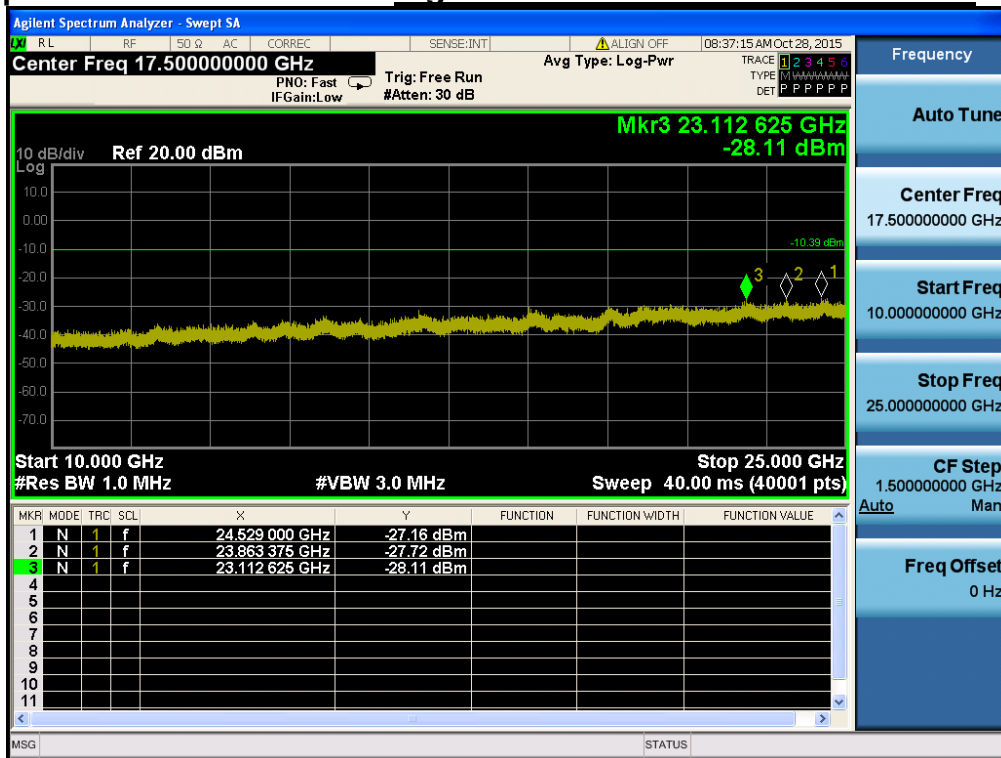

Low Band-edge

Lowest Channel & Modulation : $\pi/4$ DQPSK

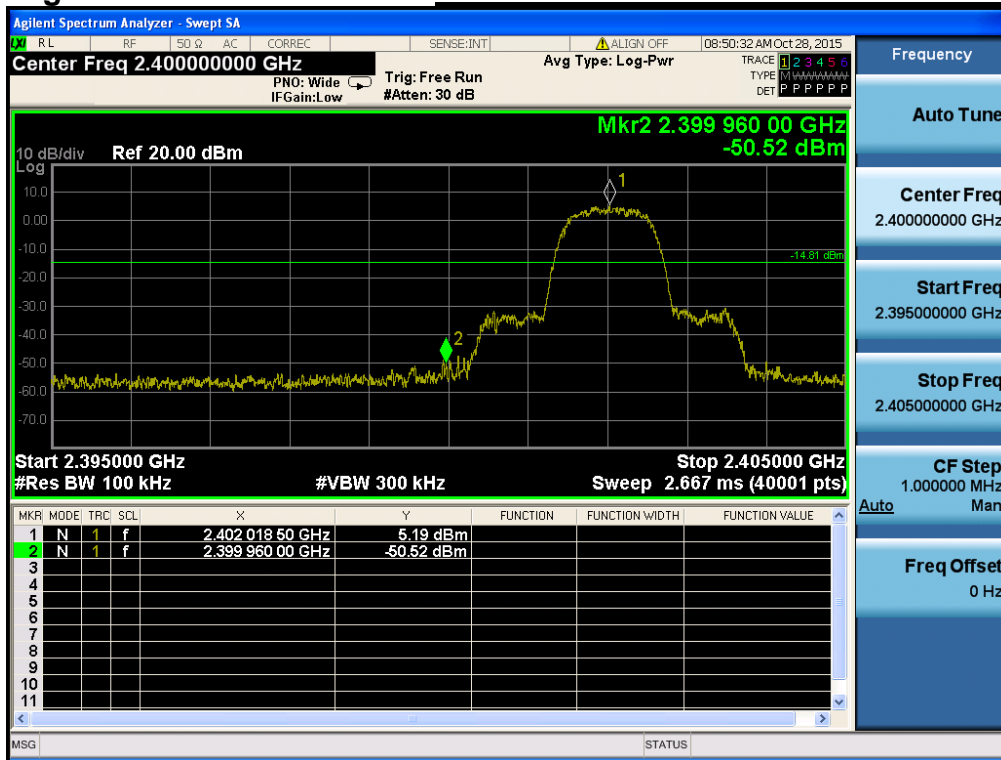

Low Band-edge

Hopping mode & Modulation : $\pi/4$ DQPSK



Conducted Spurious Emissions *Lowest Channel & Modulation : $\pi/4$ DQPSK*

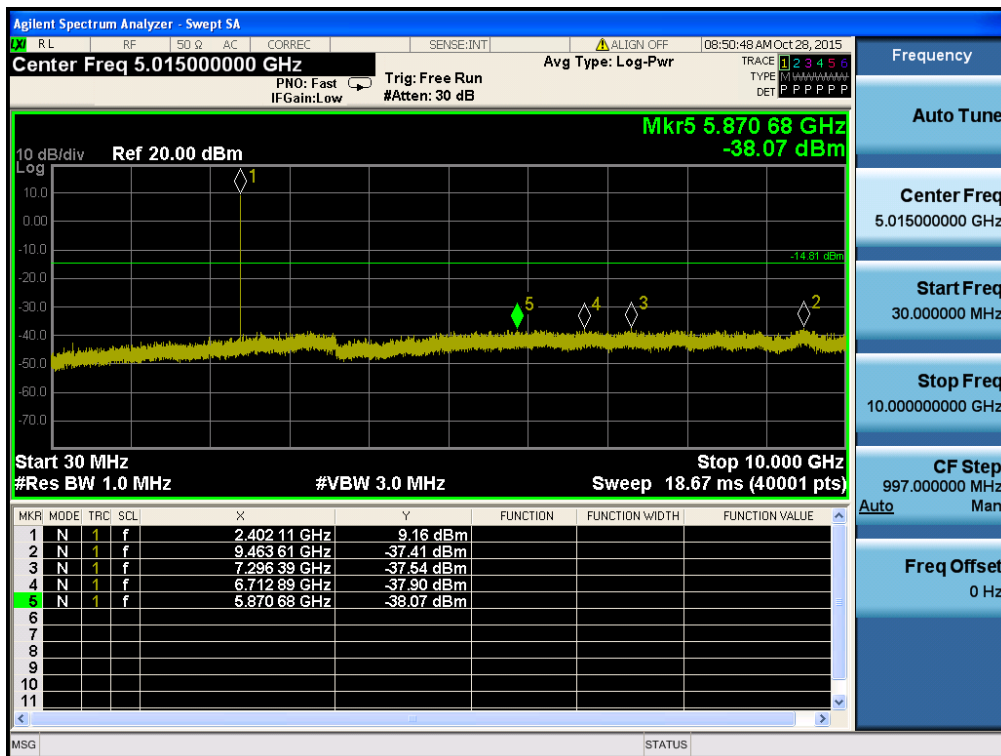
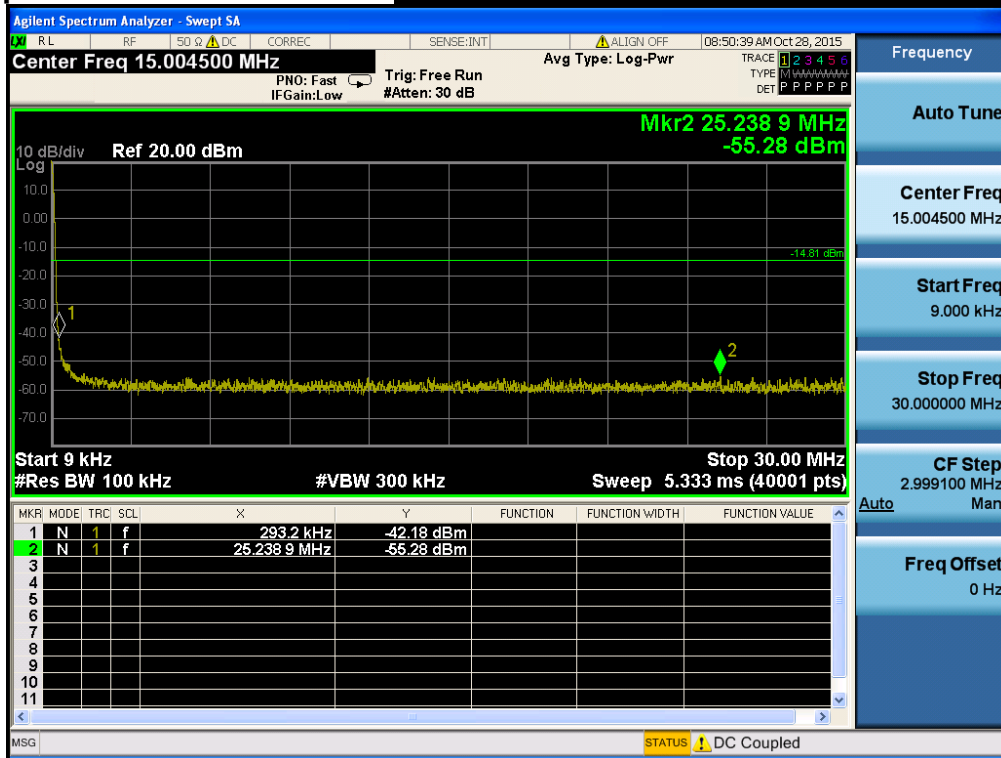



Conducted Spurious Emissions *Lowest Channel & Modulation : $\pi/4$ DQPSK*

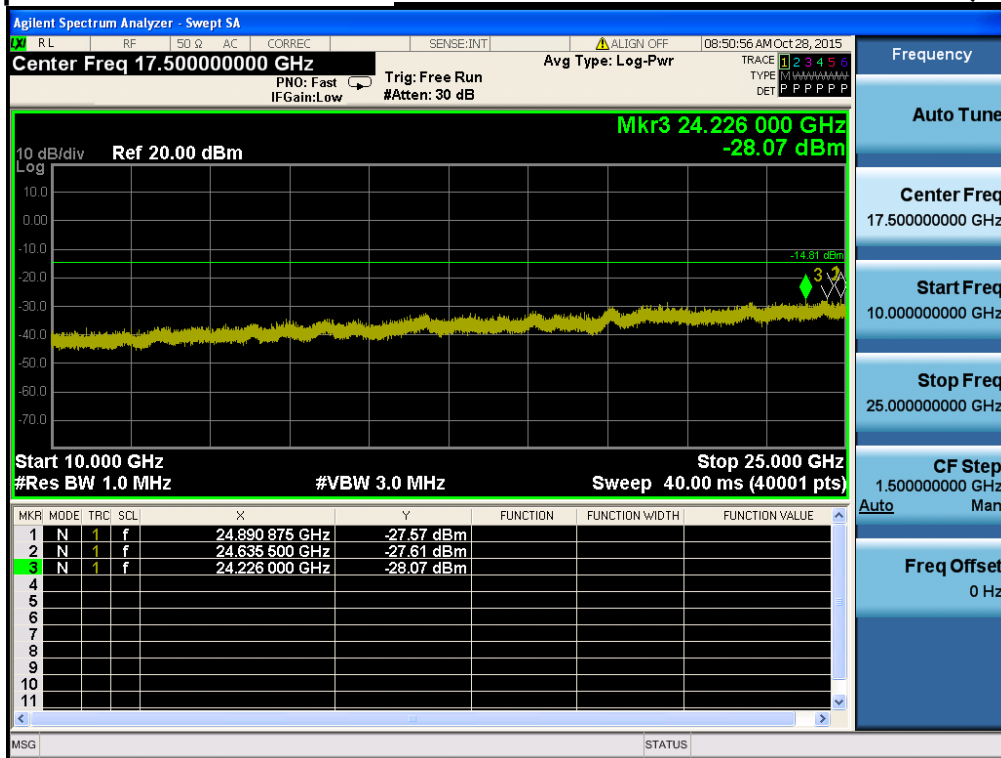

Reference for limit

Middle Channel & Modulation : $\pi/4$ DQPSK



Conducted Spurious Emissions

Middle Channel & Modulation : $\pi/4$ DQPSK

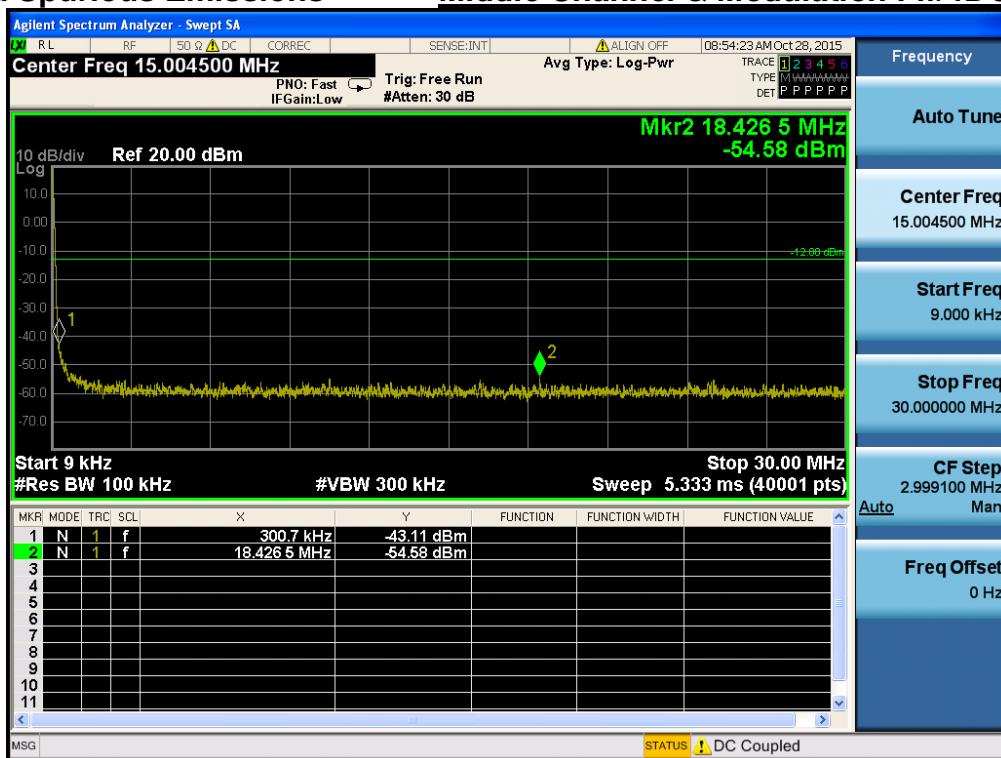

Conducted Spurious Emissions

Middle Channel & Modulation : $\pi/4$ DQPSK

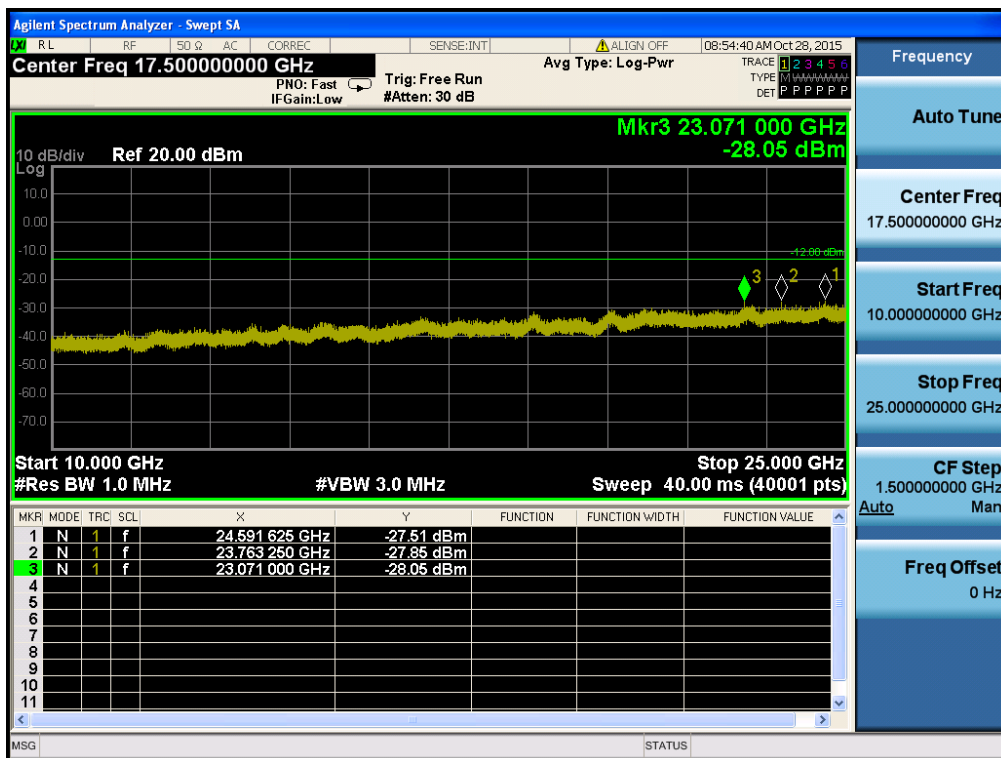
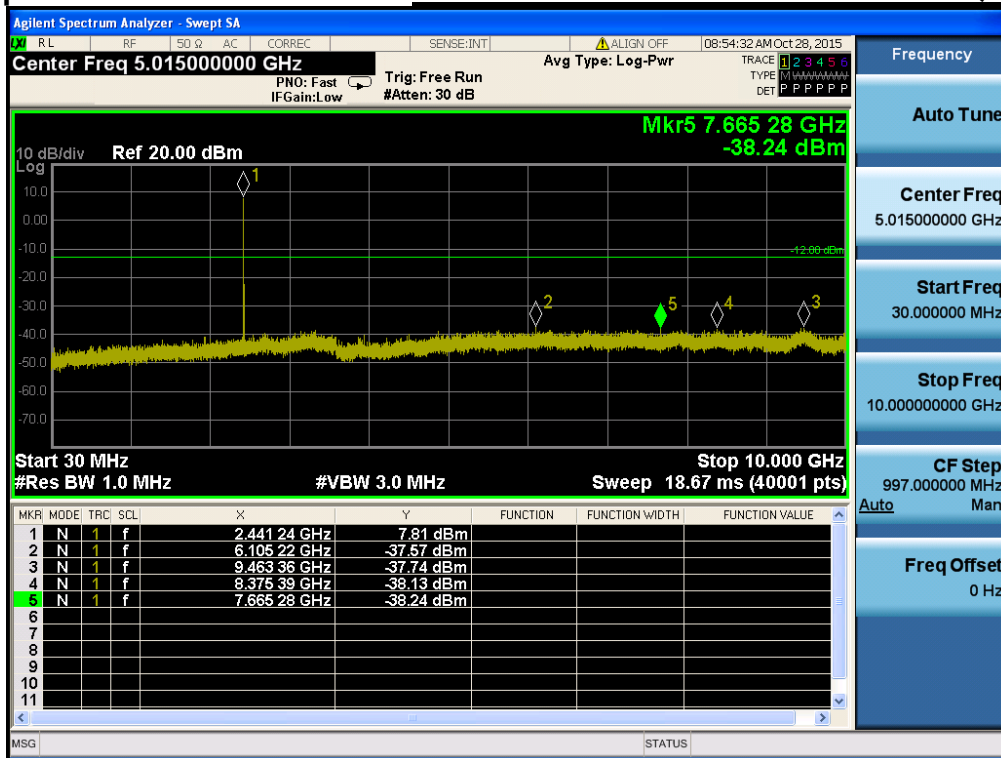

High Band-edge

Highest Channel & Modulation : $\pi/4$ DQPSK

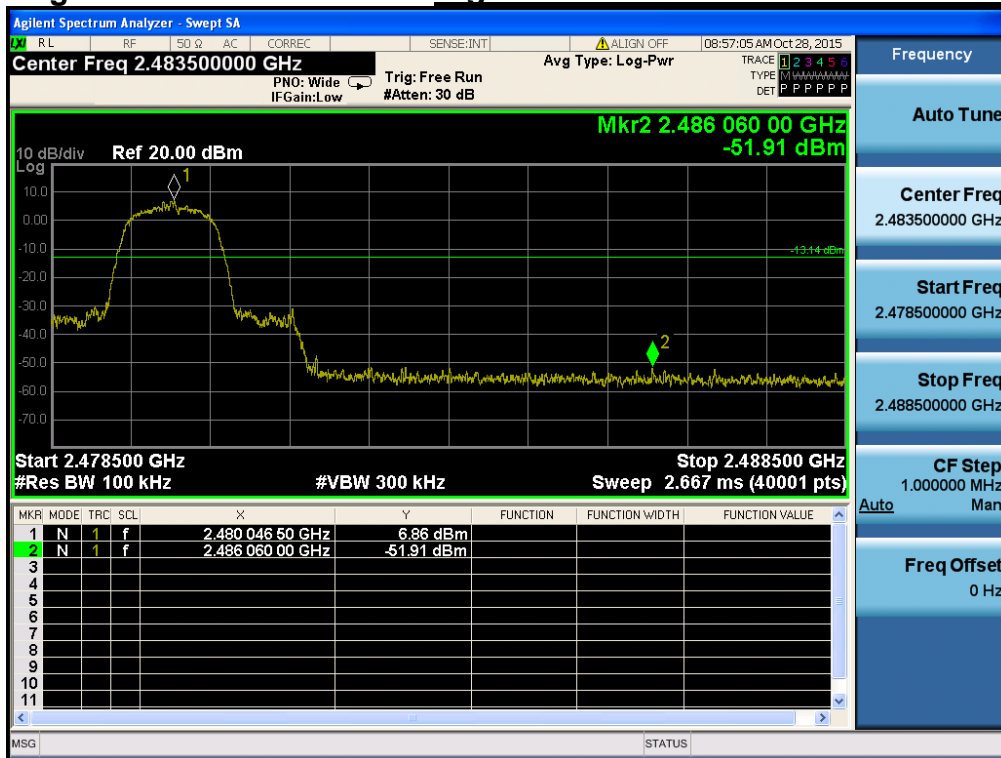

High Band-edge

Hopping mode & Modulation : $\pi/4$ DQPSK

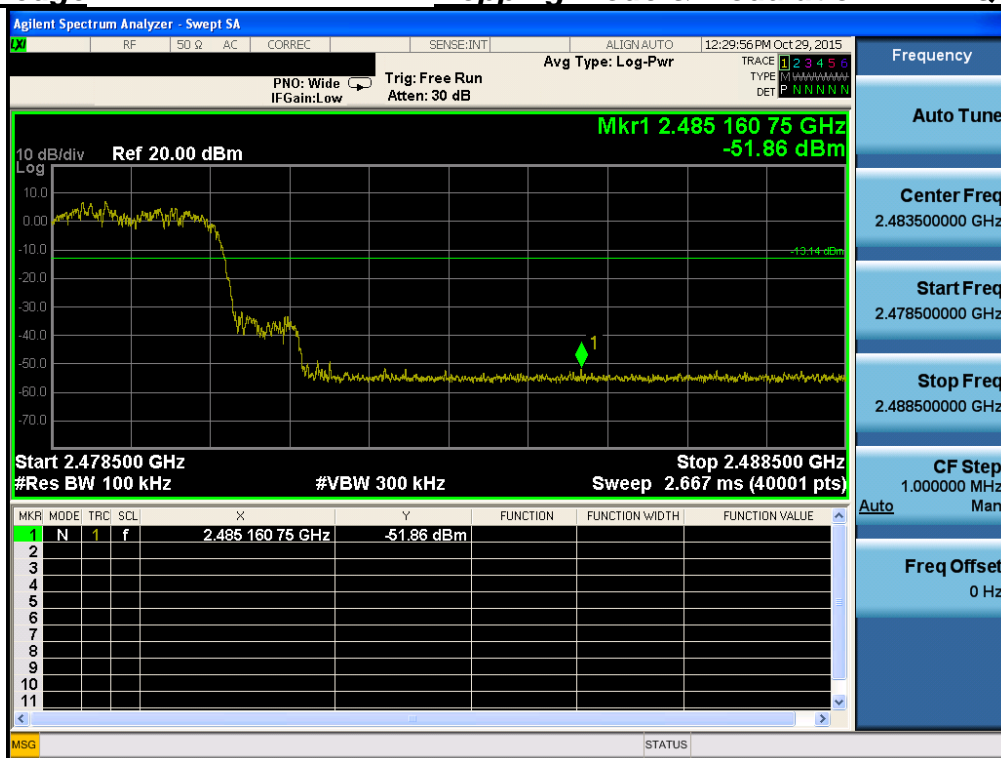

Conducted Spurious Emissions

Highest Channel & Modulation : $\pi/4$ DQPSK

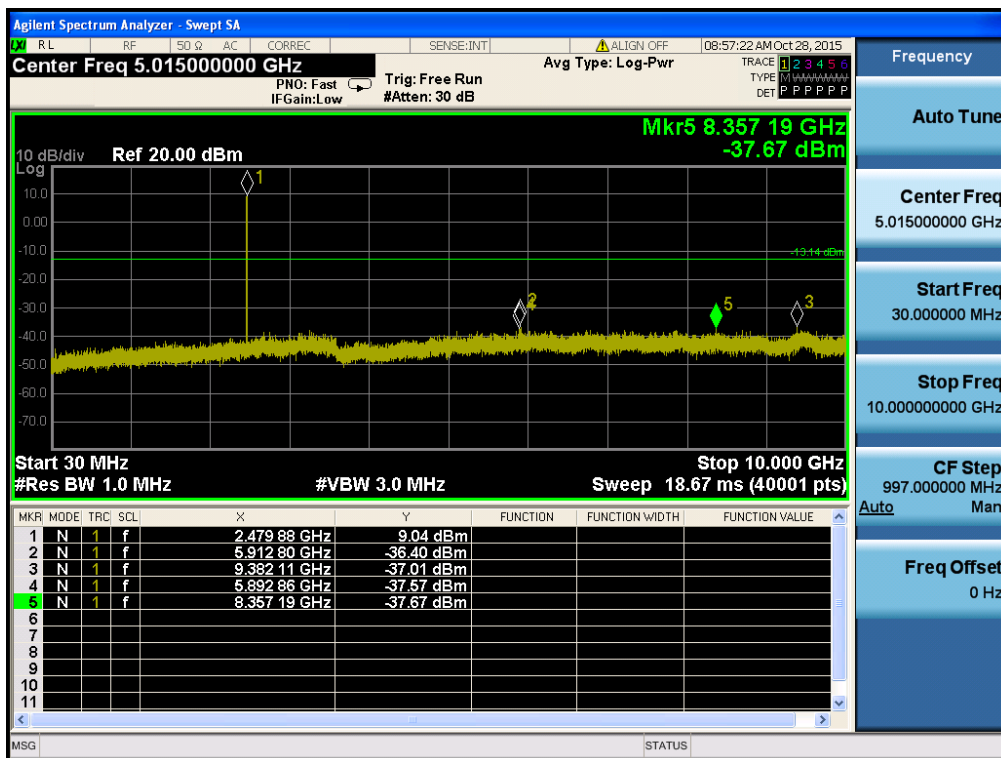
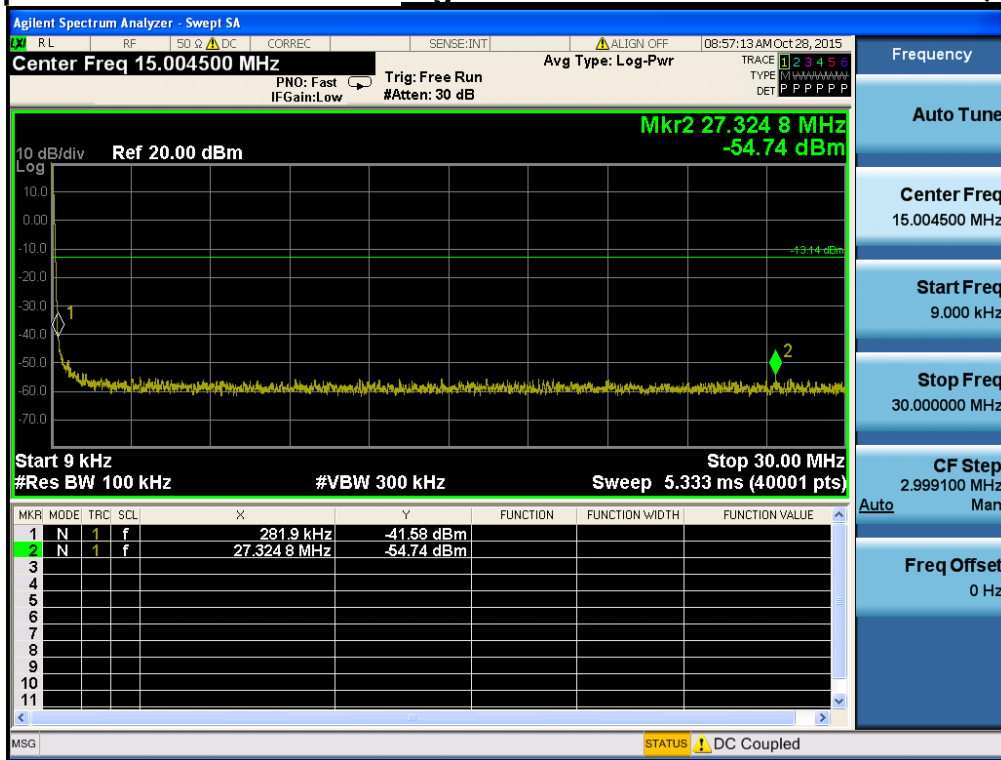

Conducted Spurious Emissions

Highest Channel & Modulation : $\pi/4$ DQPSK

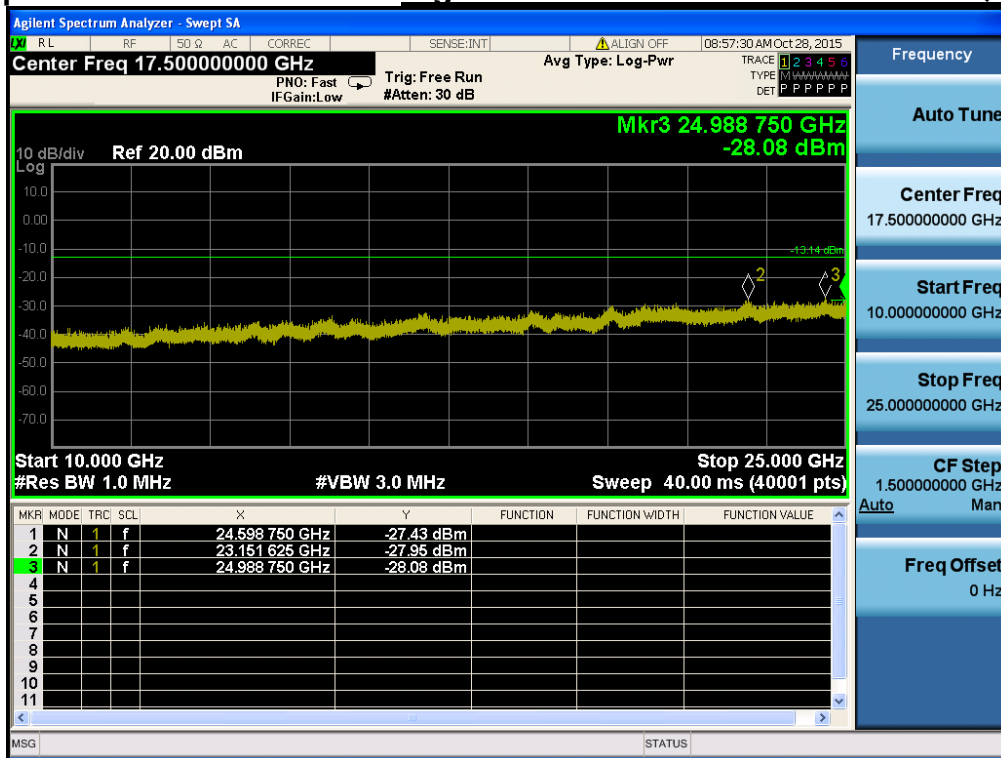

Low Band-edge

Lowest Channel & Modulation : 8DPSK

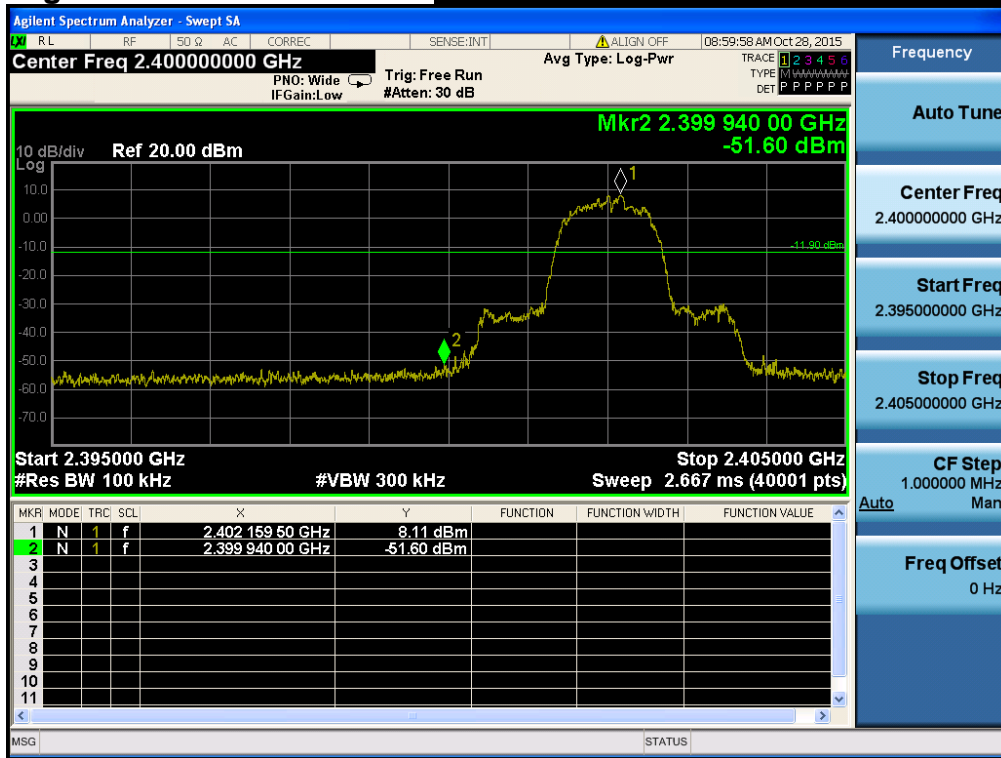

Low Band-edge

Hopping mode & Modulation : 8DPSK

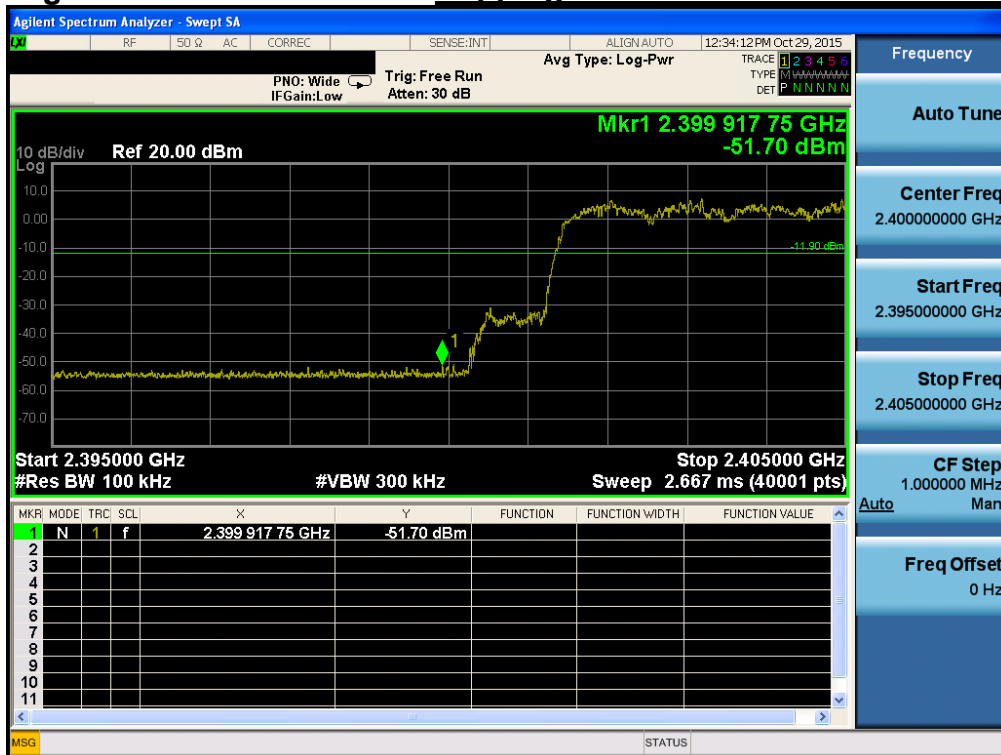

Conducted Spurious Emissions *Lowest Channel & Modulation : 8DPSK*

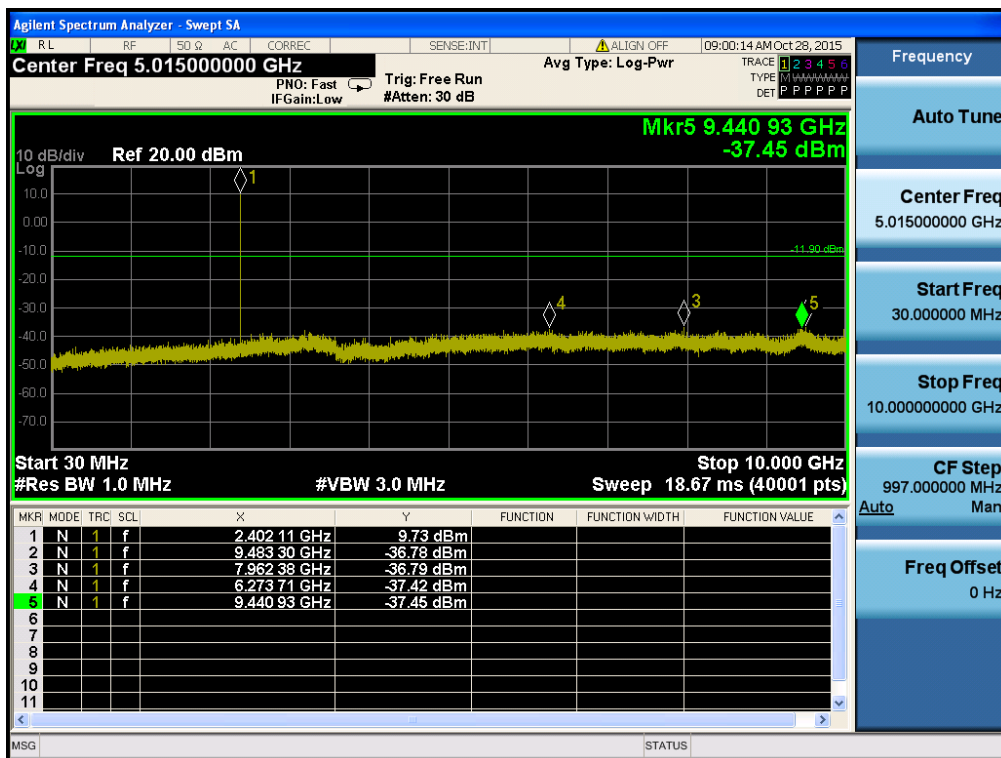
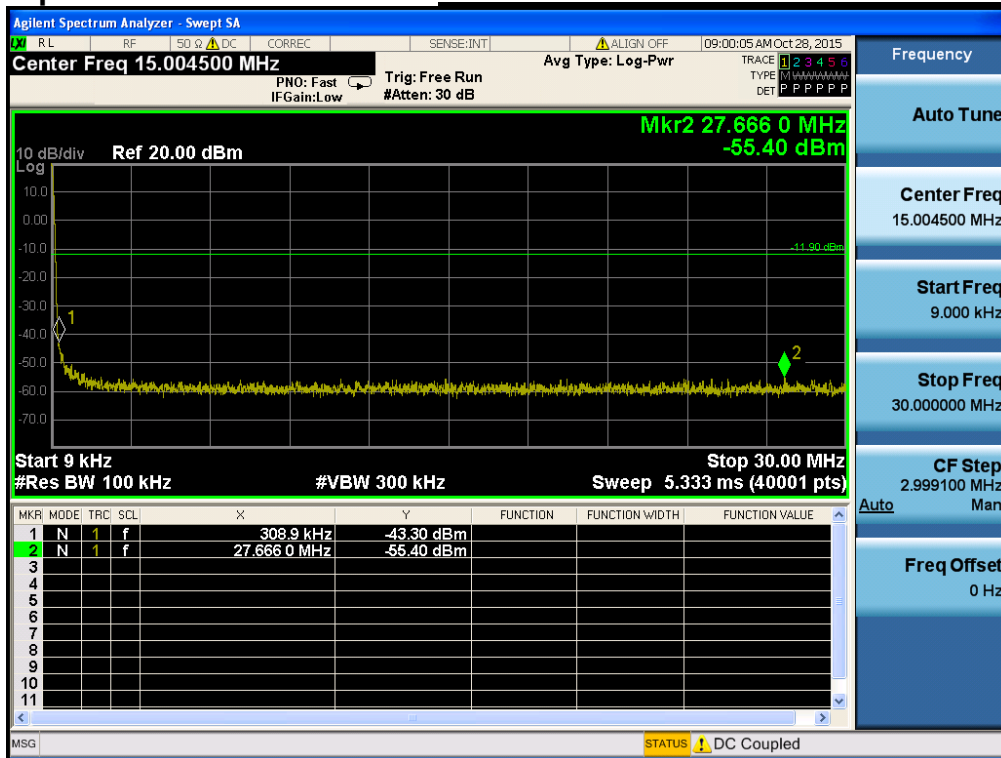



Conducted Spurious Emissions

Lowest Channel & Modulation : 8DPSK

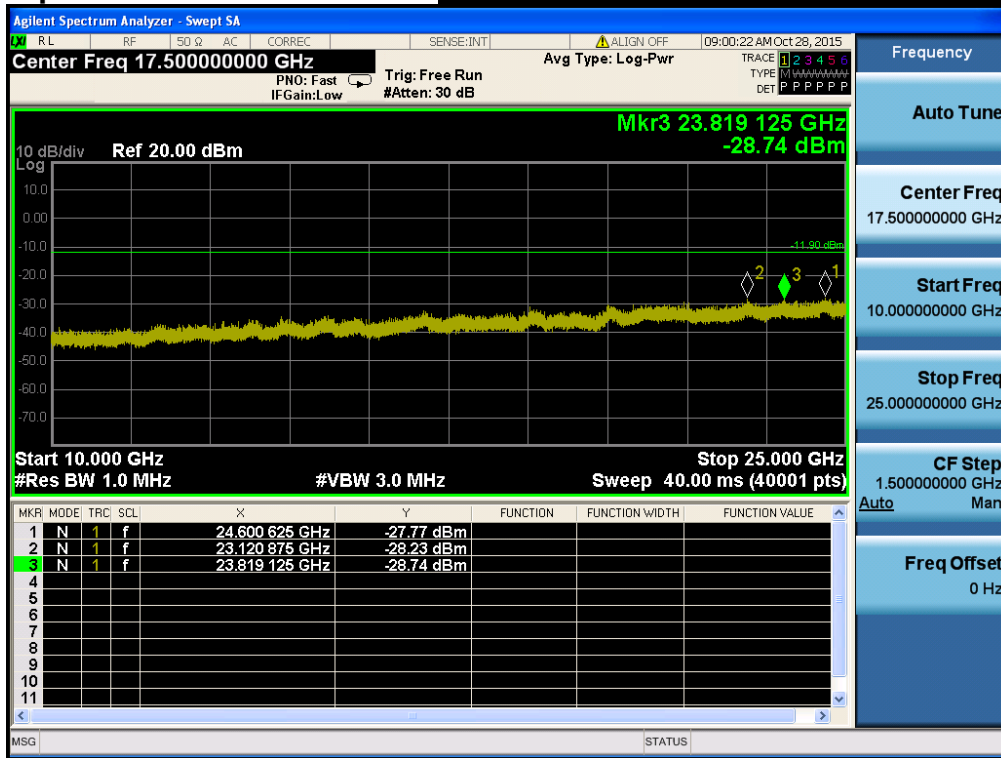

Reference for limit

Middle Channel & Modulation : 8DPSK



Conducted Spurious Emissions

Middle Channel & Modulation : 8DPSK

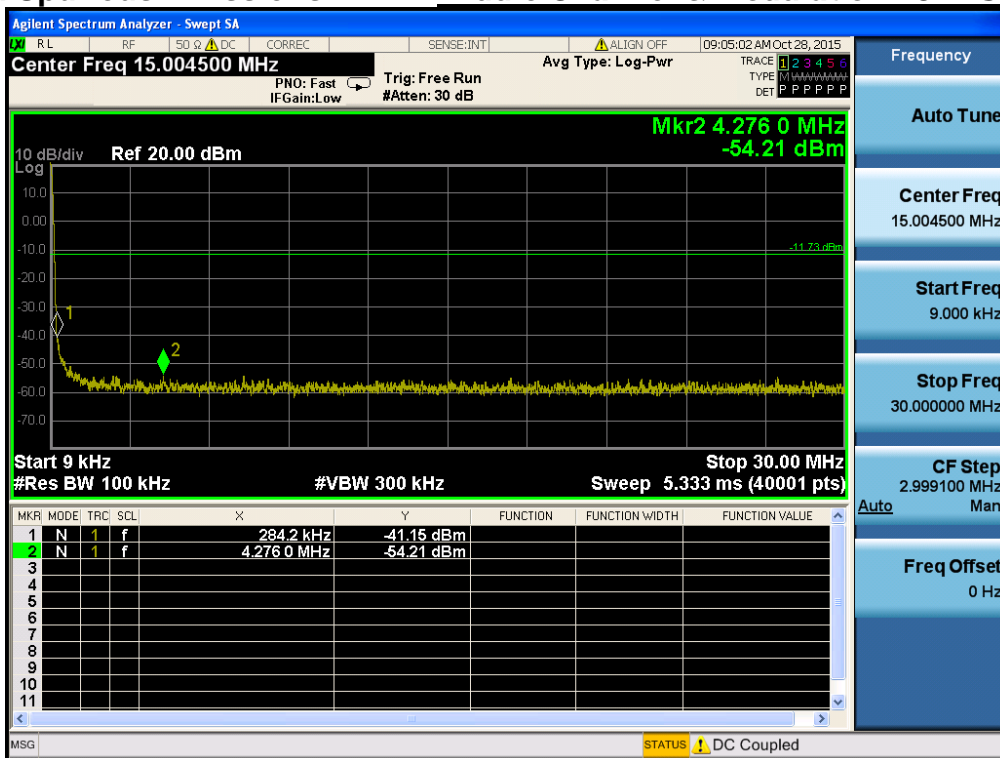

Conducted Spurious Emissions

Middle Channel & Modulation : 8DPSK

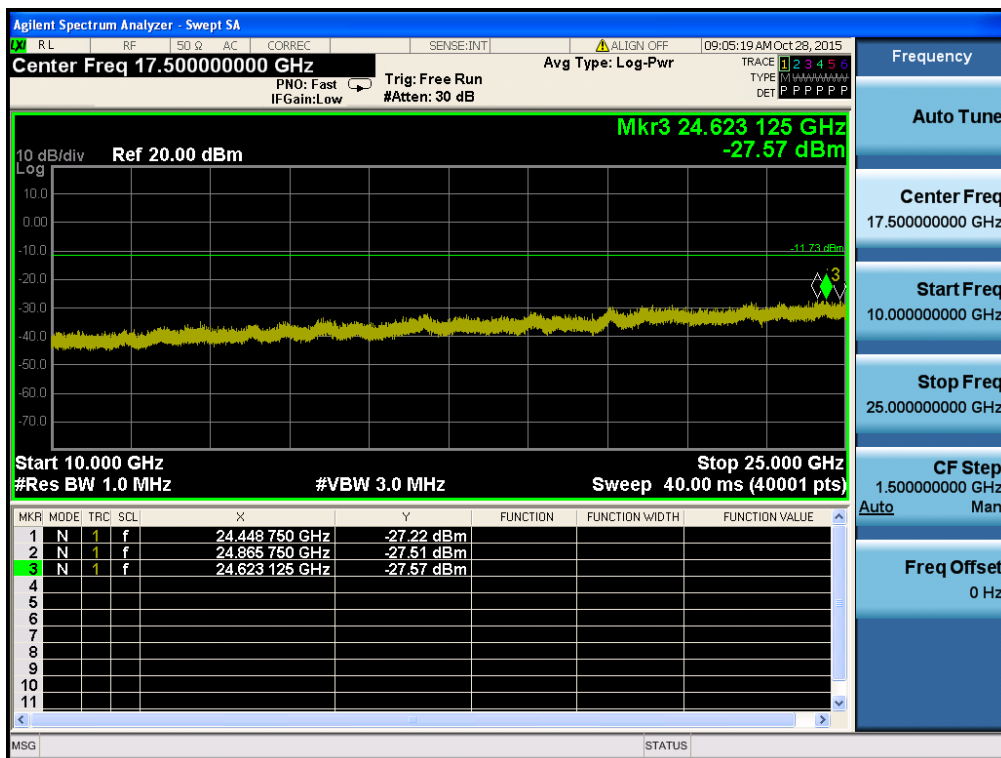
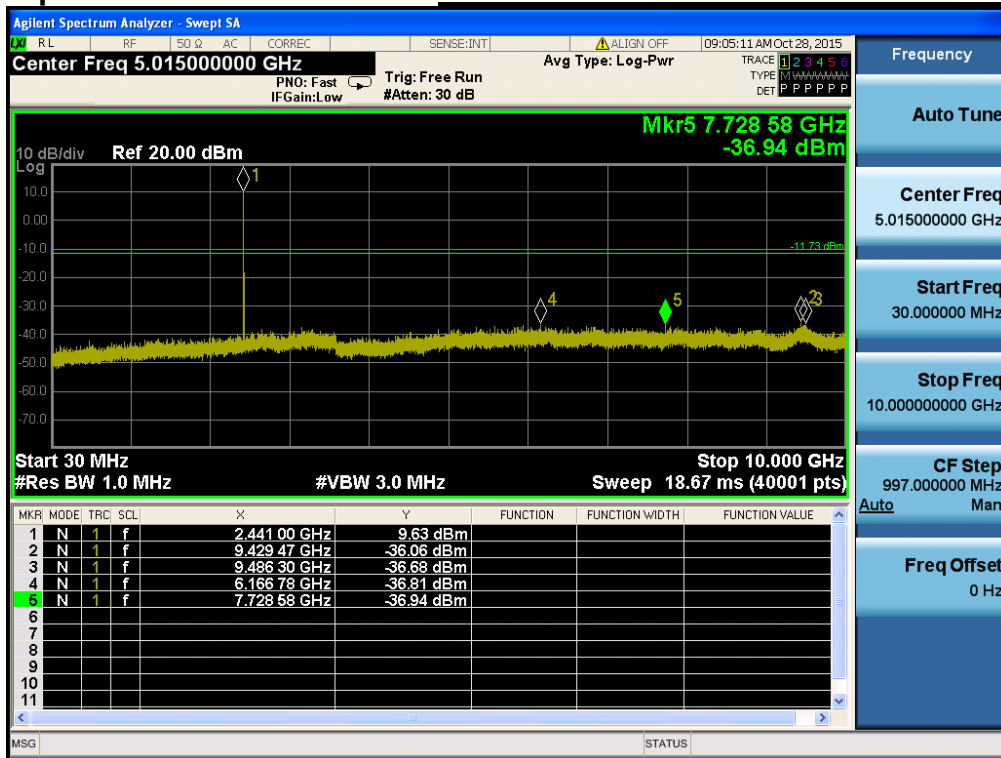

High Band-edge

Highest Channel & Modulation : 8DPSK

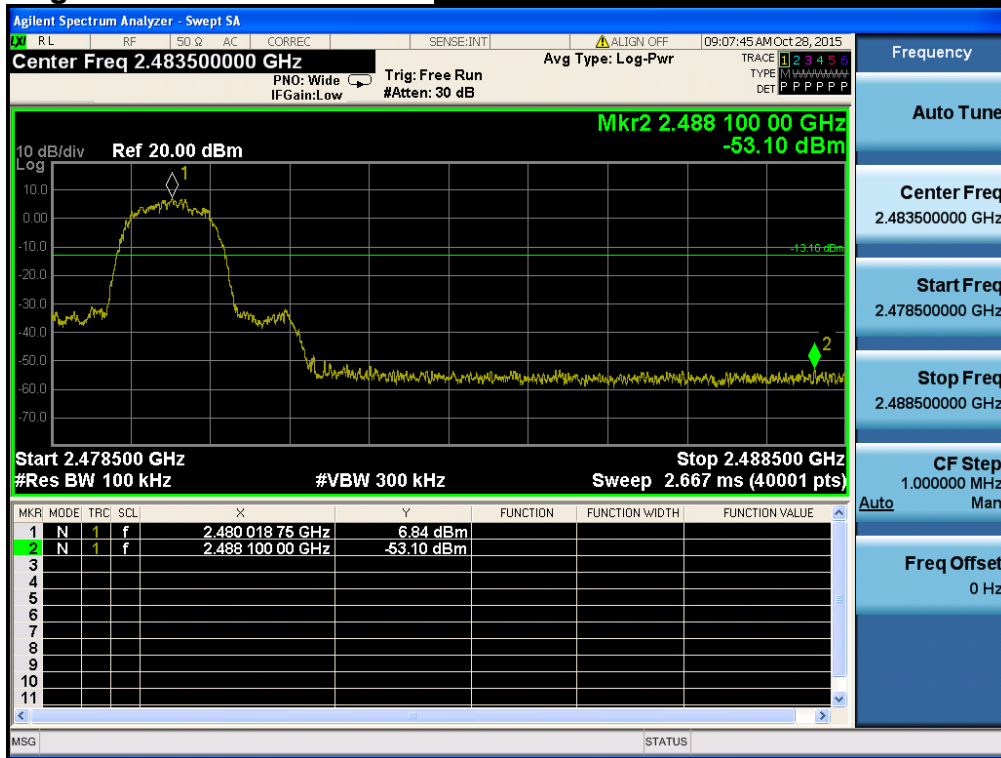

High Band-edge

Hopping mode & Modulation : 8DPSK

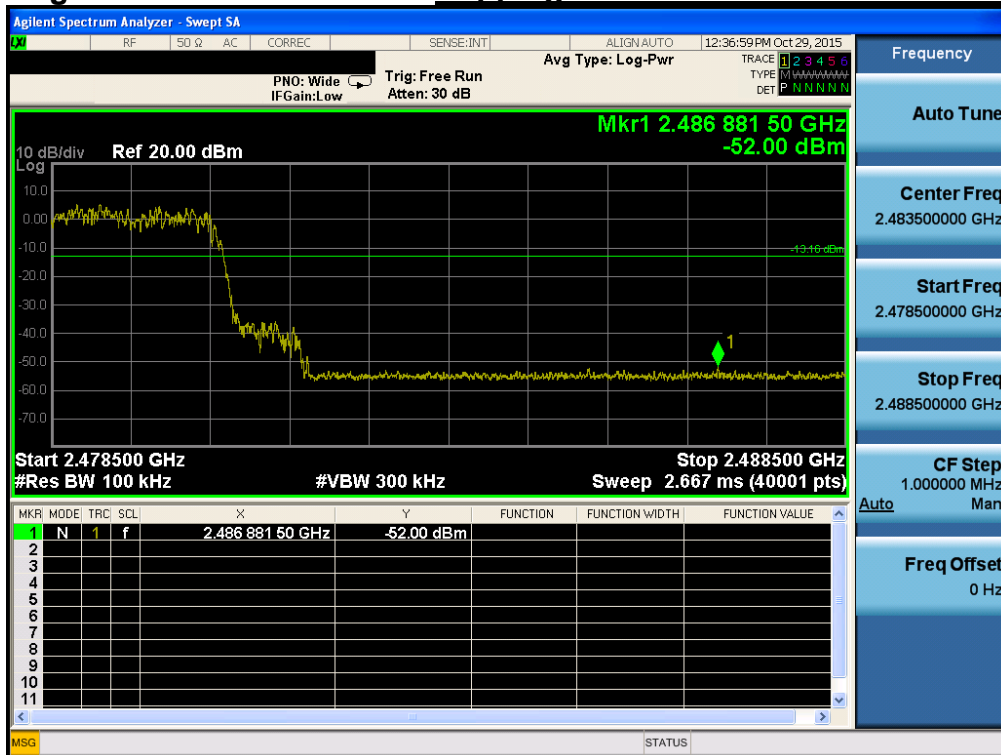

Conducted Spurious Emissions

Highest Channel & Modulation : 8DPSK

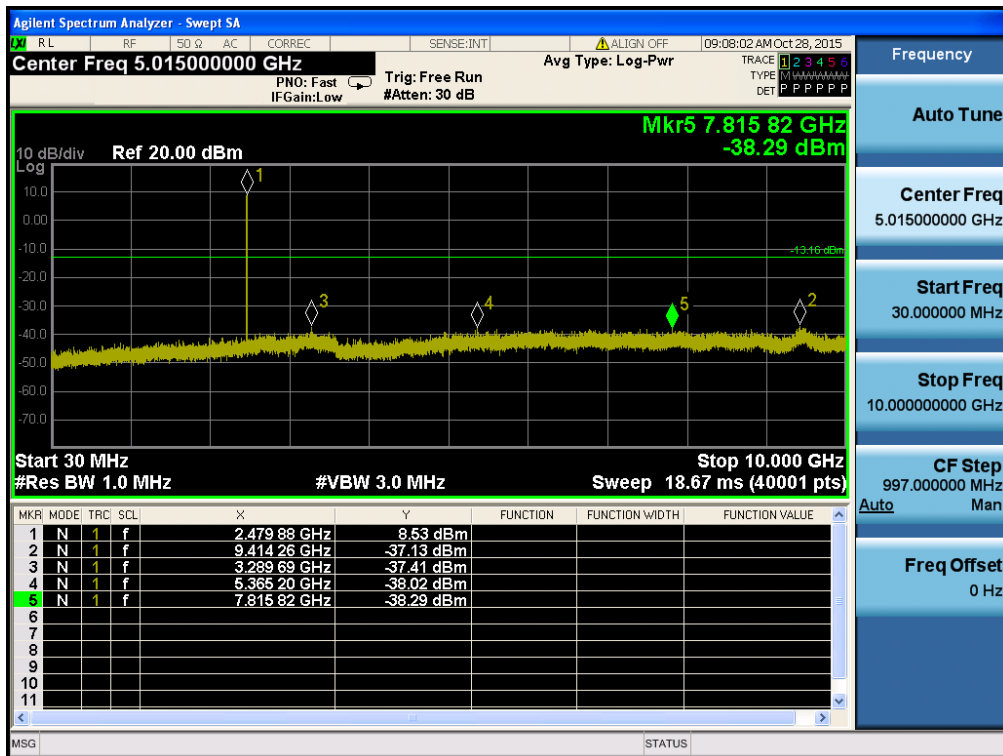
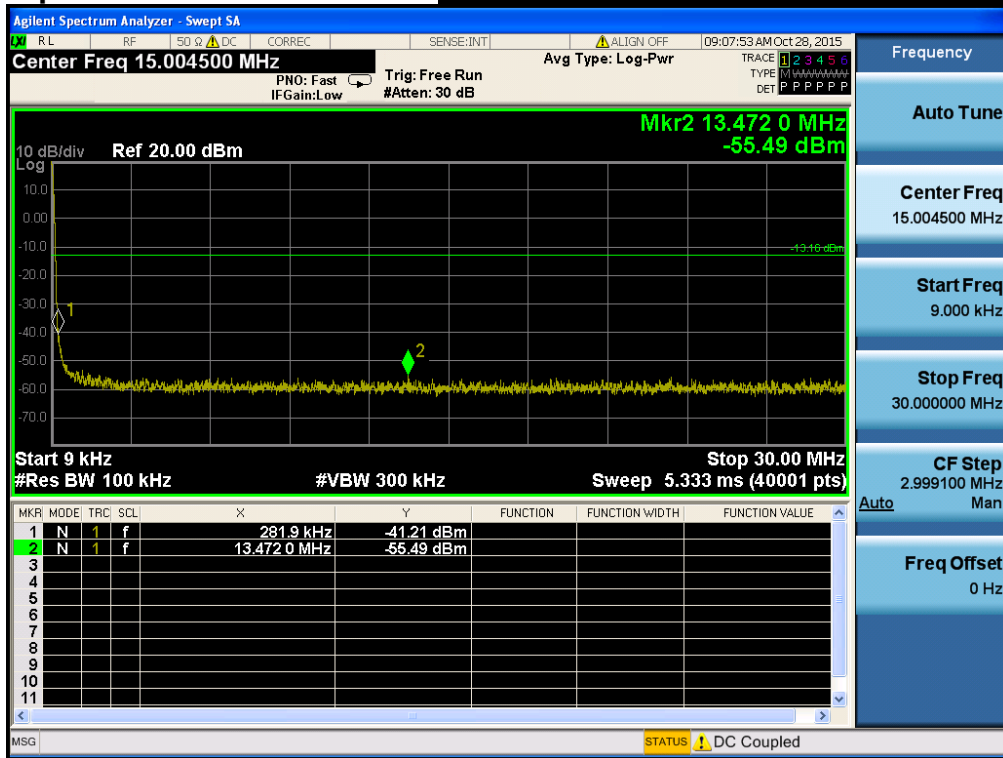



Conducted Spurious Emissions

Highest Channel & Modulation : 8DPSK

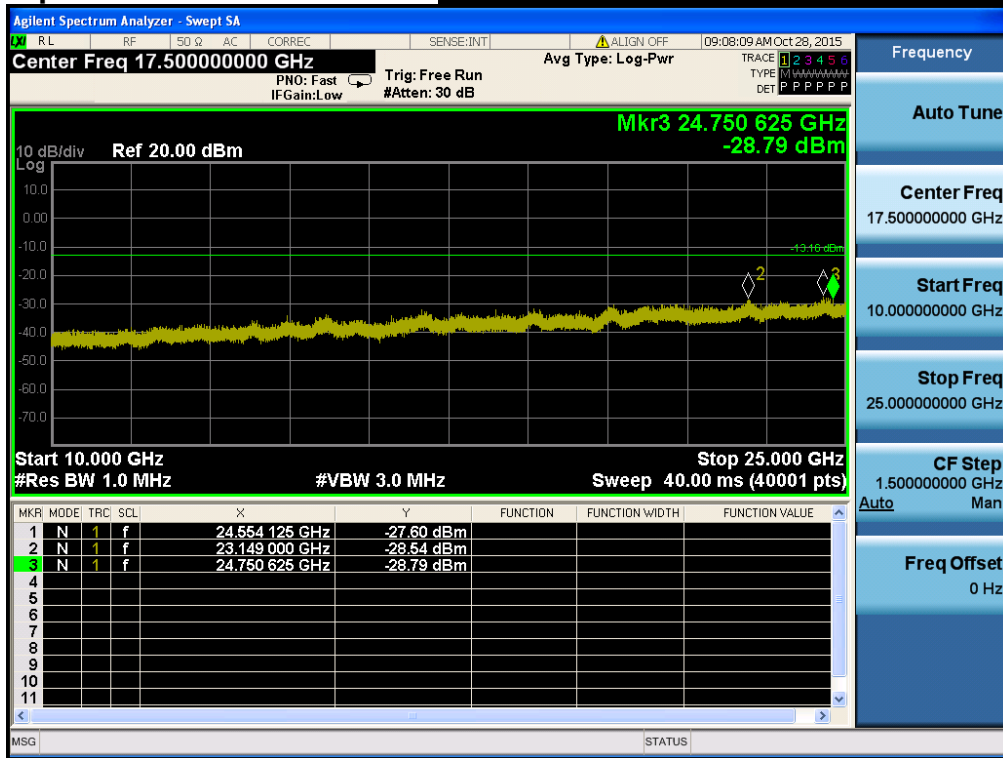

8. Transmitter AC Power Line Conducted Emission

8.1 Test Setup

Refer to test setup photo.

8.2 Limit

According to §15.207(a) for an intentional radiator that is designed to be connected to the public utility (AC) power line, the radio frequency voltage that is conducted back onto the AC power line on any frequency or frequencies, within the band 150 kHz to 30 MHz, shall not exceed the limits in the following table, as measured using a 50 uH/50 ohm line impedance stabilization network (LISN).

Compliance with the provision of this paragraph shall on the measurement of the radio frequency voltage between each power line and ground at the power terminal. The lower applies at the boundary between the frequency ranges.

Frequency Range (MHz)	Conducted Limit (dBuV)	
	Quasi-Peak	Average
0.15 ~ 0.5	66 to 56 *	56 to 46 *
0.5 ~ 5	56	46
5 ~ 30	60	50

* Decreases with the logarithm of the frequency

8.3 Test Procedures

Conducted emissions from the EUT were measured according to the ANSI C63.10.

1. The test procedure is performed in a 6.5 m x 3.5 m x 3.5 m (L x W x H) shielded room. The EUT along with its peripherals were placed on a 1.0 m (W) x 1.5 m (L) and 0.8 m in height wooden table and the EUT was adjusted to maintain a 0.4 meter space from a vertical reference plane.
2. The EUT was connected to power mains through a line impedance stabilization network (LISN) which provides 50 ohm coupling impedance for measuring instrument and the chassis ground was bounded to the horizontal ground plane of shielded room.
3. All peripherals were connected to the second LISN and the chassis ground also bounded to the horizontal ground plane of shielded room.
4. The excess power cable between the EUT and the LISN was bundled. The power cables of peripherals were unbundled. All connecting cables of EUT and peripherals were moved to find the maximum emission.

8.4 Test Results

AC Line Conducted Emissions (Graph) = Modulation : GFSK

Results of Conducted Emission

DTNC Date : 2015-10-26

Order No.	:		Reference No.	:	
Model No.	:	PM80-W	Power Supply	:	120 V / 60 Hz
Serial No.	:	Identical prototype	Temp/Humi.	:	24 °C / 48 % R.H.
Test Condition	:	2.4GHz_BT	Operator	:	J. J. LEE

Memo : 1M_HOP

LIMIT : FCC P15.207 QP
FCC P15.207 AV

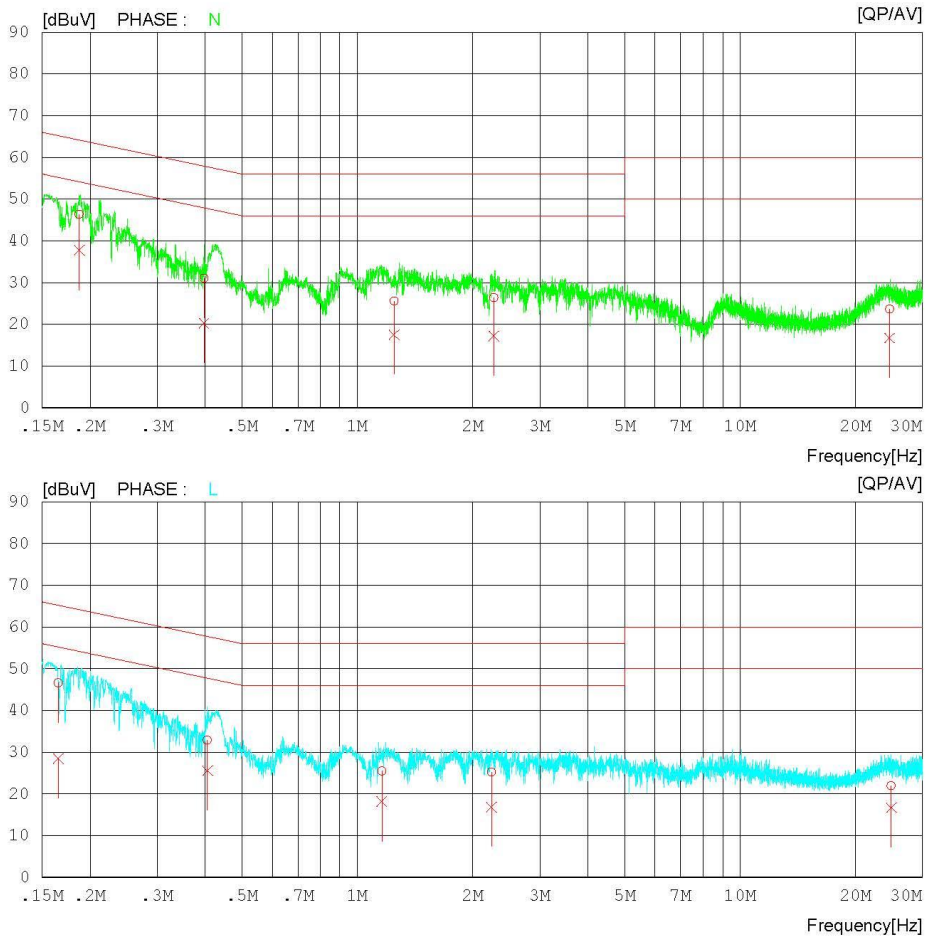



AC Line Conducted Emissions (List) = Modulation : GFSK

Results of Conducted Emission

DTNC

Date : 2015-10-26

Order No.	:		Reference No.	:	
Model No.	:	PM80-W	Power Supply	:	120 V / 60 Hz
Serial No.	:	Identical prototype	Temp/Humi.	:	24 °C / 48 % R.H.
Test Condition	:	2.4GHz_BT	Operator	:	J. J. LEE
Memo	:	1M_HOP			

LIMIT : FCC P15.207 QP
 FCC P15.207 AV

NO	FREQ [MHz]	READING		C.FACTOR [dB]	RESULT		LIMIT		MARGIN		PHASE
		QP [dBuV]	AV [dBuV]		QP [dBuV]	AV [dBuV]	QP [dBuV]	AV [dBuV]	QP [dBuV]	AV [dBuV]	
1	0.18748	36.3	27.7	10.1	46.4	37.8	64.1	54.1	17.7	16.3	N
2	0.39741	20.9	10.2	10.1	31.0	20.3	57.9	47.9	26.9	27.6	N
3	1.24820	15.4	7.3	10.2	25.6	17.5	56.0	46.0	30.4	28.5	N
4	2.27440	16.1	7.0	10.2	26.3	17.2	56.0	46.0	29.7	28.8	N
5	24.60100	12.7	5.8	10.9	23.6	16.7	60.0	50.0	36.4	33.3	N
6	0.16550	36.4	18.4	10.1	46.5	28.5	65.2	55.2	18.7	26.7	L
7	0.40552	22.7	15.4	10.1	32.8	25.5	57.7	47.7	24.9	22.2	L
8	1.15860	15.2	7.9	10.2	25.4	18.1	56.0	46.0	30.6	27.9	L
9	2.24120	14.9	6.7	10.2	25.1	16.9	56.0	46.0	30.9	29.1	L
10	24.85900	10.8	5.5	11.1	21.9	16.6	60.0	50.0	38.1	33.4	L

9. Antenna Requirement

Describe how the EUT complies with the requirement that either its antenna is permanently attached, or that it employs a unique antenna connector, for every antenna proposed for use with the EUT.

Conclusion: Comply

The internal antenna is attached on the main PCB using the special spring tension. (Refer to Internal Photo file.)

- Minimum Standard :

An intentional radiator shall be designed to ensure that no antenna other than that furnished by the responsible party shall be used with the device. The use of a permanently attached antenna or of an antenna that uses a unique coupling to the intentional radiator shall be considered sufficient to comply with the provisions.

10. Occupied Bandwidth (99 %)

10.1 Test Setup

Refer to the APPENDIX I.

10.2 Limit

Limit : Not Applicable

10.3 Test Procedure

The 99 % power bandwidth was measured with a calibrated spectrum analyzer.

The resolution bandwidth (RBW) shall be in the range of 1 % to 5 % of the occupied bandwidth (OBW) and video bandwidth (VBW) shall be approximately 3 × RBW.

Spectrum analyzer plots are included on the following pages.

10.4 Test Results

Modulation	Tested Channel	99% BW (MHz)
<u>GFSK</u>	Lowest	0.894
	Middle	0.896
	Highest	0.899
<u>π/4DQPSK</u>	Lowest	1.184
	Middle	1.186
	Highest	1.186
<u>8DPSK</u>	Lowest	1.182
	Middle	1.192
	Highest	1.185

Note 1 : See next pages for actual measured spectrum plots.

99% Bandwidth

Lowest Channel & Modulation : GFSK

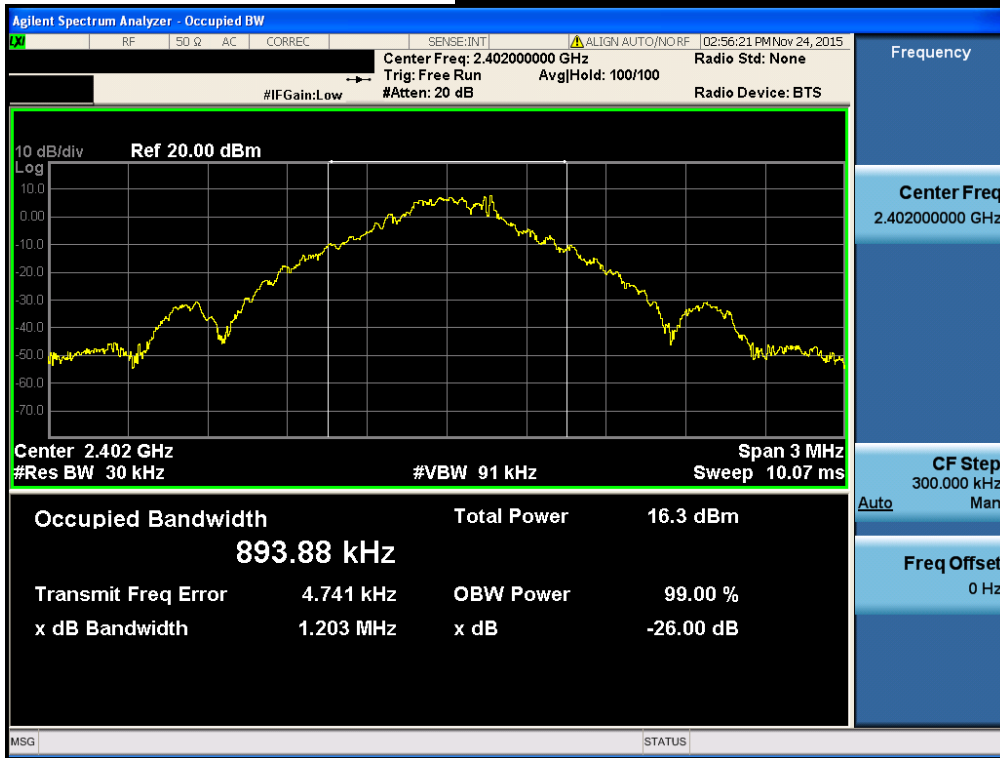

99% Bandwidth

Middle Channel & Modulation : GFSK



99% Bandwidth

Highest Channel & Modulation : GFSK



99% Bandwidth

Lowest Channel & Modulation : $\pi/4$ DQPSK

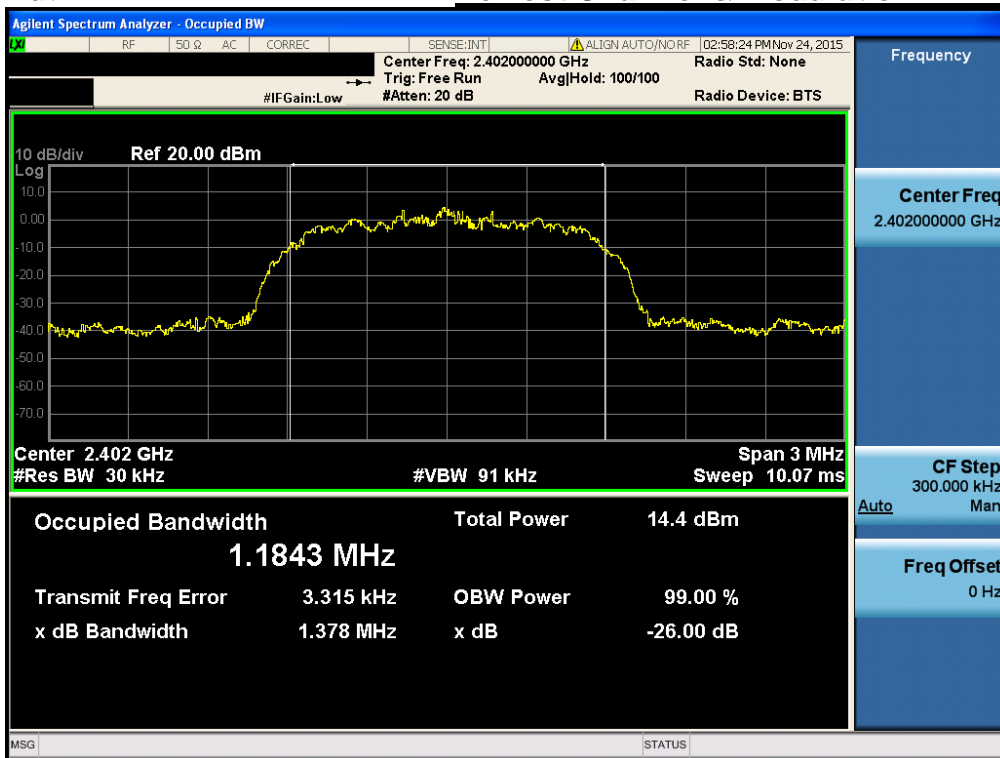

99% Bandwidth

Middle Channel & Modulation : $\pi/4$ DQPSK

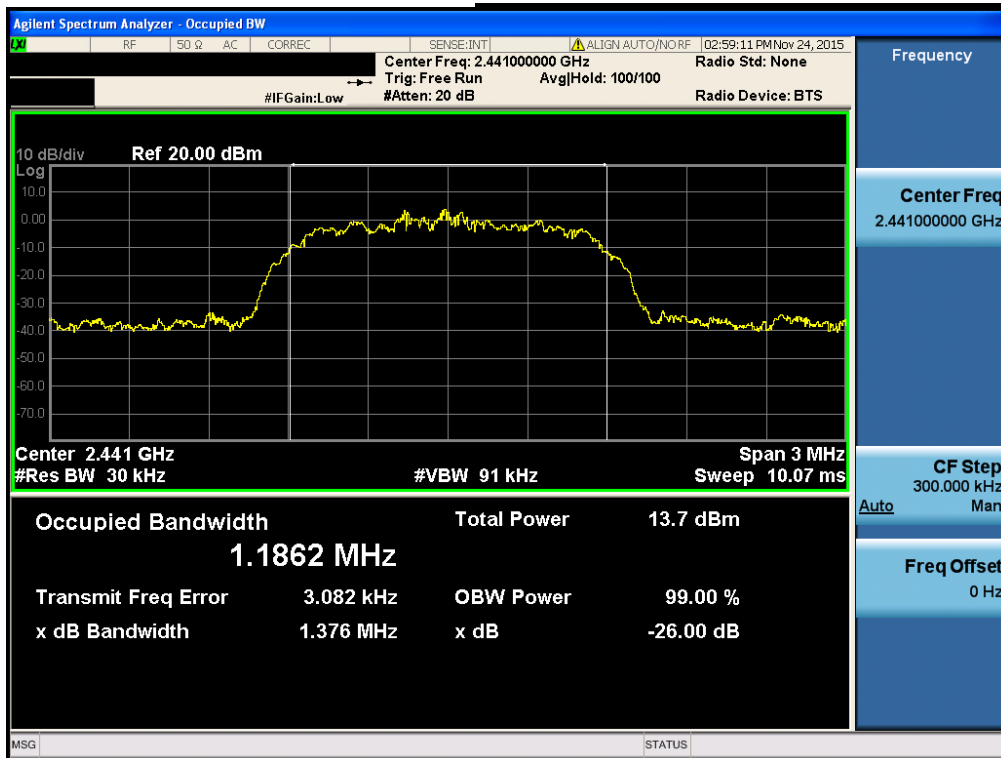

99% Bandwidth

Highest Channel & Modulation : $\pi/4$ DQPSK

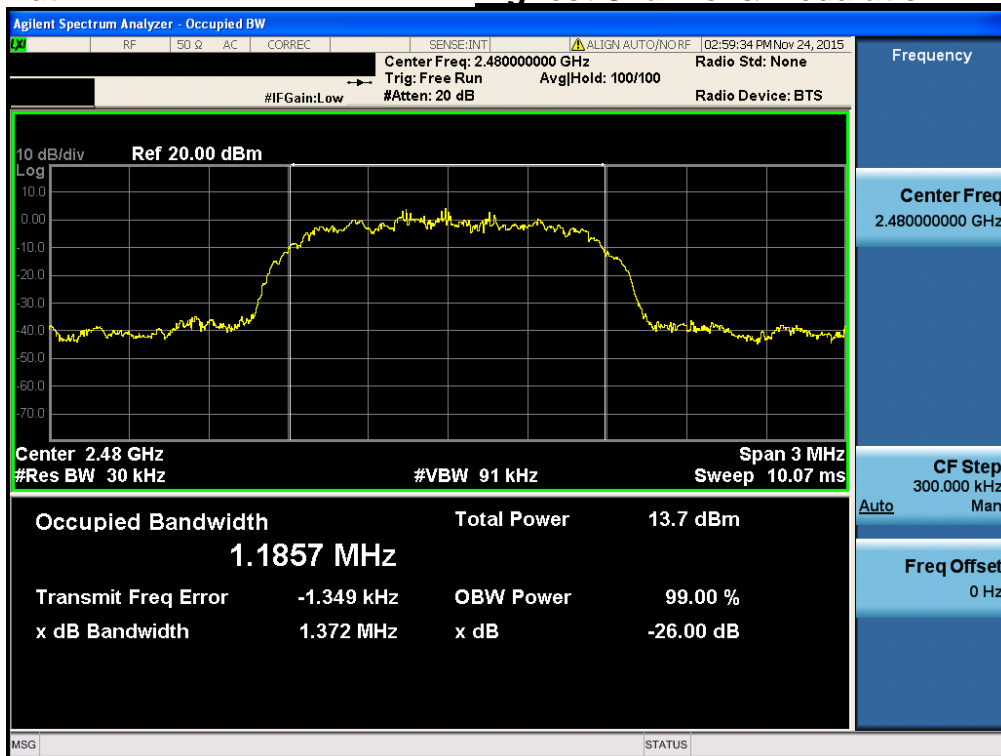

99% Bandwidth

Lowest Channel & Modulation : 8DPSK

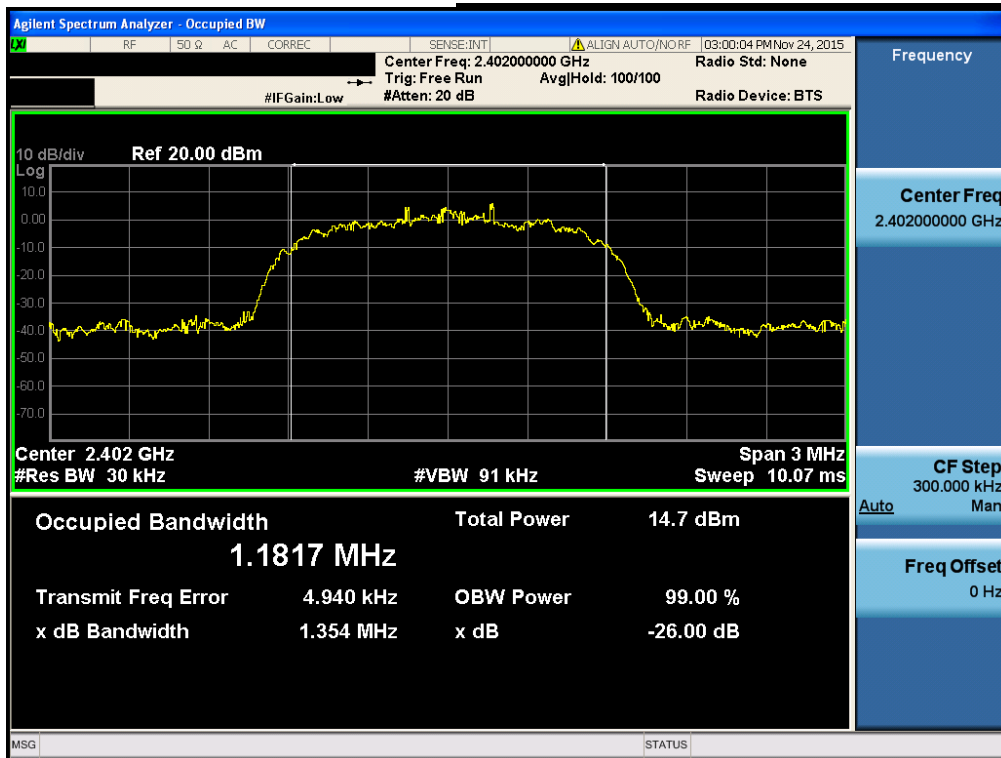

99% Bandwidth

Middle Channel & Modulation : 8DPSK

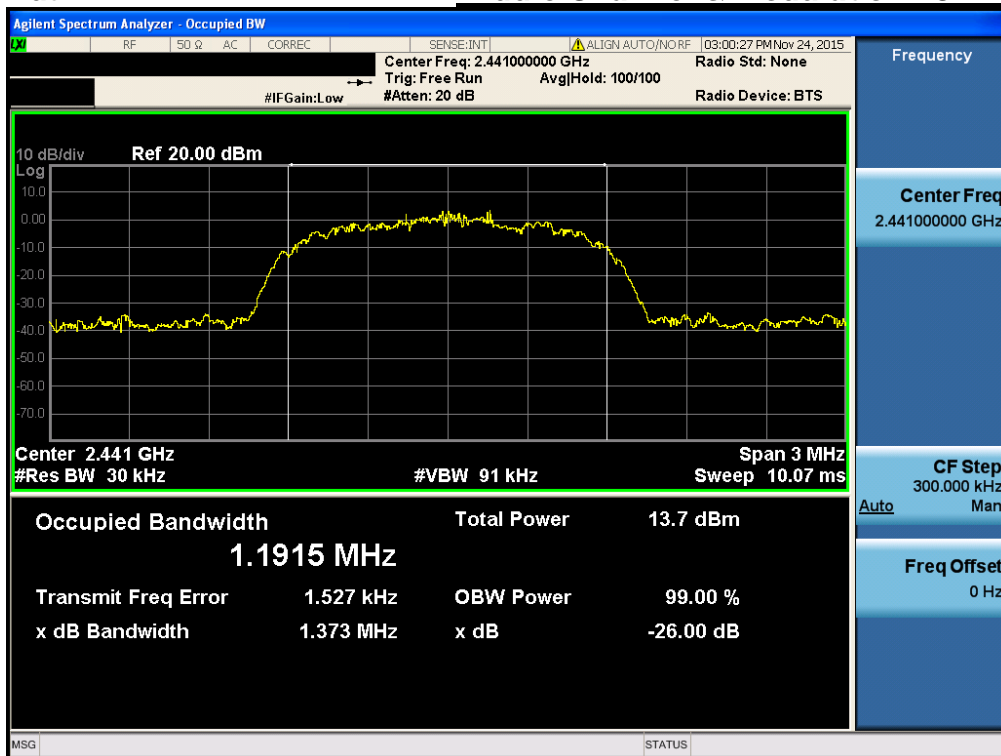

99% Bandwidth

Highest Channel & Modulation : 8DPSK

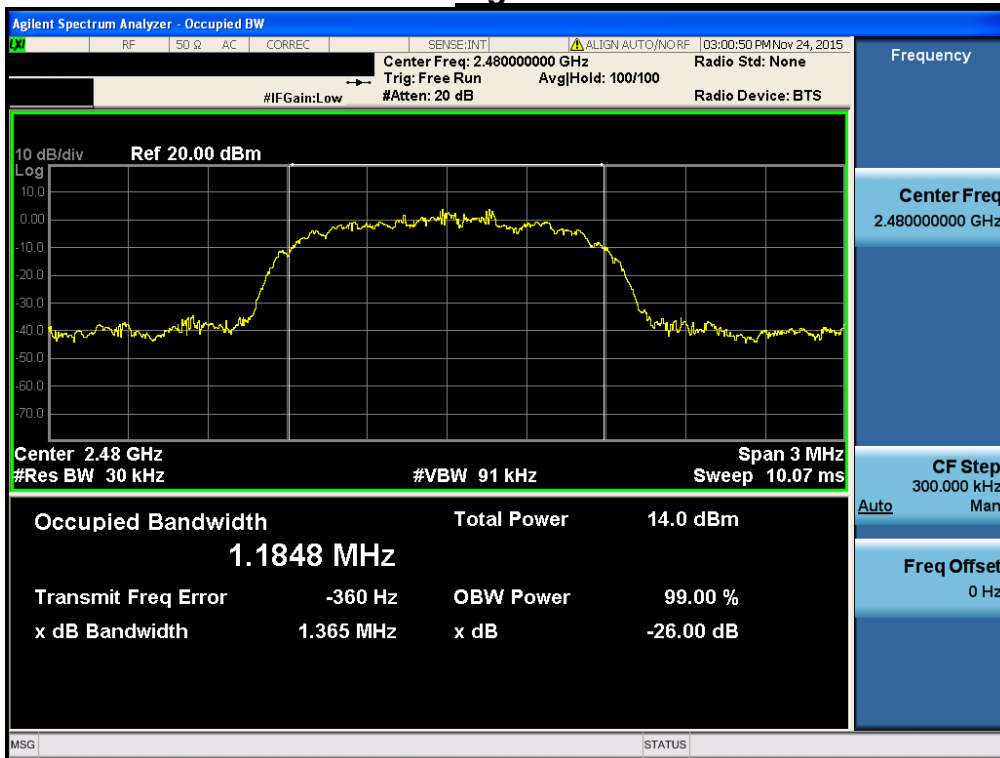

APPENDIX I

Test set up diagrams

▪ Radiated Measurement

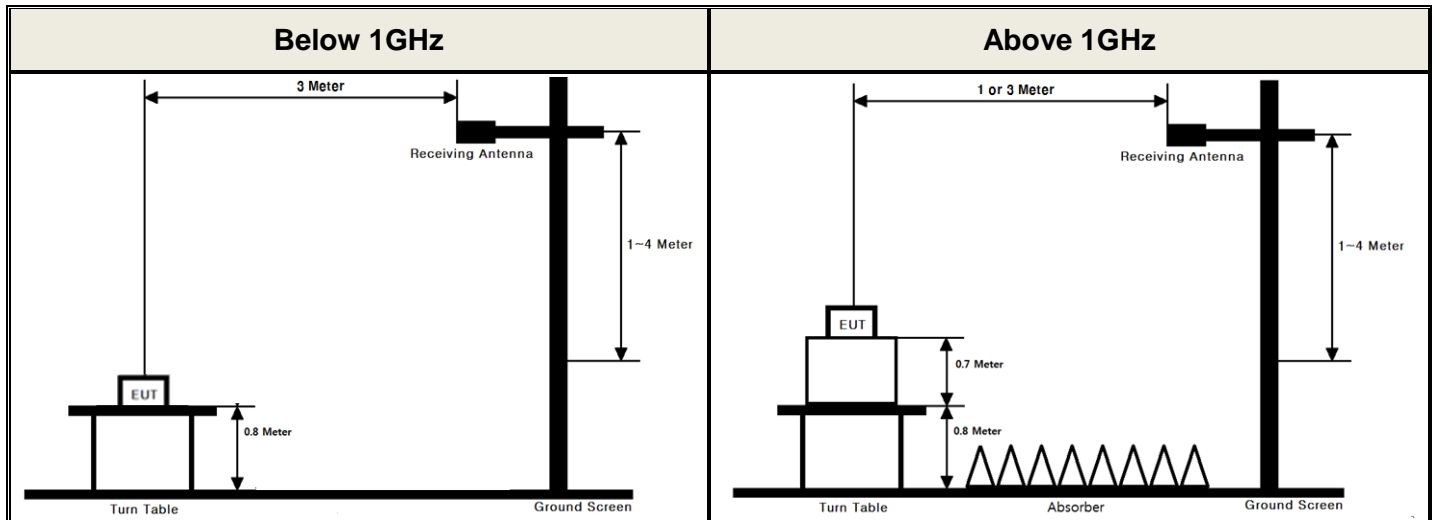

▪ Conducted Measurement

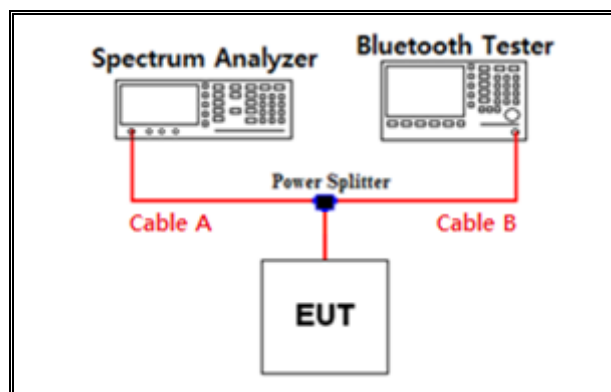

Path loss information

Frequency (GHz)	Path Loss (dB)	Frequency (GHz)	Path Loss (dB)
0.03	6.30	15	10.63
1	7.35	20	11.94
2.402 & 2.440 & 2.480	7.85	25	13.22
5	9.75	-	-
10	10.35	-	-

Note 1 : The path loss from EUT to Spectrum analyzer were measured and used for test.

Path loss (S/A's Correction factor) = Cable A + Power splitter

APPENDIX II

Unwanted Emissions (Radiated) Test Plot

GFSK & Lowest & Edge

Detector Mode : PK

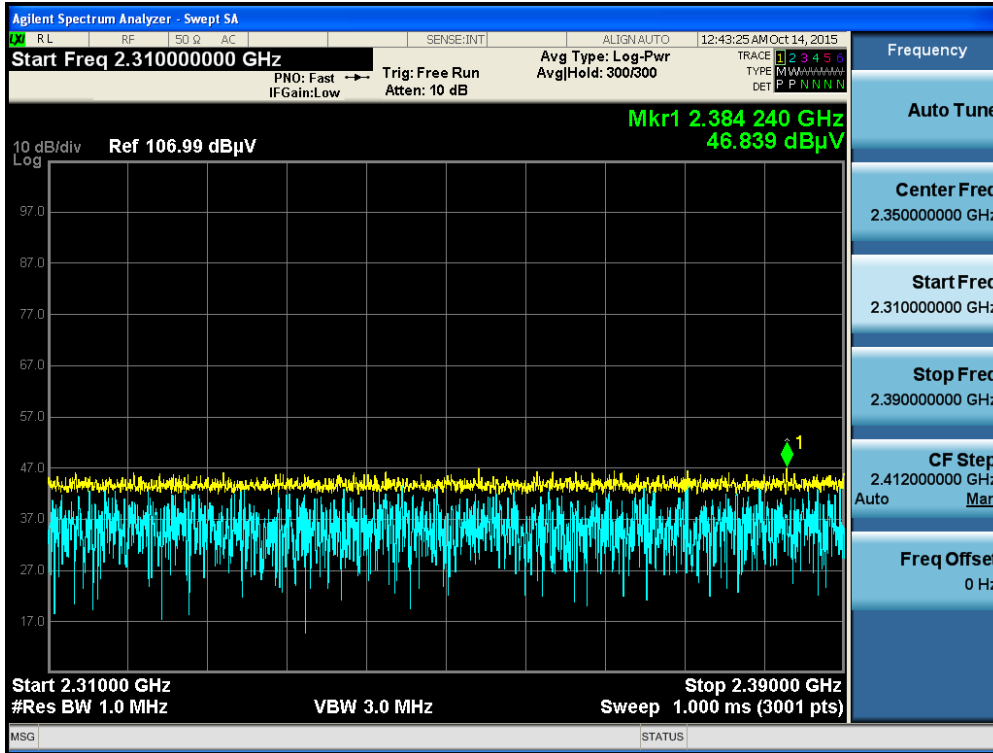

GFSK & Highest & Edge

Detector Mode : PK

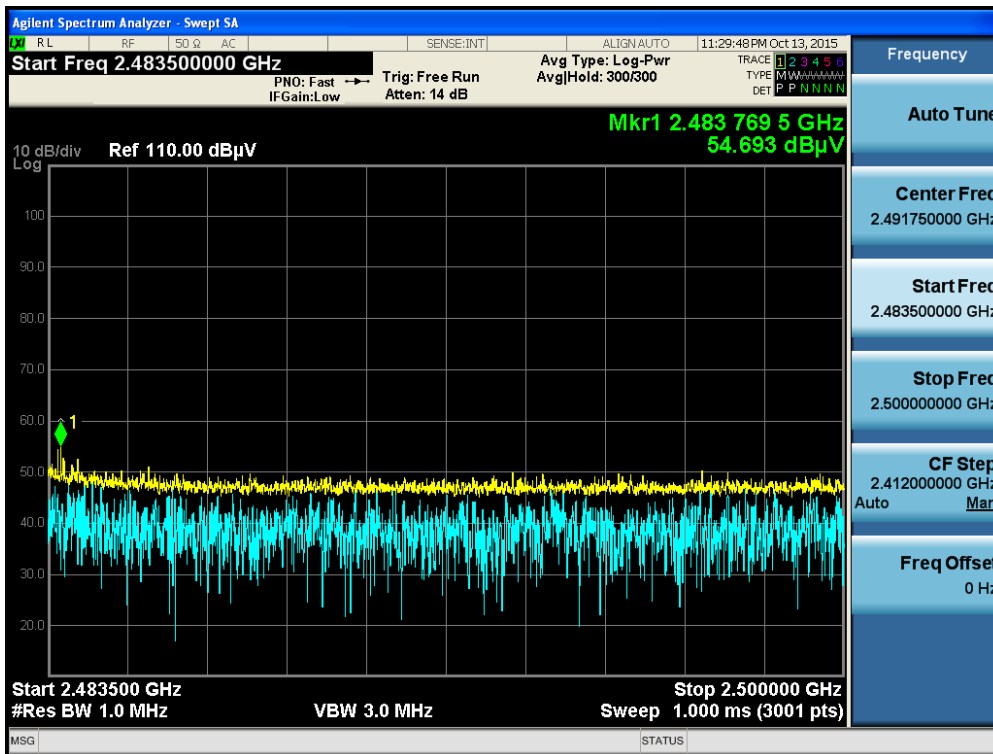

$\pi/4$ DQPSK & Lowest & Edge

Detector Mode : PK

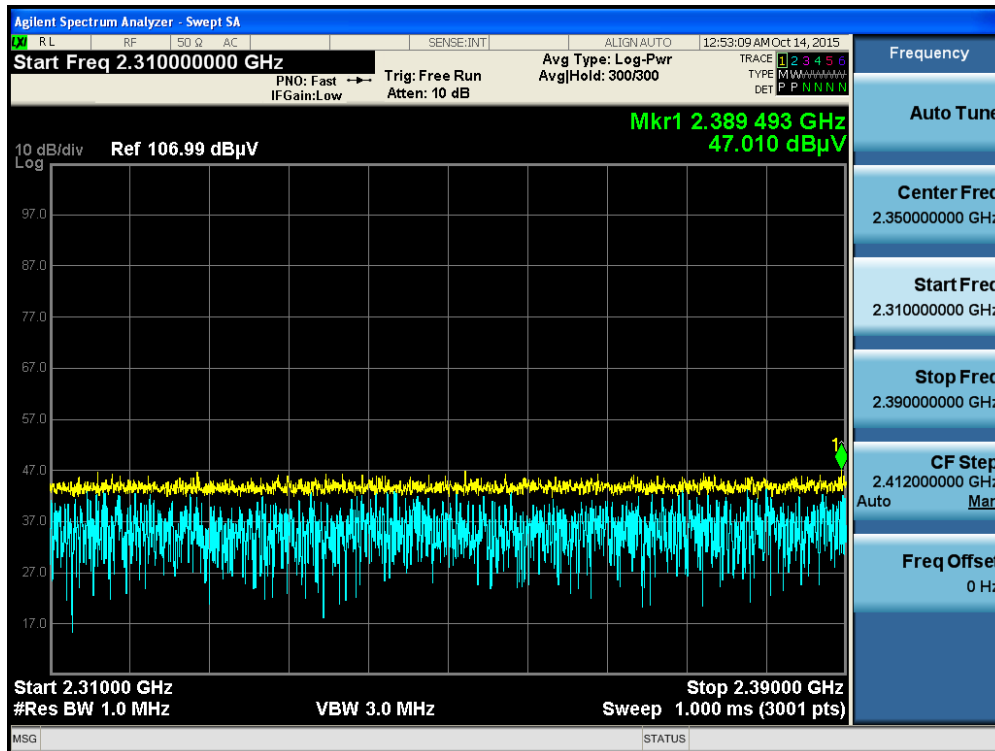

$\pi/4$ DQPSK & Highest & Edge

Detector Mode : PK

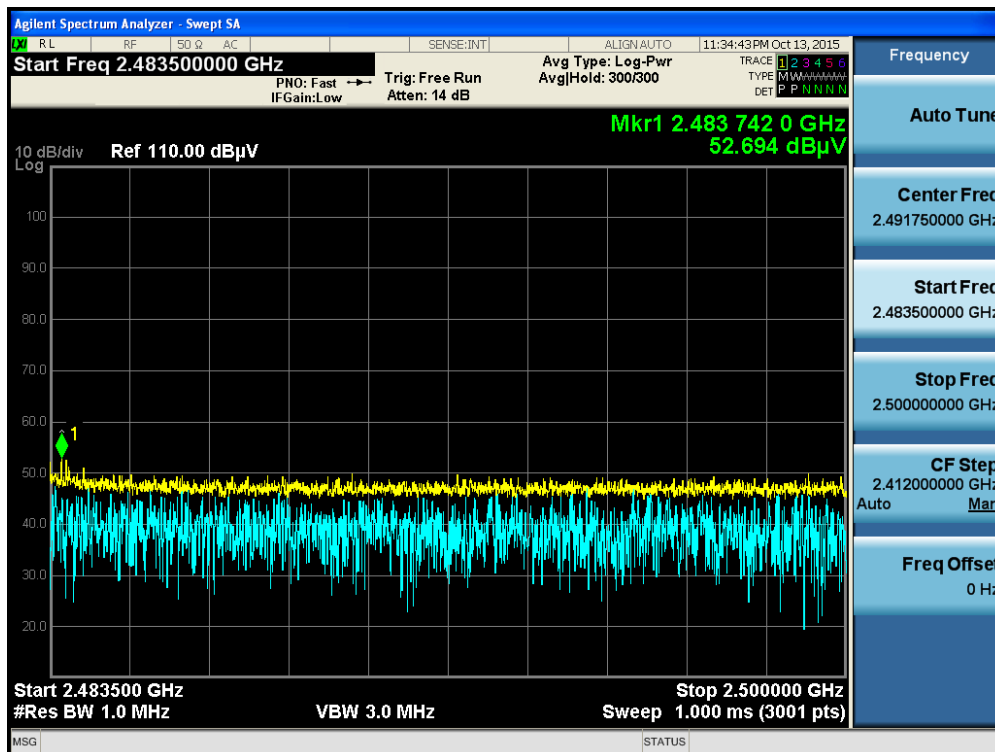



8DPSK & Lowest & Edge

Detector Mode : PK

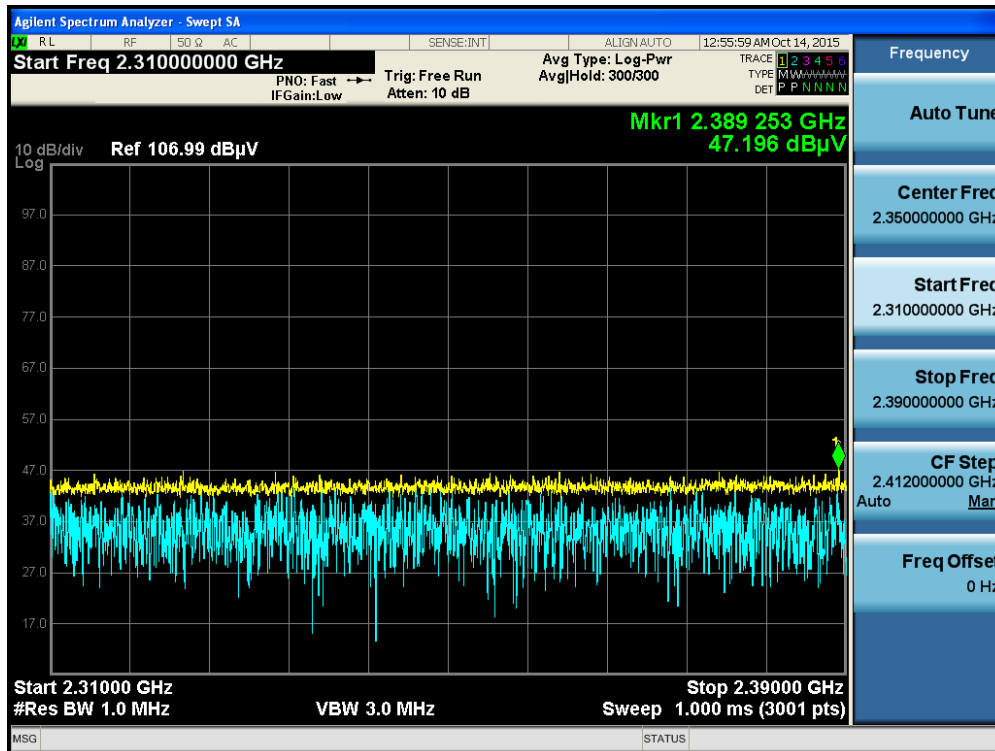

8DPSK & Highest & Edge

Detector Mode : PK

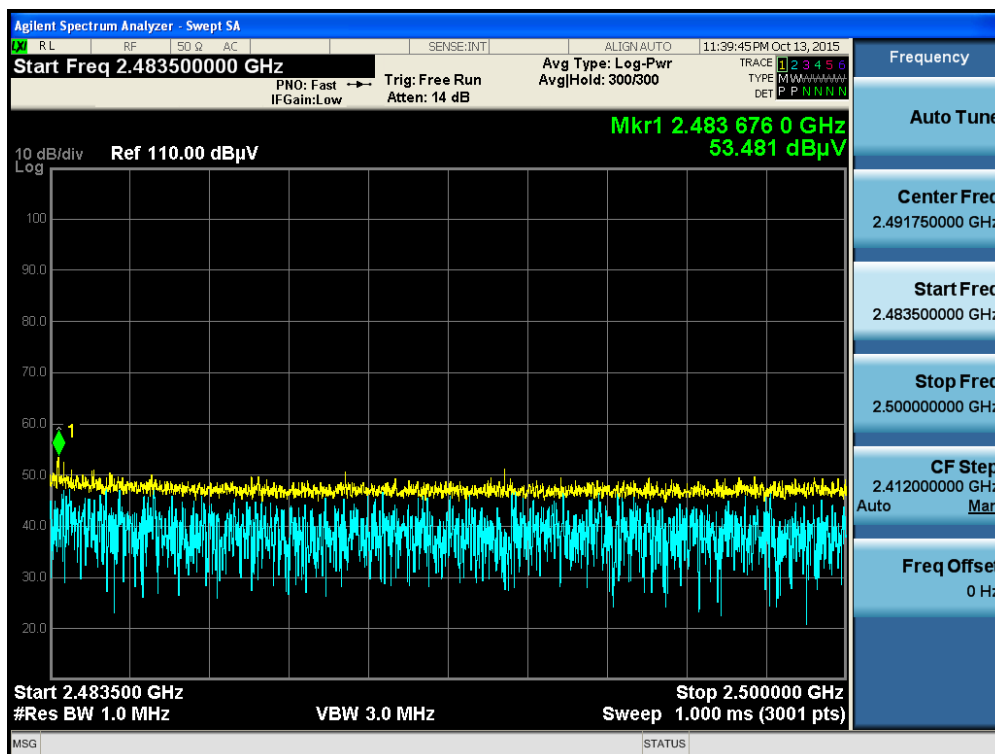

GFSK & Lowest & Harmonic

Detector Mode : PK

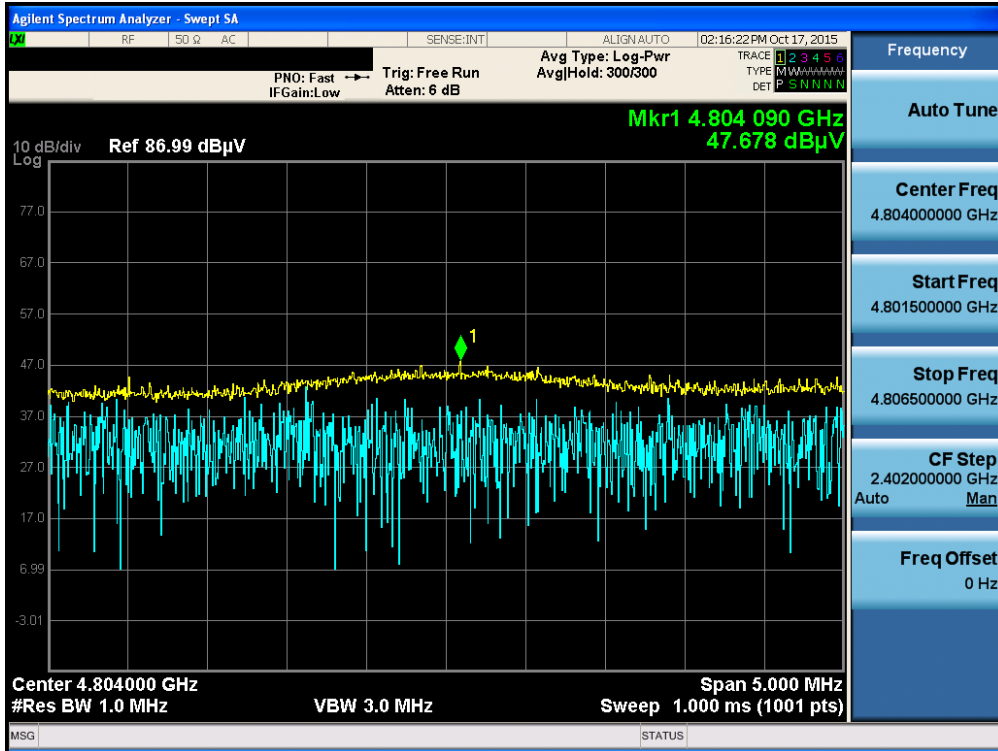

GFSK & Middle & Harmonic

Detector Mode : PK

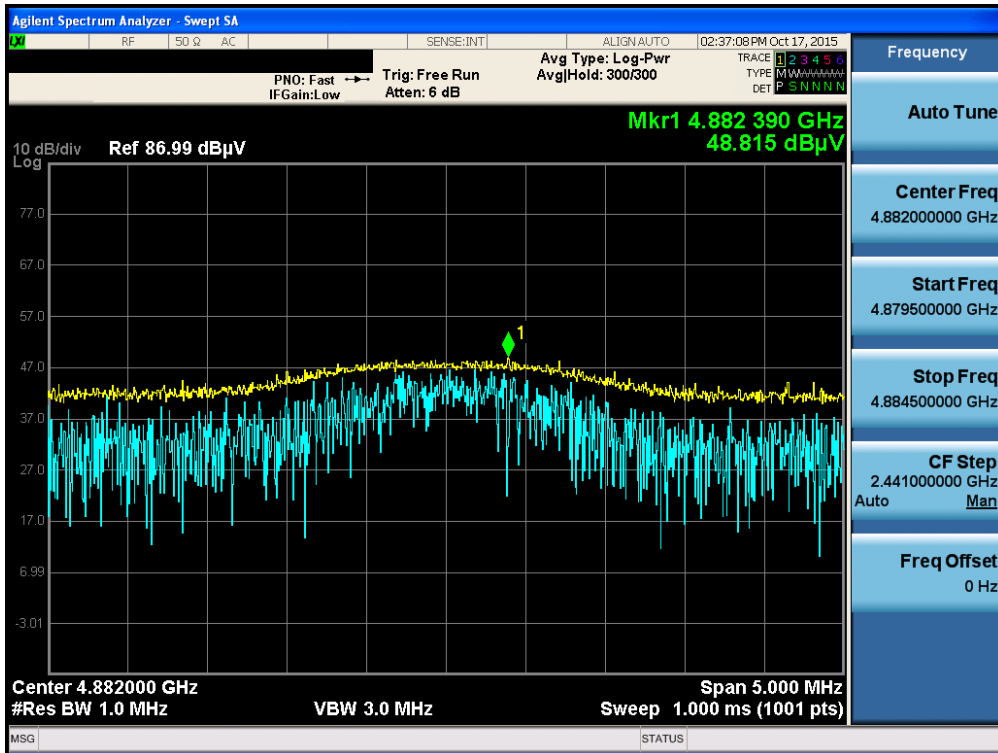

GFSK & Highest & Harmonic

Detector Mode : PK

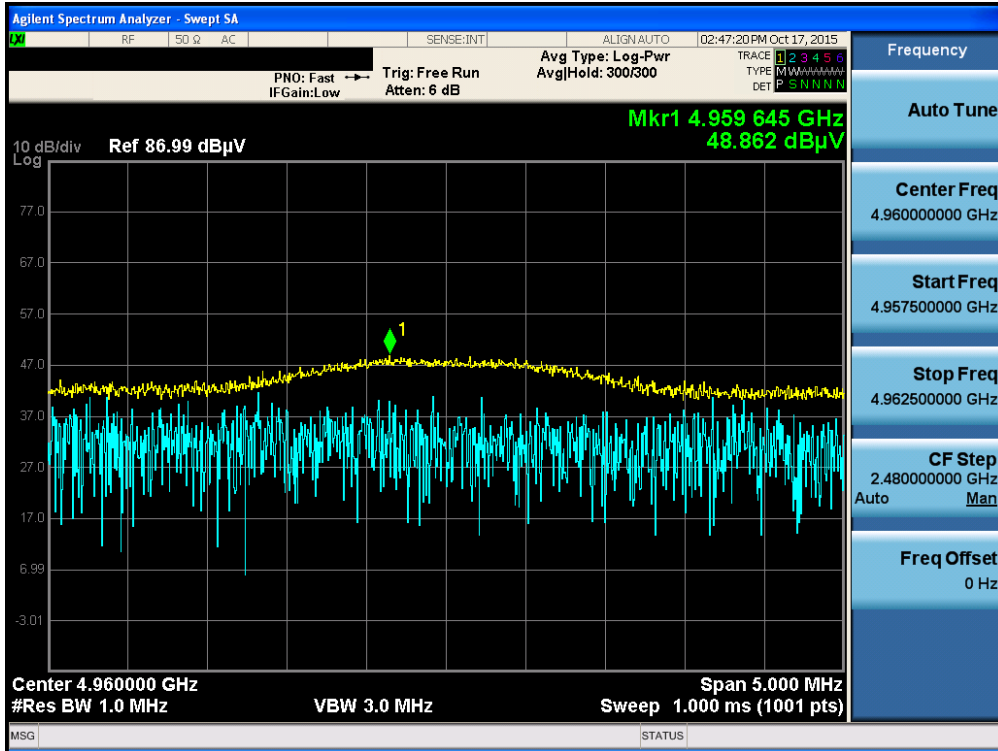

$\pi/4$ DQPSK & Lowest & Harmonic

Detector Mode : PK

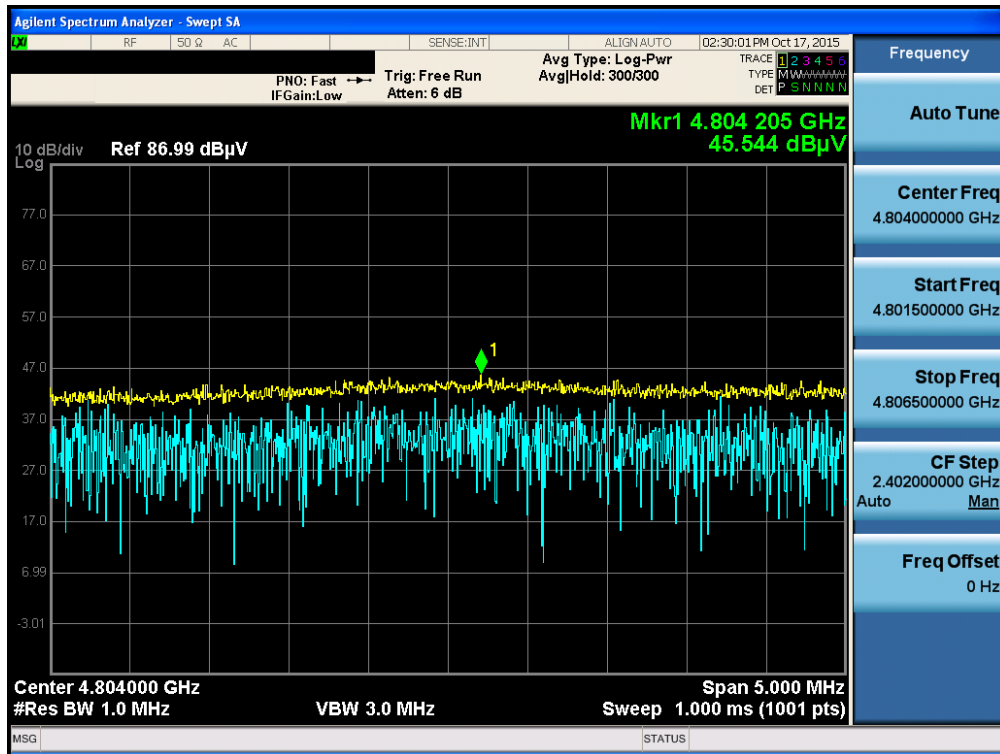

$\pi/4$ DQPSK & Middle & Harmonic

Detector Mode : PK

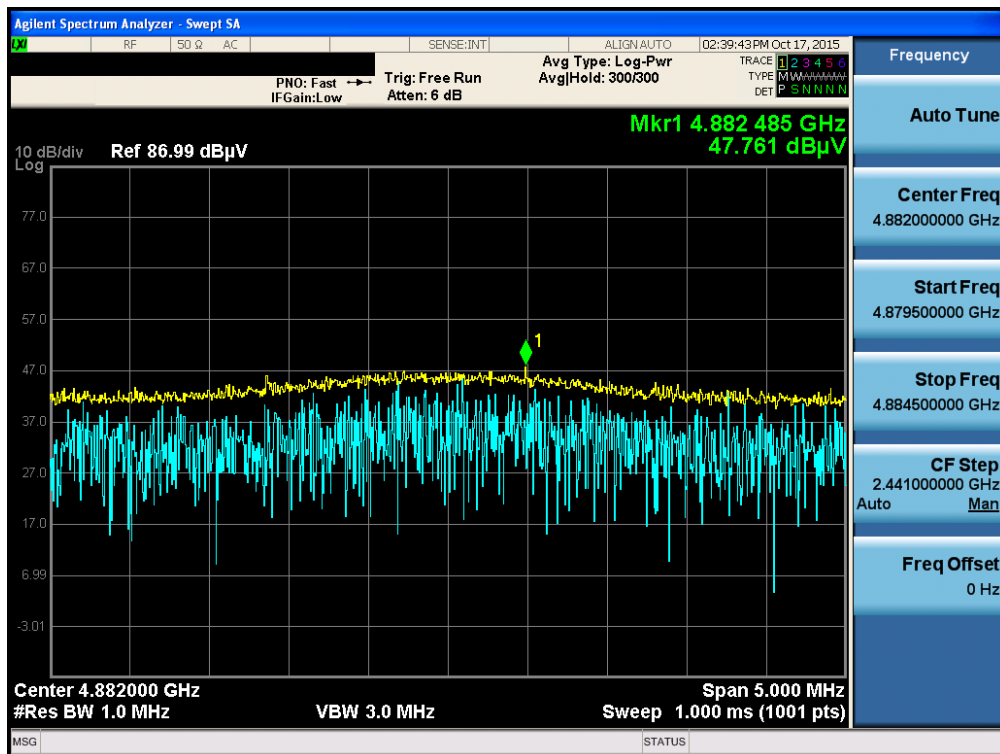

$\pi/4$ DQPSK & Highest & Harmonic

Detector Mode : PK

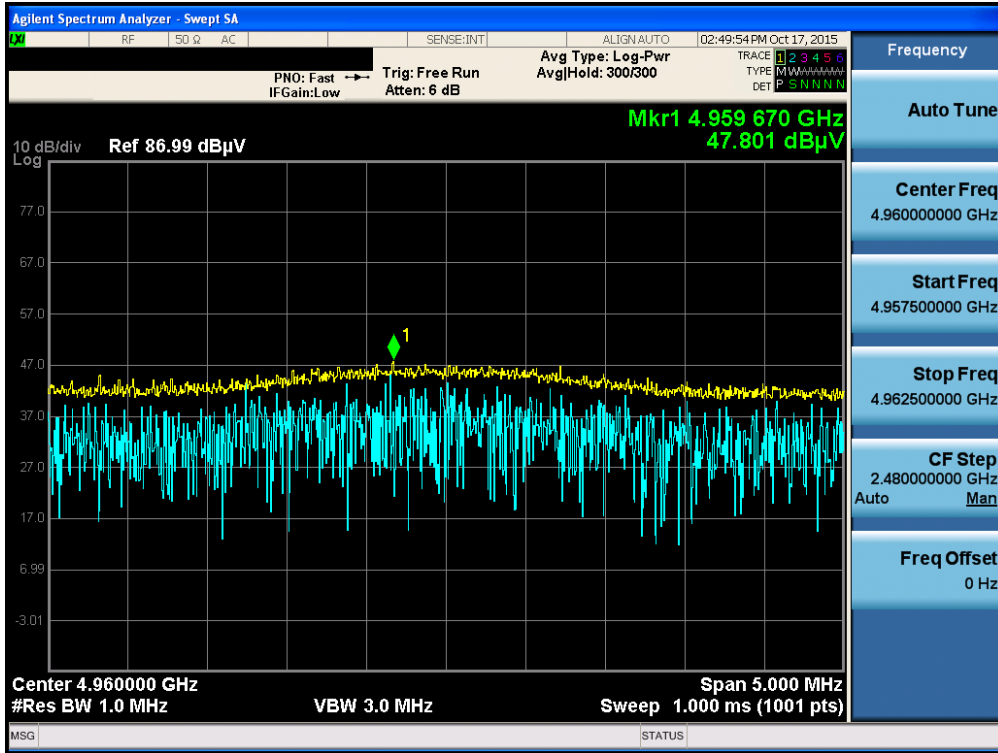

8DPSK & Lowest & Harmonic

Detector Mode : PK

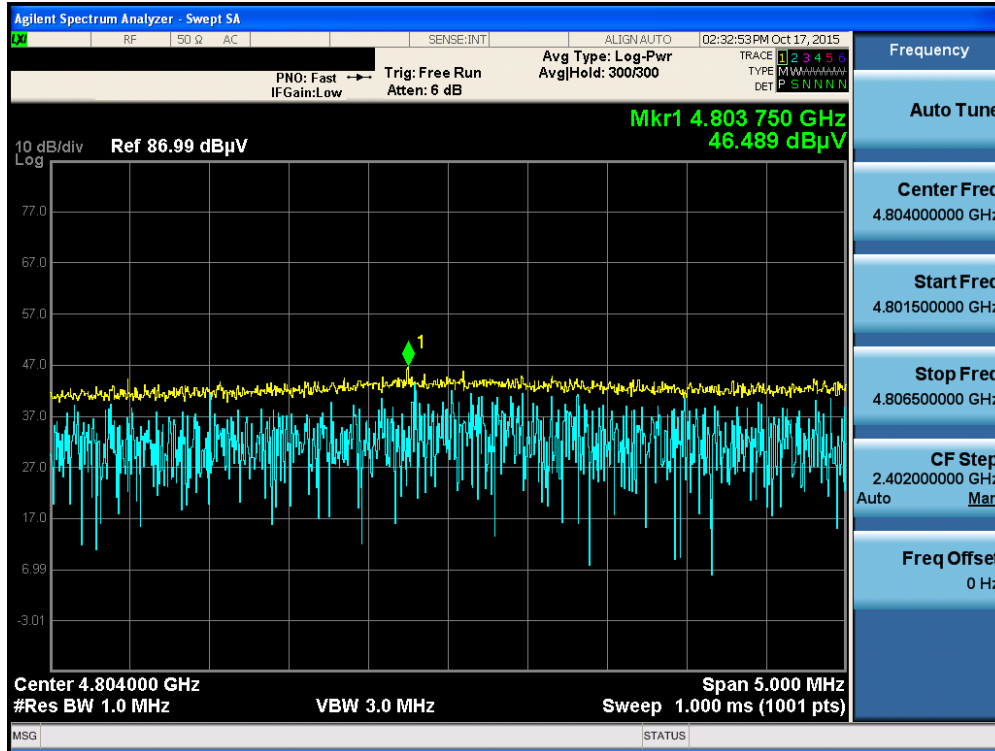

8DPSK & Middle & Harmonic

Detector Mode : PK

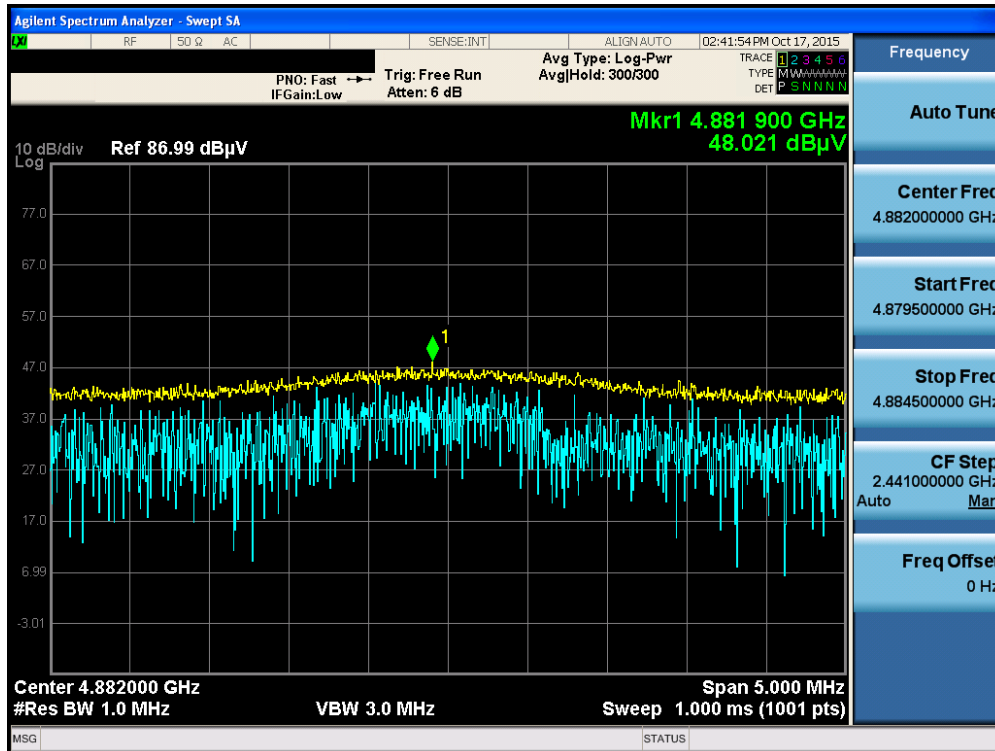



8DPSK & Highest & Harmonic

Detector Mode : PK

