

TEST REPORT



DT&C Co., Ltd.

42, Yurim-ro, 154Beon-gil, Cheoin-gu, Yongin-si, Gyeonggi-do, Korea, 17042
Tel : 031-321-2664, Fax : 031-321-1664

1. Report No : DRTFCC1707-0122

2. Customer

• Name : POINT MOBILE CO.,LTD

• Address : B-9F, Kabul Great Valley 32 Digital-ro 9-gil, Geumcheon-gu Seoul South Korea
153-709

3. Use of Report : FCC & IC Original Grant

4. Product Name / Model Name : Mobile Computer / FCC: PM80, IC: PM80P

FCC ID / IC : V2X-PM80G1 / 10664A-PM80G1

5. Test Method Used : KDB Procedure



Test Specification : FCC Part 22, 24, 27

RSS-130 Issue 1, 132 Issue 3, 133 Issue 6, 139 Issue 3, 199 Issue 3

6. Date of Test : 2017.04.10 ~ 2017.05.28

7. Testing Environment : See appended test report.

8. Test Result : Refer to the attached test result.

Affirmation	Tested by	 (Signature)	Technical Manager	 (Signature)
	Name : Jaejin Lee		Name : Geunki Son	

The test results presented in this test report are limited only to the sample supplied by applicant and the use of this test report is inhibited other than its purpose. This test report shall not be reproduced except in full, without the written approval of DT&C Co., Ltd.

2017 . 07 . 03 .

DT&C Co., Ltd.

If this report is required to confirmation of authenticity, please contact to report@dtnc.net

Test Report Version

Test Report No.	Date	Description
DRTFCC1707-0122	Jul. 03, 2017	Initial issue

Table of Contents

1. GENERAL INFORMATION	5
2. INTRODUCTION	7
2.1 EUT DESCRIPTION	7
2.2 MEASURING INSTRUMENT CALIBRATION.....	7
2.3. MEASUREMENT UNCERTAINTY.....	7
2.4 TEST FACILITY.....	7
3. DESCRIPTION OF TESTS.....	8
3.1 ERP&EIRP	8
3.2 PEAK TO AVERAGE RATIO	10
3.3 OCCUPIED BANDWIDTH.....	11
3.4 BAND EDGE EMISSIONS (Conducted).....	12
3.5 SPURIOUS AND HARMONIC EMISSIONS (Conducted).....	14
3.6 UNDESIRABLE EMISSIONS (Radiated).....	15
3.7 FREQUENCY STABILITY	16
4. LIST OF TEST EQUIPMENT	17
4. SUMMARY OF TEST RESULTS.....	18
6. SAMPLE CALCULATION	19
7. TEST DATA.....	21
7.1 OCCUPIED BANDWIDTH.....	21
7.2 PEAK TO AVERAGE RATIO	21
7.3 BAND EDEG EMISSIONS (Conducted).....	21
7.4 SPURIOUS AND HARMONICS EMISSIONS (Conducted)	21
7.5 ERP & EIRP	22
7.5.1 LTE Band 17.....	22
7.5.2 LTE Band 5.....	23
7.5.3 LTE Band 4.....	24
7.5.4 LTE Band 2.....	25
7.5.5 LTE Band 7.....	26
7.6 UNDESIRABLE EMISSIONS (Radiated).....	27
7.6.1 LTE Band 17.....	27
7.6.2 LTE Band 5.....	28
7.6.3 LTE Band 4.....	30
7.6.4 LTE Band 2.....	33
7.6.5 LTE Band 7.....	36
7.7 FREQUENCY STABILITY	38
7.7.1 LTE Band 17.....	38
7.7.2 LTE Band 5.....	39

7.7.3 LTE Band 4.....	40
7.7.4 LTE Band 2.....	41
7.7.5 LTE Band 7.....	42
8. TEST PLOTS	43
8.1 OCCUPIED BANDWIDTH	43
8.1.1 LTE Band 17.....	43
8.1.2 LTE Band 5.....	45
8.1.3 LTE Band 4.....	49
8.1.4 LTE Band 2.....	55
8.1.5 LTE Band 7.....	61
8.2 PEAK TO AVERAGE RATIO	65
8.2.1 LTE Band 17.....	65
8.2.2 LTE Band 5.....	67
8.2.3 LTE Band 4.....	71
8.2.4 LTE Band 2.....	77
8.2.5 LTE Band 7.....	83
8.3 BAND EDGE EMISSIONS(Conducted).....	87
8.3.1 LTE Band 17.....	87
8.3.2 LTE Band 5.....	91
8.3.3 LTE Band 4.....	99
8.3.4 LTE Band 2.....	111
8.3.5 LTE Band 7.....	123
8.4 SPURIOUS AND HARMONICS EMISSIONS(Conducted)	129
8.4.1 LTE Band 17.....	129
8.4.2 LTE Band 5.....	132
8.4.3 LTE Band 4.....	138
8.4.4 LTE Band 2.....	156
8.4.5 LTE Band 7.....	174

1. GENERAL INFORMATION

Applicant Name: POINT MOBILE CO.,LTD
Address: B-9F, Kabul Great Valley 32 Digital-ro 9-gil, Geumcheon-gu Seoul South Korea 153-709
FCC ID : V2X-PM80G1
IC : 10664A-PM80G1
FCC Classification : Licensed Portable Transmitter Held to Ear (PCE)
EUT Type : Mobile computer
Model Name : FCC: PM80
 : IC: PM80P
Add Model Name : FCC: CHD8, XT2
 : IC: XT2P
Supplying power : DC 3.80 V
Antenna Information : Internal Antenna
Antenna Gain : LTE Band 17: -3.80dBi
 : LTE Band 5: -2.36dBi
 : LTE Band 4: 0.95dBi
 : LTE Band 2: 0.95dBi
 : LTE Band 7: 2.39dBi

Mode	TX Frequency (MHz)	Emission Designator	Modulation	ERP(For the FCC)		EIRP(For the IC)	
				Max power (dBm)	Max power (W)	Max power (dBm)	Max power (W)
LTE Band 17	709 ~ 711	8M96G7D	QPSK	19.16	0.082	21.31	0.135
LTE Band 17	709 ~ 711	8M97W7D	16QAM	18.31	0.068	20.46	0.111
LTE Band 17	706.5 ~ 713.5	4M49G7D	QPSK	18.58	0.072	20.73	0.118
LTE Band 17	706.5 ~ 713.5	4M51W7D	16QAM	17.51	0.056	19.66	0.092
LTE Band 5	829 ~ 844	9M00G7D	QPSK	15.95	0.039	18.10	0.065
LTE Band 5	829 ~ 844	8M98W7D	16QAM	14.75	0.030	16.90	0.049
LTE Band 5	826.5 ~ 846.5	4M49G7D	QPSK	15.90	0.039	18.05	0.064
LTE Band 5	826.5 ~ 846.5	4M50W7D	16QAM	14.83	0.030	16.98	0.050
LTE Band 5	825.5 ~ 847.5	2M70G7D	QPSK	16.23	0.042	18.38	0.069
LTE Band 5	825.5 ~ 847.5	2M70W7D	16QAM	15.28	0.034	17.43	0.055
LTE Band 5	824.7 ~ 848.3	1M09G7D	QPSK	16.40	0.044	18.55	0.072
LTE Band 5	824.7 ~ 848.3	1M09W7D	16QAM	15.53	0.036	17.68	0.059

Mode	TX Frequency (MHz)	Emission Designator	Modulation	EIRP (FCC & IC)	
				Max power(dBm)	Max power(W)
LTE Band 4	1720 ~ 1745	17M9G7D	QPSK	24.45	0.279
LTE Band 4	1720 ~ 1745	18M0W7D	16QAM	23.62	0.230
LTE Band 4	1717.5 ~ 1747.5	13M4G7D	QPSK	24.03	0.253
LTE Band 4	1717.5 ~ 1747.5	13M4W7D	16QAM	23.14	0.206
LTE Band 4	1715 ~ 1750	8M97G7D	QPSK	24.23	0.265
LTE Band 4	1715 ~ 1750	8M97W7D	16QAM	23.18	0.208
LTE Band 4	1712.5 ~ 1752.5	4M50G7D	QPSK	24.13	0.259
LTE Band 4	1712.5 ~ 1752.5	4M49W7D	16QAM	23.36	0.217
LTE Band 4	1711.5 ~ 1753.5	2M70G7D	QPSK	24.05	0.254
LTE Band 4	1711.5 ~ 1753.5	2M70W7D	16QAM	23.24	0.211
LTE Band 4	1710.7 ~ 1754.3	1M09G7D	QPSK	24.19	0.262
LTE Band 4	1710.7 ~ 1754.3	1M09W7D	16QAM	23.10	0.204
LTE Band 2	1860 ~ 1900	17M9G7D	QPSK	21.57	0.144
LTE Band 2	1860 ~ 1900	17M9W7D	16QAM	20.75	0.119
LTE Band 2	1857.5 ~ 1902.5	13M5G7D	QPSK	21.67	0.147
LTE Band 2	1857.5 ~ 1902.5	13M4W7D	16QAM	20.88	0.122
LTE Band 2	1855 ~ 1905	8M99G7D	QPSK	21.27	0.134
LTE Band 2	1855 ~ 1905	8M97W7D	16QAM	20.56	0.114
LTE Band 2	1852.5 ~ 1907.5	4M49G7D	QPSK	21.17	0.131
LTE Band 2	1852.5 ~ 1907.5	4M49W7D	16QAM	20.33	0.108
LTE Band 2	1851.5 ~ 1908.5	2M70G7D	QPSK	21.25	0.133
LTE Band 2	1851.5 ~ 1908.5	2M70W7D	16QAM	20.18	0.104
LTE Band 2	1850.7 ~ 1909.3	1M09G7D	QPSK	21.25	0.133
LTE Band 2	1850.7 ~ 1909.3	1M09W7D	16QAM	20.67	0.117
LTE Band 7	2510 ~ 2560	17M9G7D	QPSK	19.36	0.086
LTE Band 7	2510 ~ 2560	17M9W7D	16QAM	18.34	0.068
LTE Band 7	2507.5 ~ 2562.5	13M4G7D	QPSK	19.03	0.080
LTE Band 7	2507.5 ~ 2562.5	13M5W7D	16QAM	18.19	0.066
LTE Band 7	2505 ~ 2565	8M98G7D	QPSK	19.13	0.082
LTE Band 7	2505 ~ 2565	8M97W7D	16QAM	18.11	0.065
LTE Band 7	2502.5 ~ 2567.5	4M50G7D	QPSK	19.04	0.080
LTE Band 7	2502.5 ~ 2567.5	4M50W7D	16QAM	18.06	0.064

2. INTRODUCTION

2.1 EUT DESCRIPTION

The Equipment under Test (EUT) supports WCDMA, LTE, WLAN, Bluetooth and NFC.

2.2 MEASURING INSTRUMENT CALIBRATION

The measuring equipment, which was utilized in performing the tests documented herein, has been calibrated in accordance with the manufacturer's recommendations for utilizing calibration equipment, which is traceable to recognized national standards.

2.3. MEASUREMENT UNCERTAINTY

Where relevant, the following measurement uncertainty levels have been estimated for tests performed on the EUT as specified in CISPR 16-4-2.

Test items	Measurement uncertainty
Conducted spurious emission	0.90 dB (The confidence level is about 95 %, k = 2)
Radiated spurious emission (1 GHz Below)	5.1 dB (The confidence level is about 95 %, k = 2)
Radiated spurious emission (1 GHz ~ 18 GHz)	5.4 dB (The confidence level is about 95 %, k = 2)
Radiated spurious emission (18 GHz Above)	5.3 dB (The confidence level is about 95 %, k = 2)

2.4 TEST FACILITY

The 3M test site and conducted measurement facility used to collect the radiated data are located at the 42, Yurim-ro, 154beon-gil, Cheoin-gu, Yongin-si, Gyeonggi-do, Korea 449-935. The site is constructed in conformance with the requirements.

- Semi anechoic chamber registration Number: 165783 (FCC) & 5740A-3 (IC)

3. DESCRIPTION OF TESTS

3.1 ERP&EIRP

(Effective Radiated Power & Equivalent Isotropic Radiated Power)

Test Set-up

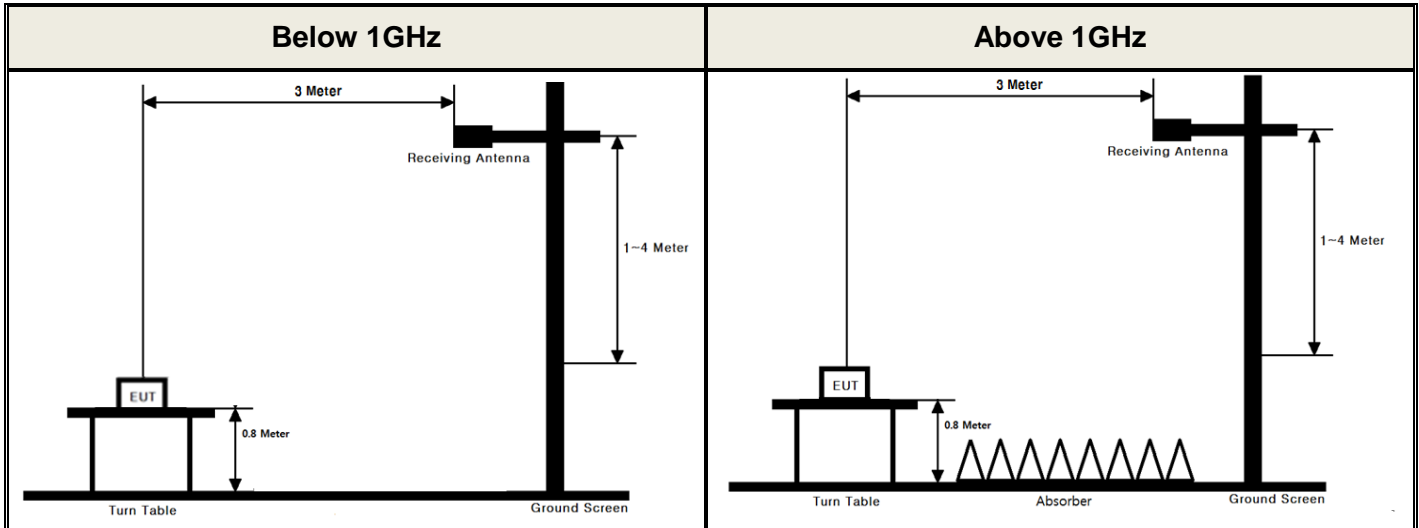

Test Procedure

- ANSI/TIA-603-E-2016 - Section 2.2.17
- KDB971168 v02r02 - Section 5.2.1

These measurements were performed at 3 m test site. The equipment under test is placed on a non-conductive table 0.8-meters above a turntable which is flush with the ground plane and 3 meters from the receive antenna. For measurements above 1GHz absorbers are placed on the floor between the turn table and the antenna mast in such a way so as to maximize the reduction of reflections. For measurements below 1 GHz, the absorbers are removed.

Test setting

1. Set span to at least 1.5 times the OBW.
2. Set RBW = 1-5 % of the OBW, not to exceed 1 MHz.
3. Set VBW $\geq 3 \times$ RBW.
4. Set number of points in sweep $\geq 2 \times$ span / RBW.
5. Sweep time = auto couple.
6. Detector = RMS (power averaging).
7. If the EUT can be configured to transmit continuously (i.e., burst duty cycle ≥ 98 %), then set the trigger to free run.
8. If the EUT cannot be configured to transmit continuously (i.e., burst duty cycle < 98 %), then use a sweep trigger with the level set to enable triggering only on full power bursts and configure the EUT to transmit at full power for the entire duration of each sweep.

Ensure that the sweep time is less than or equal to the transmission burst duration.

9. Trace average at least 100 traces in power averaging (i.e., RMS) mode.

10. Compute the power by integrating the spectrum across the OBW of the signal using the instrument's band power measurement function, with the band limits set equal to the OBW band edges. If the instrument does not have a band power function, then sum the spectrum levels (in linear power units) at intervals equal to the RBW extending across the entire OBW of the spectrum.

The receive antenna height and turntable rotations were adjusted for the highest reading on the receive spectrum analyzer.

A half-wave dipole was substituted in place of the EUT. This dipole antenna was driven by a signal generator and the level of the signal generator was adjusted to obtain the same receive spectrum analyzer reading. The conducted power at the terminal of the substitute antenna is measured.

The ERP/EIRP is calculated using the following formula:

ERP/EIRP = The conducted power at the substitute antenna's terminal [dBm] + Substitute Antenna gain [dBd for ERP , dBi for EIRP]

For readings above 1 GHz, the above procedure is repeated using horn antennas and the difference between the gain of the horn antenna and an isotropic antenna are taken into consideration.

3.2 PEAK TO AVERAGE RATIO

Test set-up

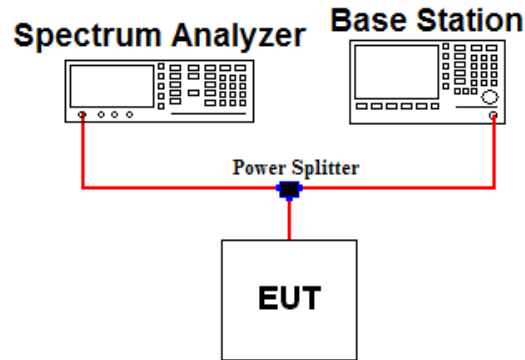

Test Procedure

- KDB971168 v02r02 - Section 5.7.1

A peak to average ratio measurement is performed at the conducted port of the EUT. The spectrum analyzer's Complementary Cumulative Distribution Function (CCDF) measurement profile is used to determine the largest deviation between the average and the peak power of the EUT in a given bandwidth. The CCDF curve shows how much time the peak waveform spends at or above a given average power level. The present of time the signal spends at or above the level defines the probability for that particular power level.

Test setting

The spectrum Analyzer's CCDF measurement function is enabled.

1. Set resolution/measurement bandwidth \geq signal's occupied bandwidth.
2. Set the number of counts to a value that stabilizes the measured CCDF curve
3. Set the measurement interval as follows:
 - 1) For continuous transmissions, set to 1 ms.
 - 2) For burst transmissions, employ an external trigger that is synchronized with the EUT burst timing sequence, or use the internal burst trigger with a trigger level that allows the burst to stabilize and set the measurement interval to a time that is less than or equal to the burst duration.
4. Record the maximum PAPR level associated with a probability of 0.1 %

3.3 OCCUPIED BANDWIDTH.

Test set-up

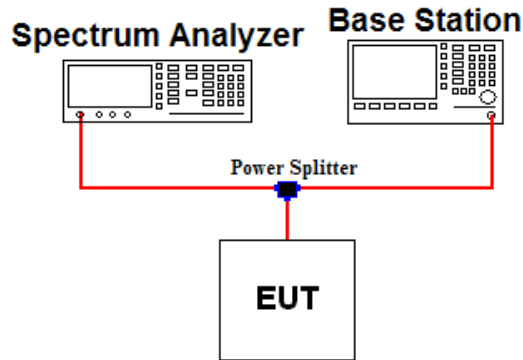

Test Procedure

- KDB971168 v02r02 - Section 4.2

The occupied bandwidth, that is the frequency bandwidth such that, below its lower and above its upper frequency limits, the mean powers radiated are each equal to 0.5 percent of the total mean power of a given emission.

Test setting

1. The signal analyzer's automatic bandwidth measurement capability was used to perform the 99 % occupied bandwidth and the 26 dB bandwidth. The bandwidth measurement was not influenced by any intermediate power nulls in the fundamental emission.
2. $RBW = 1 \sim 5 \%$ of the expected OBW & $VBW \geq 3 \times RBW$
3. Detector = Peak
4. Trance mode = Max hold
5. Sweep = Auto couple
6. The trace was allowed to stabilize
7. If necessary, step 2 ~ 6 were repeated after changing the RBW such that it would be within 1 ~ 5 % of the 99 % occupied bandwidth observed in step 6.

3.4 BAND EDGE EMISSIONS (Conducted)

Test set-up

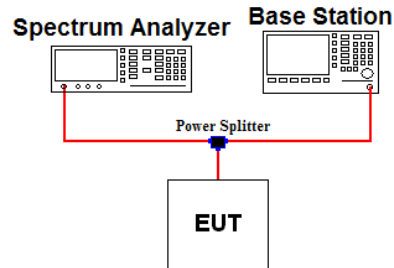

Test Procedure

- KDB971168 v02r02 - Section 6.0

All out of band emissions are measured by means of a calibrated spectrum analyzer. The EUT was setup to maximum output power at its lowest and highest channel with all bandwidths, modulations and RB configurations.

The power of any spurious emission shall be attenuated below the transmitter power (P) by at least $43 + 10 \log(P)$ dB or requirements on note 3 in case of band 7 and 41.

Test setting

1. Start and stop frequency were set such that the band edge would be placed in the center of the plot
2. Span was set large enough so as to capture all out of band emissions near the band edge
3. RBW ≥ 1 % of the emission bandwidth
4. VBW $\geq 3 \times$ RBW
5. Detector = RMS & Trace mode = Max hold
6. Sweep time = Auto couple or 1 s for band edge
7. Number of sweep point $\geq 2 \times$ span / RBW
8. The trace was allowed to stabilize

Note 1: Per Part 22.917(b)(1) / 24.238(b) / 27.53(h)(3) in the 1 MHz bands immediately outside and adjacent to the frequency block a resolution bandwidth of at least one percent of the emission bandwidth of the fundamental emission of the transmitter may be employed to demonstrate compliance with the out-of-band emissions limit.

The emission bandwidth is defined as the width of the signal between two points, one below the carrier center frequency and one above the carrier center frequency, outside of which all emission are attenuated at least 26 dB below the transmitter power.

Note 2: Per Part 27(g) for operations in the 600 MHz band and the 698-746 MHz band, compliance with this provision is based on the use of measurement instrumentation employing a resolution bandwidth of 100 kilohertz or greater. However, in the 100 kilohertz bands immediately outside and adjacent to a licensee's frequency block, a resolution bandwidth of at least 30 kHz may be employed.

Note 3: For part 27.53(m)(4) the attenuation factor shall be not less than $40 + 10 \log (P)$ dB on all frequencies between the channel edge and 5 megahertz from the channel edge, $43 + 10 \log (P)$ dB on all frequencies between 5 megahertz and X megahertz from the channel edge, and $55 + 10 \log (P)$ dB on all frequencies more than X megahertz from the channel edge, where X is the greater of 6 megahertz or the actual emission bandwidth as defined in paragraph (m)(6) of this section. In addition, the attenuation factor shall not be less than $43 + 10 \log (P)$ dB on all frequencies between 2490.5 MHz and 2496 MHz and $55 + 10 \log (P)$ dB at or below 2490.5 MHz.

Note 4: Per part 27.53(m)(6) in the 1 MHz bands immediately outside and adjacent to the frequency block a resolution bandwidth of at least two percent may be employed, except when the 1 MHz band is 2495-2496 MHz, in which case a resolution bandwidth of at least one percent may be employed.

3.5 SPURIOUS AND HARMONIC EMISSIONS (Conducted)

Test set-up

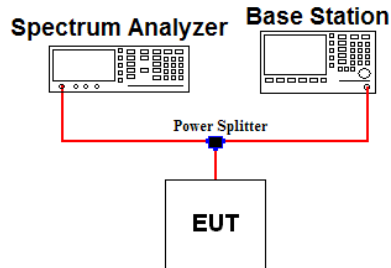

Test Procedure

- KDB971168 v02r02 - Section 6.0

The level of the carrier and the various conducted spurious and harmonic frequencies is measured by means of a calibrated spectrum analyzer. The EUT was setup to maximum output power at its low, middle, high channel with all bandwidths, modulations and RB configurations. The spectrum is scanned from 30 MHz up to a frequency including its 10th harmonic.

The power of any spurious emission shall be attenuated below the transmitter power (P) by at least $43 + 10 \log(P)$ dB or $55 + 10 \log(P)$ in case of band 7 and 41.

Test setting

1. RBW = 100 KHz or 1 MHz & VBW $\geq 3 \times$ RBW (Refer to Note 1)
2. Detector = RMS & Trace mode = Max hold
3. Sweep time = Auto couple
4. Number of sweep point $\geq 2 \times$ span / RBW
5. The trace was allowed to stabilize

Note 1: Compliance with these provisions is based on the use of measurement instrumentation employing a resolution bandwidth of 100 kHz or greater for frequencies less than 1GHz and 1MHz or greater for frequencies greater than 1GHz.

3.6 UNDESIRABLE EMISSIONS (Radiated)

Test Set-up

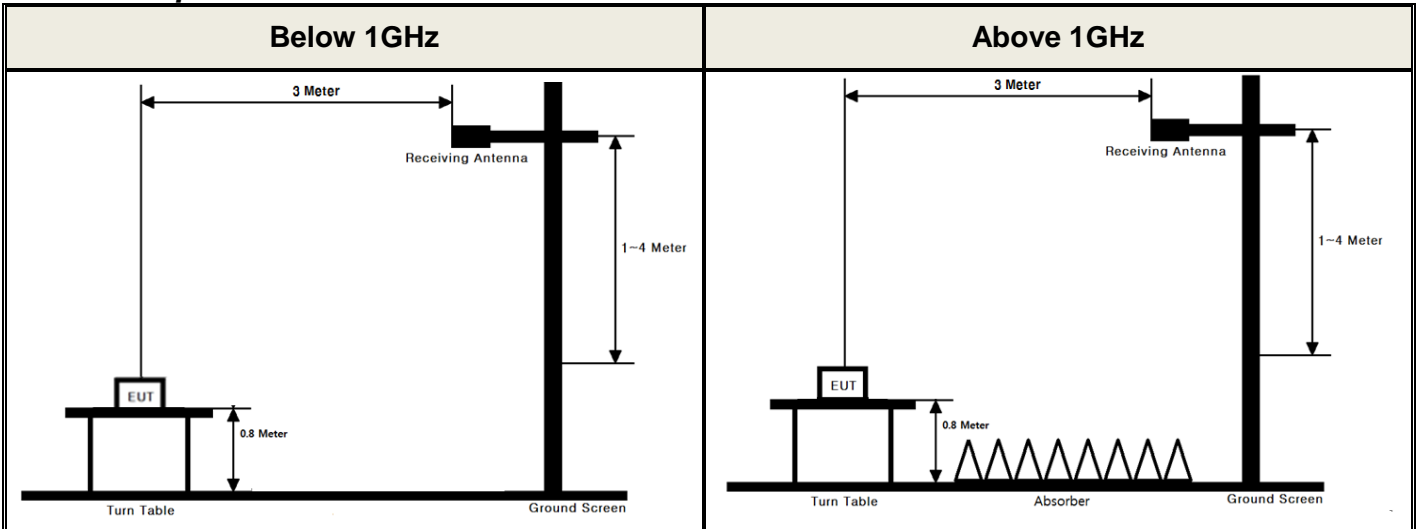

Test Procedure

- ANSI/TIA-603-E-2016 - Section 2.2.12
- KDB971168 v02r02 - Section 5.8

These measurements were performed at 3 test site. The equipment under test is placed on a non-conductive table 0.8-meters above a turntable which is flush with the ground plane and 3 meters from the receive antenna. For measurements above 1GHz absorbers are placed on the floor between the turn table and the antenna mast in such a way so as to maximize the reduction of reflections. For measurements below 1 GHz, the absorbers are removed.

Test setting

1. RBW = 100 kHz for below 1 GHz and 1 MHz for above 1 GHz / VBW ≥ 3 X RBW
2. Detector = RMS & Trace mode = Max hold
3. Sweep time = Auto couple
4. Number of sweep point ≥ 2 X span / RBW
5. The trace was allowed to stabilize

The receive antenna height and turntable rotations were adjusted for the highest reading on the receive spectrum analyzer.

For radiated power measurements below 1 GHz, a half-wave dipole was substituted in place of the EUT. This dipole antenna was driven by a signal generator and the level of the signal generator was adjusted to obtain the same spectrum analyzer reading.

For radiated power measurements above 1 GHz, a Horn antenna was substituted in place of the EUT. This Horn antenna was driven by a signal generator and the level of the signal generator was adjusted to obtain the same spectrum analyzer reading. The difference between the gain of the horn and an isotropic antenna are taken into consideration.

This measurement was performed with the EUT oriented in 3 orthogonal axis.

3.7 FREQUENCY STABILITY

Test Set-up

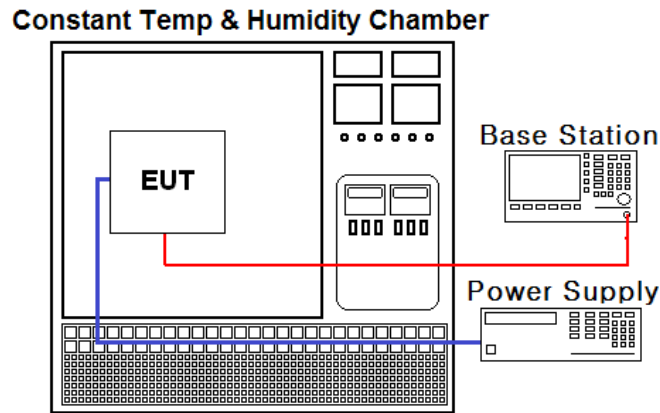

Test Procedure

- ANSI/TIA-603-E-2016
- KDB971168 v02r02 - Section 9.0

The frequency stability of the transmitter is measured by:

a.) **Temperature:**

The temperature is varied from - 30 °C to + 50 °C using an environmental chamber.

b.) **Primary Supply Voltage:**

The primary supply voltage is varied from 85 % to 115 % of the nominal value for non hand-carried battery and AC powered equipment. For hand-carried, battery-powered equipment, primary supply voltage is reduced to the battery operating end point which shall be specified by the manufacturer.

Specification:

The frequency stability shall be sufficient to ensure that the fundamental emission stays within the authorized frequency block for Part 24, 27. The frequency stability of the transmitter shall be maintained within $\pm 0.00025\%$ (± 2.5 ppm) of the center frequency for Part 22.

Time Period and Procedure:

1. The carrier frequency of the transmitter is measured at room temperature. (20 °C to provide a reference)
2. The equipment is turned on in a “standby” condition for one minute before applying power to the transmitter. Measurement of the carrier frequency of the transmitter is made within one minute after applying power to the transmitter.
3. Frequency measurements are made at 10 °C intervals ranging from -30 °C to +50 °C. A period of at least one half-hour is provided to allow stabilization of the equipment at each temperature level.

4. LIST OF TEST EQUIPMENT

Type	Manufacturer	Model	Cal.Date (yy/mm/dd)	Next.Cal. Date (yy/mm/dd)	S/N
Spectrum Analyzer	Agilent Technologies	N9020A	16/10/11	17/10/11	MY46471251
Spectrum Analyzer	Agilent Technologies	N9020A	17/01/11	18/01/11	MY48010133
DC power supply	Agilent Technologies	66332A	16/09/08	17/09/08	US37473422
Multimeter	FLUKE	17B	17/04/12	18/04/12	26030065WS
Temp & Humi Test Chamber	SJ Science	SJ-TH-S50	17/01/25	18/01/25	SJ-TH-S50-120203
Thermohygrometer	BODYCOM	BJ5478	17/01/11	18/01/11	1209
Radio Communication Analyzer	Anritsu	MT8820C	17/01/03	18/01/03	6201274516
2W 3dB Attenuator	SMAJK	SMAJK-2-3	16/10/11	17/10/11	2
Vector Signal Generator	Rohde Schwarz	SMBV100A	17/01/04	18/01/04	255571
Signal Generator	Rohde Schwarz	SMF100A	17/04/21	18/04/21	102341
Loop Antenna	Schwarzbeck	FMZB1513	16/04/22	18/04/22	1513-128
BILOG ANTENNA	Schwarzbeck	VULB 9160	16/11/11	18/11/11	3151
Dipole Antenna	Schwarzbeck	VHA9103	17/03/14	19/03/14	2116
Dipole Antenna	Schwarzbeck	VHA9103	16/04/15	18/04/15	2117
Dipole Antenna	Schwarzbeck	UHA9105	17/03/14	19/03/14	2261
Dipole Antenna	Schwarzbeck	UHA9105	16/04/15	18/04/15	2262
HORN ANT	ETS	3117	16/05/13	18/05/13	00140394
HORN ANT	ETS	3117	16/02/26	18/02/26	00152145
HORN ANT	A.H.Systems	SAS-574	17/04/25	19/04/25	154
HORN ANT	A.H.Systems	SAS-574	15/09/03	17/09/03	155
PreAmplifier	TSJ	MLA-010K01-B01-27	17/03/06	18/03/06	1844539
Amplifier	RF Bay Inc	MPA-40-40	17/04/12	18/04/12	21151801
Amplifier	EMPOWER	BBS3Q7ELU	16/09/08	17/09/08	1020
Amplifier	Agilent	8449B	16/10/19	17/10/19	3008A02108
High-pass filter	Wainwright	WHKX12-935-1000-15000-40SS	16/09/09	17/09/09	7
High-pass filter	Wainwright	WHKX12-2580-3000-18000-80SS	16/09/09	17/09/09	3
High-pass filter	Wainwright	WHNX5.0	16/09/08	17/09/08	8

4. SUMMARY OF TEST RESULTS

FCC Part Section(s)	RSS Section(s)	Test Description	Test Limit	Test Condition	Status Note 1
2.1046	-	Conducted Output Power	N/A	Conducted	C Note2
2.1049	RSS-GEN[6.6]	Occupied Bandwidth	N/A		C
24.232(d) 27.50(d.5)	RSS-130 [4.4] RSS-132 [5.4] RSS-133 [6.4] RSS-139 [6.5] RSS-199 [4.4]	Peak to Average Ratio	< 13 dB		C
2.1051 22.917(a) 24.238(a) 27.53(g) 27.53(h)	RSS-130 [4.6.1] RSS-132 [5.5] RSS-133 [6.5] RSS-139 [6.6]	Band Edge / Conducted Spurious Emissions	> 43 + 10log ₁₀ (P) dB at Band edge and for all out-of-band emissions		C
27.53(m)	RSS-199 [4.5]	Band Edge / Conducted Spurious Emissions	> 40 + 10log ₁₀ (P) dB at channel edge and 5 MHz from the channel edge > 43 + 10log ₁₀ (P) dB at 5 MHz and X MHz from the channel edge > 55 + 10log ₁₀ (P) dB at all frequencies more than X MHz from the channel edge		C Note3
2.1055 22.355 24.235 27.54	RSS-130 [4.3] RSS-132 [5.3] RSS-133 [6.3] RSS-139 [6.4] RSS-199 [4.3]	Frequency Stability	< 2.5 ppm (Part 22), (RSS-132, 133) Fundamental emissions must stay within Authorized frequency block (Part 24, 27), (RSS-130,139, 199)		C
27.50(c.10)	RSS-130 [4.4]	Radiated Output Power (B17)	< 3 Watts max. ERP (Part 27) < 5 Watts max. EIRP (RSS-130)	Radiated	C
22.913(a.2)	RSS-132 [5.4]	Radiated Output Power (B5)	< 7 Watts max. ERP (Part 22) < 11.5 Watts max. EIRP (RSS-132)		C
27.50(d.4)	RSS-139 [6.5]	Radiated Output Power (B4)	< 1 Watts max. EIRP		C
24.232(c) 27.50(h.2)	RSS-133 [6.4] RSS-199 [4.4]	Radiated Output Power (B2), (B7)	< 2 Watts max. EIRP		C
2.1053 22.917(a) 24.238(a) 27.53(g) 27.53(h)	RSS-130 [4.6.1] RSS-132 [5.5] RSS-133 [6.5] RSS-139 [6.6]	Undesirable Emissions	> 43 + 10log ₁₀ (P) dB for all out-of-band emissions		C
27.53(m)	RSS-199 [4.5]	Undesirable Emissions	> 55 + 10log ₁₀ (P) dB for all out-of-band emissions		C

Note 1: **C**=Comply **NC**=Not Comply **NT**=Not Tested **NA**=Not Applicable

Note 2: Refer to RF Exposure Report (Test Report_SAR)

Note 3: Where X is the greater of 6 MHz or the actual emission bandwidth as defined in paragraph (m)(6) of this section.

6. SAMPLE CALCULATION

A. Emission Designator

LTE Band 17(QPSK)

Emission Designator = **8M96G7D**
LTE OBW = 8.962 MHz
G = Phase Modulation
7 = Quantized/Digital Info
D = Data Transmission

LTE Band 5(QPSK)

Emission Designator = **9M00G7D**
LTE OBW = 8.997 MHz
G = Phase Modulation
7 = Quantized/Digital Info
D = Data Transmission

LTE Band 4(QPSK)

Emission Designator = **17M9G7D**
LTE OBW = 17.892 MHz
G = Phase Modulation
7 = Quantized/Digital Info
D = Data Transmission

LTE Band 2(QPSK)

Emission Designator = **17M9G7D**
LTE OBW = 17.909 MHz
G = Phase Modulation
7 = Quantized/Digital Info
D = Data Transmission

LTE Band 7(QPSK)

Emission Designator = **17M9G7D**
LTE OBW = 17.917 MHz
G = Phase Modulation
7 = Quantized/Digital Info
D = Data Transmission

LTE Band 17(16QAM)

Emission Designator = **8M97W7D**
LTE OBW = 8.965 MHz
W = Amplitude/Angle Modulated
7 = Quantized/Digital Info
D = Data Transmission

LTE Band 5(16QAM)

Emission Designator = **8M98W7D**
LTE OBW = 8.976 MHz
W = Amplitude/Angle Modulated
7 = Quantized/Digital Info
D = Data Transmission

LTE Band 4(16QAM)

Emission Designator = **18M0W7D**
LTE OBW = 17.961 MHz
W = Amplitude/Angle Modulated
7 = Quantized/Digital Info
D = Data Transmission

LTE Band 2(16QAM)

Emission Designator = **17M9W7D**
LTE OBW = 17.881 MHz
W = Amplitude/Angle Modulated
7 = Quantized/Digital Info
D = Data Transmission

LTE Band 7(16QAM)

Emission Designator = **17M9W7D**
LTE OBW = 17.886 MHz
W = Amplitude/Angle Modulated
7 = Quantized/Digital Info
D = Data Transmission

B. For substitution method

Channel Bandwidth (MHz)	Test Frequency (MHz)	Test Mode	RB Size/ Offset	Spectrum Reading Value(dBm)	EUT Axis	Ant Pol (H/V)	Level(dBm) @ Ant Terminal	TX Ant Gain (dBi)	EIRP (dBm)	EIRP (W)
20	1720	QPSK	1/0	-21.50	Y	H	18.63	5.82	24.45	0.279

ERP or EIRP = Level @ Ant Terminal LEVEL(dBm) + Tx Ant. Gain

- 1) The EUT mounted on a non-conductive turntable is 0.8 meter above test site ground level.
- 2) During the test, the turn table is rotated until the maximum signal is found.
- 3) Record the field strength meter's level.
- 4) Replace the EUT with dipole/Horn antenna that is connected to a calibrated signal generator.
- 5) Increase the signal generator output till the field strength meter's level is equal to the item (3).
- 6) The signal generator output level with substituted antenna gain is the rating of ERP, EIRP or Radiated spurious emission.

7. TEST DATA

7.1 OCCUPIED BANDWIDTH

- Plots of the EUT's Occupied Bandwidth are shown in Clause 8.1

7.2 PEAK TO AVERAGE RATIO

- Plots of the EUT's Peak- to- Average Ratio are shown in Clause 8.2

7.3 BAND EDGE EMISSIONS (Conducted)

- Plots of the EUT's Band Edge Emissions are shown in Clause 8.3

7.4 SPURIOUS AND HARMONICS EMISSIONS (Conducted)

- Plots of the EUT's Spurious Emissions are shown in Clause 8.4

7.5 ERP & EIRP

7.5.1 LTE Band 17

Channel Bandwidth (MHz)	Test Frequency (MHz)	Test Mode	RB Size/ Offset	EUT Axis	Ant Pol (H/V)	Level(dBm) @ Ant Terminal	TX Ant Gain (dBd)	ERP (dBm)	ERP (W)
10	709	QPSK	1/0	X	H	17.88	1.28	19.16	0.082
		16QAM	1/0	X	H	17.03	1.28	18.31	0.068
	711	QPSK	1/0	X	H	16.83	1.28	18.11	0.065
		16QAM	1/0	X	H	15.86	1.28	17.14	0.052
5	706.5	QPSK	1/12	X	H	17.30	1.28	18.58	0.072
		16QAM	1/12	X	H	16.23	1.28	17.51	0.056
	710	QPSK	1/24	X	H	15.91	1.28	17.19	0.052
		16QAM	1/24	X	H	15.05	1.28	16.33	0.043
	7113.5	QPSK	1/24	X	H	14.74	1.28	16.02	0.040
		16QAM	1/24	X	H	13.83	1.28	15.11	0.032

Note: This device was tested under all bandwidths, modulations and RB configurations and the worst case data are reported in the table above.

7.5.2 LTE Band 5

Channel Bandwidth (MHz)	Test Frequency (MHz)	Test Mode	RB Size/Offset	EUT Axis	Ant Pol (H/V)	Level(dBm) @ Ant Terminal	TX Ant Gain (dBd)	ERP (dBm)	ERP (W)
10	829	QPSK	1/0	X	H	14.72	1.23	15.95	0.039
		16QAM	1/0	X	H	13.52	1.23	14.75	0.030
	836.5	QPSK	1/49	X	H	13.86	1.22	15.08	0.032
		16QAM	1/49	X	H	13.05	1.22	14.27	0.027
	844	QPSK	1/49	X	H	13.98	1.21	15.19	0.033
		16QAM	1/49	X	H	13.06	1.21	14.27	0.027
5	826.5	QPSK	1/0	X	H	14.67	1.23	15.90	0.039
		16QAM	1/0	X	H	13.60	1.23	14.83	0.030
	836.5	QPSK	1/0	X	H	14.11	1.22	15.33	0.034
		16QAM	1/0	X	H	13.41	1.22	14.63	0.029
	846.5	QPSK	1/0	X	H	13.80	1.21	15.01	0.032
		16QAM	1/0	X	H	12.63	1.21	13.84	0.024
3	825.5	QPSK	1/0	X	H	14.95	1.23	16.18	0.041
		16QAM	1/0	X	H	13.95	1.23	15.18	0.033
	836.5	QPSK	1/7	X	H	13.96	1.22	15.18	0.033
		16QAM	1/7	X	H	13.07	1.22	14.29	0.027
	847.5	QPSK	1/7	X	H	15.02	1.21	16.23	0.042
		16QAM	1/7	X	H	14.07	1.21	15.28	0.034
1.4	824.7	QPSK	1/2	X	H	14.49	1.23	15.72	0.037
		16QAM	1/2	X	H	13.64	1.23	14.87	0.031
	836.5	QPSK	1/2	X	H	13.91	1.22	15.13	0.033
		16QAM	1/2	X	H	12.78	1.22	14.00	0.025
	848.3	QPSK	1/2	X	H	15.19	1.21	16.40	0.044
		16QAM	1/2	X	H	14.32	1.21	15.53	0.036

Note: This device was tested under all bandwidths, modulations and RB configurations and the worst case data are reported in the table above.

7.5.3 LTE Band 4

Channel Bandwidth (MHz)	Test Frequency (MHz)	Test Mode	RB Size/Offset	EUT Axis	Ant Pol (H/V)	Level(dBm) @ Ant Terminal	TX Ant Gain (dBi)	EIRP (dBm)	EIRP (W)
20	1720	QPSK	1/0	Y	H	18.63	5.82	24.45	0.279
		16QAM	1/0	Y	H	17.80	5.82	23.62	0.230
	1732.5	QPSK	1/0	Y	H	18.12	5.75	23.87	0.244
		16QAM	1/0	Y	H	17.20	5.75	22.95	0.197
	1745	QPSK	1/0	Y	H	18.29	5.67	23.96	0.249
		16QAM	1/0	Y	H	17.43	5.67	23.10	0.204
15	1717.5	QPSK	1/0	Y	H	17.80	5.84	23.64	0.231
		16QAM	1/0	Y	H	16.93	5.84	22.77	0.189
	1732.5	QPSK	1/0	Y	H	18.28	5.75	24.03	0.253
		16QAM	1/0	Y	H	17.39	5.75	23.14	0.206
	1747.5	QPSK	1/0	Y	H	17.96	5.66	23.62	0.230
		16QAM	1/0	Y	H	16.87	5.66	22.53	0.179
10	1715	QPSK	1/0	Y	H	17.51	5.85	23.36	0.217
		16QAM	1/0	Y	H	16.38	5.85	22.23	0.167
	1732.5	QPSK	1/0	Y	H	18.48	5.75	24.23	0.265
		16QAM	1/0	Y	H	17.43	5.75	23.18	0.208
	1750	QPSK	1/0	Y	H	17.04	5.64	22.68	0.185
		16QAM	1/0	Y	H	16.28	5.64	21.92	0.156
5	1712.5	QPSK	1/0	Y	H	17.44	5.87	23.31	0.214
		16QAM	1/0	Y	H	16.34	5.87	22.21	0.166
	1732.5	QPSK	1/0	Y	H	18.38	5.75	24.13	0.259
		16QAM	1/0	Y	H	17.61	5.75	23.36	0.217
	1752.5	QPSK	1/0	Y	H	16.69	5.63	22.32	0.171
		16QAM	1/0	Y	H	15.90	5.63	21.53	0.142
3	1711.5	QPSK	1/0	Y	H	17.13	5.87	23.00	0.200
		16QAM	1/0	Y	H	16.36	5.87	22.23	0.167
	1732.5	QPSK	1/0	Y	H	18.30	5.75	24.05	0.254
		16QAM	1/0	Y	H	17.49	5.75	23.24	0.211
	1753.5	QPSK	1/0	Y	H	16.58	5.62	22.20	0.166
		16QAM	1/0	Y	H	15.77	5.62	21.39	0.138
1.4	1710.7	QPSK	1/2	Y	H	17.17	5.88	23.05	0.202
		16QAM	1/2	Y	H	16.11	5.88	21.99	0.158
	1732.5	QPSK	1/2	Y	H	18.44	5.75	24.19	0.262
		16QAM	1/2	Y	H	17.35	5.75	23.10	0.204
	1754.3	QPSK	1/2	Y	H	17.09	5.61	22.70	0.186
		16QAM	1/2	Y	H	16.41	5.61	22.02	0.159

Note: This device was tested under all bandwidths, modulations and RB configurations and the worst case data are reported in the table above.

7.5.4 LTE Band 2

Channel Bandwidth (MHz)	Test Frequency (MHz)	Test Mode	RB Size/Offset	EUT Axis	Ant Pol (H/V)	Level(dBm) @ Ant Terminal	TX Ant Gain (dBi)	EIRP (dBm)	EIRP (W)
20	1860	QPSK	1/0	Z	V	16.26	5.02	21.28	0.134
		16QAM	1/0	Z	V	15.34	5.02	20.36	0.109
	1880	QPSK	1/0	Z	V	16.14	4.91	21.05	0.127
		16QAM	1/0	Z	V	15.29	4.91	20.20	0.105
	1900	QPSK	1/0	Z	V	16.76	4.81	21.57	0.144
		16QAM	1/0	Z	V	15.94	4.81	20.75	0.119
15	1857.5	QPSK	1/0	Z	V	16.64	5.03	21.67	0.147
		16QAM	1/0	Z	V	15.85	5.03	20.88	0.122
	1880	QPSK	1/0	Z	V	16.24	4.91	21.15	0.130
		16QAM	1/0	Z	V	15.32	4.91	20.23	0.105
	1902.5	QPSK	1/0	Z	V	16.44	4.80	21.24	0.133
		16QAM	1/0	Z	V	15.38	4.80	20.18	0.104
10	1855	QPSK	1/0	Z	V	16.10	5.05	21.15	0.130
		16QAM	1/0	Z	V	15.17	5.05	20.22	0.105
	1880	QPSK	1/0	Z	V	16.36	4.91	21.27	0.134
		16QAM	1/0	Z	V	15.65	4.91	20.56	0.114
	1905	QPSK	1/0	Z	V	15.90	4.79	20.69	0.117
		16QAM	1/0	Z	V	15.03	4.79	19.82	0.096
5	1852.5	QPSK	1/0	Z	V	16.11	5.06	21.17	0.131
		16QAM	1/0	Z	V	15.27	5.06	20.33	0.108
	1880	QPSK	1/12	Z	V	16.01	4.91	20.92	0.124
		16QAM	1/12	Z	V	15.18	4.91	20.09	0.102
	1907.5	QPSK	1/12	Z	V	15.72	4.77	20.49	0.112
		16QAM	1/12	Z	V	14.85	4.77	19.62	0.092
3	1851.5	QPSK	1/14	Z	V	16.19	5.06	21.25	0.133
		16QAM	1/14	Z	V	14.98	5.06	20.04	0.101
	1880	QPSK	1/14	Z	V	15.92	4.91	20.83	0.121
		16QAM	1/14	Z	V	14.98	4.91	19.89	0.097
	1908.5	QPSK	1/14	Z	V	16.16	4.77	20.93	0.124
		16QAM	1/14	Z	V	15.41	4.77	20.18	0.104
1.4	1850.7	QPSK	1/2	Z	V	16.18	5.07	21.25	0.133
		16QAM	1/2	Z	V	15.60	5.07	20.67	0.117
	1880	QPSK	1/2	Z	V	15.70	4.91	20.61	0.115
		16QAM	1/2	Z	V	15.01	4.91	19.92	0.098
	1909.3	QPSK	1/2	Z	V	16.48	4.76	21.24	0.133
		16QAM	1/2	Z	V	15.52	4.76	20.28	0.107

Note: This device was tested under all bandwidths, modulations and RB configurations and the worst case data are reported in the table above.

7.5.5 LTE Band 7

Channel Bandwidth (MHz)	Test Frequency (MHz)	Test Mode	RB Size/ Offset	EUT Axis	Ant Pol (H/V)	Level(dBm) @ Ant Terminal	TX Ant Gain (dBi)	EIRP (dBm)	EIRP (W)
20	2510	QPSK	1/0	Y	H	12.78	6.19	18.97	0.079
		16QAM	1/0	Y	H	11.93	6.19	18.12	0.065
	2535	QPSK	1/0	Y	H	12.50	6.21	18.71	0.074
		16QAM	1/0	Y	H	11.84	6.21	18.05	0.064
	2560	QPSK	1/0	Y	H	13.15	6.21	19.36	0.086
		16QAM	1/0	Y	H	12.13	6.21	18.34	0.068
15	2507.5	QPSK	1/0	Y	H	12.15	6.19	18.34	0.068
		16QAM	1/0	Y	H	11.36	6.19	17.55	0.057
	2535	QPSK	1/0	Y	H	11.72	6.21	17.93	0.062
		16QAM	1/0	Y	H	10.82	6.21	17.03	0.050
	2562.5	QPSK	1/0	Y	H	12.82	6.21	19.03	0.080
		16QAM	1/0	Y	H	11.98	6.21	18.19	0.066
10	2505	QPSK	1/0	Y	H	12.55	6.19	18.74	0.075
		16QAM	1/0	Y	H	11.66	6.19	17.85	0.061
	2535	QPSK	1/0	Y	H	12.84	6.21	19.05	0.080
		16QAM	1/0	Y	H	11.90	6.21	18.11	0.065
	2565	QPSK	1/0	Y	H	12.91	6.22	19.13	0.082
		16QAM	1/0	Y	H	11.78	6.22	18.00	0.063
5	2502.5	QPSK	1/0	Y	H	11.94	6.19	18.13	0.065
		16QAM	1/0	Y	H	11.12	6.19	17.31	0.054
	2535	QPSK	1/24	Y	H	12.16	6.21	18.37	0.069
		16QAM	1/24	Y	H	11.32	6.21	17.53	0.057
	2567.5	QPSK	1/12	Y	H	12.82	6.22	19.04	0.080
		16QAM	1/12	Y	H	11.84	6.22	18.06	0.064

Note: This device was tested under all bandwidths, modulations and RB configurations and the worst case data are reported in the table above.

7.6 UNDESIRABLE EMISSIONS (Radiated)

7.6.1 LTE Band 17

B.W (MHz)	Test Freq. (MHz)	RB Size/Offset	Test Mode	Freq.(MHz)	EUT Axis	Ant Pol (H/V)	Level(dBm) @ Ant Terminal	TX Ant Gain(dBd)	Result		Limit (dBc)
									(dBm)	(dBc)	
10	709	1/0	QPSK	1409.24	X	H	-50.57	2.96	-47.61	66.77	32.16
				-	-	-	-	-	-	-	
	1/0	16QAM	1409.28	X	H	-50.26	2.96	-47.30	65.61	31.31	
			-	-	-	-	-	-	-		-
	711	1/0	QPSK	1413.17	X	H	-50.49	2.98	-47.51	65.62	31.11
				-	-	-	-	-	-	-	
1/0	16QAM	1413.36	X	H	-51.03	2.98	-48.05	65.19	30.14		
		-	-	-	-	-	-	-		-	
5	706.5	1/12	QPSK	1413.10	X	H	-50.72	2.98	-47.74	66.32	31.58
				-	-	-	-	-	-	-	
	1/12	16QAM	1412.13	X	H	-50.47	2.97	-47.50	65.01	30.51	
			-	-	-	-	-	-	-		-
	710	1/24	QPSK	1424.50	X	H	-55.23	3.05	-52.18	69.37	30.19
				-	-	-	-	-	-	-	
	1/24	16QAM	1424.25	X	H	-55.05	3.05	-52.00	68.33	29.33	
			-	-	-	-	-	-	-		-
	713.5	1/24	QPSK	1431.56	X	H	-54.06	3.09	-50.97	66.99	29.02
				-	-	-	-	-	-	-	
	1/24	16QAM	1431.38	X	H	-54.33	3.09	-51.24	66.35	28.11	
			-	-	-	-	-	-	-		-

Note 1: Limit Calculation = $43 + 10\log_{10}(P[\text{Watts}])$

Note 2: This device was tested under all bandwidths, modulations and RB configurations and the worst case data are reported in the table above.

Note 3: The frequency spectrum is examined from 9 kHz to the 10th harmonic of the fundamental frequency of the transmitter. No other spurious and harmonic emissions were reported greater than listed emissions above table.

7.6.2 LTE Band 5

B.W (MHz)	Test Freq. (MHz)	RB Size/Offset	Test Mode	Freq.(MHz)	EUT Axis	Ant Pol (H/V)	Level(dBm) @ Ant Terminal	TX Ant Gain(dBd)	Result		Limit (dBc)
									(dBm)	(dBc)	
10	829	1/0	QPSK	1629.23	Z	H	-44.29	3.77	-40.52	56.47	28.95
				-	-	-	-	-	-	-	
	829	1/0	16QAM	1649.27	Z	H	-43.36	3.77	-39.59	54.34	27.75
				-	-	-	-	-	-	-	
	836.5	1/0	QPSK	1681.79	Z	H	-44.11	3.78	-40.33	55.41	28.08
				-	-	-	-	-	-	-	
		1/0	16QAM	1681.88	Z	H	-44.39	3.78	-40.61	54.88	27.27
				-	-	-	-	-	-	-	
	844	1/49	QPSK	1696.92	Z	H	-42.28	3.79	-38.49	53.68	28.19
				-	-	-	-	-	-	-	
		1/49	16QAM	1696.85	Z	H	-42.07	3.79	-38.28	52.55	27.27
				-	-	-	-	-	-	-	
5	826.5	1/0	QPSK	1648.60	Z	H	-43.86	3.77	-40.09	55.99	28.90
				-	-	-	-	-	-	-	
		1/0	16QAM	1648.76	Z	H	-43.63	3.77	-39.86	54.69	27.83
				-	-	-	-	-	-	-	
	836.5	1/0	QPSK	1668.66	Z	H	-45.24	3.78	-41.46	56.79	28.33
				-	-	-	-	-	-	-	
		1/0	16QAM	1668.64	Z	H	-45.46	3.78	-41.68	56.31	27.63
				-	-	-	-	-	-	-	
	846.5	1/0	QPSK	1688.67	Z	H	-44.65	3.79	-40.86	55.87	28.01
				-	-	-	-	-	-	-	
		1/0	16QAM	1688.64	Z	H	-44.84	3.79	-41.05	54.89	26.84
				-	-	-	-	-	-	-	

B.W (MHz)	Test Freq. (MHz)	RB Size/ Offset	Test Mode	Freq.(MHz)	EUT Axis	Ant Pol (H/V)	Level(dBm) @ Ant Terminal	TX Ant Gain(dBd)	Result		Limit (dBc)
									(dBm)	(dBc)	
3	825.5	1/0	QPSK	1648.39	Z	H	-45.26	3.77	-41.49	57.67	29.18
				-	-	-	-	-	-	-	
	1/0	16QAM	1648.61	Z	H	-45.31	3.77	-41.54	56.72	28.18	
			-	-	-	-	-	-	-		
	836.5	1/7	QPSK	1673.00	Z	H	-44.51	3.78	-40.73	55.91	28.18
				-	-	-	-	-	-	-	
	1/7	16QAM	1672.96	Z	H	-44.78	3.78	-41.00	55.29	27.29	
			-	-	-	-	-	-	-		
	847.5	1/7	QPSK	1695.12	Z	H	-43.59	3.79	-39.80	56.03	29.23
				-	-	-	-	-	-	-	
	1/7	16QAM	1694.89	Z	H	-43.48	3.79	-39.69	54.97	28.28	
			-	-	-	-	-	-	-		
1.4	824.7	1/2	QPSK	1649.15	Z	H	-46.79	3.77	-43.02	58.74	28.72
				-	-	-	-	-	-	-	
	1/2	16QAM	1649.25	Z	H	-46.28	3.77	-42.51	57.38	27.87	
			-	-	-	-	-	-	-		
	836.5	1/2	QPSK	1672.85	Z	H	-50.25	3.78	-46.47	61.60	28.13
				-	-	-	-	-	-	-	
	1/2	16QAM	1672.93	Z	H	-49.38	3.78	-45.60	59.60	27.00	
			-	-	-	-	-	-	-		
	848.3	1/2	QPSK	1696.48	Z	H	-51.37	3.79	-47.58	63.98	29.40
				-	-	-	-	-	-	-	
	1/2	16QAM	1696.50	Z	H	-51.39	3.79	-47.60	63.13	28.53	
			-	-	-	-	-	-	-		

Note 1: Limit Calculation = $43 + 10\log_{10}(P[\text{Watts}])$

Note 2: This device was tested under all bandwidths, modulations and RB configurations and the worst case data are reported in the table above.

Note 3: The frequency spectrum is examined from 9 kHz to the 10th harmonic of the fundamental frequency of the transmitter. No other spurious and harmonic emissions were reported greater than listed emissions above table.

7.6.3 LTE Band 4

B.W (MHz)	Test Freq. (MHz)	RB Size/Offset	Test Mode	Freq.(MHz)	EUT Axis	Ant Pol (H/V)	Level(dBm) @ Ant Terminal	TX Ant Gain(dBi)	Result		Limit (dBc)
									(dBm)	(dBc)	
20	1720	1/0	QPSK	3422.25	X	H	-45.07	8.24	-36.83	61.28	37.45
				-	-	-	-	-	-	-	
	1720	1/0	16QAM	3422.23	X	H	-46.09	8.24	-37.85	61.47	36.62
				-	-	-	-	-	-	-	
	1732.5	1/0	QPSK	3447.26	X	H	-46.43	8.33	-38.10	61.97	36.87
				-	-	-	-	-	-	-	
		1/0	16QAM	3447.14	X	H	-46.56	8.32	-38.24	61.19	35.95
				-	-	-	-	-	-	-	
	1745	1/0	QPSK	3472.18	X	H	-49.65	8.41	-41.24	65.20	36.96
				-	-	-	-	-	-	-	
		1/0	16QAM	3472.18	X	H	-49.96	8.41	-41.55	64.65	36.10
				-	-	-	-	-	-	-	
15	1717.5	1/0	QPSK	3421.66	X	H	-46.79	8.24	-38.55	62.19	36.64
				-	-	-	-	-	-	-	
		1/0	16QAM	3421.73	X	H	-46.53	8.24	-38.29	61.06	35.77
				-	-	-	-	-	-	-	
	1732.5	1/0	QPSK	3451.64	X	H	-47.93	8.34	-39.59	63.62	37.03
				-	-	-	-	-	-	-	
		1/0	16QAM	3451.83	X	H	-47.97	8.34	-39.63	62.77	36.14
				-	-	-	-	-	-	-	
	1747.5	1/0	QPSK	3481.61	X	H	-49.63	8.45	-41.18	64.80	36.62
				-	-	-	-	-	-	-	
		1/0	16QAM	3481.74	X	H	-49.27	8.45	-40.82	63.35	35.53
				-	-	-	-	-	-	-	

B.W (MHz)	Test Freq. (MHz)	RB Size/ Offset	Test Mode	Freq.(MHz)	EUT Axis	Ant Pol (H/V)	Level(dBm) @ Ant Terminal	TX Ant Gain(dBi)	Result		Limit (dBc)
									(dBm)	(dBc)	
10	1715	1/0	QPSK	3421.24	X	H	-47.24	8.23	-39.01	62.37	36.36
				-	-	-	-	-	-	-	
	1/0	16QAM	3421.30	X	H	-47.96	8.23	-39.73	61.96	35.23	
			-	-	-	-	-	-	-		
	1732.5	1/0	QPSK	3455.89	X	H	-52.39	8.36	-44.03	68.26	37.23
				-	-	-	-	-	-	-	
	1/0	16QAM	3455.74	X	H	-51.87	8.36	-43.51	66.69	36.18	
			-	-	-	-	-	-	-		
	1750	1/0	QPSK	3491.33	X	H	-53.72	8.48	-45.24	67.92	35.68
				-	-	-	-	-	-	-	
	1/0	16QAM	3491.20	X	H	-53.24	8.48	-44.76	66.68	34.92	
			-	-	-	-	-	-	-		
5	1712.5	1/0	QPSK	3420.59	X	H	-49.32	8.23	-41.09	64.40	36.31
				-	-	-	-	-	-	-	
	1/0	16QAM	3420.44	X	H	-49.16	8.23	-40.93	63.14	35.21	
			-	-	-	-	-	-	-		
	1732.5	1/0	QPSK	3460.64	X	H	-51.77	8.37	-43.40	67.53	37.13
				-	-	-	-	-	-	-	
	1/0	16QAM	3460.80	X	H	-52.24	8.37	-43.87	67.23	36.36	
			-	-	-	-	-	-	-		
	1752.5	1/0	QPSK	3500.29	X	H	-54.70	8.51	-46.19	68.51	35.32
				-	-	-	-	-	-	-	
	1/0	16QAM	3500.71	X	H	-54.03	8.51	-45.52	67.05	34.53	
			-	-	-	-	-	-	-		

B.W (MHz)	Test Freq. (MHz)	RB Size/ Offset	Test Mode	Freq.(MHz)	EUT Axis	Ant Pol (H/V)	Level(dBm) @ Ant Terminal	TX Ant Gain(dBi)	Result		Limit (dBc)
									(dBm)	(dBc)	
3	1711.5	1/0	QPSK	3420.41	X	H	-50.84	8.23	-42.61	65.61	36.00
				-	-	-	-	-	-	-	
	1/0	16QAM	3420.43	X	H	-50.63	8.23	-42.40	64.63	35.23	
			-	-	-	-	-	-	-		
	1732.5	1/0	QPSK	3462.24	X	H	-52.65	8.38	-44.27	68.32	37.05
				-	-	-	-	-	-	-	
	1/0	16QAM	3462.21	X	H	-52.17	8.38	-43.79	67.03	36.24	
			-	-	-	-	-	-	-		
	1753.5	1/0	QPSK	3504.29	X	H	-54.04	8.51	-45.53	67.73	35.20
				-	-	-	-	-	-	-	
	1/0	16QAM	3504.46	X	H	-54.45	8.51	-45.94	67.33	34.39	
			-	-	-	-	-	-	-		
1.4	1710.7	1/2	QPSK	3421.28	X	H	-46.64	8.23	-38.41	61.46	36.05
				-	-	-	-	-	-	-	
	1/2	16QAM	3421.24	X	H	-46.83	8.23	-38.60	60.59	34.99	
			-	-	-	-	-	-	-		
	1732.5	1/2	QPSK	3464.54	X	H	-51.39	8.39	-43.00	67.19	37.19
				-	-	-	-	-	-	-	
	1/2	16QAM	3464.70	X	H	-51.22	8.39	-42.83	65.93	36.10	
			-	-	-	-	-	-	-		
	1754.3	1/2	QPSK	3508.28	X	H	-54.96	8.51	-46.45	69.15	35.70
				-	-	-	-	-	-	-	
	1/5	16QAM	3508.46	X	H	-55.16	8.51	-46.65	68.67	35.02	
			-	-	-	-	-	-	-		

Note 1: Limit Calculation = $43 + 10\log_{10}(P[\text{Watts}])$

Note 2: This device was tested under all bandwidths, modulations and RB configurations and the worst case data are reported in the table above.

Note 3: The frequency spectrum is examined from 9 kHz to the 10th harmonic of the fundamental frequency of the transmitter. No other spurious and harmonic emissions were reported greater than listed emissions above table.

7.6.4 LTE Band 2

B.W (MHz)	Test Freq. (MHz)	RB Size/ Offset	Test Mode	Freq.(MHz)	EUT Axis	Ant Pol (H/V)	Level(dBm) @ Ant Terminal	TX Ant Gain(dBi)	Result		Limit (dBc)
									(dBm)	(dBc)	
20	1860	1/0	QPSK	3702.14	X	H	-55.41	8.49	-46.92	68.20	34.28
				-	-	-	-	-	-	-	
	1/0	16QAM	3702.16	X	H	-55.90	8.49	-47.41	67.77	33.36	
			-	-	-	-	-	-	-		-
	1880	1/0	QPSK	3742.15	X	H	-55.76	8.51	-47.25	68.30	34.05
				-	-	-	-	-	-	-	
	1/0	16QAM	3742.29	X	H	-56.73	8.51	-48.22	68.42	33.20	
			-	-	-	-	-	-	-		-
	1900	1/0	QPSK	3782.30	X	H	-54.97	8.52	-46.45	68.02	34.57
				-	-	-	-	-	-	-	
	1/0	16QAM	3782.19	X	H	-55.41	8.52	-46.89	67.64	33.75	
			-	-	-	-	-	-	-		-
15	1857.5	1/0	QPSK	3701.67	X	H	-57.06	8.49	-48.57	70.24	34.67
				-	-	-	-	-	-	-	
	1/0	16QAM	3701.69	X	H	-56.18	8.49	-47.69	68.57	33.88	
			-	-	-	-	-	-	-		-
	1880	1/0	QPSK	3746.74	X	H	-56.47	8.51	-47.96	69.11	34.15
				-	-	-	-	-	-	-	
	1/0	16QAM	3746.69	X	H	-55.93	8.51	-47.42	67.65	33.23	
			-	-	-	-	-	-	-		-
	1902.5	1/0	QPSK	3791.62	X	H	-55.57	8.53	-47.04	68.28	34.24
				-	-	-	-	-	-	-	
	1/0	16QAM	3791.58	X	H	-56.03	8.53	-47.50	67.68	33.18	
			-	-	-	-	-	-	-		-

B.W (MHz)	Test Freq. (MHz)	RB Size/Offset	Test Mode	Freq.(MHz)	EUT Axis	Ant Pol (H/V)	Level(dBm) @ Ant Terminal	TX Ant Gain(dBi)	Result		Limit (dBc)
									(dBm)	(dBc)	
10	1855	1/0	QPSK	3701.14	X	H	-56.68	8.49	-48.19	69.34	34.15
				-	-	-	-	-	-	-	
	1/0	16QAM	3701.20	X	H	-56.53	8.49	-48.04	68.26	33.22	
			-	-	-	-	-	-	-		
	1880	1/12	QPSK	3755.47	X	H	-55.72	8.51	-47.21	68.48	34.27
				-	-	-	-	-	-	-	
	1/12	16QAM	3755.51	X	H	-56.91	8.51	-48.40	68.96	33.56	
			-	-	-	-	-	-	-		
	1905	1/0	QPSK	3805.40	X	H	-55.79	8.54	-47.25	67.94	33.69
				-	-	-	-	-	-	-	
	1/0	16QAM	3805.45	X	H	-56.72	8.54	-48.18	68.00	32.82	
			-	-	-	-	-	-	-		
5	1852.5	1/0	QPSK	3704.96	X	H	-56.56	8.49	-48.07	69.24	34.17
				-	-	-	-	-	-	-	
	1/0	16QAM	3704.99	X	H	-56.01	8.49	-47.52	67.85	33.33	
			-	-	-	-	-	-	-		
	1880	1/12	QPSK	3759.88	X	H	-56.28	8.51	-47.77	68.69	33.92
				-	-	-	-	-	-	-	
	1/12	16QAM	3759.99	X	H	-56.34	8.51	-47.83	67.92	33.09	
			-	-	-	-	-	-	-		
	1907.5	1/12	QPSK	3814.03	X	H	-56.27	8.55	-47.72	68.21	33.49
				-	-	-	-	-	-	-	
	1/12	16QAM	3815.02	X	H	-56.36	8.55	-47.81	67.43	32.62	
			-	-	-	-	-	-	-		

B.W (MHz)	Test Freq. (MHz)	RB Size/ Offset	Test Mode	Freq.(MHz)	EUT Axis	Ant Pol (H/V)	Level(dBm) @ Ant Terminal	TX Ant Gain(dBi)	Result		Limit (dBc)
									(dBm)	(dBc)	
3	1851.5	1/14	QPSK	3705.50	X	H	-55.99	8.49	-47.50	68.75	34.25
				-	-	-	-	-	-	-	
	1/14	16QAM	3705.51	X	H	-56.57	8.49	-48.08	68.12	33.04	
			-	-	-	-	-	-	-		
	1880	1/14	QPSK	3762.50	X	H	-56.03	8.52	-47.51	68.34	33.83
				-	-	-	-	-	-	-	
	1/14	16QAM	3762.55	X	H	-56.24	8.52	-47.72	67.61	32.89	
			-	-	-	-	-	-	-		
	1908.5	1/14	QPSK	3819.53	X	H	-55.92	8.55	-47.37	68.30	33.93
				-	-	-	-	-	-	-	
	1/14	16QAM	3819.64	X	H	-56.49	8.55	-47.94	68.12	33.18	
			-	-	-	-	-	-	-		
1.4	1850.7	1/2	QPSK	3701.20	X	H	-56.41	8.49	-47.92	69.17	34.25
				-	-	-	-	-	-	-	
	1/2	16QAM	3701.26	X	H	-55.35	8.49	-46.86	67.53	33.67	
			-	-	-	-	-	-	-		
	1880	1/2	QPSK	3759.62	X	H	-56.57	8.51	-48.06	68.67	33.61
				-	-	-	-	-	-	-	
	1/0	16QAM	3759.79	X	H	-55.73	8.51	-47.22	67.14	32.92	
			-	-	-	-	-	-	-		
	1909.3	1/2	QPSK	3818.42	X	H	-55.67	8.55	-47.12	68.36	34.24
				-	-	-	-	-	-	-	
	1/2	16QAM	3818.43	X	H	-55.74	8.55	-47.19	67.47	33.28	
			-	-	-	-	-	-	-		

Note 1: Limit Calculation = $43 + 10\log_{10}(P[\text{Watts}])$

Note 2: This device was tested under all bandwidths, modulations and RB configurations and the worst case data are reported in the table above.

Note 3: The frequency spectrum is examined from 9 kHz to the 10th harmonic of the fundamental frequency of the transmitter. No other spurious and harmonic emissions were reported greater than listed emissions above table.

7.6.5 LTE Band 7

B.W (MHz)	Test Freq. (MHz)	RB Size/Offset	Test Mode	Freq.(MHz)	EUT Axis	Ant Pol (H/V)	Level(dBm) @ Ant Terminal	TX Ant Gain(dBi)	Result		Limit (dBc)
									(dBm)	(dBc)	
20	2510	1/0	QPSK	5002.25	X	H	-52.25	10.11	-42.14	61.11	43.97
				7503.32	Z	H	-48.52	12.35	-36.17	55.14	
		1/0	16QAM	5002.26	X	H	-52.39	10.11	-42.28	60.40	43.12
				7503.31	Z	H	-48.81	12.35	-36.46	54.58	
	2535	1/0	QPSK	5052.19	X	H	-52.13	10.20	-41.93	60.64	43.71
				7578.27	Z	H	-47.21	12.35	-34.86	53.57	
		1/0	16QAM	5052.12	X	H	-52.08	10.20	-41.88	59.93	43.05
				7578.21	Z	H	-47.29	12.35	-34.94	52.99	
	2560	1/0	QPSK	5102.43	X	H	-52.72	10.28	-42.44	61.80	44.36
				7653.37	Z	H	-49.17	12.46	-36.71	56.07	
		1/0	16QAM	5101.89	X	H	-52.69	10.28	-42.41	60.75	43.34
				7653.33	Z	H	-48.85	12.46	-36.39	54.73	
15	2507.5	1/0	QPSK	5001.69	X	H	-53.17	10.11	-43.06	61.40	43.34
				7502.54	Z	H	-48.22	12.35	-35.87	54.21	
		1/0	16QAM	5001.88	X	H	-53.02	10.11	-42.91	60.46	42.55
				7502.27	Z	H	-48.63	12.35	-36.28	53.83	
	2535	1/0	QPSK	5056.82	X	H	-52.03	10.21	-41.82	59.75	42.93
				7585.22	Z	H	-47.81	12.35	-35.46	53.39	
		1/0	16QAM	5056.50	X	H	-53.13	10.21	-42.92	59.95	42.03
				7585.08	Z	H	-47.70	12.35	-35.35	52.38	
	2562.5	1/0	QPSK	5111.48	X	H	-52.65	10.30	-42.35	61.38	44.03
				7667.02	Z	H	-48.66	12.46	-36.20	55.23	
		1/0	16QAM	5111.98	X	H	-52.28	10.30	-41.98	60.17	43.19
				7667.78	Z	H	-48.69	12.46	-36.23	54.42	

B.W (MHz)	Test Freq. (MHz)	RB Size/Offset	Test Mode	Freq.(MHz)	EUT Axis	Ant Pol (H/V)	Level(dBm) @ Ant Terminal	TX Ant Gain(dBi)	Result		Limit (dBc)
									(dBm)	(dBc)	
10	2505	1/0	QPSK	5001.33	X	H	-52.51	10.11	-42.40	61.14	43.74
				7501.52	Z	H	-48.25	12.35	-35.90	54.64	
		1/0	16QAM	5002.00	X	H	-52.86	10.11	-42.75	60.60	42.85
				7501.99	Z	H	-48.52	12.35	-36.17	54.02	
	2535	1/0	QPSK	5061.15	X	H	-52.35	10.21	-42.14	61.19	44.05
				7591.94	Z	H	-48.14	12.35	-35.79	54.84	
		1/0	16QAM	5060.93	X	H	-51.61	10.21	-41.40	59.51	43.11
				7591.50	Z	H	-47.27	12.35	-34.92	53.03	
	2565	1/0	QPSK	5121.70	X	H	-53.18	10.32	-42.86	61.99	44.13
				7681.38	Z	H	-48.79	12.46	-36.33	55.46	
		1/0	16QAM	5121.05	X	H	-52.00	10.32	-41.68	59.68	43.00
				7682.04	Z	H	-48.86	12.46	-36.40	54.40	
5	2502.5	1/0	QPSK	5001.03	X	H	-53.13	10.11	-43.02	61.15	43.13
				7500.88	Z	H	-48.03	12.35	-35.68	53.81	
		1/0	16QAM	5002.58	X	H	-52.74	10.11	-42.63	59.94	42.31
				7500.79	Z	H	-47.80	12.35	-35.45	52.76	
	2535	1/24	QPSK	5074.45	X	H	-52.30	10.24	-42.06	60.43	43.37
				7611.33	Z	H	-48.64	12.46	-36.18	54.55	
		1/24	16QAM	5073.72	X	H	-53.26	10.24	-43.02	60.55	42.53
				7611.65	Z	H	-49.07	12.46	-36.61	54.14	
	2567.5	1/12	QPSK	5135.07	X	H	-53.06	10.34	-42.72	61.76	44.04
				7702.65	Z	H	-48.89	12.47	-36.42	55.46	
		1/12	16QAM	5134.62	X	H	-52.94	10.34	-42.60	60.66	43.06
				7702.40	Z	H	-48.95	12.47	-36.48	54.54	

Note 1: Limit Calculation = $55 + 10\log_{10}(P[\text{Watts}])$ at all frequencies more than X MHz from the channel edge. (where X is the greater of 6 MHz or the actual emission bandwidth.)

Note 2: This device was tested under all bandwidths, modulations and RB configurations and the worst case data are reported in the table above.

Note 3: The frequency spectrum is examined from 9 kHz to the 10th harmonic of the fundamental frequency of the transmitter. No other spurious and harmonic emissions were reported greater than listed emissions above table.

7.7 FREQUENCY STABILITY

7.7.1 LTE Band 17

OPERATING FREQUENCY : 710 MHz
 CHANNEL : 23790
 REFERENCE VOLTAGE : 3.80 VDC
 LIMIT(FCC & IC) : The frequency stability shall be sufficient to ensure that the fundamental emission stays within the authorized frequency block.

VOLTAGE (%)	POWER (V DC)	TEMP (°C)	FREQUENCY (Hz)	FREQ.Dev (Hz)	Deviation	
					(ppm)	(%)
100%	3.80	+20(Ref)	709,999,998	-2	-0.0028	-0.000000282
100%		-30	709,999,997	-3	-0.0042	-0.000000423
100%		-20	709,999,997	-3	-0.0042	-0.000000423
100%		-10	709,999,998	-2	-0.0028	-0.000000282
100%		0	709,999,998	-2	-0.0028	-0.000000282
100%		+10	709,999,998	-2	-0.0028	-0.000000282
100%		+20	709,999,998	-2	-0.0028	-0.000000282
100%		+30	709,999,998	-2	-0.0028	-0.000000282
100%		+40	709,999,997	-3	-0.0042	-0.000000423
100%		+50	709,999,997	-3	-0.0042	-0.000000423
115%	4.37	+20	709,999,996	-4	-0.0056	-0.000000563
BATT.ENDPOINT	3.50	+20	709,999,997	-3	-0.0042	-0.000000423

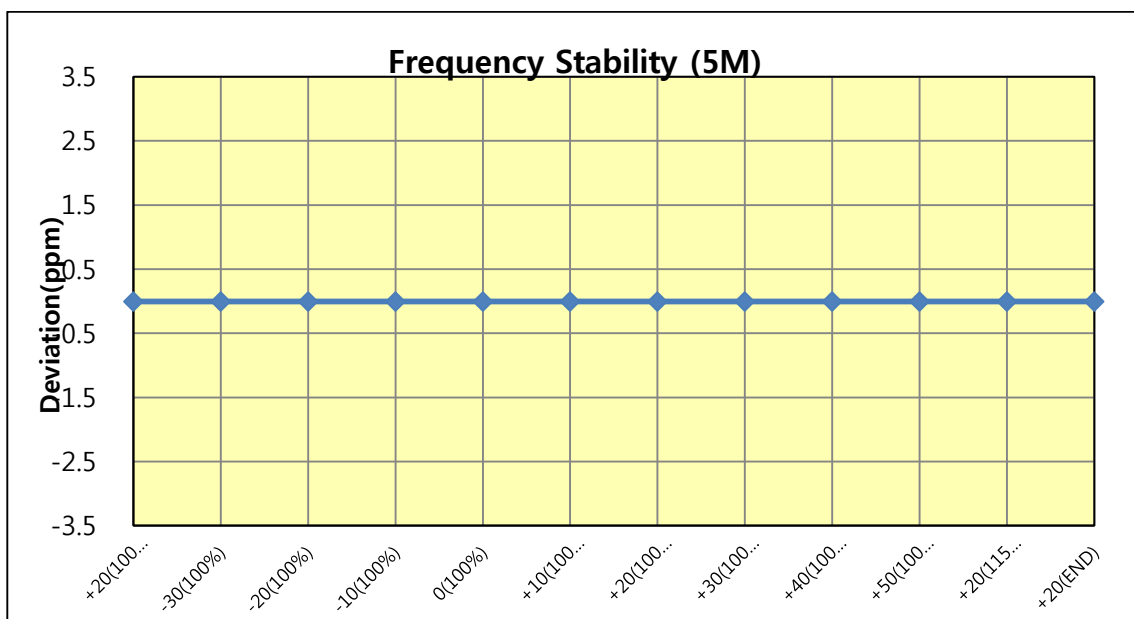

Note. Based on the results of the frequency stability test at the center channel the frequency deviation results measured are very small. as such it is determined that the channels at the band edge would remain inband when the maximum measured frequency deviation noted during the frequency stability tests is applied. therefore the device is determined to remain operating in band over the temperature and voltage range as tested.

7.7.2 LTE Band 5

OPERATING FREQUENCY : 836.5 MHz
 CHANNEL : 20525
 REFERENCE VOLTAGE : 3.80 VDC
 DEVIATION LIMIT(FCC & IC) : $\pm 0.00025\%$ or 2.5 ppm

VOLTAGE (%)	POWER (V DC)	TEMP (°C)	FREQUENCY (Hz)	FREQ.Dev (Hz)	Deviation	
					(ppm)	(%)
100%	3.80	+20(Ref)	836,499,996	-4	-0.0048	-0.000000478
100%		-30	836,499,997	-3	-0.0036	-0.000000359
100%		-20	836,499,999	-1	-0.0012	-0.000000120
100%		-10	836,499,998	-2	-0.0024	-0.000000239
100%		0	836,499,997	-3	-0.0036	-0.000000359
100%		+10	836,499,996	-4	-0.0048	-0.000000478
100%		+20	836,499,996	-4	-0.0048	-0.000000478
100%		+30	836,499,998	-2	-0.0024	-0.000000239
100%		+40	836,499,996	-4	-0.0048	-0.000000478
100%		+50	836,499,995	-5	-0.0060	-0.000000598
115%	4.37	+20	836,499,998	-2	-0.0024	-0.000000239
BATT.ENDPOINT	3.50	+20	836,499,996	-4	-0.0048	-0.000000478

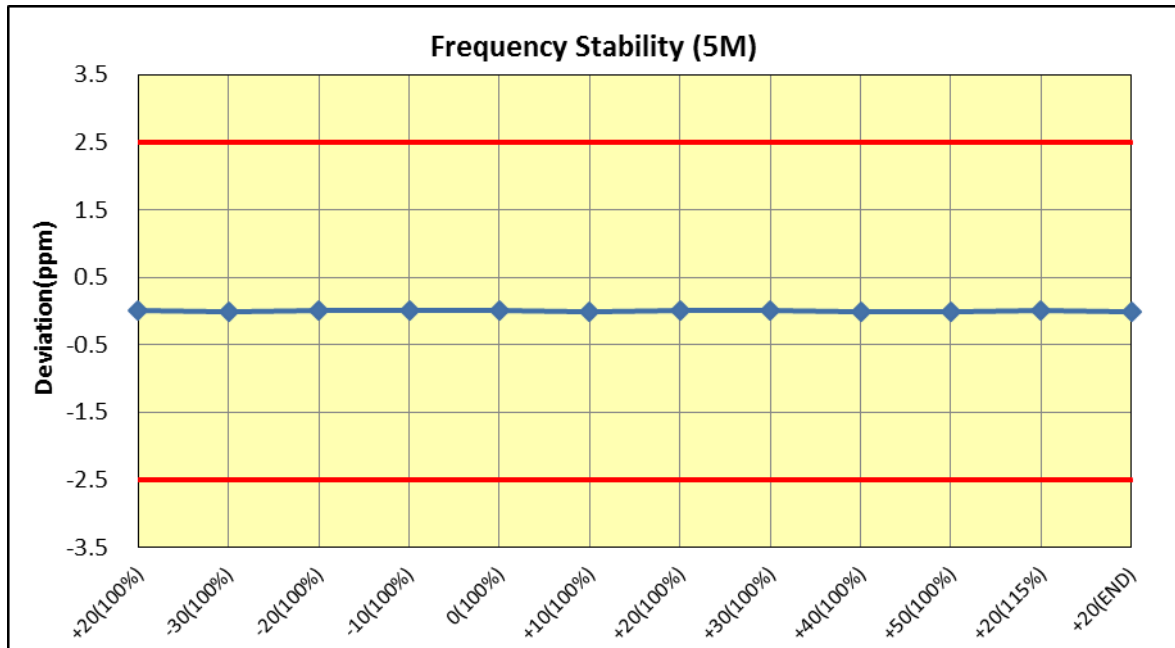

7.7.3 LTE Band 4

OPERATING FREQUENCY : 1732.5 MHz
 CHANNEL : 20175
 REFERENCE VOLTAGE : 3.80 VDC
 LIMIT(FCC & IC) : The frequency stability shall be sufficient to ensure that the fundamental emission stays within the authorized frequency block.

VOLTAGE (%)	POWER (V DC)	TEMP (°C)	FREQUENCY (Hz)	FREQ.Dev (Hz)	Deviation	
					(ppm)	(%)
100%	3.80	+20(Ref)	1,732,499,985	-15	-0.0087	-0.000000866
100%		-30	1,732,499,991	-9	-0.0052	-0.000000519
100%		-20	1,732,499,995	-5	-0.0029	-0.000000289
100%		-10	1,732,499,992	-8	-0.0046	-0.000000462
100%		0	1,732,500,012	12	0.0069	0.000000693
100%		+10	1,732,499,990	-10	-0.0058	-0.000000577
100%		+20	1,732,499,985	-15	-0.0087	-0.000000866
100%		+30	1,732,499,990	-10	-0.0058	-0.000000577
100%		+40	1,732,499,990	-10	-0.0058	-0.000000577
100%		+50	1,732,499,991	-9	-0.0052	-0.000000519
115%	4.37	+20	1,732,499,991	-9	-0.0052	-0.000000519
BATT.ENDPOINT	3.50	+20	1,732,499,988	-12	-0.0069	-0.000000693

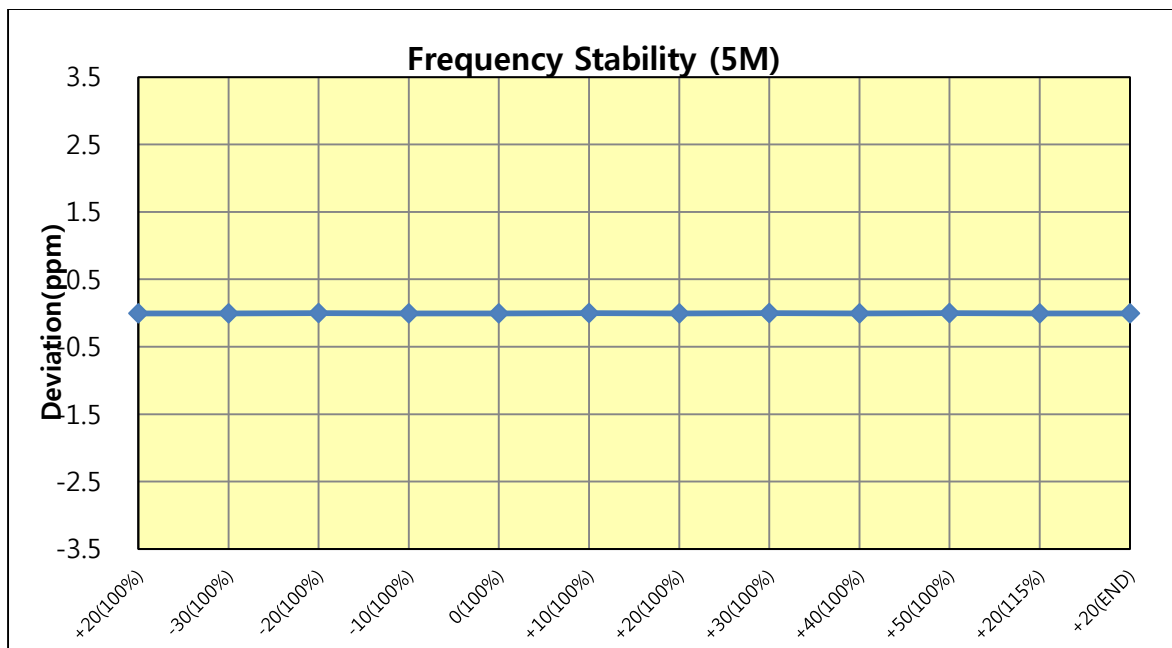

Note. Based on the results of the frequency stability test at the center channel the frequency deviation results measured are very small. as such it is determined that the channels at the band edge would remain inband when the maximum measured frequency deviation noted during the frequency stability tests is applied. therefore the device is determined to remain operating in band over the temperature and voltage range as tested.

7.7.4 LTE Band 2

OPERATING FREQUENCY : 1880 MHz
 CHANNEL : 18900
 REFERENCE VOLTAGE : 3.80 VDC
 LIMIT(FCC) : The frequency stability shall be sufficient to ensure that the fundamental emission stays within the authorized frequency block.
 DEVIATION LIMIT(IC) : ± 0.00025 % or 2.5 ppm

VOLTAGE (%)	POWER (V DC)	TEMP (°C)	FREQUENCY (Hz)	FREQ.Dev (Hz)	Deviation	
					(ppm)	(%)
100%	3.80	+20(Ref)	1,879,999,992	-8	-0.0041	-0.000000415
100%		-30	1,879,999,993	-7	-0.0036	-0.000000356
100%		-20	1,879,999,995	-6	-0.0029	-0.000000293
100%		-10	1,879,999,992	-8	-0.0040	-0.000000404
100%		0	1,879,999,993	-8	-0.0040	-0.000000399
100%		+10	1,879,999,994	-6	-0.0031	-0.000000314
100%		+20	1,879,999,992	-8	-0.0041	-0.000000415
100%		+30	1,879,999,994	-6	-0.0034	-0.000000340
100%		+40	1,879,999,989	-11	-0.0058	-0.000000580
100%		+50	1,879,999,994	-6	-0.0030	-0.000000303
115%	4.37	+20	1,879,999,993	-8	-0.0040	-0.000000399
BATT.ENDPOINT	3.50	+20	1,879,999,991	-9	-0.0050	-0.000000500

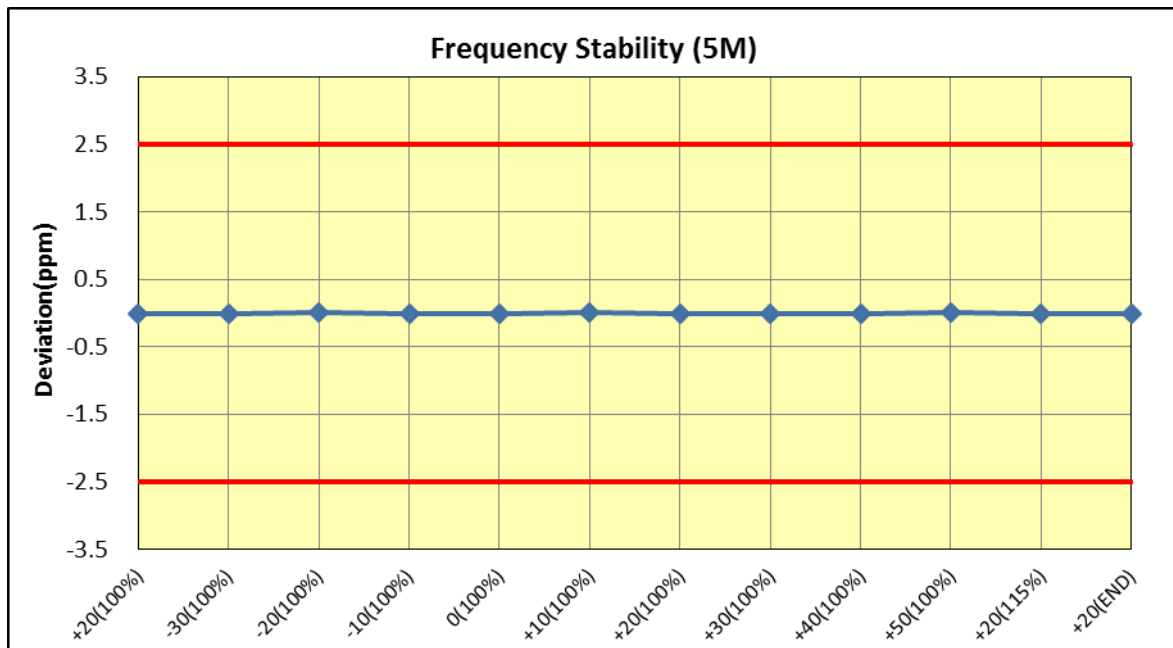

Note. Based on the results of the frequency stability test at the center channel the frequency deviation results measured are very small. as such it is determined that the channels at the band edge would remain inband when the maximum measured frequency deviation noted during the frequency stability tests is applied. therefore the device is determined to remain operating in band over the temperature and voltage range as tested.

7.7.5 LTE Band 7

OPERATING FREQUENCY : 2535 MHz
 CHANNEL : 21100
 REFERENCE VOLTAGE : 3.80 VDC
 LIMIT(FCC & IC) : The frequency stability shall be sufficient to ensure that the fundamental emission stays within the authorized frequency block.

VOLTAGE (%)	POWER (V DC)	TEMP (°C)	FREQUENCY (Hz)	FREQ.Dev (Hz)	Deviation	
					(ppm)	(%)
100%	3.80	+20(Ref)	2,534,999,994	-6	-0.0024	-0.000000237
100%		-30	2,534,999,990	-10	-0.0039	-0.000000394
100%		-20	2,534,999,995	-5	-0.0020	-0.000000197
100%		-10	2,534,999,994	-6	-0.0024	-0.000000237
100%		0	2,534,999,995	-5	-0.0020	-0.000000197
100%		+10	2,534,999,989	-11	-0.0043	-0.000000434
100%		+20	2,534,999,994	-6	-0.0024	-0.000000237
100%		+30	2,534,999,994	-6	-0.0024	-0.000000237
100%		+40	2,534,999,996	-4	-0.0016	-0.000000158
100%		+50	2,534,999,990	-10	-0.0039	-0.000000394
115%	4.37	+20	2,534,999,993	-7	-0.0028	-0.000000276
BATT.ENDPOINT	3.50	+20	2,534,999,993	-7	-0.0028	-0.000000276

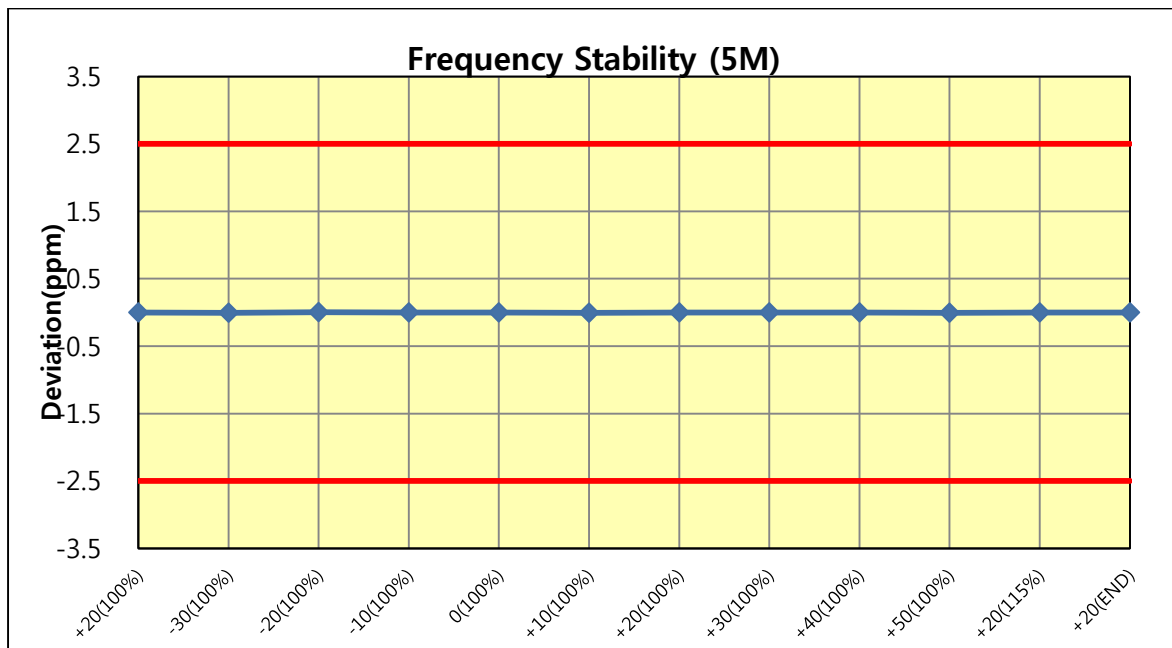

Note. Based on the results of the frequency stability test at the center channel the frequency deviation results measured are very small. as such it is determined that the channels at the band edge would remain inband when the maximum measured frequency deviation noted during the frequency stability tests is applied. therefore the device is determined to remain operating in band over the temperature and voltage range as tested.

8. TEST PLOTS

Note: All bandwidths, RB configurations, and modulations were investigated. The worst case test results are reported below.

8.1 OCCUPIED BANDWIDTH

8.1.1 LTE Band 17

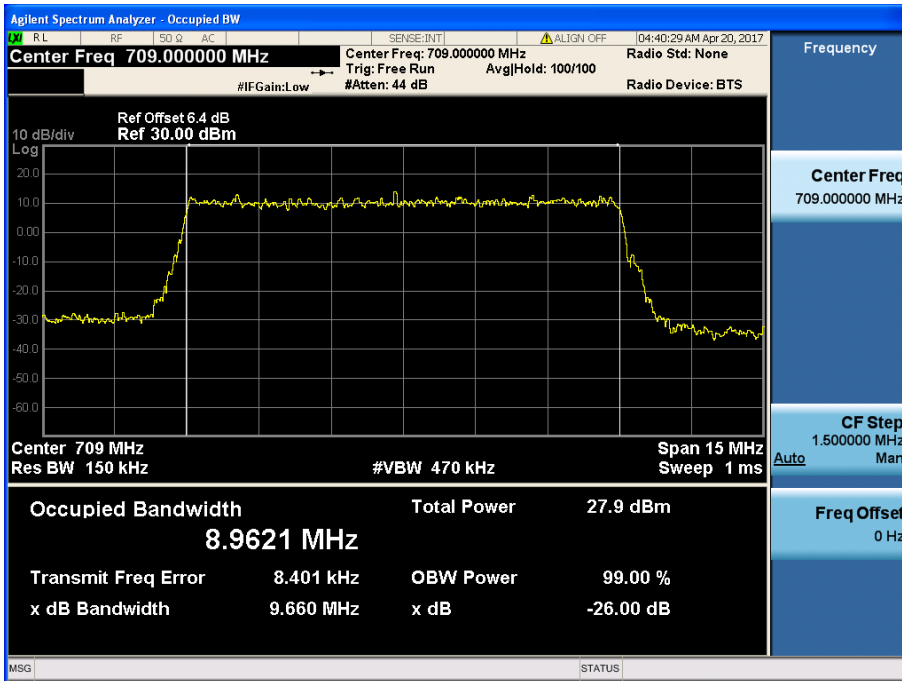

LTE Band 17 / 10 MHz / QPSK - RB Size 50

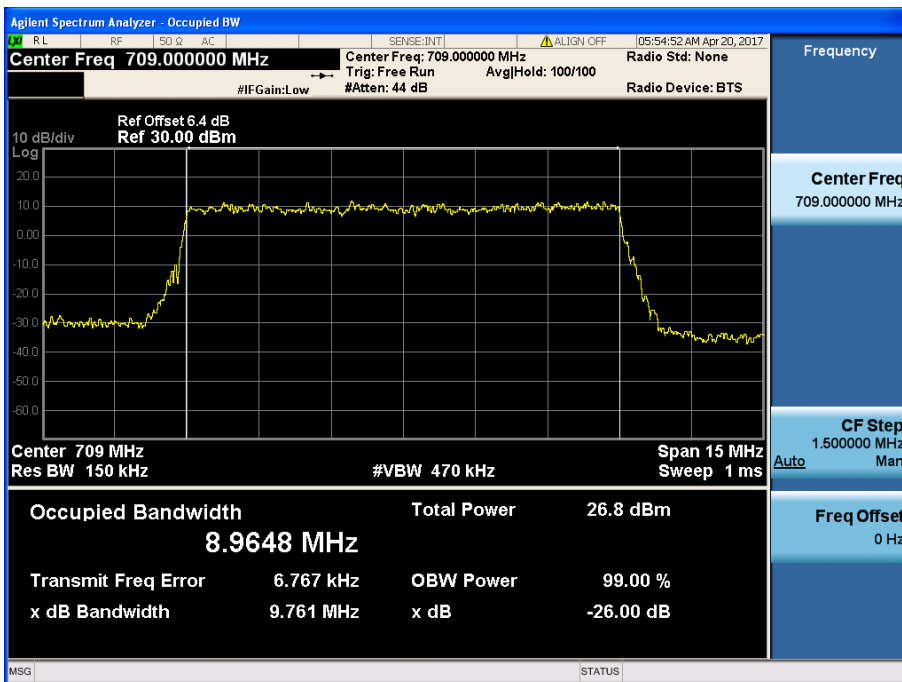

LTE Band 17 / 10 MHz / 16QAM - RB Size 50

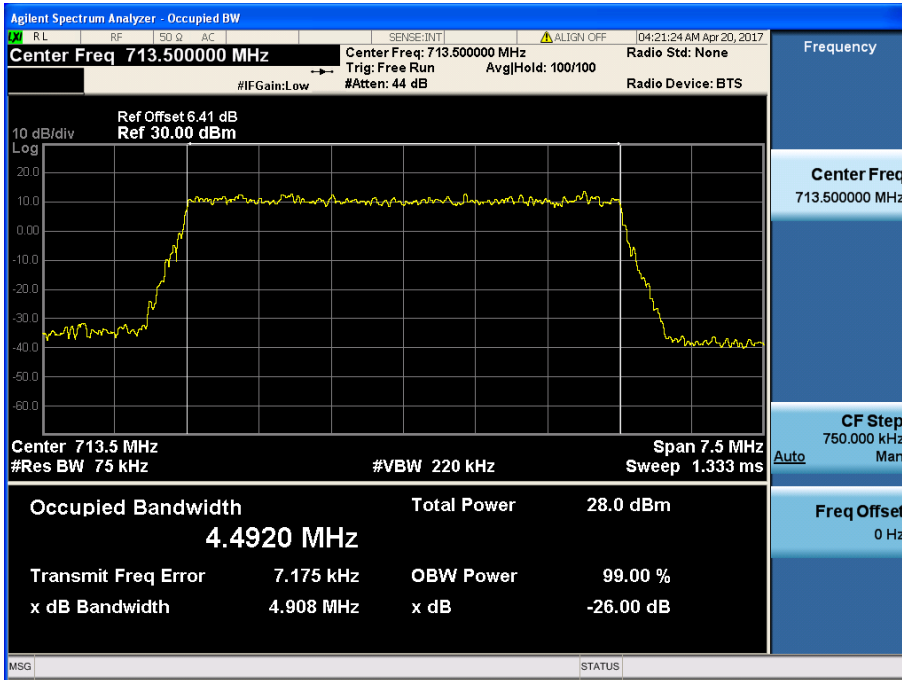

LTE Band 17 / 5 MHz / QPSK - RB Size 25

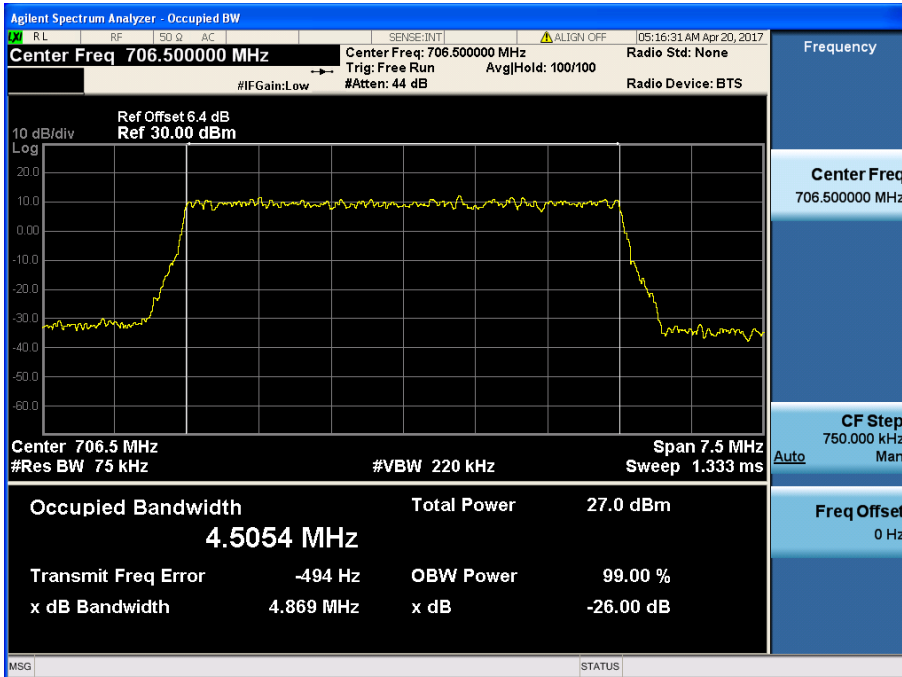

LTE Band 17 / 5 MHz / 16QAM - RB Size 25

8.1.2 LTE Band 5

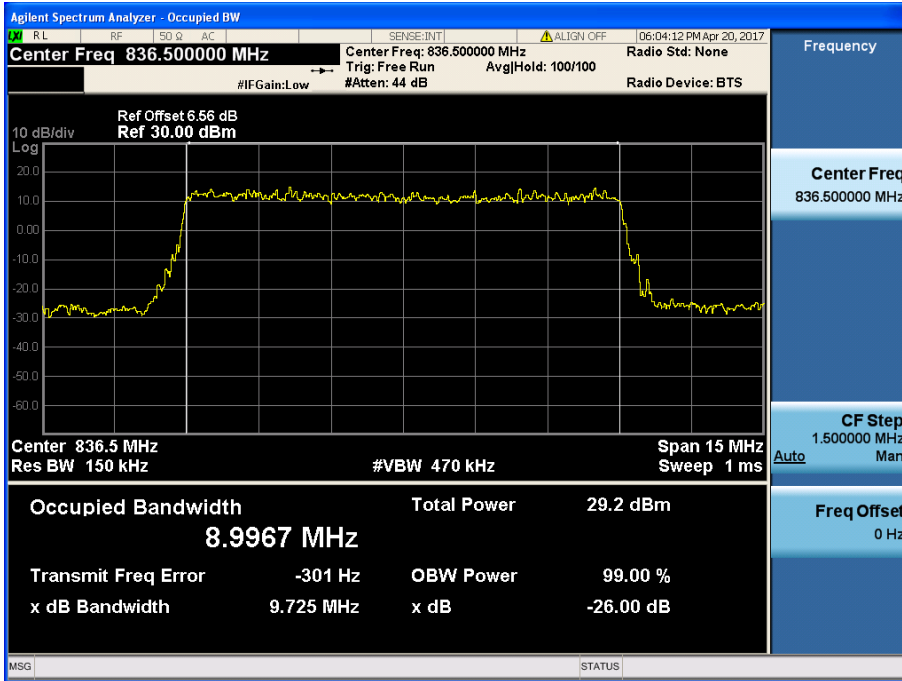

LTE Band 5 / 10 MHz / QPSK - RB Size 50

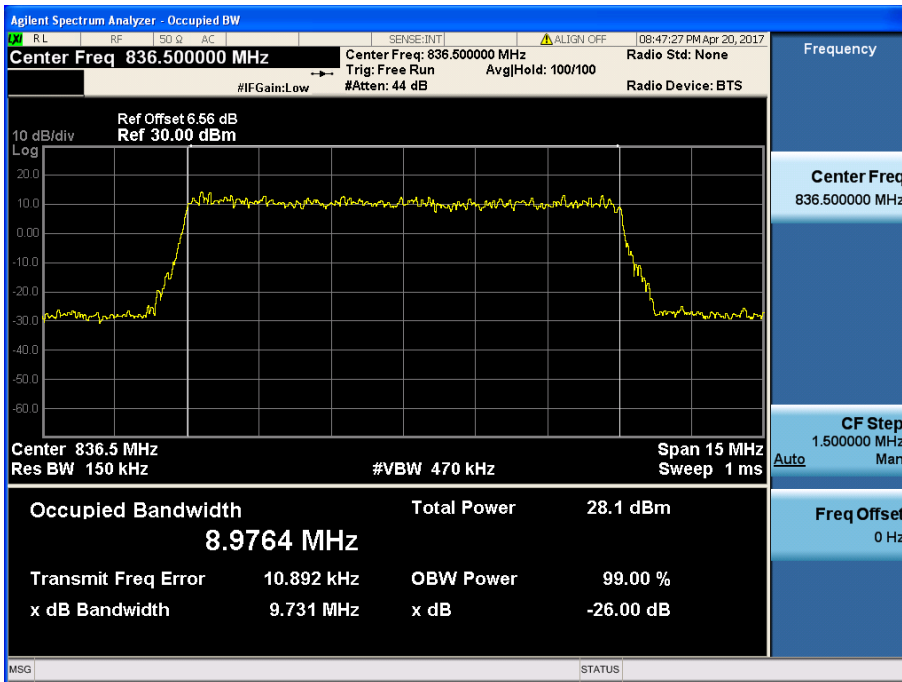

LTE Band 5 / 10 MHz / 16QAM - RB Size 50

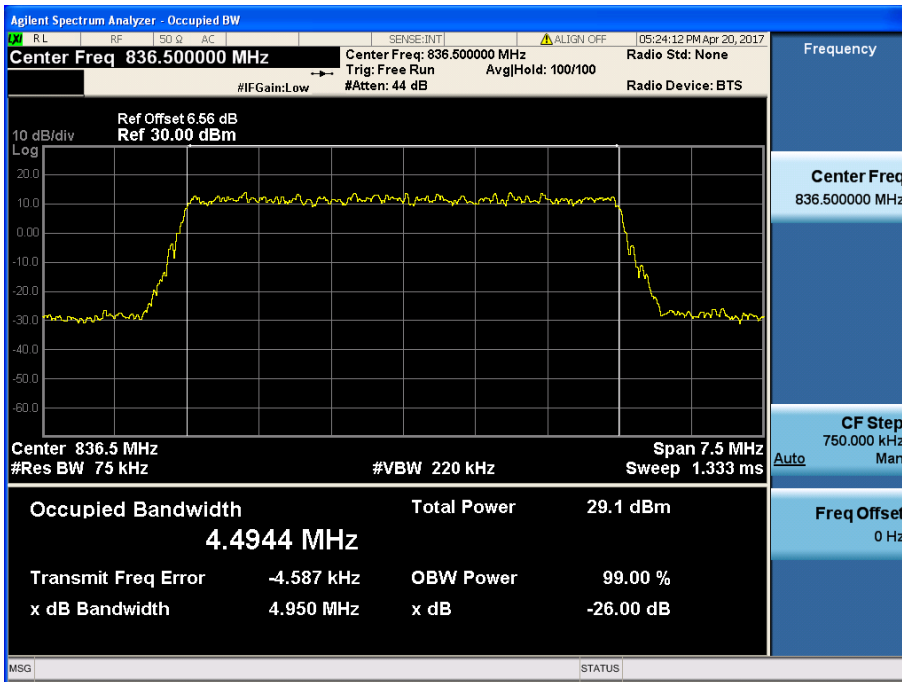

LTE Band 5 / 5 MHz / QPSK - RB Size 25

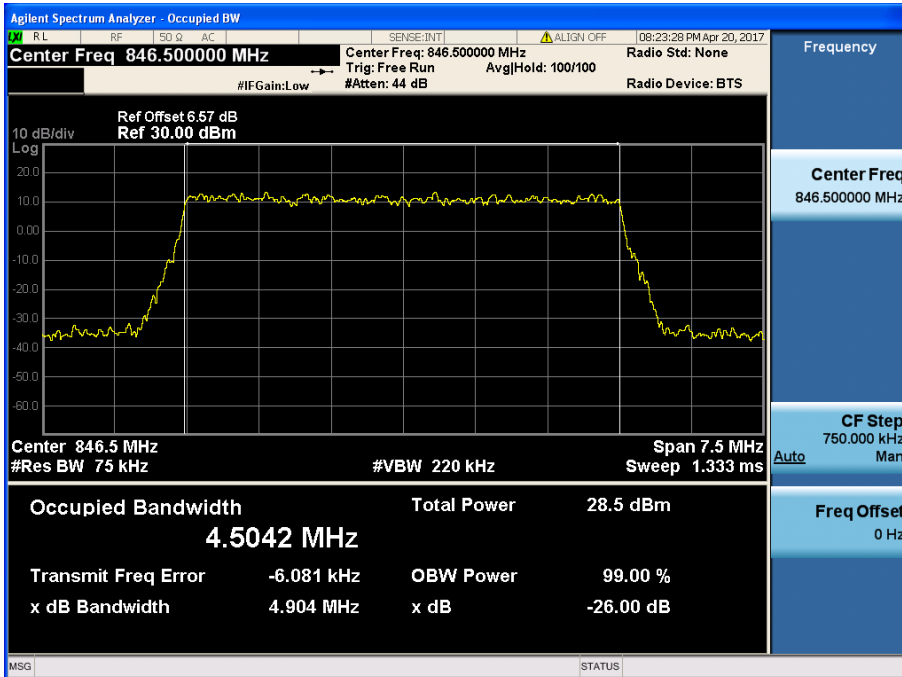

LTE Band 5 / 5 MHz / 16QAM - RB Size 25

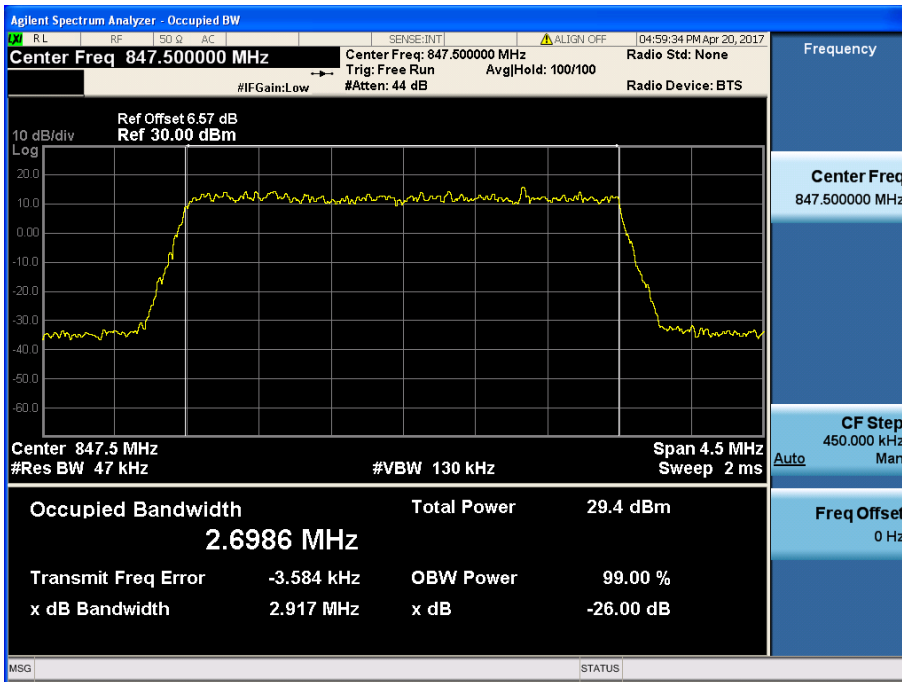

LTE Band 5 / 3 MHz / QPSK - RB Size 15

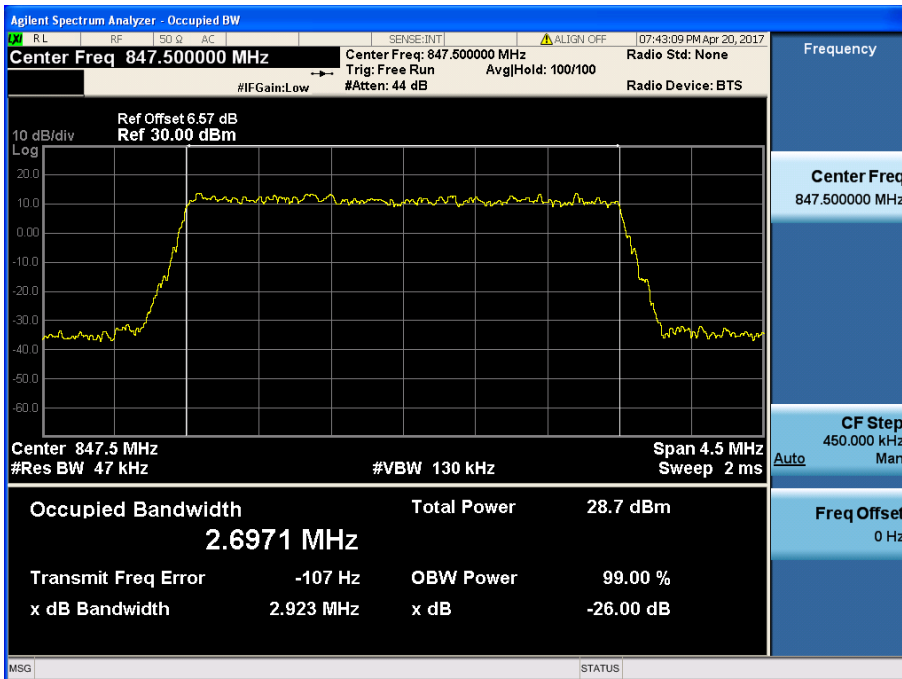

LTE Band 5 / 3 MHz / 16QAM - RB Size 15

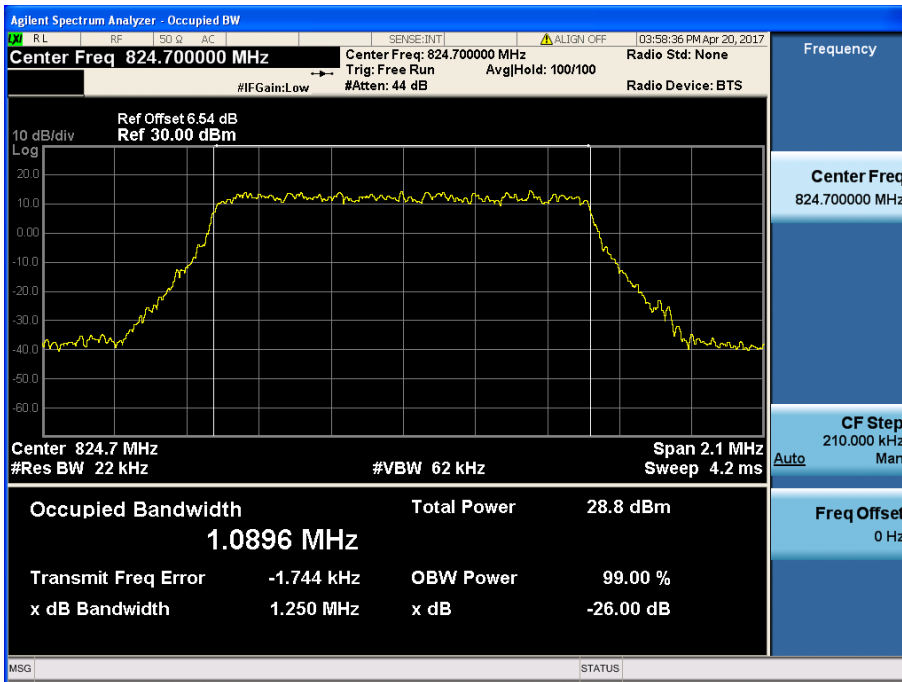

LTE Band 5 / 1.4 MHz / QPSK - RB Size 6

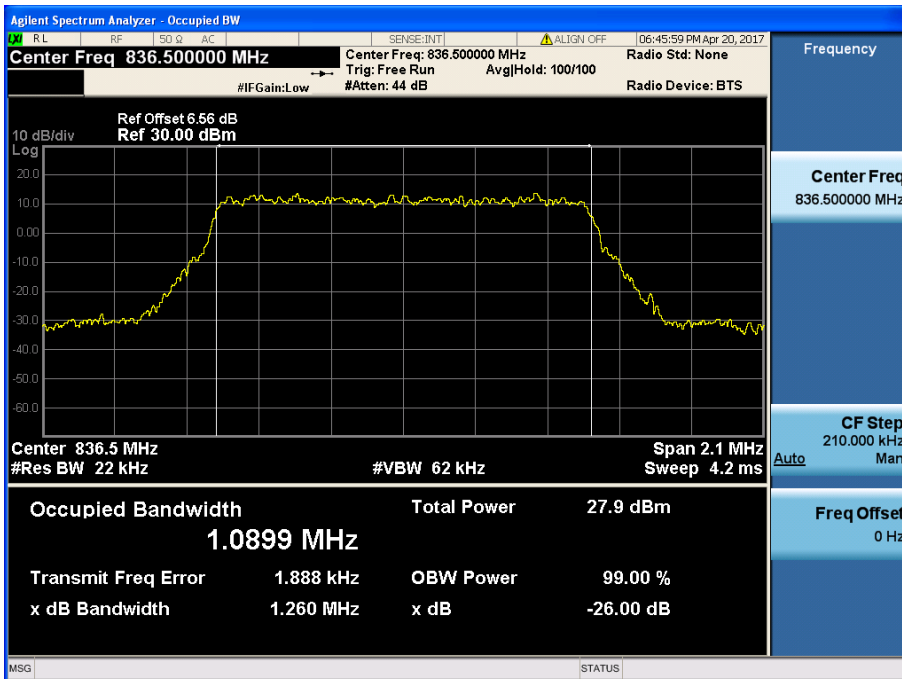

LTE Band 5 / 1.4 MHz / 16QAM - RB Size 6

8.1.3 LTE Band 4

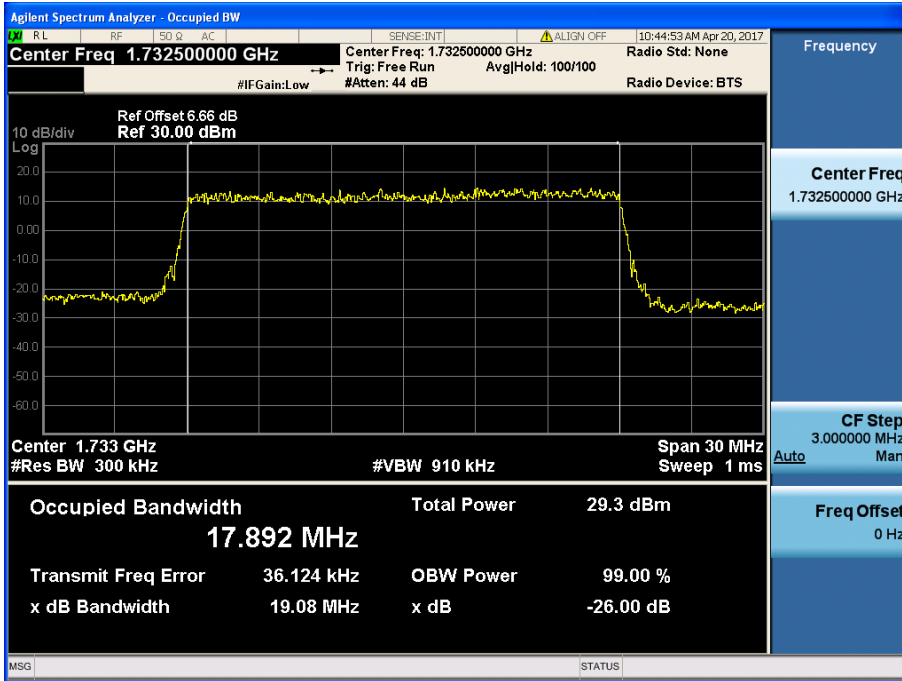

LTE Band 4 / 20 MHz / QPSK - RB Size 100

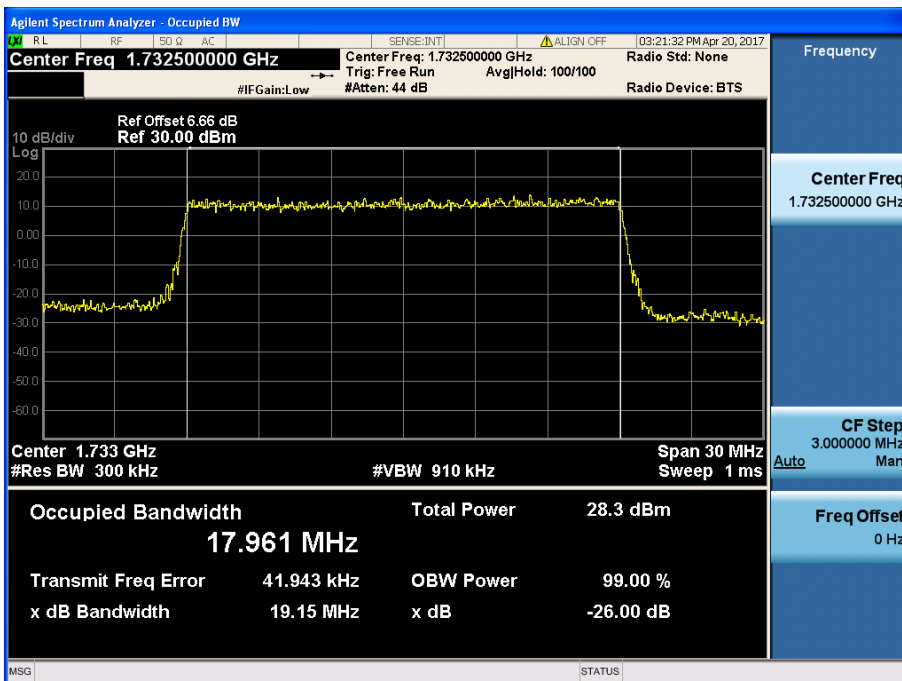

LTE Band 4 / 20 MHz / 16QAM - RB Size 100

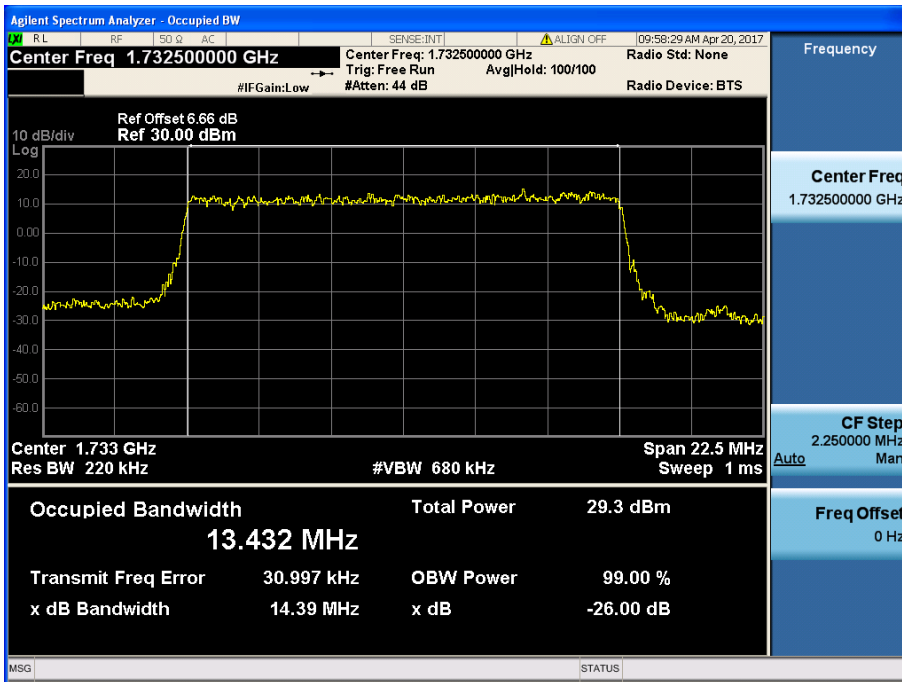

LTE Band 4 / 15 MHz / QPSK - RB Size 75

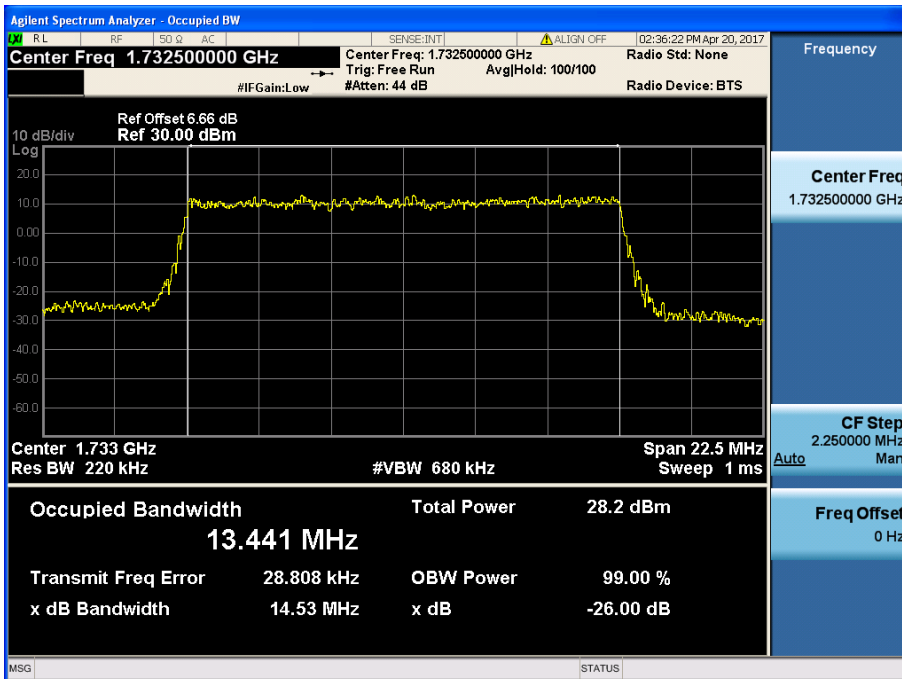

LTE Band 4 / 15 MHz / 16QAM - RB Size 75

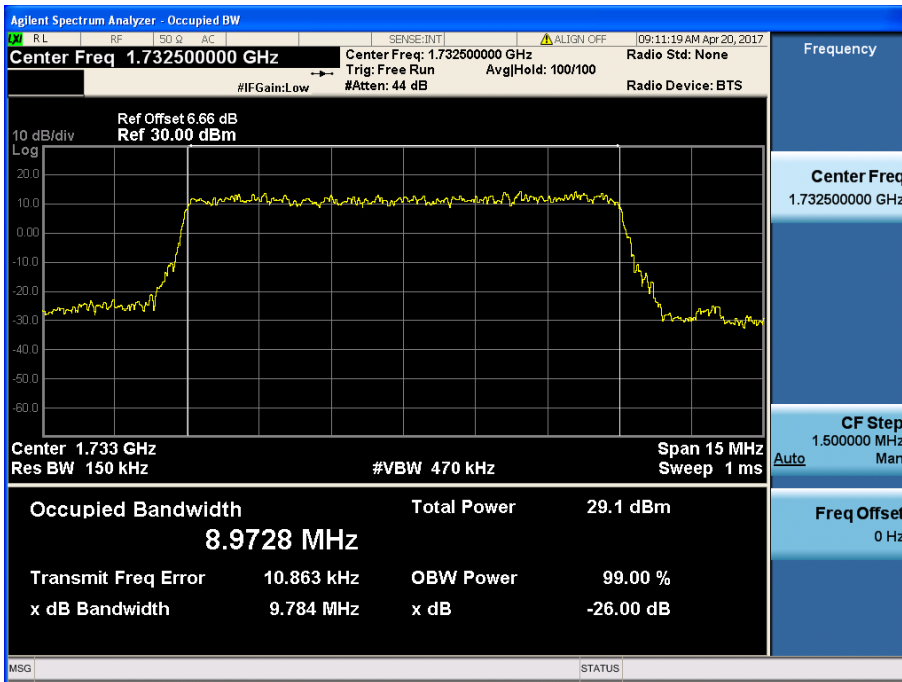

LTE Band 4 / 10 MHz / QPSK - RB Size 50

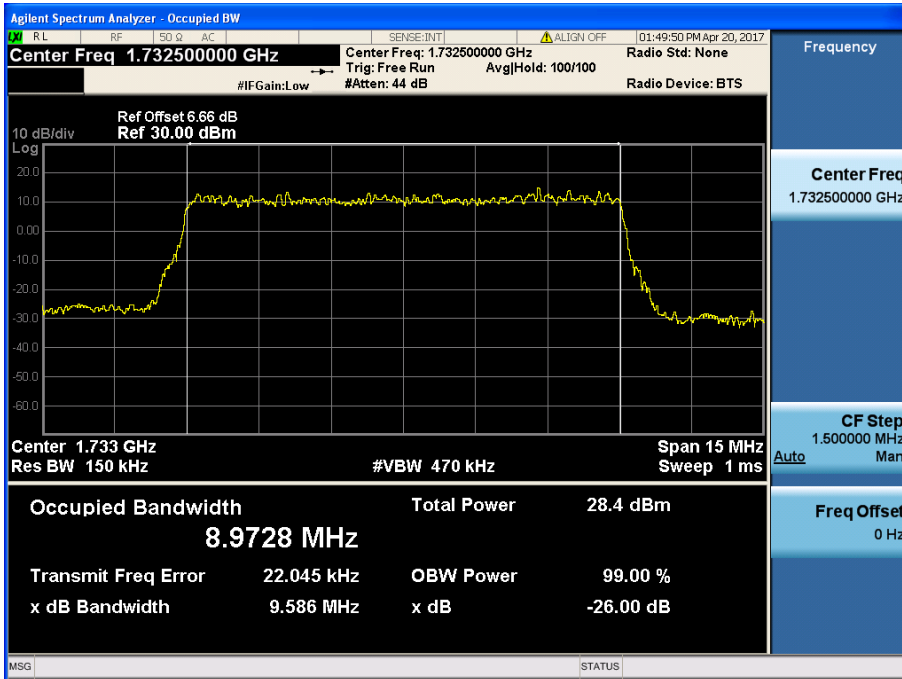

LTE Band 4 / 10 MHz / 16QAM - RB Size 50

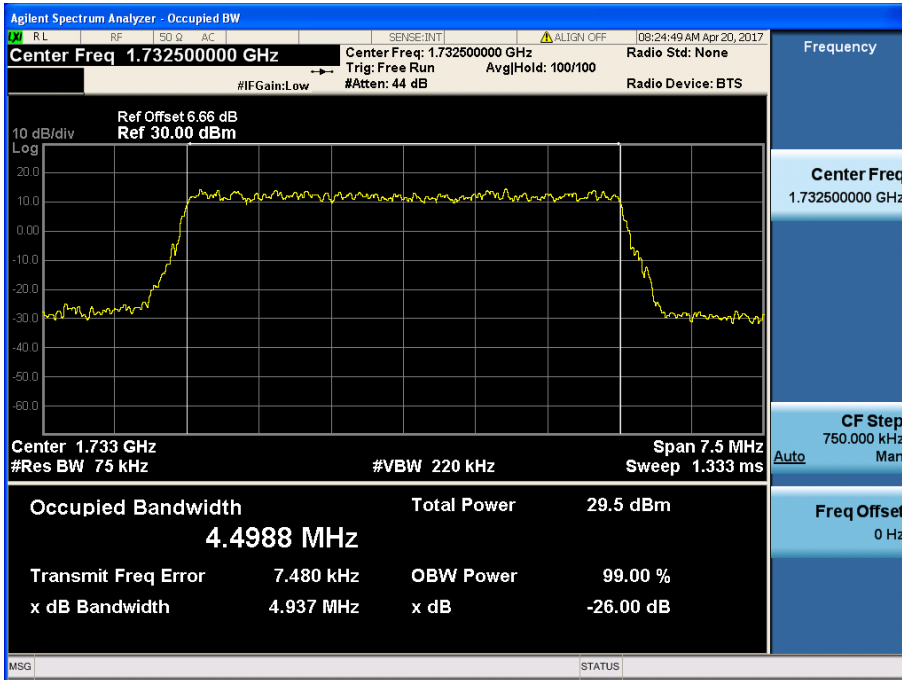

LTE Band 4 / 5 MHz / QPSK - RB Size 25

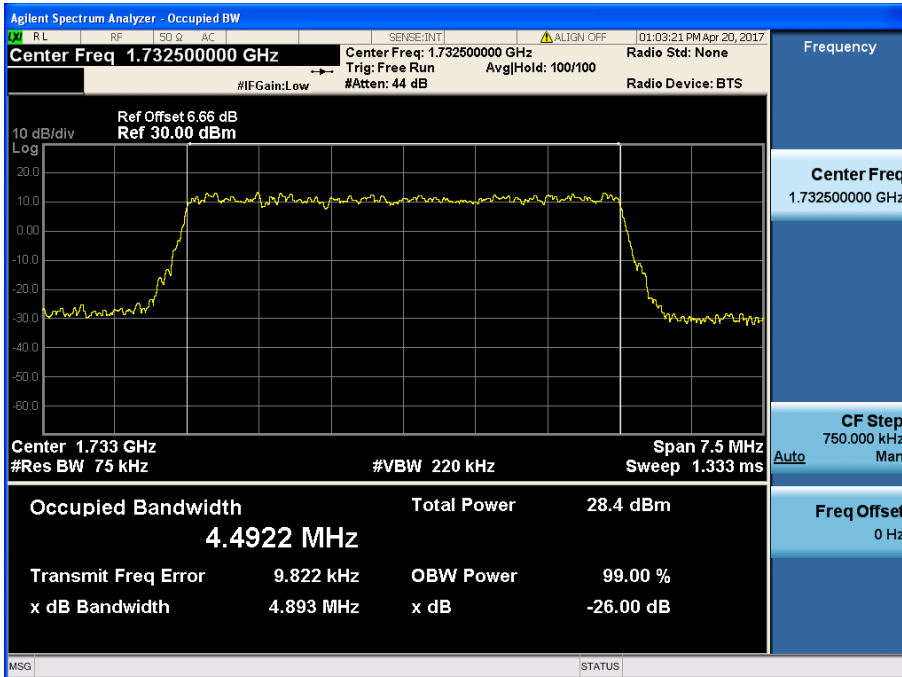

LTE Band 4 / 5 MHz / 16QAM - RB Size 25

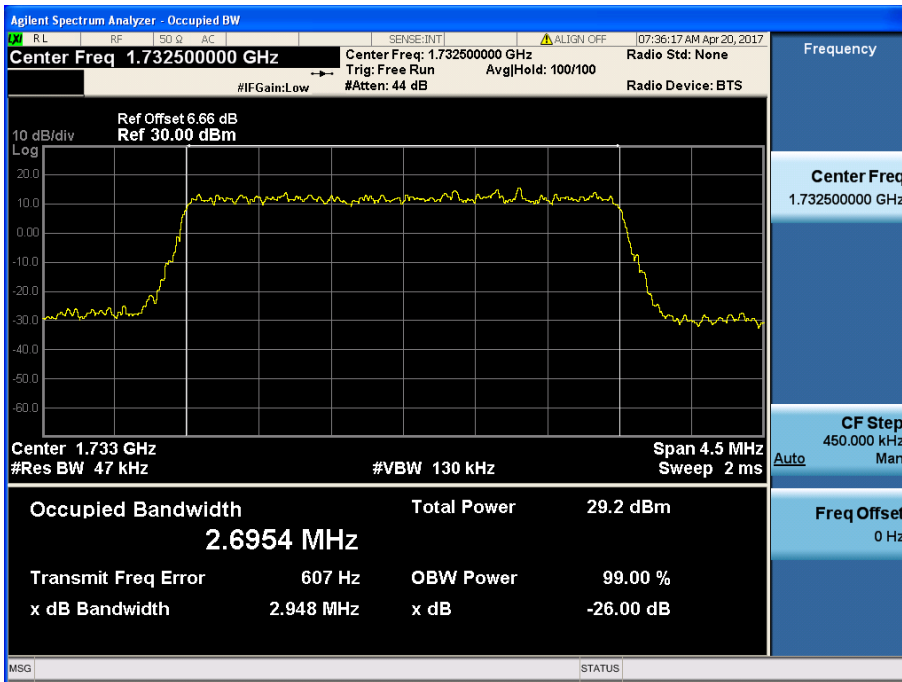

LTE Band 4 / 3 MHz / QPSK - RB Size 15

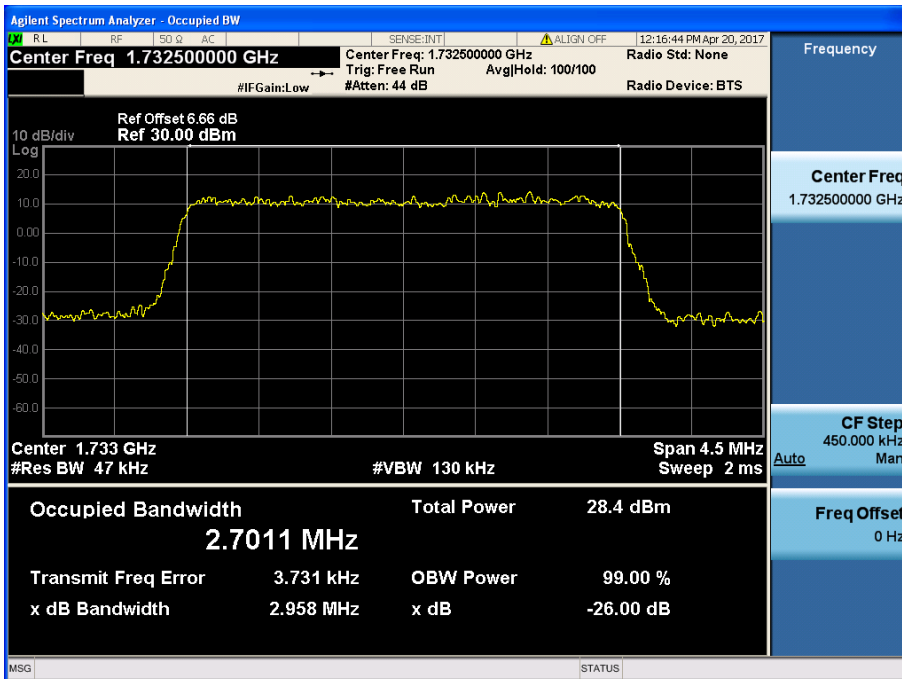

LTE Band 4 / 3 MHz / 16QAM - RB Size 15

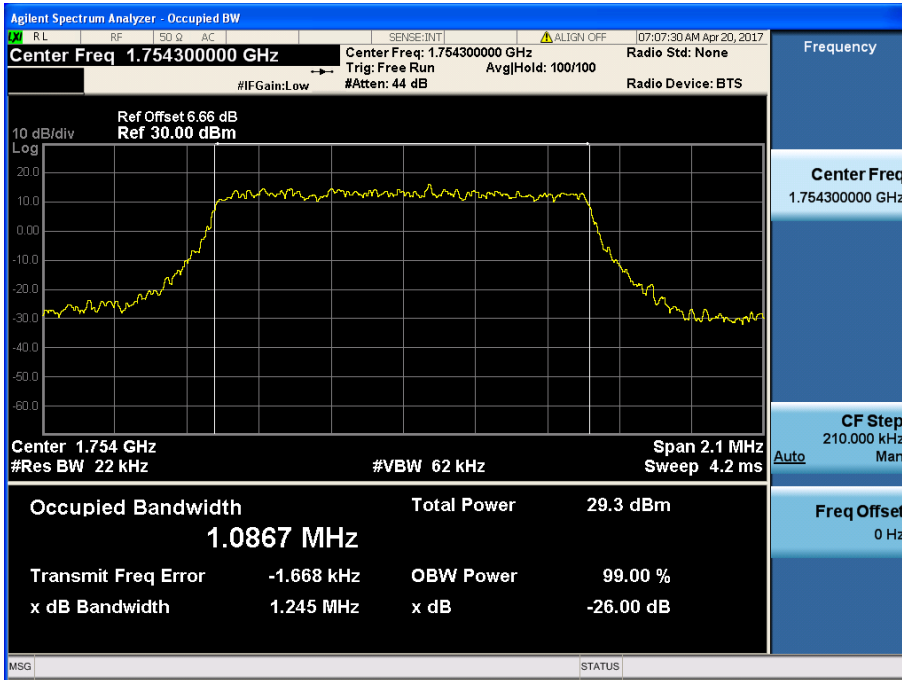

LTE Band 4 / 1.4 MHz / QPSK - RB Size 6

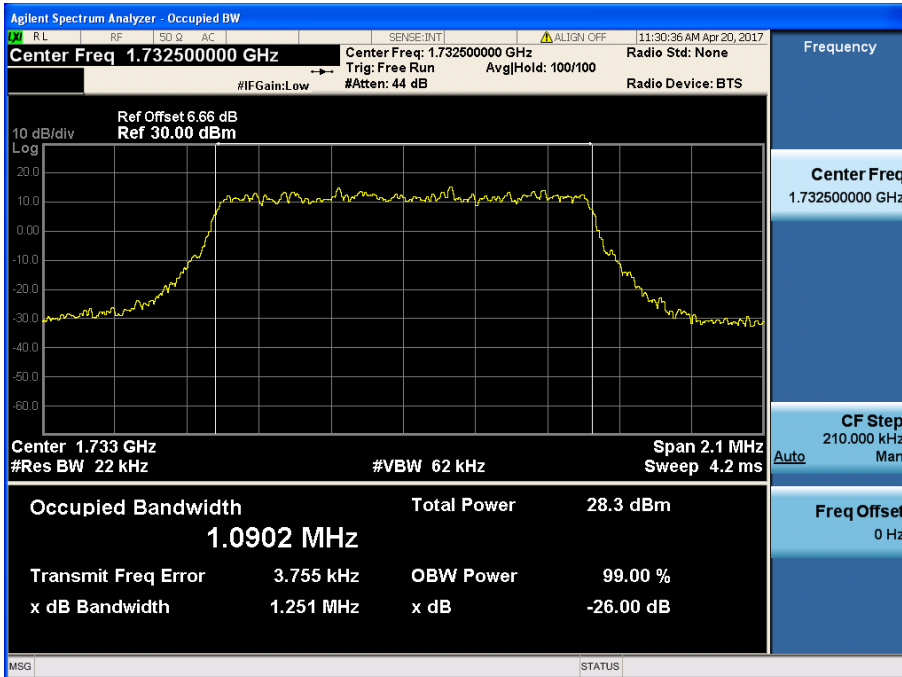

LTE Band 4 / 1.4 MHz / 16QAM - RB Size 6

8.1.4 LTE Band 2

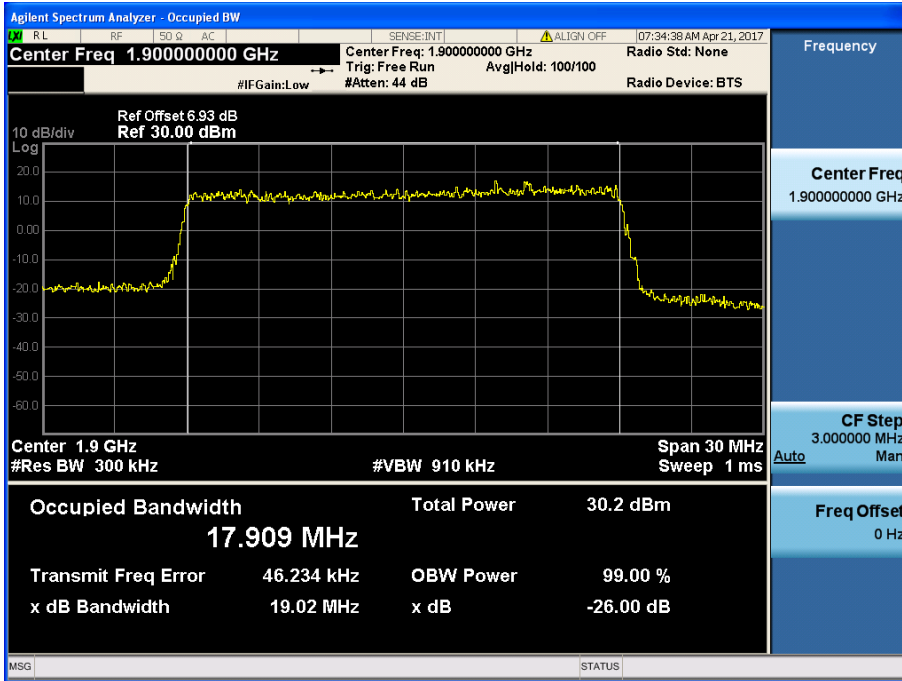

LTE Band 2 / 20 MHz / QPSK - RB Size 100

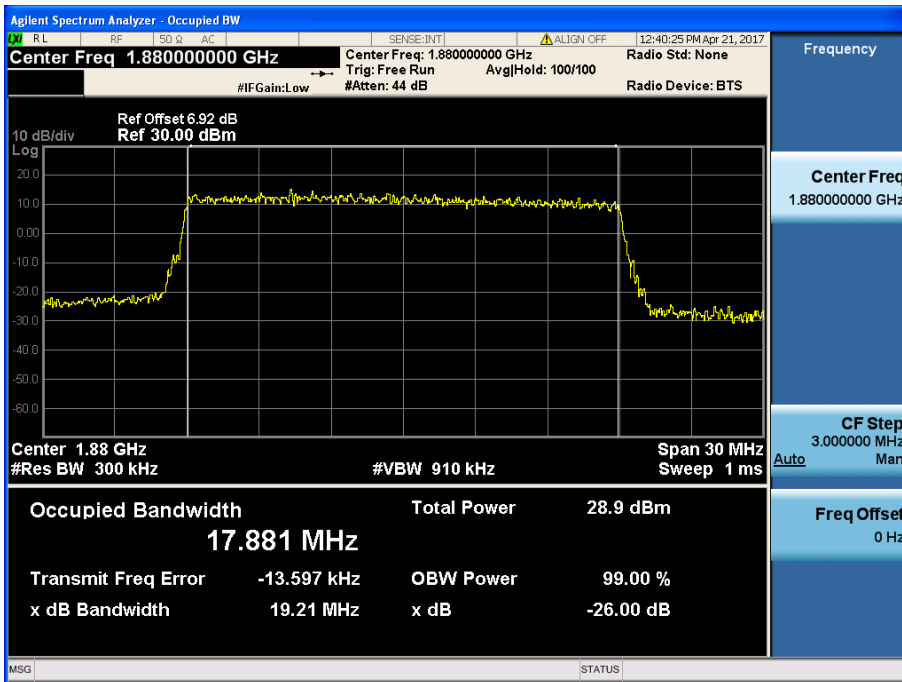

LTE Band 2 / 20 MHz / 16QAM - RB Size 100

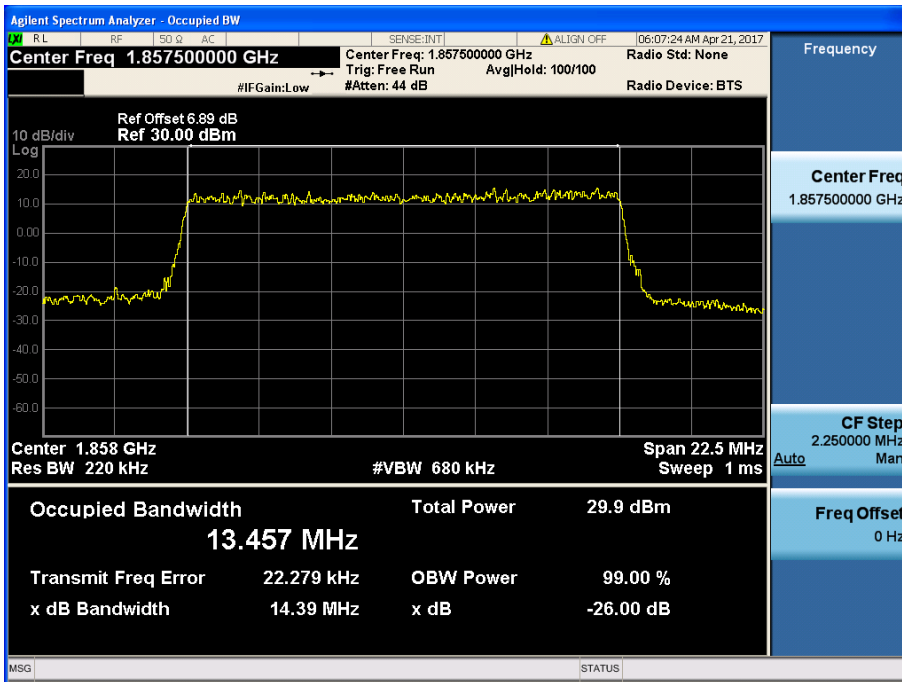

LTE Band 2 / 15 MHz / QPSK - RB Size 75

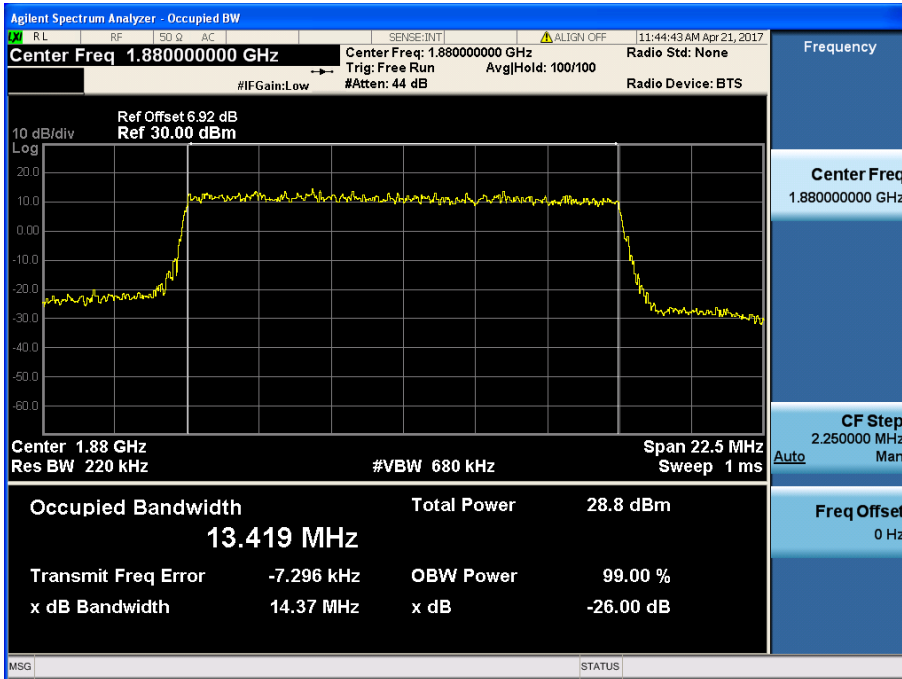

LTE Band 2 / 15 MHz / 16QAM - RB Size 75

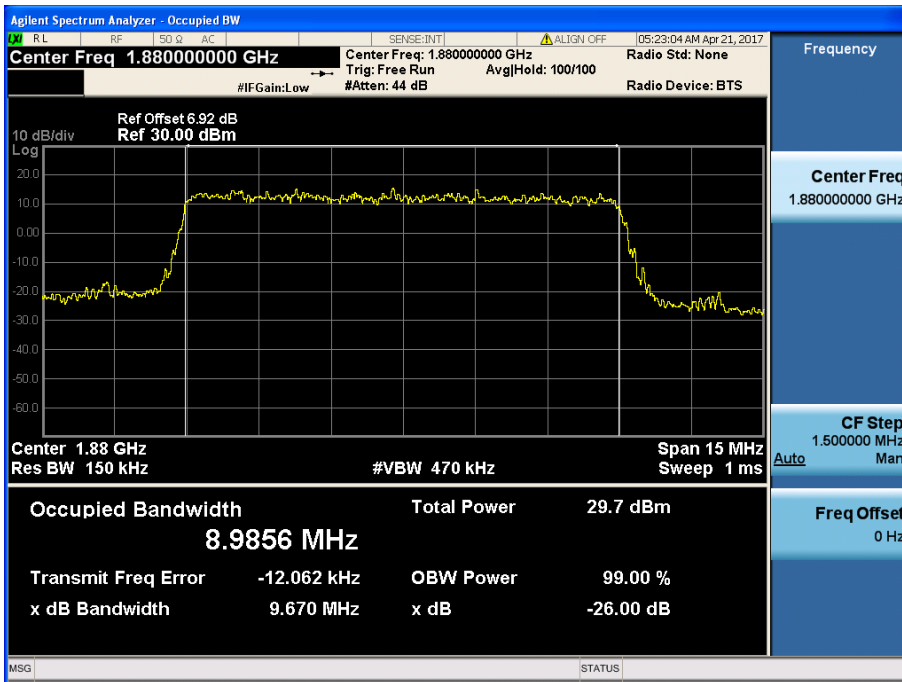

LTE Band 2 / 10 MHz / QPSK - RB Size 50

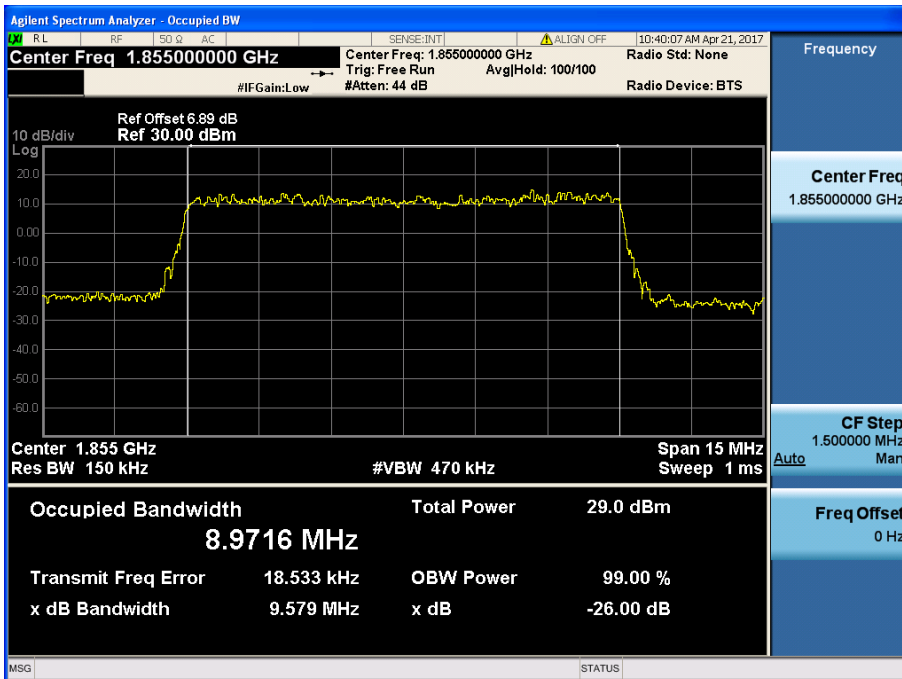

LTE Band 2 / 10 MHz / 16QAM - RB Size 50

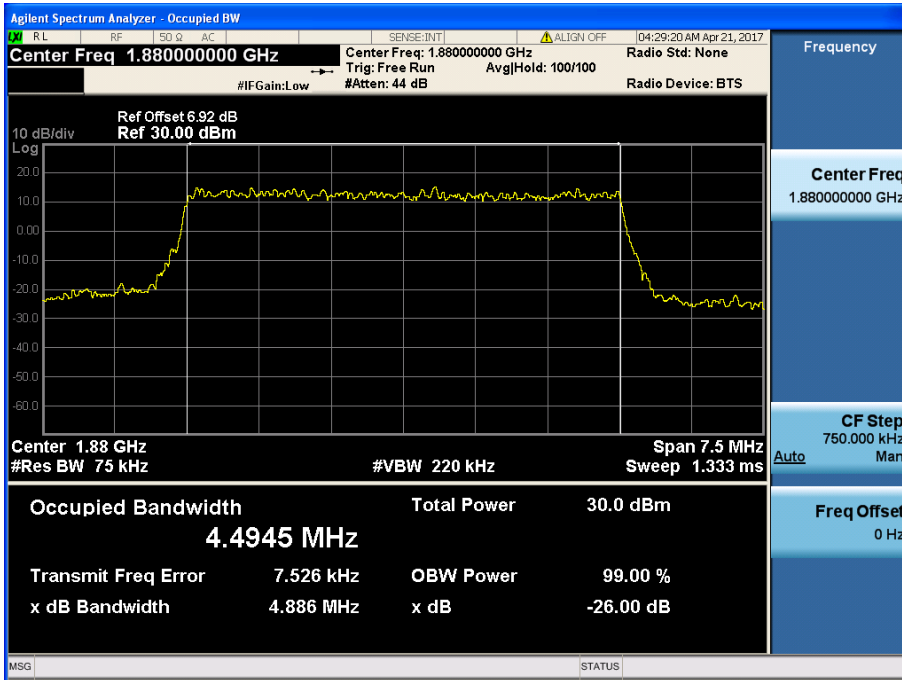

LTE Band 2 / 5 MHz / QPSK - RB Size 25

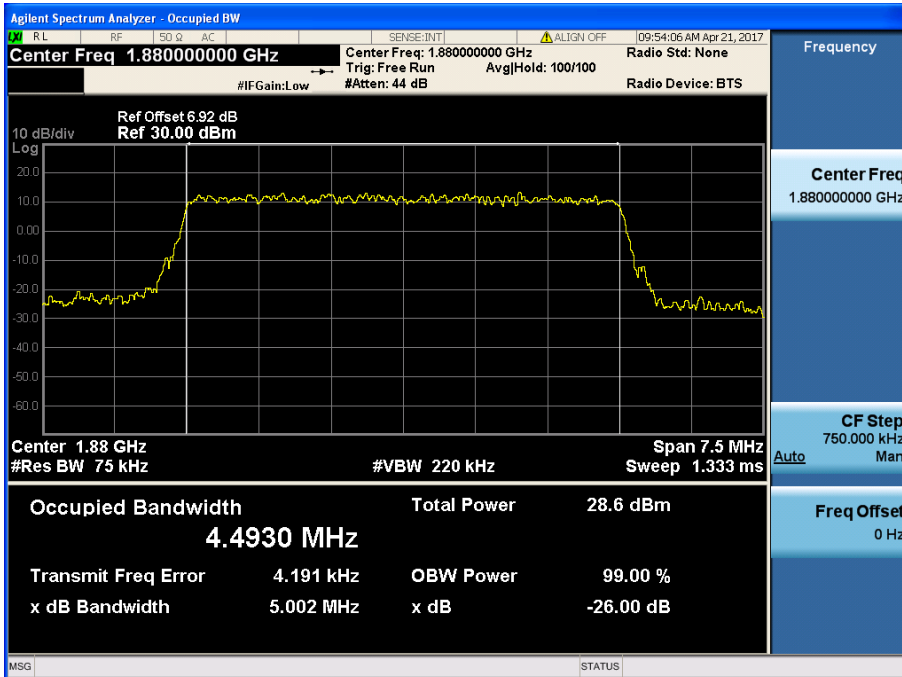

LTE Band 2 / 5 MHz / 16QAM - RB Size 25

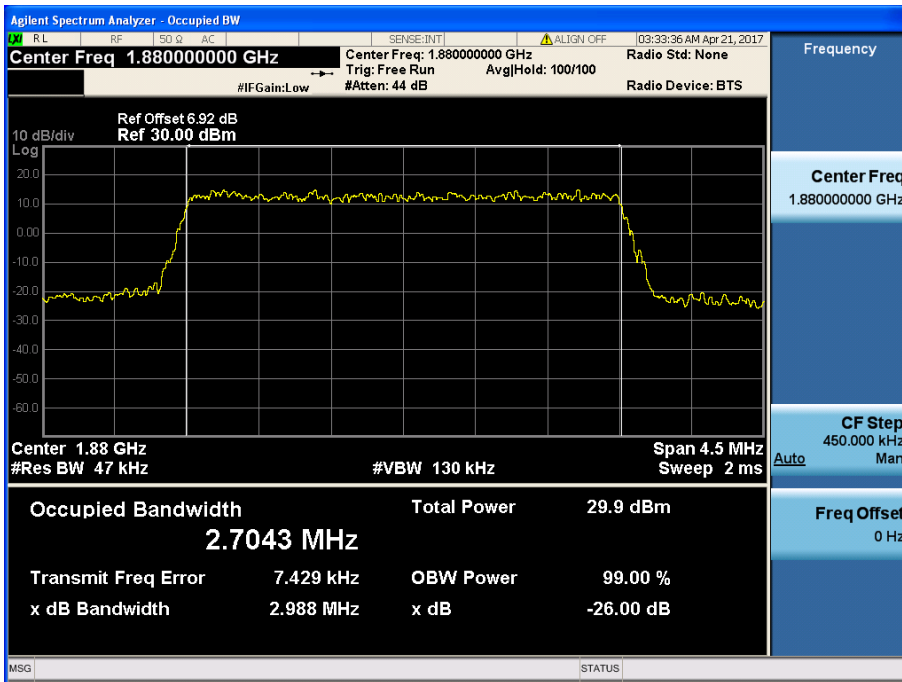

LTE Band 2 / 3 MHz / QPSK - RB Size 15

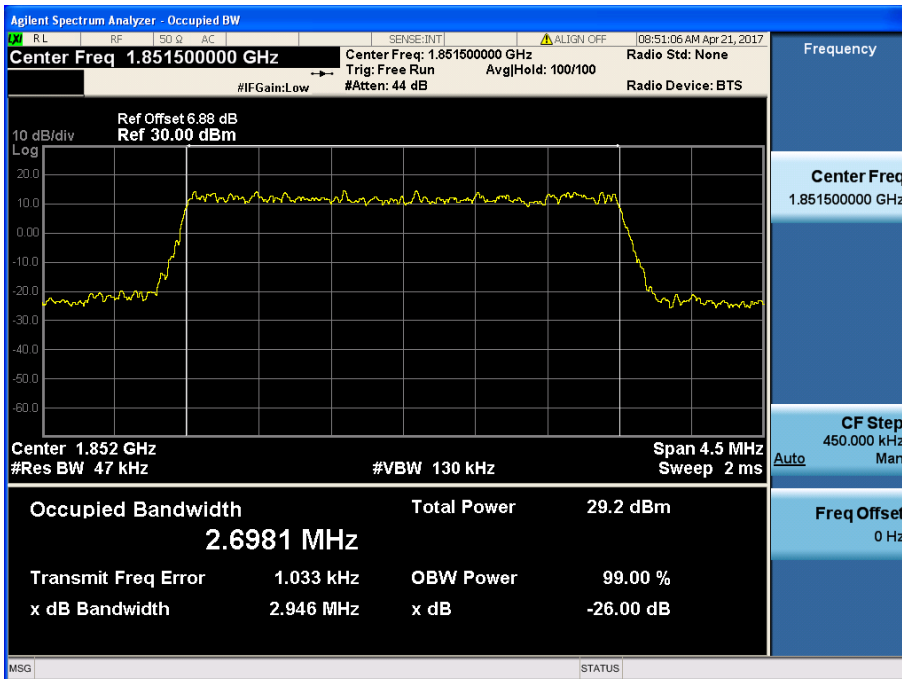

LTE Band 2 / 3 MHz / 16QAM - RB Size 15

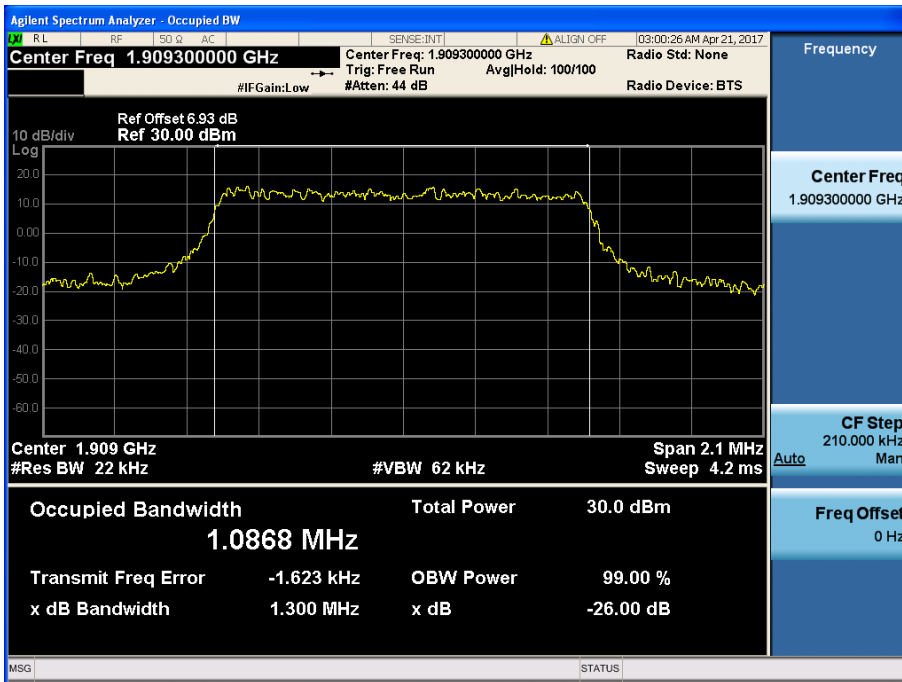

LTE Band 2 / 1.4 MHz / QPSK - RB Size 6

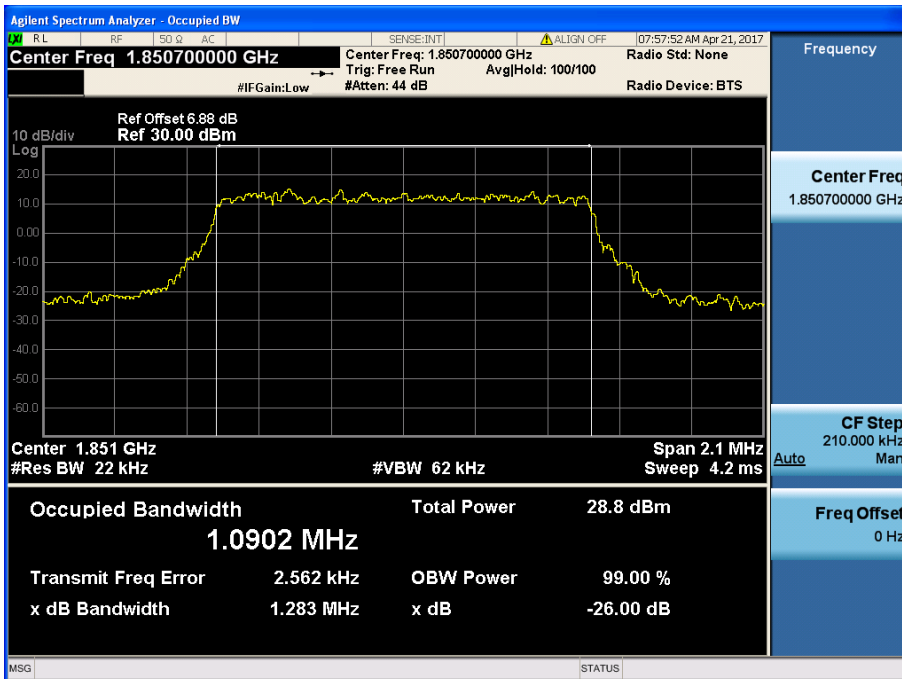

LTE Band 2 / 1.4 MHz / 16QAM - RB Size 6

8.1.5 LTE Band 7

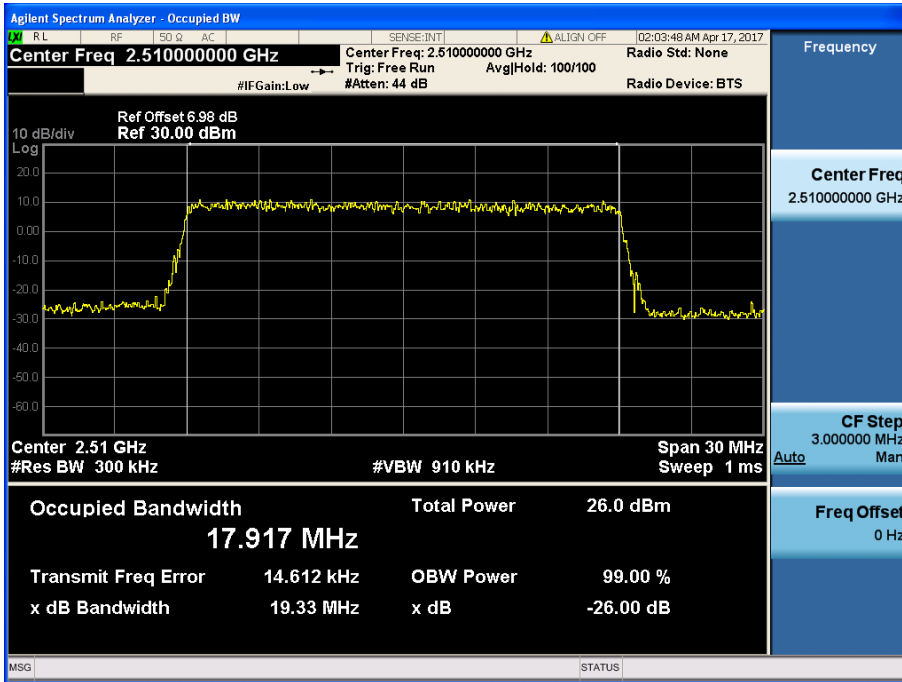

LTE Band 7 / 20 MHz / QPSK - RB Size 100

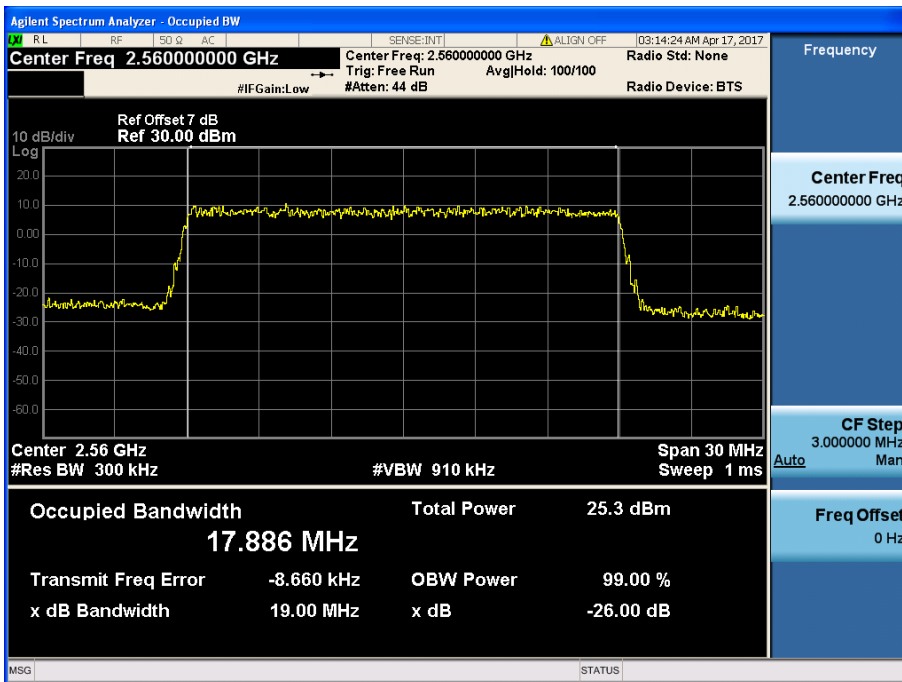

LTE Band 7 / 20 MHz / 16QAM - RB Size 100

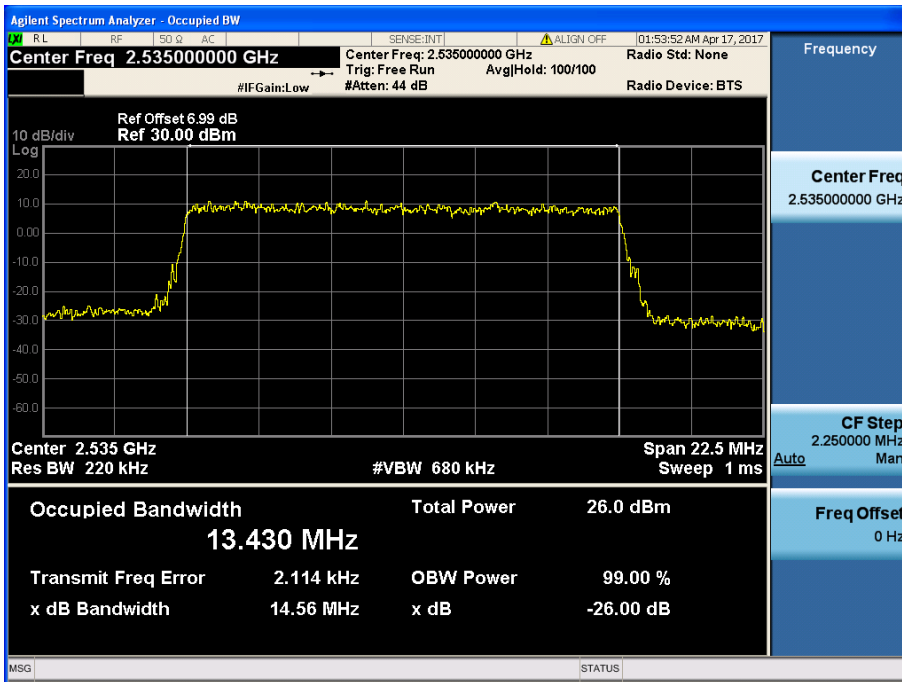

LTE Band 7 / 15 MHz / QPSK - RB Size 75

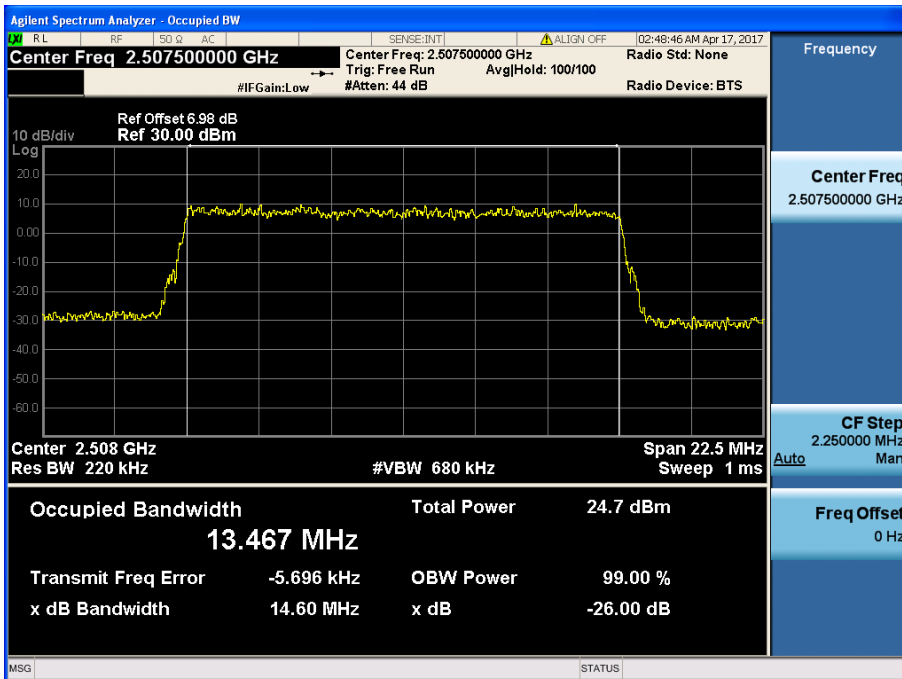

LTE Band 7 / 15 MHz / 16QAM - RB Size 75

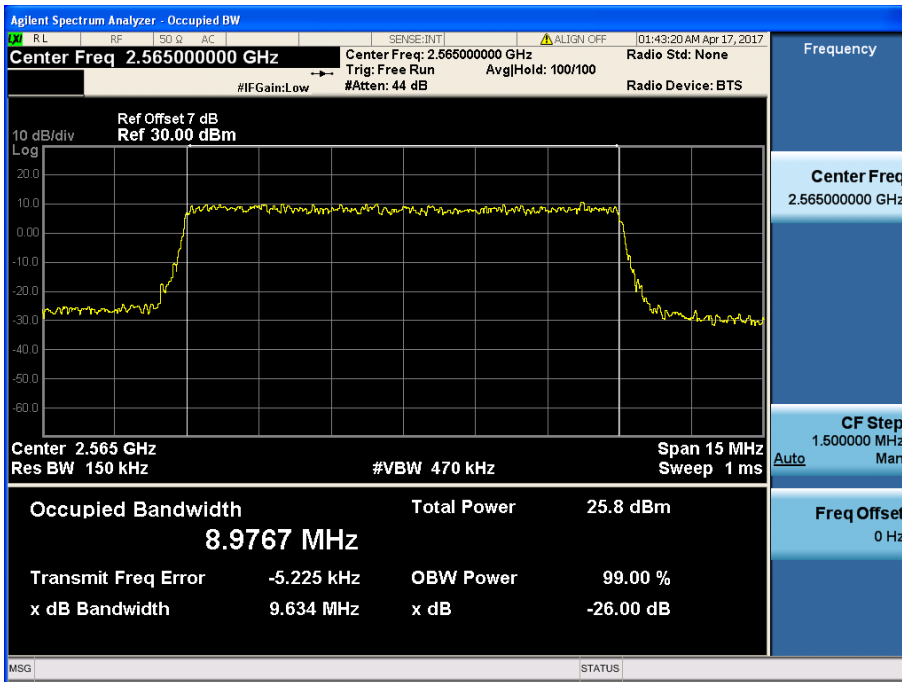

LTE Band 7 / 10 MHz / QPSK - RB Size 50

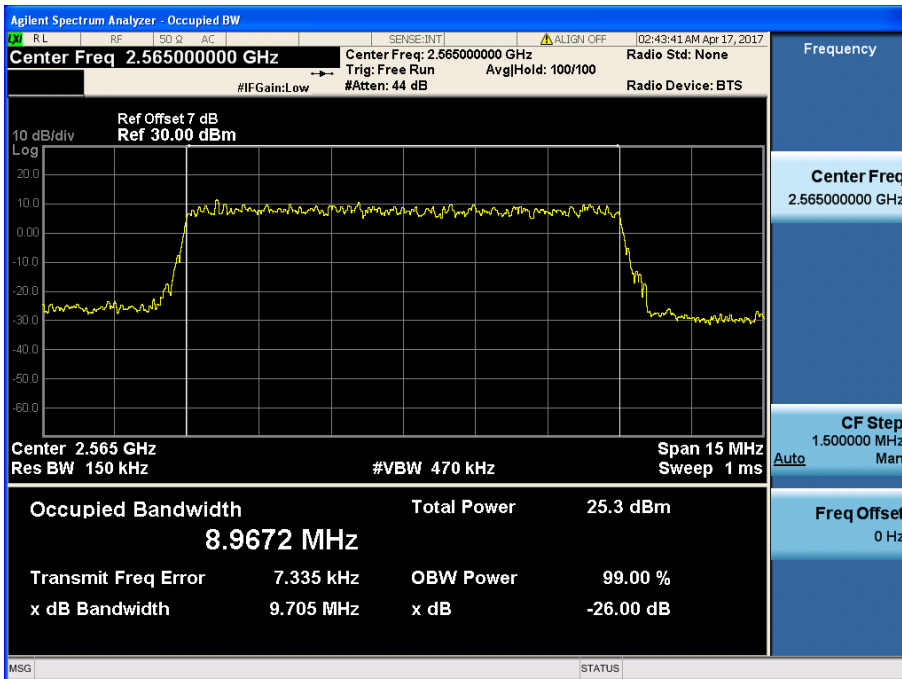

LTE Band 7 / 10 MHz / 16QAM - RB Size 50

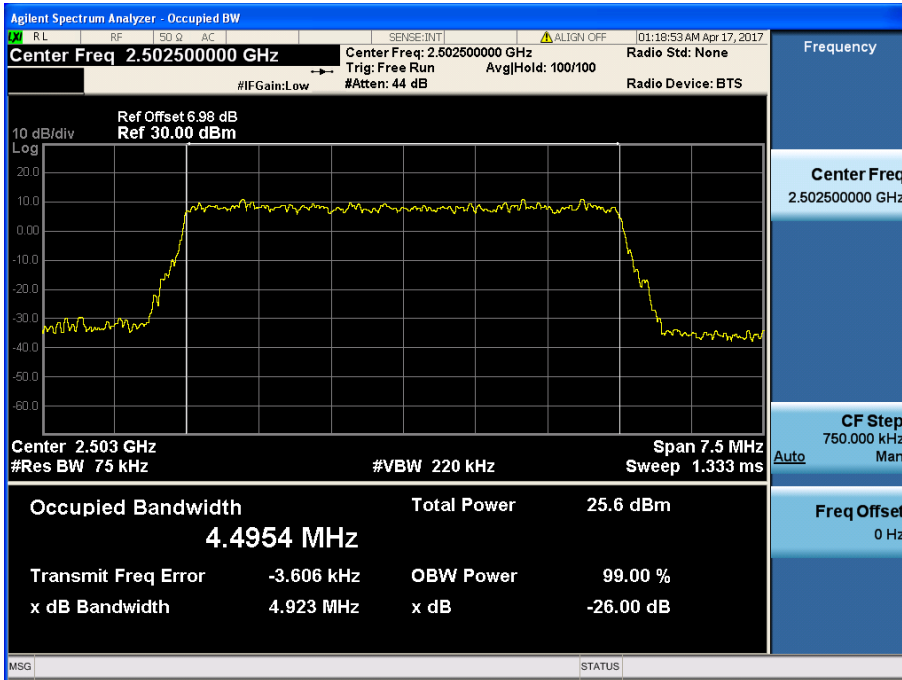

LTE Band 7 / 5 MHz / QPSK - RB Size 25

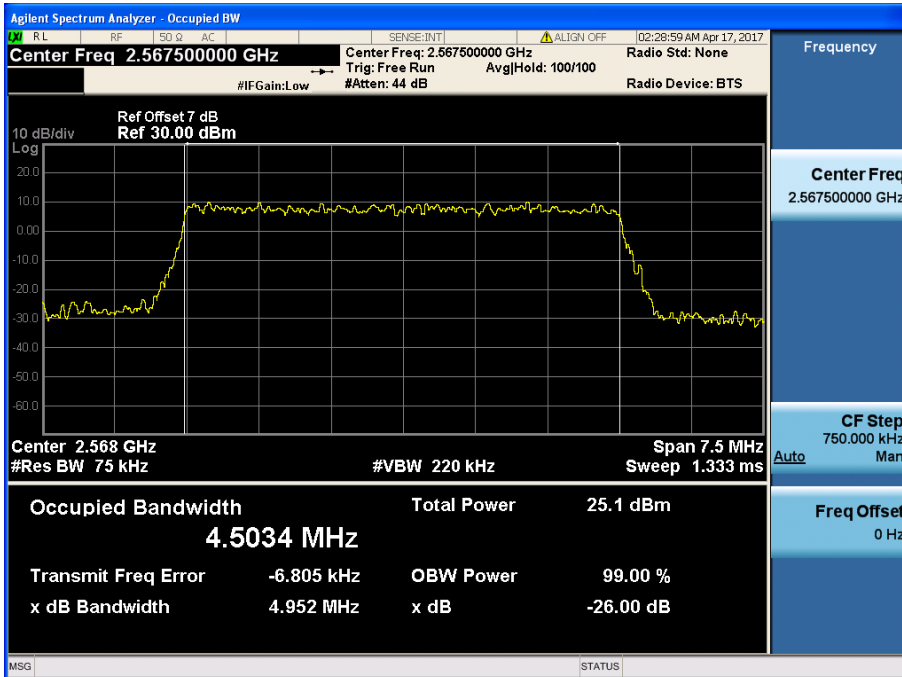

LTE Band 7 / 5 MHz / 16QAM - RB Size 25

8.2 PEAK TO AVERAGE RATIO

8.2.1 LTE Band 17

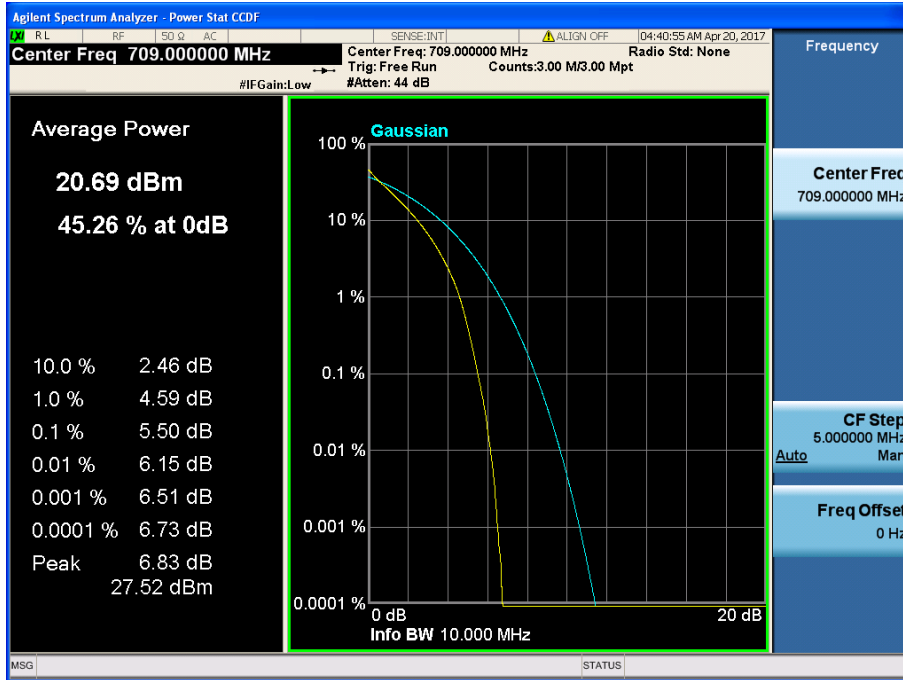

LTE Band 17 / 10 MHz / QPSK - RB Size 50

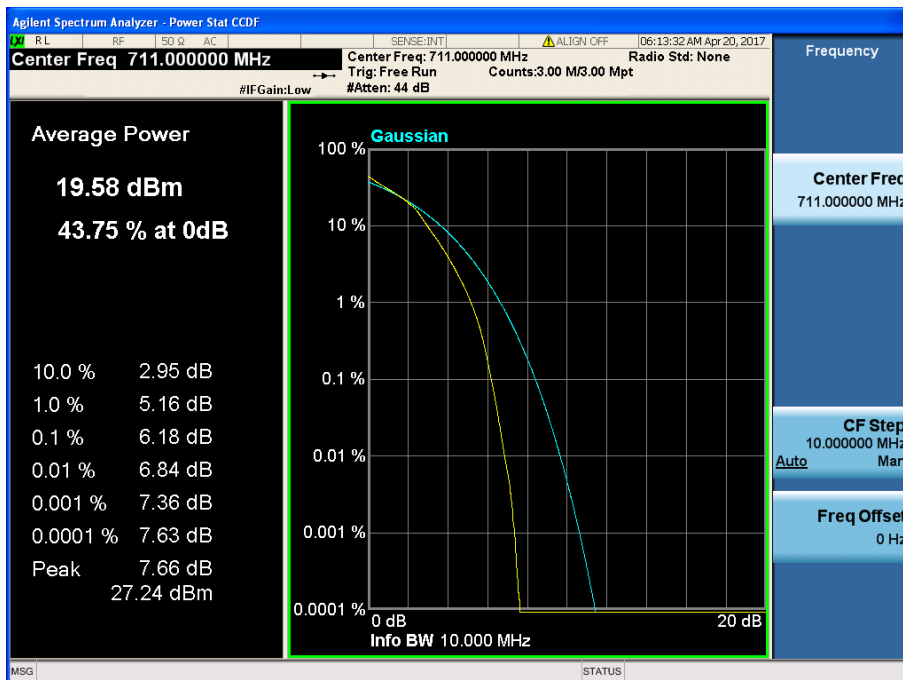

LTE Band 17 / 10 MHz / 16QAM - RB Size 50

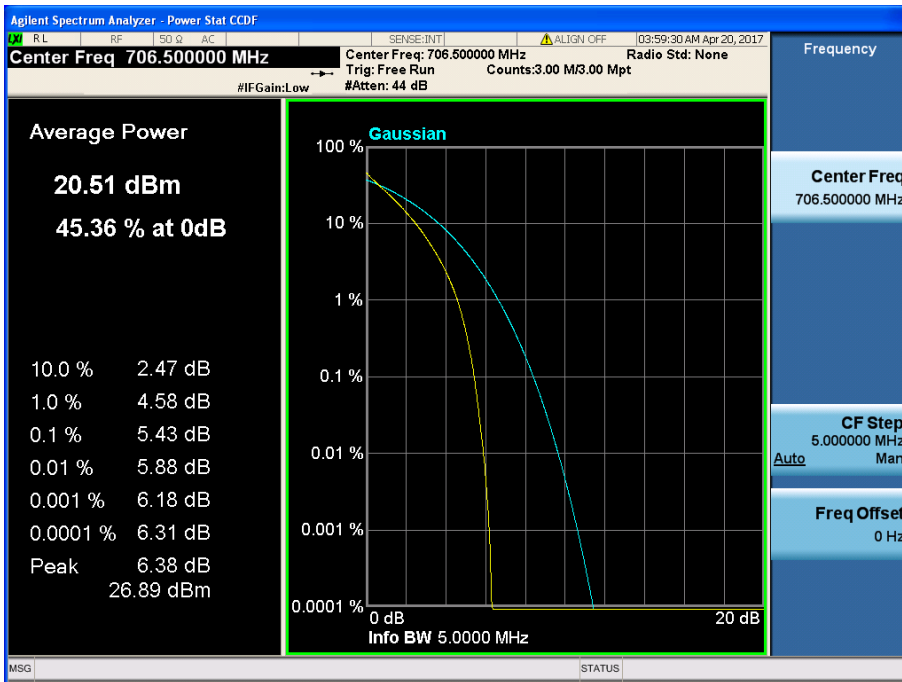

LTE Band 17 / 5 MHz / QPSK - RB Size 25

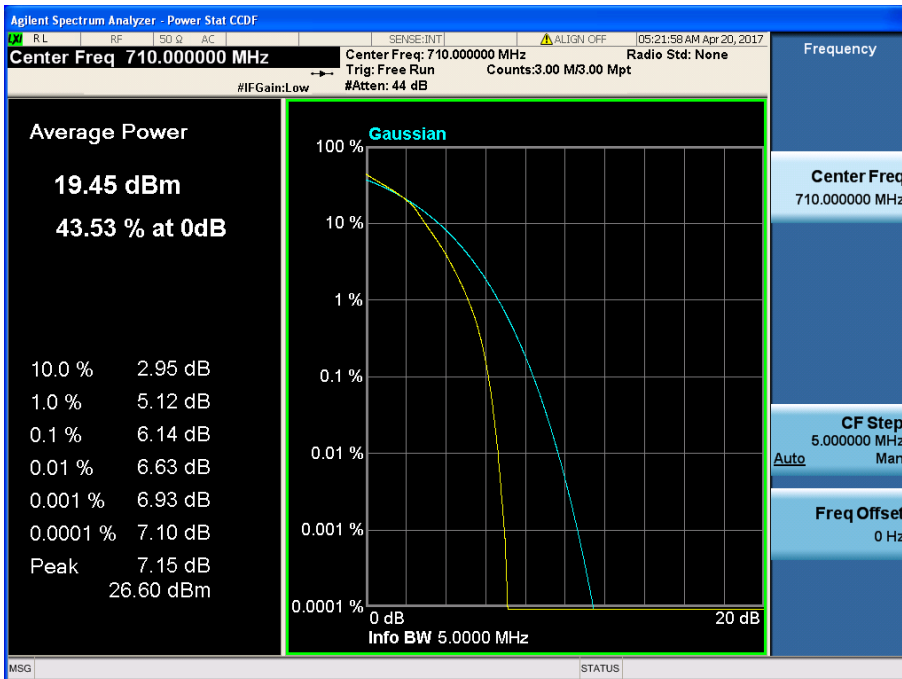

LTE Band 17 / 5 MHz / 16QAM - RB Size 25

8.2.2 LTE Band 5

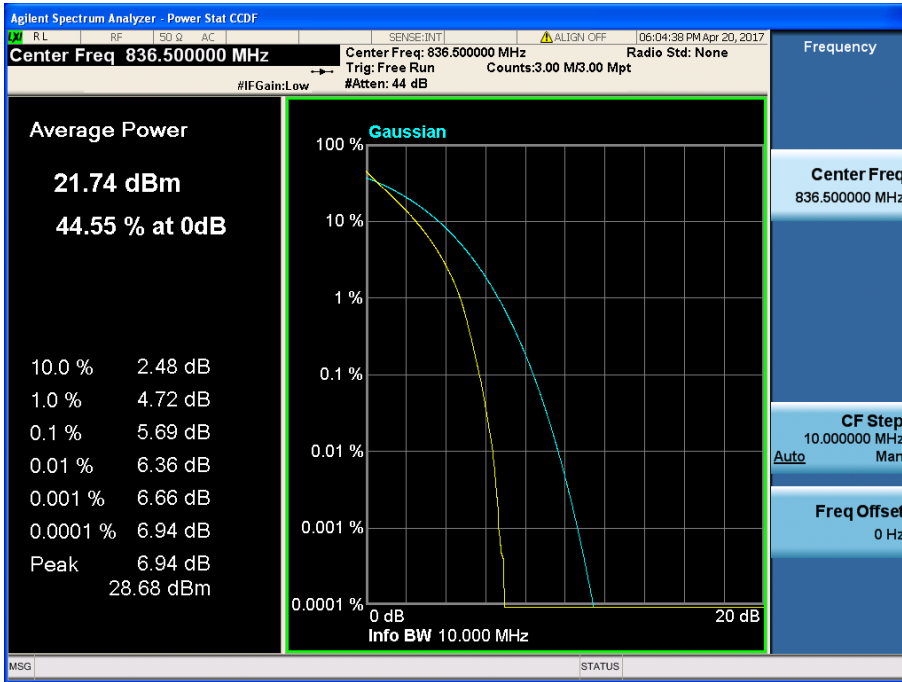

LTE Band 5 / 10 MHz / QPSK - RB Size 50

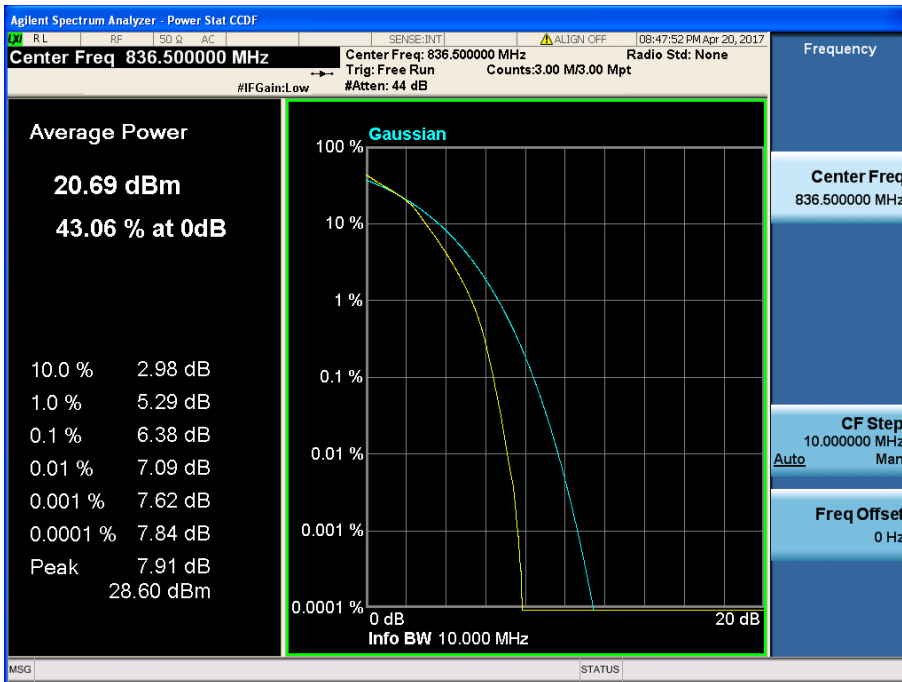

LTE Band 5 / 10 MHz / 16QAM - RB Size 50

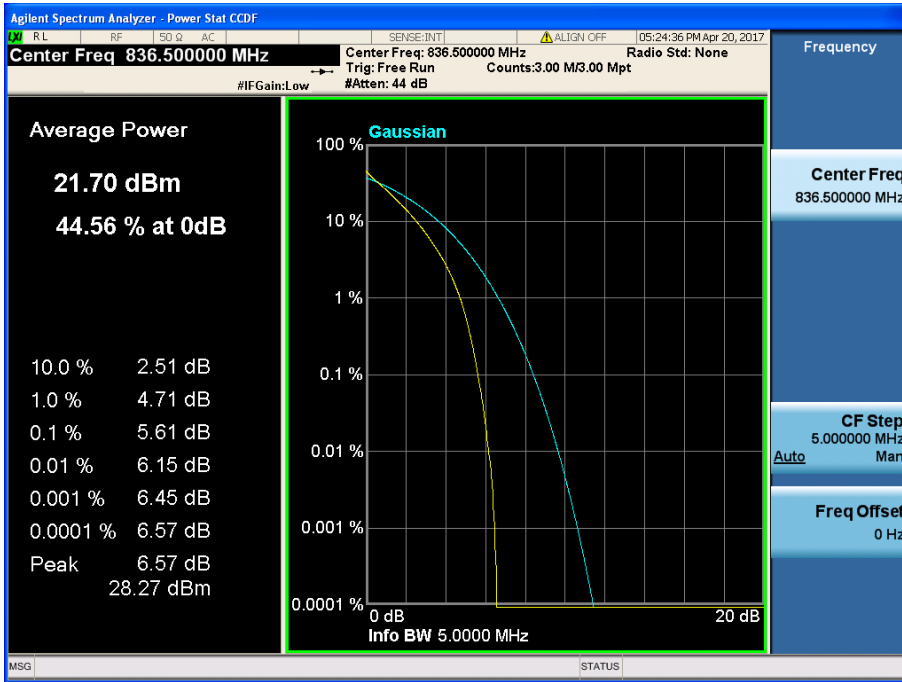

LTE Band 5 / 5 MHz / QPSK - RB Size 25

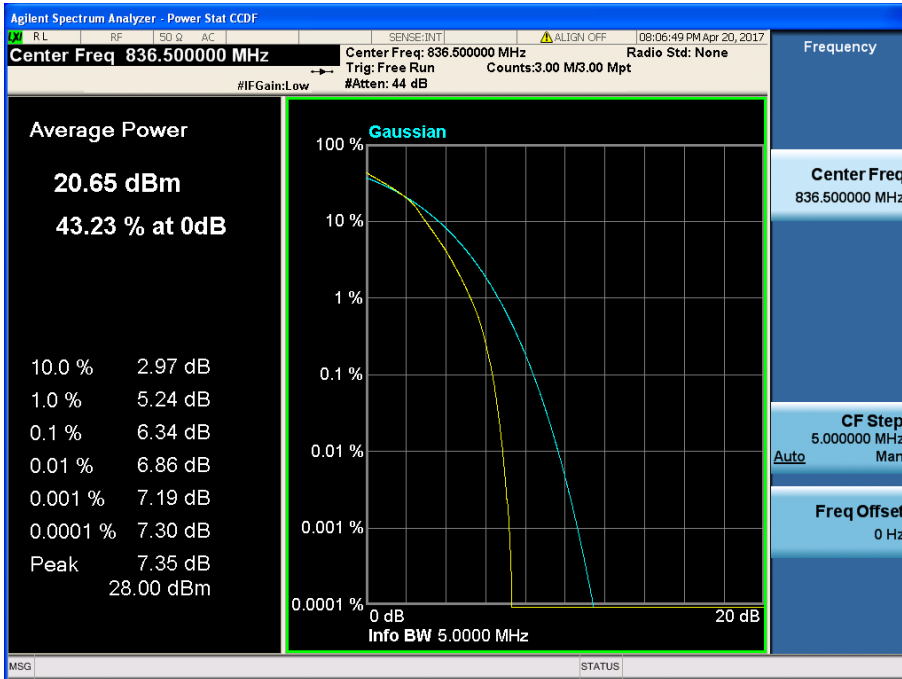

LTE Band 5 / 5 MHz / 16QAM - RB Size 25