

TEST REPORT

DT&C Co., Ltd. 42, Yurim-ro, 154Beon-gil, Cheoin-gu, Yongin-si, Gyeonggi-do, Korea Tel : 031-321-2664, Fax : 031-321-1664	Report No : DRTFCC1512-0270 Pages:(1) / (104) page	 Dt&C
---	---	---

1. Customer

- Name : POINTMOBILE CO., LTD.
- Address : Gasan-dong B-9F, Kabul Great Valley 32 Digital-ro 9-gil, Geumcheon-gu, Seoul, Korea 153-709

2. Use of Report : FCC & IC Original Grant

3. Product Name (FCCID / IC) : Mobile Computer (V2X-PM80G / 10664A-PM80G)



4. Date of Test : 2015-10-12 ~ 2015-11-13

5. Test Method Used: FCC Part 22, 24, 27
RSS-132, 133, 139

6. Testing Environment : See appended test report

7. Test Result : Pass Fail

The results shown in this test report refer only to the sample(s) tested unless otherwise stated. This Test Report cannot be reproduced, except in full.

Affirmation	Tested by Name : Jaejin Lee  (Signature)	Technical Manager Name : Bongjin Kim  (Signature)
-------------	---	--

2015 . 12 . 29 .

DT&C Co., Ltd.

Test Report Version

Test Report No.	Date	Description
DRTFCC1512-0270	Dec. 29, 2015	Initial issue

Table of Contents

1. GENERAL INFORMATION	5
2. INTRODUCTION	6
2.1. EUT DESCRIPTION	6
2.2. Support equipment.....	6
2.3. MEASURING INSTRUMENT CALIBRATION.....	6
2.4. TEST FACILITY	6
3. DESCRIPTION OF TESTS.....	7
3.1 ERP & EIRP	7
3.2 PEAK TO AVERAGE RATIO	9
3.3 OCCUPIED BANDWIDTH.....	11
3.4 BAND EDGE EMISSIONS AT ANTENNA TERMINAL.....	12
3.5 SPURIOUS AND HARMONIC EMISSIONS AT ANTENNA TERMINAL.....	13
3.6 RADIATED SPURIOUS EMISSIONS	14
3.7 FREQUENCY STABILITY / VARIATION OF AMBIENT TEMPERATURE	15
4. LIST OF TEST EQUIPMENT.....	16
5. SUMMARY OF TEST RESULTS	17
6. SAMPLE CALCULATION	18
7. TEST DATA	20
7.1 PEAK TO AVERAGE RATIO	20
7.2 OCCUPIED BANDWIDTH.....	20
7.3 SPURIOUS AND HARMONIC EMISSIONS AT ANTENNA TERMINAL	21
7.4 BAND EDGE	21
7.5 EFFECTIVE RADIATED POWER.....	22
7.6 EQUIVALENT ISOTROPIC RADIATED POWER	23
7.7 RADIATED SPURIOUS EMISSIONS	25
7.7.1 RADIATED SPURIOUS EMISSIONS (GSM850)	25
7.7.2 RADIATED SPURIOUS EMISSIONS (WCDMA850).....	26
7.7.3 RADIATED SPURIOUS EMISSIONS (HSUPA850)	27
7.7.4 RADIATED SPURIOUS EMISSIONS (WCDMA1700).....	28
7.7.5 RADIATED SPURIOUS EMISSIONS (HSUPA1700)	29
7.7.6 RADIATED SPURIOUS EMISSIONS (GSM1900)	30
7.7.7 RADIATED SPURIOUS EMISSIONS (WCDMA1900).....	31
7.7.8 RADIATED SPURIOUS EMISSIONS (HSUPA1900)	32
7.8 FREQUENCY STABILITY / VARIATION OF AMBIENT TEMPERATURE	33
7.8.1 FREQUENCY STABILITY (GSM850)	33
7.8.2 FREQUENCY STABILITY (WCDMA850).....	34
7.8.3 FREQUENCY STABILITY (HSUPA850)	35
7.8.4 FREQUENCY STABILITY (WCDMA1700).....	36
7.8.5 FREQUENCY STABILITY (HSUPA1700)	37
7.8.6 FREQUENCY STABILITY (GSM1900)	38
7.8.7 FREQUENCY STABILITY (WCDMA1900).....	39
7.8.8 FREQUENCY STABILITY (HSUPA1900)	40
8. TEST PLOTS	41
8.1 Peak to Average Ratio.....	41



8.2 Occupied Bandwidth (99 % Bandwidth)	48
8.3 Spurious Emissions at Antenna Terminal	68
8.4 Band Edge	89

1. GENERAL INFORMATION

Applicant Name: POINTMOBILE CO., LTD.

Address: Gasan-dong B-9F, Kabul Great Valley 32 Digital-ro 9-gil, Geumcheon-gu, Seoul, Korea 153-709

FCC ID : V2X-PM80G

IC : 10664A-PM80G

FCC Classification : Licensed Portable Transmitter Held to Ear (PCE)

EUT : Mobile Computer

Model Name : PM80

Add Model Name : CHD8, XT2, APT1

Supplying power : Standard Battery
 - Type: Li-ion Battery
 - M/N: 80-BTSC
 - Rating: DC 3.8V & 3000mAh / 11.4Wh

Antenna Information : Internal Antenna
 - Type: Built-In type

Mode	Tx Frequency (MHz)	Emission Designator	ERP(Max.power)		EIRP(Max.power)	
			dBm	W	dBm	W
GSM850	824.2 ~ 848.8 MHz	248KGXW	30.11	1.026	32.26	1.683
EDGE850	824.2 ~ 848.8 MHz	247KG7W	22.21	0.166	24.36	0.273
WCDMA850	826.4 ~ 846.6 MHz	4M16F9W	19.92	0.098	22.07	0.161
HSUPA850	826.4 ~ 846.6 MHz	4M17F9W	18.79	0.076	20.94	0.124
WCDMA1700	1712.4 ~ 1752.6 MHz	4M17F9W	-	-	24.87	0.307
HSUPA1700	1712.4 ~ 1752.6 MHz	4M18F9W	-	-	23.32	0.215
GSM1900	1850.2 ~ 1909.8 MHz	246KGXW	-	-	28.07	0.641
EDGE1900	1850.2 ~ 1909.8 MHz	248KG7W	-	-	23.95	0.248
WCDMA1900	1852.4 ~ 1907.6 MHz	4M18F9W	-	-	23.29	0.213
HSUPA1900	1852.4 ~ 1907.6 MHz	4M19F9W	-	-	21.50	0.141

Note: FCC is 850 band based on ERP.

2. INTRODUCTION

2.1. EUT DESCRIPTION

The Equipment Under Test(EUT) supports GSM/WCDMA/LTE Phone with Bluetooth 4.0 LE, WIFI 802.11b/g/n(2.4GHz), 802.11a/n(5GHz), NFC.

2.2. Support equipment

Equipment	Model No.	Serial No.	Manufacturer	Note
-	-	-	-	-
-	-	-	-	-

Note: The above equipment were supported by manufacturer.

2.3. MEASURING INSTRUMENT CALIBRATION

The measuring equipment, which was utilized in performing the tests documented herein, has been calibrated in accordance with the manufacturer's recommendations for utilizing calibration equipment, which is traceable to recognized national standards.

2.4. TEST FACILITY

The 3m test site and conducted measurement facility used to collect the radiated data are located at the 42, Yurim-ro, 154beon-gil, Cheoin-gu, Yongin-si, Gyeonggi-do, Korea 449-935. The site is constructed in conformance with the requirements.

- 3m test site registration Number: 165783(FCC) & 5740A-3 (IC)

3. DESCRIPTION OF TESTS

3.1 ERP & EIRP

(Effective Radiated Power & Equivalent Isotropic Radiated Power)

Test Set-up

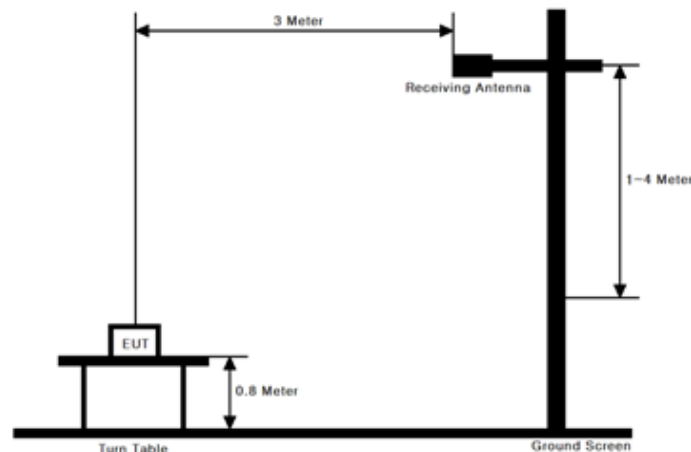

Test Procedure

- ANSI/TIA-603-C-2004 - Section 2.2.17
- KDB971168 v02r02 - Section 5.2.1

These measurements were performed at 3 & 10 m test site. The equipment under test is placed on a non-conductive table 0.8-meters above a turntable which is flush with the ground plane and 3 meters from the receive antenna.

Test setting

1. Set span to at least 1.5 times the OBW.
2. Set RBW = 1-5 % of the OBW, not to exceed 1 MHz.
3. Set VBW $\geq 3 \times$ RBW.
4. Set number of points in sweep $\geq 2 \times$ span / RBW.
5. Sweep time = auto couple.
6. Detector = RMS (power averaging).
7. If the EUT can be configured to transmit continuously (i.e., burst duty cycle ≥ 98 %), then set the trigger to free run.
8. If the EUT cannot be configured to transmit continuously (i.e., burst duty cycle < 98 %), then use a sweep trigger with the level set to enable triggering only on full power bursts and configure the EUT to transmit at full power for the entire duration of each sweep.
Ensure that the sweep time is less than or equal to the transmission burst duration.
9. Trace average at least 100 traces in power averaging (i.e., RMS) mode.
10. Compute the power by integrating the spectrum across the OBW of the signal using the instrument's band power measurement function, with the band limits set equal to the OBW band edges. If the instrument does not have a band power function, then sum the spectrum levels (in linear power units) at intervals equal to the RBW extending across the entire OBW of the spectrum.

The receive antenna height and turntable rotations were adjusted for the highest reading on the receive spectrum analyzer.

A half-wave dipole was substituted in place of the EUT. This dipole antenna was driven by a signal generator and the level of the signal generator was adjusted to obtain the same receive spectrum analyzer reading. The conducted power at the terminal of the substitute antenna is measured.

The ERP/EIRP is calculated using the following formula:

ERP/EIRP = The conducted power at the substitute antenna's terminal [dBm] + Substitute Antenna gain [dBd for ERP , dBi for EIRP]

For readings above 1 GHz, the above procedure is repeated using horn antennas and the difference between the gain of the horn antenna and an isotropic antenna are taken into consideration.

3.2 PEAK TO AVERAGE RATIO

Test set-up

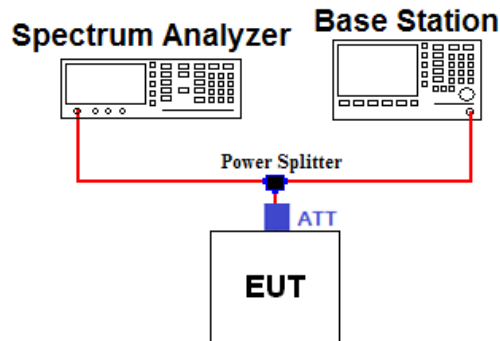

Test Procedure

A peak to average ratio measurement is performed using the following procedure.

■ CCDF Procedure

- KDB971168 v02r02-Section 5.7.1

1. Set resolution/measurement bandwidth \geq signal's occupied bandwidth
2. Set the number of counts to a value that stabilizes the measured CCDF curve
3. Set the measurement interval as follows:
 - 1) For continuous transmissions, set to 1 ms
 - 2) For burst transmissions, employ an external trigger that is synchronized with the EUT burst timing sequence, or use the internal burst trigger with a trigger level that allows the burst to stabilize and set the measurement interval to a time that is less than or equal to the burst duration.
4. Record the maximum PAPR level associated with a probability of 0.1%

■ Alternate Procedure

- KDB971168 v02r02-Section 5.7.2

Use one of the measurement procedures of the peak power and record as P_{Pk} .

Use one of the measurement procedures of the average power and record as P_{Avg} .

Both the peak and average power levels must be expressed in the same logarithmic units (e.g., dBm). Determine the PAPR from:

$$\text{PAPR (dB)} = P_{Pk} \text{ (dBm)} - P_{Avg} \text{ (dBm)}.$$

- Peak Power Measurement

1. Set the RBW \geq OBW
2. Set VBW $\geq 3 \times$ RBW
3. Set span $\geq 2 \times$ RBW
4. Sweep time = auto couple
5. Detector = peak
6. Ensure that the number of measurement points \geq span/RBW.
7. Trace mode = max hold
8. Allow trace to fully stabilize.
9. Use the peak marker function to determine the peak amplitude level.

- Average Power Measurement

1. Set span to at least 1.5 times the OBW.
2. Set RBW = 1-5% of the OBW, not to exceed 1 MHz.
3. Set VBW $\geq 3 \times$ RBW.
4. Set number of points in sweep $\geq 2 \times$ span / RBW.
5. Sweep time = auto-couple.
6. Detector = RMS (power averaging).
7. If the EUT can be configured to transmit continuously (i.e., burst duty cycle $\geq 98\%$), then set the trigger to free run.
8. If the EUT cannot be configured to transmit continuously (i.e., burst duty cycle $< 98\%$), then use a sweep trigger with the level set to enable triggering only on full power bursts and configure the EUT to transmit at full power for the entire duration of each sweep.
Ensure that the sweep time is less than or equal to the transmission burst duration.
9. Trace average at least 100 traces in power averaging (i.e., RMS) mode.
10. Compute the power by integrating the spectrum across the OBW of the signal using the instrument's band power measurement function, with the band limits set equal to the OBW band edges. If the instrument does not have a band power function, then sum the spectrum levels (in linear power units) at intervals equal to the RBW extending across the entire OBW of the spectrum.

3.3 OCCUPIED BANDWIDTH.

Test set-up

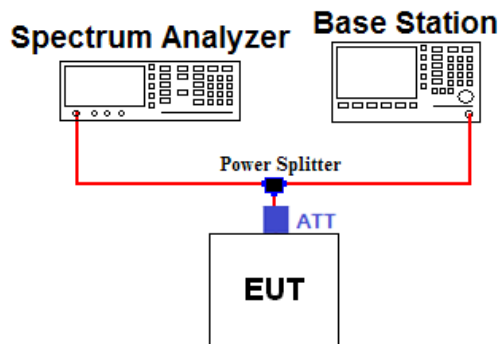

Offset value information

Frequency (MHz)	Offset Value (dB)	Frequency (MHz)	Offset Value (dB)
824.2	19.32	1752.6	19.61
826.4	19.33	1850.2	19.69
836.6	19.35	1852.4	19.71
846.6	19.37	1880.0	19.72
848.8	19.38	1907.6	19.72
1712.4	19.57	1909.8	19.76
1732.4	19.58	-	-

Note. 1: The offset values from EUT to Spectrum analyzer were measured and used for test.
 Offset value = Cable A + Splitter + ATT + Cable B

Test Procedure

- KDB971168 v02r02-Section 4.2

The occupied bandwidth, that is the frequency bandwidth such that, below its lower and above its upper frequency limits, the mean powers radiated are each equal to 0.5 percent of the total mean power of a given emission.

Test setting

1. The signal analyzer's automatic bandwidth measurement capability was used to perform the 99 % occupied bandwidth and the 26 dB bandwidth. The bandwidth measurement was not influenced by any intermediate power nulls in the fundamental emission.
2. RBW = 1 ~ 5 % of the expected OBW & VBW ≥ 3 X RBW
3. Detector = Peak
4. Trance mode = Max hold
5. Sweep = Auto couple
6. The trace was allowed to stabilize
7. If necessary, step 2 ~ 6 were repeated after changing the RBW such that it would be within 1 ~ 5 % of the 99 % occupied bandwidth observed in step 6.

3.4 BAND EDGE EMISSIONS AT ANTENNA TERMINAL.

Test set-up

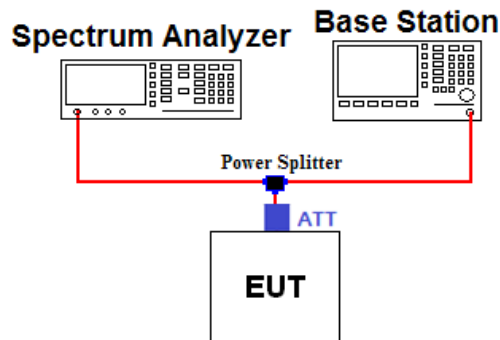

Offset value information

Frequency (MHz)	Offset Value (dB)	Frequency (MHz)	Offset Value (dB)
823.0	19.30	1755.0	19.63
824.0	19.34	1756.0	19.63
849.0	19.40	1849.0	19.68
850.0	19.40	1850.0	19.71
1709.0	19.55	1910.0	19.80
1710.0	19.55	1911.0	19.80

Note. 1: The offset value from EUT to Spectrum analyzer was measured and used for test.
Offset value = Cable A + Splitter + ATT + Cable B

Test Procedure

- KDB971168 v02r02 - Section 6.0

All out of band emissions are measured by means of a calibrated spectrum analyzer. The EUT was setup to maximum output power at its lowest and highest channel with all modulations.

The power of any spurious emission shall be attenuated below the transmitter power (P) by at least $43 + 10 \log(P)$ dB

Test setting

1. Start and stop frequency were set such that the band edge would be placed in the center of the plot
2. Span was set large enough so as to capture all out of band emissions near the band edge
3. RBW $\geq 1\%$ of the emission
4. VBW $\geq 3 \times$ RBW
5. Detector = RMS & Trace mode = Max hold
6. Sweep time = Auto couple or 1 s for band edge
7. Number of sweep point $\geq 2 \times$ span / RBW
8. The trace was allowed to stabilize

Note 1: In the 1 MHz bands immediately outside and adjacent to the frequency block a resolution bandwidth of **at least one percent** of the emission bandwidth of the fundamental emission of the transmitter may be employed to demonstrate compliance with the out-of-band emissions limit. The emission bandwidth is defined as the width of the signal between two points, one below the carrier center frequency and one above the carrier center frequency, outside of which all emission are attenuated at least 26 dB below the transmitter power.

3.5 SPURIOUS AND HARMONIC EMISSIONS AT ANTENNA TERMINAL.

Test set-up

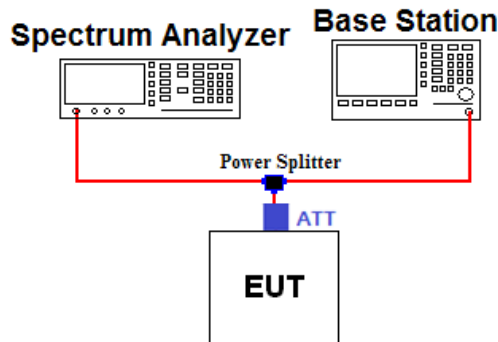

Offset value information

Frequency (MHz)	Offset Value (dB)	Frequency (MHz)	Offset Value (dB)
5000.0	20.14	15000.0	22.10
10000.0	21.68	20000.0	23.01
-	-	-	-

Note. 1: The offset value from EUT to Spectrum analyzer was measured and used for test.
 Offset value = Cable A + Splitter + ATT + Cable B

Test Procedure

- KDB971168 v02r02 - Section 6.0

The level of the carrier and the various conducted spurious and harmonic frequencies is measured by means of a calibrated spectrum analyzer. The EUT was setup to maximum output power at its low, middle, high channel with all bandwidths. The spectrum is scanned from 30 MHz up to a frequency including its 10th harmonic.

The power of any spurious emission shall be attenuated below the transmitter power (P) by at least $43 + 10 \log(P)$ dB

Test setting

1. RBW = 100 KHz or 1 MHz & VBW $\geq 3 \times$ RBW (Refer to Note 1)
2. Detector = RMS & Trace mode = Max hold
3. Sweep time = Auto couple
4. Number of sweep point $\geq 2 \times$ span / RBW
5. The trace was allowed to stabilize

Note 1: Compliance with these provisions is based on the use of measurement instrumentation employing a resolution bandwidth of 100 kHz or greater for Part 22 and 1 MHz or greater for Part 24.

3.6 RADIATED SPURIOUS EMISSIONS

Test Set-up

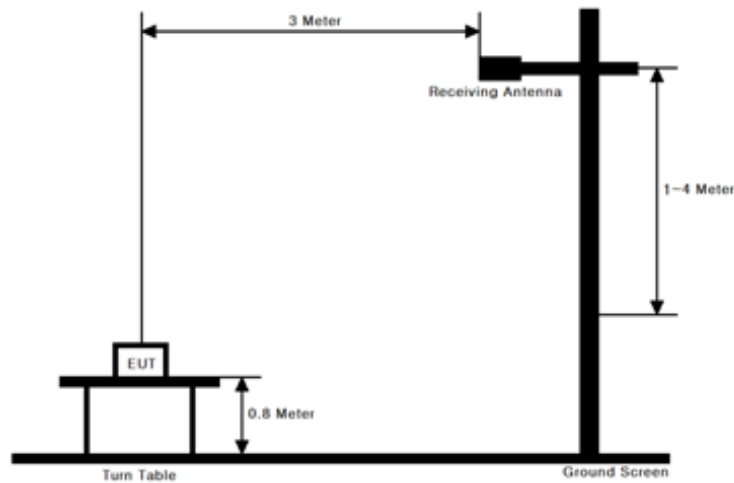

Test Procedure

- ANSI/TIA-603-C-2004 - Section 2.2.12
- KDB971168 v02r02 - Section 5.8

These measurements were performed at 3 & 10m test site. The equipment under test is placed on a non-conductive table 0.8-meters above a turntable which is flush with the ground plane and 3 meters from the receive antenna.

Test setting

1. RBW = 100 kHz for below 1 GHz and 1 MHz for above 1 GHz / VBW \geq 3 X RBW
2. Detector = Peak & Trace mode = Max hold
3. Sweep time = Auto couple
4. Number of sweep point \geq 2 X span / RBW
5. The trace was allowed to stabilize

The receive antenna height and turntable rotations were adjusted for the highest reading on the receive spectrum analyzer.

For radiated power measurements below 1 GHz, a half-wave dipole was substituted in place of the EUT. This dipole antenna was driven by a signal generator and the level of the signal generator was adjusted to obtain the same spectrum analyzer reading.

For radiated power measurements above 1 GHz, a Horn antenna was substituted in place of the EUT. This Horn antenna was driven by a signal generator and the level of the signal generator was adjusted to obtain the same spectrum analyzer reading. The difference between the gain of the horn and an isotropic antenna are taken into consideration.

This measurement was performed with the EUT oriented in 3 orthogonal axis.

3.7 FREQUENCY STABILITY / VARIATION OF AMBIENT TEMPERATURE

Test Set-up

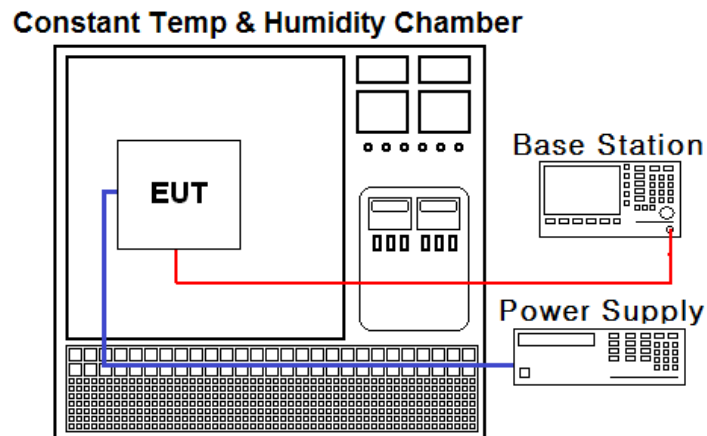

Test Procedure

- ANSI/TIA-603-C-2004
- KDB971168 v02r02 - Section 9.0

The frequency stability of the transmitter is measured by:

a.) Temperature:

The temperature is varied from - 30 °C to + 50 °C using an environmental chamber.

b.) Primary Supply Voltage:

The primary supply voltage is varied from 85 % to 115 % of the nominal value for non hand-carried battery and AC powered equipment. For hand-carried, battery-powered equipment, primary supply voltage is reduced to the battery operating end point which shall be specified by the manufacturer.

Specification:

The frequency stability shall be sufficient to ensure that the fundamental emission stays within the authorized frequency block for Part 24, 27. The frequency stability of the transmitter shall be maintained within $\pm 0.00025\%$ (± 2.5 ppm) of the center frequency for Part 22.

Time Period and Procedure:

1. The carrier frequency of the transmitter is measured at room temperature.
(25 °C to provide a reference)
2. The equipment is turned on in a “standby” condition for one minute before applying power to the transmitter. Measurement of the carrier frequency of the transmitter is made within one minute after applying power to the transmitter.
3. Frequency measurements are made at 10 °C intervals ranging from -30 °C to +50 °C.
A period of at least one half-hour is provided to allow stabilization of the equipment at each temperature level.

4. LIST OF TEST EQUIPMENT

Type	Manufacturer	Model	Cal.Date (yy/mm/dd)	Next.Cal. Date (yy/mm/dd)	S/N
MXA Signal Analyzer	Agilent Technologies	N9020A	15/08/19	16/08/18	MY50200867
Dynamic Measurement DC Source	Agilent Technologies	66332A	15/01/22	16/01/22	GB37470200
Temp & Humi Test Chamber	SJ Science	SJ-TH-S50	15/10/19	16/10/19	SJ-TH-S50-130930
Signal Generator	Rohde Schwarz	SMF100A	15/06/29	16/06/29	102341
8960 Series 10 Wireless Comms Test Set	Agilent Technologies	E5515C	15/09/10	16/09/10	GB41321164
Power Splitter	Anritsu	K241B	15/10/20	16/10/20	1701061
2W 3dB Attenuator	SMAJK	SMAJK-2-3	15/10/19	16/10/19	3
50W 10dB Attenuator	SMAJK	SMAJK-50-10	15/10/19	16/10/19	2-50-10
Thermohygrometer	BODYCOM	BJ5478	15/02/26	16/02/26	1209
Multimeter	FLUKE	17B	15/04/27	16/04/27	26030065WS
Vector Signal Generator	Rohde Schwarz	SMBV100A	15/01/06	16/01/06	25571
Loop Antenna	Schwarzbeck	FMZB1513	14/04/29	16/04/29	1513-128
TRILOG Broadband Test-Antenna	Schwarzbeck	VULB 9160	14/04/30	16/04/30	3358
Dipole Antenna	Schwarzbeck	VHA9103	15/05/29	17/05/29	2116
Dipole Antenna	Schwarzbeck	VHA9103	14/04/01	16/04/01	2117
Dipole Antenna	Schwarzbeck	UHA9105	15/05/29	17/05/29	2261
Dipole Antenna	Schwarzbeck	UHA9105	14/04/01	16/04/01	2262
HORN ANT	ETS	3115	15/02/09	17/02/09	00021097
HORN ANT	ETS	3117	14/05/12	16/05/12	140394
HORN ANT	A.H.Systems	SAS-574	15/04/30	17/04/30	154
HORN ANT	A.H.Systems	SAS-574	15/09/03	17/09/03	155
Low Noise Pre Amplifier	TSJ	MLA-010K01-B01-27	15/04/09	16/04/09	1844538
Amplifier	EMPOWER	BBS3Q7ELU	15/09/09	16/09/09	1020
Amplifier (30dB)	Agilent	8449B	15/11/06	16/11/06	3008A02108
High-pass filter	Wainwright	WHKX12-935-1000-15000-40SS	15/09/23	16/09/23	7
High-pass filter	Wainwright	WHKX12-2580-3000-18000-80SS	15/09/23	16/09/23	3

5. SUMMARY OF TEST RESULTS

FCC Part Section(s)	RSS Section(s)	Parameter	Status Note 1
2.1046	RSS-132 [5.4] RSS-133 [6.4] RSS-139 [6.5]	Conducted Output Power	C ^{Note 2}
22.913(a)(2) 24.232(c) 27.50(d)(4)	RSS-132 [5.4] RSS-133 [6.4] RSS-139 [6.5]	Effective Radiated Power (Part 22) Equivalent Isotropic Radiated Power (Part 24, 27), (RSS-132, 133, 139)	C
2.1049	RSS-Gen [6.6]	Occupied Bandwidth	C
22.917(a) 24.238(a) 27.53(h) 2.1051	RSS-132 [5.5] RSS-133 [6.5] RSS-139 [6.6]	Band Edge Spurious and Harmonic Emissions at Antenna Terminal	C
24.232(d) 27.50(d)(4)	RSS-132 [5.4] RSS-133 [6.4] RSS-139 [6.5]	Peak to Average Ratio	C
22.917(a) 24.238(a) 27.53(h) 2.1053	RSS-132 [5.5] RSS-133 [6.5] RSS-139 [6.6]	Radiated Spurious and Harmonic Emissions	C
22.355 24.235 27.54 2.1055	RSS-132 [5.3] RSS-133 [6.3] RSS-139 [6.4]	Frequency Stability	C
<p>Note 1: C=Comply NC=Not Comply NT=Not Tested NA=Not Applicable</p> <p>Note 2: Refer to RF Exposure Report (Test Report_SAR)</p>			

The sample was tested according to the following specification:
ANSI/TIA/EIA-603-C-2004 and KDB 971168 D01 v02r02

6. SAMPLE CALCULATION

A. Emission Designator

GSM850 Emission Designator

Emission Designator = **248KGXW**
 GSM OBW = 247.60 kHz
 (Measured at the 99.75 % power bandwidth)
 G = Phase Modulation
 X = Cases not otherwise covered
 W = Combination (Audio/Data)

WCDMA850 Emission Designator

Emission Designator = **4M16F9W**
 WCDMA OBW = 4.1597 MHz
 (Measured at the 99.75 % power bandwidth)
 F = Frequency Modulation
 9 = Composite Digital Information
 W = Combination (Audio/Data)

WCDMA1700 Emission Designator

Emission Designator = **4M17F9W**
 WCDMA OBW = 4.1688 MHz
 (Measured at the 99.75 % power bandwidth)
 F = Frequency Modulation
 9 = Composite Digital Information
 W = Combination (Audio/Data)

GSM1900 Emission Designator

Emission Designator = **246KGXW**
 GSM OBW = 246.29 kHz
 (Measured at the 99.75 % power bandwidth)
 G = Phase Modulation
 X = Cases not otherwise covered
 W = Combination (Audio/Data)

WCDMA1900 Emission Designator

Emission Designator = **4M18F9W**
 WCDMA OBW = 4.1752 MHz
 (Measured at the 99.75 % power bandwidth)
 F = Frequency Modulation
 9 = Composite Digital Information
 W = Combination (Audio/Data)

EDGE850 Emission Designator

Emission Designator = **247KG7W**
 GSM OBW = 247.31 kHz
 (Measured at the 99.75 % power bandwidth)
 G = Phase Modulation
 7 = Two or more channels containing
 quantized or digital information
 W = Combination (Audio/Data)

HSUPA850 Emission Designator

Emission Designator = **4M17F9W**
 HSUPA OBW = 4.1670 MHz
 (Measured at the 99.75 % power bandwidth)
 F = Frequency Modulation
 9 = Composite Digital Information
 W = Combination (Audio/Data)

HSUPA1700 Emission Designator

Emission Designator = **4M18F9W**
 WCDMA OBW = 4.1820 MHz
 (Measured at the 99.75 % power bandwidth)
 F = Frequency Modulation
 9 = Composite Digital Information
 W = Combination (Audio/Data)

EDGE1900 Emission Designator

Emission Designator = **248KG7W**
 GSM OBW = 248.17 kHz
 (Measured at the 99.75 % power bandwidth)
 G = Phase Modulation
 7 = Two or more channels containing
 quantized or digital information
 W = Combination (Audio/Data)

HSUPA1900 Emission Designator

Emission Designator = **4M19F9W**
 HSUPA OBW = 4.1900 MHz
 (Measured at the 99.75 % power bandwidth)
 F = Frequency Modulation
 9 = Composite Digital Information
 W = Combination (Audio/Data)

B. EIRP Sample Calculation

MODE	Ch./ Freq		Spectrum Reading	EUT Axis	Ant Pol (H/V)	Level(dBm)	TX Ant Gain(dBi)	Result	
	channel	Freq.(MHz)	Value(dBm)			@ Ant Terminal		(dBm)	(W)
GSM1900	661	1880.00	-15.61	Y	H	19.02	9.05	28.07	0.641

EIRP = @ Ant Terminal LEVEL(dBm) + Ant. Gain

- 1) The EUT mounted on a non-conductive turntable is 0.8 meter above test site ground level.
- 2) During the test, the turn table is rotated until the maximum signal is found.
- 3) Record the field strength meter's level.
- 4) Replace the EUT with dipole/Horn antenna that is connected to a calibrated signal generator.
- 5) Increase the signal generator output till the field strength meter's level is equal to the item (3).
- 6) The signal generator output level with Ant. Gain is the rating of effective isotropic radiated power (EIRP).

7. TEST DATA

7.1 PEAK TO AVERAGE RATIO

- Plots of the EUT's Peak- to- Average Ratio are shown in Clause 8.1

7.2 OCCUPIED BANDWIDTH

Band	Channel	Frequency	Test Result (kHz)
GSM850	128	824.2	246.26
	190	836.6	247.60
	251	848.8	247.39
EDGE850	128	824.2	247.31
	190	836.6	242.44
	251	848.8	244.43
WCDMA850	4132	826.4	4159.70
	4183	836.6	4150.70
	4233	846.6	4150.40
HSUPA850	4132	826.4	4167.00
	4183	836.6	4162.50
	4233	846.6	4157.20
WCDMA1700	1312	1712.40	4161.70
	1412	1732.40	4168.80
	1513	1752.60	4165.60
HSUPA1700	1312	1712.40	4170.10
	1412	1732.40	4182.00
	1513	1752.60	4169.50
GSM1900	512	1850.2	244.57
	661	1880.0	245.92
	810	1909.8	246.29
EDGE1900	512	1850.2	248.17
	661	1880.0	245.54
	810	1909.8	246.15
WCDMA1900	512	1850.2	4175.20
	661	1880.0	4170.60
	810	1909.8	4167.60
HSUPA1900	9262	1852.4	4166.30
	9400	1880.0	4190.00
	9538	1907.6	4189.30

- Plots of the EUT's Occupied Bandwidth are shown in Clause 8.2

7.3 SPURIOUS AND HARMONIC EMISSIONS AT ANTENNA TERMINAL

- Plots of the EUT's Conducted Spurious Emissions are shown in Clause 8.3

7.4 BAND EDGE

- Plots of the EUT's Band Edge are shown in Clause 8.4

7.5 EFFECTIVE RADIATED POWER

- GSM850

Freq(MHz) CH	EUT Position (Axis)	Test mode						
		Pol. (H/V)	LEVEL@ TX ANTENNA TERMINAL (dBm)	Antenna Gain (dBd)	ERP (dBm)	ERP (W)	Rated Voltage	Note.
824.2 128	X	H	28.88	1.23	30.11	1.026	DC 3.8V	GSM
836.6 190	X	H	25.71	1.17	26.88	0.488	DC 3.8V	GSM
848.8 251	X	H	23.94	1.11	25.05	0.320	DC 3.8V	GSM
824.2 128	X	H	20.98	1.23	22.21	0.166	DC 3.8V	EDGE

- WCDMA850 data

Freq(MHz) CH	EUT Position (Axis)	Test mode 12.2 kbps RMC						
		Pol. (H/V)	LEVEL@ TX ANTENNA TERMINAL (dBm)	Antenna Gain (dBd)	ERP (dBm)	ERP (W)	Rated Voltage	Note.
826.4 4132	X	H	18.70	1.22	19.92	0.098	DC 3.8V	-
836.6 4183	X	H	17.50	1.17	18.67	0.074	DC 3.8V	-
846.6 4233	X	H	17.74	1.12	18.86	0.077	DC 3.8V	-

- HSUPA850 data

Freq(MHz) CH	EUT Position (Axis)	Test mode subtest 1						
		Pol. (H/V)	LEVEL@ TX ANTENNA TERMINAL (dBm)	Antenna Gain (dBd)	ERP (dBm)	ERP (W)	Rated Voltage	Note.
826.4 4132	X	H	17.57	1.22	18.79	0.076	DC 3.8V	-
836.6 4183	X	H	16.61	1.17	17.78	0.060	DC 3.8V	-
846.6 4233	X	H	16.85	1.12	17.97	0.063	DC 3.8V	-

NOTES:

This device was tested under all configuration and modes which is GSM, WCDMA and HSUPA with highest power. The GSM mode of power control level is set to "0" in PCS band and "5" in cellular band.

Also, WCDMA mode is set to HSDPA inactive with 12.2kbps RMC and TPC bits set to "1".

In case of HSUPA mode it is set to subtest 1 with 12.2kbps+HSPA. This EUT was tested with the fully charged battery. Also, we have done x, y, z planes in EUT and horizontal and vertical polarization of detecting antenna.

The worst case data is reported in the table above.

7.6 EQUIVALENT ISOTROPIC RADIATED POWER

- WCDMA1700 data

Freq(MHz) CH	EUT Position (Axis)	Test mode 12.2 kbps RMC						
		Pol. (H/V)	LEVEL@ TX ANTENNA TERMINAL (dBm)	Antenna Gain (dBi)	EIRP (dBm)	EIRP (W)	Rated Voltage	Note.
1712.40 1312	Y	H	16.01	8.86	24.87	0.307	DC 3.8V	-
1732.40 1412	Y	H	15.28	8.88	24.16	0.261	DC 3.8V	-
1752.60 1513	Y	H	15.74	8.90	24.64	0.291	DC 3.8V	-

- HSUPA1700 data

Freq(MHz) CH	EUT Position (Axis)	Test mode subtest 1						
		Pol. (H/V)	LEVEL@ TX ANTENNA TERMINAL (dBm)	Antenna Gain (dBi)	EIRP (dBm)	EIRP (W)	Rated Voltage	Note.
1712.40 1312	Y	H	14.21	8.86	23.07	0.203	DC 3.8V	-
1732.40 1412	Y	H	14.02	8.88	22.90	0.195	DC 3.8V	-
1752.60 1513	Y	H	14.42	8.90	23.32	0.215	DC 3.8V	-

- GSM1900 data

Freq(MHz) CH	EUT Position (Axis)	Test mode						
		Pol. (H/V)	LEVEL@ TX ANTENNA TERMINAL (dBm)	Antenna Gain (dBi)	EIRP (dBm)	EIRP (W)	Rated Voltage	Note.
1850.2 512	Y	H	18.74	9.01	27.75	0.596	DC 3.8V	GSM
1880.0 661	Y	H	19.02	9.05	28.07	0.641	DC 3.8V	GSM
1909.80 810	Y	H	18.43	9.08	27.51	0.564	DC 3.8V	GSM
1880.0 661	X	H	14.90	9.05	23.95	0.248	DC 3.8V	EDGE

- WCDMA1900 data

Freq(MHz) CH	EUT Position (Axis)	Test mode 12.2 kbps RMC						
		Pol. (H/V)	LEVEL@ TX ANTENNA TERMINAL (dBm)	Antenna Gain (dBi)	EIRP (dBm)	EIRP (W)	Rated Voltage	Note.
1852.4 9262	Y	H	13.86	9.01	22.87	0.194	DC 3.8V	-
1880.0 9400	Y	H	12.71	9.05	21.76	0.150	DC 3.8V	-
1907.6 9538	Y	H	14.21	9.08	23.29	0.213	DC 3.8V	-

- HSUPA1900 data

Freq(MHz) CH	EUT Position (Axis)	Test mode subtest 1						
		Pol. (H/V)	LEVEL @ TX ANTENNA TERMINAL (dBm)	Antenna Gain (dBi)	EIRP (dBm)	EIRP (W)	Rated Voltage	Note.
1852.4 9262	Y	H	12.14	9.01	21.15	0.130	DC 3.8V	-
1880.0 9400	Y	H	11.51	9.05	20.56	0.114	DC 3.8V	-
1907.6 9538	Y	H	12.42	9.08	21.50	0.141	DC 3.8V	-

NOTES:

This device was tested under all configuration and modes which is GSM, WCDMA and HSUPA with highest power. The GSM mode of power control level is set to "0" in PCS band and "5" in cellular band.

Also, WCDMA mode is set to HSDPA inactive with 12.2kbps RMC and TPC bits set to "1".

In case of HSUPA mode it is set to subtest 1 with 12.2kbps+HSPA. This EUT was tested with the fully charged battery. Also, we have done x, y, z planes in EUT and horizontal and vertical polarization of detecting antenna.

The worst case data is reported in the table above.

7.7 RADIATED SPURIOUS EMISSIONS

7.7.1 RADIATED SPURIOUS EMISSIONS (GSM850)

Channel (ERP)	Freq. (MHz)	EUT Position (Axis)	POL (H/V)	LEVEL@ ANTENNA TERMINAL (dBm)	Substitute Antenna Gain (dBd)	Correct Generator Level (dBm)	Result (dBc)	Limit (dBc)
128 (1.026 W)	1648.28	Z	V	-53.18	6.64	-46.54	76.65	43.11
	2472.74	Z	V	-46.42	7.58	-38.84	68.95	
	-	-	-	-	-	-	-	
	-	-	-	-	-	-	-	
190 (0.488 W)	1673.12	Z	V	-53.21	6.66	-46.55	73.43	39.88
	2509.54	Z	V	-48.06	7.61	-40.45	67.33	
	-	-	-	-	-	-	-	
	-	-	-	-	-	-	-	
251 (0.320 W)	1697.66	Z	V	-52.85	6.69	-46.16	71.21	38.05
	2546.36	Z	V	-48.60	7.60	-41.00	66.05	
	-	-	-	-	-	-	-	
	-	-	-	-	-	-	-	

- Limit Calculation= $43 + 10 \log_{10}(ERP [W])$ [dBc]

- No other spurious and harmonic emissions were reported greater than listed emissions above table.

NOTES:

This device was tested under all configuration and modes which is GSM, WCDMA and HSUPA with highest power. The GSM mode of power control level is set to "0" in PCS band and "5" in cellular band.

Also, WCDMA mode is set to HSDPA inactive with 12.2kbps RMC and TPC bits set to "1".

In case of HSUPA mode it is set to subtest 1 with 12.2kbps+HSPA. This EUT was tested with the fully charged battery. Also, we have done x, y, z planes in EUT and horizontal and vertical polarization of detecting antenna.

The worst case data is reported in the table above.

7.7.2 RADIATED SPURIOUS EMISSIONS (WCDMA850)

Channel (ERP)	Freq. (MHz)	EUT Position (Axis)	POL (H/V)	LEVEL@ ANTENNA TERMINAL (dBm)	Substitute Antenna Gain (dBd)	Correct Generator Level (dBm)	Result (dBc)	Limit (dBc)
4132 (0.098 W)	1654.72	Y	H	-52.72	6.64	-46.08	66.00	32.92
	-	-	-	-	-	-	-	
	-	-	-	-	-	-	-	
4183 (0.074 W)	1674.96	Y	H	-55.09	6.67	-48.42	67.09	31.67
	-	-	-	-	-	-	-	
	-	-	-	-	-	-	-	
4233 (0.077 W)	1690.98	Y	H	-55.40	6.68	-48.72	67.58	31.86
	-	-	-	-	-	-	-	
	-	-	-	-	-	-	-	

- Limit Calculation= $43 + 10 \log_{10}(\text{ERP [W]})$ [dBc]

- No other spurious and harmonic emissions were reported greater than listed emissions above table.

NOTES:

This device was tested under all configuration and modes which is GSM, WCDMA and HSUPA with highest power. The GSM mode of power control level is set to "0" in PCS band and "5" in cellular band.

Also, WCDMA mode is set to HSDPA inactive with 12.2kbps RMC and TPC bits set to "1".

In case of HSUPA mode it is set to subtest 1 with 12.2kbps+HSPA. This EUT was tested with the fully charged battery. Also, we have done x, y, z planes in EUT and horizontal and vertical polarization of detecting antenna.

The worst case data is reported in the table above.

7.7.3 RADIATED SPURIOUS EMISSIONS (HSUPA850)

Channel (ERP)	Freq. (MHz)	EUT Position (Axis)	POL (H/V)	LEVEL@ ANTENNA TERMINAL (dBm)	Substitute Antenna Gain (dBd)	Correct Generator Level (dBm)	Result (dBc)	Limit (dBc)
4132 (0.076 W)	1652.12	Y	H	-54.99	6.64	-48.35	67.14	31.79
	-	-	-	-	-	-	-	
	-	-	-	-	-	-	-	
4183 (0.060 W)	1673.44	Y	H	-56.31	6.66	-49.65	67.43	30.78
	-	-	-	-	-	-	-	
	-	-	-	-	-	-	-	
4233 (0.063 W)	1692.88	Y	H	-58.71	6.69	-52.02	69.99	30.97
	-	-	-	-	-	-	-	
	-	-	-	-	-	-	-	

- Limit Calculation= $43 + 10 \log_{10}(\text{ERP [W]})$ [dBc]

- No other spurious and harmonic emissions were reported greater than listed emissions above table.

NOTES:

This device was tested under all configuration and modes which is GSM, WCDMA and HSUPA with highest power. The GSM mode of power control level is set to "0" in PCS band and "5" in cellular band.

Also, WCDMA mode is set to HSDPA inactive with 12.2kbps RMC and TPC bits set to "1".

In case of HSUPA mode it is set to subtest 1 with 12.2kbps+HSPA. This EUT was tested with the fully charged battery. Also, we have done x, y, z planes in EUT and horizontal and vertical polarization of detecting antenna.

The worst case data is reported in the table above.

7.7.4 RADIATED SPURIOUS EMISSIONS (WCDMA1700)

Channel (EIRP)	Freq. (MHz)	EUT Position (Axis)	POL (H/V)	LEVEL@ ANTENNA TERMINAL (dBm)	Substitute Antenna Gain (dBi)	Correct Generator Level (dBm)	Result (dBc)	Limit (dBc)
1312 (0.307 W)	3426.48	X	H	-58.58	10.05	-48.53	73.40	37.87
	-	-	-	-	-	-	-	
1412 (0.261 W)	3462.04	X	H	-59.45	10.08	-49.37	73.53	37.16
	-	-	-	-	-	-	-	
1513 (0.291 W)	3508.42	X	H	-59.22	10.10	-49.12	73.76	37.64
	-	-	-	-	-	-	-	

- Limit Calculation= $43 + 10 \log_{10}(\text{EIRP [W]})$ [dBc]

- No other spurious and harmonic emissions were reported greater than listed emissions above table.

NOTES:

This device was tested under all configuration and modes which is GSM, WCDMA and HSUPA with highest power. The GSM mode of power control level is set to "0" in PCS band and "5" in cellular band.

Also, WCDMA mode is set to HSDPA inactive with 12.2kbps RMC and TPC bits set to "1".

In case of HSUPA mode it is set to subtest 1 with 12.2kbps+HSPA. This EUT was tested with the fully charged battery. Also, we have done x, y, z planes in EUT and horizontal and vertical polarization of detecting antenna.

The worst case data is reported in the table above.

7.7.5 RADIATED SPURIOUS EMISSIONS (HSUPA1700)

Channel (EIRP)	Freq. (MHz)	EUT Position (Axis)	POL (H/V)	LEVEL@ ANTENNA TERMINAL (dBm)	Substitute Antenna Gain (dBi)	Correct Generator Level (dBm)	Result (dBc)	Limit (dBc)
1312 (0.203 W)	3426.48	X	H	-58.58	10.05	-48.53	71.60	36.07
	-	-	-	-	-	-	-	
1412 (0.195 W)	3462.04	X	H	-59.45	10.08	-49.37	72.27	35.90
	-	-	-	-	-	-	-	
1513 (0.215 W)	3508.42	X	H	-59.22	10.10	-49.12	72.44	36.32
	-	-	-	-	-	-	-	

- Limit Calculation= $43 + 10 \log_{10}(\text{EIRP [W]})$ [dBc]

- No other spurious and harmonic emissions were reported greater than listed emissions above table.

NOTES:

This device was tested under all configuration and modes which is GSM, WCDMA and HSUPA with highest power. The GSM mode of power control level is set to "0" in PCS band and "5" in cellular band.

Also, WCDMA mode is set to HSDPA inactive with 12.2kbps RMC and TPC bits set to "1".

In case of HSUPA mode it is set to subtest 1 with 12.2kbps+HSPA. This EUT was tested with the fully charged battery. Also, we have done x, y, z planes in EUT and horizontal and vertical polarization of detecting antenna.

The worst case data is reported in the table above.

7.7.6 RADIATED SPURIOUS EMISSIONS (GSM1900)

Channel (EIRP)	Freq. (MHz)	EUT Position (Axis)	POL (H/V)	LEVEL@ ANTENNA TERMINAL (dBm)	Substitute Antenna Gain (dBi)	Correct Generator Level (dBm)	Result (dBc)	Limit (dBc)
512 (0.596 W)	3700.58	Z	H	-52.25	9.91	-42.34	70.09	40.75
	5550.49	X	V	-44.65	10.98	-33.67	61.42	
	7400.79	Y	V	-51.79	11.55	-40.24	67.99	
	9250.76	Y	V	-44.93	11.58	-33.35	61.10	
661 (0.641 W)	3760.05	Z	H	-55.09	9.86	-45.23	73.30	41.07
	5640.26	X	V	-48.06	11.11	-36.95	65.02	
	7520.22	Y	V	-51.69	11.51	-40.18	68.25	
	9399.97	Y	V	-46.22	11.70	-34.52	62.59	
810 (0.564 W)	3819.49	Z	H	-55.21	9.80	-45.41	72.92	40.51
	5729.53	X	V	-50.04	11.24	-38.80	66.31	
	7639.26	Y	V	-48.91	11.46	-37.45	64.96	
	9548.87	Y	V	-46.020	11.83	-34.19	61.70	

- Limit Calculation = $43 + 10 \log_{10}(\text{EIRP [W]})$ [dBc]

- No other spurious and harmonic emissions were reported greater than listed emissions above table.

NOTES:

This device was tested under all configuration and modes which is GSM, WCDMA and HSUPA with highest power. The GSM mode of power control level is set to "0" in PCS band and "5" in cellular band.

Also, WCDMA mode is set to HSDPA inactive with 12.2kbps RMC and TPC bits set to "1".

In case of HSUPA mode it is set to subtest 1 with 12.2kbps+HSPA. This EUT was tested with the fully charged battery. Also, we have done x, y, z planes in EUT and horizontal and vertical polarization of detecting antenna.

The worst case data is reported in the table above.

7.7.7 RADIATED SPURIOUS EMISSIONS (WCDMA1900)

Channel (EIRP)	Freq. (MHz)	EUT Position (Axis)	POL (H/V)	LEVEL@ ANTENNA TERMINAL (dBm)	Substitute Antenna Gain (dBi)	Correct Generator Level (dBm)	Result (dBc)	Limit (dBc)
9262 (0.194 W)	3706.70	X	H	-56.83	9.91	-46.92	69.79	35.87
	-	-	-	-	-	-	-	
	-	-	-	-	-	-	-	
	-	-	-	-	-	-	-	
9400 (0.150 W)	3764.08	X	H	-59.06	9.85	-49.21	70.97	34.76
	-	-	-	-	-	-	-	
	-	-	-	-	-	-	-	
	-	-	-	-	-	-	-	
9538 (0.213 W)	3818.26	X	H	-58.60	9.80	-48.80	72.09	36.29
	-	-	-	-	-	-	-	
	-	-	-	-	-	-	-	
	-	-	-	-	-	-	-	

- Limit Calculation = $43 + 10 \log_{10}(\text{EIRP [W]})$ [dBc]

- No other spurious and harmonic emissions were reported greater than listed emissions above table.

NOTES:

This device was tested under all configuration and modes which is GSM, WCDMA and HSUPA with highest power. The GSM mode of power control level is set to "0" in PCS band and "5" in cellular band.

Also, WCDMA mode is set to HSDPA inactive with 12.2kbps RMC and TPC bits set to "1".

In case of HSUPA mode it is set to subtest 1 with 12.2kbps+HSPA. This EUT was tested with the fully charged battery. Also, we have done x, y, z planes in EUT and horizontal and vertical polarization of detecting antenna.

The worst case data is reported in the table above.

7.7.8 RADIATED SPURIOUS EMISSIONS (HSUPA1900)

Channel (EIRP)	Freq. (MHz)	EUT Position (Axis)	POL (H/V)	LEVEL@ ANTENNA TERMINAL (dBm)	Substitute Antenna Gain (dBi)	Correct Generator Level (dBm)	Result (dBc)	Limit (dBc)
9262 (0.130 W)	3705.12	X	H	-57.14	9.91	-47.23	68.38	34.15
	-	-	-	-	-	-	-	
	-	-	-	-	-	-	-	
	-	-	-	-	-	-	-	
9400 (0.114 W)	3761.24	X	H	-59.22	9.85	-49.37	69.93	33.56
	-	-	-	-	-	-	-	
	-	-	-	-	-	-	-	
	-	-	-	-	-	-	-	
9538 (0.141 W)	3814.90	X	H	-59.28	9.80	-49.48	70.98	34.50
	-	-	-	-	-	-	-	
	-	-	-	-	-	-	-	
	-	-	-	-	-	-	-	

- Limit Calculation = $43 + 10 \log_{10}(\text{EIRP [W]})$ [dBc]

- No other spurious and harmonic emissions were reported greater than listed emissions above table.

NOTES:

This device was tested under all configuration and modes which is GSM, WCDMA and HSUPA with highest power. The GSM mode of power control level is set to "0" in PCS band and "5" in cellular band.

Also, WCDMA mode is set to HSDPA inactive with 12.2kbps RMC and TPC bits set to "1".

In case of HSUPA mode it is set to subtest 1 with 12.2kbps+HSPA. This EUT was tested with the fully charged battery. Also, we have done x, y, z planes in EUT and horizontal and vertical polarization of detecting antenna.

The worst case data is reported in the table above.

7.8 FREQUENCY STABILITY / VARIATION OF AMBIENT TEMPERATURE

7.8.1 FREQUENCY STABILITY (GSM850)

OPERATING FREQUENCY : 836,600,000 Hz
 CHANNEL : 190(Mid)
 REFERENCE VOLTAGE : 3.80 V DC
 DEVIATION LIMIT(FCC & IC) : ± 0.00025 % or 2.5 ppm

VOLTAGE (%)	POWER (V DC)	TEMP (°C)	FREQ (Hz)	Deviation	
				(ppm)	(%)
100%	3.80	+25(Ref)	836,600,007	0.008	0.00000084
100%		-30	836,600,004	0.005	0.00000048
100%		-20	836,600,006	0.007	0.00000072
100%		-10	836,599,997	-0.004	-0.00000036
100%		0	836,600,005	0.006	0.00000060
100%		+10	836,599,995	-0.006	-0.00000060
100%		+20	836,599,996	-0.005	-0.00000048
100%		+30	836,600,006	0.007	0.00000072
100%		+40	836,600,010	0.012	0.00000120
100%		+50	836,599,993	-0.008	-0.00000084
115%	4.37	+25	836,600,011	0.013	0.00000131
BATT.ENDPOINT	3.50	+25	836,600,006	0.007	0.00000072

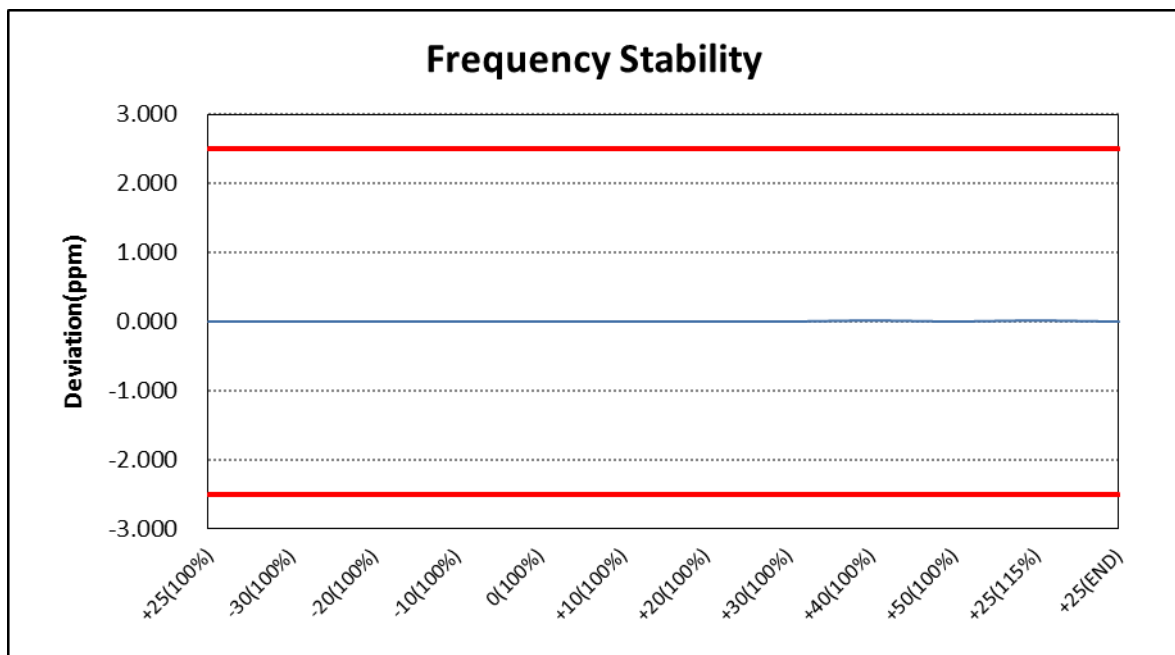

7.8.2 FREQUENCY STABILITY (WCDMA850)

OPERATING FREQUENCY : 836,600,000 Hz
 CHANNEL : 4183(Mid)
 REFERENCE VOLTAGE : 3.80 V DC
 DEVIATION LIMIT(FCC & IC) : $\pm 0.00025\%$ or ± 2.5 ppm

VOLTAGE (%)	POWER (V DC)	TEMP (°C)	FREQ (Hz)	Deviation	
				(ppm)	(%)
100%	3.80	+25(Ref)	836,599,995	-0.006	-0.00000060
100%		-30	836,600,005	0.006	0.00000060
100%		-20	836,599,997	-0.004	-0.00000036
100%		-10	836,599,992	-0.010	-0.00000096
100%		0	836,599,996	-0.005	-0.00000048
100%		+10	836,599,995	-0.006	-0.00000060
100%		+20	836,599,997	-0.004	-0.00000036
100%		+30	836,600,004	0.005	0.00000048
100%		+40	836,599,998	-0.002	-0.00000024
100%		+50	836,600,005	0.006	0.00000060
115%	4.37	+25	836,599,996	-0.005	-0.00000048
BATT.ENDPOINT	3.50	+25	836,600,006	0.007	0.00000072

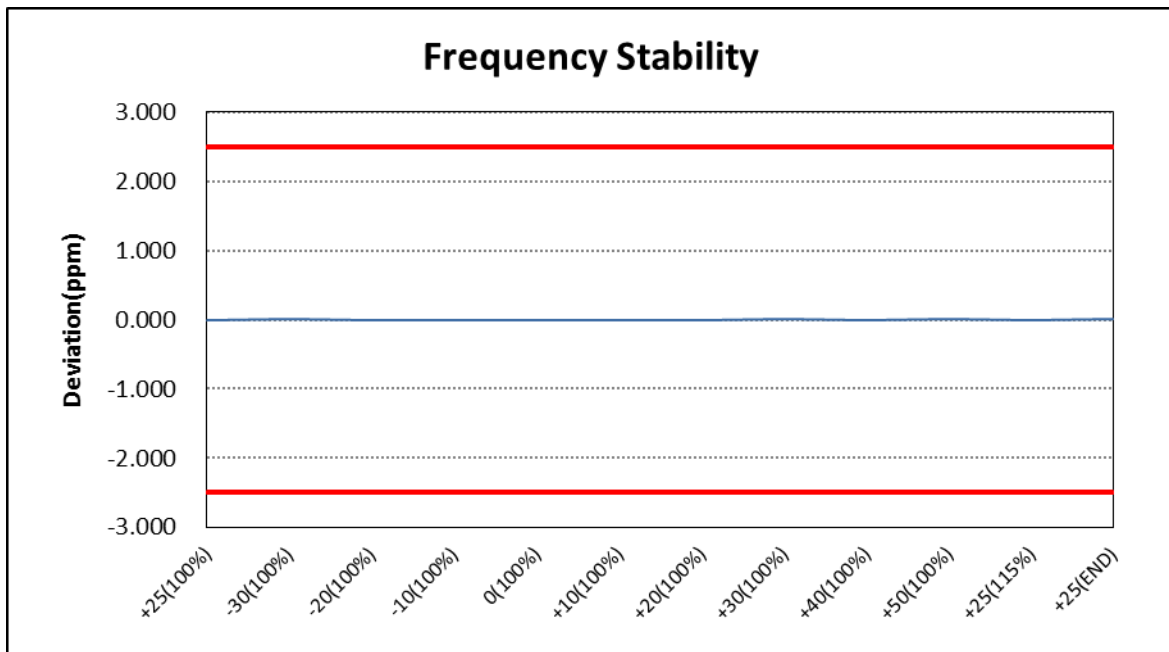

7.8.3 FREQUENCY STABILITY (HSUPA850)

OPERATING FREQUENCY : 836,600,000 Hz
 CHANNEL : 4183(Mid)
 REFERENCE VOLTAGE : 3.80 V DC
 DEVIATION LIMIT(FCC & IC) : $\pm 0.00025\%$ or ± 2.5 ppm

VOLTAGE (%)	POWER (V DC)	TEMP (°C)	FREQ (Hz)	Deviation	
				(ppm)	(%)
100%	3.80	+25(Ref)	836,600,003	0.004	0.00000036
100%		-30	836,599,995	-0.006	-0.00000060
100%		-20	836,599,995	-0.006	-0.00000060
100%		-10	836,599,998	-0.002	-0.00000024
100%		0	836,599,993	-0.008	-0.00000084
100%		+10	836,599,996	-0.005	-0.00000048
100%		+20	836,599,995	-0.006	-0.00000060
100%		+30	836,600,009	0.011	0.00000108
100%		+40	836,599,995	-0.006	-0.00000060
100%		+50	836,600,003	0.004	0.00000036
115%	4.37	+25	836,600,006	0.007	0.00000072
BATT.ENDPOINT	3.50	+25	836,599,996	-0.005	-0.00000048

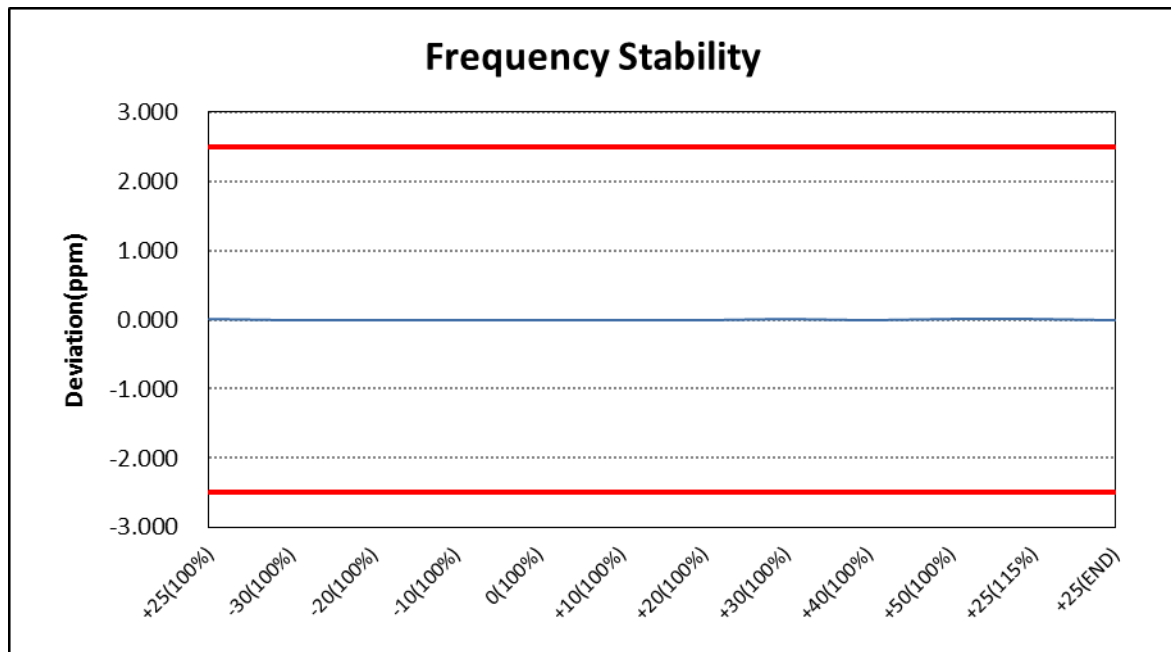

7.8.4 FREQUENCY STABILITY (WCDMA1700)

OPERATING FREQUENCY : 1,732,400,000 Hz
 CHANNEL : 1412(Mid)
 REFERENCE VOLTAGE : 3.80 V DC
 LIMIT(FCC & IC) : The frequency stability shall be sufficient to ensure that the fundamental emission stays within the authorized frequency block.

VOLTAGE (%)	POWER (V DC)	TEMP (°C)	FREQ (Hz)	Deviation	
				(ppm)	(%)
100%	3.80	+25(Ref)	1,732,399,994	-0.003	-0.00000035
100%		-30	1,732,400,020	0.012	0.00000115
100%		-20	1,732,399,997	-0.002	-0.00000017
100%		-10	1,732,400,012	0.007	0.00000069
100%		0	1,732,399,994	-0.003	-0.00000035
100%		+10	1,732,399,993	-0.004	-0.00000040
100%		+20	1,732,399,996	-0.002	-0.00000023
100%		+30	1,732,399,995	-0.003	-0.00000029
100%		+40	1,732,400,015	0.009	0.00000087
100%		+50	1,732,400,018	0.010	0.00000104
115%		4.37	+25	1,732,400,024	0.014
BATT.ENDPOINT	3.50	+25	1,732,399,994	-0.003	-0.00000035

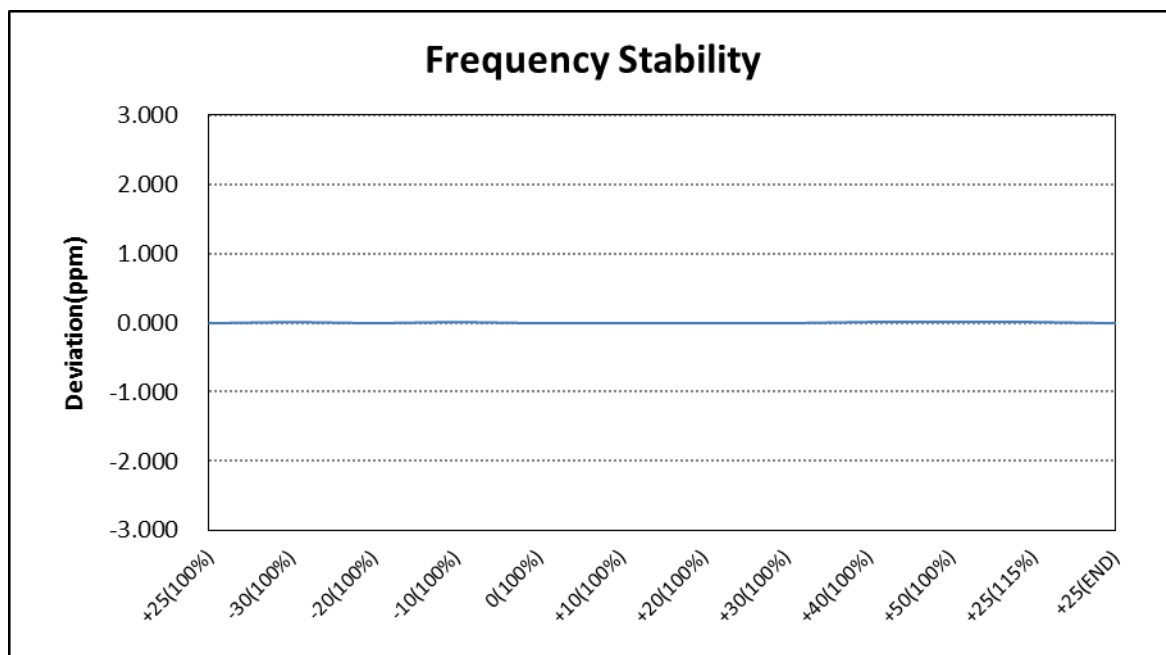

Note. Based on the results of the frequency stability test at the center channel the frequency deviation results measured are very small. as such it is determined that the channels at the band edge would remain inband when the maximum measured frequency deviation noted during the frequency stability tests is applied. therefore the device is determined to remain operating in band over the temperature and voltage range as tested.

7.8.5 FREQUENCY STABILITY (HSUPA1700)

OPERATING FREQUENCY : 1,732,400,000 Hz
 CHANNEL : 1412(Mid)
 REFERENCE VOLTAGE : 3.80 V DC
 LIMIT(FCC & IC) : The frequency stability shall be sufficient to ensure that the fundamental emission stays within the authorized frequency block.

VOLTAGE (%)	POWER (V DC)	TEMP (°C)	FREQ (Hz)	Deviation	
				(ppm)	(%)
100%	3.80	+25(Ref)	1,732,400,016	0.009	0.00000092
100%		-30	1,732,399,994	-0.003	-0.00000035
100%		-20	1,732,399,996	-0.002	-0.00000023
100%		-10	1,732,399,996	-0.002	-0.00000023
100%		0	1,732,400,012	0.007	0.00000069
100%		+10	1,732,399,997	-0.002	-0.00000017
100%		+20	1,732,399,997	-0.002	-0.00000017
100%		+30	1,732,399,995	-0.003	-0.00000029
100%		+40	1,732,400,007	0.004	0.00000040
100%		+50	1,732,399,995	-0.003	-0.00000029
115%	4.37	+25	1,732,400,011	0.006	0.00000063
BATT.ENDPOINT	3.50	+25	1,732,399,995	-0.003	-0.00000029

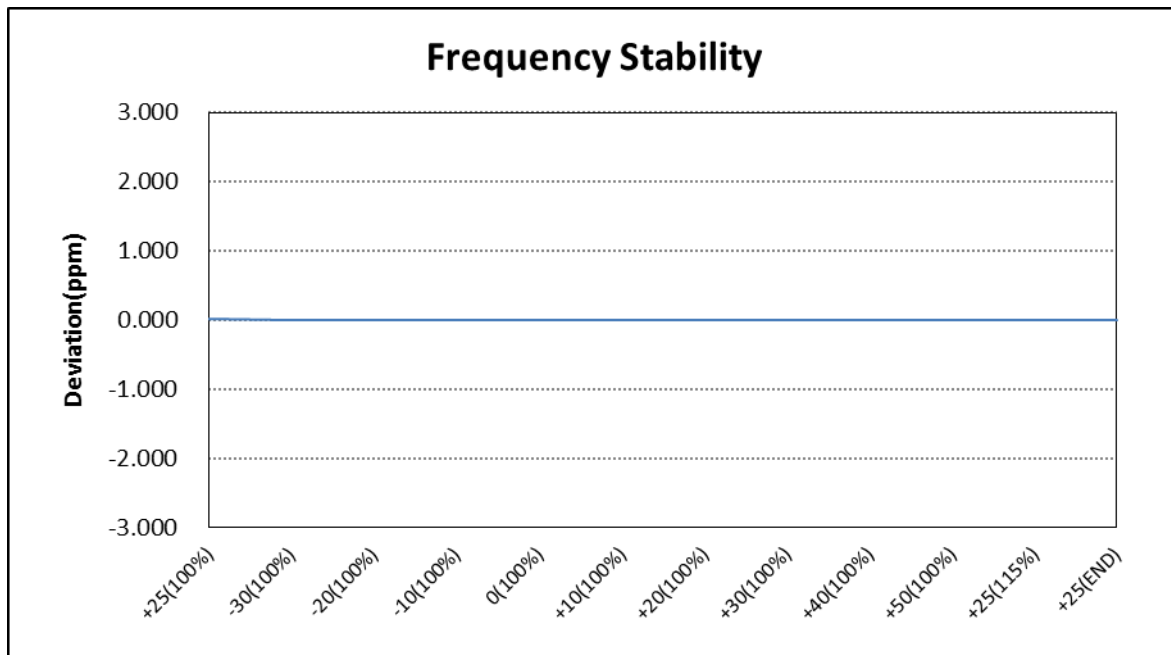

Note. Based on the results of the frequency stability test at the center channel the frequency deviation results measured are very small. as such it is determined that the channels at the band edge would remain inband when the maximum measured frequency deviation noted during the frequency stability tests is applied. therefore the device is determined to remain operating in band over the temperature and voltage range as tested.

7.8.6 FREQUENCY STABILITY (GSM1900)

OPERATING FREQUENCY : 1,880,000,000 Hz
 CHANNEL : 661(Mid)
 REFERENCE VOLTAGE : 3.80 V DC
 LIMIT(FCC) : The frequency stability shall be sufficient to ensure that the fundamental emission stays within the authorized frequency block.
 DEVIATION LIMIT(IC) : ± 0.00025 % or 2.5 ppm

VOLTAGE (%)	POWER (V DC)	TEMP (°C)	FREQ (Hz)	Deviation	
				(ppm)	(%)
100%	3.80	+25(Ref)	1,880,000,014	0.007	0.00000074
100%		-30	1,880,000,016	0.009	0.00000085
100%		-20	1,880,000,014	0.007	0.00000074
100%		-10	1,879,999,993	-0.004	-0.00000037
100%		0	1,880,000,019	0.010	0.00000101
100%		+10	1,879,999,992	-0.004	-0.00000043
100%		+20	1,879,999,994	-0.003	-0.00000032
100%		+30	1,880,000,015	0.008	0.00000080
100%		+40	1,880,000,012	0.006	0.00000064
100%		+50	1,880,000,016	0.009	0.00000085
115%	4.37	+25	1,880,000,012	0.006	0.00000064
BATT.ENDPOINT	3.50	+25	1,880,000,019	0.010	0.00000101

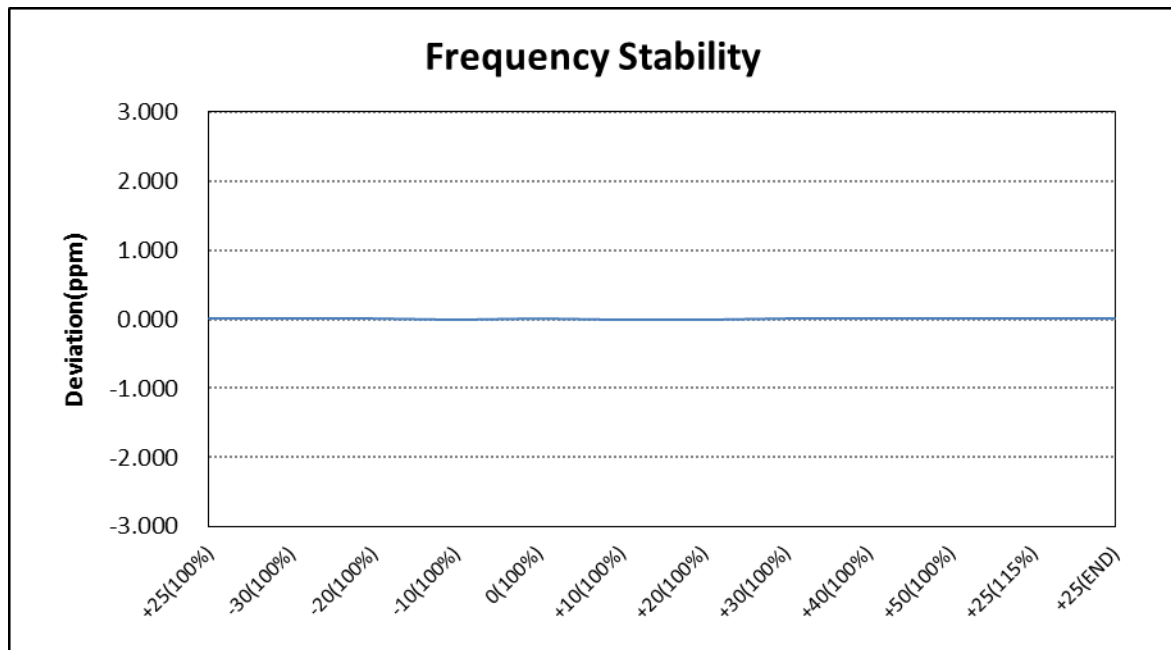

Note. Based on the results of the frequency stability test at the center channel the frequency deviation results measured are very small. as such it is determined that the channels at the band edge would remain inband when the maximum measured frequency deviation noted during the frequency stability tests is applied. therefore the device is determined to remain operating in band over the temperature and voltage range as tested.

7.8.7 FREQUENCY STABILITY (WCDMA1900)

OPERATING FREQUENCY : 1,880,000,000 Hz
 CHANNEL : 9400(Mid)
 REFERENCE VOLTAGE : 3.80 V DC
 LIMIT(FCC) : The frequency stability shall be sufficient to ensure that the fundamental emission stays within the authorized frequency block.
 DEVIATION LIMIT(IC) : ± 0.00025 % or 2.5 ppm

VOLTAGE (%)	POWER (V DC)	TEMP (°C)	FREQ (Hz)	Deviation	
				(ppm)	(%)
100%	3.80	+25(Ref)	1,880,000,019	0.010	0.00000101
100%		-30	1,880,000,005	0.003	0.00000027
100%		-20	1,880,000,006	0.003	0.00000032
100%		-10	1,880,000,009	0.005	0.00000048
100%		0	1,880,000,004	0.002	0.00000021
100%		+10	1,880,000,006	0.003	0.00000032
100%		+20	1,880,000,004	0.002	0.00000021
100%		+30	1,880,000,006	0.003	0.00000032
100%		+40	1,880,000,015	0.008	0.00000080
100%		+50	1,880,000,007	0.004	0.00000037
115%	4.37	+25	1,880,000,004	0.002	0.00000021
BATT.ENDPOINT	3.50	+25	1,880,000,008	0.004	0.00000043

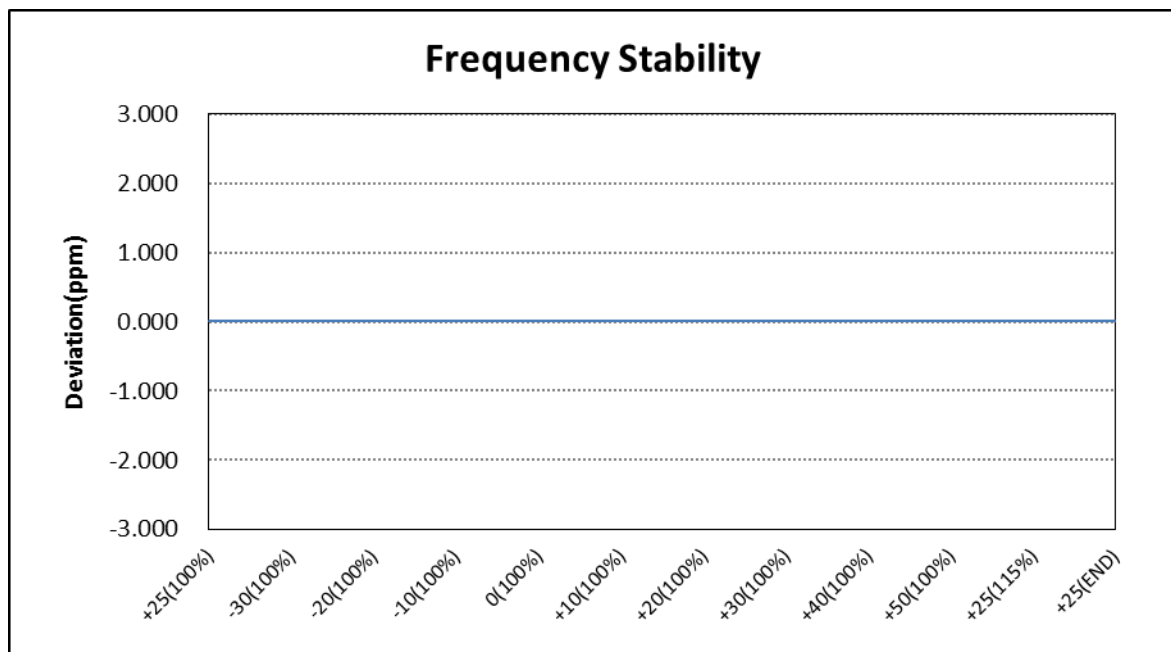

Note. Based on the results of the frequency stability test at the center channel the frequency deviation results measured are very small. as such it is determined that the channels at the band edge would remain inband when the maximum measured frequency deviation noted during the frequency stability tests is applied. therefore the device is determined to remain operating in band over the temperature and voltage range as tested.

7.8.8 FREQUENCY STABILITY (HSUPA1900)

OPERATING FREQUENCY : 1,880,000,000 Hz
 CHANNEL : 9400(Mid)
 REFERENCE VOLTAGE : 3.80 V DC
 LIMIT(FCC) : The frequency stability shall be sufficient to ensure that the fundamental emission stays within the authorized frequency block.
 DEVIATION LIMIT(IC) : ± 0.00025 % or 2.5 ppm

VOLTAGE (%)	POWER (V DC)	TEMP (°C)	FREQ (Hz)	Deviation	
				(ppm)	(%)
100%	3.80	+25(Ref)	1,880,000,006	0.003	0.00000032
100%		-30	1,880,000,007	0.004	0.00000037
100%		-20	1,880,000,003	0.002	0.00000016
100%		-10	1,880,000,005	0.003	0.00000027
100%		0	1,880,000,006	0.003	0.00000032
100%		+10	1,880,000,005	0.003	0.00000027
100%		+20	1,880,000,008	0.004	0.00000043
100%		+30	1,880,000,003	0.002	0.00000016
100%		+40	1,880,000,007	0.004	0.00000037
100%		+50	1,880,000,004	0.002	0.00000021
115%	4.37	+25	1,880,000,002	0.001	0.00000011
BATT.ENDPOINT	3.50	+25	1,880,000,005	0.003	0.00000027

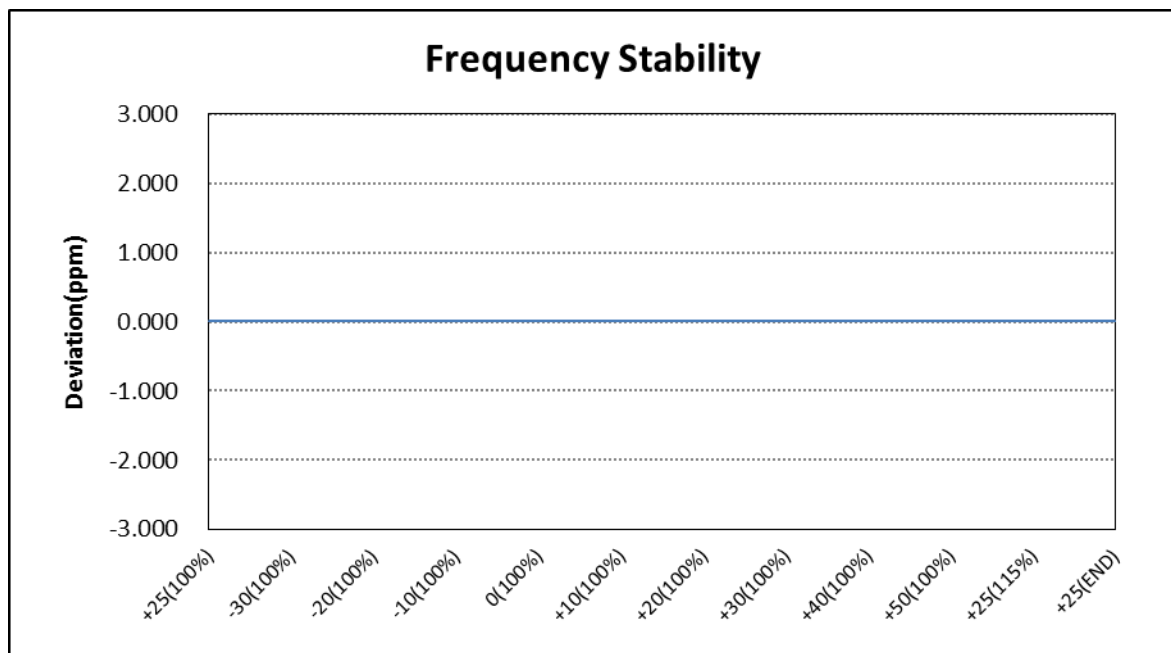

Note. Based on the results of the frequency stability test at the center channel the frequency deviation results measured are very small, as such it is determined that the channels at the band edge would remain inband when the maximum measured frequency deviation noted during the frequency stability tests is applied. therefore the device is determined to remain operating in band over the temperature and voltage range as tested.

8. TEST PLOTS

8.1 Peak to Average Ratio

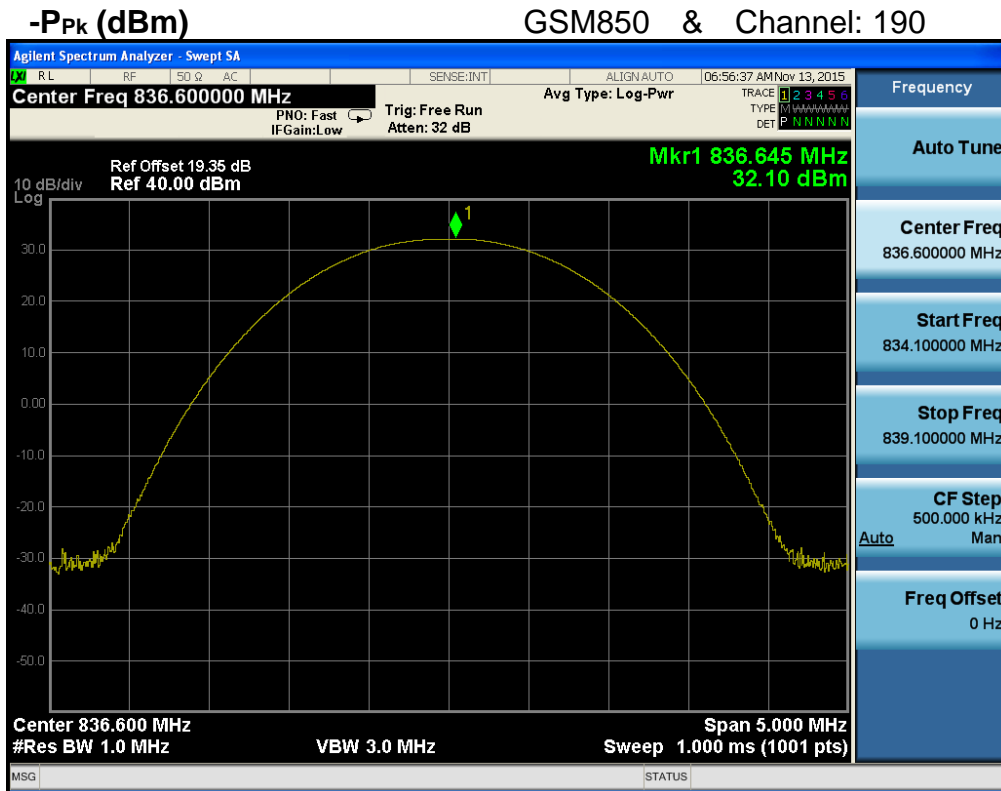

$$\text{PAPR (dB)} = P_{pk} \text{ (dBm)} - P_{avg} \text{ (dBm)} = 32.10 \text{ dBm} - 31.96 \text{ dBm} = 0.14 \text{ dB}$$

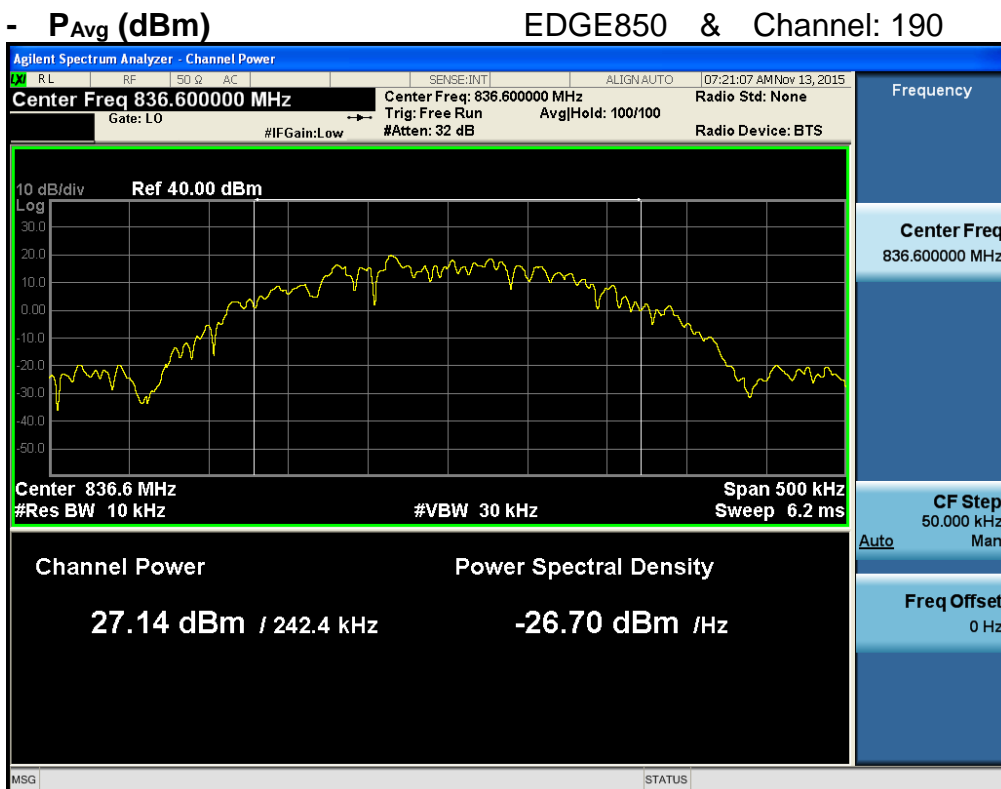
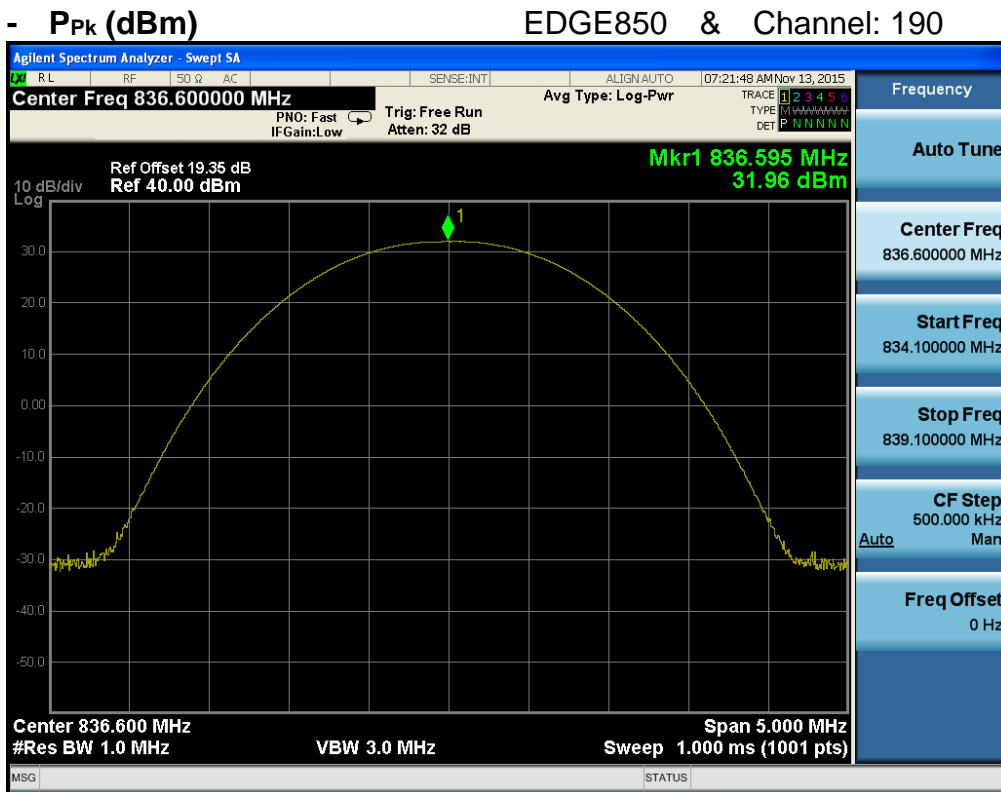

$$PAR (dB) = P_{pk} (dBm) - P_{avg} (dBm) = 31.96 \text{ dBm} - 27.14 \text{ dBm} = 4.82 \text{ dB}$$

WCDMA850 & Channel: 4183

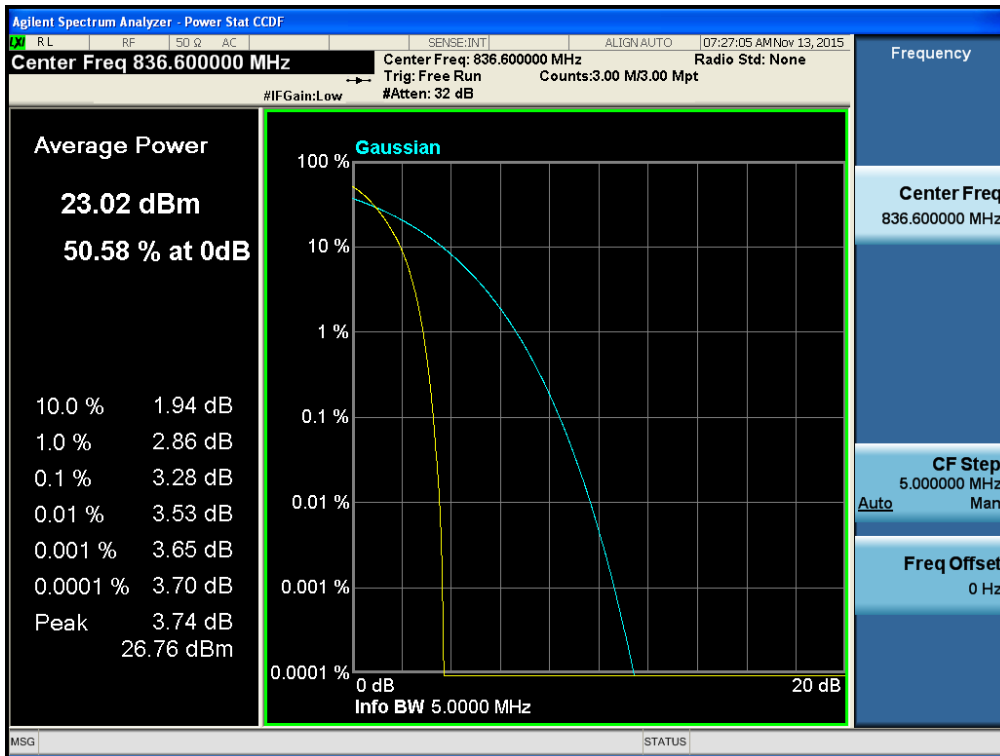

HSUPA850 & Channel: 4183

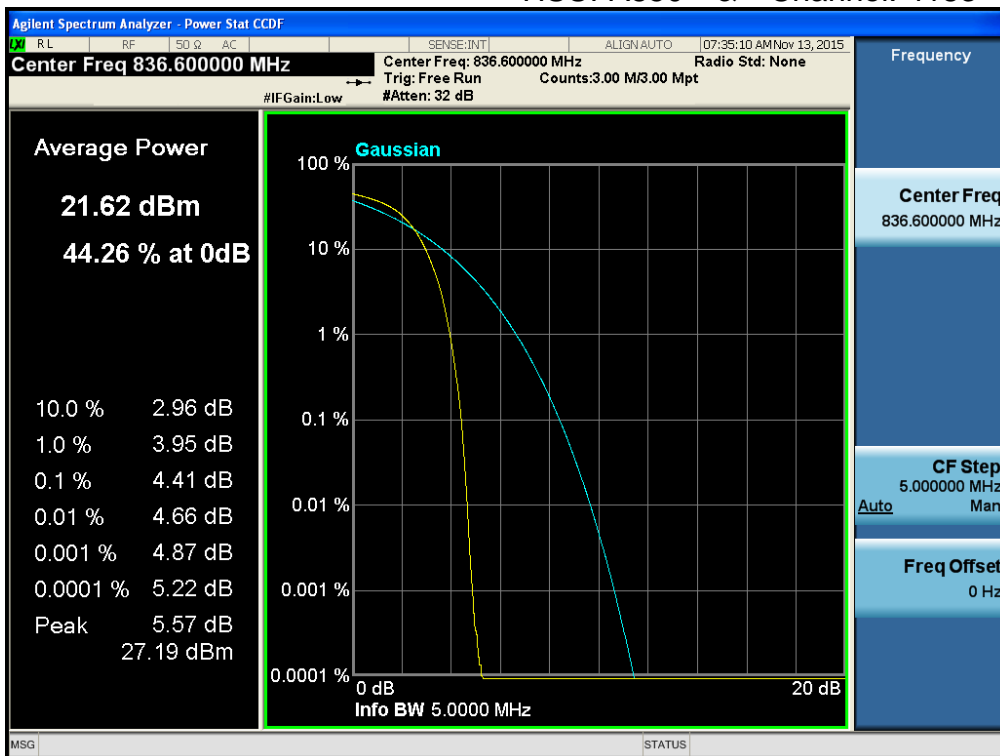

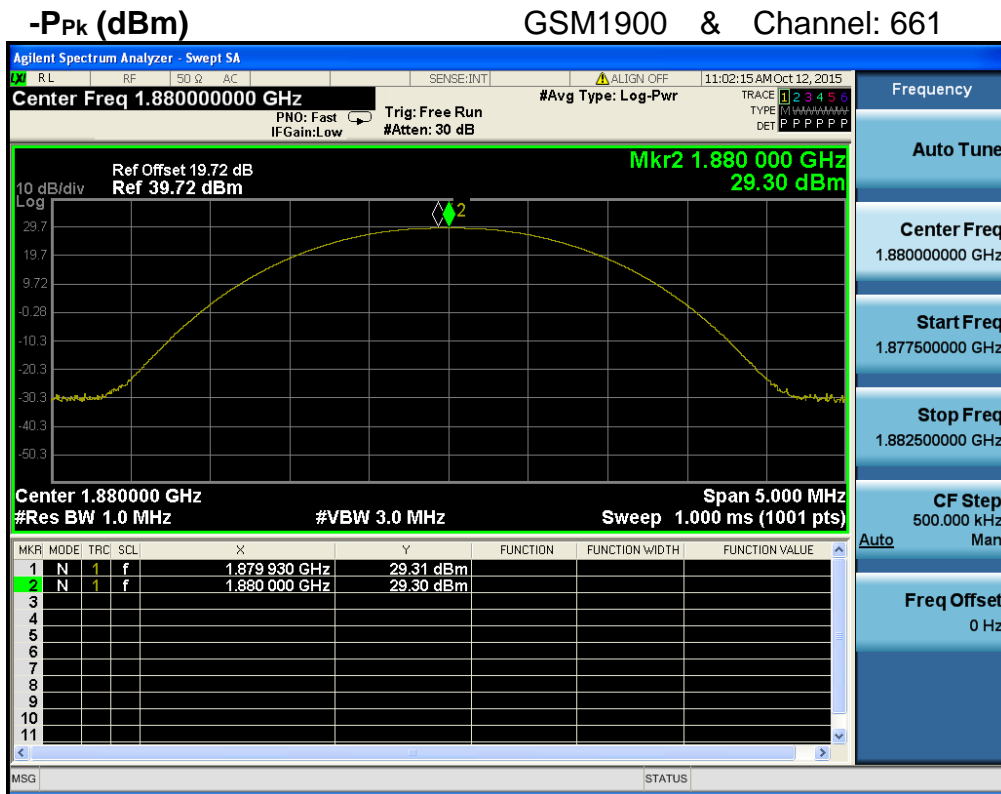

$$PAPR (dB) = P_{pk} (dBm) - P_{avg} (dBm) = 29.31 \text{ dBm} - 29.20 \text{ dBm} = 0.11 \text{ dB}$$

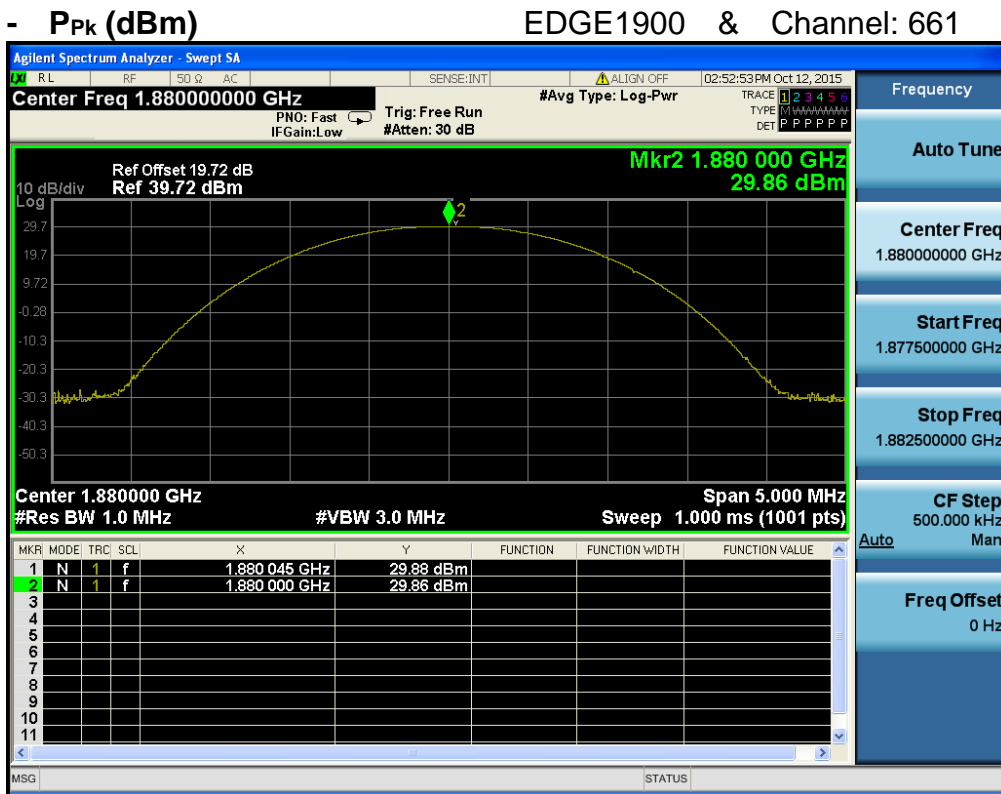

$$PAR (dB) = P_{pk} (dBm) - P_{avg} (dBm) = 29.86 \text{ dBm} - 25.96 \text{ dBm} = 3.90 \text{ dB}$$

WCDMA1700 & Channel: 1412

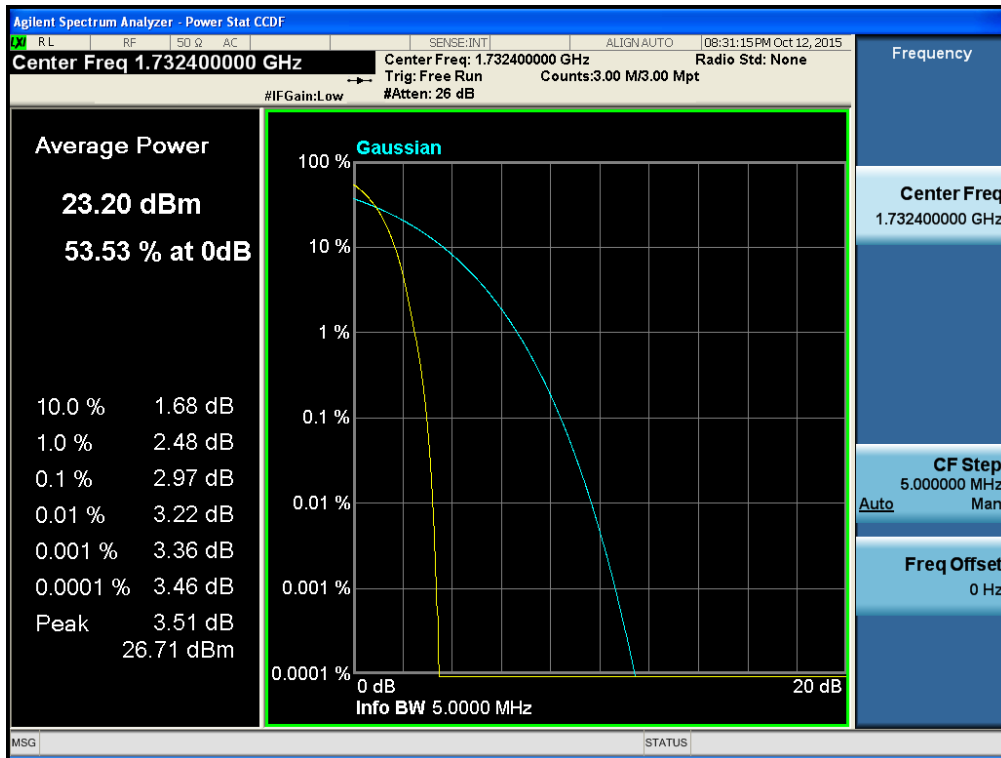

HSUPA1700 & Channel: 1412

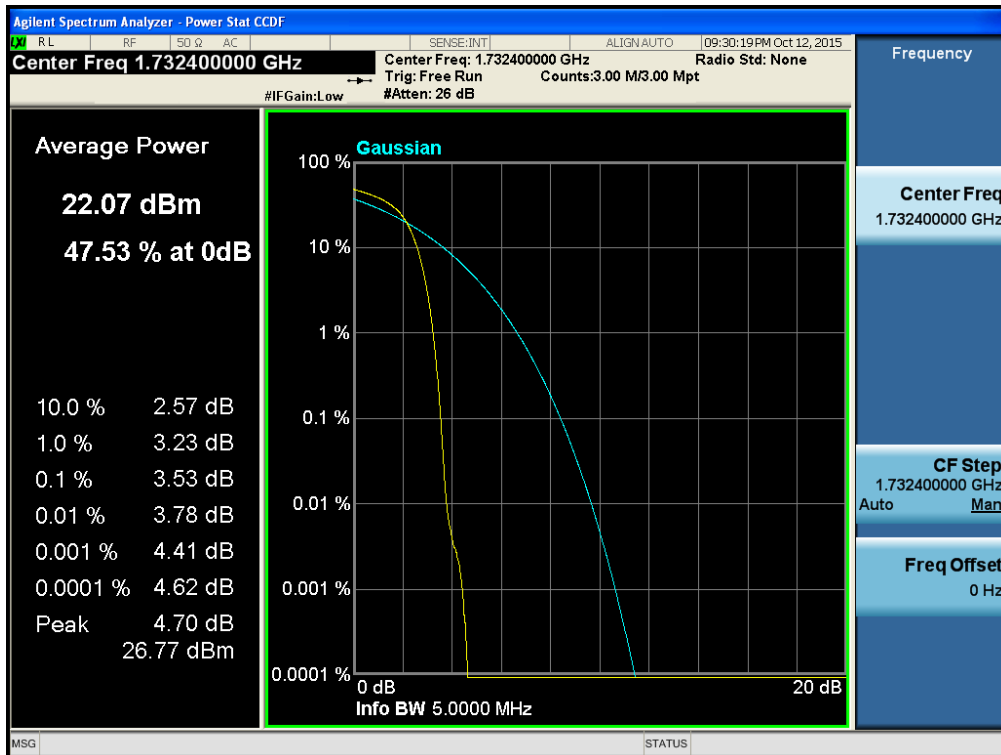

WCDMA1900 & Channel: 9400

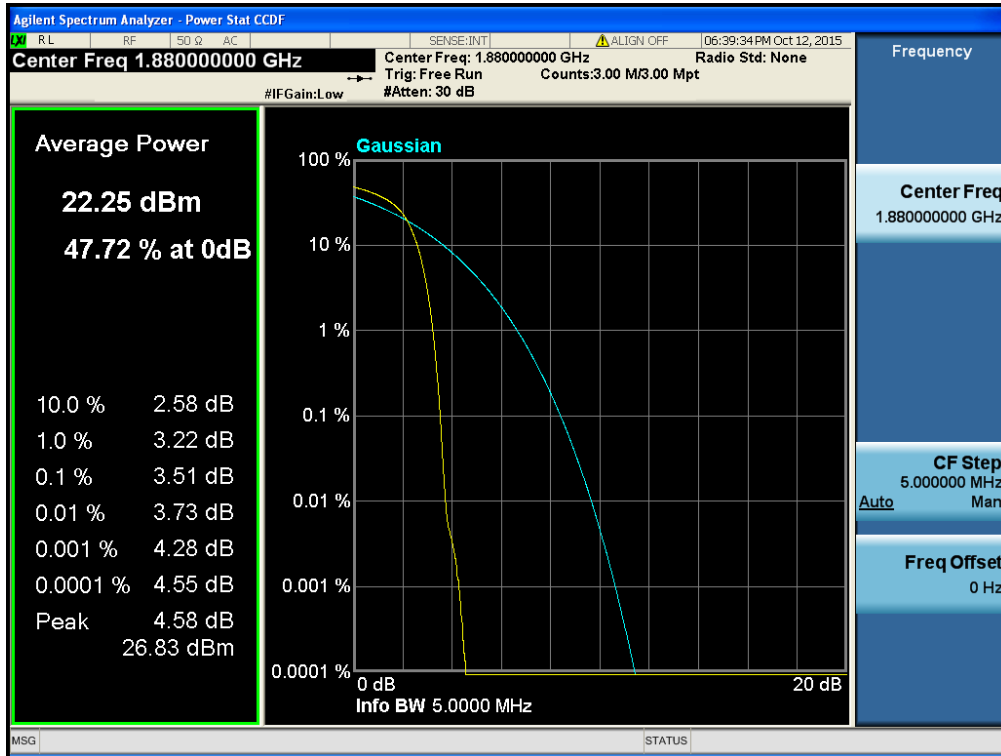

HSUPA1900 & Channel: 9400

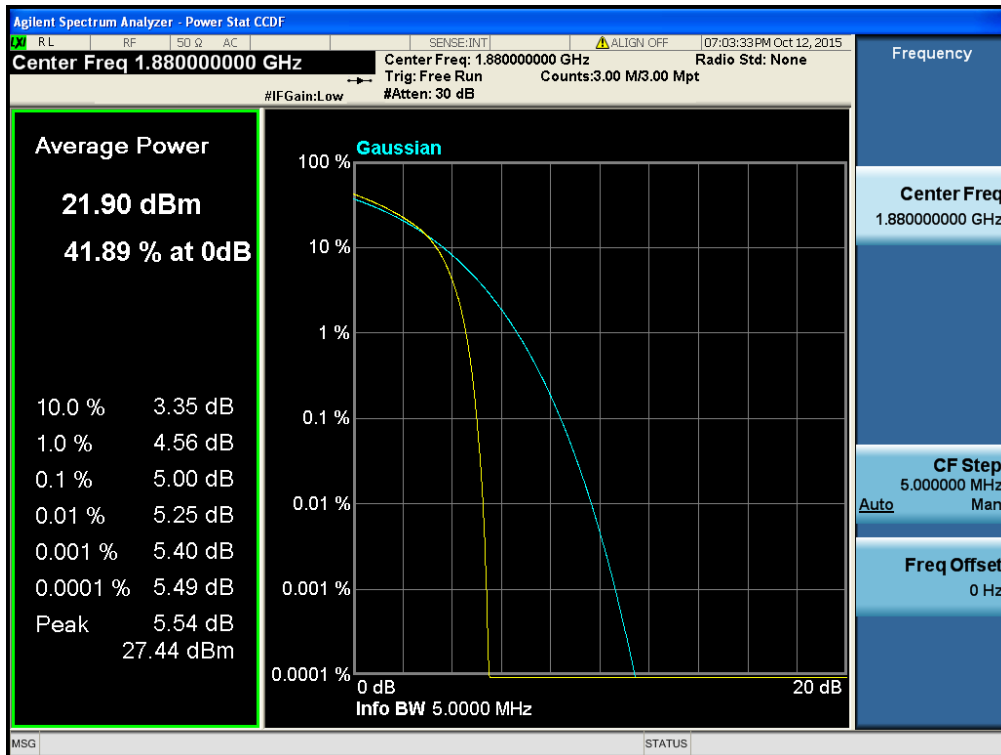

8.2 Occupied Bandwidth (99 % Bandwidth)

GSM850 & Channel: 128

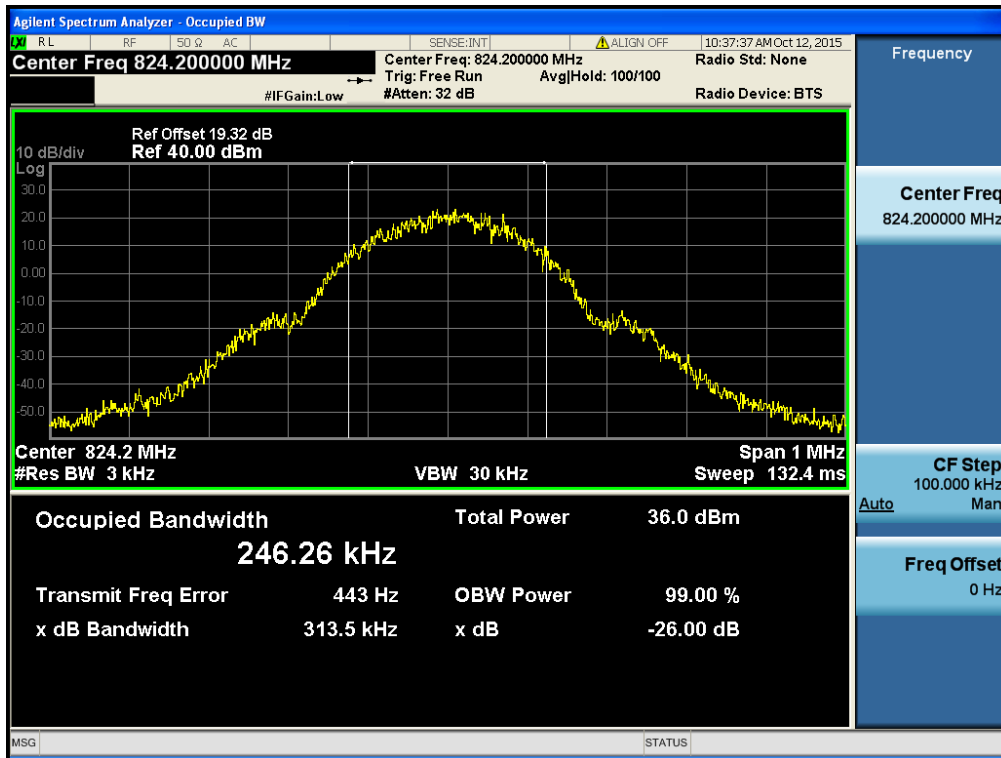

GSM850 & Channel: 190

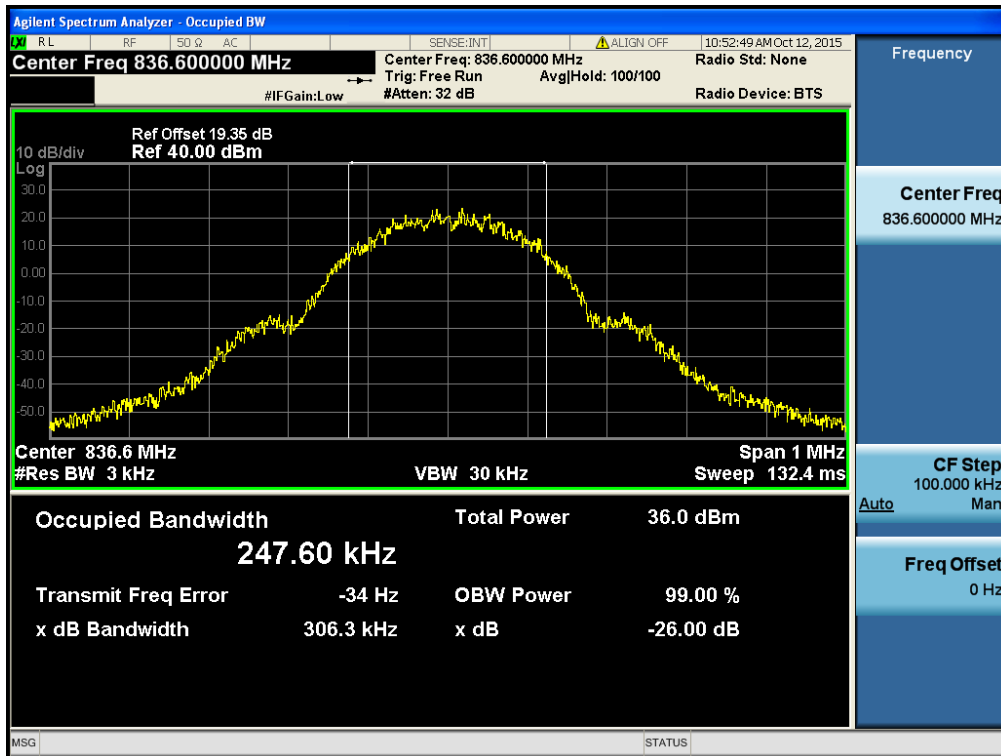

GSM850 & Channel: 251

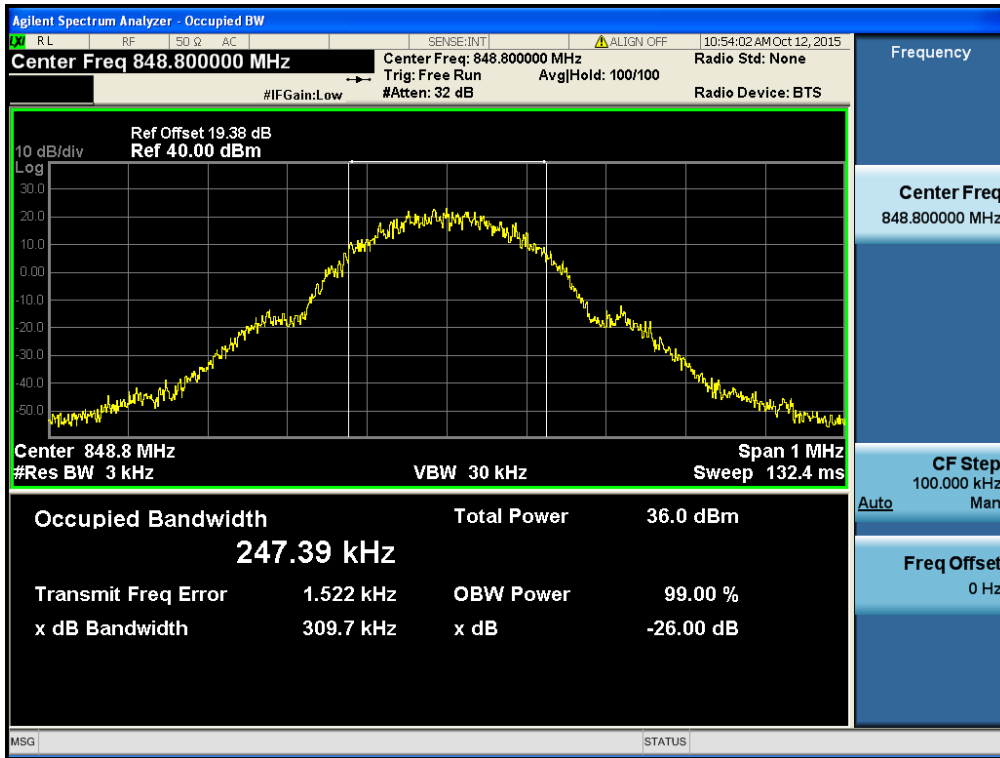

EDGE 850 & Channel: 128

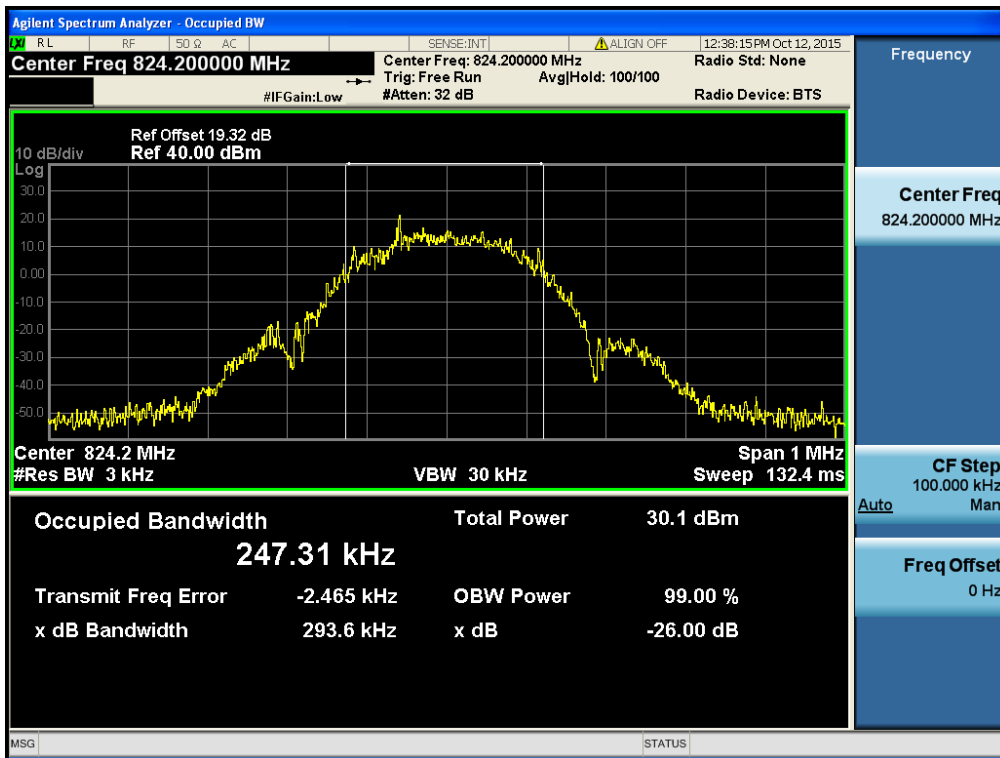

EDGE 850 & Channel: 190



EDGE 850 & Channel: 251

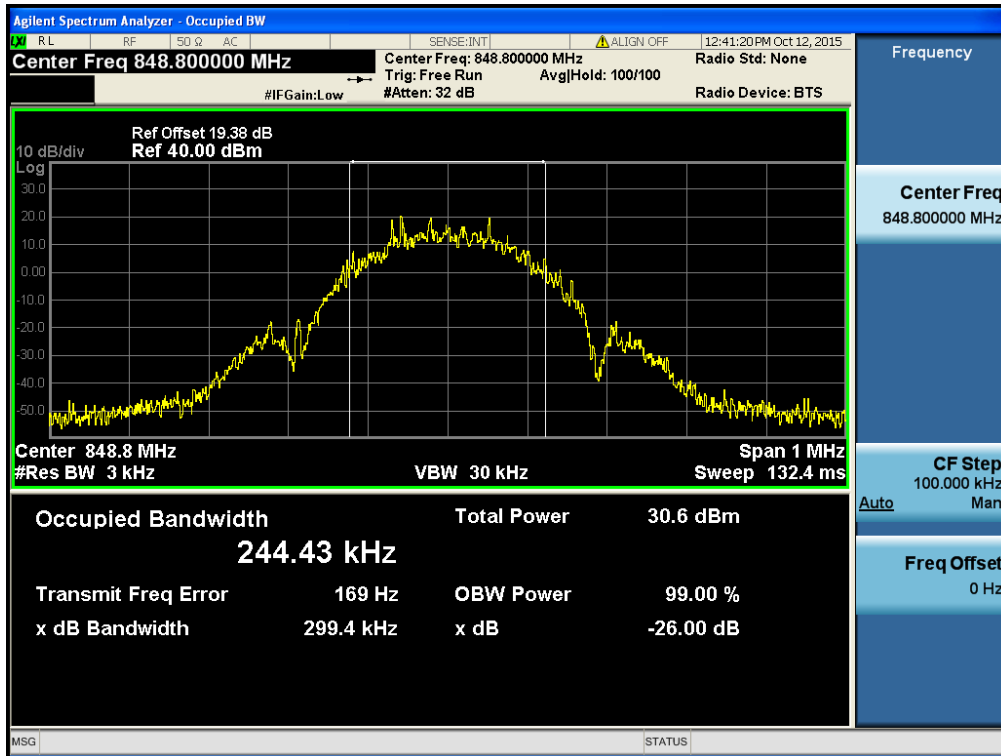

WCDMA850 & Channel: 4132

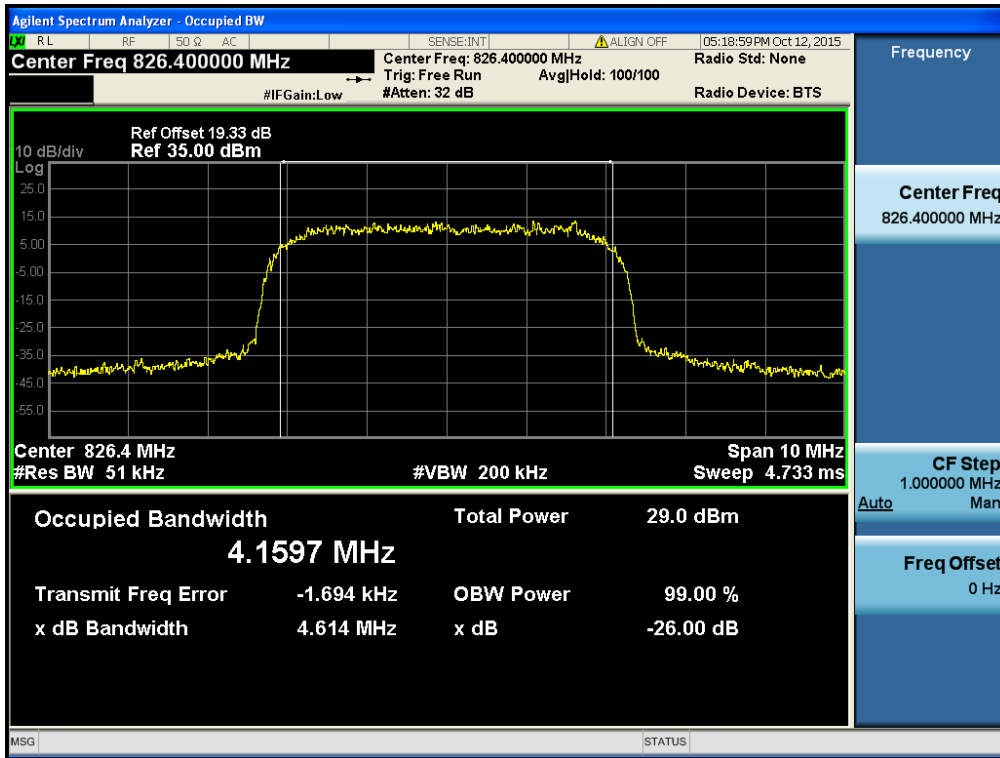

WCDMA850 & Channel: 4183

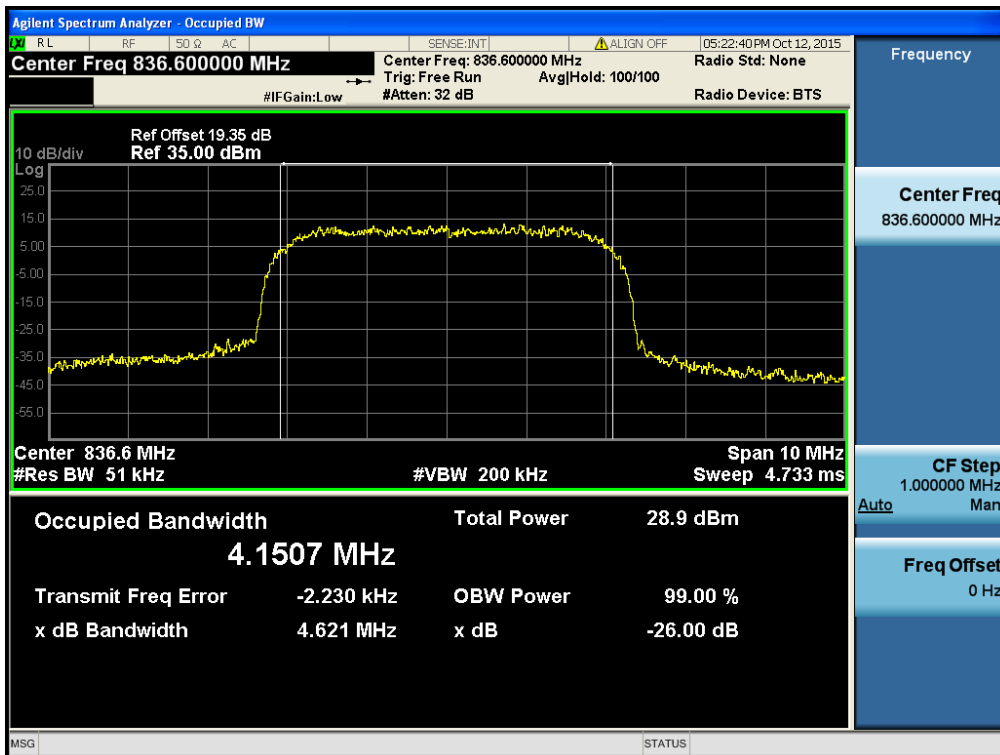

WCDMA850 & Channel: 4233

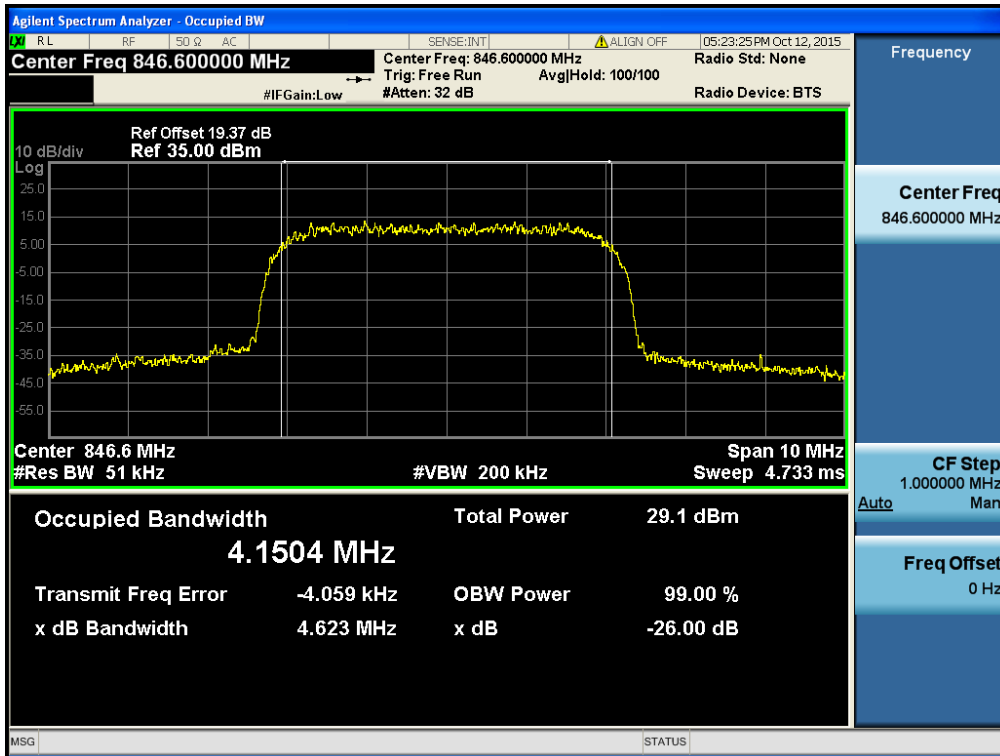

HSUPA850 & Channel: 4132

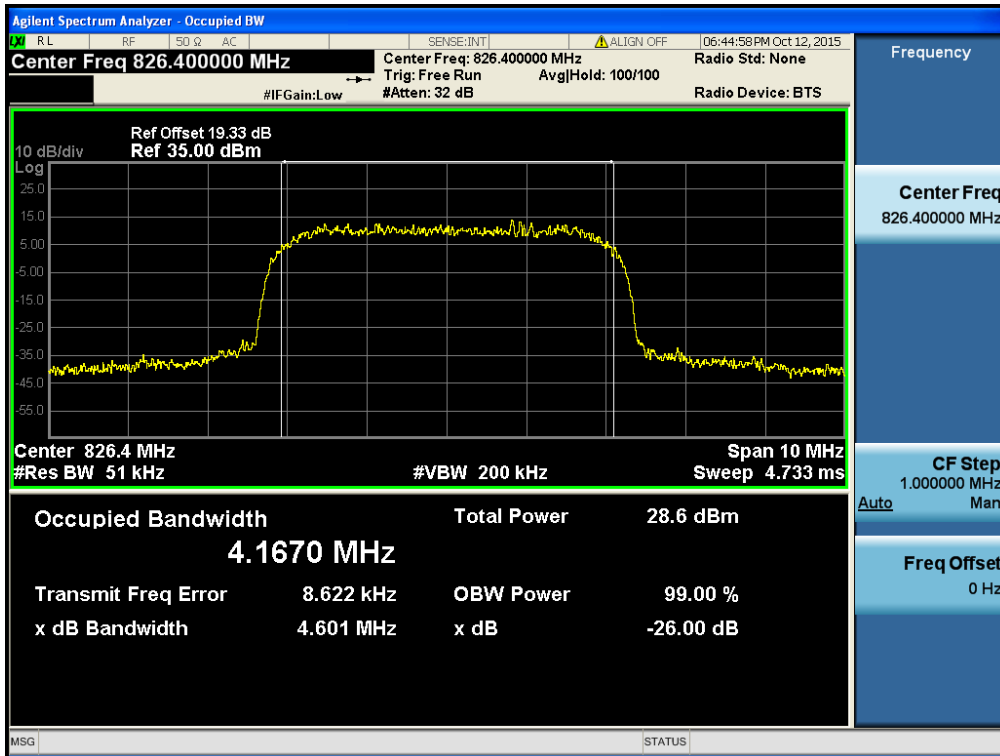

HSUPA850 & Channel: 4183

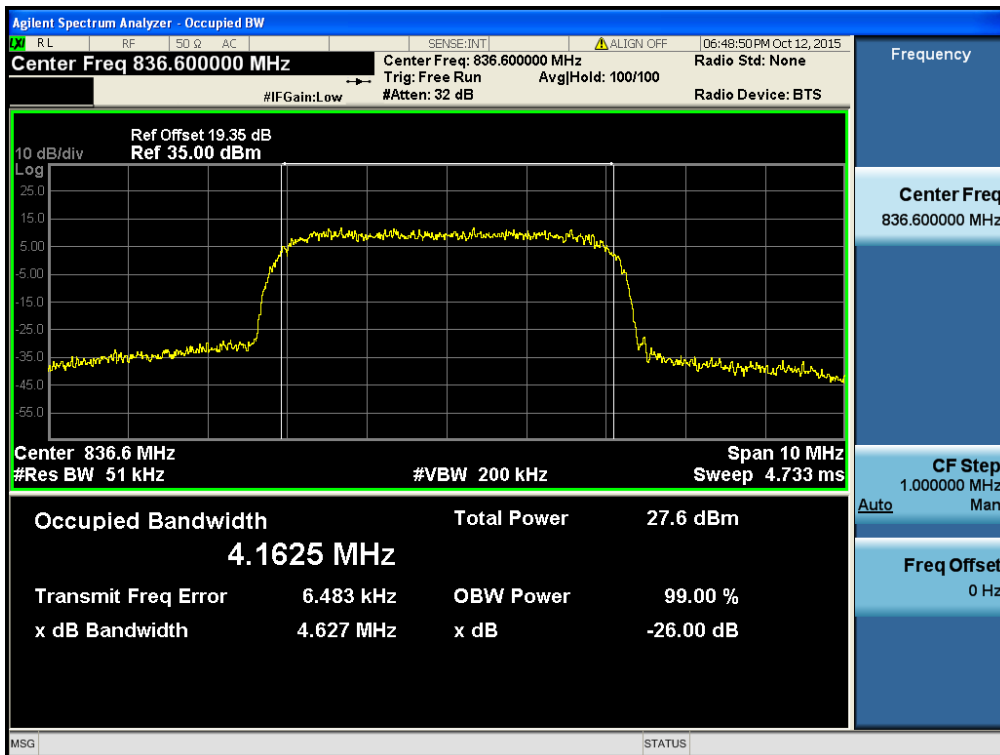

HSUPA850 & Channel: 4233

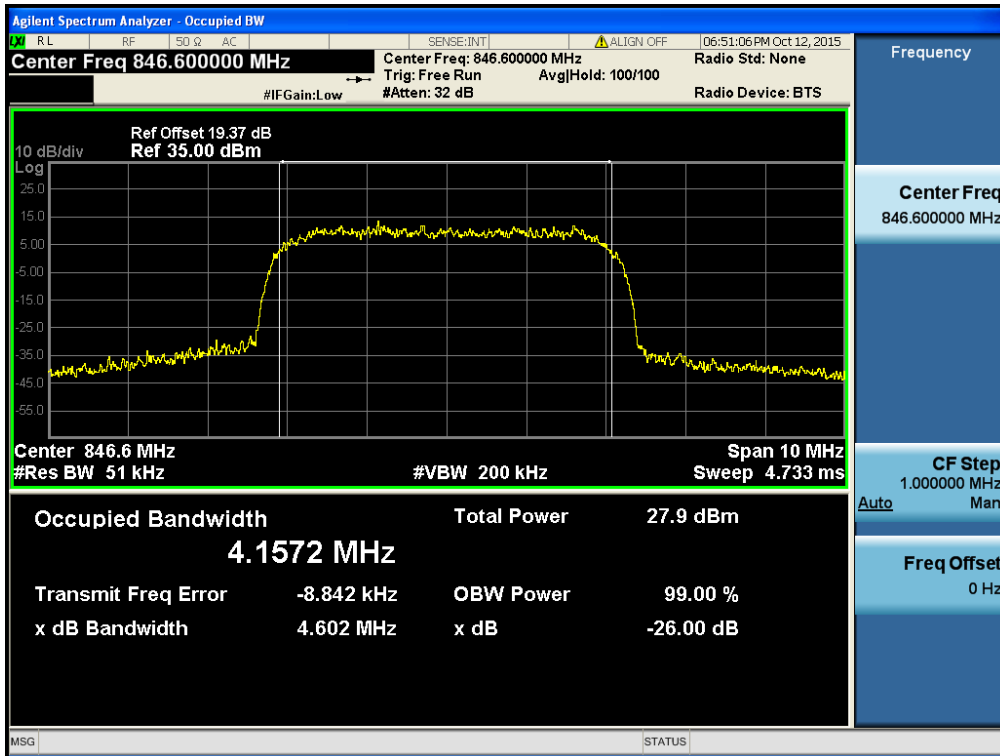

WCDMA1700 & Channel: 1312

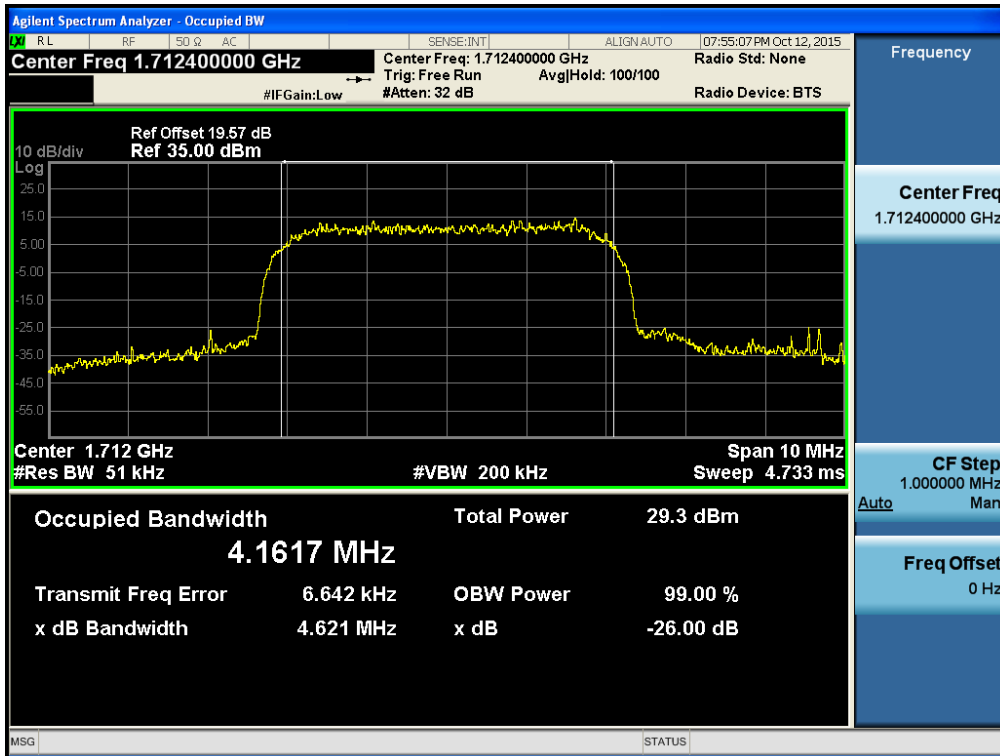

WCDMA1700 & Channel: 1412

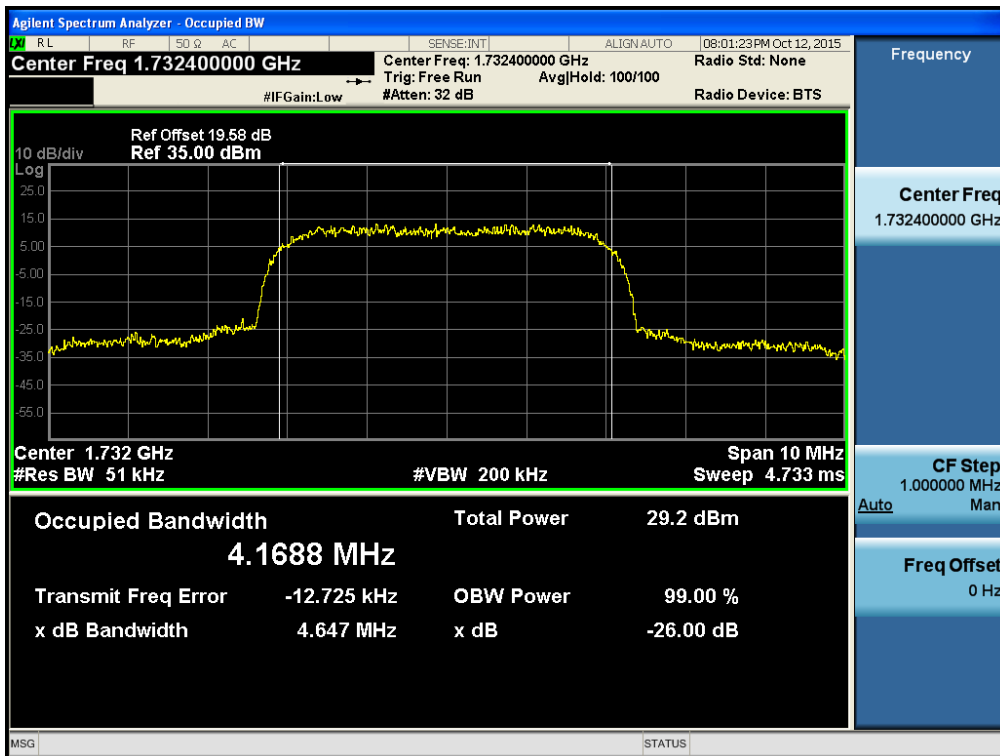

WCDMA1700 & Channel: 1513

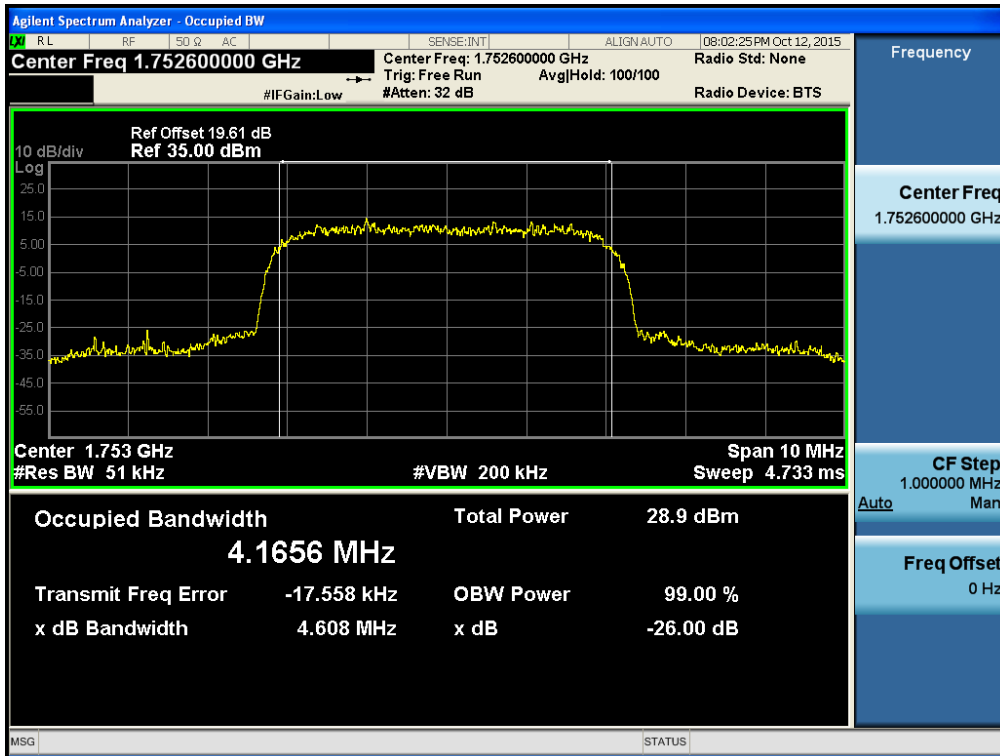

HSUPA1700 & Channel: 1312

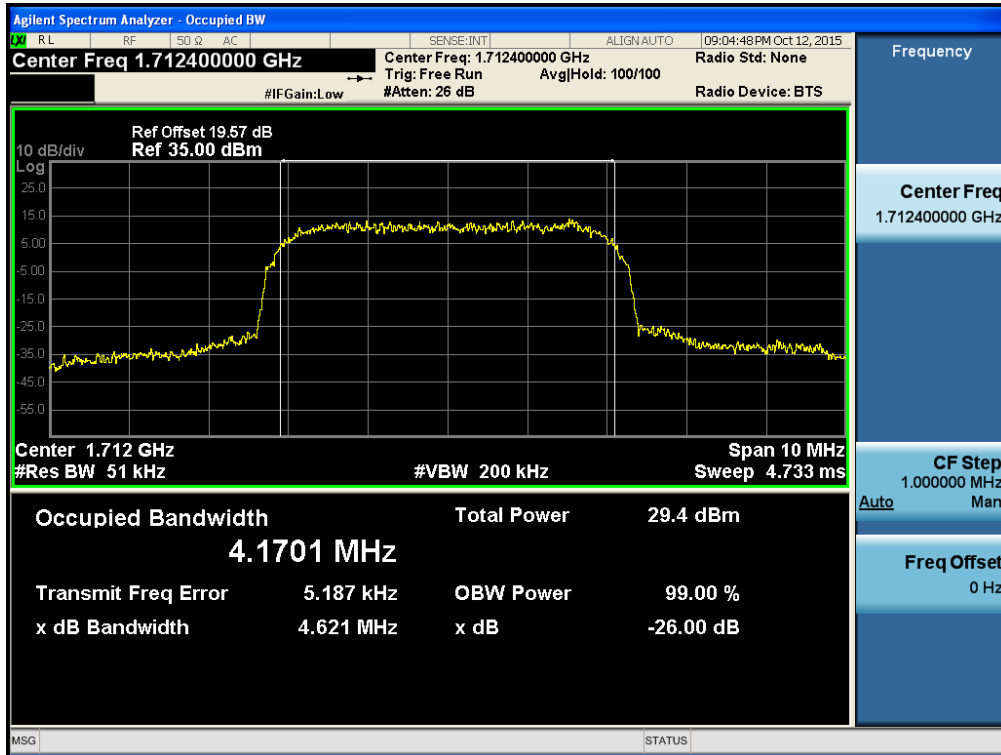

HSUPA1700 & Channel: 1412

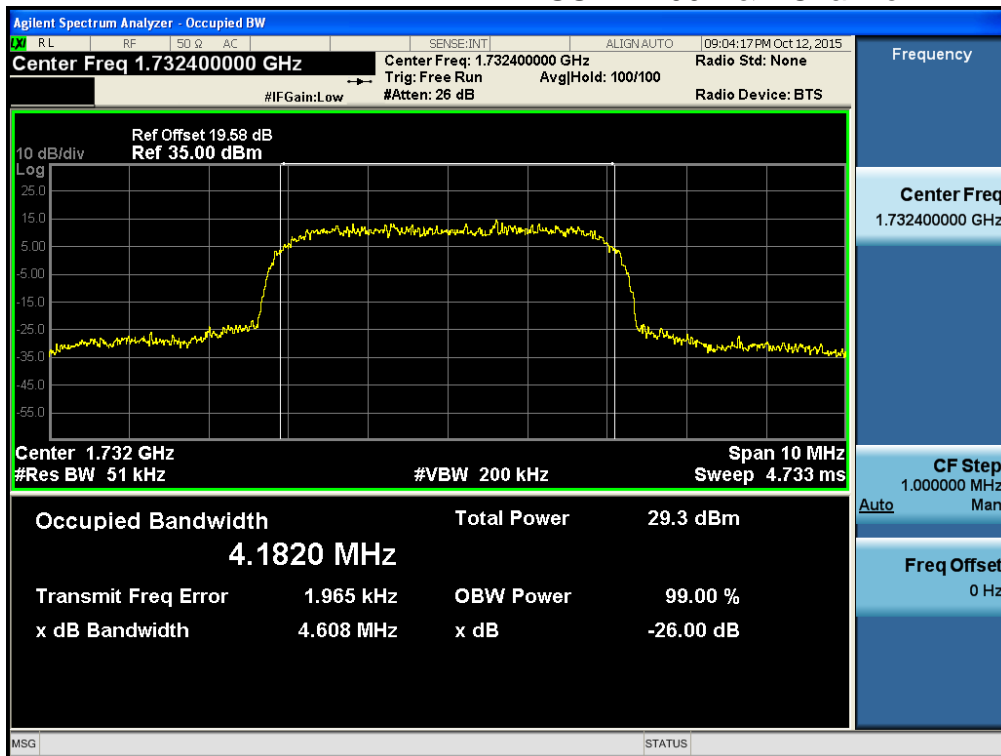

HSUPA1700 & Channel: 1513

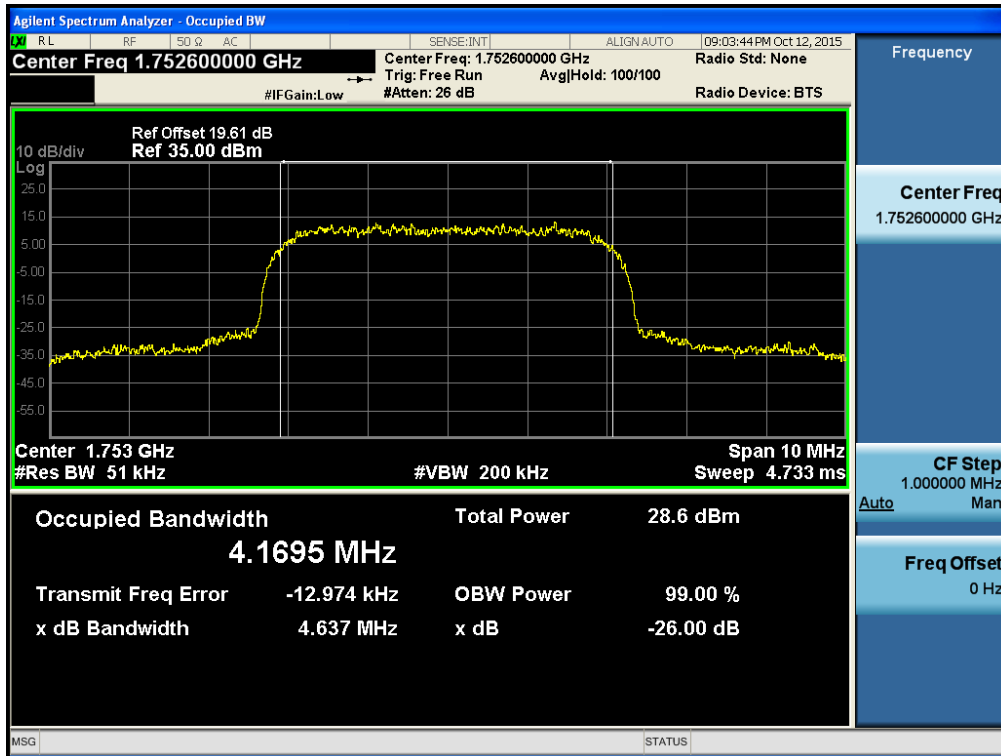

GSM 1900 & Channel: 512

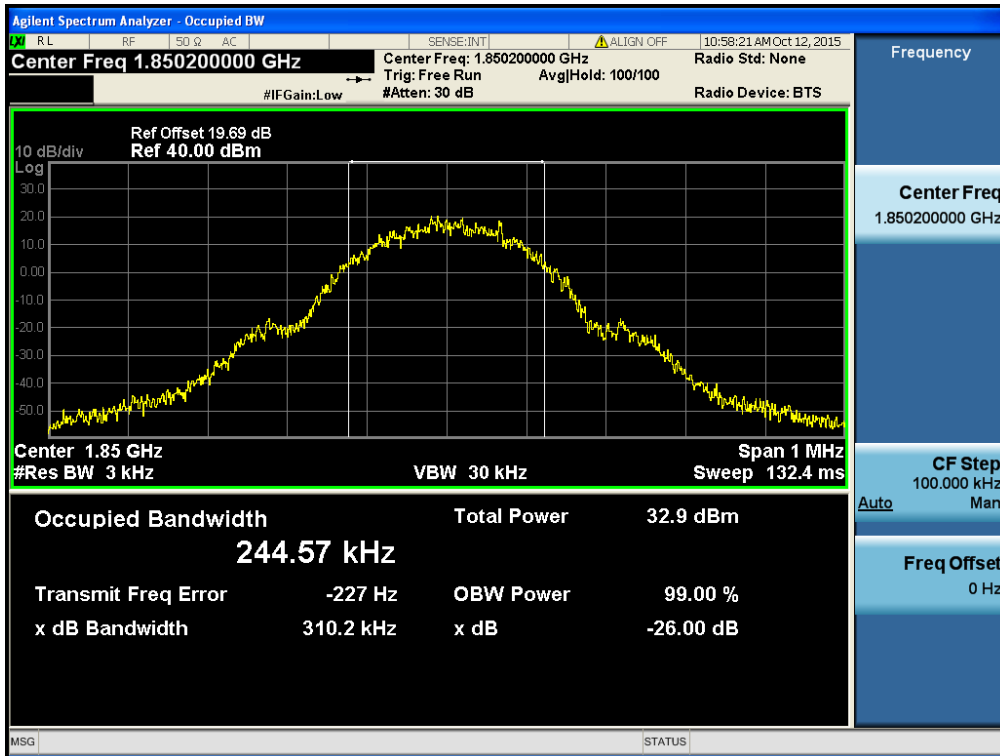

GSM 1900 & Channel: 661

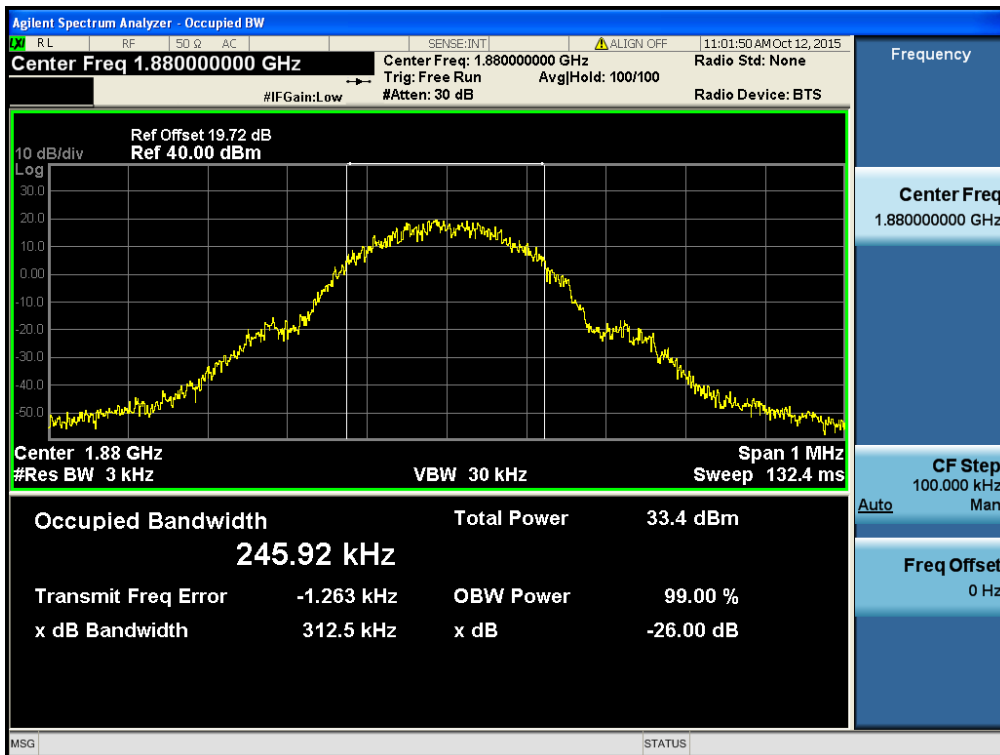

GSM 1900 & Channel: 810

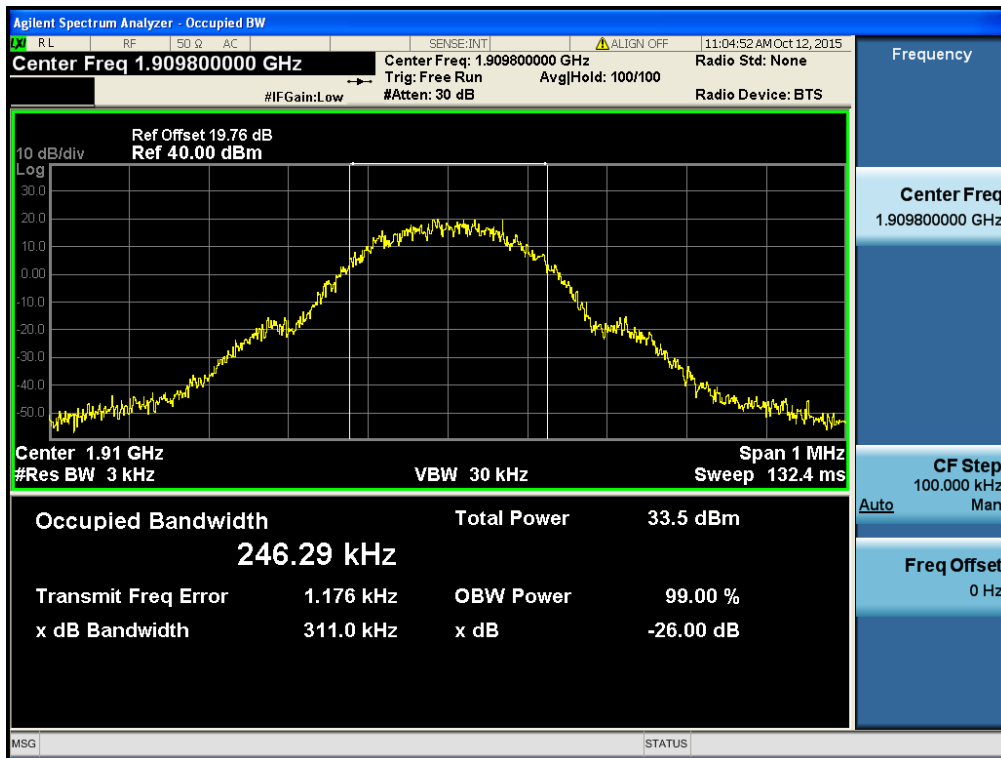

EDGE 1900 & Channel: 512

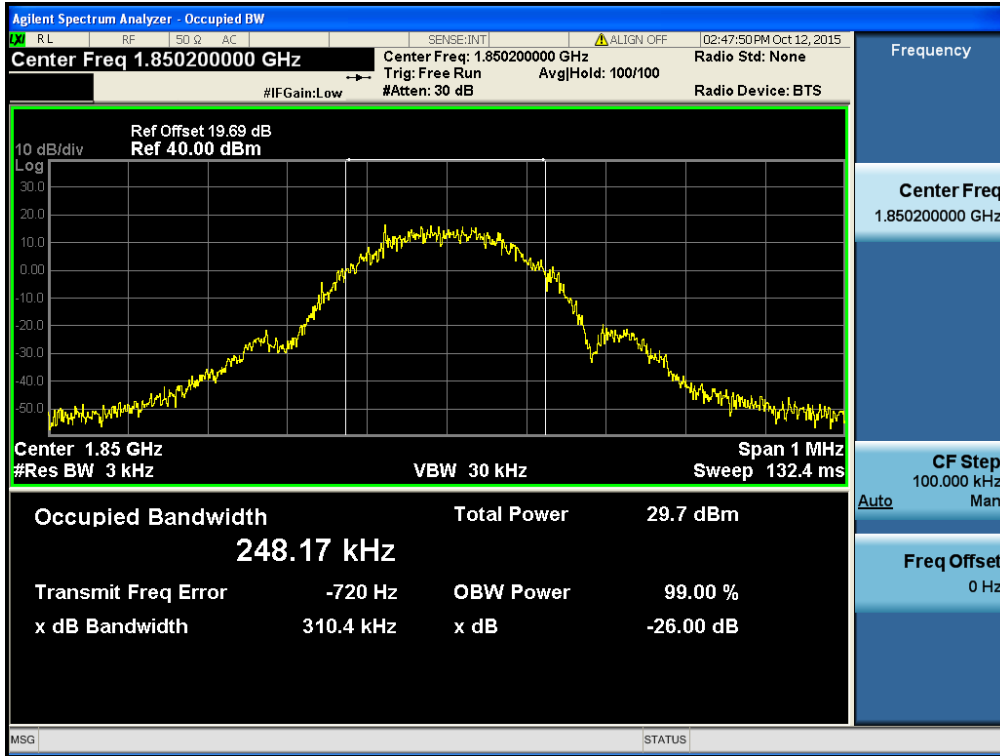

EDGE 1900 & Channel: 661

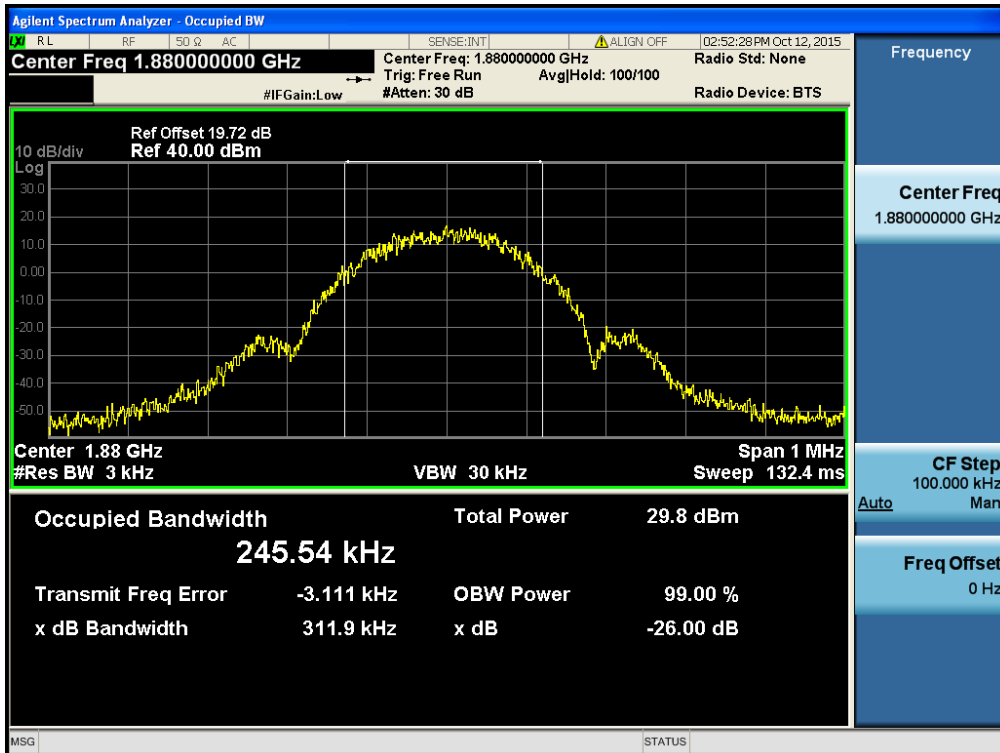

EDGE 1900 & Channel: 810

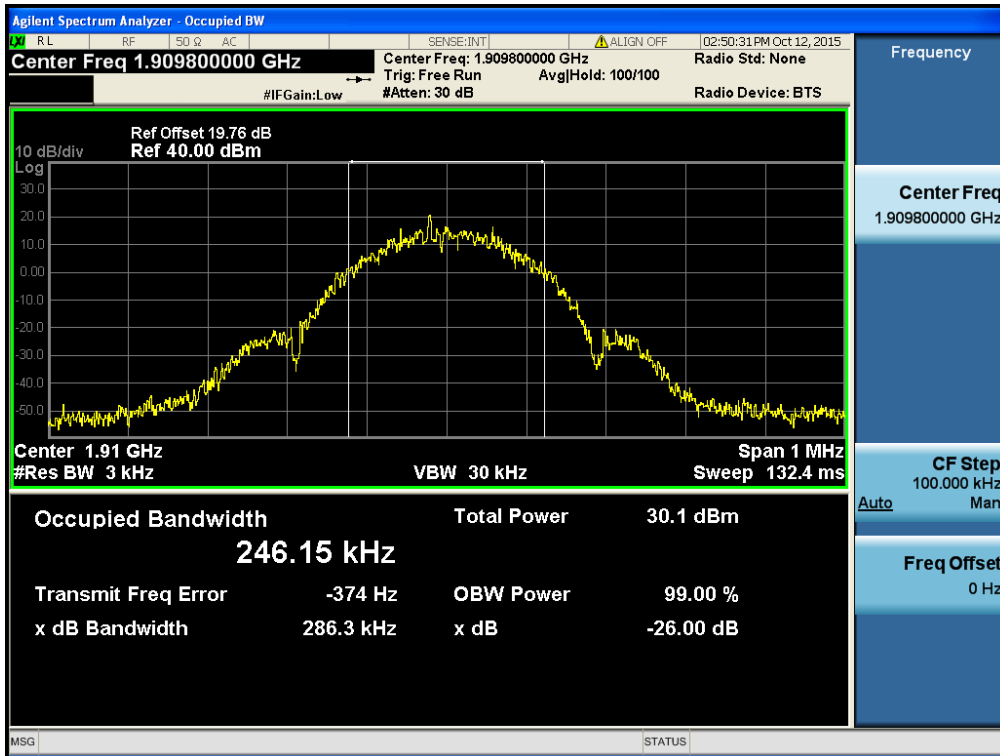

WCDMA1900 & Channel: 9262

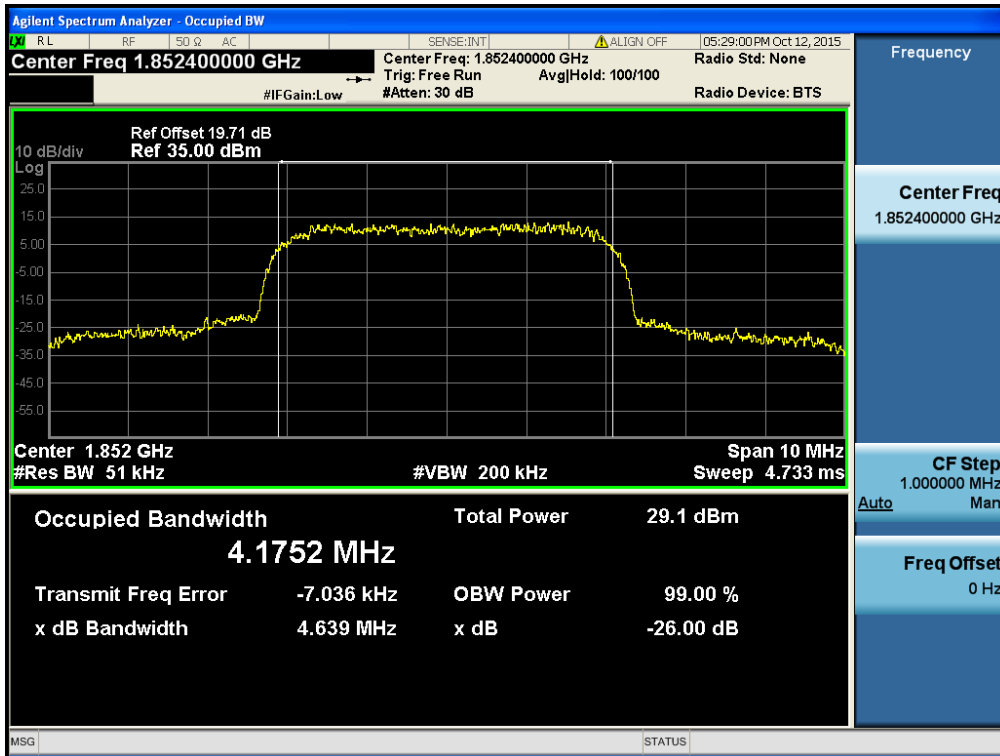

WCDMA1900 & Channel: 9400

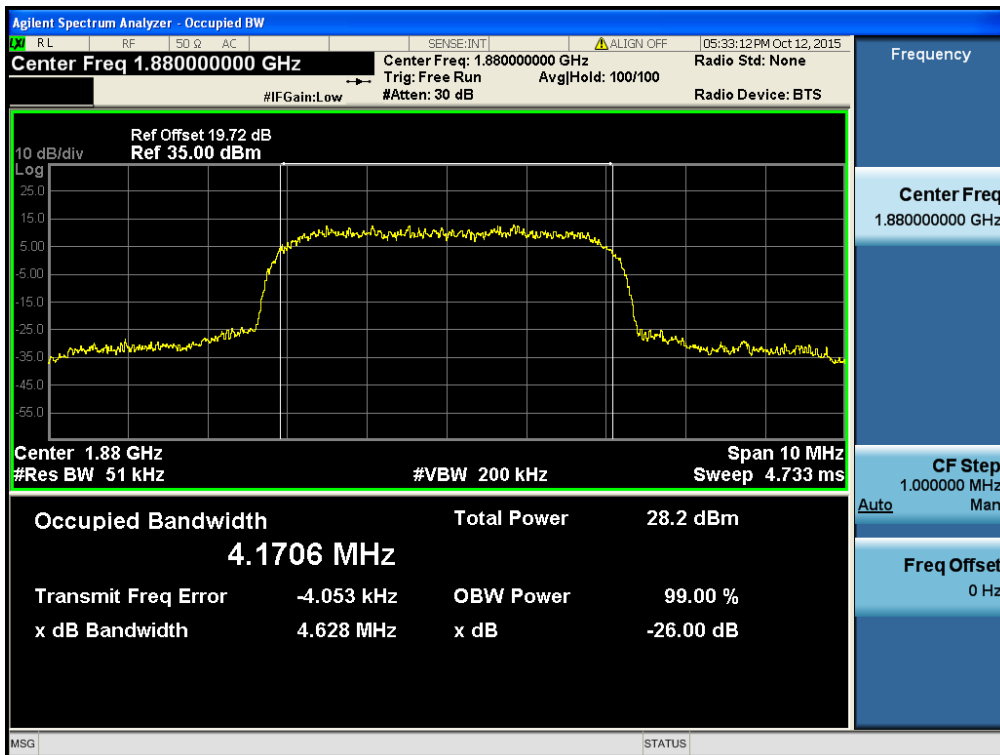

WCDMA1900 & Channel: 9538

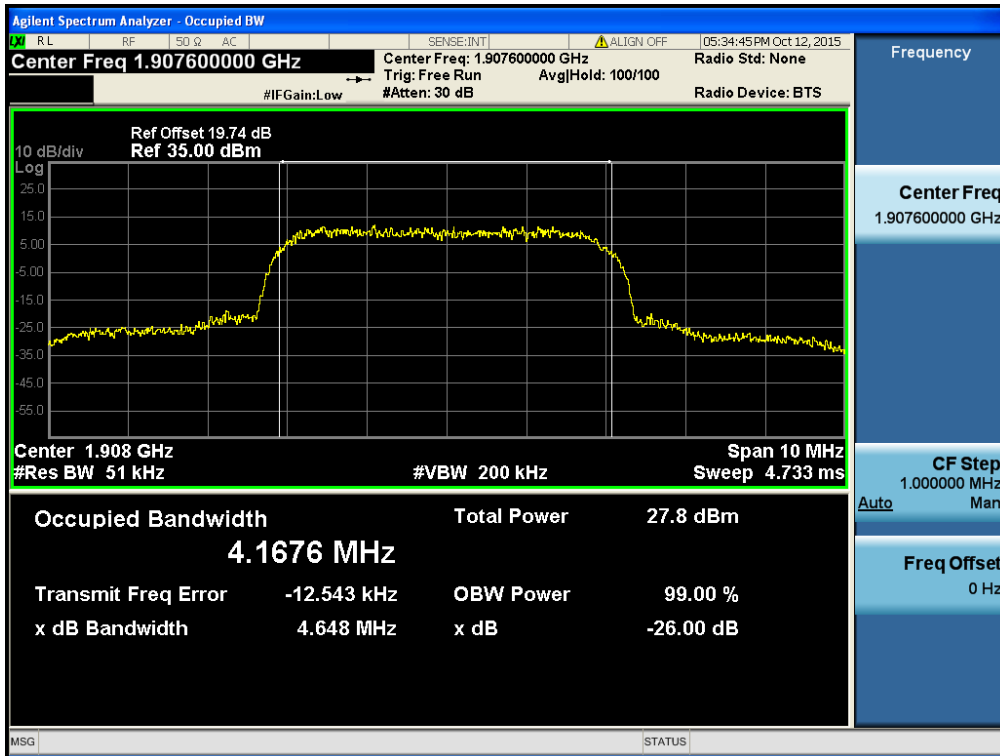

HSUPA1900 & Channel: 9262

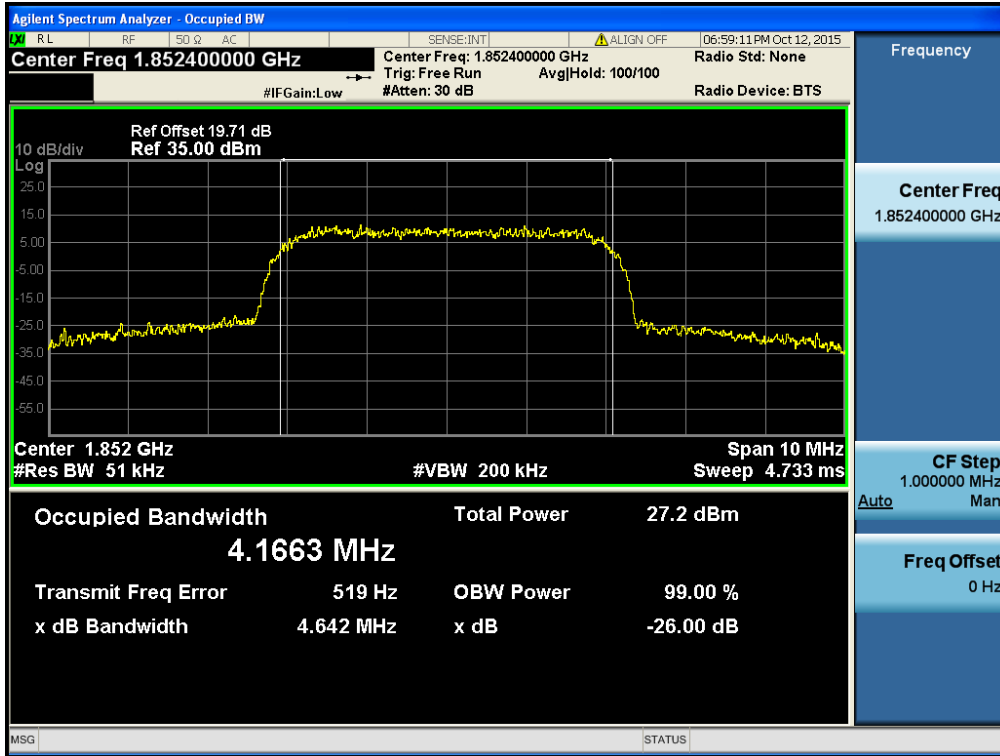

HSUPA1900 & Channel: 9400

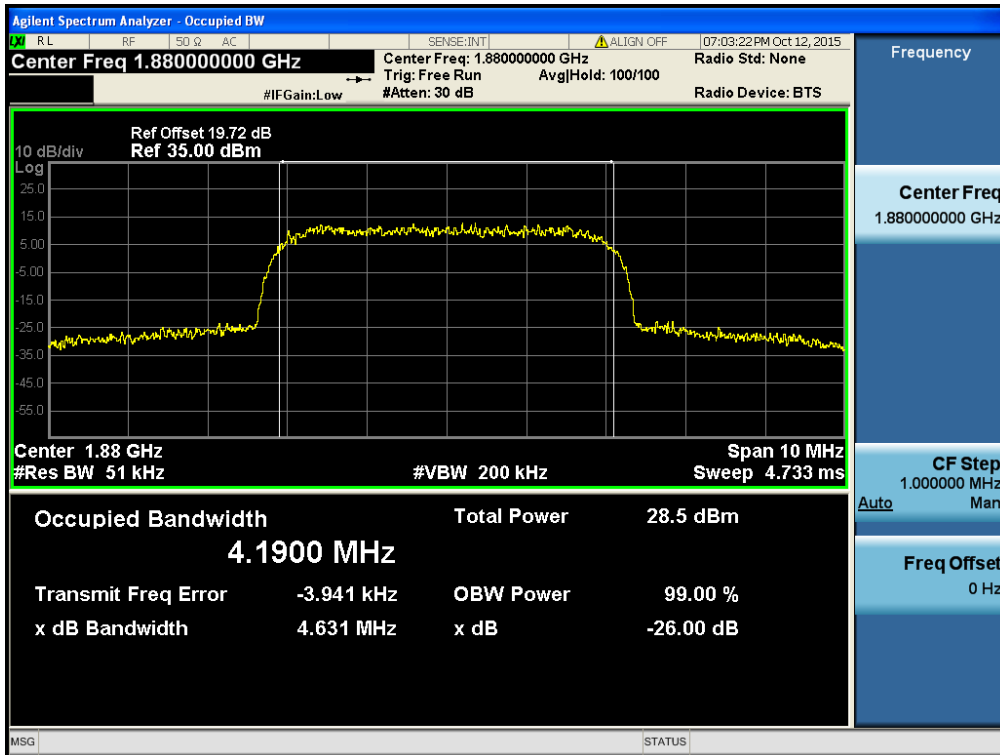

HSUPA1900 & Channel: 9538

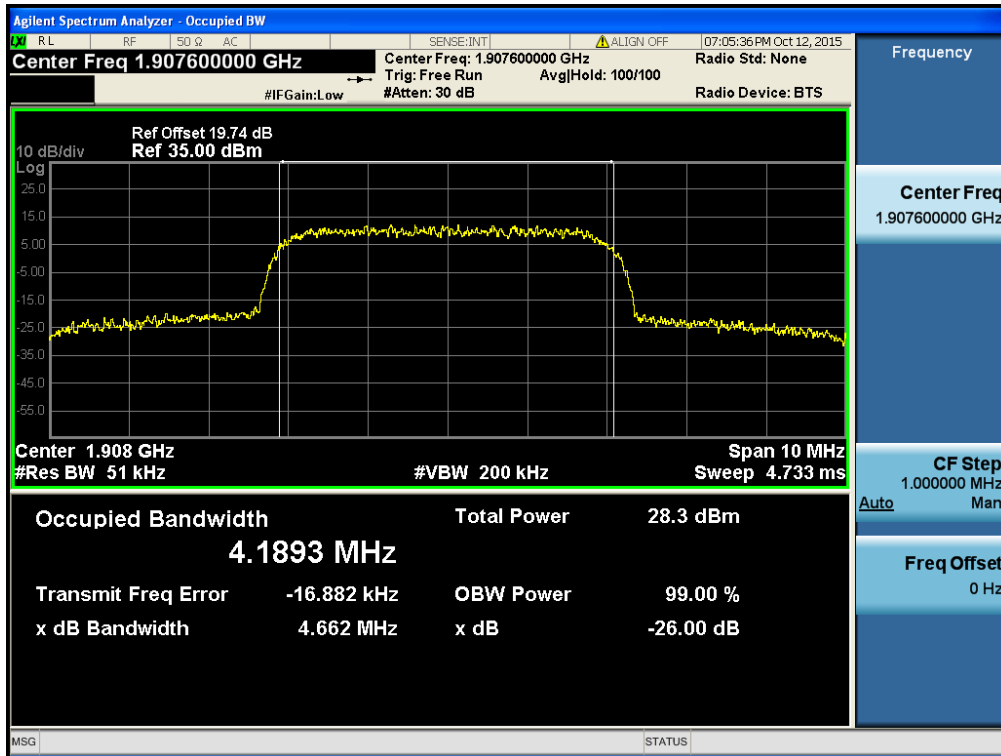

8.3 Spurious Emissions at Antenna Terminal

GSM850 & Channel: 128

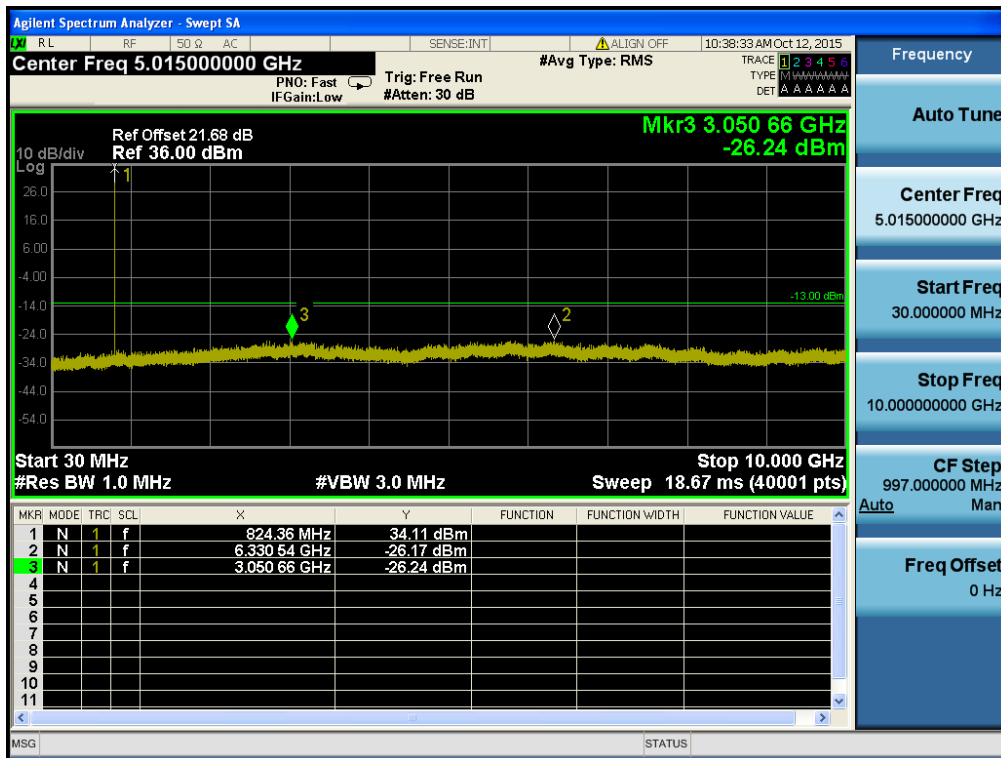

GSM850 & Channel: 190

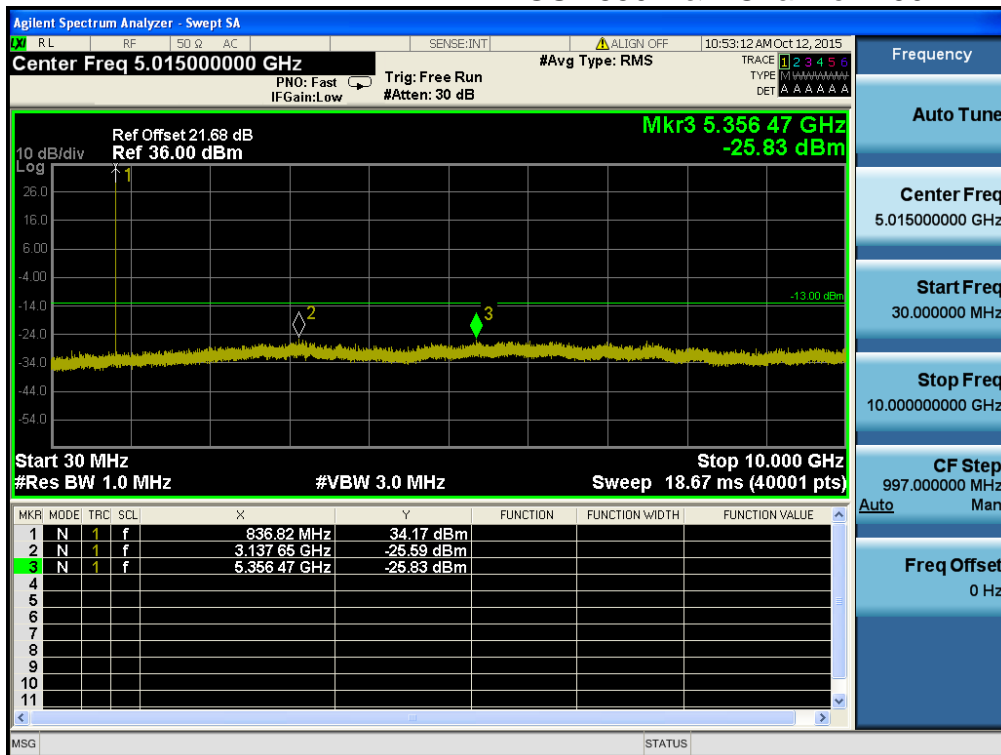

GSM850 & Channel: 251

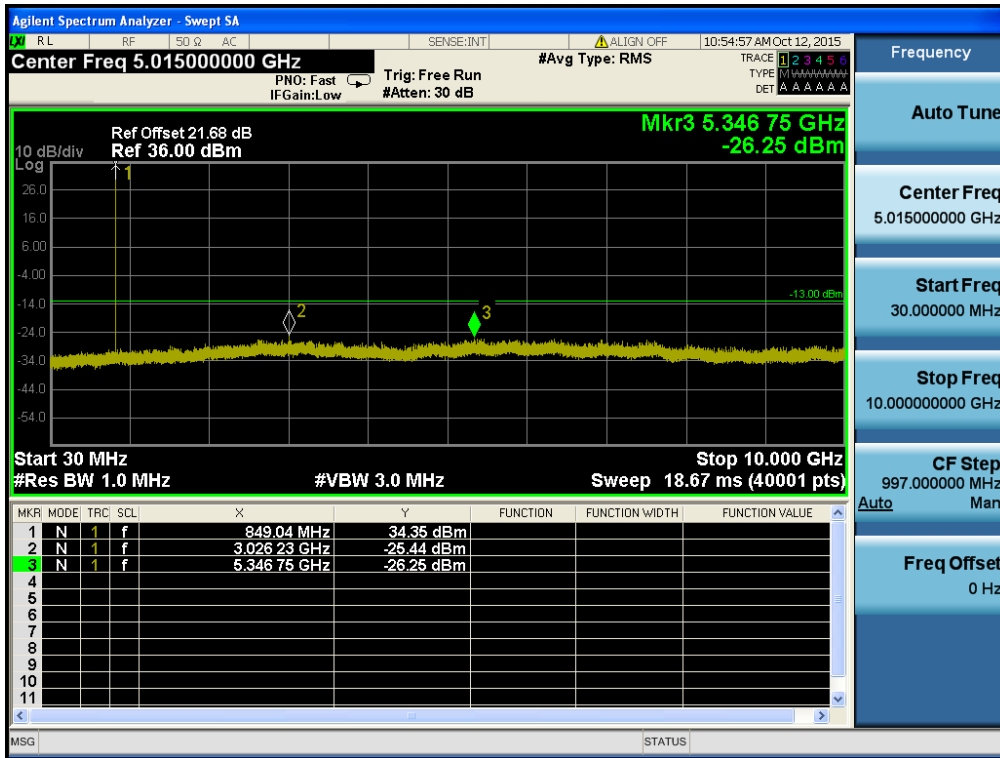

WCDMA850 & Channel: 4132

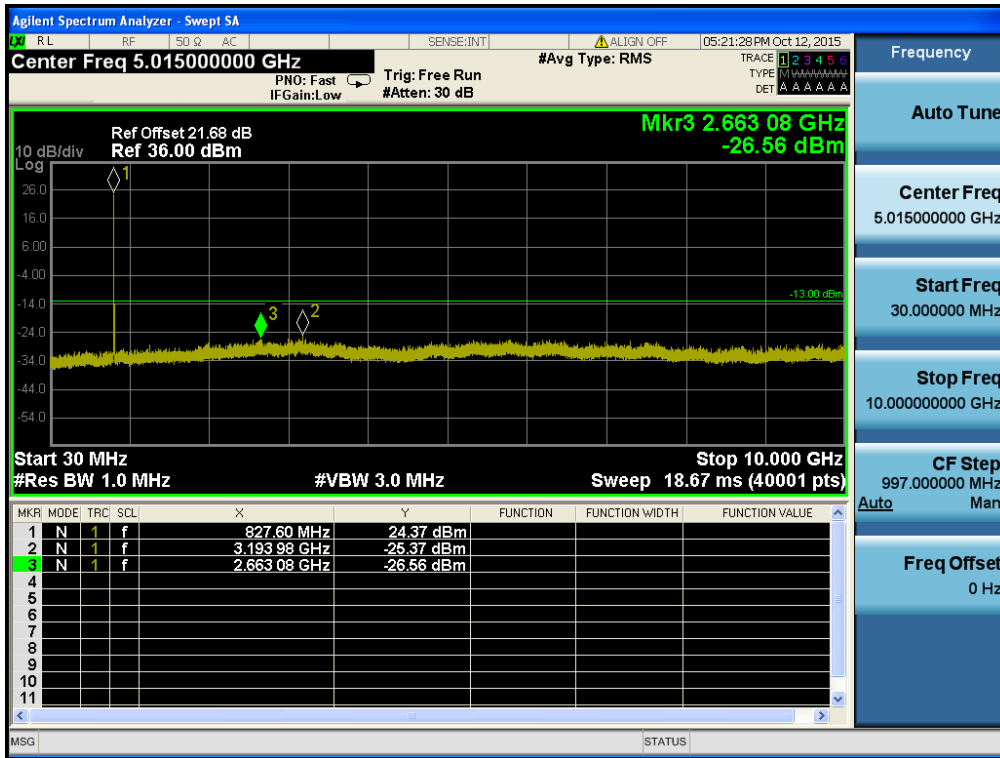

WCDMA850 & Channel: 4183

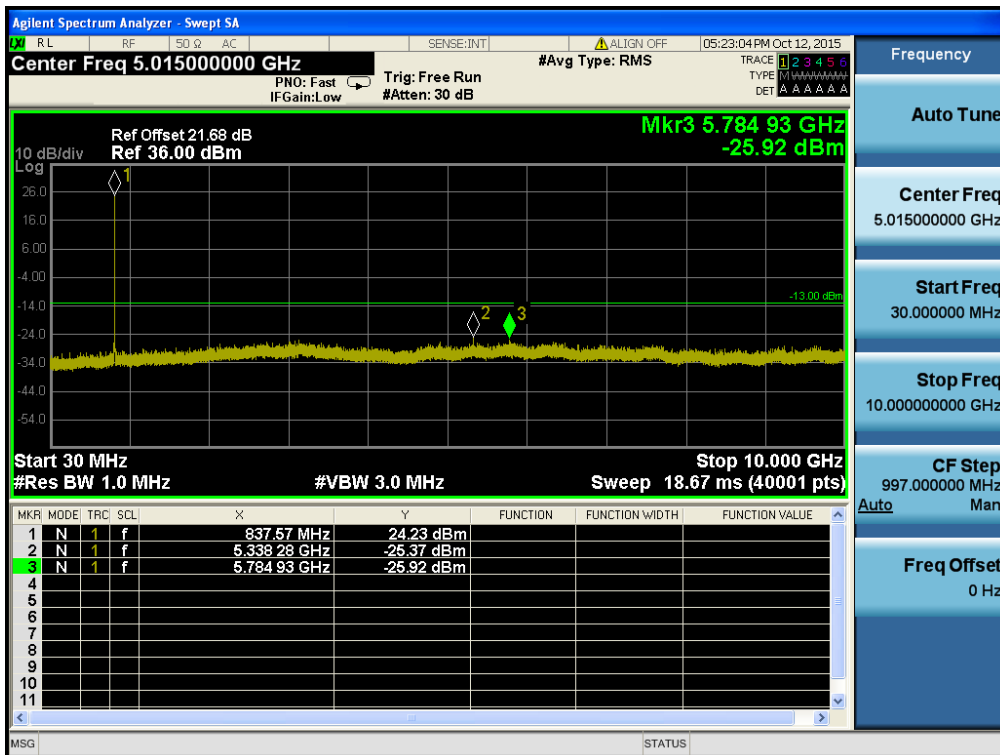

WCDMA850 & Channel: 4233

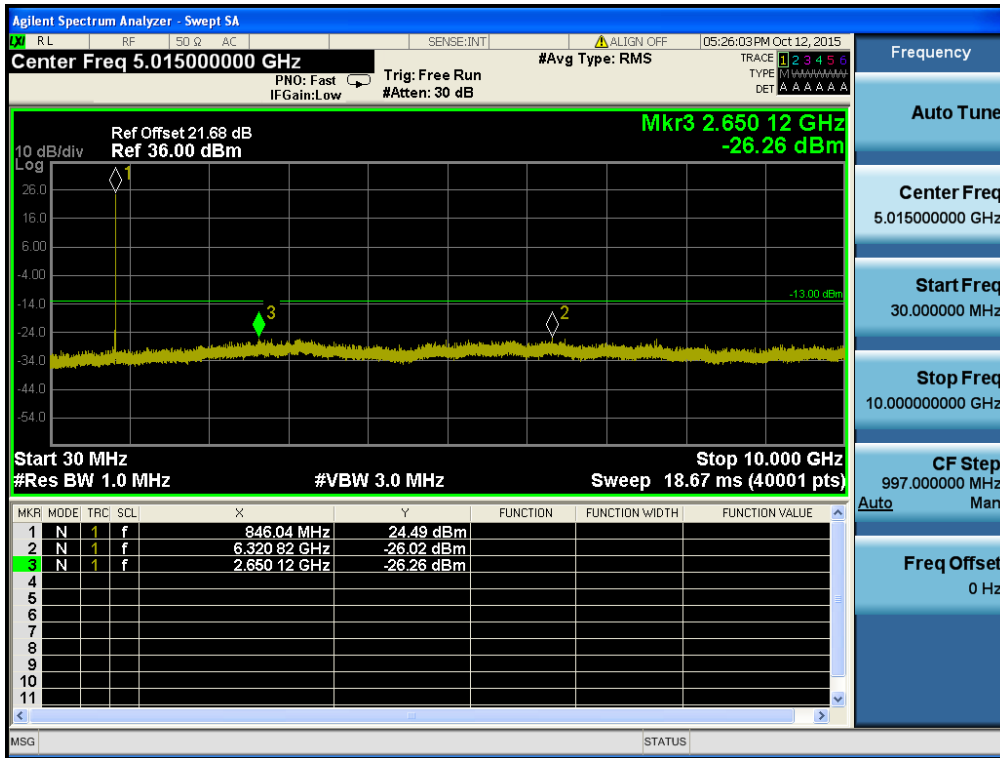

HSUPA850 & Channel: 4132

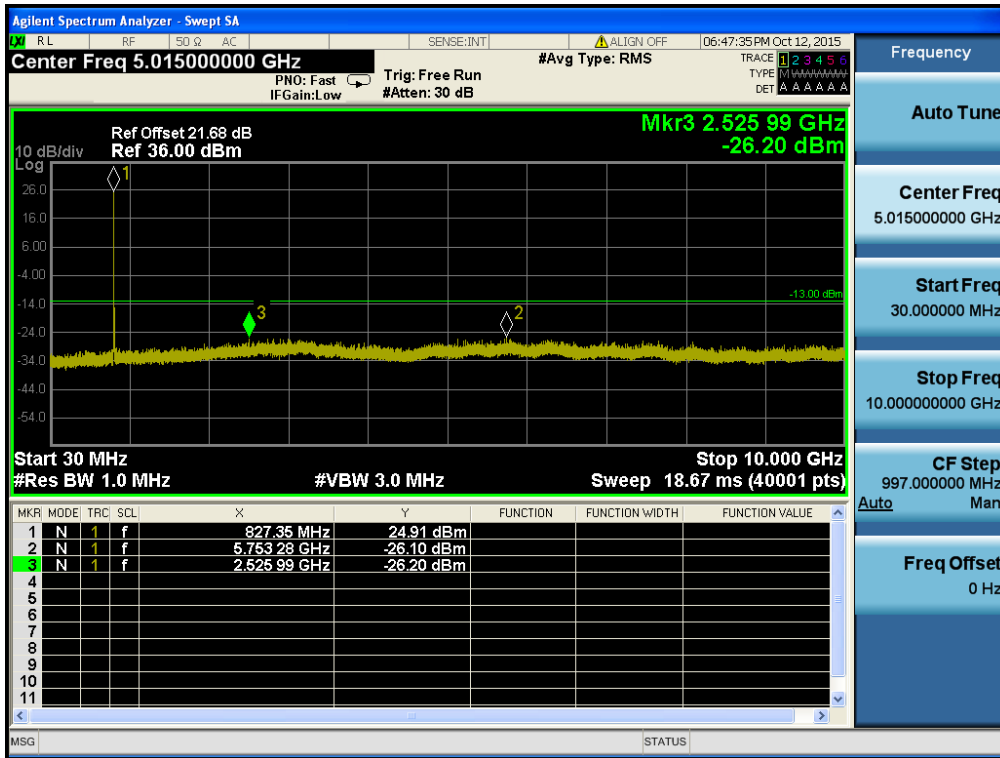

HSUPA850 & Channel: 4183

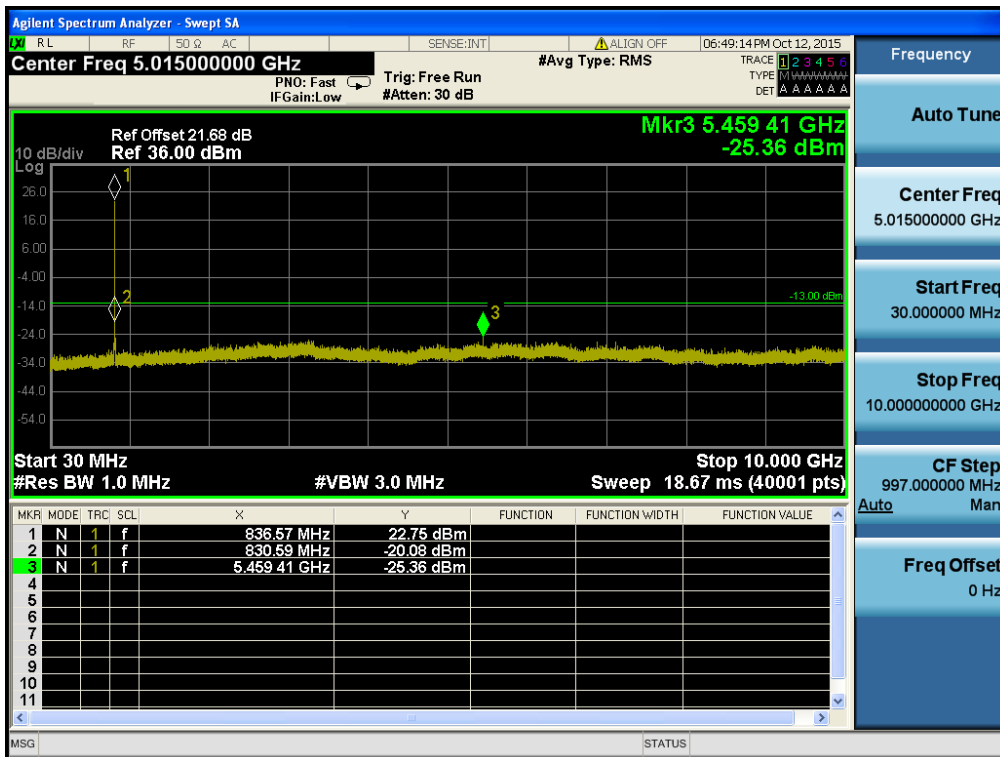

HSUPA850 & Channel: 4233

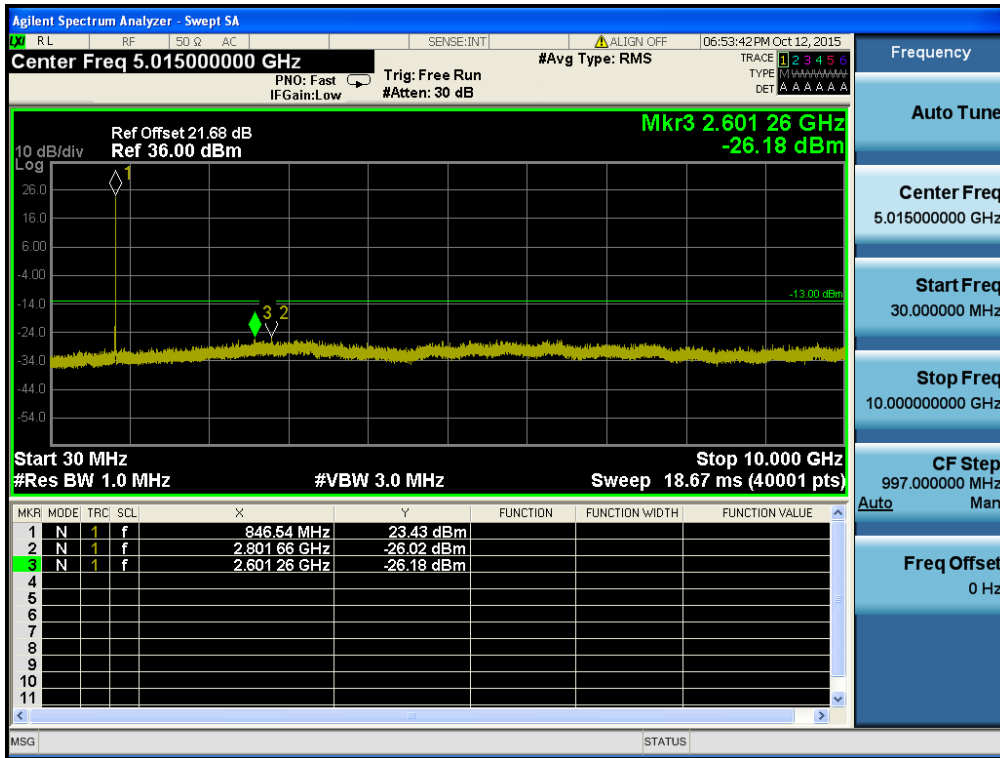

WCDMA1700 & Channel: 1312

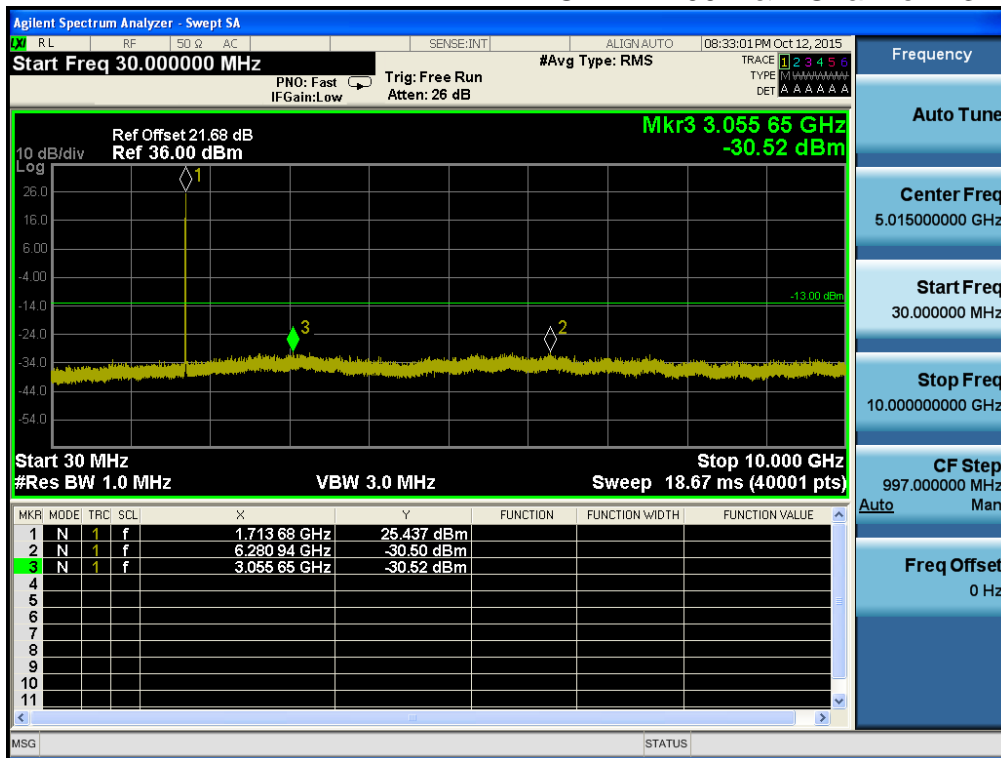

WCDMA1700 & Channel: 1312

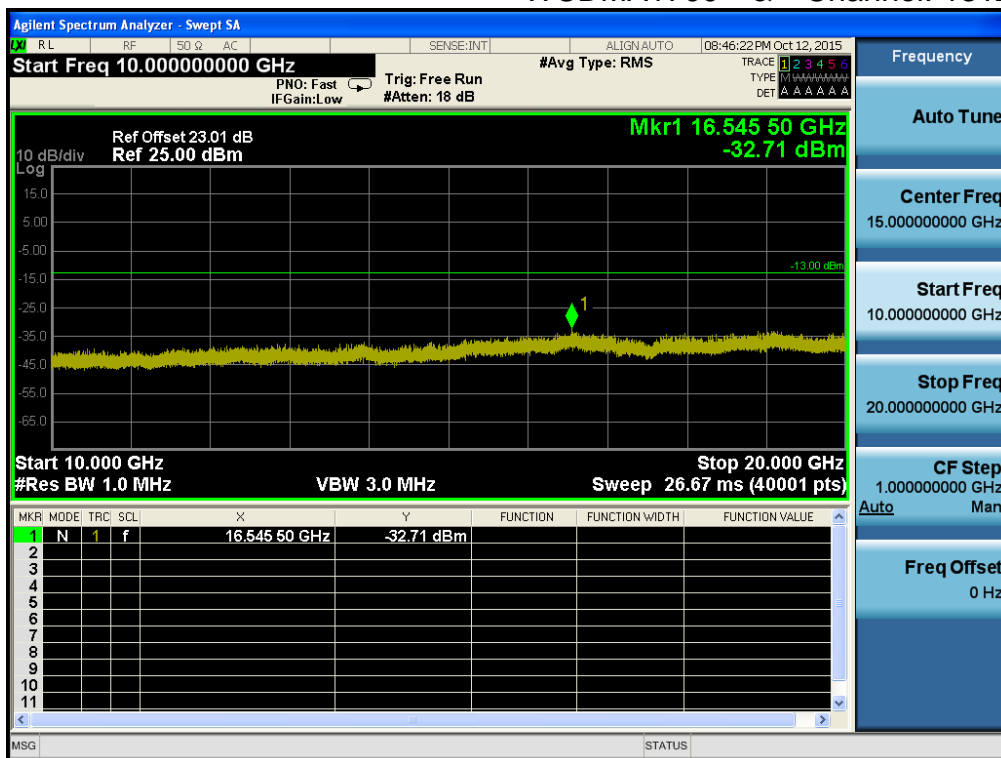

WCDMA1700 & Channel: 1412

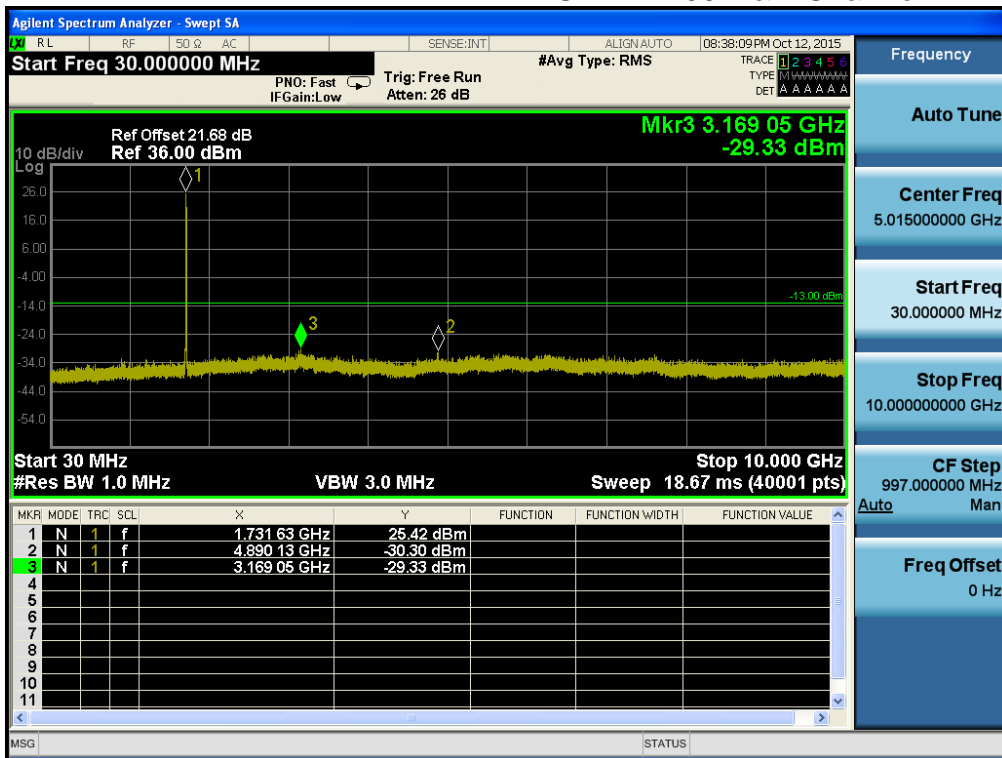

WCDMA1700 & Channel: 1412

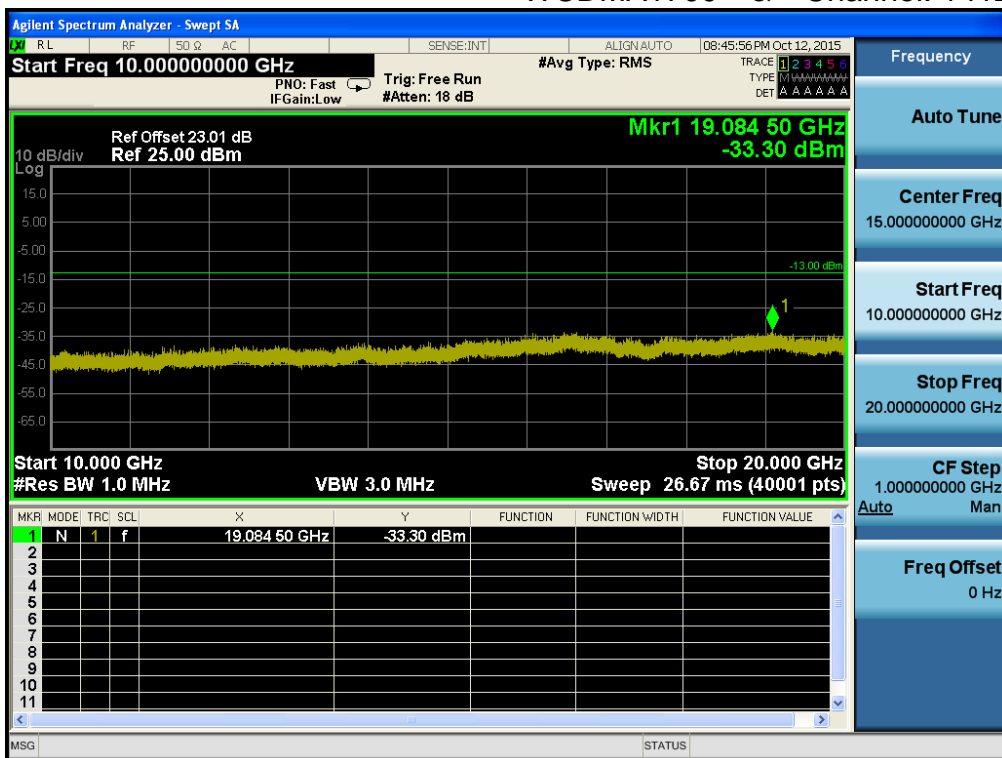

WCDMA1700 & Channel: 1513

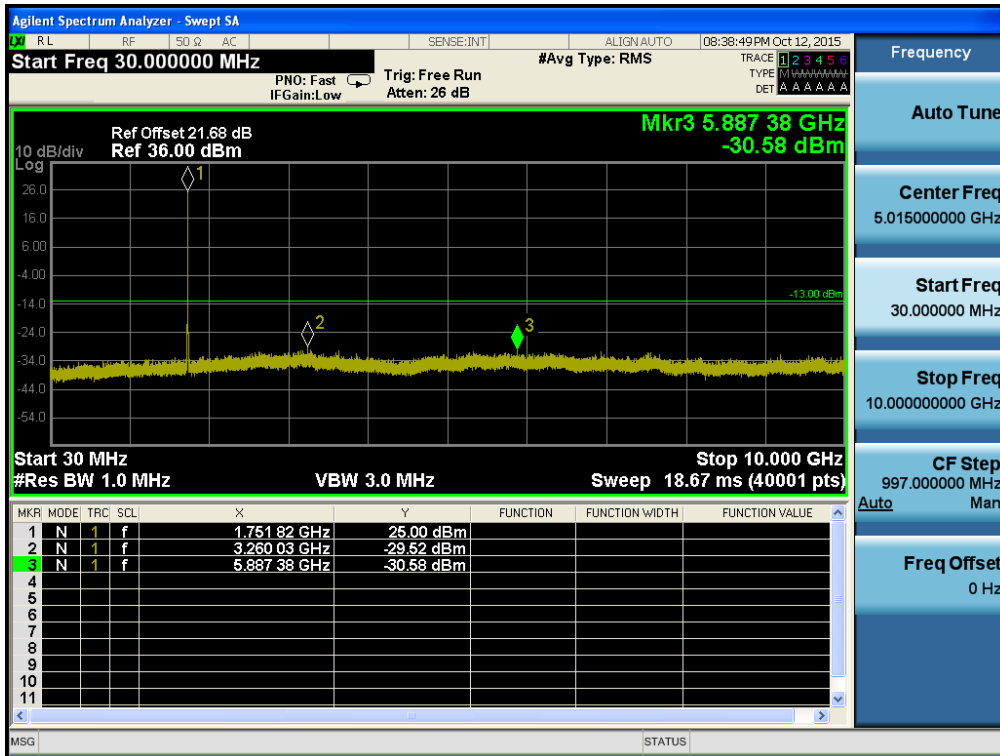

WCDMA1700 & Channel: 1513

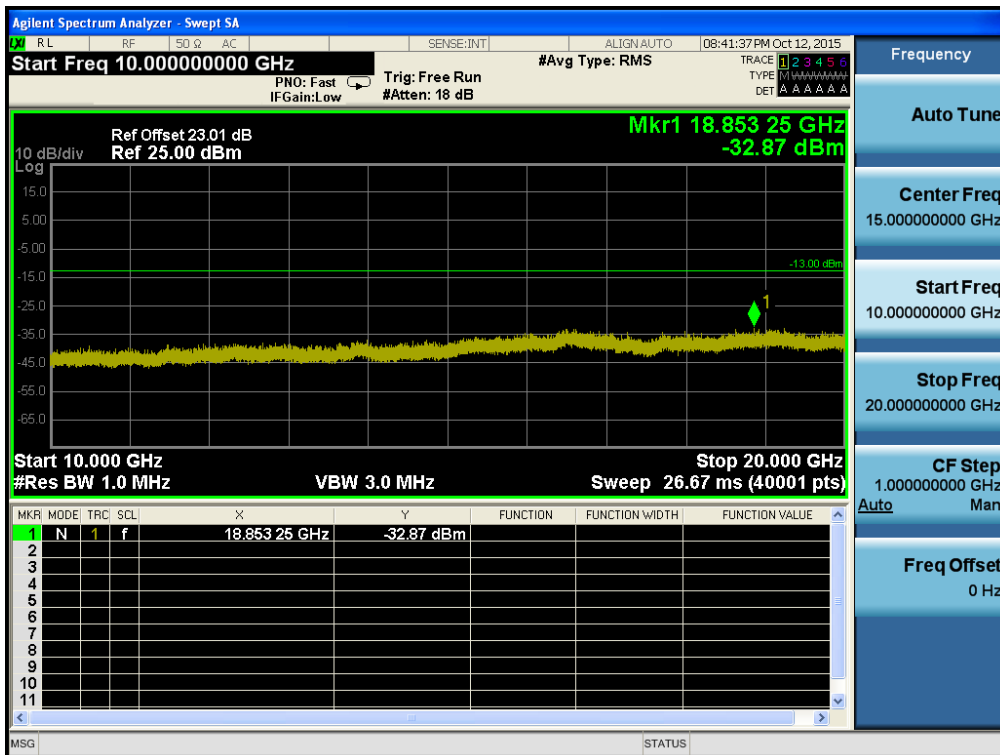

HSUPA1700 & Channel: 1312

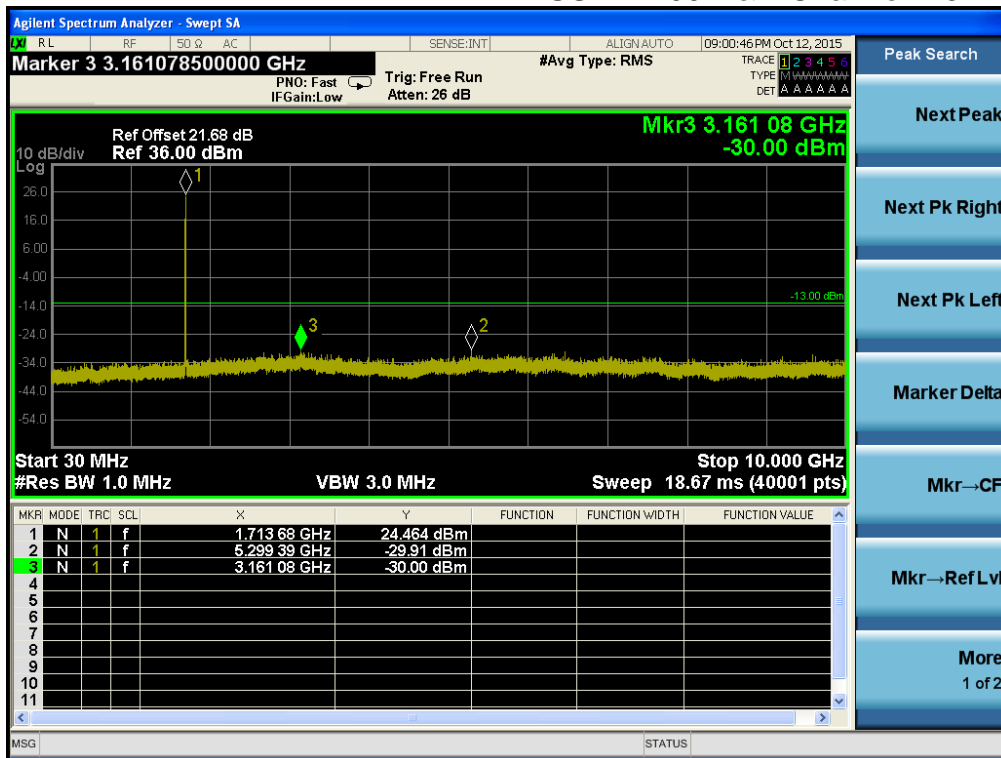

HSUPA 1700 & Channel: 1312

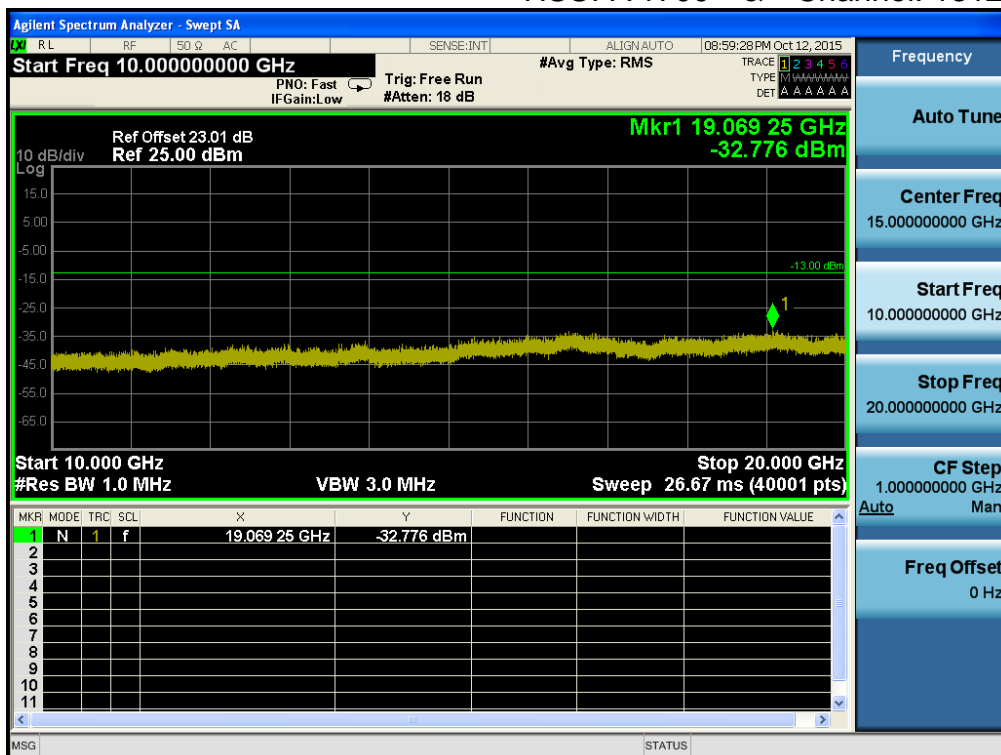

HSUPA1700 & Channel: 1412

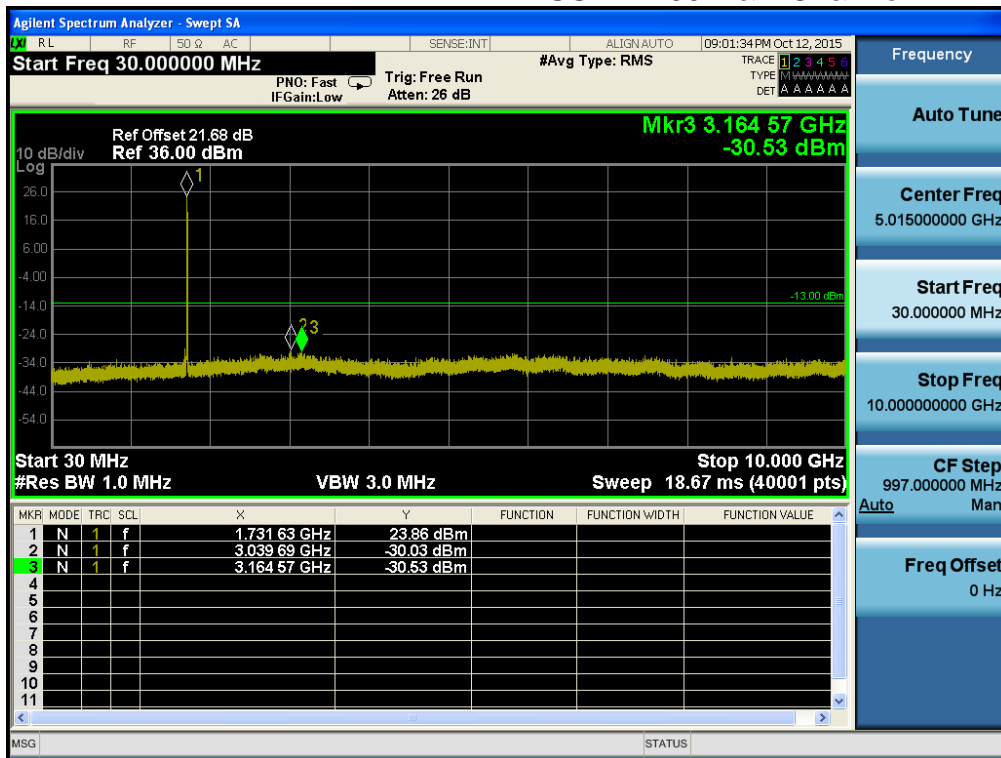

HSUPA1700 & Channel: 1412

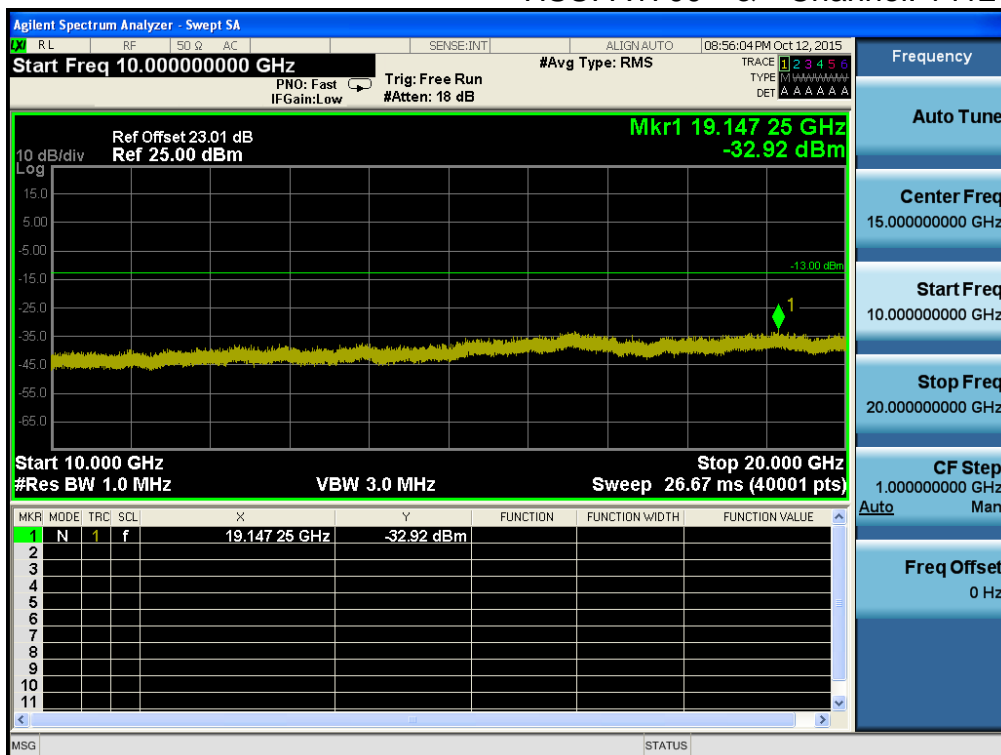

HSUPA1700 & Channel: 1513

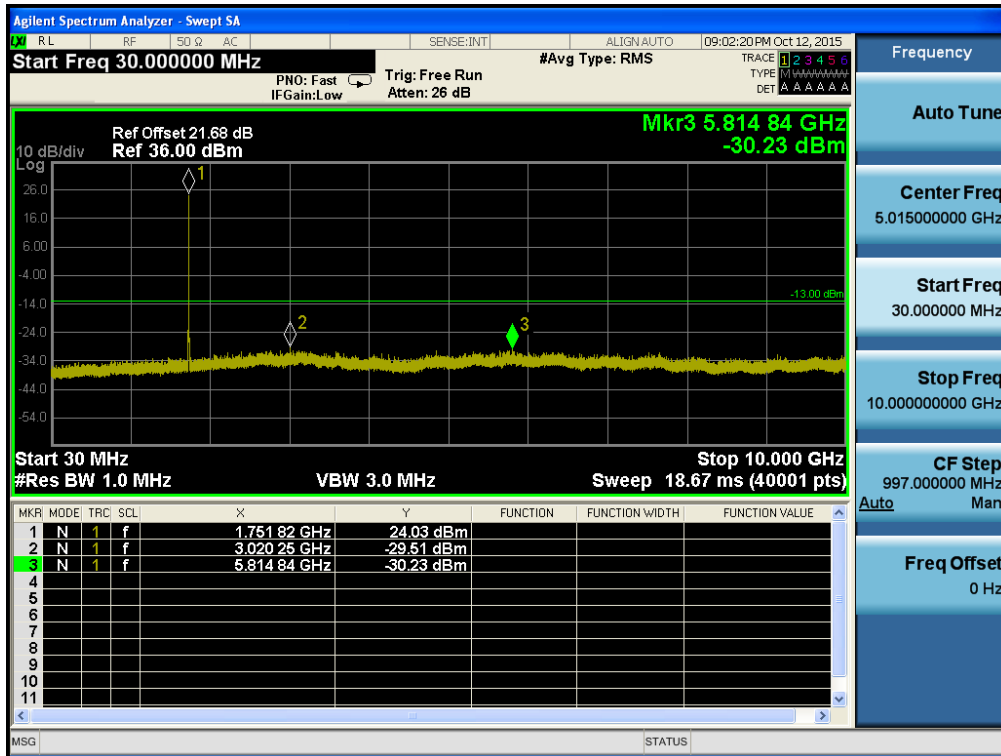

HSUPA1700 & Channel: 1513

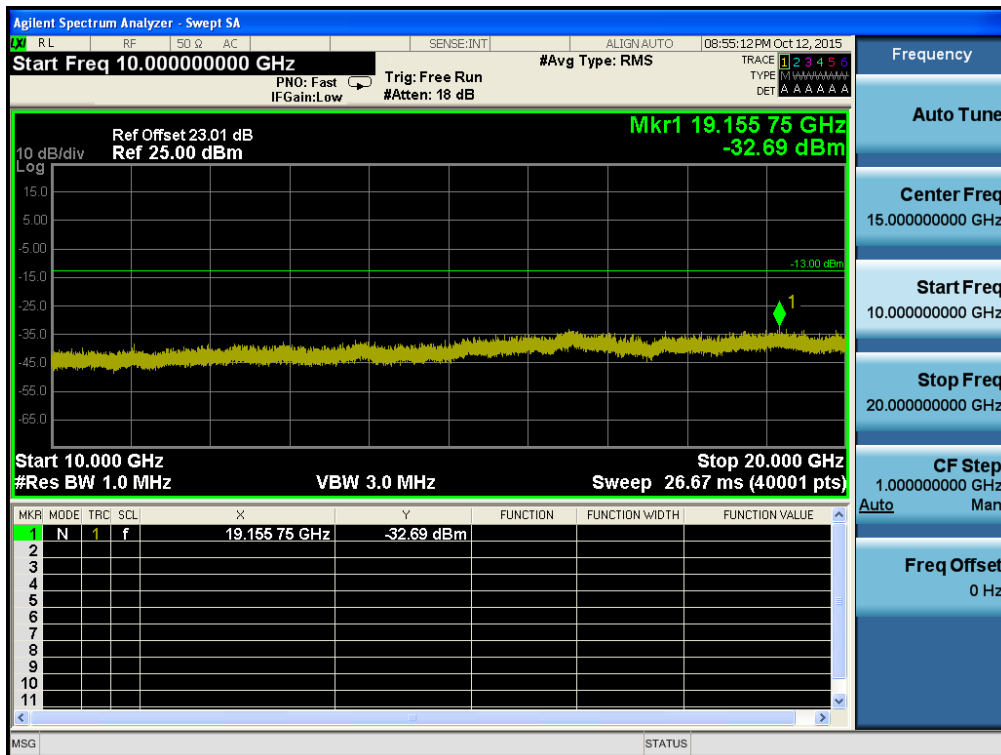

GSM1900 & Channel: 512

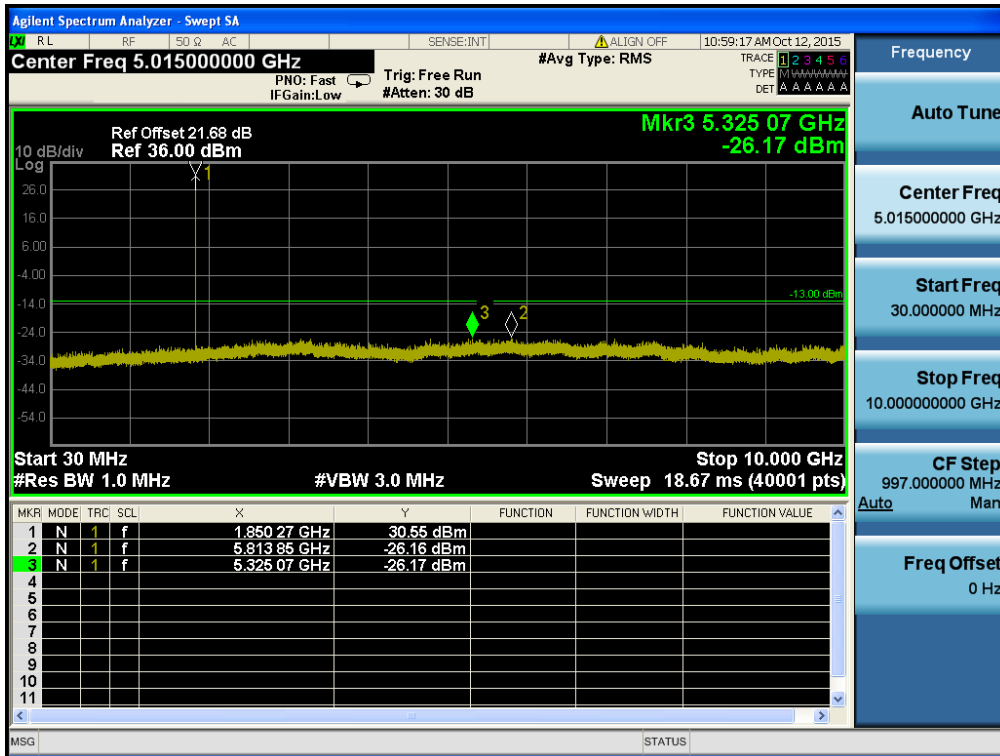

GSM1900 & Channel: 512

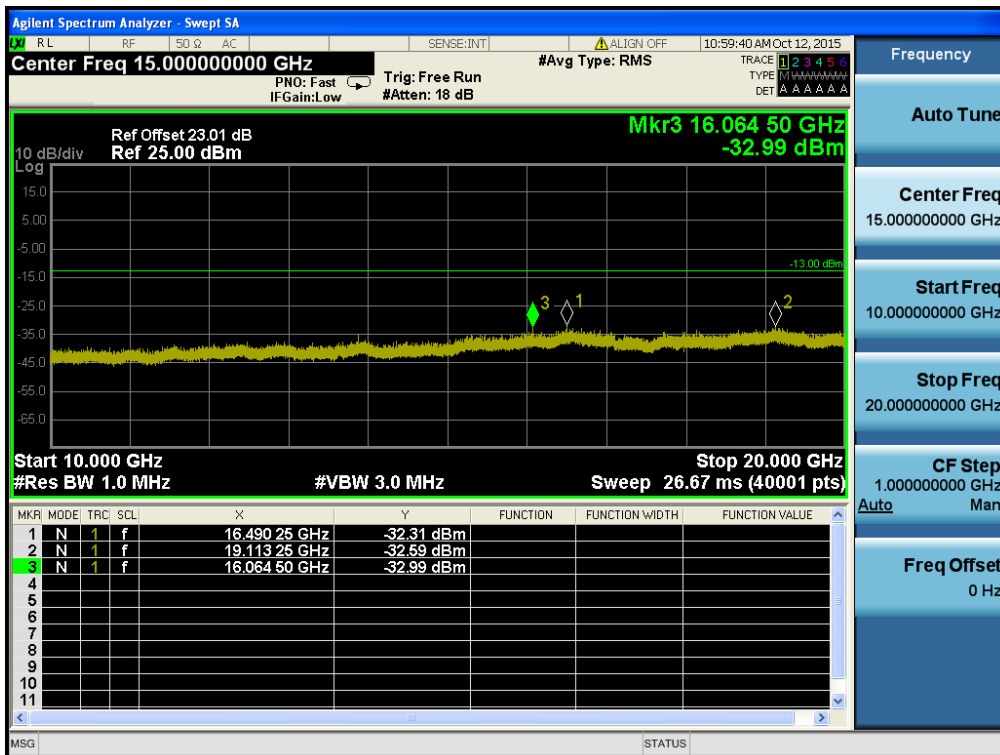

GSM1900 & Channel: 661

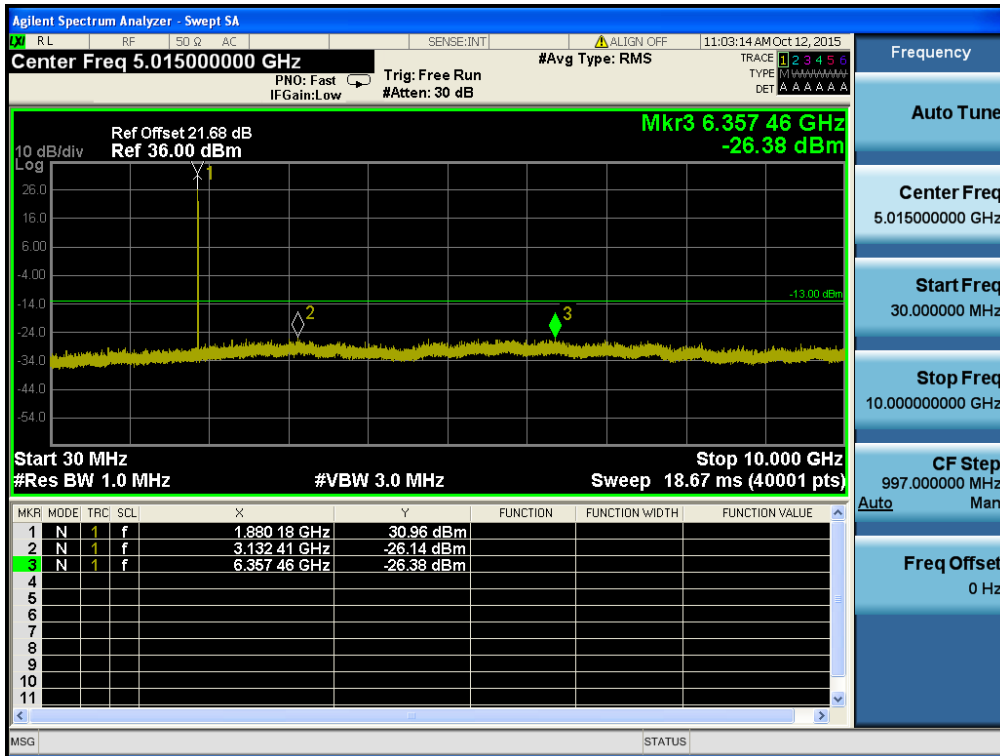

GSM1900 & Channel: 661

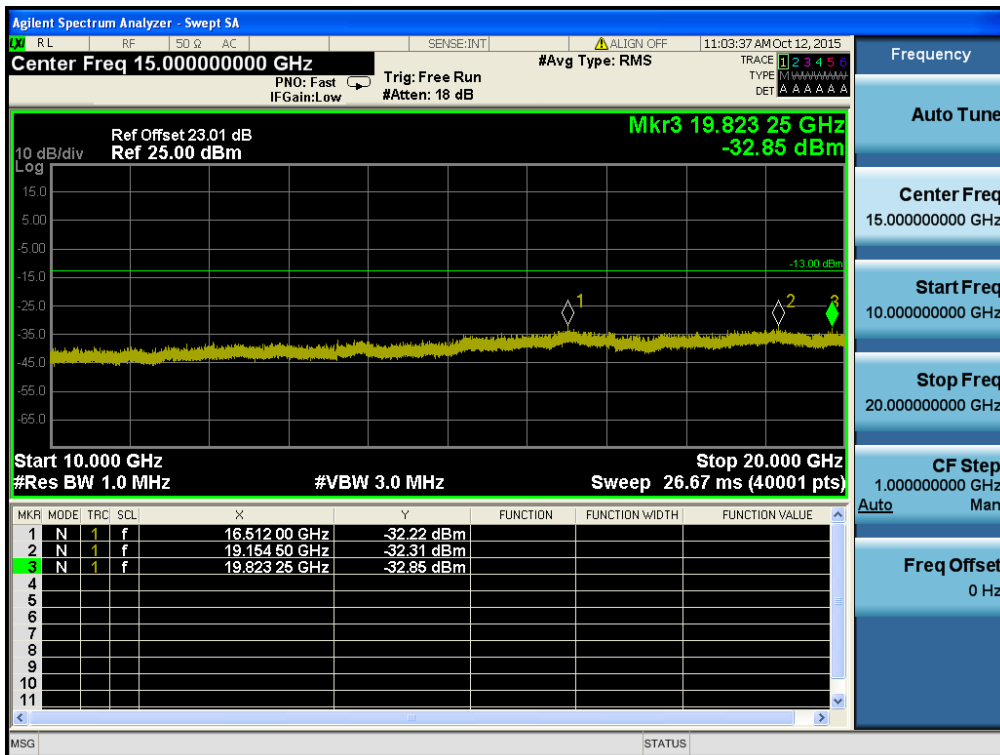

GSM1900 & Channel: 810

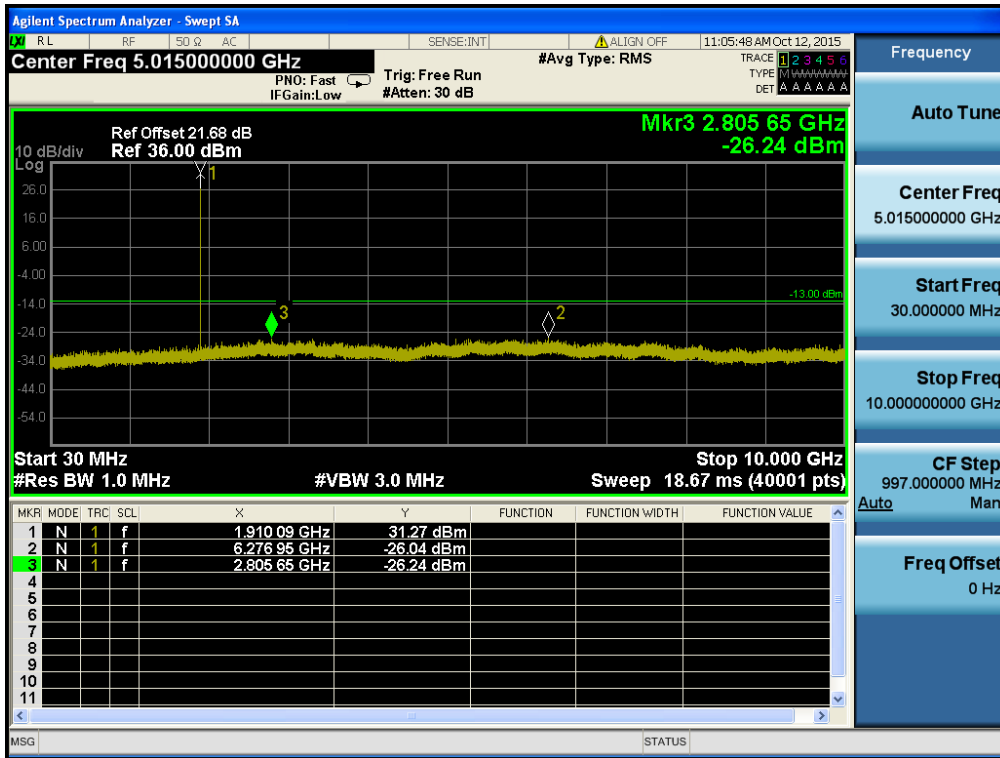

GSM1900 & Channel: 810

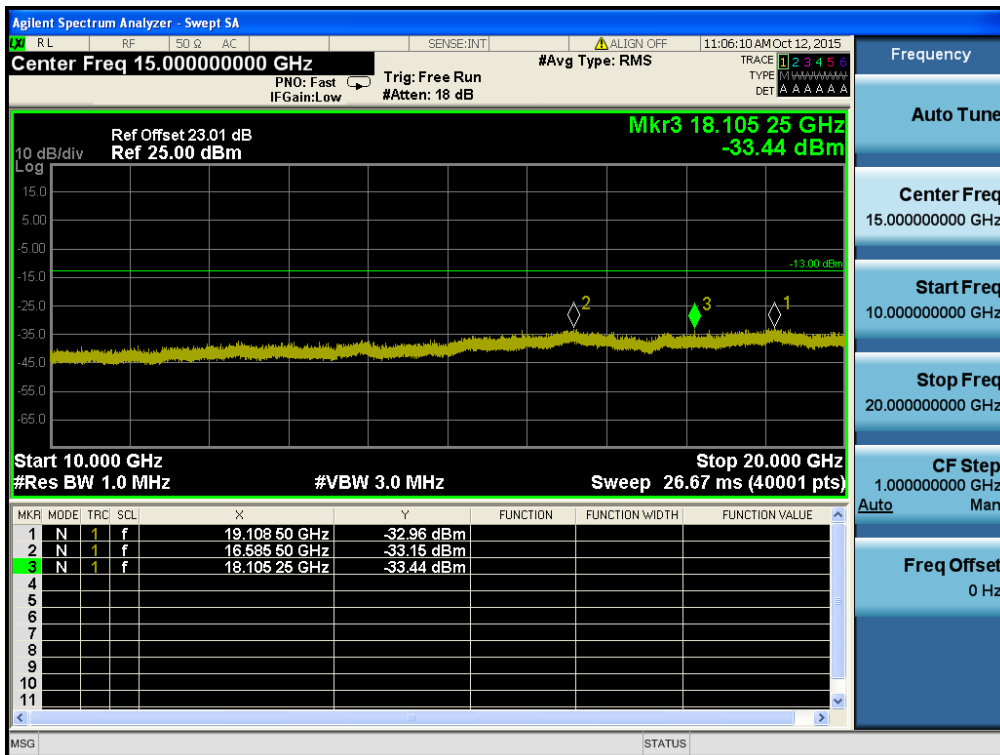

WCDMA1900 & Channel: 9262

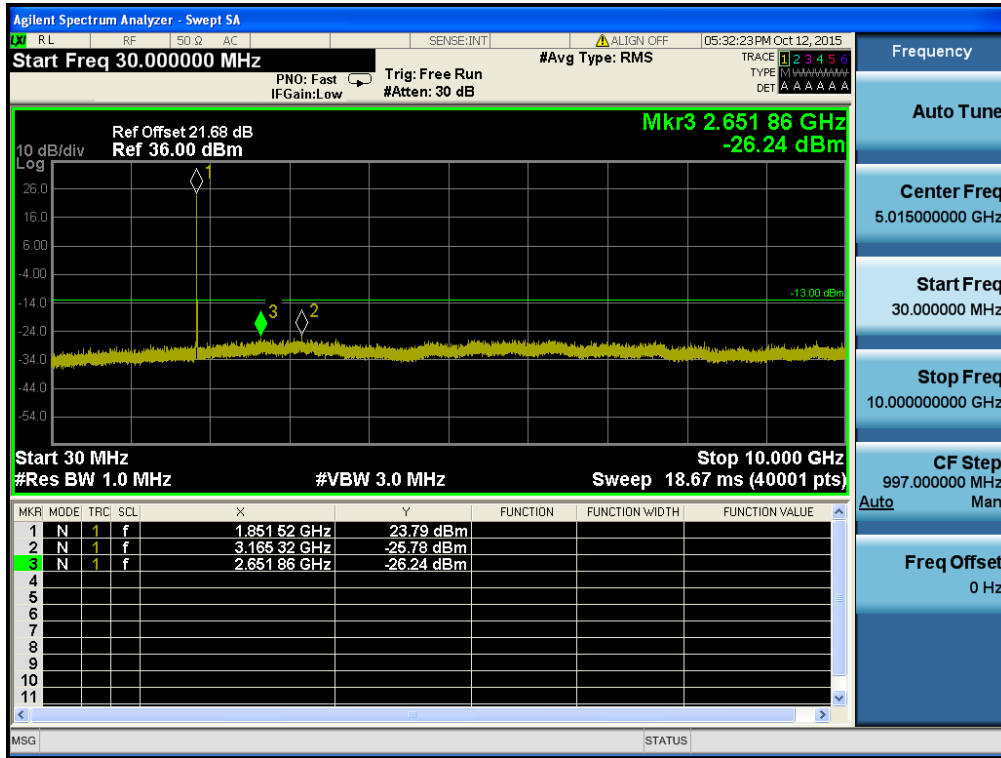

WCDMA1900 & Channel: 9262

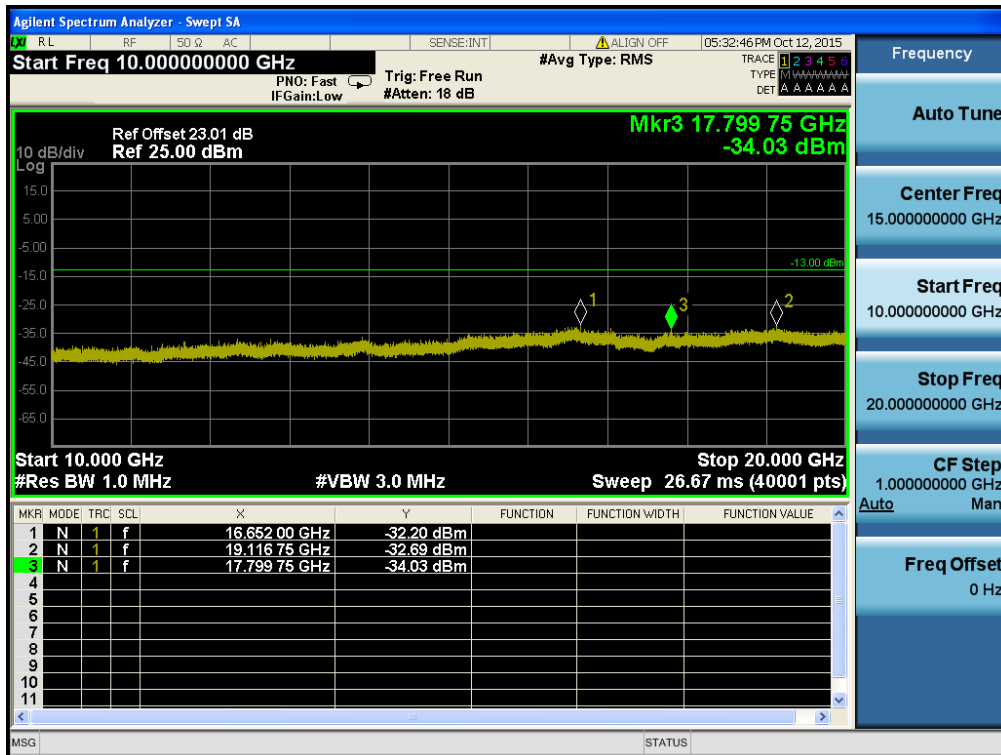

WCDMA1900 & Channel: 9400

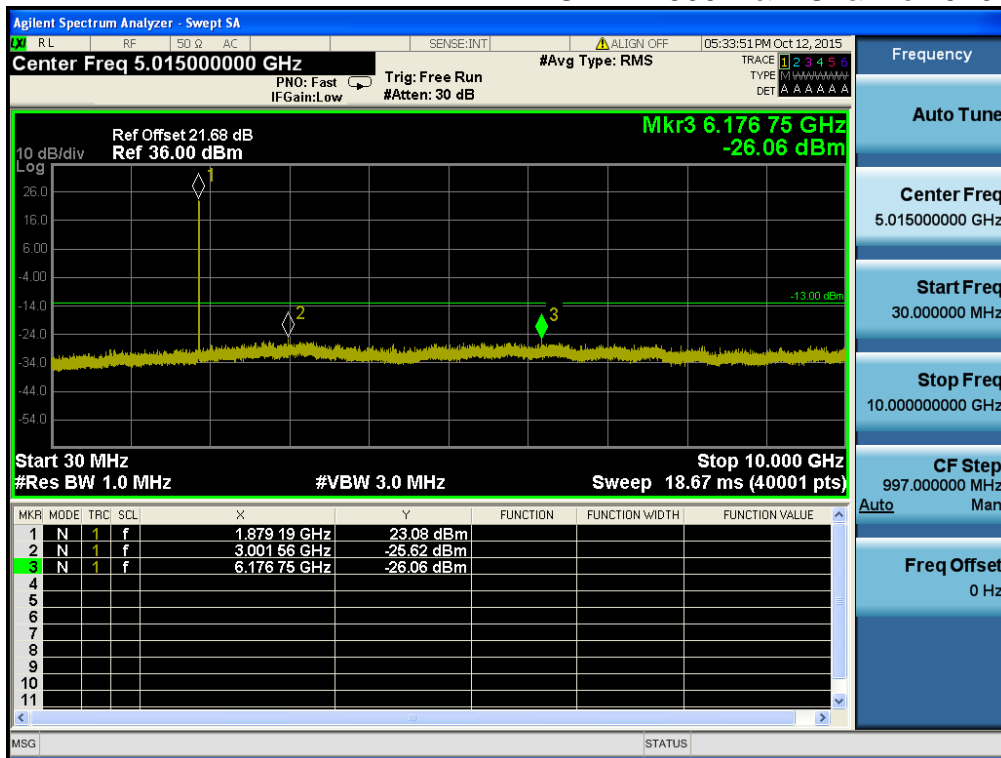

WCDMA1900 & Channel: 9400

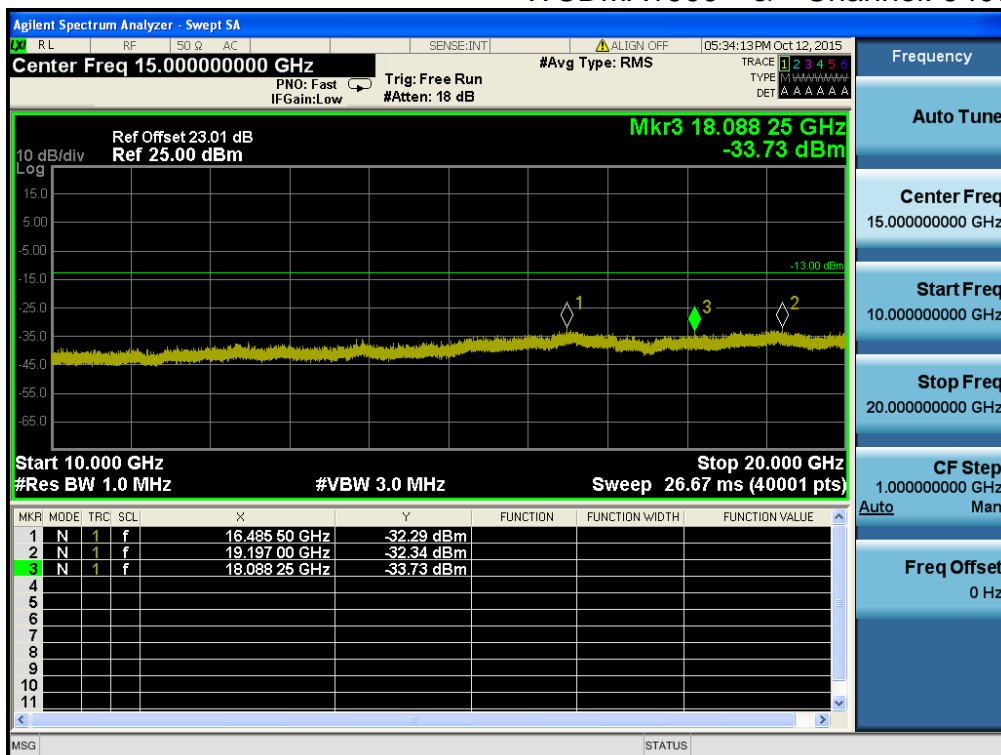

WCDMA1900 & Channel: 9538

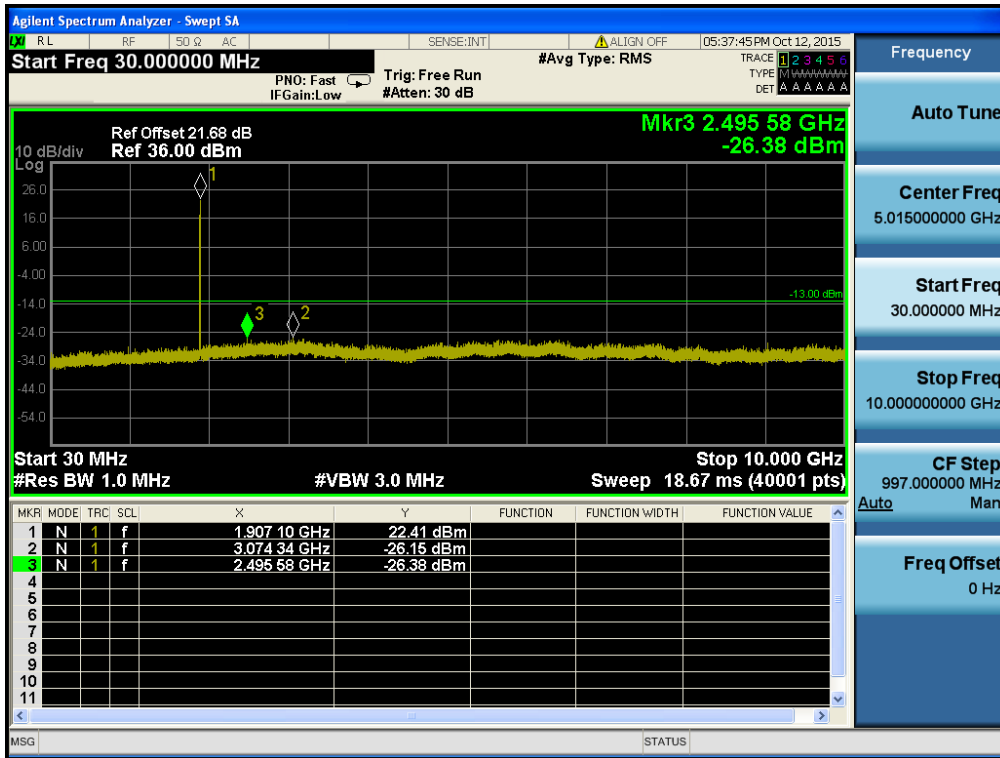

WCDMA1900 & Channel: 9538

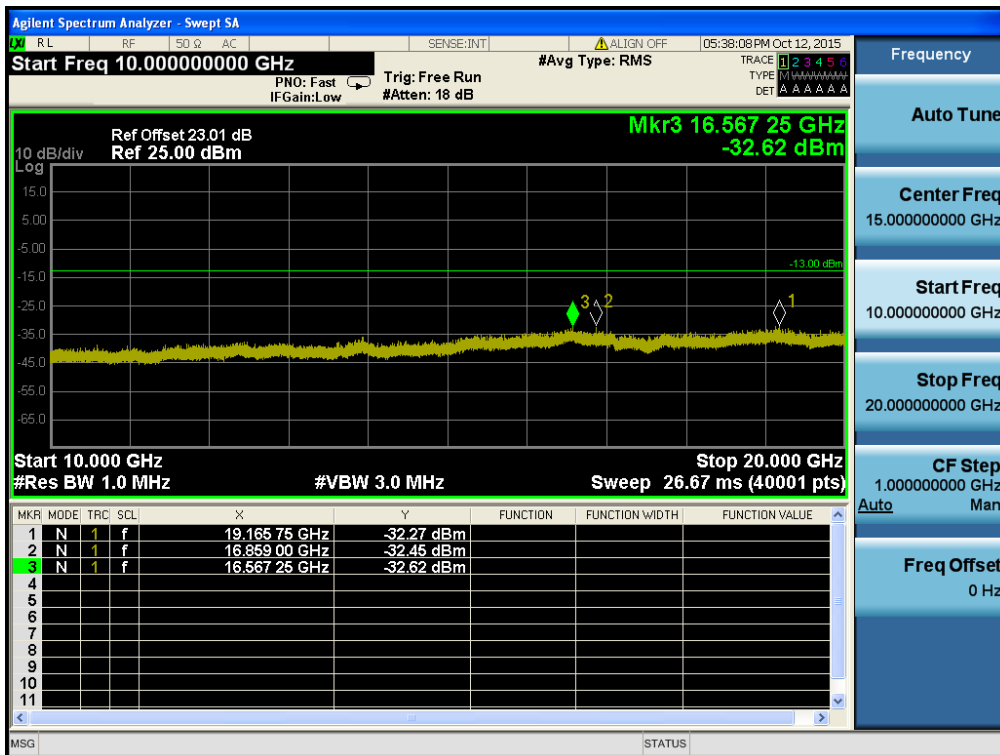

HSUPA1900 & Channel: 9262

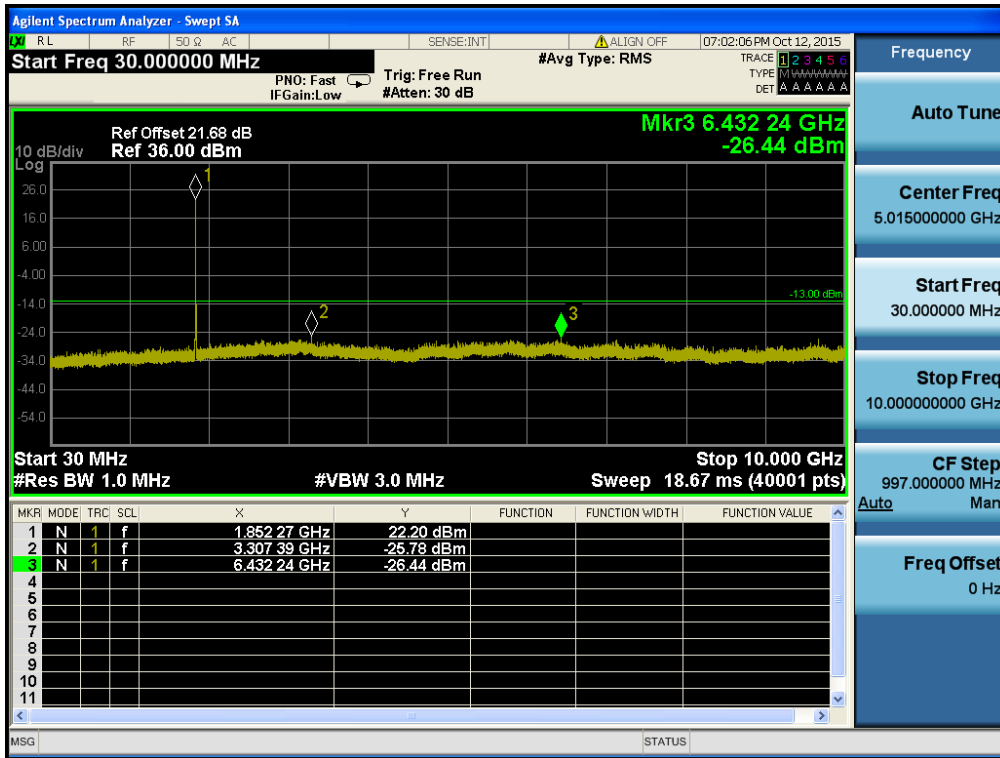

HSUPA 1900 & Channel: 9262

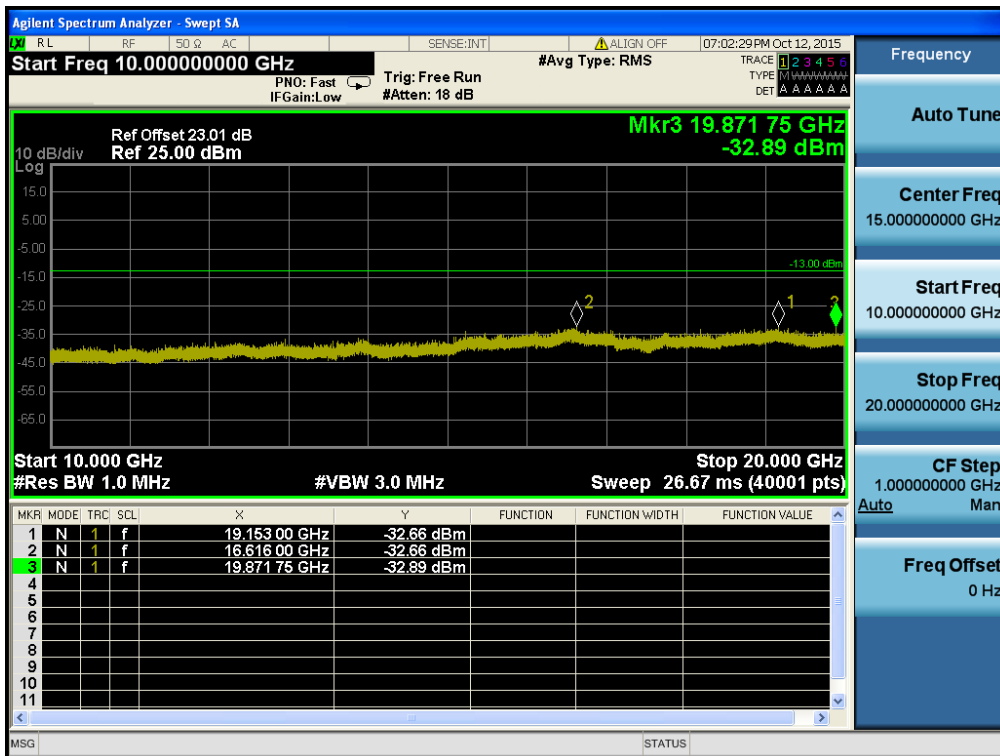

HSUPA1900 & Channel: 9400

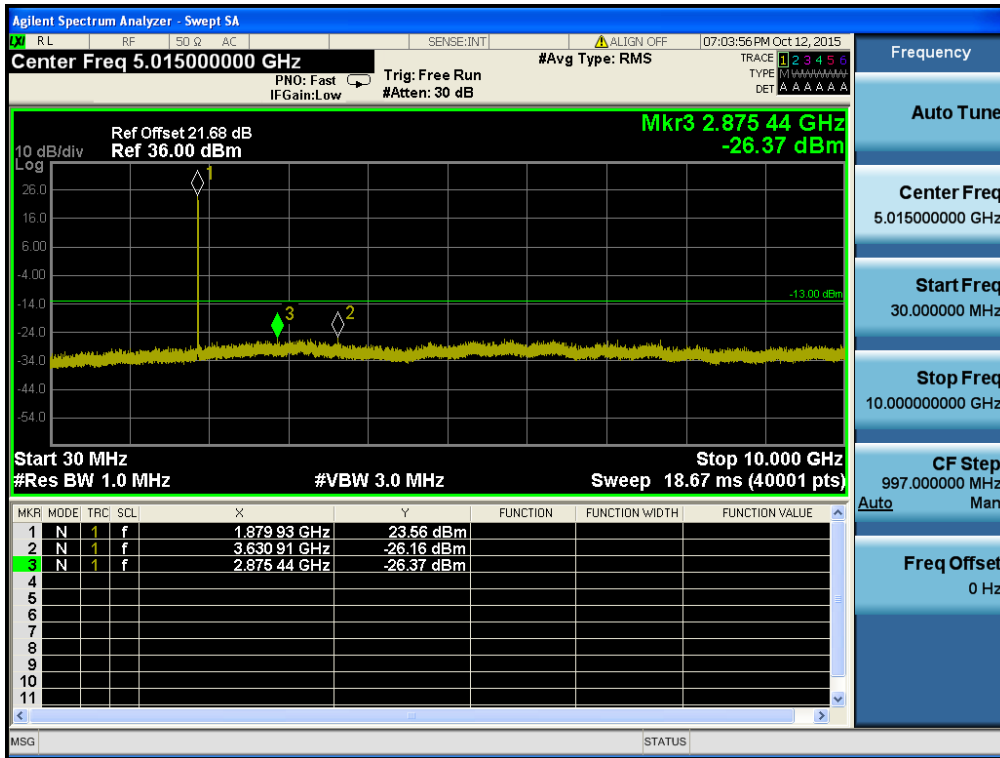

HSUPA1900 & Channel: 9400

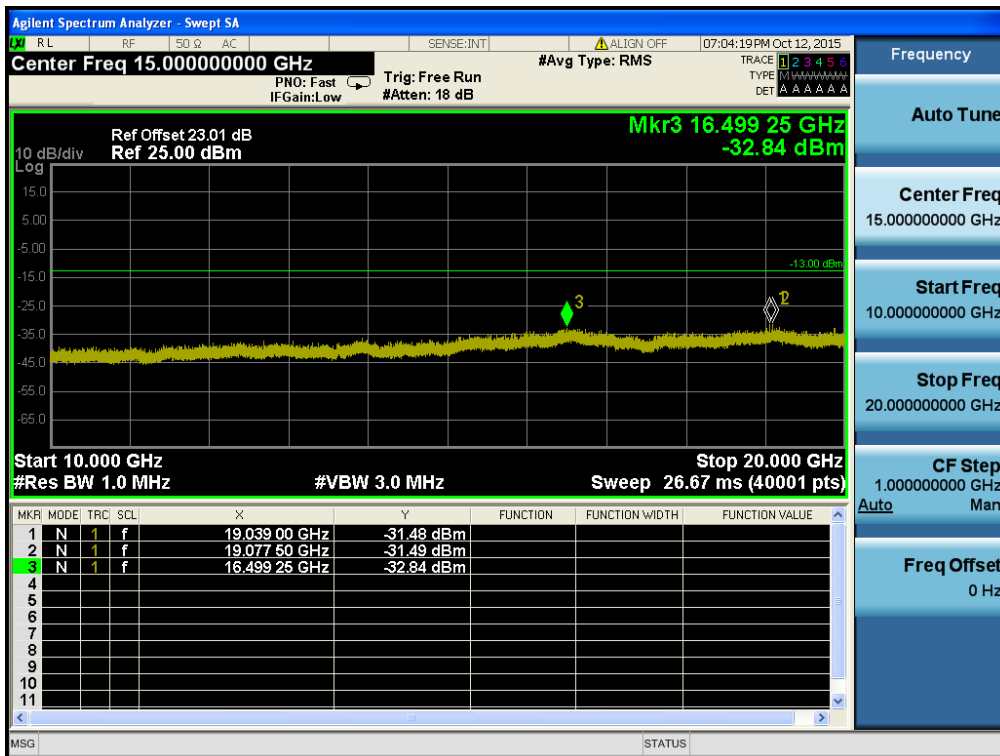

HSUPA1900 & Channel: 9538

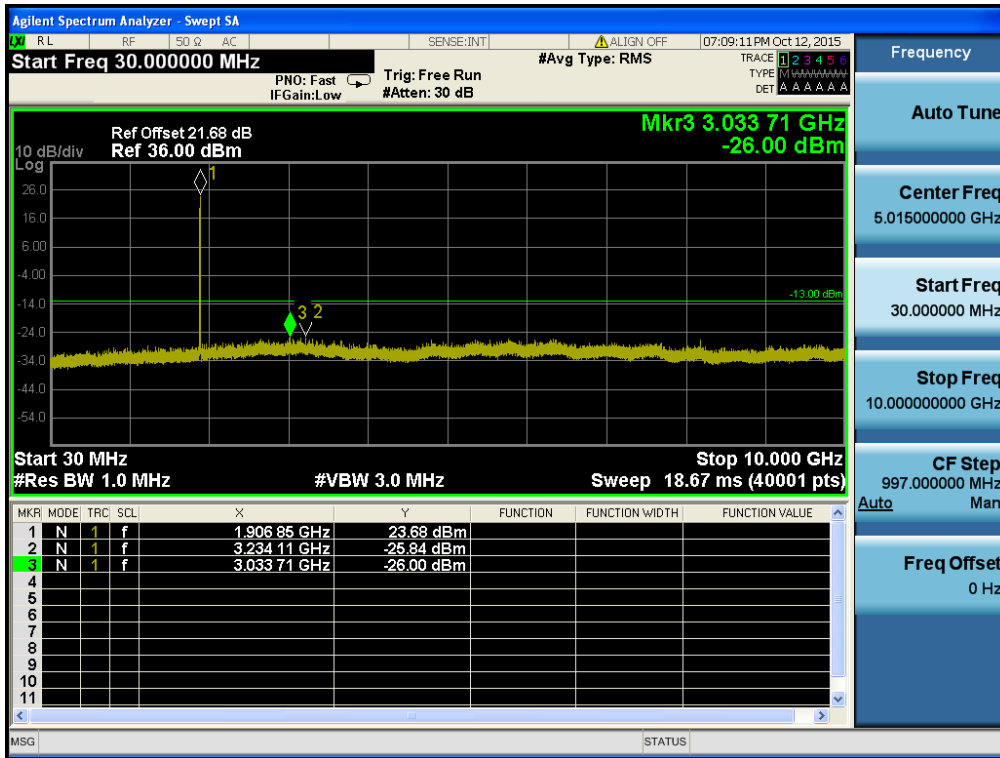

HSUPA1900 & Channel: 9538

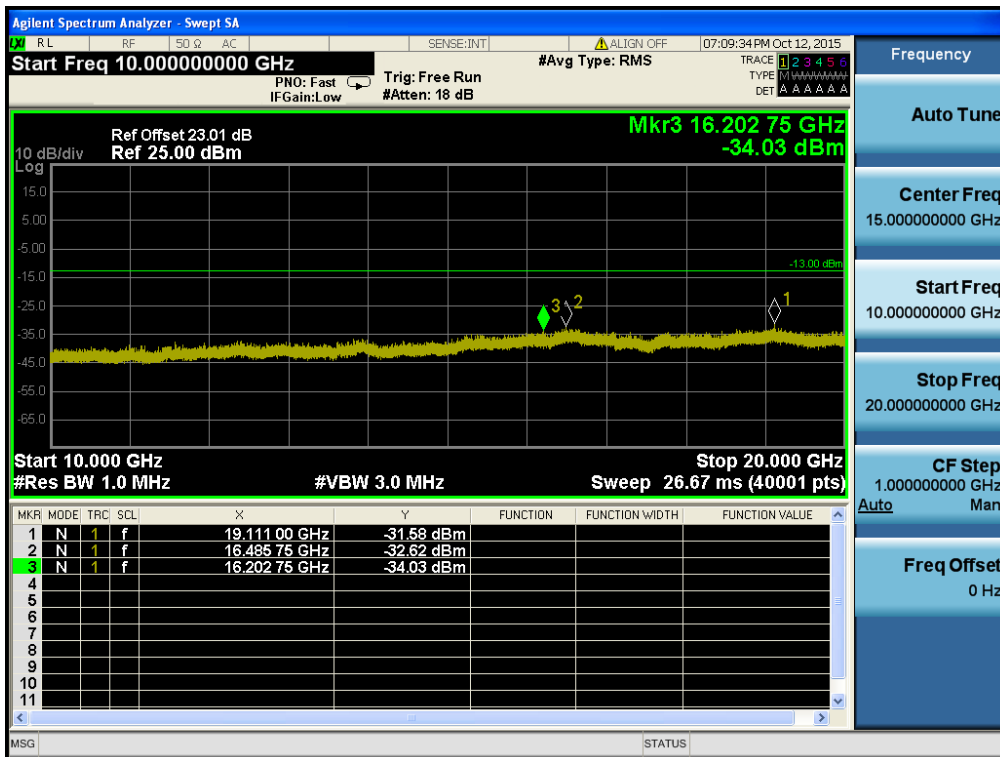

8.4 Band Edge

GSM850 & Channel: 128

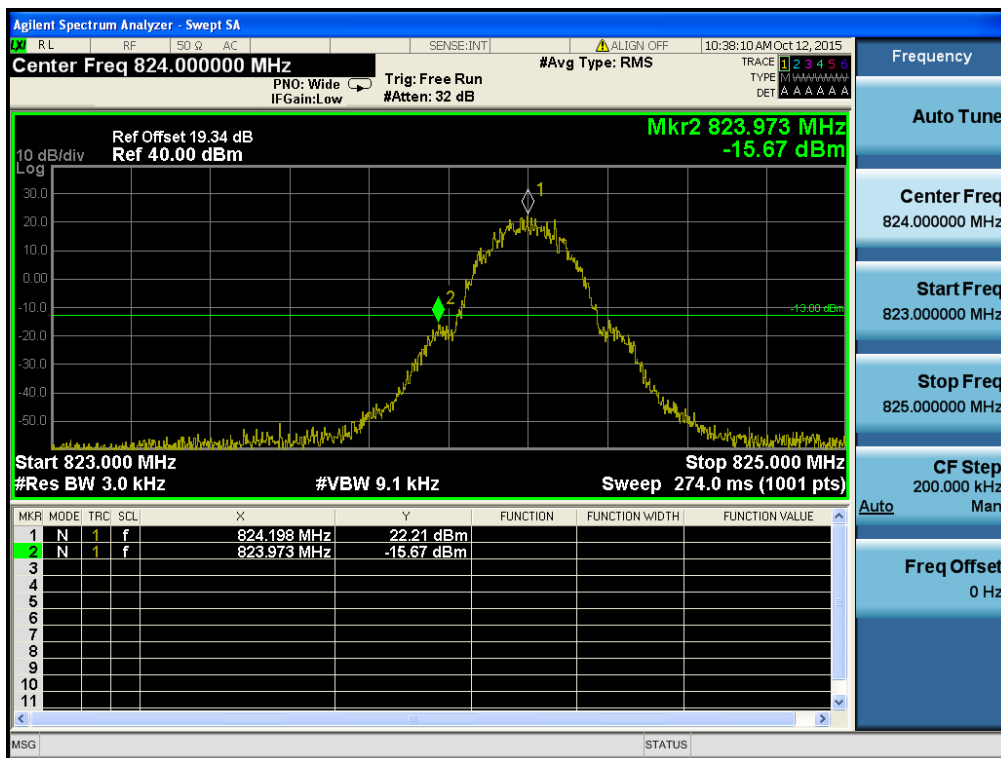

GSM850 & Channel: 251

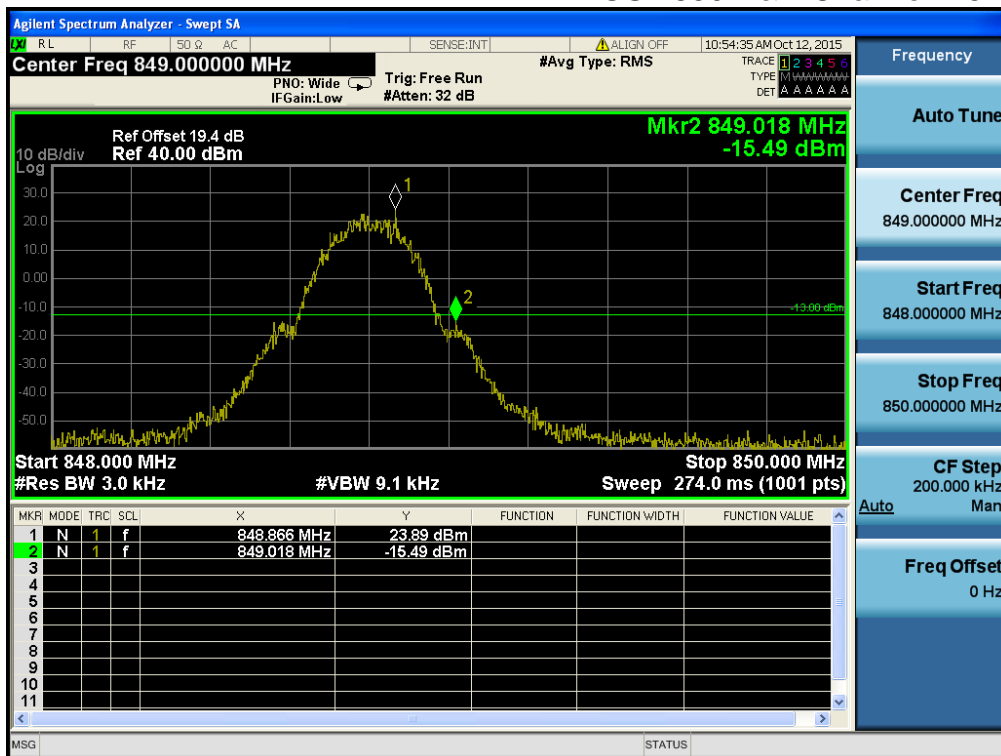

EDGE 850 & Channel: 128

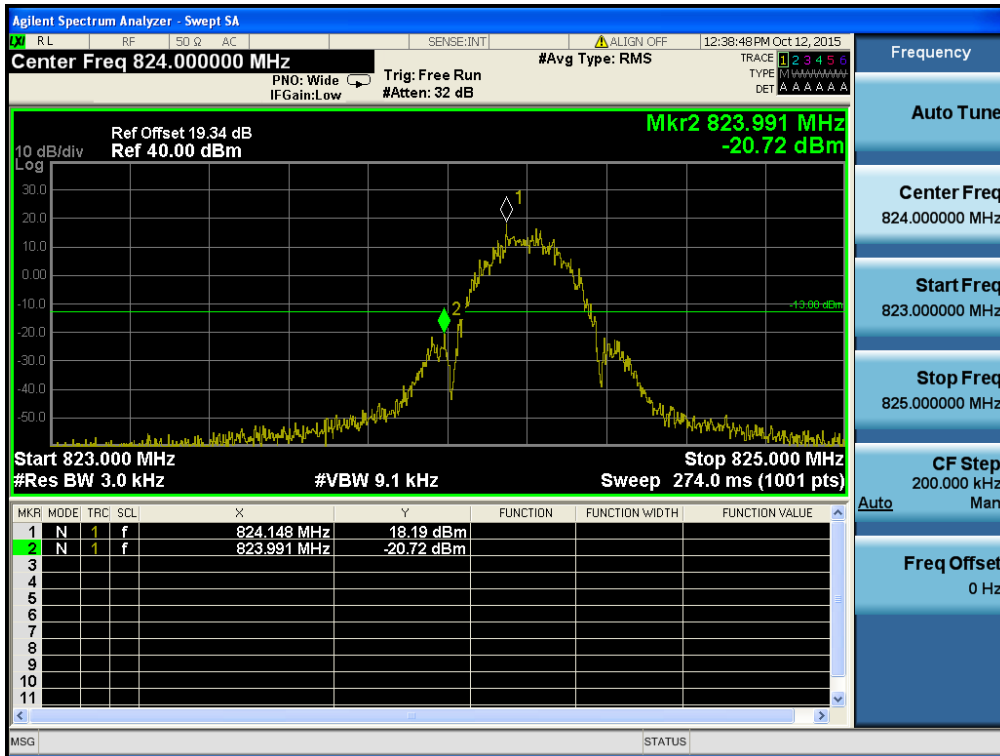

EDGE 850 & Channel: 251

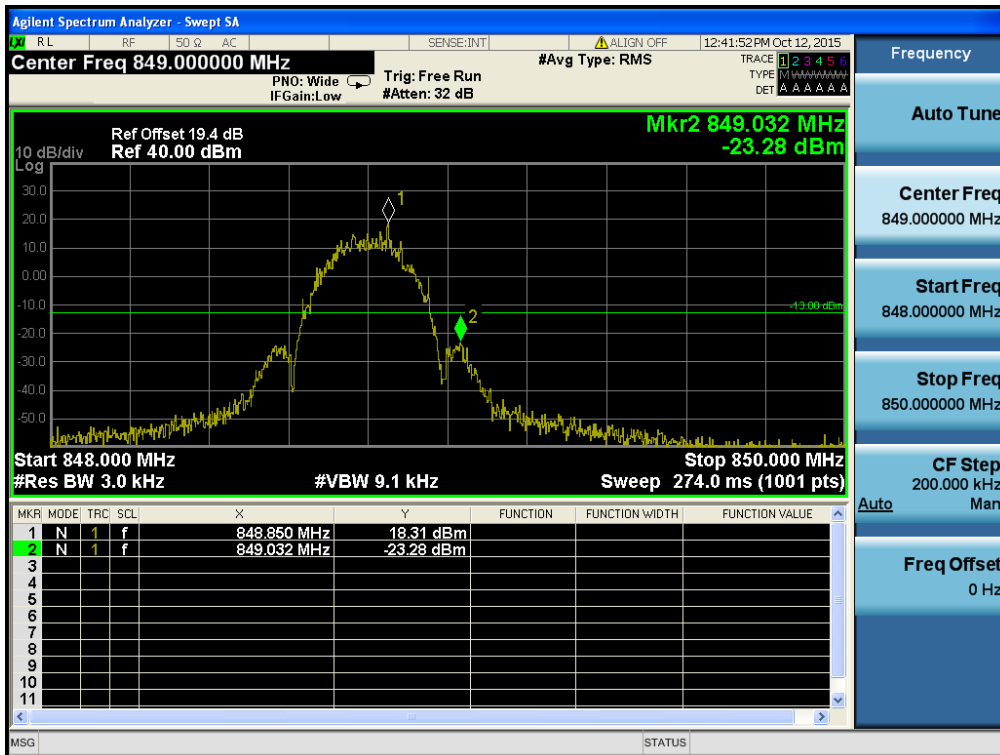

WCDMA 850 & Channel: 4132



WCDMA 850 & Channel: 4132

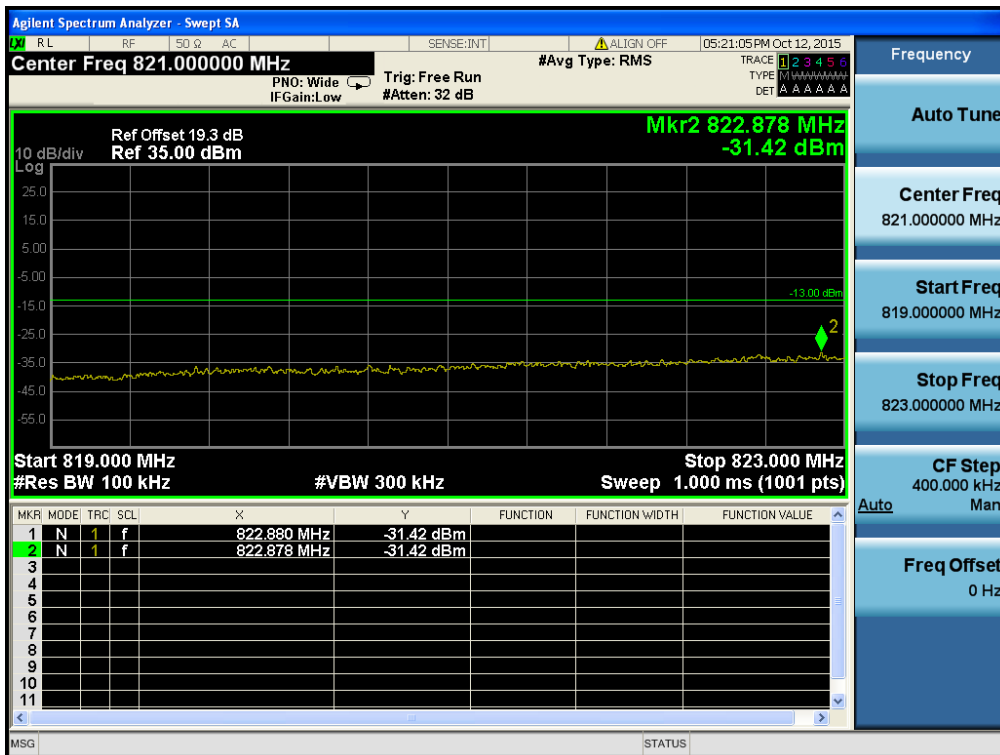

WCDMA 850 & Channel: 4233

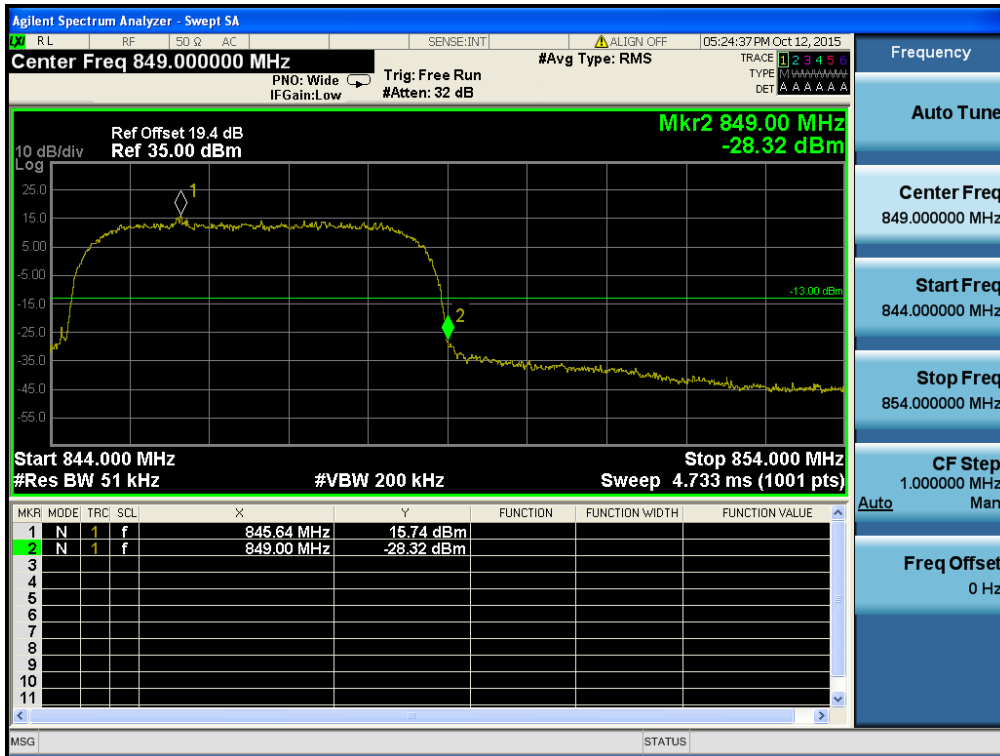

WCDMA 850 & Channel: 4233

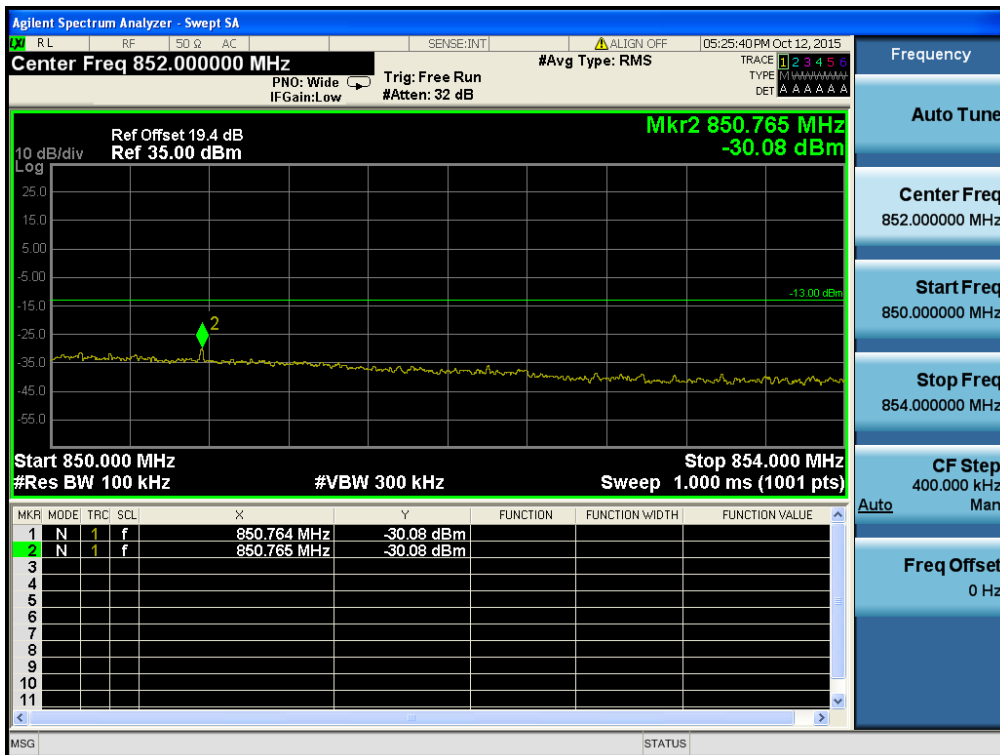

HSUPA 850 & Channel: 4132

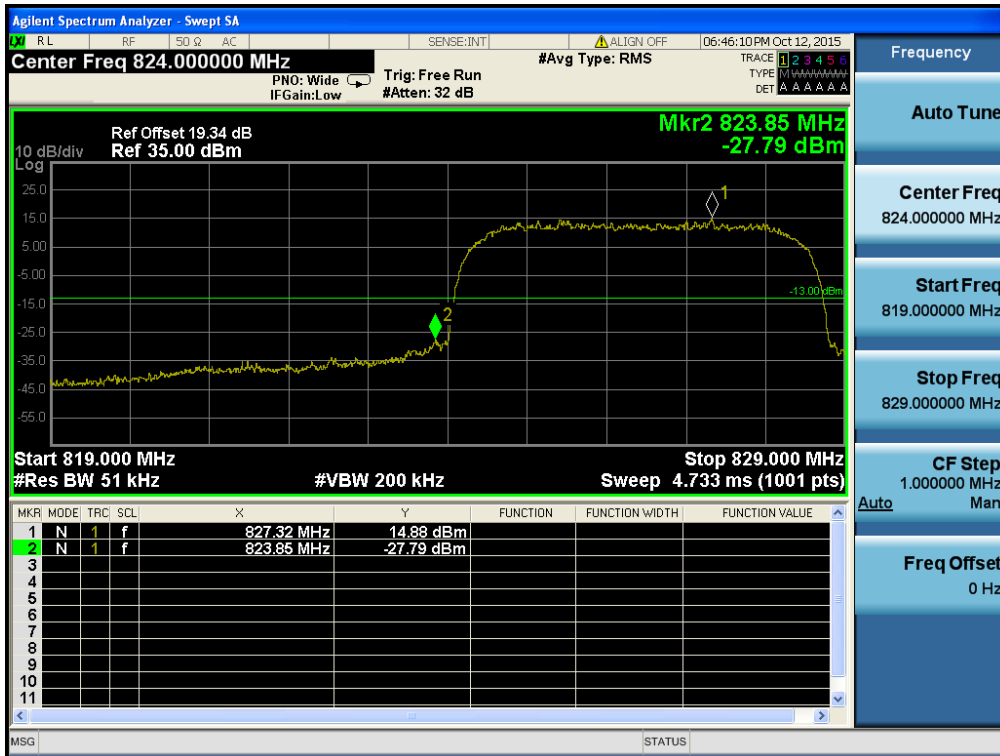

HSUPA 850 & Channel: 4132

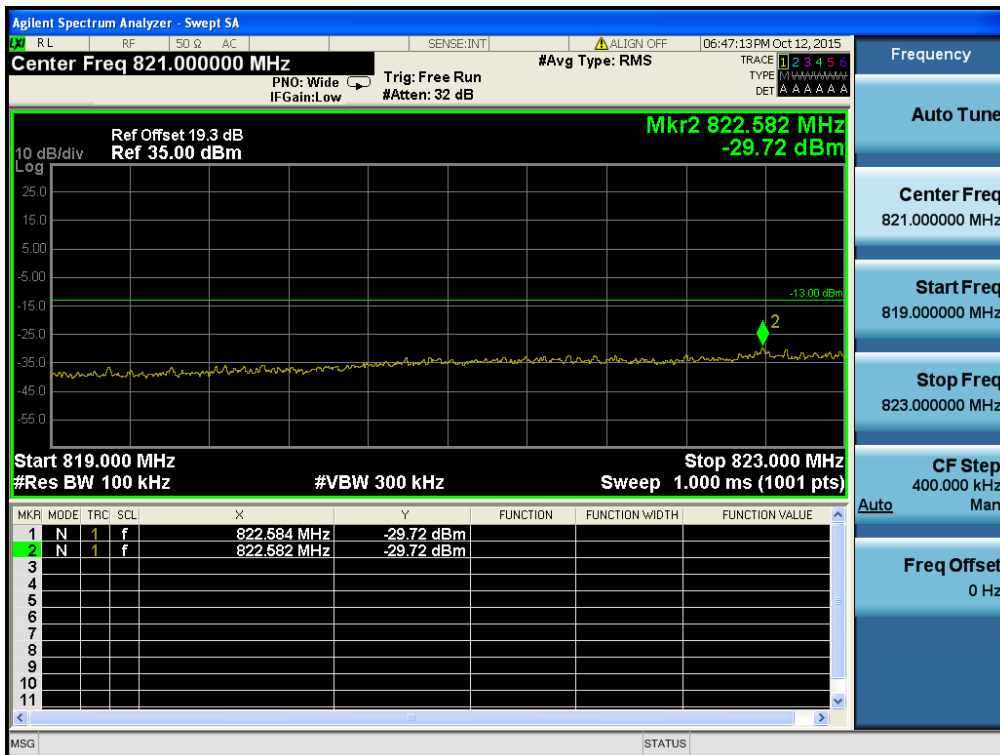

HSUPA850 & Channel: 4233

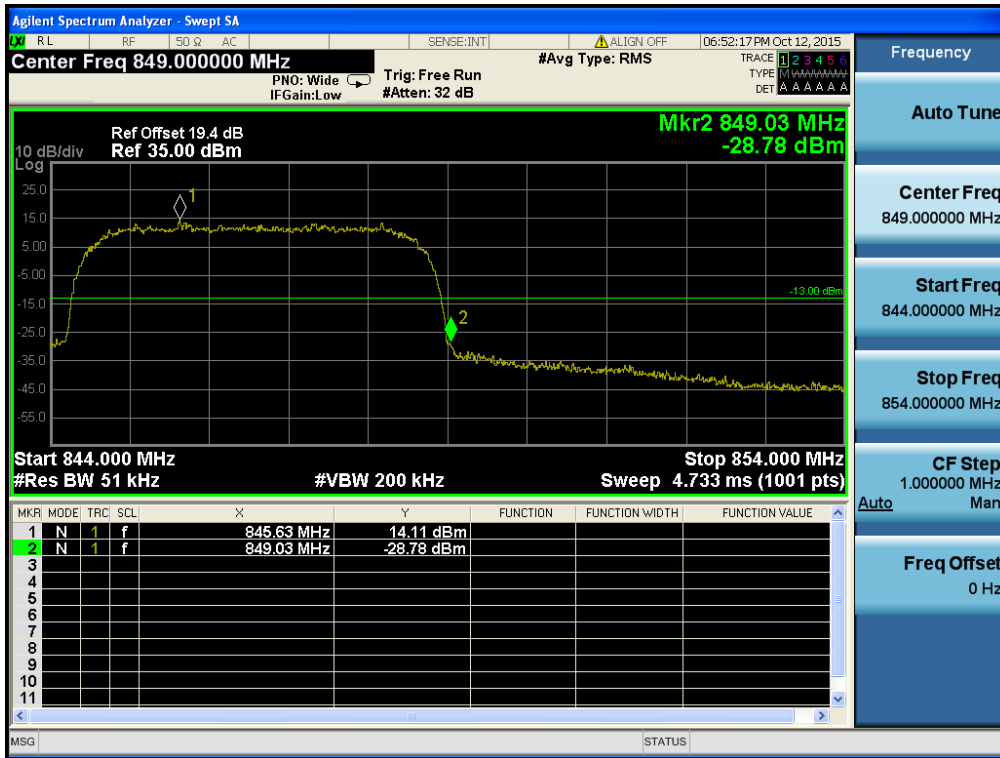

HSUPA850 & Channel: 4233

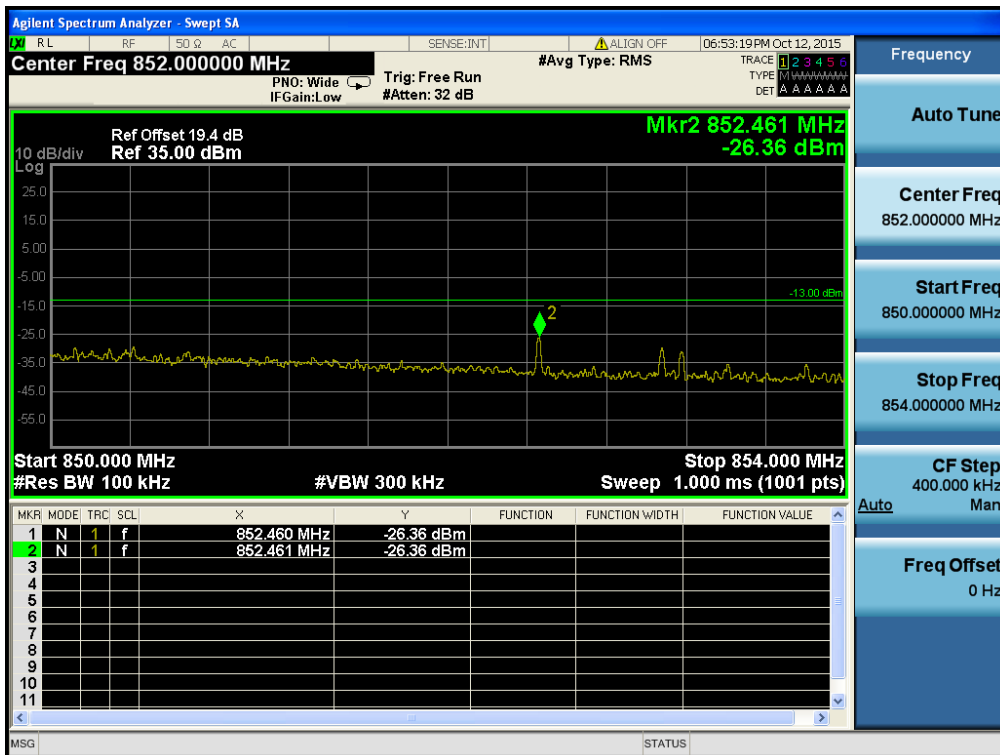

WCDMA1700 & Channel: 1312

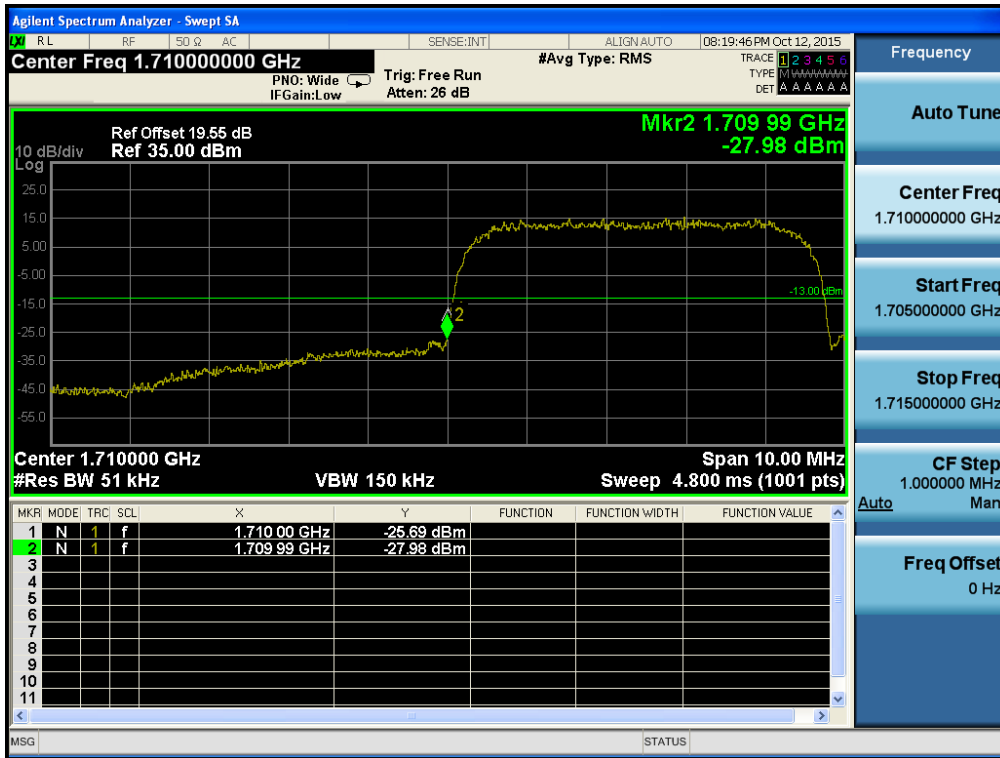

WCDMA1700 & Channel: 1312

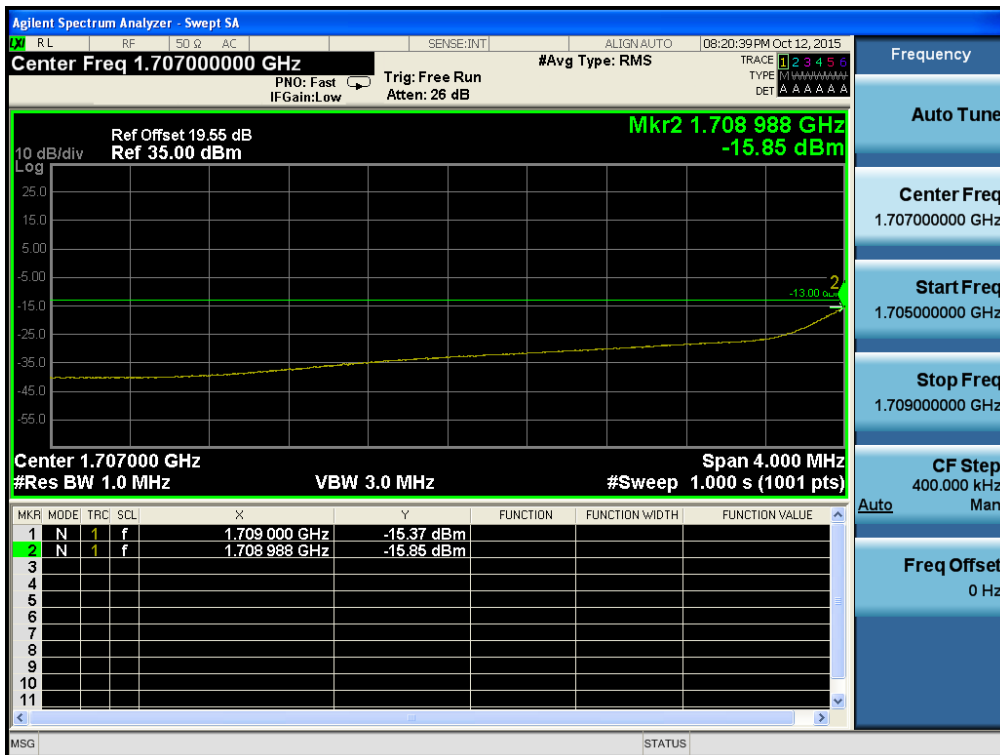

WCDMA1700 & Channel: 1513



WCDMA1700 & Channel: 1513

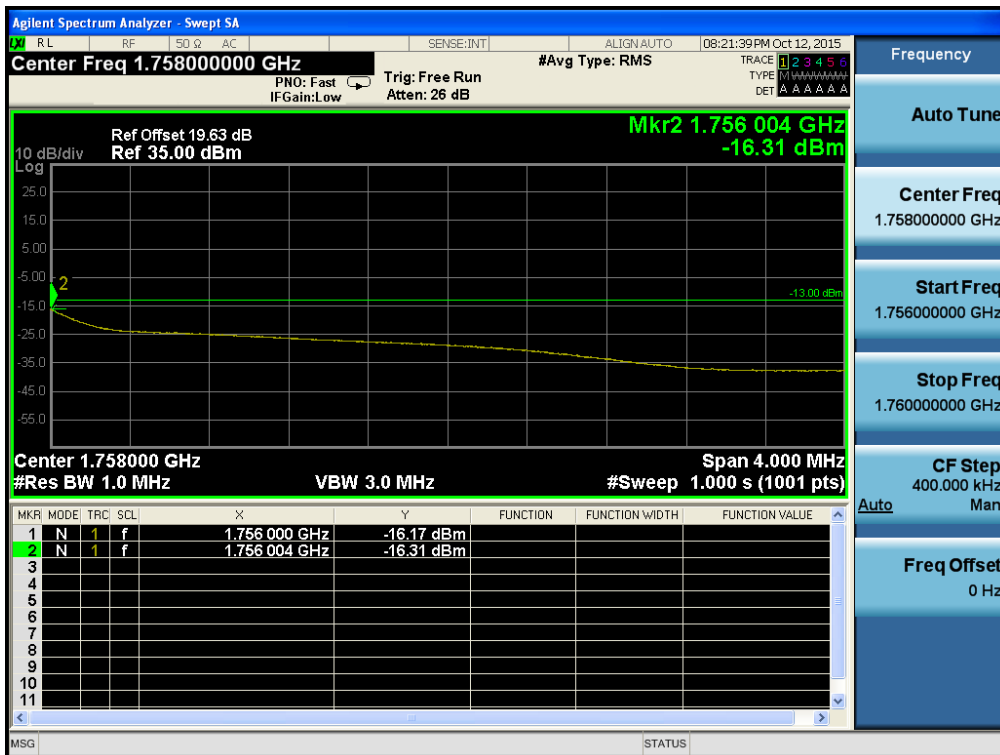

HSUPA1700 & Channel: 1312

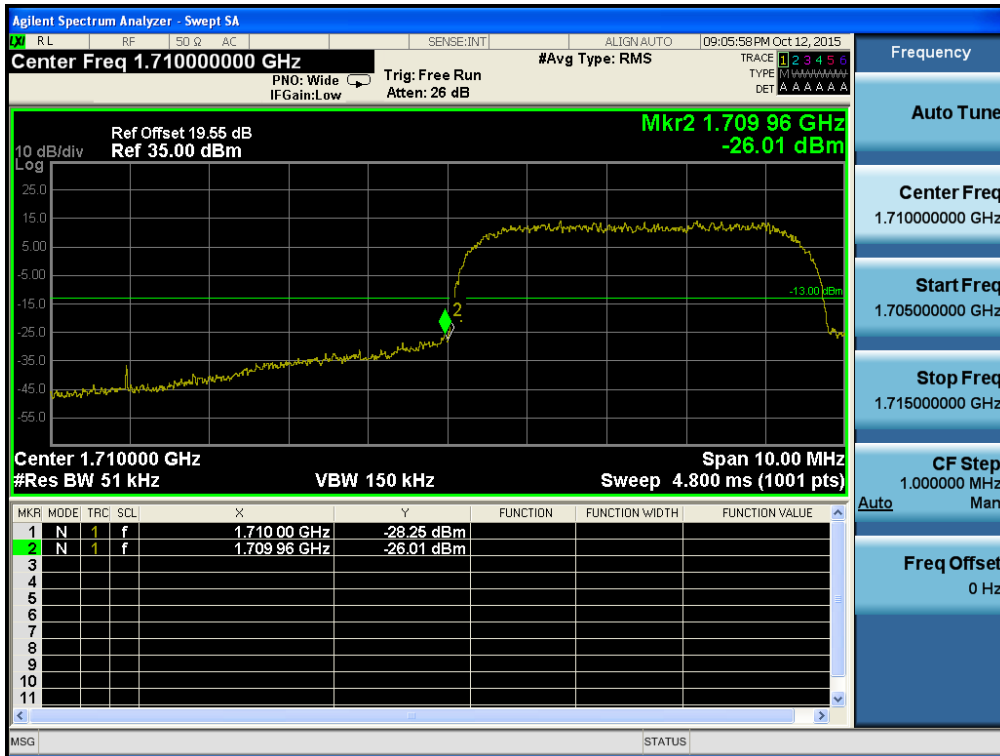

HSUPA1700 & Channel: 1312

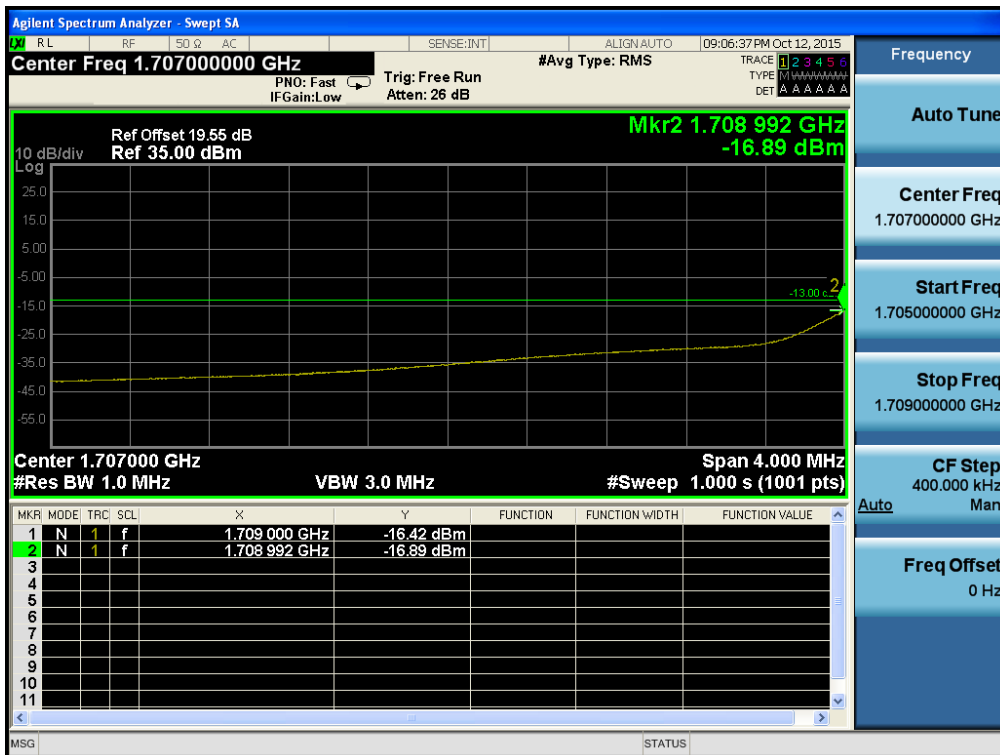

HSUPA1700 & Channel: 1513



HSUPA1700 & Channel: 1513

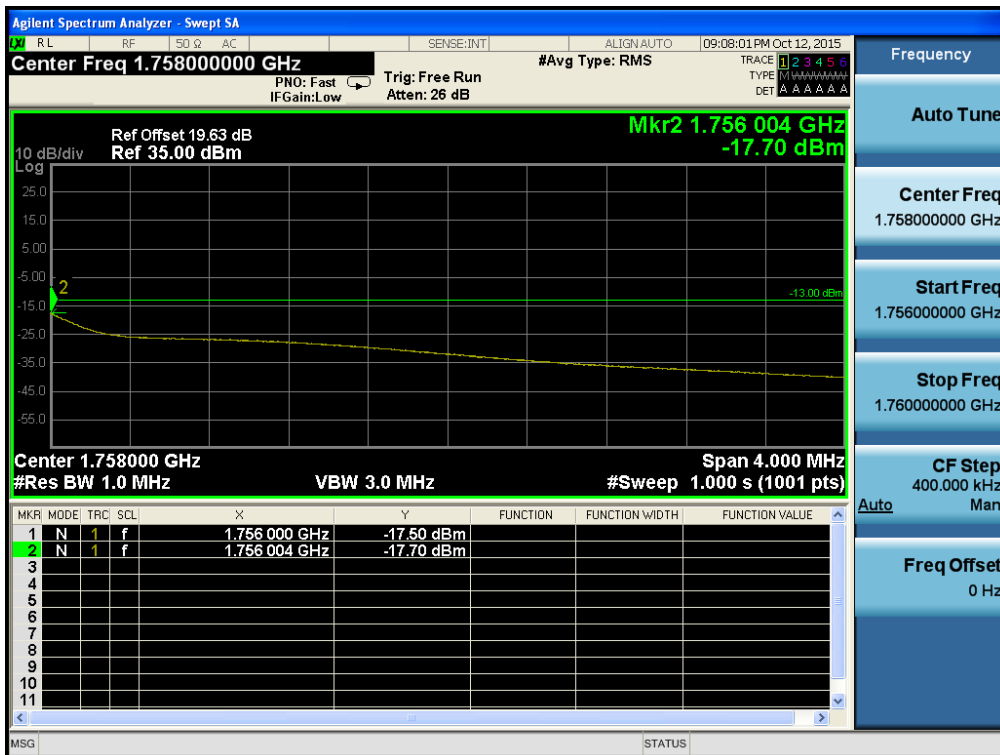

GSM1900 & Channel: 512

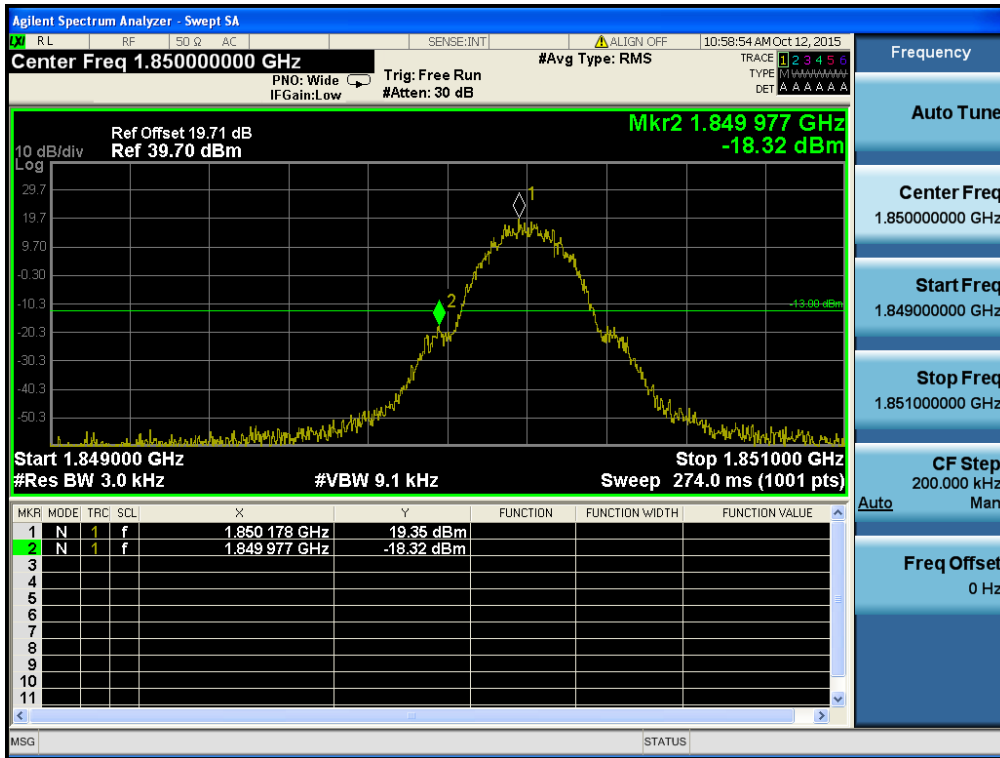

GSM1900 & Channel: 810

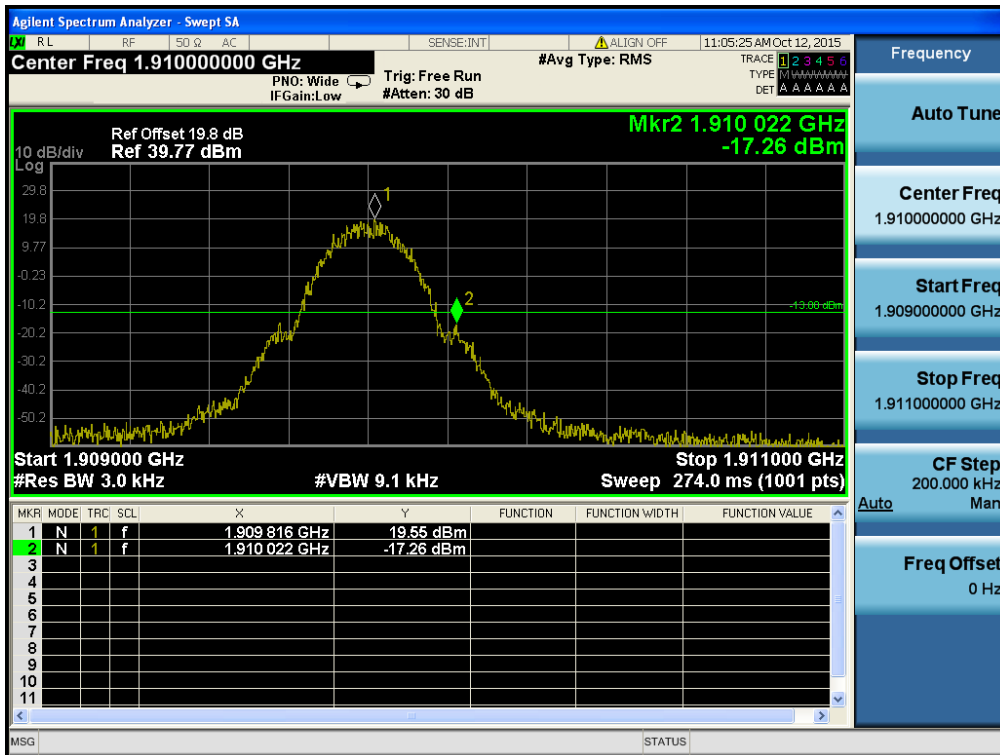

EDGE 1900 & Channel: 512

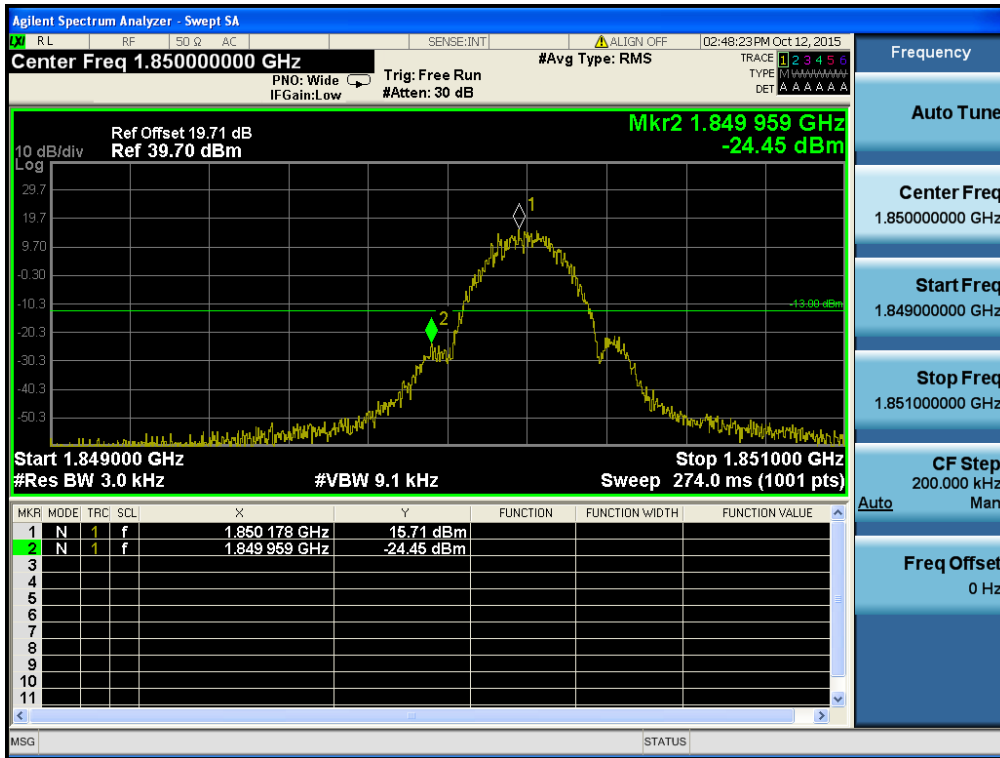

EDGE 1900 & Channel: 810

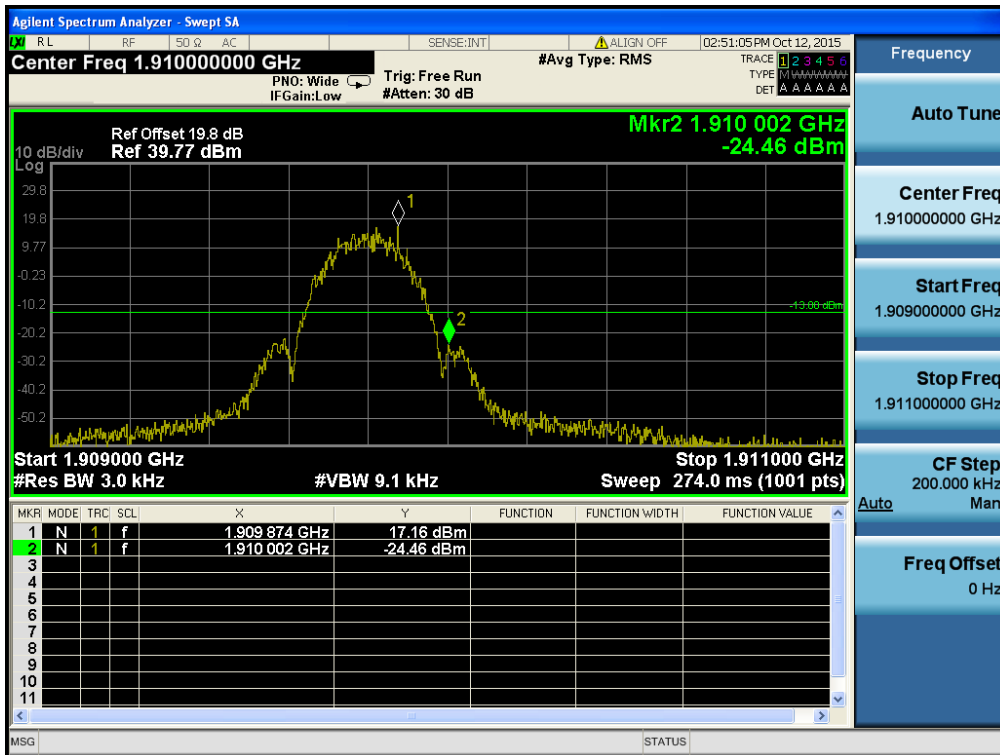

WCDMA1900 & Channel: 9262

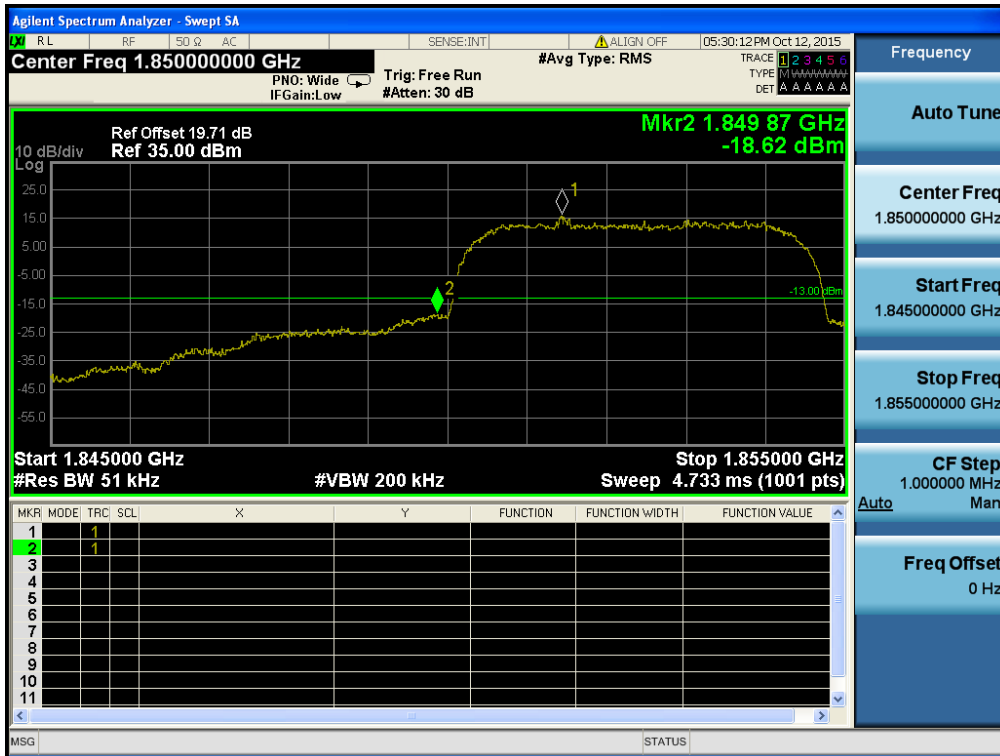

WCDMA1900 & Channel: 9262



WCDMA1900 & Channel: 9538



WCDMA1900 & Channel: 9538

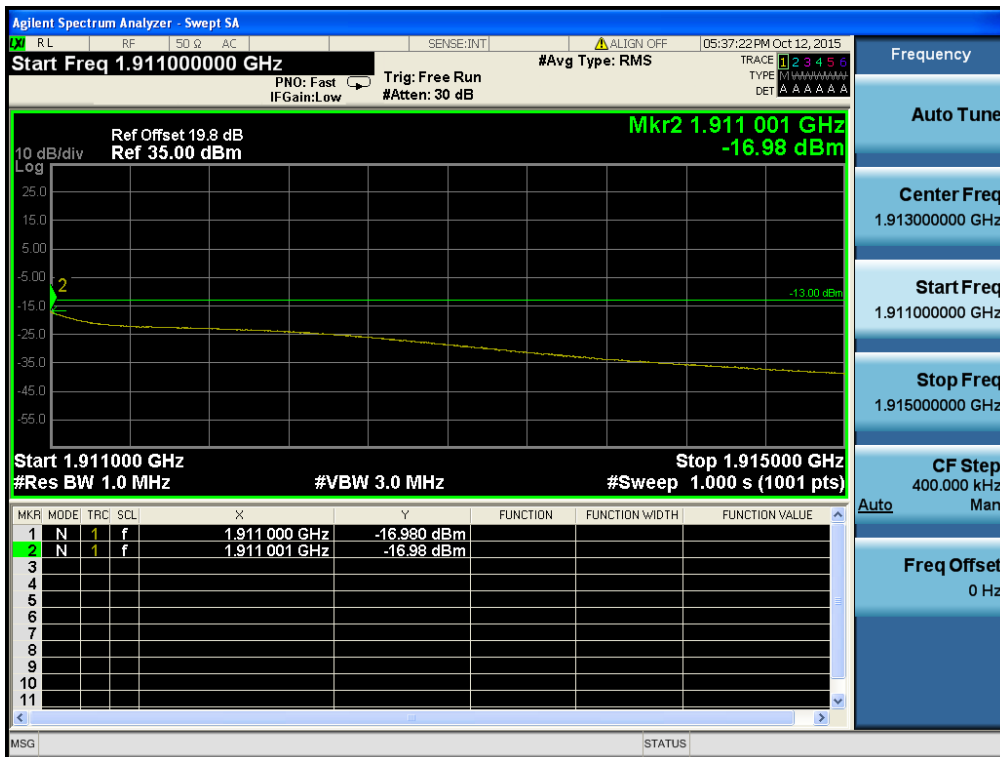

HSUPA1900 & Channel: 9262

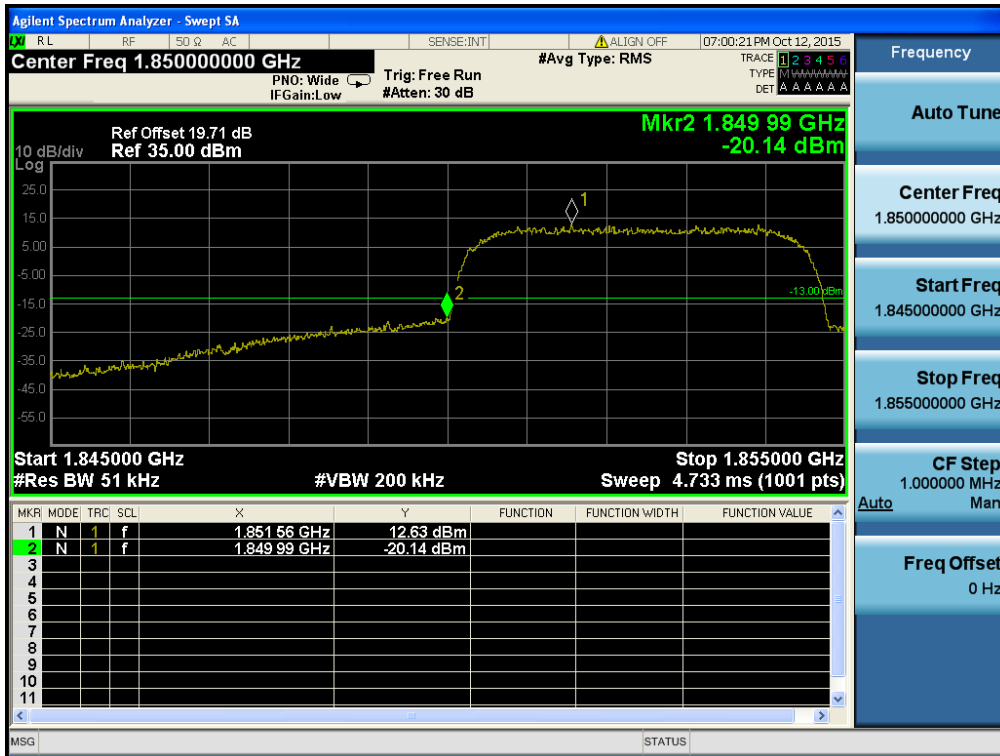

HSUPA1900 & Channel: 9262

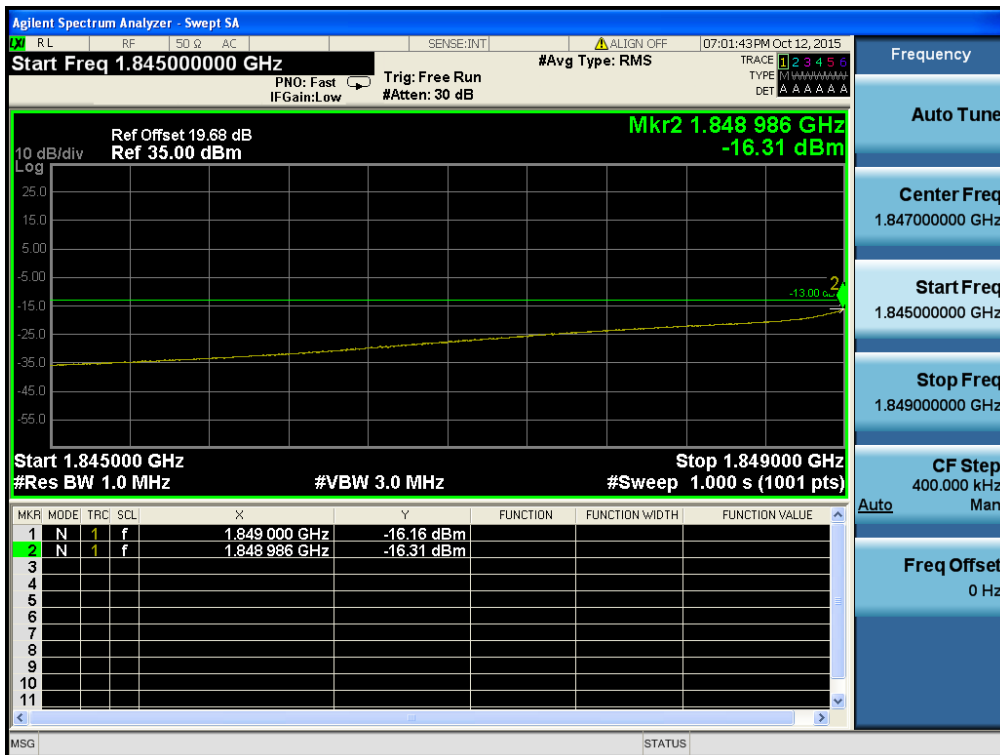

HSUPA1900 & Channel: 9538



HSUPA1900 & Channel: 9538

