

# TEST REPORT



**DT&C Co., Ltd.**

42, Yurim-ro, 154Beon-gil, Cheoin-gu, Yongin-si, Gyeonggi-do, Korea, 17042  
Tel : 031-321-2664, Fax : 031-321-1664

1. Report No : DRTFCC1709-0182

2. Customer

- Name (FCC) : POINTMOBILE CO., LTD. / Name (IC) : POINTMOBILE CO.,LTD
- Address (FCC) : B-9F, Kabul Great Valley 32 Digital-ro 9-gil, Geumcheon-gu Seoul South Korea 153-709
- Address (IC) : B-9F Kabul Great Valley, 32, Digital-ro 9-gil, Geumcheon-gu Seoul Korea (Republic Of)

3. Use of Report : FCC & IC Original Grant

4. Product Name / Model Name : Mobile Computer / FCC: PM70, IC: PM70G

FCC ID: V2X-PM70G / IC: 10664A-PM70G



5. Test Method Used : ANSI C63.10-2013

Test Specification : FCC Part 15 Subpart C.247,  
RSS-247 Issue 2 (2017-02), RSS-GEN Issue 4 (2014-11)

6. Date of Test : 2017.06.12 ~ 2017.06.30

7. Testing Environment : See appended test report.

8. Test Result : Refer to the attached test result.

Affirmation	Tested by Name : JaeHyeok Bang 	Technical Manager Name : GeunKi Son 
-------------	---	--

The test results presented in this test report are limited only to the sample supplied by applicant and the use of this test report is inhibited other than its purpose. This test report shall not be reproduced except in full, without the written approval of DT&C Co., Ltd.

2017 . 09 . 12 .

**DT&C Co., Ltd.**

If this report is required to confirmation of authenticity, please contact to [report@dtnc.net](mailto:report@dtnc.net)

## Test Report Version

Test Report No.	Date	Description
DRTFCC1709-0182	Sep. 12, 2017	Initial issue

## Table of Contents

<b>1. General Information</b> .....	<b>4</b>
1.1 Testing Laboratory .....	4
1.2 Testing Environment .....	4
1.3 Measurement Uncertainty .....	4
1.4 Details of Applicant .....	5
1.5 Description of EUT .....	5
1.6 Declaration by the applicant / manufacturer .....	5
1.7 Information about the FHSS characteristics .....	6
1.8 Test Equipment List.....	7
1.9 Summary of Test Results.....	8
1.10 Conclusion of worst-case and operation mode.....	9
<b>2. Maximum Peak Output Power Measurement</b> .....	<b>10</b>
2.1 Test Setup .....	10
2.2 Limit.....	10
2.3 Test Procedure.....	10
2.4 Test Results .....	11
<b>3. 20 dB BW</b> .....	<b>17</b>
3.1 Test Setup .....	17
3.2 Limit.....	17
3.3 Test Procedure.....	17
3.4 Test Results .....	17
<b>4. Carrier Frequency Separation</b> .....	<b>23</b>
4.1 Test Setup .....	23
4.2 Limit.....	23
4.3 Procedure.....	23
4.4 Test Results .....	23
<b>5. Number of Hopping Frequencies</b> .....	<b>28</b>
5.1 Test Setup .....	28
5.2 Limit.....	28
5.3 Procedure.....	28
5.4 Test Results .....	28
<b>6. Time of Occupancy (Dwell Time)</b> .....	<b>34</b>
6.1 Test Setup .....	34
6.2 Limit.....	34
6.3 Test Procedure.....	34
6.4 Test Results .....	34
<b>7. Transmitter Radiated Spurious Emissions and Conducted Spurious Emission</b> .....	<b>39</b>
7.1 Test Setup .....	39
7.2 Limit.....	39
7.3. Test Procedures.....	40
7.3.1. Test Procedures for Radiated Spurious Emissions .....	40
7.3.2. Test Procedures for Conducted Spurious Emissions.....	41
7.4. Test Results .....	42
7.4.1. Radiated Emissions.....	42
7.4.3. Conducted Spurious Emissions .....	45
<b>8. Transmitter AC Power Line Conducted Emission</b> .....	<b>69</b>
8.1 Test Setup .....	69
8.2 Limit.....	69
8.3 Test Procedures.....	69
8.4 Test Results .....	70
<b>9. Antenna Requirement</b> .....	<b>72</b>
<b>10. Occupied Bandwidth (99 %)</b> .....	<b>73</b>
10.1 Test Setup .....	73
10.2 Limit.....	73
10.3 Test Procedure.....	73
10.4 Test Results .....	73
<b>APPENDIX I</b> .....	<b>80</b>
<b>APPENDIX II</b> .....	<b>81</b>

## 1. General Information

### 1.1 Testing Laboratory

#### DT&C Co., Ltd.

The 3 m test site and conducted measurement facility used to collect the radiated data are located at the 42, Yurim-ro, 154beon-gil, Cheoin-gu, Yongin-si, Gyeonggi-do, Korea 17042. The site is constructed in conformance with the requirements.

- FCC MRA Accredited Test Firm No. : KR0034

- IC Test site No. : 5740A-3

[www.dtnet.net](http://www.dtnet.net)

Telephone : + 82-31-321-2664

FAX : + 82-31-321-1664

### 1.2 Testing Environment

Ambient Condition	
• Temperature	+21 °C ~ +24 °C
• Relative Humidity	40 % ~ 48 %

### 1.3 Measurement Uncertainty

The measurement uncertainties shown below were calculated in accordance with requirements of ANSI C 63.4-2014 and ANSI C 63.10-2013. All measurement uncertainty values are shown with a coverage factor of  $k = 2$  to indicate a 95 % level of confidence.

Test items	Measurement uncertainty
Transmitter Output Power	0.92 dB (The confidence level is about 95 %, $k = 2$ )
Conducted spurious emission	0.94 dB (The confidence level is about 95 %, $k = 2$ )
AC conducted emission	2.4 dB (The confidence level is about 95 %, $k = 2$ )
Radiated spurious emission (1 GHz Below)	5.1 dB (The confidence level is about 95 %, $k = 2$ )
Radiated spurious emission (1 GHz ~ 18 GHz)	5.4 dB (The confidence level is about 95 %, $k = 2$ )
Radiated spurious emission (18 GHz Above)	5.3 dB (The confidence level is about 95 %, $k = 2$ )

## 1.4 Details of Applicant

Applicant (FCC) : POINTMOBILE CO., LTD.  
 Applicant (IC) : POINTMOBILE CO.,LTD  
 Address (FCC) : B-9F, Kabul Great Valley 32 Digital-ro 9-gil, Geumcheon-gu Seoul South Korea 153-709  
 Address (IC) : B-9F Kabul Great Valley, 32, Digital-ro 9-gil, Geumcheon-gu Seoul Korea (Republic Of)  
 Contact person (FCC) : Wilson Park  
 Contact person (IC) : Edgar Cho

## 1.5 Description of EUT

<b>EUT</b>	Mobile Computer
<b>Model Name</b>	FCC: PM70 IC: PM70G
<b>Add Model Name</b>	NA
<b>Serial Number</b>	Identical prototype
<b>Hardware version</b>	MP
<b>Software version</b>	70.00
<b>Power Supply</b>	DC 3.8 V
<b>Frequency Range</b>	2402 MHz ~ 2480 MHz
<b>Modulation Technique</b>	GFSK, $\pi/4$ -DQPSK, 8DPSK
<b>Number of Channels</b>	79
<b>Antenna Type</b>	Internal Antenna
<b>Antenna Gain</b>	PK : -2.577 dBi

## 1.6 Declaration by the applicant / manufacturer

- NA

## 1.7 Information about the FHSS characteristics

- This Bluetooth module has been tested by a Bluetooth Qualification Lab, and we confirm the following :
  - A) The hopping sequence is pseudorandom
  - B) All channels are used equally on average
  - C) The receiver input bandwidth equals the transmit bandwidth
  - D) The receiver hops in sequence with the transmit signal
  
- 15.247(g) : In accordance with the Bluetooth Industry Standard, the system is designed to comply with all of the regulations in Section 15.247 when the transmitter is presented with a continuous data (or information) system.
  
- 15.247(h) : In accordance with the Bluetooth Industry Standard, the system does not coordinate its channels selection / hopping sequence with other frequency hopping systems for the express purpose of avoiding the simultaneous occupancy of individual hopping frequencies by multiple transmitters.
  
- 15.247(h) : The EUT employs Adaptive Frequency Hopping (AFH) which identifies sources of interference namely devices operating in 802.11 WLAN and excludes them from the list of available channels. The process of re-mapping reduces the number of test channels from 79 channels to a minimum number of 20 channels.

## 1.8 Test Equipment List

Type	Manufacturer	Model	Cal.Date (yy/mm/dd)	Next.Cal.Date (yy/mm/dd)	S/N
Spectrum Analyzer	Agilent Technologies	N9020A	16/09/09	17/09/09	MY50200834
Digital Multimeter	Agilent Technologies	34401A	17/01/04	18/01/04	US36099541
DC Power Supply	Agilent Technologies	66332A	16/09/08	17/09/08	US37473305
Vector Signal Generator	Rohde Schwarz	SMBV100A	17/01/04	18/01/04	255571
Signal Generator	Rohde Schwarz	SMF100A	17/04/21	18/04/21	102341
Power Splitter	Anritsu	K241B	16/09/08	17/09/08	020611
BlueTooth Tester	TESCOM	TC-3000B	17/04/11	18/04/11	3000B640046
Thermohygrometer	BODYCOM	BJ5478	17/04/11	18/04/11	120612-2
Loop Antenna	Schwarzbeck	FMZB1513	16/04/22	18/04/22	1513-128
BILOG Antenna	SCHWARZBECK	VULB9160	16/11/11	18/11/11	3151
Horn Antenna	ETS-LINDGREN	3117	16/05/03	18/05/03	00140394
Horn Antenna	A.H.Systems Inc.	SAS-574	17/04/25	19/04/25	154
PreAmplifier	Agilent Technologies	8449B	16/10/19	17/10/19	3008A02108
Low Noise Pre Amplifier	tsj	MLA-010K01- B01-27	17/03/06	18/03/06	1844539
EMI TEST RECEIVER	Rohde Schwarz	ESR7	17/02/16	18/02/16	101061
EMI TEST RECEIVER	Rohde Schwarz	ESCI	17/02/18	18/02/18	100364
Highpass Filter	Wainwright Instruments	WHKX12-2580- 3000-18000- 80SS	16/09/09	17/09/09	3
Highpass Filter	Wainwright Instruments	WHNX6-6320- 8000-26500- 40CC	16/09/13	17/09/13	1
Power Meter & Wide Bandwidth Sensor	Anritsu	ML2495A	17/04/11	18/04/11	1306007
Power Meter & Wide Bandwidth Sensor	Anritsu	MA2490A	17/04/11	18/04/11	1249001
ARTIFICIAL MAINS NETWORK	ROHDE&SCHWARZ	ESH2-Z5	16/09/08	17/09/08	828739/006
SINGLE-PHASE MASTER	NF	4420	16/09/08	17/09/08	3049354420023

Note: The measurement antennas were calibrated in accordance to the requirements of ANSI C63.5-2006.

## 1.9 Summary of Test Results

FCC Part RSS Std.	Parameter	Limit (Using in 2400~ 2483.5 MHz)	Test Condition	Status Note 1
15.247(a) RSS-247(5.1)	Carrier Frequency Separation	>= 25 kHz or >= Two thirds of the 20 dB BW, whichever is greater.	Conducted	C
	Number of Hopping Frequencies	>= 15 hops		C
	20 dB Bandwidth	N/A		C
	Dwell Time	=< 0.4 seconds		C
15.247(b) RSS-247(5.4)	Transmitter Output Power	<b>For FCC</b> =< 1 Watt , if CHs >= 75 Others =< 0.125 W <b>For IC</b> if CHs >= 75 =< 1 Watt For Conducted Power =< 4 Watt For e.i.r.p, Others =< 0.125 W For Conducted Power. =< 4 Watt For e.i.r.p		C
15.247(d) RSS-247(5.5)	Conducted Spurious Emissions	The radiated emission to any 100 kHz of out-band shall be at least 20 dB below the highest in-band spectral density.	C	
RSS Gen(6.6)	Occupied Bandwidth (99 %)	N/A	C	
15.247(d) 15.205 & 209 RSS-247(5.5) RSS-Gen (8.9 & 8.10)	Radiated Spurious Emissions	FCC 15.209 Limits RSS-Gen 8.9	Radiated	C <sup>Note2</sup>
15.207 RSS-Gen(8.8)	AC Conducted Emissions	FCC 15.207 Limits	AC Line Conducted	C
15.203 RSS-Gen(8.3)	Antenna Requirements	FCC 15.203	-	C
Note 1 : <b>C</b> = Comply <b>NC</b> = Not Comply <b>NT</b> = Not Tested <b>NA</b> = Not Applicable Note 2 : This test item was performed in each axis and the worst case data was reported. Note 3 : The sample was tested according to the following specifications : - ANSI C63.10-2013				



### 1.10 Conclusion of worst-case and operation mode

The EUT has three type of modulation (GFSK,  $\pi/4$ DQPSK and 8DPSK).

Therefore all applicable requirements were tested with all the modulations.

And packet type was tested at the worst case(DH5).

The field strength of spurious emission was measured in three orthogonal EUT positions (X-axis, Y-axis and Z-axis).

Tested frequency information,

- Hopping Function : Enable

	TX Frequency (MHz)	RX Frequency (MHz)
<b>Hopping Band</b>	2402 ~ 2480	2402 ~ 2480

- Hopping Function : Disable

	TX Frequency (MHz)	RX Frequency (MHz)
<b>Lowest Channel</b>	2402	2402
<b>Middle Channel</b>	2441	2441
<b>Highest Channel</b>	2480	2480

## 2. Maximum Peak Output Power Measurement

### 2.1 Test Setup

Refer to the APPENDIX I.

### 2.2 Limit

#### ■ FCC Requirements

The maximum peak output power of the intentional radiator shall not exceed the following :

1. §15.247(a)(1), Frequency hopping systems shall have hopping channel carrier frequencies separated by a minimum of 25 kHz or the 20 dB bandwidth of the hopping channel, whichever is greater. Alternatively, frequency hopping systems operating in the 2400-2483.5 MHz band may have hopping channel carrier frequencies that are separated by 25 kHz or two-thirds of the 20 dB bandwidth of the hopping channel, whichever is greater, provided the systems operate with an output power no greater than 125 mW.
2. §15.247(b)(1), For frequency hopping systems operating in the 2400 – 2483.5 MHz employing at least 75 non-overlapping hopping channels, and all frequency hopping systems in the 5725 – 5805 MHz band : 1 Watt.

#### ■ IC Requirements

1. RSS-247(5.4), For FHSs operating in the band 2400-2483.5 MHz, the maximum peak conducted output power shall not exceed 1.0 W if the hopset uses 75 or more hopping channels; the maximum peak conducted output power shall not exceed 0.125 W if the hopset uses less than 75 hopping channels. The e.i.r.p. shall not exceed 4 W.

### 2.3 Test Procedure

1. The RF output power was measured with a spectrum analyzer connected to the RF Antenna connector (conducted measurement) while EUT was operating in transmit mode at the appropriate center frequency, A spectrum analyzer was used to record the shape of the transmit signal.
2. The bandwidth of the fundamental frequency was measured with the spectrum analyzer using ;  
Span = approximately 5 times of the 20 dB bandwidth, centered on a hopping channel  
RBW  $\geq$  20 dB BW  
VBW  $\geq$  RBW  
Sweep = auto  
Detector function = peak  
Trace = max hold

## 2.4 Test Results

Modulation	Tested Channel	Frame Average Output Power		Peak Output Power	
		dBm	mW	dBm	mW
<b><u>GFSK</u></b>	<b>Lowest</b>	8.52	7.11	10.72	11.80
	<b>Middle</b>	8.43	6.97	10.64	11.59
	<b>Highest</b>	<b>8.60</b>	<b>7.24</b>	<b>10.84</b>	<b>12.13</b>
<b><u><math>\pi/4</math>DQPSK</u></b>	<b>Lowest</b>	5.57	3.61	9.63	9.18
	<b>Middle</b>	<b>5.74</b>	<b>3.75</b>	<b>9.77</b>	<b>9.48</b>
	<b>Highest</b>	5.66	3.68	9.43	8.77
<b><u>8DPSK</u></b>	<b>Lowest</b>	5.61	3.64	9.64	9.20
	<b>Middle</b>	<b>5.77</b>	<b>3.78</b>	<b>9.77</b>	<b>9.48</b>
	<b>Highest</b>	5.68	3.70	9.45	8.81

Note 1 : The frame average output power was tested using an average power meter for reference only.

Note 2 : See next pages for actual measured spectrum plots.

Peak Output Power

Lowest Channel & Modulation : GFSK

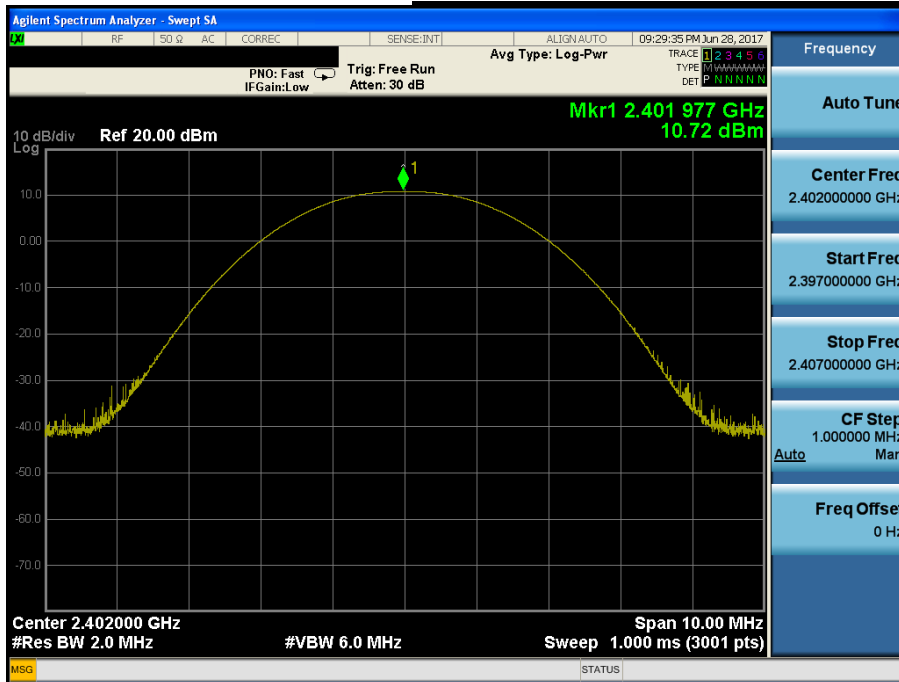

Peak Output Power

Middle Channel & Modulation : GFSK

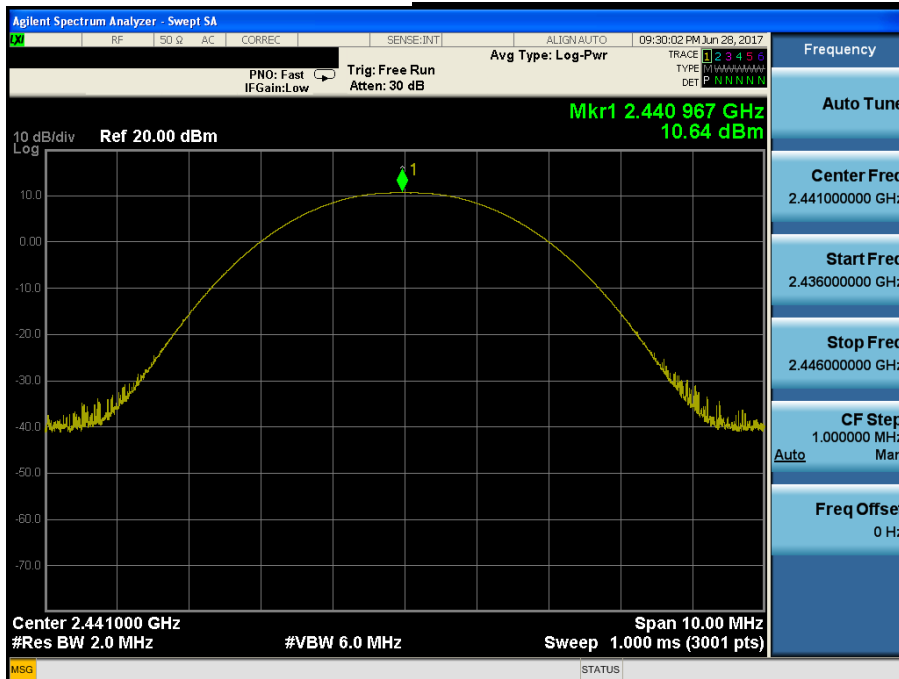

Peak Output Power

Highest Channel & Modulation : GFSK

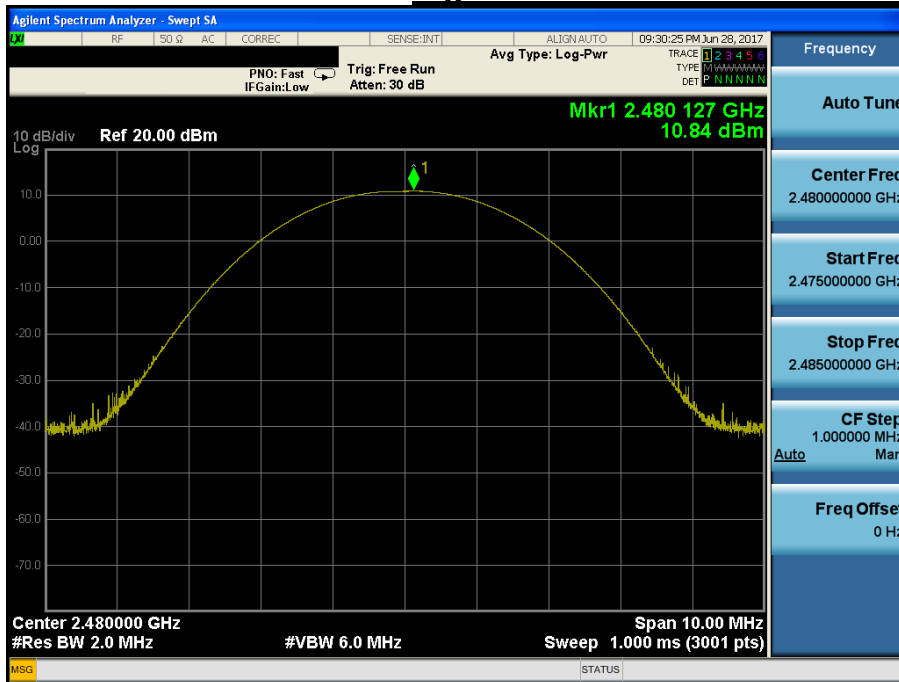

Peak Output Power

Lowest Channel & Modulation :  $\pi/4$ DQPSK

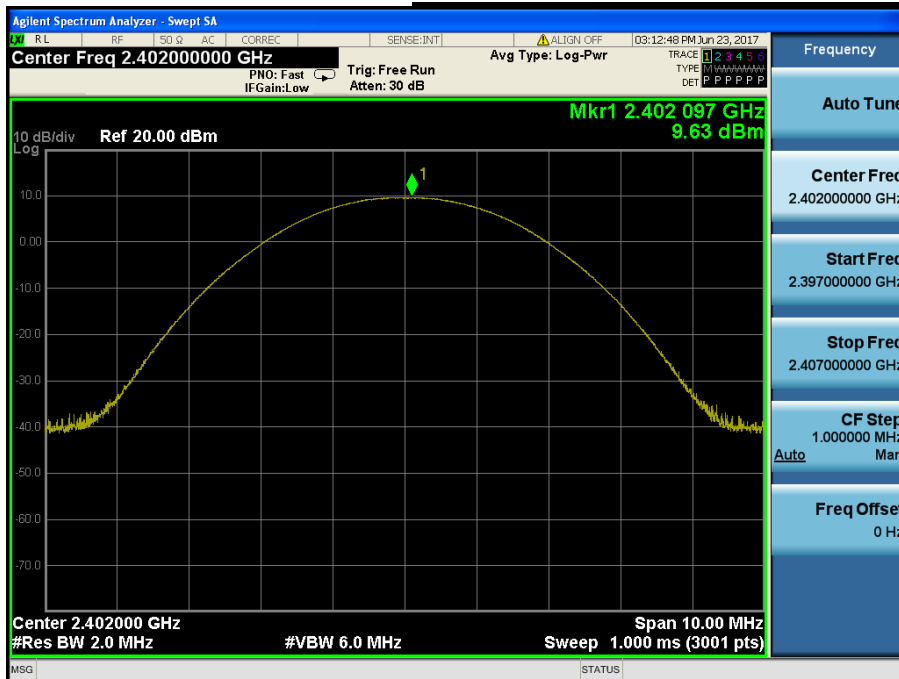

Peak Output Power

Middle Channel & Modulation :  $\pi/4$ DQPSK

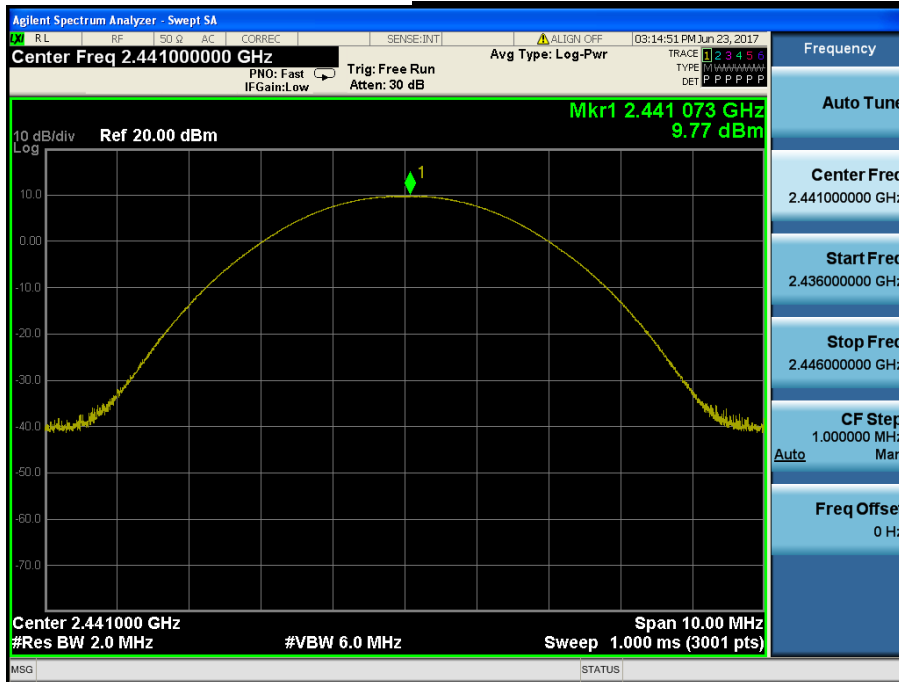

Peak Output Power

Highest Channel & Modulation :  $\pi/4$ DQPSK

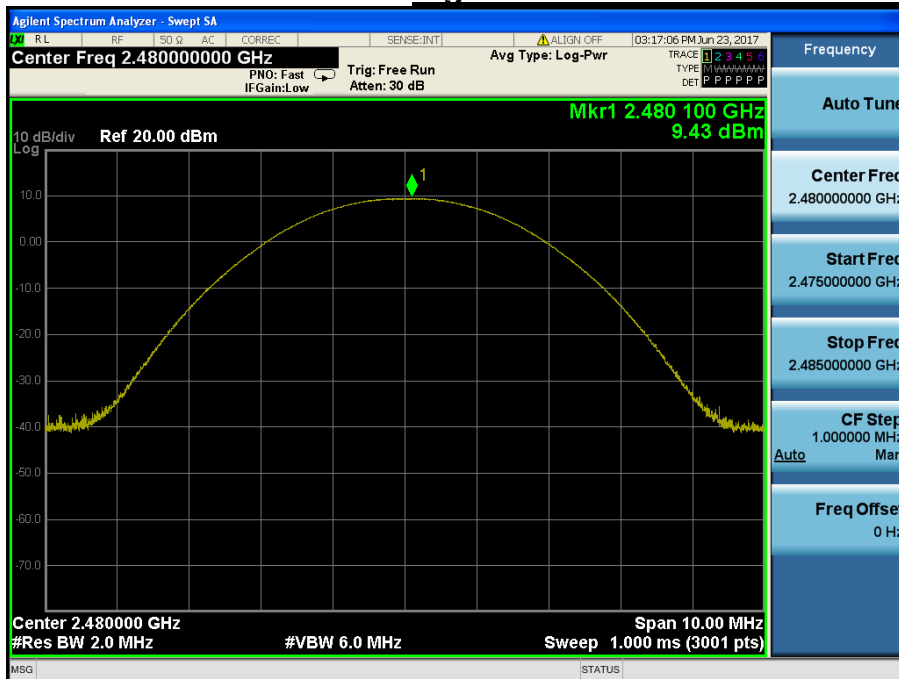

Peak Output Power

Lowest Channel & Modulation : 8DPSK

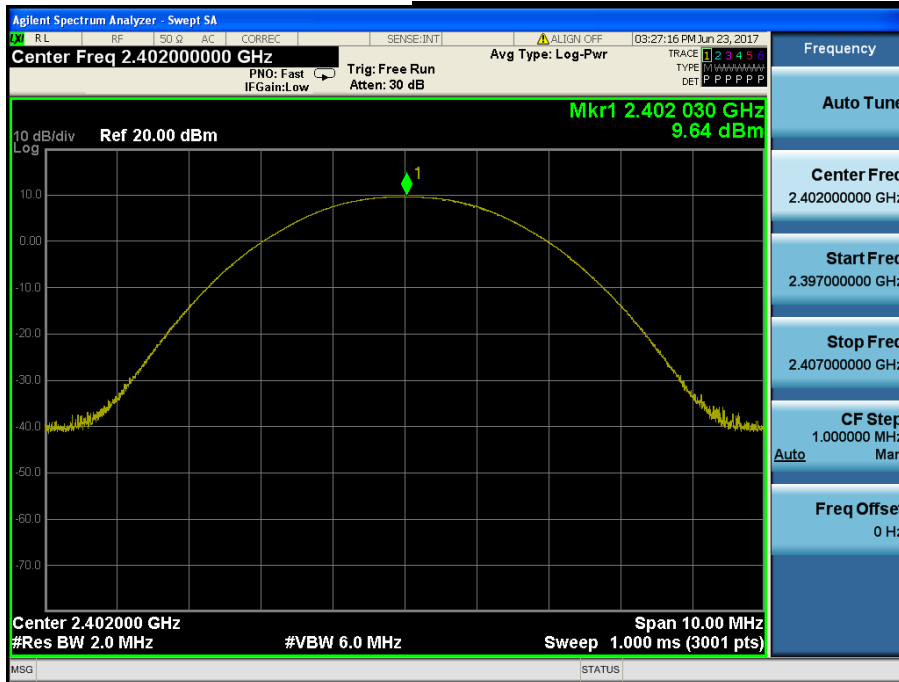

Peak Output Power

Middle Channel & Modulation : 8DPSK

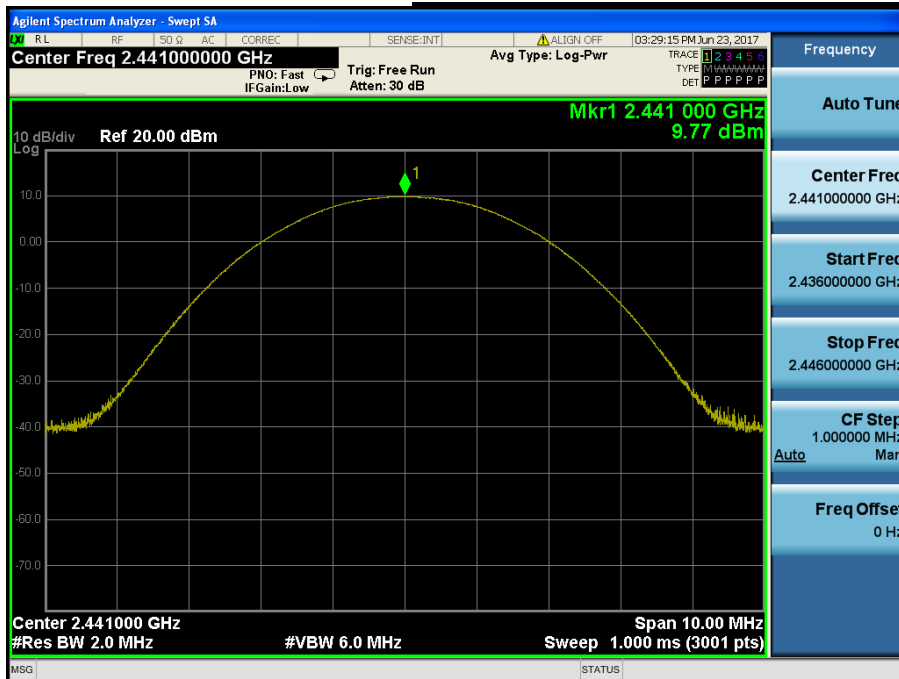

Peak Output Power

**Highest Channel & Modulation : 8DPSK**

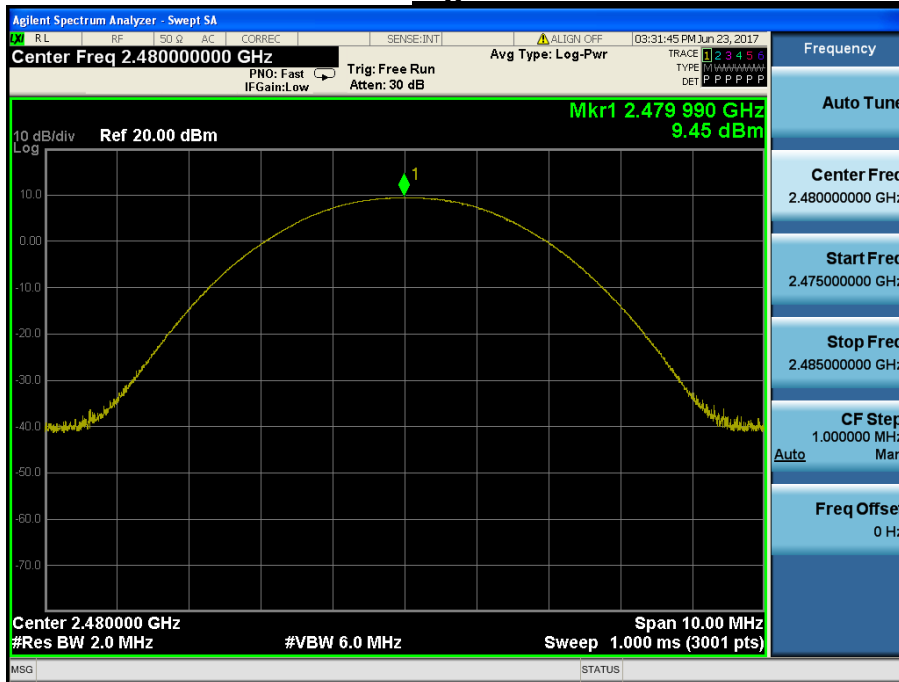



### 3. 20 dB BW

#### 3.1 Test Setup

Refer to the APPENDIX I.

#### 3.2 Limit

Limit : Not Applicable

#### 3.3 Test Procedure

1. The 20 dB bandwidth were measured with a spectrum analyzer connected to RF antenna Connector (conducted measurement) while EUT was operating in transmit mode. The analyzer center frequency was set to the EUT carrier frequency, using the analyzer.
2. The bandwidth of the fundamental frequency was measured with the spectrum analyzer using below setting: RBW shall be in the range of 1% to 5% of the 20 dB bandwidth and VBW  $\geq 3 \times$  RBW, Span = between two times and five times the 20 dB bandwidth.

#### 3.4 Test Results

Modulation	Tested Channel	20 dB BW (MHz)
<b><u>GFSK</u></b>	Lowest	0.927
	Middle	0.928
	Highest	<b>0.929</b>
<b><u><math>\pi/4</math>DQPSK</u></b>	Lowest	1.304
	Middle	1.318
	Highest	<b>1.319</b>
<b><u>8DPSK</u></b>	Lowest	1.289
	Middle	<b>1.331</b>
	Highest	1.279

Note 1 : See next pages for actual measured spectrum plots.

20 dB Bandwidth

***Lowest Channel & Modulation : GFSK***

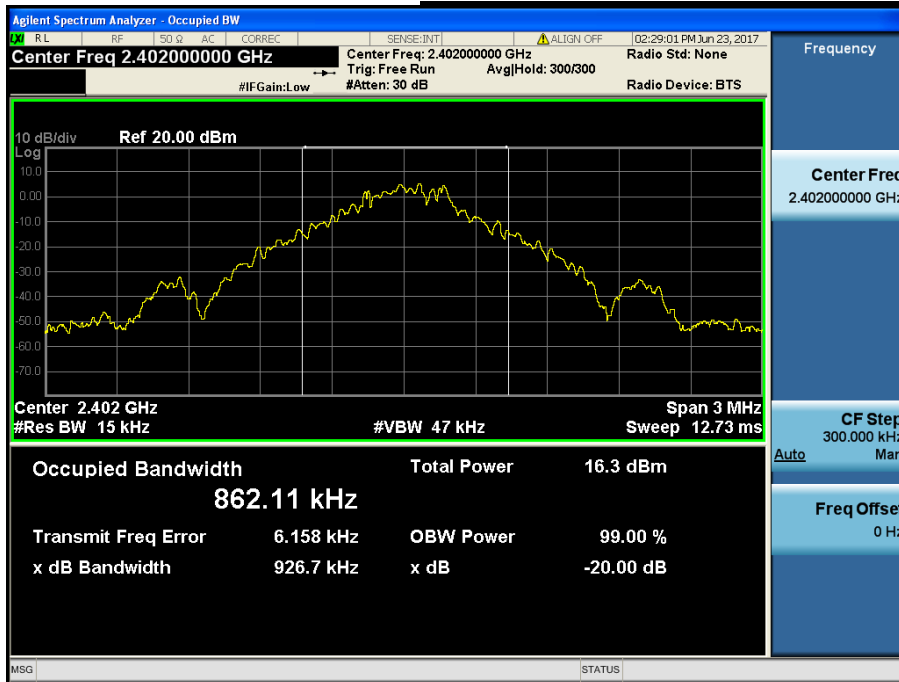

20 dB Bandwidth

***Middle Channel & Modulation : GFSK***

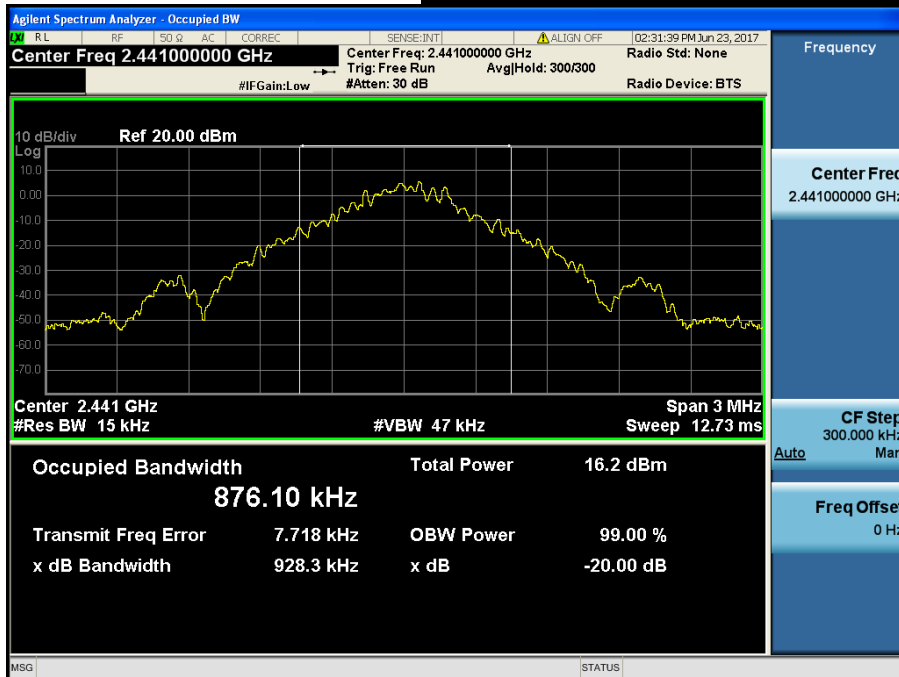

20 dB Bandwidth

**Highest Channel & Modulation : GFSK**

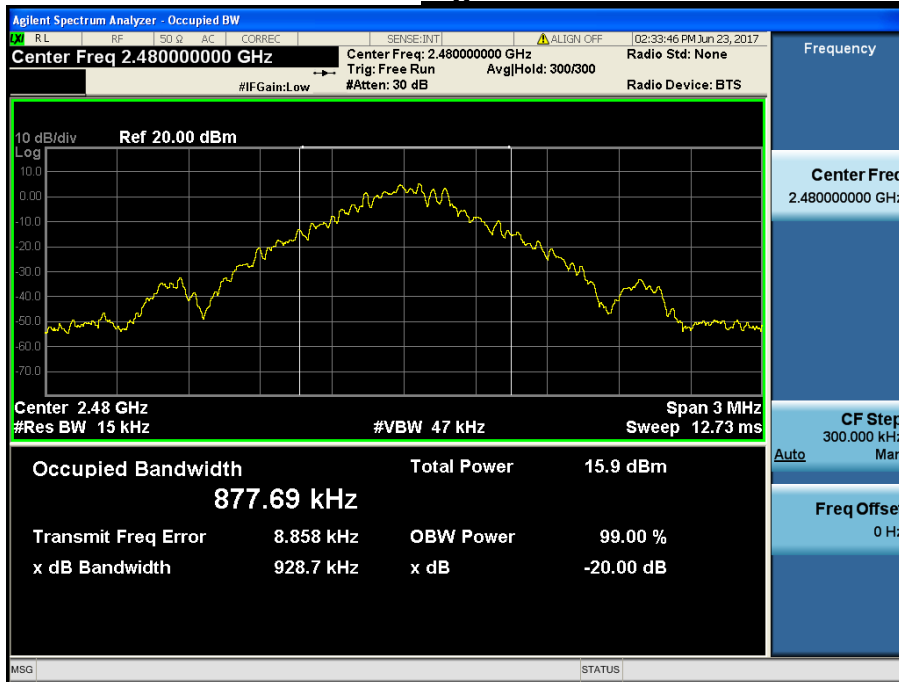

20 dB Bandwidth

**Lowest Channel & Modulation :  $\pi/4$ DQPSK**

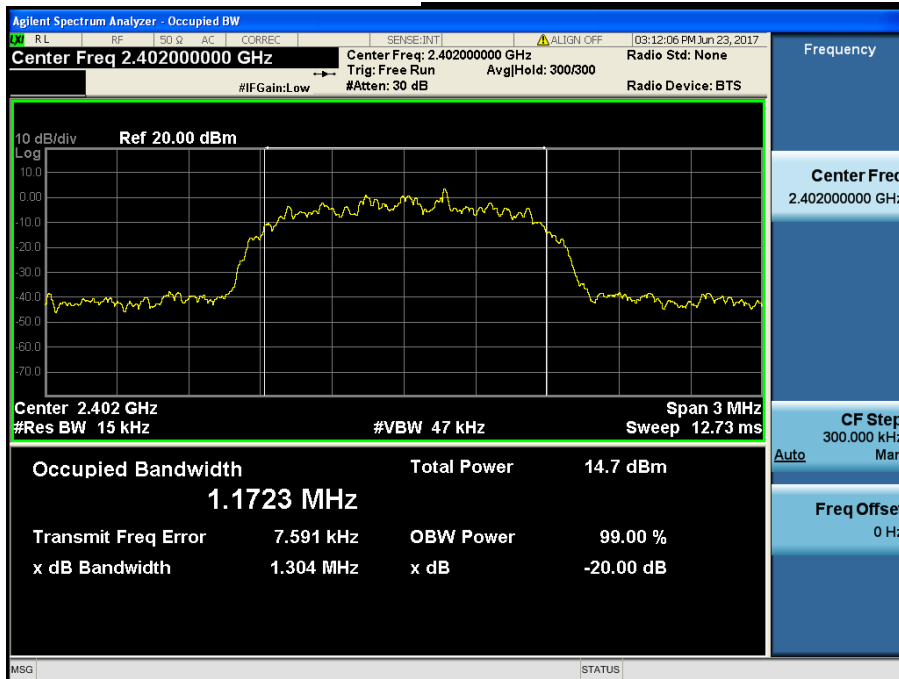

20 dB Bandwidth

***Middle Channel & Modulation :  $\pi/4$ DQPSK***

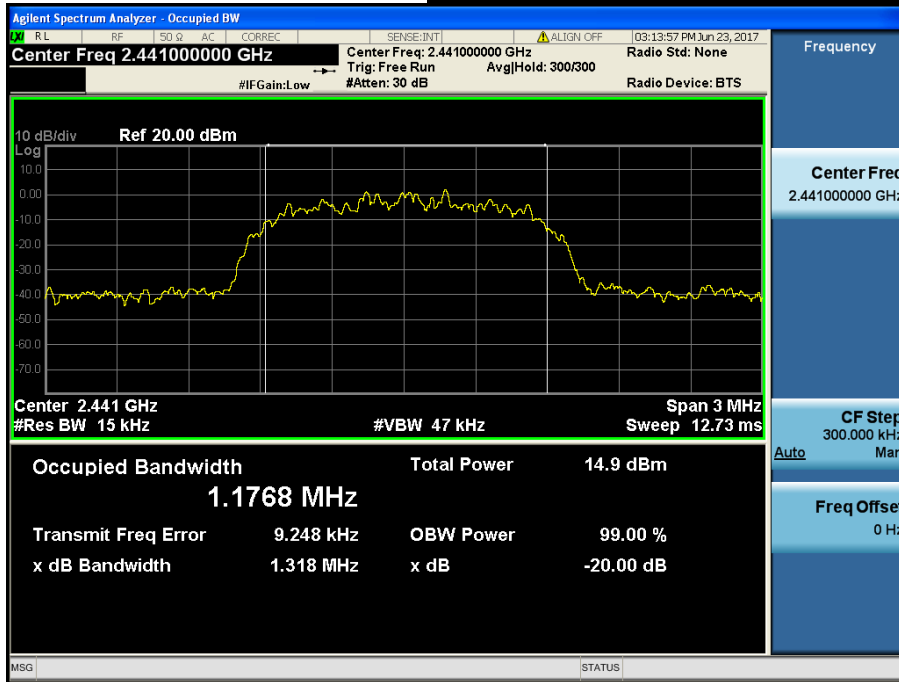

20 dB Bandwidth

***Highest Channel & Modulation :  $\pi/4$ DQPSK***

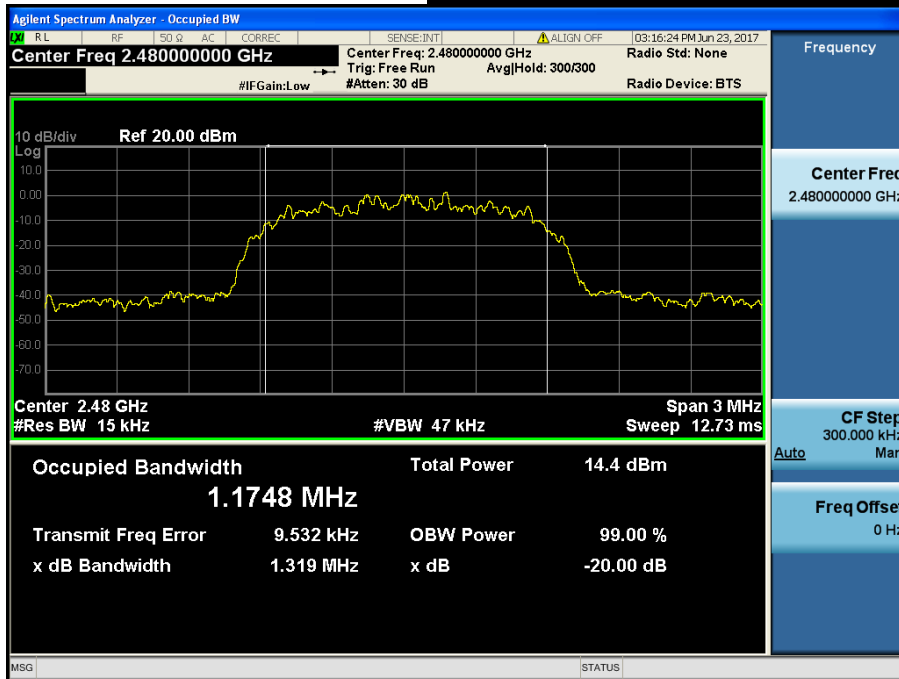

20 dB Bandwidth

***Lowest Channel & Modulation : 8DPSK***

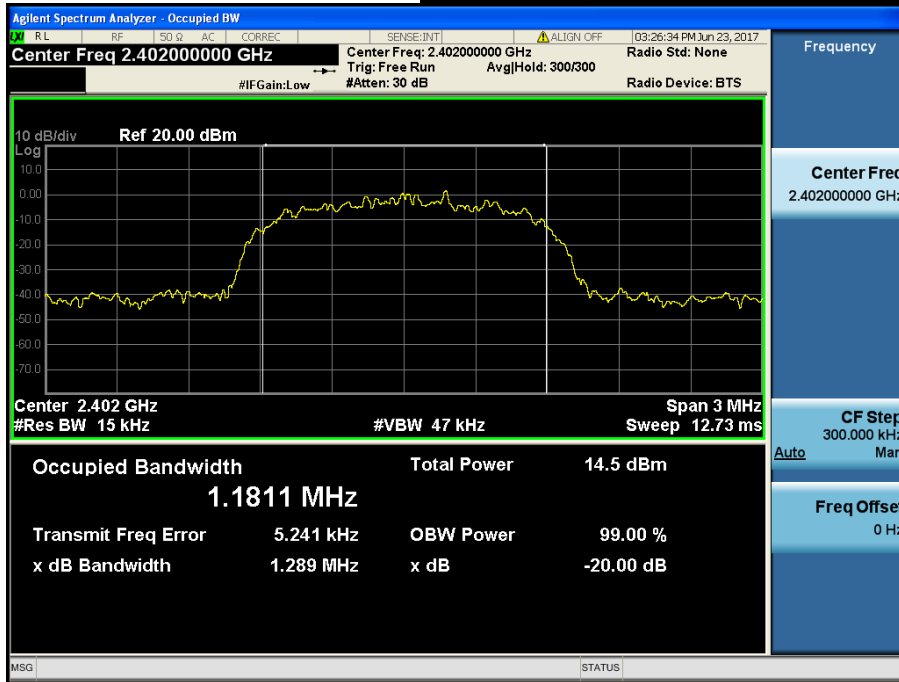

20 dB Bandwidth

***Middle Channel & Modulation : 8DPSK***

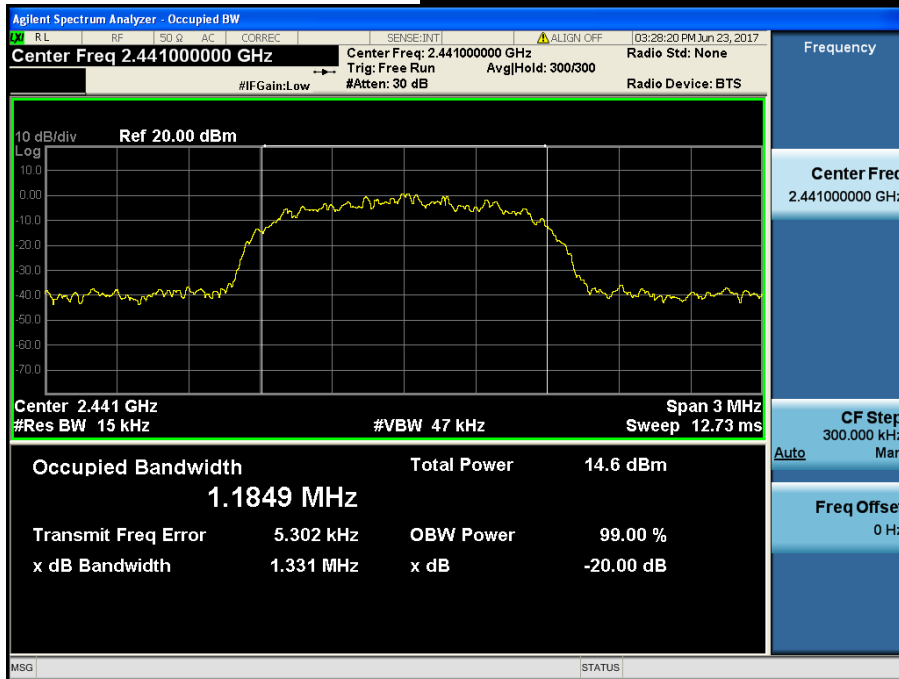

20 dB Bandwidth

***Highest Channel & Modulation : 8DPSK***

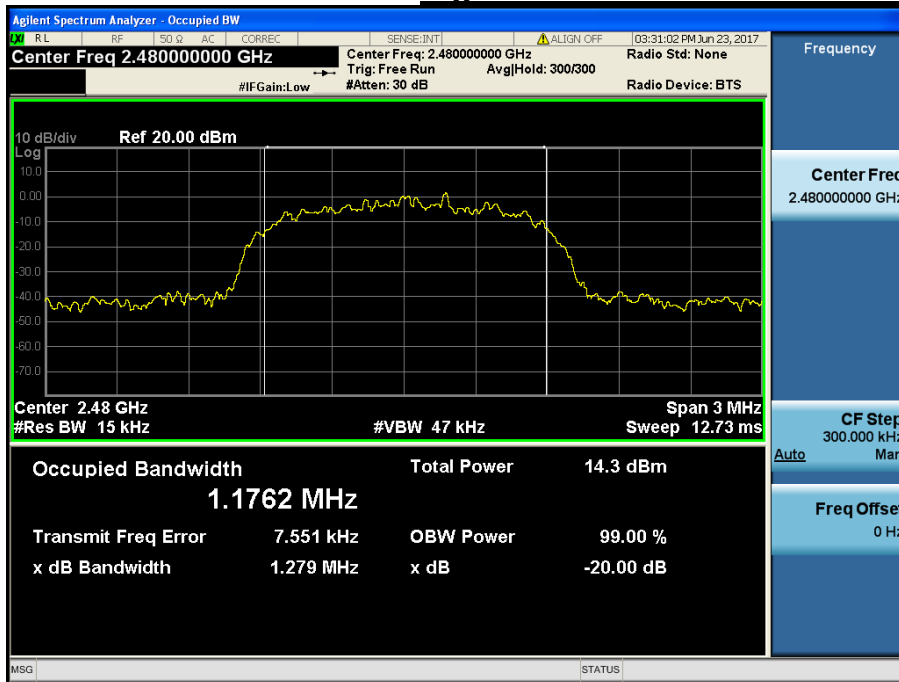

## 4. Carrier Frequency Separation

### 4.1 Test Setup

Refer to the APPENDIX I.

### 4.2 Limit

Limit :  $\geq 25$  kHz or  $\geq$  Two-Thirds of the 20 dB BW whichever is greater.

### 4.3 Procedure

The carrier frequency separation was measured with a spectrum analyzer connected to the antenna terminal, while EUT had its hopping function enabled.

After the trace being stable, the reading value between the peaks of the adjacent channels using the marker-delta function was recorded as the measurement results.

The spectrum analyzer is set to :

Span = wide enough to capture the peaks of two adjacent channels

RBW = Start with the RBW set to approximately 30% of the channel spacing; adjust as necessary to best identify the center of each individual channel.

VBW  $\geq$  RBW

Sweep = auto

Detector function = peak

Trace = max hold

### 4.4 Test Results

#### FH mode

Hopping Mode	Modulation	Peak of center channel (MHz)	Peak of adjacent Channel (MHz)	Test Result (MHz)
Enable	GFSK	2441.024	2442.023	0.999
	$\pi/4$ -DQPSK	2441.003	2442.002	0.999
	8DPSK	2441.168	2442.170	1.002

#### AFH mode

Hopping Mode	Modulation	Peak of center channel (MHz)	Peak of adjacent Channel (MHz)	Test Result (MHz)
Enable	GFSK	2441.024	2442.023	0.999
	$\pi/4$ -DQPSK	2440.997	2441.996	0.999
	8DPSK	2441.171	2442.170	0.999

Note 1 : See next pages for actual measured spectrum plots.

#### - Minimum Standard :

Frequency hopping systems shall have hopping channel carrier frequencies separated by a minimum of 25 kHz or the 20 dB bandwidth of the hopping channel, whichever is greater. Alternatively, frequency hopping systems operating in the 2400 - 2483.5 MHz band may have hopping channel carrier frequencies that are separated by 25 kHz or two-thirds of the 20 dB bandwidth of the hopping channel, whichever is greater, provided the systems operate with an output power no greater than 125 mW

**Carrier Frequency Separation (FH) *Hopping mode : Enable & GFSK***



**Carrier Frequency Separation (FH) *Hopping mode : Enable & π/4-DQPSK***

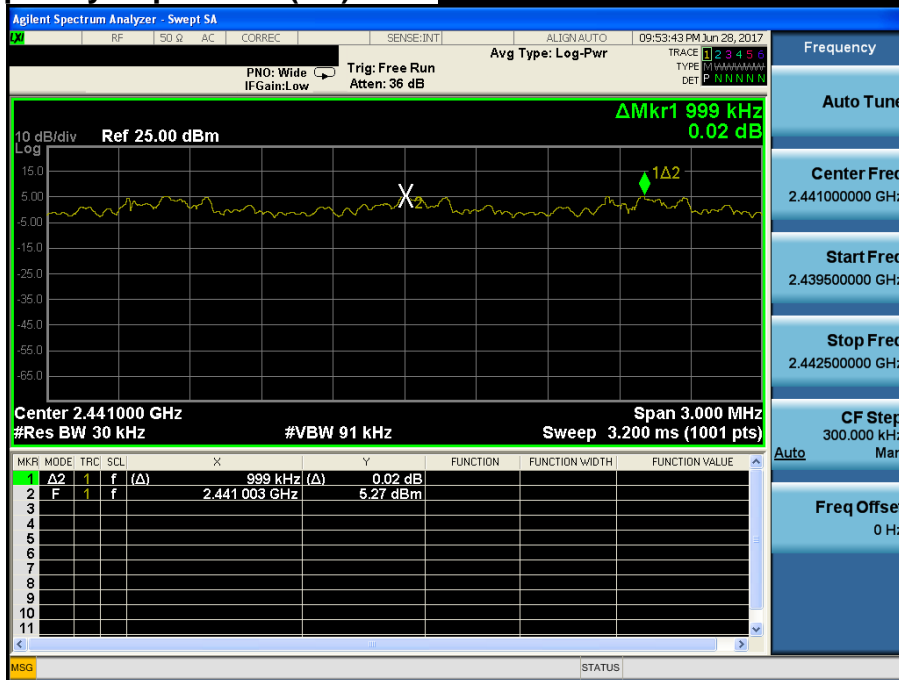



**Carrier Frequency Separation (FH) *Hopping mode : Enable & 8DPSK***

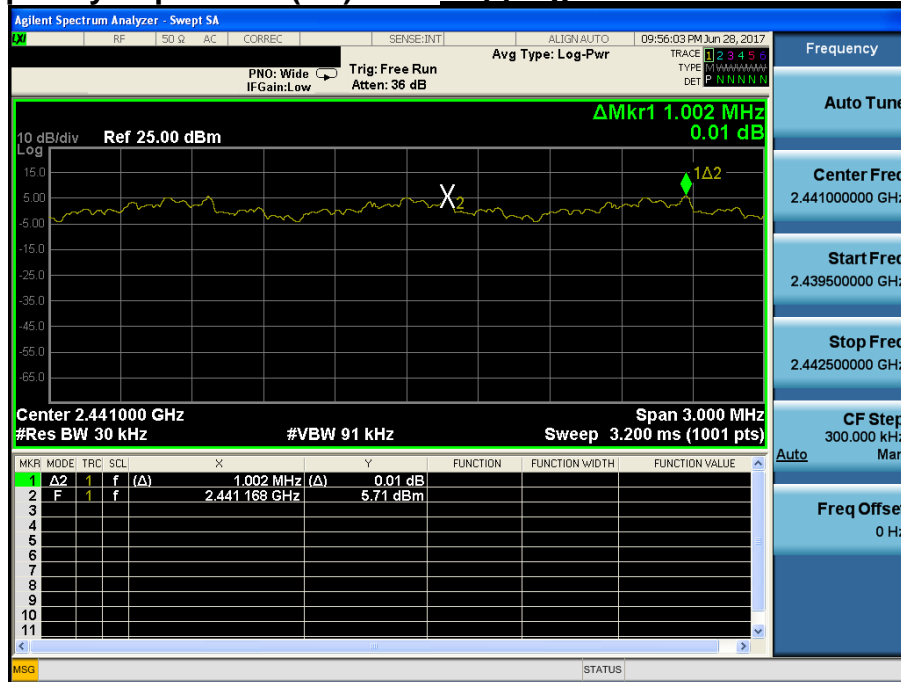

**Carrier Frequency Separation (AFH) *Hopping mode : Enable & GFSK***

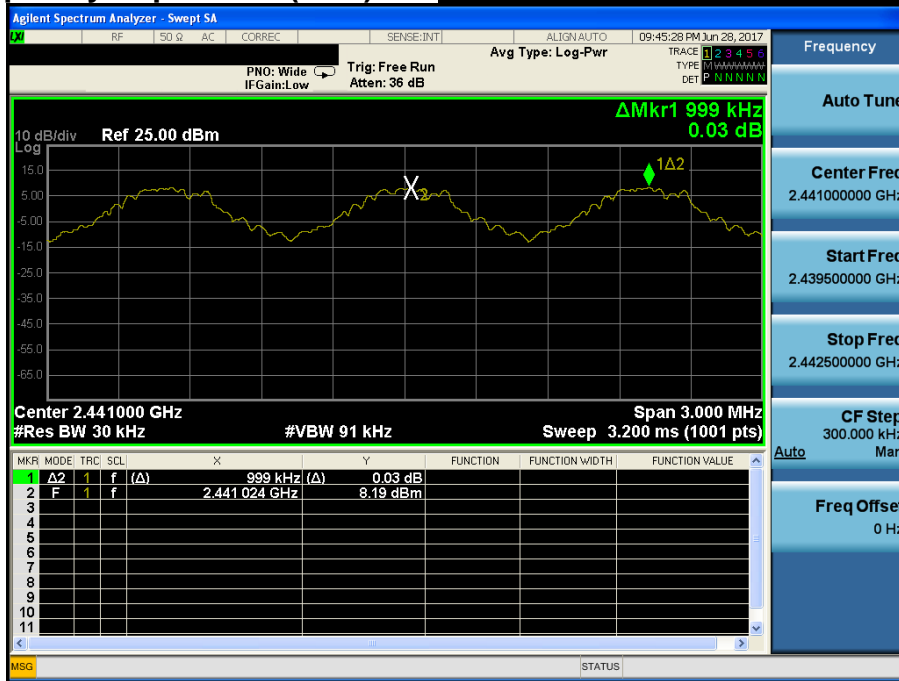

**Carrier Frequency Separation (AFH) *Hopping mode : Enable &  $\pi/4$ -DQPSK***

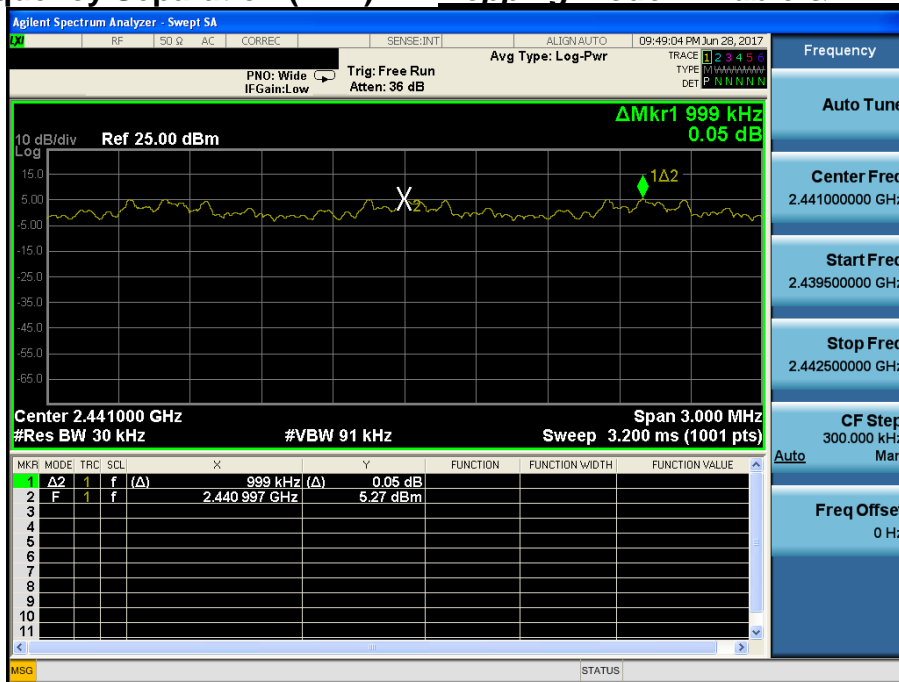

**Carrier Frequency Separation (AFH) *Hopping mode : Enable & 8DPSK***

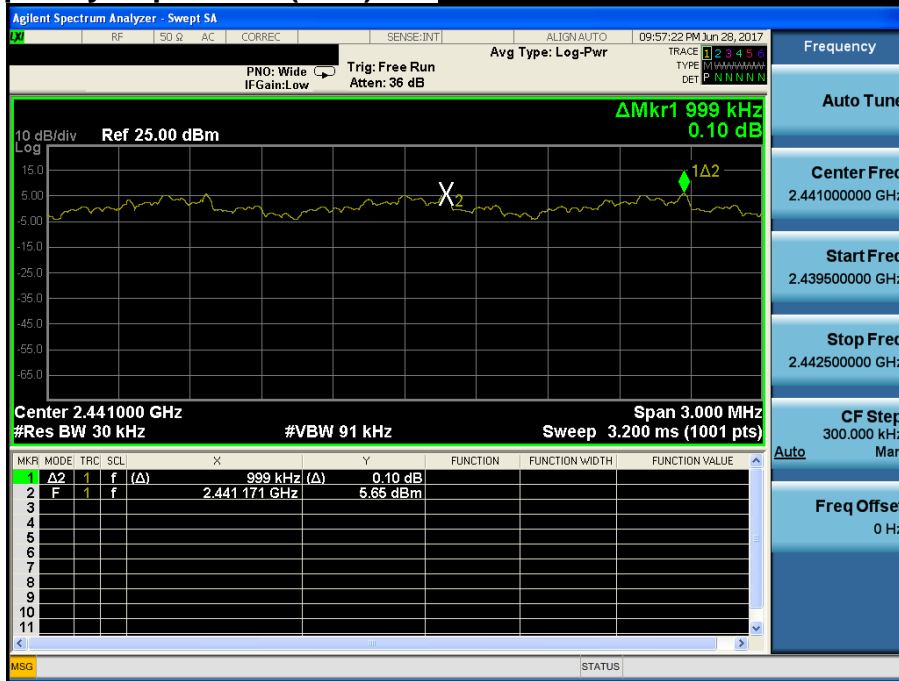

## 5. Number of Hopping Frequencies

### 5.1 Test Setup

Refer to the APPENDIX I.

### 5.2 Limit

Limit :  $\geq 15$  hops

### 5.3 Procedure

The number of hopping frequencies was measured with a spectrum analyzer connected to the antenna terminal, while EUT had its hopping function enabled.

To get higher resolution, two frequency ranges for FH mode within the 2400 ~ 2483.5 MHz were examined.

The spectrum analyzer is set to :

Span for FH mode = 50 MHz      Start Frequency = 2391.5 MHz,      Stop Frequency = 2441.5 MHz

Start Frequency = 2441.5 MHz,      Stop Frequency = 2491.5 MHz

Span for AFH mode = 50 MHz      Start Frequency = 2416.0 MHz,      Stop Frequency = 2466.0 MHz

RBW = To identify clearly the individual channels, set the RBW to less than 30% of the channel spacing or the 20 dB bandwidth, whichever is smaller.

VBW  $\geq$  RBW      Sweep = auto

Detector function = peak      Trace = max hold

### 5.4 Test Results

#### FH mode

Hopping mode	Modulation	Test Result (Total Hops)
Enable	GFSK	79
	$\pi/4$ -DQPSK	79
	8DPSK	79

#### AFH mode

Hopping mode	Modulation	Test Result (Total Hops)
Enable	GFSK	20
	$\pi/4$ -DQPSK	20
	8DPSK	20

Note 1 : See next pages for actual measured spectrum plots.

#### - Minimum Standard :

At least 15 hops
------------------

Number of Hopping Frequencies 1(FH)

Hopping mode : Enable & GFSK

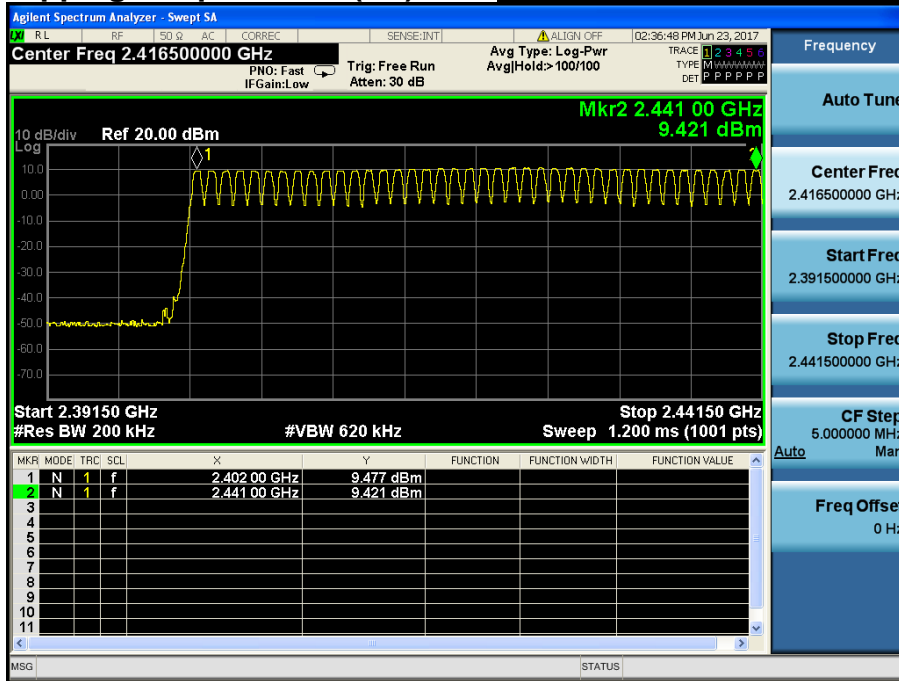

Number of Hopping Frequencies 2(FH)

Hopping mode : Enable & GFSK

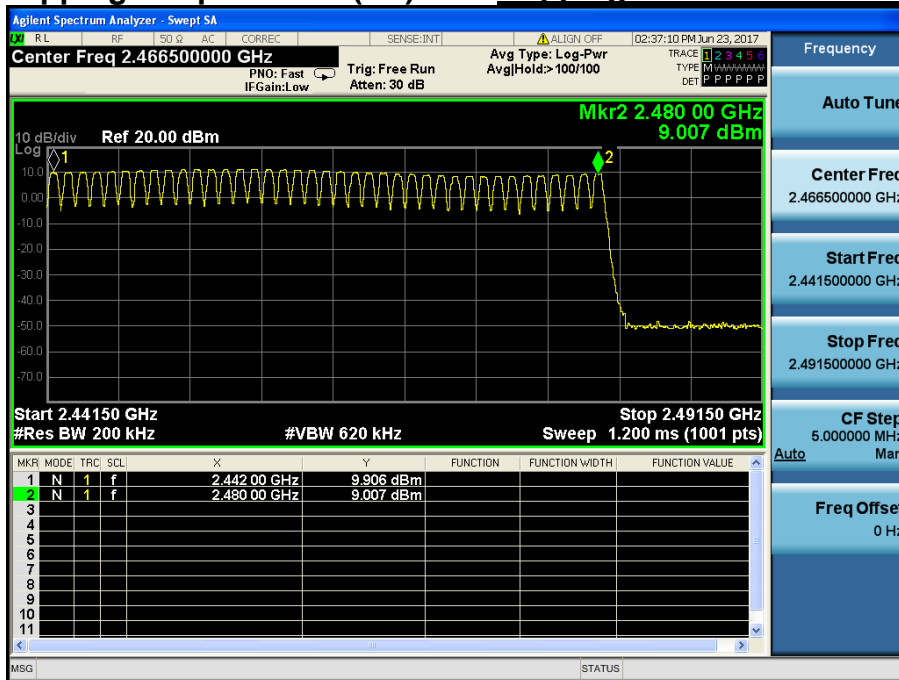

Number of Hopping Frequencies 1(FH)

Hopping mode : Enable &  $\pi/4$ -DQPSK

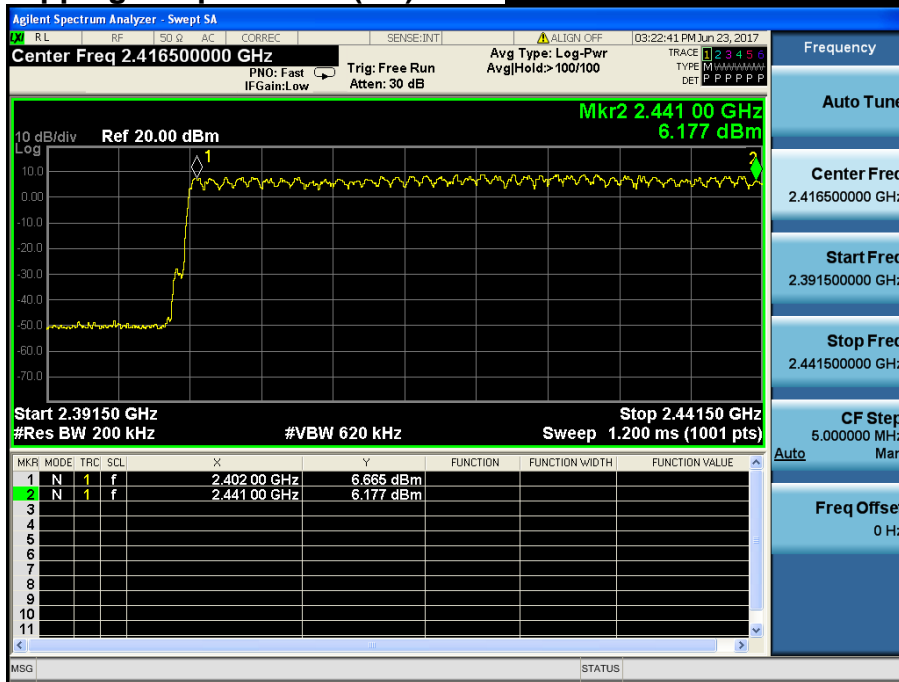

Number of Hopping Frequencies 2(FH)

Hopping mode : Enable &  $\pi/4$ -DQPSK

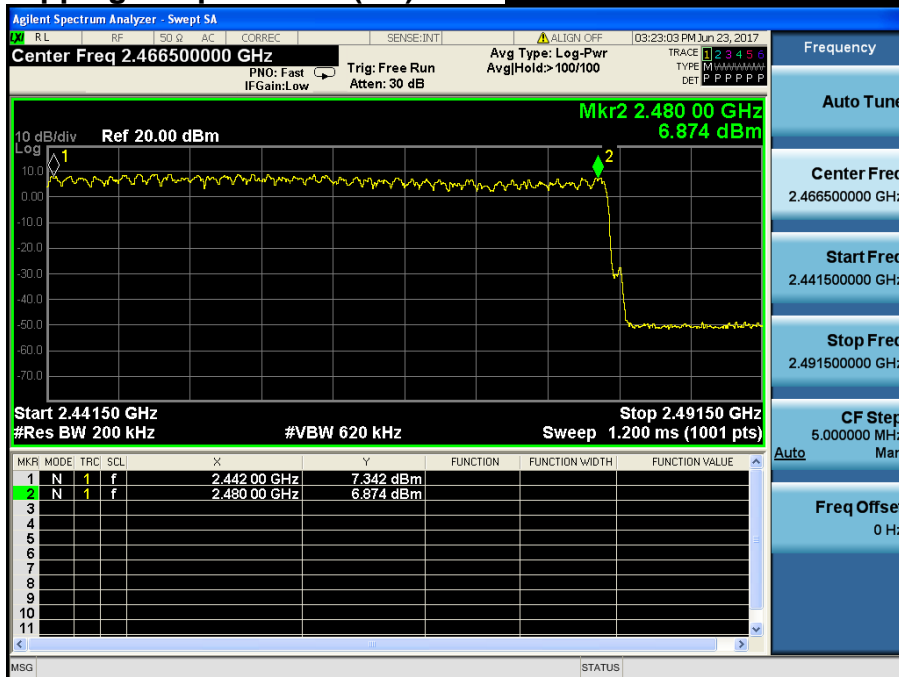

**Number of Hopping Frequencies 1(FH) *Hopping mode : Enable & 8DPSK***

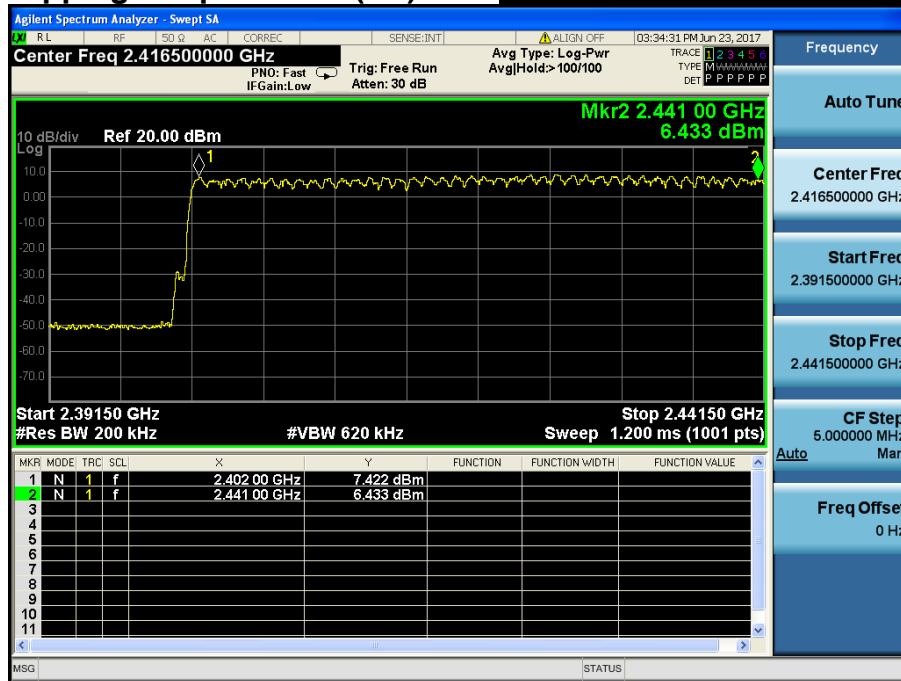

**Number of Hopping Frequencies 2(FH) *Hopping mode : Enable & 8DPSK***

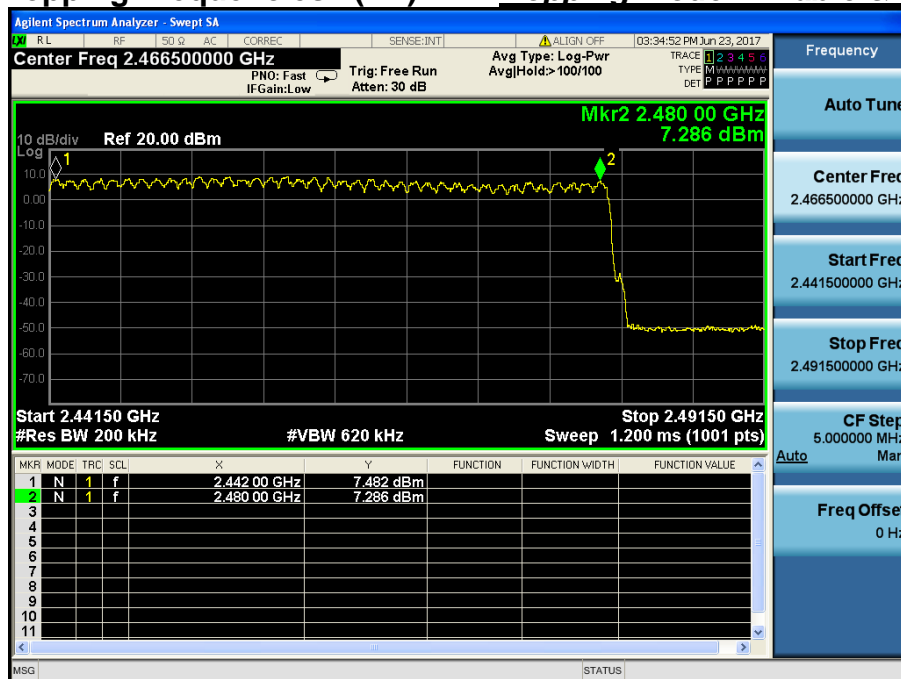

**Number of Hopping Frequencies 1(AFH) *Hopping mode : Enable & GFSK***

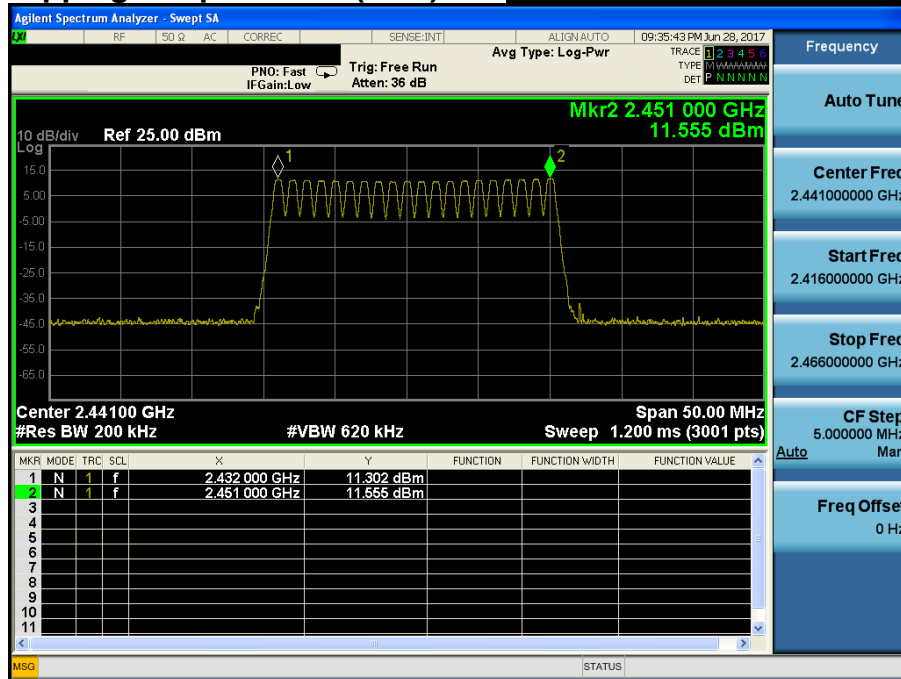

**Number of Hopping Frequencies 1(AFH) *Hopping mode : Enable & π/4-DQPSK***

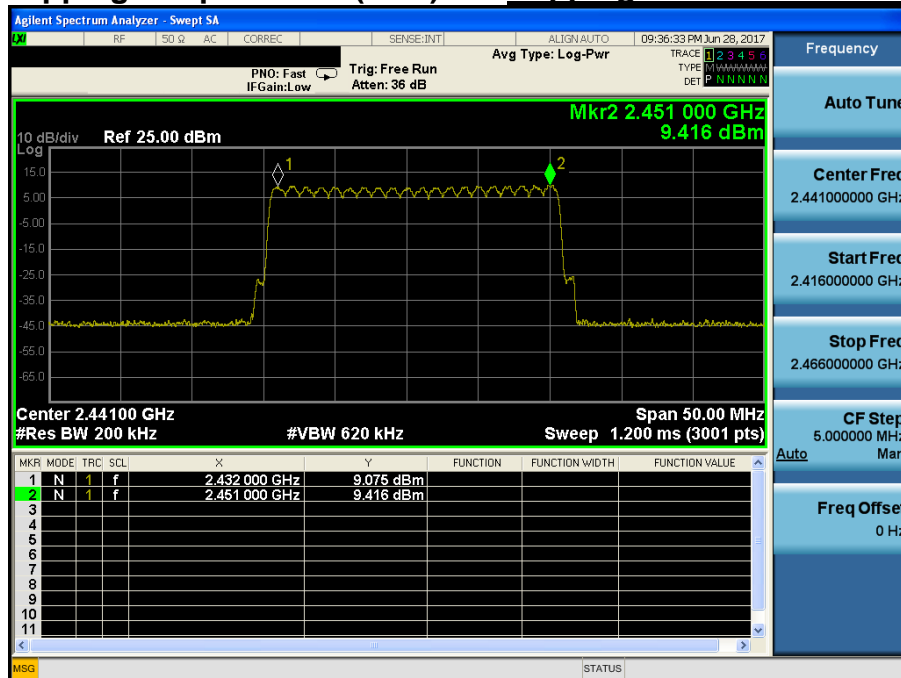



**Number of Hopping Frequencies 1(AFH) *Hopping mode : Enable & 8DPSK***

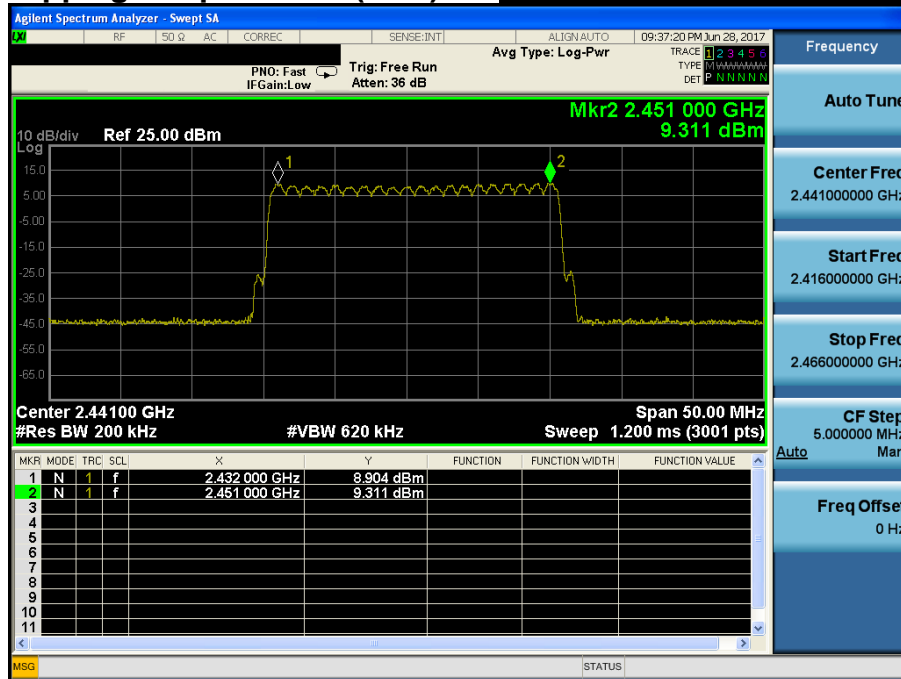

## 6. Time of Occupancy (Dwell Time)

### 6.1 Test Setup

Refer to the APPENDIX I.

### 6.2 Limit

The maximum permissible time of occupancy is 400 ms within a period of 400 ms multiplied by the number of hopping channels employed.

### 6.3 Test Procedure

The dwell time was measured with a spectrum analyzer connected to the antenna terminal, while EUT had its hopping function enabled.

The spectrum analyzer is set to :

Center frequency = 2441 MHz

Span = zero

RBW = 1 MHz (RBW shall be  $\leq$  channel spacing and where possible RBW should be set  $\gg 1 / T$ , where T is the expected dwell time per channel)

VBW  $\geq$  RBW

Detector function = peak

Trace = max hold

### 6.4 Test Results

#### FH mode

Hopping mode	Packet Type	Number of hopping Channels	Burst On Time (ms)	Period (ms)	Test Result (sec)
Enable	DH 5	79	2.880	3.750	0.307
	2 DH 5	79	2.880	3.750	0.307
	3 DH 5	79	2.880	3.750	0.307

#### AFH mode

Hopping mode	Packet Type	Number of hopping Channels	Burst On Time (ms)	Period (ms)	Test Result (sec)
Enable	DH 5	20	2.880	3.750	0.154
	2 DH 5	20	2.880	3.750	0.154
	3 DH 5	20	2.880	3.750	0.154

Note 1 : Dwell Time =  $0.4 \times \text{Hopping channel} \times \text{Burst ON time} \times ((\text{Hopping rate} \div \text{Time slots}) \div \text{Hopping channel})$

- Time slots for DH5 = 6 slots (TX = 5 slot / RX = 1 slot)
- Hopping Rate = 1600 for FH mode & 800 for AFH mode

Note 2 : See next pages for actual measured spectrum plots.

Time of Occupancy (FH)

Hopping mode : Enable & DH5

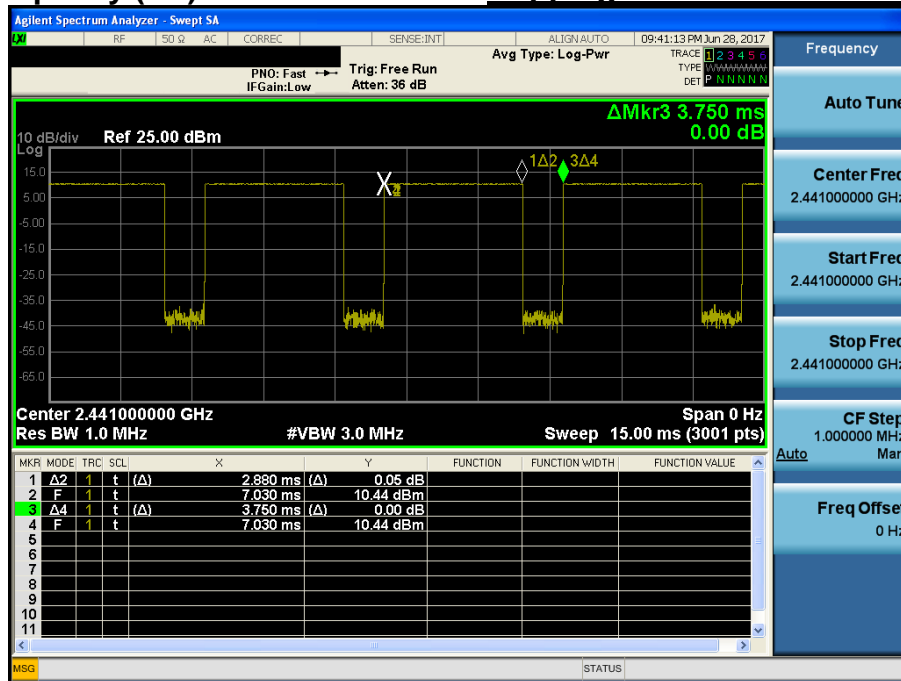

Time of Occupancy (FH)

Hopping mode : Enable & 2-DH5

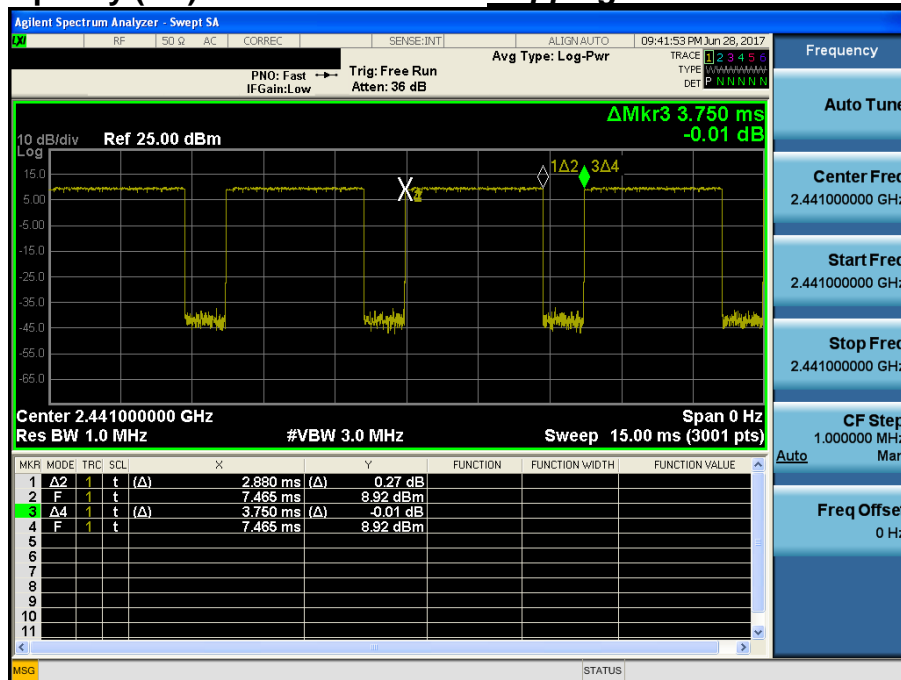

Time of Occupancy (FH)

Hopping mode : Enable & 3-DH5

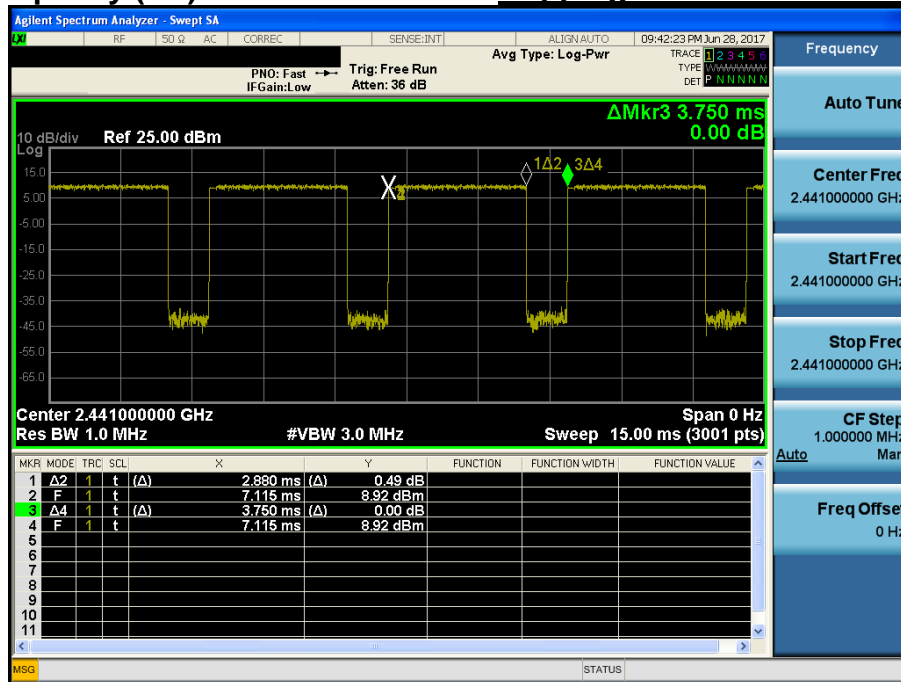

Time of Occupancy (AFH)

Hopping mode : Enable & DH5

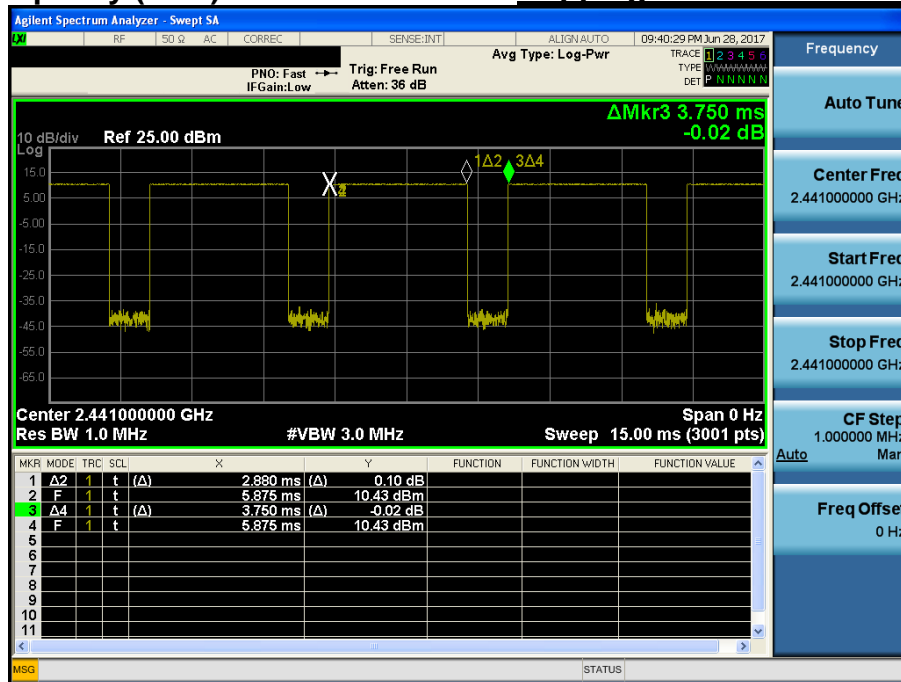

Time of Occupancy (AFH)

Hopping mode : Enable & 2-DH5

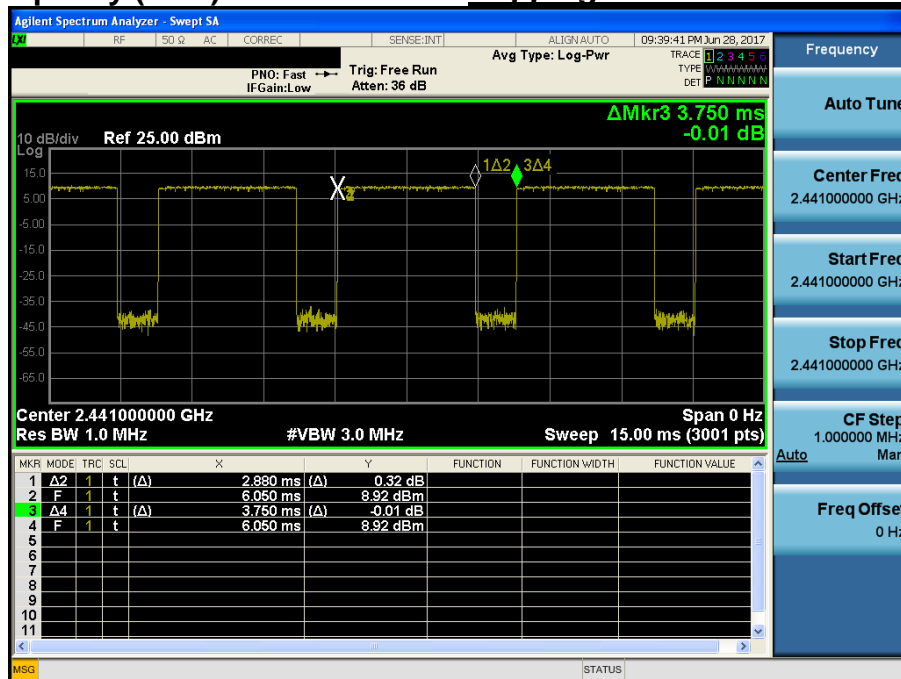

Time of Occupancy (AFH)

Hopping mode : Enable & 3-DH5

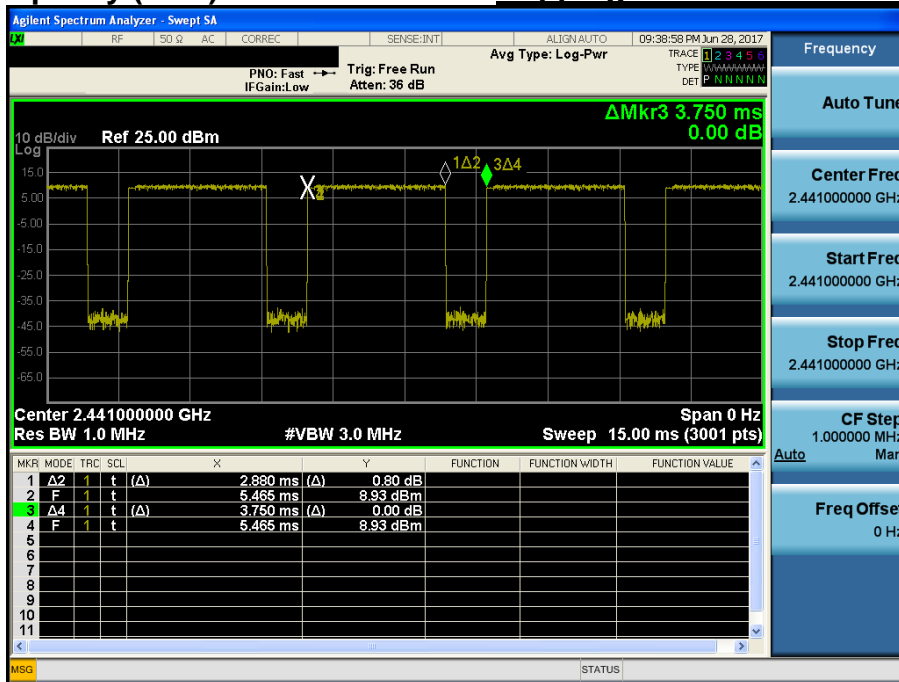

## 7. Transmitter Radiated Spurious Emissions and Conducted Spurious Emission

### 7.1 Test Setup

Refer to the APPENDIX I.

### 7.2 Limit

According to §15.247(d), in any 100 kHz bandwidth outside the frequency band in which the spread spectrum or digitally modulated intentional radiator is operating, the radio frequency power that is produced by the intentional radiator shall be at least 20 dB below that in the 100 kHz bandwidth within the band that contains the highest level of the desired power, based on either an RF conducted or a radiated measurement, provided the transmitter demonstrates compliance with the peak conducted power limits. If the transmitter complies with the conducted power limits based on the use of RMS averaging over a time interval, as permitted under paragraph(b)(3) of this section, the attenuation required under this paragraph shall be 30 dB instead of 20 dB. Attenuation below the general limits specified in section §15.209(a) is not required. In addition, radiated emission which in the restricted band, as define in section §15.205(a), must also comply the radiated emission limits specified in section §15.209(a) (see section §15.205(c))

According to § 15.209(a), except as provided elsewhere in this Subpart, the emissions from an intentional radiator shall not exceed the field strength levels specified in the following table

Frequency (MHz)	Limit (uV/m)	Measurement Distance (meter)
0.009 ~ 0.490	2400/F (kHz)	300
0.490 ~ 1705	24000/F (kHz)	30
1705 ~ 30.0	30	30
30 ~ 88	100 **	3
88 ~ 216	150 **	3
216 ~ 960	200 **	3
Above 960	500	3

\*\* Except as provided in 15.209(g), fundamental emissions from intentional radiators operating under this Section shall not be located in the frequency bands 54 - 72 MHz, 76 - 88 MHz, 174 - 216 MHz or 470 - 806 MHz. However, operation within these frequency bands is permitted under other sections of this Part, e.g. 15.231 and 15.241.

According to § 15.205(a) and (b), only spurious emissions are permitted in any of the frequency bands listed below :

MHz	MHz	MHz	MHz	GHz	GHz
0.009 ~ 0.110	8.41425 ~ 8.41475	108 ~ 121.94	1300 ~ 1427	4.5 ~ 5.15	14.47 ~ 14.5
0.495 ~ 0.505	12.29 ~ 12.293	123 ~ 138	1435 ~ 1626.5	5.35 ~ 5.46	15.35 ~ 16.2
2.1735 ~ 2.1905	12.51975 ~ 12.52025	149.9 ~ 150.05	1645.5 ~ 1646.5	7.25 ~ 7.75	17.7 ~ 21.4
4.125 ~ 4.128	12.57675 ~ 12.57725	156.52475 ~ 156.52525	1660 ~ 1710	8.025 ~ 8.5	22.01 ~ 23.12
4.17725 ~ 4.17775	13.36 ~ 13.41	156.7 ~ 156.9	1718.8 ~ 1722.2	9.0 ~ 9.2	23.6 ~ 24.0
4.20725 ~ 4.20775	16.42 ~ 16.423	162.0125 ~ 167.17	2200 ~ 2300	9.3 ~ 9.5	31.2 ~ 31.8
6.215 ~ 6.218	16.69475 ~ 16.69525	167.72 ~ 173.2	2310 ~ 2390	10.6 ~ 12.7	36.43 ~ 36.5
6.26775 ~ 6.26825	16.80425 ~ 16.80475	240 ~ 285	2483.5 ~ 2500	13.25 ~ 13.4	Above 38.6
6.31175 ~ 6.31225	25.5 ~ 25.67	322 ~ 335.4	2655 ~ 2900		
8.291 ~ 8.294	37.5 ~ 38.25	399.90 ~ 410	3260 ~ 3267		
8.362 ~ 8.366	73 ~ 74.6	608 ~ 614	3332 ~ 3339		
8.37625 ~ 8.38675	74.8 ~ 75.2	960 ~ 1240	3345.8 ~ 3358		
			3600 ~ 4400		

The field strength of emissions appearing within these frequency bands shall not exceed the limits shown in §15.209. At frequencies equal to or less than 1000 MHz, compliance with the limits in §15.209 shall be demonstrated using measurement instrumentation employing a CISPR quasi-peak detector. Above 1000 MHz, compliance with the emission limits in §15.209 shall be demonstrated based on the average value of the measured emissions. The provisions in §15.35 apply to these measurements.

## 7.3. Test Procedures

### 7.3.1. Test Procedures for Radiated Spurious Emissions

1. The EUT is placed on a non-conductive table. For emission measurements at or below 1 GHz, the table height is 80 cm. For emission measurements above 1 GHz, the table height is 1.5 m.  
The table was rotated 360 degrees to determine the position of the highest radiation.
2. During performing radiated emission below 1 GHz, the EUT was set 3 meters away from the interference receiving antenna, which was mounted on the top of a variable-height antenna tower. During performing radiated emission above 1 GHz, the EUT was set 1 or 3 meter away from the interference-receiving antenna.
3. For measurements above 1GHz absorbers are placed on the floor between the turn table and the antenna mast in such a way so as to maximize the reduction of reflections. For measurements below 1 GHz, the absorbers are removed.
4. The antenna is a broadband antenna, and its height is varied from one meter to four meters above the ground to determine the maximum value of the field strength. Both horizontal and vertical polarizations of the antenna are set to make the measurement.
5. For each suspected emission, the EUT was arranged to its worst case and then the antenna was tuned to heights from 1 meter to 4 meters and the table was turned from 0 degrees to 360 degrees to find the maximum reading.
6. The test-receiver system was set to Peak Detect Function and Specified Bandwidth with Maximum Hold Mode.
7. If the emission level of the EUT in peak mode was 10 dB lower than the limit specified, then testing could be stopped and the peak values of the EUT would be reported. Otherwise the emissions that did not have 10 dB margin would be re-tested one by one using peak, quasi-peak or average method as specified and then reported in a data sheet.

Note: The radiated spurious emission was tested with below settings.

- Frequencies less than or equal to 1000 MHz

The resolution bandwidth and video bandwidth of test receiver/spectrum analyzer is 120 kHz for Quasi-peak detection (QP) at frequency below 1 GHz.

- Frequencies above 1000 MHz

The resolution bandwidth and video bandwidth of test receiver/spectrum analyzer is 1 MHz for Peak detection and frequency above 1 GHz.

The result of Average measurement is calculated using PK result and duty correction factor.



### 7.3.2. Test Procedures for Conducted Spurious Emissions

1. The transmitter output was connected to the spectrum analyzer.
2. The **reference level** of the fundamental frequency was measured with the spectrum analyzer using RBW = 100 kHz, VBW = 300 kHz.
3. The conducted spurious emission was tested each ranges were set as below.

**Frequency range : 9 kHz ~ 30 MHz**

RBW = 100 kHz, VBW = 300 kHz, SWEEP TIME = AUTO, DETECTOR = PEAK, TRACE = MAX HOLD, SWEEP POINT : 40001

**Frequency range : 30 MHz ~ 10 GHz, 10 GHz ~ 25 GHz**

RBW = 1 MHz, VBW = 3 MHz, SWEEP TIME = AUTO, DETECTOR = PEAK, TRACE = MAX HOLD, SWEEP POINT : 40001

**LIMIT LINE = 20 dB below of the reference level of above measurement procedure Step 2. (RBW = 100 kHz, VBW = 300 kHz)**

If the emission level with above setting was close to the limit (ie, less than 3 dB margin) then zoom scan is required using RBW = 100 kHz, VBW = 300 kHz, SPAN = 100 MHz and BINS = 2001 to get accurate emission level within 100 kHz BW.

Also the path loss for conducted measurement setup was used as described on the Appendix I of this test report.

## 7.4. Test Results

### 7.4.1. Radiated Emissions

#### 9 kHz ~ 25 GHz Data (Modulation : GFSK)

##### ▪ Lowest Channel

Frequency (MHz)	ANT Pol	The worst case EUT Position (Axis)	Detector Mode	Reading (dBuV)	T.F (dB/m)	D.C.F (dB)	Distance Factor (dB)	Result (dBuV/m)	Limit (dBuV/m)	Margin (dB)
2388.88	V	X	PK	49.81	0.70	N/A	N/A	50.51	74.00	23.49
2388.88	V	X	AV	49.81	0.70	-24.79	N/A	25.72	54.00	28.28
4803.68	H	Z	PK	45.54	4.77	N/A	N/A	50.31	74.00	23.69
4803.68	H	Z	AV	45.54	4.77	-24.79	N/A	25.52	54.00	28.48

##### ▪ Middle Channel

Frequency (MHz)	ANT Pol	The worst case EUT Position (Axis)	Detector Mode	Reading (dBuV)	T.F (dB/m)	D.C.F (dB)	Distance Factor (dB)	Result (dBuV/m)	Limit (dBuV/m)	Margin (dB)
4881.98	H	Z	PK	45.66	5.11	N/A	N/A	50.77	74.00	23.23
4881.98	H	Z	AV	45.66	5.11	-24.79	N/A	25.98	54.00	28.02

##### ▪ Highest Channel

Frequency (MHz)	ANT Pol	The worst case EUT Position (Axis)	Detector Mode	Reading (dBuV)	T.F (dB/m)	D.C.F (dB)	Distance Factor (dB)	Result (dBuV/m)	Limit (dBuV/m)	Margin (dB)
2483.77	V	X	PK	50.05	1.07	N/A	N/A	51.12	74.00	22.88
2483.77	V	X	AV	50.05	1.07	-24.79	N/A	26.33	54.00	27.67
4960.41	H	Z	PK	45.75	5.34	N/A	N/A	51.09	74.00	22.91
4960.41	H	Z	AV	45.75	5.34	-24.79	N/A	26.30	54.00	27.70

##### ▪ Note.

1. No other spurious and harmonic emissions were found greater than listed emissions on above table.
2. Information of Distance Factor

For finding emissions, the test distance might be reduced from 3m to 1m. In this case, the distance factor(-9.54dB) is applied to the result.

- Calculation of distance factor =  $20 \log(\text{applied distance} / \text{required distance}) = 20 \log(1 \text{ m} / 3 \text{ m}) = -9.54 \text{ dB}$

When distance factor is "N/A", the distance is 3 m and distance factor is not applied.

3. D.C.F Calculation. (D.C.F = Duty Cycle Correction Factor)

- Time to cycle through all channels =  $\Delta t = T [\text{ms}] \times 20$  minimum hopping channels, where T = pulse width = **2.88 ms**

-  $100 \text{ ms} / \Delta t [\text{ms}] = H \rightarrow$  Round up to next highest integer, to account for worst case,  $H' = 100 / (2.88 \times 20) = 1.74 \approx 2$

- The Worst Case Dwell Time =  $T [\text{ms}] \times H' = 2.88 \text{ ms} \times 2 = 5.76 \text{ ms}$

- D.C.F =  $20 \log(\text{The Worst Case Dwell Time} / 100 \text{ ms}) \text{ dB} = 20 \log(5.76 / 100) = -24.79 \text{ dB}$

4. Sample Calculation.

Margin = Limit – Result / Result = Reading + T.F + D.C.F / T.F = AF + CL – AG

Where, T.F = Total Factor, AF = Antenna Factor, CL = Cable Loss, AG = Amplifier Gain.

**9 kHz ~ 25 GHz Data (Modulation :  $\pi/4$ DQPSK)**

## ▪ Lowest Channel

Frequency (MHz)	ANT Pol	The worst case EUT Position (Axis)	Detector Mode	Reading (dBuV)	T.F (dB/m)	D.C.F (dB)	Distance Factor (dB)	Result (dBuV/m)	Limit (dBuV/m)	Margin (dB)
2382.77	V	X	PK	48.56	0.70	N/A	N/A	49.26	74.00	24.74
2382.77	V	X	AV	48.56	0.70	-24.79	N/A	24.47	54.00	29.53
4803.18	H	Z	PK	45.07	4.77	N/A	N/A	49.84	74.00	24.16
4803.18	H	Z	AV	45.07	4.77	-24.79	N/A	25.05	54.00	28.95

## ▪ Middle Channel

Frequency (MHz)	ANT Pol	The worst case EUT Position (Axis)	Detector Mode	Reading (dBuV)	T.F (dB/m)	D.C.F (dB)	Distance Factor (dB)	Result (dBuV/m)	Limit (dBuV/m)	Margin (dB)
4881.99	H	Z	PK	45.99	5.11	N/A	N/A	51.10	74.00	22.90
4881.99	H	Z	AV	45.99	5.11	-24.79	N/A	26.31	54.00	27.69

## ▪ Highest Channel

Frequency (MHz)	ANT Pol	The worst case EUT Position (Axis)	Detector Mode	Reading (dBuV)	T.F (dB/m)	D.C.F (dB)	Distance Factor (dB)	Result (dBuV/m)	Limit (dBuV/m)	Margin (dB)
2486.40	V	X	PK	48.98	1.07	N/A	N/A	50.05	74.00	23.95
2486.40	V	X	AV	48.98	1.07	-24.79	N/A	25.26	54.00	28.74
4959.88	H	Z	PK	44.89	5.34	N/A	N/A	50.23	74.00	23.77
4959.88	H	Z	AV	44.89	5.34	-24.79	N/A	25.44	54.00	28.56

 ▪ Note.

1. No other spurious and harmonic emissions were found greater than listed emissions on above table.

2. Information of Distance Factor

For finding emissions, the test distance might be reduced from 3m to 1m. In this case, the distance factor(-9.54dB) is applied to the result.

- Calculation of distance factor =  $20 \log(\text{applied distance} / \text{required distance}) = 20 \log(1 \text{ m} / 3 \text{ m}) = \underline{-9.54 \text{ dB}}$

When distance factor is "N/A", the distance is 3 m and distance factor is not applied.

3. D.C.F Calculation. (D.C.F = Duty Cycle Correction Factor)

- Time to cycle through all channels =  $\Delta t = T [\text{ms}] \times 20$  minimum hopping channels, where T = pulse width = **2.88 ms**

-  $100 \text{ ms} / \Delta t [\text{ms}] = H \rightarrow$  Round up to next highest integer, to account for worst case,  $H' = 100 / (2.88 \times 20) = 1.74 \approx 2$

- The Worst Case Dwell Time =  $T [\text{ms}] \times H' = 2.88 \text{ ms} \times 2 = 5.76 \text{ ms}$

- D.C.F =  $20 \log(\text{The Worst Case Dwell Time} / 100 \text{ ms}) \text{ dB} = 20 \log(5.76 / 100) = \underline{-24.79 \text{ dB}}$

4. Sample Calculation.

Margin = Limit – Result / Result = Reading + T.F + D.C.F / T.F = AF + CL – AG

Where, T.F = Total Factor, AF = Antenna Factor, CL = Cable Loss, AG = Amplifier Gain.

**9 kHz ~ 25 GHz Data (Modulation : 8DPSK)**

## ▪ Lowest Channel

Frequency (MHz)	ANT Pol	The worst case EUT Position (Axis)	Detector Mode	Reading (dBuV)	T.F (dB/m)	D.C.F (dB)	Distance Factor (dB)	Result (dBuV/m)	Limit (dBuV/m)	Margin (dB)
2381.95	V	X	PK	49.96	0.70	N/A	N/A	50.66	74.00	23.34
2381.95	V	X	AV	49.96	0.70	-24.79	N/A	25.87	54.00	28.13
4804.06	H	Z	PK	44.91	4.77	N/A	N/A	49.68	74.00	24.32
4804.06	H	Z	AV	44.91	4.77	-24.79	N/A	24.89	54.00	29.11

## ▪ Middle Channel

Frequency (MHz)	ANT Pol	The worst case EUT Position (Axis)	Detector Mode	Reading (dBuV)	T.F (dB/m)	D.C.F (dB)	Distance Factor (dB)	Result (dBuV/m)	Limit (dBuV/m)	Margin (dB)
4881.79	H	Z	PK	46.22	5.11	N/A	N/A	51.33	74.00	22.67
4881.79	H	Z	AV	46.22	5.11	-24.79	N/A	26.54	54.00	27.46

## ▪ Highest Channel

Frequency (MHz)	ANT Pol	The worst case EUT Position (Axis)	Detector Mode	Reading (dBuV)	T.F (dB/m)	D.C.F (dB)	Distance Factor (dB)	Result (dBuV/m)	Limit (dBuV/m)	Margin (dB)
2488.63	V	X	PK	49.93	1.07	N/A	N/A	51.00	74.00	23.00
2488.63	V	X	AV	49.93	1.07	-24.79	N/A	26.21	54.00	27.79
4960.31	H	Z	PK	44.56	5.34	N/A	N/A	49.90	74.00	24.10
4960.31	H	Z	AV	44.56	5.34	-24.79	N/A	25.11	54.00	28.89

 ▪ Note.

1. No other spurious and harmonic emissions were found greater than listed emissions on above table.

2. Information of Distance Factor

For finding emissions, the test distance might be reduced from 3m to 1m. In this case, the distance factor(-9.54dB) is applied to the result.

- Calculation of distance factor =  $20 \log(\text{applied distance} / \text{required distance}) = 20 \log(1 \text{ m} / 3 \text{ m}) = \underline{-9.54 \text{ dB}}$

When distance factor is "N/A", the distance is 3 m and distance factor is not applied.

3. D.C.F Calculation. (D.C.F = Duty Cycle Correction Factor)

- Time to cycle through all channels =  $\Delta t = T [\text{ms}] \times 20$  minimum hopping channels, where T = pulse width = **2.88 ms**

-  $100 \text{ ms} / \Delta t [\text{ms}] = H \rightarrow$  Round up to next highest integer, to account for worst case,  $H' = 100 / (2.88 \times 20) = 1.74 \approx 2$

- The Worst Case Dwell Time =  $T [\text{ms}] \times H' = 2.88 \text{ ms} \times 2 = 5.76 \text{ ms}$

- D.C.F =  $20 \log(\text{The Worst Case Dwell Time} / 100 \text{ ms}) \text{ dB} = 20 \log(5.76 / 100) = \underline{-24.79 \text{ dB}}$

4. Sample Calculation.

Margin = Limit – Result / Result = Reading + T.F + D.C.F / T.F = AF + CL – AG

Where, T.F = Total Factor, AF = Antenna Factor, CL = Cable Loss, AG = Amplifier Gain.

7.4.3. Conducted Spurious Emissions

Low Band-edge

*Lowest Channel & Modulation : GFSK*

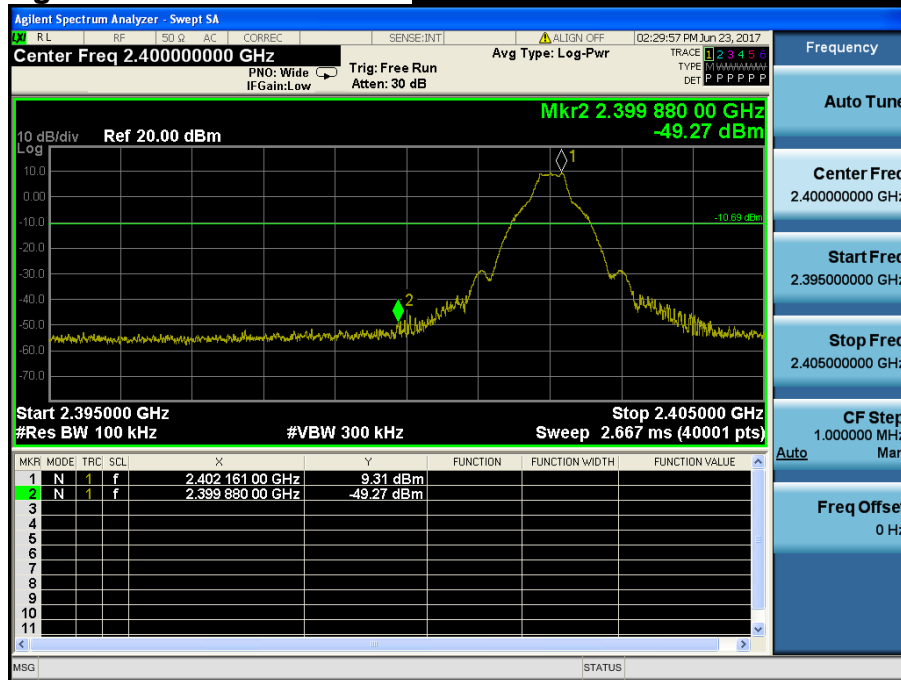

Low Band-edge

*Hopping mode & Modulation : GFSK*

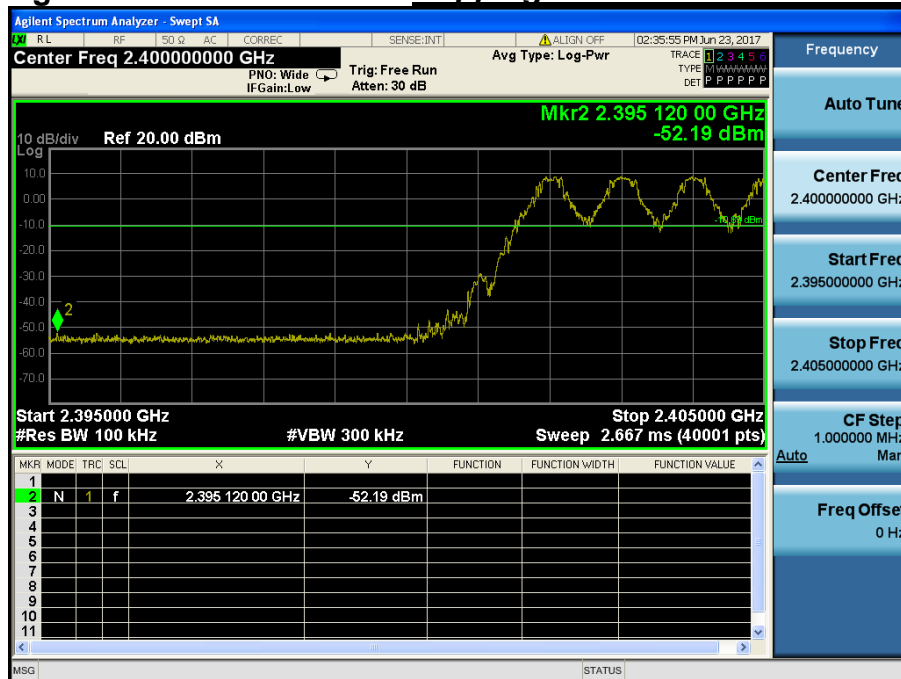

Conducted Spurious Emissions **Lowest Channel & Modulation : GFSK**

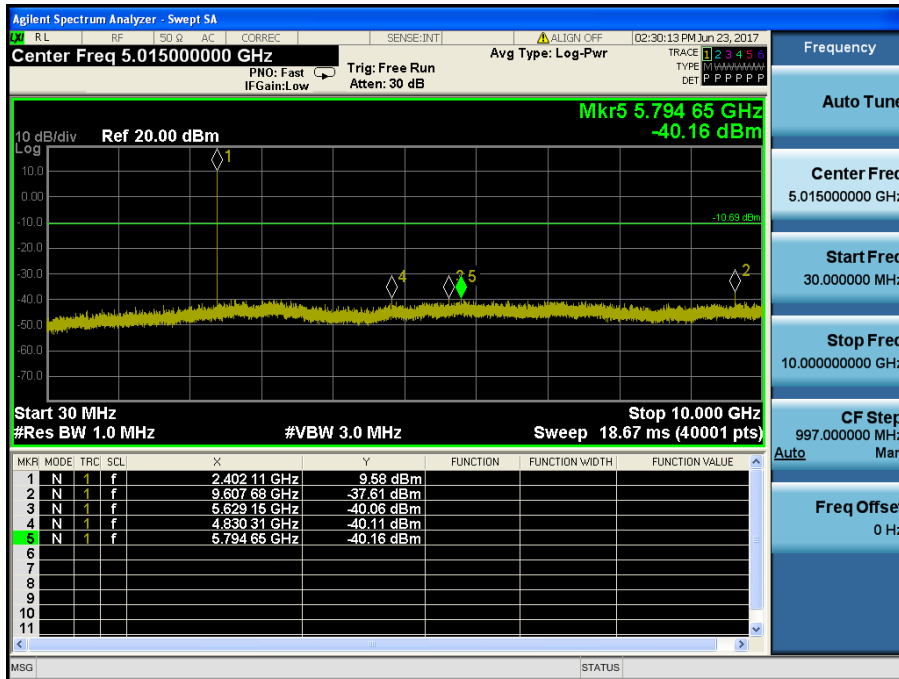
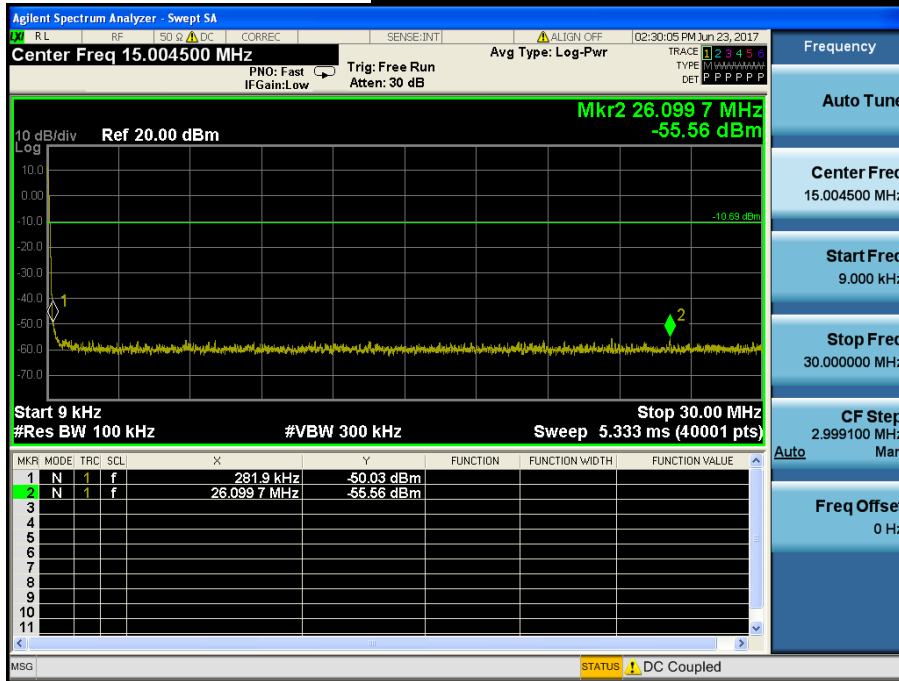

Conducted Spurious Emissions **Lowest Channel & Modulation : GFSK**

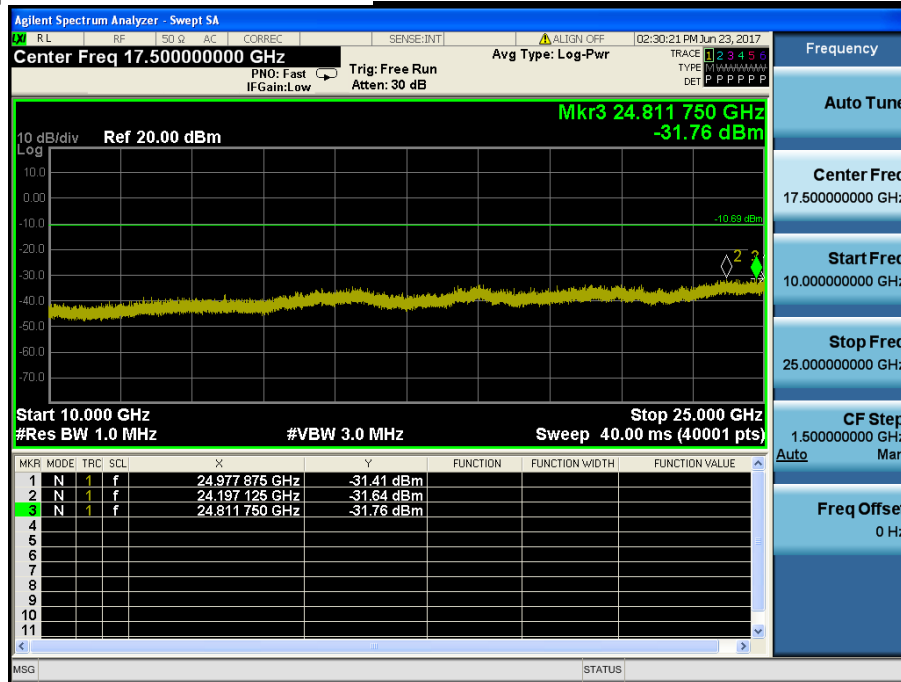

Reference for limit

**Middle Channel & Modulation : GFSK**

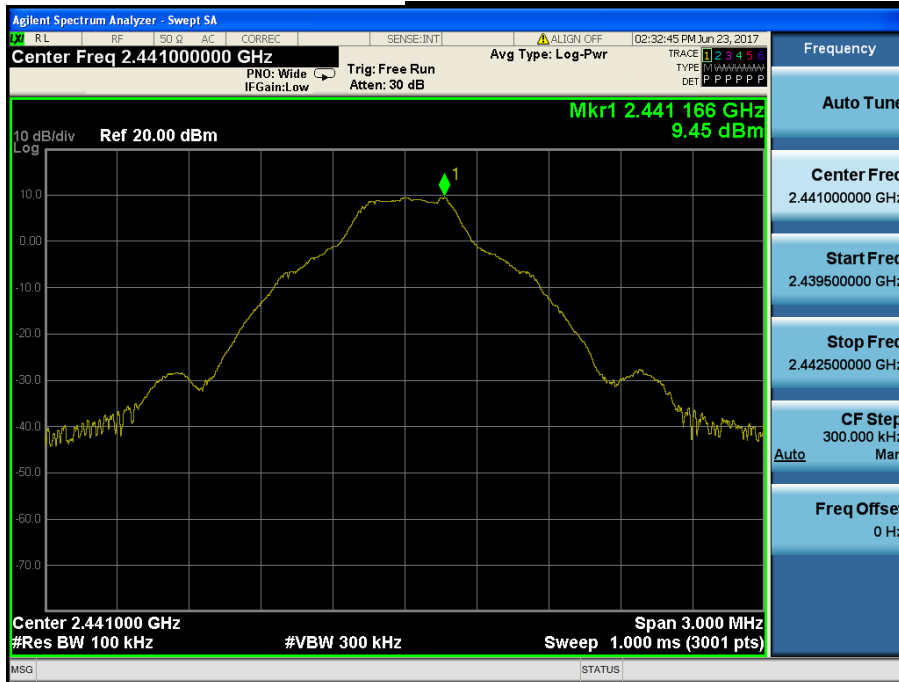

Conducted Spurious Emissions

**Middle Channel & Modulation : GFSK**

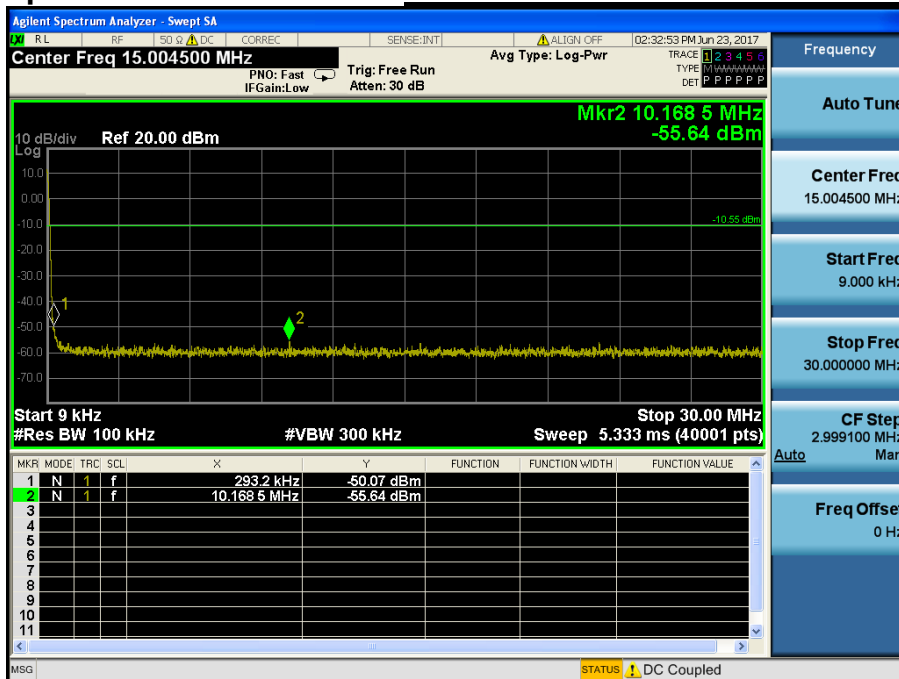



Conducted Spurious Emissions *Middle Channel & Modulation : GFSK*

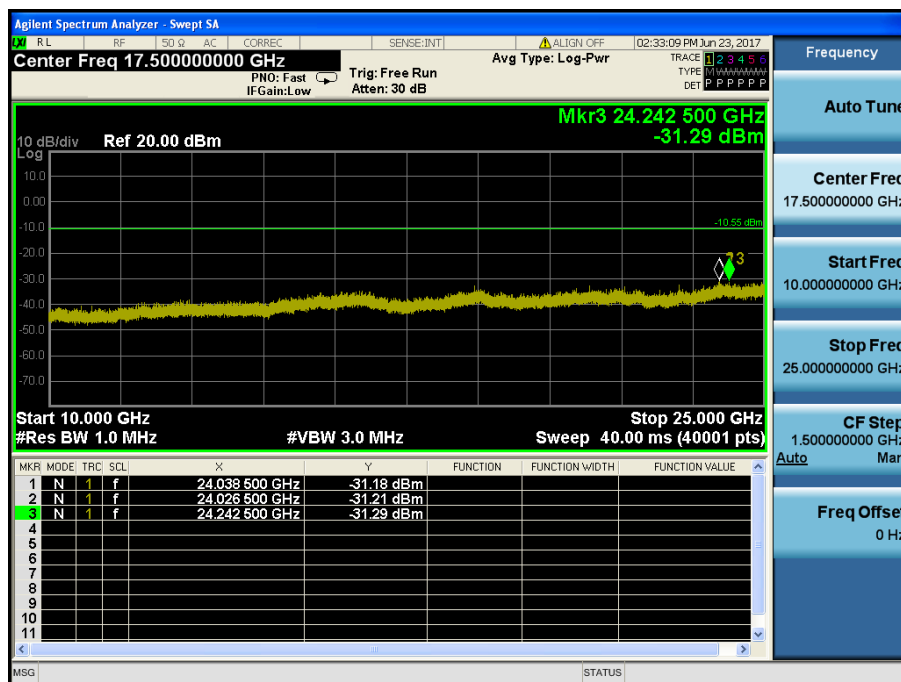
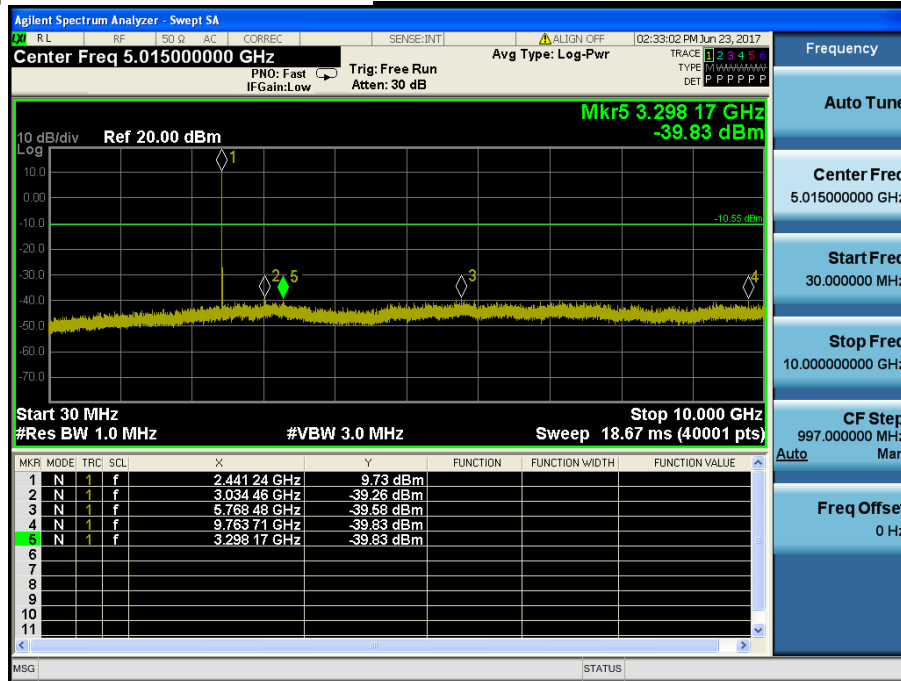

High Band-edge

**Highest Channel & Modulation : GFSK**

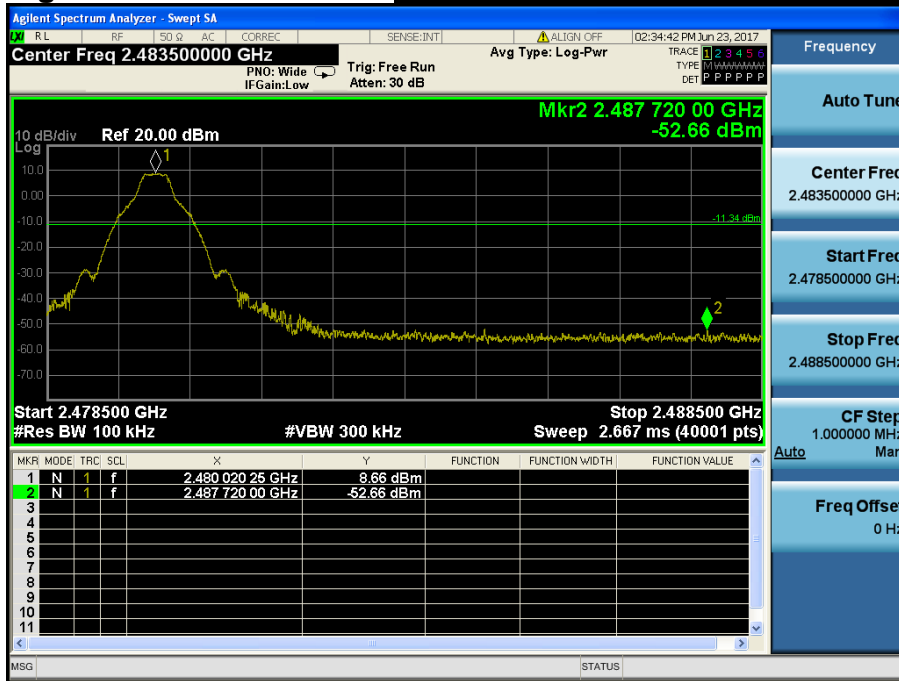

High Band-edge

**Hopping mode & Modulation : GFSK**



Conducted Spurious Emissions **Highest Channel & Modulation : GFSK**

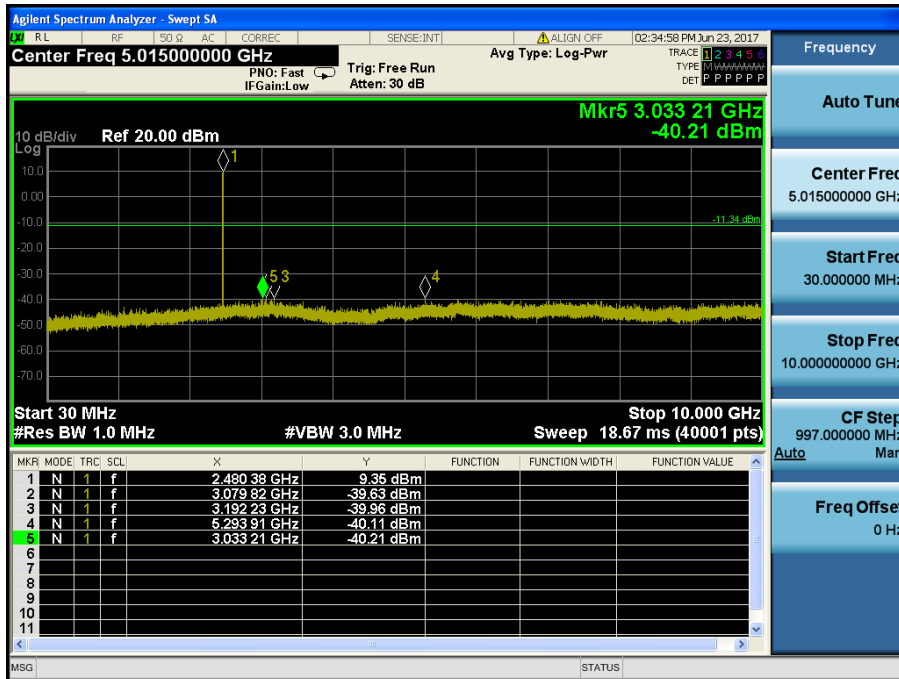
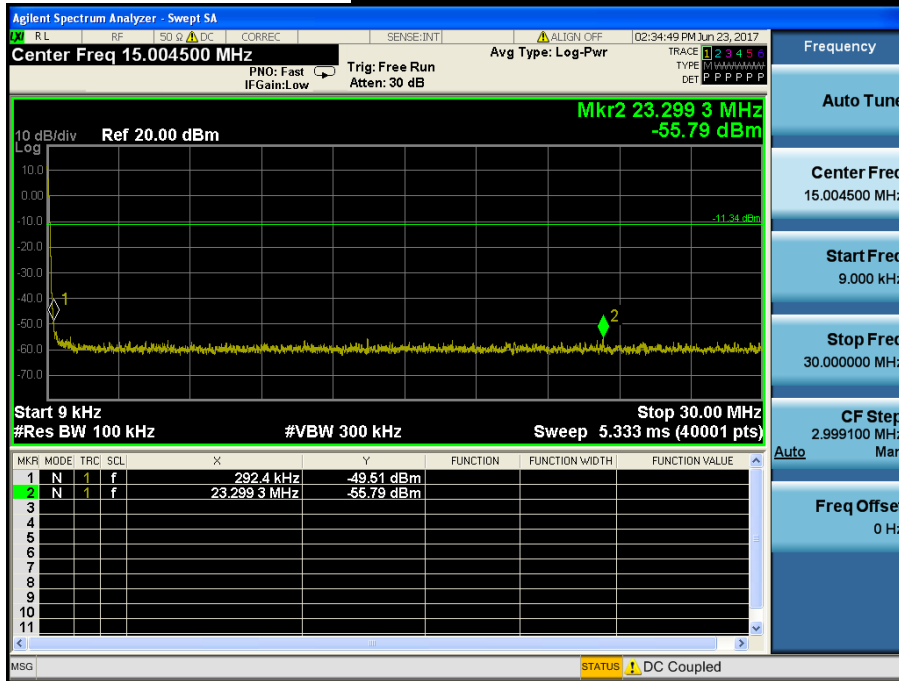

Conducted Spurious Emissions **Highest Channel & Modulation : GFSK**

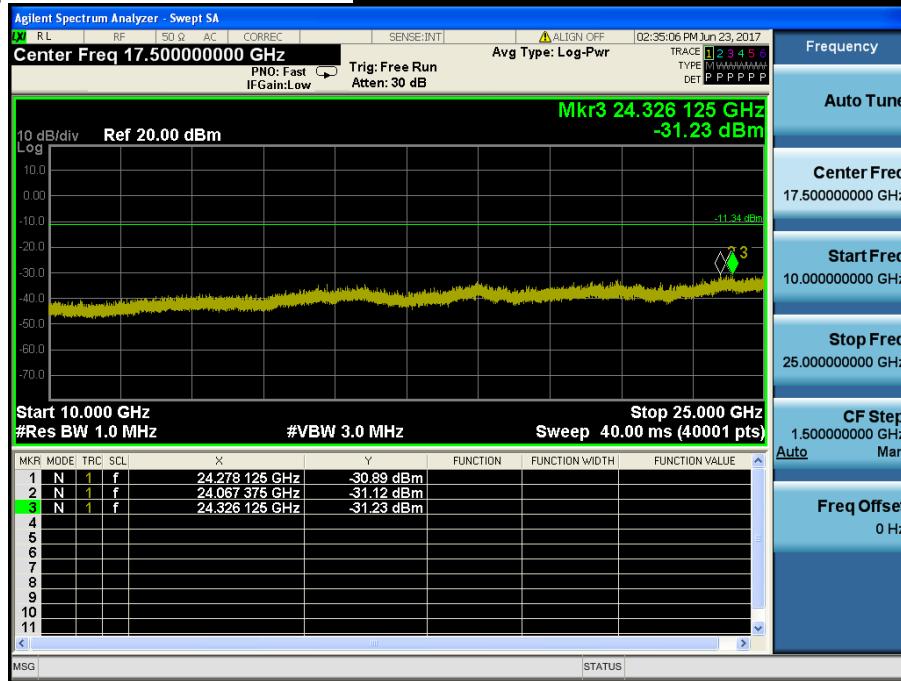

Low Band-edge

***Lowest Channel & Modulation :  $\pi/4$ DQPSK***

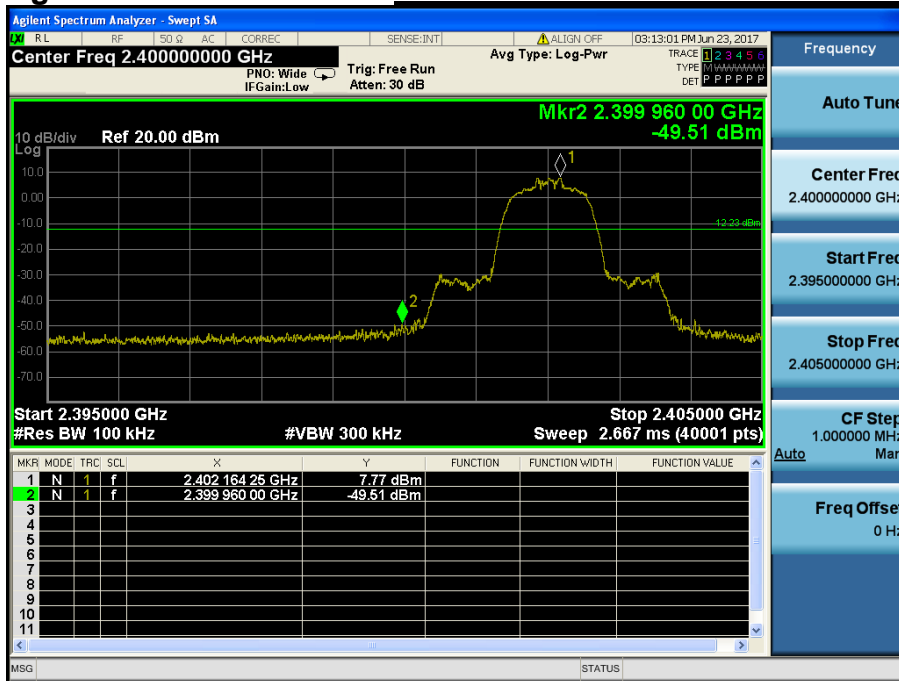

Low Band-edge

***Hopping mode & Modulation :  $\pi/4$ DQPSK***

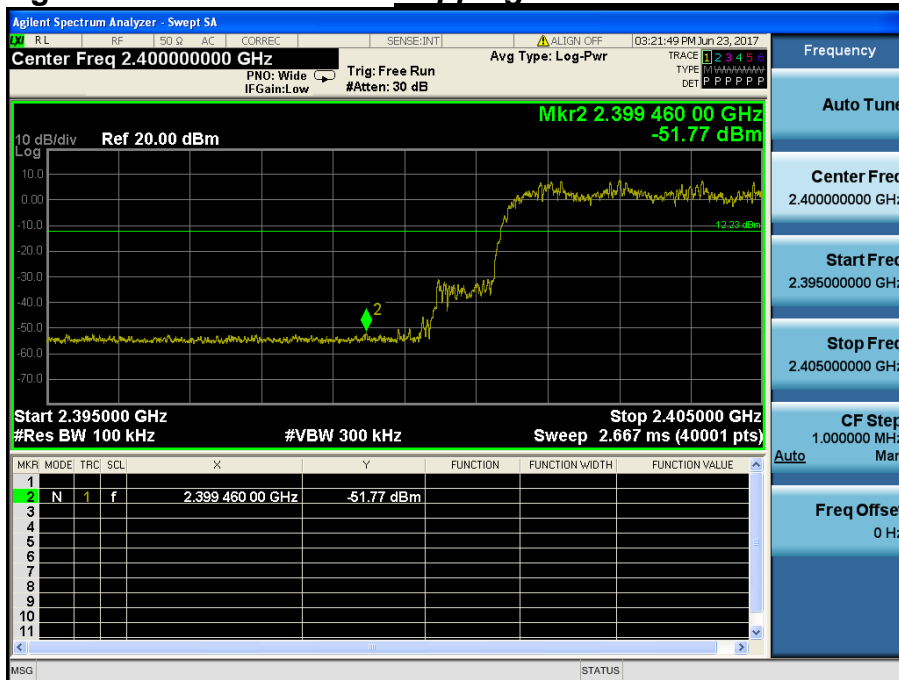

Conducted Spurious Emissions **Lowest Channel & Modulation :  $\pi/4$ DQPSK**

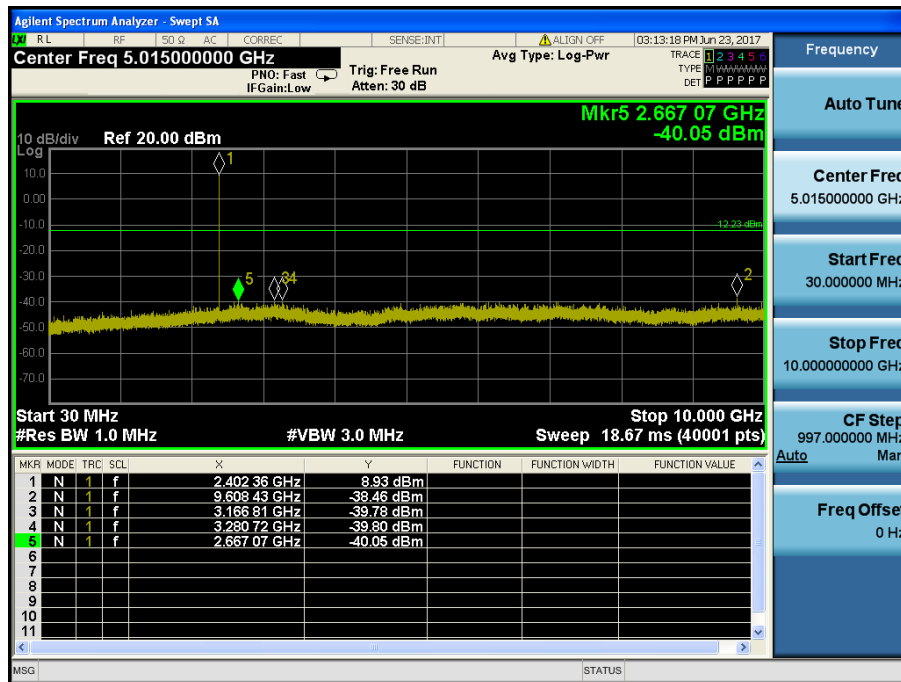
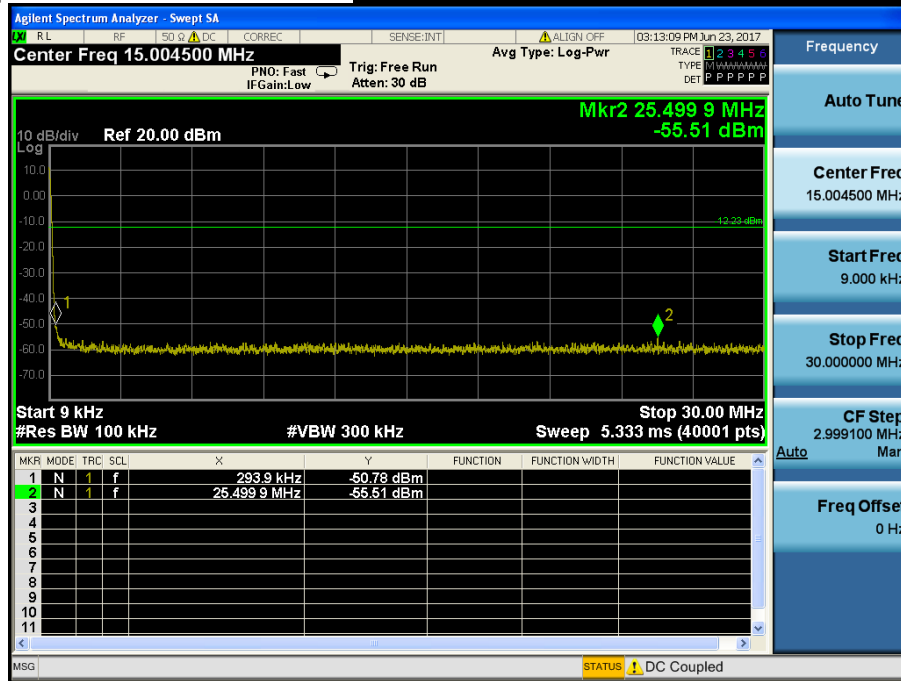

Conducted Spurious Emissions **Lowest Channel & Modulation :  $\pi/4$ DQPSK**

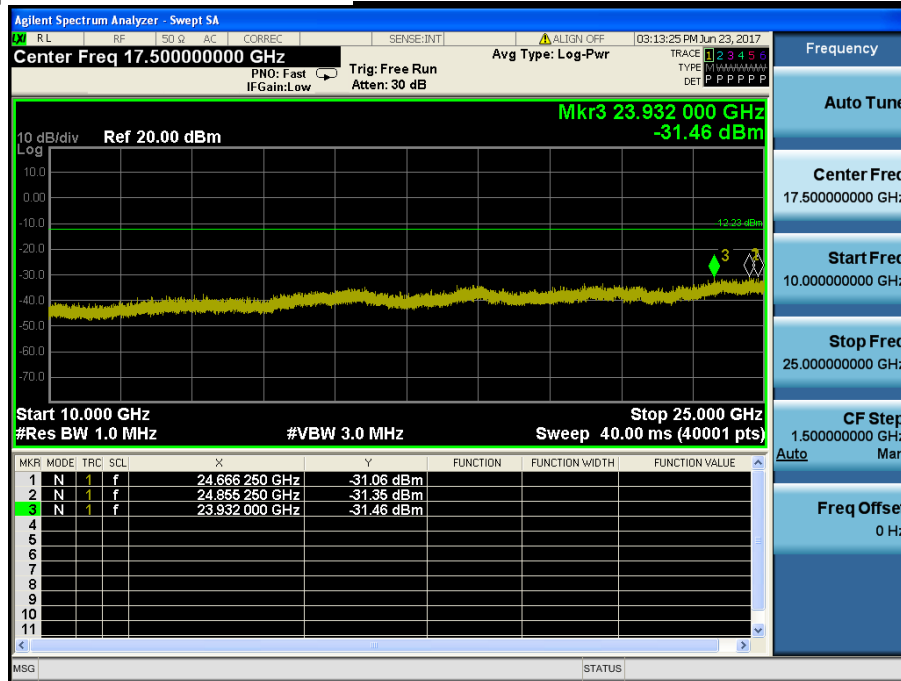

Reference for limit

**Middle Channel & Modulation :  $\pi/4$ DQPSK**

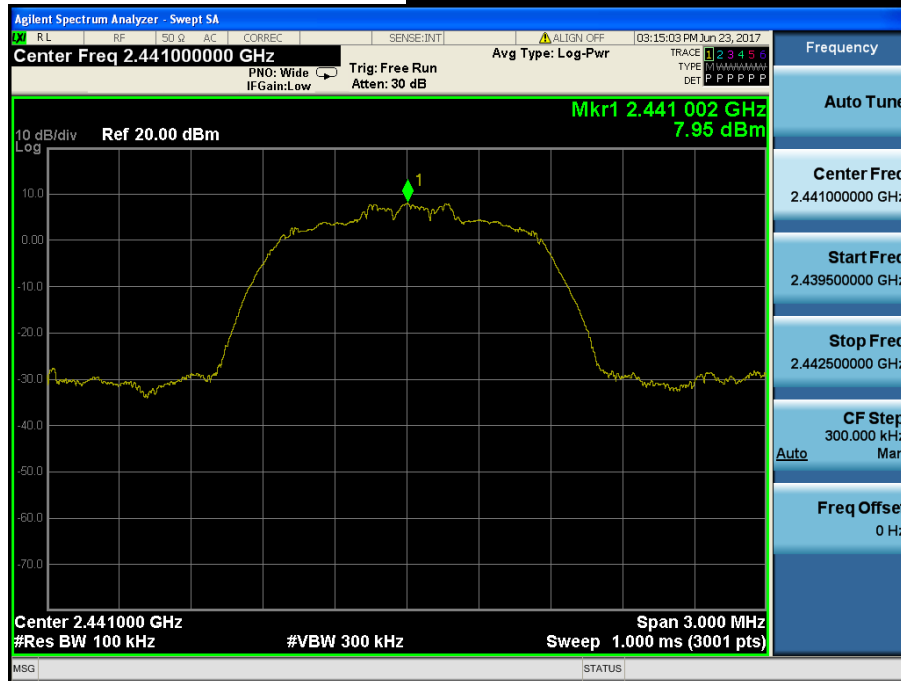

Conducted Spurious Emissions

**Middle Channel & Modulation :  $\pi/4$ DQPSK**

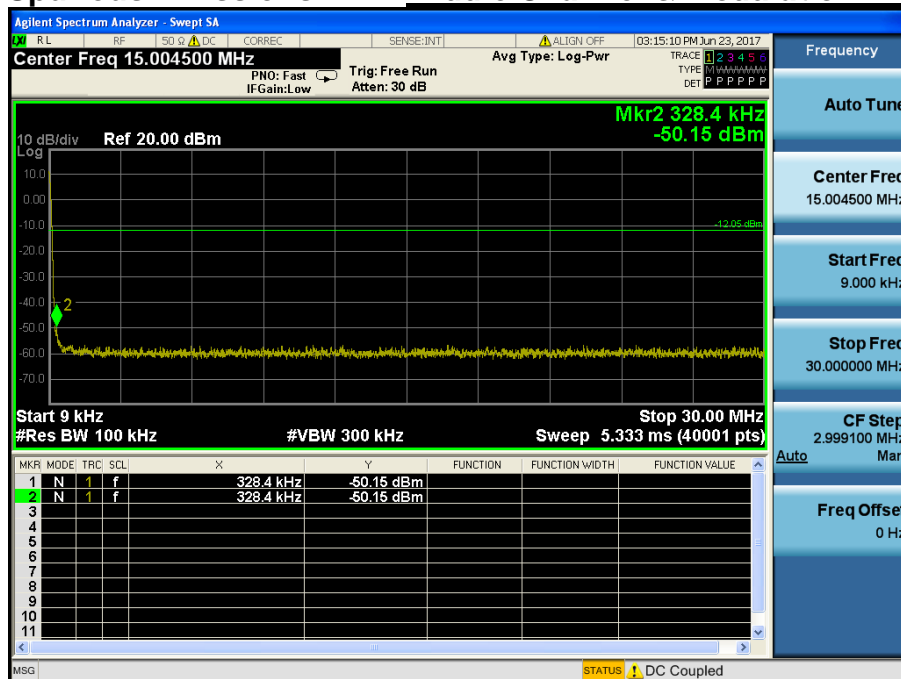



Conducted Spurious Emissions *Middle Channel & Modulation :  $\pi/4$ DQPSK*

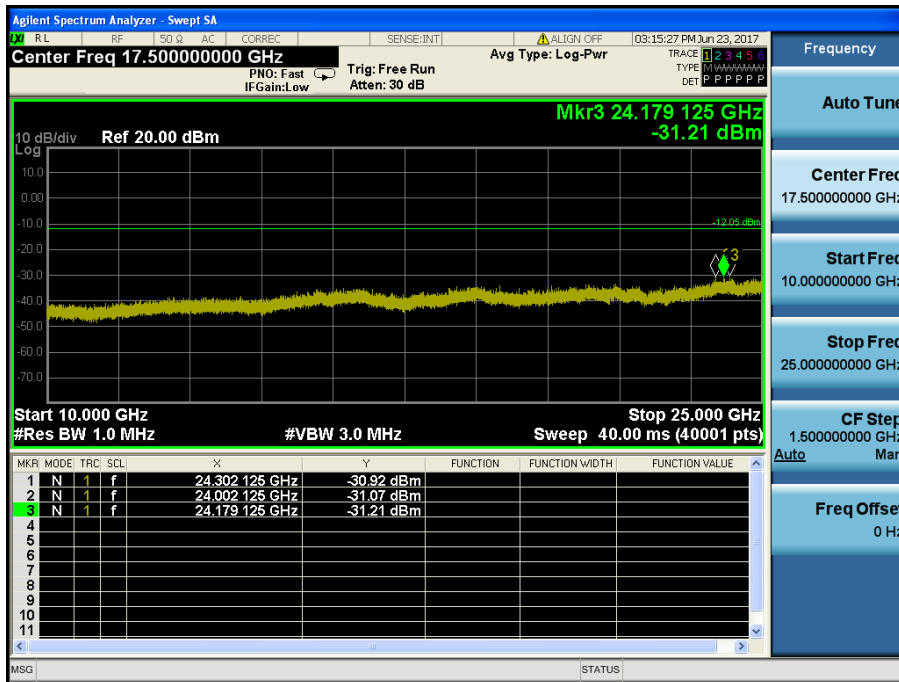
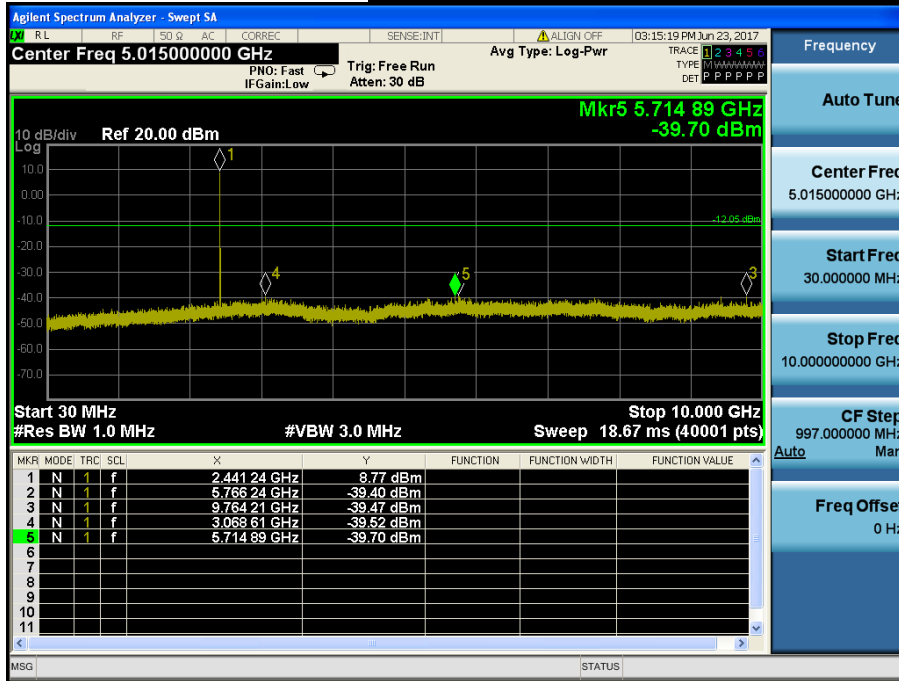

High Band-edge

***Highest Channel & Modulation :  $\pi/4$ DQPSK***

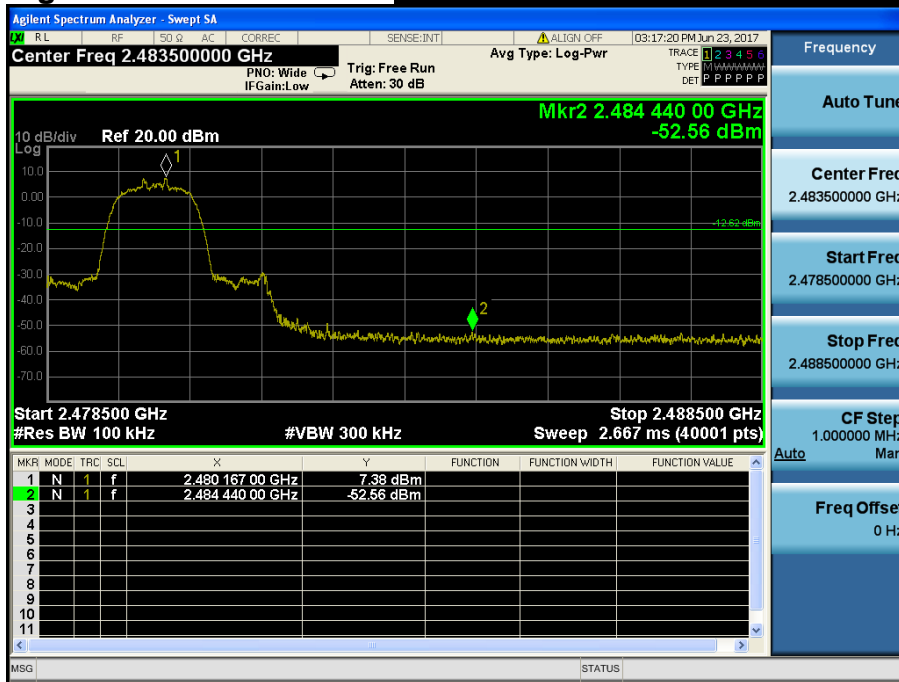

High Band-edge

***Hopping mode & Modulation :  $\pi/4$ DQPSK***

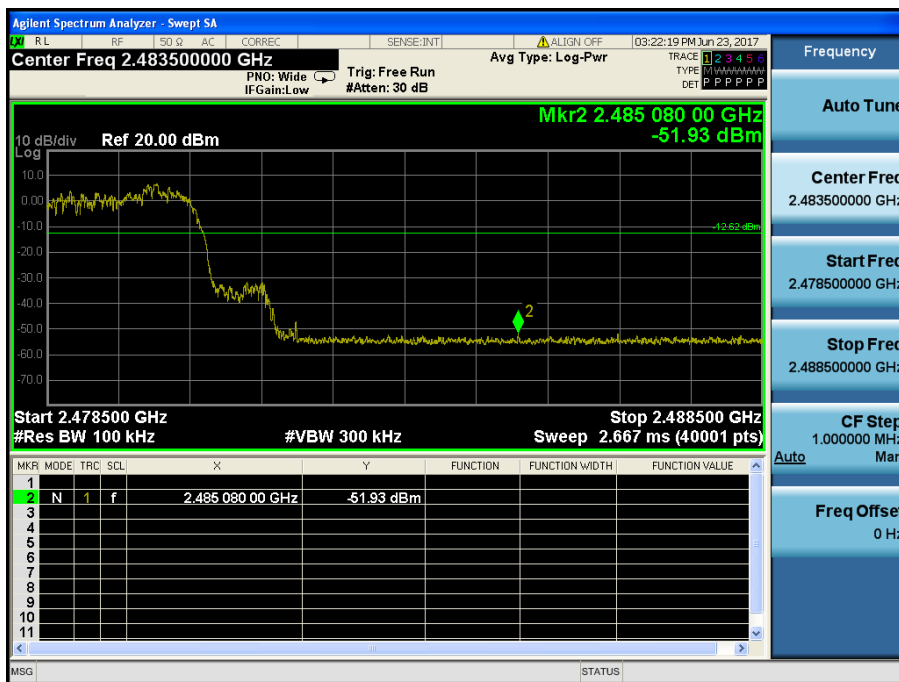

Conducted Spurious Emissions *Highest Channel & Modulation :  $\pi/4$ DQPSK*

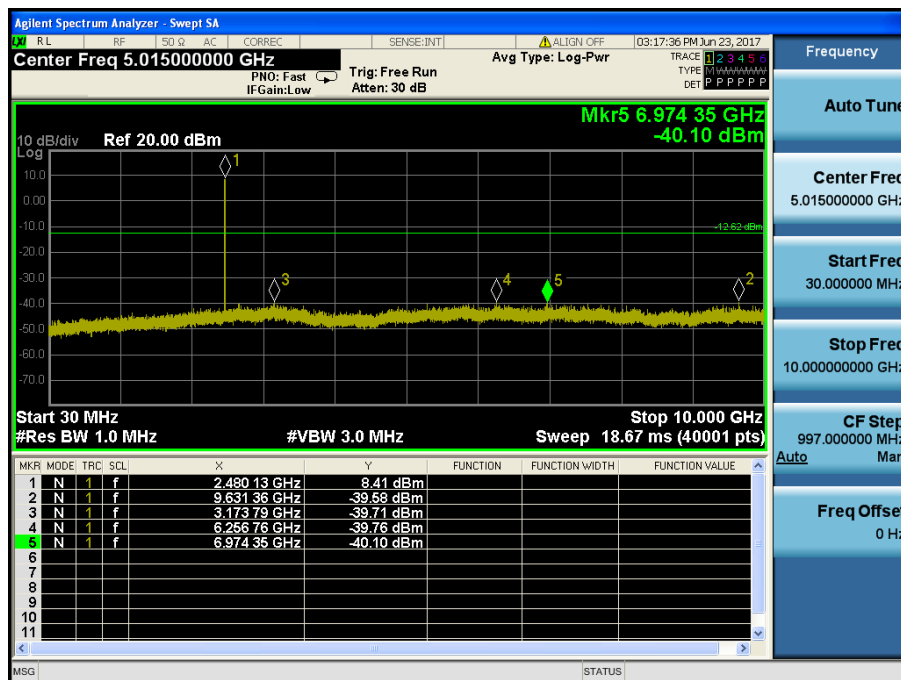
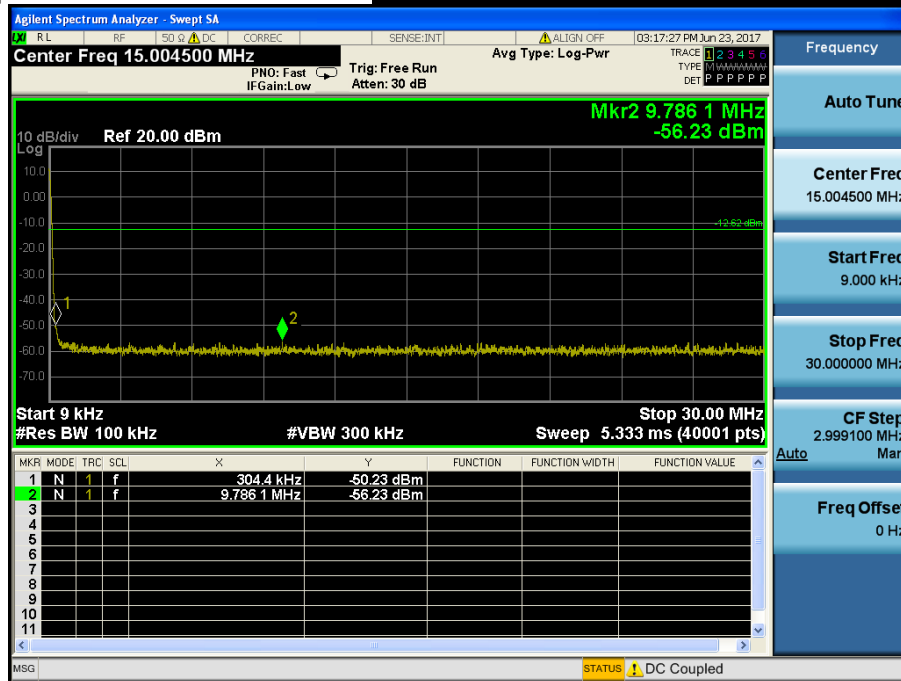

Conducted Spurious Emissions *Highest Channel & Modulation :  $\pi/4$ DQPSK*



Low Band-edge

**Lowest Channel & Modulation : 8DPSK**



Low Band-edge

**Hopping mode & Modulation : 8DPSK**

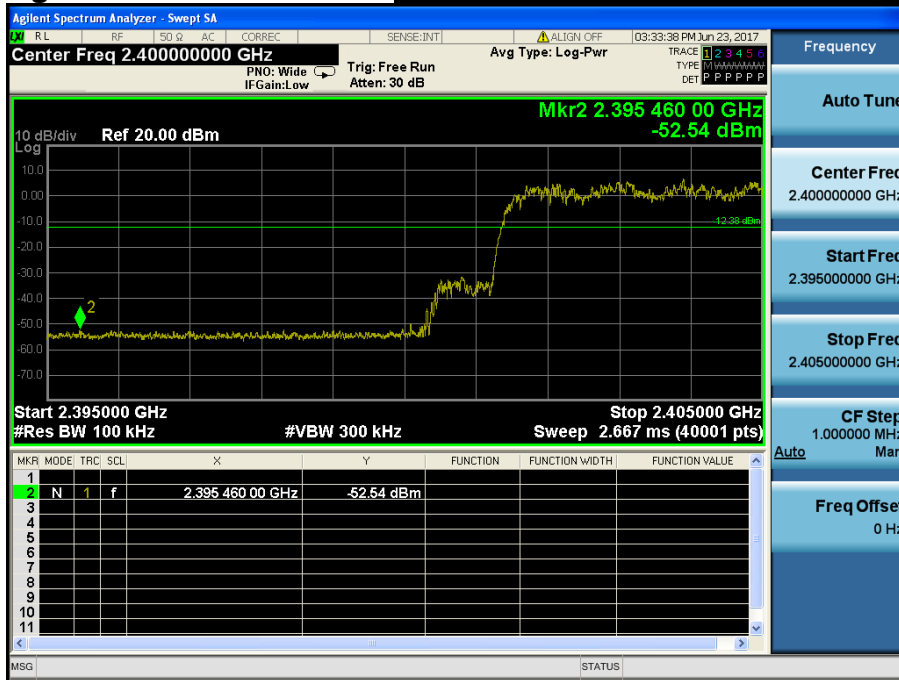

**Conducted Spurious Emissions** *Lowest Channel & Modulation : 8DPSK*

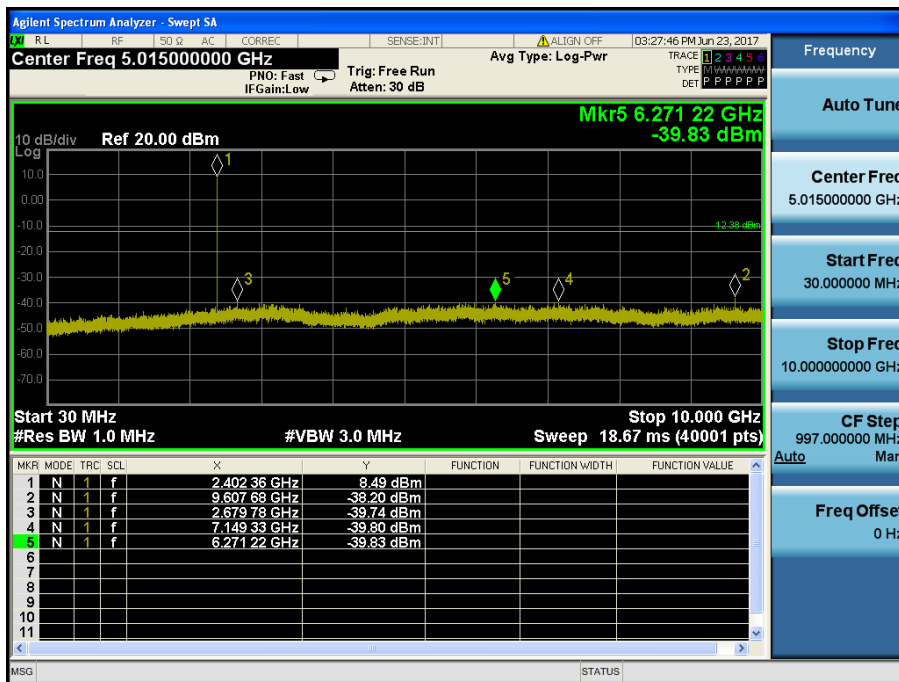
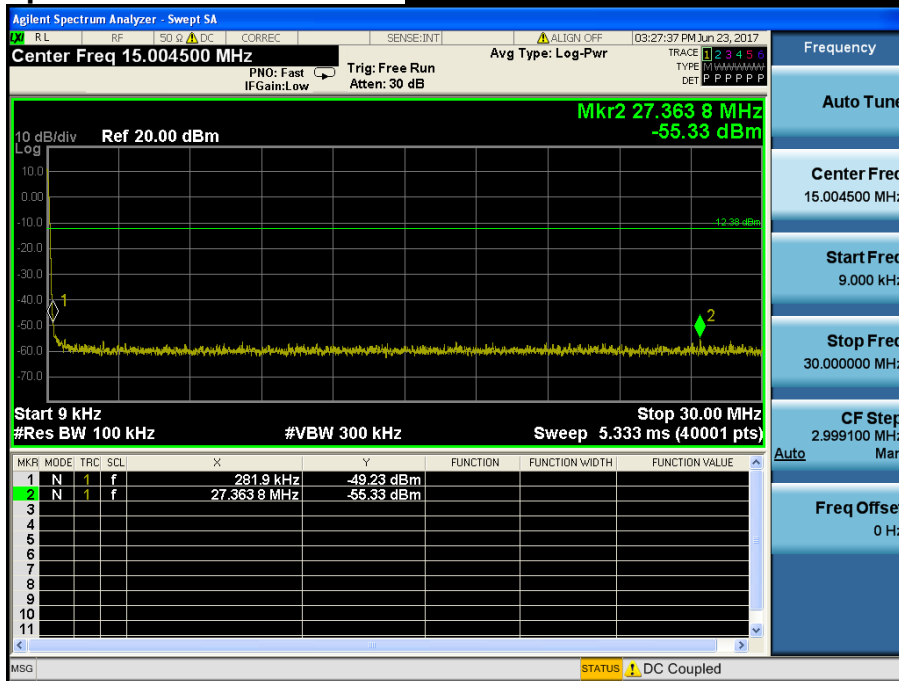

**Conducted Spurious Emissions**      ***Lowest Channel & Modulation : 8DPSK***

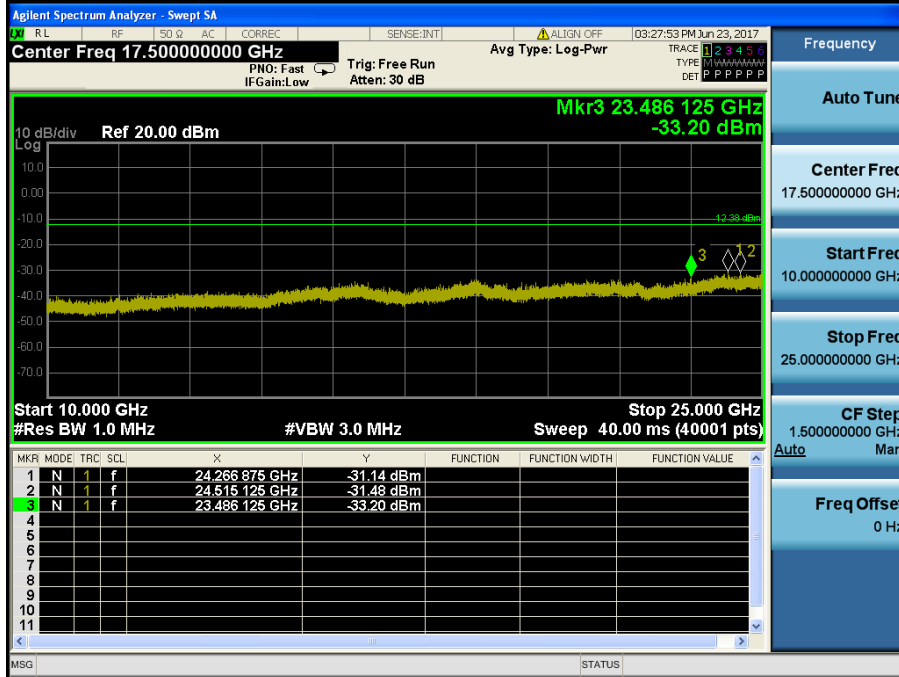

Reference for limit

**Middle Channel & Modulation : 8DPSK**

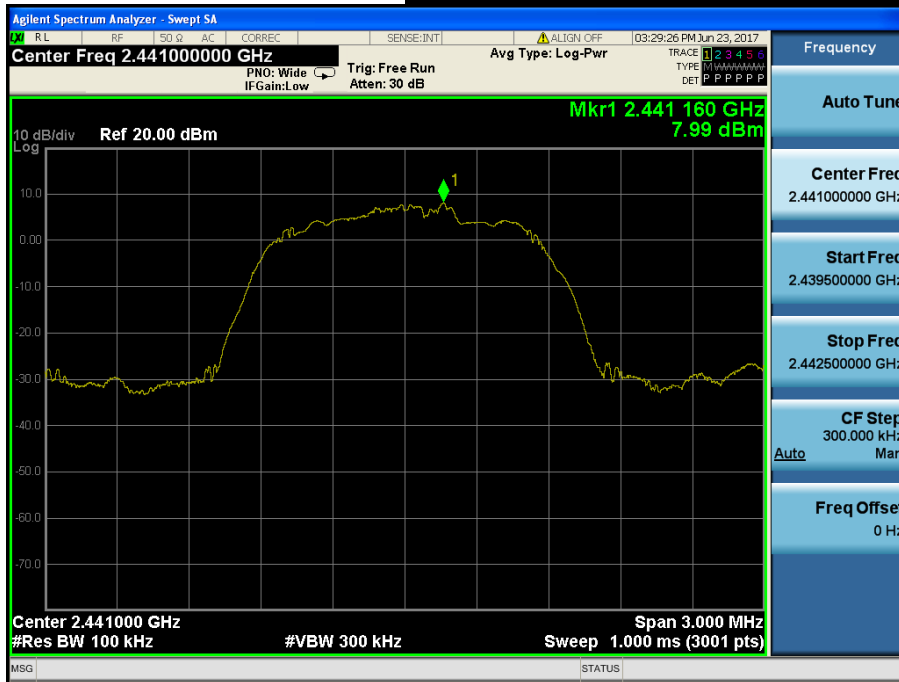

Conducted Spurious Emissions

**Middle Channel & Modulation : 8DPSK**

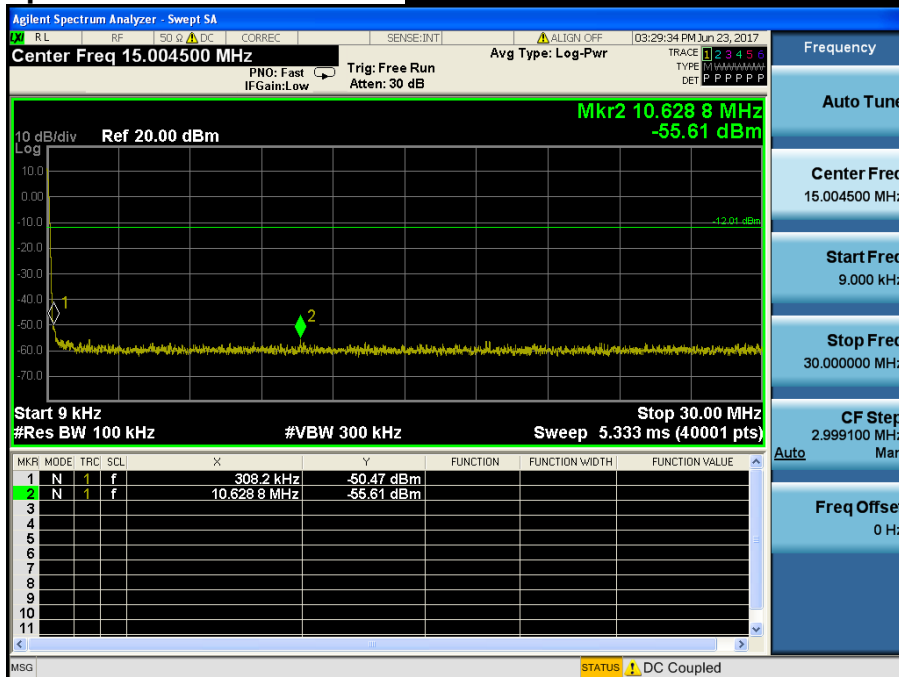



Conducted Spurious Emissions

Middle Channel & Modulation : 8DPSK

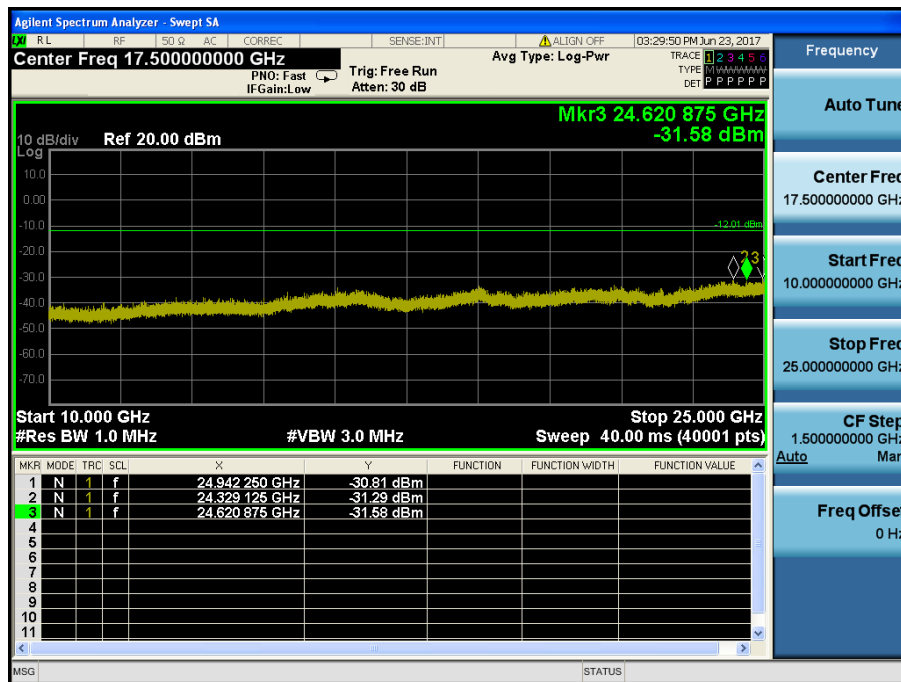
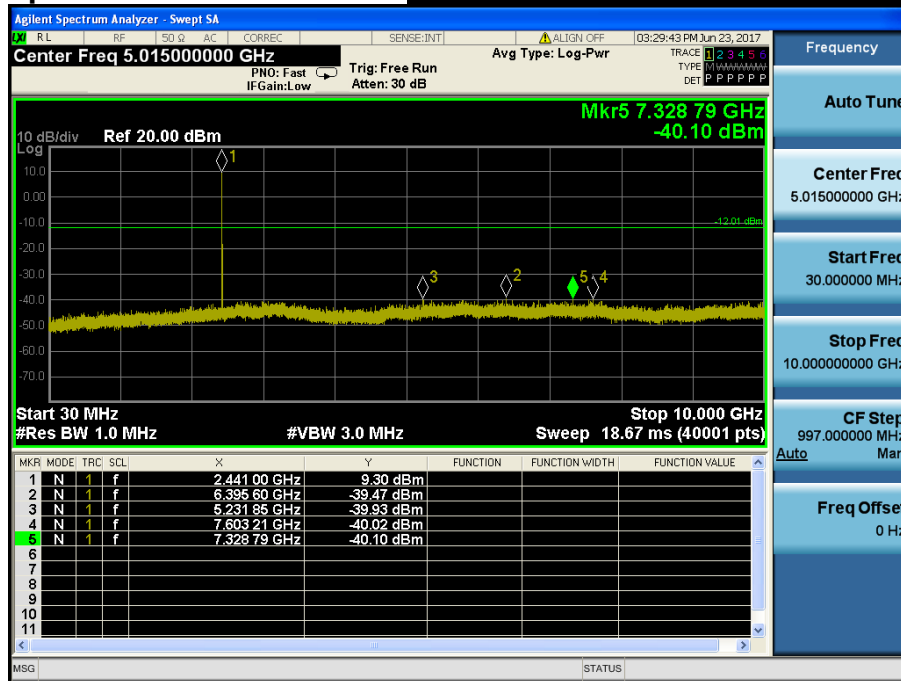

High Band-edge

**Highest Channel & Modulation : 8DPSK**

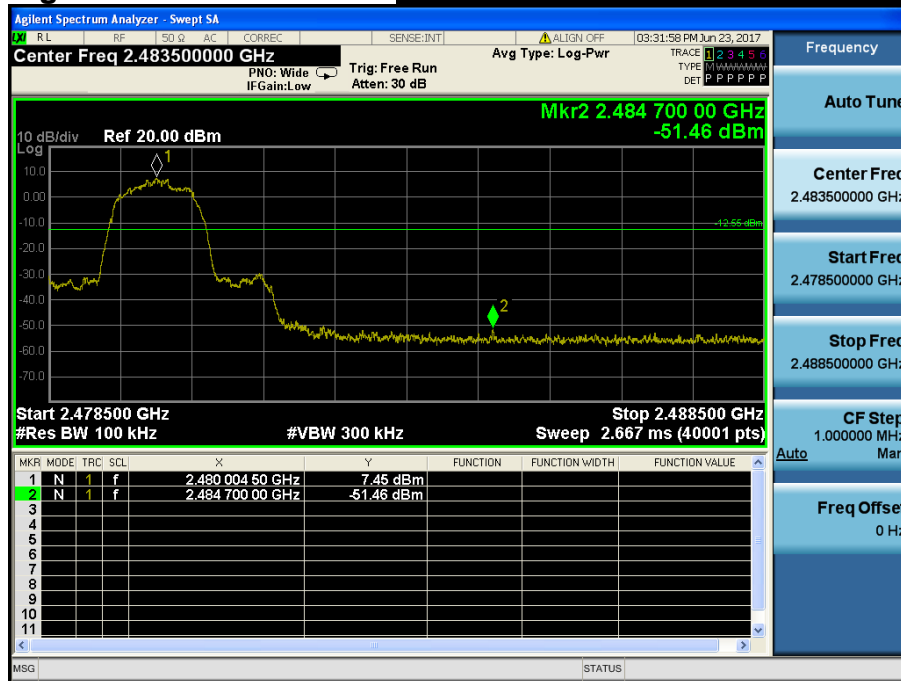

High Band-edge

**Hopping mode & Modulation : 8DPSK**

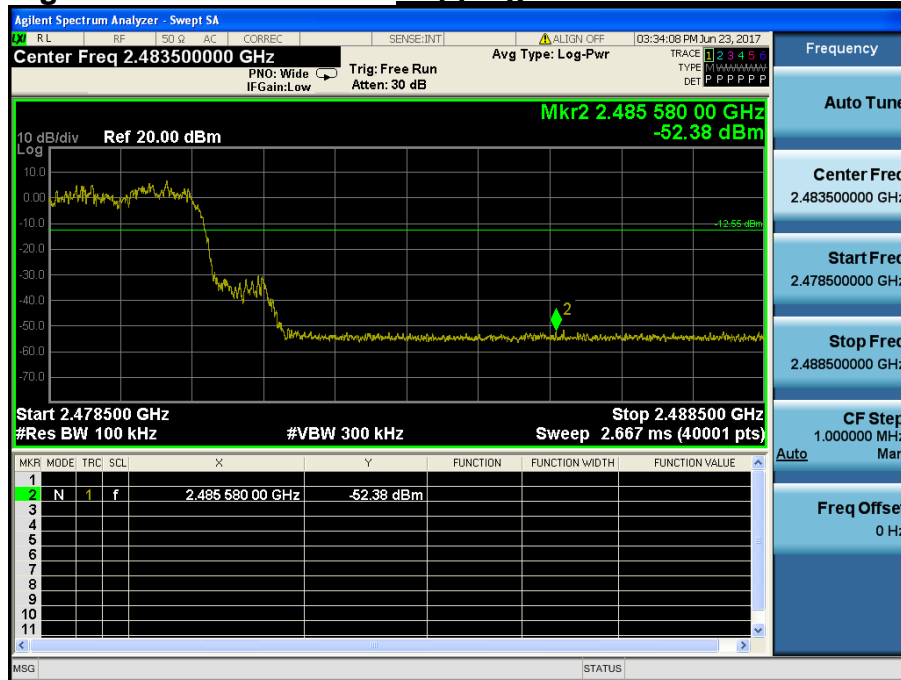

Conducted Spurious Emissions *Highest Channel & Modulation : 8DPSK*

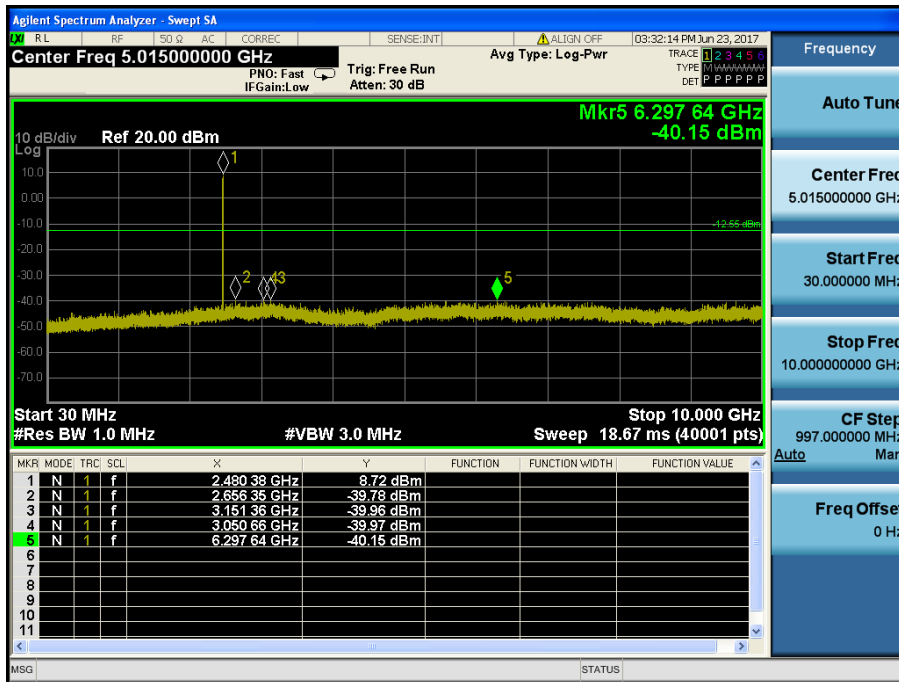
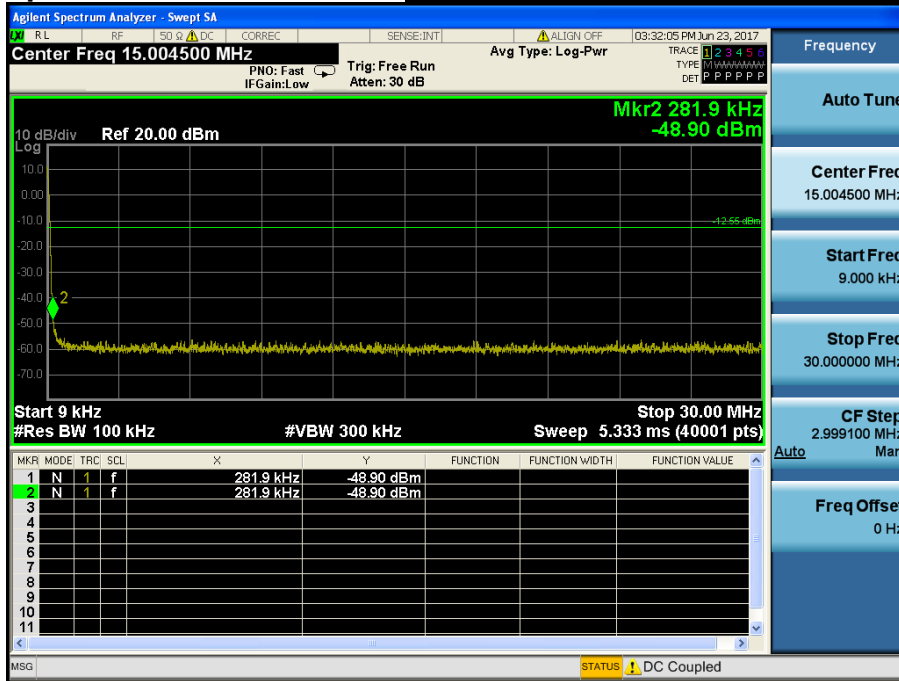

Conducted Spurious Emissions **Highest Channel & Modulation : 8DPSK**

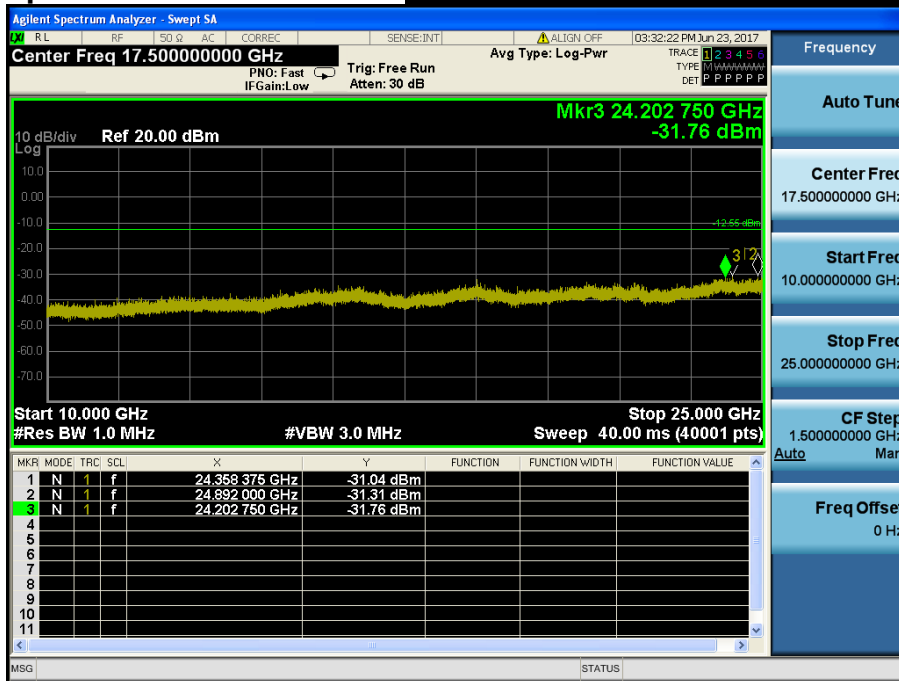

## 8. Transmitter AC Power Line Conducted Emission

### 8.1 Test Setup

See test photographs for the actual connections between EUT and support equipment.

### 8.2 Limit

According to §15.207(a) for an intentional radiator that is designed to be connected to the public utility (AC) power line, the radio frequency voltage that is conducted back onto the AC power line on any frequency or frequencies, within the band 150 kHz to 30 MHz, shall not exceed the limits in the following table, as measured using a 50 uH/50 ohm line impedance stabilization network (LISN).

Compliance with the provision of this paragraph shall on the measurement of the radio frequency voltage between each power line and ground at the power terminal. The lower applies at the boundary between the frequency ranges.

Frequency Range (MHz)	Conducted Limit (dBuV)	
	Quasi-Peak	Average
0.15 ~ 0.5	66 to 56 *	56 to 46 *
0.5 ~ 5	56	46
5 ~ 30	60	50

\* Decreases with the logarithm of the frequency

### 8.3 Test Procedures

Conducted emissions from the EUT were measured according to the ANSI C63.10.

1. The test procedure is performed in a 6.5 m × 3.5 m × 3.5 m (L × W × H) shielded room. The EUT along with its peripherals were placed on a 1.0 m (W) × 1.5 m (L) and 0.8 m in height wooden table and the EUT was adjusted to maintain a 0.4 meter space from a vertical reference plane.
2. The EUT was connected to power mains through a line impedance stabilization network (LISN) which provides 50 ohm coupling impedance for measuring instrument and the chassis ground was bounded to the horizontal ground plane of shielded room.
3. All peripherals were connected to the second LISN and the chassis ground also bounded to the horizontal ground plane of shielded room.
4. The excess power cable between the EUT and the LISN was bundled. The power cables of peripherals were unbundled. All connecting cables of EUT and peripherals were moved to find the maximum emission.

### 8.4 Test Results

### AC Line Conducted Emissions (Graph) = Modulation : 8DPSK

### Results of Conducted Emission

DT&C			Date 2017-06-23
Model	PM70	Temp/Humi.	23 'C 48 %
Function	Bluetooth	Power Supply	AC 120 V 60 Hz
Mode	1Mbps_Hopping	Operator	J.W.KIM
Test condition			
Memo			
LIMIT : FCC P15.207 QP			
FCC P15.207 AV			

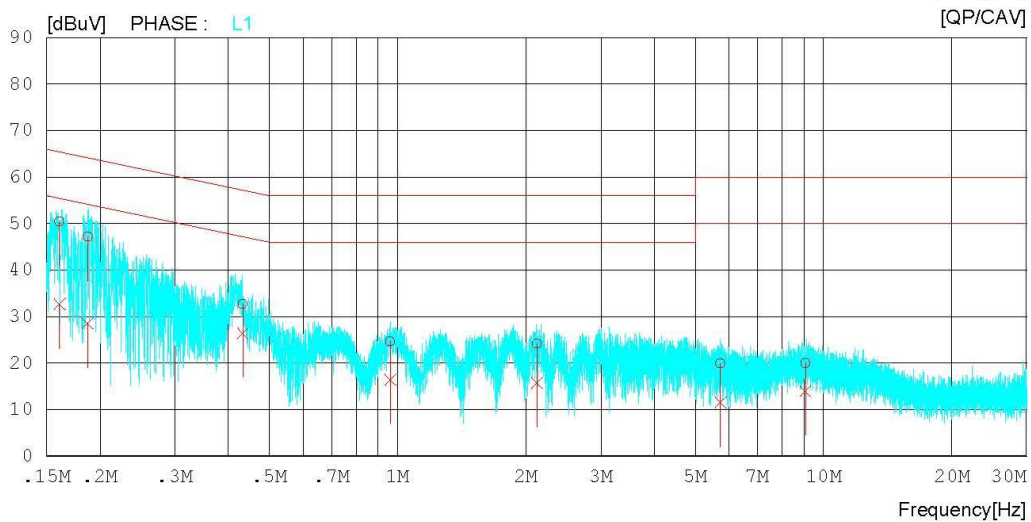
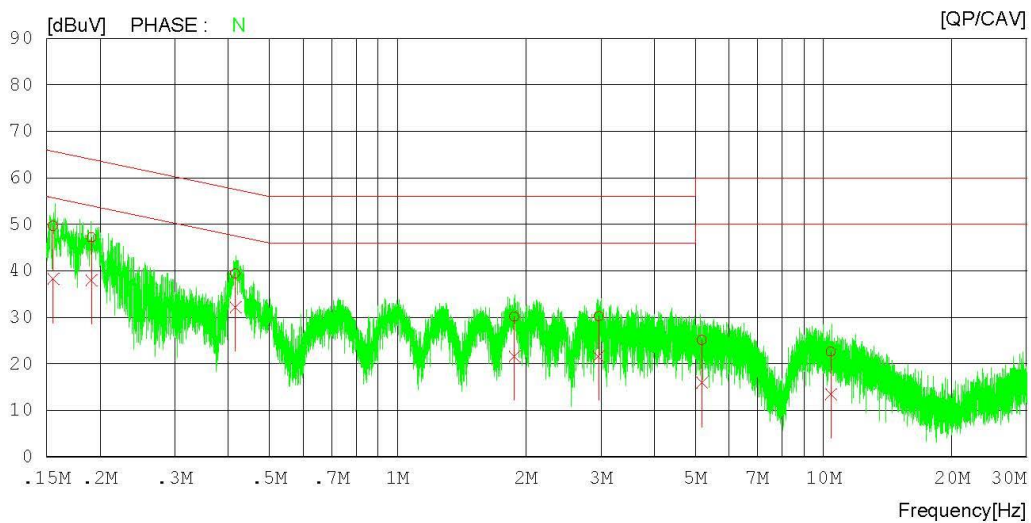

**AC Line Conducted Emissions (List) = Modulation : 8DPSK**

### Results of Conducted Emission

 DT&C Date 2017-06-23

Model	PM70	Temp/Humi.	23 'C 48 %
Function	Bluetooth	Power Supply	AC 120 V 60 Hz
Mode	1Mbps_Hopping	Operator	J.W.KIM
Test condition			

Memo

 LIMIT : FCC P15.207 QP  
 FCC P15.207 AV

NO	FREQ [MHz]	READING		C.FACTOR [dB]	RESULT		LIMIT		MARGIN		PHASE
		QP [dBuV]	CAV [dBuV]		QP [dBuV]	CAV [dBuV]	QP [dBuV]	CAV [dBuV]	QP [dBuV]	CAV [dBuV]	
1	0.15525	49.41	37.98	0.22	49.63	38.20	65.71	55.71	16.08	17.51	N
2	0.19104	46.93	37.82	0.20	47.13	38.02	63.99	53.99	16.86	15.97	N
3	0.41630	39.26	31.95	0.21	39.47	32.16	57.52	47.52	18.05	15.36	N
4	1.87980	29.77	21.37	0.30	30.07	21.67	56.00	46.00	25.93	24.33	N
5	2.96500	29.85	21.32	0.35	30.20	21.67	56.00	46.00	25.80	24.33	N
6	5.18080	24.64	15.49	0.45	25.09	15.94	60.00	50.00	34.91	34.06	N
7	10.40940	21.90	12.69	0.73	22.63	13.42	60.00	50.00	37.37	36.58	N
8	0.16079	50.20	32.43	0.19	50.39	32.62	65.42	55.42	15.03	22.80	L1
9	0.18730	46.91	28.31	0.18	47.09	28.49	64.16	54.16	17.07	25.67	L1
10	0.43274	32.52	26.20	0.20	32.72	26.40	57.20	47.20	24.48	20.80	L1
11	0.96092	24.32	16.15	0.25	24.57	16.40	56.00	46.00	31.43	29.60	L1
12	2.12460	23.83	15.36	0.29	24.12	15.65	56.00	46.00	31.88	30.35	L1
13	5.73180	19.30	10.94	0.50	19.80	11.44	60.00	50.00	40.20	38.56	L1
14	9.06860	19.25	13.18	0.74	19.99	13.92	60.00	50.00	40.01	36.08	L1

## 9. Antenna Requirement

Describe how the EUT complies with the requirement that either its antenna is permanently attached, or that it employs a unique antenna connector, for every antenna proposed for use with the EUT.

**Conclusion: Comply**

The internal antenna is attached on the main PCB using the special spring tension. (Refer to Internal Photo file.)

### - Minimum Standard :

An intentional radiator shall be designed to ensure that no antenna other than that furnished by the responsible party shall be used with the device. The use of a permanently attached antenna or of an antenna that uses a unique coupling to the intentional radiator shall be considered sufficient to comply with the provisions.
--



## 10. Occupied Bandwidth (99 %)

### 10.1 Test Setup

Refer to the APPENDIX I.

### 10.2 Limit

Limit : Not Applicable

### 10.3 Test Procedure

The 99 % power bandwidth was measured with a calibrated spectrum analyzer.

The resolution bandwidth (RBW) shall be in the range of 1 % to 5 % of the occupied bandwidth (OBW) and video bandwidth (VBW) shall be approximately 3 × RBW.

Spectrum analyzer plots are included on the following pages.

### 10.4 Test Results

Modulation	Tested Channel	Test Results (MHz)
<b><u>GFSK</u></b>	Lowest	0.868
	Middle	0.880
	Highest	<b>0.883</b>
<b><u><math>\pi/4</math>DQPSK</u></b>	Lowest	1.173
	Middle	<b>1.180</b>
	Highest	1.177
<b><u>8DPSK</u></b>	Lowest	1.182
	Middle	<b>1.183</b>
	Highest	1.178

Occupied Bandwidth (99 %)

**Lowest Channel & GFSK**

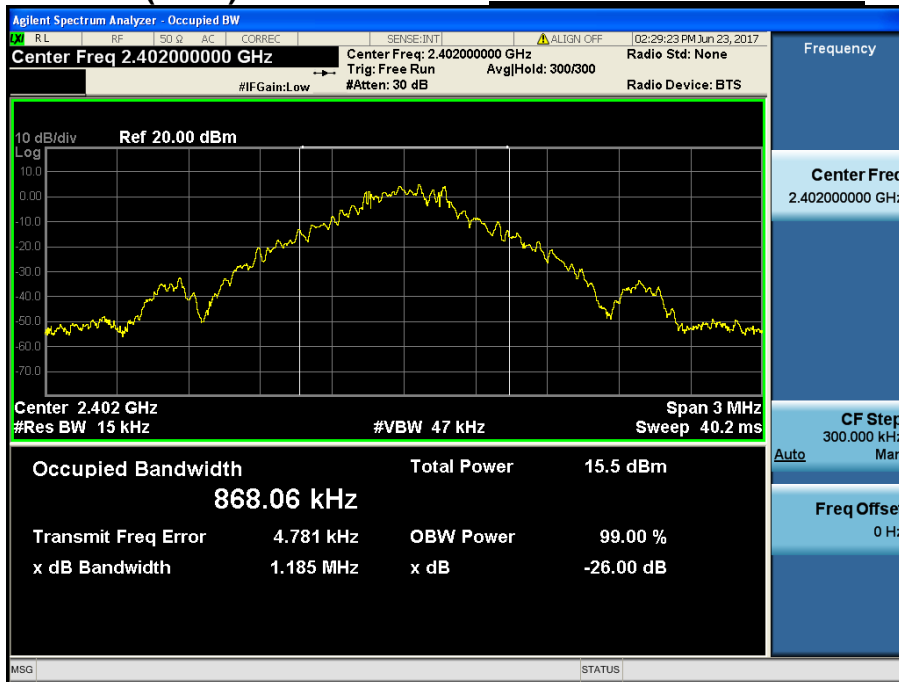

Occupied Bandwidth (99 %)

**Middle Channel & GFSK**

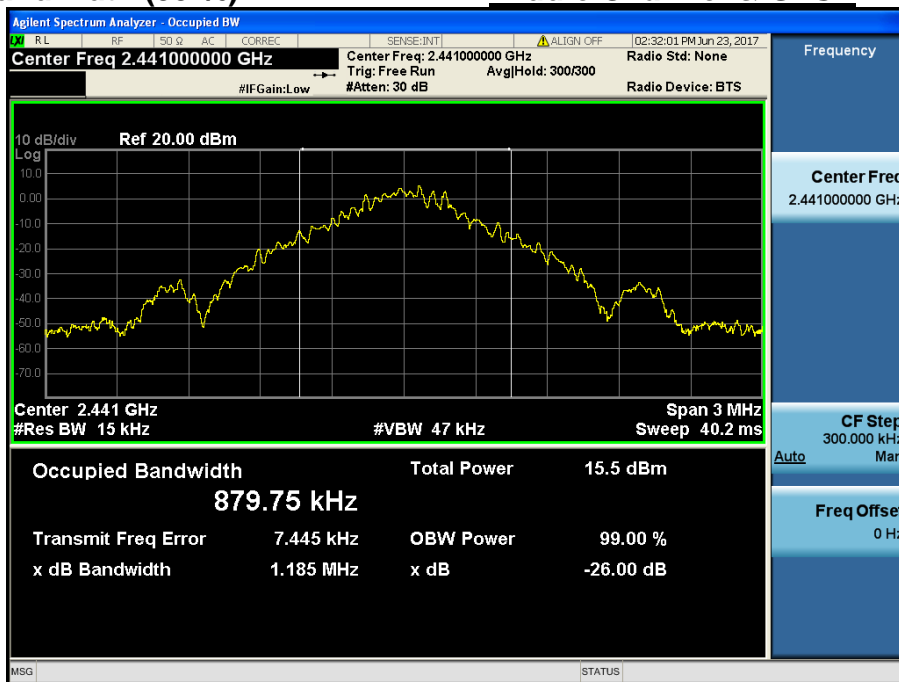

Occupied Bandwidth (99 %)

*Highest Channel & GFSK*



Occupied Bandwidth (99 %)

**Lowest Channel &  $\pi/4$  DQPSK**

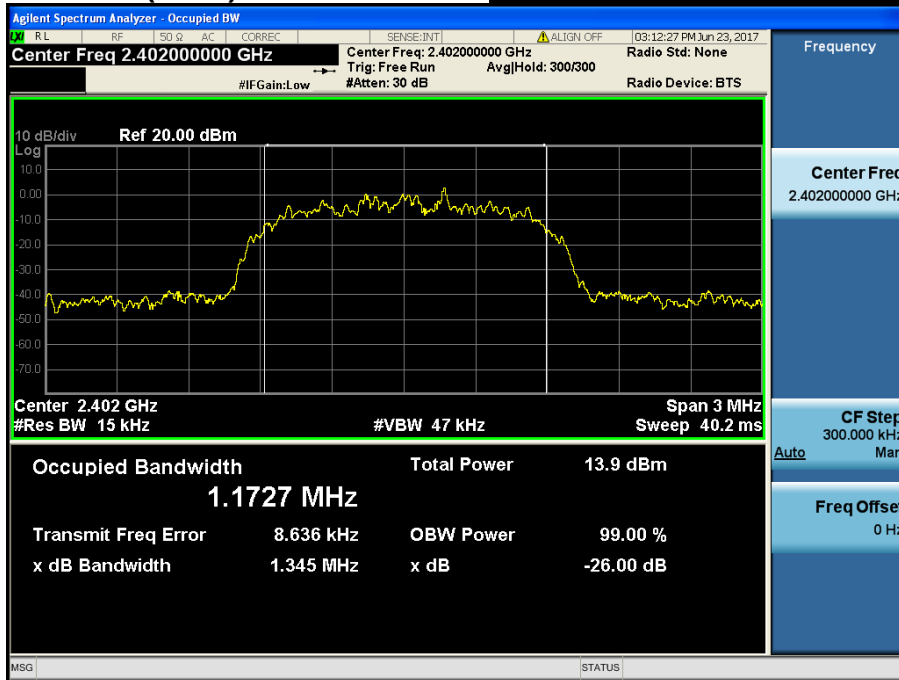

Occupied Bandwidth (99 %)

**Middle Channel &  $\pi/4$  DQPSK**

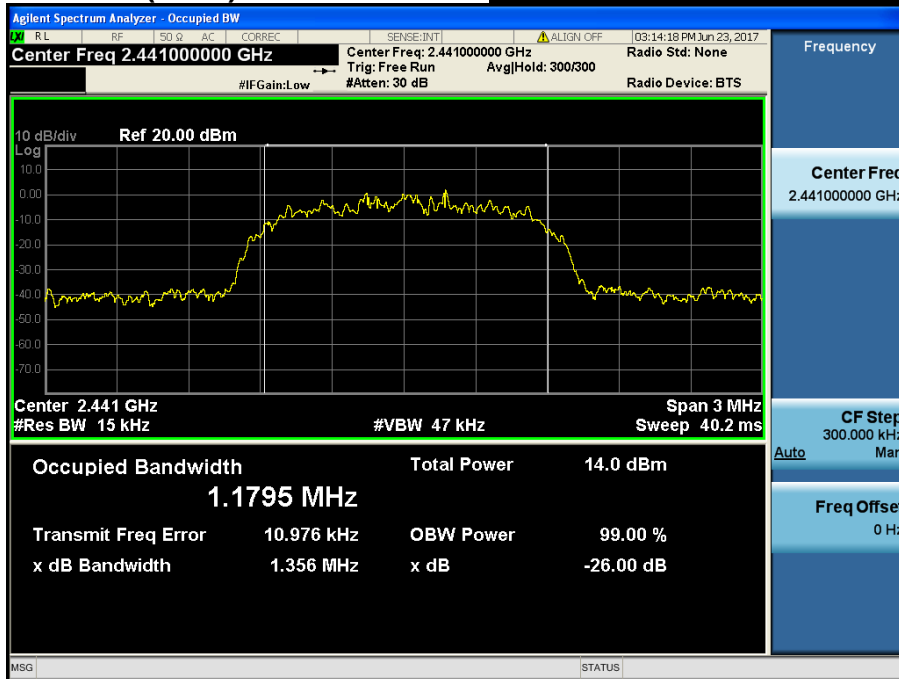

Occupied Bandwidth (99 %)

*Highest Channel &  $\pi/4$  DQPSK*

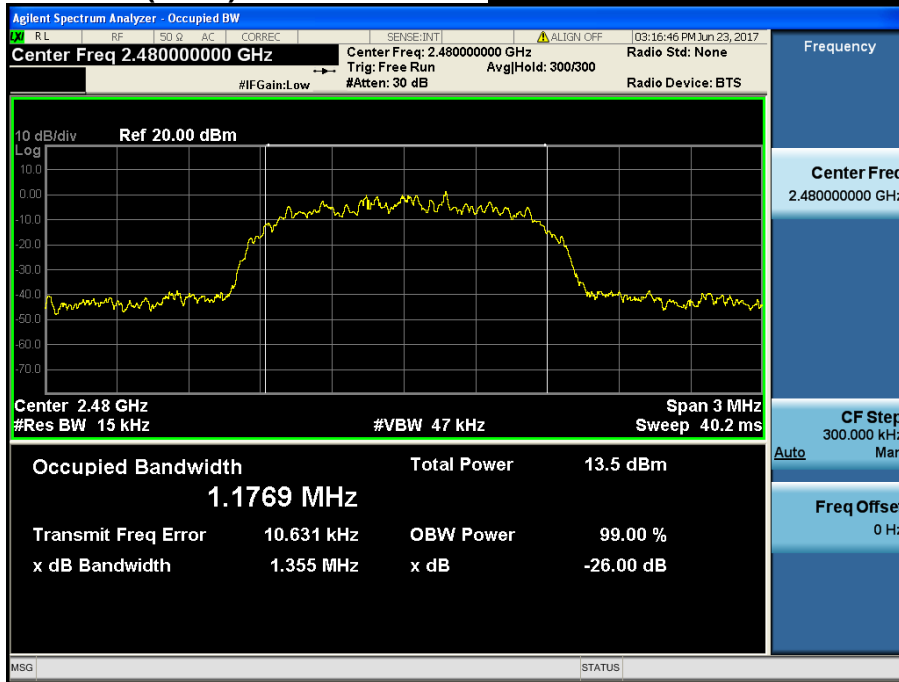

Occupied Bandwidth (99 %)

***Lowest Channel & 8DPSK***

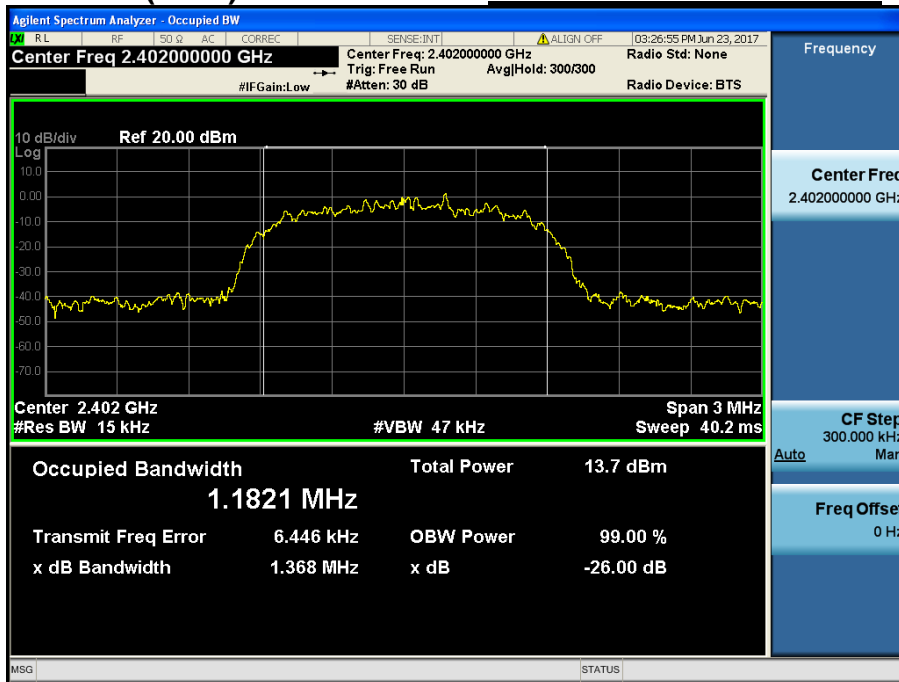

Occupied Bandwidth (99 %)

***Middle Channel & 8DPSK***

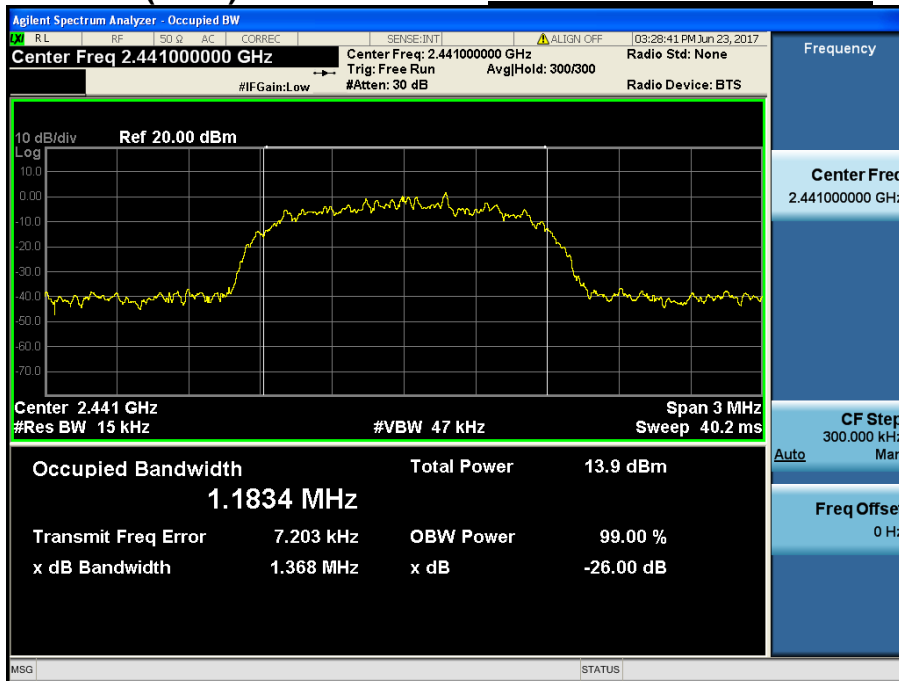

Occupied Bandwidth (99 %)

*Highest Channel & 8DPSK*

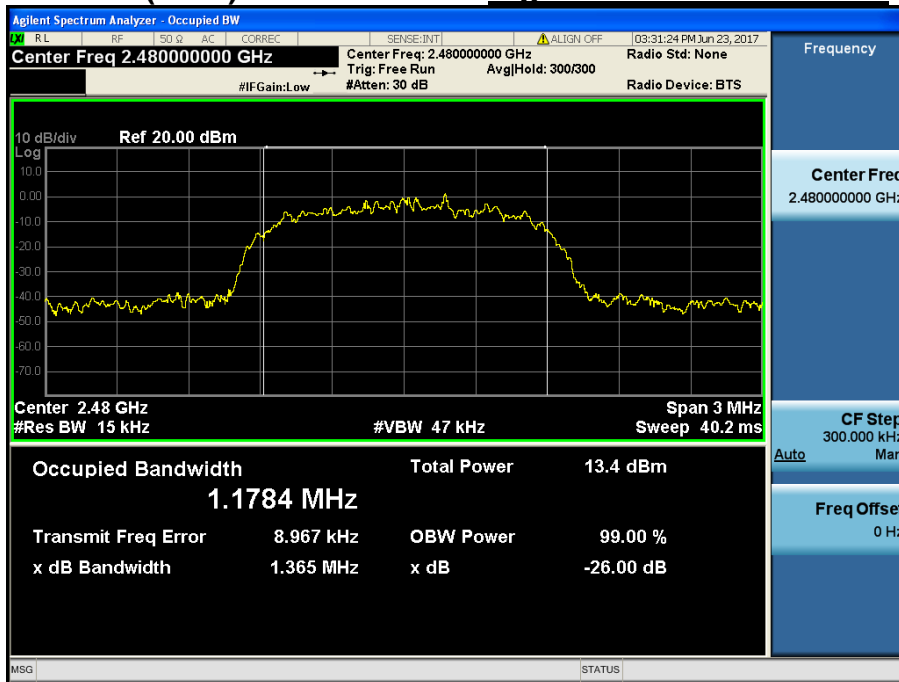

# APPENDIX I

## Test set up diagrams

### ▪ Radiated Measurement

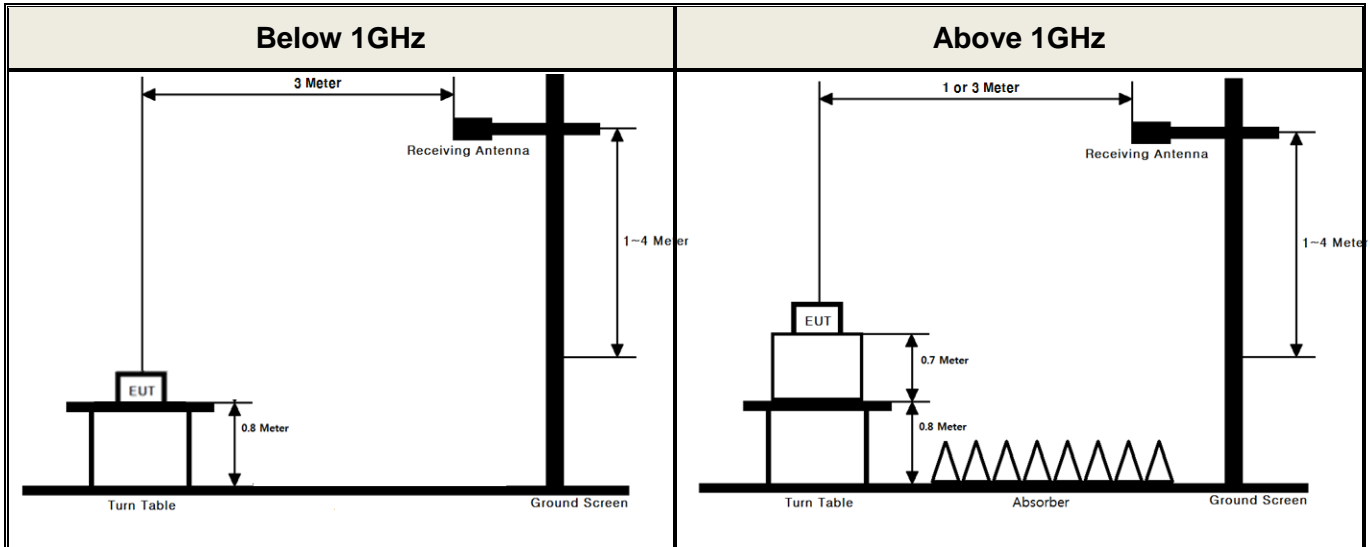

### ▪ Conducted Measurement

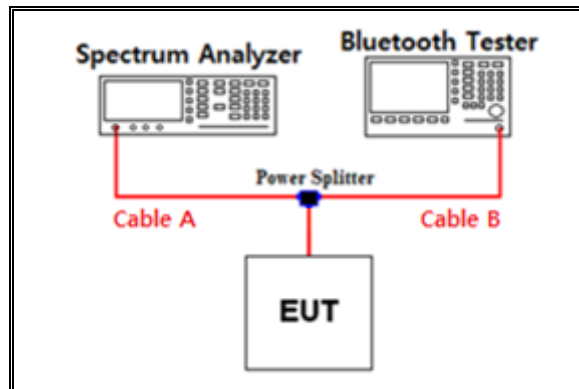

Path loss information

Frequency (GHz)	Path Loss (dB)	Frequency (GHz)	Path Loss (dB)
0.03	6.69	15	10.40
1	6.97	20	11.17
2.402 & 2.440 & 2.480	7.60	25	13.39
5	8.33	-	-
10	9.49	-	-

Note 1 : The path loss from EUT to Spectrum analyzer were measured and used for test.

$$\text{Path loss ( S/A's Correction factor )} = \text{Cable A} + \text{Power splitter}$$



### APPENDIX II

### Unwanted Emissions (Radiated) Test Plot

GFSK & Lowest & X & Ver

Detector Mode : PK

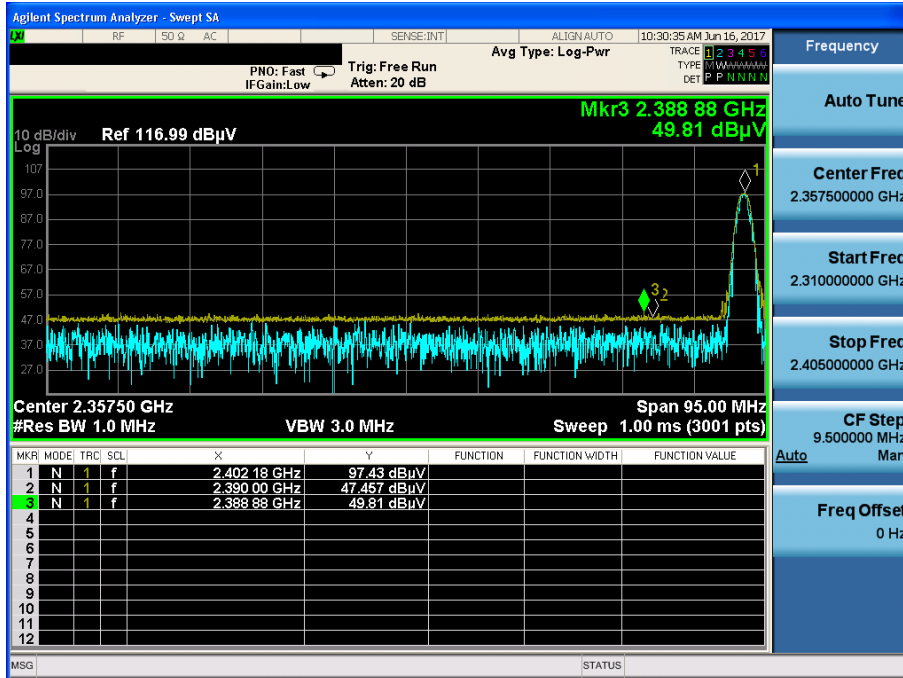

GFSK & Highest & X & Ver

Detector Mode : PK

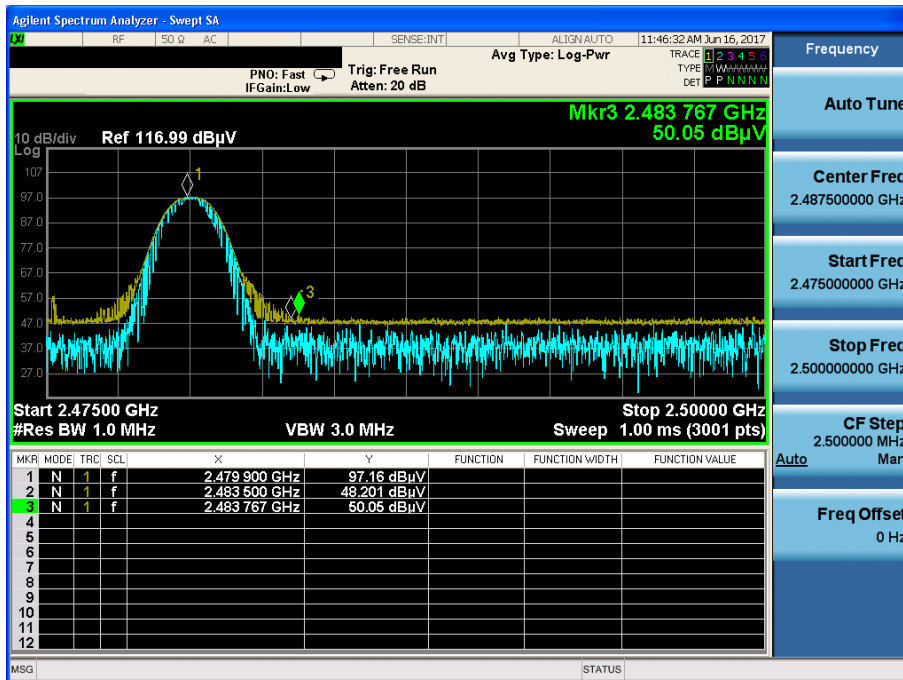

$\pi$ /4DQPSK & Lowest & X & Ver

Detector Mode : PK

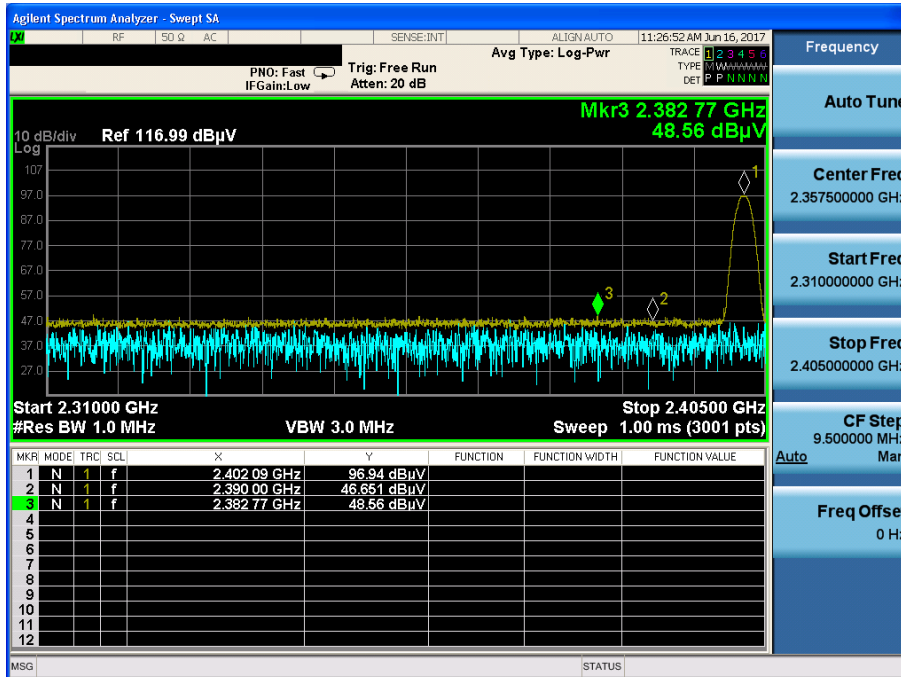

$\pi$ /4DQPSK & Highest & X & Ver

Detector Mode : PK

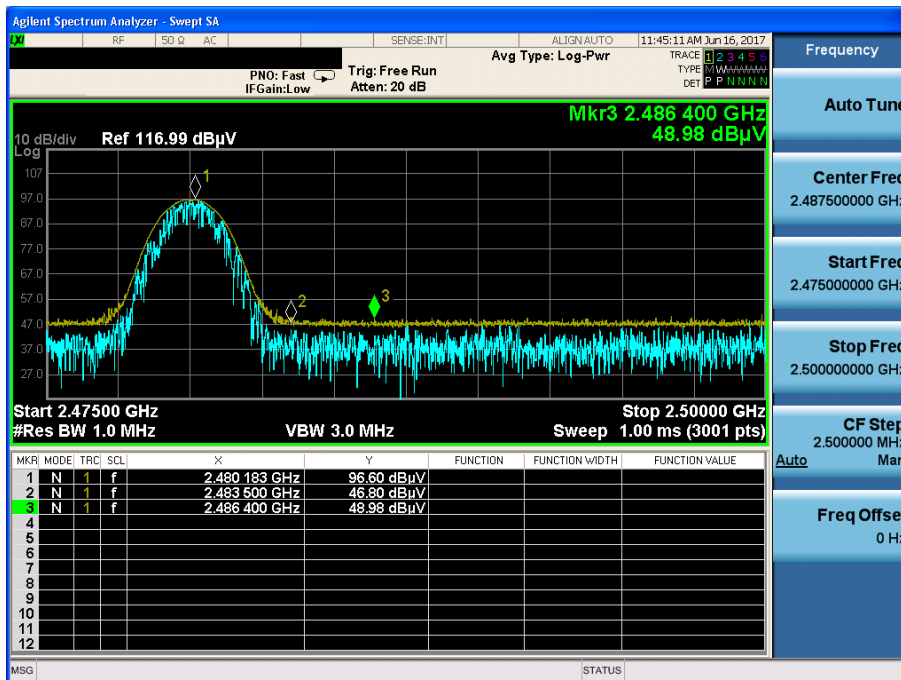

8DPSK & Lowest & X & Ver

Detector Mode : PK

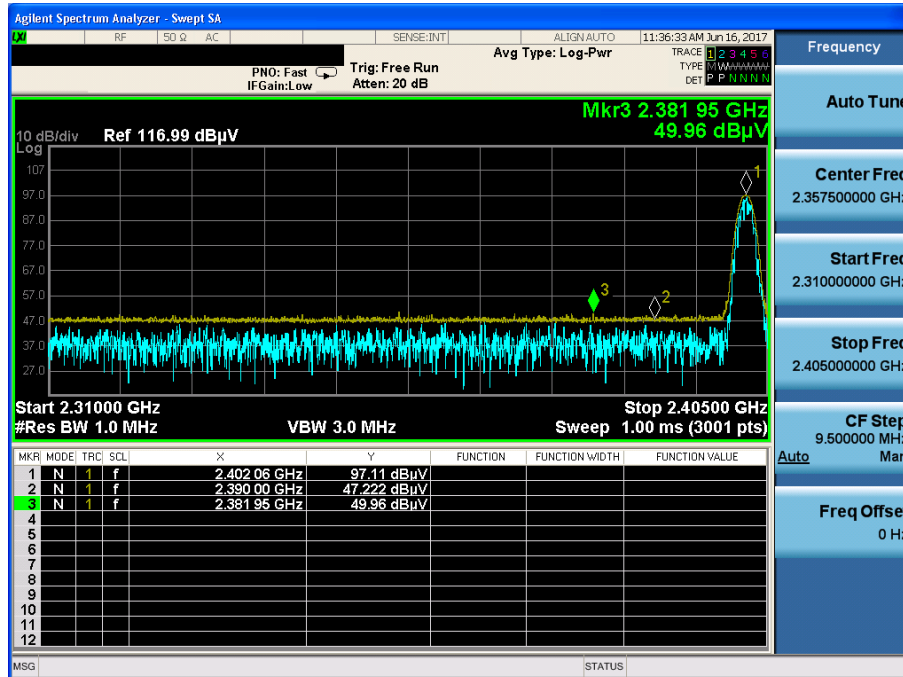

8DPSK & Highest & X & Ver

Detector Mode : PK

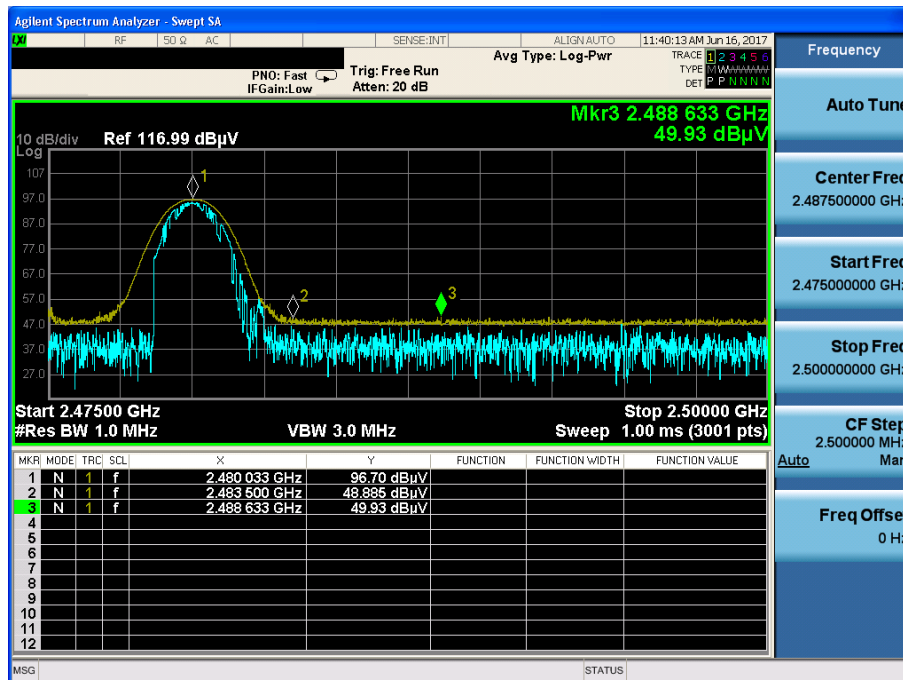

GFSK & Highest & Z & Hor

Detector Mode : PK

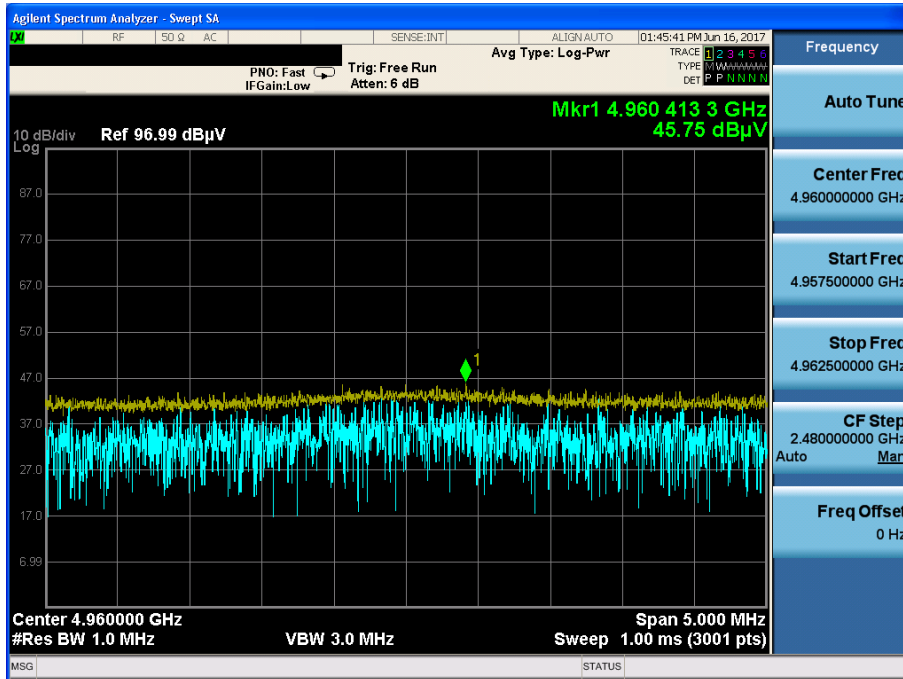

$\pi/4$ DQPSK & Middle & Z & Hor

Detector Mode : PK

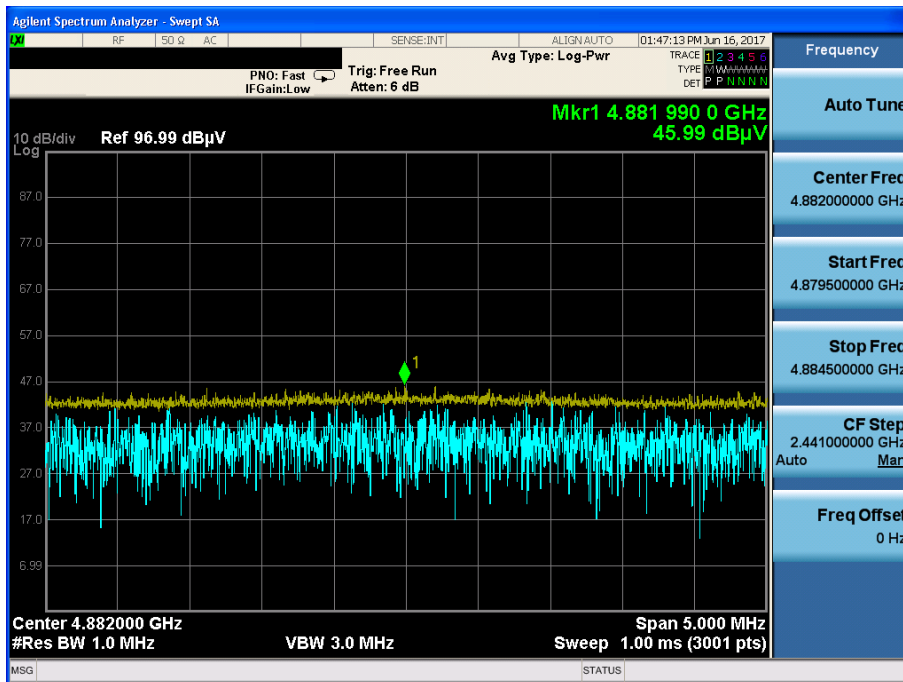

8DPSK & Middle & Z & Hor

Detector Mode : PK

