

TEST REPORT



DT&C Co., Ltd.

42, Yurim-ro, 154Beon-gil, Cheoin-gu, Yongin-si, Gyeonggi-do, Korea, 17042
Tel : 031-321-2664, Fax : 031-321-1664

1. Report No : DRTFCC1709-0186

2. Customer

- Name (FCC) : POINTMOBILE CO., LTD. / Name (IC) : POINTMOBILE CO.,LTD
- Address (FCC) : B-9F, Kabul Great Valley 32 Digital-ro 9-gil, Geumcheon-gu Seoul South Korea 153-709
Address (IC) : B-9F Kabul Great Valley, 32, Digital-ro 9-gil, Geumcheon-gu Seoul Korea (Republic Of)

3. Use of Report : FCC & IC Original Grant

4. Product Name / Model Name : Mobile Computer / FCC: PM70, IC: PM70G
FCC ID: V2X-PM70G / IC: 10664A-PM70G

5. Test Method Used : KDB Procedure



Test Specification : FCC Part 2, 22, 24, 27

RSS-130 Issue 1, 132 Issue 3, 133 Issue 6, 199 Issue 3

6. Date of Test : 2017.06.08 ~ 2017.08.29

7. Testing Environment : See appended test report.

8. Test Result : Refer to the attached test result.

Affirmation	Tested by	Technical Manager
	Name : JaeHyeok Bang 	Name : GeunKi Son  (Signature)

The test results presented in this test report are limited only to the sample supplied by applicant and the use of this test report is inhibited other than its purpose. This test report shall not be reproduced except in full, without the written approval of DT&C Co., Ltd.

2017 . 09 . 12 .

DT&C Co., Ltd.

If this report is required to confirmation of authenticity, please contact to report@dtnc.net

Test Report Version

Test Report No.	Date	Description
DRTFCC1709-0186	Sep. 12, 2017	Initial issue

Table of Contents

1. GENERAL INFORMATION	5
2. INTRODUCTION	7
2.1 EUT DESCRIPTION	7
2.2. EUT CAPABILITIES	7
2.3. TESTING ENVIRONMENT	7
2.4 MEASURING INSTRUMENT CALIBRATION.....	7
2.5. MEASUREMENT UNCERTAINTY	7
2.6. TEST FACILITY.....	7
3. DESCRIPTION OF TESTS.....	8
3.1 ERP&EIRP	8
3.2 PEAK TO AVERAGE RATIO	10
3.3 OCCUPIED BANDWIDTH.....	11
3.4 BAND EDGE EMISSIONS (Conducted).....	12
3.5 SPURIOUS AND HARMONIC EMISSIONS (Conducted).....	13
3.6 UNDESIRABLE EMISSIONS (Radiated).....	14
3.7 FREQUENCY STABILITY	15
4. LIST OF TEST EQUIPMENT	16
5. SUMMARY OF TEST RESULTS.....	17
6. SAMPLE CALCULATION	18
7. TEST DATA.....	20
7.1 OCCUPIED BANDWIDTH.....	20
7.2 PEAK TO AVERAGE RATIO	20
7.3 BAND EDEG EMISSIONS (Conducted).....	20
7.4 SPURIOUS AND HARMONICS EMISSIONS (Conducted)	20
7.5 ERP & EIRP	21
7.5.1 LTE Band 17.....	21
7.5.2 LTE Band 5.....	22
7.5.3 LTE Band 2.....	23
7.5.4 LTE Band 7.....	24
7.6 UNDESIRABLE EMISSIONS (Radiated).....	25
7.6.1 LTE Band 17.....	25
7.6.2 LTE Band 5.....	26
7.6.3 LTE Band 2.....	28
7.6.4 LTE Band 7.....	31
7.7 FREQUENCY STABILITY	33
7.7.1 LTE Band 17.....	33
7.7.2 LTE Band 5.....	34

7.7.3 LTE Band 2.....	35
7.7.4 LTE Band 7.....	36
8. TEST PLOTS	37
8.1 OCCUPIED BANDWIDTH.....	37
8.1.1 LTE Band 17.....	37
8.1.2 LTE Band 5.....	39
8.1.3 LTE Band 2.....	43
8.1.4 LTE Band 7.....	49
8.2 PEAK TO AVERAGE RATIO	53
8.2.1 LTE Band 17.....	53
8.2.2 LTE Band 5.....	55
8.2.3 LTE Band 2.....	59
8.2.4 LTE Band 7.....	65
8.3 BAND EDGE EMISSIONS(Conducted).....	69
8.3.1 LTE Band 17.....	69
8.3.2 LTE Band 5.....	73
8.3.3 LTE Band 2.....	81
8.3.4 LTE Band 7.....	93
8.4 SPURIOUS AND HARMONICS EMISSIONS(Conducted)	99
8.4.1 LTE Band 17.....	99
8.4.2 LTE Band 5.....	102
8.4.3 LTE Band 2.....	108
8.4.4 LTE Band 7.....	126

1. GENERAL INFORMATION

Applicant (FCC)	POINTMOBILE CO., LTD.
Applicant (IC)	POINTMOBILE CO.,LTD
Address (FCC)	B-9F, Kabul Great Valley 32 Digital-ro 9-gil, Geumcheon-gu Seoul South Korea 153-709
Address (IC)	B-9F Kabul Great Valley, 32, Digital-ro 9-gil, Geumcheon-gu Seoul Korea (Republic Of)
Contact person (FCC)	Wilson Park
Contact person (IC)	Edgar Cho
FCC ID	: V2X-PM70G
IC	: 10664A-PM70G
FCC Classification	: Licensed Portable Transmitter Held to Ear (PCE)
EUT Type	: WCDMA/LTE Phone with Bluetooth, WLAN and NFC
Model Name	: PM70
Add Model Name	: NA
Supplying power	: DC 3.80 V
Antenna Information	: Internal Antenna
Antenna Gain	: LTE Band 17: -1.65 dBi LTE Band 5: -1.32 dBi LTE Band 2: 1.69 dBi LTE Band 7: 1.07 dBi

Mode	TX Frequency (MHz)	Emission Designator	Modulation	ERP(For the FCC)		EIRP(For the IC)	
				Max power (dBm)	Max power (W)	Max power (dBm)	Max power (W)
LTE Band 17	709 ~ 711	8M99G7D	QPSK	20.75	0.119	22.90	0.195
LTE Band 17	709 ~ 711	8M96W7D	16QAM	20.14	0.103	22.29	0.169
LTE Band 17	706.5 ~ 713.5	4M49G7D	QPSK	20.89	0.123	23.04	0.201
LTE Band 17	706.5 ~ 713.5	4M49W7D	16QAM	20.18	0.104	22.33	0.171
LTE Band 5	829 ~ 844	8M97G7D	QPSK	22.55	0.180	24.70	0.295
LTE Band 5	829 ~ 844	8M96W7D	16QAM	22.03	0.160	24.18	0.262
LTE Band 5	826.5 ~ 846.5	4M50G7D	QPSK	23.02	0.200	25.17	0.329
LTE Band 5	826.5 ~ 846.5	4M50W7D	16QAM	22.19	0.166	24.34	0.272
LTE Band 5	825.5 ~ 847.5	2M69G7D	QPSK	22.75	0.188	24.90	0.309
LTE Band 5	825.5 ~ 847.5	2M70W7D	16QAM	22.51	0.178	24.66	0.292
LTE Band 5	824.7 ~ 848.3	1M09G7D	QPSK	22.70	0.186	24.85	0.305
LTE Band 5	824.7 ~ 848.3	1M09W7D	16QAM	22.24	0.167	24.39	0.275

Mode	TX Frequency (MHz)	Emission Designator	Modulation	EIRP (FCC & IC)	
				Max power(dBm)	Max power(W)
LTE Band 2	1860 ~ 1900	17M9G7D	QPSK	25.55	0.359
LTE Band 2	1860 ~ 1900	17M9W7D	16QAM	24.67	0.293
LTE Band 2	1857.5 ~ 1902.5	13M5G7D	QPSK	24.81	0.303
LTE Band 2	1857.5 ~ 1902.5	13M4W7D	16QAM	24.28	0.268
LTE Band 2	1855 ~ 1905	8M97G7D	QPSK	25.50	0.355
LTE Band 2	1855 ~ 1905	8M97W7D	16QAM	24.48	0.281
LTE Band 2	1852.5 ~ 1907.5	4M49G7D	QPSK	25.37	0.344
LTE Band 2	1852.5 ~ 1907.5	4M49W7D	16QAM	24.94	0.312
LTE Band 2	1851.5 ~ 1908.5	2M71G7D	QPSK	25.22	0.333
LTE Band 2	1851.5 ~ 1908.5	2M70W7D	16QAM	24.62	0.290
LTE Band 2	1850.7 ~ 1909.3	1M09G7D	QPSK	25.63	0.366
LTE Band 2	1850.7 ~ 1909.3	1M09W7D	16QAM	25.35	0.343
LTE Band 7	2510 ~ 2560	17M9G7D	QPSK	18.59	0.072
LTE Band 7	2510 ~ 2560	18M0W7D	16QAM	18.47	0.070
LTE Band 7	2507.5 ~ 2562.5	13M4G7D	QPSK	19.09	0.081
LTE Band 7	2507.5 ~ 2562.5	13M4W7D	16QAM	18.70	0.074
LTE Band 7	2505 ~ 2565	8M99G7D	QPSK	20.01	0.100
LTE Band 7	2505 ~ 2565	8M99W7D	16QAM	19.38	0.087
LTE Band 7	2502.5 ~ 2567.5	4M50G7D	QPSK	19.92	0.098
LTE Band 7	2502.5 ~ 2567.5	4M50W7D	16QAM	19.26	0.084

2. INTRODUCTION

2.1 EUT DESCRIPTION

The Equipment under Test (EUT) supports WCDMA, LTE, WLAN, Bluetooth and NFC.

2.2. EUT CAPABILITIES

This ETU contains the following capabilities:

850/1900 WCDMA/HSUPA, Multi-band LTE, 802.11b/g/n WLAN(2.4GHz), 802.11a/n WLAN(5GHz), Bluetooth(BDR, EDR, LE), NFC

2.3. TESTING ENVIRONMENT

Ambient Condition	
▪ Temperature	+22 °C ~ +25 °C
▪ Relative Humidity	41 % ~ 45 %

2.4 MEASURING INSTRUMENT CALIBRATION

The measuring equipment, which was utilized in performing the tests documented herein, has been calibrated in accordance with the manufacturer's recommendations for utilizing calibration equipment, which is traceable to recognized national standards.

2.5. MEASUREMENT UNCERTAINTY

The measurement uncertainties shown below were calculated in accordance with requirements of ANSI C 63.4-2014. All measurement uncertainty values are shown with a coverage factor of $k = 2$ to indicate a 95 % level of confidence.

Parameter	Measurement uncertainty
Radiated Disturbance (Below 1 GHz)	± 5.1 dB (The confidence level is about 95 %, $k = 2$)
Radiated Disturbance (1 GHz ~ 18 GHz)	± 5.4 dB (The confidence level is about 95 %, $k = 2$)
Radiated Disturbance (Above 18 GHz)	± 5.3 dB (The confidence level is about 95 %, $k = 2$)

2.6. TEST FACILITY

DT&C Co., Ltd.	
The 3 m test site and conducted measurement facility used to collect the radiated data are located at the 42, Yurim-ro, 154beon-gil, Cheoin-gu, Yongin-si, Gyeonggi-do, Korea 17042. The site is constructed in conformance with the requirements.	
- FCC MRA Accredited Test Firm No. : KR0034	
- IC Test site No. : 5740A-3	
www.dtnc.net	
Telephone	: + 82-31-321-2664
FAX	: + 82-31-321-1664

3. DESCRIPTION OF TESTS

3.1 ERP&EIRP

(Effective Radiated Power & Equivalent Isotropic Radiated Power)

Test Set-up

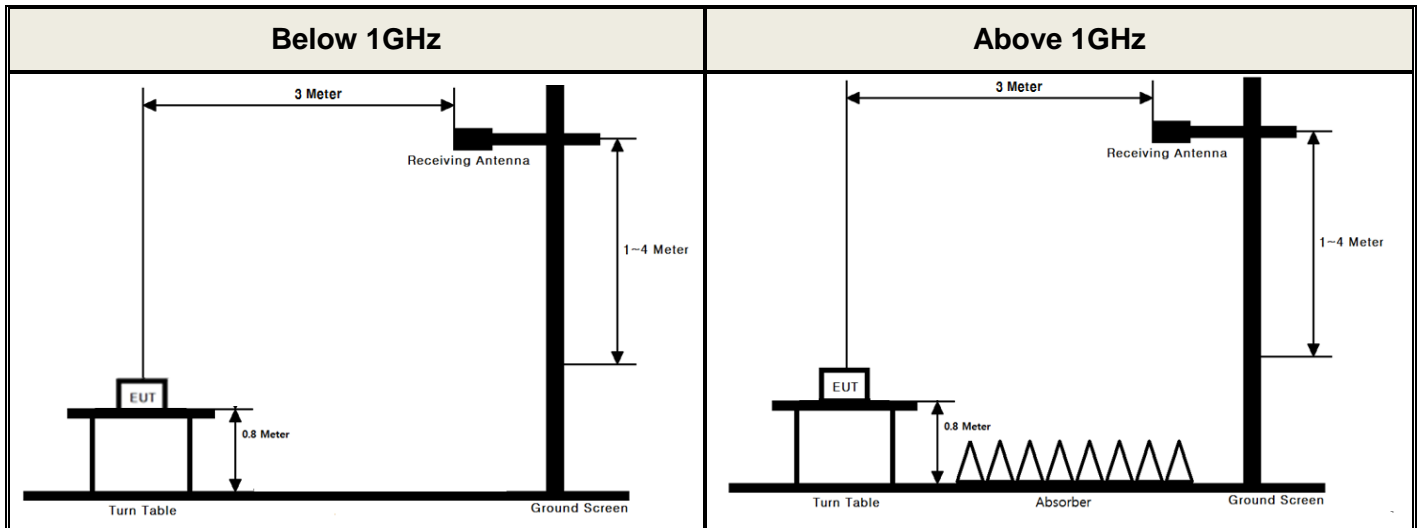

These measurements were performed at 3 m test site. The equipment under test is placed on a non-conductive table 0.8-meters above a turntable which is flush with the ground plane and 3 meters from the receive antenna. For measurements above 1GHz absorbers are placed on the floor between the turn table and the antenna mast in such a way so as to maximize the reduction of reflections. For measurements below 1 GHz, the absorbers are removed.

Test Procedure

- ANSI/TIA-603-E-2016 - Section 2.2.17
- KDB971168 v02r02 - Section 5.2.1

Test setting

1. Set span to at least 1.5 times the OBW.
 2. Set RBW = 1-5 % of the OBW, not to exceed 1 MHz.
 3. Set VBW $\geq 3 \times$ RBW.
 4. Set number of points in sweep $\geq 2 \times$ span / RBW.
 5. Sweep time = auto couple.
 6. Detector = RMS (power averaging).
 7. If the EUT can be configured to transmit continuously (i.e., burst duty cycle $\geq 98 \%$), then set the trigger to free run.
 8. If the EUT cannot be configured to transmit continuously (i.e., burst duty cycle $< 98 \%$), then use a sweep trigger with the level set to enable triggering only on full power bursts and configure the EUT to transmit at full power for the entire duration of each sweep.
- Ensure that the sweep time is less than or equal to the transmission burst duration.
9. Trace average at least 100 traces in power averaging (i.e., RMS) mode.
 10. Compute the power by integrating the spectrum across the OBW of the signal using the instrument's band power measurement function, with the band limits set equal to the OBW band edges. If the instrument does not have a band power function, then sum the spectrum levels (in linear power units) at intervals equal to the RBW extending across the entire OBW of the spectrum.

The receiver antenna height and turntable rotations were adjusted for the highest reading on the receive spectrum analyzer.

A half-wave dipole was substituted in place of the EUT. This dipole antenna was driven by a signal generator and the level of the signal generator was adjusted to obtain the same receive spectrum analyzer reading. The conducted power at the terminal of the substitute antenna is measured.

The ERP/EIRP is calculated using the following formula:

ERP/EIRP = The conducted power at the substitute antenna's terminal [dBm] + Substitute Antenna gain [dBd for ERP , dBi for EIRP]

For readings above 1 GHz, the above procedure is repeated using horn antennas and the difference between the gain of the horn antenna and an isotropic antenna are taken into consideration.

3.2 PEAK TO AVERAGE RATIO

Test set-up

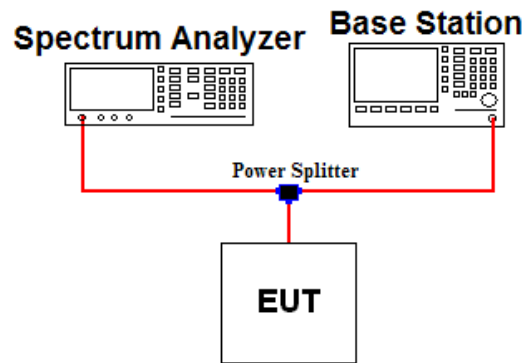

Test Procedure

- KDB971168 v02r02 - Section 5.7.1

A peak to average ratio measurement is performed at the conducted port of the EUT. The spectrum analyzers Complementary Cumulative Distribution Function (CCDF) measurement profile is used to determine the largest deviation between the average and the peak power of the EUT in a given bandwidth. The CCDF curve shows how much time the peak waveform spends at or above a given average power level. The present of time the signal spends at or above the level defines the probability for that particular power level.

Test setting

The spectrum Analyzer`s CCDF measurement function is enabled.

1. Set resolution/measurement bandwidth \geq signal`s occupied bandwidth.
2. Set the number of counts to a value that stabilizes the measured CCDF curve
3. Set the measurement interval as follows:
 - 1) For continuous transmissions, set to 1 ms.
 - 2) For burst transmissions, employ an external trigger that is synchronized with the EUT burst timing sequence, or use the internal burst trigger with a trigger level that allows the burst to stabilize and set the measurement interval to a time that is less than or equal to the burst duration.
4. Record the maximum PAPR level associated with a probability of 0.1 %

3.3 OCCUPIED BANDWIDTH.

Test set-up

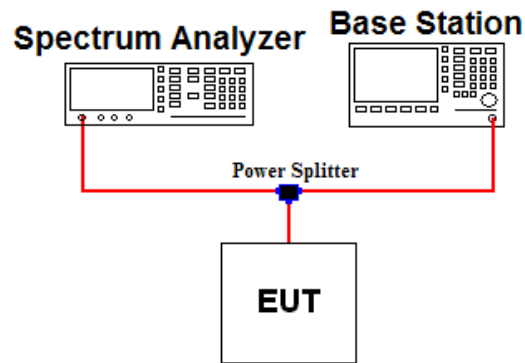

Test Procedure

- KDB971168 v02r02 - Section 4.2

The occupied bandwidth, that is the frequency bandwidth such that, below its lower and above its upper frequency limits, the mean powers radiated are each equal to 0.5 percent of the total mean power of a given emission.

Test setting

1. The signal analyzer's automatic bandwidth measurement capability was used to perform the 99 % occupied bandwidth and the 26 dB bandwidth. The bandwidth measurement was not influenced by any intermediate power nulls in the fundamental emission.
2. $RBW = 1 \sim 5 \%$ of the expected OBW & $VBW \geq 3 \times RBW$
3. Detector = Peak
4. Trance mode = Max hold
5. Sweep = Auto couple
6. The trace was allowed to stabilize
7. If necessary, step 2 ~ 6 were repeated after changing the RBW such that it would be within 1 ~ 5 % of the 99 % occupied bandwidth observed in step 6.

3.4 BAND EDGE EMISSIONS (Conducted)

Test set-up

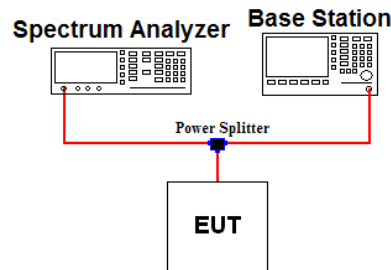

Test Procedure

- KDB971168 v02r02 - Section 6.0

All out of band emissions are measured by means of a calibrated spectrum analyzer. The EUT was setup to maximum output power at its lowest and highest channel with all bandwidths, modulations and RB configurations.

The power of any spurious emission shall be attenuated below the transmitter power (P) by at least $43 + 10 \log(P)$ dB or requirements on note 3 in case of band 7 and 41.

Test setting

1. Start and stop frequency were set such that the band edge would be placed in the center of the plot
2. Span was set large enough so as to capture all out of band emissions near the band edge
3. RBW $\geq 1\%$ of the emission bandwidth
4. VBW $\geq 3 \times$ RBW
5. Detector = RMS & Trace mode = Max hold
6. Sweep time = Auto couple or 1 s for band edge
7. Number of sweep point $\geq 2 \times$ span / RBW
8. The trace was allowed to stabilize

Note 1: Per Part 22.917(b)(1) / 24.238(b) / 27.53(h)(3) in the 1 MHz bands immediately outside and adjacent to the frequency block a resolution bandwidth of at least one percent of the emission bandwidth of the fundamental emission of the transmitter may be employed to demonstrate compliance with the out-of-band emissions limit. The emission bandwidth is defined as the width of the signal between two points, one below the carrier center frequency and one above the carrier center frequency, outside of which all emission are attenuated at least 26 dB below the transmitter power.

Note 2: Per Part 27(g) for operations in the 600 MHz band and the 698-746 MHz band, compliance with this provision is based on the use of measurement instrumentation employing a resolution bandwidth of 100 kilohertz or greater. However, in the 100 kilohertz bands immediately outside and adjacent to a licensee's frequency block, a resolution bandwidth of at least 30 kHz may be employed.

Note 3: For part 27.53(m)(4) the attenuation factor shall be not less than $40 + 10 \log(P)$ dB on all frequencies between the channel edge and 5 megahertz from the channel edge, $43 + 10 \log(P)$ dB on all frequencies between 5 megahertz and X megahertz from the channel edge, and $55 + 10 \log(P)$ dB on all frequencies more than X megahertz from the channel edge, where X is the greater of 6 megahertz or the actual emission bandwidth as defined in paragraph (m)(6) of this section. In addition, the attenuation factor shall not be less that $43 + 10 \log(P)$ dB on all frequencies between 2490.5 MHz and 2496 MHz and $55 + 10 \log(P)$ dB at or below 2490.5 MHz.

Note 4: Per part 27.53(m)(6) in the 1 MHz bands immediately outside and adjacent to the frequency block a resolution bandwidth of at least two percent may be employed, except when the 1 MHz band is 2495-2496 MHz, in which case a resolution bandwidth of at least one percent may be employed.

3.5 SPURIOUS AND HARMONIC EMISSIONS (Conducted)

Test set-up

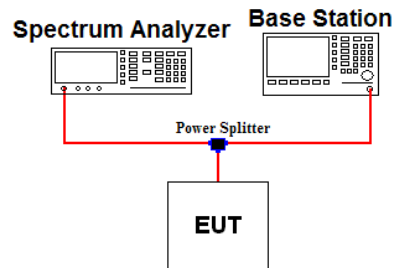

Test Procedure

- KDB971168 v02r02 - Section 6.0

The level of the carrier and the various conducted spurious and harmonic frequencies is measured by means of a calibrated spectrum analyzer. The EUT was setup to maximum output power at its low, middle, high channel with all bandwidths, modulations and RB configurations. The spectrum is scanned from 9 kHz up to a frequency including its 10th harmonic.

The power of any spurious emission shall be attenuated below the transmitter power (P) by at least $43 + 10 \log(P)$ dB or $55 + 10 \log(P)$ in case of band 7 and 41.

Test setting

1. RBW = 100 kHz(Below 1 GHz) or 1 MHz(Above 1 GHz) & VBW $\geq 3 \times$ RBW (Refer to Note 1)
2. Detector = RMS & Trace mode = Max hold
3. Sweep time = Auto couple
4. Number of sweep point $\geq 2 \times$ span / RBW
5. The trace was allowed to stabilize

Note 1: Compliance with these provisions is based on the use of measurement instrumentation employing a resolution bandwidth of 100 kHz or greater for frequencies less than 1GHz and 1MHz or greater for frequencies greater than 1GHz.

3.6 UNDESIRABLE EMISSIONS (Radiated)

Test Set-up

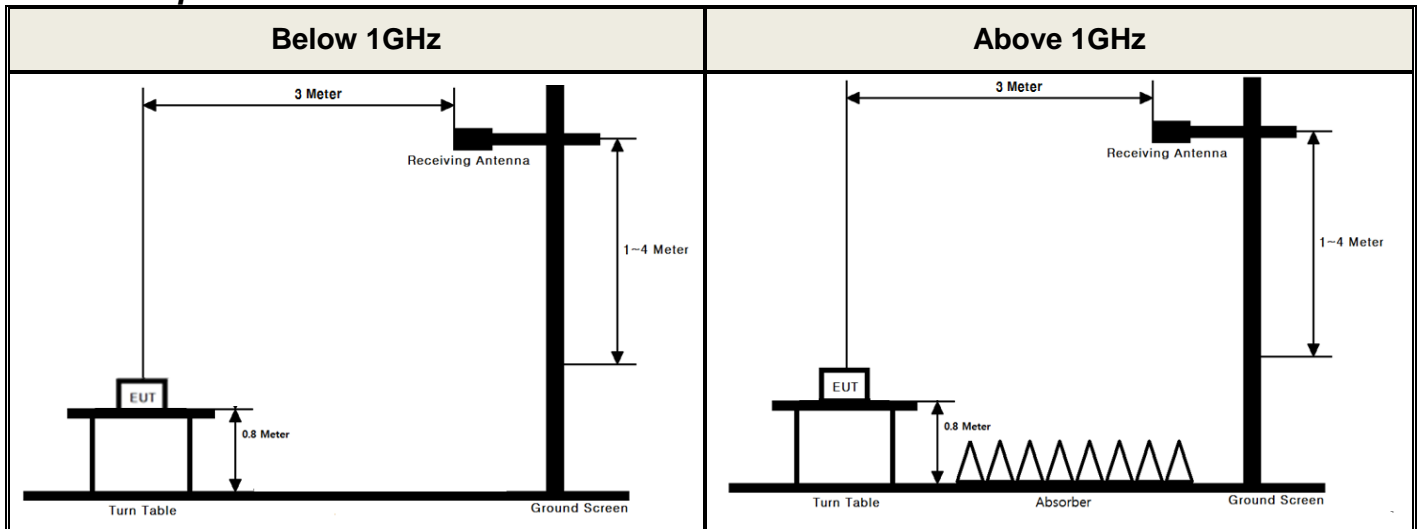

These measurements were performed at 3 test site. The equipment under test is placed on a non-conductive table 0.8-meters above a turntable which is flush with the ground plane and 3 meters from the receive antenna. For measurements above 1GHz absorbers are placed on the floor between the turn table and the antenna mast in such a way so as to maximize the reduction of reflections. For measurements below 1 GHz, the absorbers are removed.

Test Procedure

- ANSI/TIA-603-E-2016 - Section 2.2.12
- KDB971168 v02r02 - Section 5.8

Test setting

1. RBW = 100 kHz for below 1 GHz and 1 MHz for above 1 GHz / VBW $\geq 3 \times$ RBW
2. Detector = RMS & Trace mode = Max hold
3. Sweep time = Auto couple
4. Number of sweep point $\geq 2 \times$ span / RBW
5. The trace was allowed to stabilize

The receive antenna height and turntable rotations were adjusted for the highest reading on the receive spectrum analyzer.

For radiated power measurements below 1 GHz, a half-wave dipole was substituted in place of the EUT. This dipole antenna was driven by a signal generator and the level of the signal generator was adjusted to obtain the same spectrum analyzer reading.

For radiated power measurements above 1 GHz, a Horn antenna was substituted in place of the EUT. This Horn antenna was driven by a signal generator and the level of the signal generator was adjusted to obtain the same spectrum analyzer reading. The difference between the gain of the horn and an isotropic antenna are taken into consideration.

This measurement was performed with the EUT oriented in 3 orthogonal axis.

3.7 FREQUENCY STABILITY

Test Set-up

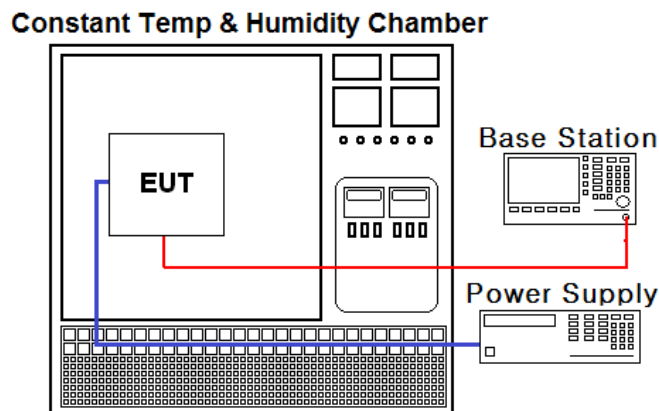

Test Procedure

- ANSI/TIA-603-E-2016
- KDB971168 v02r02 - Section 9.0

The frequency stability of the transmitter is measured by:

a.) **Temperature:**

The temperature is varied from - 30 °C to + 50 °C using an environmental chamber.

b.) **Primary Supply Voltage:**

The primary supply voltage is varied from 85 % to 115 % of the nominal value for non hand-carried battery and AC powered equipment. For hand-carried, battery-powered equipment, primary supply voltage is reduced to the battery operating end point which shall be specified by the manufacturer.

Specification:

The frequency stability shall be sufficient to ensure that the fundamental emission stays within the authorized frequency block for Part 24, 27. The frequency stability of the transmitter shall be maintained within $\pm 0.00025\%$ (± 2.5 ppm) of the center frequency for Part 22.

Time Period and Procedure:

1. The carrier frequency of the transmitter is measured at room temperature.
(20 °C to provide a reference)
2. The equipment is turned on in a "standby" condition for one minute before applying power to the transmitter. Measurement of the carrier frequency of the transmitter is made within one minute after applying power to the transmitter.
3. Frequency measurements are made at 10 °C intervals ranging from -30 °C to +50 °C.
A period of at least one half-hour is provided to allow stabilization of the equipment at each temperature level.

4. LIST OF TEST EQUIPMENT

Type	Manufacturer	Model	Cal.Date (yy/mm/dd)	Next.Cal. Date (yy/mm/dd)	S/N
Spectrum Analyzer	Agilent Technologies	N9020A	16/10/11	17/10/11	MY46471251
Spectrum Analyzer	Agilent Technologies	N9020A	17/01/11	18/01/11	MY50200828
Spectrum Analyzer	Agilent Technologies	N9030A	16/10/18	17/10/18	MY53310140
DC power supply	Agilent Technologies	66332A	16/09/08	17/09/08	GB42110550
Multimeter	FLUKE	17B	17/04/12	18/04/12	26030065WS
Temp & Humi Test Chamber	SJ Science	SJ-TH-S50	17/01/25	18/01/25	SJ-TH-S50-120203
Thermohygrometer	BODYCOM	BJ5478	17/01/11	18/01/11	1209
Radio Communication Analyzer	Anritsu	MT8820C	17/01/03	18/01/03	6201274516
Attenuator	SMAJK	SMAJK-2-3	16/10/11	17/10/11	2
Signal Generator	Rohde Schwarz	SMBV100A	17/01/04	18/01/04	255571
Signal Generator	Rohde Schwarz	SMF100A	17/04/21	18/04/21	102341
Loop Antenna	Schwarzbeck	FMZB1513	16/04/22	18/04/22	1513-128
BILOG ANTENNA	Schwarzbeck	VULB 9160	16/11/11	18/11/11	3151
Dipole Antenna	Schwarzbeck	VHA9103	17/03/14	19/03/14	2116
Dipole Antenna	Schwarzbeck	VHA9103	16/04/15	18/04/15	2117
Dipole Antenna	Schwarzbeck	UHA9105	17/03/14	19/03/14	2261
Dipole Antenna	Schwarzbeck	UHA9105	16/04/15	18/04/15	2262
HORN ANT	ETS	3117	16/05/13	18/05/13	00140394
HORN ANT	ETS	3117	16/02/26	18/02/26	00152145
HORN ANT	A.H.Systems	SAS-574	17/04/25	19/04/25	154
HORN ANT	A.H.Systems	SAS-574	15/09/03	17/09/03	155
PreAmplifier	TSJ	MLA-010K01-B01-27	17/03/06	18/03/06	1844539
Amplifier	RF Bay Inc	MPA-40-40	17/04/12	18/04/12	21151801
Amplifier	EMPOWER	BBS3Q7ELU	16/09/08	17/09/08	1020
PreAmplifier	Agilent	8449B	16/10/19	17/10/19	3008A02108
PreAmplifier	A.H.Systems Inc.	PAM-1840VH	16/12/04	17/12/04	163
High-pass filter	Wainwright	WHKX12-935-1000-15000-40SS	16/09/09	17/09/09	7
High-pass filter	Wainwright	WHKX12-2580-3000-18000-80SS	16/09/09	17/09/09	3
High-pass filter	Wainwright	WHNX5.0	16/09/08	17/09/08	8
Power Splitter	Anritsu	K241B	17/01/11	18/01/11	016681

Note: The measurement antennas were calibrated in accordance to the requirements of ANSI C63.5-2006.

5. SUMMARY OF TEST RESULTS

FCC Part Section(s)	RSS Section(s)	Test Description	Test Limit	Test Condition	Status Note 1
2.1046	-	Conducted Output Power	N/A	Conducted	C Note2
2.1049	RSS-GEN[6.6]	Occupied Bandwidth	N/A		C
24.232(d) 27.50(d.5)	RSS-130 [4.4] RSS-132 [5.4] RSS-133 [6.4] RSS-199 [4.4]	Peak to Average Ratio	< 13 dB		C
2.1051 22.917(a) 24.238(a) 27.53(g)	RSS-130 [4.6.1] RSS-132 [5.5] RSS-133 [6.5]	Band Edge / Conducted Spurious Emissions	> 43 + 10log ₁₀ (P) dB at Band edge and for all out-of-band emissions		C
27.53(m)	RSS-199 [4.5]	Band Edge / Conducted Spurious Emissions	> 40 + 10log ₁₀ (P) dB at channel edge and 5 MHz from the channel edge > 43 + 10log ₁₀ (P) dB at 5 MHz and X MHz from the channel edge > 55 + 10log ₁₀ (P) dB at all frequencies more than X MHz from the channel edge		C Note3
2.1055 22.355 24.235 27.54	RSS-130 [4.3] RSS-132 [5.3] RSS-133 [6.3] RSS-199 [4.3]	Frequency Stability	< 2.5 ppm (Part 22), (RSS-132, 133) Fundamental emissions must stay within Authorized frequency block (Part 24, 27), (RSS-130, RSS-199)		C
27.50(c.10)	RSS-130 [4.4]	Radiated Output Power (B17)	< 3 Watts max. ERP (Part 27) < 5 Watts max. EIRP (RSS-130)	Radiated	C
22.913(a.2)	RSS-132 [5.4]	Radiated Output Power (B5)	< 7 Watts max. ERP (Part 22) < 11.5 Watts max. EIRP (RSS-132)		C
24.232(c) 27.50(h.2)	RSS-133 [6.4] RSS-199 [4.4]	Radiated Output Power (B2), (B7)	< 2 Watts max. EIRP		C
2.1053 22.917(a) 24.238(a) 27.53(g)	RSS-130 [4.6.1] RSS-132 [5.5] RSS-133 [6.5]	Undesirable Emissions	> 43 + 10log ₁₀ (P) dB for all out-of-band emissions		C
27.53(m)	RSS-199 [4.5]	Undesirable Emissions	> 55 + 10log ₁₀ (P) dB for all out-of-band emissions		C

Note 1: **C**=Comply **NC**=Not Comply **NT**=Not Tested **NA**=Not Applicable

Note 2: Refer to RF Exposure Report (Test Report_SAR)

Note 3: Where X is the greater of 6 MHz or the actual emission bandwidth as defined in paragraph (m)(6) of this section.

6. SAMPLE CALCULATION

A. Emission Designator

LTE Band 17(QPSK)

Emission Designator = **8M99G7D**
LTE OBW = 8.987 MHz
G = Phase Modulation
7 = Quantized/Digital Info
D = Data Transmission

LTE Band 17(16QAM)

Emission Designator = **8M96W7D**
LTE OBW = 8.962 MHz
W = Amplitude/Angle Modulated
7 = Quantized/Digital Info
D = Data Transmission

LTE Band 5(QPSK)

Emission Designator = **8M97G7D**
LTE OBW = 8.971 MHz
G = Phase Modulation
7 = Quantized/Digital Info
D = Data Transmission

LTE Band 5(16QAM)

Emission Designator = **8M96W7D**
LTE OBW = 8.959 MHz
W = Amplitude/Angle Modulated
7 = Quantized/Digital Info
D = Data Transmission

LTE Band 2(QPSK)

Emission Designator = **17M9G7D**
LTE OBW = 17.903 MHz
G = Phase Modulation
7 = Quantized/Digital Info
D = Data Transmission

LTE Band 2(16QAM)

Emission Designator = **17M9W7D**
LTE OBW = 17.908 MHz
W = Amplitude/Angle Modulated
7 = Quantized/Digital Info
D = Data Transmission

LTE Band 7(QPSK)

Emission Designator = **17M9G7D**
LTE OBW = 17.879 MHz
G = Phase Modulation
7 = Quantized/Digital Info
D = Data Transmission

LTE Band 7(16QAM)

Emission Designator = **18M0W7D**
LTE OBW = 17.961 MHz
W = Amplitude/Angle Modulated
7 = Quantized/Digital Info
D = Data Transmission

B. For substitution method

Channel Bandwidth (MHz)	Test Frequency (MHz)	Test Mode	RB Size/ Offset	Spectrum Reading Value(dBm)	EUT Axis	Ant Pol (H/V)	Level(dBm) @ Ant Terminal	TX Ant Gain (dBi)	EIRP (dBm)	EIRP (W)
20	1880.0	QPSK	1/0	-22.02	Y	H	20.10	5.02	25.12	0.325

ERP or EIRP = Level @ Ant Terminal LEVEL(dBm) + Tx Ant. Gain

- 1) The EUT mounted on a non-conductive turntable is 0.8 meter above test site ground level.
- 2) During the test, the turn table is rotated until the maximum signal is found.
- 3) Record the field strength meter's level.
- 4) Replace the EUT with dipole/Horn antenna that is connected to a calibrated signal generator.
- 5) Increase the signal generator output till the field strength meter's level is equal to the item (3).
- 6) The signal generator output level with substituted antenna gain is the rating of ERP, EIRP or Radiated spurious emission.

7. TEST DATA

7.1 OCCUPIED BANDWIDTH

- Plots of the EUT's Occupied Bandwidth are shown in Clause 8.1

7.2 PEAK TO AVERAGE RATIO

- Plots of the EUT's Peak- to- Average Ratio are shown in Clause 8.2

7.3 BAND EDGE EMISSIONS (Conducted)

- Plots of the EUT's Band Edge Emissions are shown in Clause 8.3

7.4 SPURIOUS AND HARMONICS EMISSIONS (Conducted)

- Plots of the EUT's Spurious Emissions are shown in Clause 8.4

7.5 ERP & EIRP

7.5.1 LTE Band 17

Channel Bandwidth (MHz)	Test Frequency (MHz)	Test Mode	RB Size/ Offset	EUT Axis	Ant Pol (H/V)	Level(dBm) @ Ant Terminal	TX Ant Gain (dBd)	ERP (dBm)	ERP (W)
10	709	QPSK	1/25	Z	H	19.47	1.28	20.75	0.119
		16QAM	1/25	Z	H	18.86	1.28	20.14	0.103
	711	QPSK	1/0	Z	H	19.29	1.28	20.57	0.114
		16QAM	1/0	Z	H	18.49	1.28	19.77	0.095
5	706.5	QPSK	1/0	Z	H	19.10	1.28	20.38	0.109
		16QAM	1/0	Z	H	18.90	1.28	20.18	0.104
	710	QPSK	1/0	Z	H	19.61	1.28	20.89	0.123
		16QAM	1/0	Z	H	18.59	1.28	19.87	0.097
	713.5	QPSK	1/0	Z	H	19.06	1.28	20.34	0.108
		16QAM	1/0	Z	H	18.22	1.28	19.50	0.089

Note: This device was tested under all bandwidths, modulations and RB configurations and the worst case data are reported in the table above.

7.5.2 LTE Band 5

Channel Bandwidth (MHz)	Test Frequency (MHz)	Test Mode	RB Size/Offset	EUT Axis	Ant Pol (H/V)	Level(dBm) @ Ant Terminal	TX Ant Gain (dBd)	ERP (dBm)	ERP (W)
10	829	QPSK	1/0	X	H	21.25	1.23	22.48	0.177
		16QAM	1/0	X	H	20.80	1.23	22.03	0.160
	836.5	QPSK	1/25	X	H	21.33	1.22	22.55	0.180
		16QAM	1/25	X	H	20.78	1.22	22.00	0.158
	844	QPSK	1/49	X	H	21.17	1.21	22.38	0.173
		16QAM	1/49	X	H	20.18	1.21	21.39	0.138
5	826.5	QPSK	1/0	X	H	21.36	1.23	22.59	0.182
		16QAM	1/0	X	H	20.64	1.23	21.87	0.154
	836.5	QPSK	1/0	X	H	21.38	1.22	22.60	0.182
		16QAM	1/0	X	H	20.62	1.22	21.84	0.153
	846.5	QPSK	1/0	X	H	21.81	1.21	23.02	0.200
		16QAM	1/0	X	H	20.98	1.21	22.19	0.166
3	825.5	QPSK	1/0	X	H	20.85	1.23	22.08	0.161
		16QAM	1/0	X	H	20.31	1.23	21.54	0.143
	836.5	QPSK	1/0	X	H	21.29	1.22	22.51	0.178
		16QAM	1/0	X	H	20.87	1.22	22.09	0.162
	847.5	QPSK	1/0	X	H	21.54	1.21	22.75	0.188
		16QAM	1/0	X	H	21.29	1.21	22.50	0.178
1.4	824.7	QPSK	1/2	X	H	20.79	1.23	22.02	0.159
		16QAM	1/2	X	H	20.18	1.23	21.41	0.138
	836.5	QPSK	1/2	X	H	21.48	1.22	22.70	0.186
		16QAM	1/2	X	H	21.02	1.22	22.24	0.167
	848.3	QPSK	1/2	X	H	21.34	1.21	22.55	0.180
		16QAM	1/2	X	H	20.23	1.21	21.44	0.139

Note: This device was tested under all bandwidths, modulations and RB configurations and the worst case data are reported in the table above.

7.5.3 LTE Band 2

Channel Bandwidth (MHz)	Test Frequency (MHz)	Test Mode	RB Size/Offset	EUT Axis	Ant Pol (H/V)	Level(dBm) @ Ant Terminal	TX Ant Gain (dBi)	EIRP (dBm)	EIRP (W)
20	1860	QPSK	1/0	Y	H	20.10	5.02	25.12	0.325
		16QAM	1/0	Y	H	19.51	5.02	24.53	0.284
	1880	QPSK	1/0	Y	H	20.01	4.91	24.92	0.310
		16QAM	1/0	Y	H	19.37	4.91	24.28	0.268
	1900	QPSK	1/0	Y	H	20.74	4.81	25.55	0.359
		16QAM	1/0	Y	H	19.86	4.81	24.67	0.293
15	1857.5	QPSK	1/74	Y	H	19.78	5.03	24.81	0.303
		16QAM	1/74	Y	H	19.25	5.03	24.28	0.268
	1880	QPSK	1/74	Y	H	19.14	4.91	24.05	0.254
		16QAM	1/74	Y	H	18.08	4.91	22.99	0.199
	1902.5	QPSK	1/74	Y	H	19.32	4.80	24.12	0.258
		16QAM	1/74	Y	H	18.54	4.80	23.34	0.216
10	1855	QPSK	1/49	Y	H	20.45	5.05	25.50	0.355
		16QAM	1/49	Y	H	19.40	5.05	24.45	0.279
	1880	QPSK	1/49	Y	H	20.37	4.91	25.28	0.337
		16QAM	1/49	Y	H	19.57	4.91	24.48	0.281
	1905	QPSK	1/49	Y	H	20.16	4.79	24.95	0.313
		16QAM	1/49	Y	H	19.13	4.79	23.92	0.247
5	1852.5	QPSK	1/24	Y	H	20.14	5.06	25.20	0.331
		16QAM	1/24	Y	H	19.88	5.06	24.94	0.312
	1880	QPSK	1/24	Y	H	20.46	4.91	25.37	0.344
		16QAM	1/24	Y	H	19.81	4.91	24.72	0.296
	1907.5	QPSK	1/24	Y	H	19.92	4.77	24.69	0.294
		16QAM	1/24	Y	H	19.33	4.77	24.10	0.257
3	1851.5	QPSK	1/14	Y	H	20.13	5.06	25.19	0.330
		16QAM	1/14	Y	H	19.56	5.06	24.62	0.290
	1880	QPSK	1/14	Y	H	20.16	4.91	25.07	0.321
		16QAM	1/14	Y	H	19.62	4.91	24.53	0.284
	1908.5	QPSK	1/14	Y	H	20.45	4.77	25.22	0.333
		16QAM	1/14	Y	H	19.73	4.77	24.50	0.282
1.4	1850.7	QPSK	1/2	Y	H	20.37	5.07	25.44	0.350
		16QAM	1/2	Y	H	19.53	5.07	24.60	0.288
	1880	QPSK	1/2	Y	H	20.72	4.91	25.63	0.366
		16QAM	1/2	Y	H	20.44	4.91	25.35	0.343
	1909.3	QPSK	1/2	Y	H	20.35	4.76	25.11	0.324
		16QAM	1/2	Y	H	19.54	4.76	24.30	0.269

Note: This device was tested under all bandwidths, modulations and RB configurations and the worst case data are reported in the table above.

7.5.4 LTE Band 7

Channel Bandwidth (MHz)	Test Frequency (MHz)	Test Mode	RB Size/Offset	EUT Axis	Ant Pol (H/V)	Level(dBm) @ Ant Terminal	TX Ant Gain (dBi)	EIRP (dBm)	EIRP (W)
20	2510	QPSK	1/99	X	H	12.20	6.19	18.39	0.069
		16QAM	1/99	X	H	11.52	6.19	17.71	0.059
	2535	QPSK	1/99	X	H	12.22	6.21	18.43	0.070
		16QAM	1/99	X	H	12.05	6.21	18.26	0.067
	2560	QPSK	1/99	X	H	12.38	6.21	18.59	0.072
		16QAM	1/99	X	H	12.26	6.21	18.47	0.070
15	2507.5	QPSK	1/74	X	H	12.25	6.19	18.44	0.070
		16QAM	1/74	X	H	12.01	6.19	18.20	0.066
	2535	QPSK	1/74	X	H	12.88	6.21	19.09	0.081
		16QAM	1/74	X	H	12.49	6.21	18.70	0.074
	2562.5	QPSK	1/74	X	H	12.28	6.21	18.49	0.071
		16QAM	1/74	X	H	12.04	6.21	18.25	0.067
10	2505	QPSK	1/25	X	H	13.03	6.19	19.22	0.084
		16QAM	1/25	X	H	12.47	6.19	18.66	0.073
	2535	QPSK	1/25	X	H	13.80	6.21	20.01	0.100
		16QAM	1/25	X	H	13.17	6.21	19.38	0.087
	2565	QPSK	1/25	X	H	12.87	6.22	19.09	0.081
		16QAM	1/25	X	H	12.39	6.22	18.61	0.073
5	2502.5	QPSK	1/12	X	H	13.69	6.19	19.88	0.097
		16QAM	1/12	X	H	12.91	6.19	19.10	0.081
	2535	QPSK	1/12	X	H	13.71	6.21	19.92	0.098
		16QAM	1/12	X	H	13.05	6.21	19.26	0.084
	2567.5	QPSK	1/12	X	H	12.66	6.22	18.88	0.077
		16QAM	1/12	X	H	12.01	6.22	18.23	0.067

Note: This device was tested under all bandwidths, modulations and RB configurations and the worst case data are reported in the table above.

7.6 UNDESIRABLE EMISSIONS (Radiated)

7.6.1 LTE Band 17

B.W (MHz)	Test Freq. (MHz)	RB Size/ Offset	Test Mode	Freq.(MHz)	EUT Axis	Ant Pol (H/V)	Level(dBm) @ Ant Terminal	TX Ant Gain(dBd)	Result		Limit (dBc)
									(dBm)	(dBc)	
10	709	1/25	QPSK	1418.24	Z	H	-53.14	3.01	-50.13	70.88	33.75
				2127.05	Z	H	-53.54	2.67	-50.87	71.62	
		1/25	16QAM	1418.20	Z	H	-53.52	3.01	-50.51	70.65	33.14
				2127.38	Z	H	-53.77	2.67	-51.10	71.24	
	711	1/0	QPSK	1413.05	Z	H	-52.60	2.98	-49.62	68.04	33.57
				2119.91	Z	H	-52.12	2.60	-49.52	70.19	
		1/0	16QAM	1413.06	Z	H	-53.01	2.98	-50.03	69.80	32.77
				2119.78	Z	H	-52.62	2.60	-50.02	69.79	
5	706.5	1/0	QPSK	1408.72	Z	H	-54.02	2.95	-51.07	71.45	33.38
				2112.89	Z	H	-52.66	2.54	-50.12	70.50	
		1/0	16QAM	1408.84	Z	H	-54.41	2.95	-51.46	71.64	33.18
				2112.93	Z	H	-52.99	2.54	-50.45	70.63	
	710	1/0	QPSK	1415.82	Z	H	-53.34	2.99	-50.35	71.24	33.89
				2123.60	Z	H	-52.56	2.63	-49.93	70.82	
		1/0	16QAM	1415.86	Z	H	-53.45	3.00	-50.45	70.32	32.87
				2123.27	Z	H	-53.61	2.63	-50.98	70.85	
	713.5	1/0	QPSK	1422.61	Z	H	-55.10	3.04	-52.06	72.40	33.34
				2133.14	Z	H	-52.66	2.72	-49.94	70.28	
		1/0	16QAM	1422.52	Z	H	-55.52	3.04	-52.48	71.98	32.50
				2133.21	Z	H	-53.49	2.72	-50.77	70.27	

Note 1: Limit Calculation = $43 + 10\log_{10}(P[\text{Watts}])$

Note 2: This device was tested under all bandwidths, modulations and RB configurations and the worst case data are reported in the table above.

Note 3: The frequency spectrum is examined from 9 kHz to the 10th harmonic of the fundamental frequency of the transmitter. No other spurious and harmonic emissions were reported greater than listed emissions above table.

7.6.2 LTE Band 5

B.W (MHz)	Test Freq. (MHz)	RB Size/ Offset	Test Mode	Freq.(MHz)	EUT Axis	Ant Pol (H/V)	Level(dBm) @ Ant Terminal	TX Ant Gain(dBd)	Result		Limit (dBc)
									(dBm)	(dBc)	
10	829	1/0	QPSK	1649.30	X	H	-47.19	3.77	-43.42	65.90	35.48
				2473.71	X	H	-47.30	4.05	-43.25	65.73	
		1/0	16QAM	1649.20	X	H	-47.44	3.77	-43.67	65.70	35.03
				2473.65	X	H	-47.59	4.05	-43.54	65.57	
	836.5	1/25	QPSK	1673.16	X	H	-47.14	3.78	-43.36	65.91	35.55
				2509.72	X	H	-50.02	4.04	-45.98	68.53	
		1/25	16QAM	1673.22	X	H	-47.52	3.78	-43.74	65.74	35.00
				2509.47	X	H	-50.52	4.04	-46.48	68.48	
	844	1/49	QPSK	1696.87	X	H	-47.64	3.79	-43.85	66.23	35.38
				2545.33	X	H	-51.70	4.06	-47.64	70.02	
		1/49	16QAM	1696.95	X	H	-47.76	3.79	-43.97	65.36	34.39
				2545.47	X	H	-51.72	4.06	-47.66	69.05	
5	826.5	1/0	QPSK	1648.80	X	H	-47.74	3.77	-43.97	66.56	35.59
				2473.14	X	H	-48.04	4.05	-43.99	66.58	
		1/0	16QAM	1648.73	X	H	-47.90	3.77	-44.13	66.00	34.87
				2473.07	X	H	-48.30	4.05	-44.25	66.12	
	836.5	1/0	QPSK	1668.57	X	H	-49.02	3.78	-45.24	67.84	35.60
				2503.09	X	H	-50.07	4.04	-46.03	68.63	
		1/0	16QAM	1668.77	X	H	-49.20	3.78	-45.42	67.26	34.84
				2502.94	X	H	-50.41	4.04	-46.37	68.21	
	846.5	1/0	QPSK	1688.59	X	H	-49.98	3.79	-46.19	69.21	36.02
				2533.10	X	H	-50.82	4.05	-46.77	69.79	
		1/0	16QAM	1688.48	X	H	-50.34	3.79	-46.55	68.74	35.19
				2533.12	X	H	-51.05	4.05	-47.00	69.19	

B.W (MHz)	Test Freq. (MHz)	RB Size/ Offset	Test Mode	Freq.(MHz)	EUT Axis	Ant Pol (H/V)	Level(dBm) @ Ant Terminal	TX Ant Gain(dBd)	Result		Limit (dBc)
									(dBm)	(dBc)	
3	825.5	1/0	QPSK	1648.62	X	H	-48.88	3.77	-45.11	67.19	35.08
				2472.56	X	H	-48.34	4.05	-44.29	66.37	
		1/0	16QAM	1648.56	X	H	-49.10	3.77	-45.33	66.87	34.54
				2472.67	X	H	-48.35	4.05	-44.30	65.84	
	836.5	1/0	QPSK	1670.52	X	H	-50.22	3.78	-46.44	68.95	35.51
				2505.60	X	H	-50.96	4.04	-46.92	69.43	
		1/0	16QAM	1670.49	X	H	-51.18	3.78	-47.40	69.49	35.09
				2505.53	X	H	-51.53	4.04	-47.49	69.58	
	847.5	1/0	QPSK	1692.49	X	H	-49.69	3.79	-45.90	68.65	35.75
				2538.91	X	H	-51.39	4.06	-47.33	70.08	
		1/0	16QAM	1692.57	X	H	-49.93	3.79	-46.14	68.64	35.50
				2538.69	X	H	-51.89	4.06	-47.83	70.33	
1.4	824.7	1/2	QPSK	1649.32	X	H	-49.89	3.77	-46.12	68.14	35.02
				2473.67	X	H	-48.15	4.05	-44.10	66.12	
		1/2	16QAM	1649.35	X	H	-50.09	3.77	-46.32	67.73	34.41
				2473.78	X	H	-48.41	4.05	-44.36	65.77	
	836.5	1/2	QPSK	1672.89	X	H	-51.08	3.78	-47.30	70.00	35.70
				2509.25	X	H	-50.28	4.04	-46.24	68.94	
		1/2	16QAM	1672.81	X	H	-51.35	3.78	-47.57	69.81	35.24
				2509.29	X	H	-50.64	4.04	-46.60	68.84	
	848.3	1/2	QPSK	1696.54	X	H	-50.67	3.79	-46.88	69.43	35.55
				2544.70	X	H	-52.04	4.06	-47.98	70.53	
		1/2	16QAM	1696.64	X	H	-50.73	3.79	-46.94	68.38	34.44
				2544.63	X	H	-52.22	4.06	-48.16	69.60	

Note 1: Limit Calculation = $43 + 10\log_{10}(P[\text{Watts}])$

Note 2: This device was tested under all bandwidths, modulations and RB configurations and the worst case data are reported in the table above.

Note 3: The frequency spectrum is examined from 9 kHz to the 10th harmonic of the fundamental frequency of the transmitter. No other spurious and harmonic emissions were reported greater than listed emissions above table.

7.6.3 LTE Band 2

B.W (MHz)	Test Freq. (MHz)	RB Size/Offset	Test Mode	Freq.(MHz)	EUT Axis	Ant Pol (H/V)	Level(dBm) @ Ant Terminal	TX Ant Gain(dBi)	Result		Limit (dBc)
									(dBm)	(dBc)	
20	1860	1/0	QPSK	3702.17	X	H	-50.77	8.49	-42.28	67.40	38.12
				-	-	-	-	-	-	-	
	1880	1/0	16QAM	3701.84	X	H	-51.08	8.49	-42.59	67.12	37.53
				-	-	-	-	-	-	-	
	1880	1/0	QPSK	3742.12	X	H	-52.14	8.51	-43.63	68.55	37.92
				-	-	-	-	-	-	-	
	1880	1/0	16QAM	3742.20	X	H	-52.21	8.51	-43.70	67.98	37.28
				-	-	-	-	-	-	-	
	1900	1/0	QPSK	3782.24	X	H	-49.80	8.52	-41.28	66.83	38.55
				-	-	-	-	-	-	-	
	1900	1/0	16QAM	3782.35	X	H	-50.11	8.52	-41.59	66.26	37.67
				-	-	-	-	-	-	-	
15	1857.5	1/74	QPSK	3728.18	X	H	-50.75	8.50	-42.25	67.06	37.81
				-	-	-	-	-	-	-	
	1880	1/74	16QAM	3728.41	X	H	-50.93	8.50	-42.43	66.71	37.28
				-	-	-	-	-	-	-	
	1880	1/74	QPSK	3773.35	X	H	-50.86	8.52	-42.34	66.39	37.05
				-	-	-	-	-	-	-	
	1880	1/74	16QAM	3773.21	X	H	-50.95	8.52	-42.43	65.42	35.99
				-	-	-	-	-	-	-	
	1902.5	1/74	QPSK	3818.20	X	H	-52.41	8.55	-43.86	67.98	37.12
				-	-	-	-	-	-	-	
	1902.5	1/74	16QAM	3818.22	X	H	-52.72	8.55	-44.17	67.51	36.34
				-	-	-	-	-	-	-	

B.W (MHz)	Test Freq. (MHz)	RB Size/ Offset	Test Mode	Freq.(MHz)	EUT Axis	Ant Pol (H/V)	Level(dBm) @ Ant Terminal	TX Ant Gain(dBi)	Result		Limit (dBc)
									(dBm)	(dBc)	
10	1855	1/49	QPSK	3718.97	X	H	-50.61	8.50	-42.11	67.61	38.50
				-	-	-	-	-	-	-	
		1/49	16QAM	3718.87	X	H	-51.07	8.50	-42.57	67.02	37.45
				-	-	-	-	-	-	-	
	1880	1/24	QPSK	3760.30	X	H	-51.20	8.51	-42.69	67.97	38.28
				-	-	-	-	-	-	-	
		1/24	16QAM	3760.08	X	H	-51.71	8.51	-43.20	67.68	37.48
				-	-	-	-	-	-	-	
	1905	1/49	QPSK	3880.99	X	H	-50.37	8.63	-41.74	66.69	37.95
				-	-	-	-	-	-	-	
		1/49	16QAM	3801.18	X	H	-50.93	8.53	-42.40	66.32	36.92
				-	-	-	-	-	-	-	
5	1852.5	1/24	QPSK	3709.13	X	H	-50.39	8.49	-41.90	67.10	38.20
				-	-	-	-	-	-	-	
		1/24	16QAM	3709.34	X	H	-50.44	8.49	-41.95	66.89	37.94
				-	-	-	-	-	-	-	
	1880	1/24	QPSK	3764.47	X	H	-51.01	8.52	-42.49	67.86	38.37
				-	-	-	-	-	-	-	
		1/24	16QAM	3764.51	X	H	-51.14	8.52	-42.62	67.34	37.72
				-	-	-	-	-	-	-	
	1907.5	1/24	QPSK	3819.11	X	H	-51.87	8.55	-43.32	68.01	37.69
				-	-	-	-	-	-	-	
		1/24	16QAM	3819.15	X	H	-52.40	8.55	-43.85	67.95	37.10
				-	-	-	-	-	-	-	

B.W (MHz)	Test Freq. (MHz)	RB Size/Offset	Test Mode	Freq.(MHz)	EUT Axis	Ant Pol (H/V)	Level(dBm) @ Ant Terminal	TX Ant Gain(dBi)	Result		Limit (dBc)
									(dBm)	(dBc)	
3	1851.5	1/14	QPSK	3705.38	X	H	-50.39	8.49	-41.90	67.09	38.19
				-	-	-	-	-	-	-	
		1/14	16QAM	3705.47	X	H	-50.93	8.49	-42.44	67.06	37.62
				-	-	-	-	-	-	-	
	1880	1/14	QPSK	3762.49	X	H	-50.60	8.51	-42.09	67.16	38.07
				-	-	-	-	-	-	-	
		1/14	16QAM	3762.54	X	H	-51.12	8.52	-42.60	67.13	37.53
				-	-	-	-	-	-	-	
	1908.5	1/14	QPSK	3819.53	X	H	-52.22	8.55	-43.67	68.89	38.22
				-	-	-	-	-	-	-	
		1/14	16QAM	3819.41	X	H	-52.42	8.55	-43.87	68.37	37.50
				-	-	-	-	-	-	-	
1.4	1850.7	1/2	QPSK	3701.25	X	H	-50.89	8.49	-42.40	67.84	38.44
				-	-	-	-	-	-	-	
		1/2	16QAM	3701.12	X	H	-51.30	8.49	-42.81	67.41	37.60
				-	-	-	-	-	-	-	
	1880	1/2	QPSK	3759.87	X	H	-51.05	8.51	-42.54	68.17	38.63
				-	-	-	-	-	-	-	
		1/2	16QAM	3759.64	X	H	-51.34	8.51	-42.83	68.18	38.35
				-	-	-	-	-	-	-	
	1909.3	1/2	QPSK	3818.42	X	H	-51.71	8.55	-43.16	68.27	38.11
				-	-	-	-	-	-	-	
		1/2	16QAM	3818.80	X	H	-51.84	8.55	-43.29	67.59	37.30
				-	-	-	-	-	-	-	

Note 1: Limit Calculation = $43 + 10\log_{10}(P[\text{Watts}])$

Note 2: This device was tested under all bandwidths, modulations and RB configurations and the worst case data are reported in the table above.

Note 3: The frequency spectrum is examined from 9 kHz to the 10th harmonic of the fundamental frequency of the transmitter. No other spurious and harmonic emissions were reported greater than listed emissions above table.

7.6.4 LTE Band 7

B.W (MHz)	Test Freq. (MHz)	RB Size/Offset	Test Mode	Freq.(MHz)	EUT Axis	Ant Pol (H/V)	Level(dBm) @ Ant Terminal	TX Ant Gain(dBi)	Result		Limit (dBc)
									(dBm)	(dBc)	
20	2510	1/99	QPSK	5037.87	Y	H	-42.38	10.17	-32.21	50.60	43.39
				7556.59	Y	V	-38.52	12.35	-26.17	44.56	
		1/99	16QAM	5037.90	Y	H	-42.52	10.17	-32.35	50.06	42.71
				7556.62	Y	V	-38.67	12.35	-26.32	44.03	
	2535	1/99	QPSK	5087.78	Y	H	-44.32	10.26	-34.06	52.49	43.43
				7631.60	Y	V	-42.74	12.46	-30.28	48.71	
		1/99	16QAM	5087.71	Y	H	-44.42	10.26	-34.16	52.42	43.26
				7631.63	Y	V	-42.81	12.46	-30.35	48.61	
	2560	1/99	QPSK	5137.81	Y	H	-46.03	10.34	-35.69	54.28	43.59
				7706.84	Y	V	-43.15	12.47	-30.68	49.27	
		1/99	16QAM	5137.79	Y	H	-46.88	10.34	-36.54	55.01	43.47
				7706.96	Y	V	-43.47	12.47	-31.00	49.47	
15	2507.5	1/74	QPSK	5028.30	Y	H	-42.17	10.16	-32.01	50.45	43.44
				7542.39	Y	V	-41.63	12.35	-29.28	47.72	
		1/74	16QAM	5028.26	Y	H	-42.46	10.16	-32.30	50.50	43.20
				7542.72	Y	V	-41.90	12.35	-29.55	47.75	
	2535	1/74	QPSK	5083.40	Y	H	-45.54	10.25	-35.29	54.38	44.09
				7624.98	Y	V	-43.31	12.46	-30.85	49.94	
		1/74	16QAM	5083.55	Y	H	-45.98	10.25	-35.73	54.43	43.70
				7624.88	Y	V	-43.45	12.46	-30.99	49.69	
	2562.5	1/74	QPSK	5138.28	Y	H	-46.46	10.35	-36.11	54.60	43.49
				7707.53	Y	V	-43.71	12.47	-31.24	49.73	
		1/74	16QAM	5138.27	Y	H	-46.55	10.35	-36.20	54.45	43.25
				7707.54	Y	V	-43.99	12.47	-31.52	49.77	

B.W (MHz)	Test Freq. (MHz)	RB Size/Offset	Test Mode	Freq.(MHz)	EUT Axis	Ant Pol (H/V)	Level(dBm) @ Ant Terminal	TX Ant Gain(dBi)	Result		Limit (dBc)	
									(dBm)	(dBc)		
10	2505	1/25	QPSK	5010.31	Y	H	-45.22	10.13	-35.09	54.31	44.22	
				7515.22	Y	V	-42.27	12.35	-29.92	49.14		
		1/25	16QAM	5010.27	Y	H	-45.58	10.13	-35.45	54.11		43.66
				7515.47	Y	V	-42.68	12.35	-30.33	48.99		
	2535	1/25	QPSK	5070.14	Y	H	-47.71	10.23	-37.48	57.49	45.01	
				7605.42	Y	V	-43.07	12.46	-30.61	50.62		
		1/25	16QAM	5070.23	Y	H	-48.20	10.23	-37.97	57.35	44.38	
				7605.18	Y	V	-43.87	12.46	-31.41	50.79		
	2565	1/25	QPSK	5130.35	Y	H	-46.26	10.33	-35.93	55.02	44.09	
				7695.28	Y	V	-42.78	12.46	-30.32	49.41		
		1/25	16QAM	5130.14	Y	H	-46.39	10.33	-36.06	54.67	43.61	
				7695.49	Y	V	-42.89	12.46	-30.43	49.04		
5	2502.5	1/12	QPSK	5005.11	Y	H	-45.54	10.12	-35.42	55.30	44.88	
				7507.52	Y	V	-43.16	12.35	-30.81	50.69		
		1/12	16QAM	5004.98	Y	H	-46.36	10.12	-36.24	55.34	44.10	
				7507.66	Y	V	-43.40	12.35	-31.05	50.15		
	2535	1/12	QPSK	5069.88	Y	H	-46.46	10.23	-36.23	56.15	44.92	
				7605.11	Y	V	-43.01	12.46	-30.55	50.47		
		1/12	16QAM	5070.17	Y	H	-45.99	10.23	-35.76	55.02	44.26	
				7604.95	Y	V	-43.74	12.46	-31.28	50.54		
	2567.5	1/12	QPSK	5134.97	Y	H	-46.00	10.34	-35.66	54.54	43.88	
				7702.62	Y	V	-43.19	12.47	-30.72	49.60		
		1/12	16QAM	5134.90	Y	H	-46.14	10.34	-35.80	54.03	43.23	
				7702.52	Y	V	-43.70	12.47	-31.23	49.46		

Note 1: Limit Calculation = $55 + 10\log_{10}(P[\text{Watts}])$

Note 2: This device was tested under all bandwidths, modulations and RB configurations and the worst case data are reported in the table above.

Note 3: The frequency spectrum is examined from 9 kHz to the 10th harmonic of the fundamental frequency of the transmitter. No other spurious and harmonic emissions were reported greater than listed emissions above table.

7.7 FREQUENCY STABILITY

7.7.1 LTE Band 17

OPERATING FREQUENCY : 710 MHz
 CHANNEL : 23790
 REFERENCE VOLTAGE : 3.80 VDC
 LIMIT(FCC & IC) : The frequency stability shall be sufficient to ensure that the fundamental emission stays within the authorized frequency block.

VOLTAGE (%)	POWER (V DC)	TEMP (°C)	FREQUENCY (Hz)	FREQ.Dev (Hz)	Deviation	
					(ppm)	(%)
100%	3.80	+20(Ref)	710,000,003	3	0.0042	0.000000423
100%		-30	710,000,003	3	0.0038	0.000000380
100%		-20	710,000,001	1	0.0014	0.000000141
100%		-10	710,000,002	2	0.0028	0.000000282
100%		0	710,000,004	4	0.0056	0.000000563
100%		+10	710,000,002	2	0.0028	0.000000282
100%		+20	710,000,003	3	0.0042	0.000000423
100%		+30	709,999,998	-2	-0.0028	-0.000000282
100%		+40	710,000,002	2	0.0028	0.000000282
100%		+50	709,999,997	-3	-0.0042	-0.000000423
115%	4.37	+20	709,999,998	-2	-0.0028	-0.000000282
BATT.ENDPOINT	3.40	+20	710,000,002	2	0.0028	0.000000282

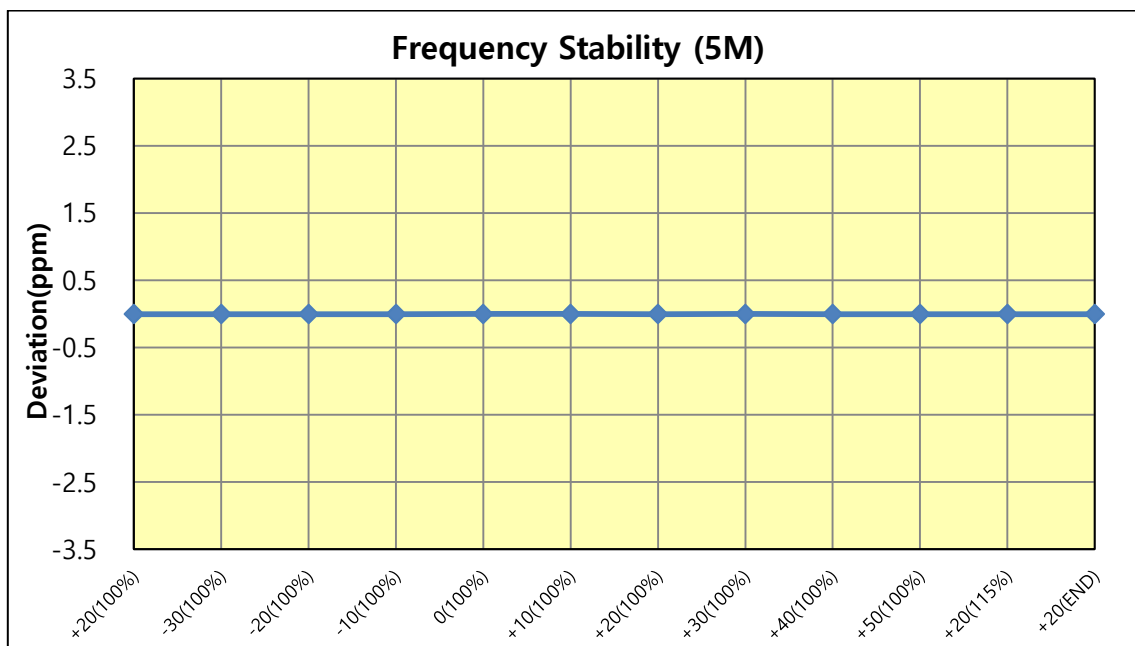

Note. Based on the results of the frequency stability test at the center channel the frequency deviation results measured are very small. as such it is determined that the channels at the band edge would remain inband when the maximum measured frequency deviation noted during the frequency stability tests is applied. therefore the device is determined to remain operating in band over the temperature and voltage range as tested.

7.7.2 LTE Band 5

OPERATING FREQUENCY : 836.5 MHz
 CHANNEL : 20525
 REFERENCE VOLTAGE : 3.80 VDC
 DEVIATION LIMIT(FCC & IC) : ± 0.00025 % or 2.5 ppm

VOLTAGE (%)	POWER (V DC)	TEMP (°C)	FREQUENCY (Hz)	FREQ.Dev (Hz)	Deviation	
					(ppm)	(%)
100%	3.80	+20(Ref)	836,500,003	3	0.0036	0.000000359
100%		-30	836,499,997	-3	-0.0036	-0.000000359
100%		-20	836,499,997	-3	-0.0036	-0.000000359
100%		-10	836,499,998	-2	-0.0024	-0.000000239
100%		0	836,499,997	-3	-0.0036	-0.000000359
100%		+10	836,500,003	3	0.0036	0.000000359
100%		+20	836,500,003	3	0.0036	0.000000359
100%		+30	836,499,997	-3	-0.0036	-0.000000359
100%		+40	836,499,996	-4	-0.0048	-0.000000478
100%		+50	836,499,995	-5	-0.0060	-0.000000598
115%	4.37	+20	836,500,002	2	0.0024	0.000000239
BATT.ENDPOINT	3.40	+20	836,499,997	-3	-0.0036	-0.000000359

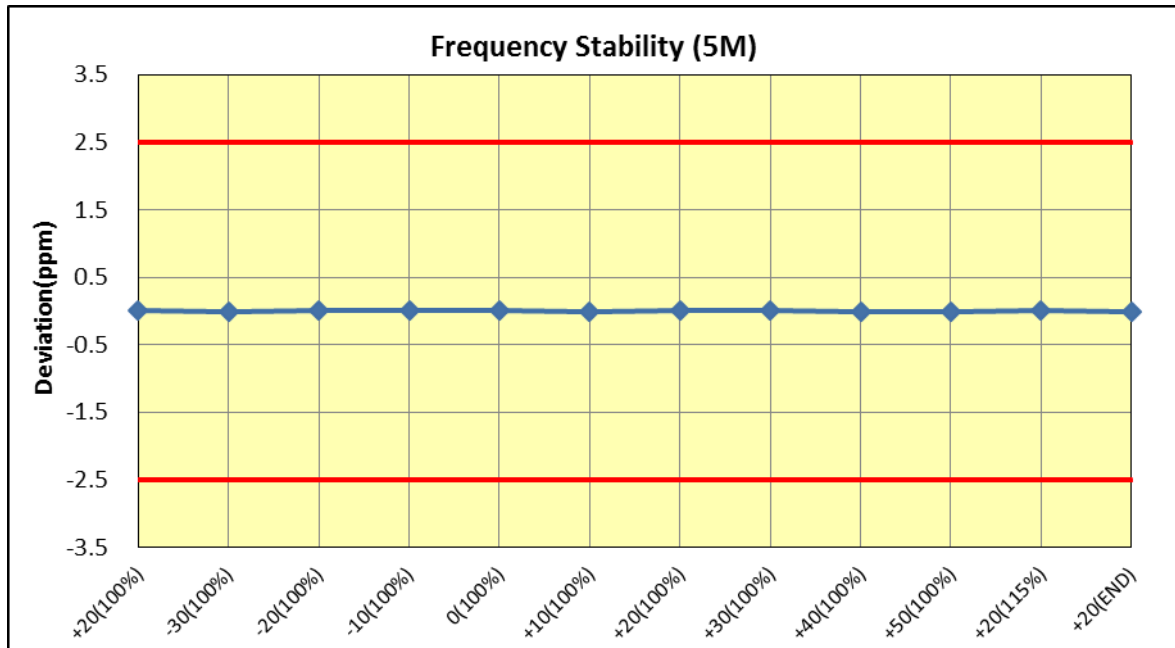

7.7.3 LTE Band 2

OPERATING FREQUENCY : 1880 MHz
 CHANNEL : 18900
 REFERENCE VOLTAGE : 3.80 VDC
 LIMIT(FCC) : The frequency stability shall be sufficient to ensure that the fundamental emission stays within the authorized frequency block.
 DEVIATION LIMIT(IC) : ± 0.00025 % or 2.5 ppm

VOLTAGE (%)	POWER (V DC)	TEMP (°C)	FREQUENCY (Hz)	FREQ.Dev (Hz)	Deviation	
					(ppm)	(%)
100%	3.80	+20(Ref)	1,879,999,993	-7	-0.0037	-0.000000372
100%		-30	1,879,999,990	-10	-0.0053	-0.000000532
100%		-20	1,879,999,997	-3	-0.0016	-0.000000160
100%		-10	1,879,999,989	-11	-0.0059	-0.000000585
100%		0	1,879,999,989	-11	-0.0059	-0.000000585
100%		+10	1,880,000,006	6	0.0032	0.000000319
100%		+20	1,879,999,993	-7	-0.0037	-0.000000372
100%		+30	1,879,999,989	-11	-0.0059	-0.000000585
100%		+40	1,879,999,994	-6	-0.0032	-0.000000319
100%		+50	1,880,000,005	5	0.0027	0.000000266
115%	4.37	+20	1,880,000,006	6	0.0032	0.000000319
BATT.ENDPOINT	3.40	+20	1,880,000,005	5	0.0027	0.000000266

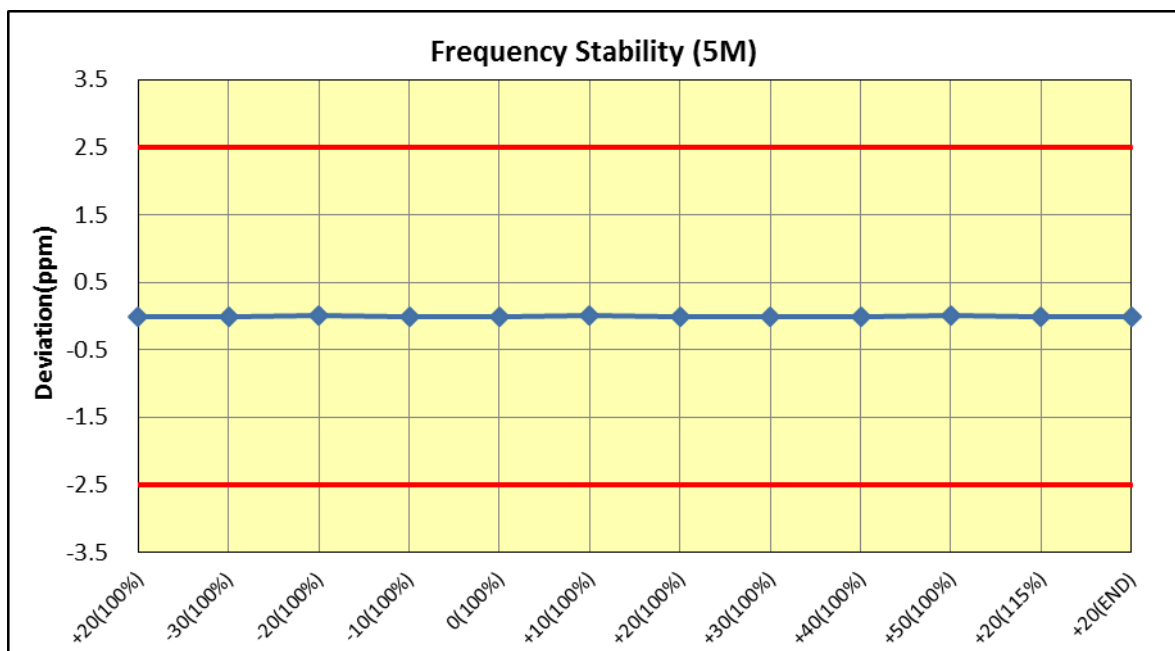

Note. Based on the results of the frequency stability test at the center channel the frequency deviation results measured are very small. as such it is determined that the channels at the band edge would remain inband when the maximum measured frequency deviation noted during the frequency stability tests is applied. therefore the device is determined to remain operating in band over the temperature and voltage range as tested.

7.7.4 LTE Band 7

OPERATING FREQUENCY : 2535 MHz
 CHANNEL : 21100
 REFERENCE VOLTAGE : 3.80 VDC
 LIMIT(FCC & IC) : The frequency stability shall be sufficient to ensure that the fundamental emission stays within the authorized frequency block.

VOLTAGE (%)	POWER (V DC)	TEMP (°C)	FREQUENCY (Hz)	FREQ.Dev (Hz)	Deviation	
					(ppm)	(%)
100%	3.80	+20(Ref)	2,534,999,994	-6	-0.0024	-0.000000237
100%		-30	2,535,000,011	11	0.0043	0.000000434
100%		-20	2,535,000,012	12	0.0047	0.000000473
100%		-10	2,535,000,007	7	0.0028	0.000000276
100%		0	2,534,999,995	-5	-0.0020	-0.000000197
100%		+10	2,534,999,993	-7	-0.0028	-0.000000276
100%		+20	2,534,999,994	-6	-0.0024	-0.000000237
100%		+30	2,534,999,991	-9	-0.0036	-0.000000355
100%		+40	2,534,999,996	-4	-0.0016	-0.000000158
100%		+50	2,534,999,990	-10	-0.0039	-0.000000394
115%	4.37	+20	2,535,000,010	10	0.0039	0.000000394
BATT.ENDPOINT	3.40	+20	2,534,999,992	-8	-0.0032	-0.000000316

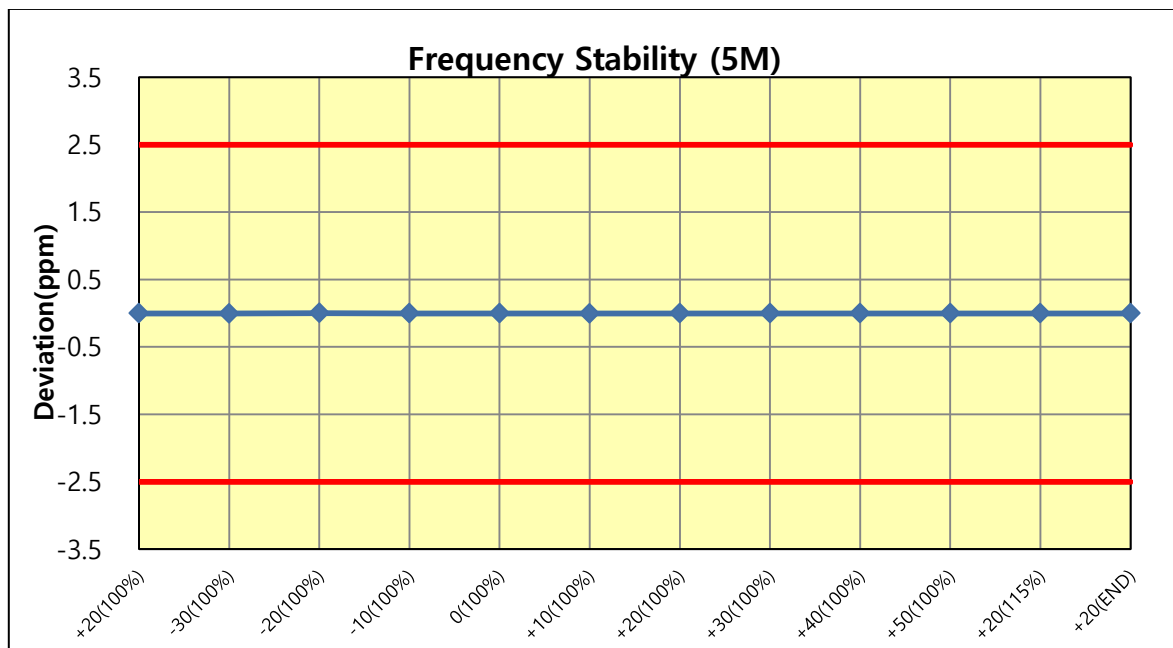

Note. Based on the results of the frequency stability test at the center channel the frequency deviation results measured are very small. as such it is determined that the channels at the band edge would remain inband when the maximum measured frequency deviation noted during the frequency stability tests is applied. therefore the device is determined to remain operating in band over the temperature and voltage range as tested.

8. TEST PLOTS

Note: All bandwidths, RB configurations, and modulations were investigated. The worst case test results are reported below.

8.1 OCCUPIED BANDWIDTH

8.1.1 LTE Band 17

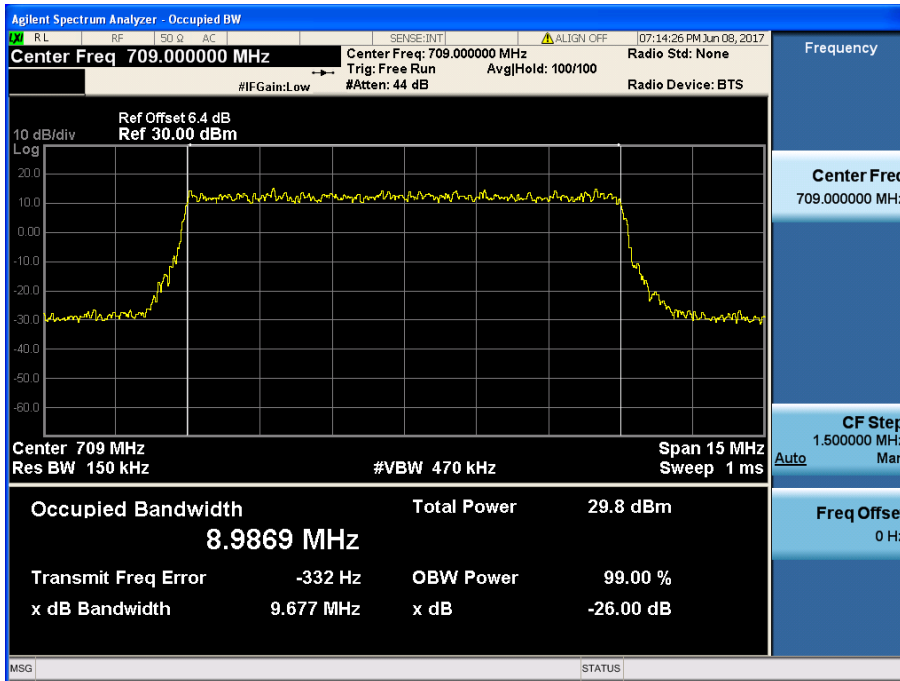

LTE Band 17 / 10 MHz / QPSK - RB Size 50

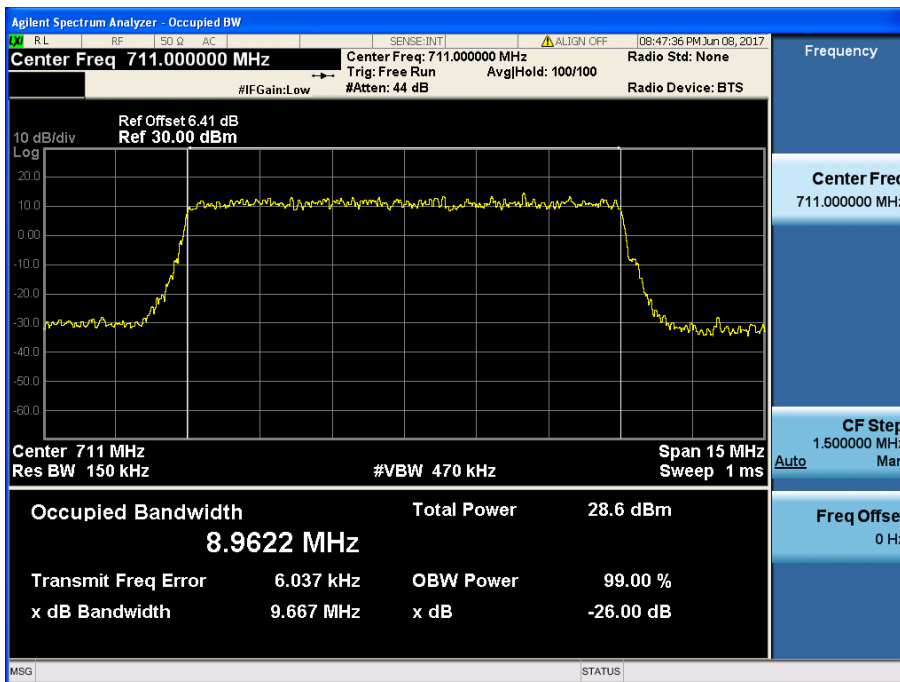

LTE Band 17 / 10 MHz / 16QAM - RB Size 50

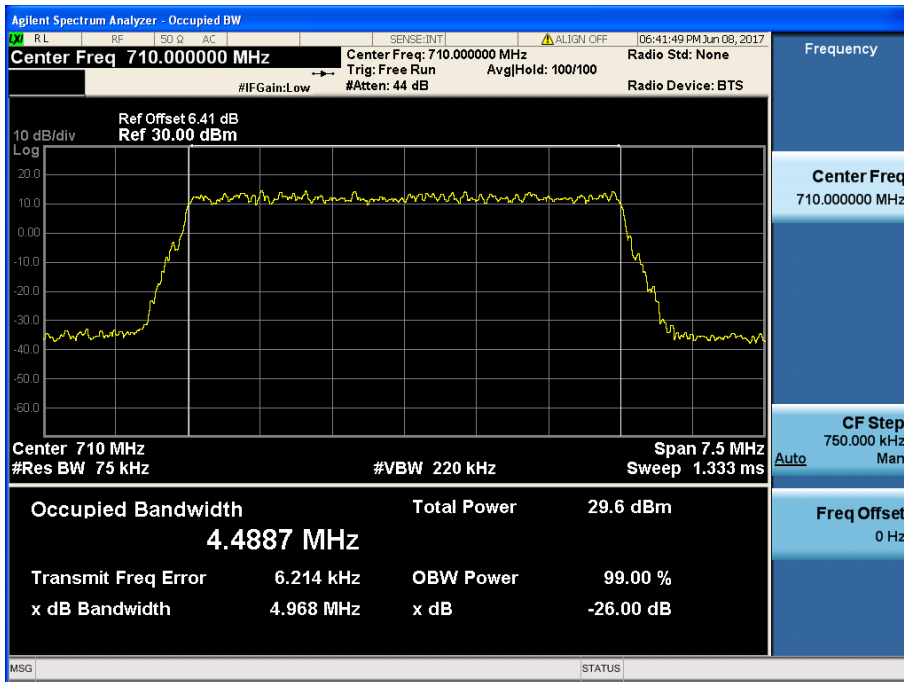

LTE Band 17 / 5 MHz / QPSK - RB Size 25

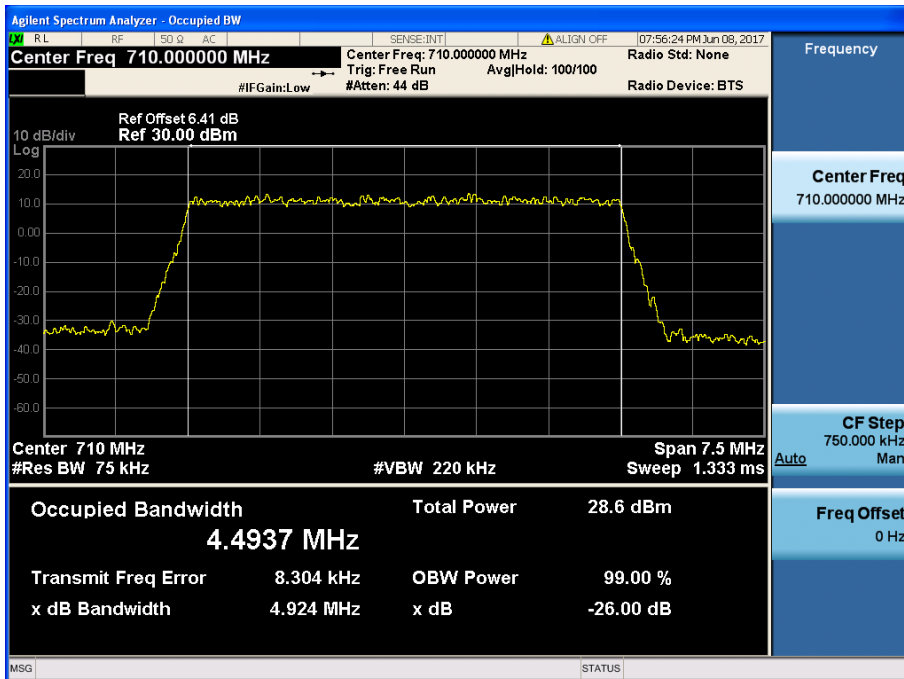

LTE Band 17 / 5 MHz / 16QAM - RB Size 25

8.1.2 LTE Band 5

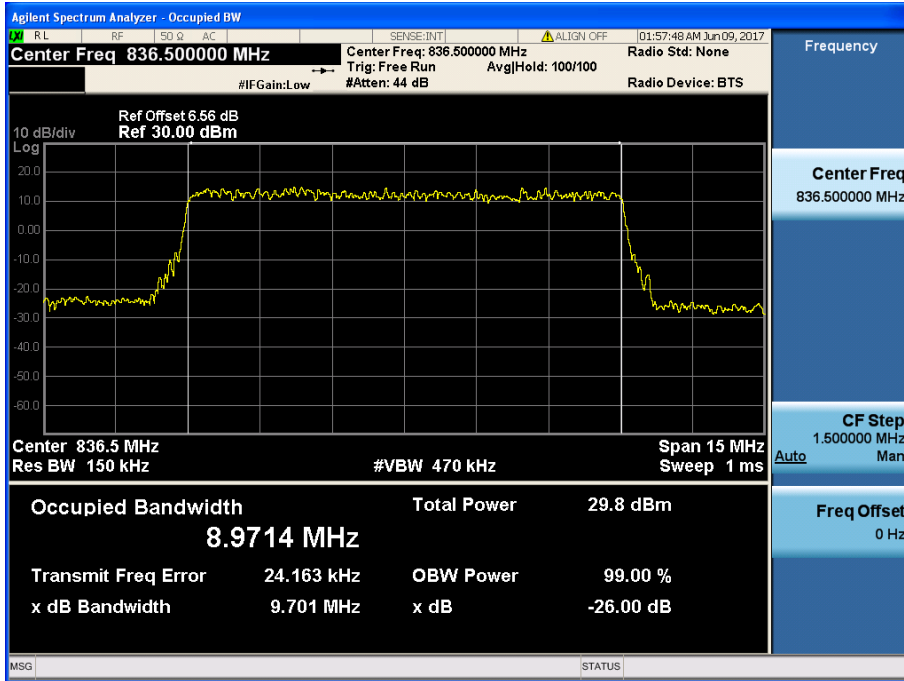

LTE Band 5 / 10 MHz / QPSK - RB Size 25

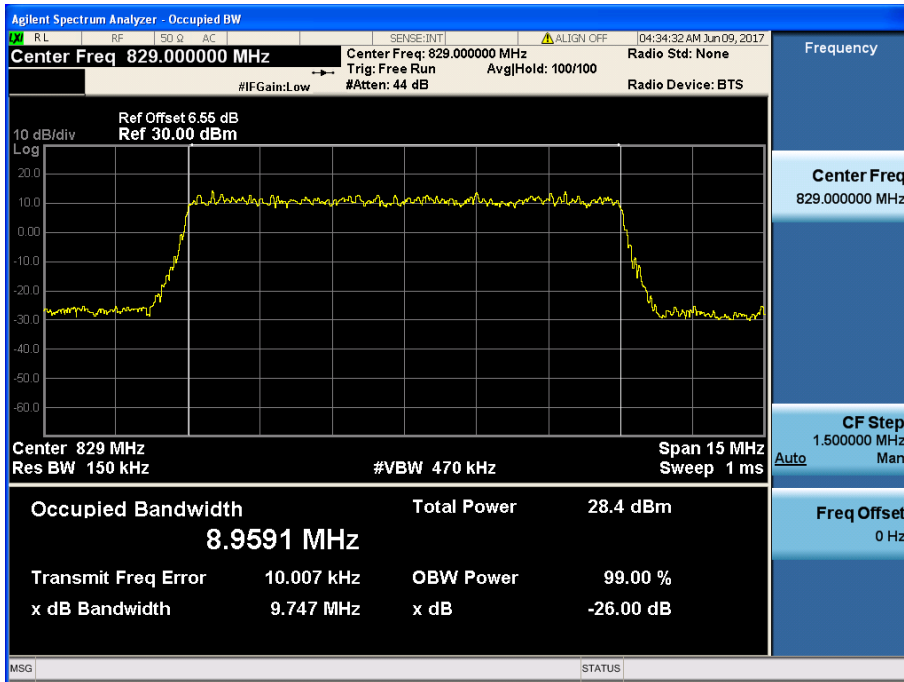

LTE Band 5 / 10 MHz / 16QAM - RB Size 1

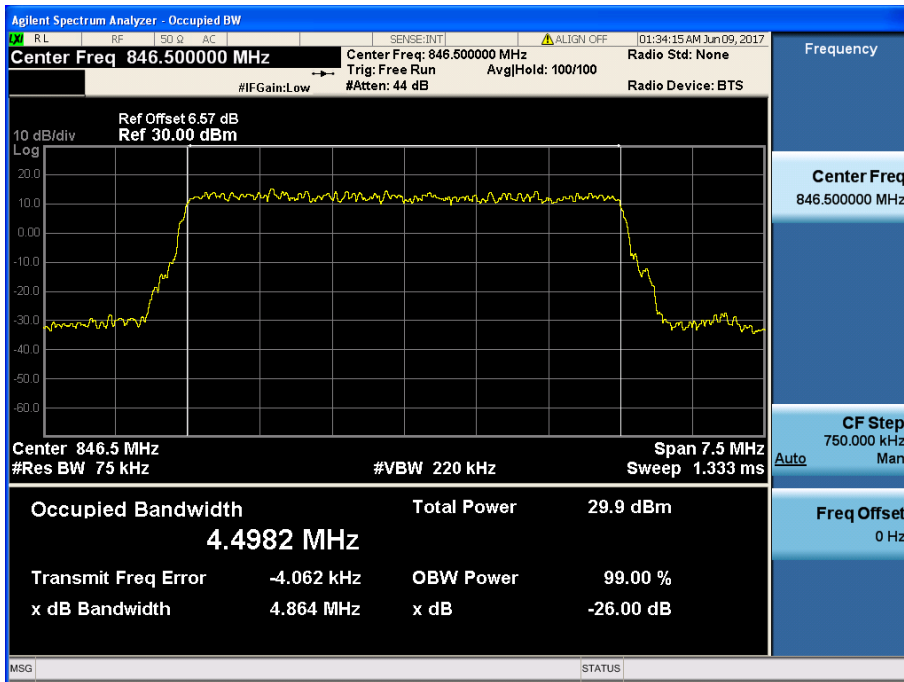

LTE Band 5 / 5 MHz / QPSK - RB Size 25

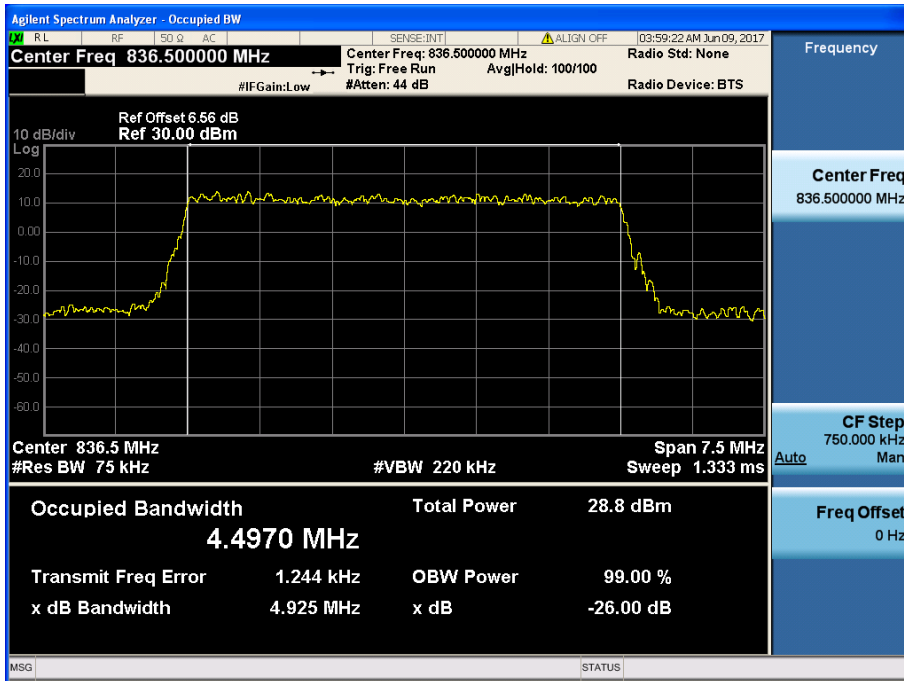

LTE Band 5 / 5 MHz / 16QAM - RB Size 12

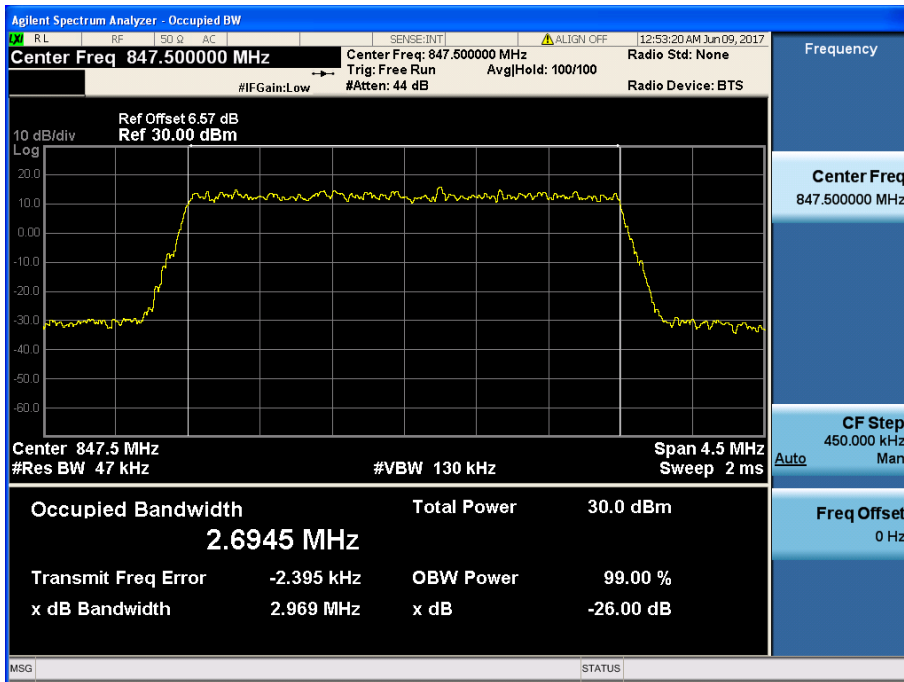

LTE Band 5 / 3 MHz / QPSK - RB Size 15

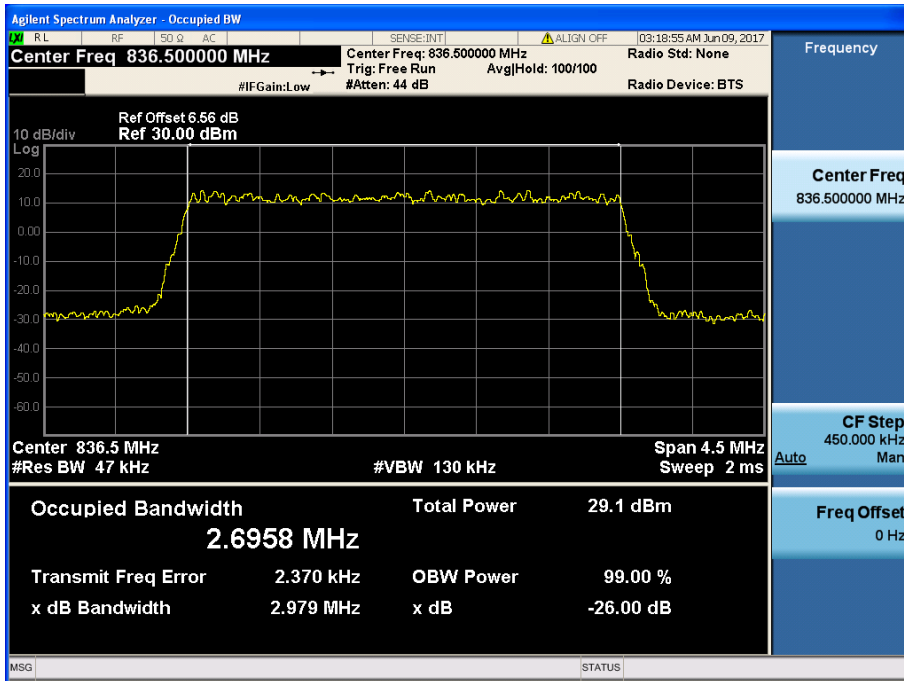

LTE Band 5 / 3 MHz / 16QAM - RB Size 8

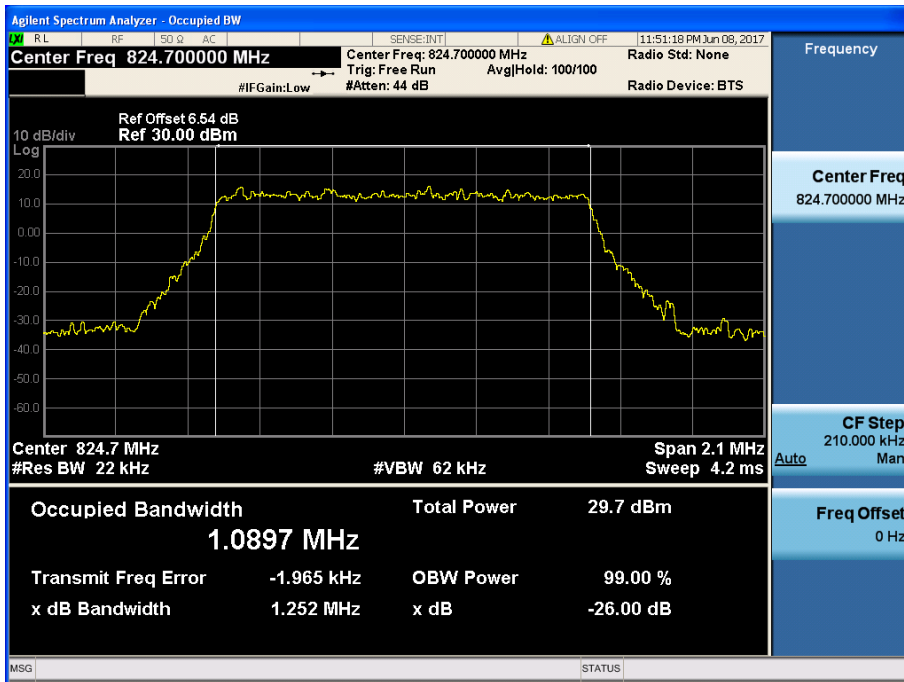

LTE Band 5 / 1.4 MHz / QPSK - RB Size 1

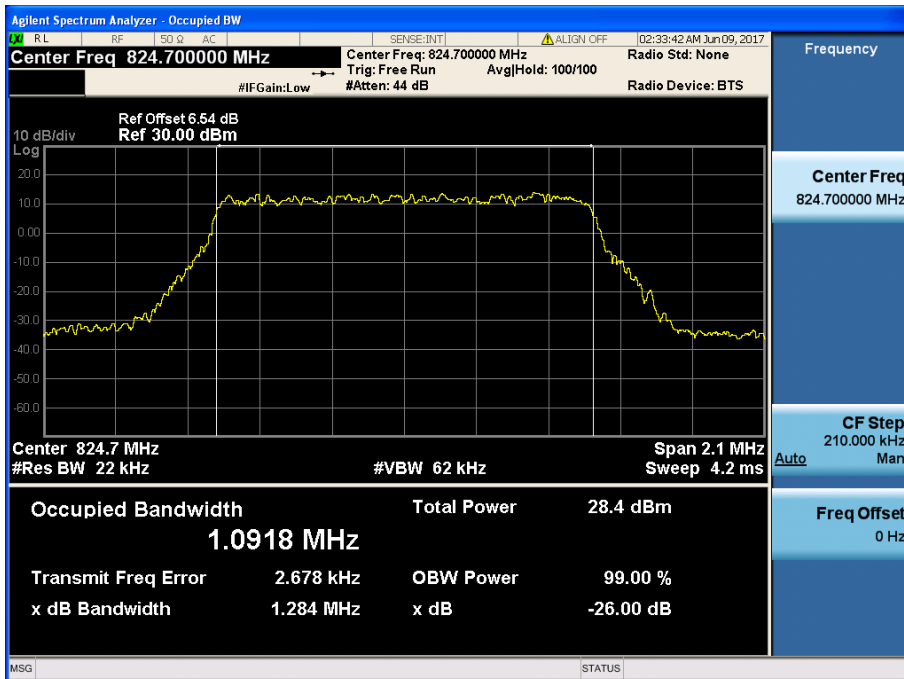

LTE Band 5 / 1.4 MHz / 16QAM - RB Size 1

8.1.3 LTE Band 2

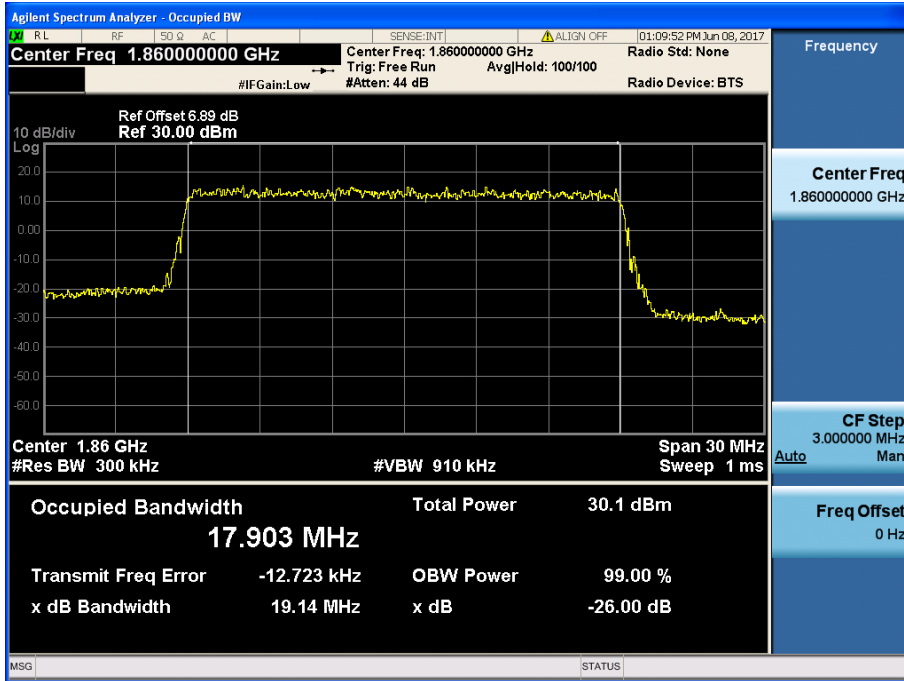

LTE Band 2 / 20 MHz / QPSK - RB Size 1

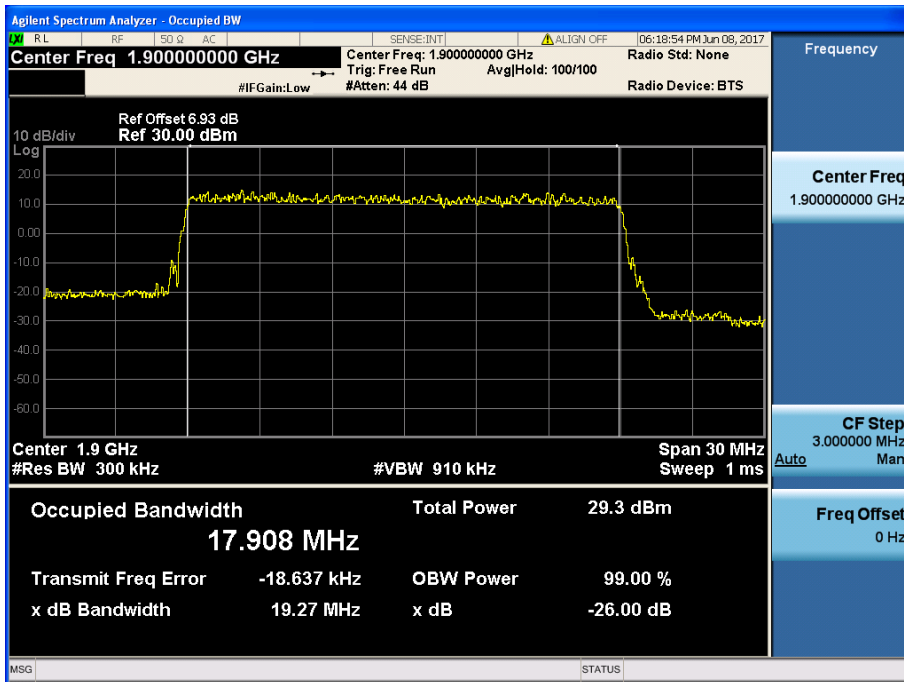

LTE Band 2 / 20 MHz / 16QAM - RB Size 100

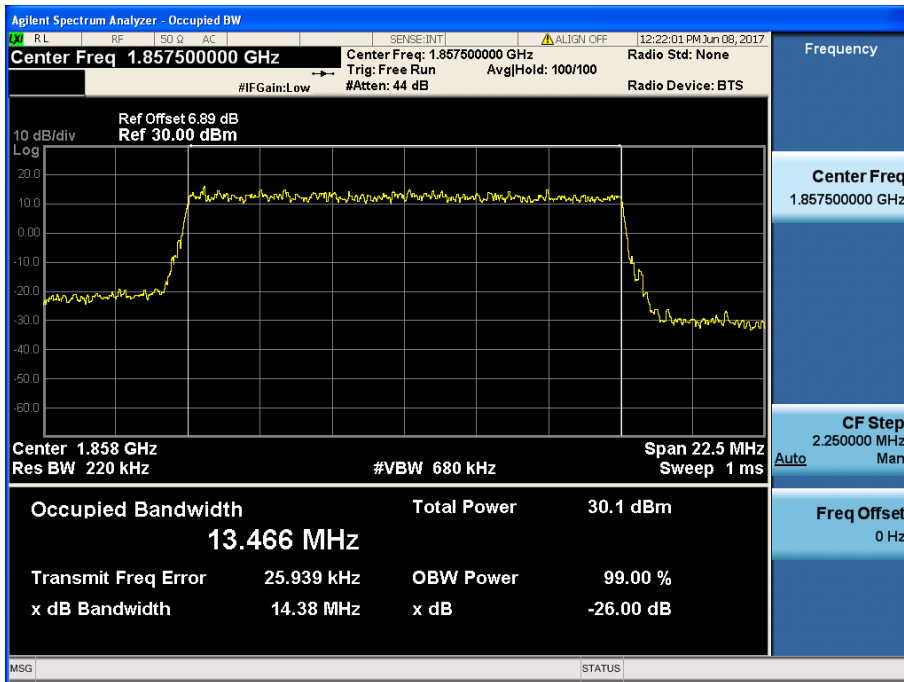

LTE Band 2 / 15 MHz / QPSK - RB Size 1

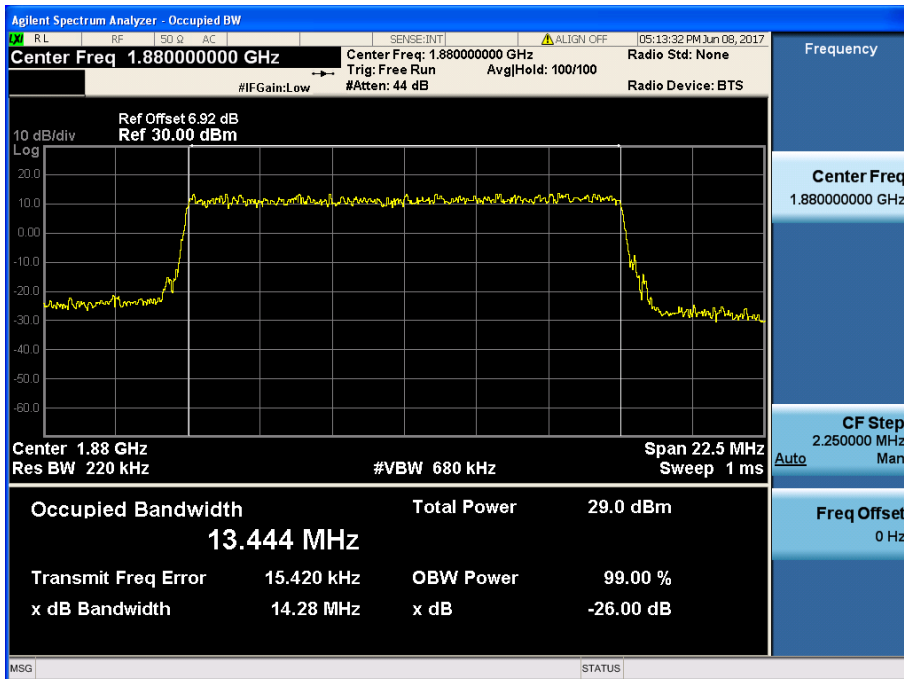

LTE Band 2 / 15 MHz / 16QAM - RB Size 36

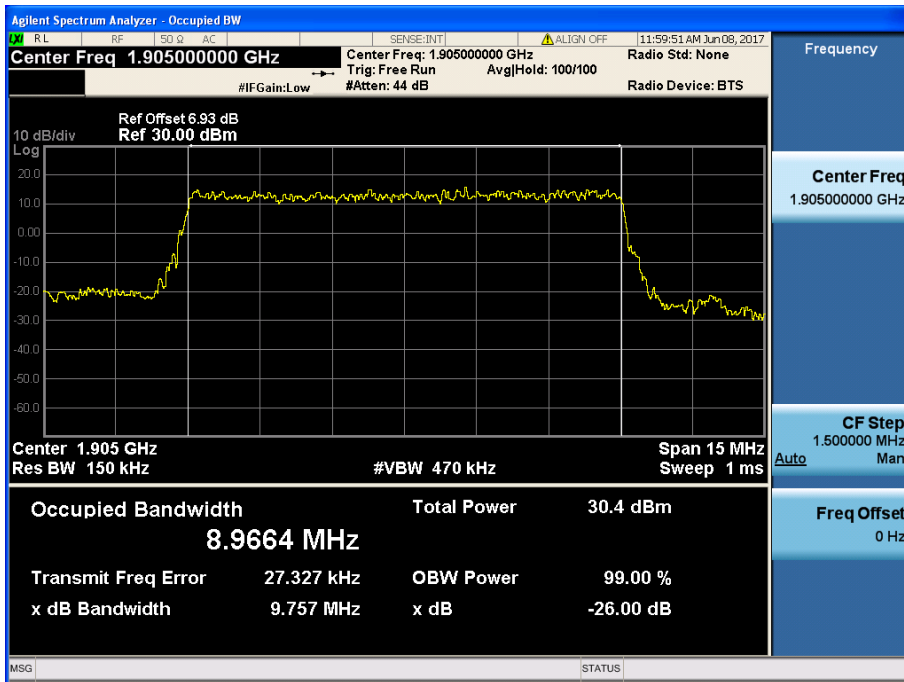

LTE Band 2 / 10 MHz / QPSK - RB Size 50

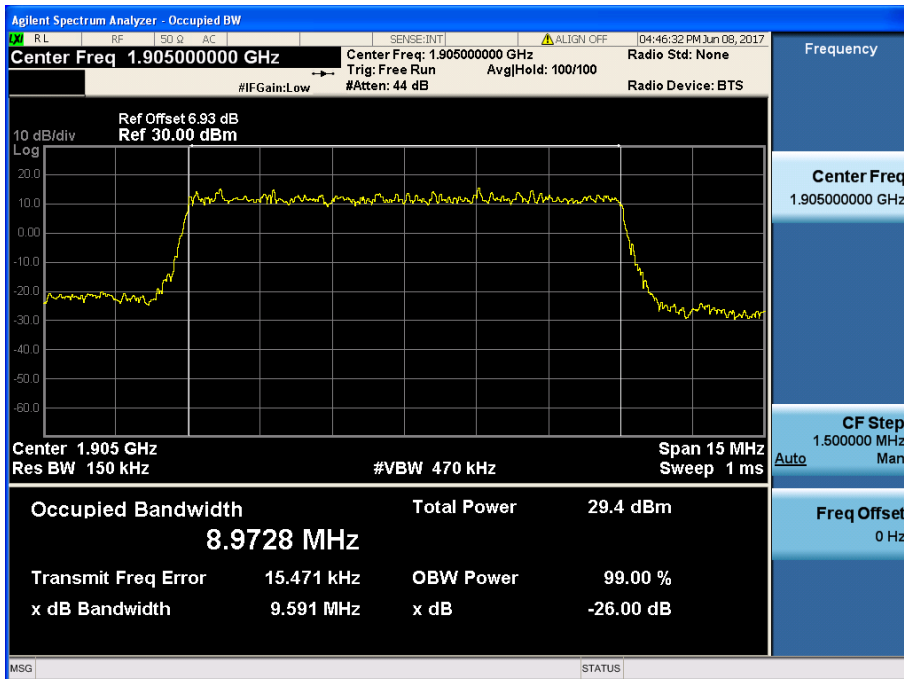

LTE Band 2 / 10 MHz / 16QAM - RB Size 50

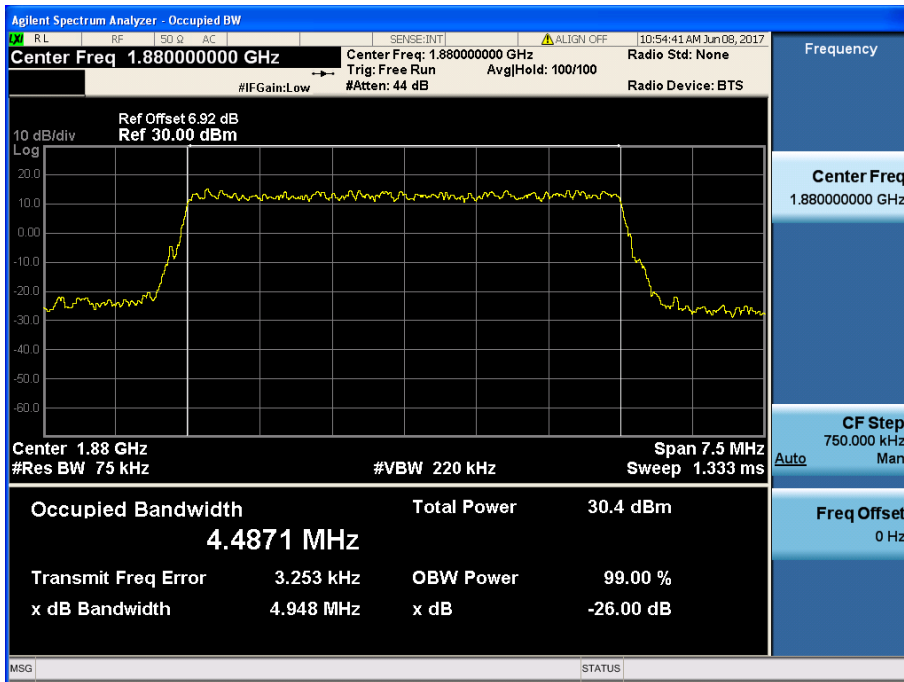

LTE Band 2 / 5 MHz / QPSK - RB Size 12

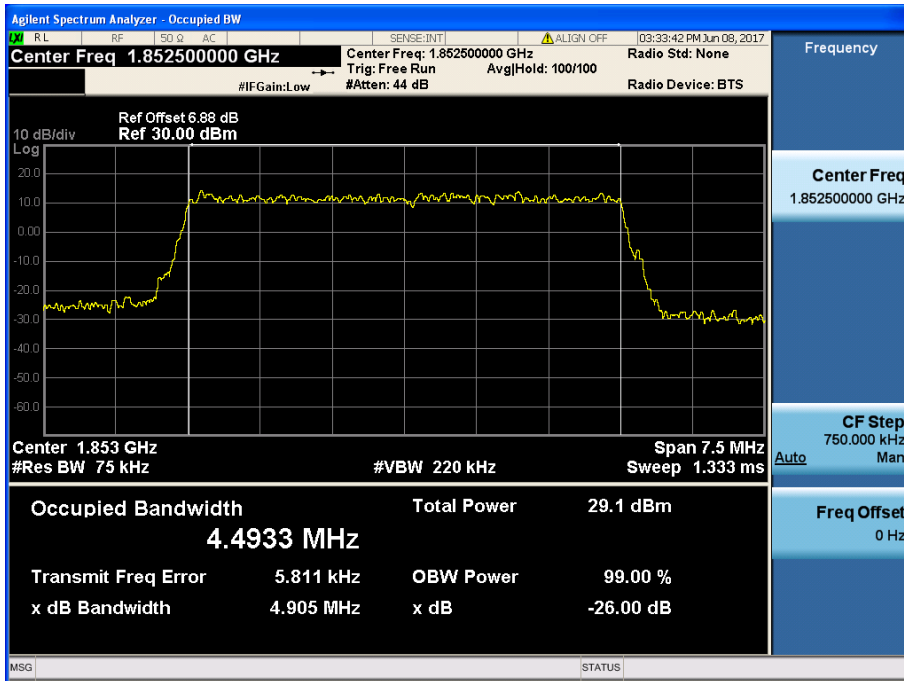

LTE Band 2 / 5 MHz / 16QAM - RB Size 1

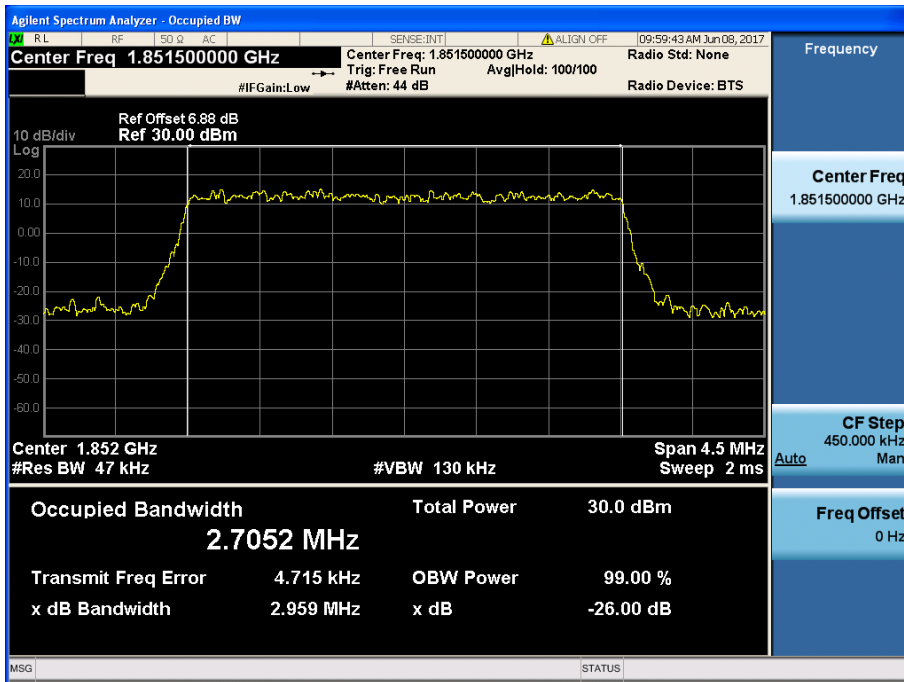

LTE Band 2 / 3 MHz / QPSK - RB Size 1

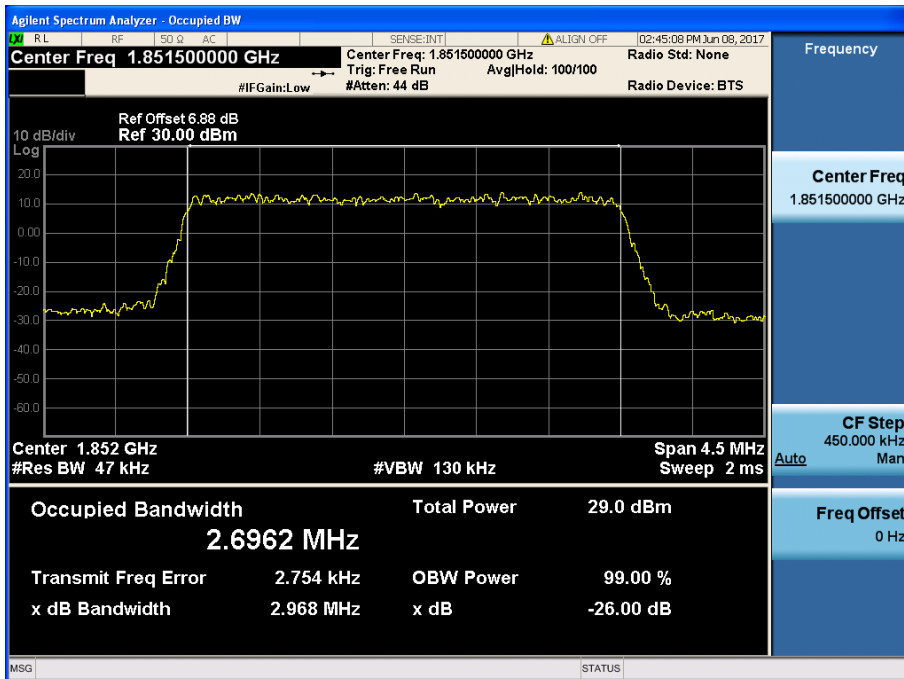

LTE Band 2 / 3 MHz / 16QAM - RB Size 1

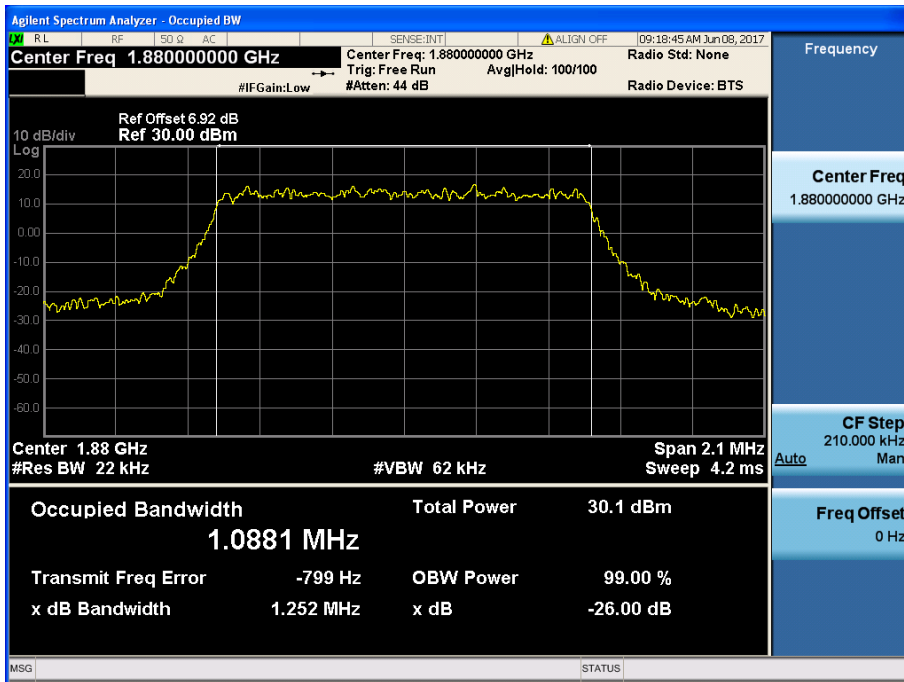

LTE Band 2 / 1.4 MHz / QPSK - RB Size 3

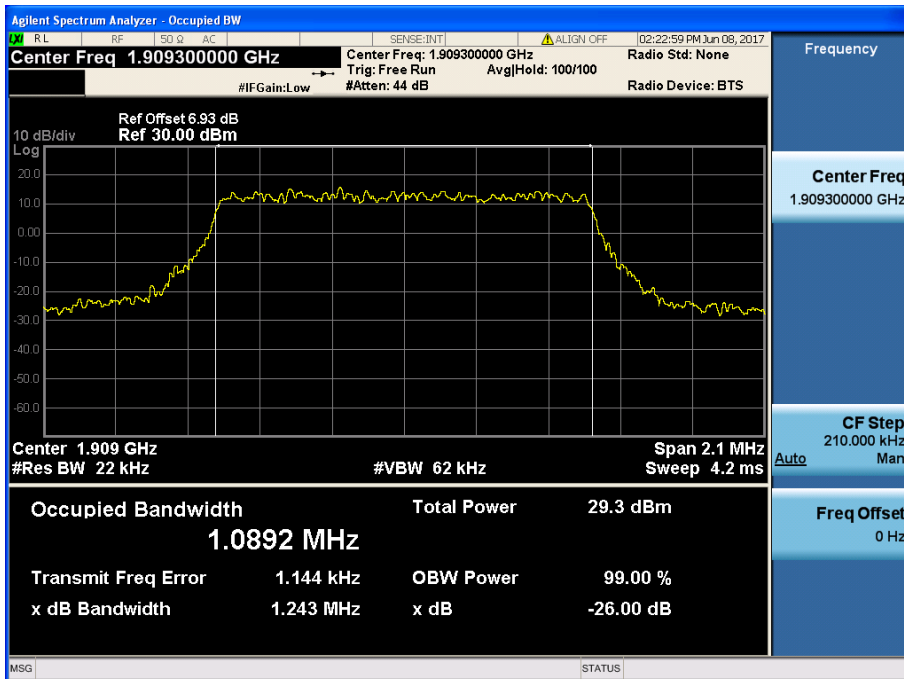

LTE Band 2 / 1.4 MHz / 16QAM - RB Size 6

8.1.4 LTE Band 7

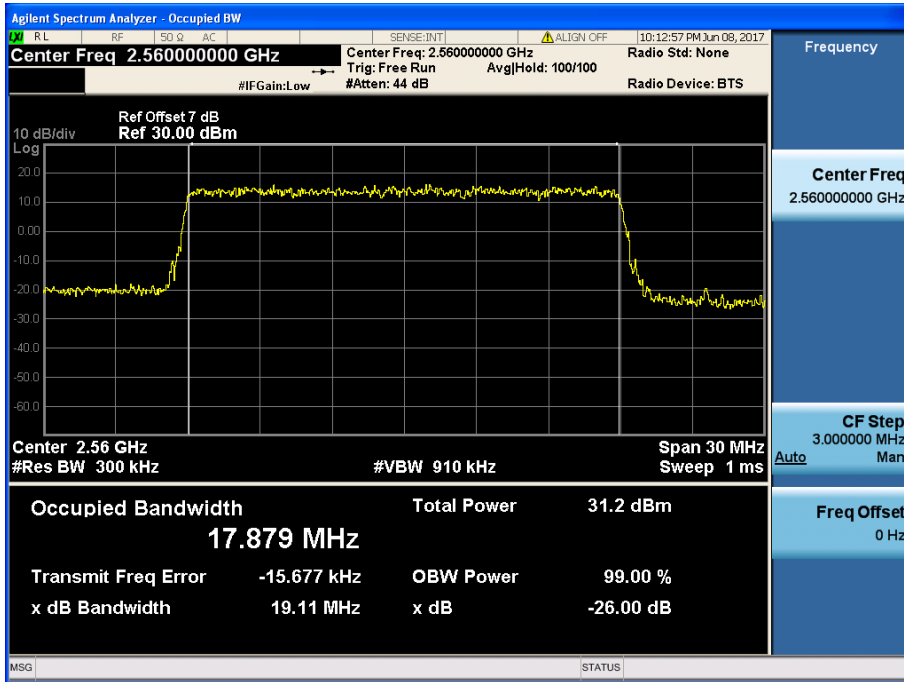

LTE Band 7 / 20 MHz / QPSK - RB Size 100

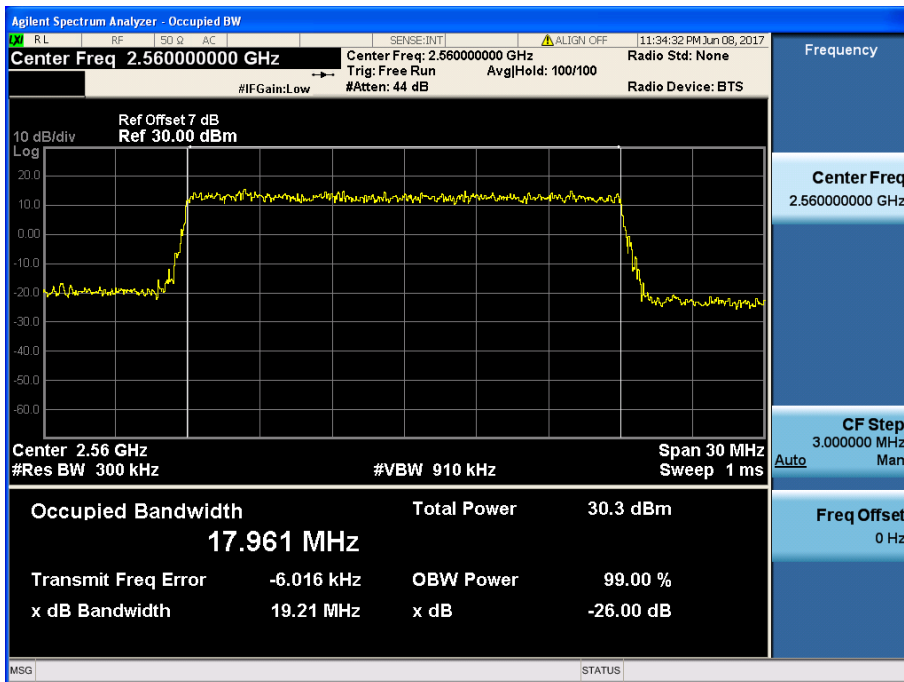

LTE Band 7 / 20 MHz / 16QAM - RB Size 100

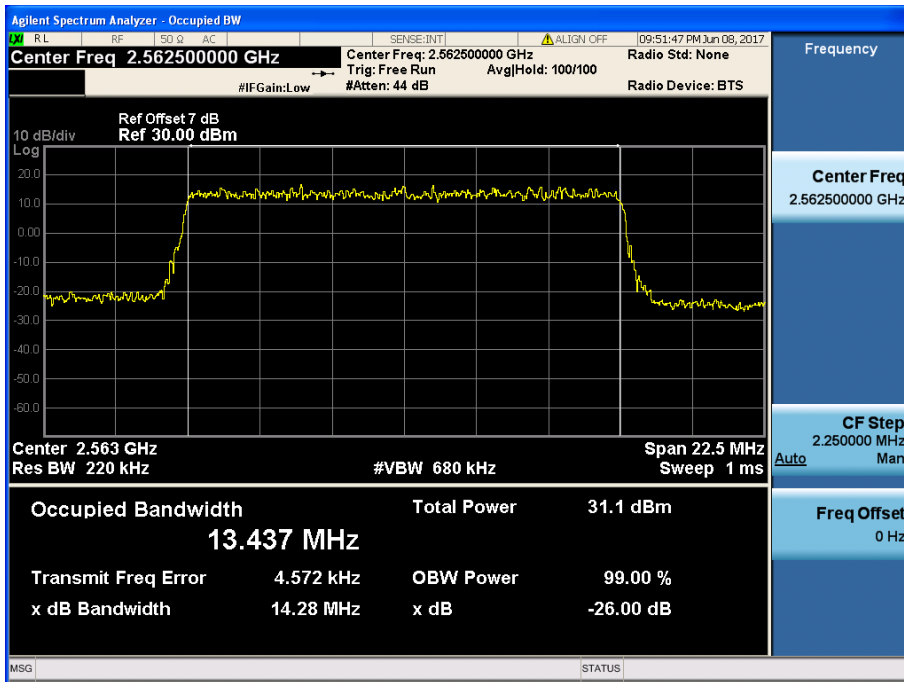

LTE Band 7 / 15 MHz / QPSK - RB Size 75

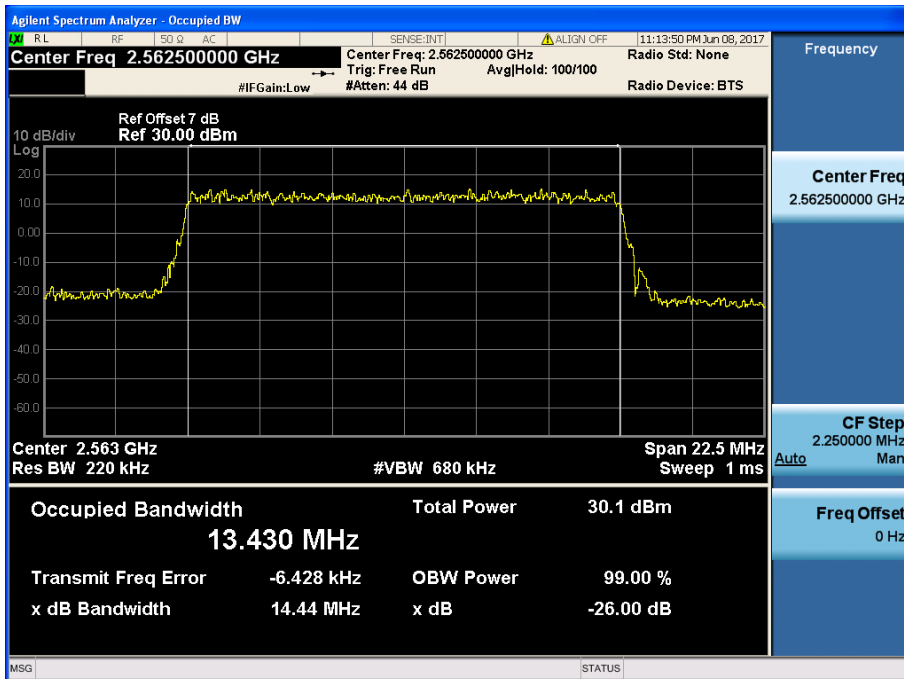

LTE Band 7 / 15 MHz / 16QAM - RB Size 75

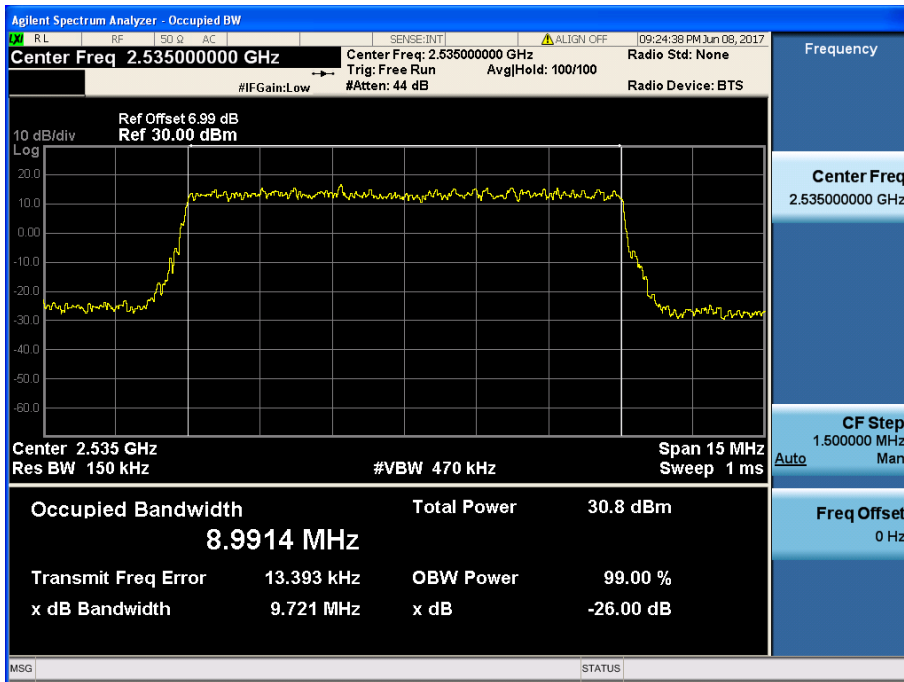

LTE Band 7 / 10 MHz / QPSK - RB Size 25

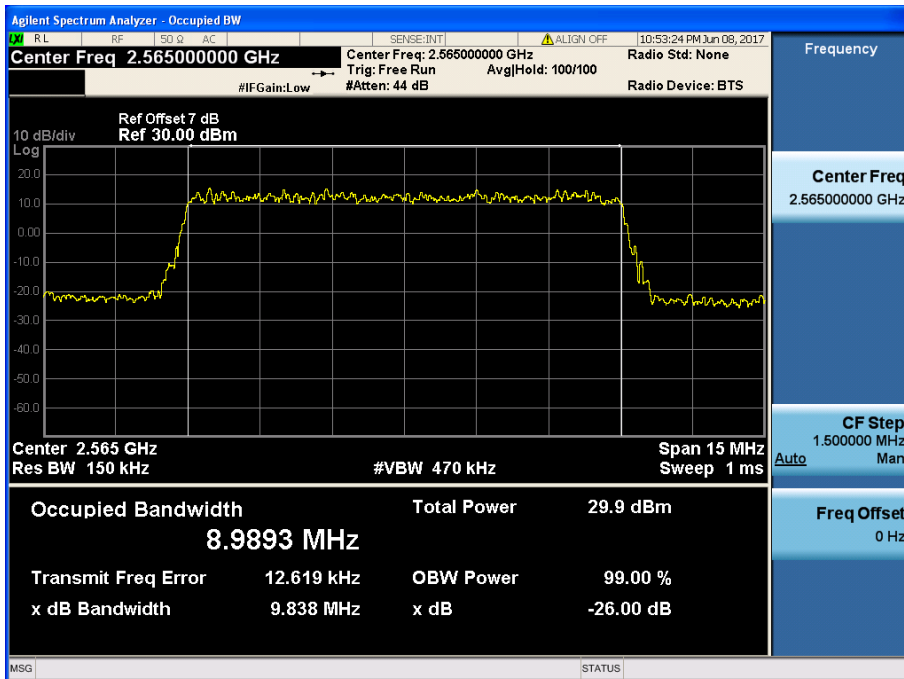

LTE Band 7 / 10 MHz / 16QAM - RB Size 50

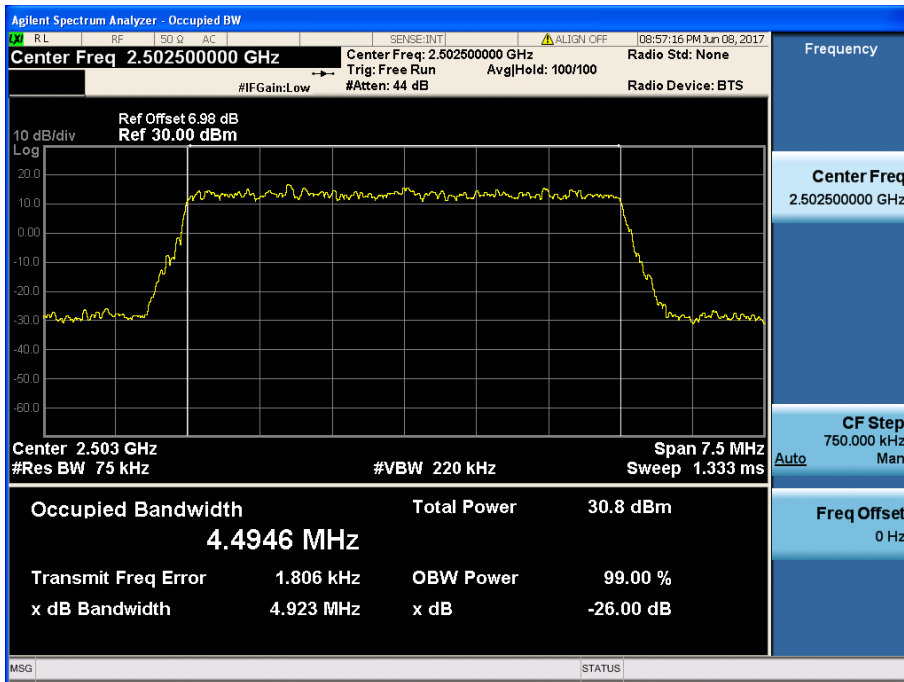

LTE Band 7 / 5 MHz / QPSK - RB Size 1

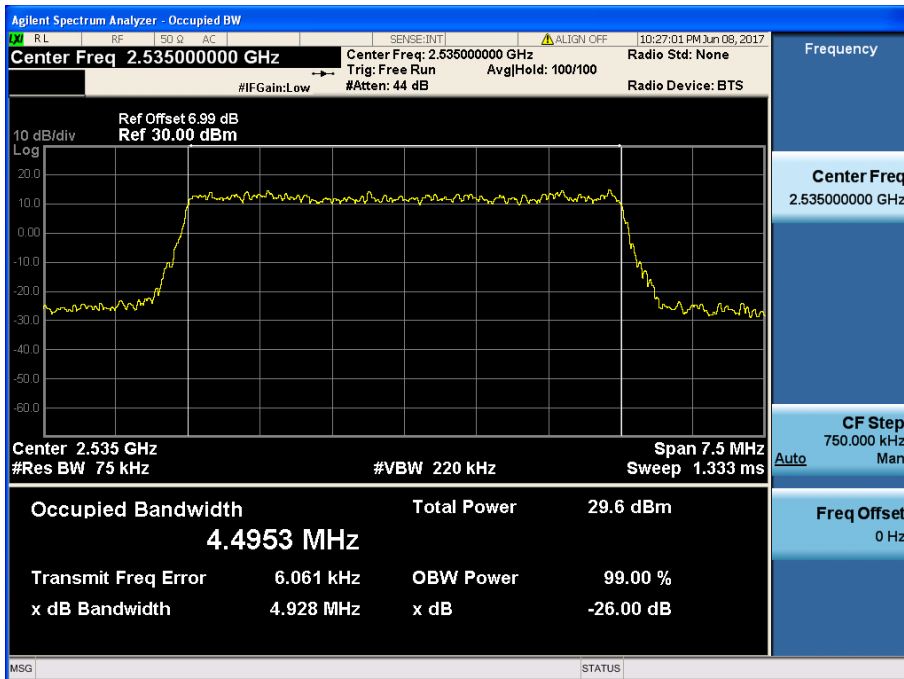

LTE Band 7 / 5 MHz / 16QAM - RB Size 12

8.2 PEAK TO AVERAGE RATIO

8.2.1 LTE Band 17

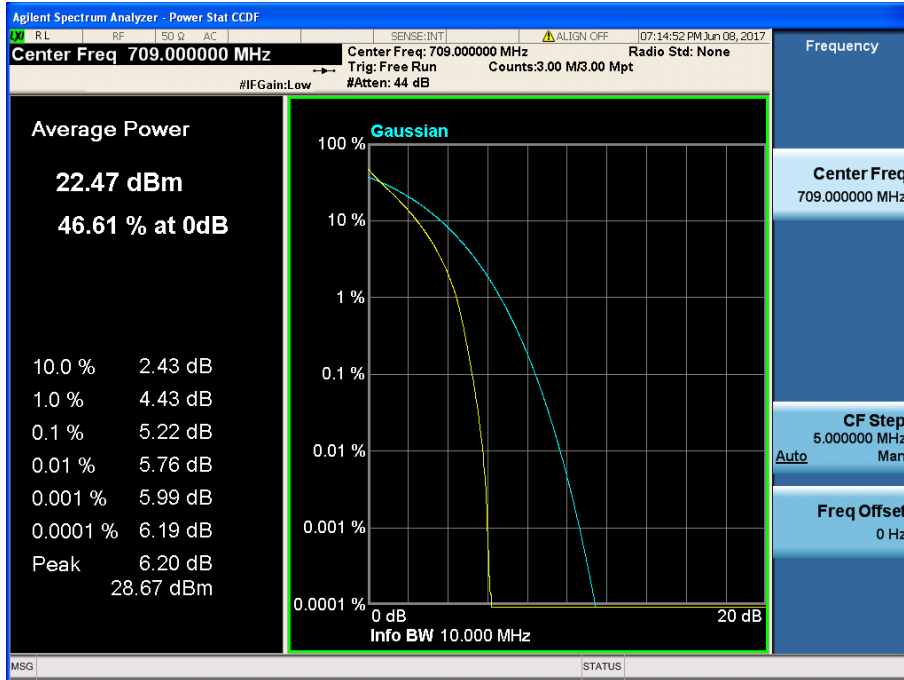

LTE Band 17 / 10 MHz / QPSK - RB Size 50

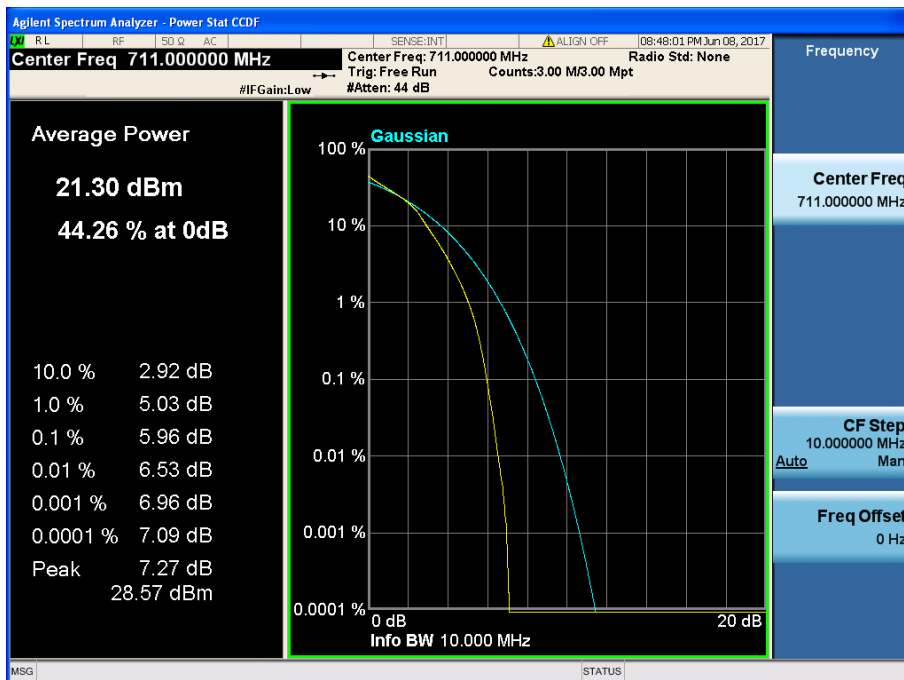

LTE Band 17 / 10 MHz / 16QAM - RB Size 50

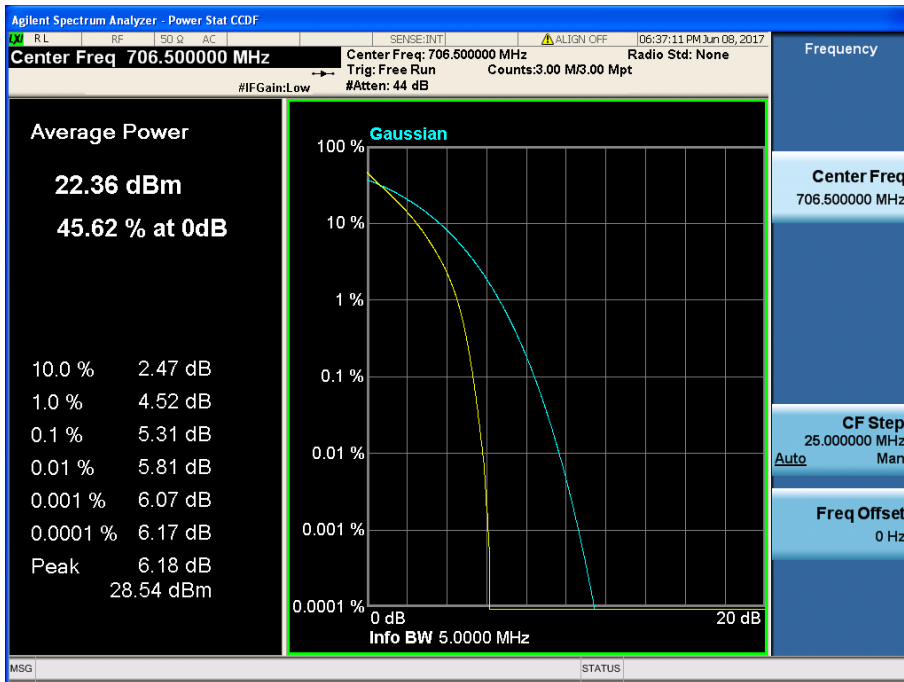

LTE Band 17 / 5 MHz / QPSK - RB Size 25



LTE Band 17 / 5 MHz / 16QAM - RB Size 25

8.2.2 LTE Band 5

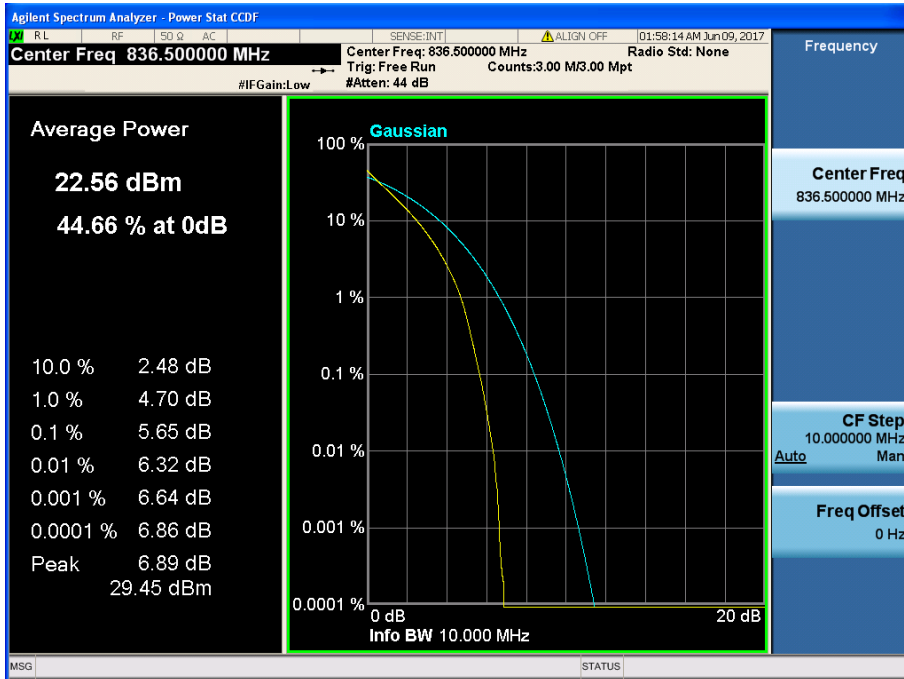

LTE Band 5 / 10 MHz / QPSK - RB Size 50

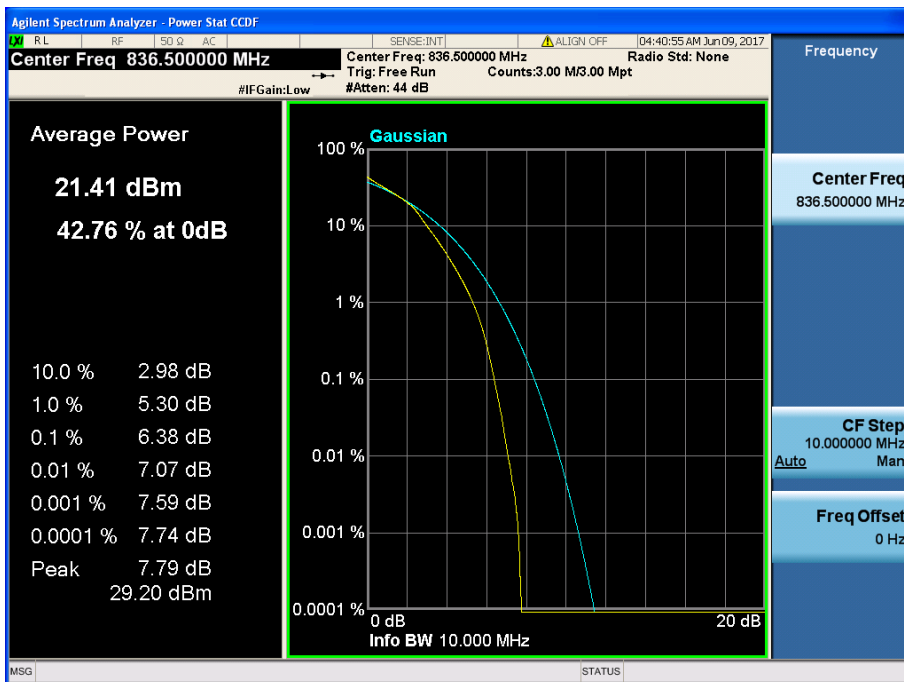

LTE Band 5 / 10 MHz / 16QAM - RB Size 50

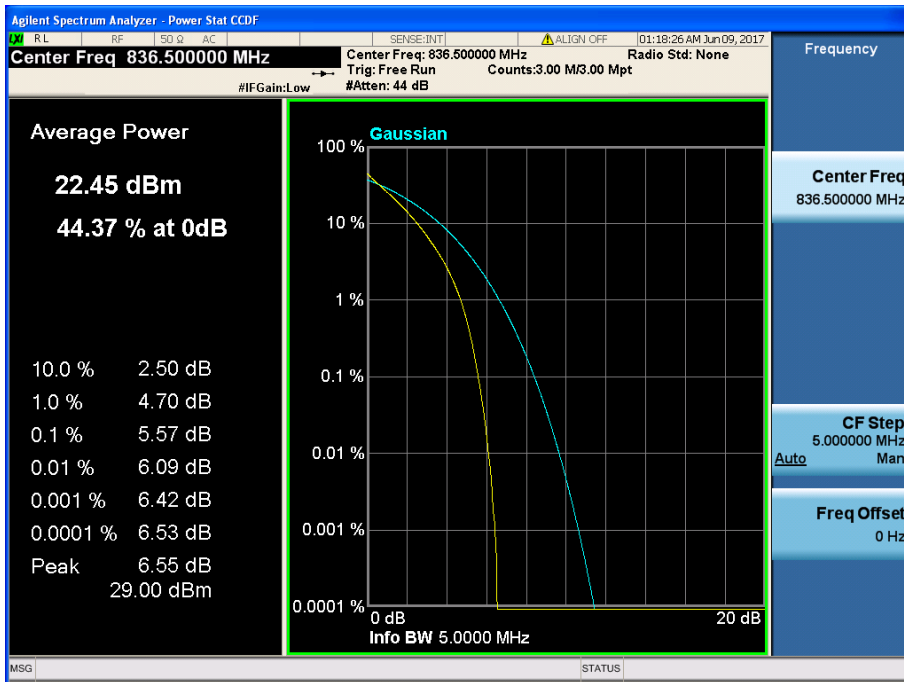

LTE Band 5 / 5 MHz / QPSK - RB Size 25

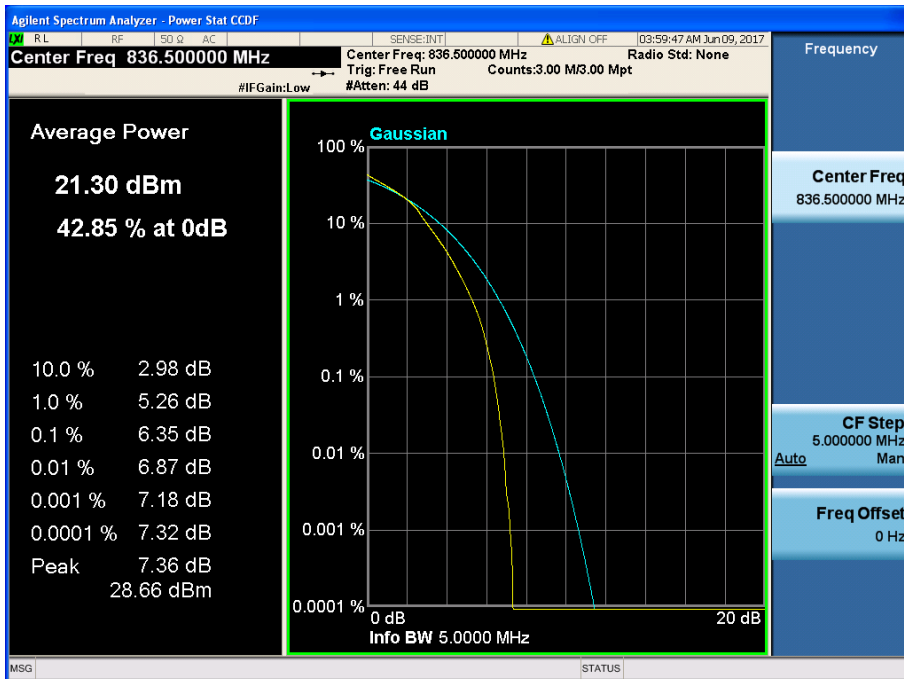

LTE Band 5 / 5 MHz / 16QAM - RB Size 25

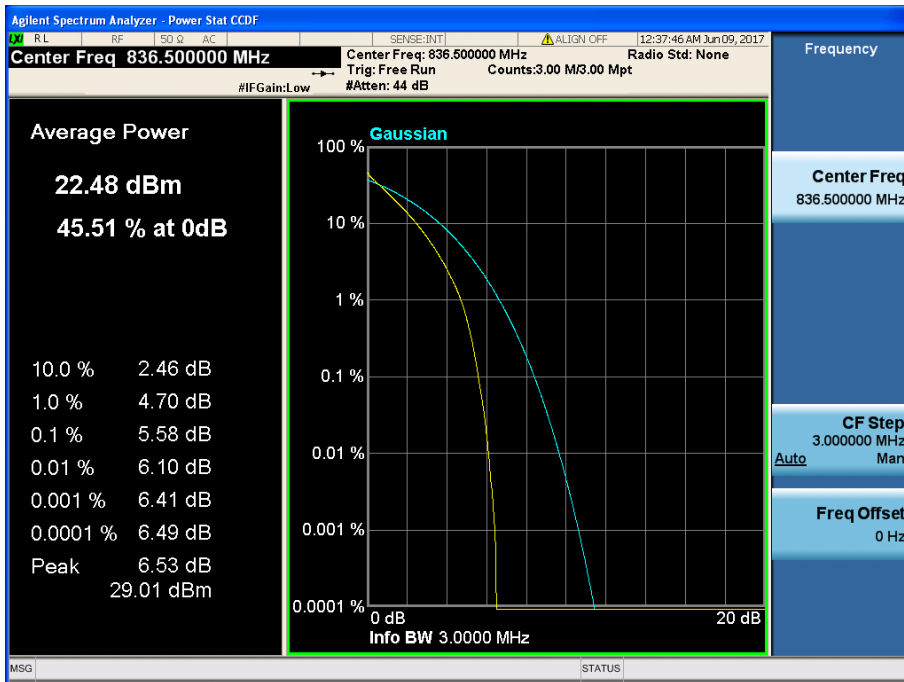

LTE Band 5 / 3 MHz / QPSK - RB Size 15

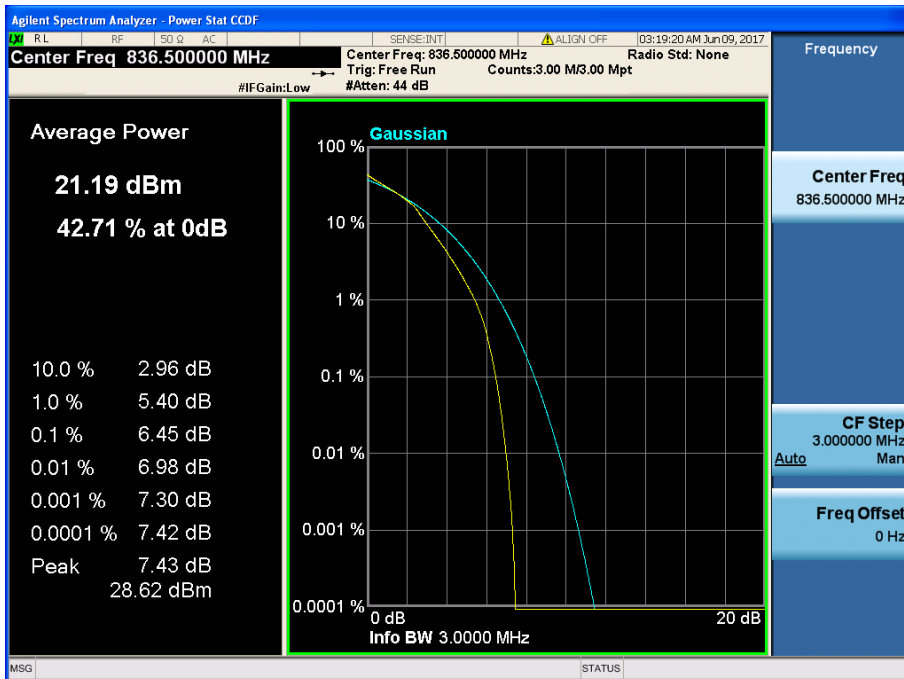

LTE Band 5 / 3 MHz / 16QAM - RB Size 15

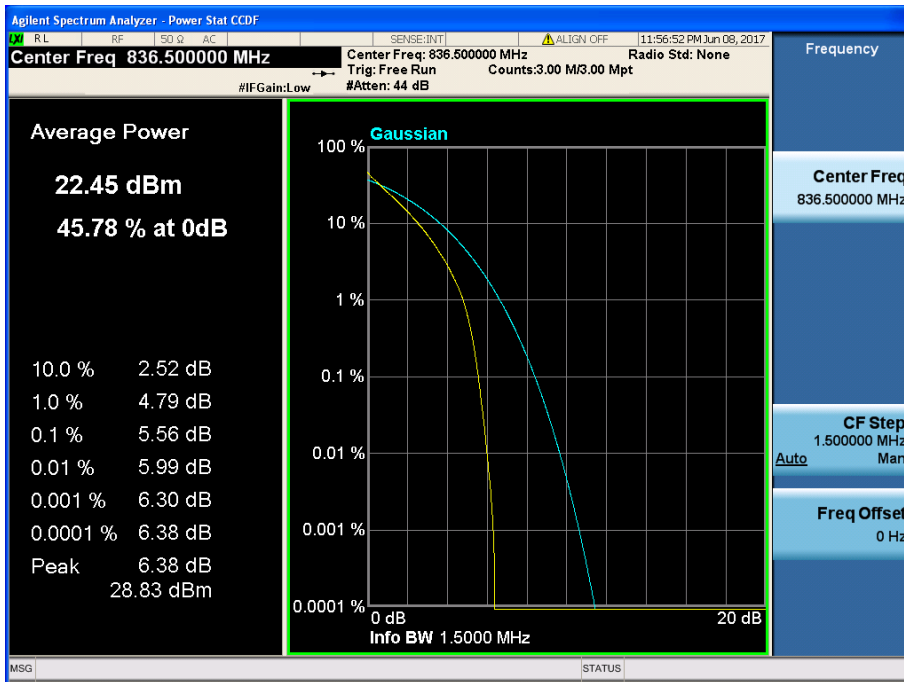

LTE Band 5 / 1.4 MHz / QPSK - RB Size 6

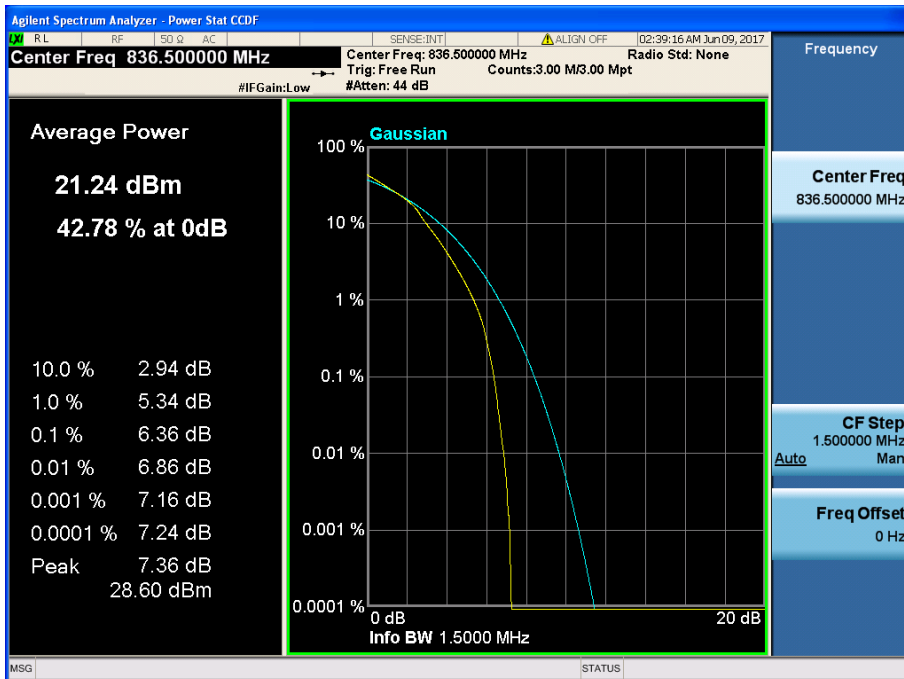

LTE Band 5 / 1.4 MHz / 16QAM - RB Size 6

8.2.3 LTE Band 2

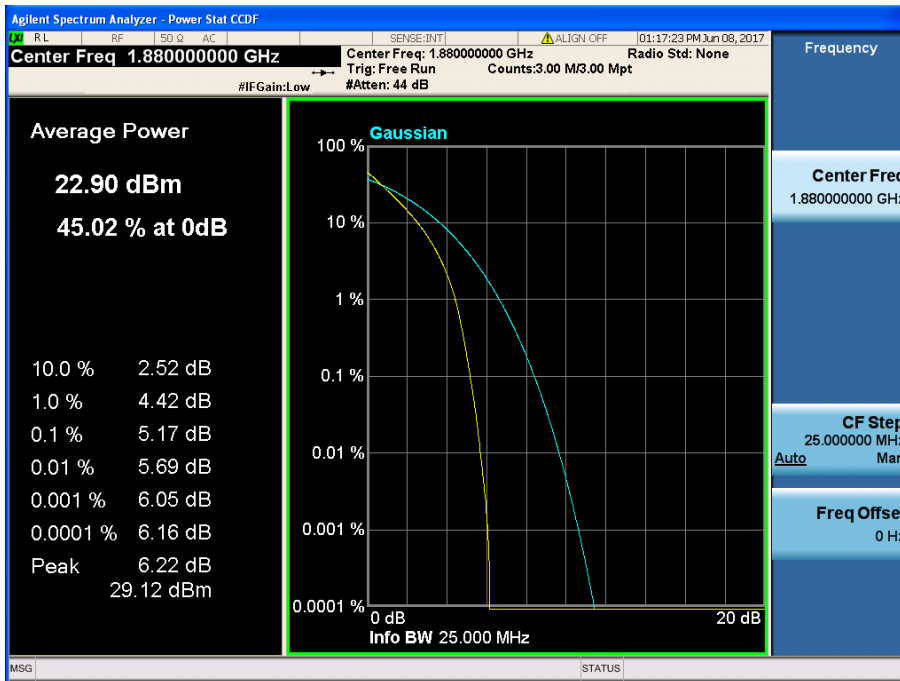

LTE Band 2 / 20 MHz / QPSK - RB Size 100



LTE Band 2 / 20 MHz / 16QAM - RB Size 100

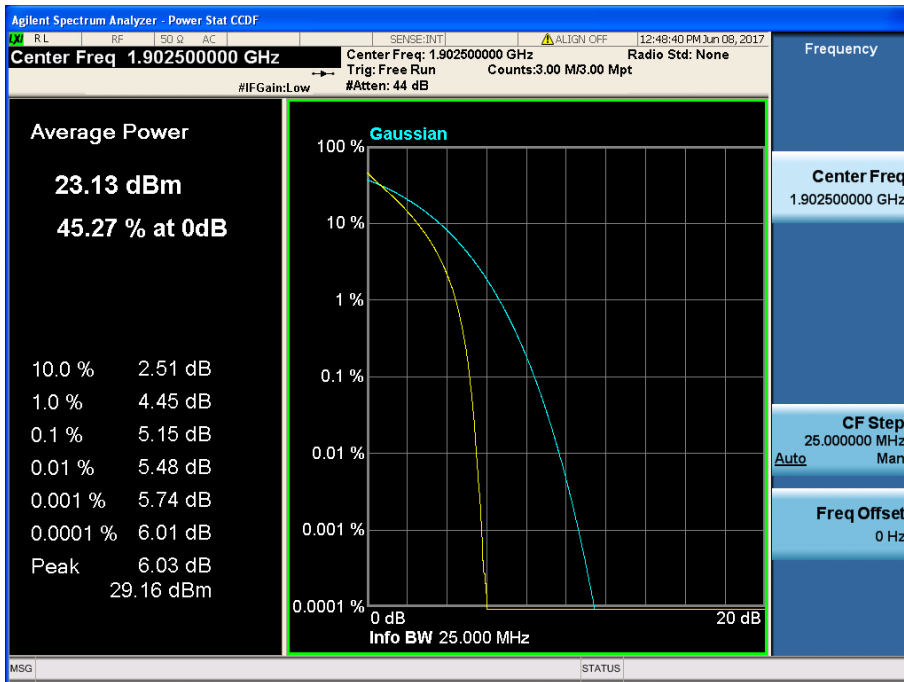

LTE Band 2 / 15 MHz / QPSK - RB Size 75



LTE Band 2 / 15 MHz / 16QAM - RB Size 75

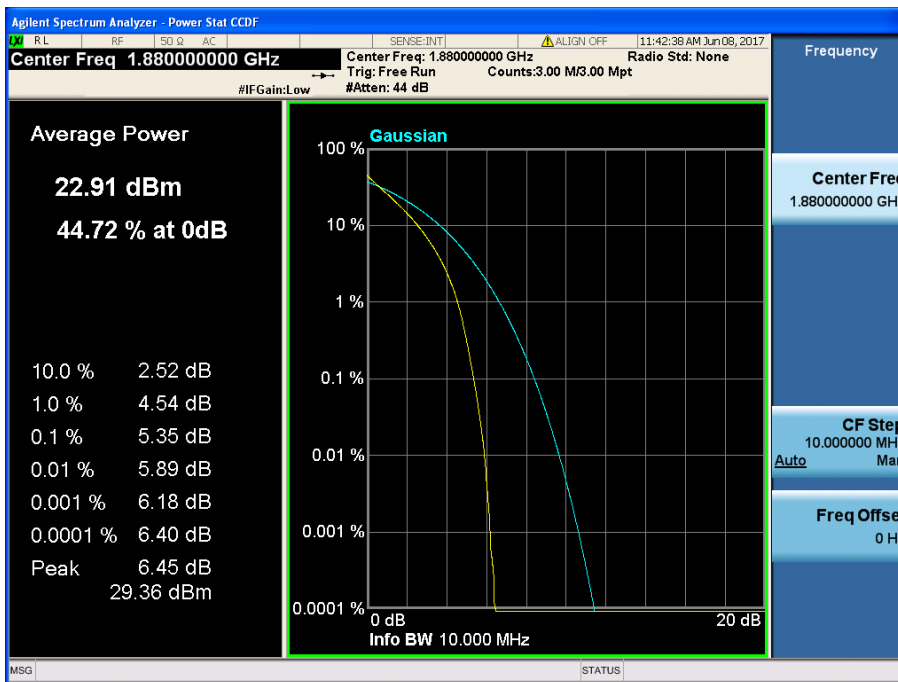

LTE Band 2 / 10 MHz / QPSK - RB Size 50

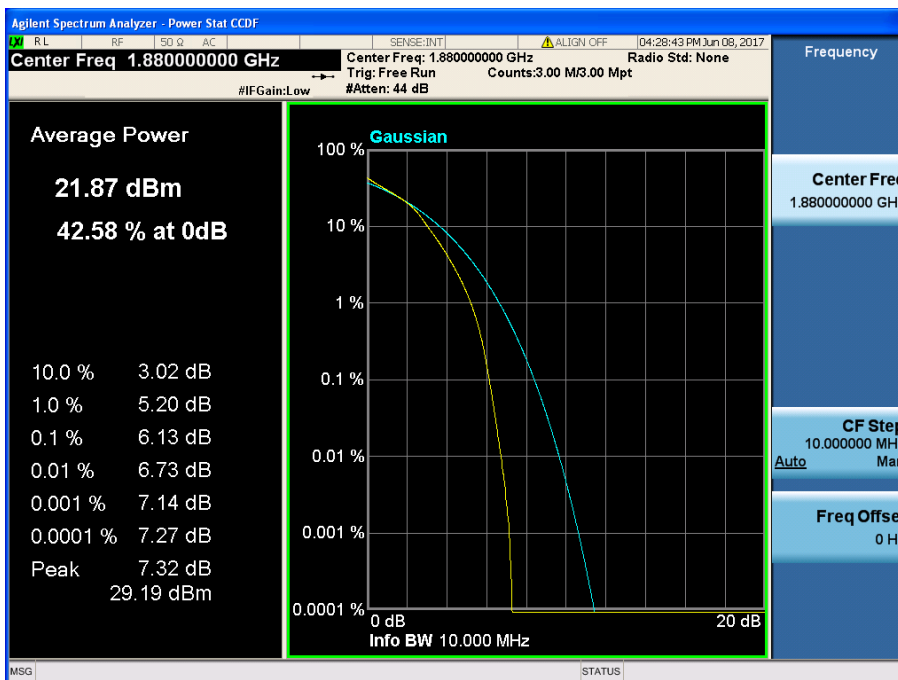

LTE Band 2 / 10 MHz / 16QAM - RB Size 50

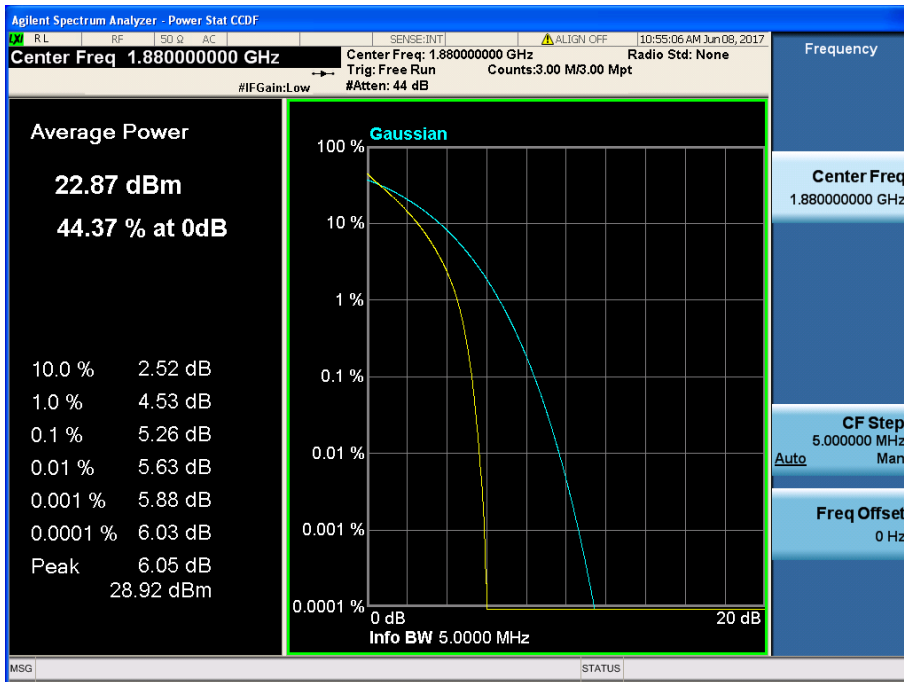

LTE Band 2 / 5 MHz / QPSK - RB Size 25

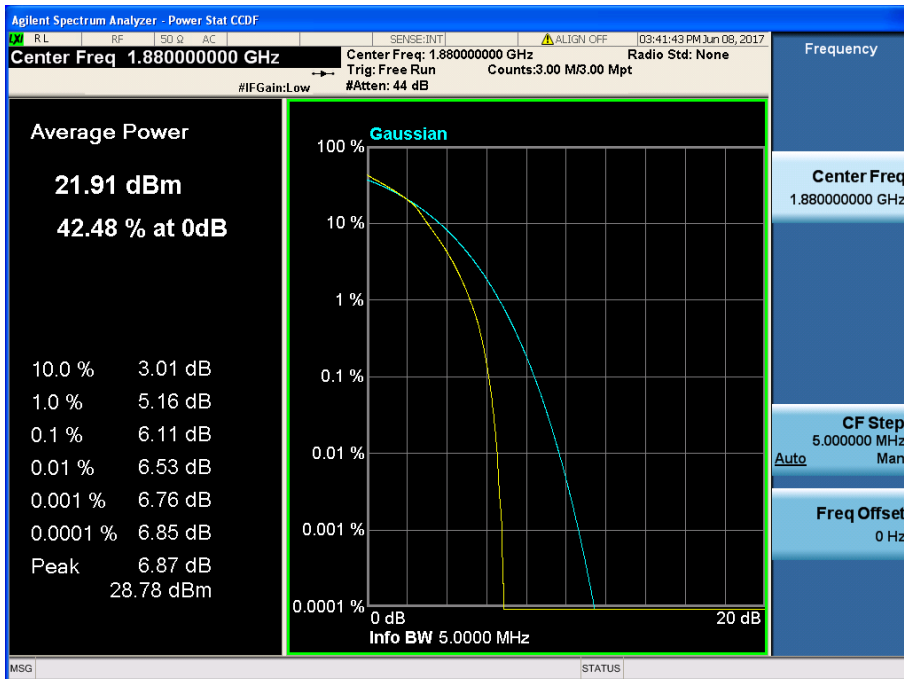

LTE Band 2 / 5 MHz / 16QAM - RB Size 25

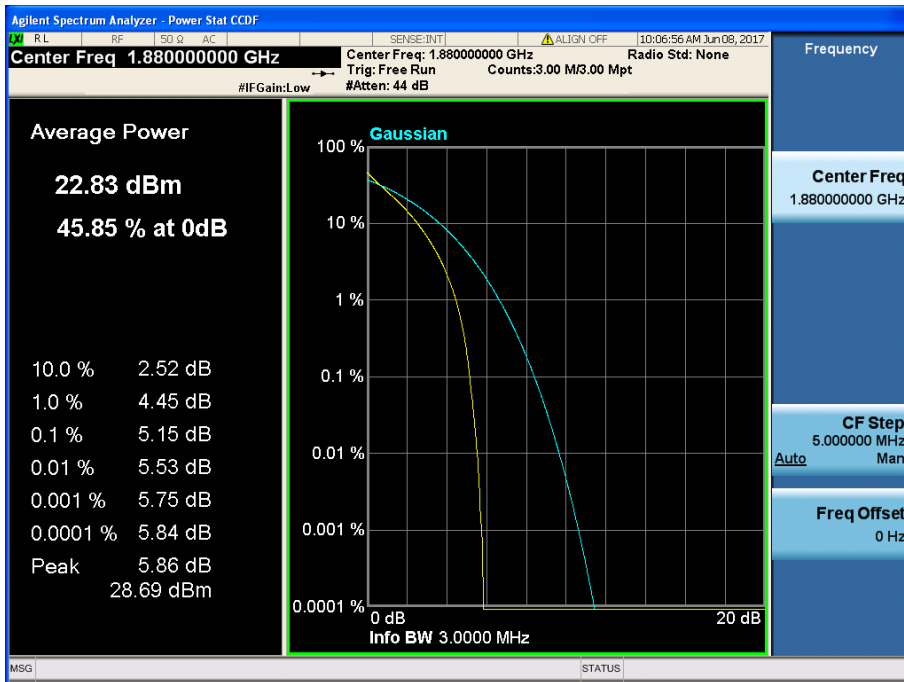

LTE Band 2 / 3 MHz / QPSK - RB Size 15

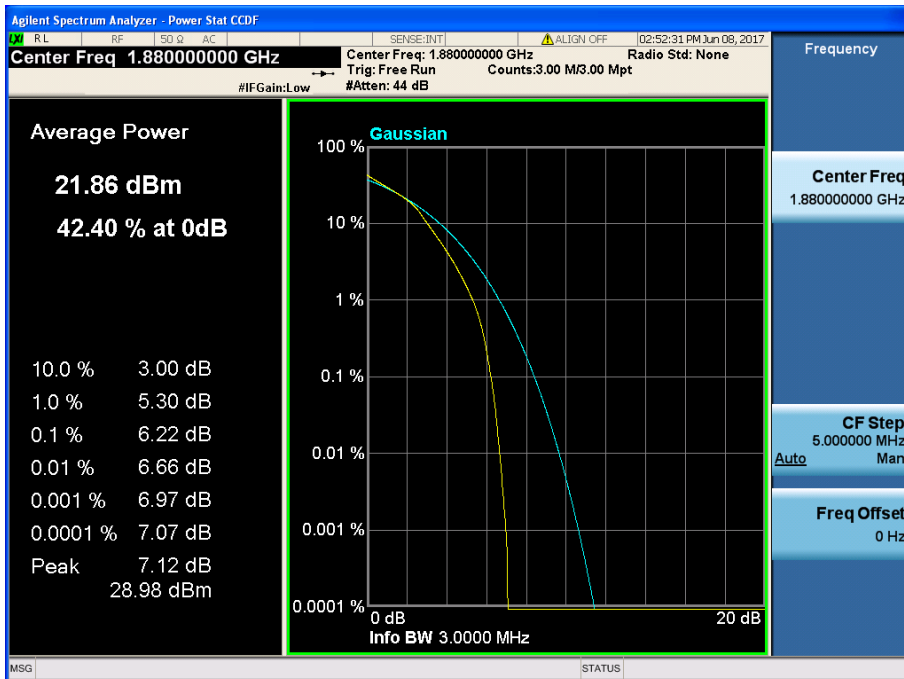

LTE Band 2 / 3 MHz / 16QAM - RB Size 15

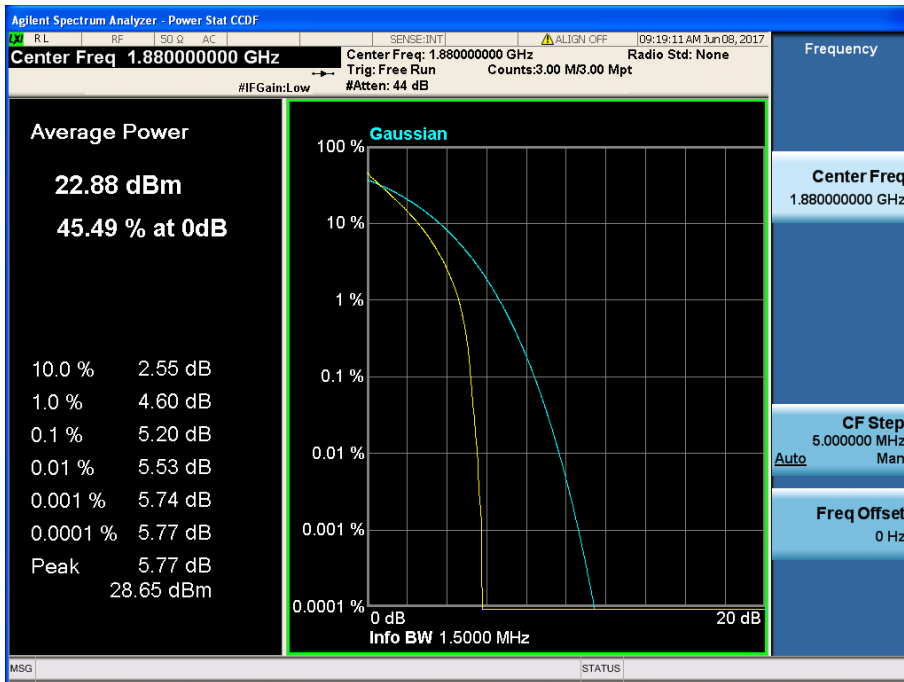

LTE Band 2 / 1.4 MHz / QPSK - RB Size 6



LTE Band 2 / 1.4 MHz / 16QAM - RB Size 6

8.2.4 LTE Band 7

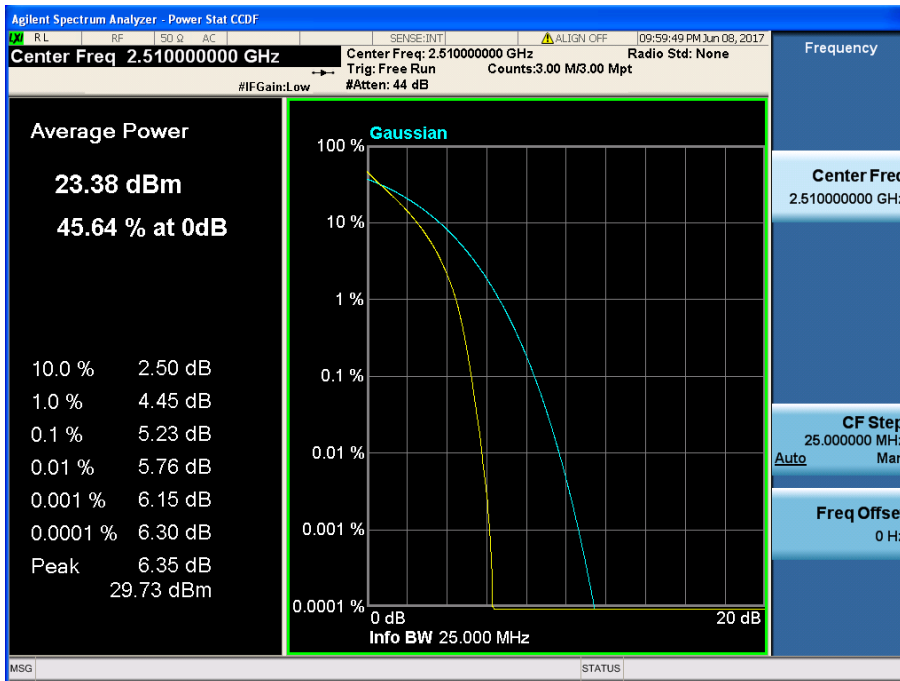

LTE Band 7 / 20 MHz / QPSK - RB Size 100



LTE Band 7 / 20 MHz / 16QAM - RB Size 100

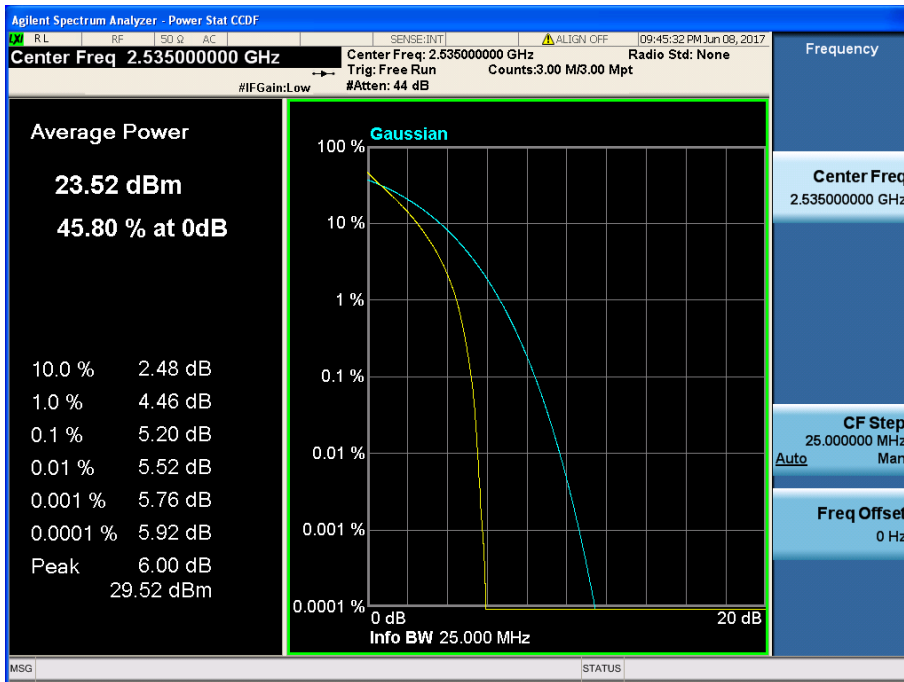

LTE Band 7 / 15 MHz / QPSK - RB Size 75



LTE Band 7 / 15 MHz / 16QAM - RB Size 75

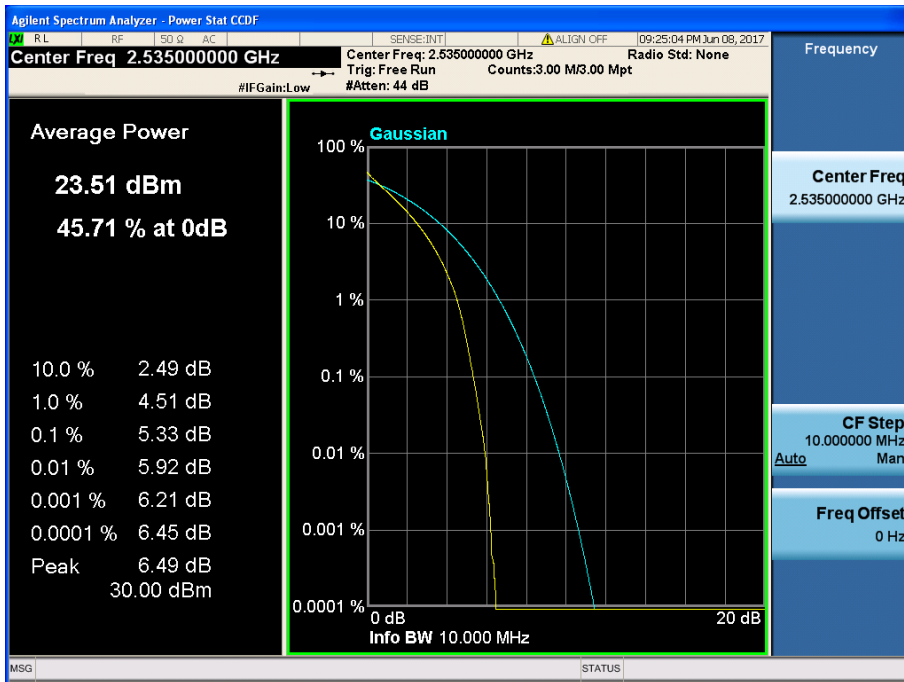

LTE Band 7 / 10 MHz / QPSK - RB Size 50

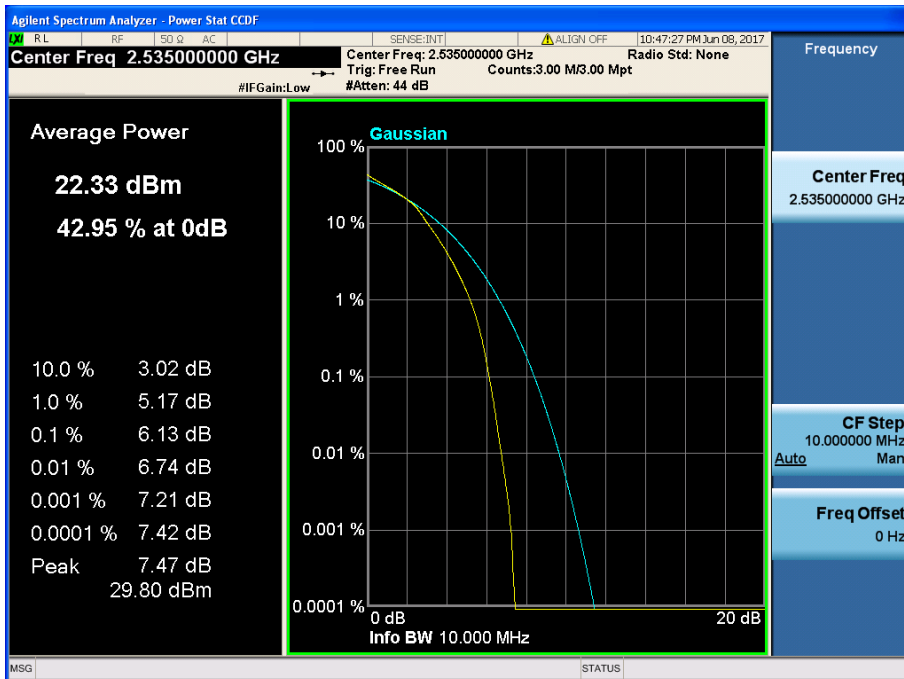

LTE Band 7 / 10 MHz / 16QAM - RB Size 50

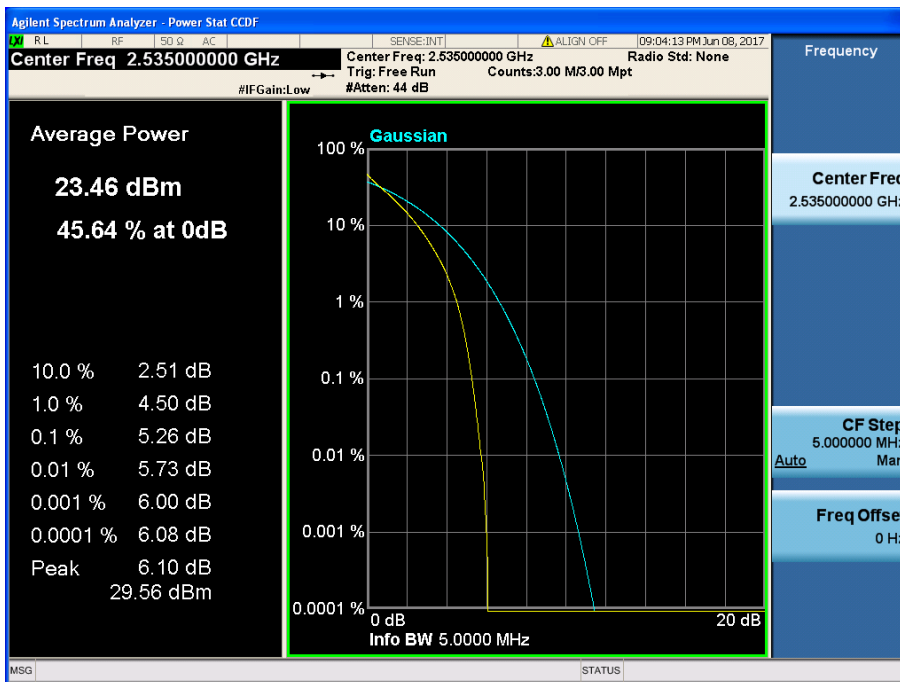

LTE Band 7 / 5 MHz / QPSK - RB Size 25

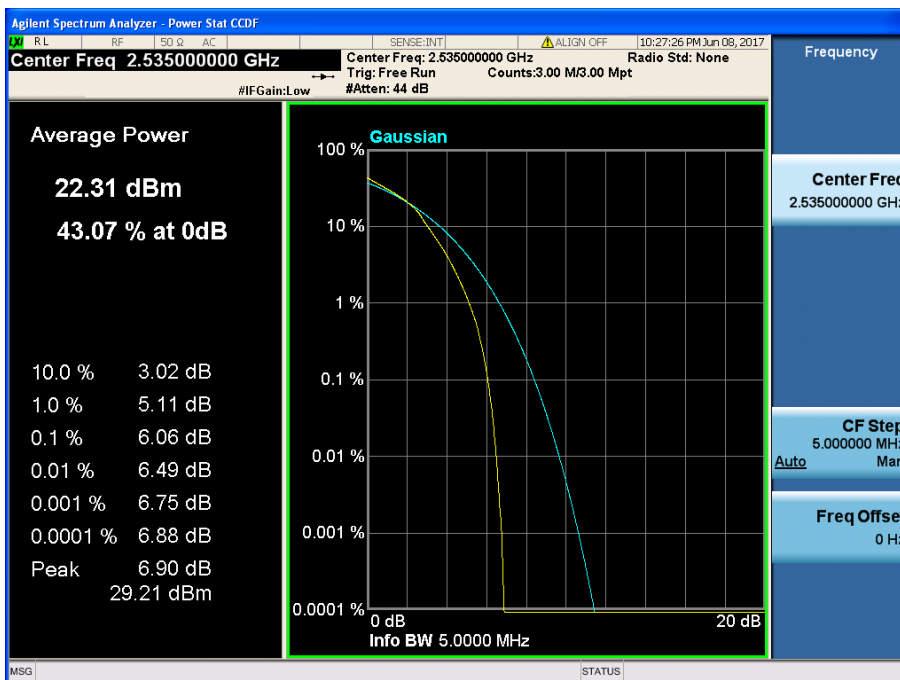

LTE Band 7 / 5 MHz / 16QAM - RB Size 25

8.3 BAND EDGE EMISSIONS(Conducted)

8.3.1 LTE Band 17

- Lower Band Edge

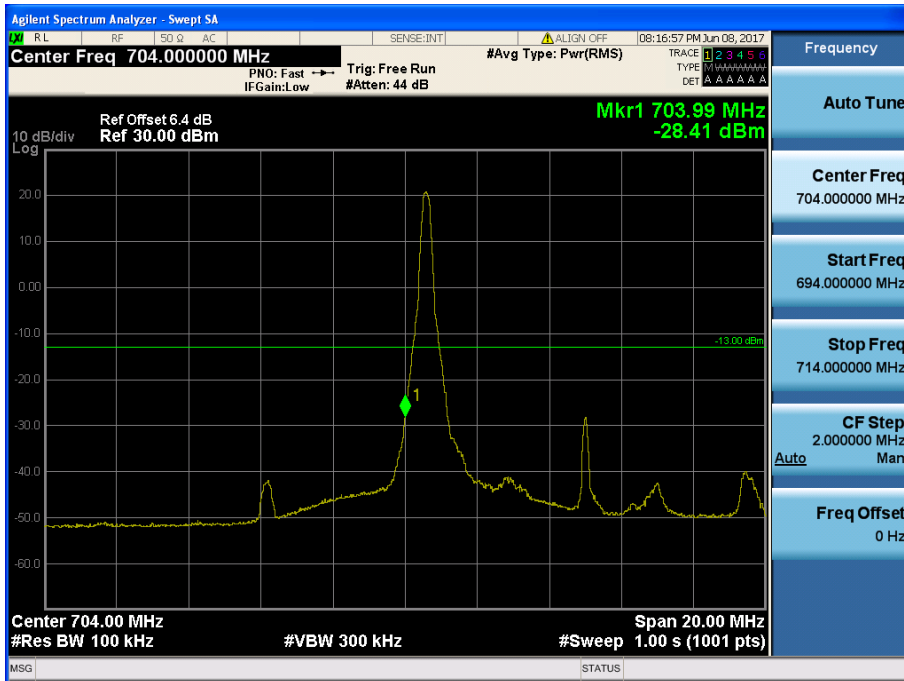

LTE Band 17 / 10MHz / 16QAM - RB Size/Offset (1/0)

- Lower Extended Band Edge

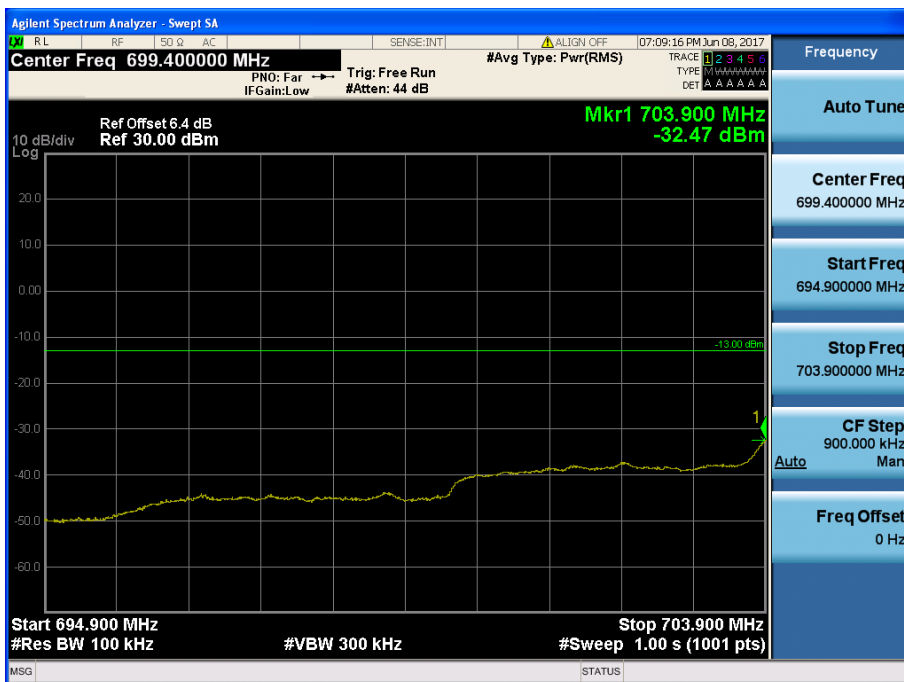

LTE Band 17 / 10MHz / QPSK - RB Size/Offset (25/0)

- Upper Band Edge

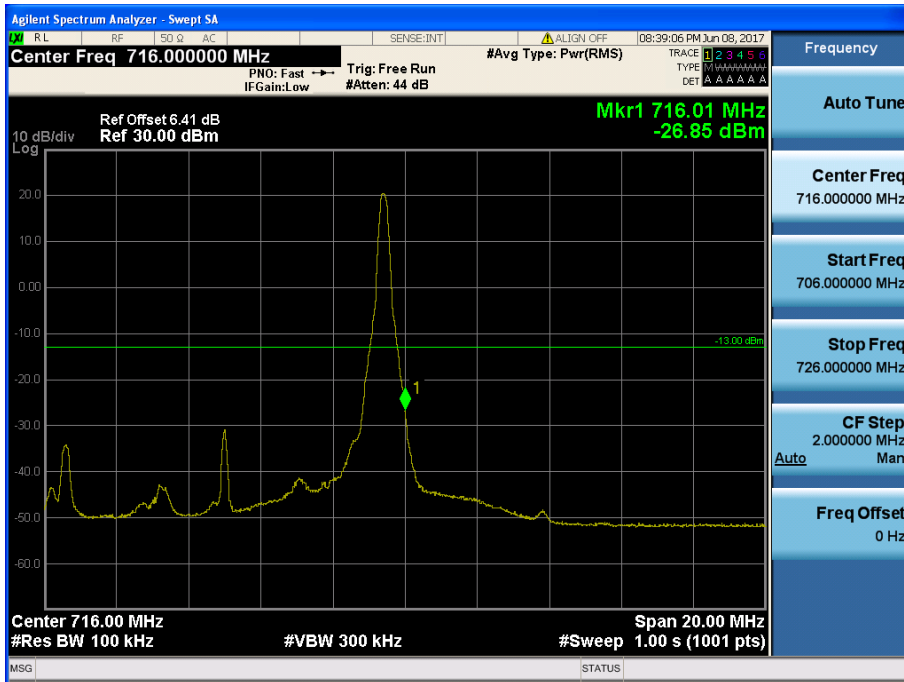

LTE Band 17 / 10MHz / 16QAM - RB Size/Offset (1/49)

- Upper Extended Band Edge

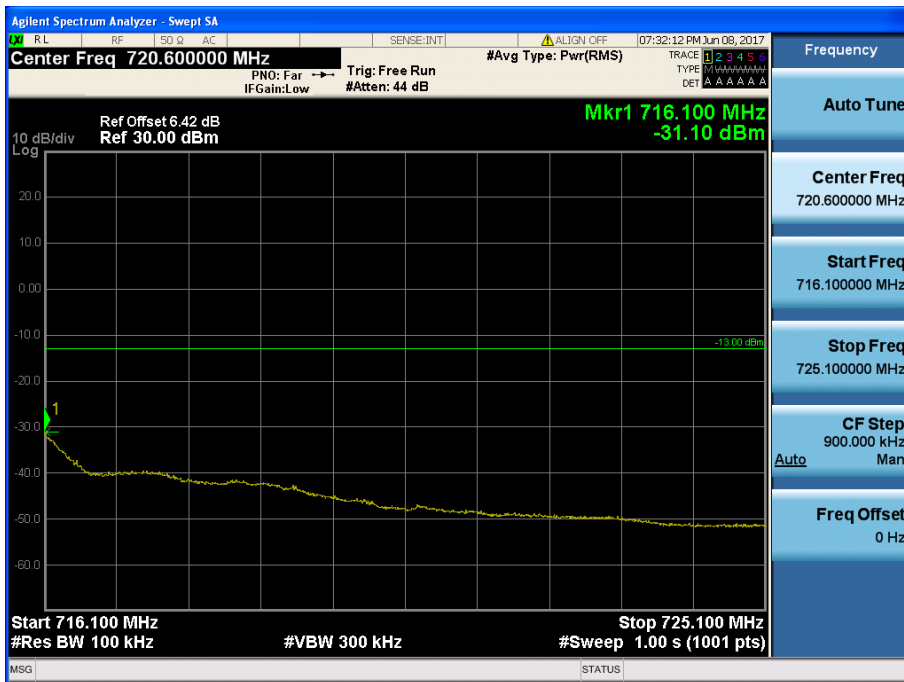

LTE Band 17 / 10MHz / QPSK - RB Size/Offset (25/25)

- Lower Band Edge

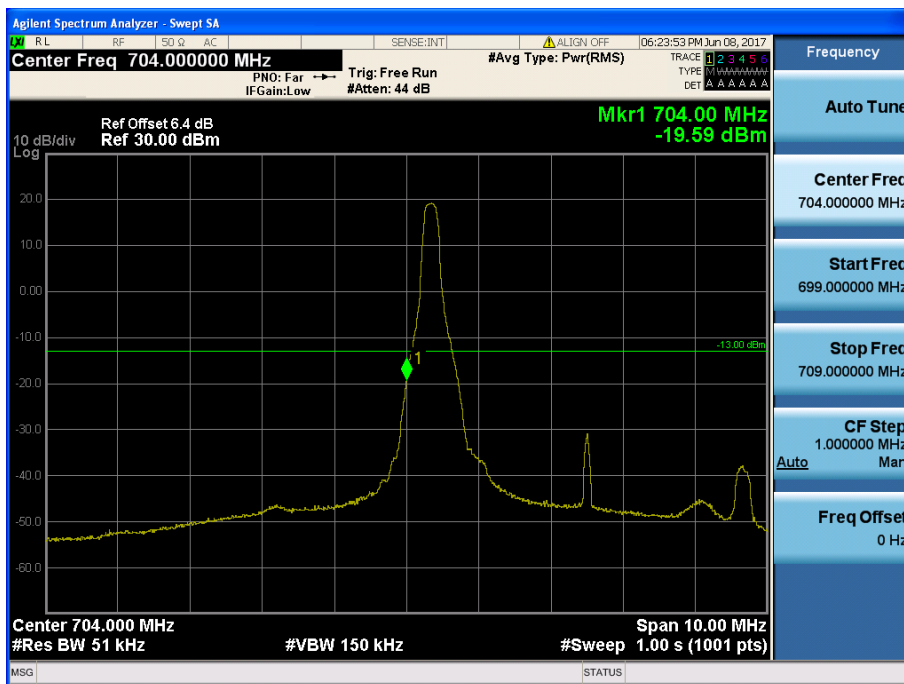

LTE Band 17 / 5MHz / QPSK RB Size/Offset (1/0)

- Lower Extended Band Edge

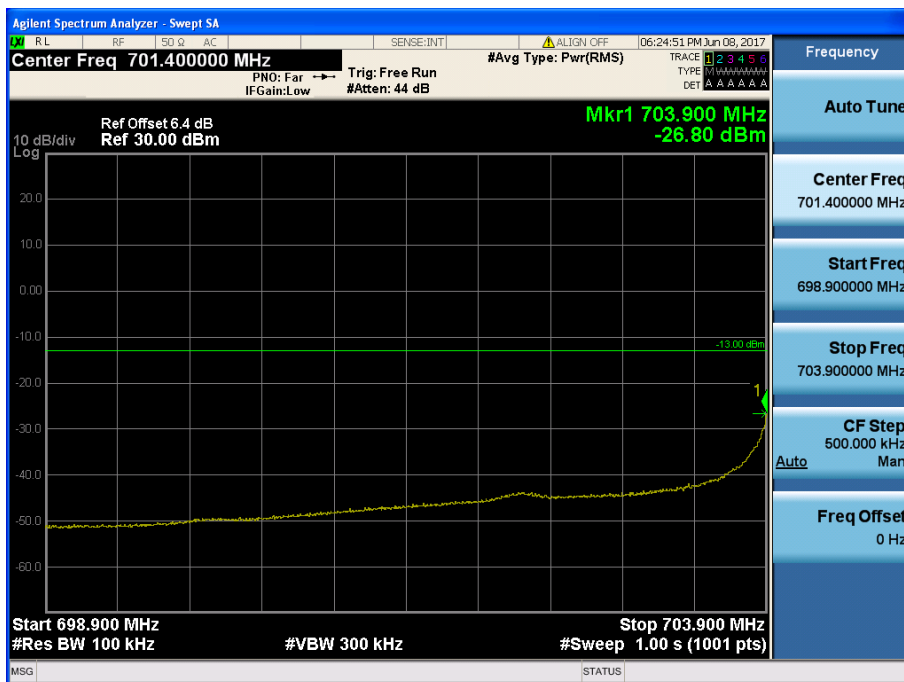

LTE Band 17 / 5MHz / QPSK RB Size/Offset (1/0)

- Upper Band Edge

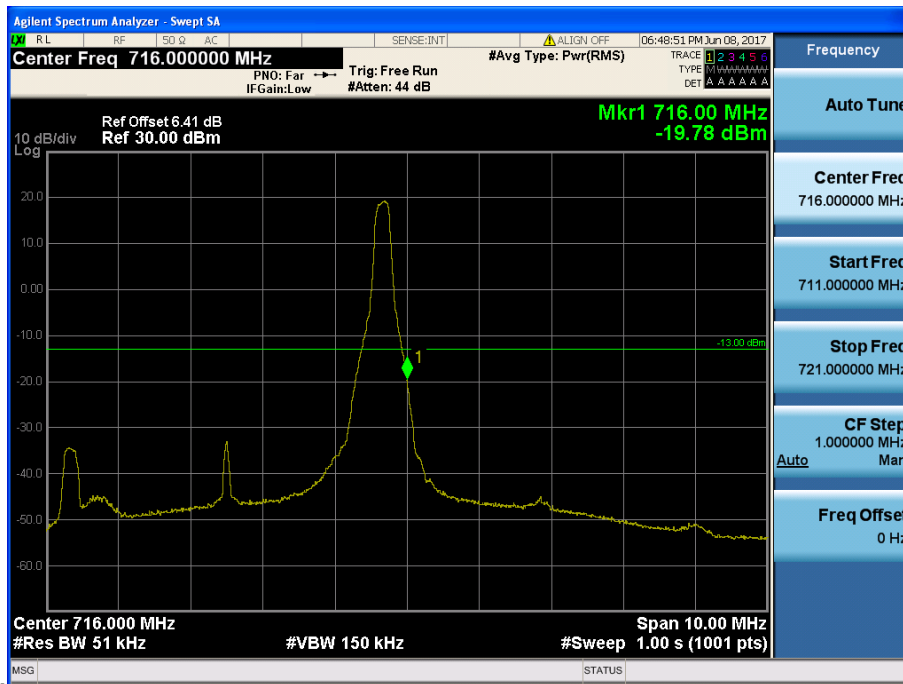

LTE Band 17 / 5MHz / QPSK - RB Size/Offset (1/24)

- Upper Extended Band Edge

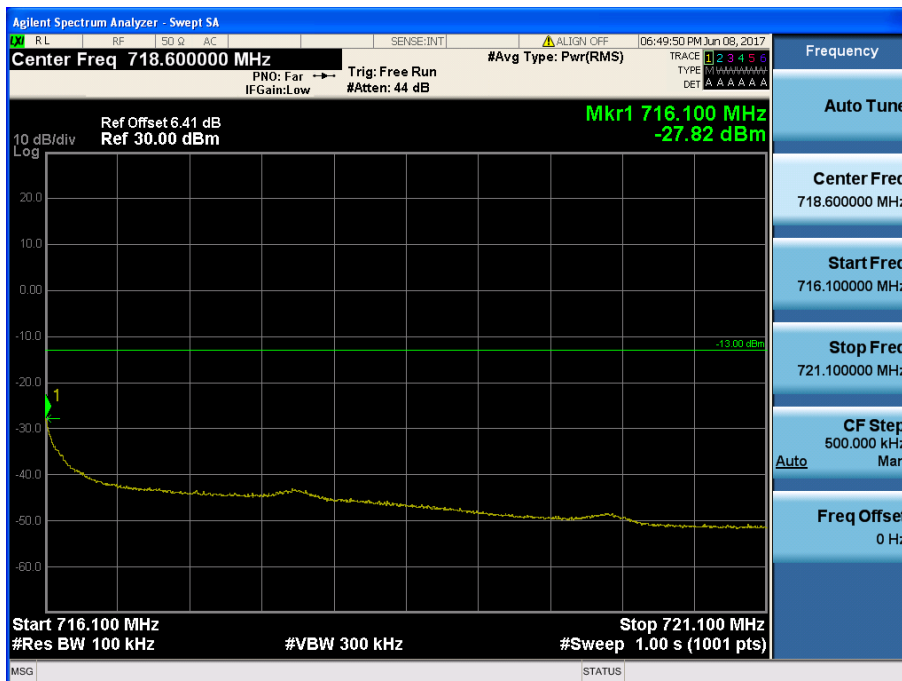

LTE Band 17 / 5MHz / QPSK - RB Size/Offset (1/24)

8.3.2 LTE Band 5

- Lower Band Edge

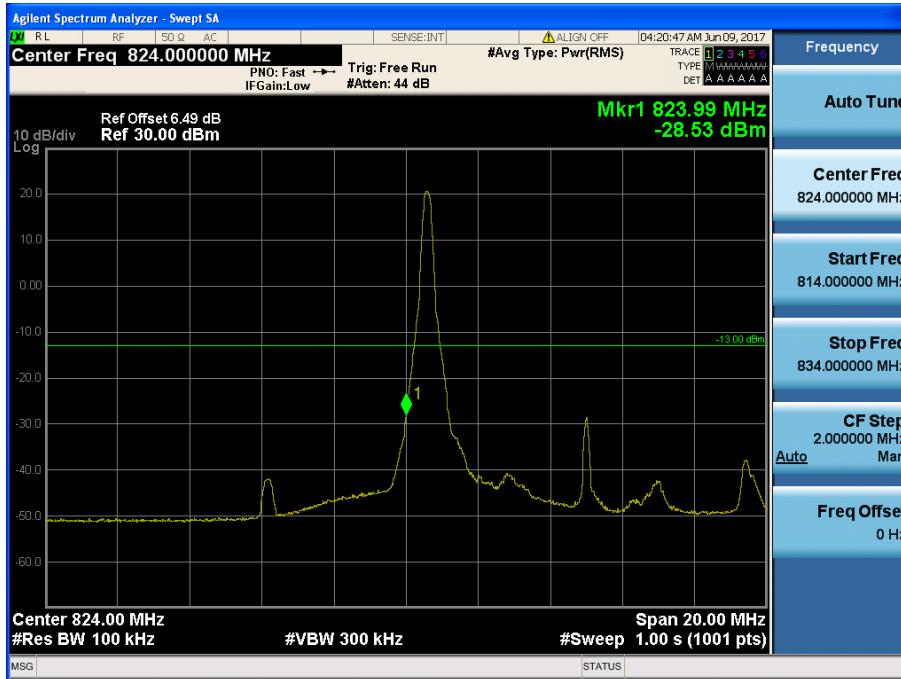

LTE Band 5 / 10MHz / 16QAM - RB Size/Offset (1/0)

- Lower Extended Band Edge

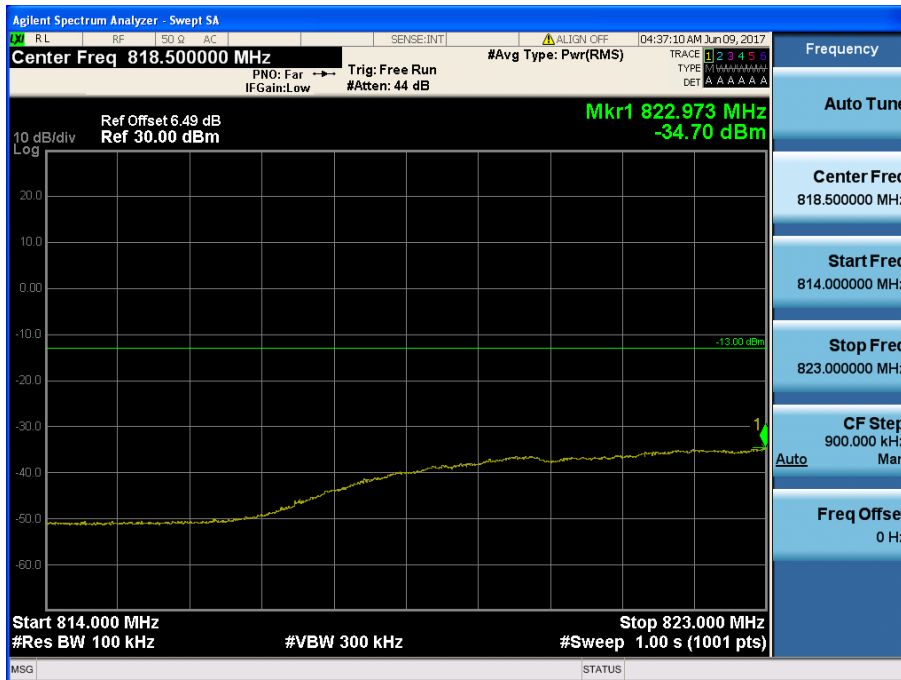

LTE Band 5 / 10MHz / 16QAM - RB Size/Offset (50/0)

- Upper Band Edge

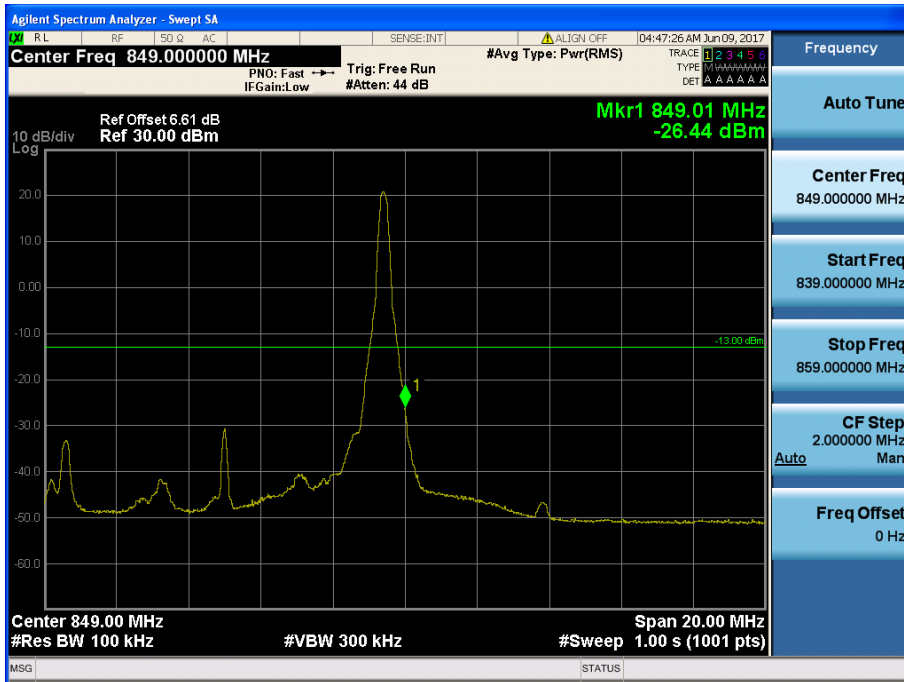

LTE Band 5 / 10MHz / 16QAM - RB Size/Offset (1/49)

- Upper Extended Band Edge

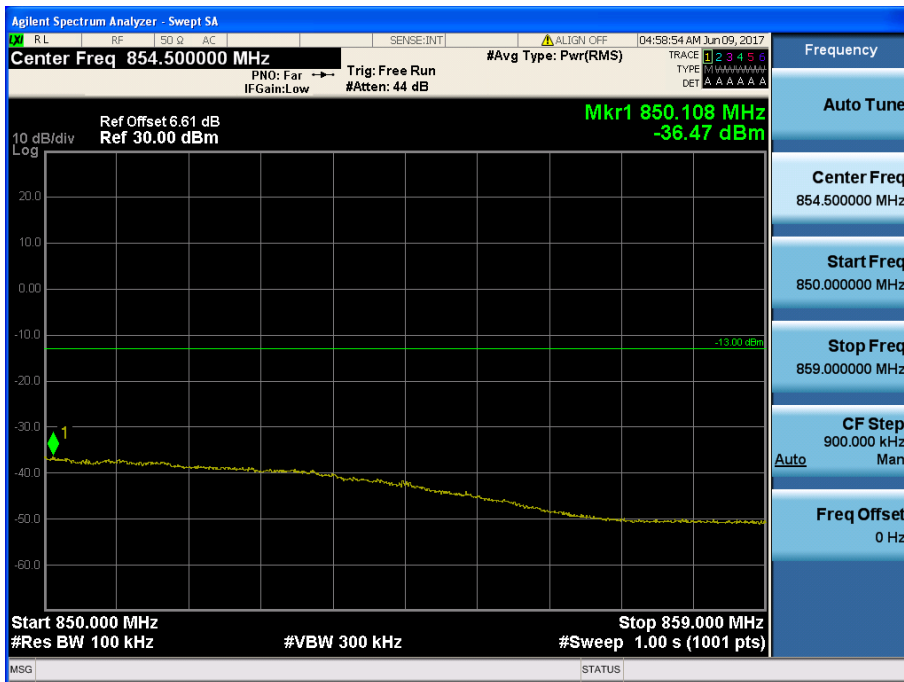

LTE Band 5 / 10MHz / 16QAM - RB Size/Offset (50/0)

- Lower Band Edge

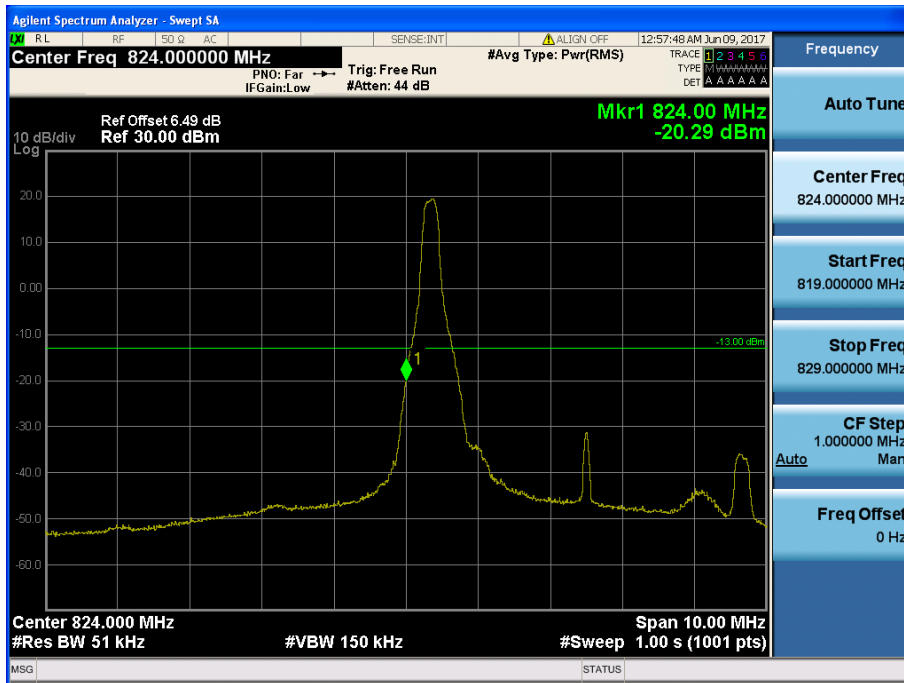

LTE Band 5 / 5MHz / QPSK Offset/Size (1/0)

- Lower Extended Band Edge



LTE Band 5 / 5MHz / QPSK Offset/Size (25/0)

- Upper Band Edge

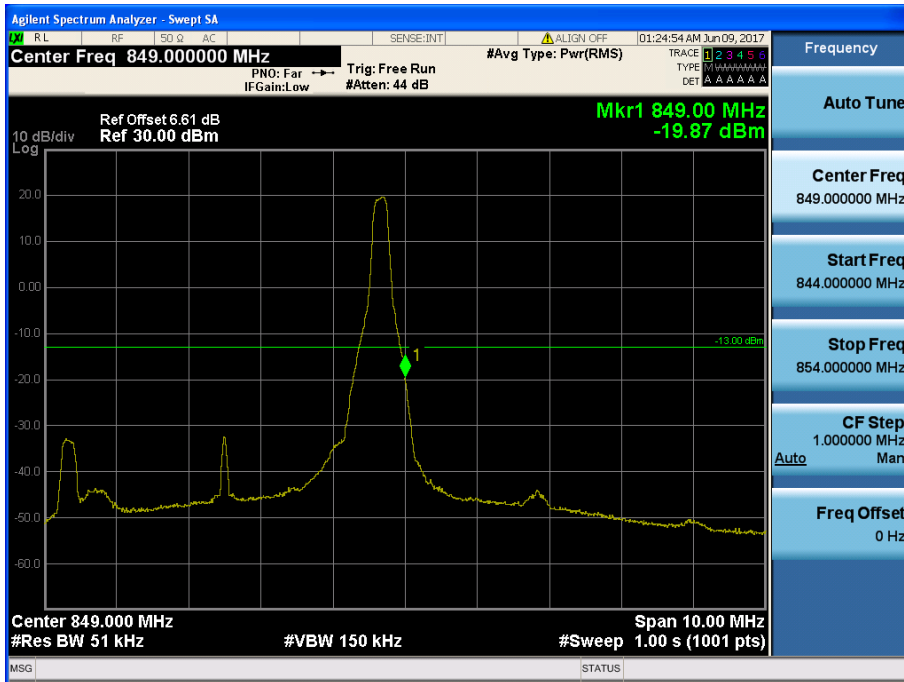

LTE Band 5 / 5MHz / QPSK - RB Size/Offset (1/24)

- Upper Extended Band Edge



LTE Band 5 / 5MHz / 16QAM - RB Size/Offset (25/0)

- Lower Band Edge

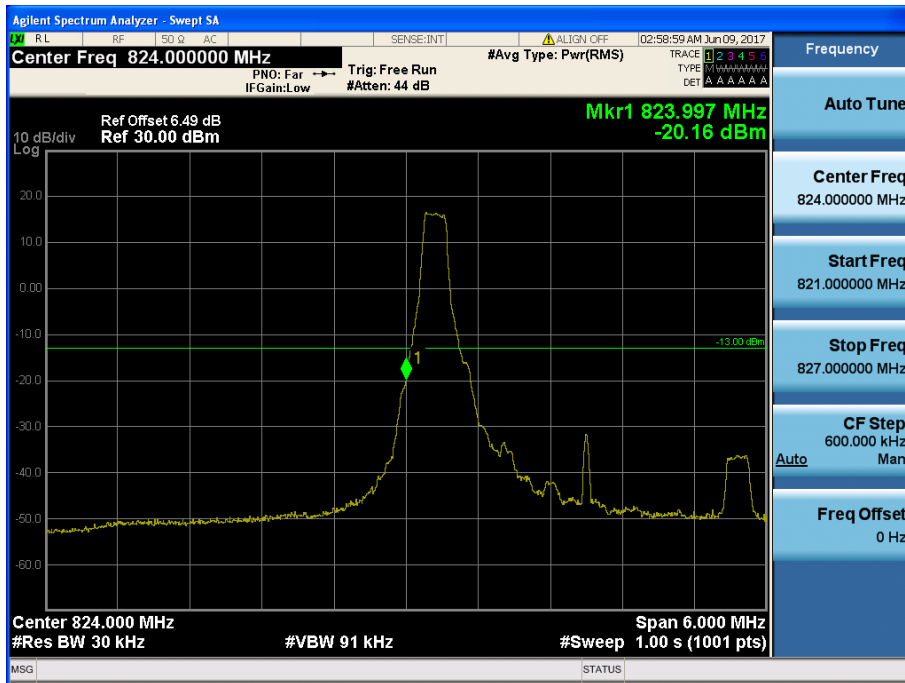

LTE Band 5 / 3MHz / 16QAM - RB Size/Offset (1/0)

- Lower Extended Band Edge

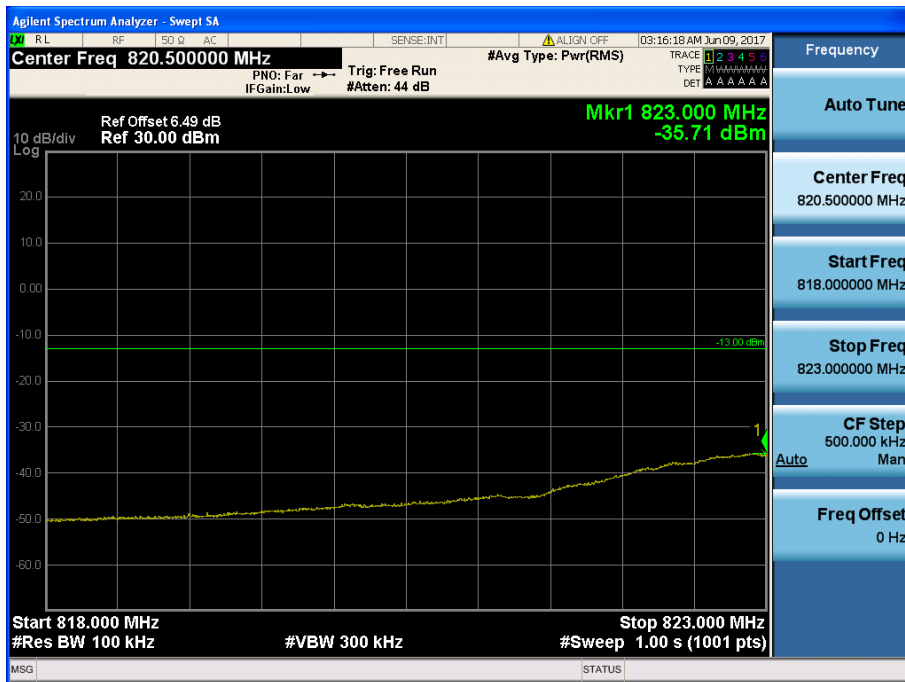

LTE Band 5 / 3MHz / 16QAM - RB Size/Offset (15/0)