



TEST REPORT



DT&C Co., Ltd.

42, Yurim-ro, 154Beon-gil, Cheoin-gu, Yongin-si, Gyeonggi-do, Korea, 17042
Tel : 031-321-2664, Fax : 031-321-1664

1. Report No : DRTFCC1708-0162(1)
2. Customer
 - Name : POINT MOBILE CO.,LTD
 - Address : B-9F, Kabul Great Valley 32 Digital-ro 9-gil, Geumcheon-gu Seoul South Korea
153-709
3. Use of Report : FCC & IC Original Grant
4. Product Name / Model Name : Mobile Computer / FCC: PM66, IC: PM66G
FCC ID : V2X-PM66G / IC : 10664A-PM66G
5. Test Method Used : KDB971168 D01v02r02, ANSI/TIA-603-E-2016
Test Specification : FCC Part 22, 24
RSS-132, 133
6. Date of Test : 2017.06.11 ~ 2017.06.26
7. Testing Environment : See appended test report.
8. Test Result : Refer to the attached test result.

Affirmation	Tested by	Technical Manager
	Name : JaeHyeok Bang 	Name : GeunKi Son  (Signature)

The test results presented in this test report are limited only to the sample supplied by applicant and the use of this test report is inhibited other than its purpose. This test report shall not be reproduced except in full, without the written approval of DT&C Co., Ltd.

2017 . 09 . 04 .

DT&C Co., Ltd.

If this report is required to confirmation of authenticity, please contact to report@dtnc.net

Test Report Version

Test Report No.	Date	Description
DRTFCC1708-0162	Aug. 29, 2017	Initial issue
DRTFCC1708-0162(1)	Sep. 04, 2017	Edit 1 page typo

Table of Contents

1. GENERAL INFORMATION	4
2. INTRODUCTION	5
2.1. EUT DESCRIPTION	5
2.2. TESTING ENVIRONMENT	5
2.3. MEASURING INSTRUMENT CALIBRATION.....	5
2.4. MEASUREMENT UNCERTAINTY.....	5
2.5. TEST FACILITY	5
3. DESCRIPTION OF TESTS	6
3.1 ERP & EIRP	6
3.2 PEAK TO AVERAGE RATIO	8
3.3 OCCUPIED BANDWIDTH.....	10
3.4 BAND EDGE EMISSIONS AT ANTENNA TERMINAL.....	11
3.5 SPURIOUS AND HARMONIC EMISSIONS AT ANTENNA TERMINAL.....	12
3.6 RADIATED SPURIOUS EMISSIONS	13
3.7 FREQUENCY STABILITY / VARIATION OF AMBIENT TEMPERATURE	14
4. LIST OF TEST EQUIPMENT.....	15
5. SUMMARY OF TEST RESULTS	16
6. SAMPLE CALCULATION	17
7. TEST DATA	18
7.1 PEAK TO AVERAGE RATIO.....	18
7.2 OCCUPIED BANDWIDTH.....	18
7.3 SPURIOUS AND HARMONIC EMISSIONS AT ANTENNA TERMINAL.....	18
7.4 BAND EDGE.....	18
7.5 Effective Radiated Power	19
7.6 Equivalent Isotropic Radiated Power	20
7.7 RADIATED SPURIOUS EMISSIONS	21
7.7.1 RADIATED SPURIOUS EMISSIONS (WCDMA850).....	21
7.7.2 RADIATED SPURIOUS EMISSIONS (HSUPA850)	22
7.7.3 RADIATED SPURIOUS EMISSIONS (WCDMA1900).....	23
7.7.4 RADIATED SPURIOUS EMISSIONS (HSUPA1900)	24
7.8 FREQUENCY STABILITY / VARIATION OF AMBIENT TEMPERATURE	25
7.8.1 FREQUENCY STABILITY (WCDMA850).....	25
7.8.2 FREQUENCY STABILITY (WCDMA1900).....	26
8. TEST PLOTS	27
8.1 Peak to Average Ratio.....	27
8.2 Occupied Bandwidth (99 % Bandwidth)	29
8.3 Spurious Emissions at Antenna Terminal	37
8.4 Band Edge	47

2. INTRODUCTION

2.1. EUT DESCRIPTION

The Equipment under Test (EUT) supports WCDMA, LTE, WLAN, BT(BDR,EDR),BLE and NFC.

2.2. TESTING ENVIRONMENT

Ambient Condition	
▪ Temperature	+23 °C ~ +26 °C
▪ Relative Humidity	38 % ~ 43 %

2.3. MEASURING INSTRUMENT CALIBRATION

The measuring equipment, which was utilized in performing the tests documented herein, has been calibrated in accordance with the manufacturer's recommendations for utilizing calibration equipment, which is traceable to recognized national standards.

2.4. MEASUREMENT UNCERTAINTY

The measurement uncertainties shown below were calculated in accordance with requirements of ANSI C 63.4-2014. All measurement uncertainty values are shown with a coverage factor of $k = 2$ to indicate a 95 % level of confidence.

Test items	Measurement uncertainty
<i>Radiated Disturbance (Below 1 GHz)</i>	± 5.1 dB (The confidence level is about 95 %, $k = 2$)
<i>Radiated Disturbance (1 GHz ~ 18 GHz)</i>	± 5.4 dB (The confidence level is about 95 %, $k = 2$)
<i>Radiated Disturbance (Above 18 GHz)</i>	± 5.3 dB (The confidence level is about 95 %, $k = 2$)

2.5. TEST FACILITY

DT&C Co., Ltd.		
The 3 m test site and conducted measurement facility used to collect the radiated data are located at the 42, Yurim-ro, 154beon-gil, Cheoin-gu, Yongin-si, Gyeonggi-do, Korea 17042. The site is constructed in conformance with the requirements.		
- FCC MRA Accredited Test Firm No. : KR0034		
- IC Test site No. : 5740A-3		
www.dtnc.net		
Telephone	:	+ 82-31-321-2664
FAX	:	+ 82-31-321-1664

3. DESCRIPTION OF TESTS

3.1 ERP & EIRP

(Effective Radiated Power & Equivalent Isotropic Radiated Power)

Test Set-up

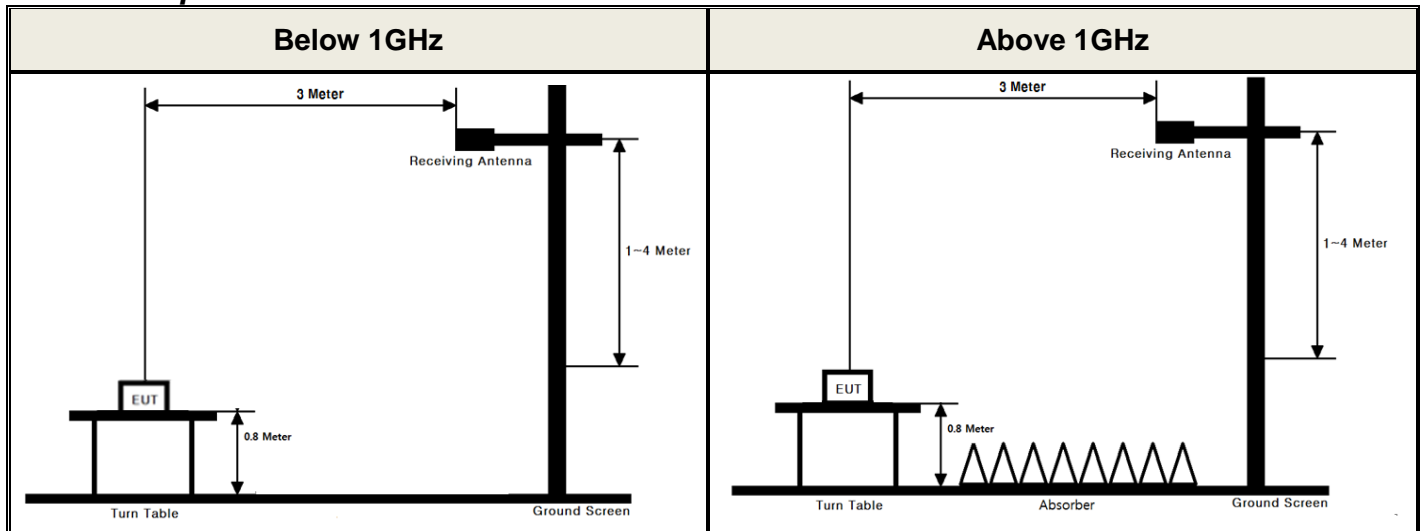

These measurements were performed at 3 m test site. The equipment under test is placed on a non-conductive table 0.8-meters above a turntable which is flush with the ground plane and 3 meters from the receive antenna. For measurements above 1GHz absorbers are placed on the floor between the turn table and the antenna mast in such a way so as to maximize the reduction of reflections. For measurements below 1 GHz, the absorbers are removed.

Test Procedure

- ANSI/TIA-603-E-2016 - Section 2.2.17
- KDB971168 v02r02 - Section 5.2.1

Test setting

1. Set span to at least 1.5 times the OBW.
2. Set RBW = 1-5 % of the OBW, not to exceed 1 MHz.
3. Set VBW $\geq 3 \times$ RBW.
4. Set number of points in sweep $\geq 2 \times$ span / RBW.
5. Sweep time = auto couple.
6. Detector = RMS (power averaging).
7. If the EUT can be configured to transmit continuously (i.e., burst duty cycle ≥ 98 %), then set the trigger to free run.
8. If the EUT cannot be configured to transmit continuously (i.e., burst duty cycle < 98 %), then use a sweep trigger with the level set to enable triggering only on full power bursts and configure the EUT to transmit at full power for the entire duration of each sweep.
Ensure that the sweep time is less than or equal to the transmission burst duration.
9. Trace average at least 100 traces in power averaging (i.e., RMS) mode.
10. Compute the power by integrating the spectrum across the OBW of the signal using the instrument's band power measurement function, with the band limits set equal to the OBW band edges. If the instrument does not have a band power function, then sum the spectrum levels (in linear power units) at intervals equal to the RBW extending across the entire OBW of the spectrum.

The receive antenna height and turntable rotations were adjusted for the highest reading on the receive spectrum analyzer.

A half-wave dipole was substituted in place of the EUT. This dipole antenna was driven by a signal generator and the level of the signal generator was adjusted to obtain the same receive spectrum analyzer reading. The conducted power at the terminal of the substitute antenna is measured.

The ERP/EIRP is calculated using the following formula:

ERP/EIRP = The conducted power at the substitute antenna's terminal [dBm] + Substitute Antenna gain [dBd for ERP , dBi for EIRP]

For measurements above 1 GHz, the above procedure is repeated using horn antennas and the difference between the gain of the horn antenna and an isotropic antenna are taken into consideration.

3.2 PEAK TO AVERAGE RATIO

Test set-up

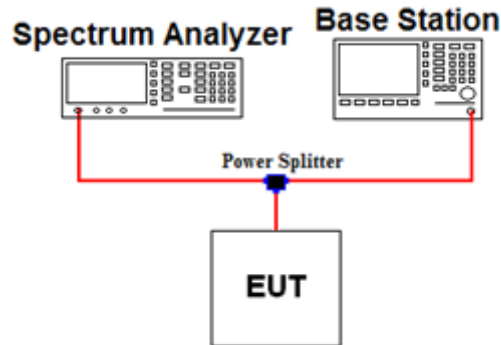

Test Procedure

- KDB971168 v02r02 - Section 5.7.1

A peak to average ratio measurement is performed at the conducted port of the EUT. The spectrum analyzers Complementary Cumulative Distribution Function (CCDF) measurement profile is used to determine the largest deviation between the average and the peak power of the EUT in a given bandwidth. The CCDF curve shows how much time the peak waveform spends at or above a given average power level. The present of time the signal spends at or above the level defines the probability for that particular power level.

Test setting

The spectrum Analyzer's CCDF measurement function is enabled.

1. Set resolution/measurement bandwidth \geq signal's occupied bandwidth.
2. Set the number of counts to a value that stabilizes the measured CCDF curve
3. Set the measurement interval as follows:
 - 1) For continuous transmissions, set to 1 ms.
 - 2) For burst transmissions, employ an external trigger that is synchronized with the EUT burst timing sequence, or use the internal burst trigger with a trigger level that allows the burst to stabilize and set the measurement interval to a time that is less than or equal to the burst duration.
4. Record the maximum PAPR level associated with a probability of 0.1 %

■ Alternate Procedure

- KDB971168 v02r02-Section 5.7.2

Use one of the measurement procedures of the peak power and record as P_{Pk} .

Use one of the measurement procedures of the average power and record as P_{Avg} .

Both the peak and average power levels must be expressed in the same logarithmic units (e.g., dBm). Determine the PAPR from:

$$\text{PAPR (dB)} = P_{Pk} \text{ (dBm)} - P_{Avg} \text{ (dBm)}.$$

- Peak Power Measurement

1. Set the RBW \geq OBW
2. Set VBW $\geq 3 \times$ RBW
3. Set span $\geq 2 \times$ RBW
4. Sweep time = auto couple
5. Detector = peak
6. Ensure that the number of measurement points \geq span/RBW.
7. Trace mode = max hold
8. Allow trace to fully stabilize.
9. Use the peak marker function to determine the peak amplitude level.

- Average Power Measurement

1. Set span to at least 1.5 times the OBW.
2. Set RBW = 1-5% of the OBW, not to exceed 1 MHz.
3. Set VBW $\geq 3 \times$ RBW.
4. Set number of points in sweep $\geq 2 \times$ span / RBW.
5. Sweep time = auto-couple.
6. Detector = RMS (power averaging).
7. If the EUT can be configured to transmit continuously (i.e., burst duty cycle $\geq 98\%$), then set the trigger to free run.
8. If the EUT cannot be configured to transmit continuously (i.e., burst duty cycle $< 98\%$), then use a sweep trigger with the level set to enable triggering only on full power bursts and configure the EUT to transmit at full power for the entire duration of each sweep.
Ensure that the sweep time is less than or equal to the transmission burst duration.
9. Trace average at least 100 traces in power averaging (i.e., RMS) mode.
10. Compute the power by integrating the spectrum across the OBW of the signal using the instrument's band power measurement function, with the band limits set equal to the OBW band edges. If the instrument does not have a band power function, then sum the spectrum levels (in linear power units) at intervals equal to the RBW extending across the entire OBW of the spectrum.

3.3 OCCUPIED BANDWIDTH.

Test set-up

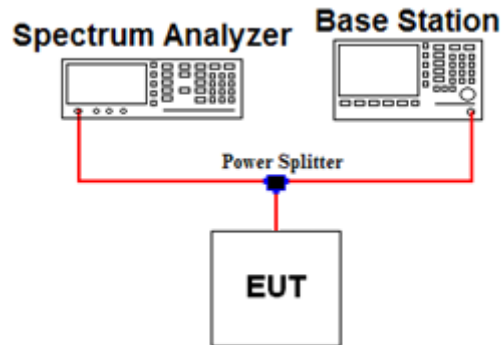

Offset value information

Frequency (MHz)	Offset Value (dB)	Frequency (MHz)	Offset Value (dB)
826.4	7.32	1852.4	7.90
836.6	7.33	1880.0	7.95
846.6	7.33	1907.6	7.98
-	-	-	-

Note. 1: The offset values from EUT to Spectrum analyzer were measured and used for test.

Test Procedure

- KDB971168 v02r02-Section 4.2

The occupied bandwidth, that is the frequency bandwidth such that, below its lower and above its upper frequency limits, the mean powers radiated are each equal to 0.5 percent of the total mean power of a given emission.

Test setting

1. The signal analyzer's automatic bandwidth measurement capability was used to perform the 99 % occupied bandwidth and the 26 dB bandwidth. The bandwidth measurement was not influenced by any intermediate power nulls in the fundamental emission.
2. $RBW = 1 \sim 5 \%$ of the expected OBW & $VBW \geq 3 \times RBW$
3. Detector = Peak
4. Trance mode = Max hold
5. Sweep = Auto couple
6. The trace was allowed to stabilize
7. If necessary, step 2 ~ 6 were repeated after changing the RBW such that it would be within 1 ~ 5 % of the 99 % occupied bandwidth observed in step 6.

3.4 BAND EDGE EMISSIONS AT ANTENNA TERMINAL.

Test set-up

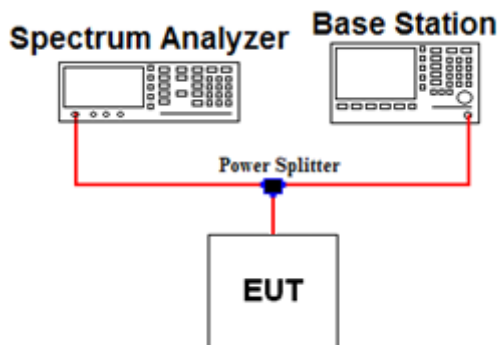

Offset value information

Frequency (MHz)	Offset Value (dB)	Frequency (MHz)	Offset Value (dB)
823.0	7.32	1849.0	7.90
824.0	7.32	1850.0	7.90
849.0	7.34	1910.0	7.98
850.0	7.34	1911.0	7.98
-	-	-	-

Note. 1: The offset value from EUT to Spectrum analyzer was measured and used for test.

Test Procedure

- KDB971168 v02r02 - Section 6.0

All out of band emissions are measured by means of a calibrated spectrum analyzer. The EUT was setup to maximum output power at its lowest and highest channel with all modulations.

The power of any spurious emission shall be attenuated below the transmitter power (P) by at least $43 + 10 \log(P)$ dB, where P is the transmitter power in Watts.

Test setting

1. Start and stop frequency were set such that the band edge would be placed in the center of the plot
2. Span was set large enough so as to capture all out of band emissions near the band edge
3. RBW $\geq 1\%$ of the emission
4. VBW $\geq 3 \times$ RBW
5. Detector = RMS & Trace mode = Max hold
6. Sweep time = Auto couple or 1 s for band edge
7. Number of sweep point $\geq 2 \times$ span / RBW
8. The trace was allowed to stabilize

Note 1: In the 1 MHz bands immediately outside and adjacent to the frequency block a resolution bandwidth of **at least one percent** of the emission bandwidth of the fundamental emission of the transmitter may be employed to demonstrate compliance with the out-of-band emissions limit.

The emission bandwidth is defined as the width of the signal between two points, one below the carrier center frequency and one above the carrier center frequency, outside of which all emission are attenuated at least 26 dB below the transmitter power.

3.5 SPURIOUS AND HARMONIC EMISSIONS AT ANTENNA TERMINAL.

Test set-up

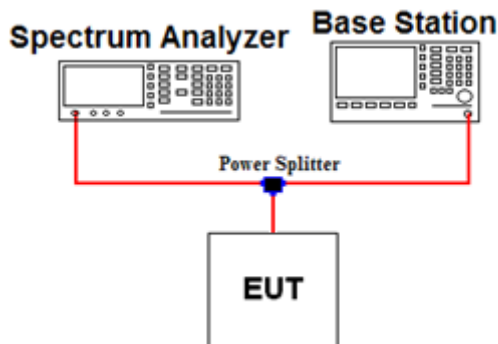

Offset value information

Frequency (MHz)	Offset Value (dB)	Frequency (MHz)	Offset Value (dB)
10000.0	11.98	20000.0	14.31
-	-	-	-
-	-	-	-

Note. 1: The offset value from EUT to Spectrum analyzer was measured and used for test.

Test Procedure

- KDB971168 v02r02 - Section 6.0

The level of the carrier and the various conducted spurious and harmonic frequencies is measured by means of a calibrated spectrum analyzer. The EUT was setup to maximum output power at its low, middle, high channel with all bandwidths. The spectrum is scanned from 9 kHz up to a frequency including its 10th harmonic.

The power of any spurious emission shall be attenuated below the transmitter power (P) by at least $43 + 10 \log(P)$ dB , where P is the transmitter power in Watts.

Test setting

1. RBW = 100 kHz(Below 1 GHz) or 1 MHz(Above 1 GHz) & VBW $\geq 3 \times$ RBW (Refer to Note 1)
2. Detector = RMS & Trace mode = Max hold
3. Sweep time = Auto couple
4. Number of sweep point $\geq 2 \times$ span / RBW
5. The trace was allowed to stabilize

Note 1: Compliance with these provisions is based on the use of measurement instrumentation employing a resolution bandwidth of 100 kHz or greater for Part 22 and 1 MHz or greater for Part 24.

3.6 RADIATED SPURIOUS EMISSIONS

Test Set-up

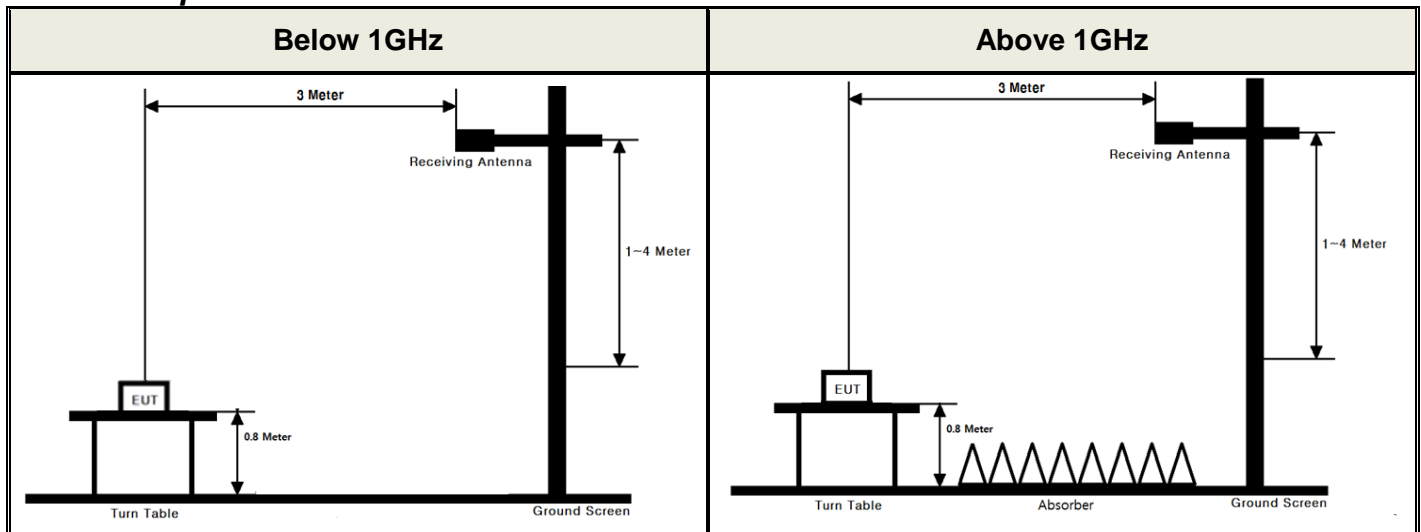

These measurements were performed at 3 m test site. The equipment under test is placed on a non-conductive table 0.8-meters above a turntable which is flush with the ground plane and 3 meters from the receive antenna. For measurements above 1GHz absorbers are placed on the floor between the turn table and the antenna mast in such a way so as to maximize the reduction of reflections. For measurements below 1 GHz, the absorbers are removed.

Test Procedure

- ANSI/TIA-603-E-2016 - Section 2.2.12
- KDB971168 v02r02 - Section 5.8

Test setting

1. RBW = 100 kHz for below 1 GHz and 1 MHz for above 1 GHz / VBW \geq 3 X RBW
2. Detector = RMS & Trace mode = Max hold
3. Sweep time = Auto couple
4. Number of sweep point \geq 2 X span / RBW
5. The trace was allowed to stabilize

The receive antenna height and turntable rotations were adjusted for the highest reading on the receive spectrum analyzer.

For radiated spurious emission measurements below 1 GHz, a half-wave dipole was substituted in place of the EUT. This dipole antenna was driven by a signal generator and the level of the signal generator was adjusted to obtain the same spectrum analyzer reading.

For radiated spurious emission measurements above 1 GHz, a Horn antenna was substituted in place of the EUT. This Horn antenna was driven by a signal generator and the level of the signal generator was adjusted to obtain the same spectrum analyzer reading. The difference between the gain of the horn and an isotropic antenna are taken into consideration.

This measurement was performed with the EUT oriented in 3 orthogonal axis.

3.7 FREQUENCY STABILITY / VARIATION OF AMBIENT TEMPERATURE

Test Set-up

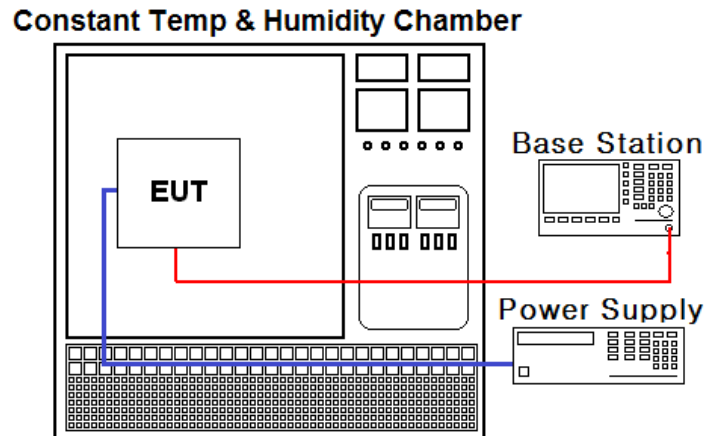

Test Procedure

- ANSI/TIA-603-E-2016
- KDB971168 v02r02 - Section 9.0

The frequency stability of the transmitter is measured by:

- a.) **Temperature:**
The temperature is varied from - 30 °C to + 50 °C in 10 °C increments using an environmental chamber.
- b.) **Primary Supply Voltage:**
The primary supply voltage is varied from 85 % to 115 % of the nominal value for non hand-carried battery and AC powered equipment. For hand-carried, battery-powered equipment, primary supply voltage is reduced to the battery operating end point which shall be specified by the manufacturer.

Specification:

The frequency stability shall be sufficient to ensure that the fundamental emission stays within the authorized frequency block for Part 24. The frequency stability of the transmitter shall be maintained within $\pm 0.00025\%$ (± 2.5 ppm) of the center frequency for Part 22.

Time Period and Procedure:

1. The carrier frequency of the transmitter is measured at room temperature.
(20 °C to provide a reference)
2. The equipment is turned on in a "standby" condition for one minute before applying power to the transmitter. Measurement of the carrier frequency of the transmitter is made within one minute after applying power to the transmitter.
3. Frequency measurements are made at 10 °C intervals ranging from -30 °C to +50 °C.
A period of at least one half-hour is provided to allow stabilization of the equipment at each temperature level.

4. LIST OF TEST EQUIPMENT

Type	Manufacturer	Model	Cal.Date (yy/mm/dd)	Next.Cal. Date (yy/mm/dd)	S/N
Spectrum Analyzer	Agilent Technologies	N9020A	16/10/11	17/10/11	MY46471251
Spectrum Analyzer	Agilent Technologies	N9020A	17/01/11	18/01/11	MY50200828
DC Power Supply	Agilent Technologies	66332A	16/09/08	17/09/08	GB42110550
Multimeter	FLUKE	17B	17/04/12	18/04/12	26030065WS
Power Splitter	Anritsu	K241B	17/01/11	18/01/11	016681
Temp & Humi Test Chamber	SJ Science	SJ-TH-S50	17/01/25	18/01/25	SJ-TH-S50120203
Thermohyrometer	BODYCOM	BJ5478	17/04/11	18/04/11	120612-1
Radio Communication Analyzer	Agilent Technologies	E5515C	16/09/09	17/09/09	GB41321164
Signal Generator	R&S	SMBV100A	17/01/04	18/01/04	255571
Signal Generator	R&S	SMF100A	17/04/21	18/04/21	102341
Loop Antenna	Schwarzbeck	FMZB1513	16/04/22	18/04/22	1513-128
Bilog Antenna	Schwarzbeck	VULB9160	16/11/11	18/11/11	3151
Dipole Antenna	Schwarzbeck	VHA9103	17/03/14	19/03/14	2116
Dipole Antenna	Schwarzbeck	VHA9103	16/04/15	18/04/15	2117
Dipole Antenna	Schwarzbeck	UHA9105	17/03/14	19/03/14	2261
Dipole Antenna	Schwarzbeck	UHA9105	16/04/15	18/04/15	2262
HORN ANT	ETS-LINDGREN	3117	16/02/26	18/02/26	00152145
HORN ANT	ETS-LINDGREN	3117	16/05/03	18/05/03	00140394
HORN ANT	A.H.Systems	SAS-574	17/04/25	19/04/25	154
HORN ANT	A.H.Systems	SAS-574	15/09/03	17/09/03	155
Amplifier	EMPOWER	BBS3Q7ELU	16/09/08	17/09/08	1020
PreAmplifier	tsj	MLA-010K01-B01-27	17/03/06	18/03/06	1844539
Amplifier	Agilent	8449B	16/10/19	17/10/19	3008A02108
High-pass filter	Wainwright	WHKX12-935-1000-15000-40SS	16/09/09	17/09/09	7
High-pass filter	Wainwright	WHKX12-2580-3000-18000-80SS	16/09/09	17/09/09	3

5. SUMMARY OF TEST RESULTS

FCC Part Section(s)	RSS Section(s)	Parameter	Status Note 1
2.1046	-	Conducted Output Power	C ^{Note 2}
22.913(a) 24.232(c)	RSS-132 [5.4] RSS-133 [6.4]	Effective Radiated Power Equivalent Isotropic Radiated Power	C
22.917(a) 24.238(a) 2.1049	RSS-Gen [6.6]	Occupied Bandwidth	C
22.917(a) 24.238(a) 2.1051	RSS-132 [5.5] RSS-133 [6.5]	Band Edge Spurious and Harmonic Emissions at Antenna Terminal	C
24.232(d)	RSS-132 [5.4] RSS-133 [6.4]	Peak to Average Ratio	C
22.917(a) 24.238(a) 2.1053	RSS-132 [5.5] RSS-133 [6.5]	Radiated Spurious and Harmonic Emissions	C
22.355 24.235 2.1055	RSS-132 [5.3] RSS-133 [6.3]	Frequency Stability	C
Note 1: C =Comply NC =Not Comply NT =Not Tested NA =Not Applicable Note 2: Refer to RF Exposure Report (SAR_Test_Report)			

6. SAMPLE CALCULATION

A. Emission Designator

WCDMA850 Emission Designator

Emission Designator = **4M17F9W**
 WCDMA OBW = 4.1661 MHz
 (Measured at the 99.75 % power bandwidth)
 F = Frequency Modulation
 9 = Composite Digital Information
 W = Combination (Audio/Data)

WCDMA1900 Emission Designator

Emission Designator = **4M21F9W**
 WCDMA OBW = 4.2079 MHz
 (Measured at the 99.75 % power bandwidth)
 F = Frequency Modulation
 9 = Composite Digital Information
 W = Combination (Audio/Data)

HSUPA850 Emission Designator

Emission Designator = **4M17F9W**
 HSUPA OBW = 4.1661 MHz
 (Measured at the 99.75 % power bandwidth)
 F = Frequency Modulation
 9 = Composite Digital Information
 W = Combination (Audio/Data)

HSUPA1900 Emission Designator

Emission Designator = **4M18F9W**
 HSUPA OBW = 4.1843 MHz
 (Measured at the 99.75 % power bandwidth)
 F = Frequency Modulation
 9 = Composite Digital Information
 W = Combination (Audio/Data)

B. For substitution method

MODE	Channel	Freq.(MHz)	Spectrum Reading Value(dBm)	EUT Axis	Ant Pol (H/V)	Level(dBm) @ Ant Terminal	TX Ant Gain(dBi)	EIRP	
								(dBm)	(W)
WCDMA1900	9400	1880.0	-27.15	Z	V	16.12	4.92	21.04	0.127

ERP or EIRP = Level @ Ant Terminal LEVEL(dBm) + Tx Ant. Gain

- 1) The EUT mounted on a non-conductive turntable is 0.8 meter above test site ground level.
- 2) During the test, the turn table is rotated until the maximum signal is found.
- 3) Record the field strength meter's level.
- 4) Replace the EUT with dipole/Horn antenna that is connected to a calibrated signal generator.
- 5) Increase the signal generator output till the field strength meter's level is equal to the item (3).
- 6) The signal generator output level with substituted antenna gain is the rating of ERP, EIRP or Radiated spurious emission.

7. TEST DATA

7.1 PEAK TO AVERAGE RATIO

- Plots of the EUT's Peak- to- Average Ratio are shown in Clause 8.1

7.2 OCCUPIED BANDWIDTH

Band	Channel	Frequency	Test Result (kHz)
WCDMA850	4132	826.4	4138.50
	4183	836.6	4150.70
	4233	846.6	4166.10
HSUPA850	4132	826.4	4155.30
	4183	836.6	4146.50
	4233	846.6	4166.10
WCDMA1900	9262	1852.4	4176.10
	9400	1880.0	4207.90
	9538	1907.6	4185.60
HSUPA1900	9262	1852.4	4177.80
	9400	1880.0	4184.30
	9538	1907.6	4169.30

- Plots of the EUT's Occupied Bandwidth are shown in Clause 8.2

7.3 SPURIOUS AND HARMONIC EMISSIONS AT ANTENNA TERMINAL

- Plots of the EUT's Conducted Spurious Emissions are shown in Clause 8.3

7.4 BAND EDGE

- Plots of the EUT's Band Edge are shown in Clause 8.4

7.5 Effective Radiated Power

- WCDMA850 data

Freq(MHz) CH	EUT Position (Axis)	Test mode 12.2 kbps RMC						
		Pol. (H/V)	LEVEL@ TX ANTENNA TERMINAL (dBm)	Antenna Gain (dBd)	ERP (dBm)	ERP (W)	Rated Voltage	Note.
826.4 4132	Z	H	21.54	1.23	22.77	0.189	DC 3.85V	-
836.6 4183	Z	H	20.55	1.22	21.77	0.150	DC 3.85V	-
846.6 4233	X	H	20.35	1.21	21.56	0.143	DC 3.85V	-

- HSUPA850 data

Freq(MHz) CH	EUT Position (Axis)	Test mode subtest 1						
		Pol. (H/V)	LEVEL@ TX ANTENNA TERMINAL (dBm)	Antenna Gain (dBd)	ERP (dBm)	ERP (W)	Rated Voltage	Note.
826.4 4132	Z	H	20.52	1.23	21.75	0.150	DC 3.85V	-
836.6 4183	Z	H	19.93	1.22	21.15	0.130	DC 3.85V	-
846.6 4233	Z	H	19.70	1.21	20.91	0.123	DC 3.85V	-

NOTES:

This EUT was tested under all configurations and the highest power is reported in WCDMA mode with HSDPA inactive at 12.2 kbps RMC and TPC bits set to "1" and HSUPA mode with 12.2 kbps + HSPA and subtest 1. Also, we have done x plane in EUT and horizontal and vertical polarization of detecting antenna.

The worst case data is reported.

7.6 Equivalent Isotropic Radiated Power

- WCDMA1900 data

Freq(MHz) CH	EUT Position (Axis)	Test mode 12.2 kbps RMC						
		Pol. (H/V)	LEVEL@ TX ANTENNA TERMINAL (dBm)	Antenna Gain (dBi)	EIRP (dBm)	EIRP (W)	Rated Voltage	Note.
1852.4 9262	Y	H	17.75	5.06	22.81	0.191	DC 3.85V	-
1880.0 9400	Z	V	16.12	4.92	21.04	0.127	DC 3.85V	-
1907.6 9538	Z	V	16.47	4.77	21.24	0.133	DC 3.85V	-

- HSUPA1900 data

Freq(MHz) CH	EUT Position (Axis)	Test mode subtest 1						
		Pol. (H/V)	LEVEL@ TX ANTENNA TERMINAL (dBm)	Antenna Gain (dBi)	EIRP (dBm)	EIRP (W)	Rated Voltage	Note.
1852.4 9262	Z	V	18.69	5.06	23.75	0.237	DC 3.85V	-
1880.0 9400	Y	H	16.38	4.92	21.30	0.135	DC 3.85V	-
1907.6 9538	Y	H	17.08	4.77	21.85	0.153	DC 3.85V	-

NOTES:

This EUT was tested under all configurations and the highest power is reported in WCDMA mode with HSDPA inactive at 12.2 kbps RMC and TPC bits set to "1" and HSUPA mode with 12.2 kbps + HSPA and subtest 1. Also, we have done x plane in EUT and horizontal and vertical polarization of detecting antenna.

The worst case data is reported.

7.7 RADIATED SPURIOUS EMISSIONS

7.7.1 RADIATED SPURIOUS EMISSIONS (WCDMA850)

Channel (ERP)	Freq. (MHz)	EUT Position (Axis)	POL (H/V)	LEVEL@ ANTENNA TERMINAL (dBm)	Substitute Antenna Gain (dBd)	Correct Generator Level (dBm)	Result (dBc)	Limit (dBc)
4132 (0.189 W)	1655.29	Y	H	-49.12	3.78	-45.34	68.11	35.77
	2483.00	Y	V	-48.75	4.05	-44.70	67.47	
4183 (0.150 W)	1671.46	Y	H	-49.18	3.78	-45.40	67.17	34.77
	2511.07	X	H	-50.20	4.04	-46.16	67.93	
4233 (0.143 W)	1690.89	Y	H	-47.65	3.79	-43.86	65.42	34.56
	2536.81	Y	V	-47.83	4.05	-43.78	65.34	

- Limit Calculation= $43 + 10 \log_{10}(\text{ERP [W]})$ [dBc]

- No other spurious and harmonic emissions were reported greater than listed emissions above table.

NOTES:

This EUT was tested under all configurations and the highest power is reported in WCDMA mode with HSDPA inactive at 12.2 kbps RMC and TPC bits set to "1" and HSUPA mode with 12.2 kbps + HSPA and subtest 1. Also, we have done x plane in EUT and horizontal and vertical polarization of detecting antenna.

The worst case data is reported.

7.7.2 RADIATED SPURIOUS EMISSIONS (HSUPA850)

Channel (ERP)	Freq. (MHz)	EUT Position (Axis)	POL (H/V)	LEVEL@ ANTENNA TERMINAL (dBm)	Substitute Antenna Gain (dBd)	Correct Generator Level (dBm)	Result (dBc)	Limit (dBc)
4132 (0.150 W)	1654.37	Y	H	-50.67	3.78	-46.89	68.64	34.75
	2482.88	X	H	-49.82	4.05	-45.77	67.52	
4183 (0.130 W)	1672.84	Y	H	-53.71	3.78	-49.93	71.08	34.15
	2513.76	X	H	-50.69	4.05	-46.64	67.79	
4233 (0.123 W)	1690.90	Z	V	-54.23	3.79	-50.44	71.35	33.91
	2537.14	Y	V	-48.61	4.05	-44.56	65.47	

- Limit Calculation= $43 + 10 \log_{10}(\text{ERP [W]})$ [dBc]

- No other spurious and harmonic emissions were reported greater than listed emissions above table.

NOTES:

This EUT was tested under all configurations and the highest power is reported in WCDMA mode with HSDPA inactive at 12.2 kbps RMC and TPC bits set to "1" and HSUPA mode with 12.2 kbps + HSPA and subtest 1. Also, we have done x plane in EUT and horizontal and vertical polarization of detecting antenna.

The worst case data is reported.

7.7.3 RADIATED SPURIOUS EMISSIONS (WCDMA1900)

Channel (EIRP)	Freq. (MHz)	EUT Position (Axis)	POL (H/V)	LEVEL@ ANTENNA TERMINAL (dBm)	Substitute Antenna Gain (dBi)	Correct Generator Level (dBm)	Result (dBc)	Limit (dBc)
9262 (0.191 W)	3703.29	Z	V	-52.13	8.49	-43.64	66.45	35.81
	-	-	-	-	-	-	-	
	-	-	-	-	-	-	-	
9400 (0.127 W)	3761.70	Z	V	-53.07	8.51	-44.56	65.60	34.04
	-	-	-	-	-	-	-	
	-	-	-	-	-	-	-	
9538 (0.133 W)	3816.38	Z	V	-53.59	8.55	-45.04	66.28	34.24
	-	-	-	-	-	-	-	
	-	-	-	-	-	-	-	

- Limit Calculation = $43 + 10 \log_{10}(\text{EIRP [W]})$ [dBc]

- No other spurious and harmonic emissions were reported greater than listed emissions above table.

NOTES:

This EUT was tested under all configurations and the highest power is reported in WCDMA mode with HSDPA inactive at 12.2 kbps RMC and TPC bits set to "1" and HSUPA mode with 12.2 kbps + HSPA and subtest 1. Also, we have done x plane in EUT and horizontal and vertical polarization of detecting antenna.

The worst case data is reported.

7.7.4 RADIATED SPURIOUS EMISSIONS (HSUPA1900)

Channel (EIRP)	Freq. (MHz)	EUT Position (Axis)	POL (H/V)	LEVEL@ ANTENNA TERMINAL (dBm)	Substitute Antenna Gain (dBi)	Correct Generator Level (dBm)	Result (dBc)	Limit (dBc)
9262 (0.237 W)	3704.13	Z	V	-51.53	8.49	-43.04	66.79	36.75
	-	-	-	-	-	-	-	
	-	-	-	-	-	-	-	
9400 (0.135 W)	3761.12	Z	V	-51.42	8.51	-42.91	64.21	34.30
	-	-	-	-	-	-	-	
	-	-	-	-	-	-	-	
9538 (0.153 W)	3816.89	Z	V	-53.43	8.55	-44.88	66.73	34.85
	-	-	-	-	-	-	-	
	-	-	-	-	-	-	-	

- Limit Calculation = $43 + 10 \log_{10}(\text{EIRP [W]})$ [dBc]

- No other spurious and harmonic emissions were reported greater than listed emissions above table.

NOTES:

This EUT was tested under all configurations and the highest power is reported in WCDMA mode with HSDPA inactive at 12.2 kbps RMC and TPC bits set to "1" and HSUPA mode with 12.2 kbps + HSPA and subtest 1. Also, we have done x plane in EUT and horizontal and vertical polarization of detecting antenna.

The worst case data is reported.

7.8 FREQUENCY STABILITY / VARIATION OF AMBIENT TEMPERATURE

7.8.1 FREQUENCY STABILITY (WCDMA850)

OPERATING FREQUENCY : 836,600,000 Hz
 CHANNEL : 4183(Mid)
 REFERENCE VOLTAGE : 3.85 V DC
 DEVIATION LIMIT(FCC & IC) : ± 0.00025 % or 2.5 ppm

VOLTAGE (%)	POWER (V DC)	TEMP (°C)	FREQ (Hz)	Deviation	
				(ppm)	(%)
100%	3.85	+20(Ref)	836,599,999	-0.001	-0.00000012
100%		-30	836,600,003	0.004	0.00000036
100%		-20	836,599,996	-0.005	-0.00000048
100%		-10	836,599,998	-0.002	-0.00000024
100%		0	836,599,997	-0.004	-0.00000036
100%		+10	836,600,001	0.001	0.00000012
100%		+20	836,599,999	-0.001	-0.00000012
100%		+30	836,600,001	0.001	0.00000012
100%		+40	836,600,001	0.001	0.00000012
100%		+50	836,599,998	-0.002	-0.00000024
115%	4.37	+20	836,599,999	-0.001	-0.00000012
BATT.ENDPOINT	3.40	+20	836,600,004	0.005	0.00000048

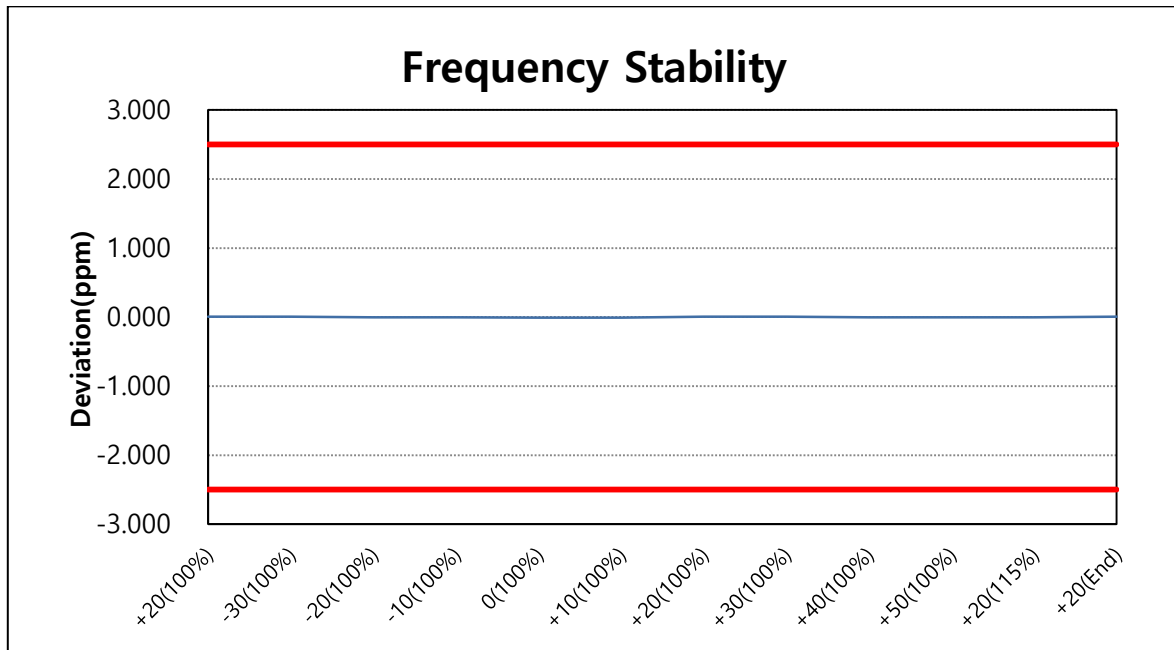

7.8.2 FREQUENCY STABILITY (WCDMA1900)

OPERATING FREQUENCY : 1,880,000,000 Hz
 CHANNEL : 9400(Mid)
 REFERENCE VOLTAGE : 3.85 V DC
 LIMIT(FCC) : The frequency stability shall be sufficient to ensure that the fundamental emission stays within the authorized frequency block.
 DEVIATION LIMIT(IC) : ± 0.00025 % or 2.5 ppm

VOLTAGE (%)	POWER (V DC)	TEMP (°C)	FREQ (Hz)	Deviation	
				(ppm)	(%)
100%	3.85	+20(Ref)	1,879,999,993	-0.004	-0.00000037
100%		-30	1,879,999,994	-0.003	-0.00000032
100%		-20	1,879,999,999	-0.001	-0.00000005
100%		-10	1,880,000,002	0.001	0.00000011
100%		0	1,879,999,998	-0.001	-0.00000011
100%		+10	1,879,999,999	-0.001	-0.00000005
100%		+20	1,879,999,993	-0.004	-0.00000037
100%		+30	1,879,999,994	-0.003	-0.00000032
100%		+40	1,880,000,002	0.001	0.00000011
100%		+50	1,879,999,999	-0.001	-0.00000005
115%	4.37	+20	1,879,999,997	-0.002	-0.00000016
BATT.ENDPOINT	3.40	+20	1,879,999,995	-0.003	-0.00000027

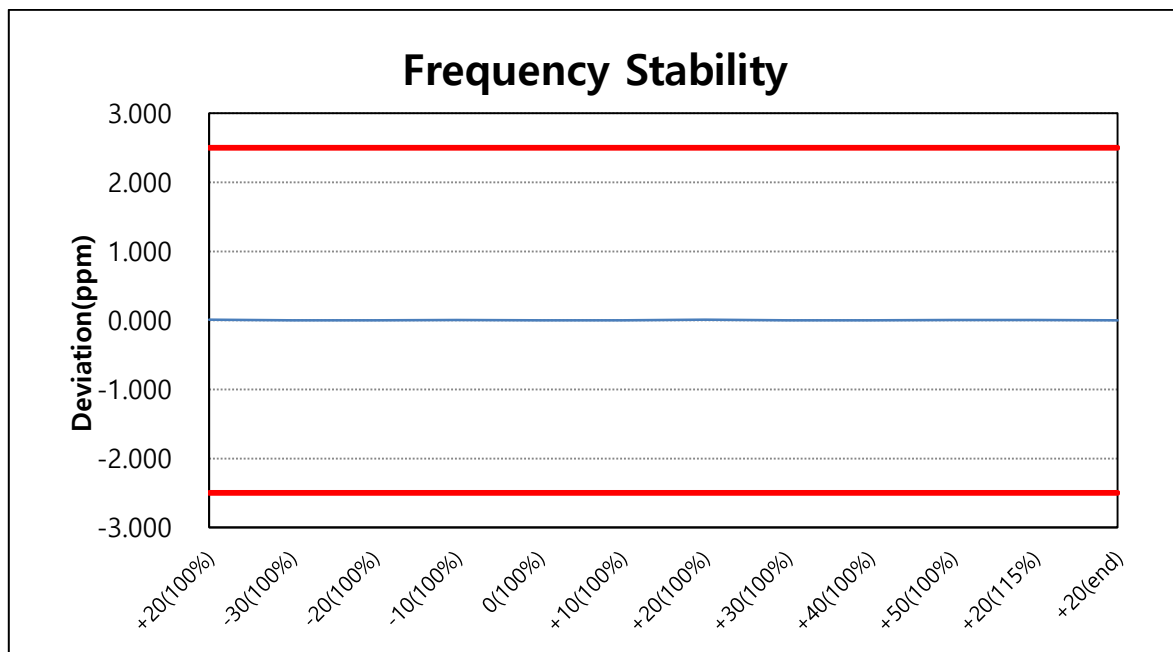

Note. Based on the results of the frequency stability test at the center channel the frequency deviation results measured are very small. as such it is determined that the channels at the band edge would remain inband when the maximum measured frequency deviation noted during the frequency stability tests is applied. therefore the device is determined to remain operating in band over the temperature and voltage range as tested.

8. TEST PLOTS

8.1 Peak to Average Ratio

WCDMA850 & Channel: 4183

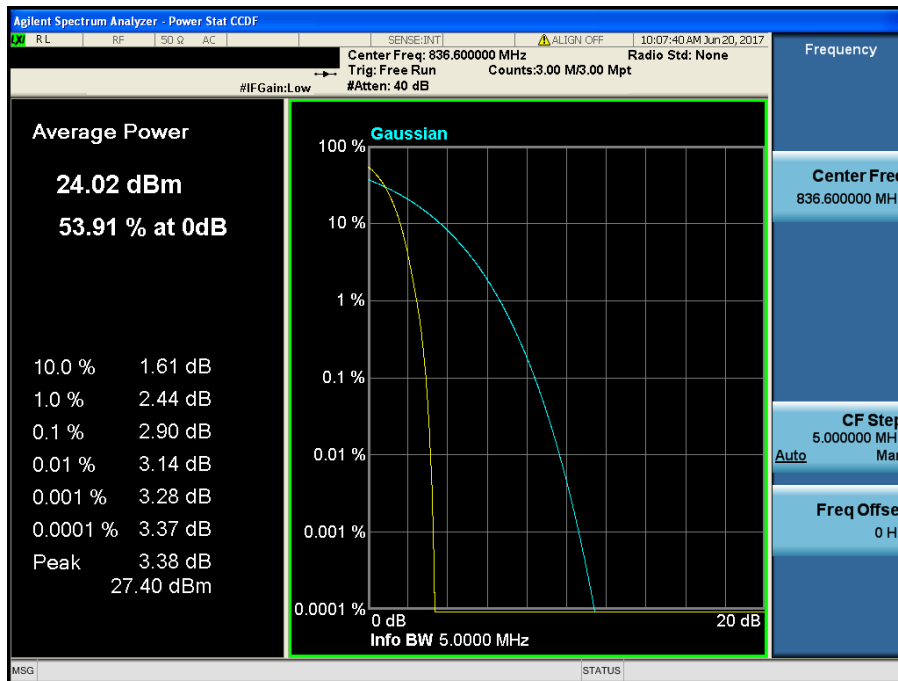

HSUPA850 & Channel: 4183

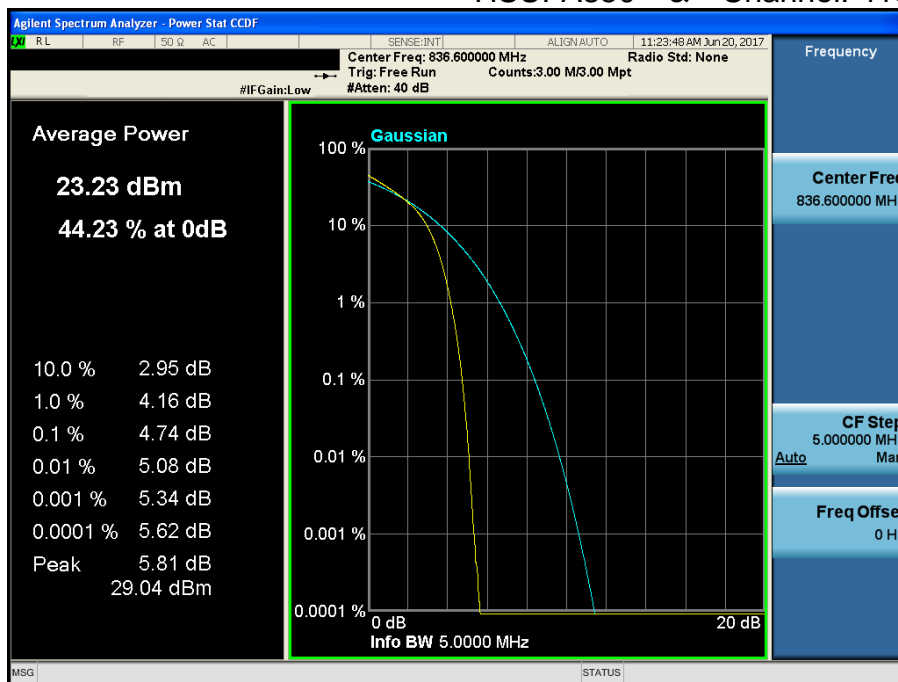

WCDMA1900 & Channel: 9400

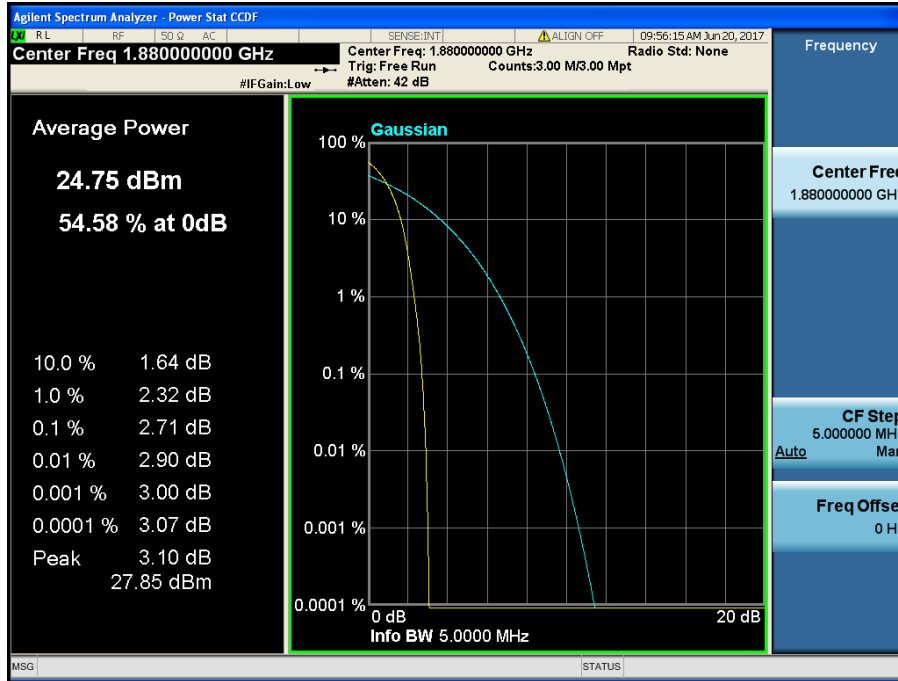

HSUPA1900 & Channel: 9400

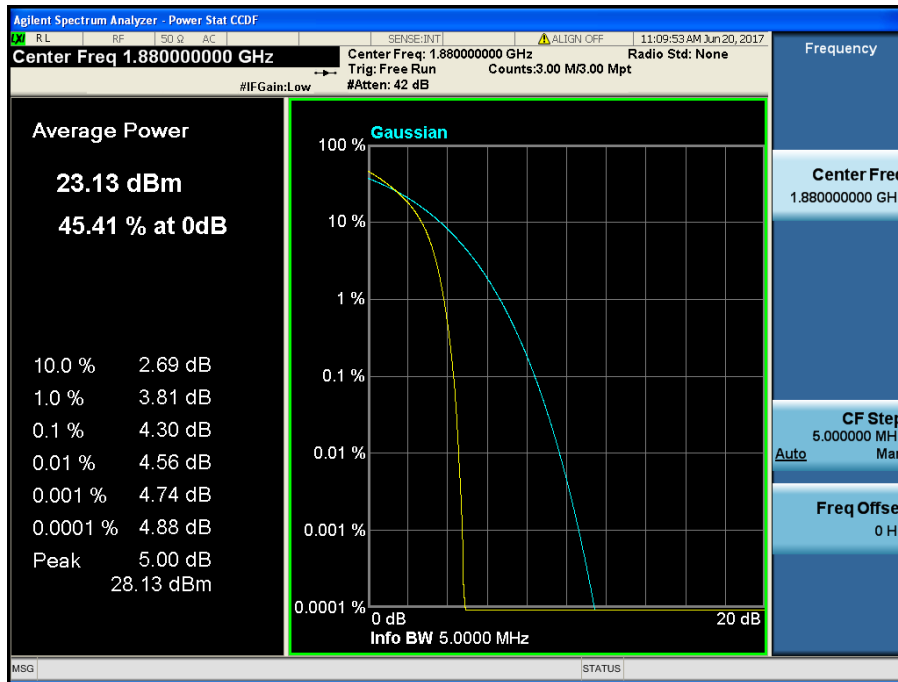

8.2 Occupied Bandwidth (99 % Bandwidth)

WCDMA850 & Channel: 4132

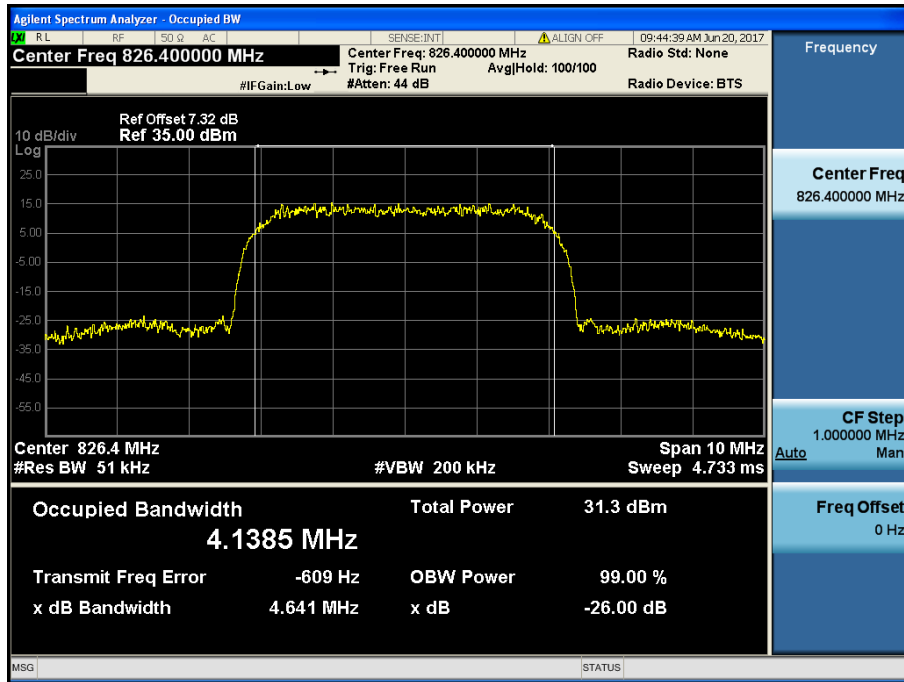

WCDMA850 & Channel: 4183

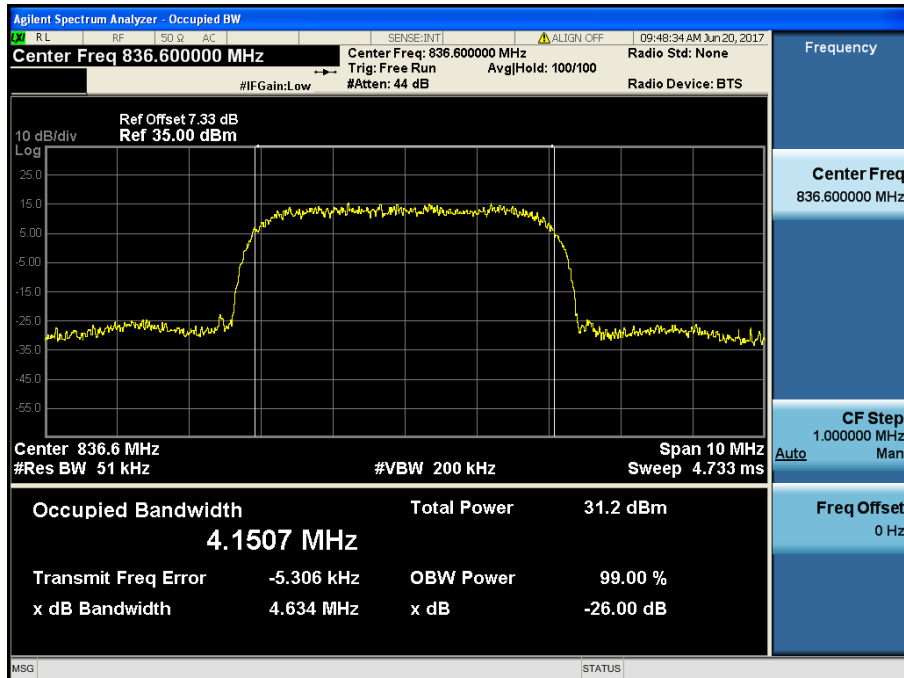

WCDMA850 & Channel: 4233

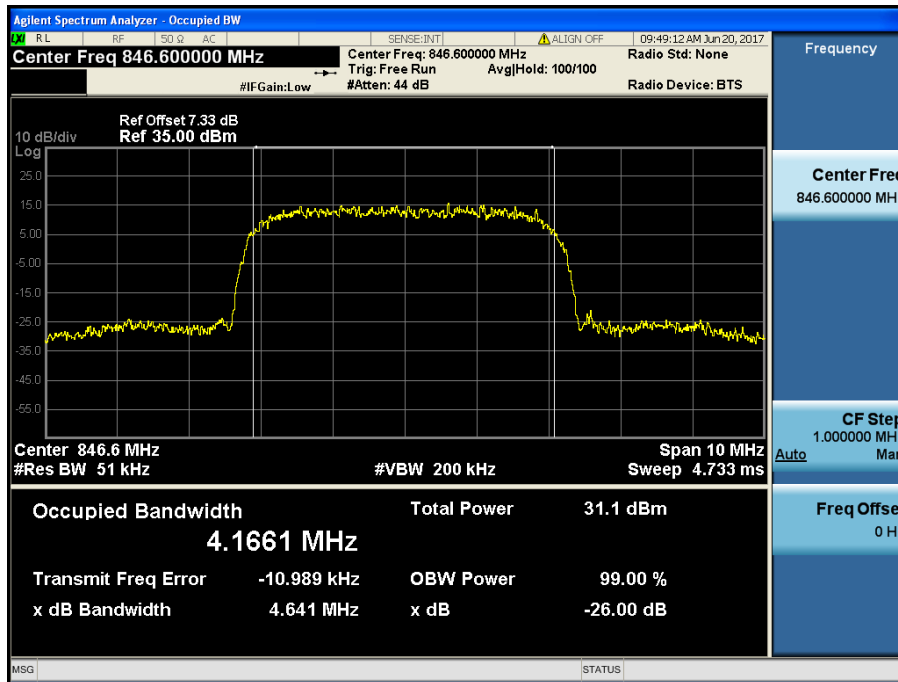

HSUPA850 & Channel: 4132

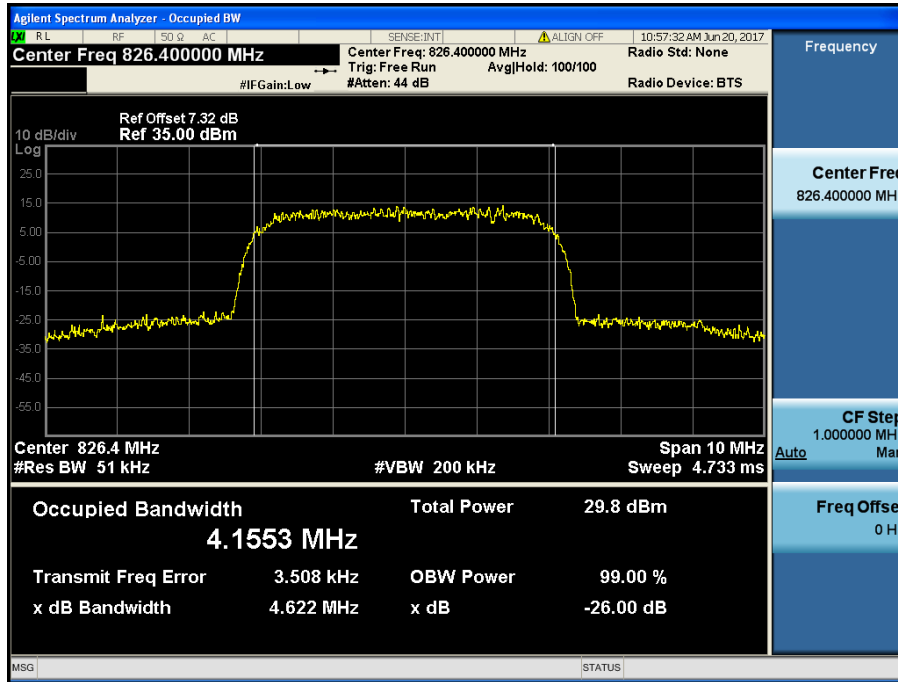

HSUPA850 & Channel: 4183

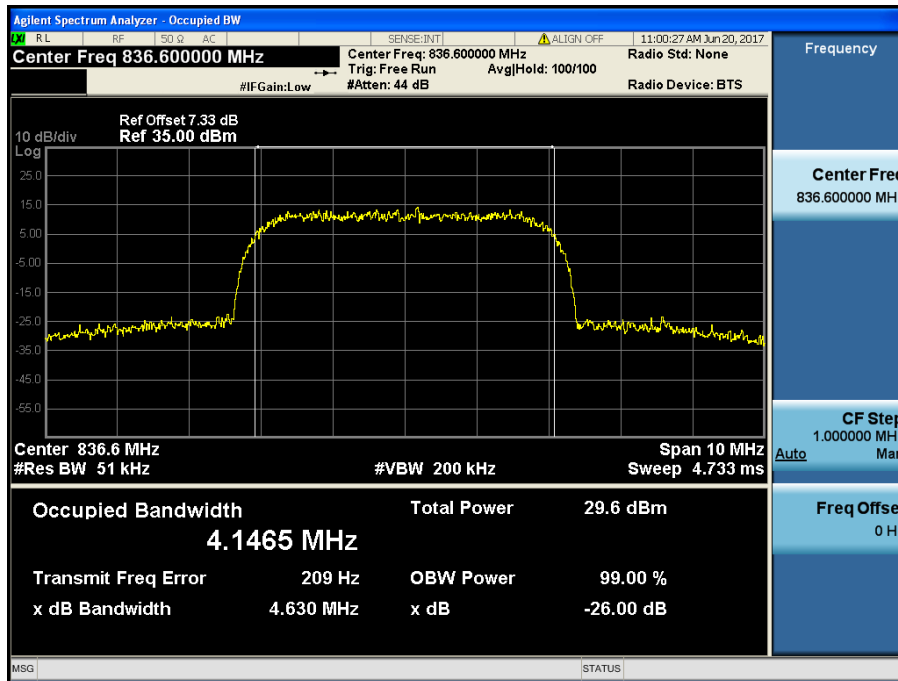

HSUPA850 & Channel: 4233

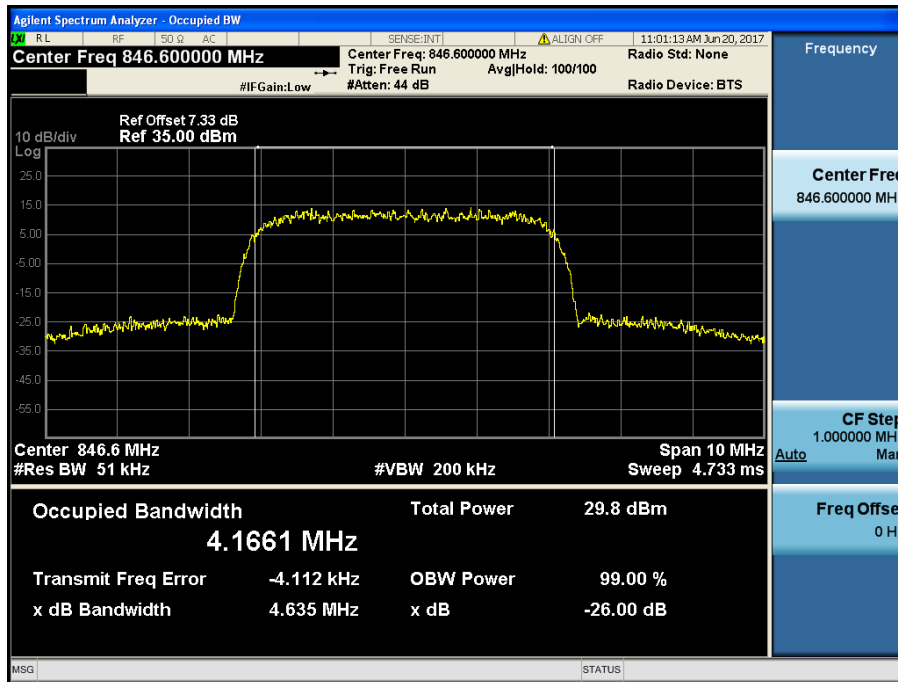

WCDMA1900 & Channel: 9262

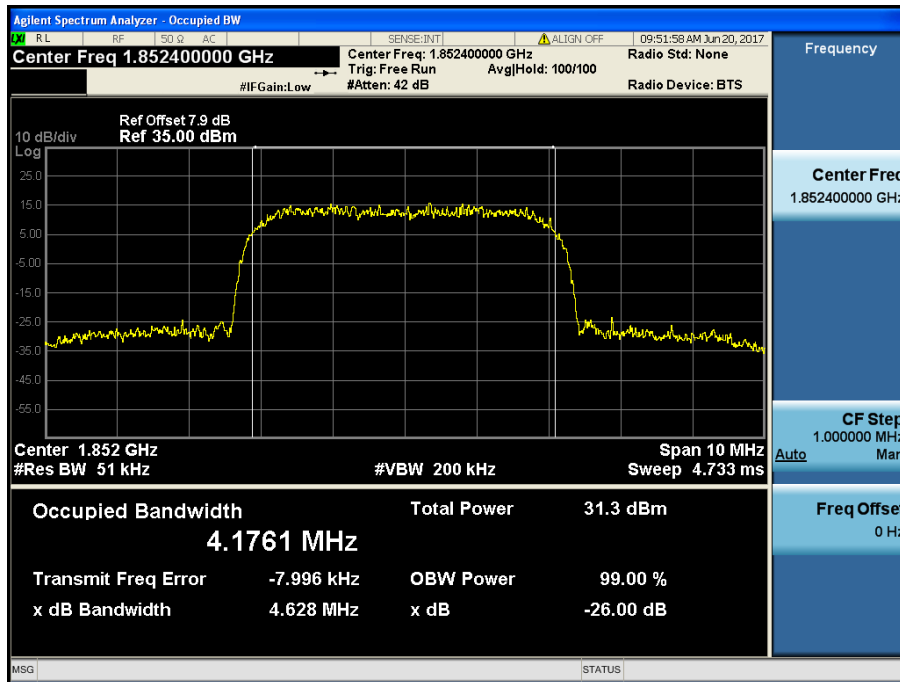

WCDMA1900 & Channel: 9400

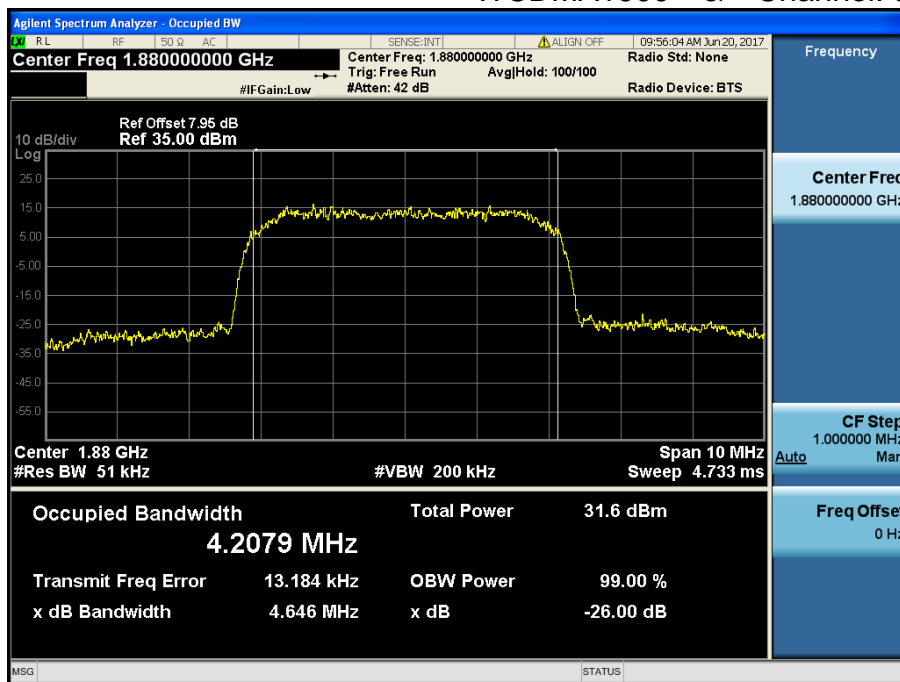

WCDMA1900 & Channel: 9538

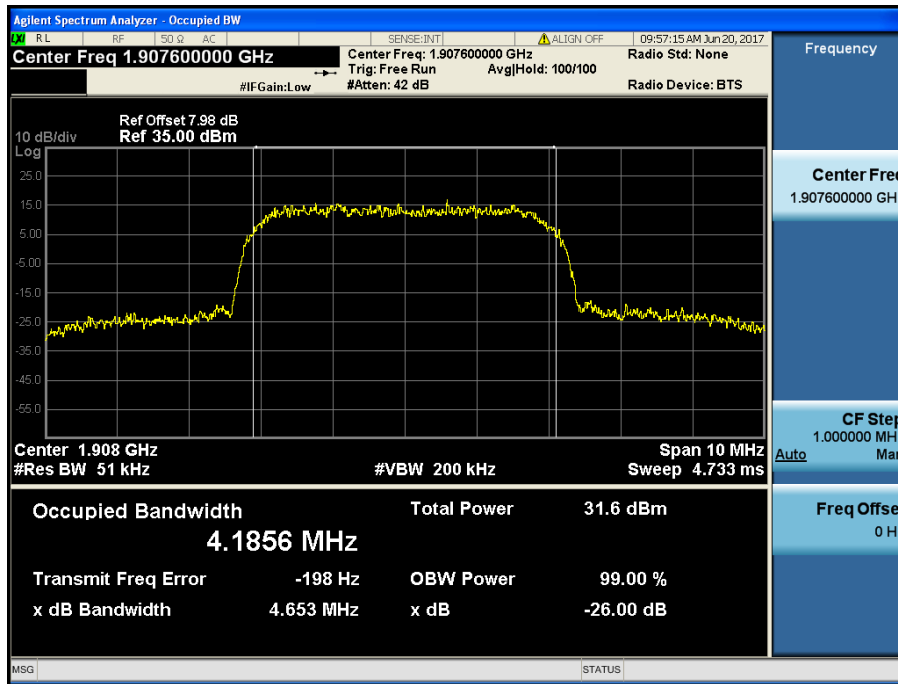

HSUPA1900 & Channel: 9262

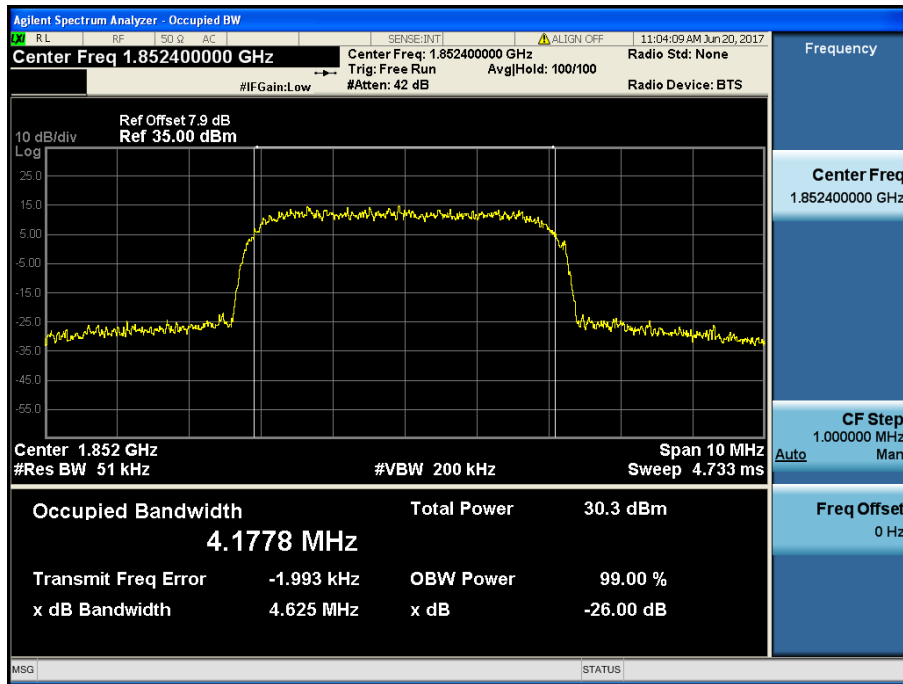

HSUPA1900 & Channel: 9400

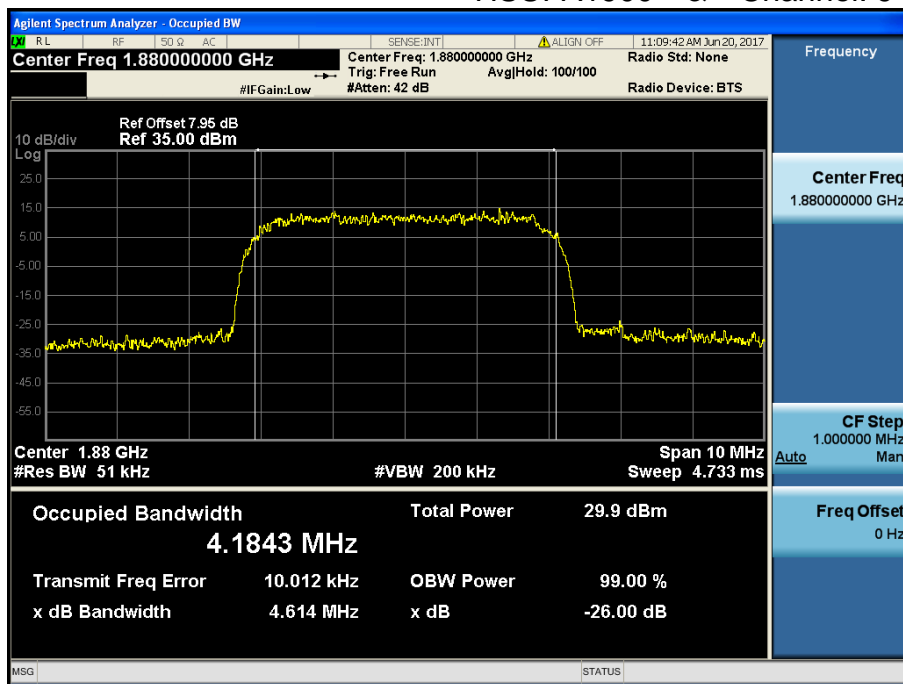

HSUPA1900 & Channel: 9538

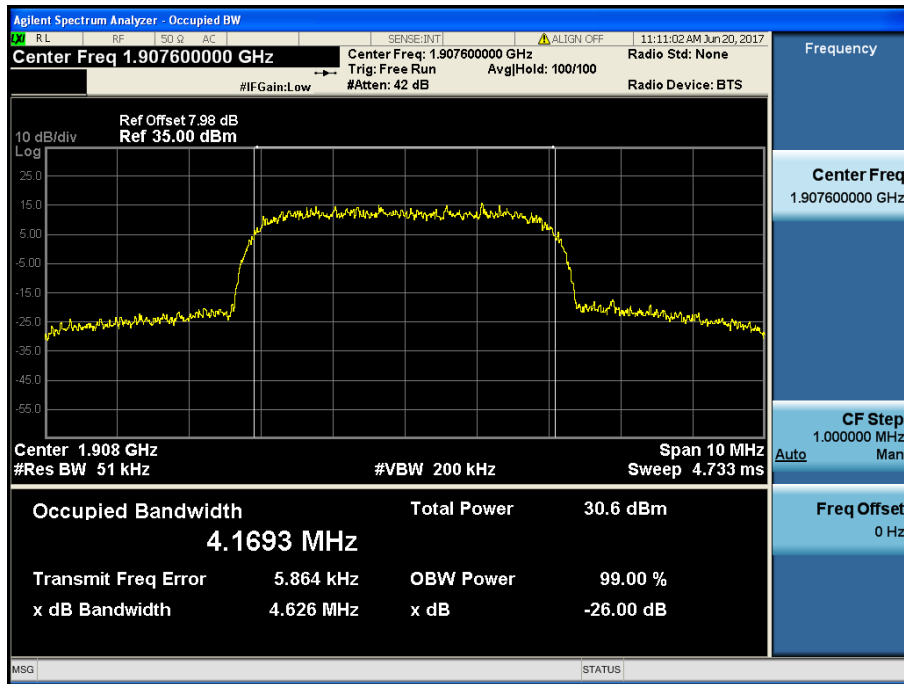

8.3 Spurious Emissions at Antenna Terminal

WCDMA850 & Channel: 4132

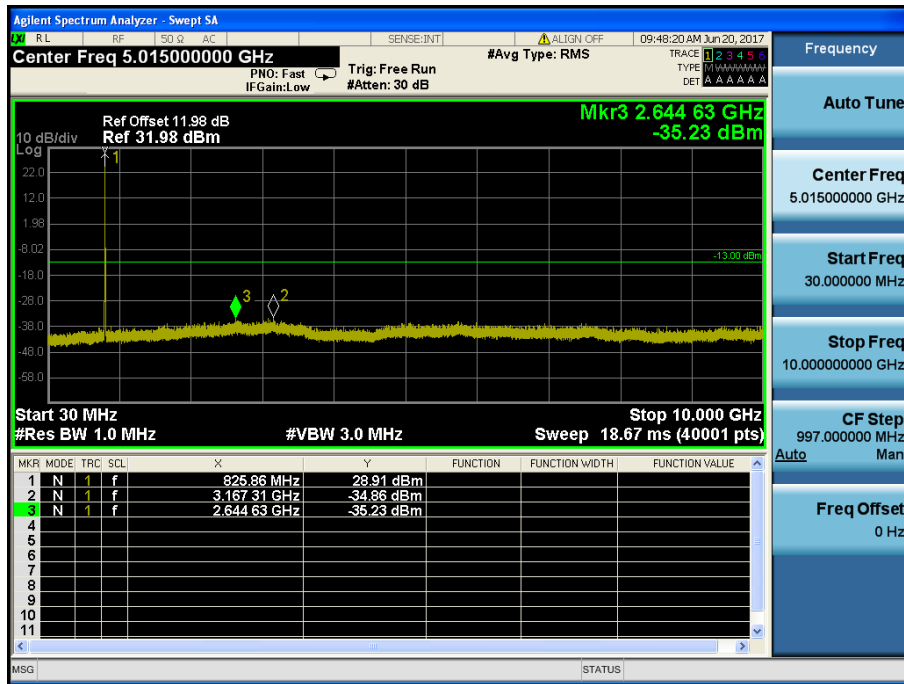

WCDMA850 & Channel: 4183

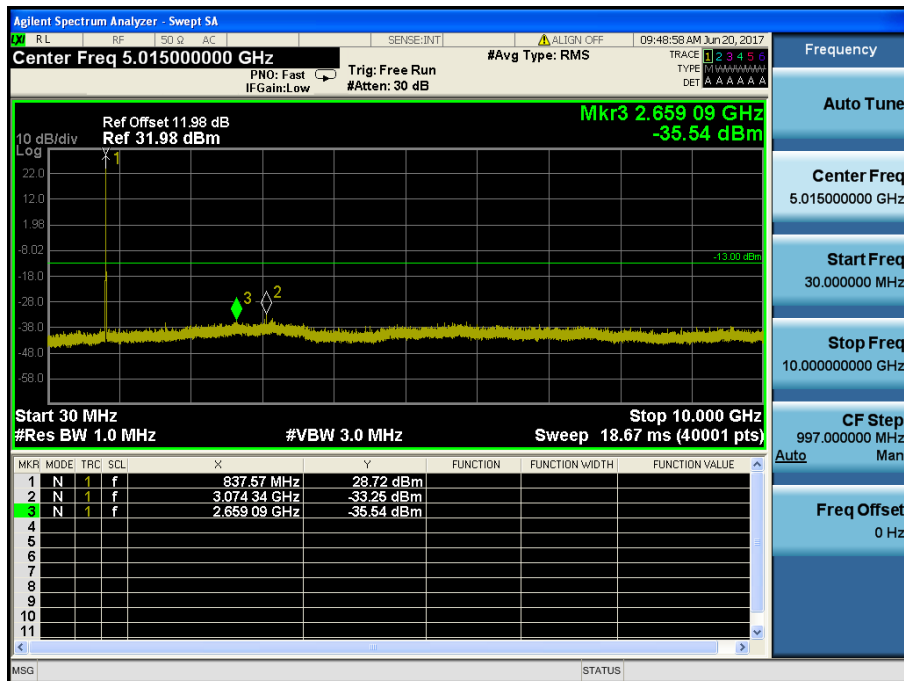

WCDMA850 & Channel: 4233

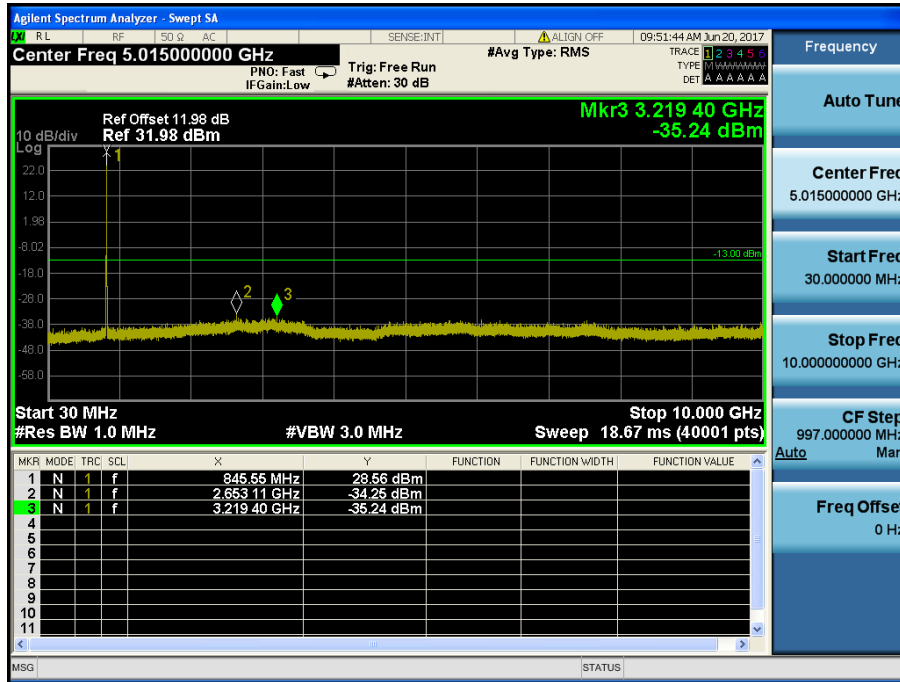

HSUPA850 & Channel: 4132

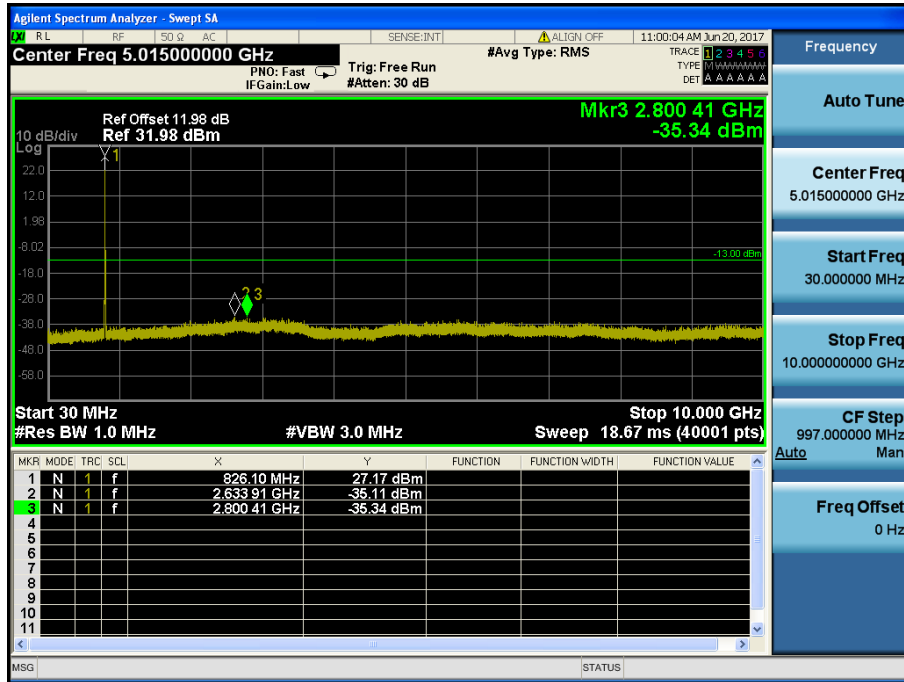

HSUPA850 & Channel: 4183

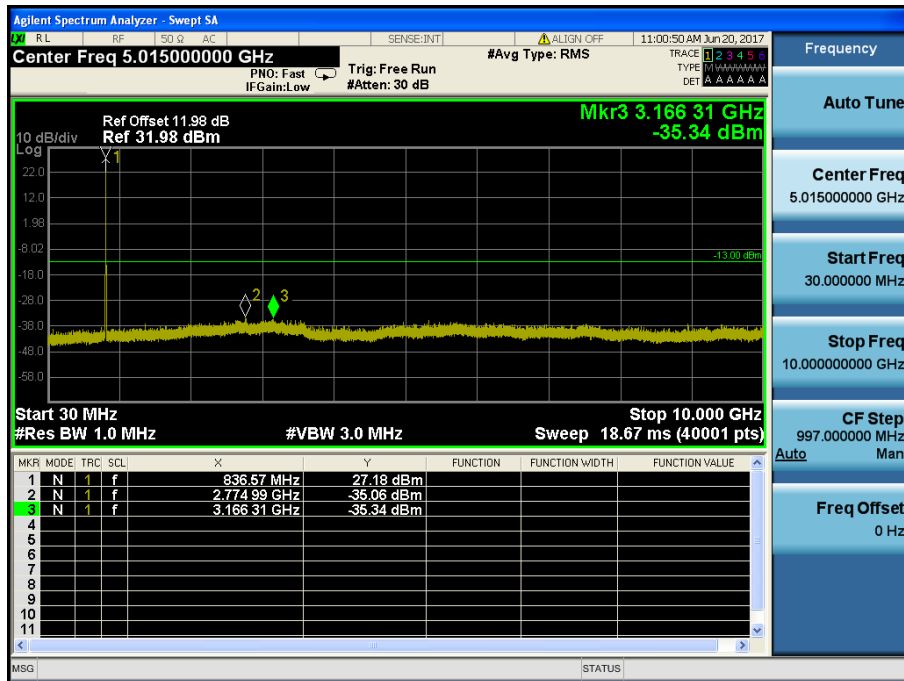

HSUPA850 & Channel: 4233

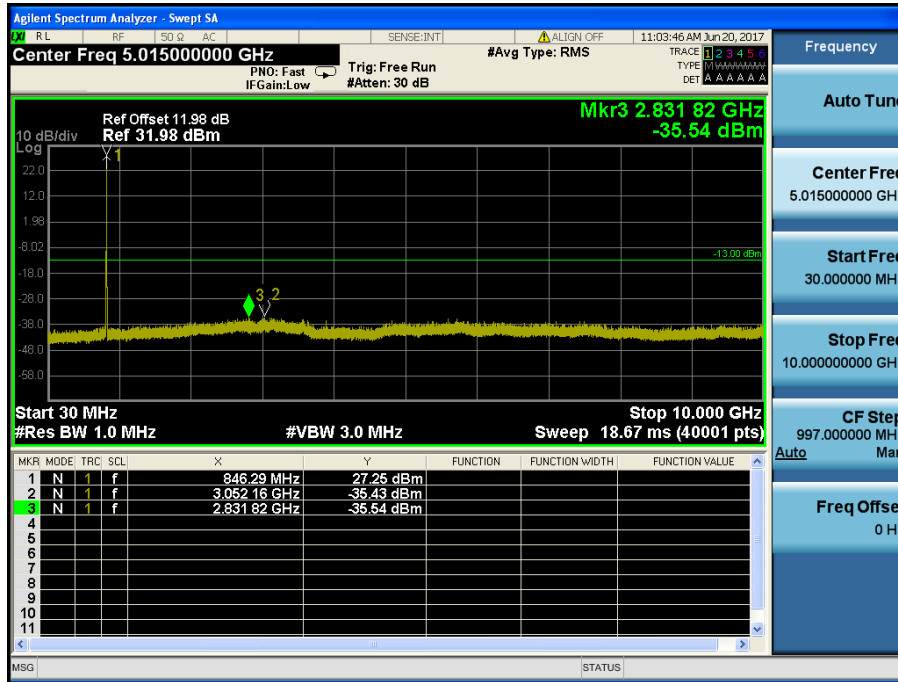

WCDMA1900 & Channel: 9262

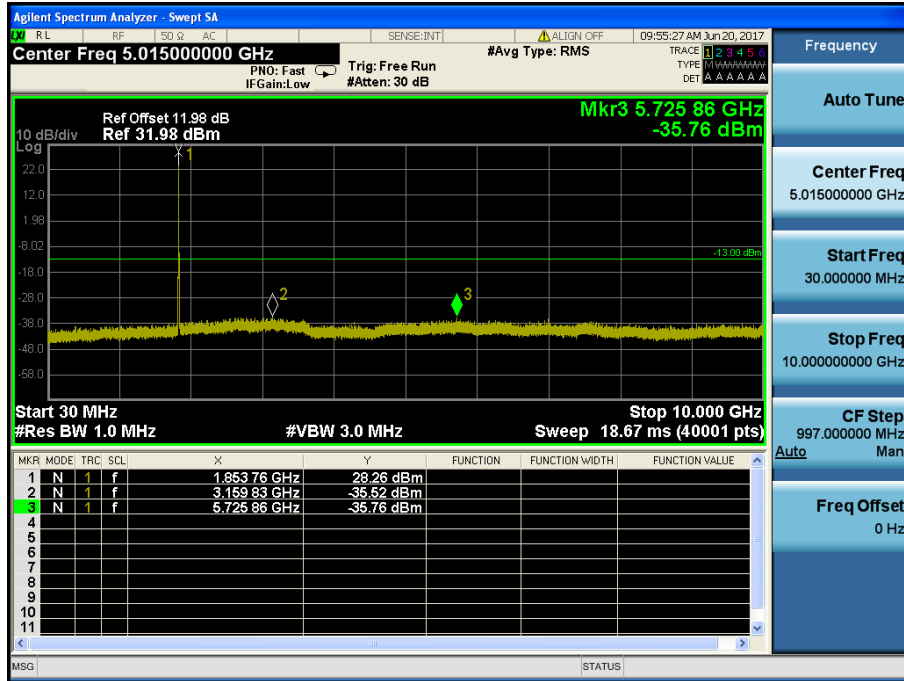

WCDMA1900 & Channel: 9262

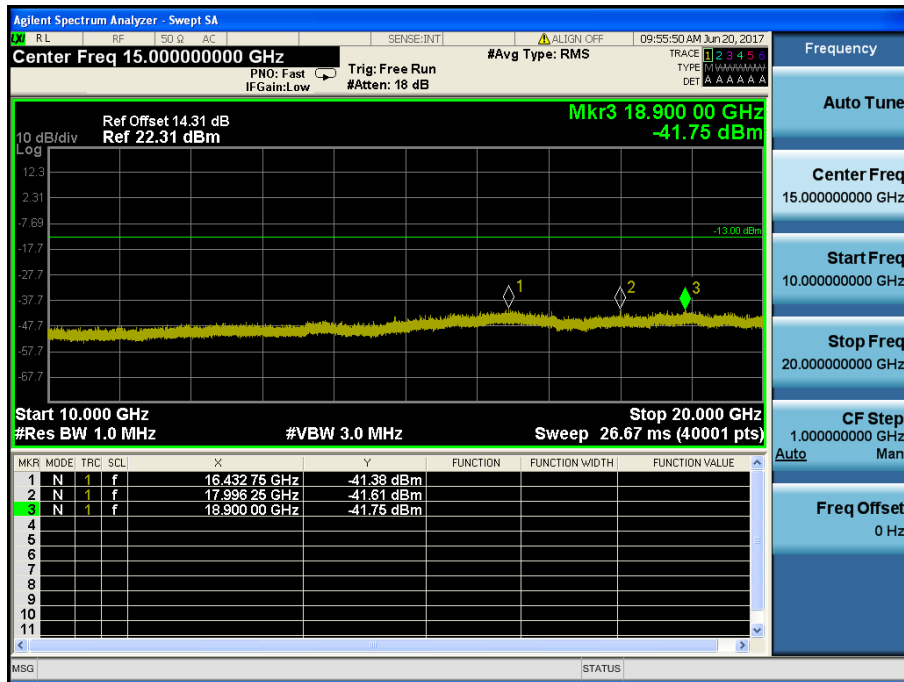

WCDMA1900 & Channel: 9400

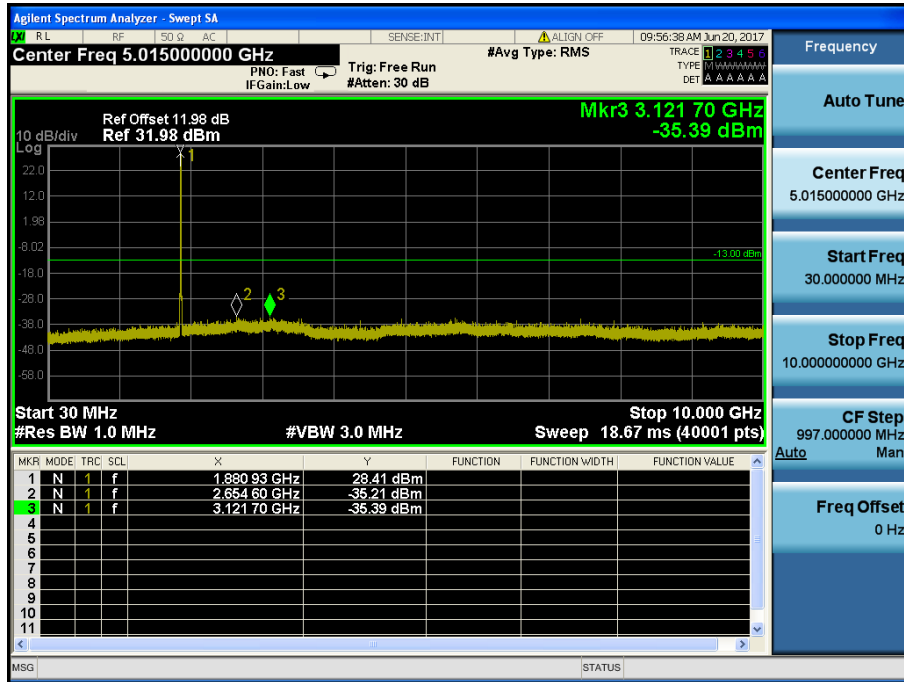

WCDMA1900 & Channel: 9400

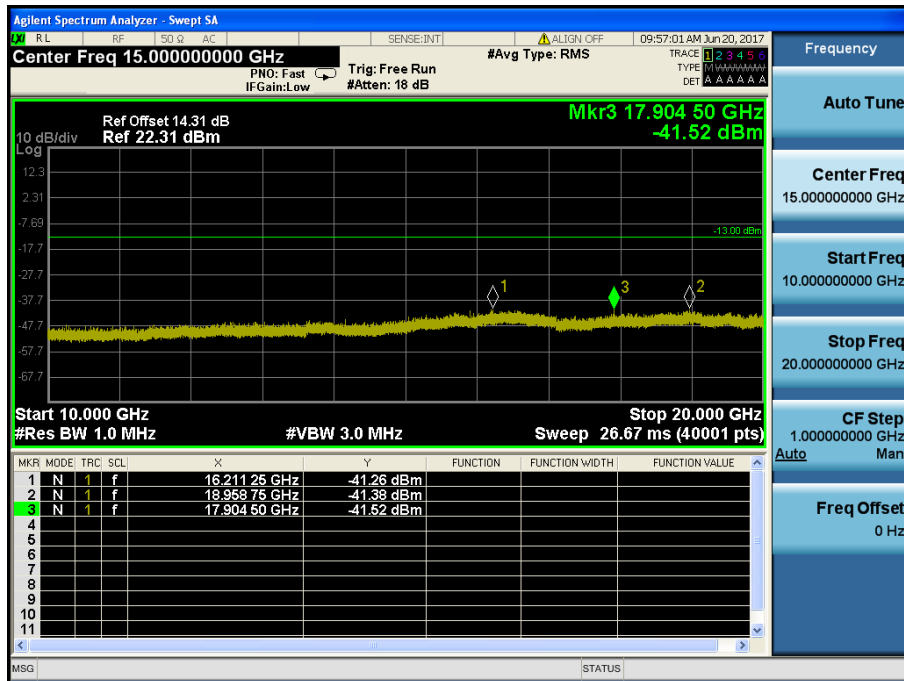

WCDMA1900 & Channel: 9538

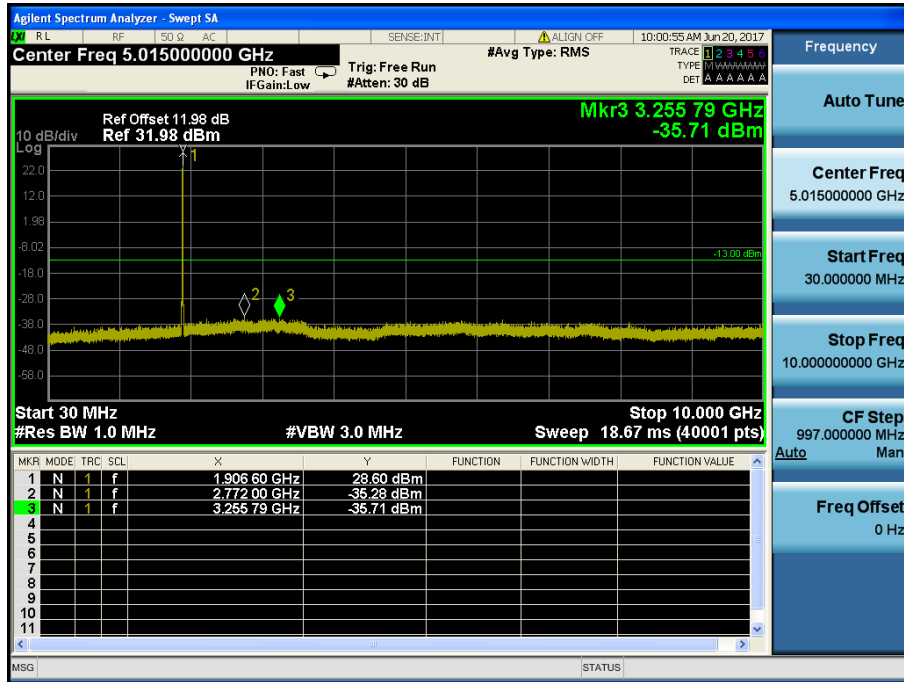

WCDMA1900 & Channel: 9538

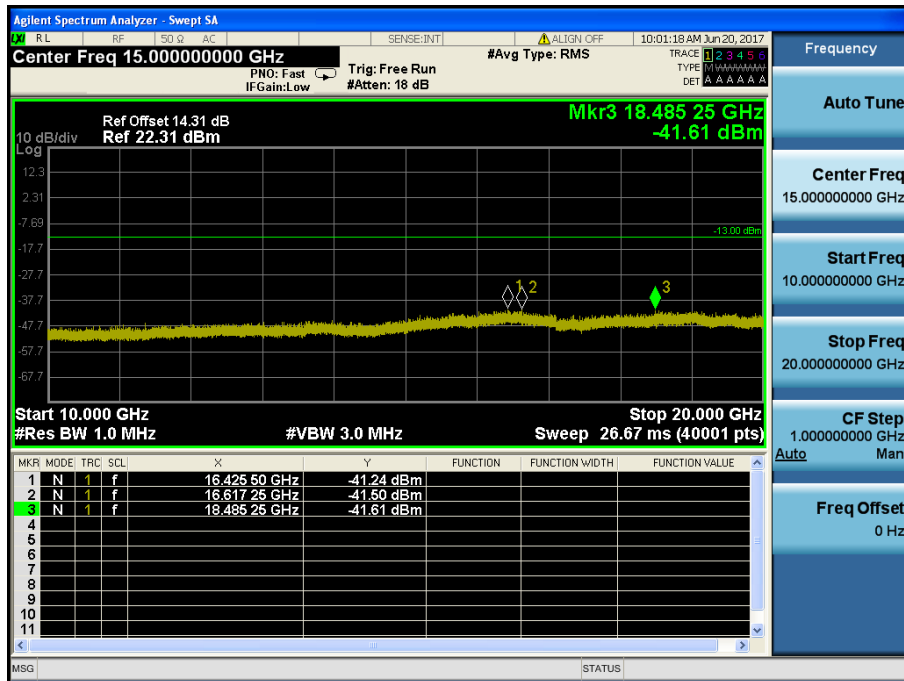

HSUPA1900 & Channel: 9262

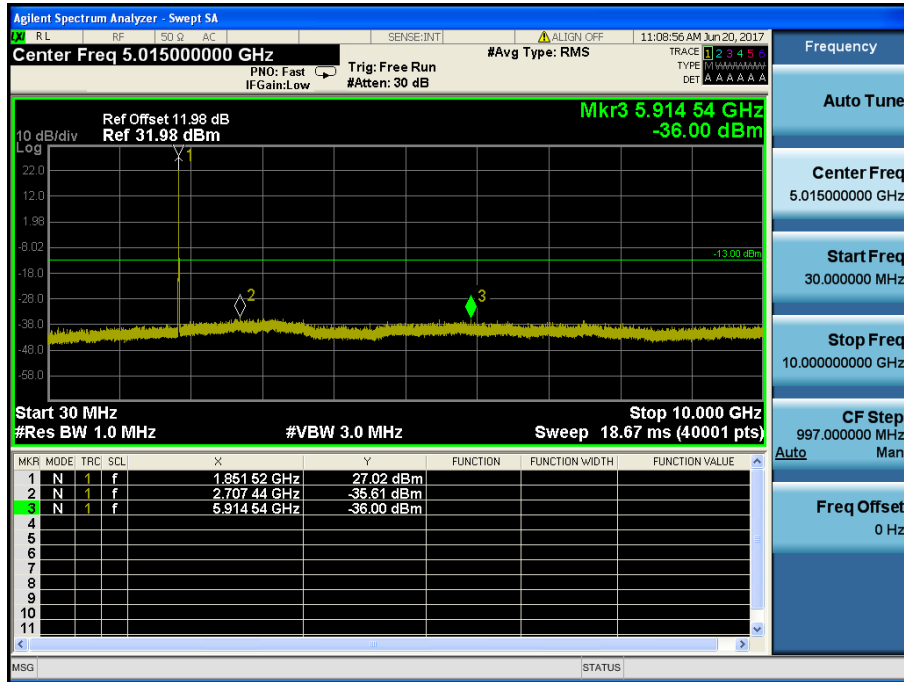

HSUPA 1900 & Channel: 9262

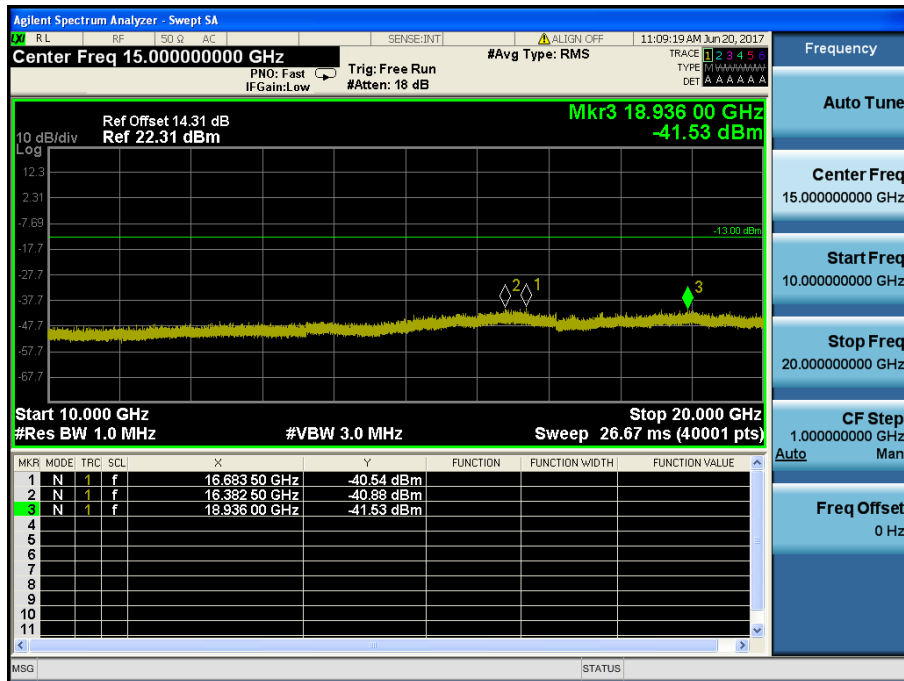

HSUPA1900 & Channel: 9400

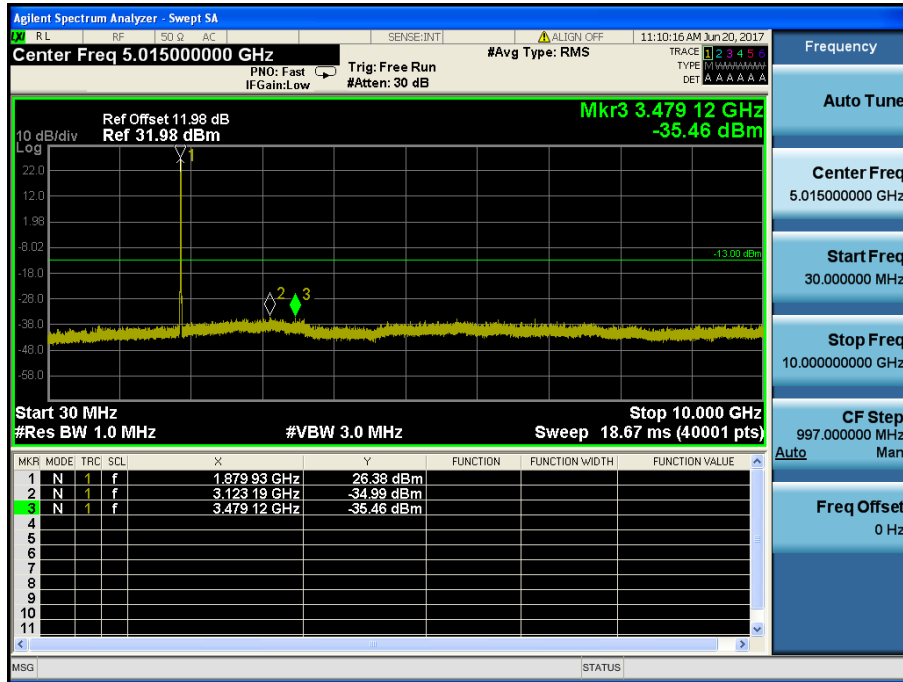

HSUPA1900 & Channel: 9400

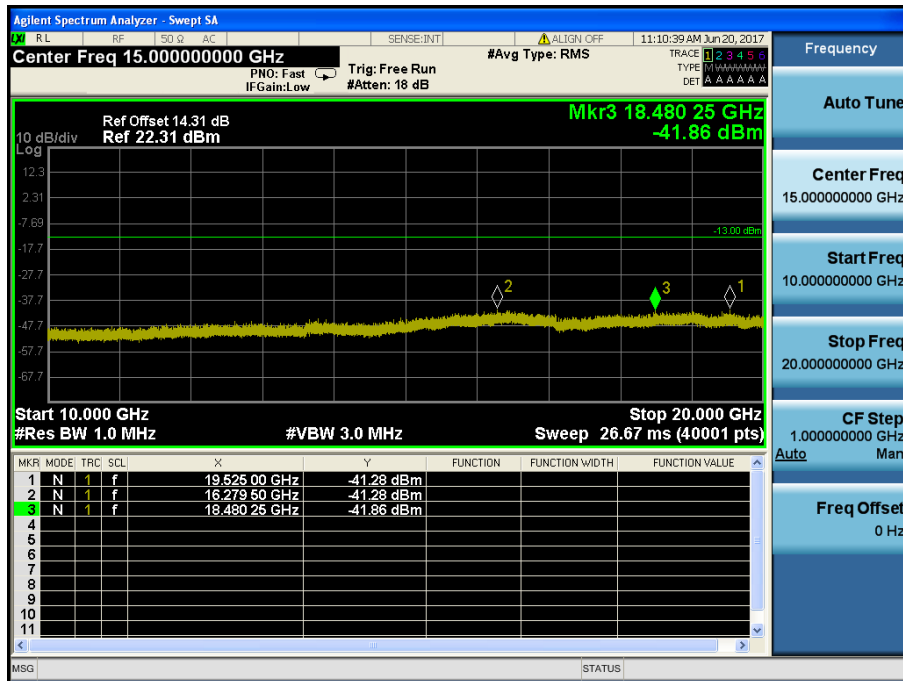

HSUPA1900 & Channel: 9538

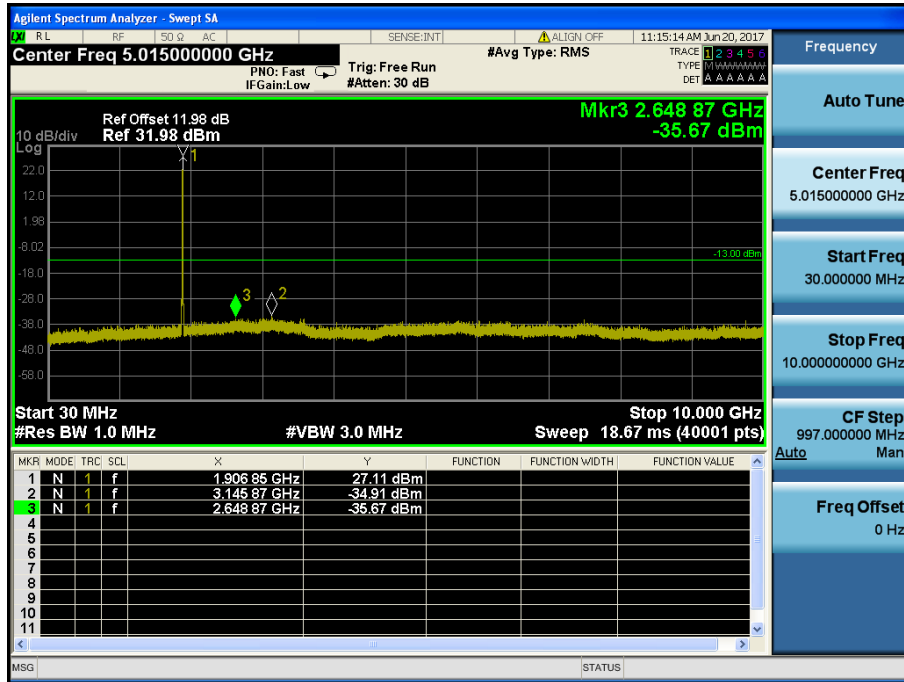

HSUPA1900 & Channel: 9538

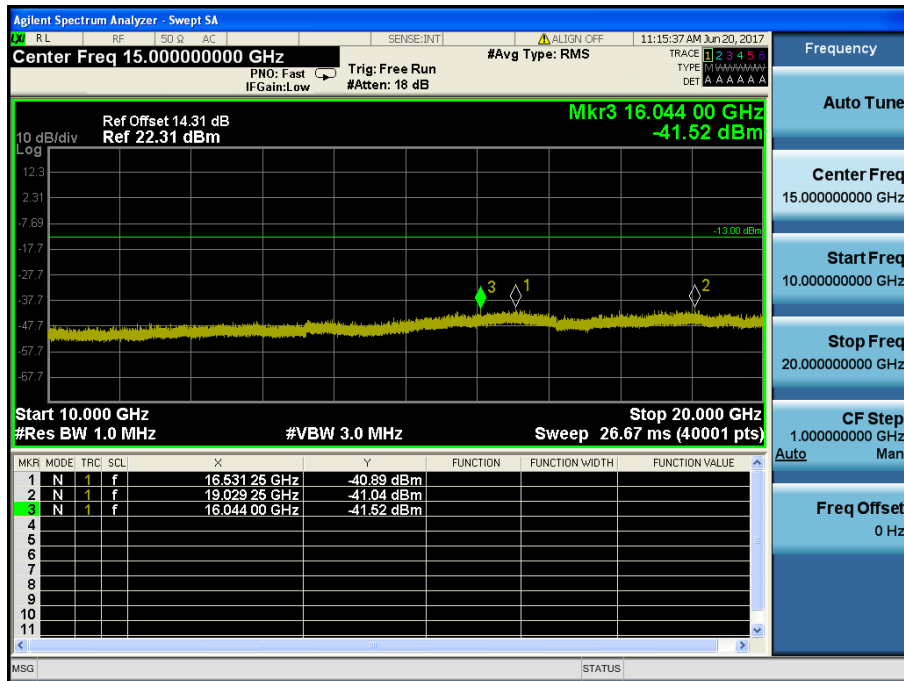

8.4 Band Edge

WCDMA850& Channel: 4132

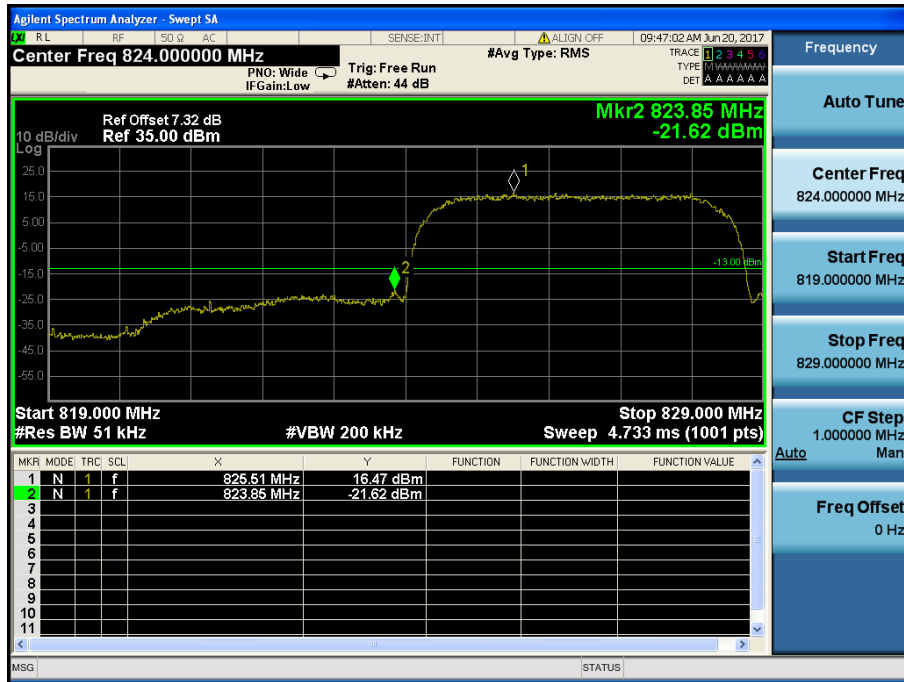

WCDMA850& Channel: 4132

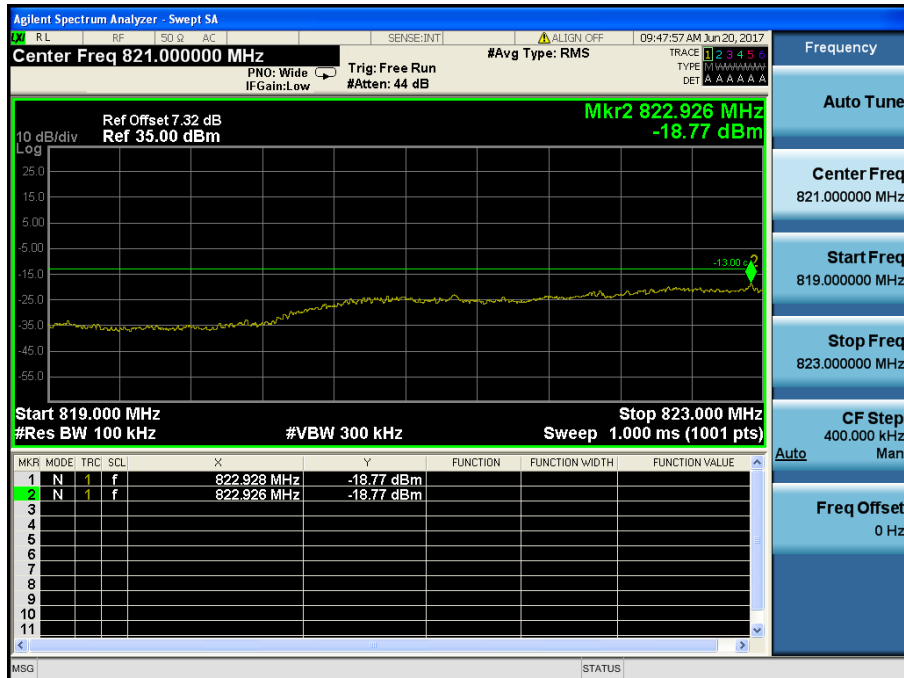

WCDMA850& Channel: 4233



WCDMA850& Channel: 4233

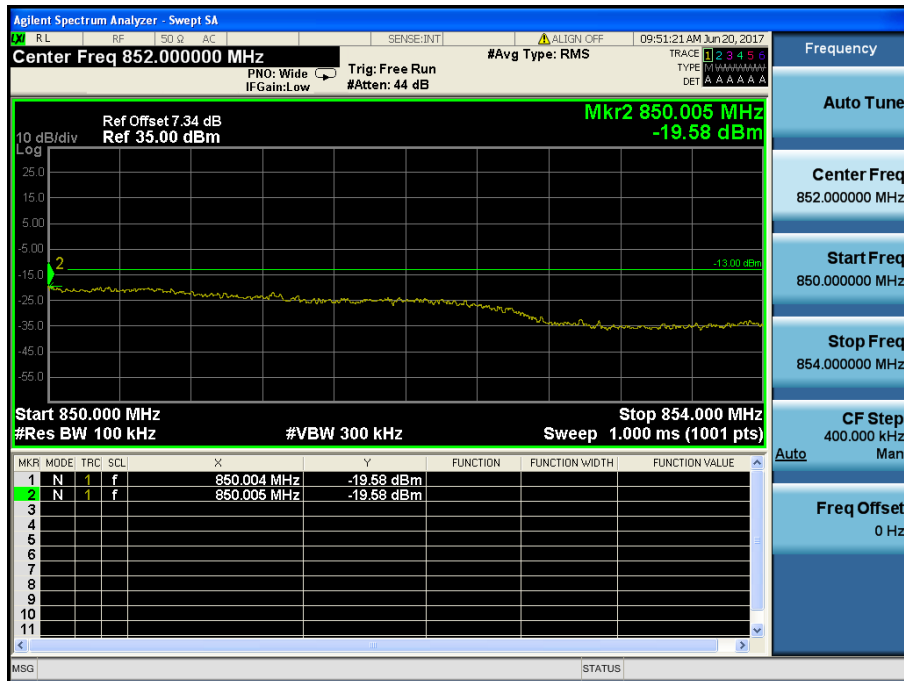

HSUPA850& Channel: 4132

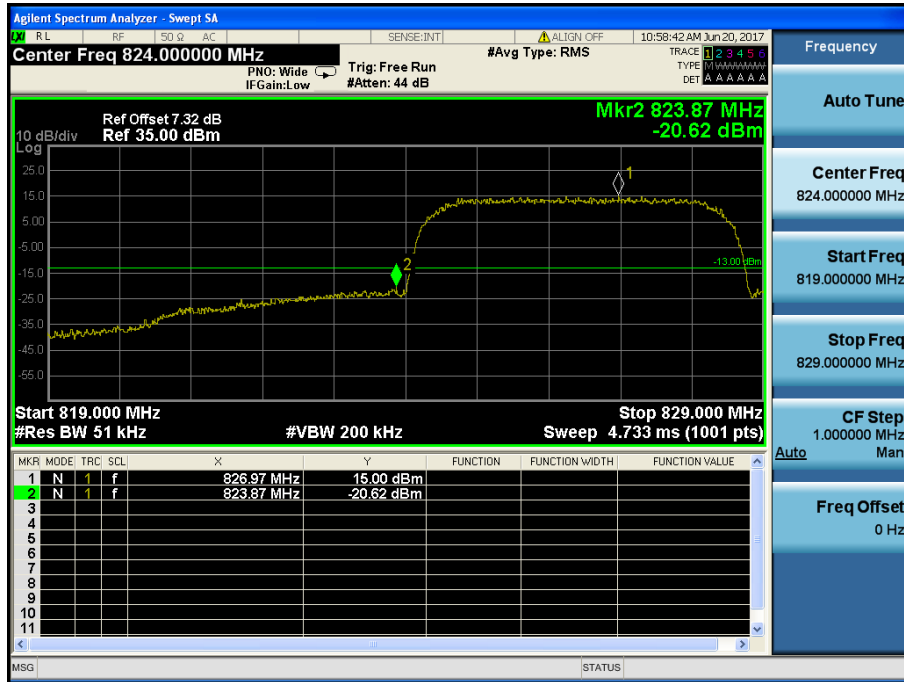

HSUPA850 & Channel: 4132

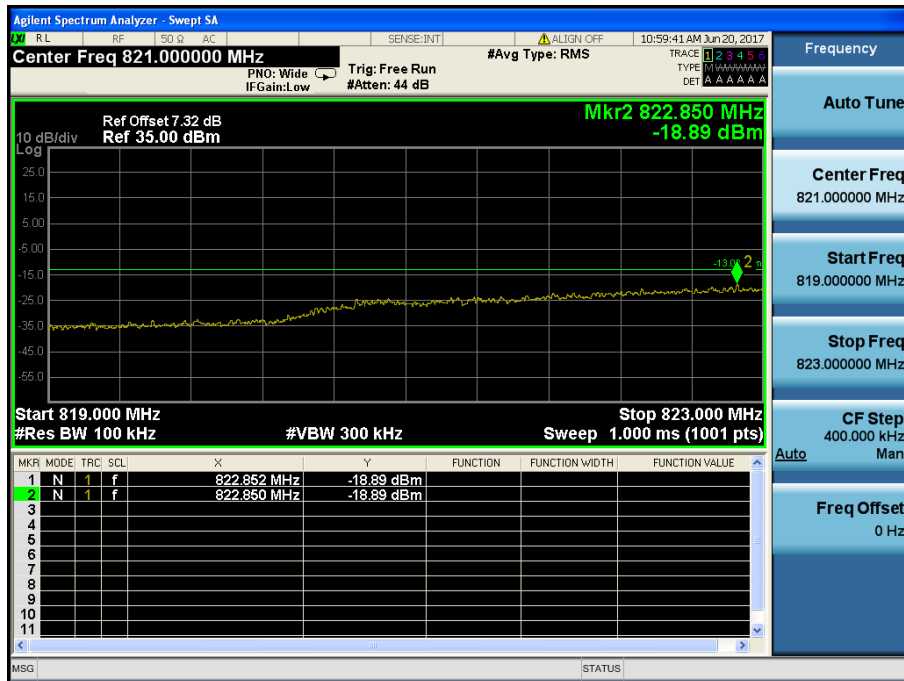

HSUPA850 & Channel: 4233



HSUPA850 & Channel: 4233

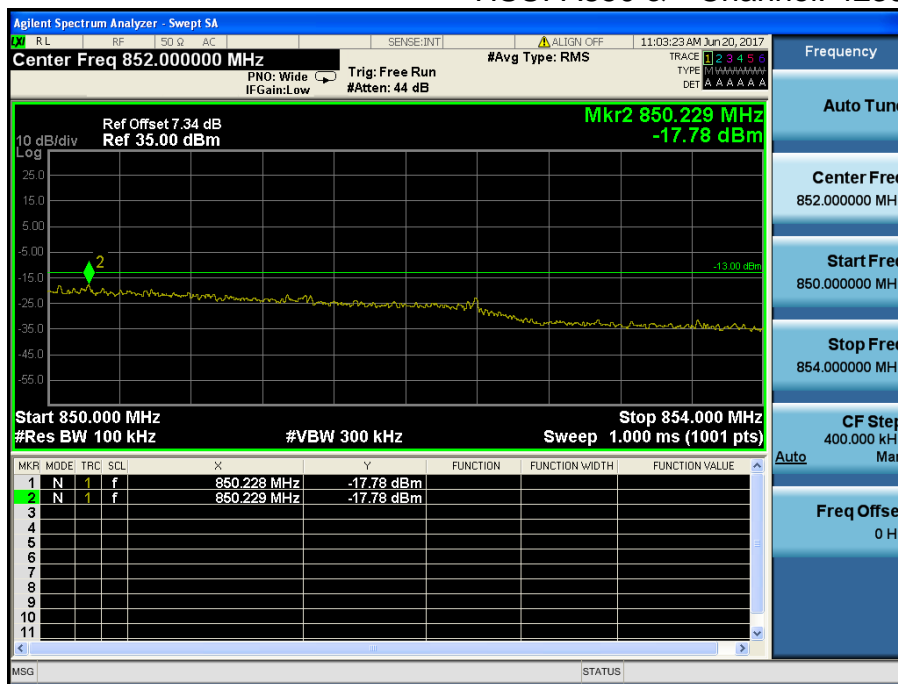

WCDMA1900 & Channel: 9262

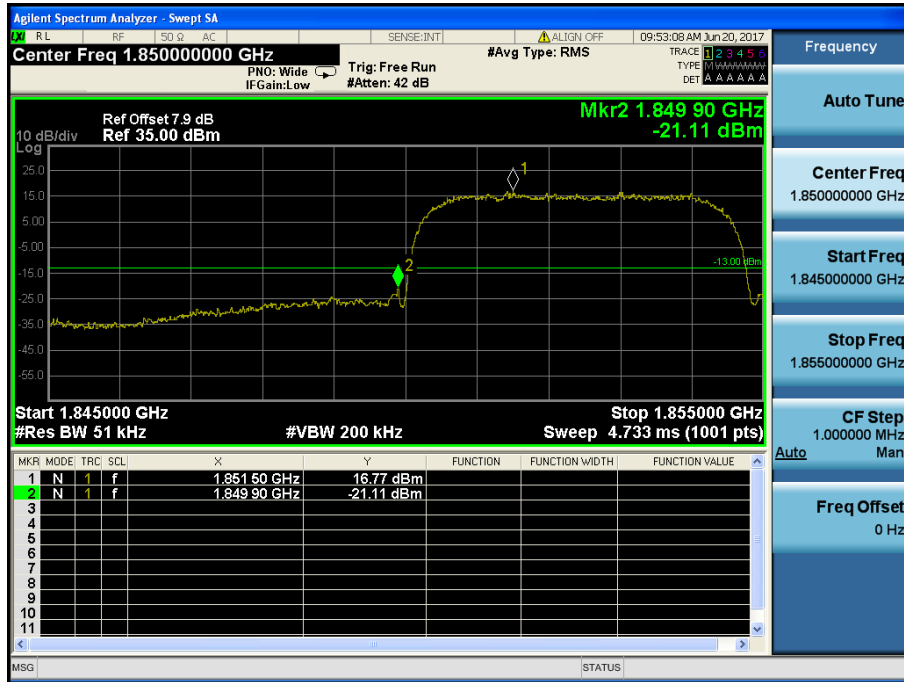

WCDMA1900 & Channel: 9262

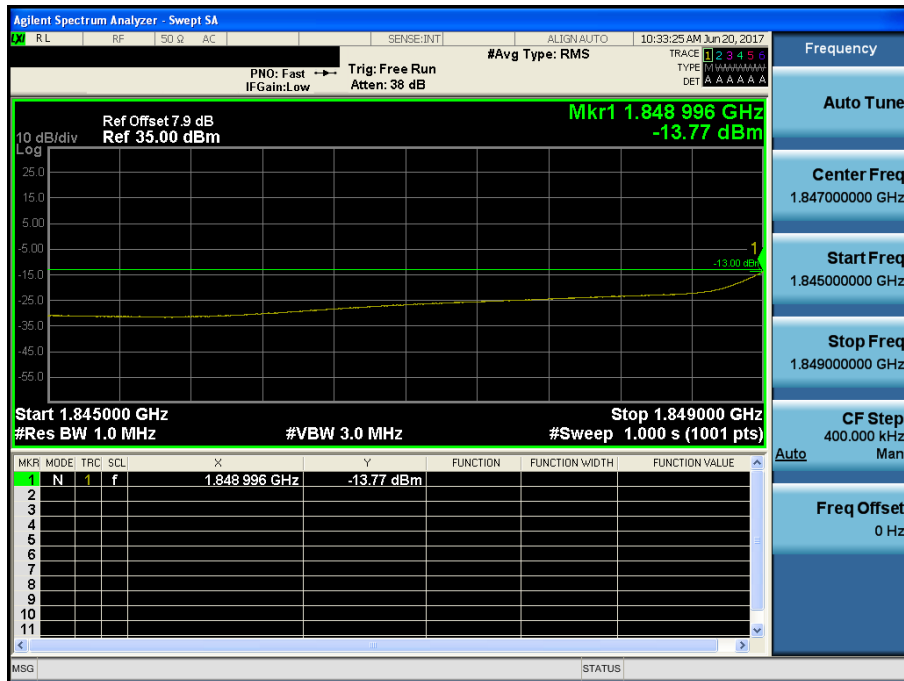

WCDMA1900 & Channel: 9538



WCDMA1900 & Channel: 9538



HSUPA1900 & Channel: 9262

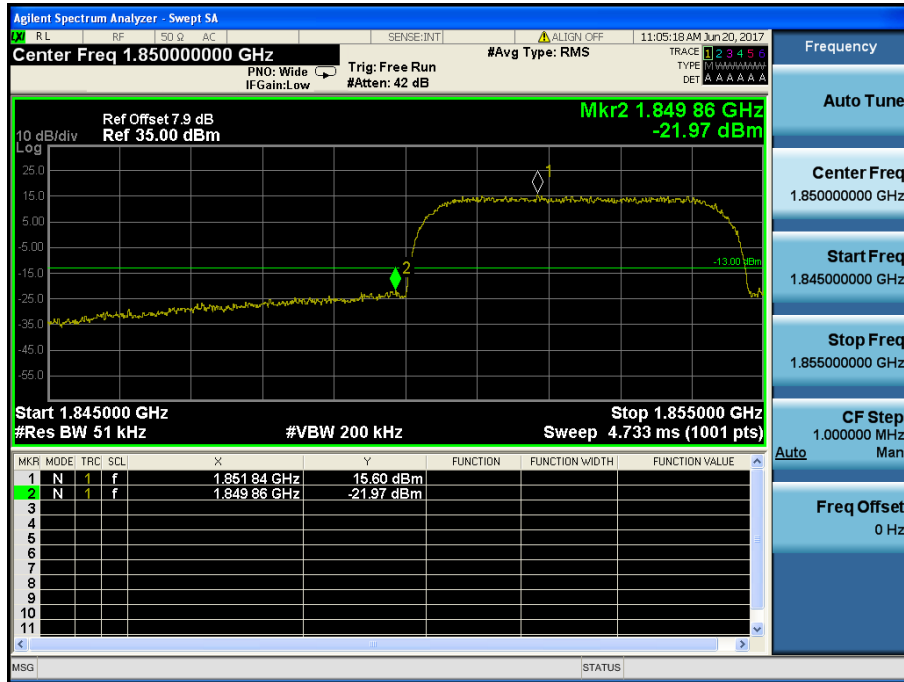

HSUPA1900 & Channel: 9262

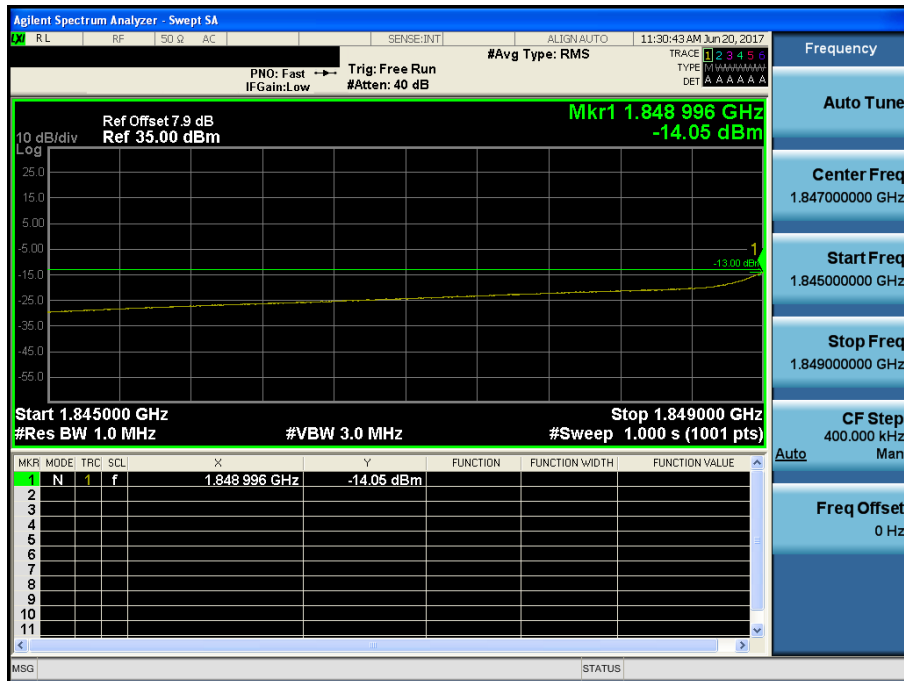

HSUPA1900 & Channel: 9538



HSUPA1900 & Channel: 9538

