

# TEST REPORT



**Dt&C Co., Ltd.**

42, Yurim-ro, 154Beon-gil, Cheoin-gu, Yongin-si, Gyeonggi-do, Korea, 17042  
Tel : 031-321-2664, Fax : 031-321-1664

1. Report No : DRTFCC2304-0053

2. Customer

- Name (FCC) : Point Mobile Co., LTD. / Name (IC) : POINTMOBILE CO.,LTD
- Address (FCC) : B-9F, Kabul Great Valley 32 Digital-ro 9-gil, Geumcheon-gu Seoul South Korea 153-709  
Address (IC) : B-9F Kabul Great Valley, 32, Digital-ro 9-gil, Geumcheon-gu Seoul Korea (Republic Of)

3. Use of Report : FCC & IC Certification

4. Product Name / Model Name : Mobile Computer / PM560

FCC ID : V2X-PM560

IC : 10664A-PM560

5. FCC Regulation(s): Part 15.247

IC Standard(s): RSS-247 Issue 2, RSS-Gen Issue 5

Test Method used: KDB558074 D01v05r02, ANSI C63.10-2013

6. Date of Test : 2023.02.22 ~ 2023.04.03



7. Location of Test :  Permanent Testing Lab  On Site Testing

8. Testing Environment : See appended test report.

9. Test Result : Refer to the attached test result.

The results shown in this test report refer only to the sample(s) tested unless otherwise stated.

This test report is not related to KOLAS accreditation.

Affirmation	Tested by	Technical Manager
	Name : SeungMin Gil  (Signature)	Name : JaeJin Lee  (Signature)

2023 . 04 . 14 .

**Dt&C Co., Ltd.**

If this report is required to confirmation of authenticity, please contact to [report@dtnc.net](mailto:report@dtnc.net)

## Test Report Version

Test Report No.	Date	Description	Revised by	Reviewed by
DRTFCC2304-0053	Apr. 14, 2023	Initial issue	SeungMin Gil	JaeJin Lee

## Table of Contents

<b>1. General Information</b> .....	<b>4</b>
1.1. Description of EUT .....	4
1.2. Declaration by the applicant / manufacturer .....	4
1.3. Testing Laboratory .....	5
1.4. Testing Environment .....	5
1.5. Measurement Uncertainty .....	5
1.6. Information about the FHSS characteristics .....	6
1.7. Conclusion of worst-case and operation mode .....	7
1.8. Test Equipment List.....	8
<b>2. Antenna Requirement</b> .....	<b>9</b>
<b>3. Summary of Test Results</b> .....	<b>10</b>
<b>4. Maximum Peak Conducted Output Power</b> .....	<b>11</b>
4.1. Test Setup .....	11
4.2. Limit.....	11
4.3. Test Procedure.....	11
4.4. Test Results .....	12
<b>5. 20 dB BW &amp; Occupied BW</b> .....	<b>18</b>
5.1. Test Setup .....	18
5.2. Limit.....	18
5.3. Test Procedure.....	18
5.4. Test Results .....	18
<b>6. Carrier Frequency Separation</b> .....	<b>24</b>
6.1. Test Setup .....	24
6.2. Limit.....	24
6.3. Test Procedure.....	24
6.4. Test Results .....	24
<b>7. Number of Hopping Channels</b> .....	<b>29</b>
7.1. Test Setup .....	29
7.2. Limit.....	29
7.3. Test Procedure.....	29
7.4. Test Results .....	29
<b>8. Time of Occupancy</b> .....	<b>35</b>
8.1. Test Setup .....	35
8.2. Limit.....	35
8.3. Test Procedure.....	35
8.4. Test Results .....	35
<b>9. Unwanted Emissions</b> .....	<b>40</b>
9.1. Test Setup .....	40
9.2. Limit.....	40
9.3. Test Procedures.....	42
9.3.1. Test Procedures for Unwanted Emissions(Radiated) .....	42
9.3.2. Test Procedures for Unwanted Emissions(Conducted).....	43
9.4. Test Results .....	44
9.4.1. Unwanted Emissions(Radiated).....	44
9.4.2. Unwanted Emissions(Conducted) .....	47
<b>10. AC Power-Line Conducted Emissions</b> .....	<b>71</b>
10.1. Test Setup .....	71
10.2. Limit.....	71
10.3. Test Procedure.....	71
10.4. Test Results .....	72
<b>APPENDIX I</b> .....	<b>74</b>
<b>APPENDIX II</b> .....	<b>75</b>

## 1. General Information

### 1.1. Description of EUT

<b>Equipment Class</b>	Part 15 Spread Spectrum Transmitter (DSS)
<b>Product Name</b>	Mobile Computer
<b>Model Name</b>	PM560
<b>Add Model Name</b>	-
<b>Firmware Version Identification Number</b>	56.00xx
<b>EUT Serial Number</b>	Conducted : 2223710235, Radiated: 2303310292
<b>Power Supply</b>	DC 3.63 V
<b>Frequency Range</b>	2 402 MHz ~ 2 480 MHz
<b>Max. RF Output Power</b>	11.4 dBm (0.014 W)
<b>Modulation Technique (Data rate)</b>	GFSK(1 Mbps), $\pi/4$ DQPSK(2 Mbps), 8DPSK(3 Mbps)
<b>Number of Channels</b>	79
<b>Antenna Specification</b>	Antenna Type: LDS Antenna Gain: 1.979 dBi (PK)

### 1.2. Declaration by the applicant / manufacturer

- NA

### 1.3. Testing Laboratory

<b>Dt&amp;C Co., Ltd.</b>		
The 3 m test site and conducted measurement facility used to collect the radiated data are located at the 42, Yurim-ro, 154beon-gil, Cheoin-gu, Yongin-si, Gyeonggi-do, Korea 17042.		
The test site complies with the requirements of Part 2.948 according to ANSI C63.4-2014.		
- FCC & IC MRA Designation No. : KR0034		
- ISED#: 5740A		
<a href="http://www.dtnc.net">www.dtnc.net</a>		
Telephone	:	+ 82-31-321-2664
FAX	:	+ 82-31-321-1664

### 1.4. Testing Environment

Ambient Condition	
▪ Temperature	+21 °C ~ +24 °C
▪ Relative Humidity	36 % ~ 41 %

### 1.5. Measurement Uncertainty

The measurement uncertainties shown below were calculated in accordance with requirements of ANSI C63.4-2014 and ANSI C63.10-2013. All measurement uncertainty values are shown with a coverage factor of  $k = 2$  to indicate a 95 % level of confidence.

Parameter	Measurement uncertainty
Antenna-port conducted emission	1.0 dB (The confidence level is about 95 %, $k = 2$ )
AC power-line conducted emission	3.4 dB (The confidence level is about 95 %, $k = 2$ )
Radiated emission (1 GHz Below)	4.8 dB (The confidence level is about 95 %, $k = 2$ )
Radiated emission (1 GHz ~ 18 GHz)	5.0 dB (The confidence level is about 95 %, $k = 2$ )
Radiated emission (18 GHz Above)	5.2 dB (The confidence level is about 95 %, $k = 2$ )

## 1.6. Information about the FHSS characteristics

- This Bluetooth module has been tested by a Bluetooth Qualification Lab, and we confirm the following :

A) The hopping sequence is pseudorandom

Note 1 : Pseudorandom Frequency Hopping Sequence Table as below:

Channel: 08, 24, 40, 56, 42, 54, 72, 09, 01, 11, 33, 41, 34, 42, 65, 73, 53, 69, 06, 22, 04, 20,  
36, 52, 38, 46, 70, 78, 68, 76, 21, 29, 10, 26, 41, 58, 44, 60, 76, 13, 03, 11, 35, 43,  
37, 45, 69, 77, 52, 71, 08, 24, 06, 24, 48, 56, 45, 46, 70, 01, 72, 06, 25, 33, 12, 28,  
49, 60, 45, 58, 74, 13, 05, 18, 37, 49 etc

The System receiver have input bandwidths that match the hopping channel bandwidths of their corresponding transmitters and shift frequencies in synchroniztation with the transmitted signals.

B) All channels are used equally on average

C) The receiver input bandwidth equals the transmit bandwidth

D) The receiver hops in sequence with the transmit signal

- 15.247(g) : In accordance with the Bluetooth Industry Standard, the system is designed to comply with all of the regulations in Section 15.247 when the transmitter is presented with a continuous data (or information) system.
- 15.247(h) : In accordance with the Bluetooth Industry Standard, the system does not coordinate its channels selection / hopping sequence with other frequency hopping systems for the express purpose of avoiding the simultaneous occupancy of individual hopping frequencies by multiple transmitters.
- 15.247(h) : The EUT employs Adaptive Frequency Hopping (AFH) which identifies sources of interference namely devices operating in 802.11 WLAN and excludes them from the list of available channels. The process of re-mapping reduces the number of test channels from 79 channels to a minimum number of 20 channels.

### 1.7. Conclusion of worst-case and operation mode

The EUT has three types of modulation (GFSK,  $\pi/4$ DQPSK and 8DPSK). Therefore all applicable requirements were tested with all the modulations. And packet type was tested at the worst case(DH5).

#### EUT Operation test setup

Bluetooth tester was used to control the transmit parameters during test.

#### Tested frequency information

- Hopping Function : Enable

	Tested Frequency (MHz)
Hopping Band	2 402 ~ 2 480

- Hopping Function : Disable

	Tested Frequency (MHz)
Lowest Channel	2 402
Middle Channel	2 441
Highest Channel	2 480

## 1.8. Test Equipment List

Type	Manufacturer	Model	Cal.Date (yy/mm/dd)	Next.Cal.Date (yy/mm/dd)	S/N
Spectrum Analyzer	Agilent Technologies	N9020A	22/06/24	23/06/24	MY46471622
Spectrum Analyzer	Agilent Technologies	N9020A	22/12/16	23/12/16	MY48011700
Spectrum Analyzer	Agilent Technologies	N9020A	22/06/24	23/06/24	US47360812
DC Power Supply	Agilent Technologies	66332A	22/06/24	23/06/24	US37473627
Multimeter	FLUKE	17B+	22/12/16	23/12/16	36390701WS
BlueTooth Tester	TESCOM	TC-3000C	22/06/24	23/06/24	3000C000563
Power Splitter	Anritsu	K241B	22/06/24	23/06/24	020611
Signal Generator	Rohde Schwarz	SMBV100A	22/12/16	23/12/16	255571
Signal Generator	ANRITSU	MG3695C	22/12/16	23/12/16	173501
Thermohygrometer	BODYCOM	BJ5478	22/12/16	23/12/16	120612-1
Thermohygrometer	BODYCOM	BJ5478	22/12/16	23/12/16	120612-2
Thermohygrometer	BODYCOM	BJ5478	22/06/24	23/06/24	N/A
Loop Antenna	ETS-Lindgren	6502	22/12/16	24/12/16	00226186
Hybrid Antenna	Schwarzbeck	VULB 9160	22/12/16	23/12/16	3362
Horn Antenna	ETS-Lindgren	3117	22/06/24	23/06/24	00143278
Horn Antenna	A.H.Systems Inc.	SAS-574	22/06/24	23/06/24	155
PreAmplifier	tsj	MLA-0118-B01-40	22/12/16	23/12/16	1852267
PreAmplifier	tsj	MLA-1840-J02-45	22/06/24	23/06/24	16966-10728
PreAmplifier	H.P	8447D	22/12/16	23/12/16	2944A07774
High Pass Filter	Wainwright Instruments	WHKX12-935-1000-15000-40SS	22/06/24	23/06/24	8
High Pass Filter	Wainwright Instruments	WHKX10-2838-3300-18000-60SS	22/06/24	23/06/24	1
High Pass Filter	Wainwright Instruments	WHNX8.0/26.5-6SS	22/06/24	23/06/24	3
Attenuator	Hefei Shunze	SS5T2.92-10-40	22/06/24	23/06/24	16012202
Attenuator	Aeroflex/Weinschel	56-3	22/06/24	23/06/24	Y2370
Attenuator	SMAJK	SMAJK-2-3	22/06/24	23/06/24	3
Attenuator	SMAJK	SMAJK-2-3	22/06/24	23/06/24	2
Attenuator	Aeroflex/Weinschel	86-10-11	22/06/24	23/06/24	408
Power Meter & Wide Bandwidth Sensor	Anritsu	ML2496A MA2411B	22/12/16	23/12/16	1338004 1911481
EMI Test Receiver	ROHDE&SCHWARZ	ESC17	23/01/31	24/01/31	100910
PULSE LIMITER	Rohde Schwarz	ESH3-Z2	22/08/22	23/08/22	101333
LISN	SCHWARZBECK	NSLK 8128 RC	22/10/26	23/10/26	8128 RC-387
Thermo Hygro Meter	TESTO	608-H1	23/01/13	24/01/13	45084791
Cable	Dt&C	Cable	23/01/04	24/01/04	G-2
Cable	HUBER+SUHNER	SUCOFLEX 100	23/01/04	24/01/04	G-3
Cable	Dt&C	Cable	23/01/04	24/01/04	G-4
Cable	OMT	YSS21S	23/01/04	24/01/04	G-5
Cable	Junkosha	MWX241	23/01/03	24/01/03	mmW-1
Cable	Junkosha	MWX241	23/01/03	24/01/03	mmW-4
Cable	HUBER+SUHNER	SUCOFLEX100	23/01/04	24/01/04	M-01
Cable	HUBER+SUHNER	SUCOFLEX100	23/01/04	24/01/04	M-02
Cable	JUNKOSHA	MWX241/B	23/01/04	24/01/04	M-03
Cable	JUNKOSHA	J12J101757-00	23/01/04	24/01/04	M-07
Cable	HUBER+SUHNER	SUCOFLEX106	23/01/04	24/01/04	M-09
Cable	RADIALL	TESTPRO 3	23/01/04	24/01/04	RFC-44
Cable	Dt&C	Cable	23/01/04	24/01/04	RFC-69
Test Software	tsj	Radiated Emission Measurement	NA	NA	Version 2.00.0147
Test Software	tsj	Noise Terminal Measurement	NA	NA	Version 2.00.0185

Note1: The measurement antennas were calibrated in accordance to the requirements of ANSI C63.5-2017

Note2: The cable is not a regular calibration item, so it has been calibrated by Dt&C itself.



## 2. Antenna Requirement

An intentional radiator shall be designed to ensure that no antenna other than that furnished by the responsible party shall be used with the device. The use of a permanently attached antenna or of an antenna that uses a unique coupling to the intentional radiator shall be considered sufficient to comply with the provisions.

**Conclusion: Comply**

**The antenna is attached on the device by means of unique coupling method (Spring Tension).  
Therefore this E.U.T complies with the requirement of Part 15.203**

### 3. Summary of Test Results

FCC part section(s)	RSS section(s)	Test Description	Limit (Using in 2 400~ 2 483.5 MHz)	Test Condition	Status Note 1
15.247(a) 15.247(b)	RSS-247[5.1] RSS-247[5.4]	Maximum Peak Conducted Output Power	<b>For FCC</b> =< 0.125 W(conducted)  <b>For IC</b> =< 0.125 W(conducted) =< 4 Watt(e.i.r.p)	Conducted	C
15.247(a)	RSS-247[5.1]	20 dB Bandwidth	NA		C
		Carrier Frequency Separation	>= 25 kHz or >= Two thirds of the 20 dB BW, whichever is greater.		C
		Number of Hopping Channels	>= 15 hops		C
		Time of Occupancy	=< 0.4 seconds		C
-	RSS-Gen[6.7]	Occupied Bandwidth (99 %)	NA		C
15.247(d)	RSS-247[5.5]	Unwanted Emissions (Conducted)	The radiated emission to any 100 kHz of out-band shall be at least 20 dB below the highest in-band spectral density.	C	
15.247(d) 15.205 15.209	RSS-247[5.5] RSS-Gen[8.9] RSS-Gen[8.10]	Unwanted Emissions (Radiated)	Part 15.209 Limits (Refer to section 9)	Radiated	C <sup>Note3</sup>
15.207	RSS-Gen[8.8]	AC Power-Line Conducted Emissions	Part 15.207 Limits (Refer to section 10)	AC Line Conducted	C
15.203	-	Antenna Requirement	Part 15.203 (Refer to section 2)	-	C
Note 1: C = Comply    NC = Not Comply    NT = Not Tested    NA = Not Applicable Note 2: For radiated emission tests below 30 MHz were performed on semi-anechoic chamber which is correlated with OATS. Note 3: This test item was performed in three orthogonal EUT positions and the worst case data was reported.					

## 4. Maximum Peak Conducted Output Power

### 4.1. Test Setup

Refer to the APPENDIX I.

### 4.2. Limit

#### ■ FCC Requirements

The maximum peak output power of the intentional radiator shall not exceed the following :

1. §15.247(a)(1), Frequency hopping systems shall have hopping channel carrier frequencies separated by a minimum of 25 kHz or the 20 dB bandwidth of the hopping channel, whichever is greater. Alternatively, frequency hopping systems operating in the 2 400 MHz - 2 483.5 MHz band may have hopping channel carrier frequencies that are separated by 25 kHz or two-thirds of the 20 dB bandwidth of the hopping channel, whichever is greater, provided the systems operate with an output power no greater than 125 mW.
2. §15.247(b)(1), For frequency hopping systems operating in the 2 400 – 2 483.5 MHz employing at least 75 non-overlapping hopping channels, and all frequency hopping systems in the 5 725 MHz – 5 805 MHz band : 1 Watt. For all other frequency hopping systems in the 2 400 MHz – 2 483.5 MHz band: 0.125 watts.

#### ■ IC Requirements

1. RSS-247[5.1] (b), For FHSs shall have hopping channel carrier frequencies separated by a minimum of 25 kHz or the 20 dB bandwidth of the hopping channel, whichever is greater. Alternatively, FHSs operating in the band 2 400-2 483.5 MHz may have hopping channel carrier frequencies that are separated by 25 kHz or two thirds of the 20 dB bandwidth of the hopping channel, whichever is greater, provided that the systems operate with an output power no greater than 0.125 W.
2. RSS-247[5.4] (b), For FHSS operating in the band 2 400 MHz – 2 483.5 MHz, the maximum peak conducted output power shall not exceed 1.0 W if the hopset uses 75 or more hopping channels, the maximum peak conducted output power shall not exceed 0.125 W if the hopset uses less than 75 hopping channels. The e.i.r.p shall not exceed 4 W, except as provided in section 5.4(e)

### 4.3. Test Procedure

1. The RF output power was measured with a spectrum analyzer connected to the RF Antenna connector (conducted measurement) while EUT was operating in transmit mode at the appropriate center frequency, A spectrum analyzer was used to record the shape of the transmit signal.
2. The peak output power of the fundamental frequency was measured with the spectrum analyzer using ;  
Span = approximately 5 times of the 20 dB bandwidth, centered on a hopping channel  
RBW  $\geq$  20 dB BW  
VBW  $\geq$  RBW  
Sweep = auto  
Detector function = peak  
Trace = max hold

#### 4.4. Test Results

Modulation	Tested Channel	Burst Average Output Power		Peak Output Power		Antenna Gain (dBi)	e.i.r.p <sup>Note3</sup> (dBm)
		dBm	mW	dBm	mW		
<b><u>GFSK</u></b>	<b>Lowest</b>	8.97	7.89	10.10	10.23	1.98	12.08
	<b>Middle</b>	8.25	6.68	9.36	8.63	1.98	11.34
	<b>Highest</b>	6.71	4.69	8.62	7.28	1.98	10.60
<b><u><math>\pi/4</math>DQPSK</u></b>	<b>Lowest</b>	8.28	6.73	11.29	13.46	1.98	13.27
	<b>Middle</b>	7.08	5.11	9.80	9.55	1.98	11.78
	<b>Highest</b>	5.70	3.72	9.14	8.20	1.98	11.12
<b><u>8DPSK</u></b>	<b>Lowest</b>	8.28	6.73	<b>11.40</b>	<b>13.80</b>	1.98	13.38
	<b>Middle</b>	7.09	5.12	9.99	9.98	1.98	11.97
	<b>Highest</b>	5.70	3.72	9.34	8.59	1.98	11.32

Note 1: The average output power was tested using an average power meter for reference only.

Note 2: See next pages for actual measured spectrum plots.

Note 3:  $e.i.r.p = P_{cond} + G_{EUT}$

$P_{cond}$  = measured power at feedpoint of the EUT antenna, in dBm (Peak Conducted Output Power)

$G_{EUT}$  = gain of the EUT radiating element (antenna), in dBi

Peak Output Power

**Lowest Channel & Modulation : GFSK**

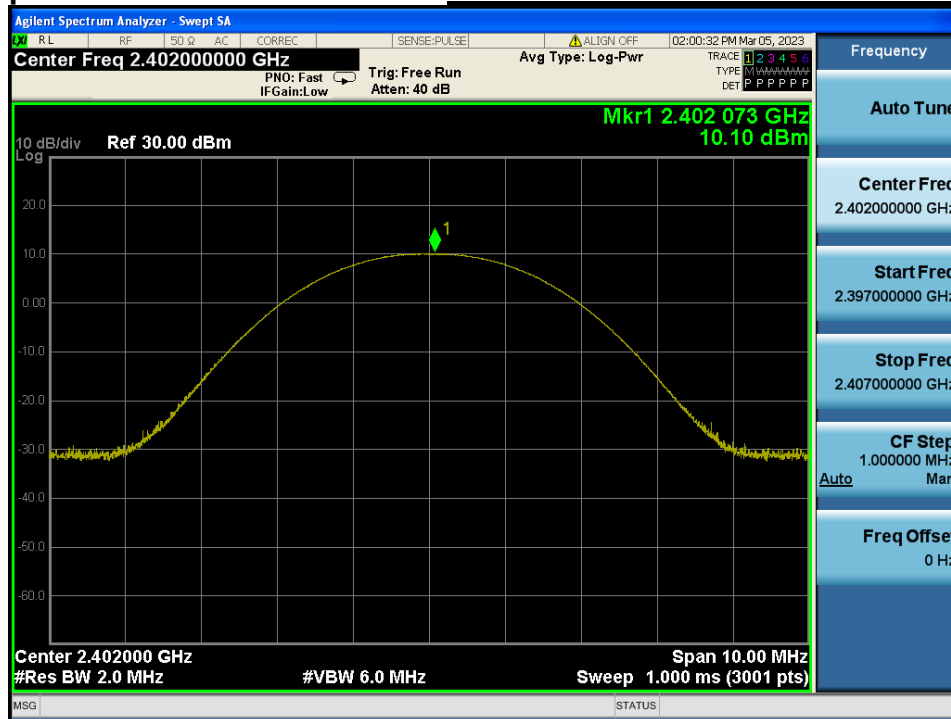

Peak Output Power

**Middle Channel & Modulation : GFSK**

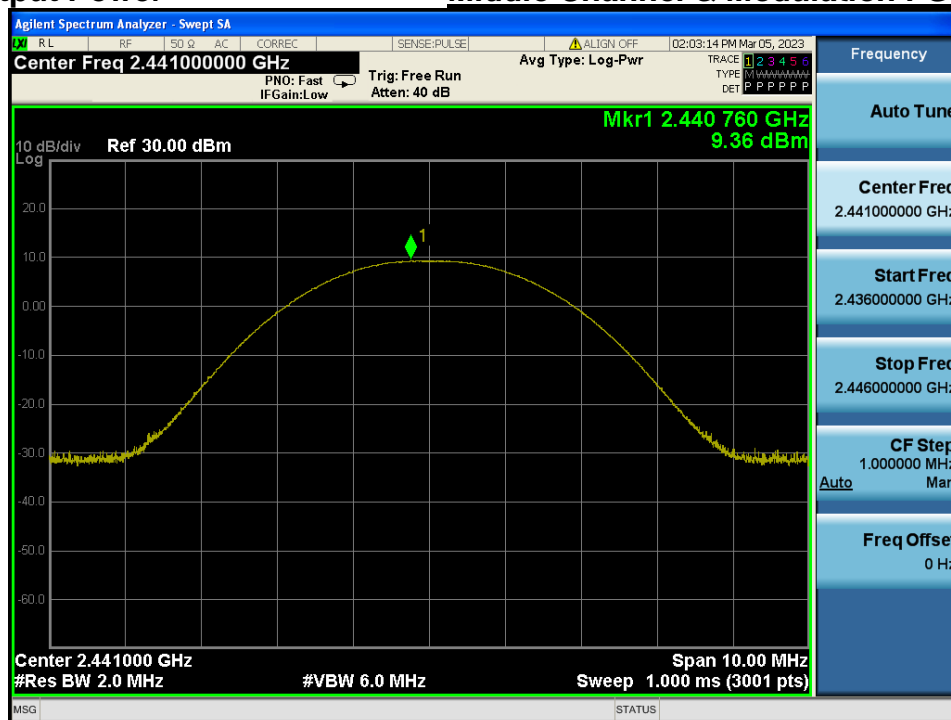

Peak Output Power

Highest Channel & Modulation : GFSK

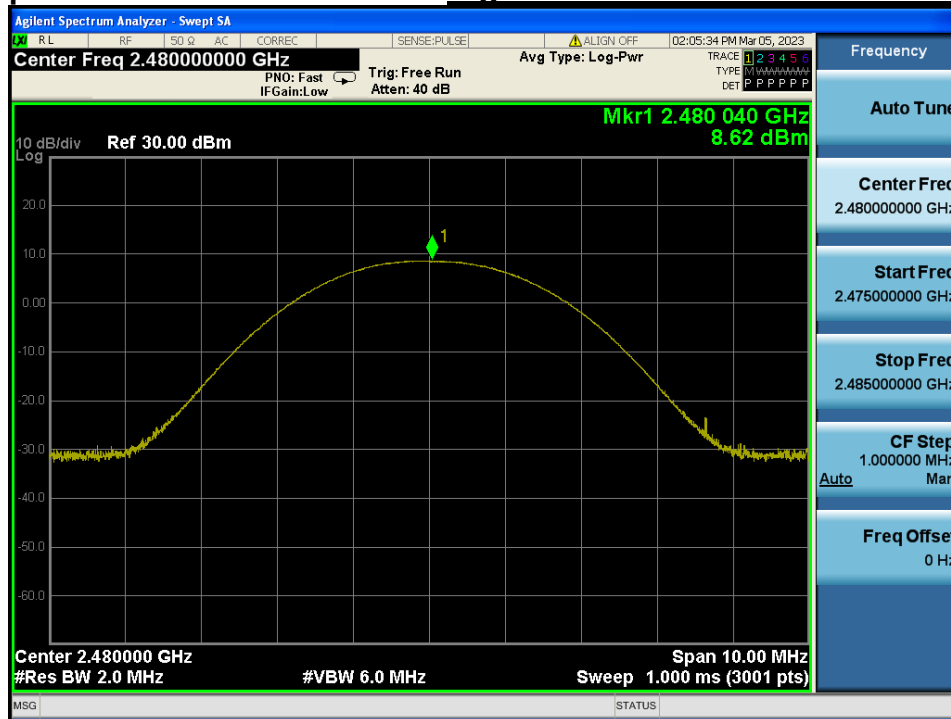

Peak Output Power

Lowest Channel & Modulation :  $\pi/4$ DQPSK

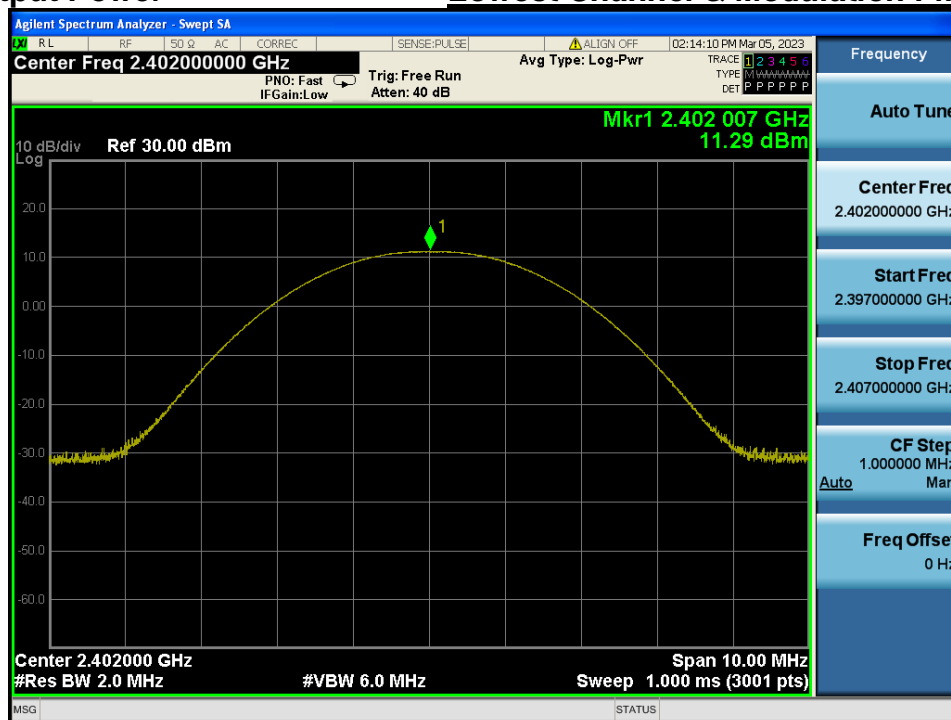

Peak Output Power

*Middle Channel & Modulation :  $\pi/4$ DQPSK*

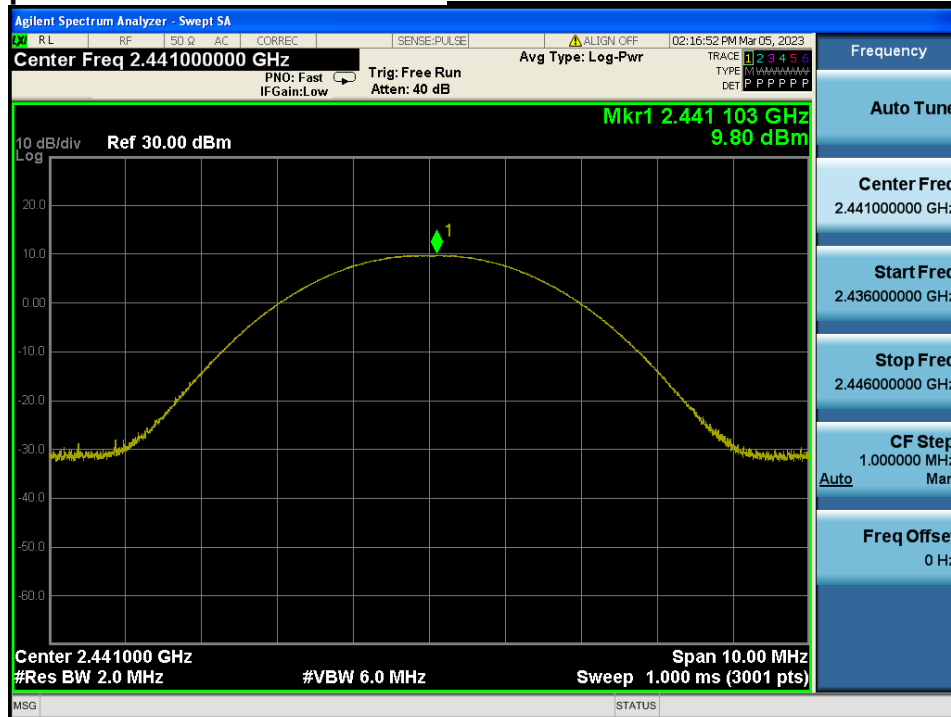

Peak Output Power

*Highest Channel & Modulation :  $\pi/4$ DQPSK*

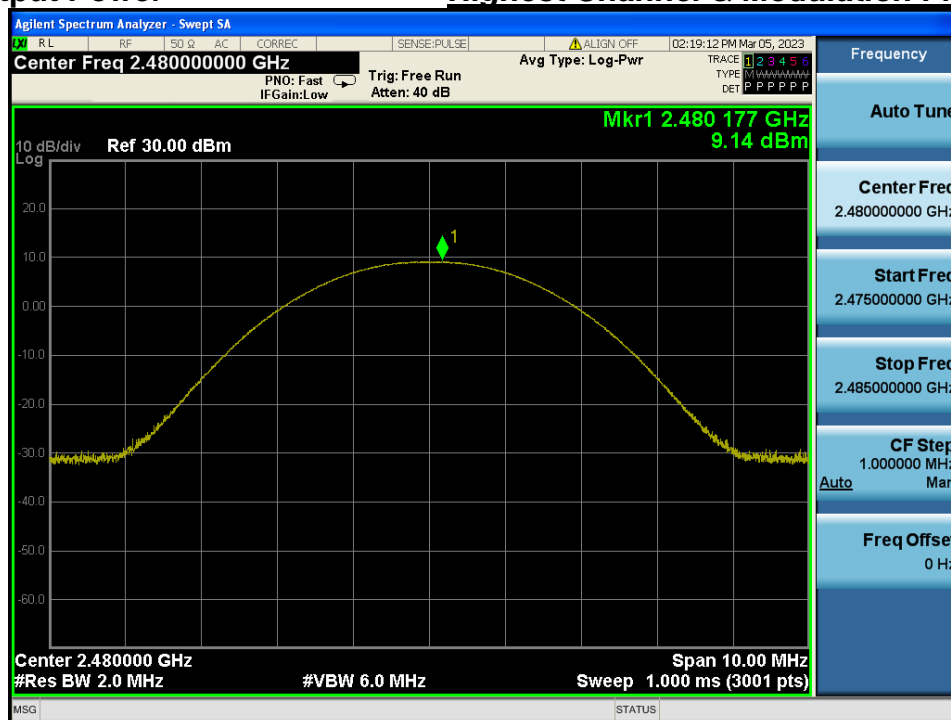

Peak Output Power

Lowest Channel & Modulation : 8DPSK

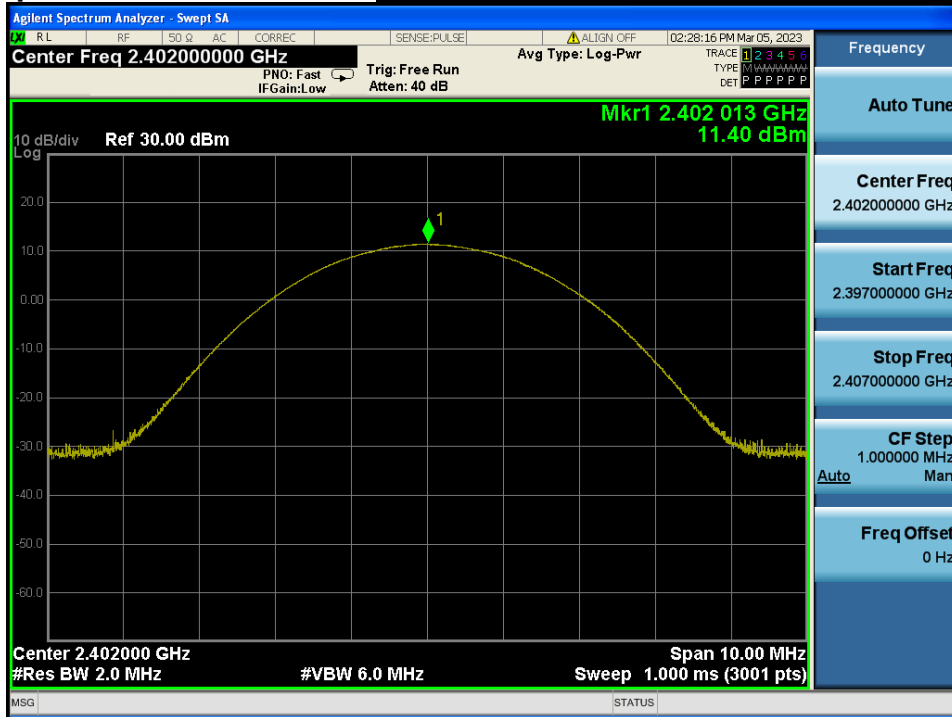

Peak Output Power

Middle Channel & Modulation : 8DPSK

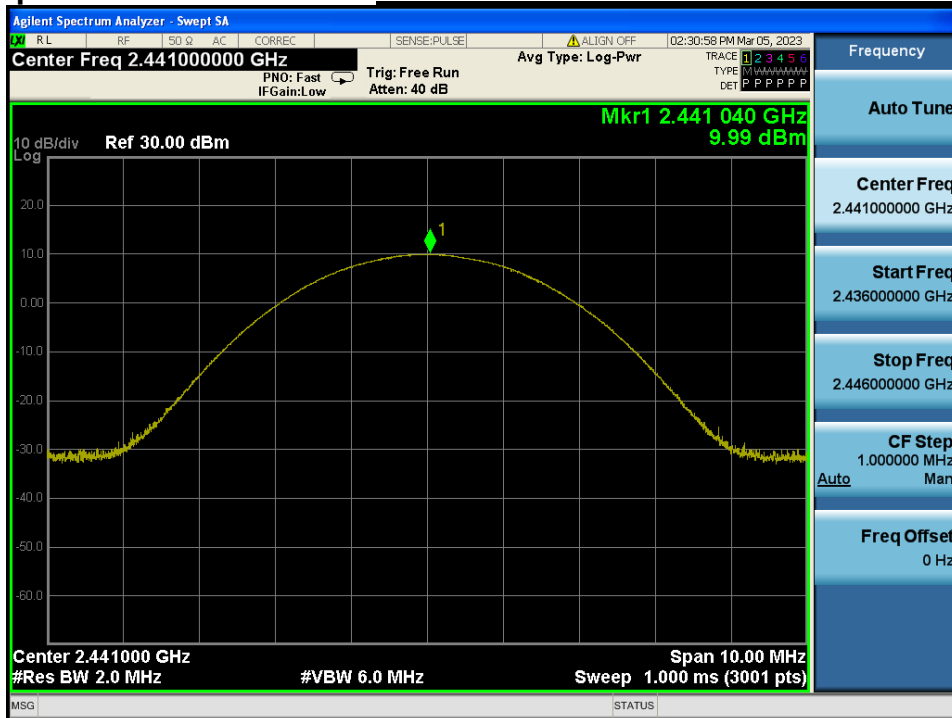



Peak Output Power

**Highest Channel & Modulation : 8DPSK**

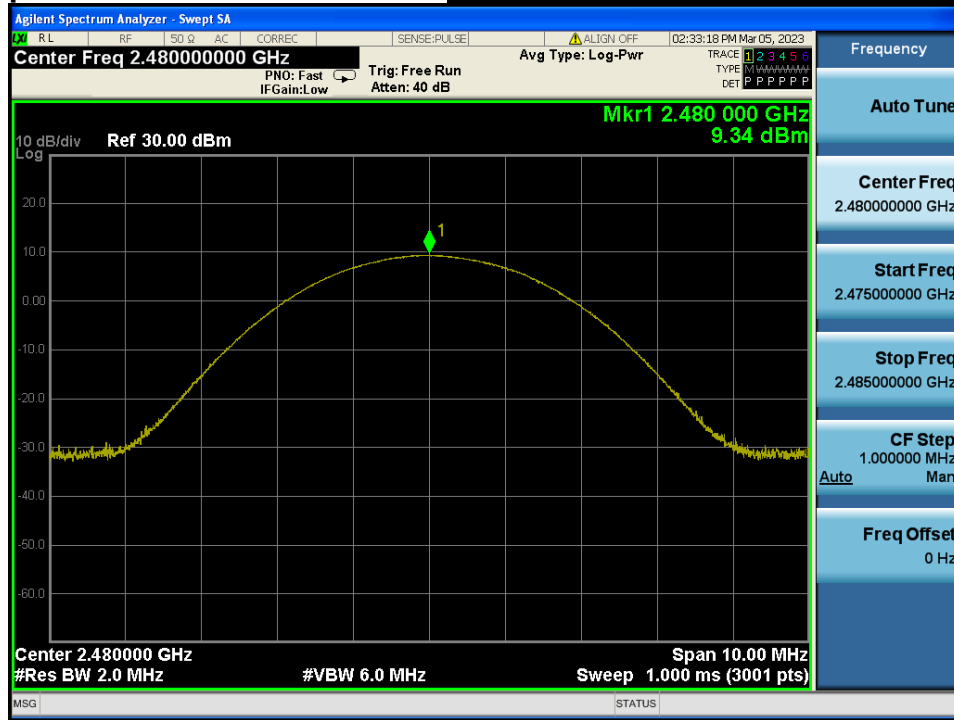

## 5. 20 dB BW & Occupied BW

### 5.1. Test Setup

Refer to the APPENDIX I.

### 5.2. Limit

Limit : Not Applicable

### 5.3. Test Procedure

1. The 20 dB bandwidth was measured with a spectrum analyzer connected to RF antenna Connector (conducted measurement) while EUT was operating in transmit mode. The analyzer center frequency was set to the EUT carrier frequency, using the analyzer.
2. The bandwidth of the fundamental frequency was measured with the spectrum analyzer using below setting:  
 RBW = 1 % to 5 % of the 20 dB BW & Occupied BW  
 VBW  $\geq$  3  $\times$  RBW  
 Span = between two times and five times the 20 dB bandwidth & Occupied BW  
 Sweep = auto  
 Detector function = peak  
 Trace = max hold

### 5.4. Test Results

Modulation	Tested Channel	20 dB BW (MHz)	Occupied BW (MHz)
<b><u>GFSK</u></b>	Lowest	<b>0.888</b>	0.858
	Middle	<b>0.888</b>	0.857
	Highest	0.887	<b>0.859</b>
<b><u><math>\pi/4</math>DQPSK</u></b>	Lowest	<b>1.344</b>	1.200
	Middle	1.343	1.197
	Highest	1.343	<b>1.200</b>
<b><u>8DPSK</u></b>	Lowest	<b>1.342</b>	<b>1.209</b>
	Middle	1.340	1.205
	Highest	1.340	1.205

20 dB BW & Occupied BW

Lowest Channel & Modulation : GFSK

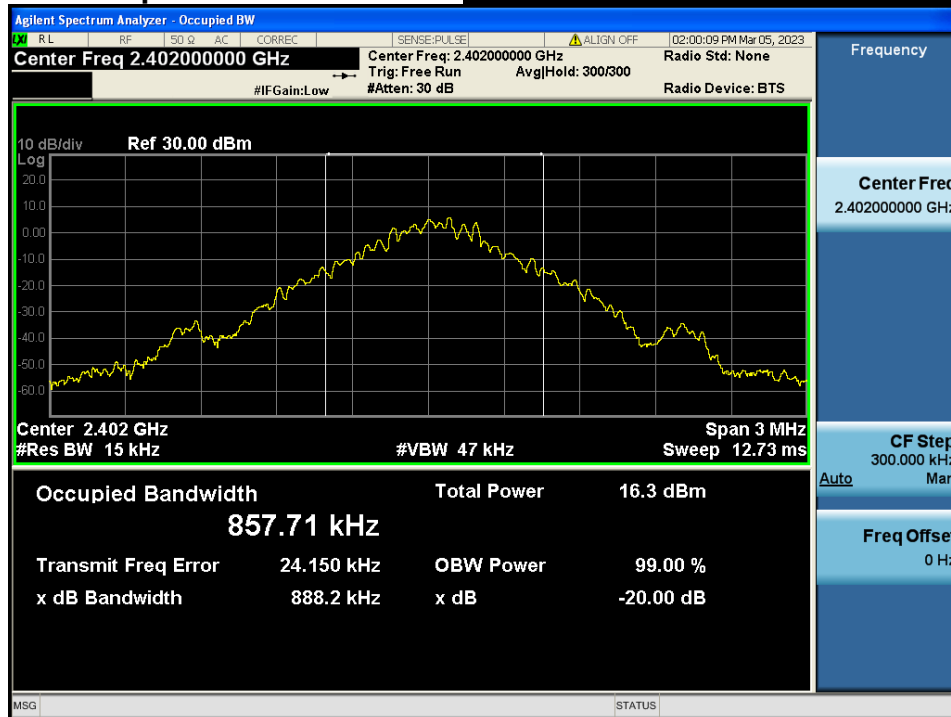

20 dB BW & Occupied BW

Middle Channel & Modulation : GFSK

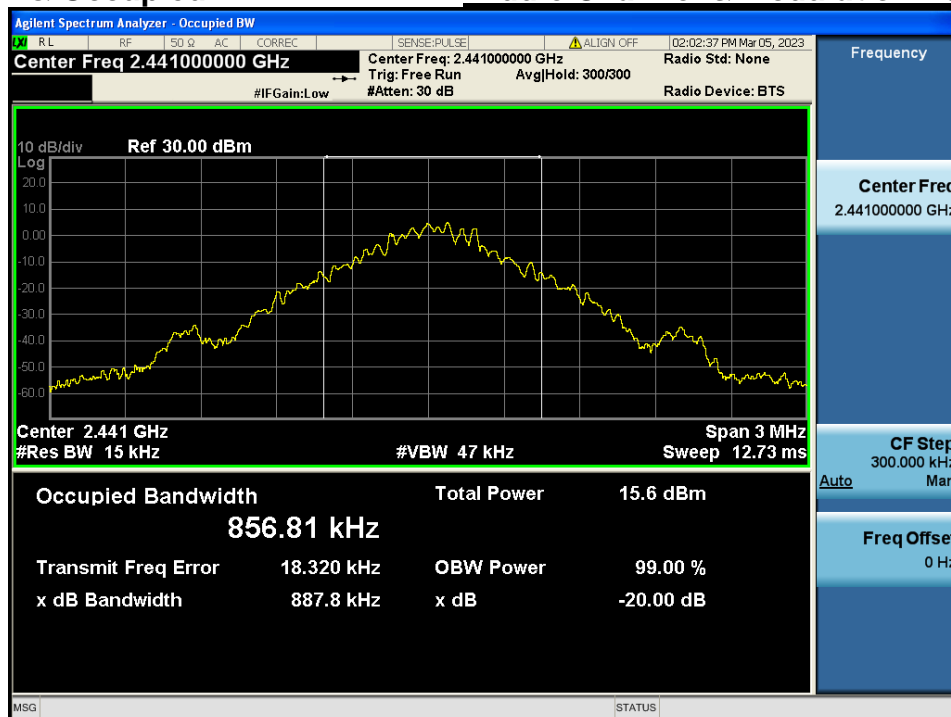

20 dB BW & Occupied BW

Highest Channel & Modulation : GFSK

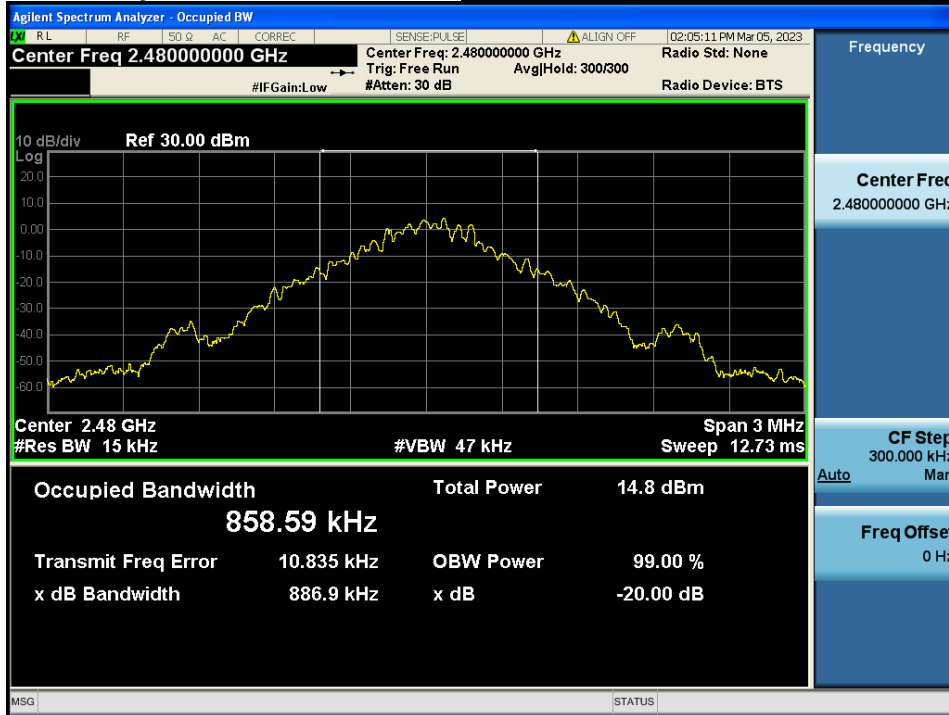

20 dB BW & Occupied BW

Lowest Channel & Modulation :  $\pi/4$ DQPSK

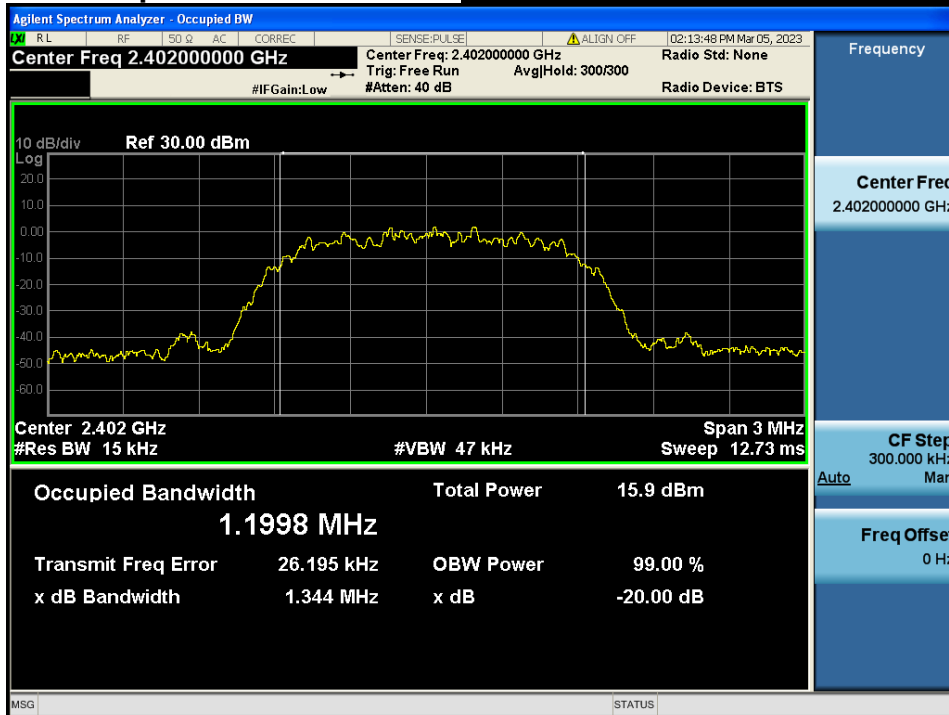

20 dB BW & Occupied BW

*Middle Channel & Modulation :  $\pi/4$ DQPSK*

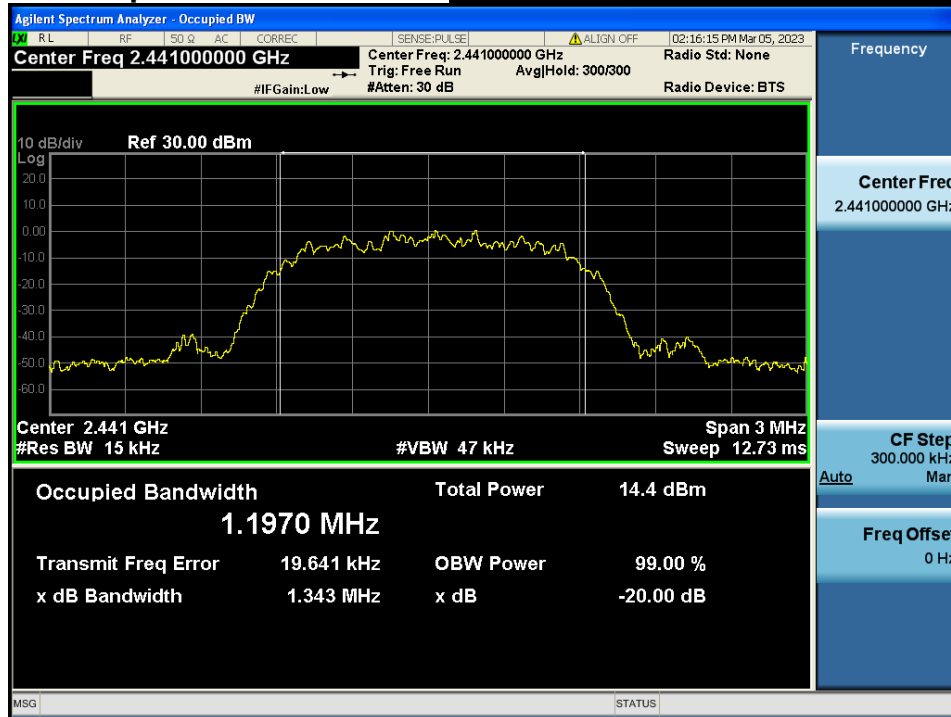

20 dB BW & Occupied BW

*Highest Channel & Modulation :  $\pi/4$ DQPSK*

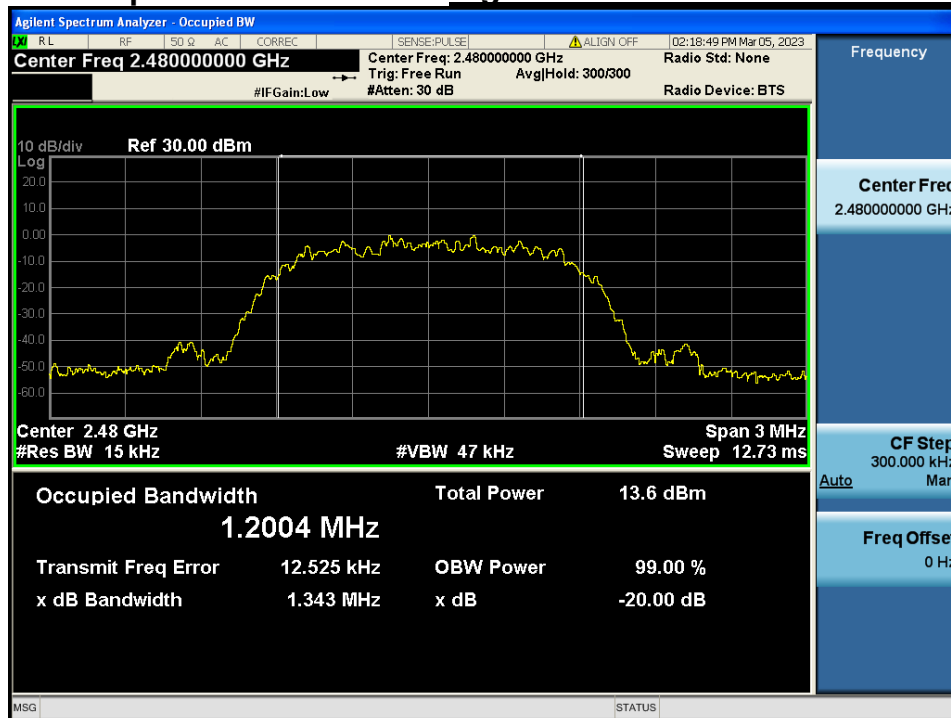

20 dB BW & Occupied BW

**Lowest Channel & Modulation : 8DPSK**

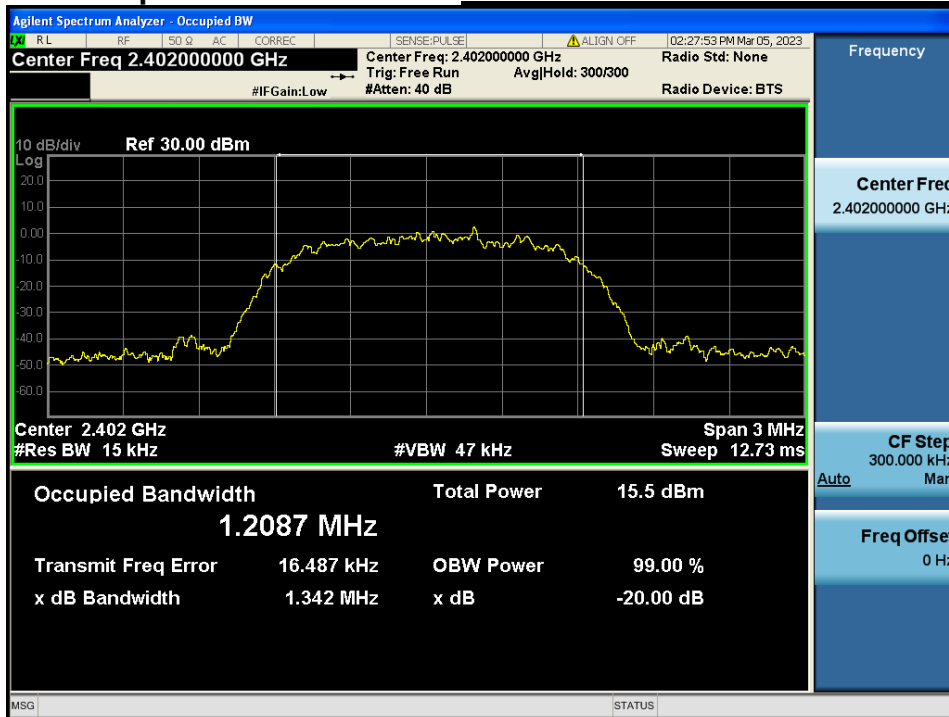

20 dB BW & Occupied BW

**Middle Channel & Modulation : 8DPSK**

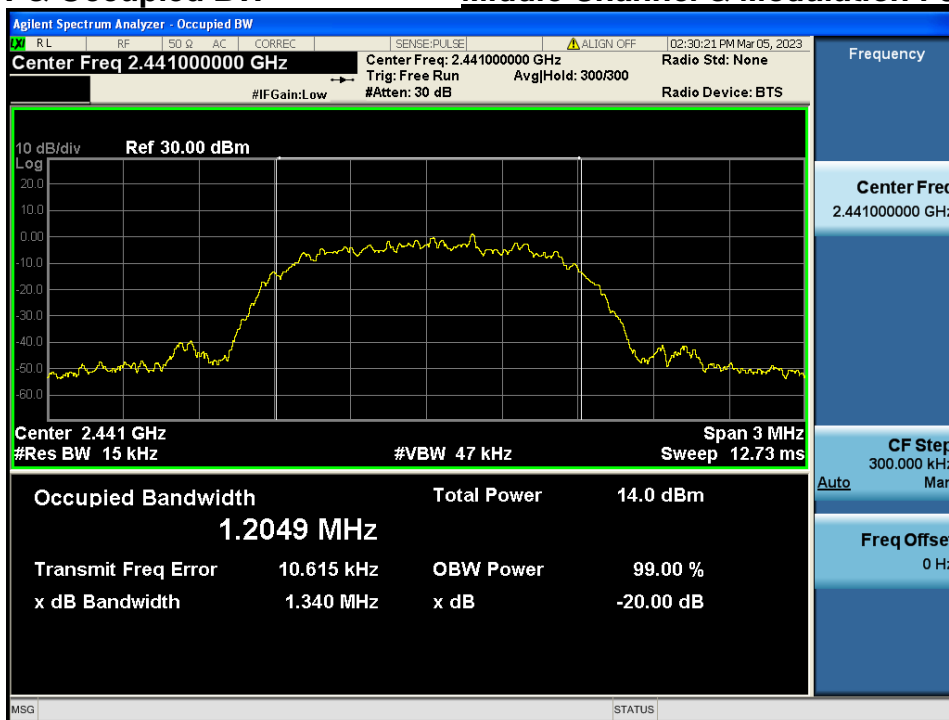

20 dB BW & Occupied BW

Highest Channel & Modulation : 8DPSK

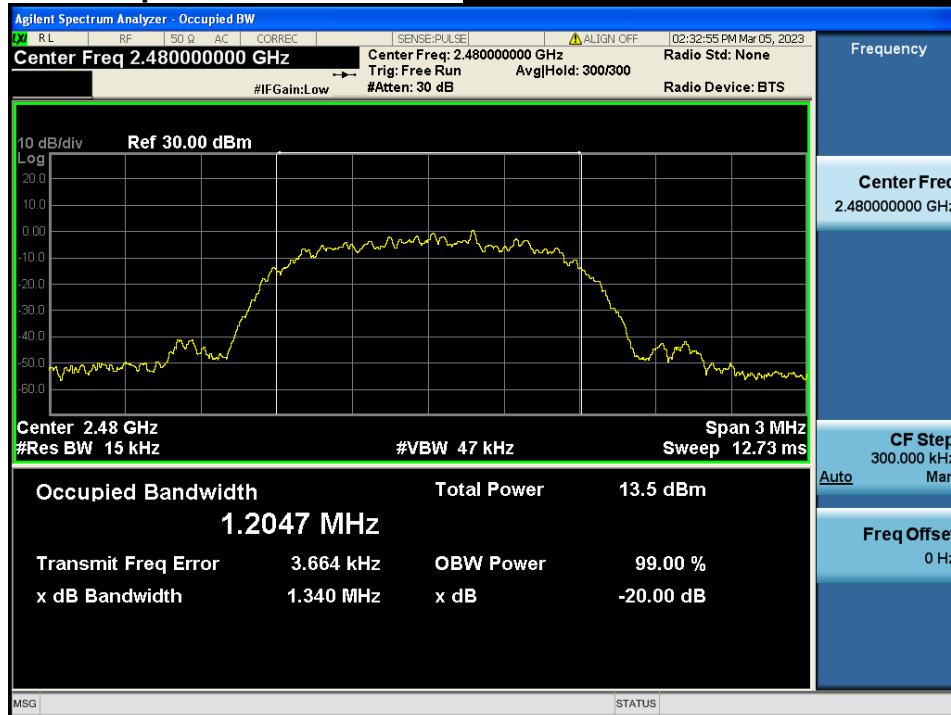

## 6. Carrier Frequency Separation

### 6.1. Test Setup

Refer to the APPENDIX I.

### 6.2. Limit

Limit :  $\geq 25$  kHz or  $\geq$  Two-Thirds of the 20 dB BW whichever is greater.

### 6.3. Test Procedure

The carrier frequency separation was measured with a spectrum analyzer connected to the antenna terminal, while EUT had its hopping function enabled.

After the trace being stable, the reading value between the peaks of the adjacent channels using the marker-delta function was recorded as the measurement results.

The spectrum analyzer is set to :

Span = wide enough to capture the peaks of two adjacent channels

RBW = Start with the RBW set to approximately 30 % of the channel spacing; adjust as necessary to best identify the center of each individual channel.

VBW  $\geq$  RBW

Sweep = auto

Detector function = peak

Trace = max hold

### 6.4. Test Results

#### FH mode

Hopping Mode	Modulation	Peak of reference channel(MHz)	Peak of adjacent Channel(MHz)	Test Result (MHz)
Enable	GFSK	2 441.073	2 442.072	0.999
	$\pi/4$ DQPSK	2 441.171	2 442.173	1.002
	8DPSK	2 441.178	2 442.169	0.991

#### AFH mode

Hopping Mode	Modulation	Peak of reference channel(MHz)	Peak of adjacent Channel(MHz)	Test Result (MHz)
Enable	GFSK	2 441.000	2 442.001	1.001
	$\pi/4$ DQPSK	2 440.863	2 441.865	1.002
	8DPSK	2 441.000	2 441.998	0.998

Note 1 : See next pages for actual measured spectrum



**Carrier Frequency Separation (FH) *Hopping mode : Enable&GFSK***

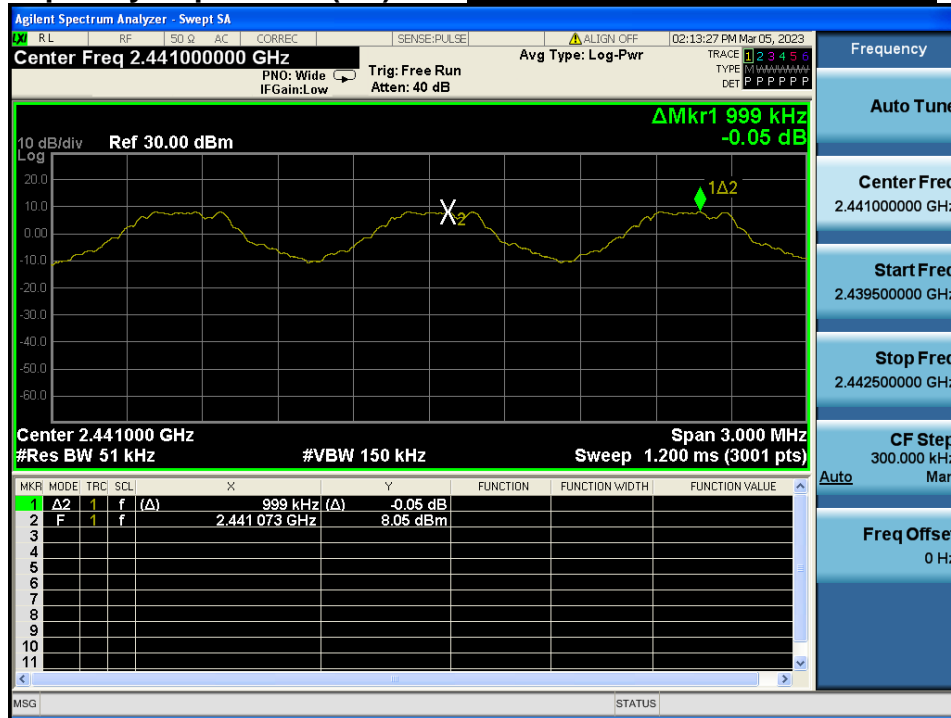

**Carrier Frequency Separation (FH) *Hopping mode : Enable& $\pi/4$ QPSK***

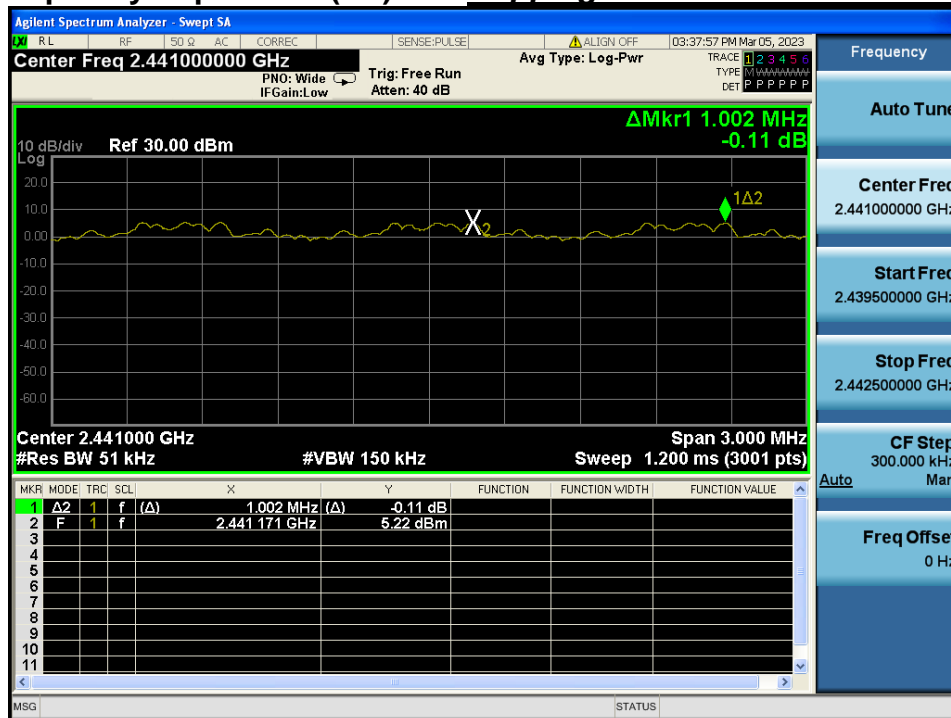

**Carrier Frequency Separation (FH) *Hopping mode : Enable&8DPSK***

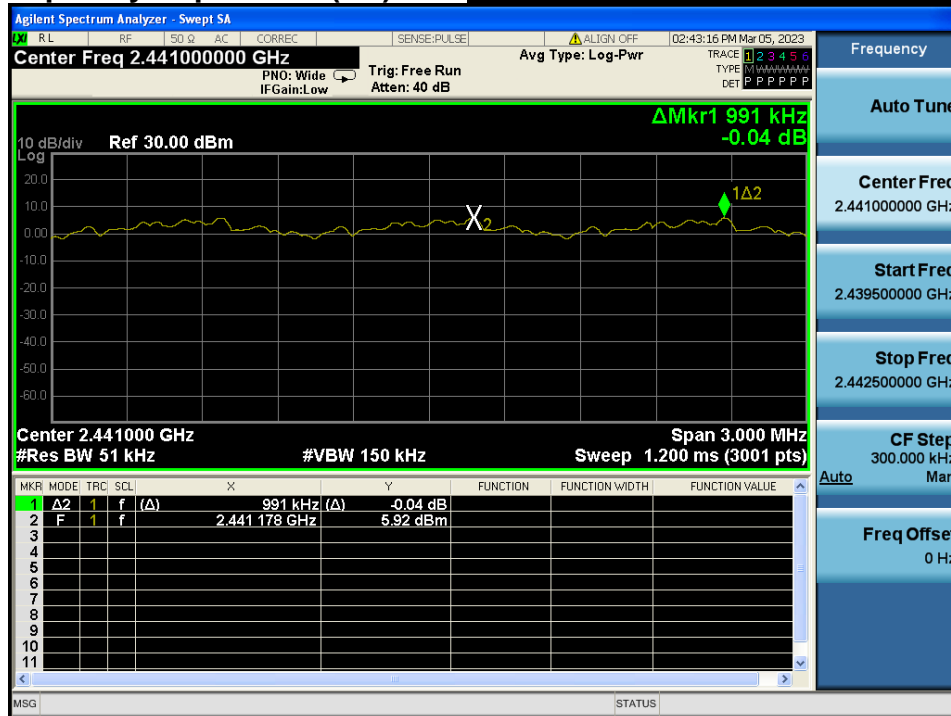

**Carrier Frequency Separation (AFH) *Hopping mode : Enable&GFSK***

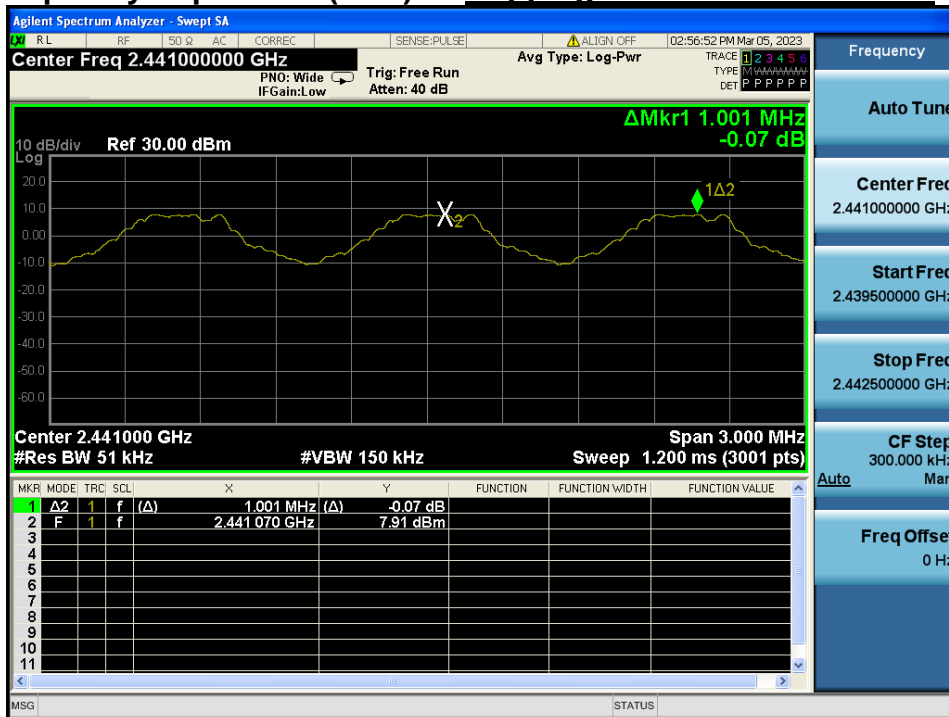

**Carrier Frequency Separation (AFH) *Hopping mode : Enable& $\pi/4$ DQPSK***

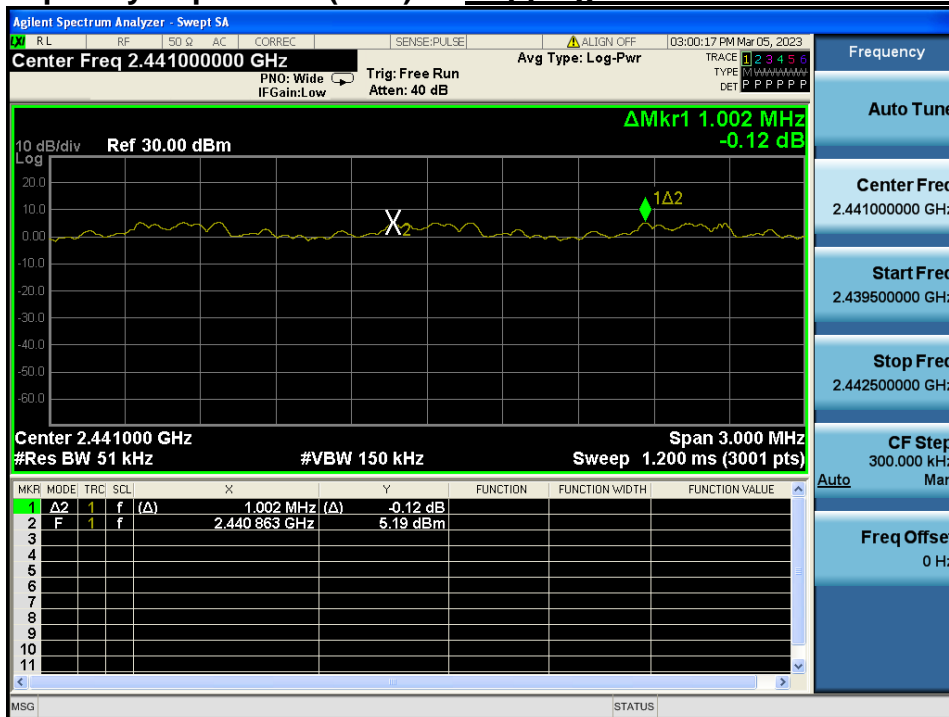

Carrier Frequency Separation (AFH) *Hopping mode : Enable&8DPSK*

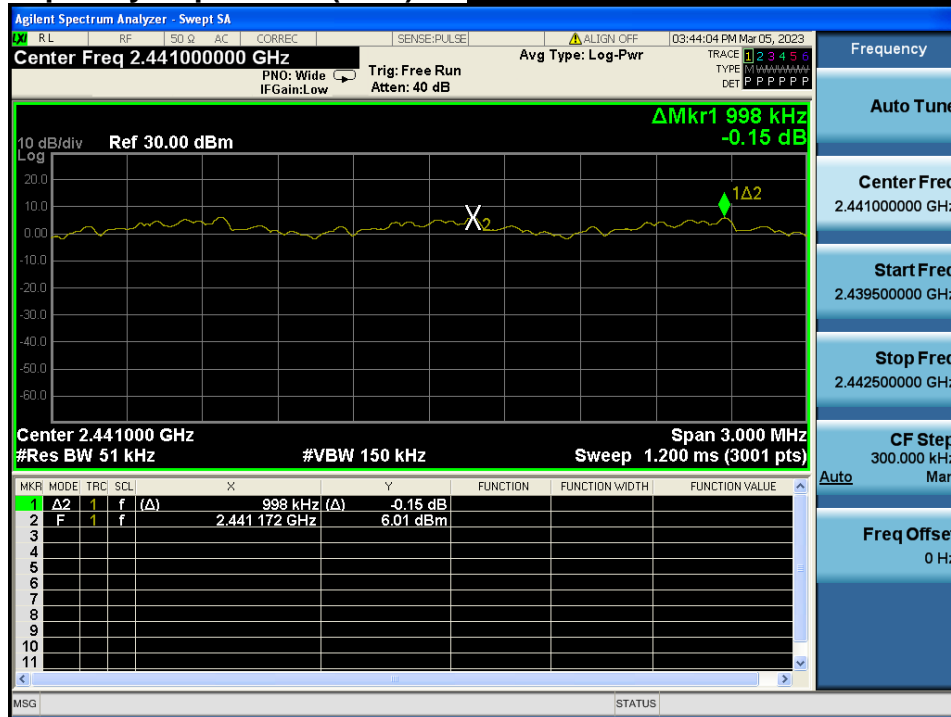

## 7. Number of Hopping Channels

### 7.1. Test Setup

Refer to the APPENDIX I.

### 7.2. Limit

Limit :  $\geq 15$  hops

### 7.3. Test Procedure

The number of hopping frequencies was measured with a spectrum analyzer connected to the antenna terminal, while EUT had its hopping function enabled.

To get higher resolution, two frequency ranges for FH mode within the 2 400 MHz ~ 2 483.5 MHz were examined.

The spectrum analyzer is set to :

Span for FH mode = 50 MHz      Start Frequency = 2 391.5 MHz,      Stop Frequency = 2 441.5 MHz

Start Frequency = 2 441.5 MHz,      Stop Frequency = 2 491.5 MHz

Span for AFH mode = 30 MHz      Start Frequency = 2 426.0 MHz,      Stop Frequency = 2 456.0 MHz

RBW = To identify clearly the individual channels, set the RBW to less than 30 % of the channel spacing or the 20 dB bandwidth, whichever is smaller.

VBW  $\geq$  RBW

Sweep = auto

Detector function = peak

Trace = max hold

### 7.4. Test Results

#### FH mode

Hopping mode	Modulation	Test Result (Total Hops)
Enable	GFSK	79
	$\pi/4$ DQPSK	79
	8DPSK	79

#### AFH mode

Hopping mode	Modulation	Test Result (Total Hops)
Enable	GFSK	20
	$\pi/4$ DQPSK	20
	8DPSK	20

Note 1 : See next pages for actual measured spectrum plots.

Number of Hopping Channels 1(FH)

Hopping mode : Enable & GFSK

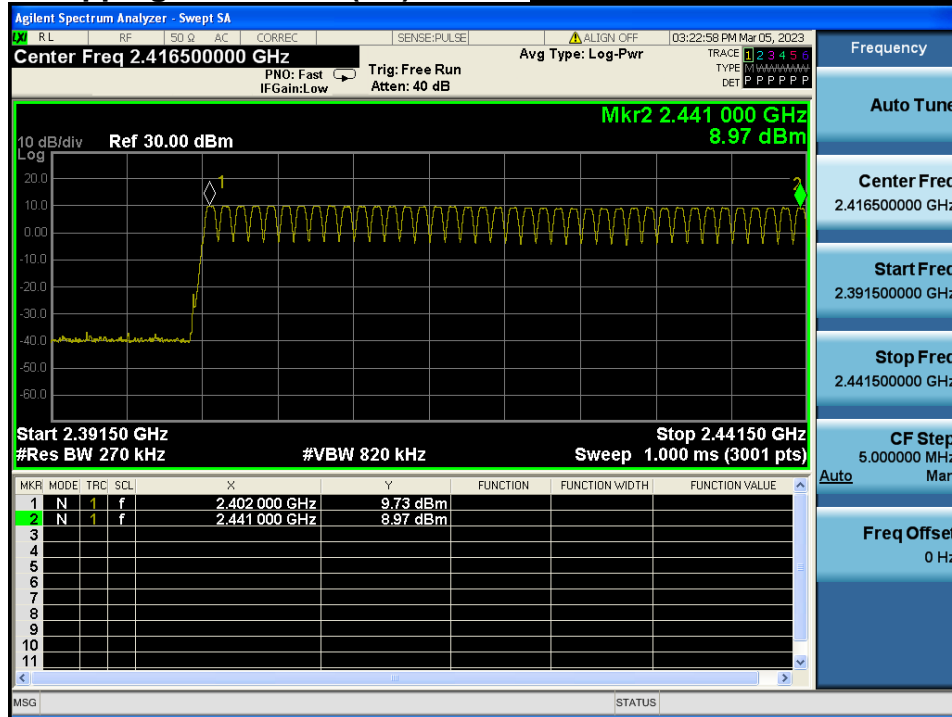

Number of Hopping Channels 2(FH)

Hopping mode : Enable & GFSK

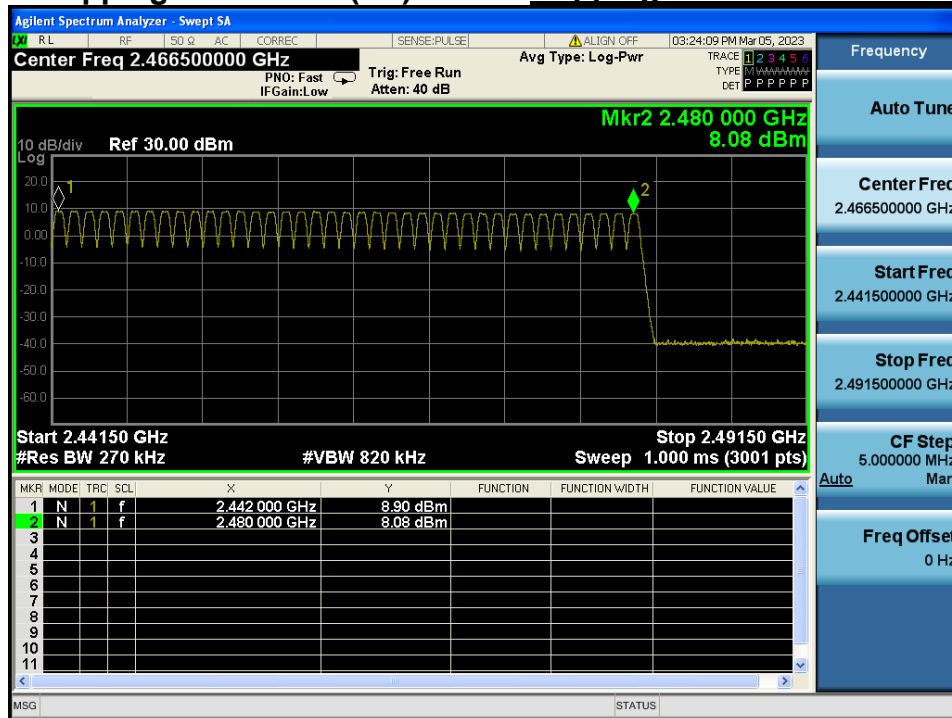

Number of Hopping Channels 1(FH)

Hopping mode : Enable &  $\pi/4$ DQPSK

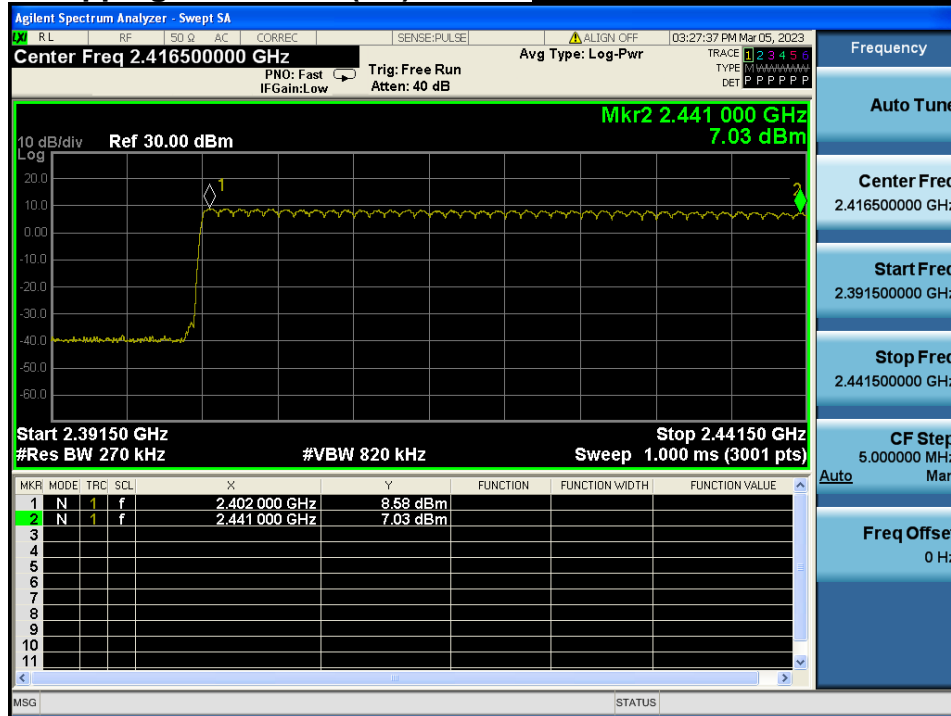

Number of Hopping Channels 2(FH)

Hopping mode : Enable &  $\pi/4$ DQPSK



**Number of Hopping Channels 1(FH)      Hopping mode : Enable&8DPSK**

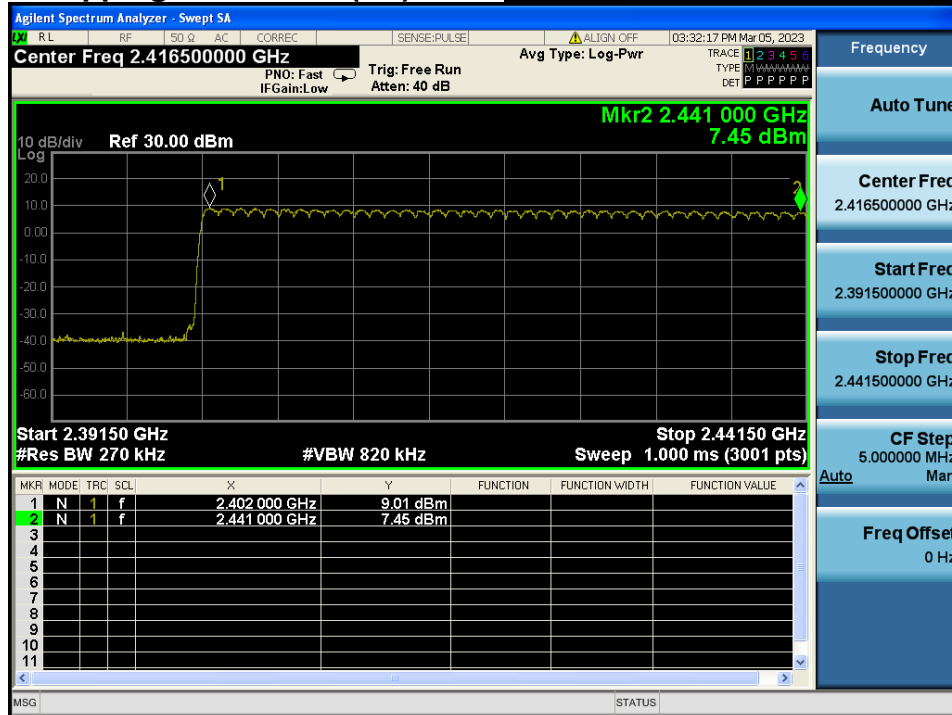

**Number of Hopping Channels 2(FH)      Hopping mode : Enable & 8DPSK**

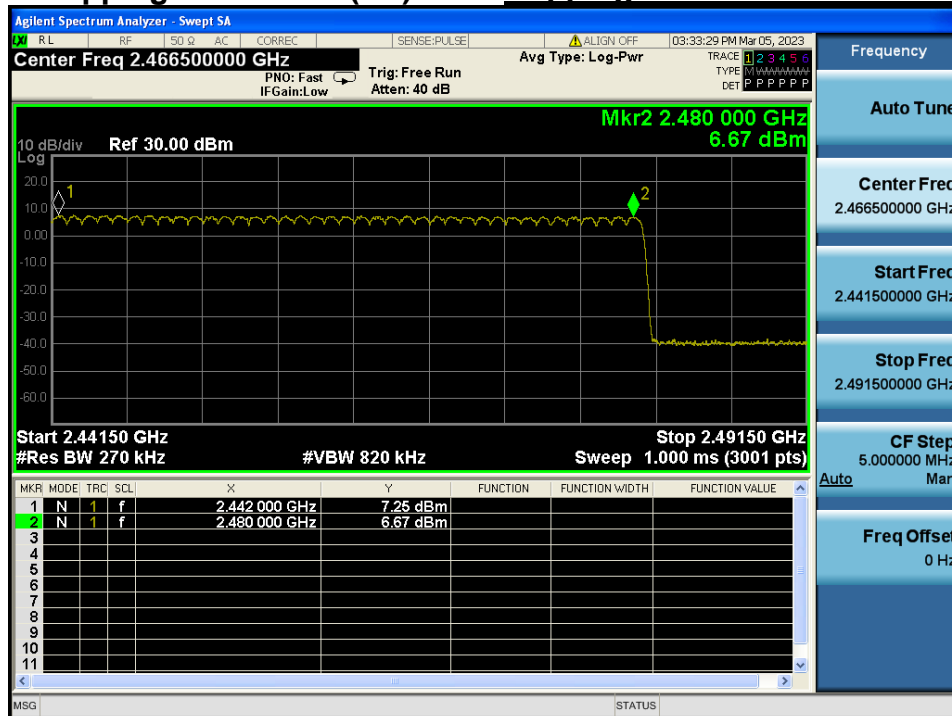



Number of Hopping Channels 1(AFH) *Hopping mode : Enable &GFSK*

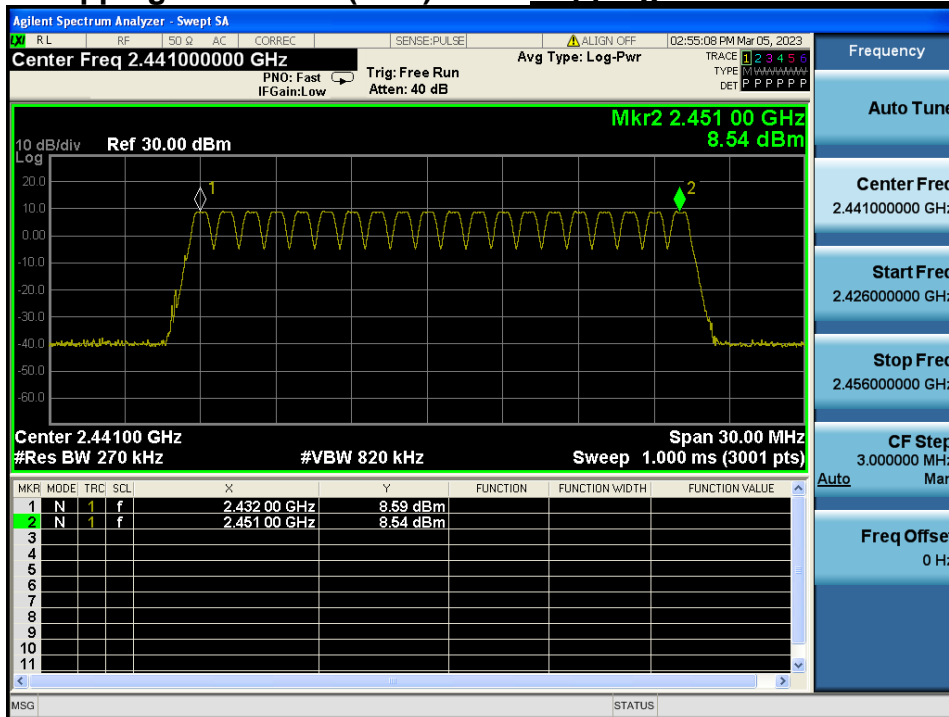

Number of Hopping Channels 1(AFH) *Hopping mode : Enable & $\pi/4$ DQPSK*

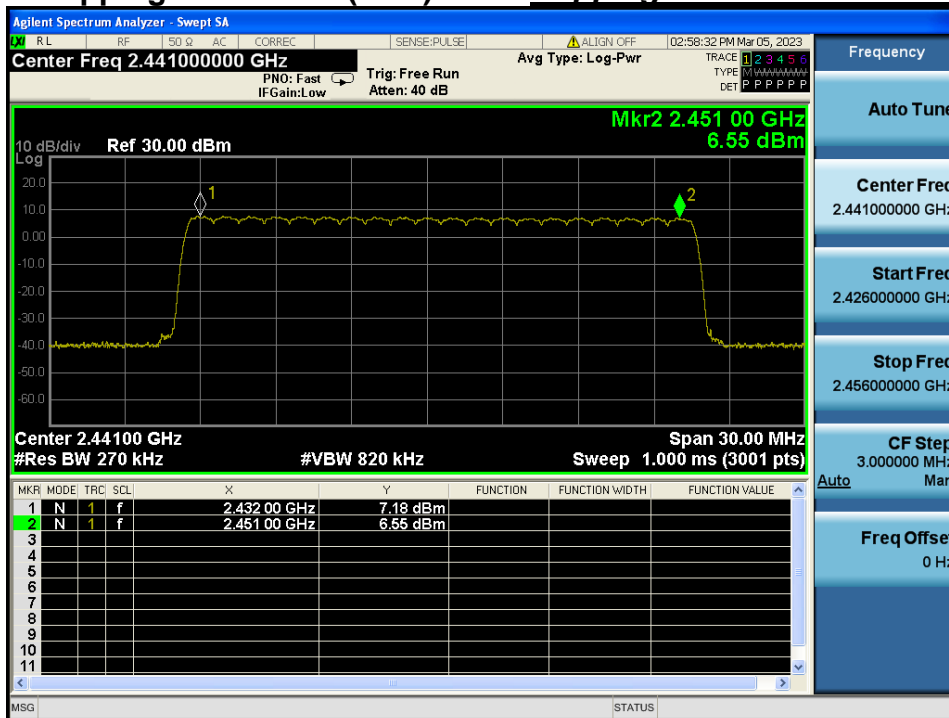

Number of Hopping Channels 1(AFH) *Hopping mode : Enable & 8DPSK*

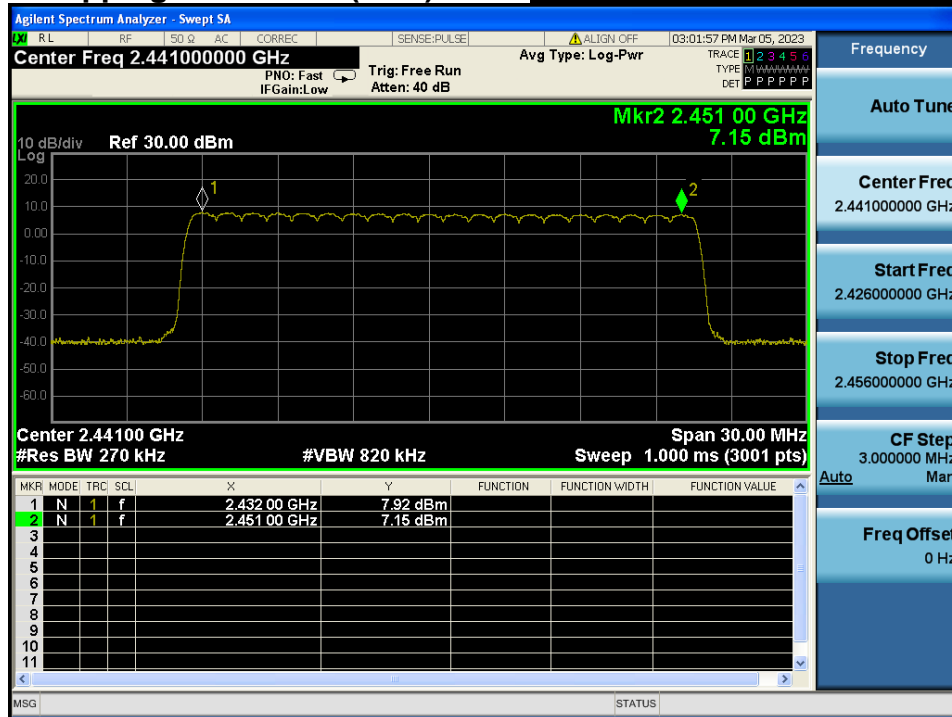

## 8. Time of Occupancy

### 8.1. Test Setup

Refer to the APPENDIX I.

### 8.2. Limit

The maximum permissible time of occupancy is 400 ms within a period of 400 ms multiplied by the number of hopping channels employed.

### 8.3. Test Procedure

The dwell time was measured with a spectrum analyzer connected to the antenna terminal, while EUT had its hopping function enabled.

The spectrum analyzer is set to :

Center frequency = 2 441 MHz

Span = zero

RBW = 1 MHz (RBW shall be  $\leq$  channel spacing and where possible RBW should be set  $\gg 1 / T$ , where T is the expected dwell time per channel)

VBW  $\geq$  RBW

Detector function = peak

Trace = max hold

### 8.4. Test Results

#### FH mode

Hopping mode	Packet Type	Number of hopping Channels	Burst On Time (ms)	Period (ms)	Test Result (sec)
Enable	DH 5	79	2.865	3.750	0.306
	2 DH 5	79	2.880	3.750	0.307
	3 DH 5	79	2.880	3.750	0.307

#### AFH mode

Hopping mode	Packet Type	Number of hopping Channels	Burst On Time (ms)	Period (ms)	Test Result (sec)
Enable	DH 5	20	2.865	3.750	0.153
	2 DH 5	20	2.880	3.750	0.154
	3 DH 5	20	2.865	3.750	0.153

Note 1 : Dwell Time =  $0.4 \times \text{Hopping channel} \times \text{Burst ON time} \times ((\text{Hopping rate} \div \text{Time slots}) \div \text{Hopping channel})$

- Time slots for DH5 = 6 slots (TX = 5 slots / RX = 1 slot)
- Hopping Rate = 1 600 for FH mode & 800 for AFH mode

Note 2 : See next pages for actual measured spectrum plots.

Time of Occupancy (FH)

Hopping mode : Enable&DH5

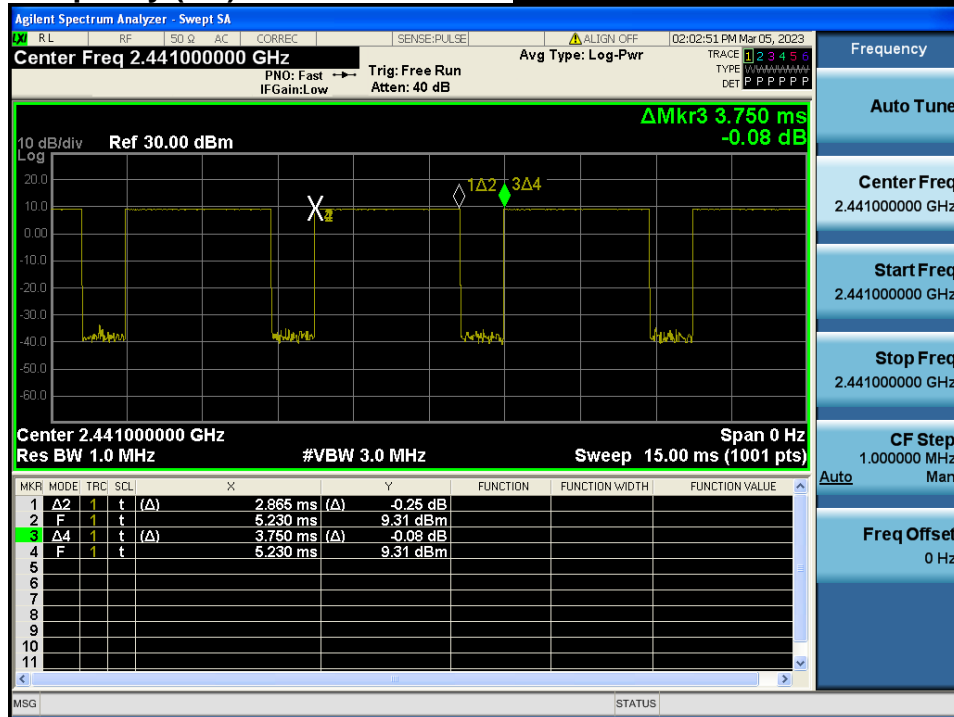

Time of Occupancy (FH)

Hopping mode : Enable&2-DH5

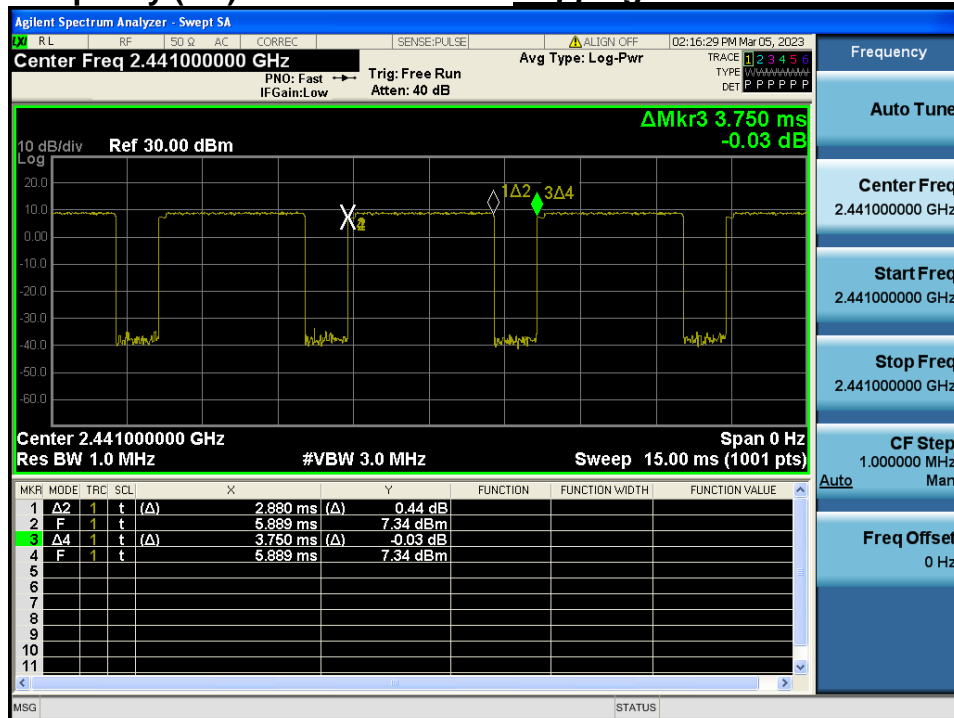

Time of Occupancy (FH)

Hopping mode : Enable&3-DH5

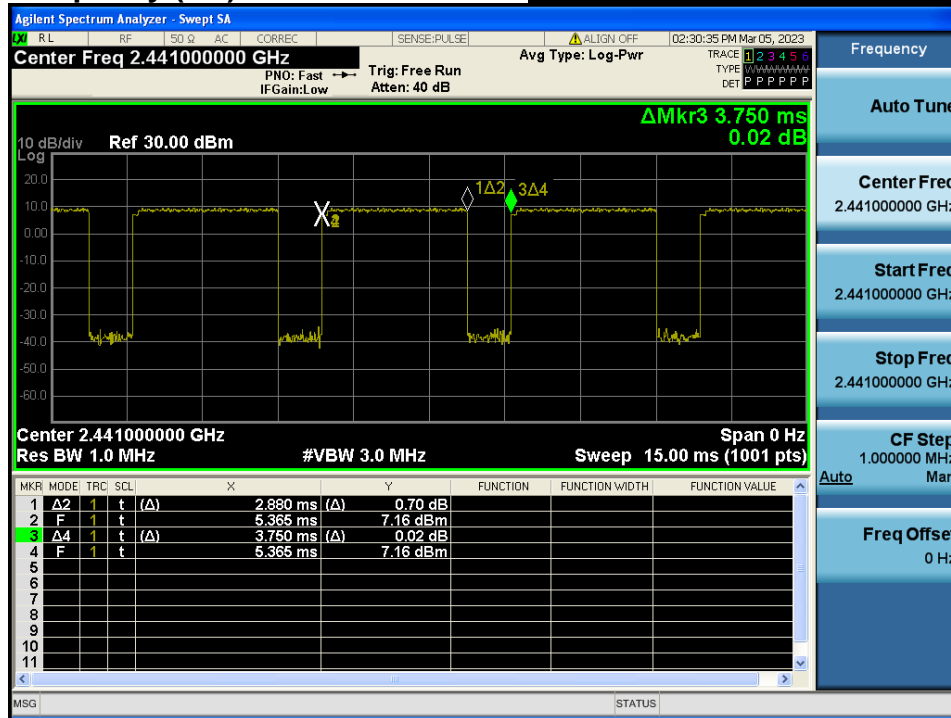

Time of Occupancy (AFH)

Hopping mode : Enable&DH5

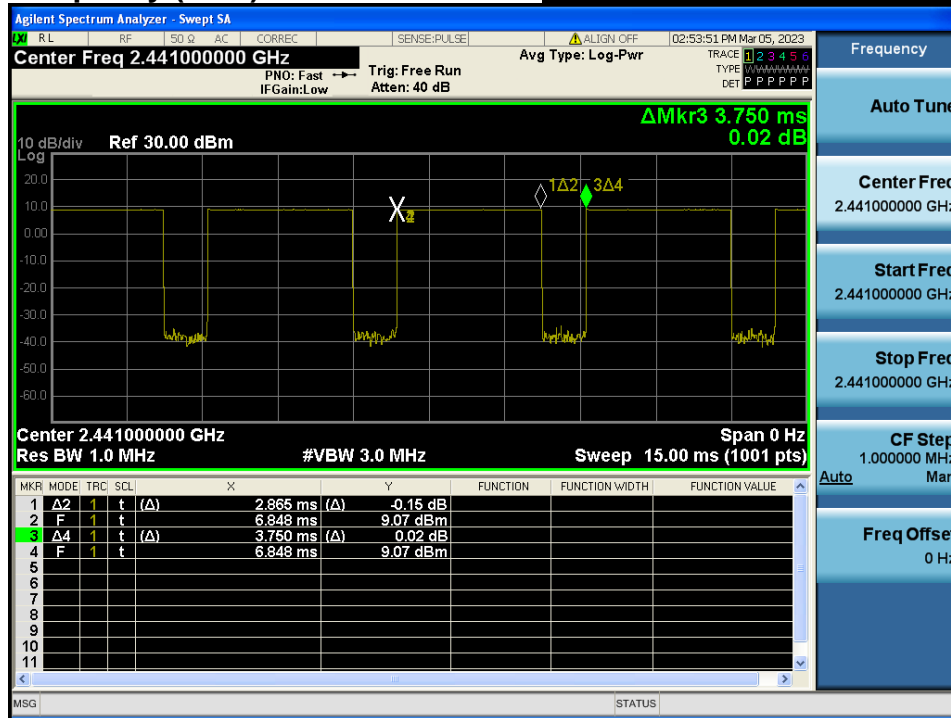

Time of Occupancy (AFH)

Hopping mode : Enable&2-DH5

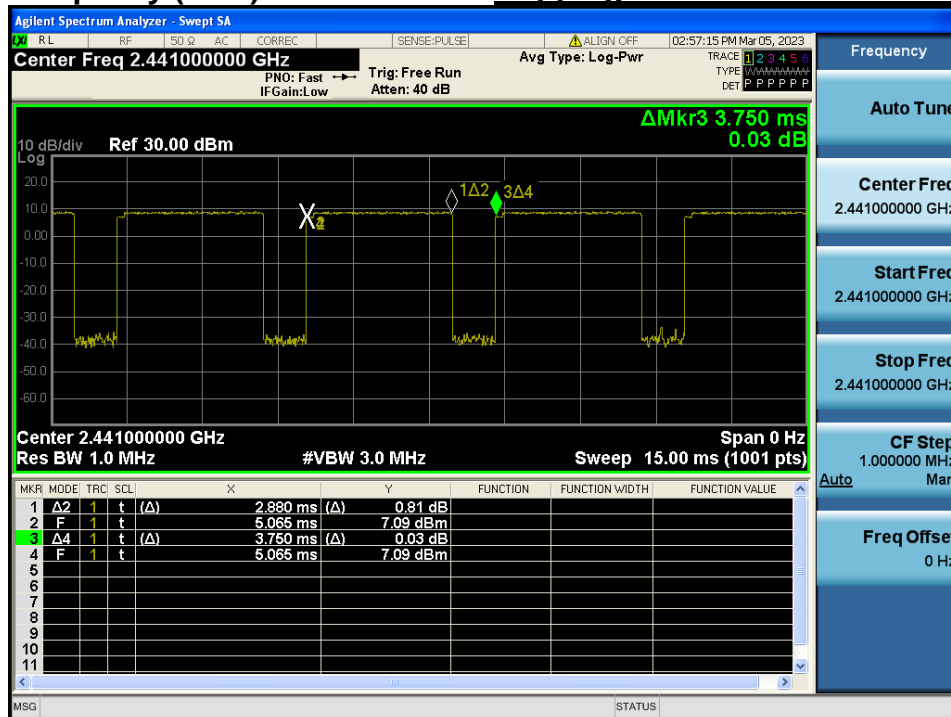

Time of Occupancy (AFH)

Hopping mode : Enable&3-DH5

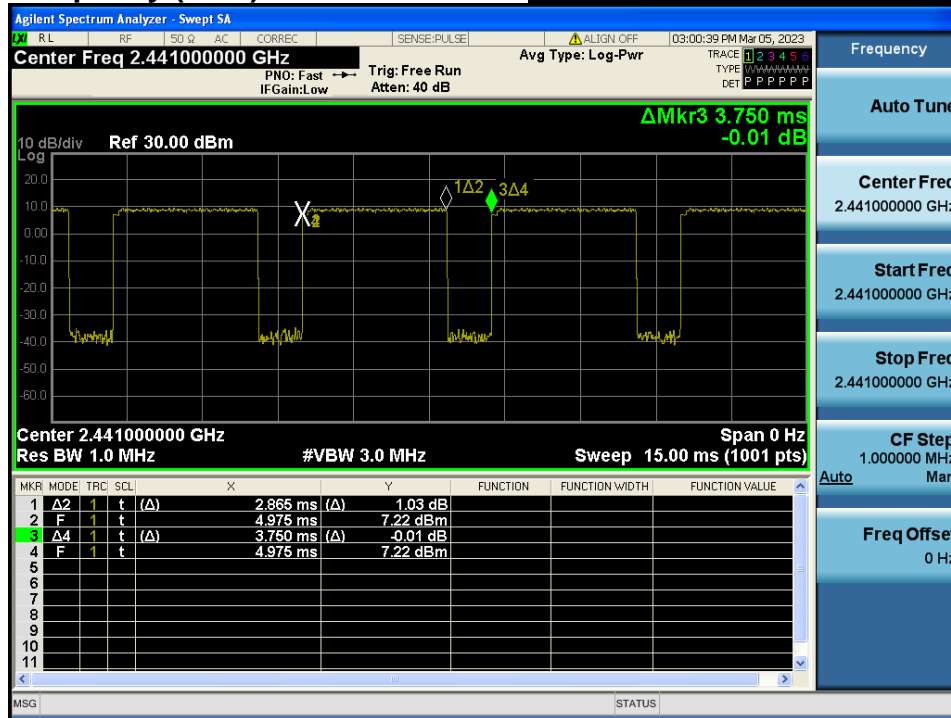

## 9. Unwanted Emissions

### 9.1. Test Setup

Refer to the APPENDIX I.

### 9.2. Limit

Part 15.247(d), Part 15.205, Part 15.209 & RSS-247 [5.5], RSS-Gen [8.9], RSS-Gen [8.10]

In any 100 kHz bandwidth outside the frequency band in which the spread spectrum or digitally modulated intentional radiator is operating, the radio frequency power that is produced by the intentional radiator shall be at least 20 dB below that in the 100 kHz bandwidth within the band that contains the highest level of the desired power, based on either an RF conducted or a radiated measurement, provided the transmitter demonstrates compliance with the peak conducted power limits. If the transmitter complies with the conducted power limits based on the use of RMS averaging over a time interval, as permitted under paragraph (b)(3) of Part 15.247 the attenuation required under this paragraph shall be 30 dB instead of 20 dB. Attenuation below the general limits specified in §15.209(a) is not required. In addition, radiated emissions which fall in the restricted bands, as defined in §15.205(a), must also comply with the radiated emission limits specified in §15.209(a) (see §15.205(c)).

#### - Part 15.209 & RSS-Gen[8.9]: General requirement

Frequency (MHz)	FCC Limit (uV/m)	IC Limit (uA/m)	Measurement Distance (m)
0.009 – 0.490	2 400 / F (kHz)	6.37/F (F in kHz)	300
0.490 – 1.705	24 000 / F (kHz)	63.7/F (F in kHz)	30
1.705 – 30.0	30	0.08	30

Frequency (MHz)	FCC Limit (uV/m)	IC Limit (uV/m)	Measurement Distance (m)
30 ~ 88	100 **	100	3
88 ~ 216	150 **	150	3
216 ~ 960	200 **	200	3
Above 960	500	500	3

\*\*Except as provided in paragraph (g), fundamental emissions from intentional radiators operating under this section shall not be located in the frequency bands 54-72 MHz, 76-88 MHz, 174-216 MHz or 470-806 MHz. However, operation within these frequency bands is permitted under other sections of this part, e.g., §15.231 and 15.241.



**- Part 15.205(a): Restricted band of operation**

MHz	MHz	MHz	MHz	GHz	GHz
0.009 ~ 0.110	8.414 25 ~ 8.414 75	108 ~ 121.94	1 300 ~ 1 427	4.5 ~ 5.15	14.47 ~ 14.5
0.495 ~ 0.505	12.29 ~ 12.293	123 ~ 138	1 435 ~ 1 626.5	5.35 ~ 5.46	15.35 ~ 16.2
2.173 5 ~ 2.190 5	12.519 75 ~ 12.520 25	149.9 ~ 150.05	1 645.5 ~ 1 646.5	7.25 ~ 7.75	17.7 ~ 21.4
4.125 ~ 4.128	12.576 75 ~ 12.577 25	156.524 75 ~ 156.525 25	1 660 ~ 1 710	8.025 ~ 8.5	22.01 ~ 23.12
4.177 25 ~ 4.177 75	13.36 ~ 13.41	156.7 ~ 156.9	1 718.8 ~ 1 722.2	9.0 ~ 9.2	23.6 ~ 24.0
4.207 25 ~ 4.207 75	16.42 ~ 16.423	162.012 5 ~ 167.17	2 200 ~ 2 300	9.3 ~ 9.5	31.2 ~ 31.8
6.215 ~ 6.218	16.694 75 ~ 16.695 25	167.72 ~ 173.2	2 310 ~ 2 390	10.6 ~ 12.7	36.43 ~ 36.5
6.267 75 ~ 6.268 25	16.804 25 ~ 16.804 75	240 ~ 285	2 483.5 ~ 2 500	13.25 ~ 13.4	Above 38.6
6.311 75 ~ 6.312 25	25.5 ~ 25.67	322 ~ 335.4	2 655 ~ 2 900		
8.291 ~ 8.294	37.5 ~ 38.25	399.90 ~ 410	3 260 ~ 3 267		
8.362 ~ 8.366	73 ~ 74.6	608 ~ 614	3 332 ~ 3 339		
8.376 25 ~ 8.386 75	74.8 ~ 75.2	960 ~ 1 240	3 345.8 ~ 3 358		
			3 600 ~ 4 400		

**- RSS-GEN[8.10]: Restricted frequency bands**

MHz	MHz	MHz	MHz	MHz	GHz
0.090 ~ 0.110	8.362 ~ 8.366	73 ~ 74.6	608 ~ 614	3 345.8 ~ 3 358	9.0 ~ 9.2
0.495 ~ 0.505	8.376 25 ~ 8.386 75	74.8 ~ 75.2	960 ~ 1 427	3 500 ~ 4 400	9.3 ~ 9.5
2.173 5 ~ 2.190 5	8.414 25 ~ 8.414 75	108 ~ 138	1 435 ~ 1 626.5	4 500 ~ 5 150	10.6 ~ 12.7
3.020 ~ 3.026	12.29 ~ 12.293	149.9 ~ 150.05	1 645.5 ~ 1 646.5	5 350 ~ 5 460	13.25 ~ 13.4
4.125 ~ 4.128	12.519 75 ~ 12.520 25	156.524 75 ~	1 660 ~ 1 710	7 250 ~ 7 750	14.47 ~ 14.5
4.177 25 ~ 4.177 75	12.576 75 ~ 12.577 25	156.525 25	1 718.8 ~ 1 722.2	8 025 ~ 8 500	15.35 ~ 16.2
4.207 25 ~ 4.207 75	13.36 ~ 13.41	156.7 ~ 156.9	2 200 ~ 2 300		17.7 ~ 21.4
5.677 ~ 5.683	16.42 ~ 16.423	162.01 25 ~ 167.17	2 310 ~ 2 390		22.01 ~ 23.12
6.215 ~ 6.218	16.694 75 ~ 16.695 25	167.72 ~ 173.2	2 483.5 ~ 2 500		23.6 ~ 24.0
6.267 75 ~ 6.268 25	16.804 25 ~ 16.804 75	240 ~ 285	2 655 ~ 2 900		31.2 ~ 31.8
6.311 75 ~ 6.312 25	25.5 ~ 25.67	322 ~ 335.4	3 260 ~ 3 267		36.43 ~ 36.5
8.291 ~ 8.294	37.5 ~ 38.25	399.90 ~ 410	3 332 ~ 3 339		Above 38.6

## 9.3. Test Procedures

### 9.3.1. Test Procedures for Unwanted Emissions(Radiated)

1. The EUT is placed on a non-conductive table. For emission measurements at or below 1 GHz, the table height is 80 cm. For emission measurements above 1 GHz, the table height is 1.5 m. The table was rotated 360 degrees to determine the position of the highest radiation.
2. During performing radiated emission below 1 GHz, the EUT was set 3 meters away from the interference receiving antenna, which was mounted on the top of a variable-height antenna tower. During performing radiated emission above 1 GHz, the EUT was set 1 or 3 meter away from the interference-receiving antenna.
3. For measurements above 1 GHz absorbers are placed on the floor between the turn table and the antenna mast in such a way so as to maximize the reduction of reflections. For measurements below 1 GHz, the absorbers are removed.
4. The antenna is a broadband antenna, and its height is varied from one meter to four meters above the ground to determine the maximum value of the field strength. Both horizontal and vertical polarizations of the antenna are set to make the measurement.
5. For each suspected emission, the EUT was arranged to its worst case and then the antenna was tuned to heights from 1 meter to 4 meters and the table was turned from 0 degrees to 360 degrees to find the maximum reading.
6. The test-receiver system was set to Peak Detect Function and Specified Bandwidth with Maximum Hold Mode.
7. If the emission level of the EUT in peak mode was 10 dB lower than the limit specified, then testing could be stopped and the peak values of the EUT would be reported. Otherwise the emissions that did not have 10 dB margin would be re-tested one by one using peak, quasi-peak or average method as specified and then reported in a data sheet.

#### Measurement Instrument Setting

- Frequencies less than or equal to 1 000 MHz  
The resolution bandwidth and video bandwidth of test receiver/spectrum analyzer is 120 kHz for Quasi-peak detection (QP) at frequency below 1 GHz.
- Frequencies above 1 000 MHz  
The resolution bandwidth and video bandwidth of test receiver/spectrum analyzer is 1 MHz for Peak detection and frequency above 1 GHz.  
The result of Average measurement is calculated using PK result and duty correction factor.

### 9.3.2. Test Procedures for Unwanted Emissions(Conducted)

1. The transmitter output was connected to the spectrum analyzer.
2. The **reference level** of the fundamental frequency was measured with the spectrum analyzer using RBW = 100 kHz, VBW = 300 kHz.
3. The conducted spurious emission was tested each ranges were set as below.

**Frequency range : 9 kHz ~ 30 MHz**

RBW = 100 kHz, VBW = 300 kHz, SWEEP TIME = AUTO, DETECTOR = PEAK, TRACE = MAX HOLD, SWEEP POINT : 40 001

**Frequency range : 30 MHz ~ 10 GHz, 10 GHz ~ 25 GHz**

RBW = 1 MHz, VBW = 3 MHz, SWEEP TIME = AUTO, DETECTOR = PEAK, TRACE = MAX HOLD, SWEEP POINT : 40 001

**LIMIT LINE = 20 dB below of the reference level of above measurement procedure Step 2. (RBW = 100 kHz, VBW = 300 kHz)**

If the emission level with above setting was close to the limit (ie, less than 3 dB margin) then zoom scan is required using RBW = 100 kHz, VBW = 300 kHz, SPAN = 100 MHz and BINS = 2 001 to get accurate emission level within 100 kHz BW.

Also the path loss for conducted measurement setup was used as described on the Appendix I of this test report.

## 9.4. Test Results

### 9.4.1. Unwanted Emissions(Radiated)

#### ▪ Test Notes.

- The radiated emissions were investigated 9 kHz to 25 GHz. And no other spurious and harmonic emissions were found below listed frequencies.
- Information of Distance Correction Factor  
For finding emissions, measurements may be performed at a distance closer than that specified in the regulations. In this case, the distance correction factor is applied to the result.  
- Calculation of distance factor  
At frequencies below 30 MHz =  $40 \log(\text{tested distance} / \text{specified distance})$   
At frequencies at or above 30 MHz =  $20 \log(\text{tested distance} / \text{specified distance})$   
When distance factor is "N/A", the measurements were performed at the specified distance and distance factor is not applied.
- DCCF Calculation. (DCCF = Duty Cycle Correction Factor)  
- Time to cycle through all channels =  $\Delta t = T [\text{ms}] \times 20$  minimum hopping channels, where T = pulse width = **2.88 ms**  
-  $100 \text{ ms} / \Delta t [\text{ms}] = H \rightarrow$  Round up to next highest integer, to account for worst case,  $H' = 100 / (2.88 \times 20) = 1.74 \approx 2$   
- The Worst Case Dwell Time =  $T [\text{ms}] \times H' = 2.88 \text{ ms} \times 2 = 5.76 \text{ ms}$   
-  $\text{DCCF} = 20 \text{ Log}(\text{The Worst Case Dwell Time} / 100 \text{ ms}) \text{ dB} = 20 \text{ log}(5.76 / 100) = -24.79 \text{ dB}$
- Sample Calculation.  
 $\text{Margin} = \text{Limit} - \text{Result} / \text{Result} = \text{Reading} + \text{TF} + \text{DCCF} + \text{DCF} / \text{TF} = \text{AF} + \text{CL} + \text{HL} + \text{AL} - \text{AG}$   
Where, TF = Total Factor, AF = Antenna Factor, CL = Cable Loss, AG = Amplifier Gain, HL = High pass filter Loss, AL = Attenuator Loss, DCCF = Duty Cycle Correction Factor, DCF = Distance Correction Factor

#### 9 kHz ~ 25 GHz Data (Modulation : GFSK)

##### ▪ Lowest Channel

Frequency (MHz)	ANT Pol	EUT Position (Axis)	Detector Mode	Reading (dBuV)	TF (dB/m)	DCCF (dB)	DCF (dB)	Result (dBuV/m)	Limit (dBuV/m)	Margin (dB)
2 389.01	H	X	PK	49.61	4.60	N/A	N/A	54.21	74.00	19.79
2 389.01	H	X	AV	49.61	4.60	-24.79	N/A	29.42	54.00	24.58
4 804.77	H	Y	PK	50.31	2.43	N/A	N/A	52.74	74.00	21.26
4 804.77	H	Y	AV	50.31	2.43	-24.79	N/A	27.95	54.00	26.05

##### ▪ Middle Channel

Frequency (MHz)	ANT Pol	EUT Position (Axis)	Detector Mode	Reading (dBuV)	TF (dB/m)	DCCF (dB)	DCF (dB)	Result (dBuV/m)	Limit (dBuV/m)	Margin (dB)
4 883.62	H	Y	PK	50.09	2.40	N/A	N/A	52.49	74.00	21.51
4 883.62	H	Y	AV	50.09	2.40	-24.79	N/A	27.70	54.00	26.30

##### ▪ Highest Channel

Frequency (MHz)	ANT Pol	EUT Position (Axis)	Detector Mode	Reading (dBuV)	TF (dB/m)	DCCF (dB)	DCF (dB)	Result (dBuV/m)	Limit (dBuV/m)	Margin (dB)
2 483.93	H	X	PK	50.72	5.62	N/A	N/A	56.34	74.00	17.66
2 483.93	H	X	AV	50.72	5.62	-24.79	N/A	31.55	54.00	22.45
4 961.77	H	Y	PK	50.79	2.69	N/A	N/A	53.48	74.00	20.52
4 961.77	H	Y	AV	50.79	2.69	-24.79	N/A	28.69	54.00	25.31

**9 kHz ~ 25 GHz Data (Modulation :  $\pi/4$ DQPSK)**

## ▪ Lowest Channel

Frequency (MHz)	ANT Pol	EUT Position (Axis)	Detector Mode	Reading (dBuV)	TF (dB/m)	DCCF (dB)	DCF (dB)	Result (dBuV/m)	Limit (dBuV/m)	Margin (dB)
2 386.56	H	X	PK	50.07	4.61	N/A	N/A	54.68	74.00	19.32
2 386.56	H	X	AV	50.07	4.61	-24.79	N/A	29.89	54.00	24.11
4 805.87	H	Y	PK	50.02	2.42	N/A	N/A	52.44	74.00	21.56
4 805.87	H	Y	AV	50.02	2.42	-24.79	N/A	27.65	54.00	26.35

## ▪ Middle Channel

Frequency (MHz)	ANT Pol	EUT Position (Axis)	Detector Mode	Reading (dBuV)	TF (dB/m)	DCCF (dB)	DCF (dB)	Result (dBuV/m)	Limit (dBuV/m)	Margin (dB)
4 883.07	H	Y	PK	49.43	2.40	N/A	N/A	51.83	74.00	22.17
4 883.07	H	Y	AV	49.43	2.40	-24.79	N/A	27.04	54.00	26.96

## ▪ Highest Channel

Frequency (MHz)	ANT Pol	EUT Position (Axis)	Detector Mode	Reading (dBuV)	TF (dB/m)	DCCF (dB)	DCF (dB)	Result (dBuV/m)	Limit (dBuV/m)	Margin (dB)
2 484.18	H	X	PK	49.36	5.63	N/A	N/A	54.99	74.00	19.01
2 484.18	H	X	AV	49.36	5.63	-24.79	N/A	30.20	54.00	23.80
4 960.63	H	Y	PK	49.46	2.69	N/A	N/A	52.15	74.00	21.85
4 960.63	H	Y	AV	49.46	2.69	-24.79	N/A	27.36	54.00	26.64

**9 kHz ~ 25 GHz Data (Modulation : 8DPSK)**

## ▪ Lowest Channel

Frequency (MHz)	ANT Pol	EUT Position (Axis)	Detector Mode	Reading (dBuV)	TF (dB/m)	DCCF (dB)	DCF (dB)	Result (dBuV/m)	Limit (dBuV/m)	Margin (dB)
2 389.22	H	X	PK	49.60	4.60	N/A	N/A	54.20	74.00	19.80
2 389.22	H	X	AV	49.60	4.60	-24.79	N/A	29.41	54.00	24.59
4 806.24	H	Y	PK	49.39	2.42	N/A	N/A	51.81	74.00	22.19
4 806.24	H	Y	AV	49.39	2.42	-24.79	N/A	27.02	54.00	26.98

## ▪ Middle Channel

Frequency (MHz)	ANT Pol	EUT Position (Axis)	Detector Mode	Reading (dBuV)	TF (dB/m)	DCCF (dB)	DCF (dB)	Result (dBuV/m)	Limit (dBuV/m)	Margin (dB)
4 880.77	H	Y	PK	49.22	2.36	N/A	N/A	51.58	74.00	22.42
4 880.77	H	Y	AV	49.22	2.36	-24.79	N/A	26.79	54.00	27.21

## ▪ Highest Channel

Frequency (MHz)	ANT Pol	EUT Position (Axis)	Detector Mode	Reading (dBuV)	TF (dB/m)	DCCF (dB)	DCF (dB)	Result (dBuV/m)	Limit (dBuV/m)	Margin (dB)
2 485.35	H	X	PK	51.07	5.64	N/A	N/A	56.71	74.00	17.29
2 485.35	H	X	AV	51.07	5.64	-24.79	N/A	31.92	54.00	22.08
4 960.43	H	Y	PK	49.34	2.69	N/A	N/A	52.03	74.00	21.97
4 960.43	H	Y	AV	49.34	2.69	-24.79	N/A	27.24	54.00	26.76

9.4.2. Unwanted Emissions(Conducted)

Low Band-edge

***Lowest Channel & Modulation : GFSK***

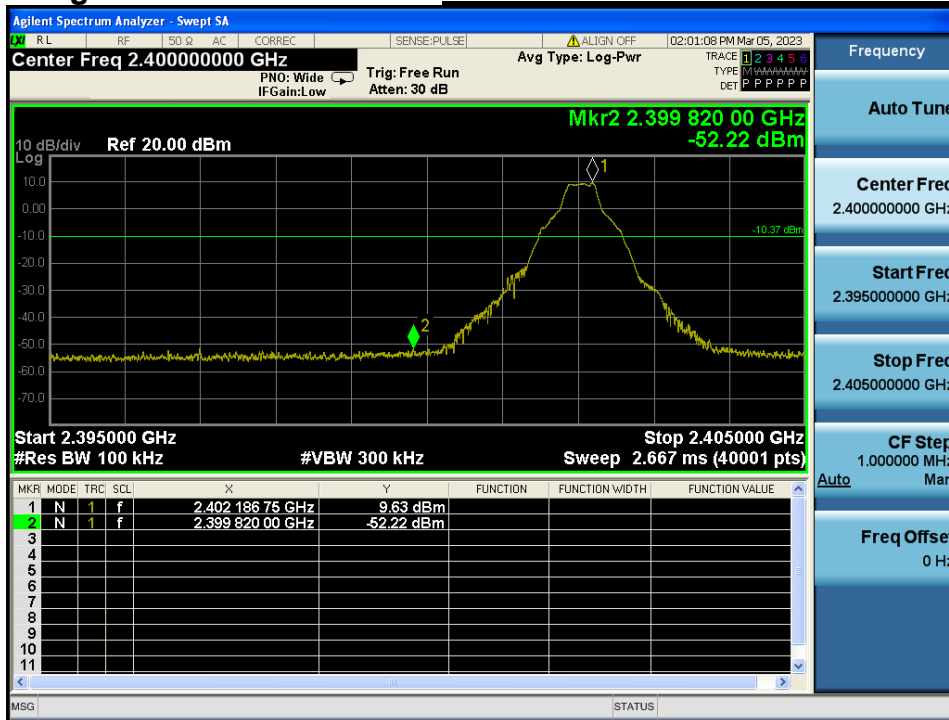

Low Band-edge

***Hopping mode & Modulation : GFSK***

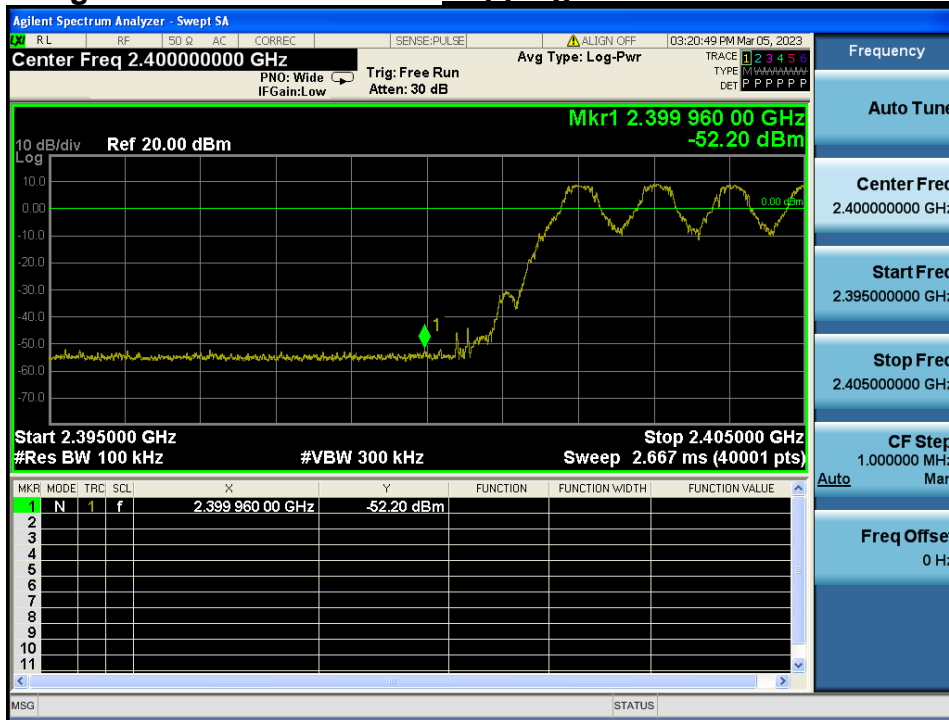

Conducted Spurious Emissions **Lowest Channel & Modulation : GFSK**

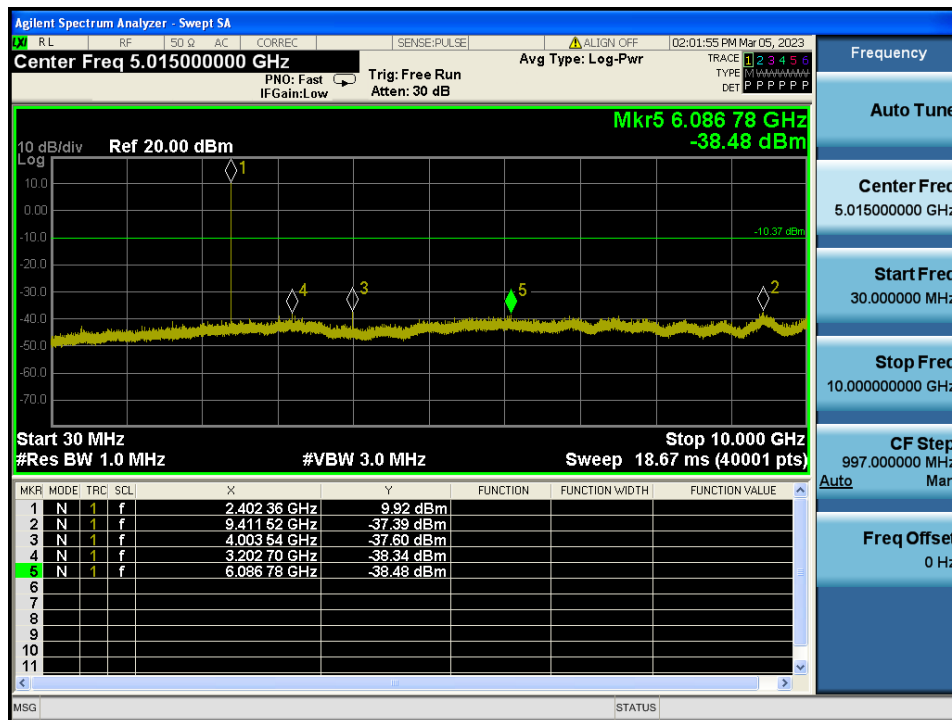
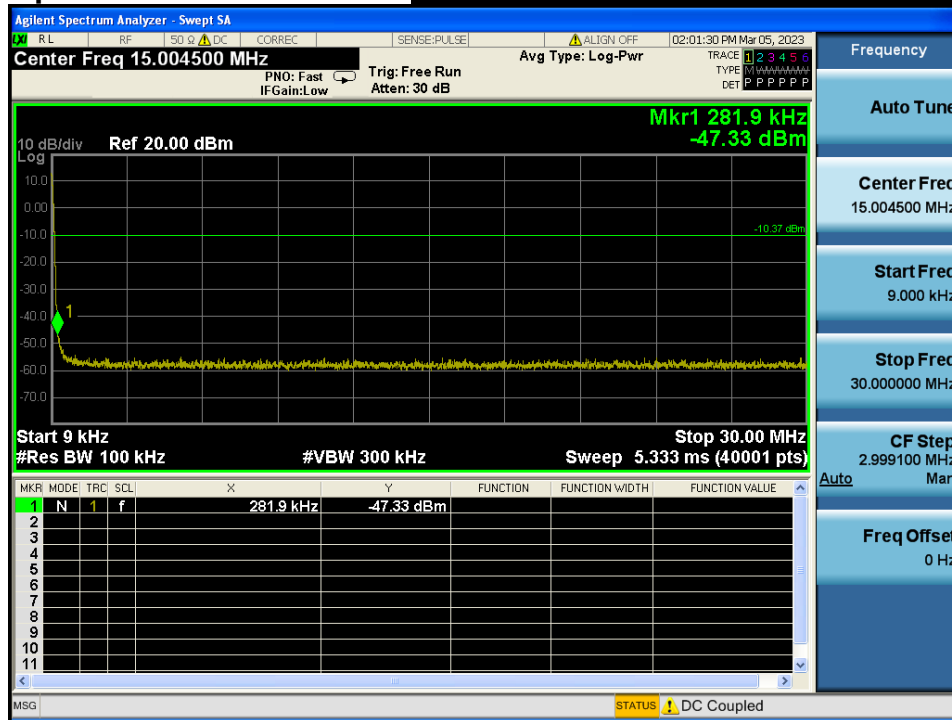



Conducted Spurious Emissions **Lowest Channel & Modulation : GFSK**

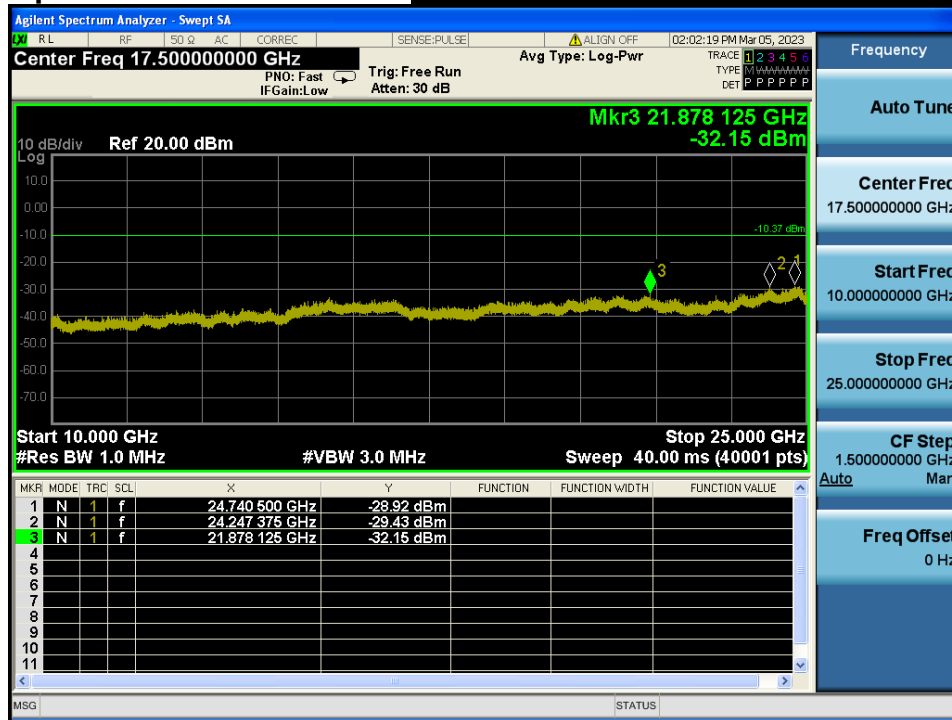

Reference for limit

Middle Channel & Modulation : GFSK

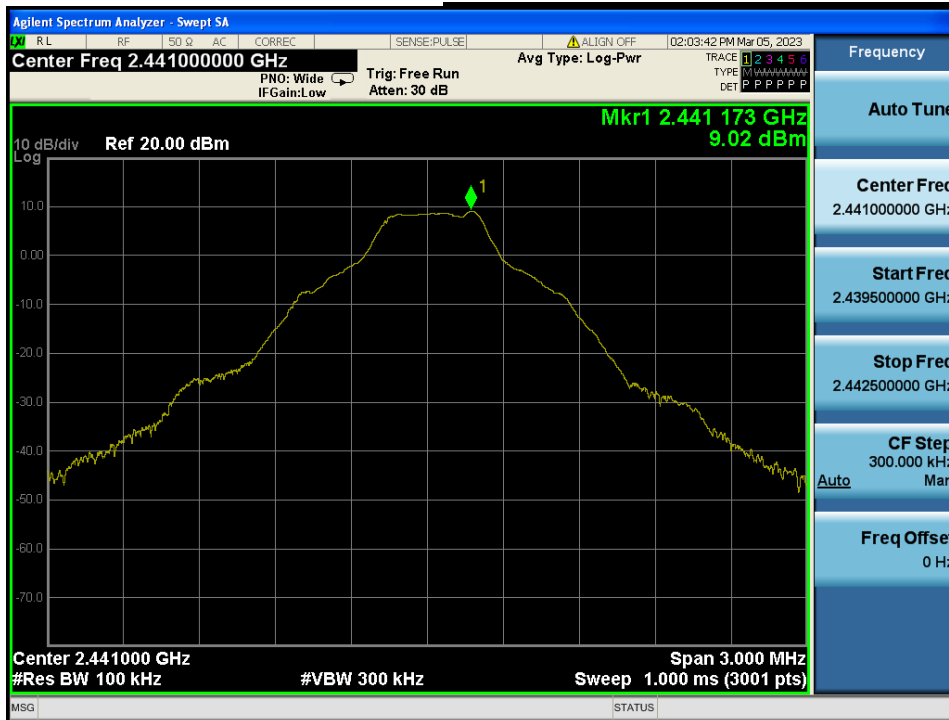

Conducted Spurious Emissions

Middle Channel & Modulation : GFSK

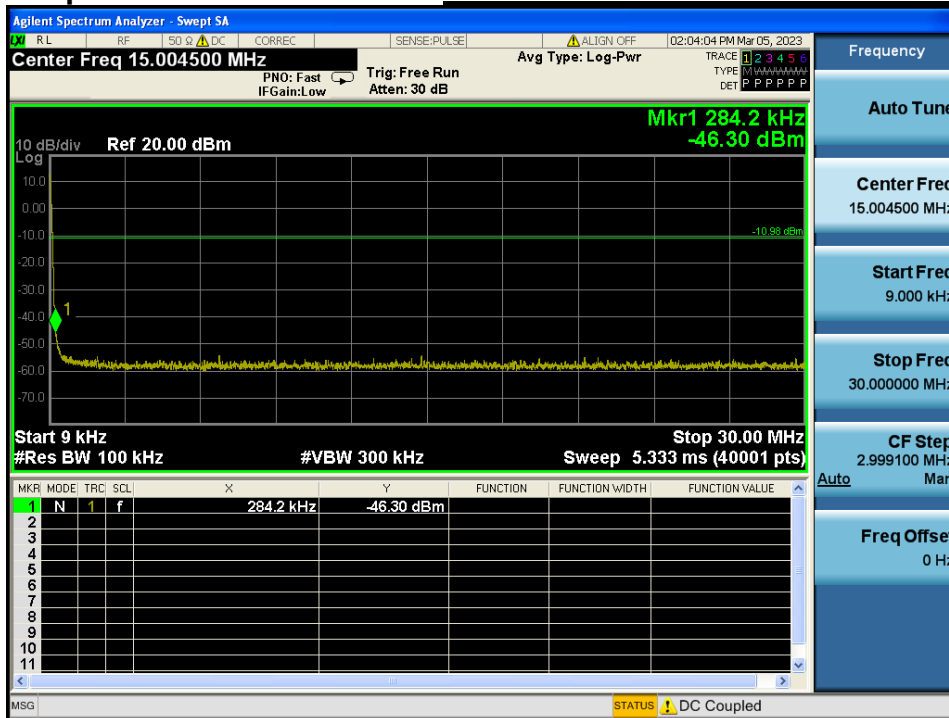

Conducted Spurious Emissions *Middle Channel & Modulation : GFSK*

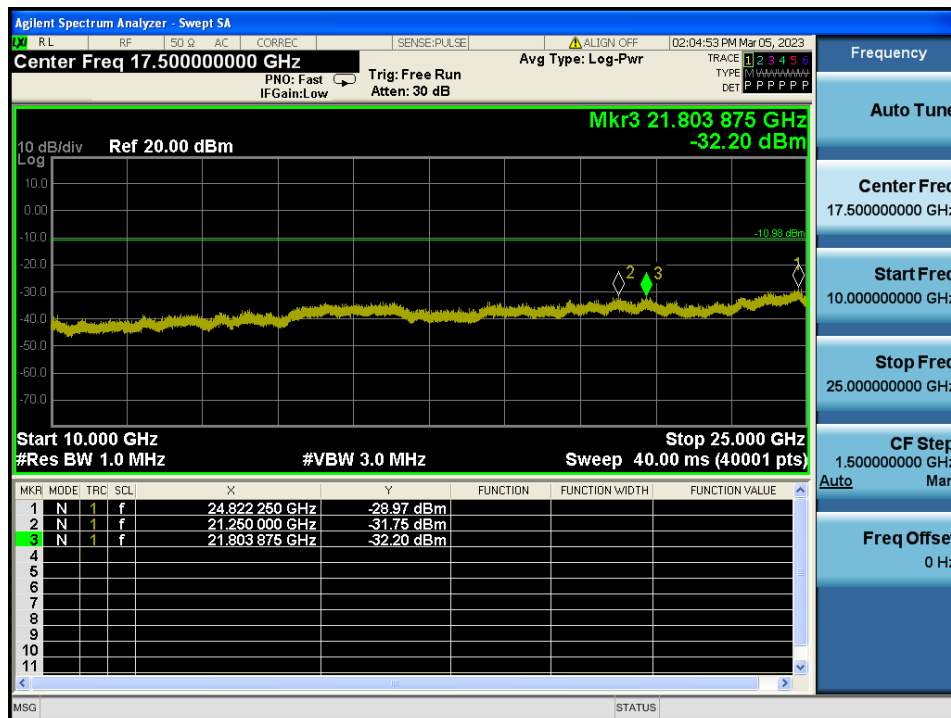
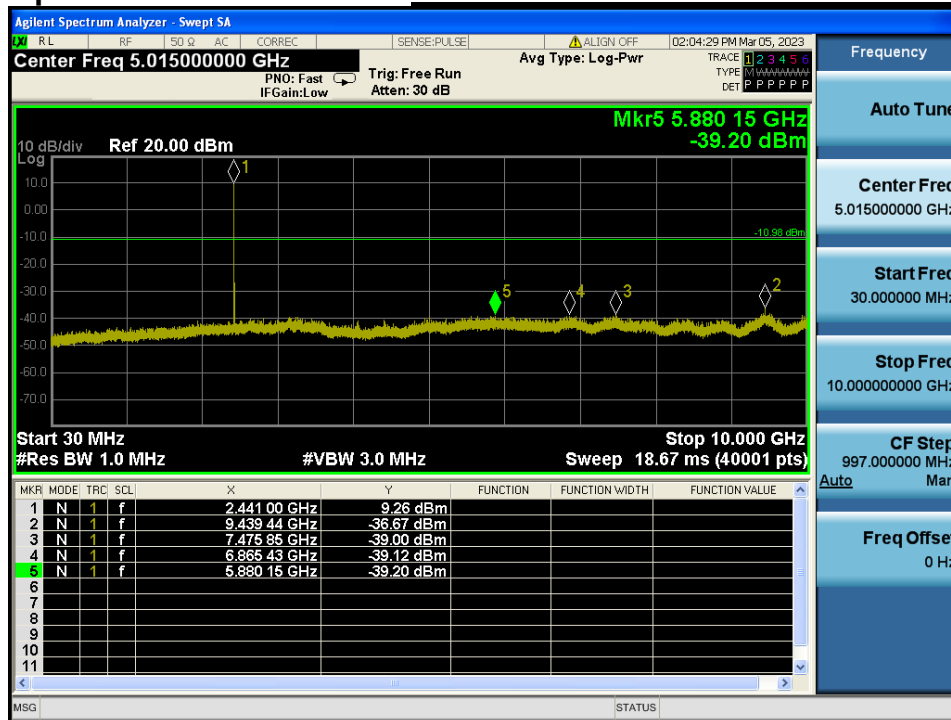

High Band-edge

**Highest Channel & Modulation : GFSK**

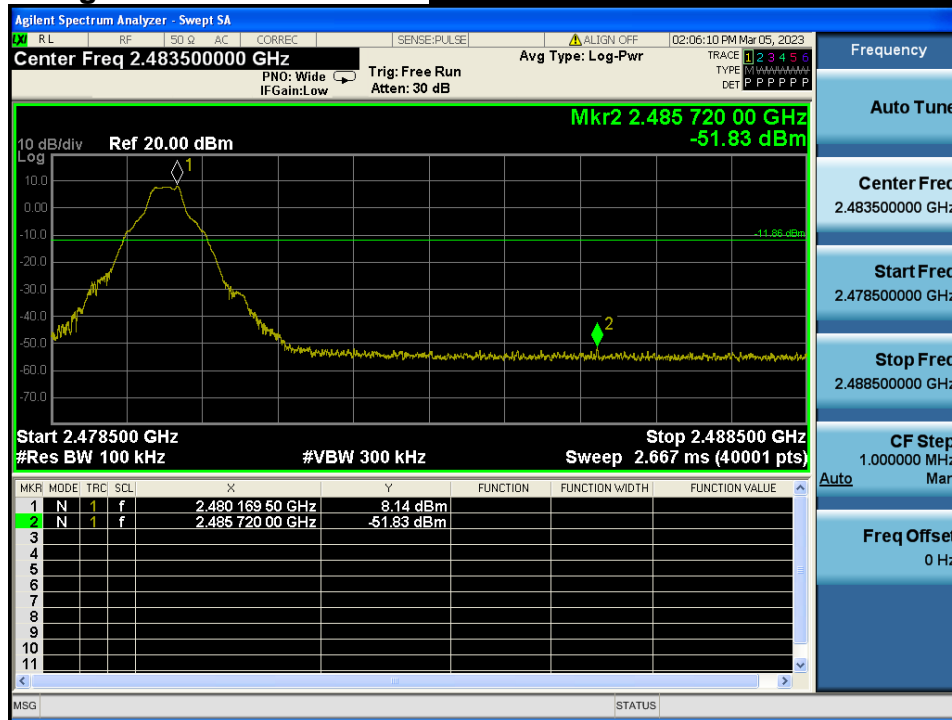

High Band-edge

**Hopping mode & Modulation : GFSK**

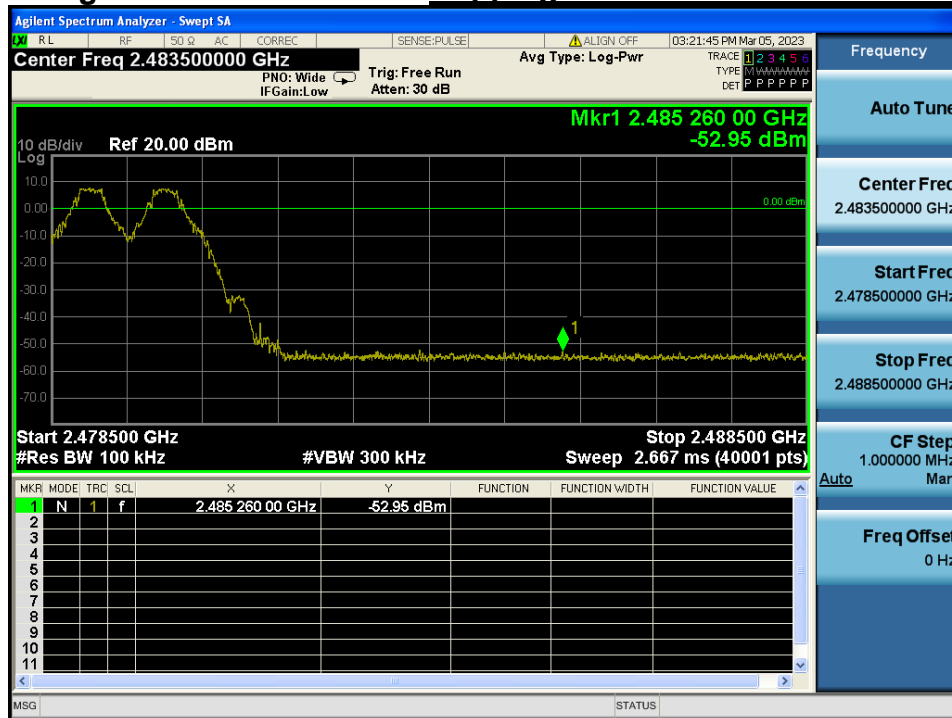

Conducted Spurious Emissions **Highest Channel & Modulation : GFSK**

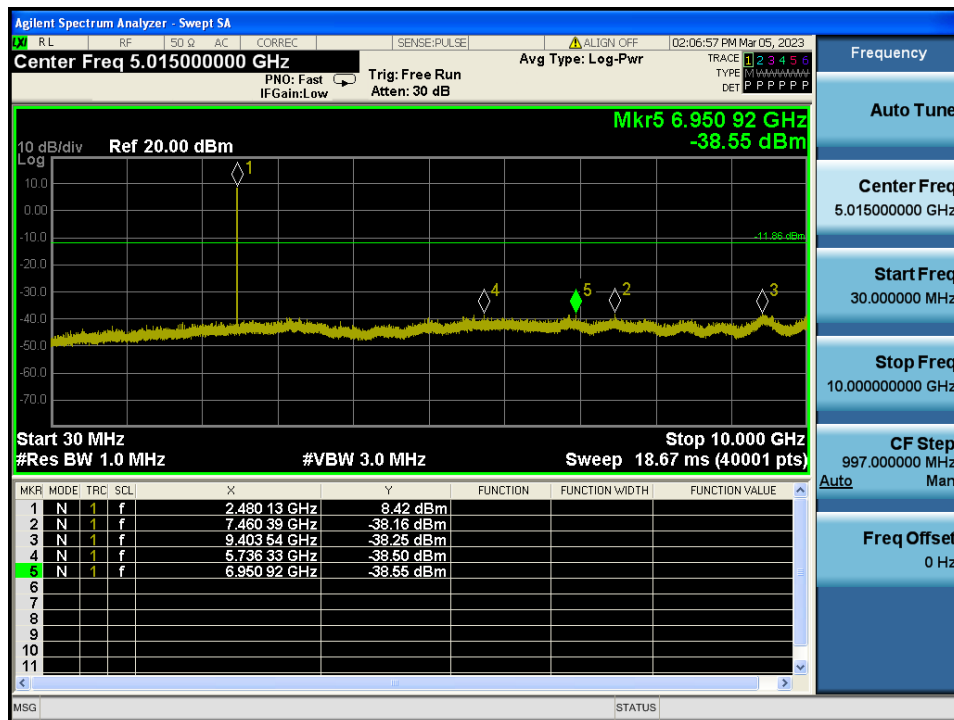
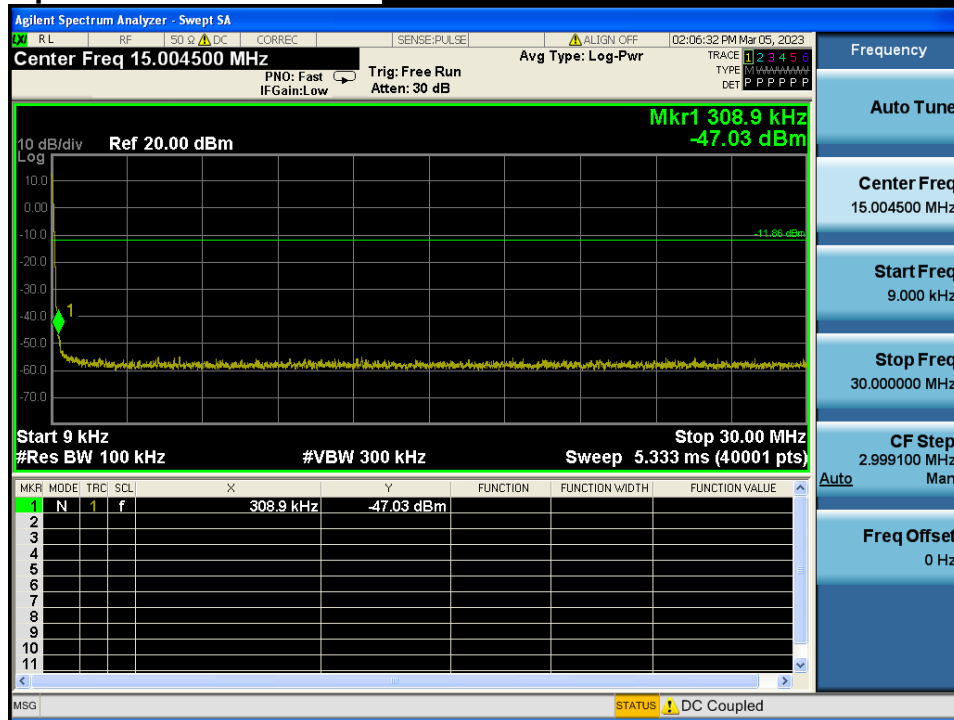

Conducted Spurious Emissions **Highest Channel & Modulation : GFSK**

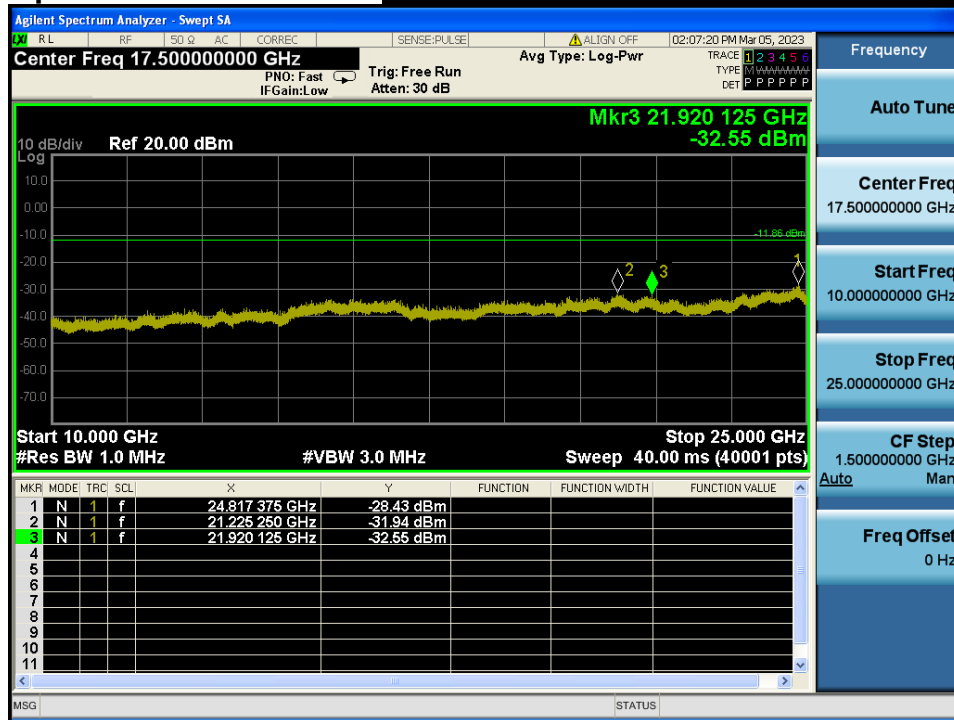

Low Band-edge

Lowest Channel & Modulation :  $\pi/4$ DQPSK

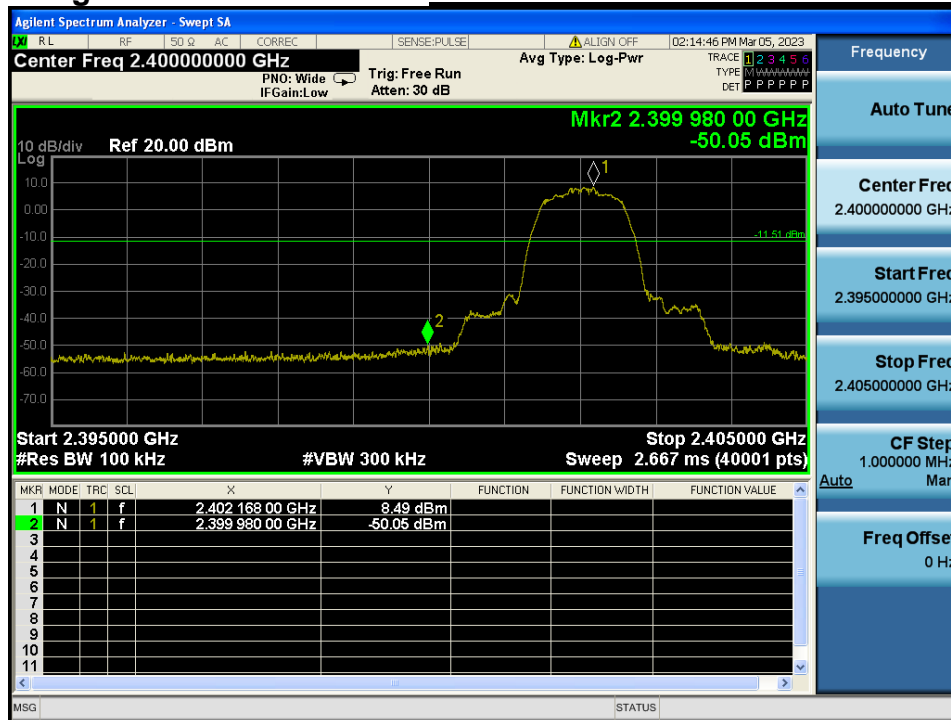

Low Band-edge

Hopping mode & Modulation :  $\pi/4$ DQPSK

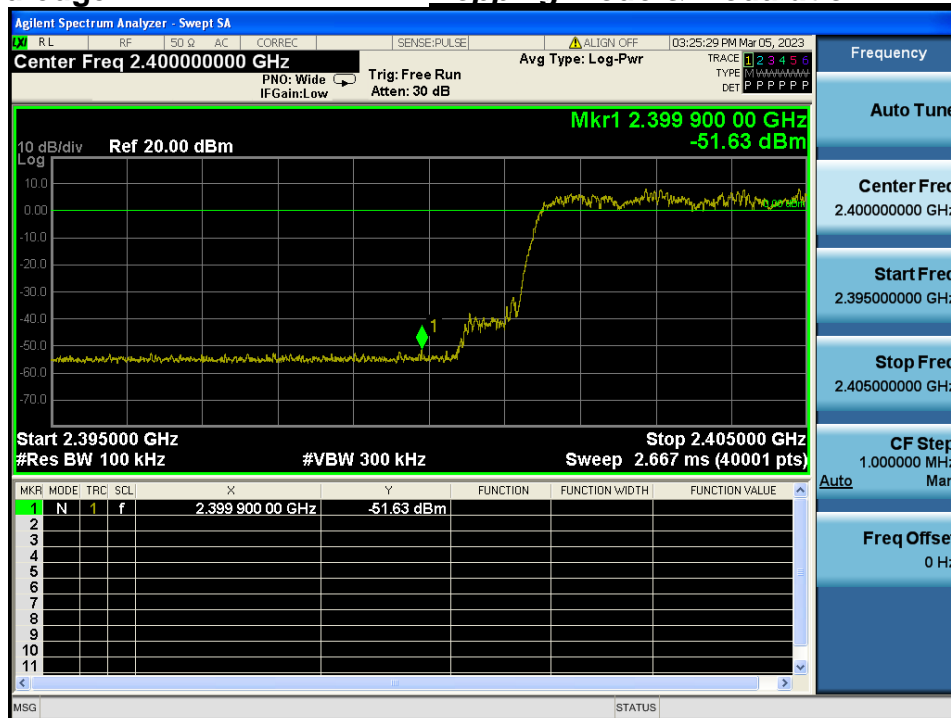

Conducted Spurious Emissions **Lowest Channel & Modulation :  $\pi/4$ DQPSK**

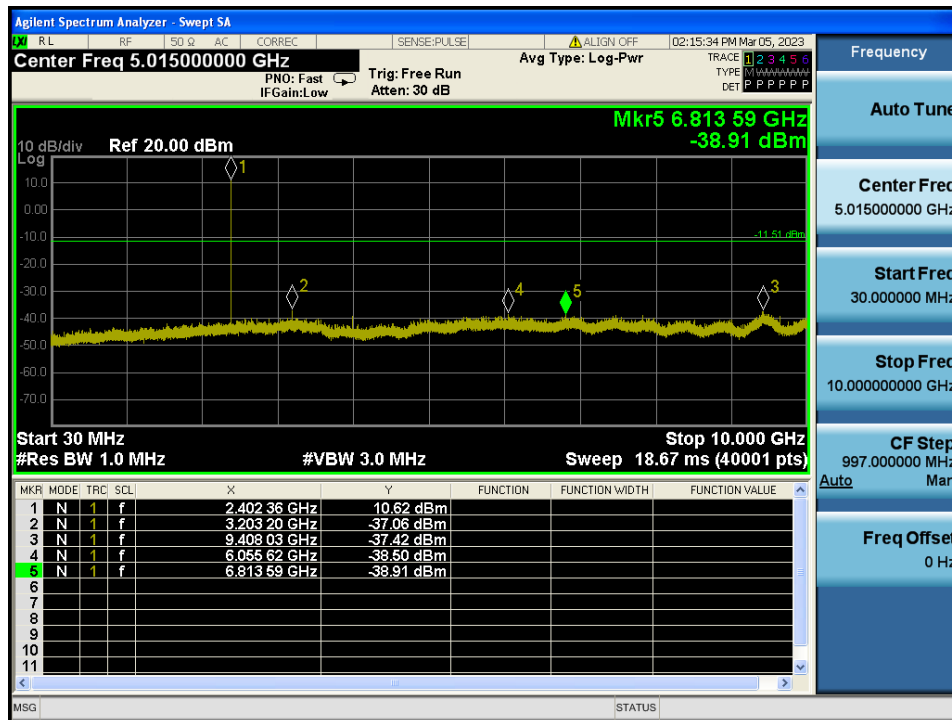
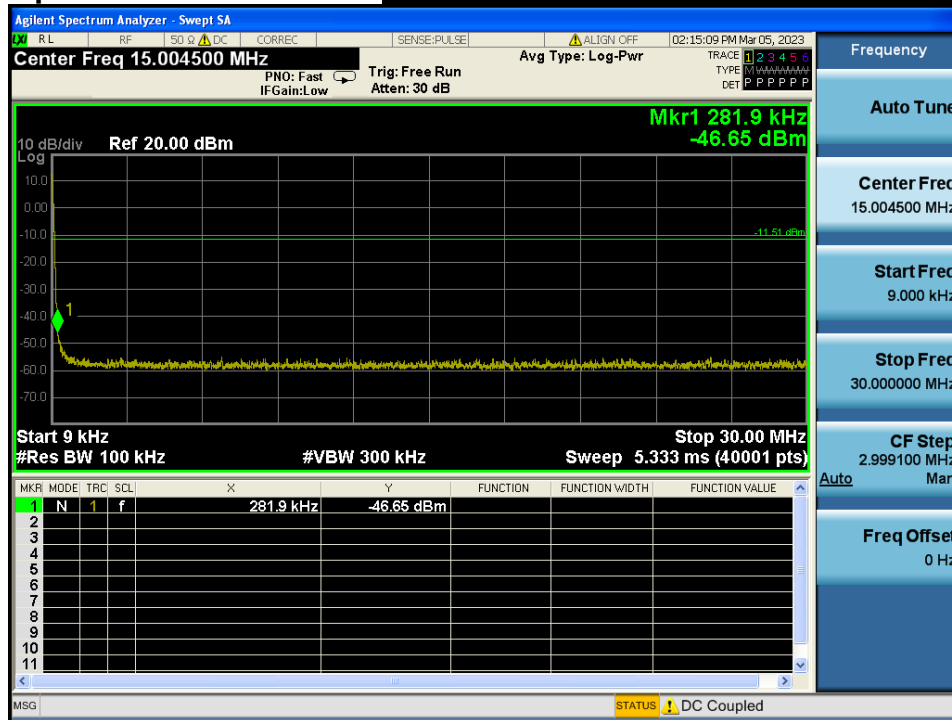



Conducted Spurious Emissions **Lowest Channel & Modulation :  $\pi/4$ DQPSK**

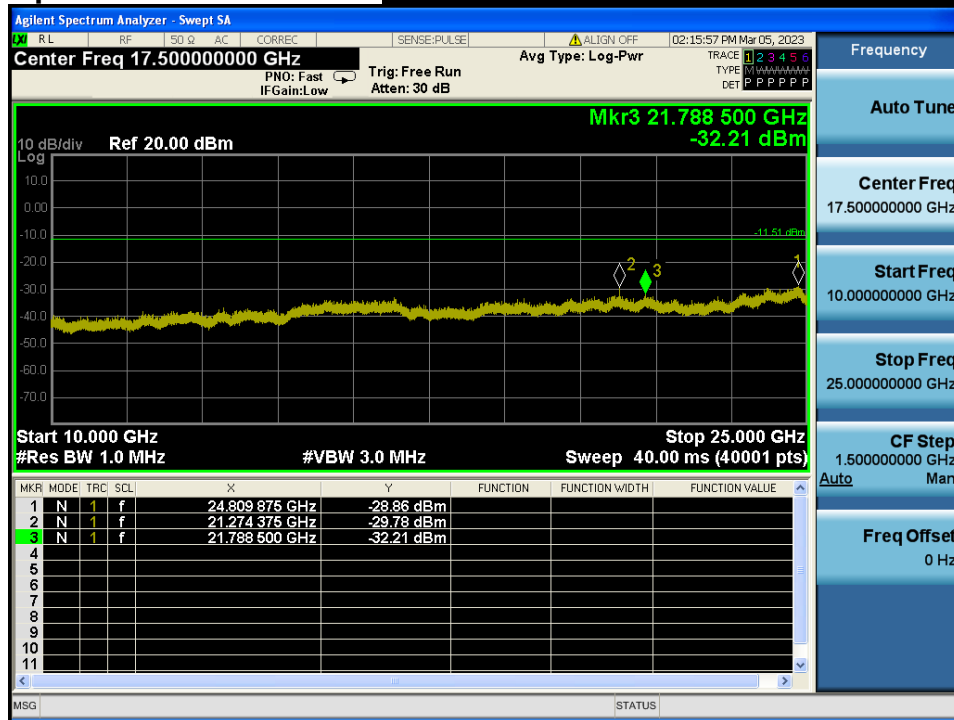

Reference for limit

Middle Channel & Modulation :  $\pi/4$ DQPSK

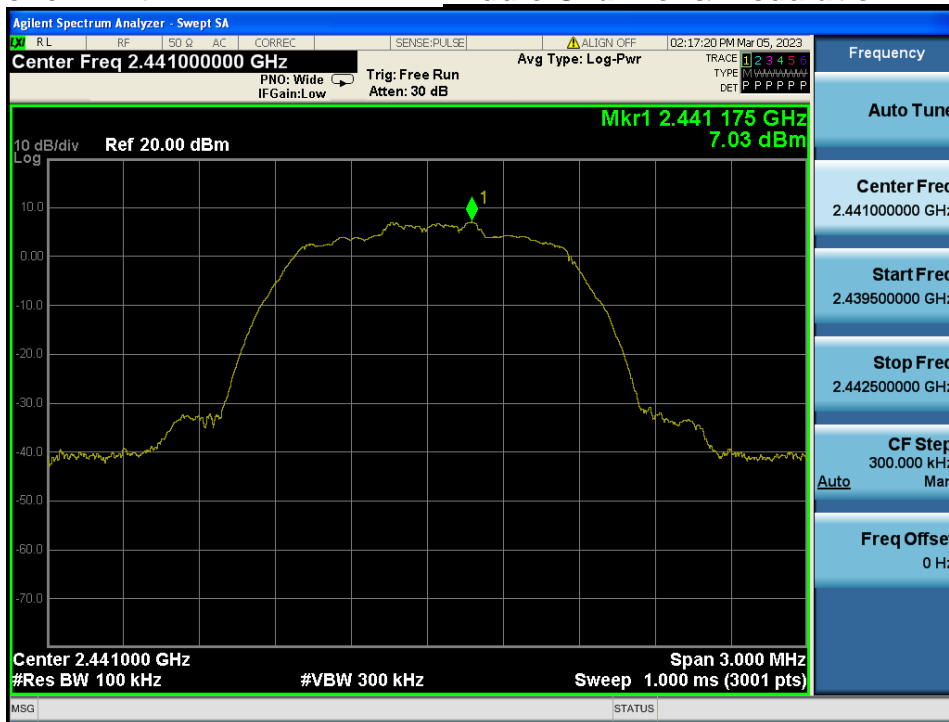

Conducted Spurious Emissions

Middle Channel & Modulation :  $\pi/4$ DQPSK

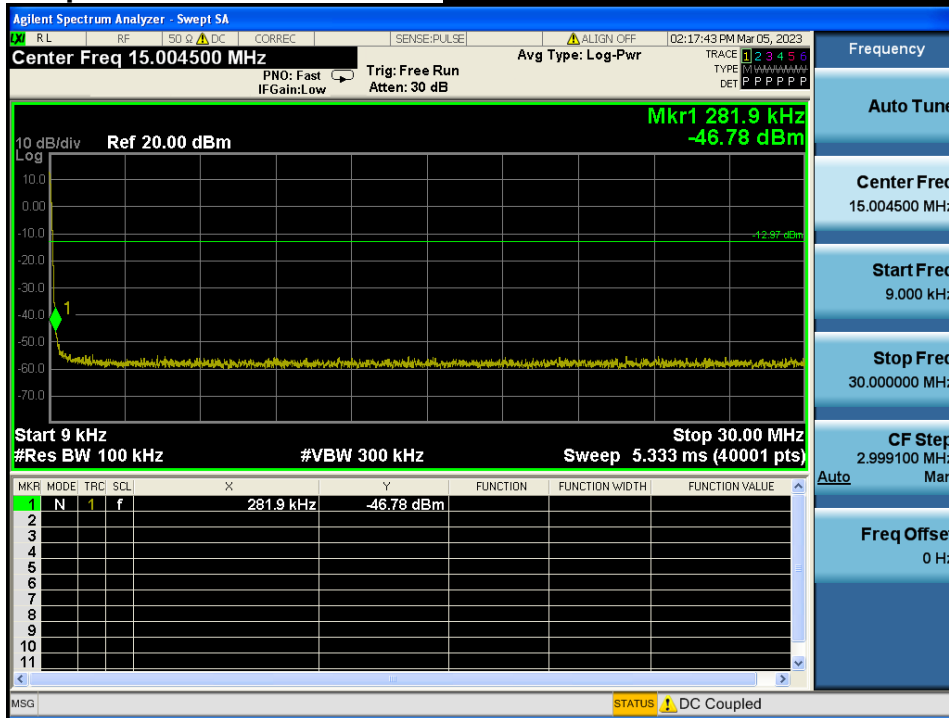

Conducted Spurious Emissions *Middle Channel & Modulation :  $\pi/4$ DQPSK*

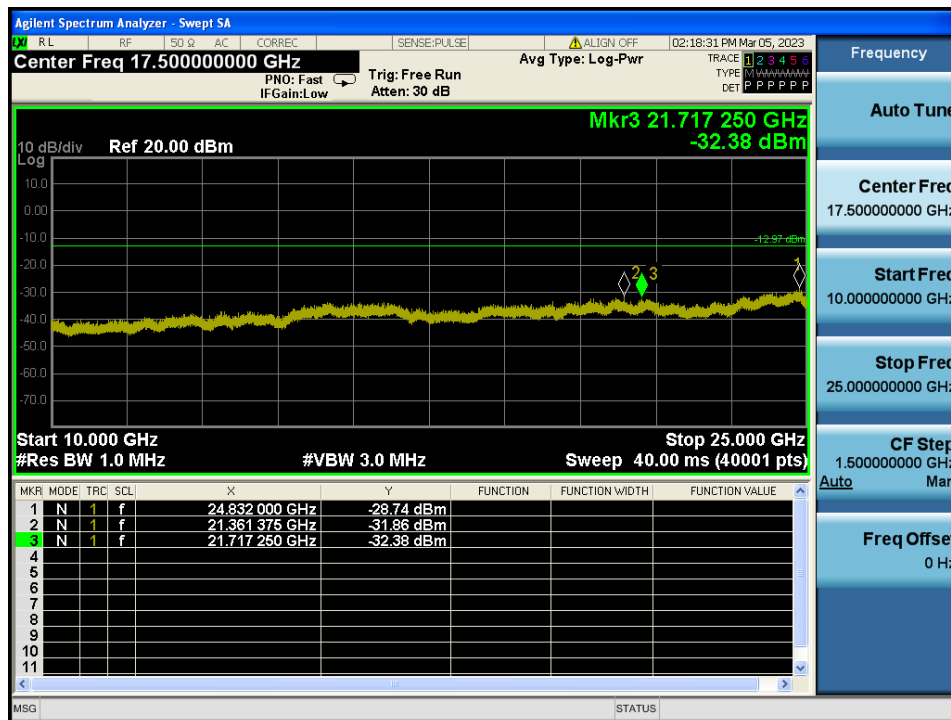
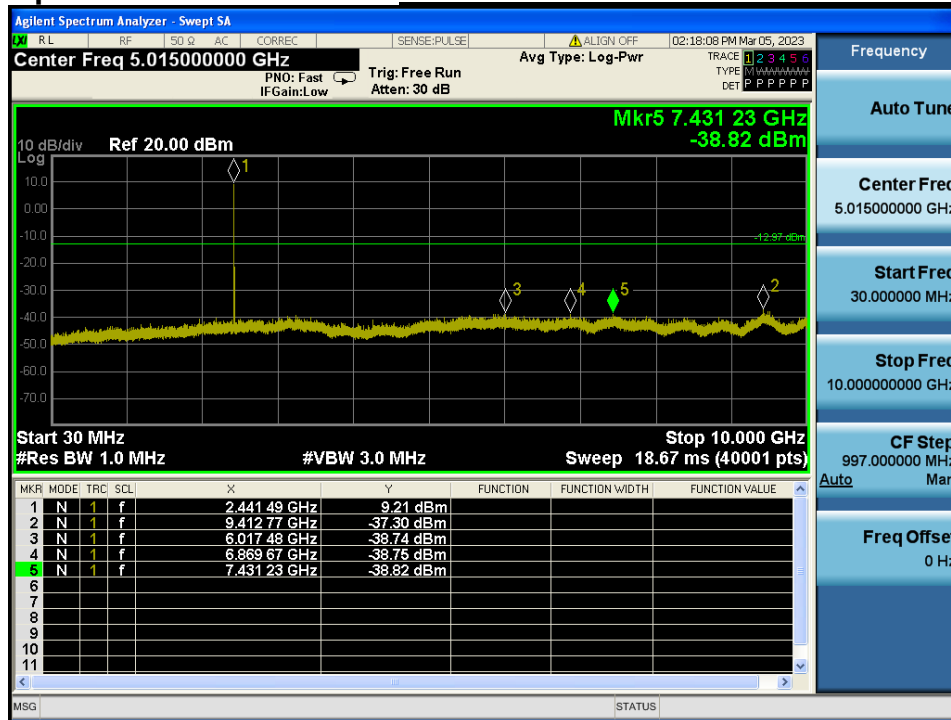

High Band-edge

Highest Channel & Modulation :  $\pi/4$ DQPSK

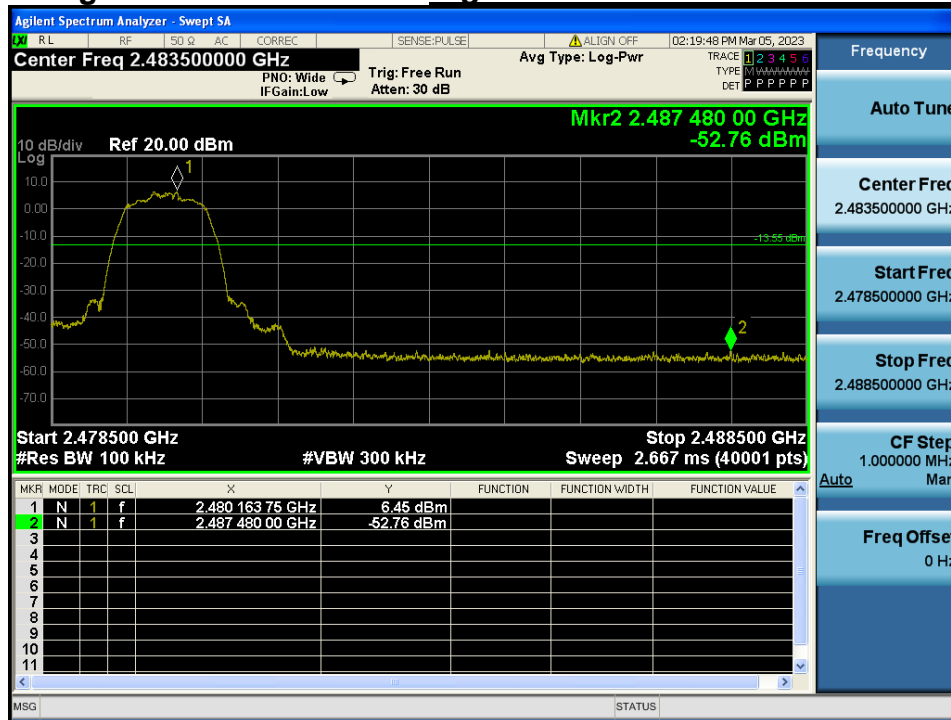

High Band-edge

Hopping mode & Modulation :  $\pi/4$ DQPSK

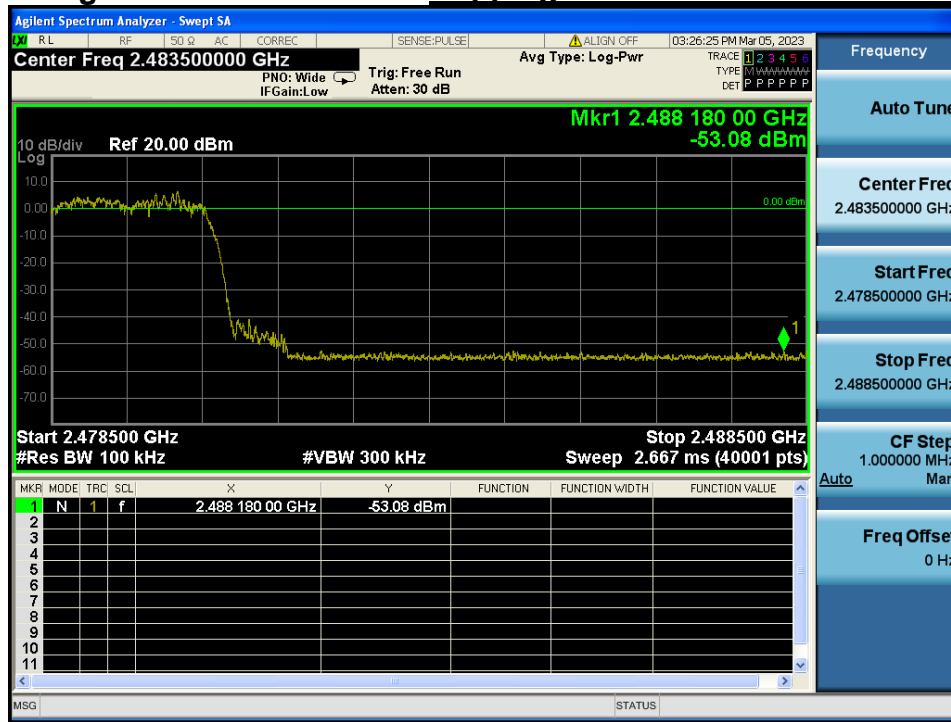

Conducted Spurious Emissions

Highest Channel & Modulation :  $\pi/4$ DQPSK

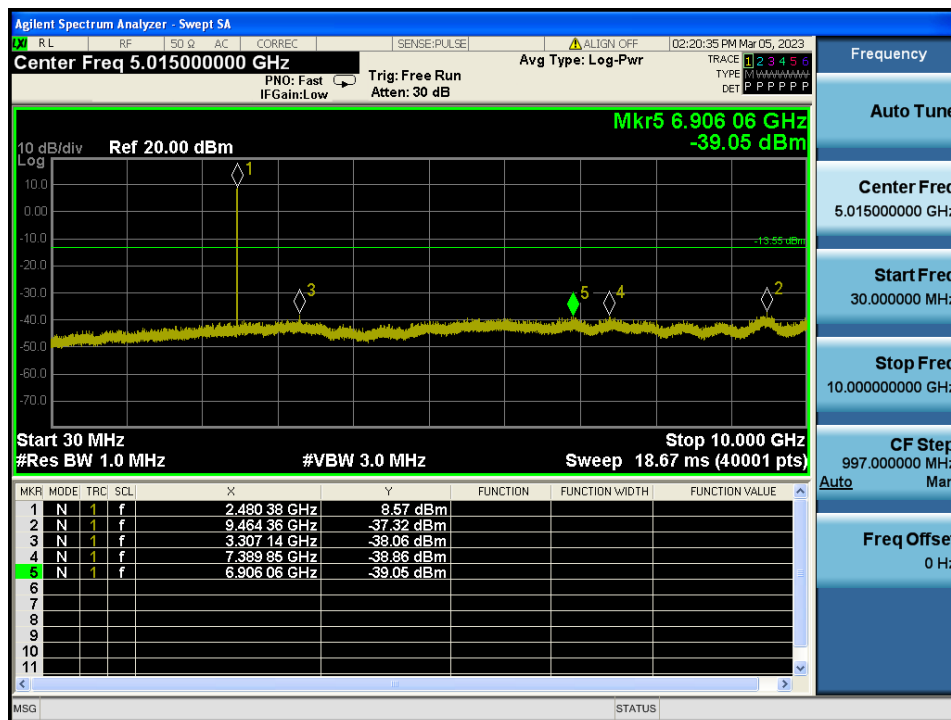
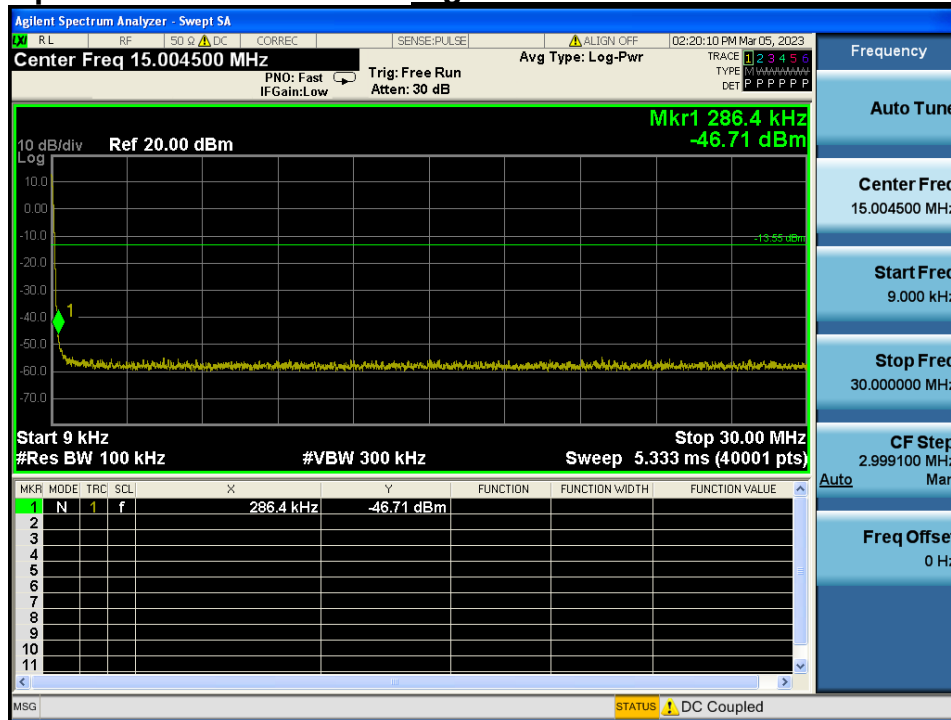

Conducted Spurious Emissions

Highest Channel & Modulation :  $\pi/4$ DQPSK

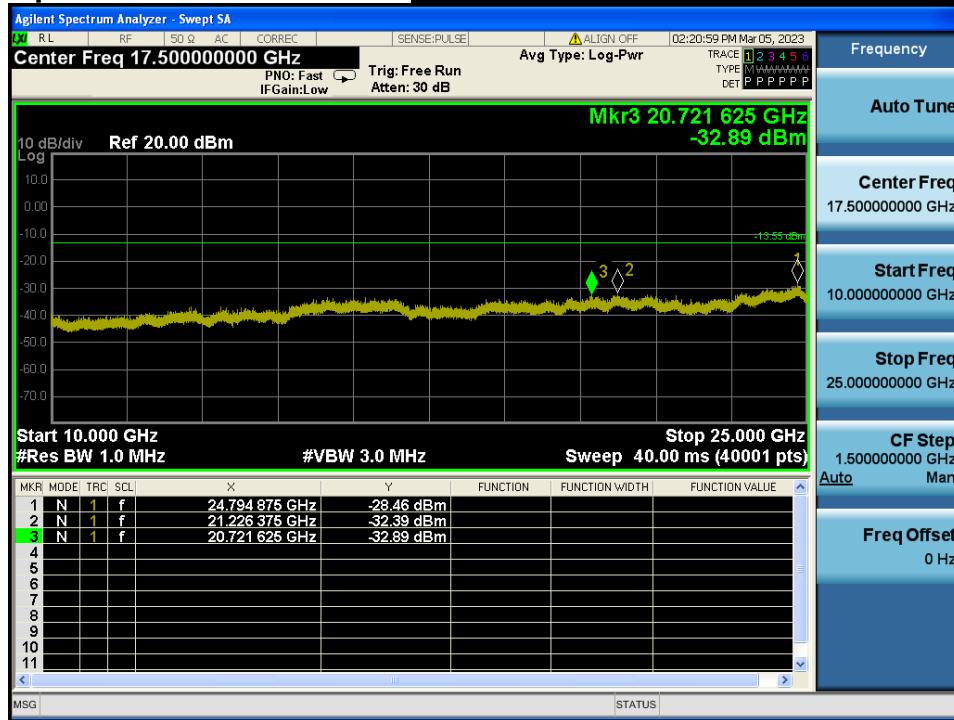

Low Band-edge

***Lowest Channel & Modulation : 8DPSK***

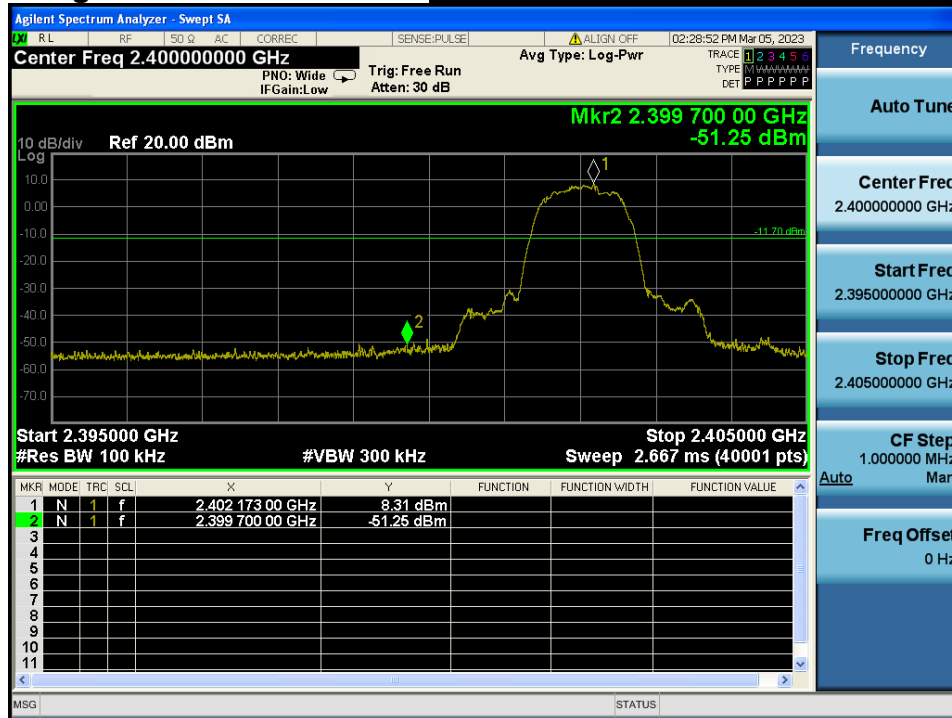

Low Band-edge

***Hopping mode & Modulation : 8DPSK***

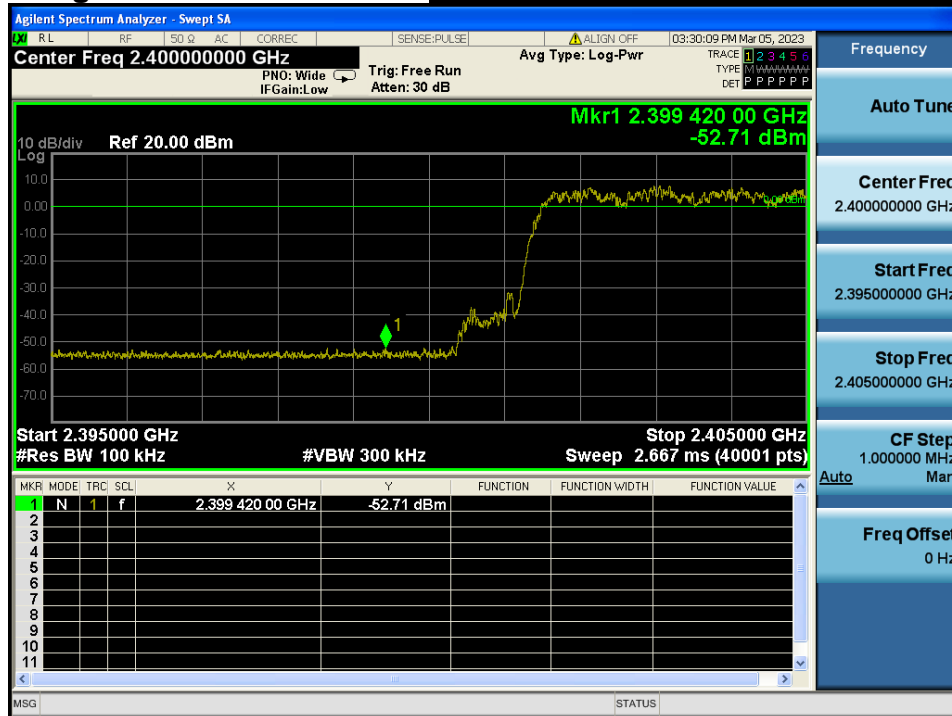

**Conducted Spurious Emissions** *Lowest Channel & Modulation : 8DPSK*

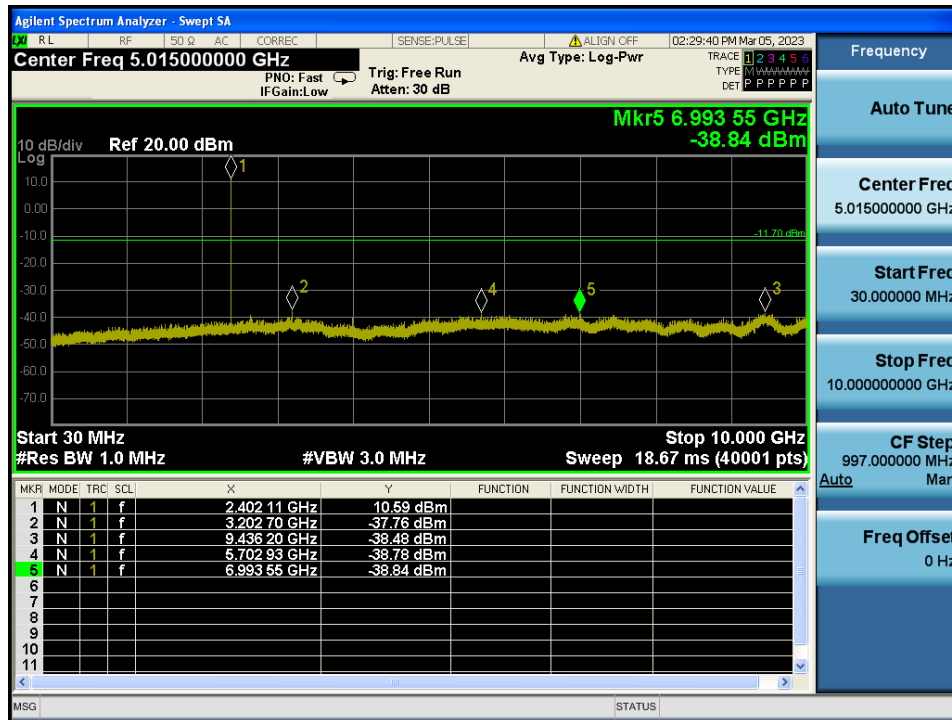
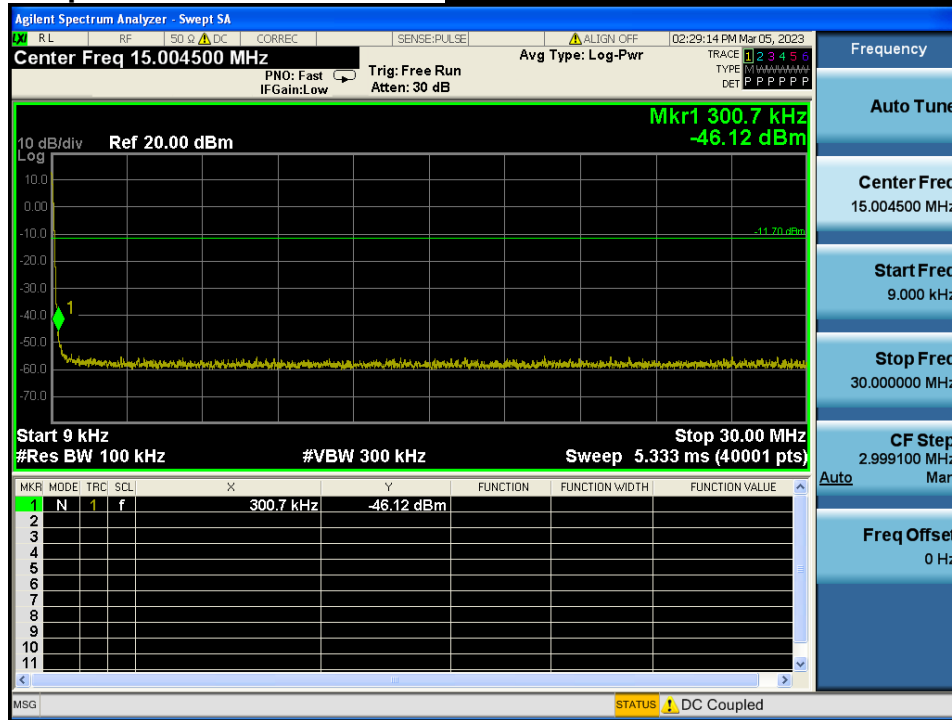



**Conducted Spurious Emissions** *Lowest Channel & Modulation : 8DPSK*

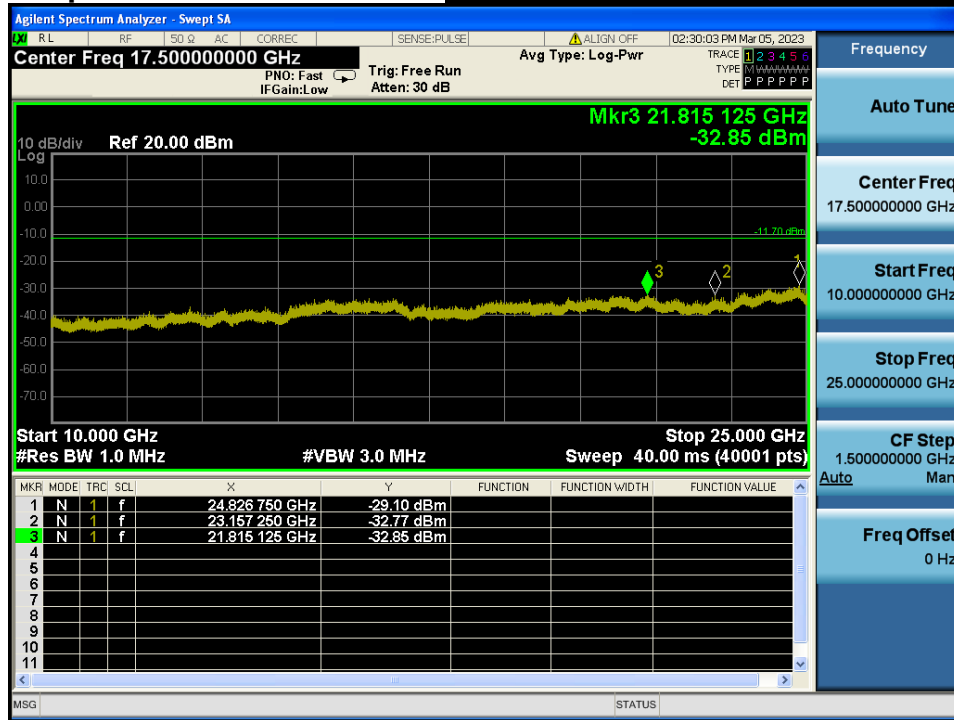

Reference for limit

Middle Channel & Modulation : 8DPSK

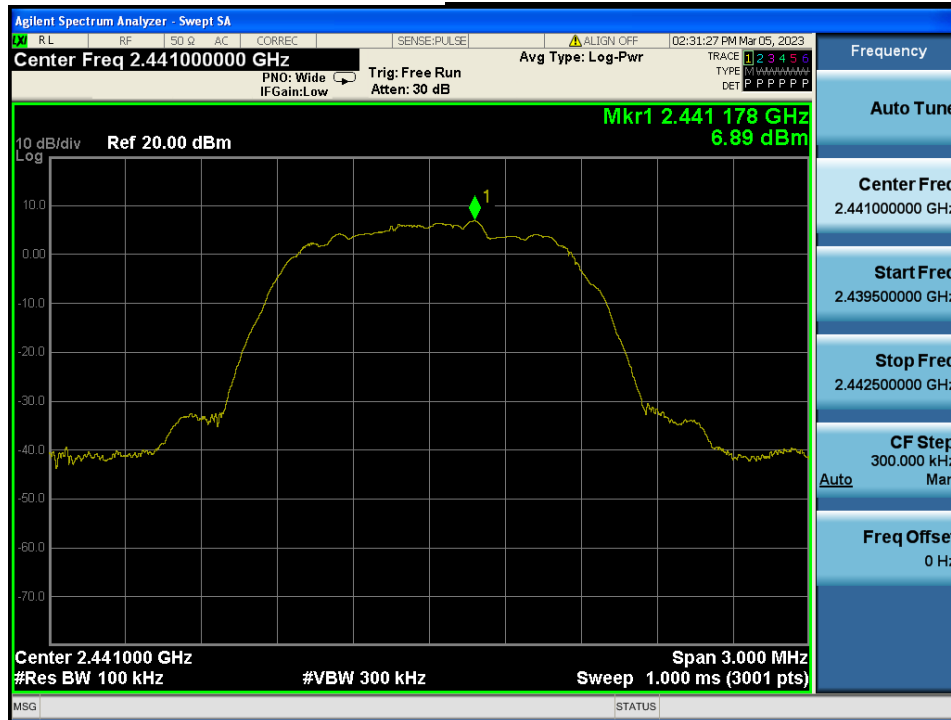

Conducted Spurious Emissions

Middle Channel & Modulation : 8DPSK

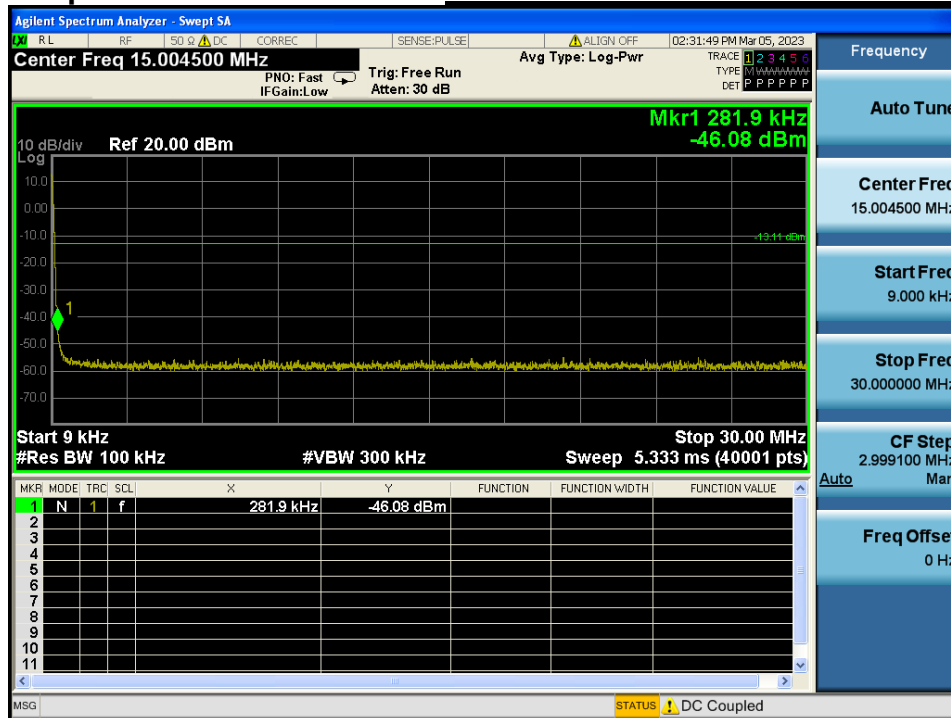

Conducted Spurious Emissions *Middle Channel & Modulation : 8DPSK*

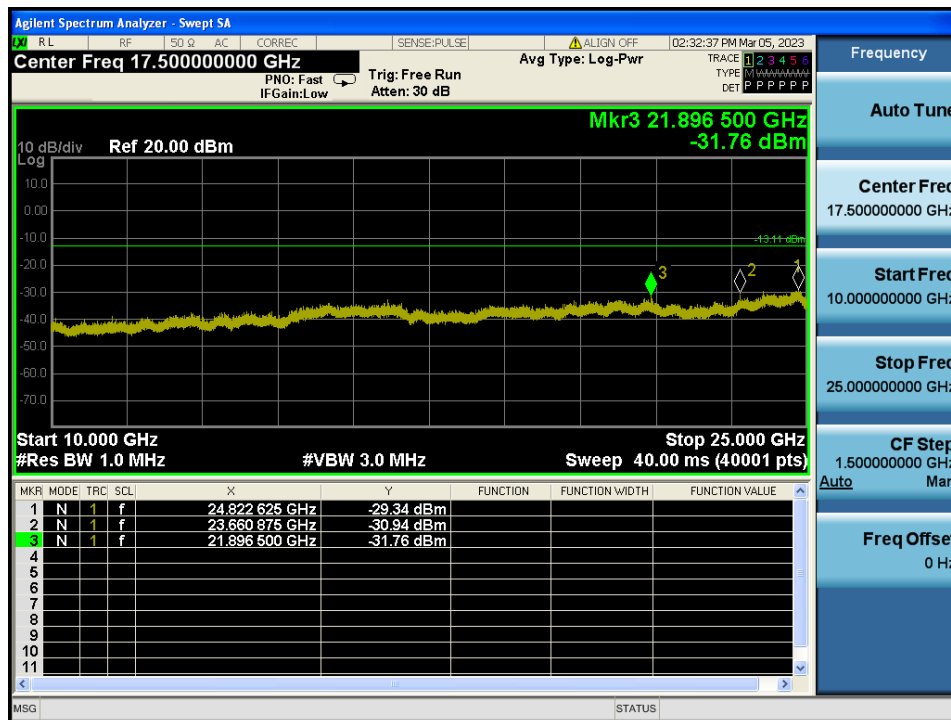
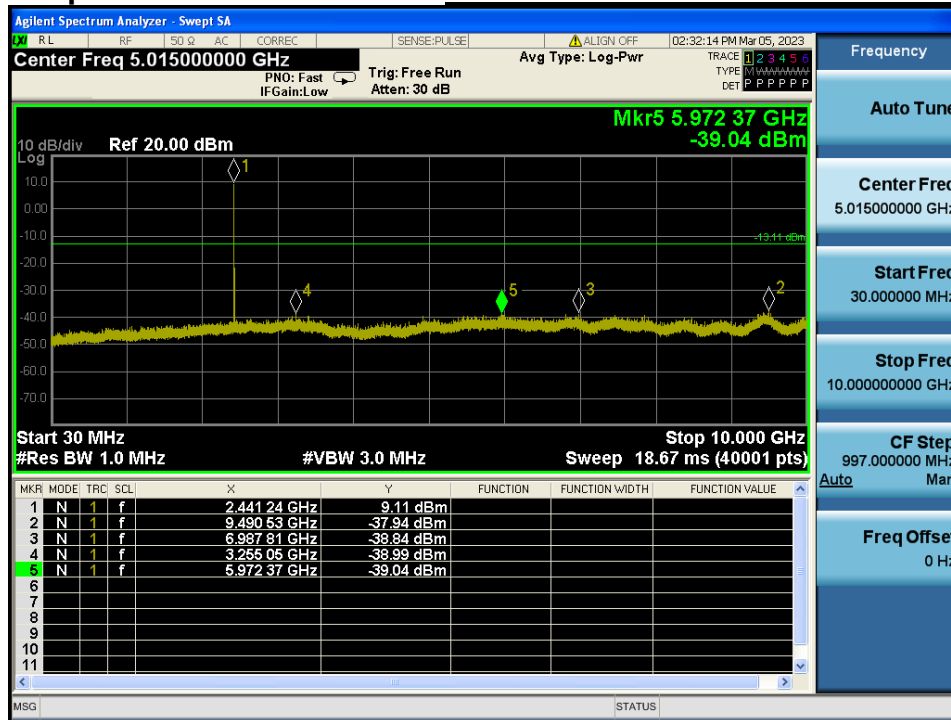

High Band-edge

Highest Channel & Modulation : 8DPSK

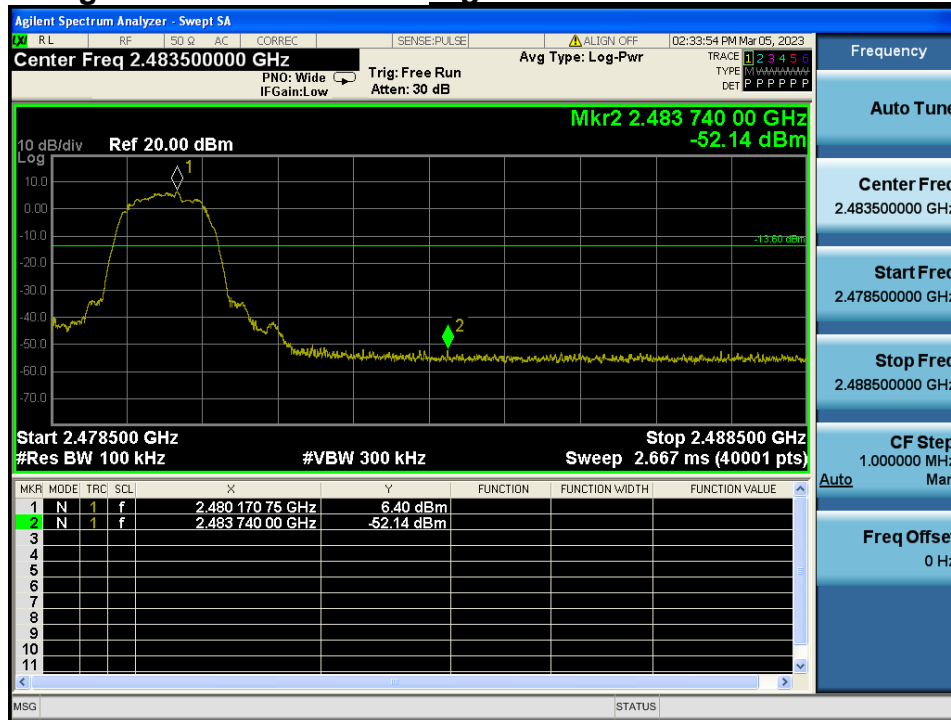

High Band-edge

Hopping mode & Modulation : 8DPSK

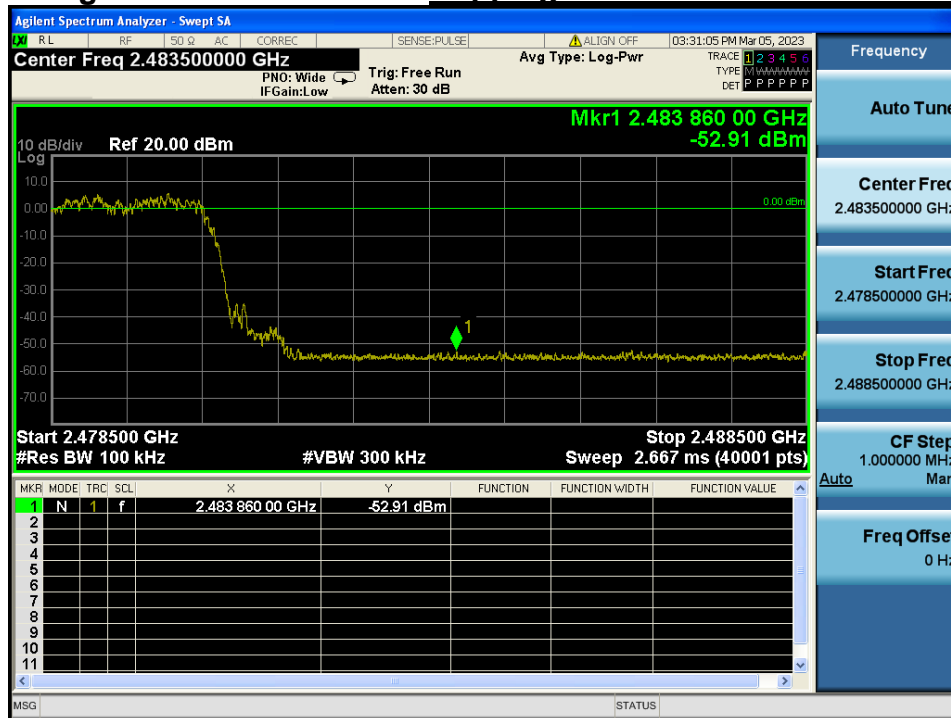

Conducted Spurious Emissions **Highest Channel & Modulation : 8DPSK**

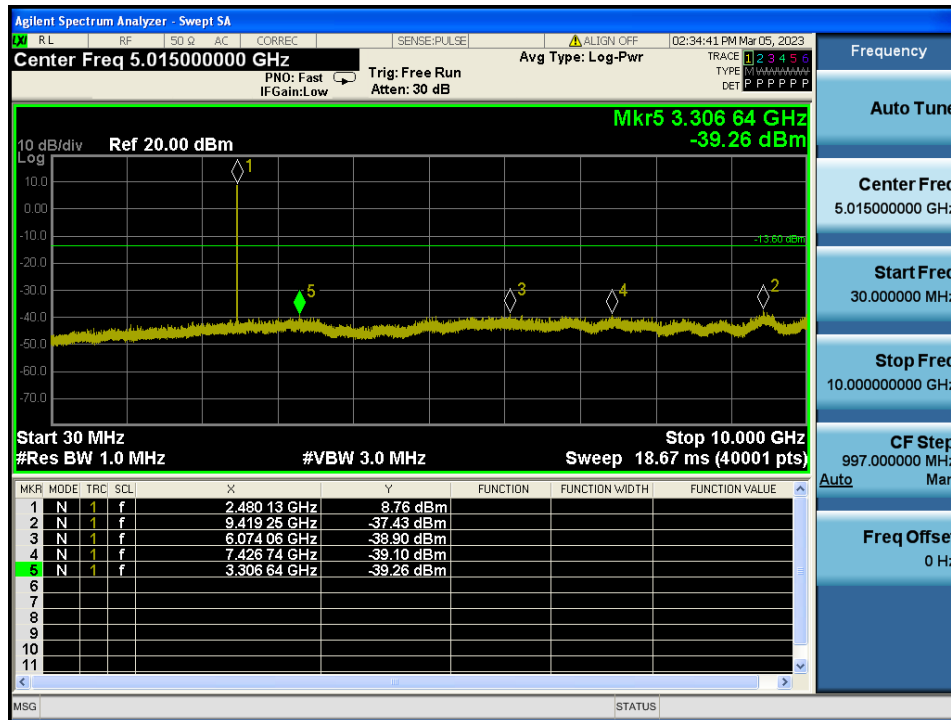
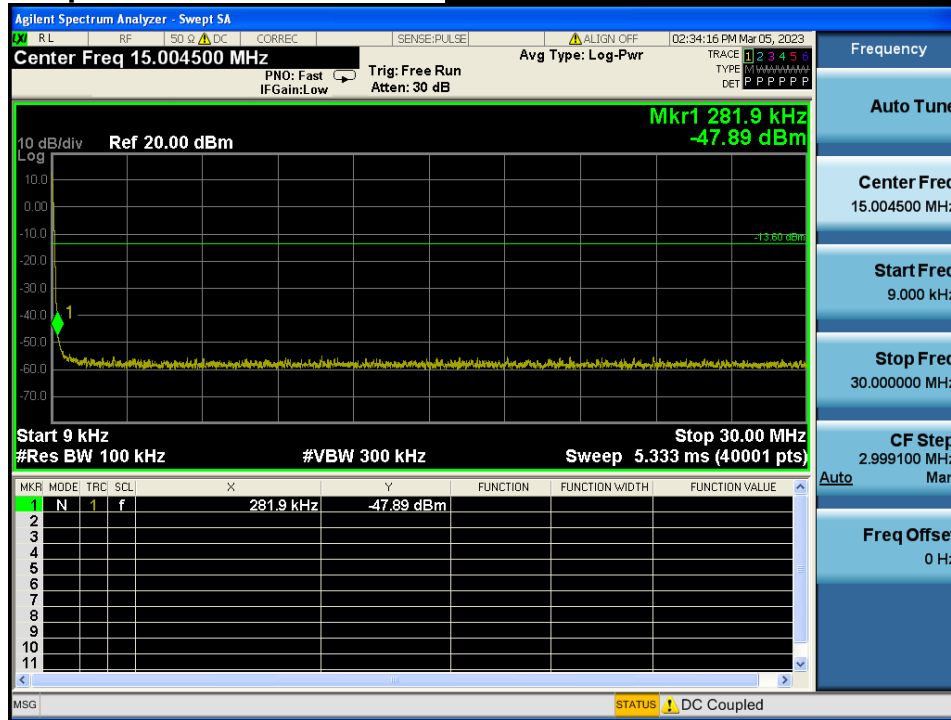

Conducted Spurious Emissions **Highest Channel & Modulation : 8DPSK**

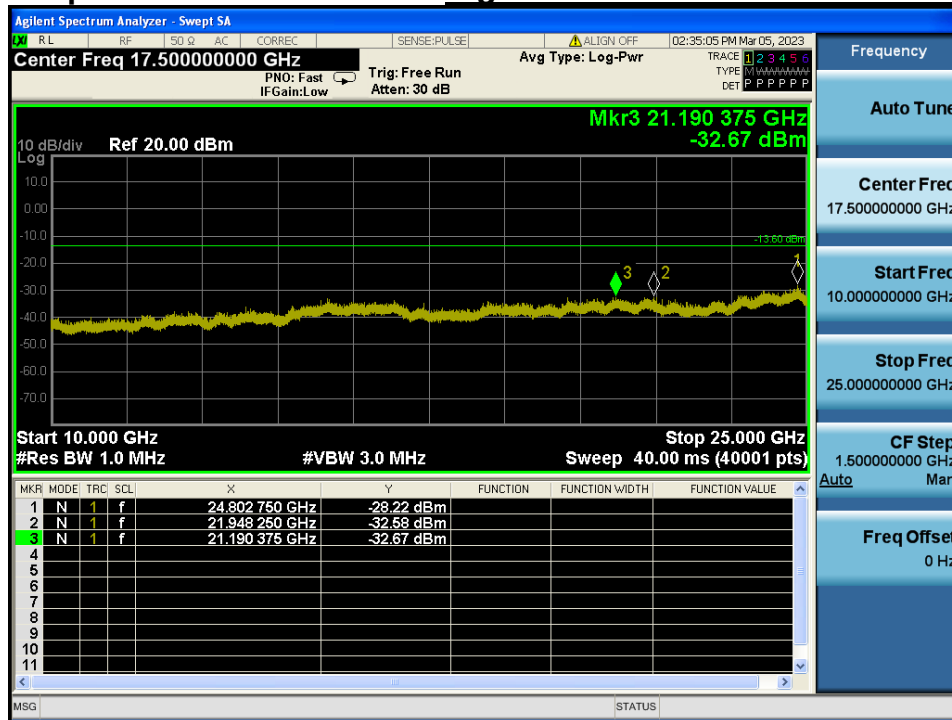

## 10. AC Power-Line Conducted Emissions

### 10.1. Test Setup

See test photographs for the actual connections between EUT and support equipment.

### 10.2. Limit

According to §15.207(a) for an intentional radiator that is designed to be connected to the public utility (AC) power line, the radio frequency voltage that is conducted back onto the AC power line on any frequency or frequencies, within the band 150 kHz to 30 MHz, shall not exceed the limits in the following table, as measured using a 50 uH/50 ohm line impedance stabilization network (LISN).

Compliance with the provision of this paragraph shall on the measurement of the radio frequency voltage between each power line and ground at the power terminal. The lower applies at the boundary between the frequency ranges.

Frequency Range (MHz)	Conducted Limit (dBuV)	
	Quasi-Peak	Average
0.15 ~ 0.50	66 to 56 *	56 to 46 *
0.5 ~ 5.0	56	46
5 ~ 30	60	50

\* Decreases with the logarithm of the frequency

### 10.3. Test Procedure

Conducted emissions from the EUT were measured according to the ANSI C63.10.

1. The test procedure is performed in a 6.5 m × 3.5 m × 3.5 m (L × W × H) shielded room. The EUT along with its peripherals were placed on a 1.0 m (W) × 1.5 m (L) and 0.8 m in height wooden table and the EUT was adjusted to maintain a 0.4 meter space from a vertical reference plane.
2. The EUT was connected to power mains through a line impedance stabilization network (LISN) which provides 50 ohm coupling impedance for measuring instrument and the chassis ground was bounded to the horizontal ground plane of shielded room.
3. All peripherals were connected to the second LISN and the chassis ground also bounded to the horizontal ground plane of shielded room.
4. The excess power cable between the EUT and the LISN was bundled. The power cables of peripherals were unbundled. All connecting cables of EUT and peripherals were moved to find the maximum emission.

10.4. Test Results

AC Power-Line Conducted Emissions (Graph) = Modulation : GFSK

Results of Conducted Emission

DTNC

Date 2023-03-24

Order No.  
Model No. PM560  
Serial No.  
Test Condition BT

Reference No.  
Power Supply  
Temp/Humi. 21 °C / 41 %  
Operator S.M.Gil

Memo

LIMIT : FCC P15.207 AV  
FCC P15.207 QP

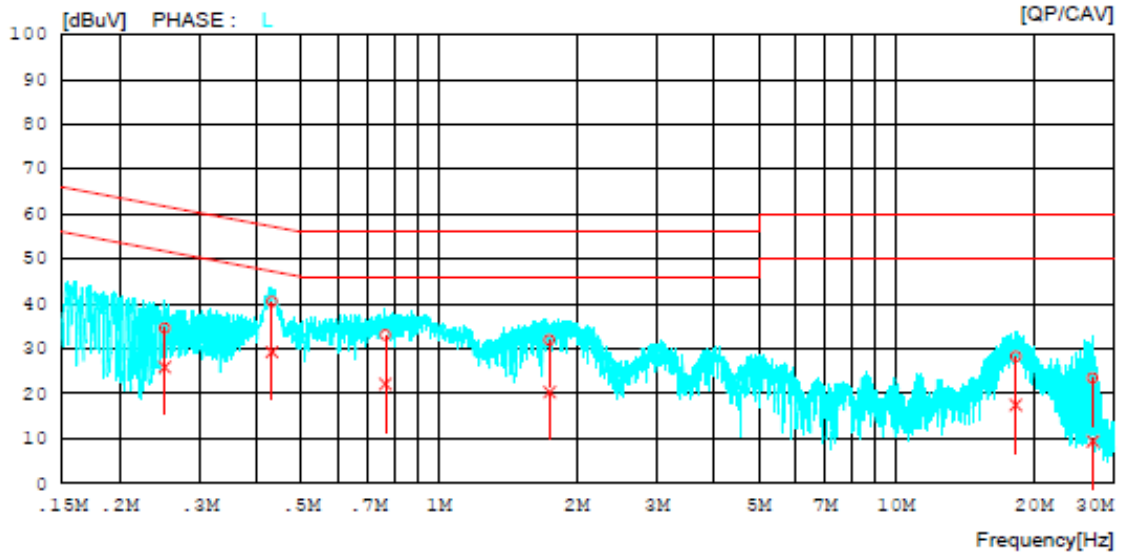
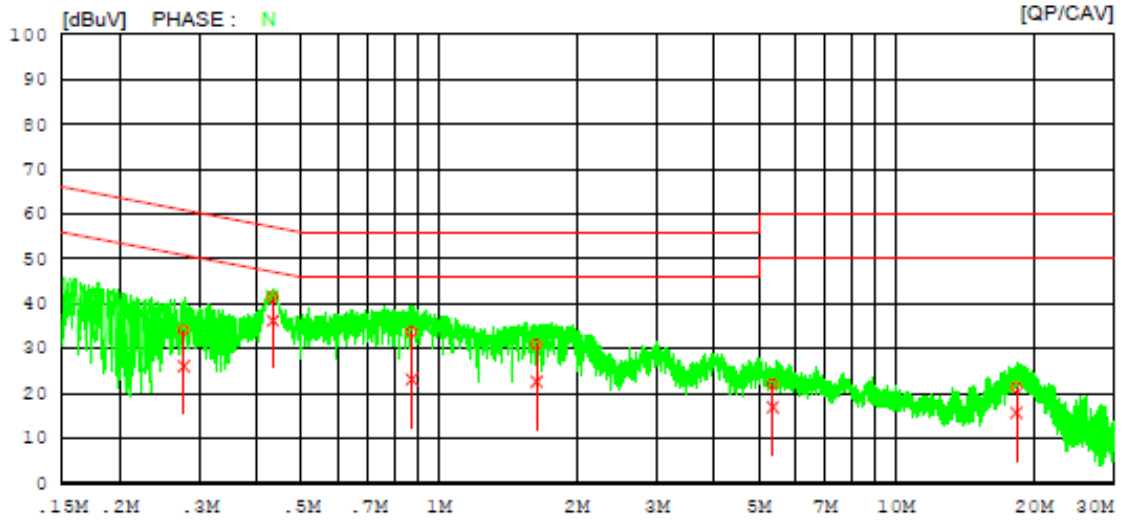



**AC Power-Line Conducted Emissions (List) = Modulation : 8DPSK**

**Results of Conducted Emission**

DTNC

Date 2023-03-24

Order No.		Reference No.	
Model No.	PM560	Power Supply	
Serial No.		Temp/Humi.	21 °C / 41 %
Test Condition	BT	Operator	S.M.Gil

Memo

LIMIT : FCC P15.207 AV  
FCC P15.207 QP

NO	FREQ [MHz]	READING		C.FACTOR [dB]	RESULT		LIMIT		MARGIN		PHASE
		QP [dBuV]	CAV [dBuV]		QP [dBuV]	CAV [dBuV]	QP [dBuV]	CAV [dBuV]			
1	0.27661	24.16	16.06	9.99	34.15	26.05	60.92	50.92	26.77	24.87	N
2	0.43308	31.42	26.22	10.00	41.42	36.22	57.19	47.19	15.77	10.97	N
3	0.87257	23.74	13.16	10.00	33.74	23.16	56.00	46.00	22.26	22.84	N
4	1.63420	20.92	12.59	10.03	30.95	22.62	56.00	46.00	25.05	23.38	N
5	5.37440	11.94	6.73	10.21	22.15	16.94	60.00	50.00	37.85	33.06	N
6	18.33560	10.85	5.13	10.55	21.40	15.68	60.00	50.00	38.60	34.32	N
7	0.25140	24.70	16.07	9.88	34.58	25.95	61.71	51.71	27.13	25.76	L
8	0.43138	30.61	19.33	9.90	40.51	29.23	57.23	47.23	16.72	18.00	L
9	0.76380	23.17	12.25	9.89	33.06	22.14	56.00	46.00	22.94	23.86	L
10	1.74540	21.89	10.28	10.03	31.92	20.31	56.00	46.00	24.08	25.69	L
11	18.28680	17.89	7.05	10.35	28.24	17.40	60.00	50.00	31.76	32.60	L
12	26.92180	13.06	-0.97	10.36	23.42	9.39	60.00	50.00	36.58	40.61	L

## APPENDIX I

### Test set up diagrams

#### ▪ Radiated Measurement

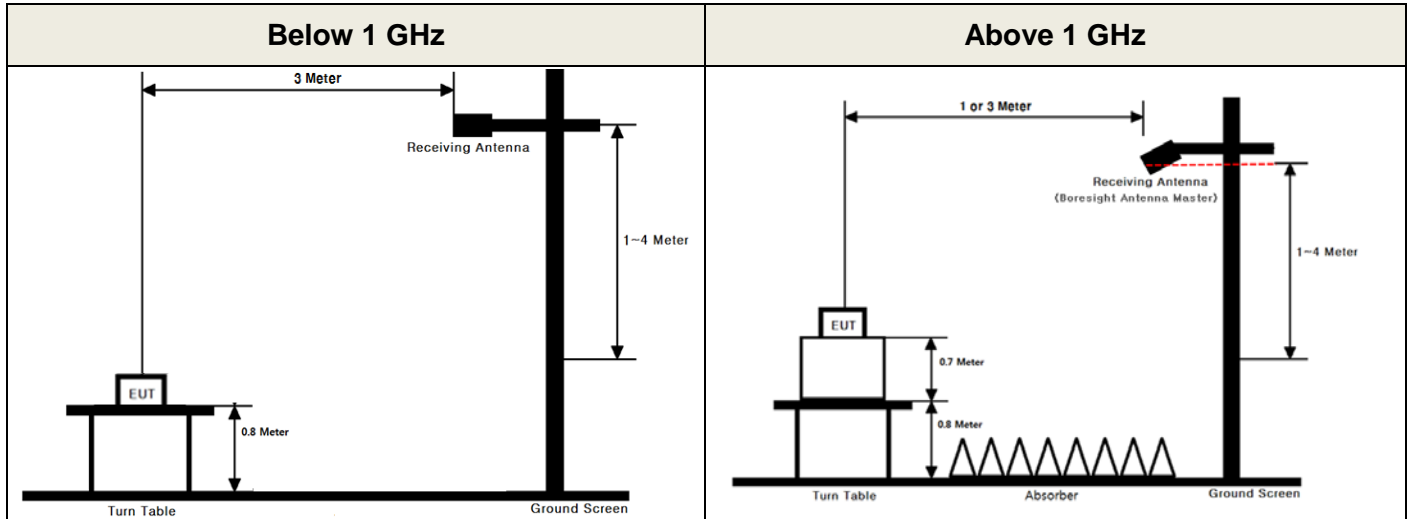

#### ▪ Conducted Measurement

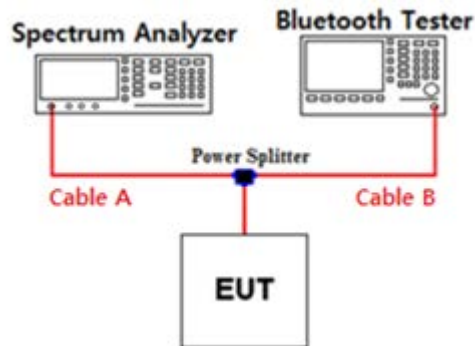

Path loss information

Frequency (GHz)	Path Loss (dB)	Frequency (GHz)	Path Loss (dB)
0.03	6.53	15	7.83
1	6.83	20	8.09
2.402 & 2.441 & 2.480	6.96	25	8.69
5	7.04	-	-
10	7.38	-	-

Note 1: The path loss from EUT to Spectrum analyzer was measured and used for test.  
 Path loss (S/A's correction factor) = Cable A + Power Splitter

## APPENDIX II

### Unwanted Emissions (Radiated) Test Plot

GFSK & Lowest & X & Hor

Detector Mode : PK

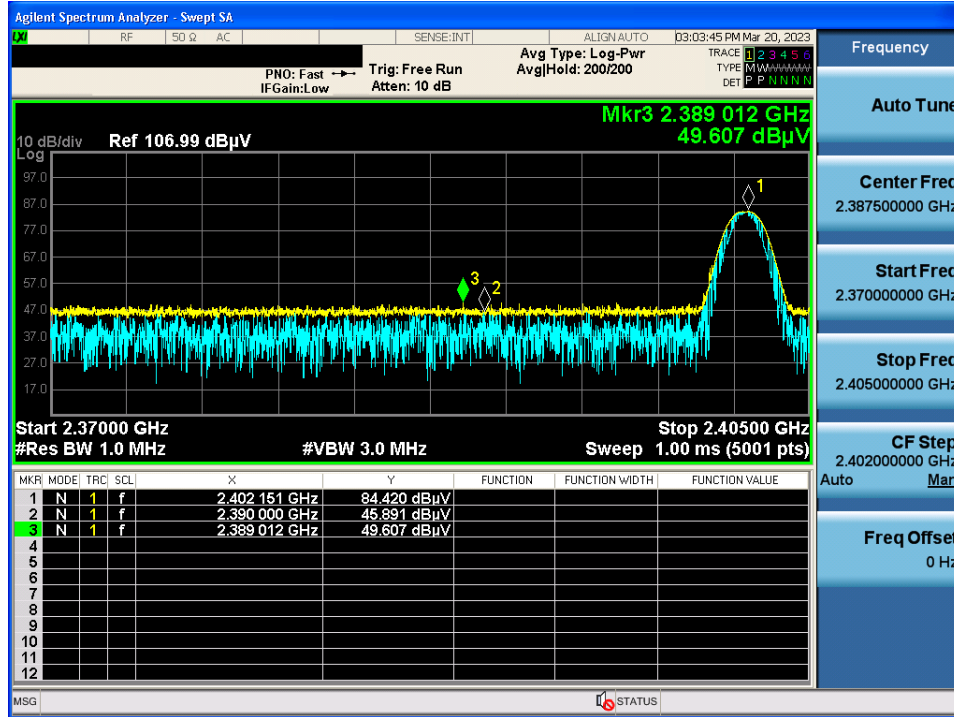

GFSK & Highest & X & Hor

Detector Mode : PK

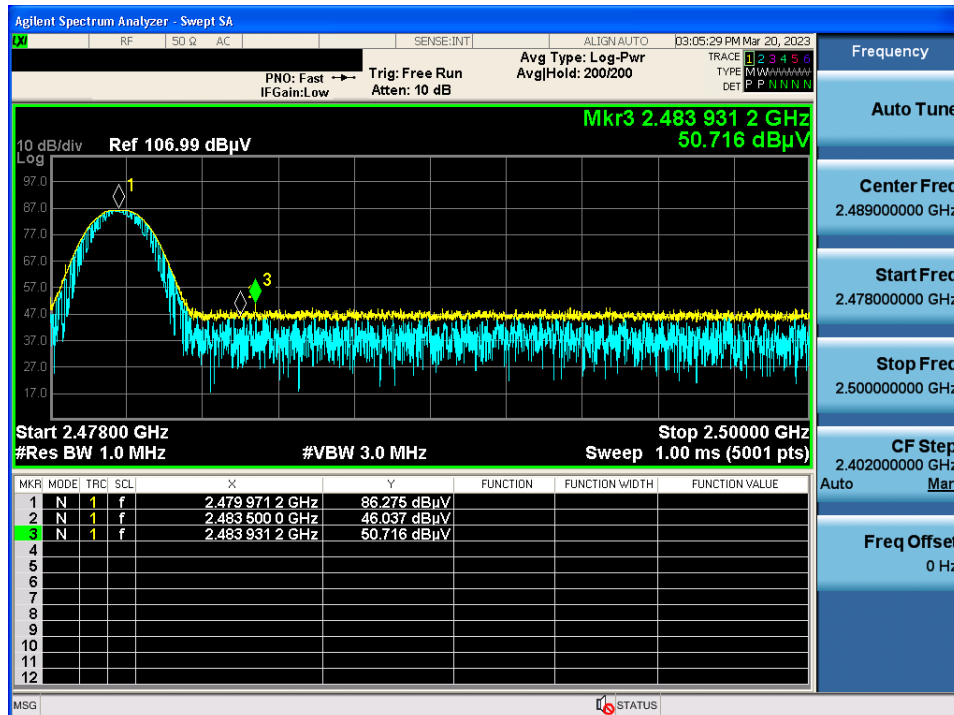

$\pi/4$ DQPSK & Lowest & X & Hor

Detector Mode : PK

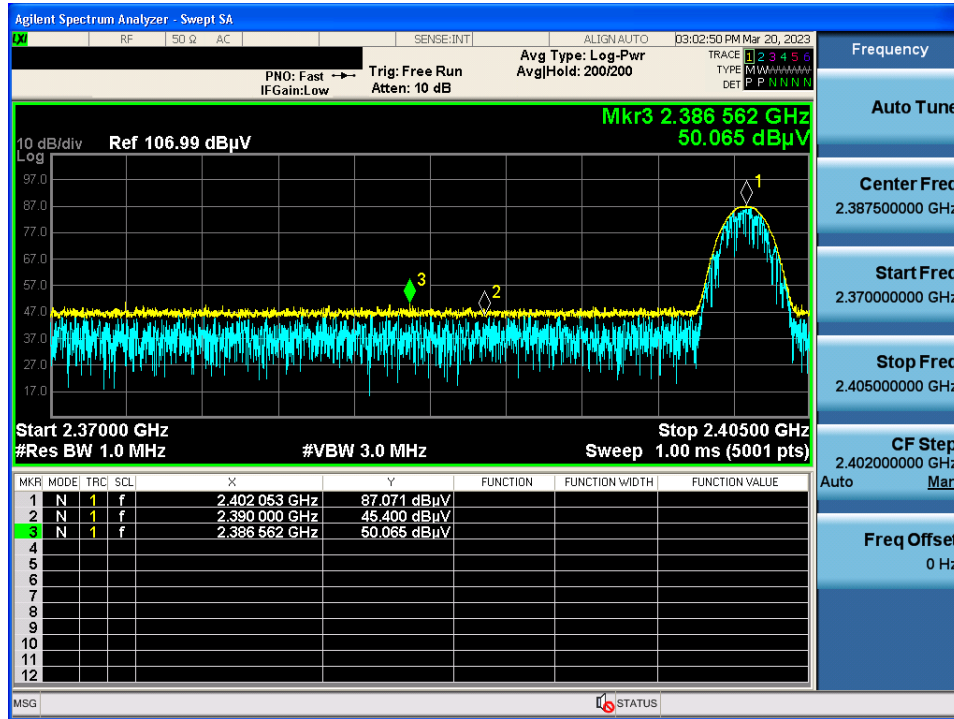

$\pi/4$ DQPSK & Highest & X & Hor

Detector Mode : PK

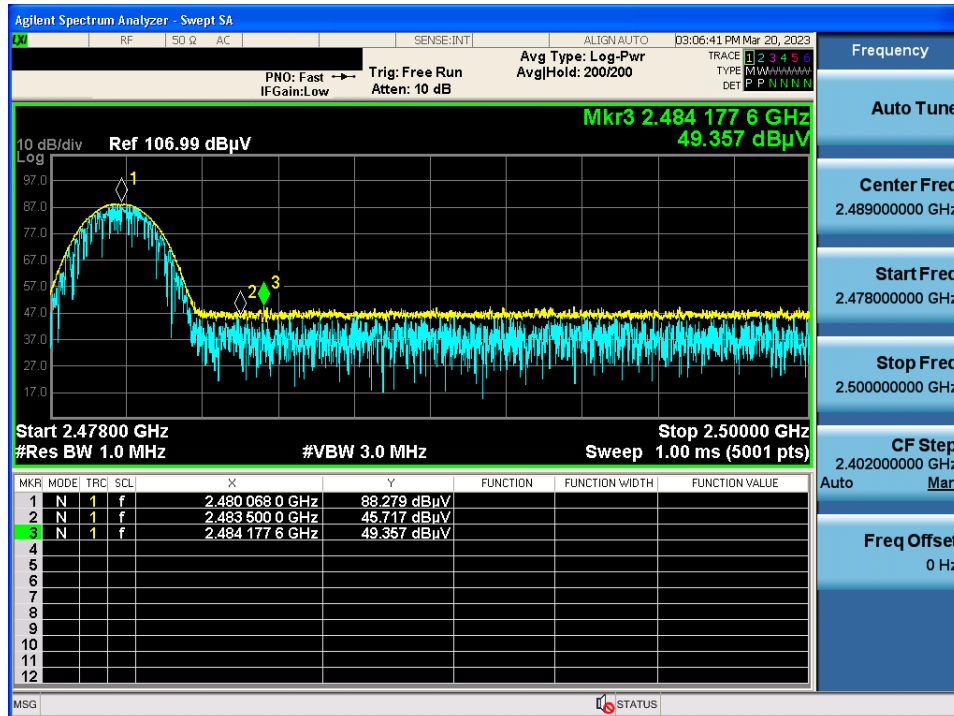

8DPSK & Lowest & X & Hor

Detector Mode : PK

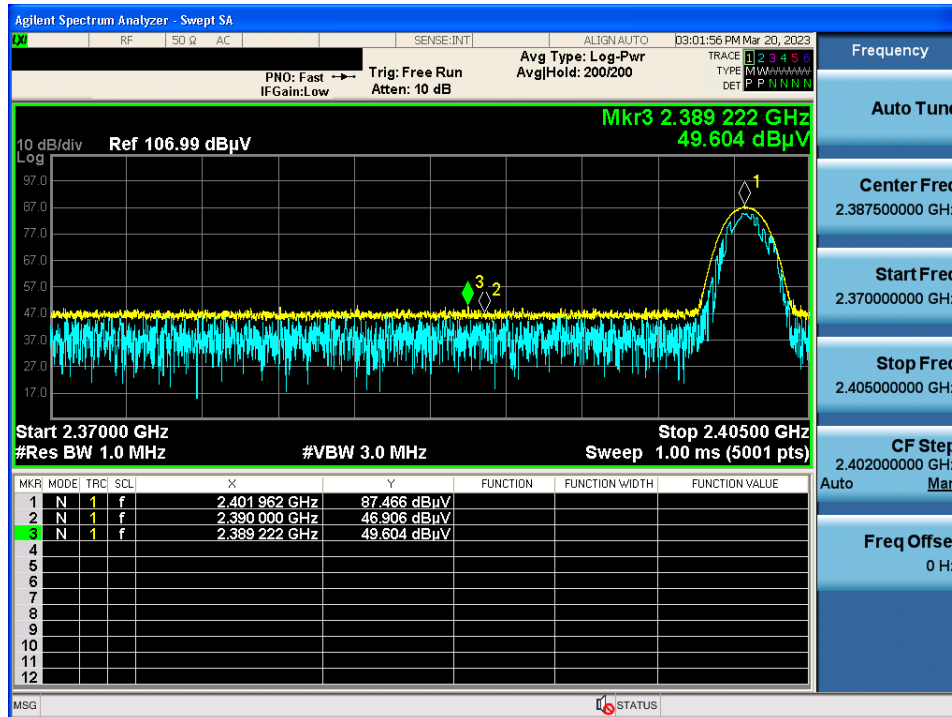

8DPSK & Highest & X & Hor

Detector Mode : PK

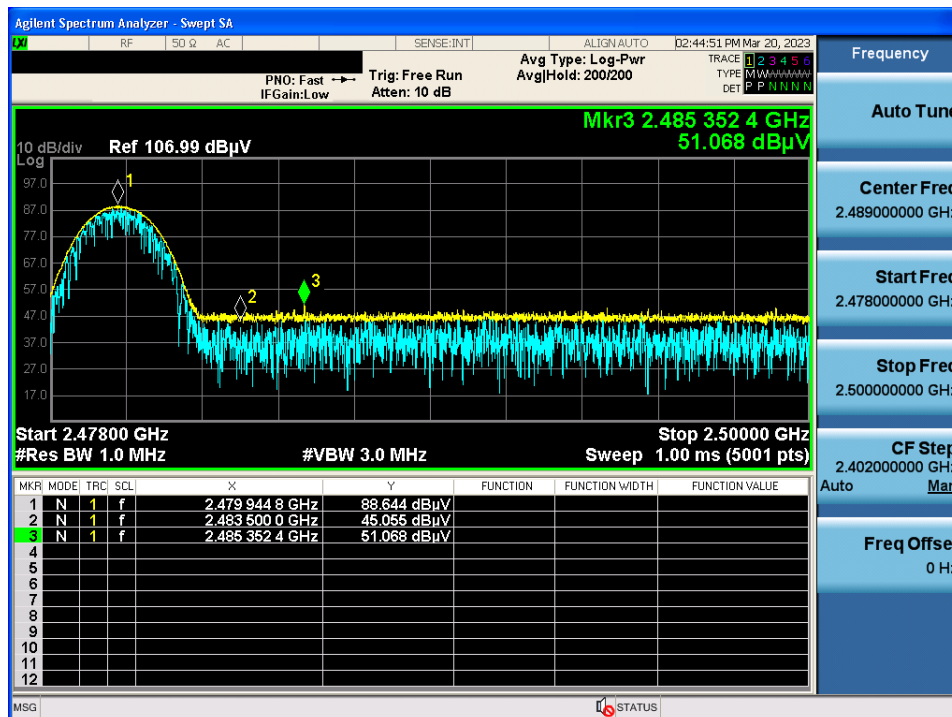

GFSK & Highest & Y & Hor

Detector Mode : PK

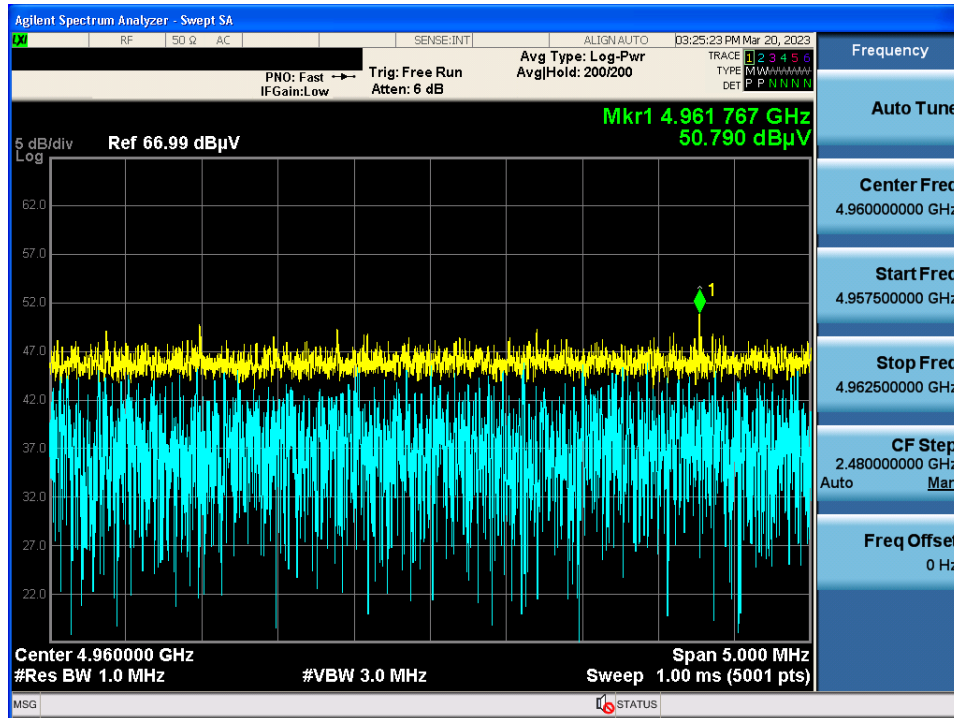

$\pi/4$ DQPSK & Lowest & Y & Hor

Detector Mode : PK

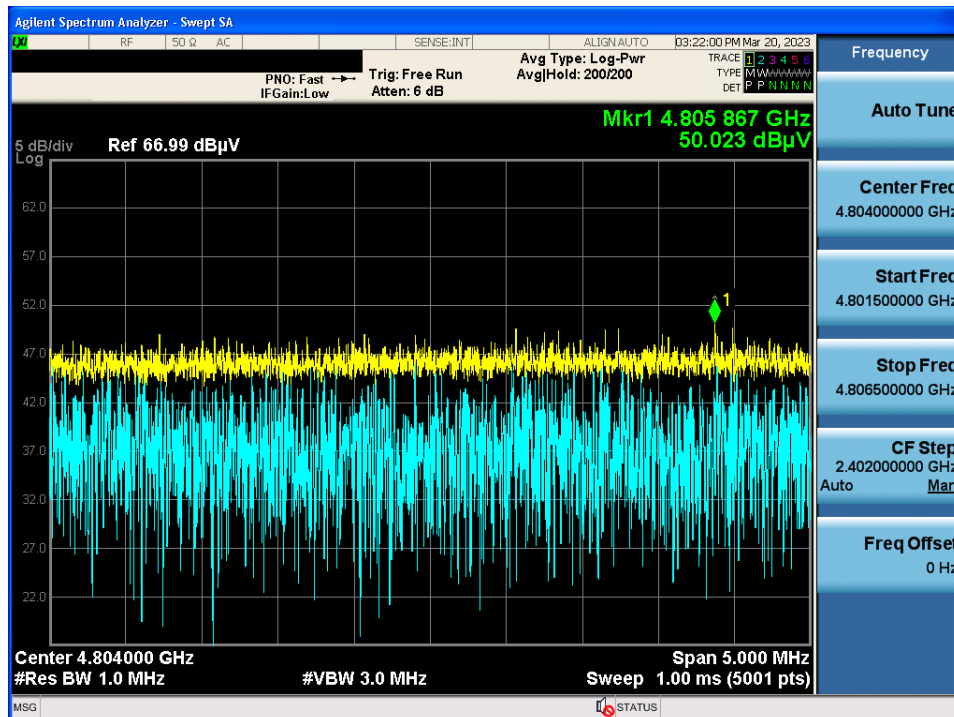

8DPSK & Highest & X & Ver

Detector Mode : PK

