

## SAR Plots

- Verification Plots
- SAR Test Plots

## DT&C Co., Ltd.

**DUT: Dipole 750 MHz; Type: D750V3; Serial: D750V3 - SN:1049**

Communication System: UID 0, CW (0); Frequency: 750 MHz; Duty Cycle: 1:1  
Medium parameters used:  $f = 750$  MHz;  $\sigma = 0.899$  S/m;  $\epsilon_r = 41.883$ ;  $\rho = 1000$  kg/m<sup>3</sup>  
Phantom section: Flat Section

### **DASY5 Configuration:**

Probe: EX3DV4 - SN3866; ConvF(9.46, 9.46, 9.46); Calibrated: 5/27/2020 Electronics: DAE4 Sn1392  
Sensor-Surface: 2mm (Mechanical Surface Detection)  
Phantom: SAM-twin right\_2013\_09\_24; Type: QD000P40CD; Serial: TP:1783  
Measurement SW: DASY52, Version 52.10 (3); SEMCAD X Version 14.6.13 (7474)

Test Date: 2020-09-10; Ambient Temp: 20.5; Tissue Temp: 20.4

### **750 MHz System Verification (250 mW)**

**Area Scan (5x14x1):** Measurement grid: dx=15mm, dy=15mm

**Zoom Scan (7x7x7)/Cube 0:** Measurement grid: dx=5mm, dy=5mm, dz=5mm

Power Drift = 0.01 dB

Peak SAR (extrapolated) = 2.42 W/kg

**SAR(1 g) = 2.12 W/kg; SAR(10 g) = 1.33 W/kg**

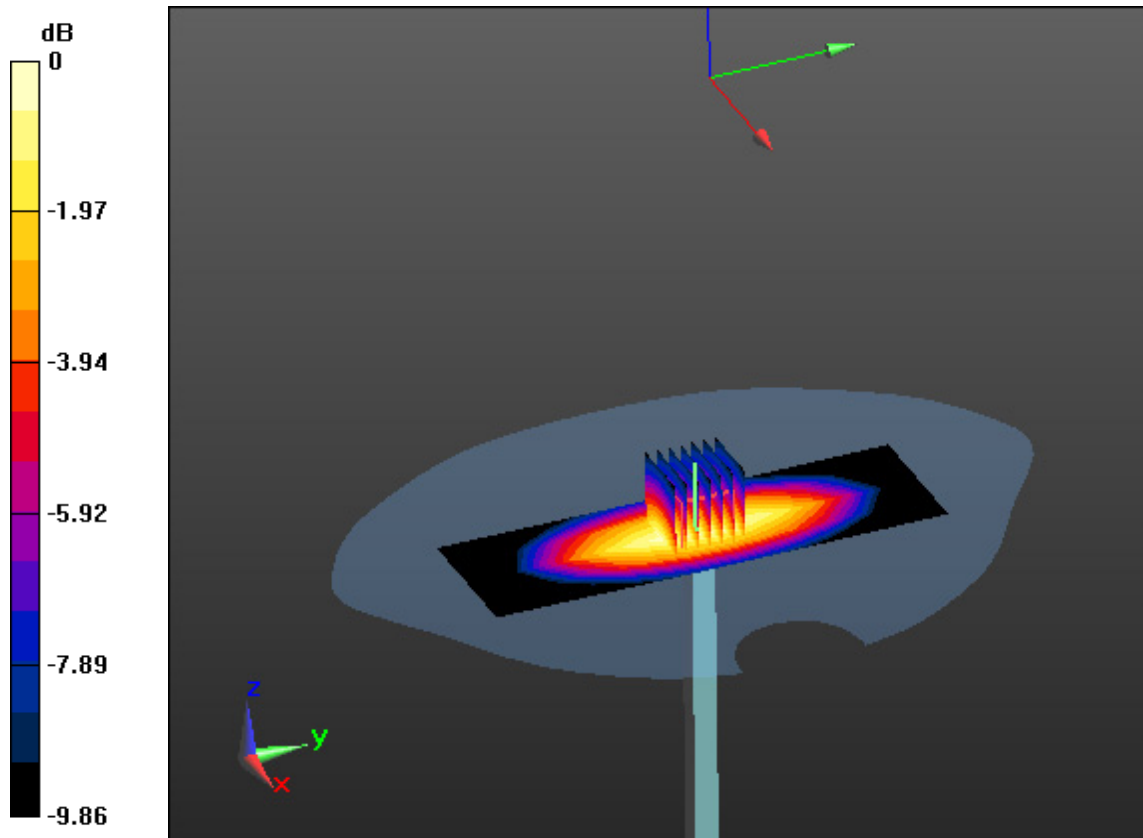

0 dB = 1.67 W/kg

## DT&C Co., Ltd.

**DUT: Dipole 835 MHz; Type: D835V2; Serial: D835V2 - SN:4d159**

Communication System: UID 0, CW (0); Frequency: 835 MHz; Duty Cycle: 1:1  
Medium parameters used:  $f = 835$  MHz;  $\sigma = 0.898$  S/m;  $\epsilon_r = 42.308$ ;  $\rho = 1000$  kg/m<sup>3</sup>  
Phantom section: Flat Section

### **DASY5 Configuration:**

Probe: EX3DV4 - SN3866; ConvF(9.2, 9.2, 9.2); Calibrated: 5/27/2020 Electronics: DAE4 Sn1392  
Sensor-Surface: 2mm (Mechanical Surface Detection)  
Phantom: SAM-twin right\_2013\_09\_24; Type: QD000P40CD; Serial: TP:1783  
Measurement SW: DASY52, Version 52.10 (3); SEMCAD X Version 14.6.13 (7474)

Test Date: 2020-09-09; Ambient Temp: 20.8; Tissue Temp: 20.5

### **835 MHz System Verification (250 mW)**

**Area Scan (6x11x1):** Measurement grid: dx=15mm, dy=15mm

**Zoom Scan (7x7x7)/Cube 0:** Measurement grid: dx=5mm, dy=5mm, dz=5mm

Power Drift = 0.01 dB

Peak SAR (extrapolated) = 5.88 W/kg

**SAR(1 g) = 2.48 W/kg; SAR(10 g) = 1.59 W/kg**

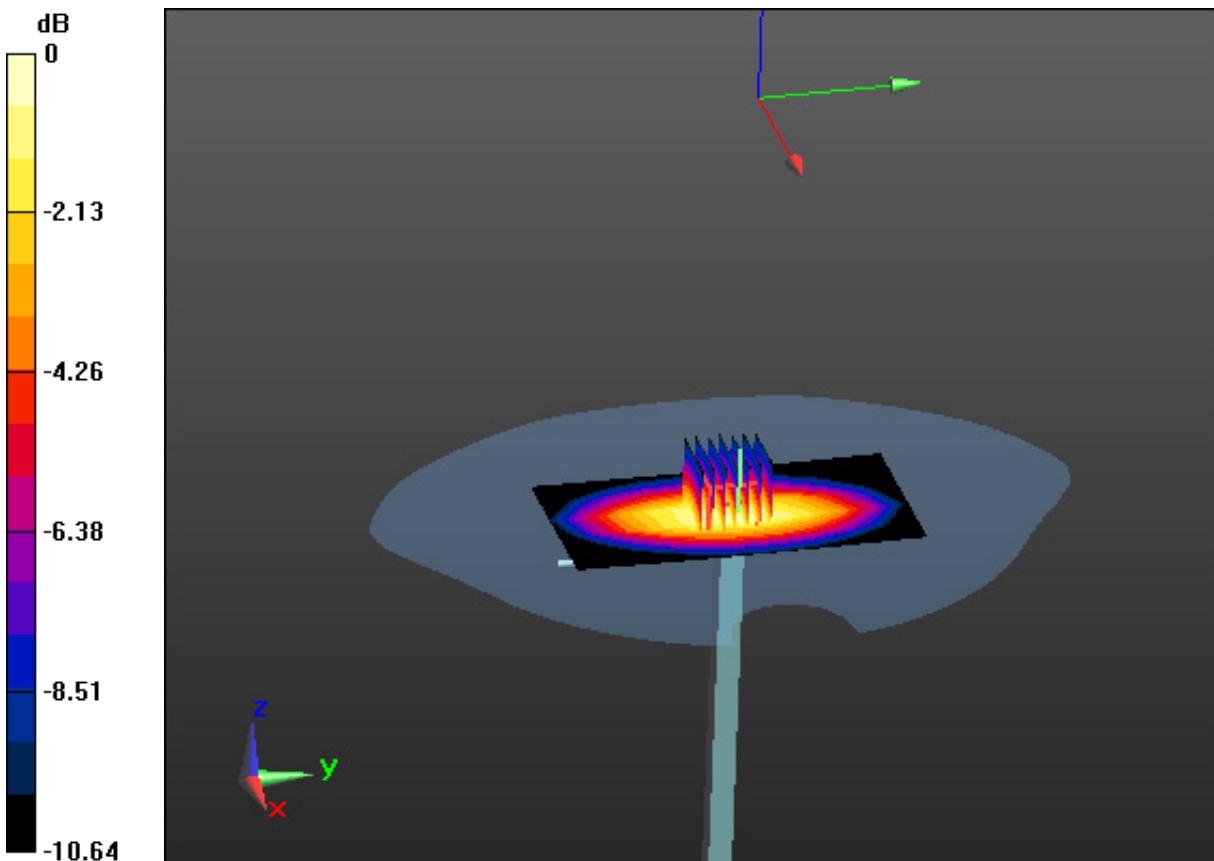

## DT&C Co., Ltd.

**DUT: Dipole 1800 MHz; Type: D1800V2; Serial: D1800V2 - SN:2d202**

Communication System: UID 0, CW (0); Frequency: 1800 MHz; Duty Cycle: 1:1  
Medium parameters used:  $f = 1800$  MHz;  $\sigma = 1.415$  S/m;  $\epsilon_r = 41.198$ ;  $\rho = 1000$  kg/m<sup>3</sup>  
Phantom section: Flat Section

### **DASY5 Configuration:**

Probe: EX3DV4 - SN7368; ConvF(8.78, 8.78, 8.78); Calibrated: 1/30/2020 Electronics: DAE4 Sn1335  
Sensor-Surface: 2mm (Mechanical Surface Detection)  
Phantom: SAM with CRP v5.0; Type: QD000P40CD; Serial: TP:1837  
Measurement SW: DASY52, Version 52.10 (3); SEMCAD X Version 14.6.13 (7474)

Test Date: 2020-09-11; Ambient Temp: 21.8; Tissue Temp: 21.6

### **1800 MHz System Verification (100 mW)**

**Area Scan (6x9x1):** Measurement grid: dx=15mm, dy=15mm

**Zoom Scan (7x7x7)/Cube 0:** Measurement grid: dx=5mm, dy=5mm, dz=5mm

Power Drift = -0.13 dB

Peak SAR (extrapolated) = 8.25 W/kg

**SAR(1 g) = 4.02 W/kg; SAR(10 g) = 2.13 W/kg**

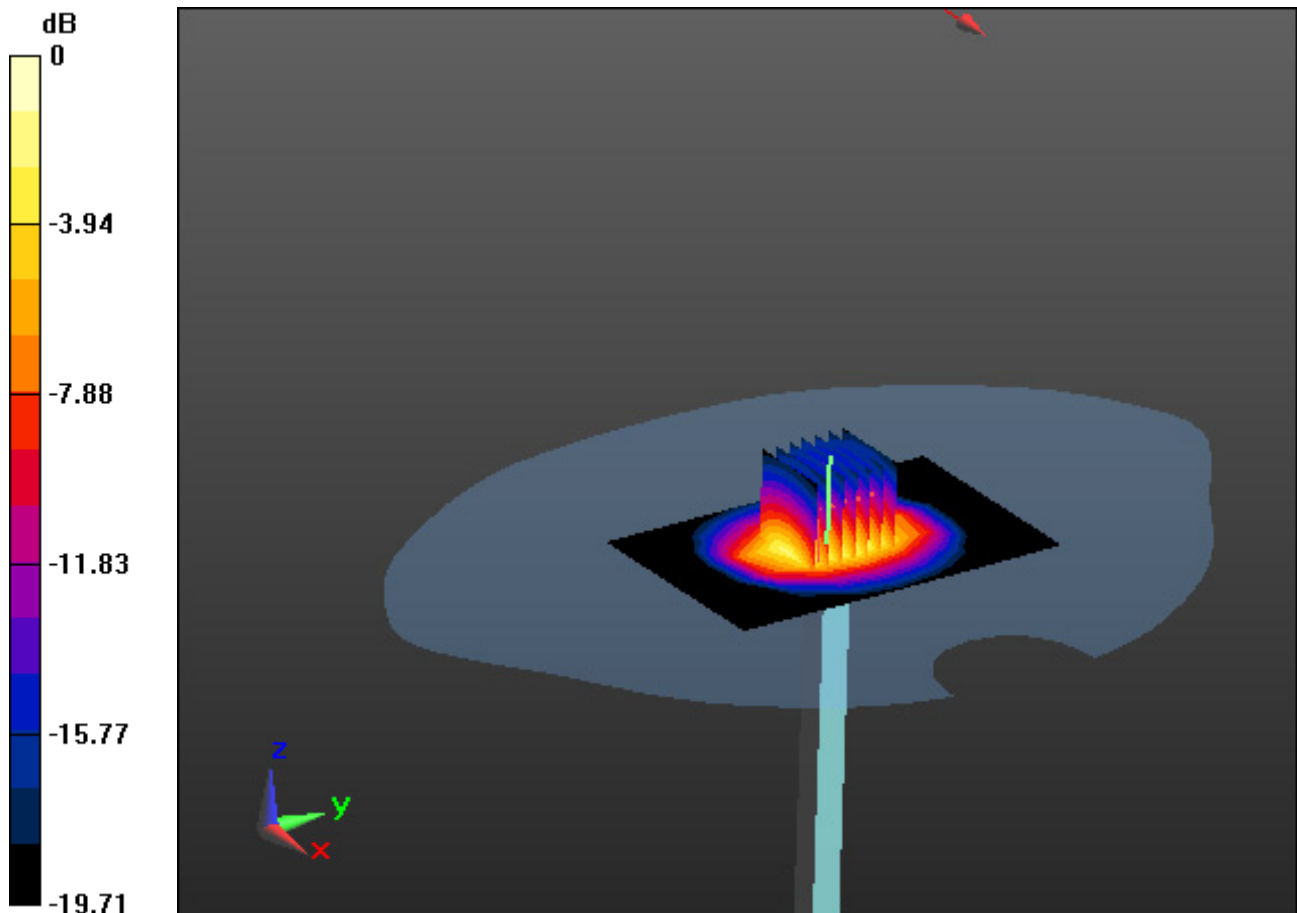

## DT&C Co., Ltd.

**DUT: Dipole 1900 MHz; Type: D1900V2; Serial: D1900V2 - SN:5d176**

Communication System: UID 0, CW (0); Frequency: 1900 MHz; Duty Cycle: 1:1  
Medium parameters used:  $f = 1900$  MHz;  $\sigma = 1.397$  S/m;  $\epsilon_r = 38.73$ ;  $\rho = 1000$  kg/m<sup>3</sup>  
Phantom section: Flat Section

### **DASY5 Configuration:**

Probe: EX3DV4 - SN7368; ConvF(8.43, 8.43, 8.43); Calibrated: 1/30/2020 Electronics: DAE4 Sn1335  
Sensor-Surface: 2mm (Mechanical Surface Detection)  
Phantom: SAM with CRP v5.0; Type: QD000P40CD; Serial: TP:1837  
Measurement SW: DASY52, Version 52.10 (3); SEMCAD X Version 14.6.13 (7474)

Test Date: 2020-09-14; Ambient Temp: 21.2; Tissue Temp: 21.0

### **1900 MHz System Verification (100 mW)**

**Area Scan (6x9x1):** Measurement grid: dx=15mm, dy=15mm

**Zoom Scan (7x7x7)/Cube 0:** Measurement grid: dx=5mm, dy=5mm, dz=5mm

Power Drift = -0.13 dB

Peak SAR (extrapolated) = 8.3 W/kg

**SAR(1 g) = 4.11 W/kg; SAR(10 g) = 2.14 W/kg**

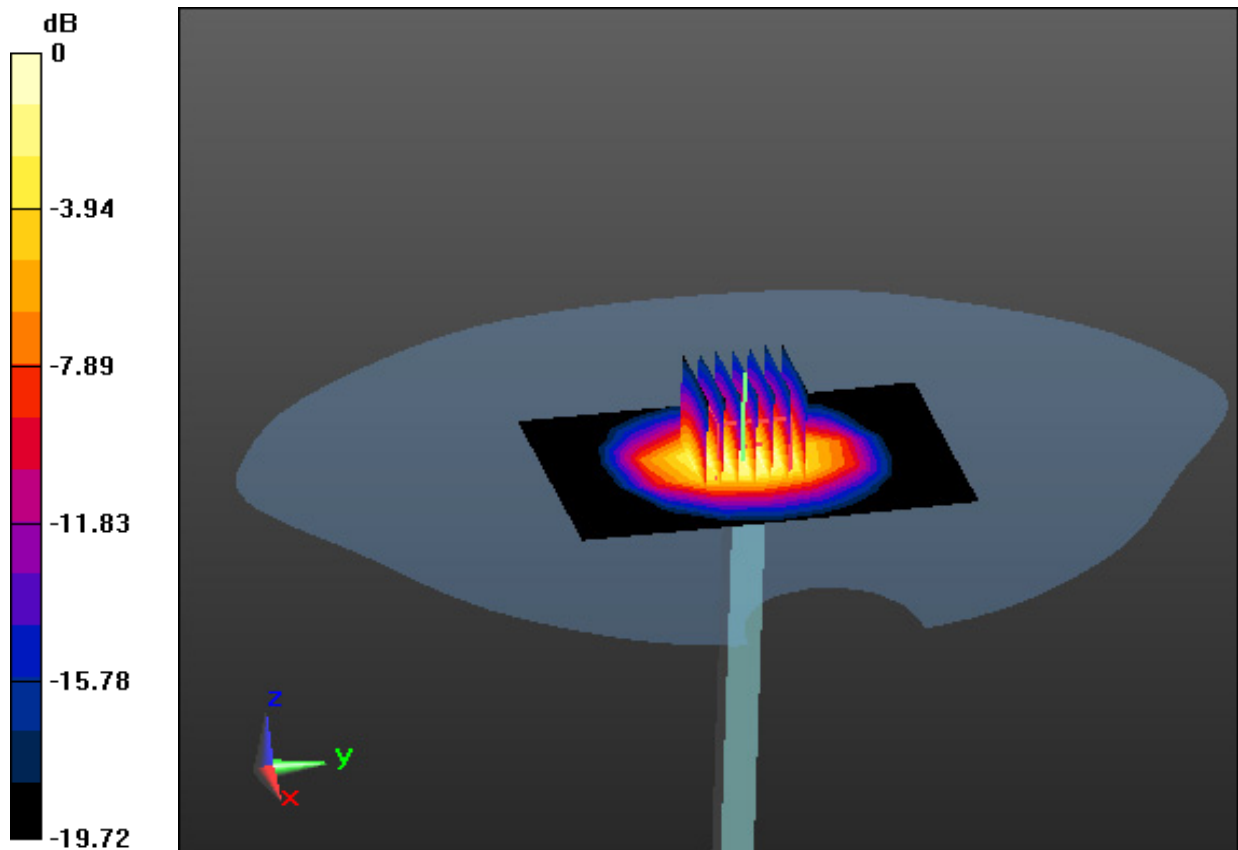

0 dB = 4.68 W/kg

## DT&C Co., Ltd.

**DUT: Dipole 2450 MHz; Type: D2450V2; Serial: D2450V2 - SN:920**

Communication System: UID 0, CW (0); Frequency: 2450 MHz; Duty Cycle: 1:1  
Medium parameters used:  $f = 2450$  MHz;  $\sigma = 1.809$  S/m;  $\epsilon_r = 40.082$ ;  $\rho = 1000$  kg/m<sup>3</sup>  
Phantom section: Flat Section

### **DASY5 Configuration:**

Probe: EX3DV4 - SN7368; ConvF(7.81, 7.81, 7.81); Calibrated: 1/30/2020 Electronics: DAE4 Sn1335  
Sensor-Surface: 2mm (Mechanical Surface Detection)  
Phantom: SAM with CRP v5.0; Type: QD000P40CD; Serial: TP:1837  
Measurement SW: DASY52, Version 52.10 (3); SEMCAD X Version 14.6.13 (7474)

Test Date: 2020-09-10; Ambient Temp: 20.9; Tissue Temp: 20.8

### **2450 MHz System Verification (100 mW)**

**Area Scan (7x9x1):** Measurement grid: dx=12mm, dy=12mm

**Zoom Scan (7x7x7)/Cube 0:** Measurement grid: dx=5mm, dy=5mm, dz=5mm

Power Drift = 0.16 dB

Peak SAR (extrapolated) = 12.27 W/kg

**SAR(1 g) = 5.21 W/kg; SAR(10 g) = 2.51 W/kg**

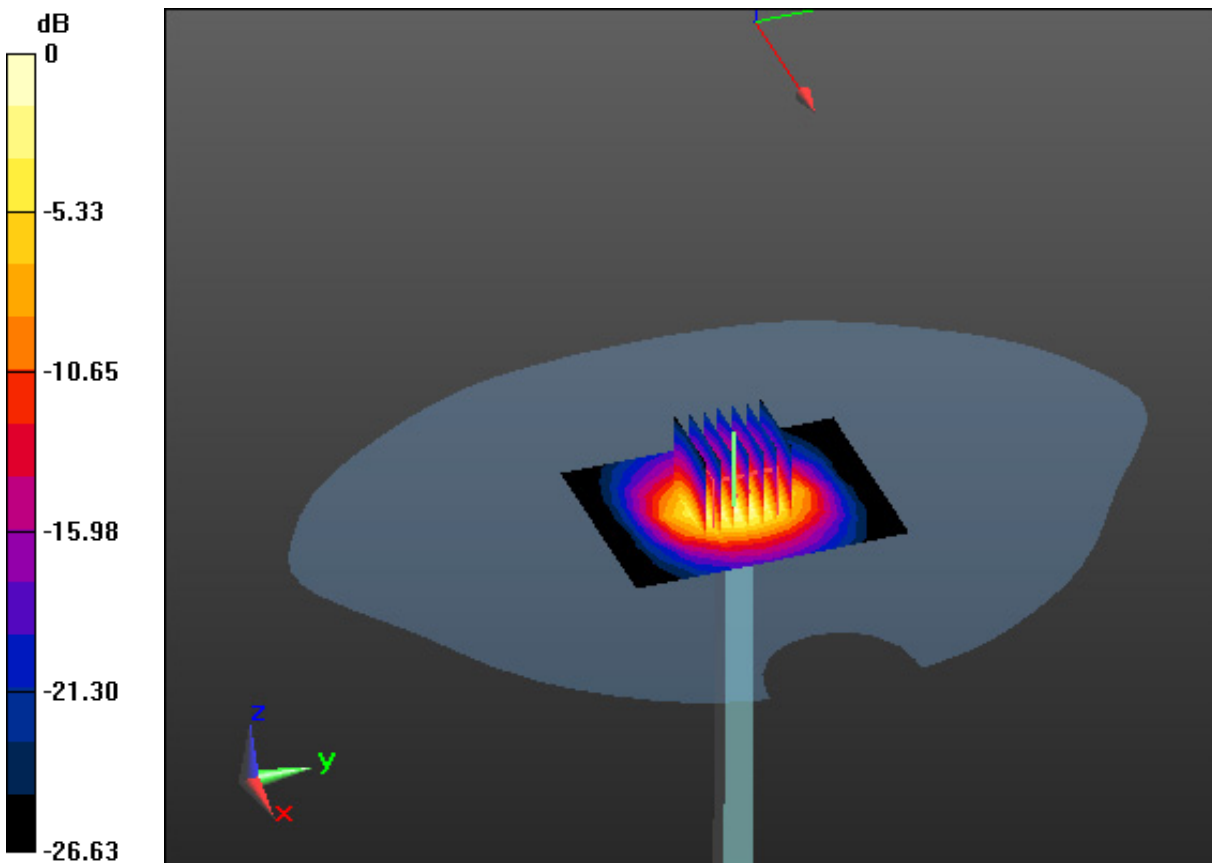

0 dB = 6.91 W/kg

## DT&C Co., Ltd.

**DUT: Dipole 2600 MHz; Type: D2600V2; Serial: D2600V2 - SN:1103**

Communication System: UID 0, CW (0); Frequency: 2600 MHz; Duty Cycle: 1:1  
Medium parameters used:  $f = 2600$  MHz;  $\sigma = 2.021$  S/m;  $\epsilon_r = 38.156$ ;  $\rho = 1000$  kg/m<sup>3</sup>  
Phantom section: Flat Section

### **DASY5 Configuration:**

Probe: EX3DV4 - SN7368; ConvF(7.44, 7.44, 7.44); Calibrated: 1/30/2020 Electronics: DAE4 Sn1335  
Sensor-Surface: 2mm (Mechanical Surface Detection)  
Phantom: SAM with CRP v5.0; Type: QD000P40CD; Serial: TP:1837  
Measurement SW: DASY52, Version 52.10 (3); SEMCAD X Version 14.6.13 (7474)

Test Date: 2020-09-10; Ambient Temp: 20.9; Tissue Temp: 20.8

### **2600 MHz System Verification (100 mW)**

**Area Scan (7x9x1):** Measurement grid: dx=12mm, dy=12mm

**Zoom Scan (7x7x7)/Cube 0:** Measurement grid: dx=5mm, dy=5mm, dz=5mm

Power Drift = 0.09 dB

Peak SAR (extrapolated) = 12.3 W/kg

**SAR(1 g) = 5.35 W/kg; SAR(10 g) = 2.44 W/kg**

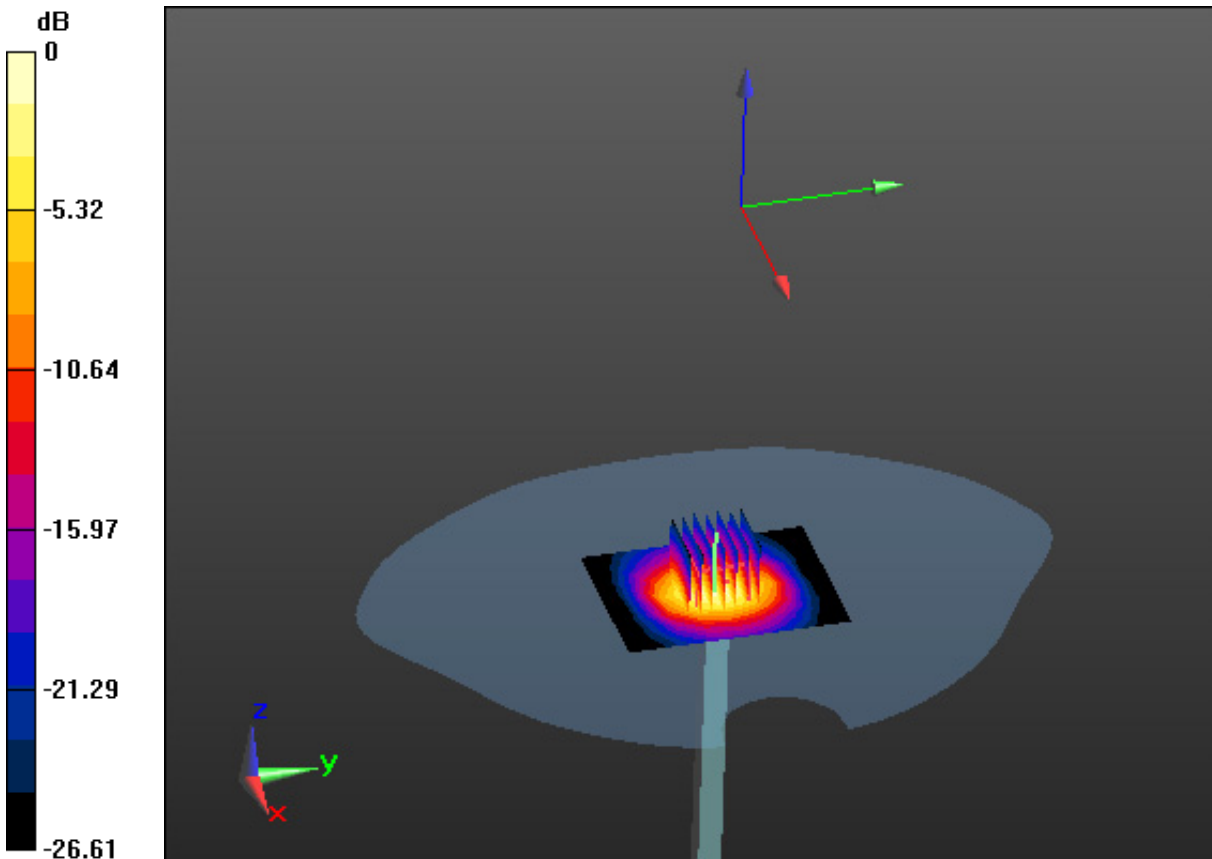

0 dB = 7.28 W/kg

## DT&C Co., Ltd.

**DUT: Dipole 5000 MHz; Type: D5GHzV2; Serial: D5GHzV2 - SN:1212**

Communication System: UID 0, CW (0); Frequency: 5300 MHz; Duty Cycle: 1:1  
Medium parameters used:  $f = 5300$  MHz;  $\sigma = 4.884$  S/m;  $\epsilon_r = 36.632$ ;  $\rho = 1000$  kg/m<sup>3</sup>  
Phantom section: Flat Section

### **DASY5 Configuration:**

Probe: EX3DV4 - SN7368; ConvF(5.45, 5.45, 5.45); Calibrated: 1/30/2020 Electronics: DAE4 Sn1335  
Sensor-Surface: 1.4mm (Mechanical Surface Detection)  
Phantom: SAM with CRP v5.0; Type: QD000P40CD; Serial: TP:1837  
Measurement SW: DASY52, Version 52.10 (3); SEMCAD X Version 14.6.13 (7474)

Test Date: 2020-09-07; Ambient Temp: 20.6; Tissue Temp: 20.5

### **5300 MHz System Verification (100 mW)**

**Area Scan (7x9x1):** Measurement grid: dx=10mm, dy=10mm

**Zoom Scan (8x8x7)/Cube 0:** Measurement grid: dx=4mm, dy=4mm, dz=1.4mm, Graded Ratio:1.4

Power Drift = 0.01 dB

Peak SAR (extrapolated) = 33.6 W/kg

**SAR(1 g) = 8.28 W/kg; SAR(10 g) = 2.36 W/kg**

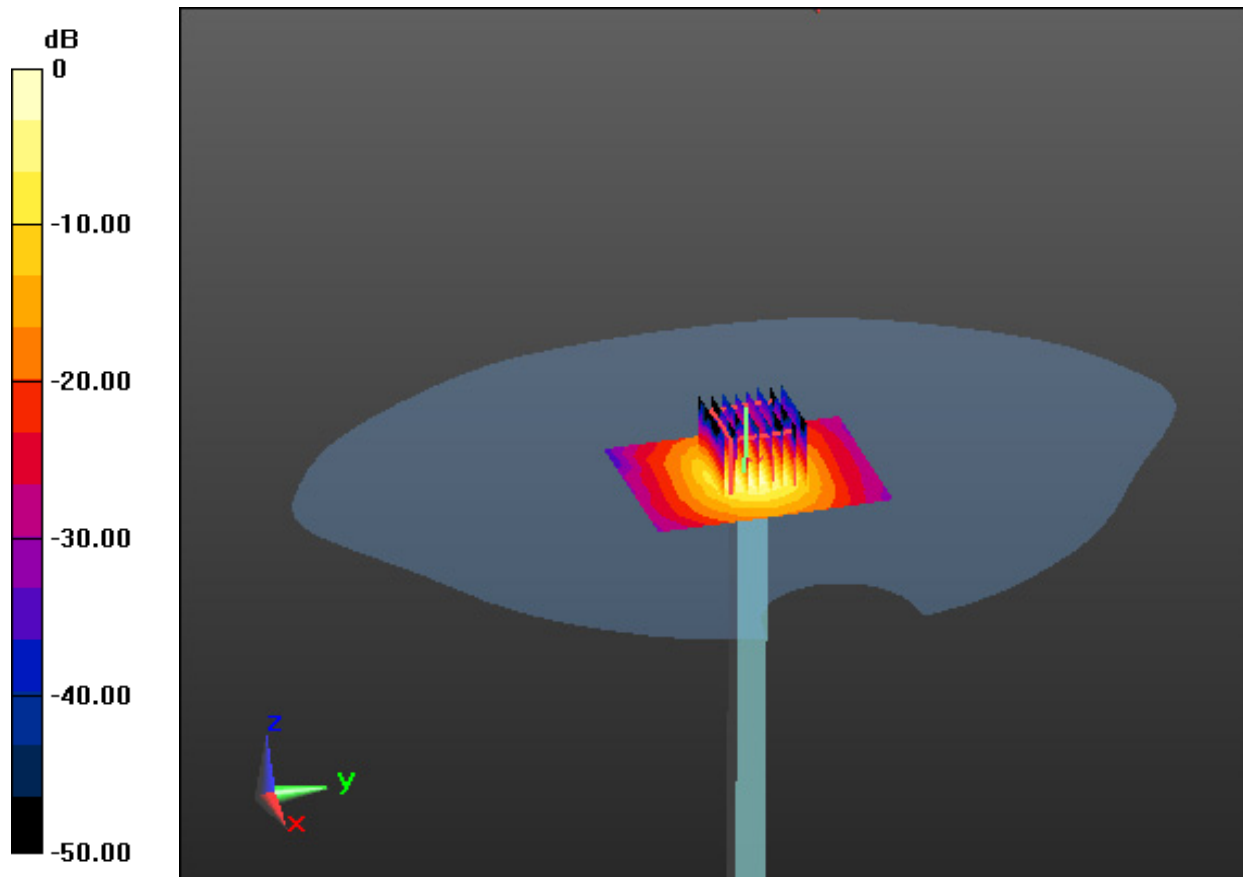

0 dB = 18.3 W/kg



## DT&C Co., Ltd.

**DUT: Dipole 5000 MHz; Type: D5GHzV2; Serial: D5GHzV2 - SN:1212**

Communication System: UID 0, CW (0); Frequency: 5600 MHz; Duty Cycle: 1:1  
Medium parameters used:  $f = 5600$  MHz;  $\sigma = 5.233$  S/m;  $\epsilon_r = 36.292$ ;  $\rho = 1000$  kg/m<sup>3</sup>  
Phantom section: Flat Section

### **DASY5 Configuration:**

Probe: EX3DV4 - SN7368; ConvF(4.85, 4.85, 4.85); Calibrated: 1/30/2020 Electronics: DAE4 Sn1335  
Sensor-Surface: 1.4mm (Mechanical Surface Detection)  
Phantom: SAM with CRP v5.0; Type: QD000P40CD; Serial: TP:1837  
Measurement SW: DASY52, Version 52.10 (3); SEMCAD X Version 14.6.13 (7474)

Test Date: 2020-09-07; Ambient Temp: 20.6; Tissue Temp: 20.5

### **5600 MHz System Verification (100 mW)**

**Area Scan (7x9x1):** Measurement grid: dx=10mm, dy=10mm

**Zoom Scan (8x8x7)/Cube 0:** Measurement grid: dx=4mm, dy=4mm, dz=1.4mm, Graded Ratio:1.4

Power Drift = 0.05 dB

Peak SAR (extrapolated) = 38.2 W/kg

**SAR(1 g) = 8.36 W/kg; SAR(10 g) = 2.33 W/kg**

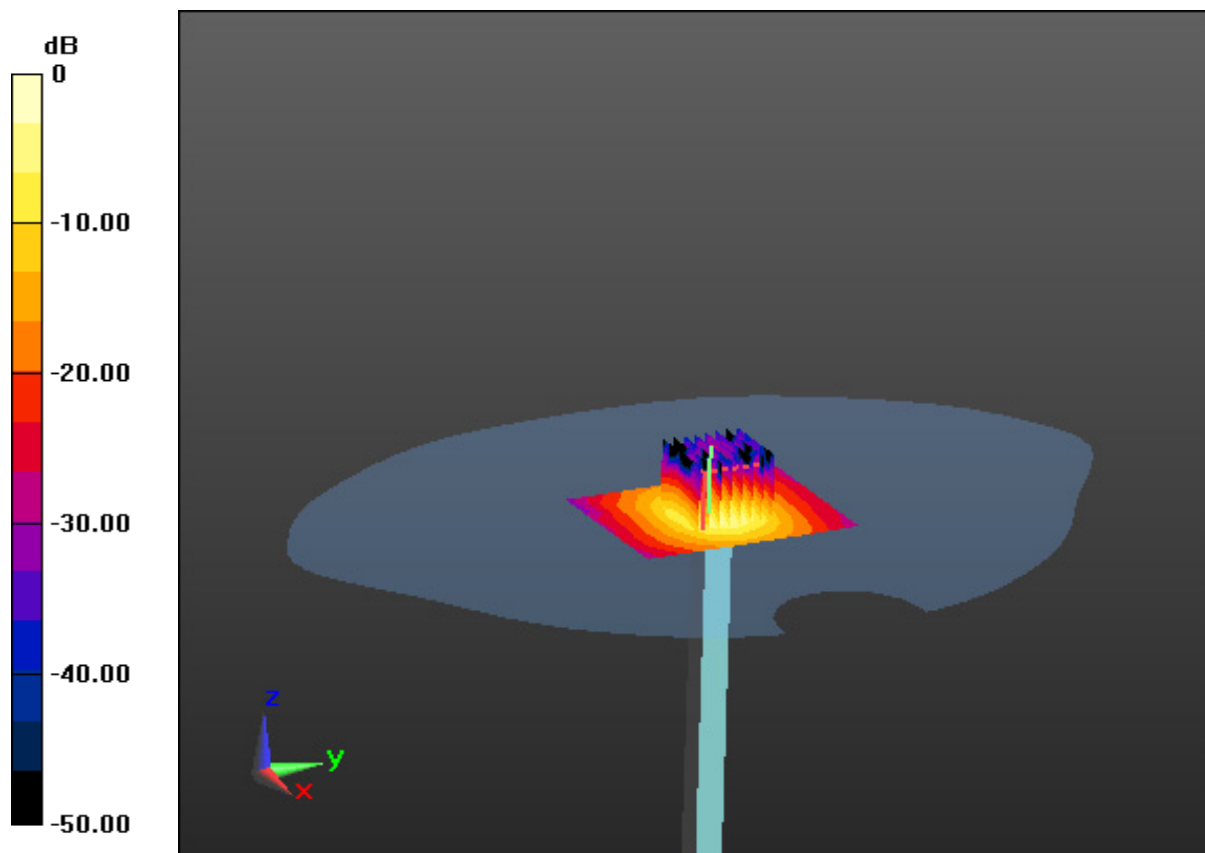

0 dB = 20.0 W/kg

## DT&C Co., Ltd.

**DUT: Dipole 5000 MHz; Type: D5GHzV2; Serial: D5GHzV2 - SN:1212**

Communication System: UID 0, CW (0); Frequency: 5800 MHz; Duty Cycle: 1:1  
Medium parameters used:  $f = 5800$  MHz;  $\sigma = 5.412$  S/m;  $\epsilon_r = 35.765$ ;  $\rho = 1000$  kg/m<sup>3</sup>  
Phantom section: Flat Section

### **DASY5 Configuration:**

Probe: EX3DV4 - SN7368; ConvF(5.02, 5.02, 5.02); Calibrated: 1/30/2020 Electronics: DAE4 Sn1335  
Sensor-Surface: 1.4mm (Mechanical Surface Detection)  
Phantom: SAM with CRP v5.0; Type: QD000P40CD; Serial: TP:1837  
Measurement SW: DASY52, Version 52.10 (3); SEMCAD X Version 14.6.13 (7474)

Test Date: 2020-09-07; Ambient Temp: 20.6; Tissue Temp: 20.5

### **5800 MHz System Verification (100 mW)**

**Area Scan (7x9x1):** Measurement grid: dx=10mm, dy=10mm

**Zoom Scan (8x8x7)/Cube 0:** Measurement grid: dx=4mm, dy=4mm, dz=1.4mm, Graded Ratio:1.4  
Power Drift = -0.11 dB  
Peak SAR (extrapolated) = 38.9 W/kg  
**SAR(1 g) = 8.17 W/kg; SAR(10 g) = 2.30 W/kg**

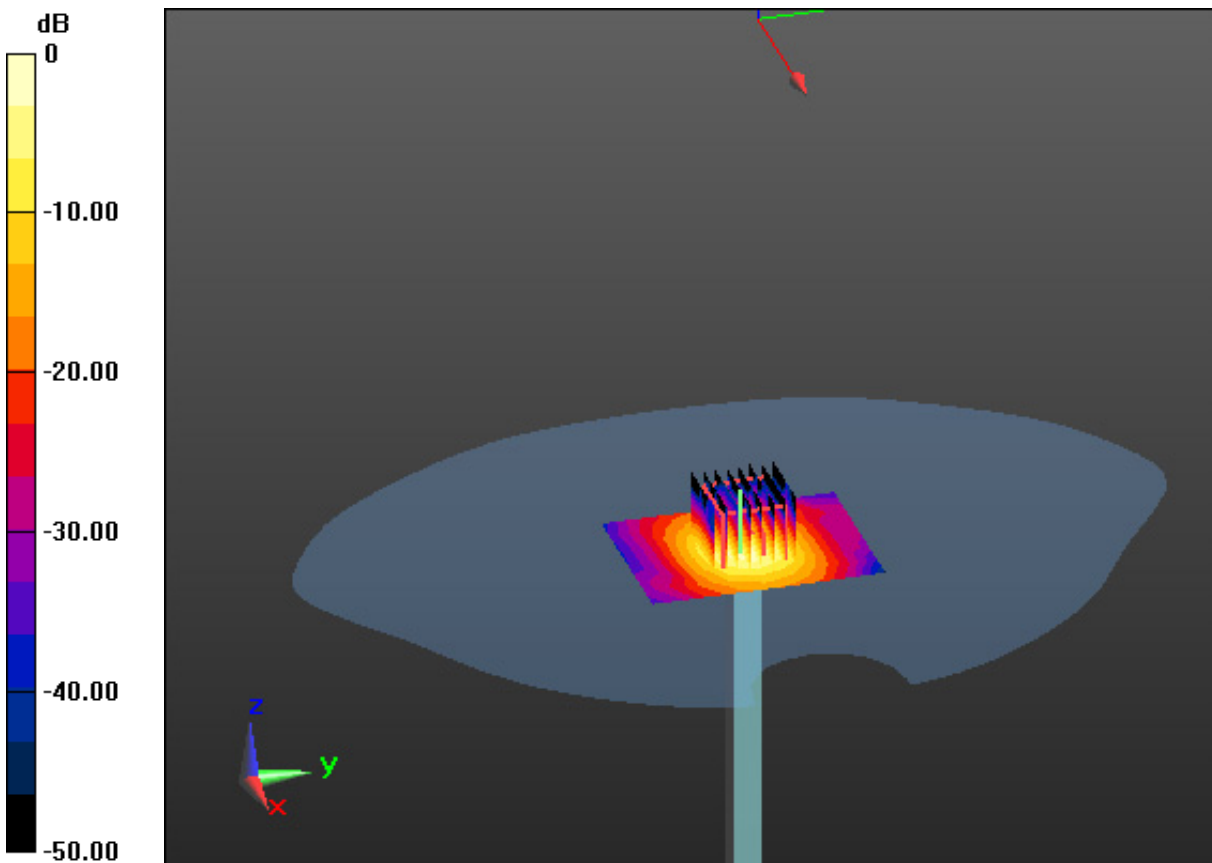

# DT&C Co., Ltd.

**DUT: PM500; Type: PDA**

Communication System: UID 0, GSM 850\_2 Tx (0); Frequency: 836.6 MHz; Duty Cycle: 1:4.15

Medium parameters used:  $f = 836.6$  MHz;  $\sigma = 0.899$  S/m;  $\epsilon_r = 42.286$ ;  $\rho = 1000$  kg/m<sup>3</sup>

Phantom section: Flat Section

## **DASY5 Configuration:**

Probe: EX3DV4 - SN3866; ConvF(9.2, 9.2, 9.2); Calibrated: 5/27/2020 Electronics: DAE4 Sn1392

Sensor-Surface: 2mm (Mechanical Surface Detection)

Phantom: SAM-twin right\_2013\_09\_24; Type: QD000P40CD; Serial: TP:1783

Measurement SW: DASY52, Version 52.10 (3); SEMCAD X Version 14.6.13 (7474)

Test Date: 2020-09-09; Ambient Temp: 20.8; Tissue Temp: 20.5

**Touch from Body, Left, GSM850 GPRS 2 Tx Ch. 190, Ant Internal**

**Area Scan (6x15x1):** Measurement grid: dx=15mm, dy=15mm

**Zoom Scan (5x5x7)/Cube 0:** Measurement grid: dx=8mm, dy=8mm, dz=5mm

Power Drift = -0.02 dB

Peak SAR (extrapolated) = 4.36 W/kg

**SAR(1 g) = 2.53 W/kg; SAR(10 g) = 1.43 W/kg**

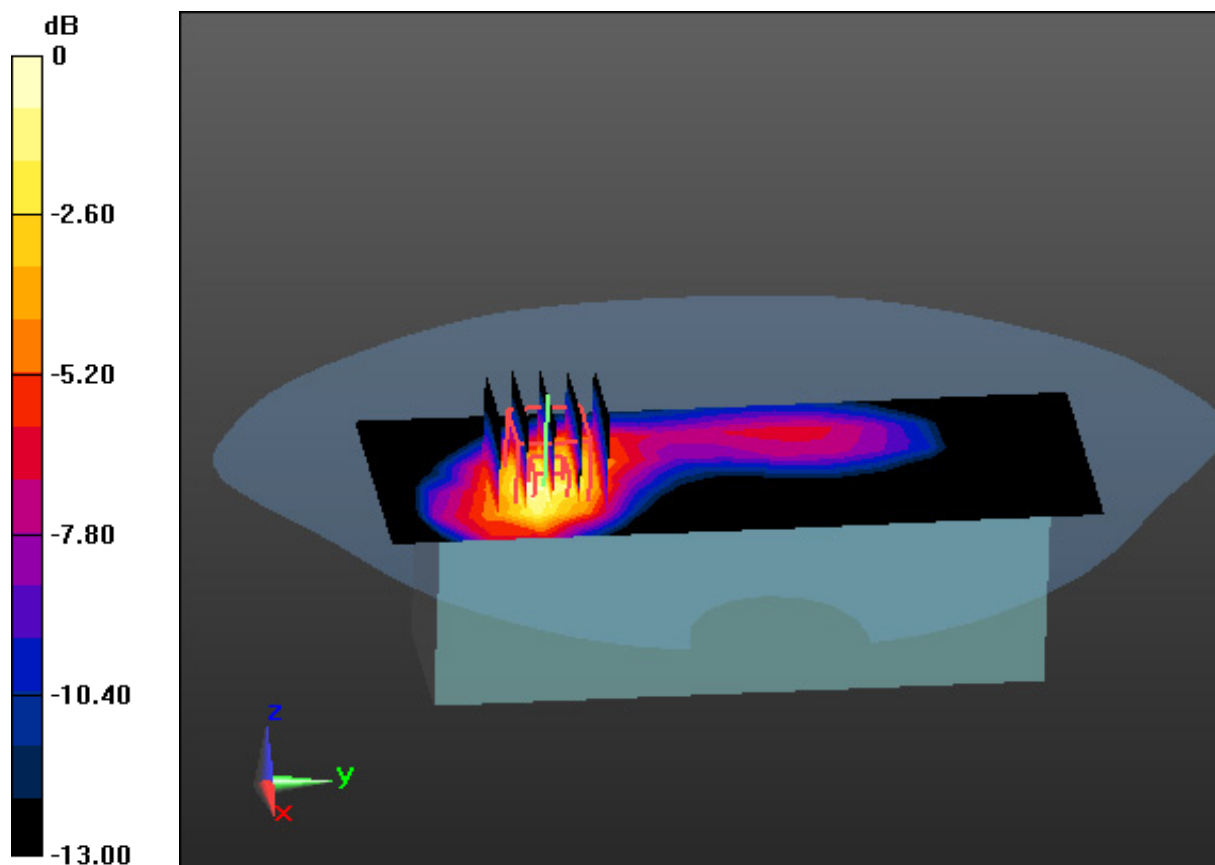

0 dB = 3.48 W/kg

# DT&C Co., Ltd.

**DUT: PM500; Type: PDA**

Communication System: UID 0, PCS 1900 4TX (0); Frequency: 1850.2 MHz; Duty Cycle: 1:2.075

Medium parameters used:  $f = 1850.2$  MHz;  $\sigma = 1.348$  S/m;  $\epsilon_r = 38.863$ ;  $\rho = 1000$  kg/m<sup>3</sup>

Phantom section: Flat Section

## **DASY5 Configuration:**

Probe: EX3DV4 - SN7368; ConvF(8.43, 8.43, 8.43); Calibrated: 1/30/2020 Electronics: DAE4 Sn1335

Sensor-Surface: 2mm (Mechanical Surface Detection)

Phantom: SAM with CRP v5.0; Type: QD000P40CD; Serial: TP:1837

Measurement SW: DASY52, Version 52.10 (3); SEMCAD X Version 14.6.13 (7474)

Test Date: 2020-09-14; Ambient Temp: 21.2; Tissue Temp: 21.0

**Touch from Body, Left, PCS1900 GPRS 4Tx Ch. 512, Ant Internal**

**Area Scan (6x15x1):** Measurement grid: dx=15mm, dy=15mm

**Zoom Scan (5x5x7)/Cube 0:** Measurement grid: dx=8mm, dy=8mm, dz=5mm

Power Drift = 0.19 dB

Peak SAR (extrapolated) = 8.37 W/kg

**SAR(1 g) = 4.42 W/kg; SAR(10 g) = 2.24 W/kg**

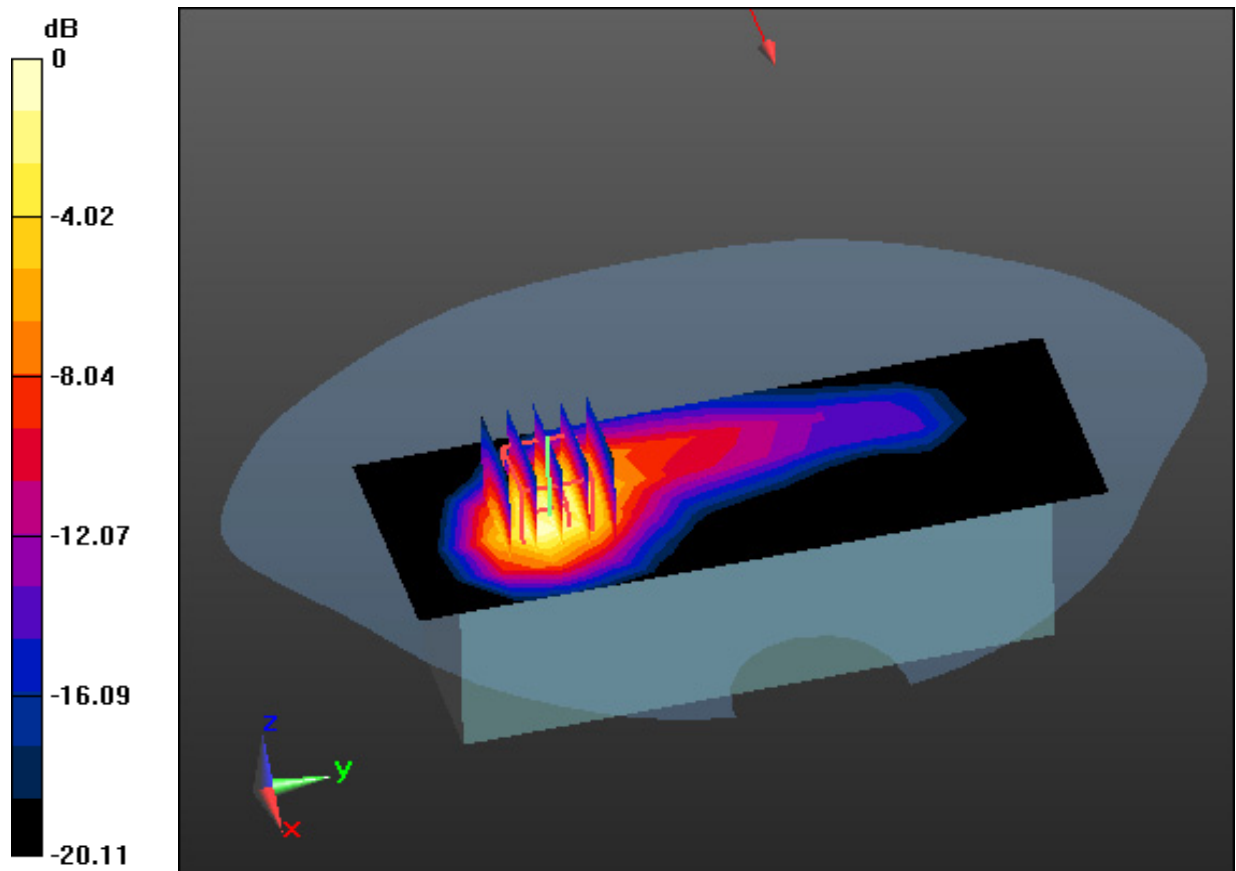

0 dB = 6.42 W/kg

# DT&C Co., Ltd.

**DUT: PM500; Type: PDA**

Communication System: UID 0, WCDMA 850 (0); Frequency: 836.6 MHz; Duty Cycle: 1:1

Medium parameters used:  $f = 836.6$  MHz;  $\sigma = 0.899$  S/m;  $\epsilon_r = 42.286$ ;  $\rho = 1000$  kg/m<sup>3</sup>

Phantom section: Flat Section

## **DASY5 Configuration:**

Probe: EX3DV4 - SN3866; ConvF(9.2, 9.2, 9.2); Calibrated: 5/27/2020 Electronics: DAE4 Sn1392

Sensor-Surface: 2mm (Mechanical Surface Detection)

Phantom: SAM-twin right\_2013\_09\_24; Type: QD000P40CD; Serial: TP:1783

Measurement SW: DASY52, Version 52.10 (3); SEMCAD X Version 14.6.13 (7474)

Test Date: 2020-09-09; Ambient Temp: 20.8; Tissue Temp: 20.5

**Touch from Body, Left, WCDMA Band 5 Ch. 4183, Ant. Internal**

**Area Scan (6x15x1):** Measurement grid: dx=15mm, dy=15mm

**Zoom Scan (5x5x7)/Cube 0:** Measurement grid: dx=8mm, dy=8mm, dz=5mm

Power Drift = -0.03 dB

Peak SAR (extrapolated) = 4.37 W/kg

**SAR(1 g) = 2.38 W/kg; SAR(10 g) = 1.32 W/kg**

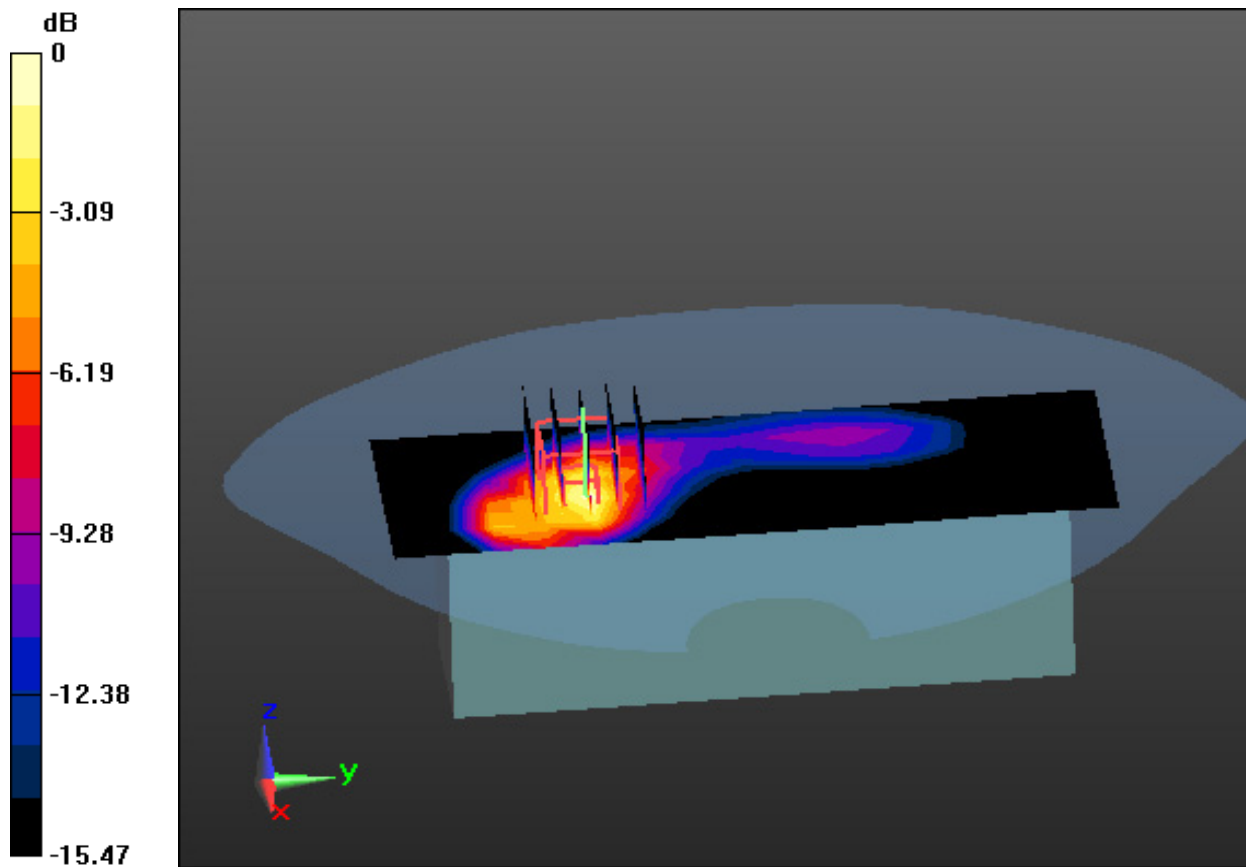

0 dB = 3.32 W/kg

# DT&C Co., Ltd.

**DUT: PM500; Type: PDA**

Communication System: UID 0, WCDMA Band 4 (0); Frequency: 1732.4 MHz; Duty Cycle: 1:1  
Medium parameters used:  $f = 1732.4$  MHz;  $\sigma = 1.348$  S/m;  $\epsilon_r = 41.479$ ;  $\rho = 1000$  kg/m<sup>3</sup>  
Phantom section: Flat Section

## **DASY5 Configuration:**

Probe: EX3DV4 - SN7368; ConvF(8.78, 8.78, 8.78); Calibrated: 1/30/2020 Electronics: DAE4 Sn1335  
Sensor-Surface: 2mm (Mechanical Surface Detection)  
Phantom: SAM with CRP v5.0; Type: QD000P40CD; Serial: TP:1837  
Measurement SW: DASY52, Version 52.10 (3); SEMCAD X Version 14.6.13 (7474)

Test Date: 2020-09-11; Ambient Temp: 21.8; Tissue Temp: 21.6

**Touch from Body, Left, WCDMA Band 4 Ch. 1412, Ant. Internal**

**Area Scan (6x15x1):** Measurement grid: dx=15mm, dy=15mm

**Zoom Scan (5x5x7)/Cube 0:** Measurement grid: dx=8mm, dy=8mm, dz=5mm

Power Drift = -0.09 dB

Peak SAR (extrapolated) = 14.8 W/kg

**SAR(1 g) = 7.15 W/kg; SAR(10 g) = 3.39 W/kg**

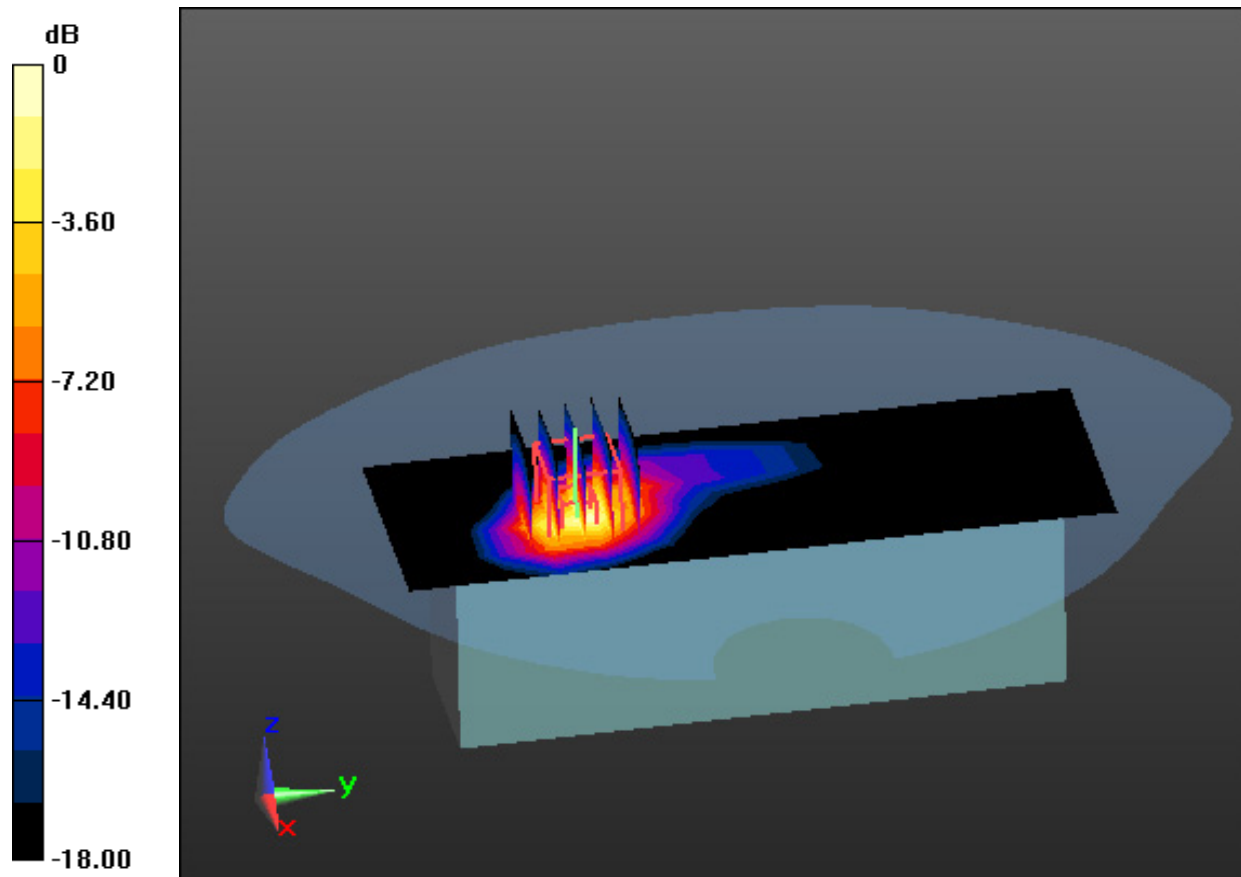

0 dB = 11.1 W/kg

# DT&C Co., Ltd.

**DUT: PM500; Type: PDA**

Communication System: UID 0, WCDMA 1900 (0); Frequency: 1880 MHz; Duty Cycle: 1:1  
Medium parameters used:  $f = 1880$  MHz;  $\sigma = 1.377$  S/m;  $\epsilon_r = 38.79$ ;  $\rho = 1000$  kg/m<sup>3</sup>  
Phantom section: Flat Section

## **DASY5 Configuration:**

Probe: EX3DV4 - SN7368; ConvF(8.43, 8.43, 8.43); Calibrated: 1/30/2020 Electronics: DAE4 Sn1335  
Sensor-Surface: 2mm (Mechanical Surface Detection)  
Phantom: SAM with CRP v5.0; Type: QD000P40CD; Serial: TP:1837  
Measurement SW: DASY52, Version 52.10 (3); SEMCAD X Version 14.6.13 (7474)

Test Date: 2020-09-14; Ambient Temp: 21.2; Tissue Temp: 21.0

**Touch from Body, Left, WCDMA Band 2 Ch. 9400, Ant. Internal**

**Area Scan (6x15x1):** Measurement grid: dx=15mm, dy=15mm

**Zoom Scan (5x5x7)/Cube 0:** Measurement grid: dx=8mm, dy=8mm, dz=5mm

Power Drift = 0.17 dB

Peak SAR (extrapolated) = 12.7 W/kg

**SAR(1 g) = 6.11 W/kg; SAR(10 g) = 3.08 W/kg**

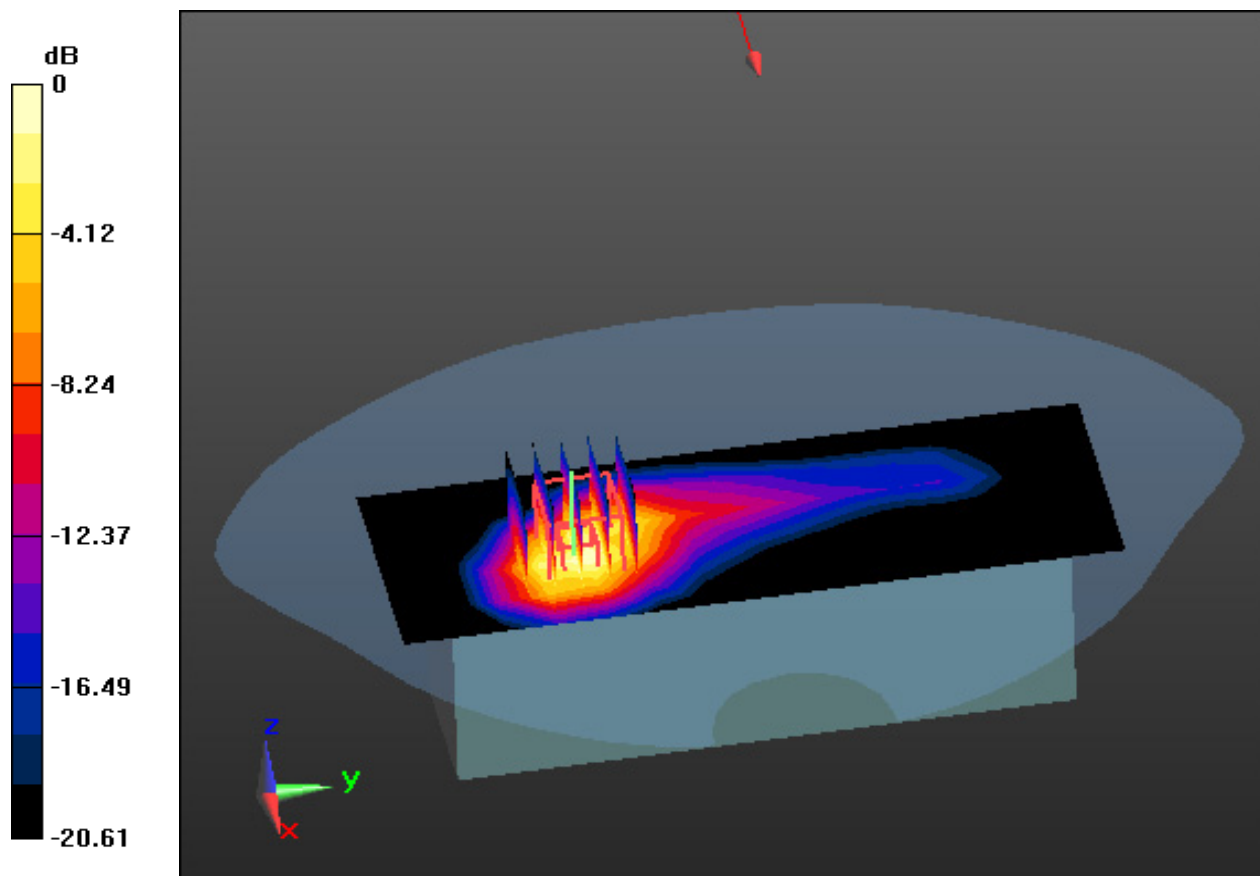

0 dB = 8.55 W/kg

# DT&C Co., Ltd

**DUT: PM500; Type: PDA**

Communication System: UID 0, LTE Band 12 (FCC) (0); Frequency: 707.5 MHz; Duty Cycle: 1:1

Medium parameters used:  $f = 707.5 \text{ MHz}$ ;  $\sigma = 0.864 \text{ S/m}$ ;  $\epsilon_r = 42.199$ ;  $\rho = 1000 \text{ kg/m}^3$

Phantom section: Flat Section

## **DASY5 Configuration:**

Probe: EX3DV4 - SN3866; ConvF(9.46, 9.46, 9.46); Calibrated: 5/27/2020 Electronics: DAE4 Sn1392

Sensor-Surface: 2mm (Mechanical Surface Detection)

Phantom: SAM-twin right\_2013\_09\_24; Type: QD000P40CD; Serial: TP:1783

Measurement SW: DASY52, Version 52.10 (3); SEMCAD X Version 14.6.13 (7474)

Test Date: 2020-09-10; Ambient Temp: 20.5; Tissue Temp: 20.4

**Touch from Body, Left, LTE Band 12 Ch. 23095, Ant Internal**

**Mode : BandWidth 10 MHz, QPSK, RB Size : 1**

**Area Scan (6x15x1):** Measurement grid:  $dx=15\text{mm}$ ,  $dy=15\text{mm}$

**Zoom Scan (5x5x7)/Cube 0:** Measurement grid:  $dx=8\text{mm}$ ,  $dy=8\text{mm}$ ,  $dz=5\text{mm}$

Power Drift = -0.12 dB

Peak SAR (extrapolated) = 3.32 W/kg

**SAR(1 g) = 1.63 W/kg; SAR(10 g) = 1.03 W/kg**

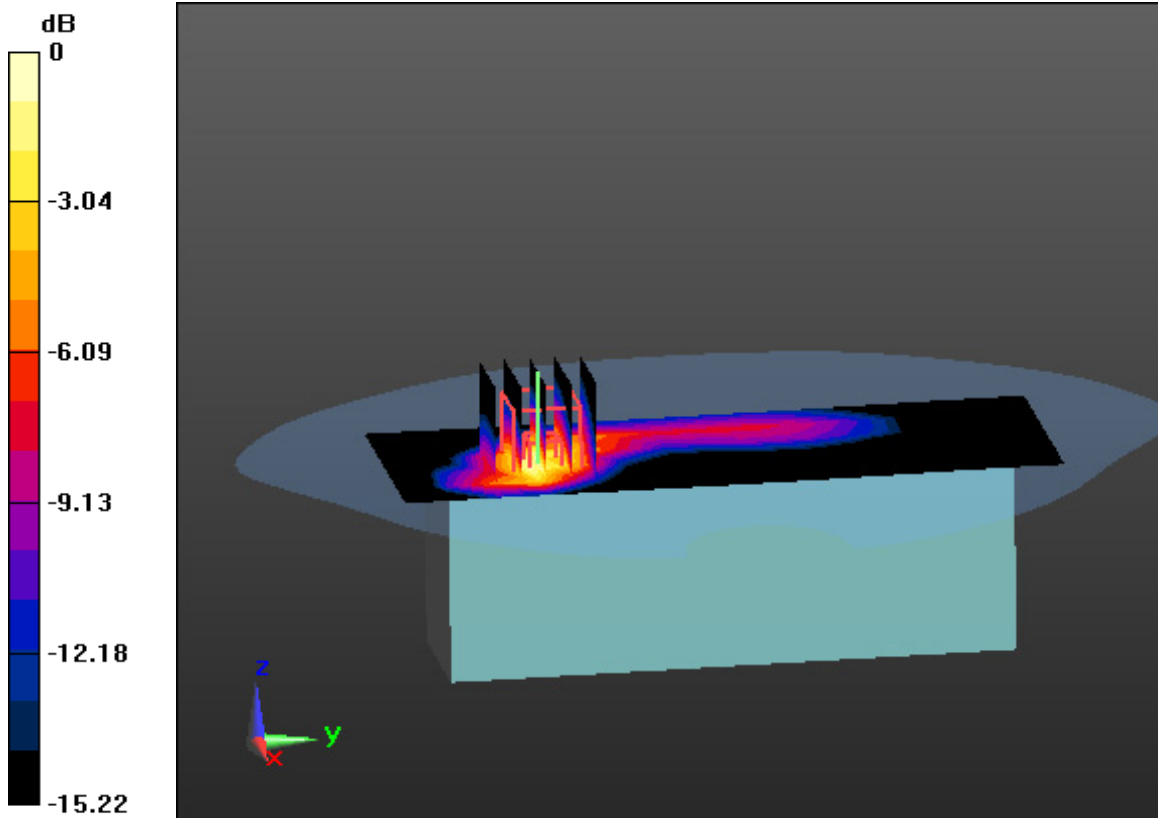

0 dB = 2.58 W/kg



# DT&C Co., Ltd

**DUT: PM500; Type: PDA**

Communication System: UID 0, LTE Band 13 (0); Frequency: 782 MHz; Duty Cycle: 1:1

Medium parameters used:  $f = 782 \text{ MHz}$ ;  $\sigma = 0.928 \text{ S/m}$ ;  $\epsilon_r = 41.528$ ;  $\rho = 1000 \text{ kg/m}^3$

Phantom section: Flat Section

## **DASY5 Configuration:**

Probe: EX3DV4 - SN3866; ConvF(9.46, 9.46, 9.46); Calibrated: 5/27/2020 Electronics: DAE4 Sn1392

Sensor-Surface: 2mm (Mechanical Surface Detection)

Phantom: SAM-twin right\_2013\_09\_24; Type: QD000P40CD; Serial: TP:1783

Measurement SW: DASY52, Version 52.10 (3); SEMCAD X Version 14.6.13 (7474)

Test Date: 2020-09-10; Ambient Temp: 20.5; Tissue Temp: 20.4

**Touch from Body, Left, LTE Band 13 Ch. 23230, Ant Internal**

**Mode : BandWidth 10 MHz, QPSK, RB Size : 1**

**Area Scan (6x15x1):** Measurement grid:  $dx=15\text{mm}$ ,  $dy=15\text{mm}$

**Zoom Scan (5x5x7)/Cube 0:** Measurement grid:  $dx=8\text{mm}$ ,  $dy=8\text{mm}$ ,  $dz=5\text{mm}$

Power Drift = -0.19 dB

Peak SAR (extrapolated) = 2.83 W/kg

**SAR(1 g) = 1.55 W/kg; SAR(10 g) = 0.870 W/kg**

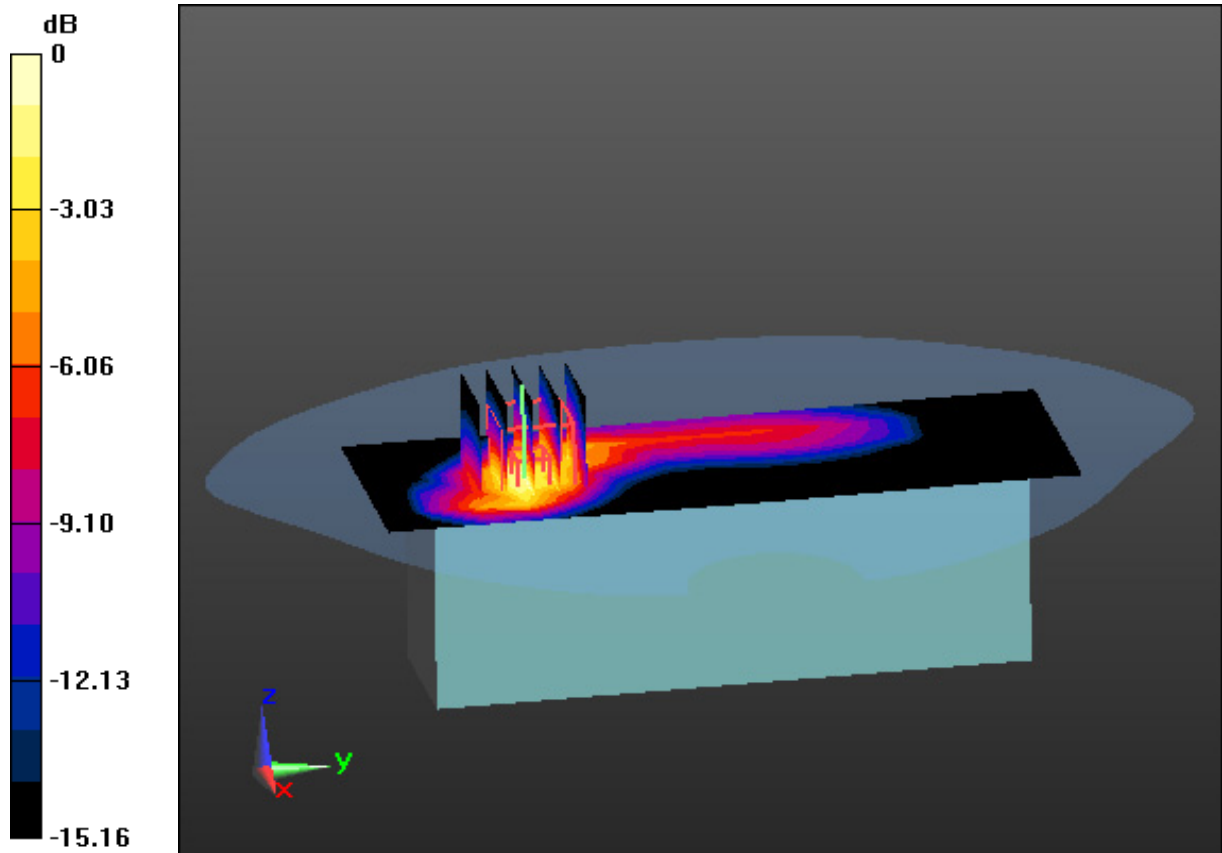

0 dB = 2.19 W/kg

# DT&C Co., Ltd

**DUT: PM500; Type: PDA**

Communication System: UID 0, LTE Band 26(FCC) (0); Frequency: 831.5 MHz; Duty Cycle: 1:1  
Medium parameters used:  $f = 831.5 \text{ MHz}$ ;  $\sigma = 0.895 \text{ S/m}$ ;  $\epsilon_r = 42.345$ ;  $\rho = 1000 \text{ kg/m}^3$   
Phantom section: Flat Section

## **DASY5 Configuration:**

Probe: EX3DV4 - SN3866; ConvF(9.2, 9.2, 9.2); Calibrated: 5/27/2020 Electronics: DAE4 Sn1392  
Sensor-Surface: 2mm (Mechanical Surface Detection)  
Phantom: SAM-twin right\_2013\_09\_24; Type: QD000P40CD; Serial: TP:1783  
Measurement SW: DASY52, Version 52.10 (3); SEMCAD X Version 14.6.13 (7474)

Test Date: 2020-09-09; Ambient Temp: 20.8; Tissue Temp: 20.5

**Touch from Body, Left, LTE Band 26 Ch. 26865, Ant Internal**

**Mode : BandWidth 15 MHz, QPSK, RB Size : 1**

**Area Scan (6x15x1):** Measurement grid:  $dx=15\text{mm}$ ,  $dy=15\text{mm}$

**Zoom Scan (5x5x7)/Cube 0:** Measurement grid:  $dx=8\text{mm}$ ,  $dy=8\text{mm}$ ,  $dz=5\text{mm}$

Power Drift = 0.00 dB

Peak SAR (extrapolated) = 3.56 W/kg

**SAR(1 g) = 1.95 W/kg; SAR(10 g) = 1.07 W/kg**

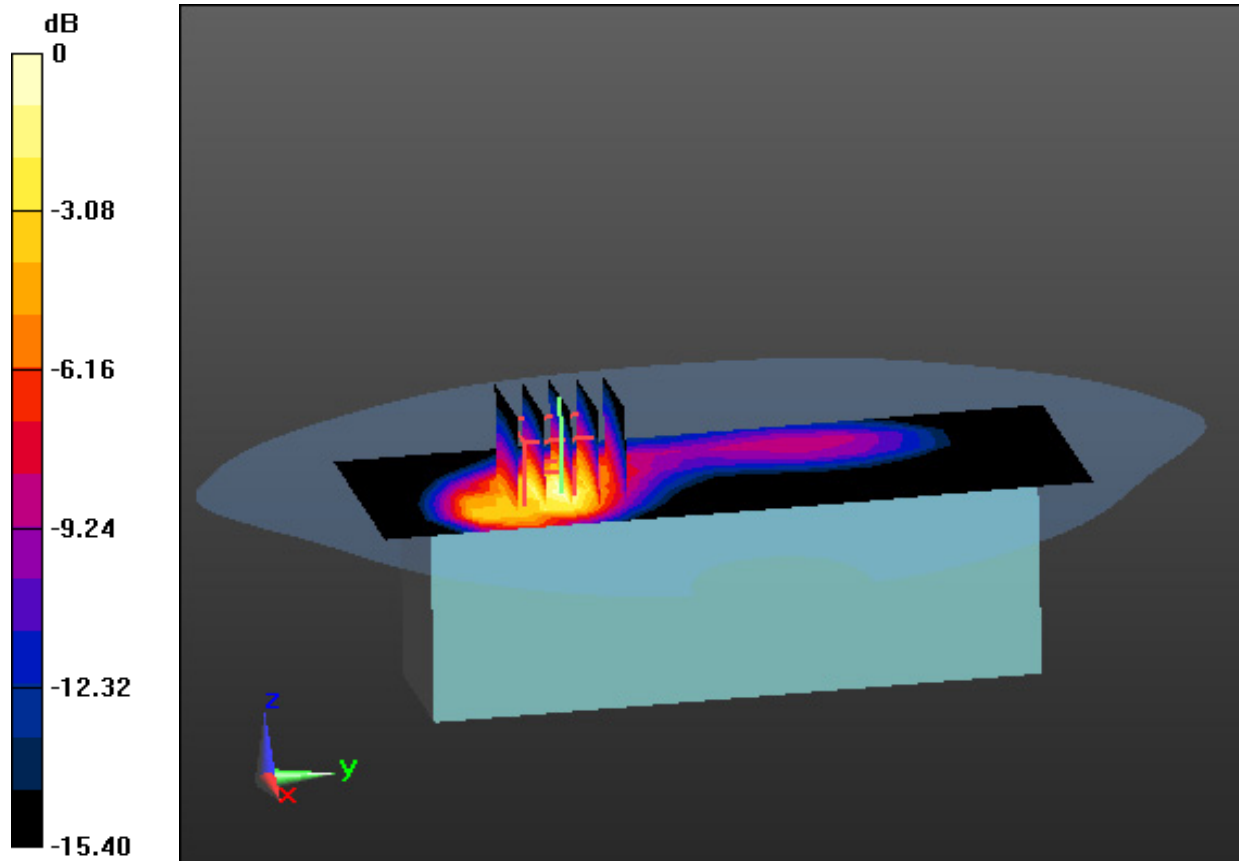

0 dB = 2.72 W/kg

# DT&C Co., Ltd

**DUT: PM500; Type: PDA**

Communication System: UID 0, LTE Band 4 (0); Frequency: 1732.5 MHz; Duty Cycle: 1:1  
Medium parameters used:  $f = 1732.5$  MHz;  $\sigma = 1.348$  S/m;  $\epsilon_r = 41.478$ ;  $\rho = 1000$  kg/m<sup>3</sup>  
Phantom section: Flat Section

## **DASY5 Configuration:**

Probe: EX3DV4 - SN7368; ConvF(8.78, 8.78, 8.78); Calibrated: 1/30/2020 Electronics: DAE4 Sn1335  
Sensor-Surface: 2mm (Mechanical Surface Detection)  
Phantom: SAM with CRP v5.0; Type: QD000P40CD; Serial: TP:1837  
Measurement SW: DASY52, Version 52.10 (3); SEMCAD X Version 14.6.13 (7474)

Test Date: 2020-09-11; Ambient Temp: 21.8; Tissue Temp: 21.6

**Touch from Body, Left, LTE Band 4 Ch. 20175, Ant Internal**

**Mode : BandWidth 20 MHz, QPSK, RB Size : 1**

**Area Scan (6x15x1):** Measurement grid: dx=15mm, dy=15mm

**Zoom Scan (5x5x7)/Cube 0:** Measurement grid: dx=8mm, dy=8mm, dz=5mm

Power Drift = 0.03 dB

Peak SAR (extrapolated) = 13.5 W/kg

**SAR(1 g) = 6.68 W/kg; SAR(10 g) = 3.2 W/kg**

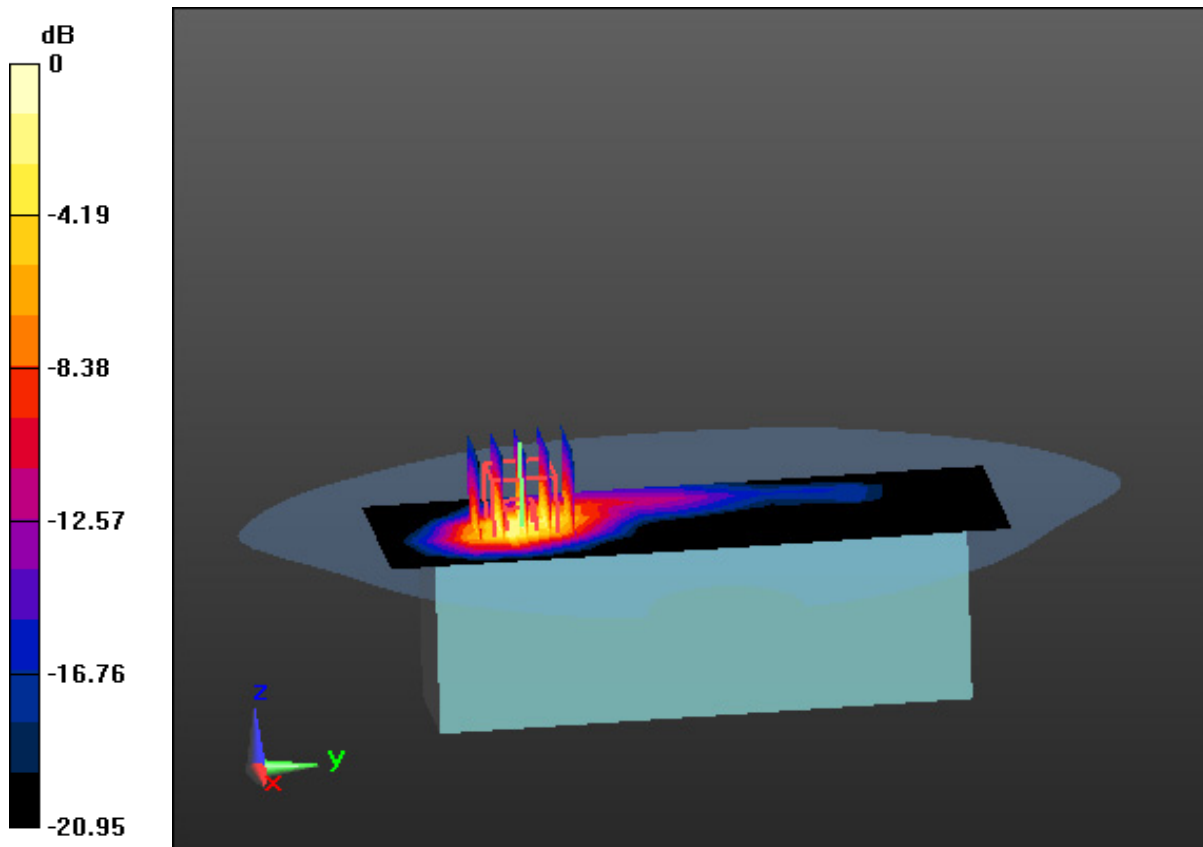

0 dB = 10.2 W/kg

# DT&C Co., Ltd

**DUT: PM500; Type: PDA**

Communication System: UID 0, LTE Band 25 (0); Frequency: 1882.5 MHz; Duty Cycle: 1:1

Medium parameters used:  $f = 1882.5$  MHz;  $\sigma = 1.38$  S/m;  $\epsilon_r = 38.782$ ;  $\rho = 1000$  kg/m<sup>3</sup>

Phantom section: Flat Section

## **DASY5 Configuration:**

Probe: EX3DV4 - SN7368; ConvF(8.43, 8.43, 8.43); Calibrated: 1/30/2020 Electronics: DAE4 Sn1335

Sensor-Surface: 2mm (Mechanical Surface Detection)

Phantom: SAM with CRP v5.0; Type: QD000P40CD; Serial: TP:1837

Measurement SW: DASY52, Version 52.10 (3); SEMCAD X Version 14.6.13 (7474)

Test Date: 2020-09-14; Ambient Temp: 21.2; Tissue Temp: 21.0

**Touch from Body, Left, LTE Band 25 Ch. 26365, Ant Internal**

**Mode : BandWidth 20 MHz, QPSK, RB Size : 1**

**Area Scan (6x15x1):** Measurement grid: dx=15mm, dy=15mm

**Zoom Scan (5x5x7)/Cube 0:** Measurement grid: dx=8mm, dy=8mm, dz=5mm

Power Drift = 0.18 dB

Peak SAR (extrapolated) = 10.1 W/kg

SAR(1 g) = 5.1 W/kg; SAR(10 g) = 2.59 W/kg

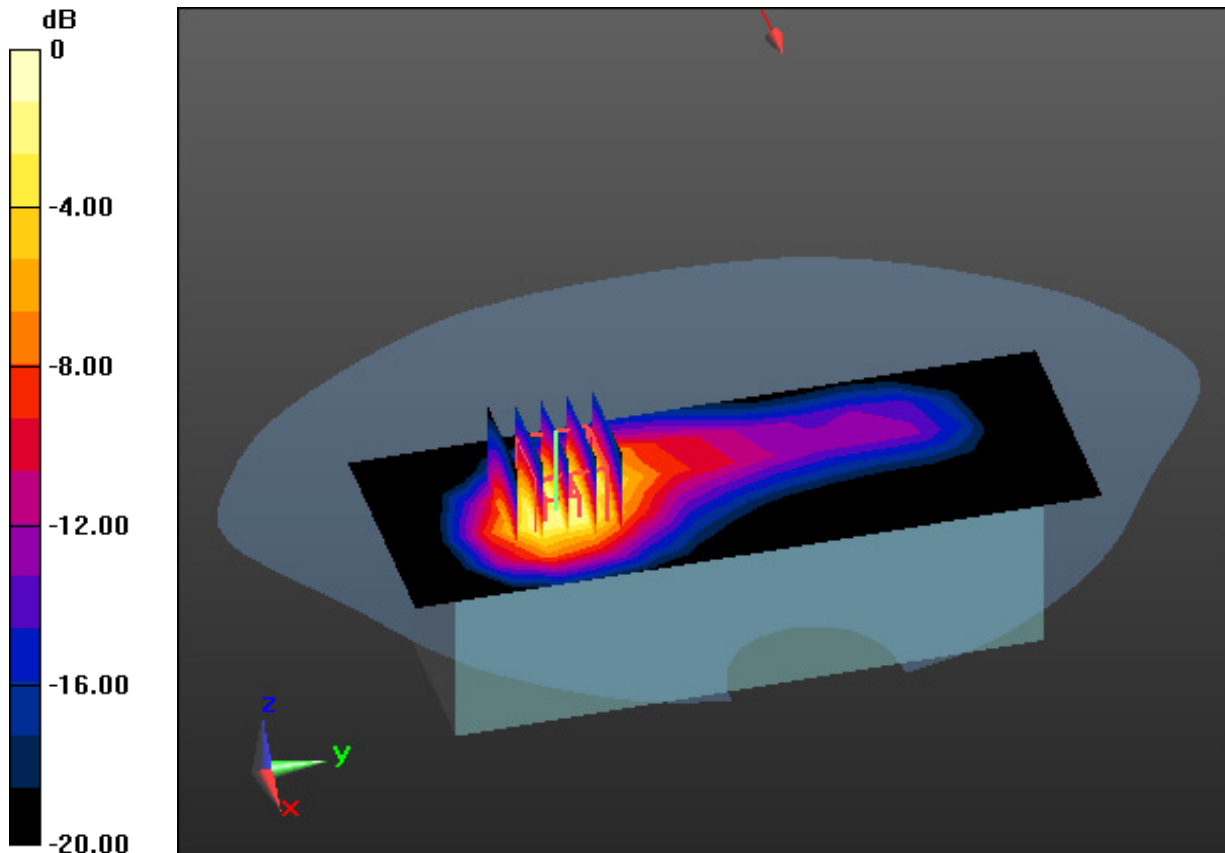

0 dB = 7.43 W/kg

# DT&C Co., Ltd

**DUT: PM500; Type: PDA**

Communication System: UID 0, LTE Band 7 (FCC) (0); Frequency: 2510 MHz; Duty Cycle: 1:1  
Medium parameters used:  $f = 2510$  MHz;  $\sigma = 1.922$  S/m;  $\epsilon_r = 38.518$ ;  $\rho = 1000$  kg/m<sup>3</sup>  
Phantom section: Flat Section

## **DASY5 Configuration:**

Probe: EX3DV4 - SN7368; ConvF(7.44, 7.44, 7.44); Calibrated: 1/30/2020 Electronics: DAE4 Sn1335  
Sensor-Surface: 2mm (Mechanical Surface Detection)  
Phantom: SAM with CRP v5.0; Type: QD000P40CD; Serial: TP:1837  
Measurement SW: DASY52, Version 52.10 (3); SEMCAD X Version 14.6.13 (7474)

Test Date: 2020-09-10; Ambient Temp: 20.9; Tissue Temp: 20.8

**Touch from Body, Left, LTE Band 7 Ch. 21100, Ant Internal**

**Mode : BandWidth 20 MHz, QPSK, RB Size : 1**

**Area Scan (7x19x1):** Measurement grid: dx=12mm, dy=12mm

**Zoom Scan (7x7x7)/Cube 0:** Measurement grid: dx=5mm, dy=5mm, dz=5mm

Power Drift = 0.04 dB

Peak SAR (extrapolated) = 18.0 W/kg

**SAR(1 g) = 7.79 W/kg; SAR(10 g) = 3.44 W/kg**

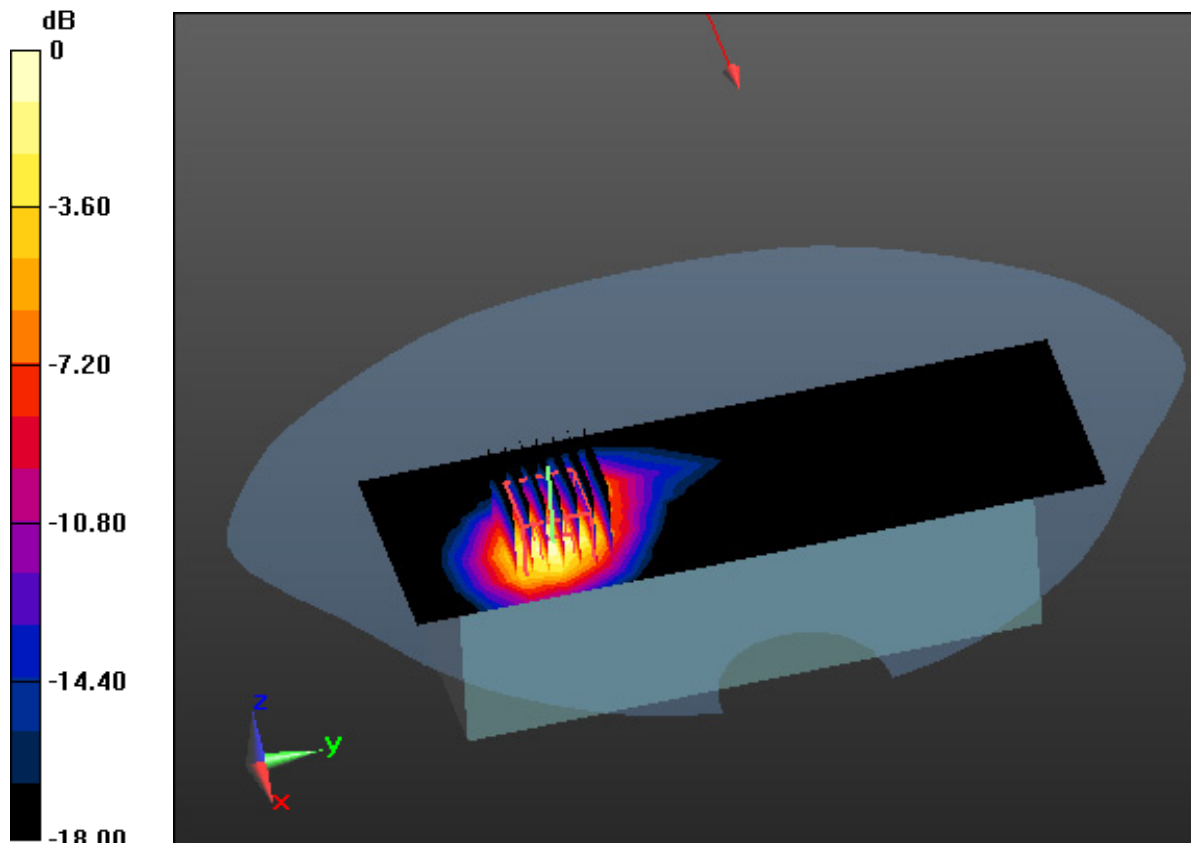

0 dB = 12.5 W/kg

# DT&C Co., Ltd.

**DUT: PM500; Type: PDA**

Communication System: UID 0, W-LAN (0); Frequency: 2412 MHz; Duty Cycle: 1:1  
Medium parameters used:  $f = 2412$  MHz;  $\sigma = 1.765$  S/m;  $\epsilon_r = 40.187$ ;  $\rho = 1000$  kg/m<sup>3</sup>  
Phantom section: Flat Section

## **DASY5 Configuration:**

Probe: EX3DV4 - SN7368; ConvF(7.81, 7.81, 7.81); Calibrated: 1/30/2020 Electronics: DAE4 Sn1335  
Sensor-Surface: 2mm (Mechanical Surface Detection)  
Phantom: SAM with CRP v5.0; Type: QD000P40CD; Serial: TP:1837  
Measurement SW: DASY52, Version 52.10 (3); SEMCAD X Version 14.6.13 (7474)

Test Date: 2020-09-10; Ambient Temp: 20.9; Tissue Temp: 20.8

**Touch from Body, Left, WLAN(802.11b) Ch. 1, Ant Internal**

**Area Scan (7x19x1):** Measurement grid: dx=12mm, dy=12mm

**Zoom Scan (7x7x7)/Cube 0:** Measurement grid: dx=5mm, dy=5mm, dz=5mm

Power Drift = 0.06 dB

Peak SAR (extrapolated) = 2.21 W/kg

**SAR(1 g) = 0.793 W/kg; SAR(10 g) = 0.337 W/kg**

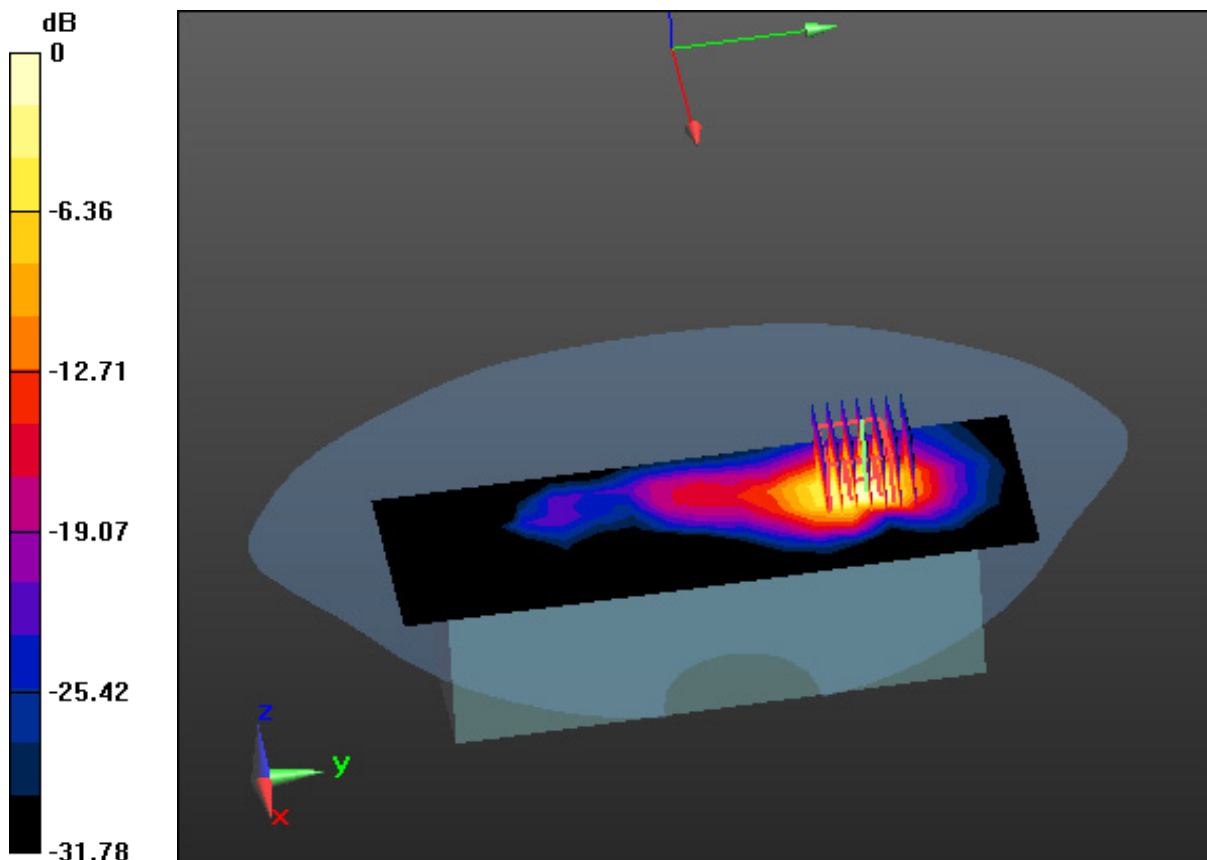

0 dB = 1.25 W/kg

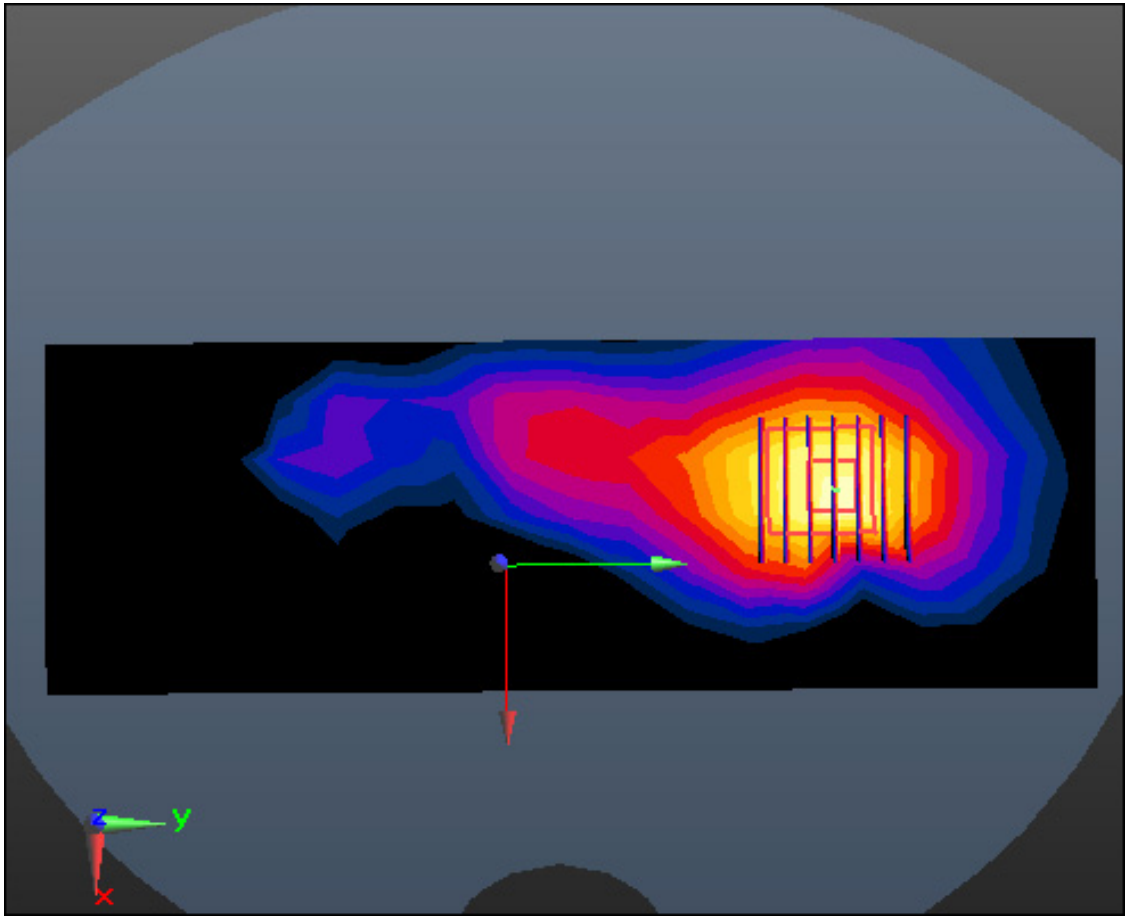

Enlarged Plot for A12

# DT&C Co., Ltd.

**DUT: PM500; Type: PDA**

Communication System: UID 0, W-LAN(5G) (0); Frequency: 5280 MHz; Duty Cycle: 1:1

Medium parameters used:  $f = 5280$  MHz;  $\sigma = 4.863$  S/m;  $\epsilon_r = 36.673$ ;  $\rho = 1000$  kg/m<sup>3</sup>

Phantom section: Flat Section

## **DASY5 Configuration:**

Probe: EX3DV4 - SN7368; ConvF(5.45, 5.45, 5.45); Calibrated: 1/30/2020 Electronics: DAE4 Sn1335

Sensor-Surface: 1.4mm (Mechanical Surface Detection)

Phantom: SAM with CRP v5.0; Type: QD000P40CD; Serial: TP:1837

Measurement SW: DASY52, Version 52.10 (3); SEMCAD X Version 14.6.13 (7474)

Test Date: 2020-09-07; Ambient Temp: 20.6; Tissue Temp: 20.5

**Touch from Body, Rear #5, WLAN(802.11n HT20) Ch. 56, Ant Internal**

**Area Scan (12x14x1):** Measurement grid: dx=10mm, dy=10mm

**Zoom Scan (8x8x7)/Cube 0:** Measurement grid: dx=4mm, dy=4mm, dz=1.4mm, Graded Ratio:1.4

Power Drift = 0.11 dB

Peak SAR (extrapolated) = 0.799 W/kg

**SAR(1 g) = 0.192 W/kg; SAR(10 g) = 0.060 W/kg**

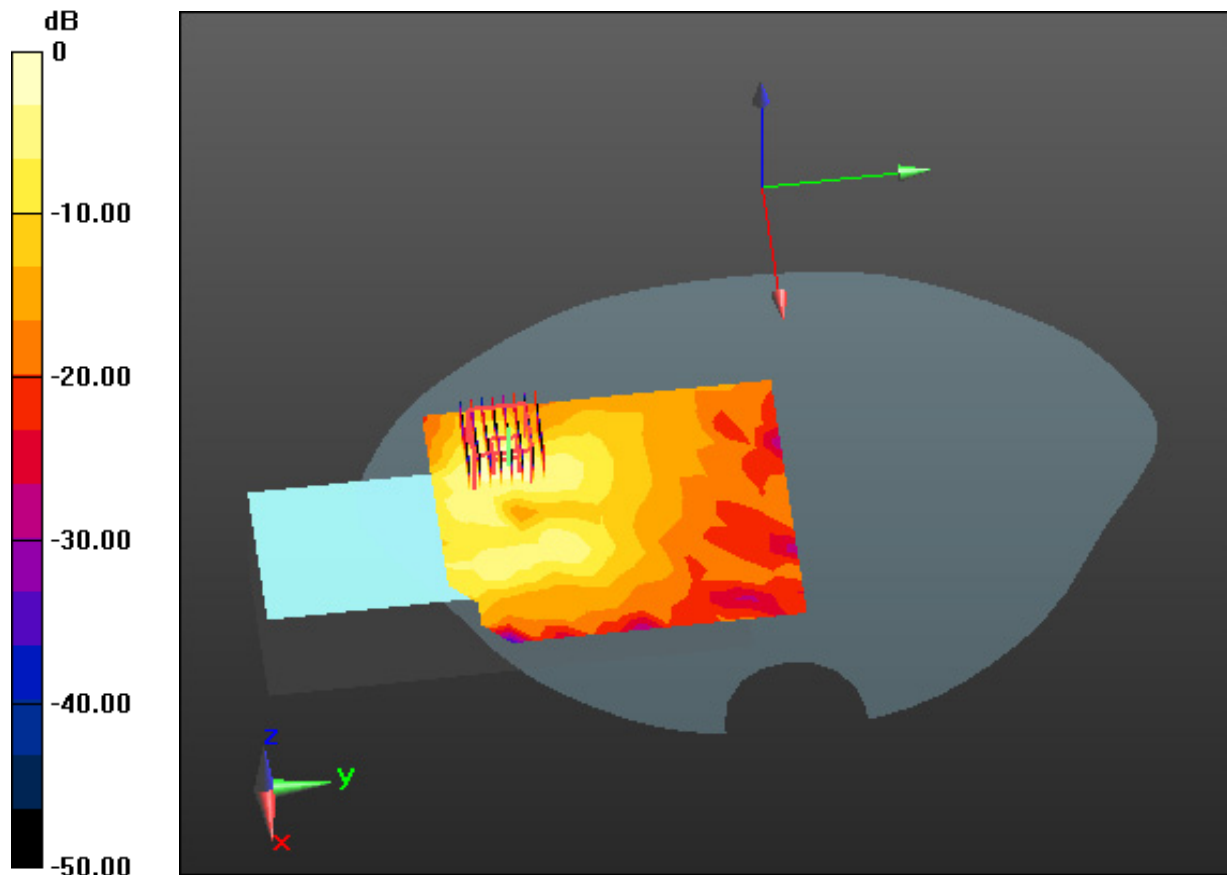

0 dB = 0.466 W/kg



# DT&C Co., Ltd.

**DUT: PM500; Type: PDA**

Communication System: UID 0, W-LAN(5G) (0); Frequency: 5580 MHz; Duty Cycle: 1:1

Medium parameters used:  $f = 5580$  MHz;  $\sigma = 5.208$  S/m;  $\epsilon_r = 36.312$ ;  $\rho = 1000$  kg/m<sup>3</sup>

Phantom section: Flat Section

## **DASY5 Configuration:**

Probe: EX3DV4 - SN7368; ConvF(4.85, 4.85, 4.85); Calibrated: 1/30/2020 Electronics: DAE4 Sn1335

Sensor-Surface: 1.4mm (Mechanical Surface Detection)

Phantom: SAM with CRP v5.0; Type: QD000P40CD; Serial: TP:1837

Measurement SW: DASY52, Version 52.10 (3); SEMCAD X Version 14.6.13 (7474)

Test Date: 2020-09-07; Ambient Temp: 20.6; Tissue Temp: 20.5

## **Touch from Body, Rear #5, WLAN(802.11a) Ch. 116, Ant Internal**

**Area Scan (12x21x1):** Measurement grid: dx=10mm, dy=10mm

**Zoom Scan (8x8x7)/Cube 0:** Measurement grid: dx=4mm, dy=4mm, dz=1.4mm, Graded Ratio:1.4

Power Drift = 0.08 dB

Peak SAR (extrapolated) = 2.05 W/kg

**SAR(1 g) = 0.222 W/kg; SAR(10 g) = 0.062 W/kg**

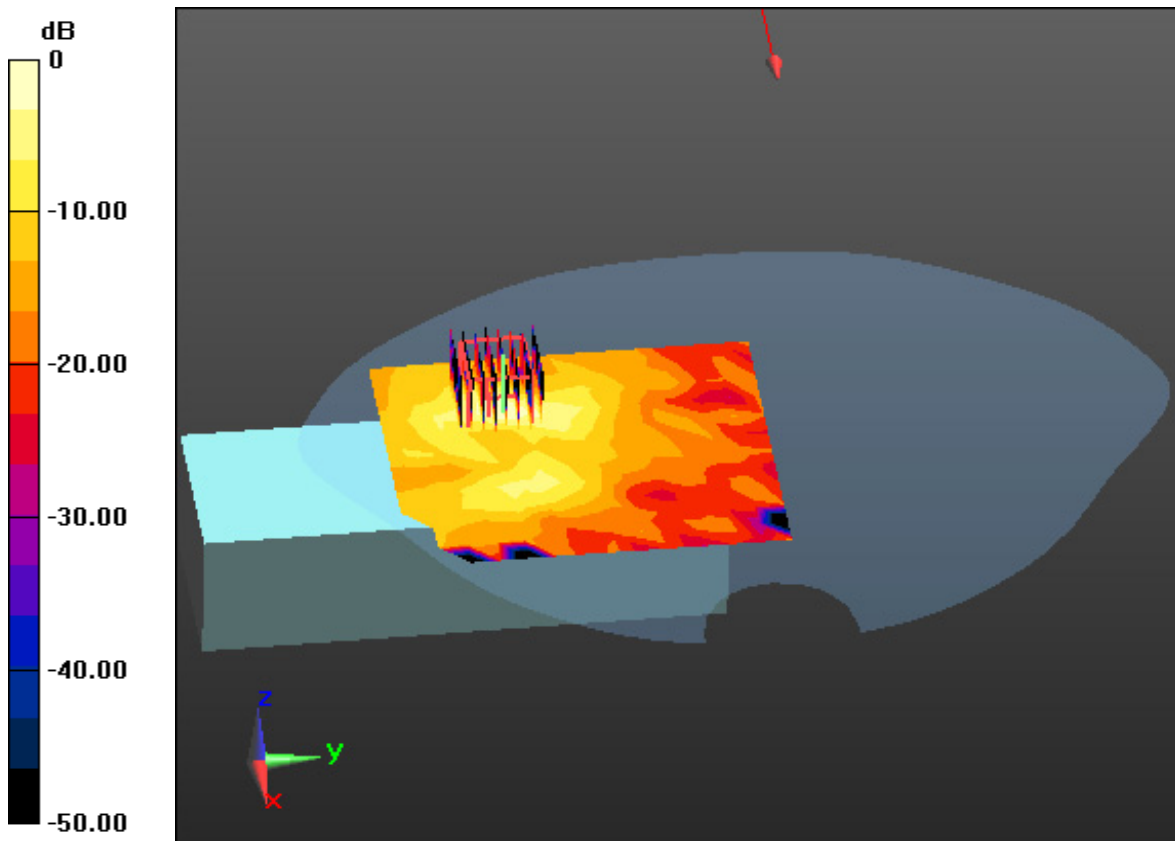

0 dB = 0.563 W/kg

# DT&C Co., Ltd.

**DUT: PM500; Type: PDA**

Communication System: UID 0, W-LAN(5G) (0); Frequency: 5785 MHz; Duty Cycle: 1:1

Medium parameters used:  $f = 5785$  MHz;  $\sigma = 5.388$  S/m;  $\epsilon_r = 35.792$ ;  $\rho = 1000$  kg/m<sup>3</sup>

Phantom section: Flat Section

## **DASY5 Configuration:**

Probe: EX3DV4 - SN7368; ConvF(5.02, 5.02, 5.02); Calibrated: 1/30/2020 Electronics: DAE4 Sn1335

Sensor-Surface: 1.4mm (Mechanical Surface Detection)

Phantom: SAM with CRP v5.0; Type: QD000P40CD; Serial: TP:1837

Measurement SW: DASY52, Version 52.10 (3); SEMCAD X Version 14.6.13 (7474)

Test Date: 2020-09-07; Ambient Temp: 20.6; Tissue Temp: 20.5

**Touch from Body, Rear #5, WLAN(802.11a) Ch. 157, Ant Internal**

**Area Scan (12x14x1):** Measurement grid: dx=10mm, dy=10mm

**Zoom Scan (8x8x7)/Cube 0:** Measurement grid: dx=4mm, dy=4mm, dz=1.4mm, Graded Ratio:1.4

Power Drift = 0.11 dB

Peak SAR (extrapolated) = 0.962 W/kg

**SAR(1 g) = 0.231 W/kg; SAR(10 g) = 0.072 W/kg**

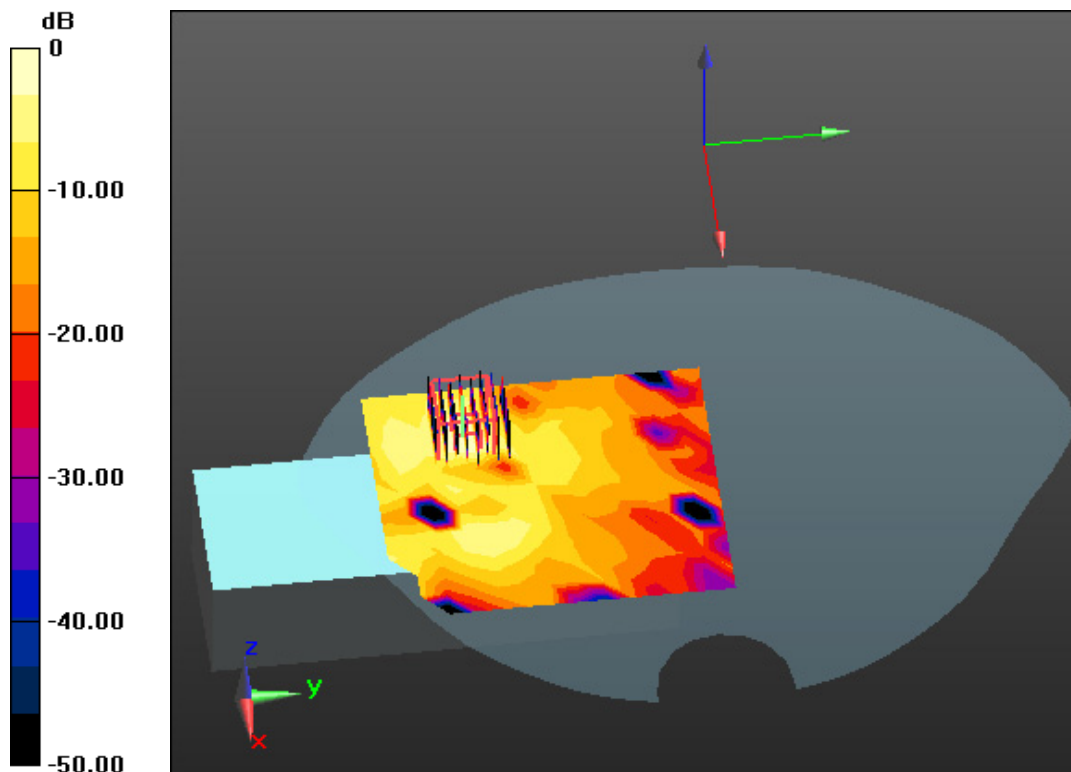

0 dB = 0.562 W/kg

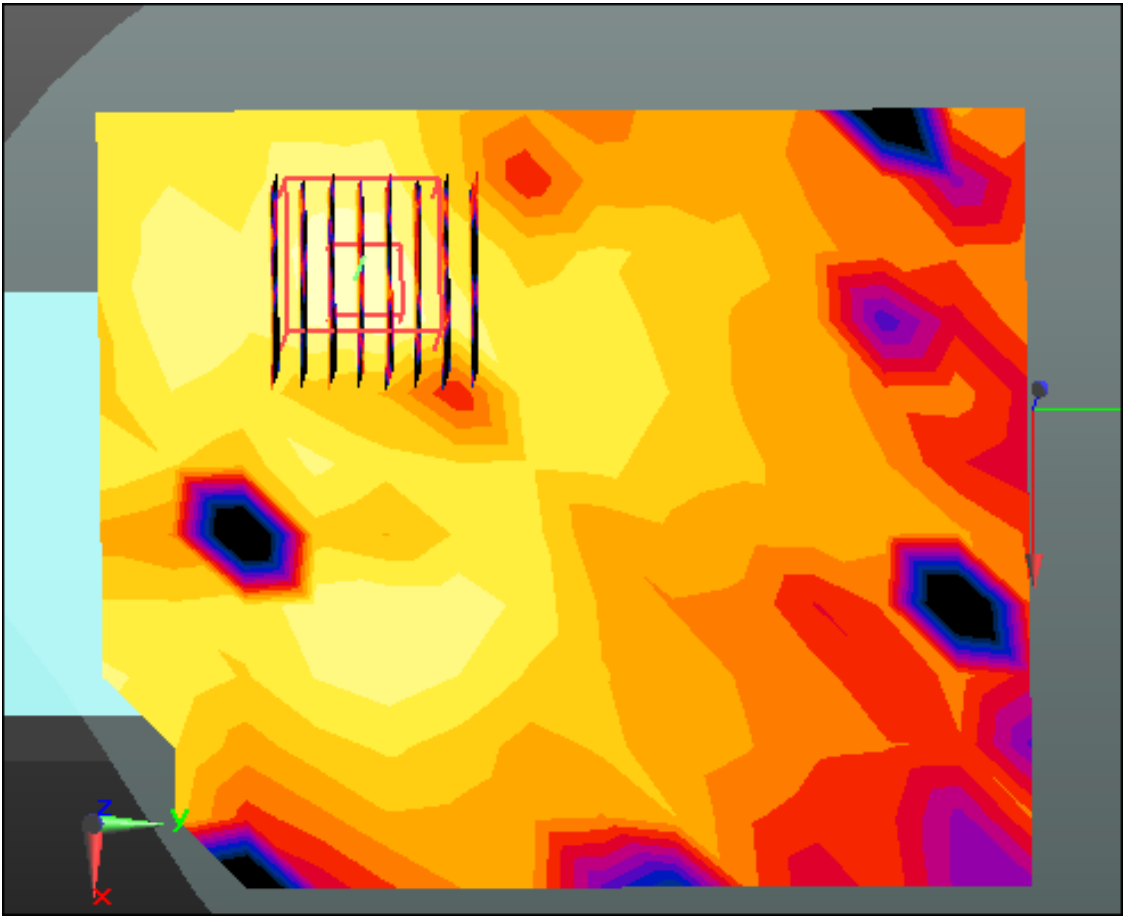

Enlarged Plot for A15

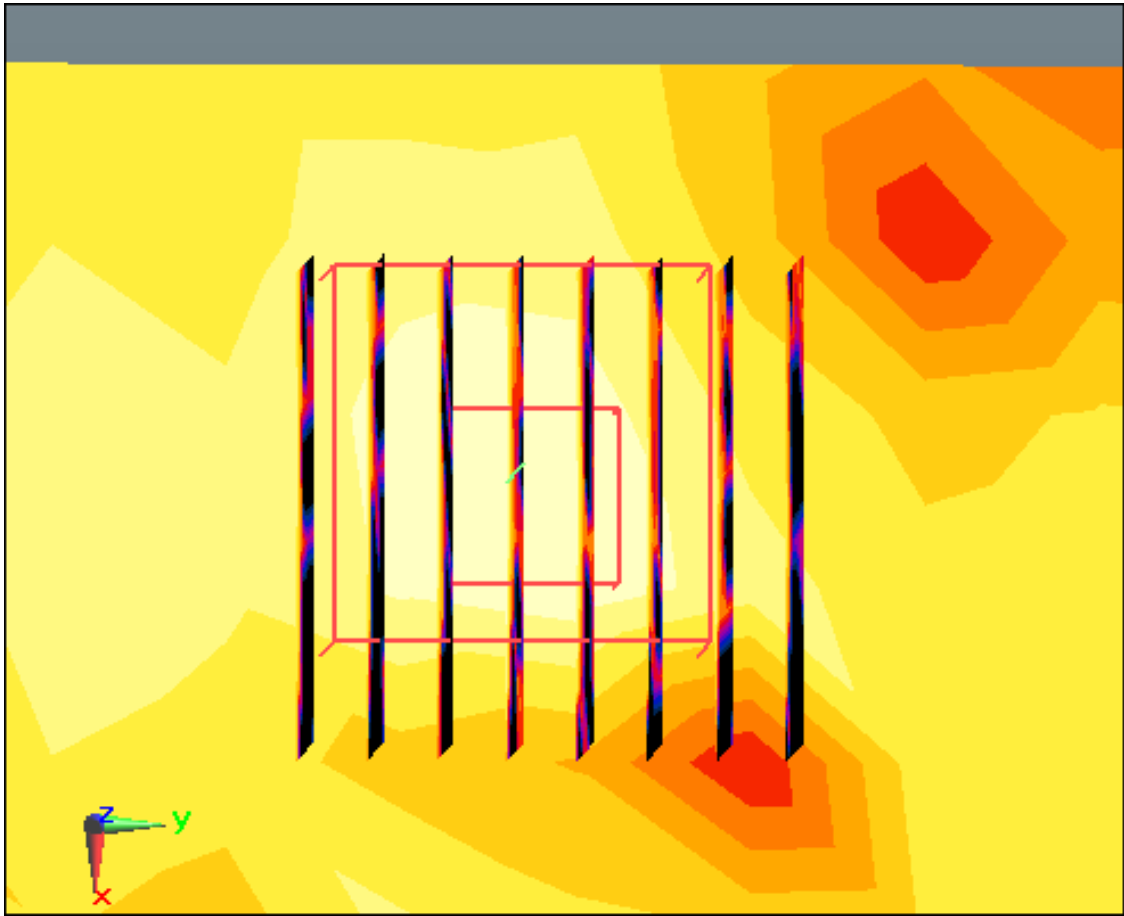

Enlarged Plot for A15

# DT&C Co., Ltd.

**DUT: PM500; Type: PDA**

Communication System: UID 0, Bluetooth (0); Frequency: 2441 MHz; Duty Cycle: 1:1.302

Medium parameters used:  $f = 2441$  MHz;  $\sigma = 1.799$  S/m;  $\epsilon_r = 40.109$ ;  $\rho = 1000$  kg/m<sup>3</sup>

Phantom section: Flat Section

## **DASY5 Configuration:**

Probe: EX3DV4 - SN7368; ConvF(7.81, 7.81, 7.81); Calibrated: 1/30/2020 Electronics: DAE4 Sn1335

Sensor-Surface: 2mm (Mechanical Surface Detection)

Phantom: SAM with CRP v5.0; Type: QD000P40CD; Serial: TP:1837

Measurement SW: DASY52, Version 52.10 (3); SEMCAD X Version 14.6.13 (7474)

Test Date: 2020-09-10; Ambient Temp: 20.9; Tissue Temp: 20.8

## **Touch from Body, Left, Bluetooth 1Mbps Ch. 39, Ant Internal**

**Area Scan (7x19x1):** Measurement grid: dx=12mm, dy=12mm

**Zoom Scan (7x7x7)/Cube 0:** Measurement grid: dx=5mm, dy=5mm, dz=5mm

Power Drift = -0.07 dB

Peak SAR (extrapolated) = 0.123 W/kg

**SAR(1 g) = 0.057 W/kg; SAR(10 g) = 0.026 W/kg**

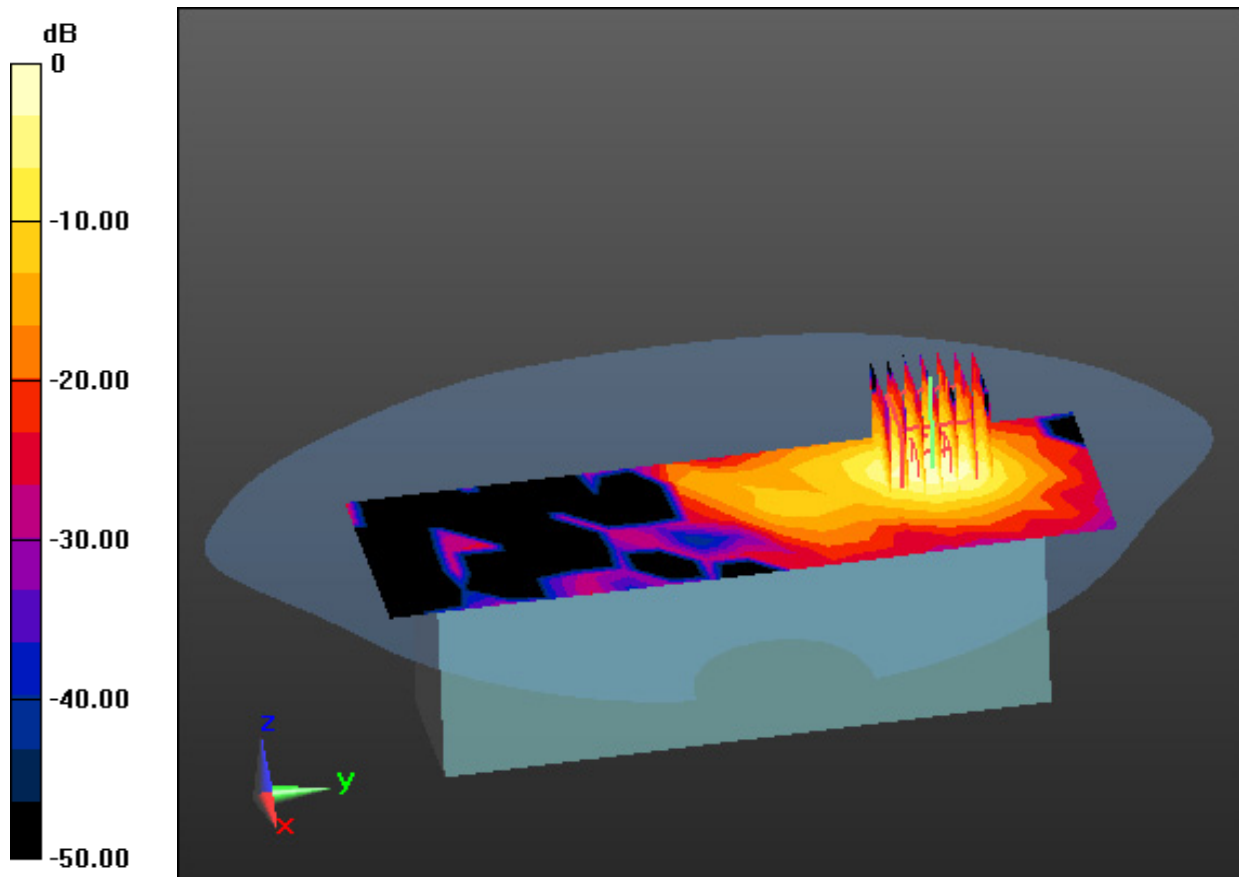

0 dB = 0.0879 W/kg