

# FCC&IC Radio Test Report

**FCC ID: UZZWB9805B1**

**IC: 7633A-WB9805B1**

This report concerns (check one):  Original Grant  Class II Change

**Project No.** : 1506C193  
**Equipment** : Bluetooth Module  
**Model Name** : WB-9805B1  
**Applicant** : Beautiful Enterprise Co., Ltd.  
**Address** : 27th Floor, Beautiful Group Tower, 77 Connaught Road Central, Hong Kong

**Date of Receipt** : Jun. 18, 2015  
**Date of Test** : Jun. 18, 2015 ~ Jul. 05, 2015  
**Issued Date** : Jul. 06, 2015  
**Tested by** : BTL Inc.

**Testing Engineer** : David Mao  
(David Mao)

**Technical Manager** : Leo Hung  
(Leo Hung)

**Authorized Signatory** : Steven Lu  
(Steven Lu)

## **B T L I N C .**

No.3, Jinshagang 1st Road, Shixia, Dalang Town, Dongguan,  
Guangdong, China.

TEL: +86-769-8318-3000 FAX: +86-769-8319-6000

### **Declaration**

**BTL** represents to the client that testing is done in accordance with standard procedures as applicable and that test instruments used has been calibrated with the standards traceable to National Measurement Laboratory (**NML**) of **CHINA**, or National Institute of Standards and Technology (**NIST**) of **U.S.A.**

**BTL's** reports apply only to the specific samples tested under conditions. It is manufacture's responsibility to ensure that additional production units of this model are manufactured with the identical electrical and mechanical components. **BTL** shall have no liability for any declarations, inferences or generalizations drawn by the client or others from **BTL** issued reports.

**BTL's** report must not be used by the client to claim product certification, approval, or endorsement by NVLAP, NIST, or any agency of the Federal Government.

This report is the confidential property of the client. As a mutual protection to the clients, the public and **BTL-self**, extracts from the test report shall not be reproduced except in full with **BTL's** authorized written approval.

**BTL's** laboratory quality assurance procedures are in compliance with the **ISO Guide 17025** requirements, and accredited by the conformity assessment authorities listed in this test report.

### **Limitation**

For the use of the authority's logo is limited unless the Test Standard(s)/Scope(s)/Item(s) mentioned in this test report is (are) included in the conformity assessment authorities acceptance respective.

<b>Table of Contents</b>	<b>Page</b>
<b>1 . CERTIFICATION</b>	<b>7</b>
<b>2 . SUMMARY OF TEST RESULTS</b>	<b>8</b>
2.1 TEST FACILITY	9
2.2 MEASUREMENT UNCERTAINTY	9
<b>3 . GENERAL INFORMATION</b>	<b>10</b>
3.1 GENERAL DESCRIPTION OF EUT	10
3.2 DESCRIPTION OF TEST MODES	12
3.3 TABLE OF PARAMETERS OF TEXT SOFTWARE SETTING	12
3.4 BLOCK DIAGRAM SHOWING THE CONFIGURATION OF SYSTEM TESTED	13
3.5 DESCRIPTION OF SUPPORT UNITS	13
<b>4 . EMC EMISSION TEST</b>	<b>14</b>
4.1 CONDUCTED EMISSION MEASUREMENT	14
4.1.1 POWER LINE CONDUCTED EMISSION LIMITS	14
4.1.2 TEST PROCEDURE	14
4.1.3 DEVIATION FROM TEST STANDARD	14
4.1.4 TEST SETUP	15
4.1.5 EUT OPERATING CONDITIONS	15
4.1.6 EUT TEST CONDITIONS	15
4.1.7 TEST RESULTS	15
4.2 RADIATED EMISSION MEASUREMENT	16
4.2.1 RADIATED EMISSION LIMITS	16
4.2.2 TEST PROCEDURE	17
4.2.3 DEVIATION FROM TEST STANDARD	17
4.2.4 TEST SETUP	18
4.2.5 EUT OPERATING CONDITIONS	19
4.2.6 EUT TEST CONDITIONS	19
4.2.7 TEST RESULTS (9KHZ TO 30MHZ)	19
4.2.8 TEST RESULTS (30MHZ TO 1000 MHZ)	20
4.2.9 TEST RESULTS (ABOVE 1000 MHZ)	20
<b>5 . NUMBER OF HOPPING CHANNEL</b>	<b>21</b>
5.1 APPLIED PROCEDURES	21
5.1.1 TEST PROCEDURE	21
5.1.2 DEVIATION FROM STANDARD	21
5.1.3 TEST SETUP	21
5.1.4 EUT OPERATION CONDITIONS	21
5.1.5 EUT TEST CONDITIONS	21
5.1.6 TEST RESULTS	21

<b>Table of Contents</b>	<b>Page</b>
<b>6 . AVERAGE TIME OF OCCUPANCY</b>	<b>22</b>
<b>6.1 APPLIED PROCEDURES / LIMIT</b>	<b>22</b>
6.1.1 TEST PROCEDURE	22
6.1.2 DEVIATION FROM STANDARD	22
6.1.3 TEST SETUP	22
6.1.4 EUT OPERATION CONDITIONS	23
6.1.5 EUT TEST CONDITIONS	23
6.1.6 TEST RESULTS	23
<b>7 . HOPPING CHANNEL SEPARATION MEASUREMENT</b>	<b>24</b>
<b>7.1 APPLIED PROCEDURES / LIMIT</b>	<b>24</b>
7.1.1 TEST PROCEDURE	24
7.1.2 DEVIATION FROM STANDARD	24
7.1.3 TEST SETUP	24
7.1.4 EUT TEST CONDITIONS	24
7.1.5 TEST RESULTS	24
<b>8 . BANDWIDTH TEST</b>	<b>25</b>
<b>8.1 APPLIED PROCEDURES</b>	<b>25</b>
8.1.1 TEST PROCEDURE	25
8.1.2 DEVIATION FROM STANDARD	25
8.1.3 TEST SETUP	25
8.1.4 EUT OPERATION CONDITIONS	25
8.1.5 EUT TEST CONDITIONS	25
8.1.6 TEST RESULTS	25
<b>9 . PEAK OUTPUT POWER TEST</b>	<b>26</b>
<b>9.1 APPLIED PROCEDURES / LIMIT</b>	<b>26</b>
9.1.1 TEST PROCEDURE	26
9.1.2 DEVIATION FROM STANDARD	26
9.1.3 TEST SETUP	26
9.1.4 EUT OPERATION CONDITIONS	26
9.1.5 EUT TEST CONDITIONS	26
9.1.6 TEST RESULTS	26
<b>10 . ANTENNA CONDUCTED SPURIOUS EMISSION</b>	<b>27</b>
<b>10.1 APPLIED PROCEDURES / LIMIT</b>	<b>27</b>
10.1.1 TEST PROCEDURE	27
10.1.2 DEVIATION FROM STANDARD	27
10.1.3 TEST SETUP	27
10.1.4 EUT OPERATION CONDITIONS	27
10.1.5 EUT TEST CONDITIONS	27
10.1.6 TEST RESULTS	27
<b>11 . MEASUREMENT INSTRUMENTS LIST</b>	<b>28</b>

<b>Table of Contents</b>	<b>Page</b>
<b>12 . EUT TEST PHOTO</b>	<b>30</b>
<b>ATTACHMENT A - CONDUCTED EMISSION</b>	<b>34</b>
<b>ATTACHMENT B - RADIATED EMISSION (9KHZ-30MHZ)</b>	<b>37</b>
<b>ATTACHMENT C - RADIATED EMISSION (30MHZ TO 1000MHZ)</b>	<b>39</b>
<b>ATTACHMENT D - RADIATED EMISSION (ABOVE 1000MHZ)</b>	<b>52</b>
<b>ATTACHMENT E - NUMBER OF HOPPING CHANNEL</b>	<b>77</b>
<b>ATTACHMENT F - AVERAGE TIME OF OCCUPANCY</b>	<b>79</b>
<b>ATTACHMENT G - HOPPING CHANNEL SEPARATION MEASUREMENT</b>	<b>92</b>
<b>ATTACHMENT H - BANDWIDTH</b>	<b>97</b>
<b>ATTACHMENT I - PEAK OUTPUT POWER</b>	<b>102</b>
<b>ATTACHMENT J - ANTENNA CONDUCTED SPURIOUS EMISSION</b>	<b>107</b>

### REPORT ISSUED HISTORY

Issued No.	Description	Issued Date
BTL-FICP-1-1506C193	Original Issue.	Jul. 06, 2015

## 1. CERTIFICATION

Equipment : Bluetooth Module  
Brand Name : YAMAHA  
Model Name : WB-9805B1  
Applicant : Beautiful Enterprise Co., Ltd.  
Manufacturer : Beautiful Enterprise Co., Ltd.  
Address : 27th Floor, Beautiful Group Tower, 77 Connaught Road Central, Hong Kong  
Factory : Shenzhen Synchron Electronics Co., Ltd.  
1) No. 9 Mei Li Road, Xia Mei Lin, Fu Tian Area, Shenzhen, Guangdong, China  
Address : 2) No.1 building, Xia Mei Lin Industrial Park, Fu Tian Area, Shenzhen,  
Guangdong, China  
Date of Test : Jun. 18, 2015 ~ Jul. 05, 2015  
Test Sample : Engineering Sample  
Standard(s) : FCC Part15, Subpart C : 2014 (15.247)/ ANSI C63.10-2013/  
FCC Public Notice DA 00-705, March 30, 2000.  
RSS-247 Issue 1, May 2015  
RSS-GEN Issue 4, Nov 2014

The above equipment has been tested and found compliance with the requirement of the relative standards by BTL Inc.

The test data, data evaluation, and equipment configuration contained in our test report (Ref No. BTL-FICP-1-1506C193) were obtained utilizing the test procedures, test instruments, test sites that has been accredited by the Authority of TAF according to the ISO-17025 quality assessment standard and technical standard(s).

## 2. SUMMARY OF TEST RESULTS

Test procedures according to the technical standard(s):

Applied Standard(s): 47 CFR Part 15, Subpart C: 2014; RSS-247 Issue 1, May 2015; RSS-GEN Issue 4, Nov 2014				
Standard(s) Section		Test Item	Judgment	Remark
FCC	IC			
15.207	RSS-GEN 8.8	Conducted Emission	PASS	
15.247(d)	RSS-247 5.5	Antenna conducted Spurious Emission	PASS	
15.247 (a)(1)	RSS-247 5.1 (2)	Hopping Channel Separation	PASS	
15.247(a)(1)	RSS-247 5.1 (1)	Bandwidth	PASS	
15.247 (b)(1)	RSS-247 5.4 (2)	Peak Output Power	PASS	
15.247(d) 15.209	RSS-247 5.5	Radiated Spurious Emission	PASS	
15.247 (a)(1)(iii)	RSS-247 5.1 (4)	Number of Hopping Frequency	PASS	
15.247 (a)(1)(iii)	RSS-247 5.1 (4)	Dwell Time	PASS	
15.205	RSS-GEN 8.10	Restricted Bands	PASS	
15.203	-	Antenna Requirement	PASS	

Note:

- (1) "N/A" denotes test is not applicable in this test report
- (2) According to FCC Public Notice DA 00-705, March 30, 2000.



## 2.1 TEST FACILITY

The test facilities used to collect the test data in this report is at the location of No.3, Jinshagang 1st Road, Shixia, Dalang Town, Dongguan, Guangdong, China.

BTL's test firm number for FCC: 319330

BTL's test firm number for IC: 4428B-1

## 2.2 MEASUREMENT UNCERTAINTY

Where relevant, the following measurement uncertainty levels have been estimated for tests performed on the EUT as specified in CISPR 16-4-2. The measurement instrumentation uncertainty considerations contained in CISPR 16-4-2.

The reported uncertainty of measurement  $y \pm U$ , where expanded uncertainty  $U$  is based on a standard uncertainty multiplied by a coverage factor of  $k=2$ , providing a level of confidence of approximately **95 %**.

### A. Conducted Measurement :

Test Site	Method	Measurement Frequency Range	U, (dB)	Note
DG-C02	CISPR	150 KHz ~ 30MHz	2.32	

### B. Radiated Measurement :

Test Site	Method	Measurement Frequency Range	Ant. H / V	U, (dB)	Note
DG-CB03	CISPR	9KHz~30MHz	V	3.79	
		9KHz~30MHz	H	3.57	
		30MHz ~ 200MHz	V	3.82	
		30MHz ~ 200MHz	H	3.60	
		200MHz ~ 1,000MHz	V	3.86	
		200MHz ~ 1,000MHz	H	3.94	
		1GHz~18GHz	V	3.12	
		1GHz~18GHz	H	3.68	
		18GHz~40GHz	V	4.15	
		18GHz~40GHz	H	4.14	

Note: Unless specifically mentioned, the uncertainty of measurement has not been taken into account to declare the compliance or non-compliance to the specification.

### 3. GENERAL INFORMATION

#### 3.1 GENERAL DESCRIPTION OF EUT

Equipment	Bluetooth Module	
Brand Name	YAMAHA	
Model Name	WB-9805B1	
Model Difference	N/A	
Output Power (Max.)	Operation Frequency	2402~2480 MHz
	Modulation Technology	GFSK(1Mbps) $\pi/4$ -DQPSK(2Mbps)
	Bit Rate of Transmitter	8-DPSK(3Mbps)
	Output Power Max.	2.14 dBm(1Mbps) 2.42 dBm(3Mbps)
Power Source	Supplied from system.	
Power Rating	DC 5V	

Note:

1. For a more detailed features description, please refer to the manufacturer's specifications or the user's manual.

## 2. Channel List:

Channel	Frequency (MHz)	Channel	Frequency (MHz)	Channel	Frequency (MHz)
00	2402	27	2429	54	2456
01	2403	28	2430	55	2457
02	2404	29	2431	56	2458
03	2405	30	2432	57	2459
04	2406	31	2433	58	2460
05	2407	32	2434	59	2461
06	2408	33	2435	60	2462
07	2409	34	2436	61	2463
08	2410	35	2437	62	2464
09	2411	36	2438	63	2465
10	2412	37	2439	64	2466
11	2413	38	2440	65	2467
12	2414	39	2441	66	2468
13	2415	40	2442	67	2469
14	2416	41	2443	68	2470
15	2417	42	2444	69	2471
16	2418	43	2445	70	2472
17	2419	44	2446	71	2473
18	2420	45	2447	72	2474
19	2421	46	2448	73	2475
20	2422	47	2449	74	2476
21	2423	48	2450	75	2477
22	2424	49	2451	76	2478
23	2425	50	2452	77	2479
24	2426	51	2453	78	2480
25	2427	52	2454		
26	2428	53	2455		

## 3 Table for Filed Antenna

Ant.	Brand	Model Name	Antenna Type	Connector	Gain (dBi)
1	N/A	N/A	Printed	N/A	1.84

### 3.2 DESCRIPTION OF TEST MODES

To investigate the maximum EMI emission characteristics generates from EUT, the test system was pre-scanning tested base on the consideration of following EUT operation mode or test configuration mode which possible have effect on EMI emission level. Each of these EUT operation mode(s) or test configuration mode(s) mentioned above was evaluated respectively.

Pretest Mode	Description
Mode 1	TX Mode <b>Note (1)</b>

The EUT system operated these modes were found to be the worst case during the pre-scanning test as following:

For Conducted Emission	
Final Test Mode	Description
Mode 1	TX Mode

For Radiated Emission	
Final Test Mode	Description
Mode 1	TX Mode <b>Note (1)</b>

**Note:**

- (1) The measurements are performed at the high, middle, low available channels.
- (2) The measurements for Hopping Channel Separation, Bandwidth and Peak Output Power were tested during 1Mbps, 2Mbps and 3Mbps, the worst case are 1Mbps and 3Mbps, only worst case was documented.

### 3.3 TABLE OF PARAMETERS OF TEXT SOFTWARE SETTING

During testing, channel & power controlling software provided by the customer was used to control the operating channel as well as the output power level. The RF output power selection is for the setting of RF output power expected by the customer and is going to be fixed on the firmware of the final end product power parameters of FHSS

1Mbps

Test Software Version	RTK_BT_MP		
Frequency (MHz)	2402	2441	2480
Parameters	5	5	5

3Mbps

Test Software Version	RTK_BT_MP		
Frequency (MHz)	2402	2441	2480
Parameters	6	6	6

### 3.4 BLOCK DIAGRAM SHOWING THE CONFIGURATION OF SYSTEM TESTED

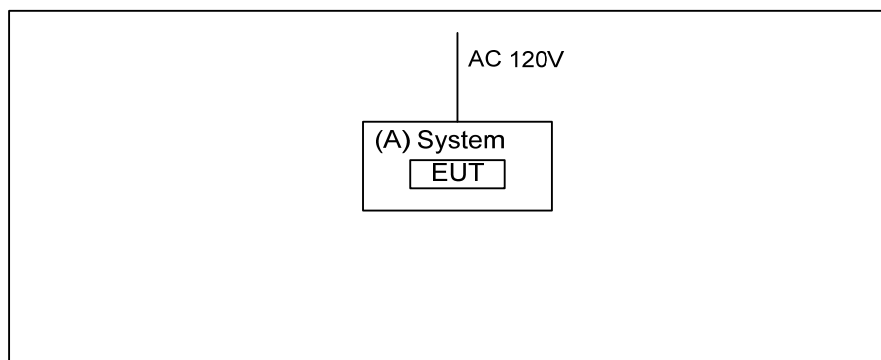

### 3.5 DESCRIPTION OF SUPPORT UNITS

The EUT has been tested as an independent unit together with other necessary accessories or support units. The following support units or accessories were used to form a representative test configuration during the tests.

Item	Equipment	Mfr/Brand	Model/Type No.	FCC ID	Series No.	Note
A	MICRO COMPONENT SYSTEM	YAMAHA	MCR-B020	VER	N/A	

Item	Shielded Type	Ferrite Core	Length	Note
-	-	-	-	

## 4. EMC EMISSION TEST

### 4.1 CONDUCTED EMISSION MEASUREMENT

#### 4.1.1 POWER LINE CONDUCTED EMISSION LIMITS (Frequency Range 150KHz-30MHz)

Frequency of Emission (MHz)	Conducted Limit (dB $\mu$ V)	
	Quasi-peak	Average
0.15 -0.	66 to 56*	56 to 46*
0.50 -5.0	56	46
5.0 -30.0	60	50

Note:

- (1) The limit of " \* " decreases with the logarithm of the frequency
- (2) The test result calculated as following:  
 Measurement Value = Reading Level + Correct Factor  
 Correct Factor = Insertion Loss + Cable Loss + Attenuator Factor(if use)  
 Margin Level = Measurement Value - Limit Value

The following table is the setting of the receiver

Receiver Parameters	Setting
Attenuation	10 dB
Start Frequency	0.15 MHz
Stop Frequency	30 MHz
IF Bandwidth	9 KHz

#### 4.1.2 TEST PROCEDURE

- a. The EUT was placed 0.8 meters from the horizontal ground plane with EUT being connected to the power mains through a line impedance stabilization network (LISN). All other support equipment powered from additional LISN(s). The LISN provide 50 Ohm/ 50uH of coupling impedance for the measuring instrument.
- b. Interconnecting cables that hang closer than 40 cm to the ground plane shall be folded back and forth in the center forming a bundle 30 to 40 cm long.
- c. I/O cables that are not connected to a peripheral shall be bundled in the center. The end of the cable may be terminated, if required, using the correct terminating impedance. The overall length shall not exceed 1 m.
- d. LISN at least 80 cm from nearest part of EUT chassis.
- e. For the actual test configuration, please refer to the related Item –EUT Test Photos.

#### 4.1.3 DEVIATION FROM TEST STANDARD

No deviation

#### 4.1.4 TEST SETUP

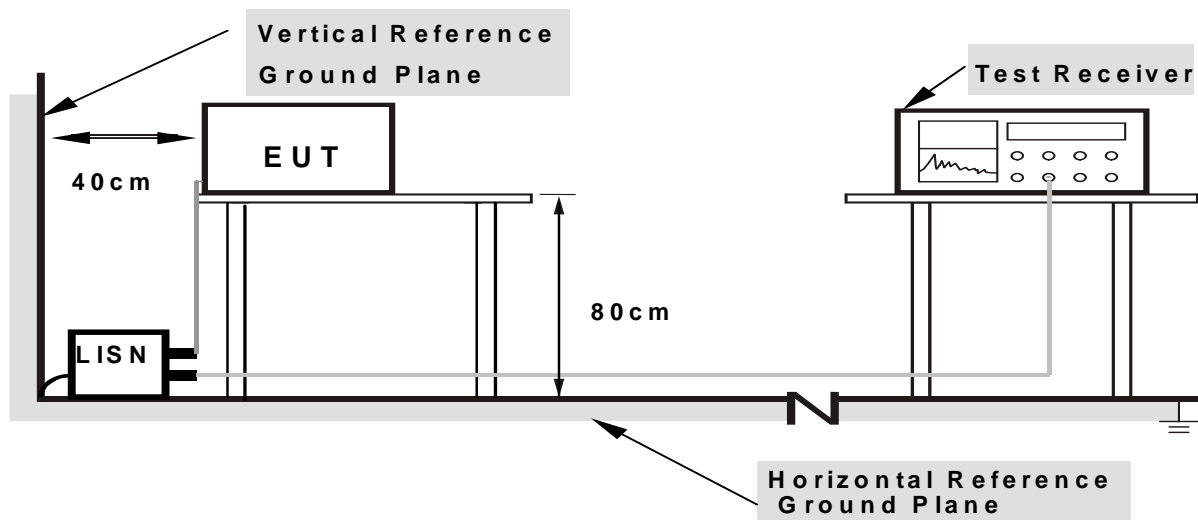

- Note:**
1. Support units were connected to second LISN.
  2. Both of LISNs (AMN) are 80 cm from EUT and at least 80 from other units and other metal planes

#### 4.1.5 EUT OPERATING CONDITIONS

The EUT was configured for testing in a typical function (as a customer would normally use it), EUT was programmed to be in continuously transmitting/receiving data or hopping on mode.

#### 4.1.6 EUT TEST CONDITIONS

Temperature: 26° C  
 Relative Humidity: 60%  
 Test Voltage: AC 120V/60Hz

#### 4.1.7 TEST RESULTS

Please refer to the Attachment A.

Remark:

- (1) All readings are QP Mode value unless otherwise stated AVG in column of 'Note'. If the QP Mode Measured value compliance with the QP Limits and lower than AVG Limits, the EUT shall be deemed to meet both QP & AVG Limits and then only QP Mode was measured, but AVG Mode didn't perform in this case, a "\*" marked in AVG Mode column of Interference Voltage Measured.
- (2) Measuring frequency range from 150KHz to 30MHz.

## 4.2 RADIATED EMISSION MEASUREMENT

### 4.2.1 RADIATED EMISSION LIMITS (Frequency Range 9KHz -1000MHz)

20dB in any 100 KHz bandwidth outside the operating frequency band. In case the emission fall within the restricted band specified on 15.205(a) & RSS-247 5.5, then the 15.209(a) & RSS-Gen limit in the table below has to be followed.

Frequency (MHz)	Field Strength (microvolts/meter)	Measurement Distance (meters)
0.009~0.490	2400/F(KHz)	300
0.490~1.705	24000/F(KHz)	30
1.705~30.0	30	30
30~88	100	3
88~216	150	3
216~960	200	3
960~1000	500	3

### LIMITS OF RADIATED EMISSION MEASUREMENT (Above 1000MHz)

Frequency (MHz)	dB(uV/m) (at 3 meters)	
	Peak	Average
Above 1000	74	54

Notes:

- (1) The limit for radiated test was performed according to FCC PART 15C.
- (2) The tighter limit applies at the band edges.
- (3) Emission level (dBuV/m) = 20log Emission level (uV/m).
- (4) The test result calculated as following:  
 Measurement Value = Reading Level + Correct Factor  
 Correct Factor = Antenna Factor + Cable Loss - Amplifier Gain(if use)  
 Margin Level = Measurement Value - Limit Value

Spectrum Parameter	Setting
Attenuation	Auto
Start Frequency	1000 MHz
Stop Frequency	10th carrier harmonic
RBW / VBW (emission in restricted band)	1 MHz / 1 MHz for Peak, 1 MHz / 10Hz for Average



Spectrum Receiver Parameter	Setting
Attenuation	Auto
Start ~ Stop Frequency	9KHz ~90KHz for PK/AVG detector
Start ~ Stop Frequency	90KHz ~110KHz for QP detector
Start ~ Stop Frequency	110KHz ~490KHz for PK/AVG detector
Start ~ Stop Frequency	490KHz ~30MHz for QP detector
Start ~ Stop Frequency	30MHz~1000MHz for QP detector

#### 4.2.2 TEST PROCEDURE

- a. The EUT was placed on the top of a rotating table 0.8 meter above the ground at a 3 meter semi-anechoic chamber. The table was rotated 360 degrees to determine the position of the highest radiation.(below 1GHz)
- b. The EUT was placed on the top of a rotating table 1.5 meter above the ground at a 3 meter semi-anechoic chamber. The table was rotated 360 degrees to determine the position of the highest radiation.(above 1GHz)
- c. The height of the equipment or of the substitution antenna shall be 0.8 m or 1.5m; the height of the test antenna shall vary between 1 m to 4 m. Both horizontal and vertical polarizations of the antenna are set to make the measurement.
- d. The initial step in collecting conducted emission data is a receiver peak detector mode pre-scanning the measurement frequency range. Significant peaks are then marked and then Quasi Peak detector mode re-measured.
- e. If the Peak Mode measured value compliance with and lower than Quasi Peak Mode Limit, the EUT shall be deemed to meet QP Limits and then no additional QP Mode measurement performed.
- f. For the actual test configuration, please refer to the related Item –EUT Test Photos.

#### 4.2.3 DEVIATION FROM TEST STANDARD

No deviation

#### 4.2.4 TEST SETUP

(A) Radiated Emission Test Set-Up Frequency Below 1 GHz

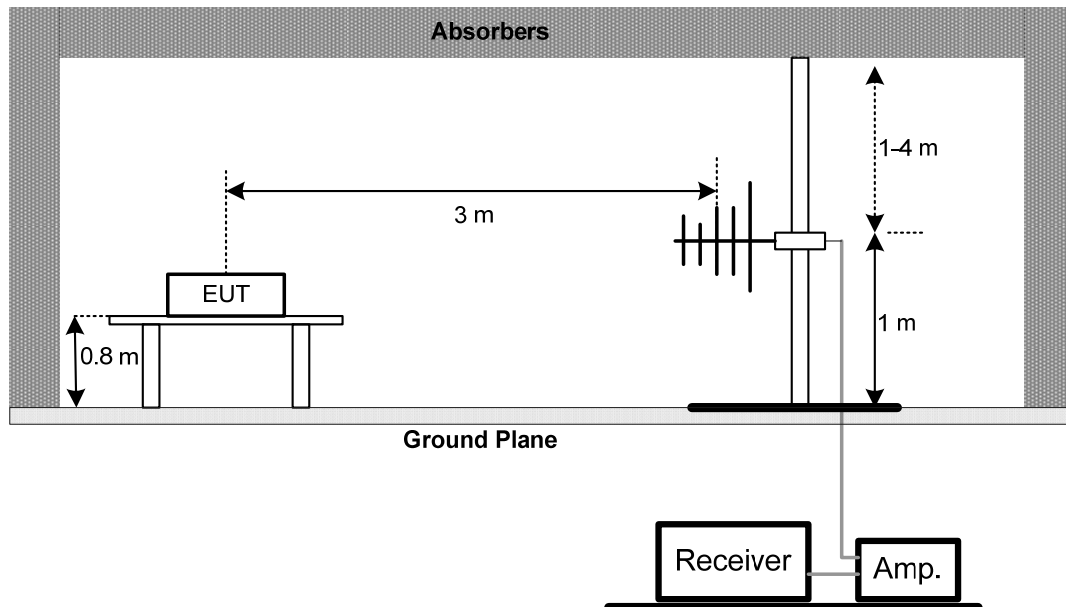

(B) Radiated Emission Test Set-Up Frequency Above 1 GHz

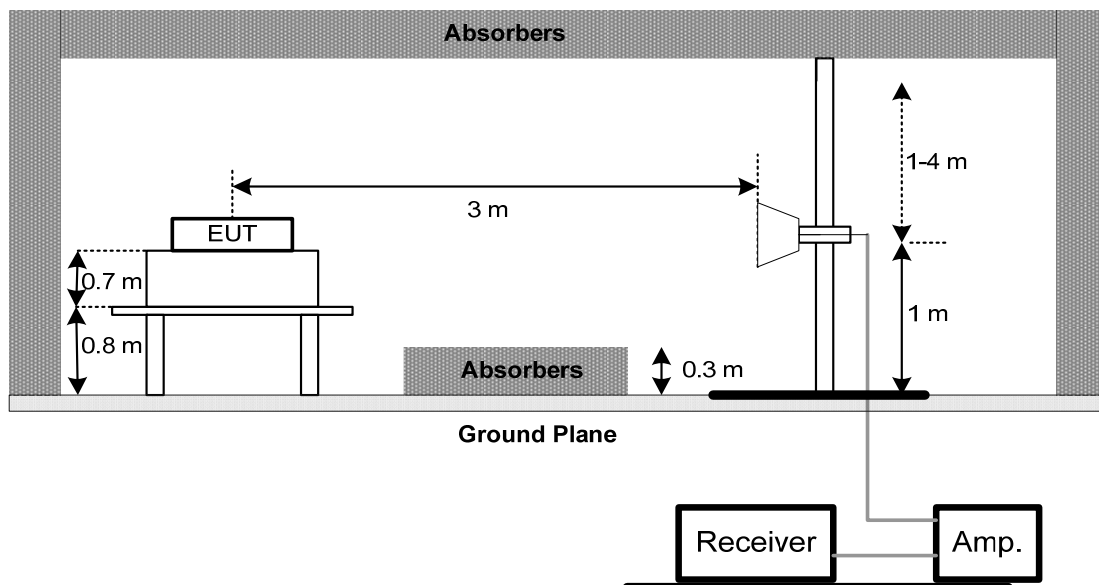

(C) For Radiated Emissions Below 30MHz

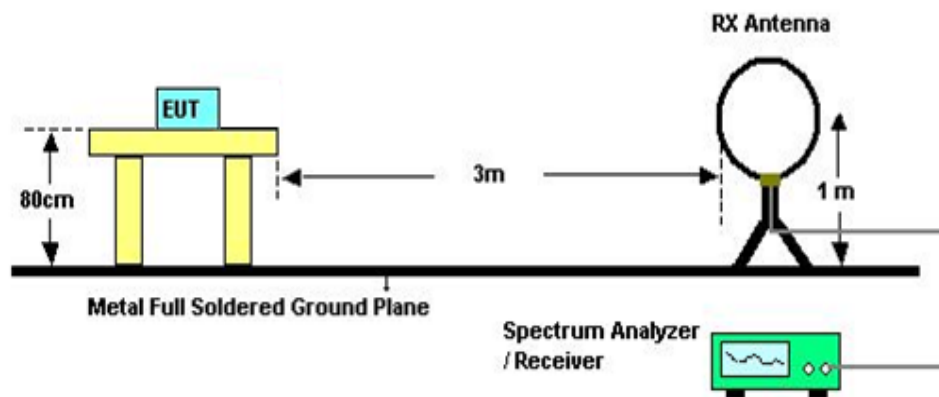

#### 4.2.5 EUT OPERATING CONDITIONS

The EUT tested system was configured as the statements of 4.1.5 unless otherwise a special operating condition is specified in the follows during the testing

#### 4.2.6 EUT TEST CONDITIONS

Temperature: 26° C  
 Relative Humidity: 60%  
 Test Voltage: DC 5V

#### 4.2.7 TEST RESULTS (9KHZ TO 30MHZ)

Please refer to the Attachment B

Remark:

- (1) The amplitude of spurious emissions which are attenuated by more than 20 dB below the permissible value has no need to be reported.
- (2) Distance extrapolation factor =  $40 \log(\text{specific distance} / \text{test distance})$  (dB).
- (3) Limit line = specific limits (dBuV) + distance extrapolation factor.

#### **4.2.8 TEST RESULTS (30MHZ TO 1000 MHZ)**

Please refer to the Attachment C.

Remark:

- (1) Reading in which marked as QP or Peak means measurements by using are Quasi-Peak Mode or Peak Mode with Detector BW=120KHz; SPA setting in RBW=120KHz, VBW =120KHz, Swp. Time = 0.3 sec./MHz.
- (2) All readings are Peak unless otherwise stated QP in column of 『Note』 . Peak denotes that the Peak reading compliance with the QP Limits and then QP Mode measurement didn't perform.
- (3) Measuring frequency range from 30MHz to 1000MHz.
- (4) If the peak scan value lower limit more than 20dB, then this signal data does not show in table.

#### **4.2.9 TEST RESULTS (ABOVE 1000 MHZ)**

Please refer to the Attachment D.

Remark:

- (1) Radiated emissions measured in frequency range above 1000MHz were made with an instrument using Peak detector mode and AV detector mode of the emission
- (2) A preamp and high pass filter were used for this test in order to provide sufficient measurement sensitivity.
- (3) EUT Orthogonal Axis:  
"X" - denotes Laid on Table; "Y" - denotes Vertical Stand; "Z" - denotes Side Stand
- (4) During the measurements above 1 GHz it is taken care of that the EUT is always within the 3 dB cone of radiation BW of the used antenna
- (5) No limit: This is fundamental signal, the judgment is not applicable.  
For fundamental signal judgment was referred to Peak output test.

## 5. NUMBER OF HOPPING CHANNEL

### 5.1 APPLIED PROCEDURES

FCC Part15 (15.247) , Subpart C/ RSS-GEN and RSS-247			
Section	Test Item	Frequency Range (MHz)	Result
15.247(a)(1)(iii) RSS-247 5.1 (4)	Number of Hopping Channel	2400-2483.5	PASS

Spectrum Parameters	Setting
Attenuation	Auto
Span Frequency	> Operating Frequency Range
RBW	100 KHz
VBW	100 KHz
Detector	Peak
Trace	Max Hold
Sweep Time	Auto

#### 5.1.1 TEST PROCEDURE

- a. The EUT was directly connected to the spectrum analyzer and antenna output port as show in the block diagram below,
- b. Spectrum Setting: RBW=100KHz, VBW=100KHz, Sweep time = Auto.

#### 5.1.2 DEVIATION FROM STANDARD

No deviation.

#### 5.1.3 TEST SETUP



#### 5.1.4 EUT OPERATION CONDITIONS

The EUT tested system was configured as the statements of 4.1.5 unless otherwise a special operating condition is specified in the follows during the testing.

#### 5.1.5 EUT TEST CONDITIONS

Temperature: 26° C  
 Relative Humidity: 60%  
 Test Voltage: DC 5V

#### 5.1.6 TEST RESULTS

Please refer to the Attachment E

## 6. AVERAGE TIME OF OCCUPANCY

### 6.1 APPLIED PROCEDURES / LIMIT

FCC Part15 (15.247) , Subpart C/ RSS-GEN and RSS-247				
Section	Test Item	Limit	Frequency Range (MHz)	Result
15.247(a)(1)(iii) RSS-247 5.1 (4)	Average Time of Occupancy	0.4sec	2400-2483.5	PASS

#### 6.1.1 TEST PROCEDURE

- a. The transmitter output (antenna port) was connected to the spectrum analyzer
- b. Set RBW of spectrum analyzer to 1MHz and VBW to 1MHz.
- c. Use a video trigger with the trigger level set to enable triggering only on full pulses.
- d. Sweep Time is more than once pulse time.
- e. Set the center frequency on any frequency would be measure and set the frequency span to zero span.
- f. Measure the maximum time duration of one single pulse.
- g. Set the EUT for DH5, DH3 and DH1 packet transmitting.
- h. Measure the maximum time duration of one single pulse.
- i. DH5 Packet permit maximum  $1600 / 79 / 6 = 3.37$  hops per second in each channel (5 time slots TX, 1 time slot RX). So, the dwell time is the time duration of the pulse times  $3.37 \times 31.6 = 106.6$  within 31.6 seconds.
- j. DH3 Packet permit maximum  $1600 / 79 / 4 = 5.06$  hops per second in each channel (3 time slots TX, 1 time slot RX). So, the dwell time is the time duration of the pulse times  $5.06 \times 31.6 = 160$  within 31.6 seconds.
- k. DH1 Packet permit maximum  $1600 / 79 / 2 = 10.12$  hops per second in each channel (1 time slot TX, 1 time slot RX). So, the dwell time is the time duration of the pulse times  $10.12 \times 31.6 = 320$  within 31.6 seconds.

#### 6.1.2 DEVIATION FROM STANDARD

No deviation.

#### 6.1.3 TEST SETUP

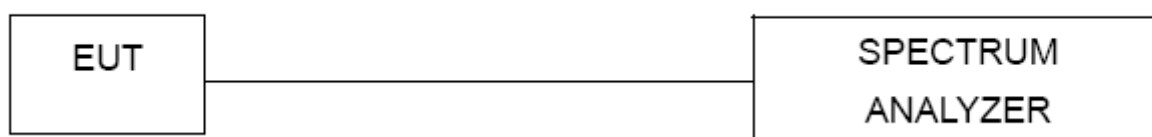

#### **6.1.4 EUT OPERATION CONDITIONS**

The EUT tested system was configured as the statements of 4.1.5 unless otherwise a special operating condition is specified in the follows during the testing.

#### **6.1.5 EUT TEST CONDITIONS**

Temperature: 26° C

Relative Humidity: 60%

Test Voltage: DC 5V

#### **6.1.6 TEST RESULTS**

Please refer to the Attachment F

## 7. HOPPING CHANNEL SEPARATION MEASUREMENT

### 7.1 APPLIED PROCEDURES / LIMIT

Frequency hopping systems operating in the 2400-2483.5 MHz band may have hopping channel carrier frequencies that are separated by 25 KHz or two-thirds of the 20 dB bandwidth of the hopping channel, whichever is greater.

Spectrum Parameter	Setting
Attenuation	Auto
Span Frequency	> Measurement Bandwidth or Channel Separation
RBW	30 KHz
VBW	100 KHz
Detector	Peak
Trace	Max Hold
Sweep Time	Auto

#### 7.1.1 TEST PROCEDURE

- a. The EUT must have its hopping function enabled
- b. Span = wide enough to capture the peaks of two adjacent channels
  - Resolution (or IF) Bandwidth (RBW)  $\geq$  1% of the span
  - Video (or Average) Bandwidth (VBW)  $\geq$  RBW
  - Sweep = Auto
  - Detector function = Peak
  - Trace = Max Hold

#### 7.1.2 DEVIATION FROM STANDARD

No deviation.

#### 7.1.3 TEST SETUP

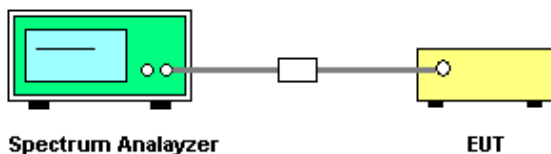

#### 7.1.4 EUT TEST CONDITIONS

Temperature: 26° C  
 Relative Humidity: 60%  
 Test Voltage: DC 5V

#### 7.1.5 TEST RESULTS

Please refer to the Attachment G



## 8. BANDWIDTH TEST

### 8.1 APPLIED PROCEDURES

FCC Part15 (15.247) , Subpart C/ RSS-GEN and RSS-247		
Section	Test Item	Frequency Range (MHz)
15.247(a)(2) RSS-GEN 6.6 RSS-247 5.1 (1)	Bandwidth	2400-2483.5

Spectrum Parameter	Setting
Attenuation	Auto
Span Frequency	> Measurement Bandwidth or Channel Separation
RBW	30 KHz (20dB Bandwidth) / 30 KHz (Channel Separation)
VBW	100 KHz (20dB Bandwidth) / 100 KHz (Channel Separation)
Detector	Peak
Trace	Max Hold
Sweep Time	Auto

#### 8.1.1 TEST PROCEDURE

- The EUT was directly connected to the spectrum analyzer and antenna output port as show in the block diagram below,
- Spectrum Setting: RBW= 30KHz, VBW=100KHz, Sweep Time = Auto.

#### 8.1.2 DEVIATION FROM STANDARD

No deviation.

#### 8.1.3 TEST SETUP



#### 8.1.4 EUT OPERATION CONDITIONS

The EUT tested system was configured as the statements of 4.1.5 unless otherwise a special operating condition is specified in the follows during the testing.

#### 8.1.5 EUT TEST CONDITIONS

Temperature: 26° C  
Relative Humidity: 60%  
Test Voltage: DC 5V

#### 8.1.6 TEST RESULTS

Please refer to the Attachment H

## 9. PEAK OUTPUT POWER TEST

### 9.1 APPLIED PROCEDURES / LIMIT

FCC Part15 (15.247) , Subpart C/ RSS-247				
Section	Test Item	Limit	Frequency Range (MHz)	Result
15.247(b)(1) RSS-247 5.4 (2)	Peak Output Power	1 Watt or 30dBm	2400-2483.5	PASS

#### 9.1.1 TEST PROCEDURE

- a. The EUT was directly connected to the spectrum analyzer and antenna output port as show in the block diagram below,
- b. Spectrum Setting: RBW= 1MHz/3MHz, VBW= 1MHz/3MHz, Sweep time = Auto.

#### 9.1.2 DEVIATION FROM STANDARD

No deviation.

#### 9.1.3 TEST SETUP

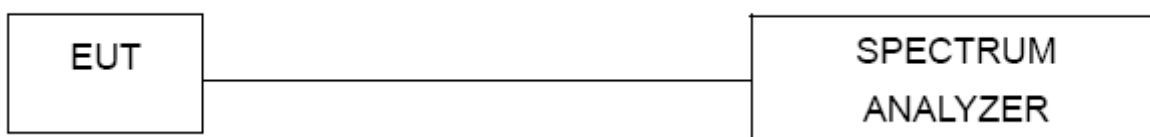

#### 9.1.4 EUT OPERATION CONDITIONS

The EUT tested system was configured as the statements of 4.1.5 unless otherwise a special operating condition is specified in the follows during the testing.

#### 9.1.5 EUT TEST CONDITIONS

Temperature: 26° C  
 Relative Humidity: 60%  
 Test Voltage: DC 5V

#### 9.1.6 TEST RESULTS

Please refer to the Attachment I

## **10. ANTENNA CONDUCTED SPURIOUS EMISSION**

### **10.1 APPLIED PROCEDURES / LIMIT**

In any 100 kHz bandwidth outside the frequency band in which the spread spectrum or digitally modulated device is operating, the RF power that is produced shall be at least 20 dB below that in the 100 kHz bandwidth within the band that contains the highest level of the desired power, based on either an RF conducted or a radiated measurement, provided that the transmitter demonstrates compliance with the peak conducted power limits.

#### **10.1.1 TEST PROCEDURE**

- a. The EUT was directly connected to the spectrum analyzer and antenna output port as show in the block diagram below,
- b. Spectrum Setting: RBW= 100KHz, VBW=100KHz, Sweep time = Auto.

#### **10.1.2 DEVIATION FROM STANDARD**

No deviation.

#### **10.1.3 TEST SETUP**

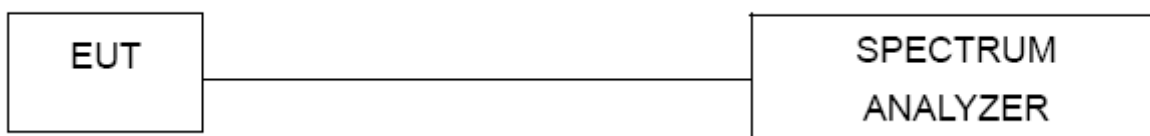

#### **10.1.4 EUT OPERATION CONDITIONS**

The EUT tested system was configured as the statements of 4.1.5 unless otherwise a special operating condition is specified in the follows during the testing.

#### **10.1.5 EUT TEST CONDITIONS**

Temperature: 26° C  
Relative Humidity: 60%  
Test Voltage: DC 5V

#### **10.1.6 TEST RESULTS**

Please refer to the Attachment J

## 11. MEASUREMENT INSTRUMENTS LIST

Conducted Emission Measurement					
Item	Kind of Equipment	Manufacturer	Type No.	Serial No.	Calibrated until
1	LISN	EMCO	3816/2	00052765	Mar. 28, 2016
2	LISN	R&S	ENV216	101447	Mar. 28, 2016
3	Test Cable	emci	RG223(9KHz-30 MHz)	C_17	Mar. 13, 2016
4	EMI TEST RECEIVER	R&S	ESCS30	833364/017	Mar. 28, 2016
5	50Ω Terminator	SHX	TF2-3G-A	08122902	Mar. 28, 2016
6	Measurement Software	Farad	EZ-EMC Ver.NB-03A1-01	N/A	N/A

Radiated Emission Measurement					
Item	Kind of Equipment	Manufacturer	Type No.	Serial No.	Calibrated until
1	Antenna	Schwarbeck	VULB9160	9160-3232	Mar. 28, 2016
2	Amplifier	HP	8447D	2944A09673	Nov. 17, 2015
3	Receiver	AGILENT	N9038A	MY52130039	Sep. 30, 2015
4	Test Cable	emci	LMR-400(30MHz-1GHz)	C-01	Jun. 28, 2016
5	Controller	CT	SC100	N/A	N/A
6	Measurement Software	Farad	EZ-EMC Ver.NB-03A1-01	N/A	N/A
7	Antenna	ETS	3115	00075789	Mar. 28, 2016
8	Amplifier	Agilent	8449B	3008A02274	Nov. 02, 2015
9	Receiver	AGILENT	N9038A	MY52130039	Sep. 30, 2015
10	Test Cable	emci	EMC104-SM-SM-10000(1GHz-26.5GHz)	C-68	Jun. 28, 2016
11	Controller	CT	SC100	N/A	N/A
12	Broad-Band Horn Antenna	Schwarzbeck	BBHA 9170	9170319	Mar. 28, 2016
13	Active Loop Antenna	R&S	HFH2-Z2	830749/020	Aug. 16, 2015

**Number of Hopping Channel**

Item	Kind of Equipment	Manufacturer	Type No.	Serial No.	Calibrated until
1	Spectrum Analyzer	R&S	FSP 40	100185	Nov. 02, 2015

**Average Time of Occupancy**

Item	Kind of Equipment	Manufacturer	Type No.	Serial No.	Calibrated until
1	Spectrum Analyzer	R&S	FSP 40	100185	Nov. 02, 2015

**Hopping Channel Separation Measurement**

Item	Kind of Equipment	Manufacturer	Type No.	Serial No.	Calibrated until
1	Spectrum Analyzer	R&S	FSP 40	100185	Nov. 02, 2015

**Bandwidth**

Item	Kind of Equipment	Manufacturer	Type No.	Serial No.	Calibrated until
1	Spectrum Analyzer	R&S	FSP 40	100185	Nov. 02, 2015

**Peak Output Power**

Item	Kind of Equipment	Manufacturer	Type No.	Serial No.	Calibrated until
1	Spectrum Analyzer	R&S	FSP 40	100185	Nov. 02, 2015

**Antenna Conducted Spurious Emission**

Item	Kind of Equipment	Manufacturer	Type No.	Serial No.	Calibrated until
1	Spectrum Analyzer	R&S	FSP 40	100185	Nov. 02, 2015

Remark: "N/A" denotes no model name, serial no. or calibration specified.  
 All calibration period of equipment list is one year.

## 12. EUT TEST PHOTO

### Conducted Measurement Photos



## Radiated Measurement Photos

9KHz to 30MHz



## Radiated Measurement Photos

30MHz to 1000MHz

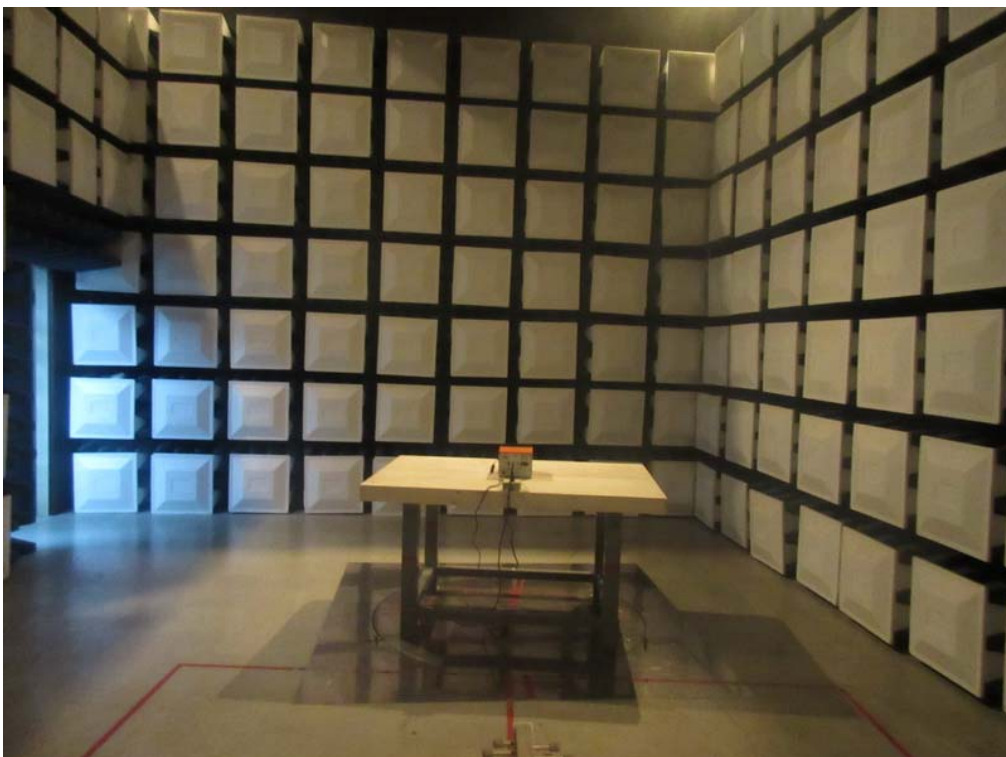



## Radiated Measurement Photos

Above 1000MHz



## ATTACHMENT A - CONDUCTED EMISSION

Test Mode: TX Mode

### Line

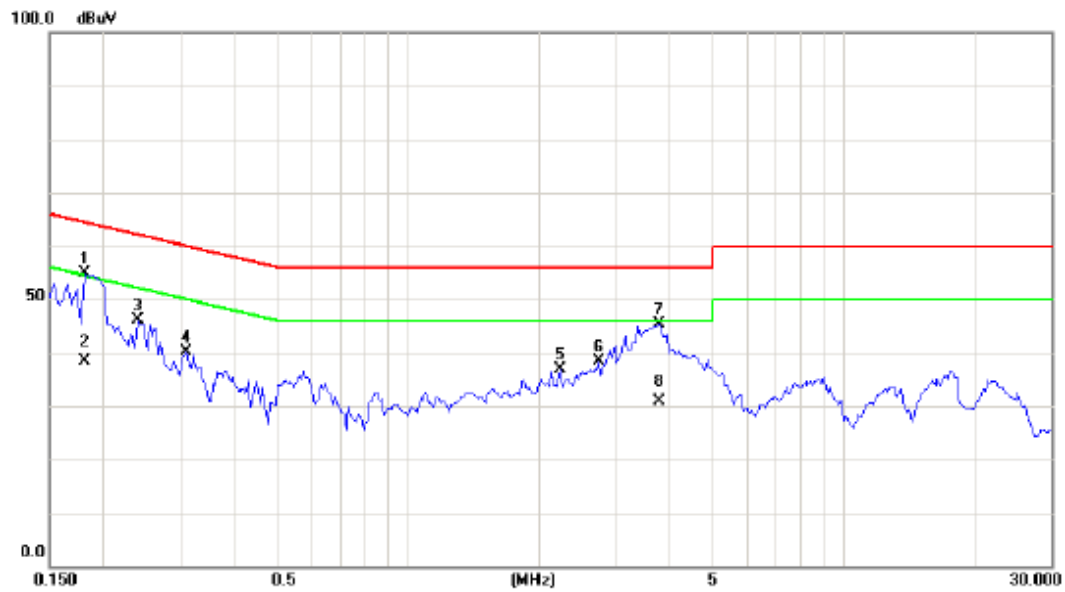

No.	Mk.	Freq. MHz	Reading Level dBuV	Correct Factor dB	Measure- ment dBuV	Limit dBuV	Margin dB	Detector	Comment
1	*	0.1812	45.31	9.50	54.81	64.43	-9.62	peak	
2		0.1812	29.00	9.50	38.50	54.43	-15.93	AVG	
3		0.2398	36.55	9.51	46.06	62.10	-16.04	peak	
4		0.3102	30.70	9.52	40.22	59.97	-19.75	peak	
5		2.2360	27.25	9.61	36.86	56.00	-19.14	peak	
6		2.7477	28.65	9.63	38.28	56.00	-17.72	peak	
7		3.7773	35.83	9.65	45.48	56.00	-10.52	peak	
8		3.7773	21.30	9.65	30.95	46.00	-15.05	AVG	

Test Mode: TX Mode

### Neutral



No.	Mk.	Freq. MHz	Reading Level dBuV	Correct Factor dB	Measure- ment dBuV	Limit dBuV	Margin dB	Detector	Comment
1	*	0.1655	45.33	9.49	54.82	65.18	-10.36	peak	
2		0.1655	30.50	9.49	39.99	55.18	-15.19	AVG	
3		0.2281	37.70	9.50	47.20	62.52	-15.32	peak	
4		0.2790	30.50	9.51	40.01	60.85	-20.84	peak	
5		0.5875	27.36	9.53	36.89	56.00	-19.11	peak	
6		3.7227	34.80	9.63	44.43	56.00	-11.57	peak	
7		3.7227	20.50	9.63	30.13	46.00	-15.87	AVG	
8		15.9023	26.74	10.14	36.88	60.00	-23.12	peak	

## **ATTACHMENT B - RADIATED EMISSION (9KHZ-30MHZ)**

Test Mode:	TX Mode
------------	---------

Frequency (MHz)	Ant 0°/90°	Read level dBuV/m	Factor (dB)	Measured(FS) (dBuV/m)	Limit (dBuV/m)	Margin (dB)	Note
0.0097	0°	12.41	24.95	37.36	127.83	-90.47	AVG
0.0097	0°	15.28	24.95	40.23	147.83	-107.60	PK
0.0224	0°	6.73	24.15	30.88	120.60	-89.72	AVG
0.0224	0°	7.12	24.15	31.27	140.60	-109.33	PK
0.0333	0°	2.17	23.46	25.63	117.16	-91.53	AVG
0.0333	0°	4.58	23.46	28.04	137.16	-109.12	PK
0.0427	0°	1.16	22.86	24.02	115.00	-90.97	AVG
0.0427	0°	2.51	22.86	25.37	135.00	-109.62	PK
0.4935	0°	19.38	19.82	39.20	73.74	-34.54	QP
1.7179	0°	23.74	19.53	43.27	69.54	-26.27	QP

Frequency (MHz)	Ant 0°/90°	Read level dBuV/m	Factor (dB)	Measured(FS) (dBuV/m)	Limit (dBuV/m)	Margin (dB)	Note
0.0095	90°	12.16	24.30	36.46	128.09	-91.63	AVG
0.0095	90°	13.89	24.30	38.19	148.09	-109.90	PK
0.0246	90°	7.28	24.01	31.29	119.79	-88.50	AVG
0.0246	90°	8.94	24.01	32.95	139.79	-106.84	PK
0.0388	90°	5.23	23.11	28.34	115.83	-87.49	AVG
0.0388	90°	6.19	23.11	29.30	135.83	-106.53	PK
0.0453	90°	1.54	22.70	24.24	114.48	-90.24	AVG
0.0453	90°	2.86	22.70	25.56	134.48	-108.92	PK
0.4965	90°	22.17	19.81	41.98	73.69	-31.71	QP
1.7147	90°	24.56	19.53	44.09	69.54	-25.45	QP

**ATTACHMENT C - RADIATED EMISSION (30MHZ TO 1000MHZ)**

Test Mode: TX 2402MHz\_CH00\_1Mbps

### Vertical

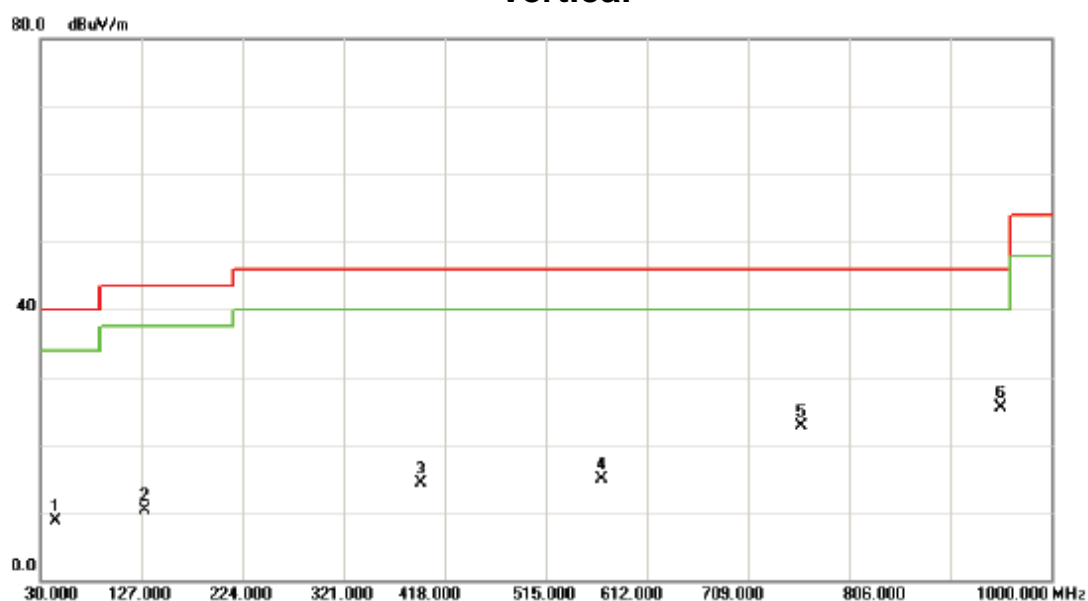

No.	Mk.	Freq. MHz	Reading Level dBuV	Correct Factor dB	Measure- ment dBuV/m	Limit dBuV/m	Margin dB	Detector	Comment
1		44.5500	28.89	-20.27	8.62	40.00	-31.38	peak	
2		129.9100	29.93	-19.53	10.40	43.50	-33.10	peak	
3		394.7200	28.39	-14.18	14.21	46.00	-31.79	peak	
4		568.3500	29.09	-14.09	15.00	46.00	-31.00	peak	
5		760.4100	29.47	-6.70	22.77	46.00	-23.23	peak	
6	*	951.5000	30.58	-5.09	25.49	46.00	-20.51	peak	



Test Mode: TX 2402MHz\_CH00\_1Mbps

### Horizontal

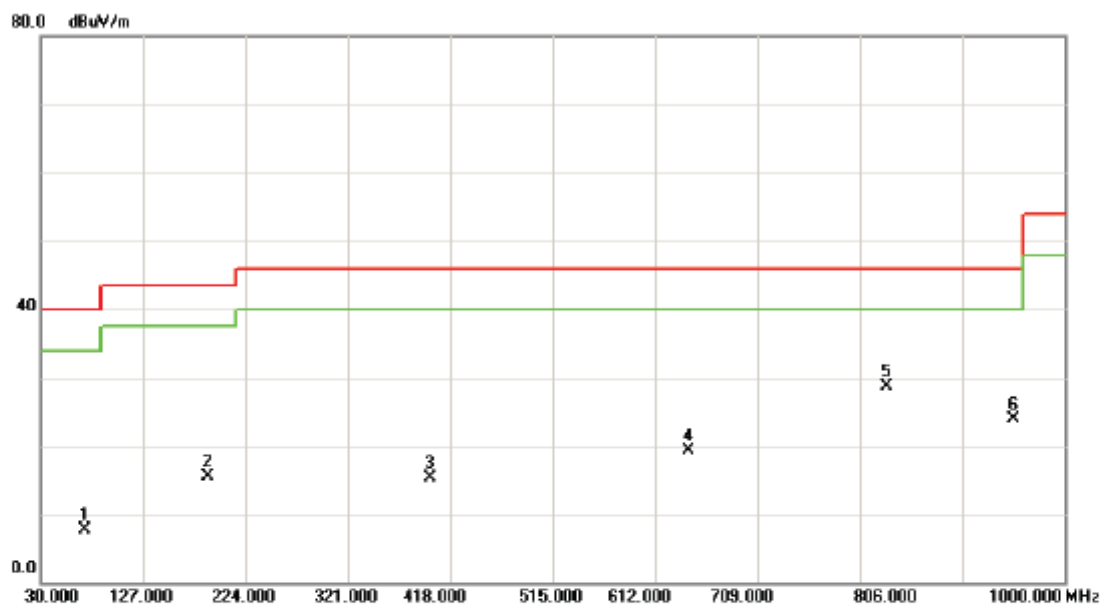

No.	Mk.	Freq. MHz	Reading Level dBuV	Correct Factor dB	Measure- ment dBuV/m	Limit dBuV/m	Margin dB	Detector	Comment
1		71.7100	32.92	-25.16	7.76	40.00	-32.24	peak	
2		188.1100	37.99	-22.53	15.46	43.50	-28.04	peak	
3		399.5700	29.80	-14.53	15.27	46.00	-30.73	peak	
4		644.0100	29.61	-10.26	19.35	46.00	-26.65	peak	
5	*	831.2200	39.63	-10.98	28.65	46.00	-17.35	peak	
6		951.5000	29.20	-5.22	23.98	46.00	-22.02	peak	

Test Mode: TX 2441MHz \_CH39\_1Mbps

### Vertical

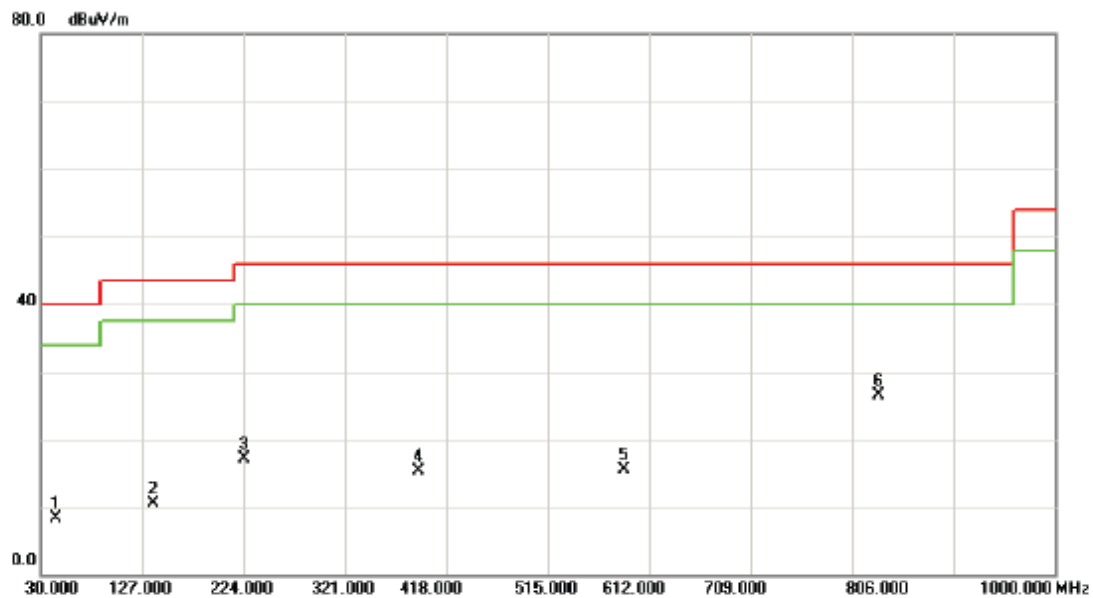

No.	Mk.	Freq. MHz	Reading Level dBuV	Correct Factor dB	Measure- ment dBuV/m	Limit dBuV/m	Margin dB	Detector	Comment
1		44.5500	28.61	-20.27	8.34	40.00	-31.66	peak	
2		138.6400	30.21	-19.66	10.55	43.50	-32.95	peak	
3		224.9700	36.22	-19.18	17.04	46.00	-28.96	peak	
4		390.8400	29.62	-14.29	15.33	46.00	-30.67	peak	
5		587.7500	29.59	-14.15	15.44	46.00	-30.56	peak	
6	*	831.2200	35.83	-9.42	26.41	46.00	-19.59	peak	

Test Mode: TX 2441MHz\_CH39\_1Mbps

### Horizontal



No.	Mk.	Freq. MHz	Reading Level dBuV	Correct Factor dB	Measure- ment dBuV/m	Limit dBuV/m	Margin dB	Detector	Comment
1		71.7100	32.98	-25.16	7.82	40.00	-32.18	peak	
2		188.1100	36.74	-22.53	14.21	43.50	-29.29	peak	
3		468.4400	29.18	-13.70	15.48	46.00	-30.52	peak	
4		714.8200	29.97	-9.40	20.57	46.00	-25.43	peak	
5	*	831.2200	42.94	-10.98	31.96	46.00	-14.04	peak	
6		941.8000	29.90	-5.51	24.39	46.00	-21.61	peak	

Test Mode: TX 2480MHz\_CH78\_1Mbps

### Vertical

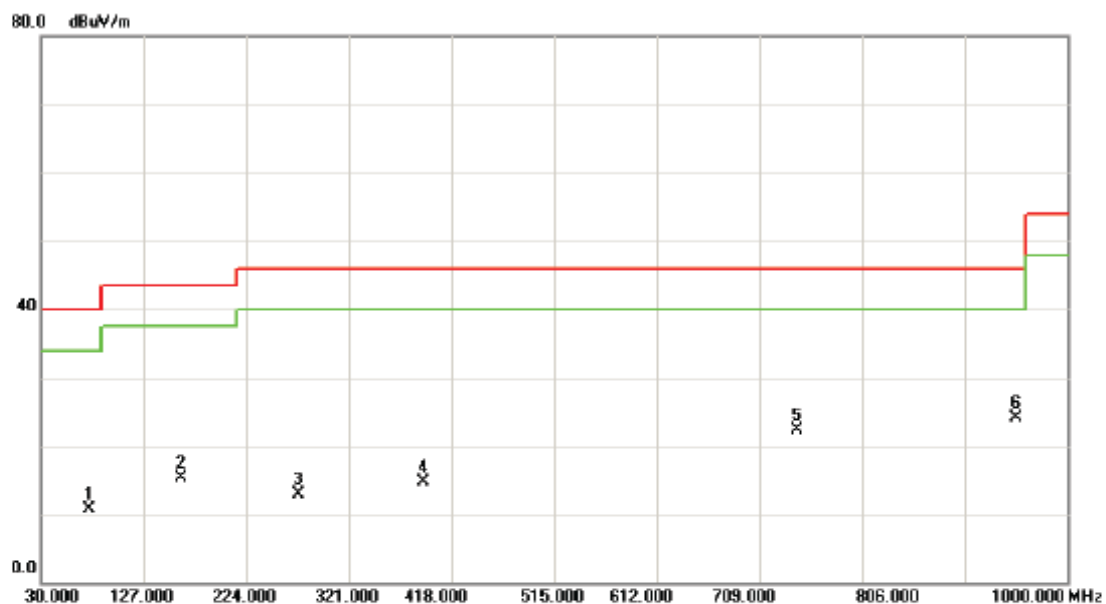

No.	Mk.	Freq. MHz	Reading Level dBuV	Correct Factor dB	Measure- ment dBuV/m	Limit dBuV/m	Margin dB	Detector	Comment
1		75.5900	37.83	-27.09	10.74	40.00	-29.26	peak	
2		162.8900	33.85	-18.61	15.24	43.50	-28.26	peak	
3		273.4700	28.75	-15.76	12.99	46.00	-33.01	peak	
4		390.8400	29.09	-14.29	14.80	46.00	-31.20	peak	
5		744.8900	29.05	-6.83	22.22	46.00	-23.78	peak	
6	*	951.5000	29.27	-5.09	24.18	46.00	-21.82	peak	

Test Mode: TX 2480MHz\_CH78\_1Mbps

### Horizontal

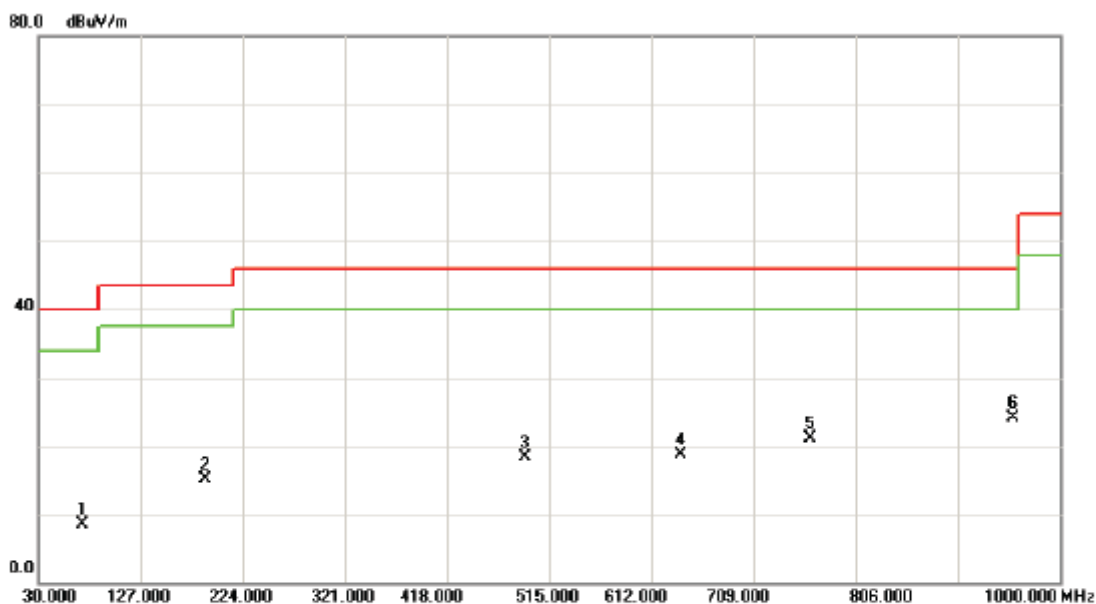

No.	Mk.	Freq. MHz	Reading Level dBuV	Correct Factor dB	Measure- ment dBuV/m	Limit dBuV/m	Margin dB	Detector	Comment
1		71.7100	33.62	-25.16	8.46	40.00	-31.54	peak	
2		188.1100	37.64	-22.53	15.11	43.50	-28.39	peak	
3		492.6900	32.53	-14.20	18.33	46.00	-27.67	peak	
4		640.1300	28.87	-10.23	18.64	46.00	-27.36	peak	
5		762.3500	29.02	-8.00	21.02	46.00	-24.98	peak	
6	*	955.3800	29.41	-5.22	24.19	46.00	-21.81	peak	

Test Mode: TX 2402MHz\_CH00\_3Mbps

### Vertical

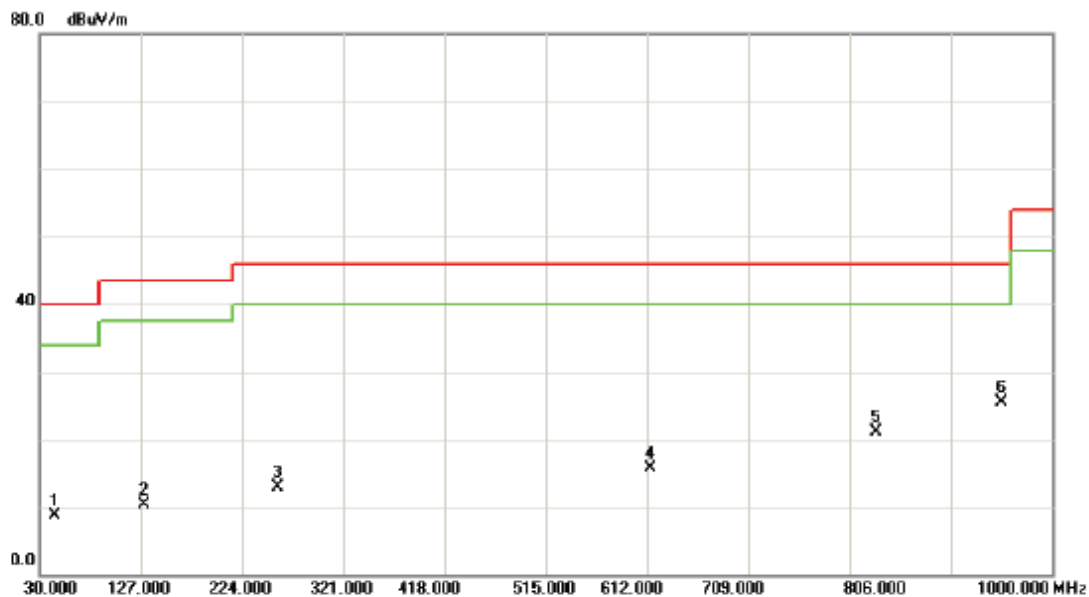

No.	Mk.	Freq. MHz	Reading Level dBuV	Correct Factor dB	Measure- ment dBuV/m	Limit dBuV/m	Margin dB	Detector	Comment
1		44.5500	28.89	-20.27	8.62	40.00	-31.38	peak	
2		129.9100	29.93	-19.53	10.40	43.50	-33.10	peak	
3		257.9500	28.45	-15.45	13.00	46.00	-33.00	peak	
4		614.9100	29.68	-13.98	15.70	46.00	-30.30	peak	
5		831.2200	30.46	-9.42	21.04	46.00	-24.96	peak	
6	*	951.5000	30.58	-5.09	25.49	46.00	-20.51	peak	

Test Mode: TX 2402MHz\_CH00\_3Mbps

### Horizontal

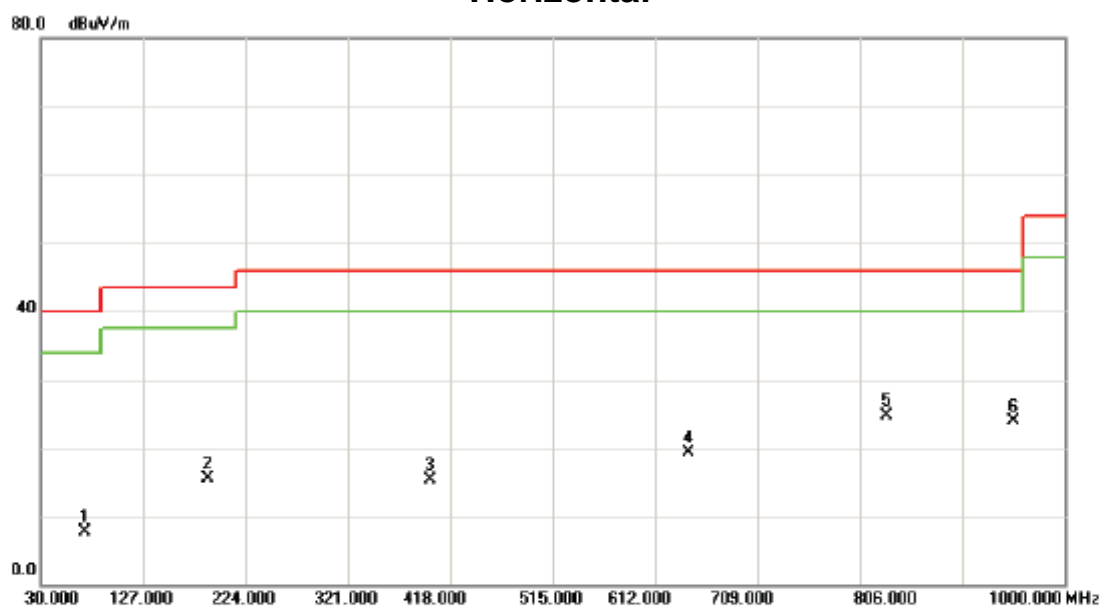

No.	Mk.	Freq. MHz	Reading Level dBuV	Correct Factor dB	Measure- ment dBuV/m	Limit dBuV/m	Margin dB	Detector	Comment
1		71.7100	32.92	-25.16	7.76	40.00	-32.24	peak	
2		188.1100	37.99	-22.53	15.46	43.50	-28.04	peak	
3		399.5700	29.80	-14.53	15.27	46.00	-30.73	peak	
4		644.0100	29.61	-10.26	19.35	46.00	-26.65	peak	
5	*	831.2200	35.63	-10.98	24.65	46.00	-21.35	peak	
6		951.5000	29.20	-5.22	23.98	46.00	-22.02	peak	

Test Mode: TX 2441MHz\_CH39\_3Mbps

### Vertical

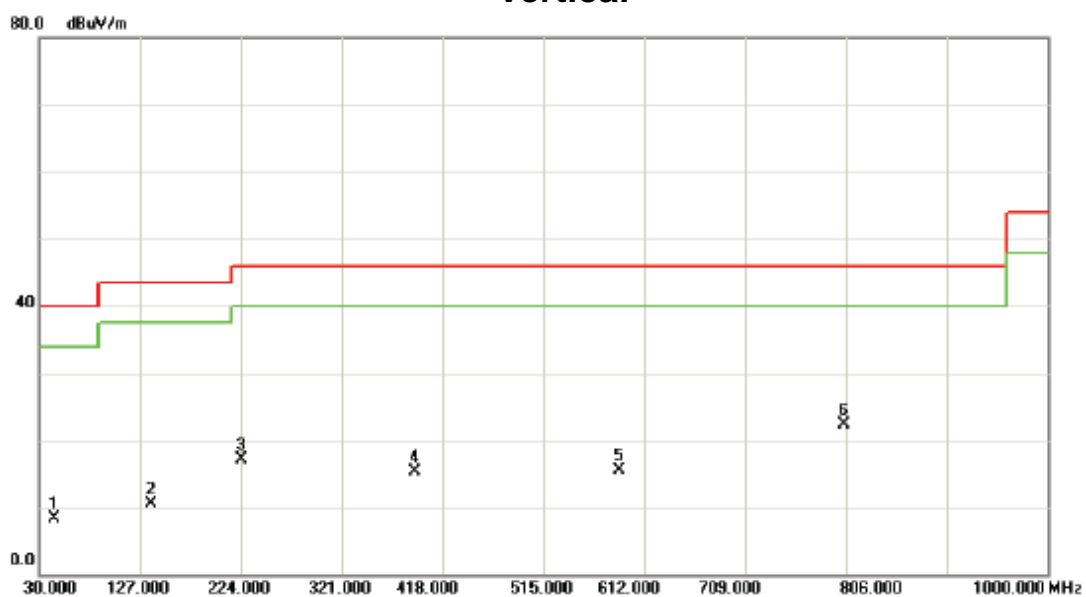

No.	Mk.	Freq. MHz	Reading Level dBuV	Correct Factor dB	Measure- ment dBuV/m	Limit dBuV/m	Margin dB	Detector	Comment
1		44.5500	28.61	-20.27	8.34	40.00	-31.66	peak	
2		138.6400	30.21	-19.66	10.55	43.50	-32.95	peak	
3		224.9700	36.22	-19.18	17.04	46.00	-28.96	peak	
4		390.8400	29.62	-14.29	15.33	46.00	-30.67	peak	
5		587.7500	29.59	-14.15	15.44	46.00	-30.56	peak	
6	*	804.0600	30.12	-7.83	22.29	46.00	-23.71	peak	



Test Mode: TX 2441MHz\_CH39\_3Mbps

### Horizontal

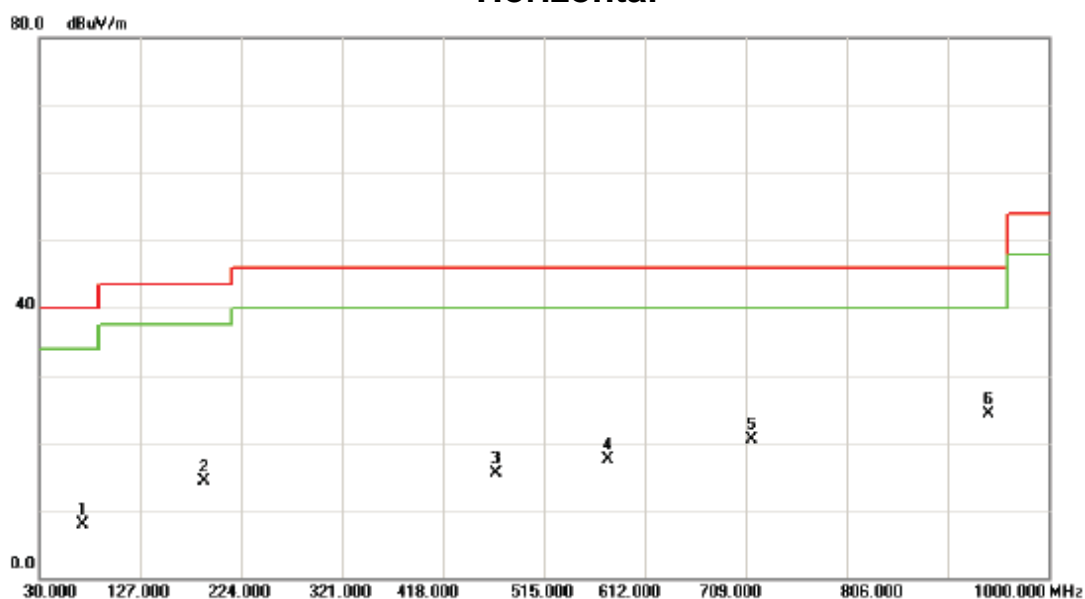

No.	Mk.	Freq. MHz	Reading Level dBuV	Correct Factor dB	Measure- ment dBuV/m	Limit dBuV/m	Margin dB	Detector	Comment
1		71.7100	32.98	-25.16	7.82	40.00	-32.18	peak	
2		188.1100	36.74	-22.53	14.21	43.50	-29.29	peak	
3		468.4400	29.18	-13.70	15.48	46.00	-30.52	peak	
4		576.1100	30.25	-12.72	17.53	46.00	-28.47	peak	
5		714.8200	29.97	-9.40	20.57	46.00	-25.43	peak	
6	*	941.8000	29.90	-5.51	24.39	46.00	-21.61	peak	

Test Mode: TX 2480MHz \_CH78\_3Mbps

### Vertical

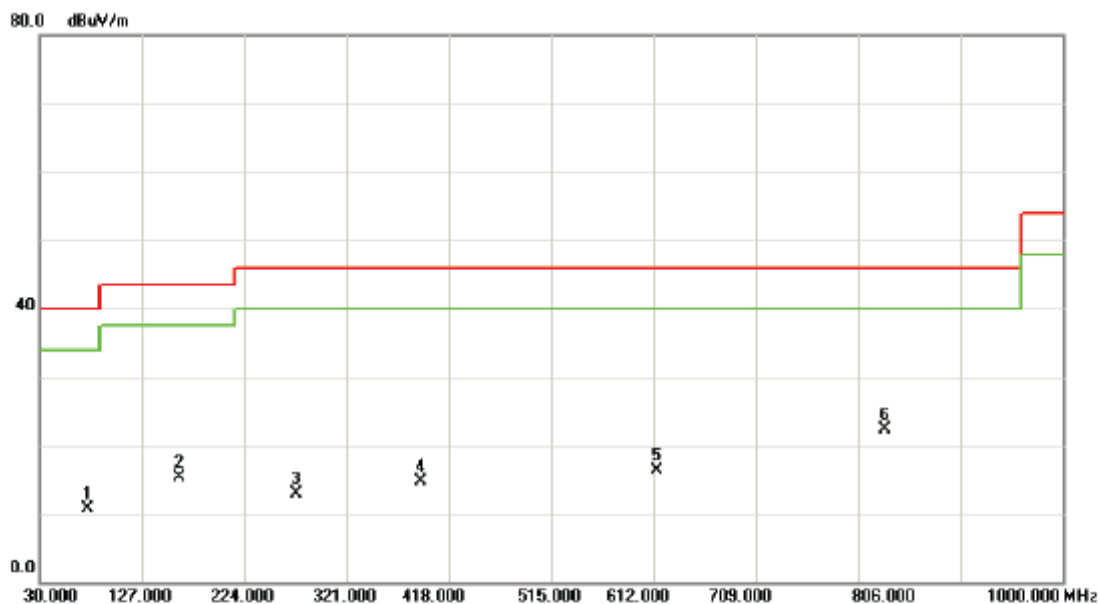

No.	Mk.	Freq. MHz	Reading Level dBuV	Correct Factor dB	Measure- ment dBuV/m	Limit dBuV/m	Margin dB	Detector	Comment
1		75.5900	37.83	-27.09	10.74	40.00	-29.26	peak	
2		162.8900	33.85	-18.61	15.24	43.50	-28.26	peak	
3		273.4700	28.75	-15.76	12.99	46.00	-33.01	peak	
4		390.8400	29.09	-14.29	14.80	46.00	-31.20	peak	
5		614.9100	30.31	-13.98	16.33	46.00	-29.67	peak	
6	*	831.2200	31.81	-9.42	22.39	46.00	-23.61	peak	

Test Mode: TX 2480MHz\_CH78\_3Mbps

### Horizontal



No.	Mk.	Freq. MHz	Reading Level dBuV	Correct Factor dB	Measure- ment dBuV/m	Limit dBuV/m	Margin dB	Detector	Comment
1		71.7100	33.62	-25.16	8.46	40.00	-31.54	peak	
2		188.1100	37.64	-22.53	15.11	43.50	-28.39	peak	
3		492.6900	32.54	-14.20	18.34	46.00	-27.66	peak	
4		640.1300	28.87	-10.23	18.64	46.00	-27.36	peak	
5		799.2100	29.43	-8.34	21.09	46.00	-24.91	peak	
6	*	955.3800	29.41	-5.22	24.19	46.00	-21.81	peak	

## **ATTACHMENT D - RADIATED EMISSION (ABOVE 1000MHZ)**

Orthogonal Axis :	X
Test Mode :	TX 2402MHz _CH00_1Mbps

### Vertical

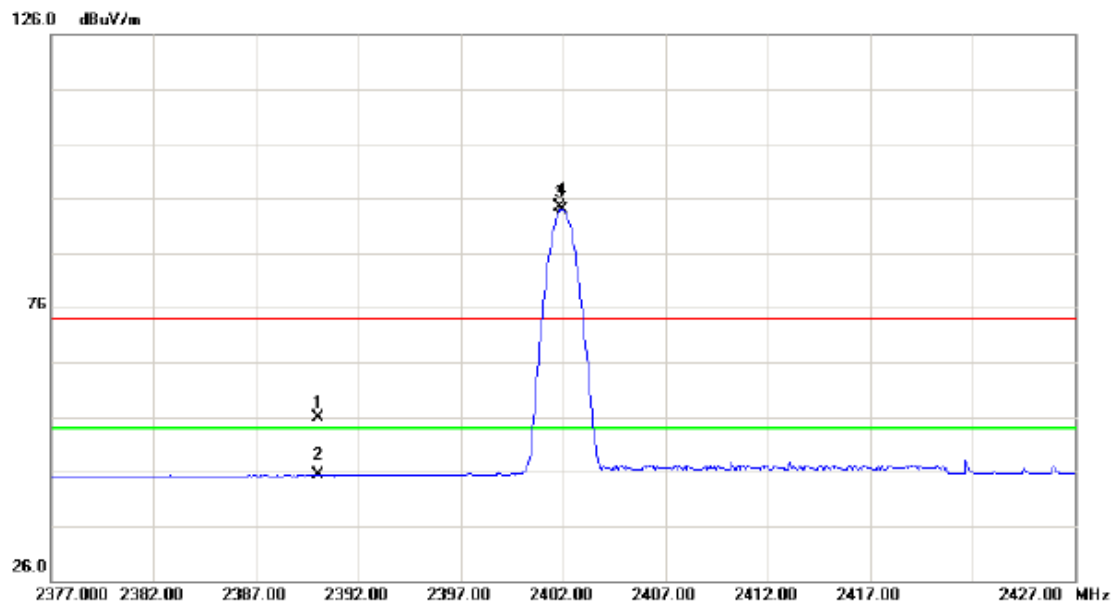

No.	Mk.	Freq. MHz	Reading Level dBuV	Correct Factor dB	Measure- ment dBuV/m	Limit dBuV/m	Margin dB	Detector	Comment
1		2390.000	23.97	31.88	55.85	74.00	-18.15	peak	
2		2390.000	13.42	31.88	45.30	54.00	-8.70	AVG	
3	X	2401.850	62.61	31.89	94.50	74.00	20.50	peak	NO LIMIT
4	*	2401.950	62.05	31.89	93.94	54.00	39.94	AVG	NO LIMIT

Orthogonal Axis :	X
Test Mode :	TX 2402MHz _CH00_1Mbps

### Vertical

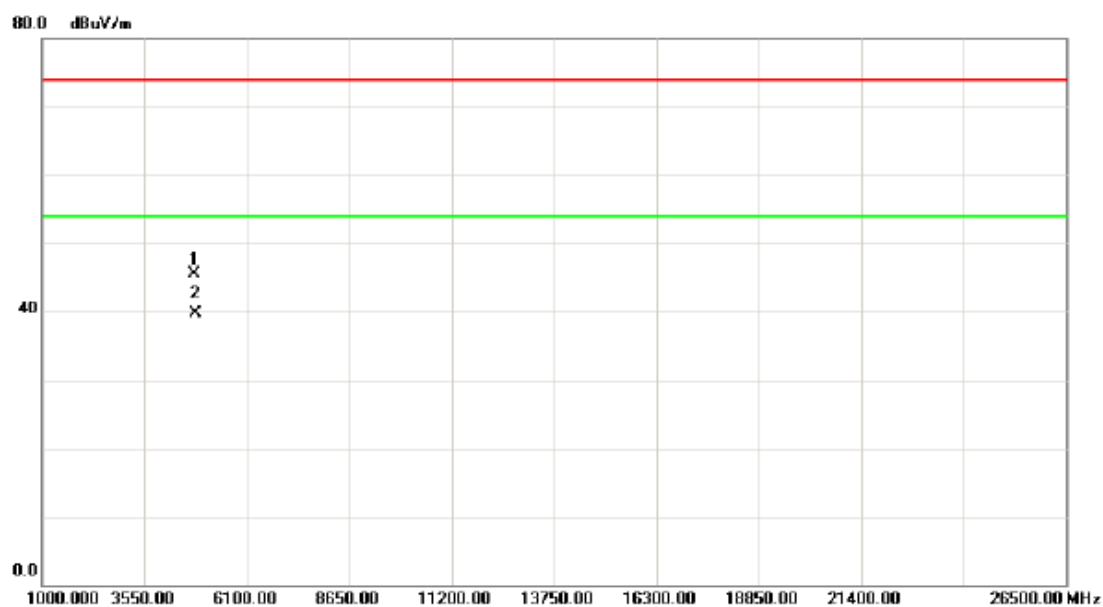

No.	Mk.	Freq. MHz	Reading Level dBuV	Correct Factor dB	Measure- ment dBuV/m	Limit dBuV/m	Margin dB	Detector	Comment
1		4803.690	41.97	3.58	45.55	74.00	-28.45	peak	
2	*	4803.880	36.08	3.58	39.66	54.00	-14.34	AVG	

Orthogonal Axis :	X
Test Mode :	TX 2402MHz_CH00_1Mbps

### Horizontal

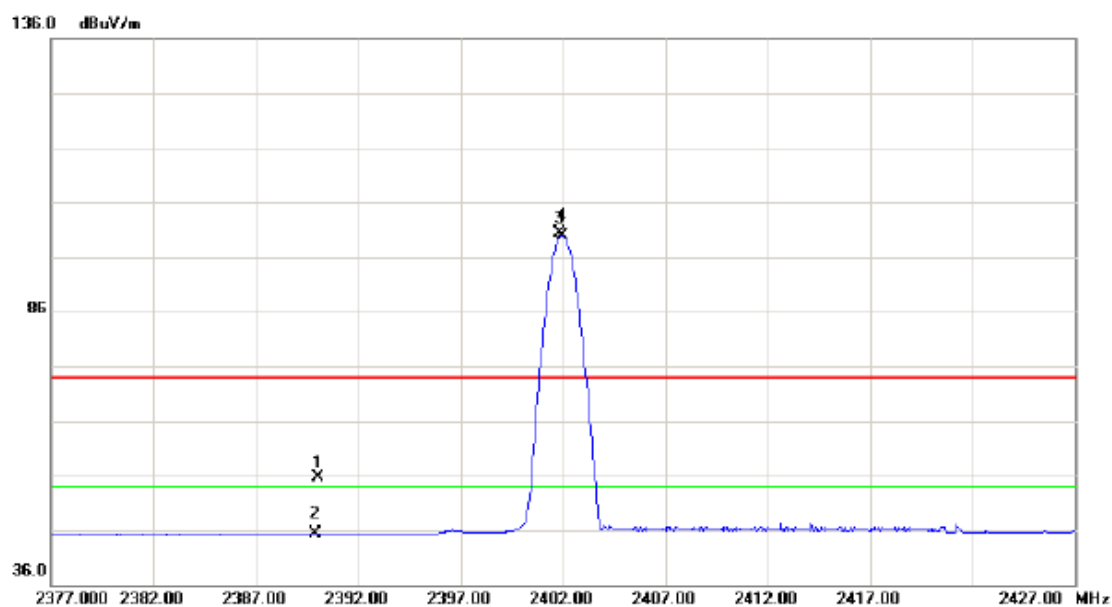

No.	Mk.	Freq. MHz	Reading Level dBuV	Correct Factor dB	Measure- ment dBuV/m	Limit dBuV/m	Margin dB	Detector	Comment
1		2390.000	23.76	31.88	55.64	74.00	-18.36	peak	
2		2390.000	13.50	31.88	45.38	54.00	-8.62	AVG	
3	X	2401.800	68.56	31.89	100.45	74.00	26.45	peak	NO LIMIT
4	*	2401.950	67.89	31.89	99.78	54.00	45.78	AVG	NO LIMIT

Orthogonal Axis :	X
Test Mode :	TX 2402MHz _CH00_1Mbps

### Horizontal

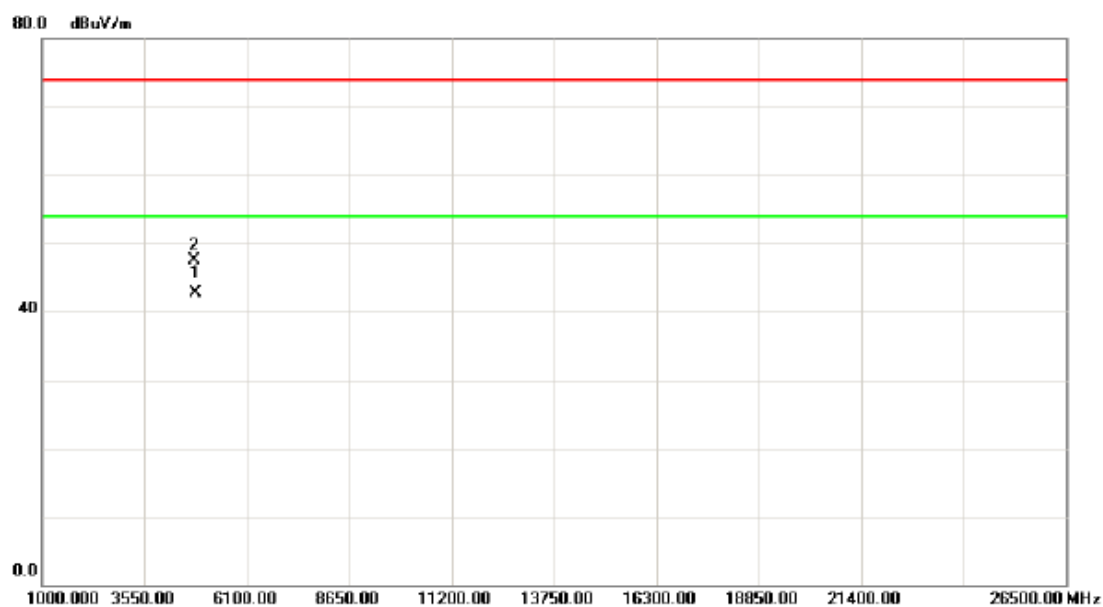

No.	Mk.	Freq. MHz	Reading Level dBuV	Correct Factor dB	Measure- ment dBuV/m	Limit dBuV/m	Margin dB	Detector	Comment
1	*	4803.920	39.12	3.58	42.70	54.00	-11.30	AVG	
2		4804.090	43.90	3.58	47.48	74.00	-26.52	peak	



Orthogonal Axis :	X
Test Mode :	TX 2441MHz _CH39_1Mbps

**Vertical**

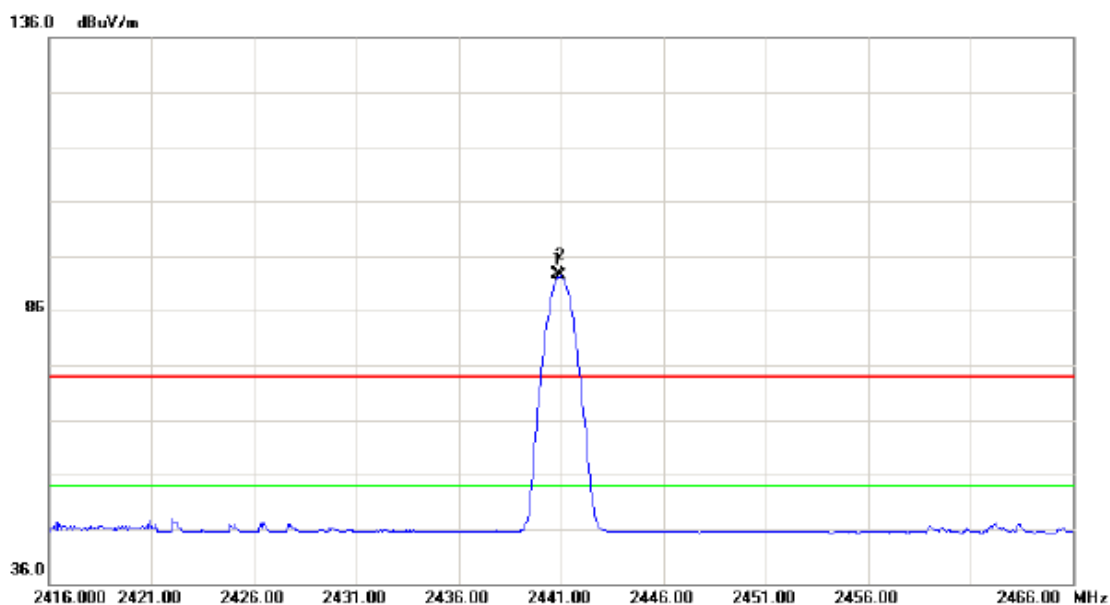

No.	Mk.	Freq. MHz	Reading Level dBuV	Correct Factor dB	Measure- ment dBuV/m	Limit dBuV/m	Margin dB	Detector	Comment
1	X	2440.800	60.75	31.95	92.70	74.00	18.70	peak	NO LIMIT
2	*	2440.950	60.33	31.95	92.28	54.00	38.28	AVG	NO LIMIT

Orthogonal Axis :	X
Test Mode :	TX 2441MHz _CH39_1Mbps

### Vertical

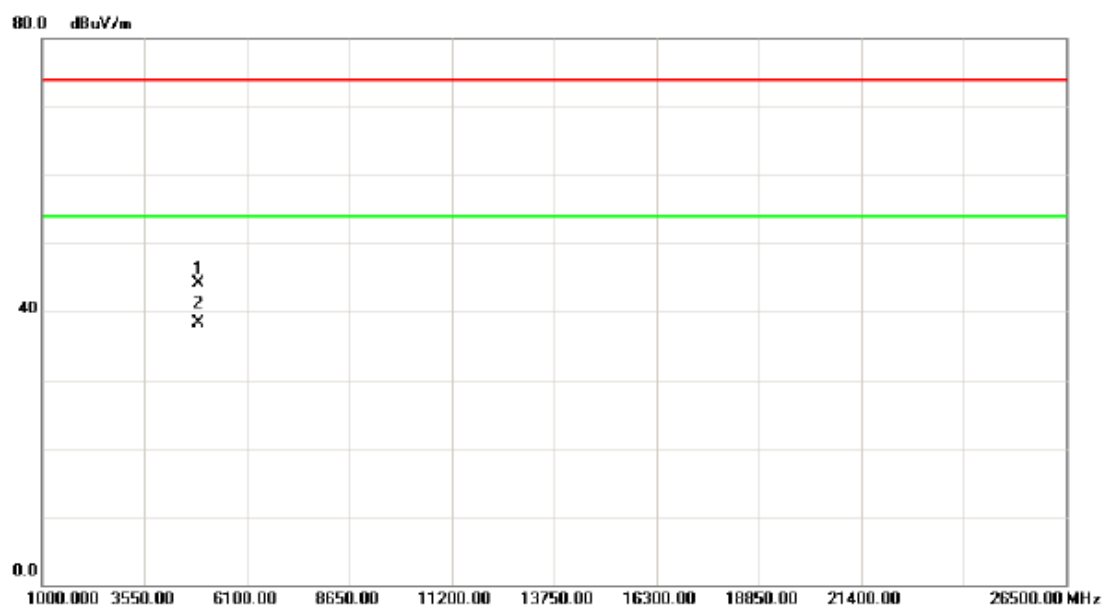

No.	Mk.	Freq. MHz	Reading Level dBuV	Correct Factor dB	Measure- ment dBuV/m	Limit dBuV/m	Margin dB	Detector	Comment
1		4881.560	40.32	3.73	44.05	74.00	-29.95	peak	
2	*	4881.820	34.58	3.73	38.31	54.00	-15.69	AVG	

Orthogonal Axis :	X
Test Mode :	TX 2441MHz _CH39_1Mbps

### Horizontal

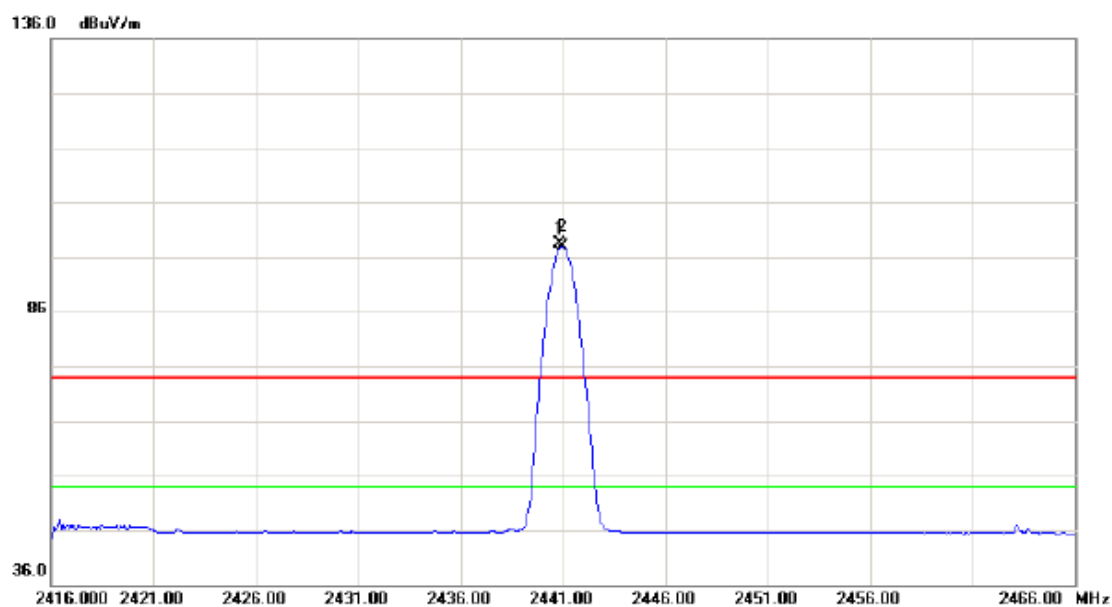

No.	Mk.	Freq. MHz	Reading Level dBuV	Correct Factor dB	Measure- ment dBuV/m	Limit dBuV/m	Margin dB	Detector	Comment
1	X	2440.800	66.50	31.95	98.45	74.00	24.45	peak	NO LIMIT
2	*	2440.950	65.87	31.95	97.82	54.00	43.82	AVG	NO LIMIT

Orthogonal Axis :	X
Test Mode :	TX 2441MHz _CH39_1Mbps

### Horizontal

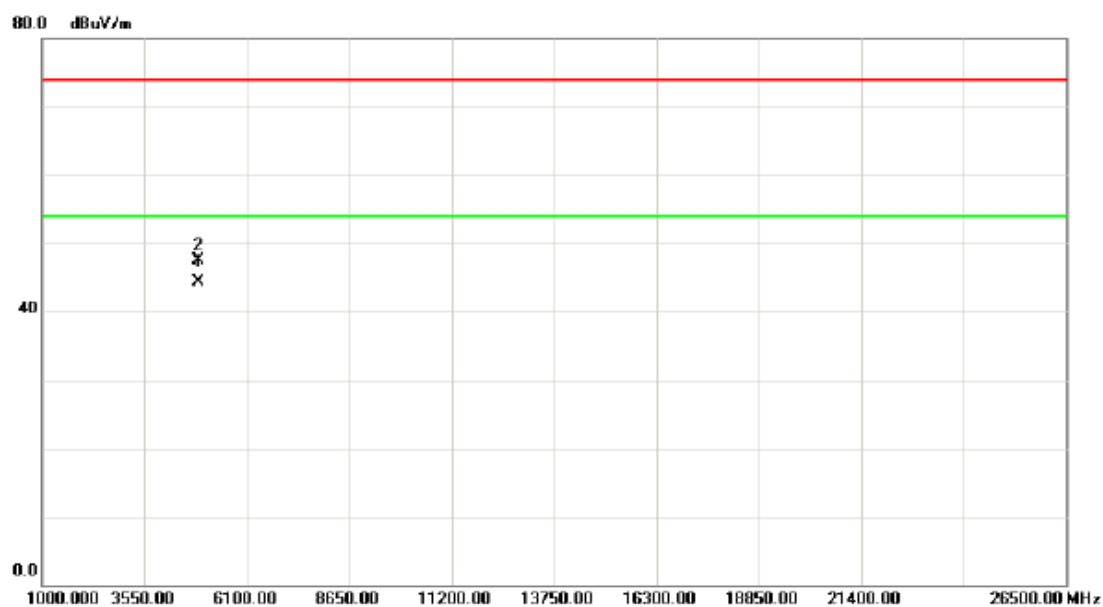

No.	Mk.	Freq. MHz	Reading Level dBuV	Correct Factor dB	Measure- ment dBuV/m	Limit dBuV/m	Margin dB	Detector	Comment
1	*	4881.910	40.59	3.73	44.32	54.00	-9.68	AVG	
2		4882.380	43.78	3.73	47.51	74.00	-26.49	peak	

Orthogonal Axis :	X
Test Mode :	TX 2480MHz_CH78_1Mbps

### Vertical

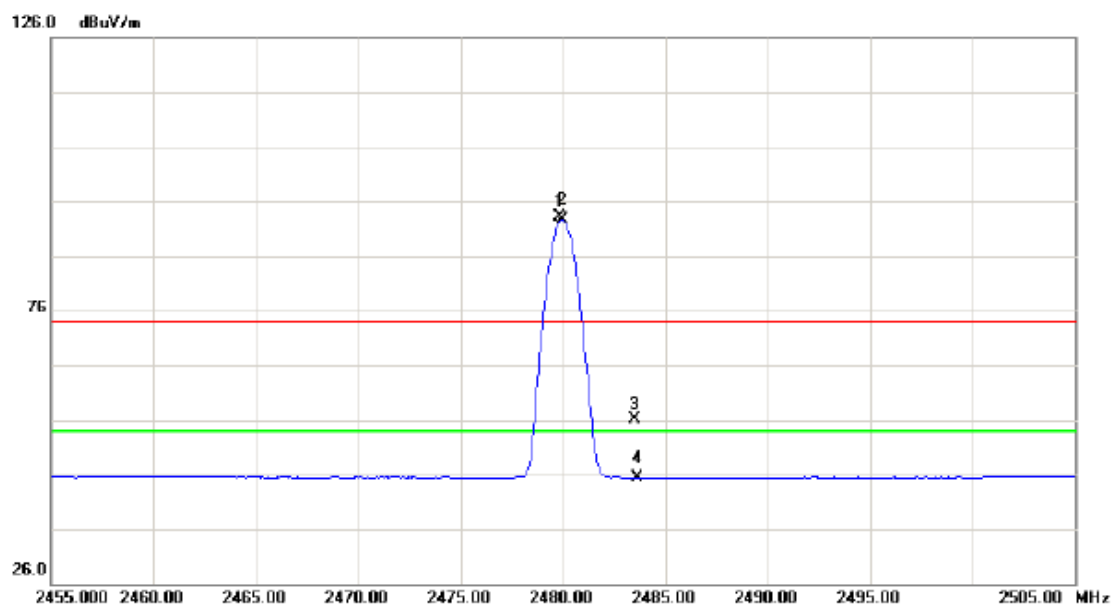

No.	Mk.	Freq. MHz	Reading Level dBuV	Correct Factor dB	Measure- ment dBuV/m	Limit dBuV/m	Margin dB	Detector	Comment
1	X	2479.800	61.05	32.00	93.05	74.00	19.05	peak	NO LIMIT
2	*	2479.950	60.54	32.00	92.54	54.00	38.54	AVG	NO LIMIT
3		2483.500	24.12	32.01	56.13	74.00	-17.87	peak	
4		2483.500	13.45	32.01	45.46	54.00	-8.54	AVG	

Orthogonal Axis :	X
Test Mode :	TX 2480MHz _CH78_1Mbps

### Vertical

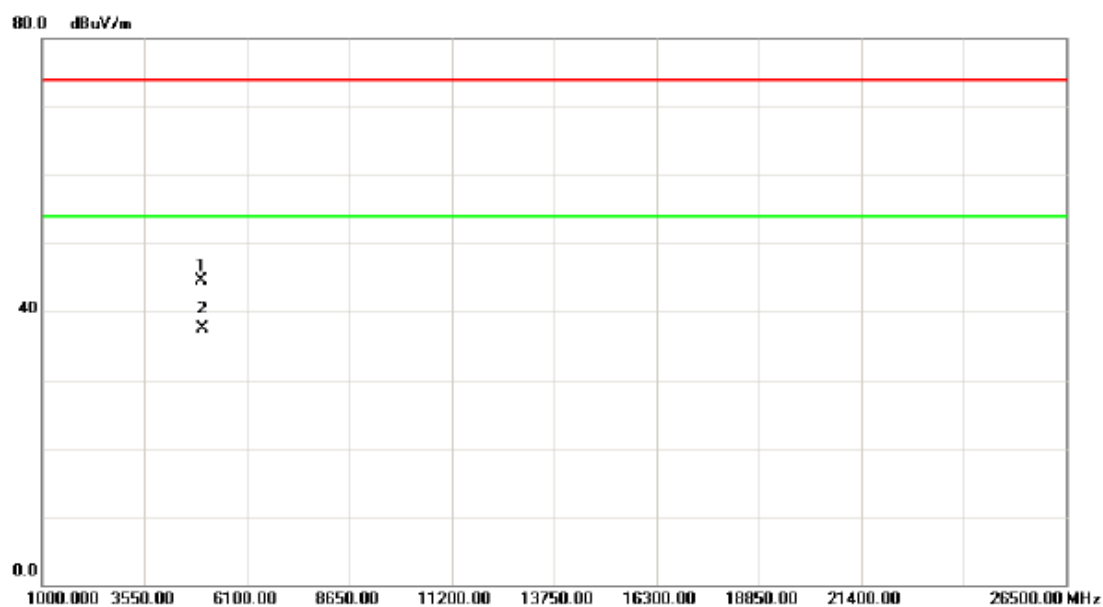

No.	Mk.	Freq. MHz	Reading Level dBuV	Correct Factor dB	Measure- ment dBuV/m	Limit dBuV/m	Margin dB	Detector	Comment
1		4959.730	40.56	3.88	44.44	74.00	-29.56	peak	
2	*	4959.910	33.55	3.88	37.43	54.00	-16.57	AVG	

Orthogonal Axis :	X
Test Mode :	TX 2480MHz _CH78_1Mbps

### Horizontal

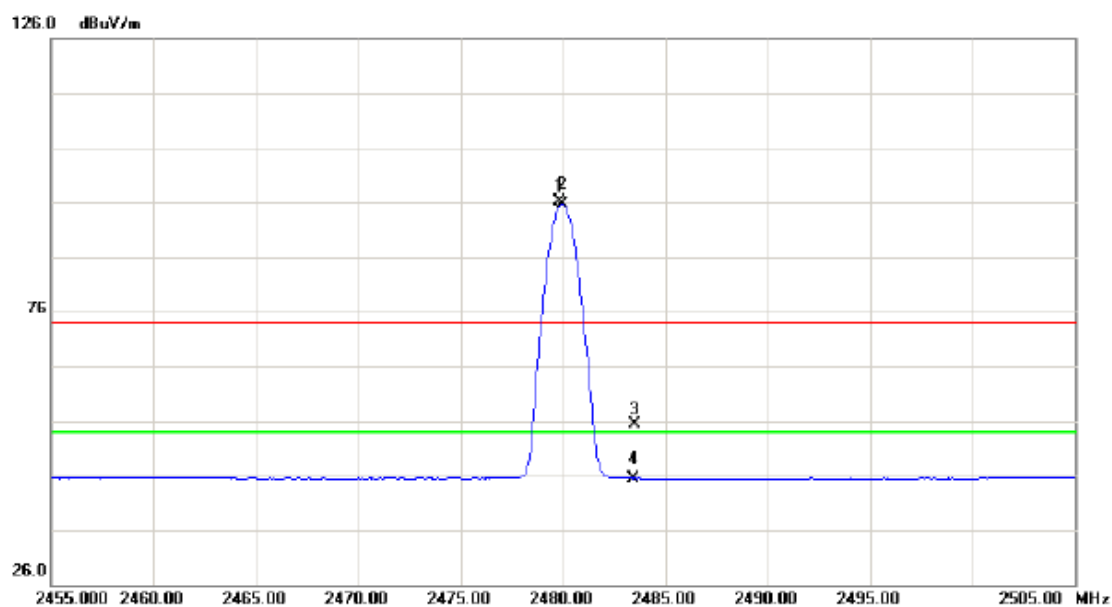

No.	Mk.	Freq. MHz	Reading Level dBuV	Correct Factor dB	Measure- ment dBuV/m	Limit dBuV/m	Margin dB	Detector	Comment
1	X	2479.850	64.25	32.00	96.25	74.00	22.25	peak	NO LIMIT
2	*	2479.950	63.65	32.00	95.65	54.00	41.65	AVG	NO LIMIT
3		2483.500	23.45	32.01	55.46	74.00	-18.54	peak	
4		2483.500	13.49	32.01	45.50	54.00	-8.50	AVG	

Orthogonal Axis :	X
Test Mode :	TX 2480MHz _CH78_1Mbps

### Horizontal

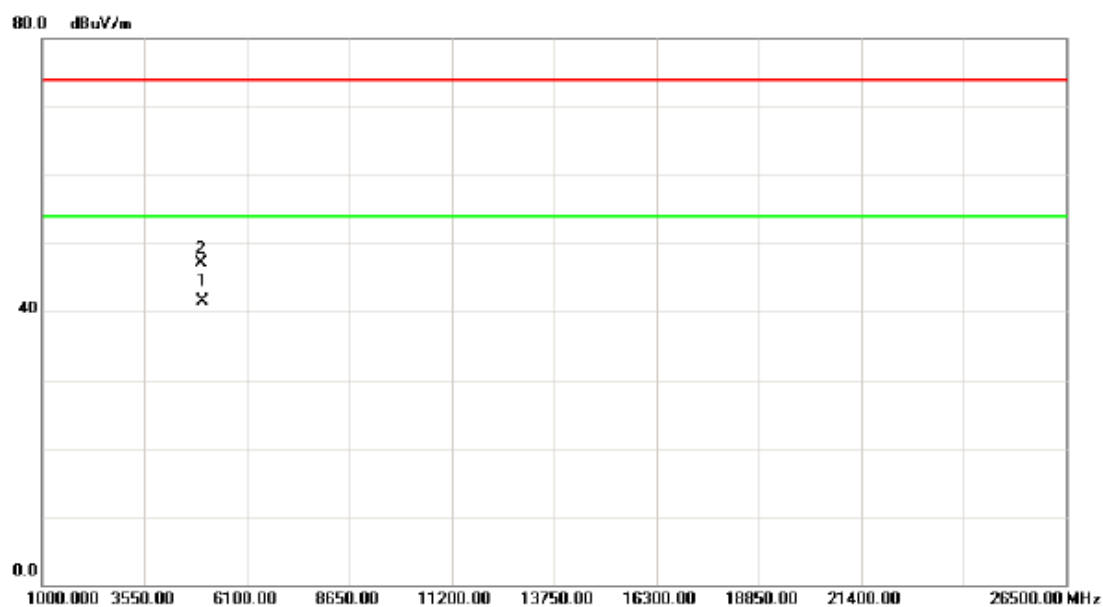

No.	Mk.	Freq. MHz	Reading Level dBuV	Correct Factor dB	Measure- ment dBuV/m	Limit dBuV/m	Margin dB	Detector	Comment
1	*	4959.910	37.72	3.88	41.60	54.00	-12.40	AVG	
2		4960.140	43.22	3.88	47.10	74.00	-26.90	peak	



Orthogonal Axis :	X
Test Mode :	TX 2402MHz_CH00_3Mbps

### Vertical

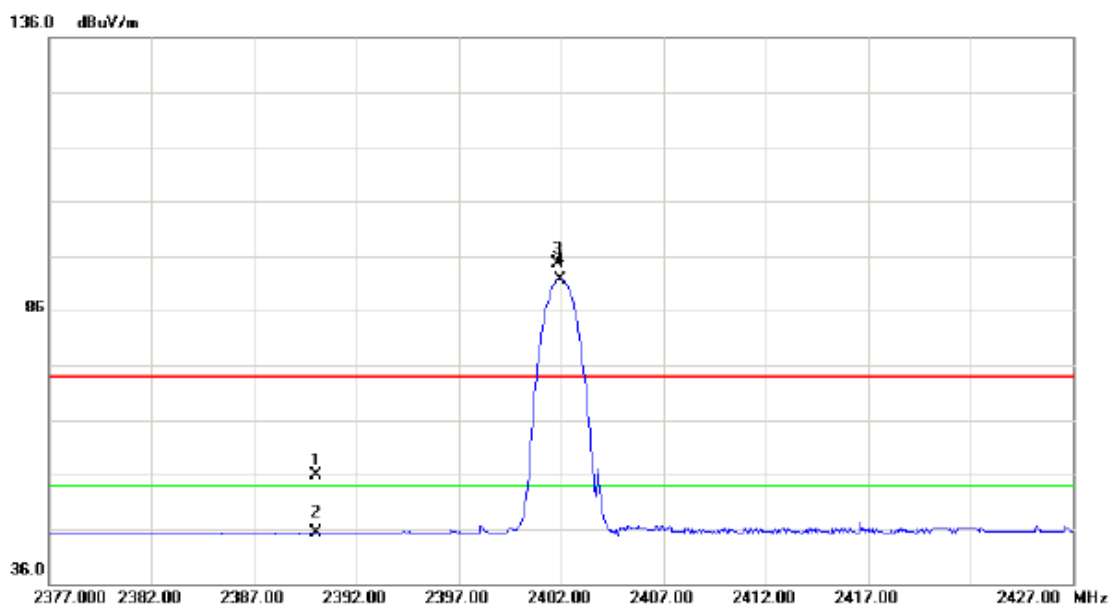

No.	Mk.	Freq. MHz	Reading Level dBuV	Correct Factor dB	Measure- ment dBuV/m	Limit dBuV/m	Margin dB	Detector	Comment
1		2390.000	24.10	31.88	55.98	74.00	-18.02	peak	
2		2390.000	13.40	31.88	45.28	54.00	-8.72	AVG	
3	X	2401.850	62.76	31.89	94.65	74.00	20.65	peak	NO LIMIT
4	*	2401.950	59.84	31.89	91.73	54.00	37.73	AVG	NO LIMIT

Orthogonal Axis :	X
Test Mode :	TX 2402MHz _CH00_3Mbps

### Vertical

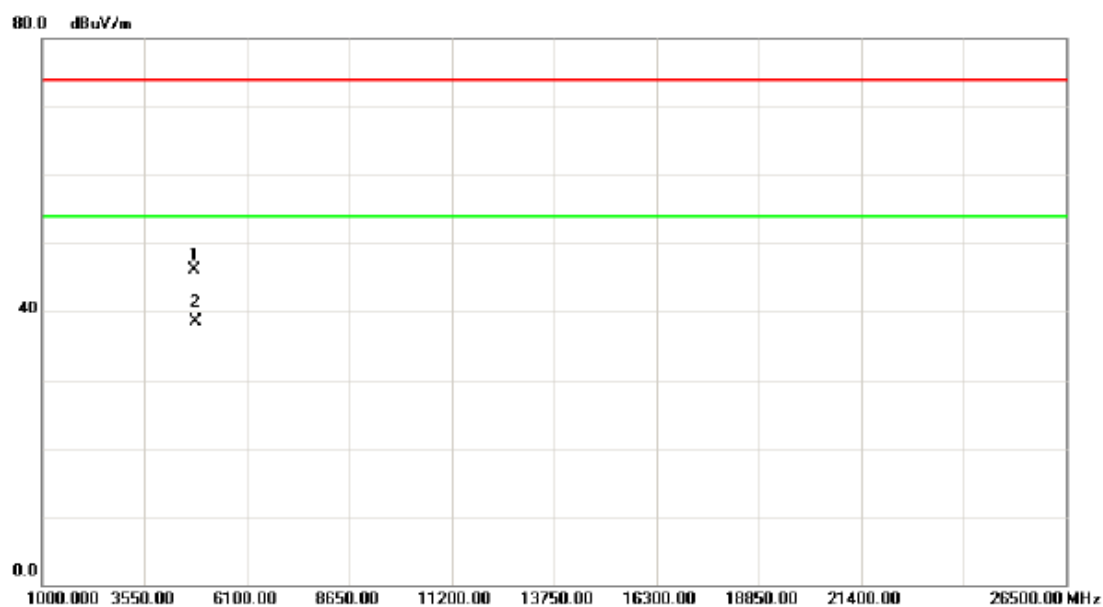

No.	Mk.	Freq. MHz	Reading Level dBuV	Correct Factor dB	Measure- ment dBuV/m	Limit dBuV/m	Margin dB	Detector	Comment
1		4803.520	42.59	3.58	46.17	74.00	-27.83	peak	
2	*	4803.790	34.95	3.58	38.53	54.00	-15.47	AVG	

Orthogonal Axis :	X
Test Mode :	TX 2402MHz _CH00_3Mbps

### Horizontal

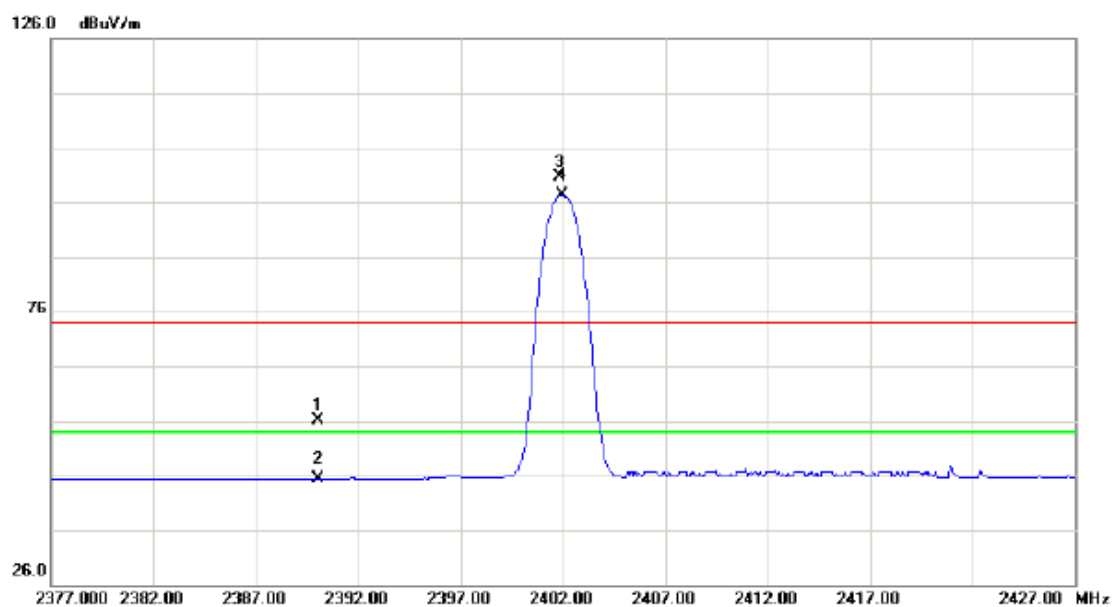

No.	Mk.	Freq. MHz	Reading Level dBuV	Correct Factor dB	Measure- ment dBuV/m	Limit dBuV/m	Margin dB	Detector	Comment
1		2390.000	24.30	31.88	56.18	74.00	-17.82	peak	
2		2390.000	13.54	31.88	45.42	54.00	-8.58	AVG	
3	X	2401.800	68.75	31.89	100.64	74.00	26.64	peak	NO LIMIT
4	*	2401.950	65.59	31.89	97.48	54.00	43.48	AVG	NO LIMIT

Orthogonal Axis :	X
Test Mode :	TX 2402MHz _CH00_3Mbps

### Horizontal

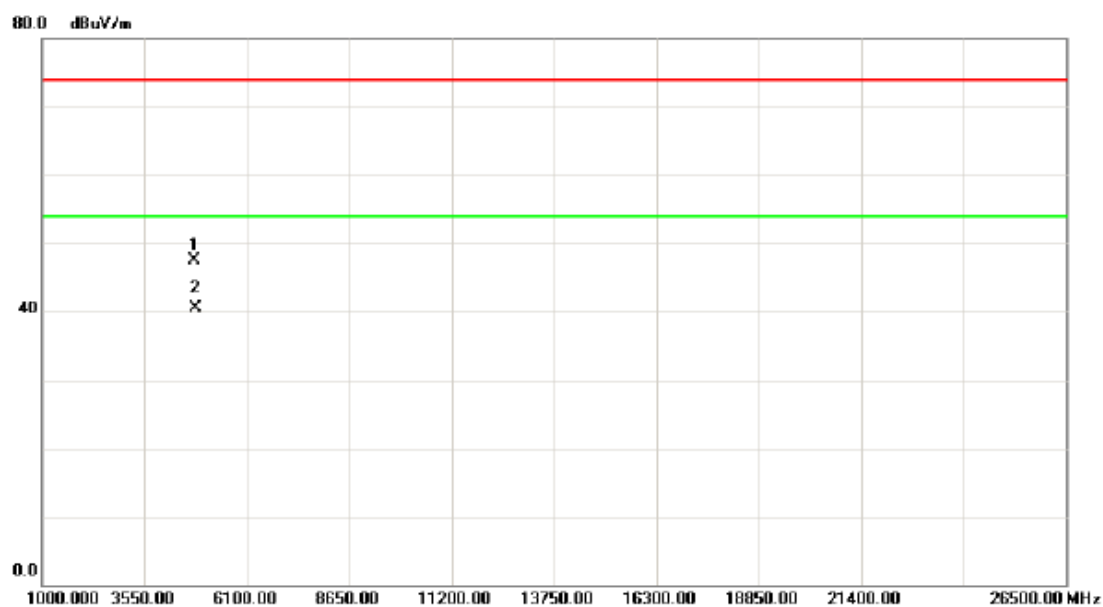

No.	Mk.	Freq. MHz	Reading Level dBuV	Correct Factor dB	Measure- ment dBuV/m	Limit dBuV/m	Margin dB	Detector	Comment
1		4803.720	43.83	3.58	47.41	74.00	-26.59	peak	
2	*	4803.950	36.91	3.58	40.49	54.00	-13.51	AVG	

Orthogonal Axis :	X
Test Mode :	TX 2441MHz _CH39_3Mbps

### Vertical

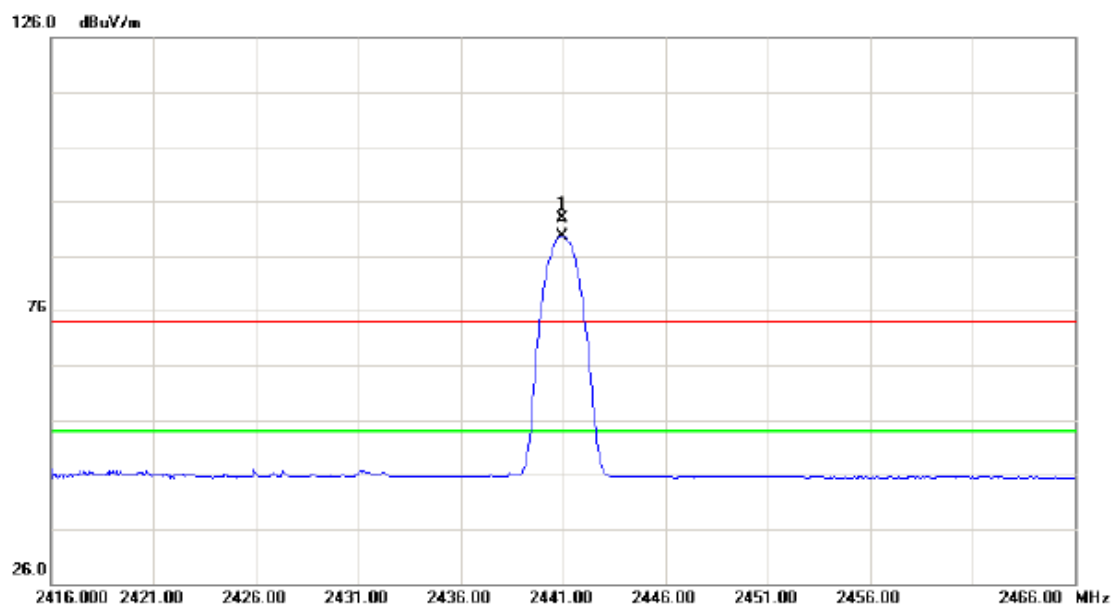

No.	Mk.	Freq. MHz	Reading Level dBuV	Correct Factor dB	Measure- ment dBuV/m	Limit dBuV/m	Margin dB	Detector	Comment
1	X	2440.950	60.98	31.95	92.93	74.00	18.93	peak	NO LIMIT
2	*	2440.950	57.69	31.95	89.64	54.00	35.64	AVG	NO LIMIT

Orthogonal Axis :	X
Test Mode :	TX 2441MHz _CH39_3Mbps

### Vertical

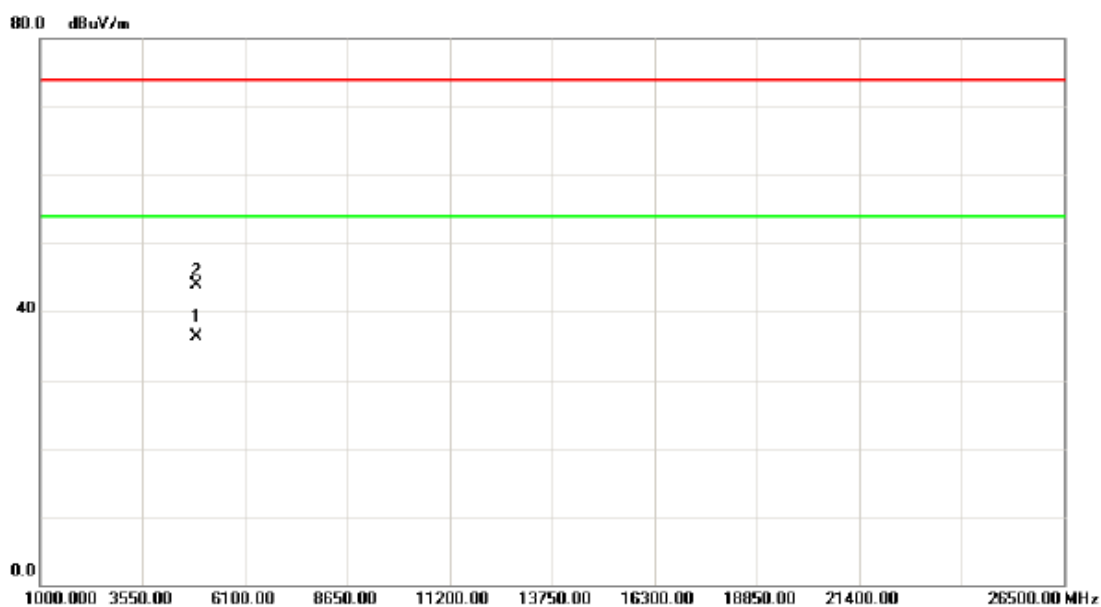

No.	Mk.	Freq. MHz	Reading Level dBuV	Correct Factor dB	Measure- ment dBuV/m	Limit dBuV/m	Margin dB	Detector	Comment
1	*	4881.910	32.49	3.73	36.22	54.00	-17.78	AVG	
2		4882.110	40.13	3.73	43.86	74.00	-30.14	peak	

Orthogonal Axis :	X
Test Mode :	TX 2441MHz _CH39_3Mbps

### Horizontal

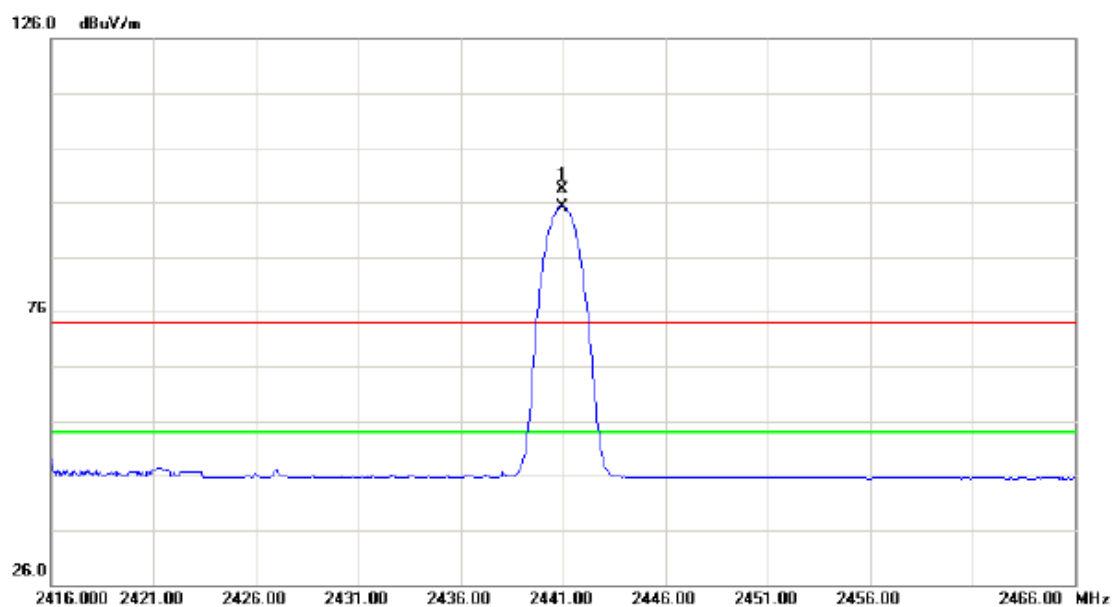

No.	Mk.	Freq. MHz	Reading Level dBuV	Correct Factor dB	Measure- ment dBuV/m	Limit dBuV/m	Margin dB	Detector	Comment
1	X	2440.950	66.50	31.95	98.45	74.00	24.45	peak	NO LIMIT
2	*	2440.950	63.24	31.95	95.19	54.00	41.19	AVG	NO LIMIT

Orthogonal Axis :	X
Test Mode :	TX 2441MHz _CH39_3Mbps

### Horizontal

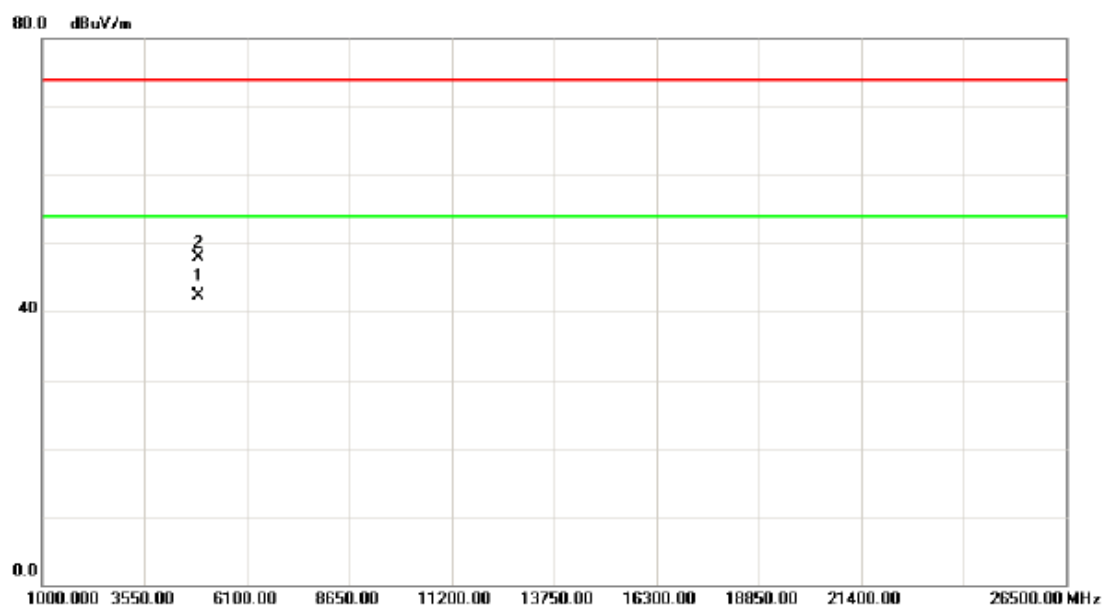

No.	Mk.	Freq. MHz	Reading Level dBuV	Correct Factor dB	Measure- ment dBuV/m	Limit dBuV/m	Margin dB	Detector	Comment
1	*	4881.790	38.51	3.73	42.24	54.00	-11.76	AVG	
2		4881.910	44.12	3.73	47.85	74.00	-26.15	peak	



Orthogonal Axis :	X
Test Mode :	TX 2480MHz _CH78_3Mbps

### Vertical

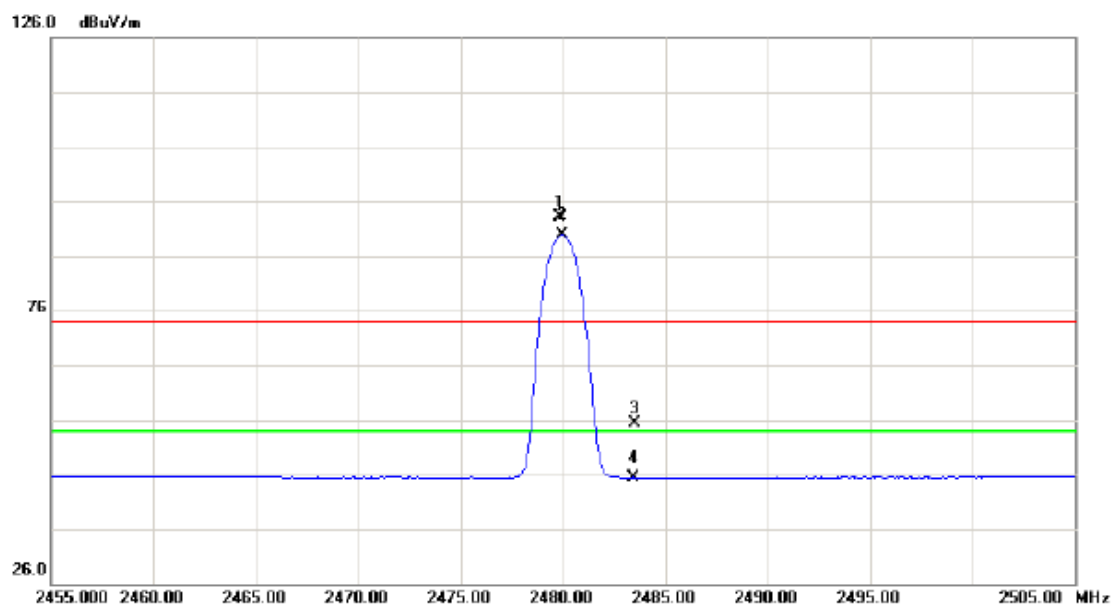

No.	Mk.	Freq. MHz	Reading Level dBuV	Correct Factor dB	Measure- ment dBuV/m	Limit dBuV/m	Margin dB	Detector	Comment
1	X	2479.850	61.12	32.00	93.12	74.00	19.12	peak	NO LIMIT
2	*	2479.950	57.84	32.00	89.84	54.00	35.84	AVG	NO LIMIT
3		2483.500	23.46	32.01	55.47	74.00	-18.53	peak	
4		2483.500	13.48	32.01	45.49	54.00	-8.51	AVG	

Orthogonal Axis :	X
Test Mode :	TX 2480MHz _CH78_3Mbps

### Vertical

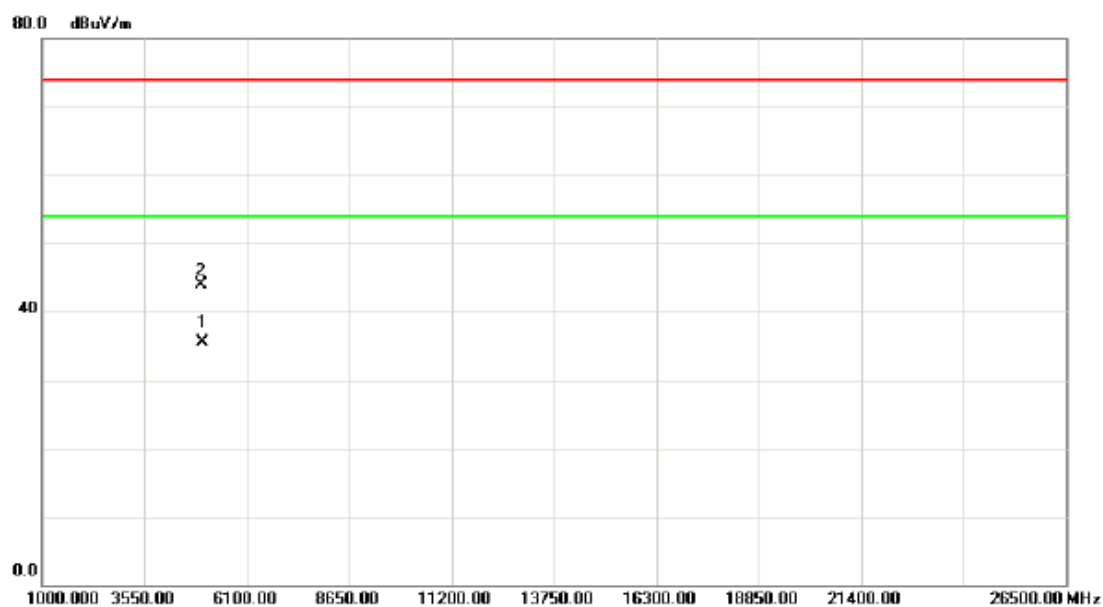

No.	Mk.	Freq. MHz	Reading Level dBuV	Correct Factor dB	Measure- ment dBuV/m	Limit dBuV/m	Margin dB	Detector	Comment
1	*	4959.940	31.63	3.88	35.51	54.00	-18.49	AVG	
2		4960.120	40.09	3.88	43.97	74.00	-30.03	peak	

Orthogonal Axis :	X
Test Mode :	TX 2480MHz _CH78_3Mbps

### Horizontal

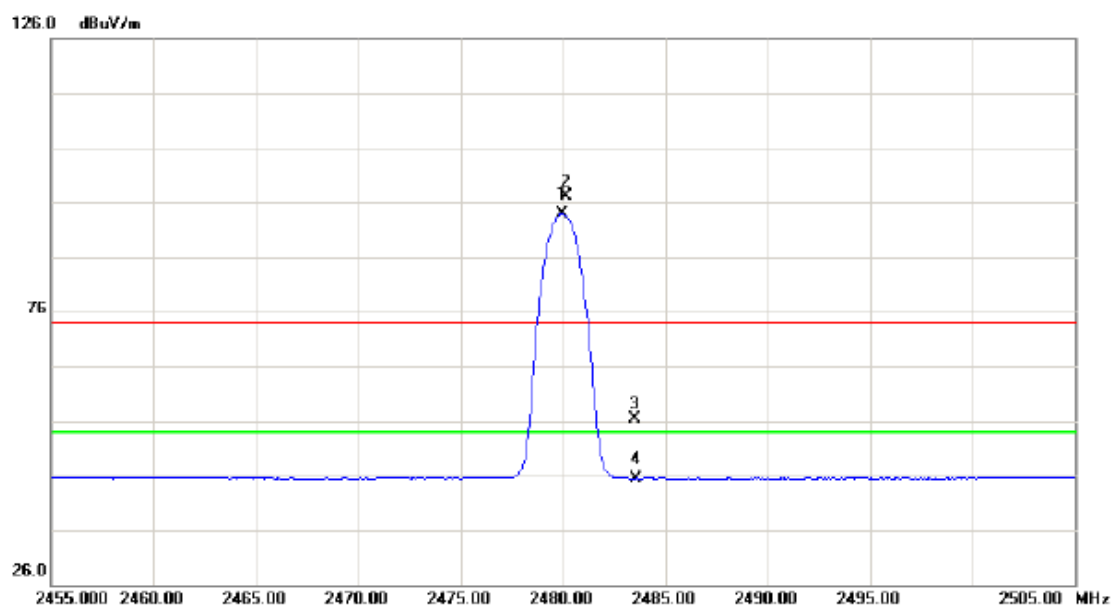

No.	Mk.	Freq. MHz	Reading Level dBuV	Correct Factor dB	Measure- ment dBuV/m	Limit dBuV/m	Margin dB	Detector	Comment
1	*	2479.950	61.85	32.00	93.85	54.00	39.85	AVG	NO LIMIT
2	X	2480.150	65.17	32.00	97.17	74.00	23.17	peak	NO LIMIT
3		2483.500	24.40	32.01	56.41	74.00	-17.59	peak	
4		2483.500	13.48	32.01	45.49	54.00	-8.51	AVG	

Orthogonal Axis :	X
Test Mode :	TX 2480MHz _CH78_3Mbps

### Horizontal

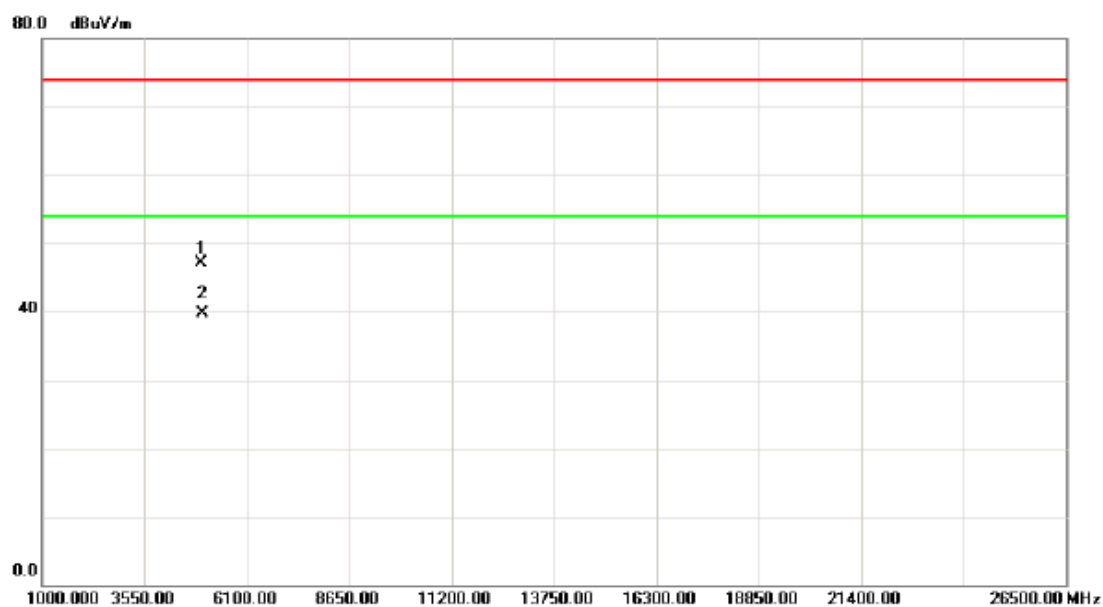

No.	Mk.	Freq. MHz	Reading Level dBuV	Correct Factor dB	Measure- ment dBuV/m	Limit dBuV/m	Margin dB	Detector	Comment
1		4959.850	43.22	3.88	47.10	74.00	-26.90	peak	
2	*	4959.920	35.84	3.88	39.72	54.00	-14.28	AVG	

## **ATTACHMENT E - NUMBER OF HOPPING CHANNEL**

**Test Mode**      **Hopping Mode\_1Mbps**  
 Number of Hopping Channel      79

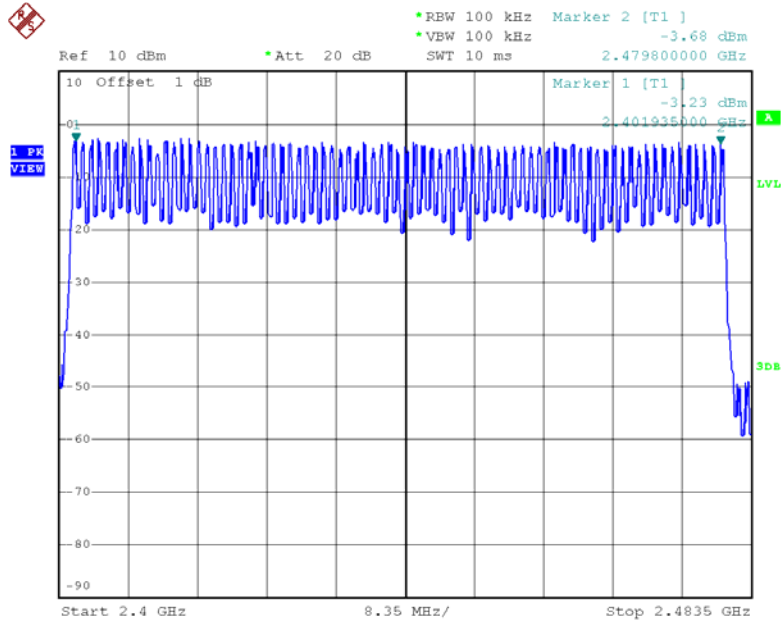

Date: 25.JUN.2015 16:41:12

**Test Mode**      **Hopping Mode\_3Mbps**  
 Number of Hopping Channel      79

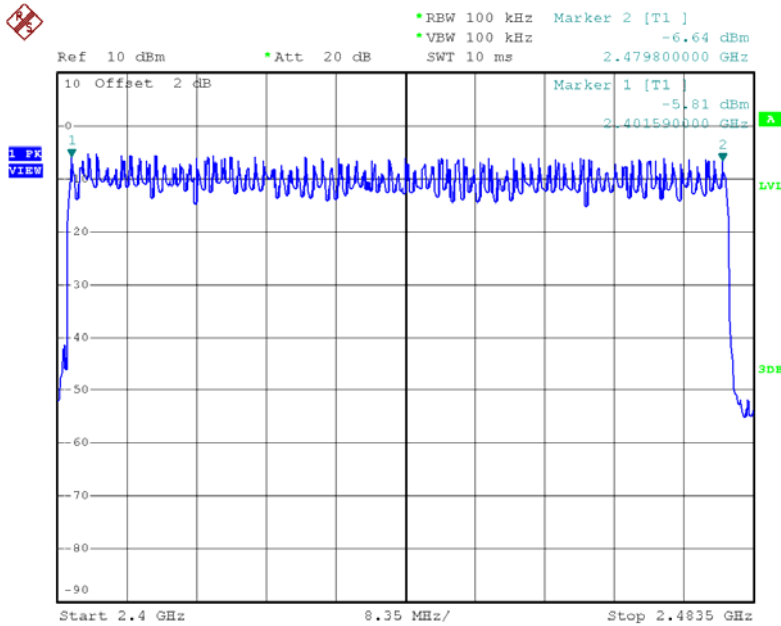

Date: 25.JUN.2015 16:58:45

## ATTACHMENT F - AVERAGE TIME OF OCCUPANCY

Test Mode :	TX Mode_1Mbps
-------------	---------------

Data Packet	Frequency (MHz)	Pulse Duration (ms)	Dwell Time (s)	Limits (s)	Test Result
DH5	2402	3.0790	0.3284	0.4000	Complies
DH3	2402	1.7800	0.2848	0.4000	Complies
DH1	2402	0.4290	0.1373	0.4000	Complies
DH5	2441	3.0390	0.3242	0.4000	Complies
DH3	2441	1.7390	0.2782	0.4000	Complies
DH1	2441	0.4240	0.1357	0.4000	Complies
DH5	2480	3.1190	0.3327	0.4000	Complies
DH3	2480	1.7790	0.2846	0.4000	Complies
DH1	2480	0.4290	0.1373	0.4000	Complies



### CH00-DH1

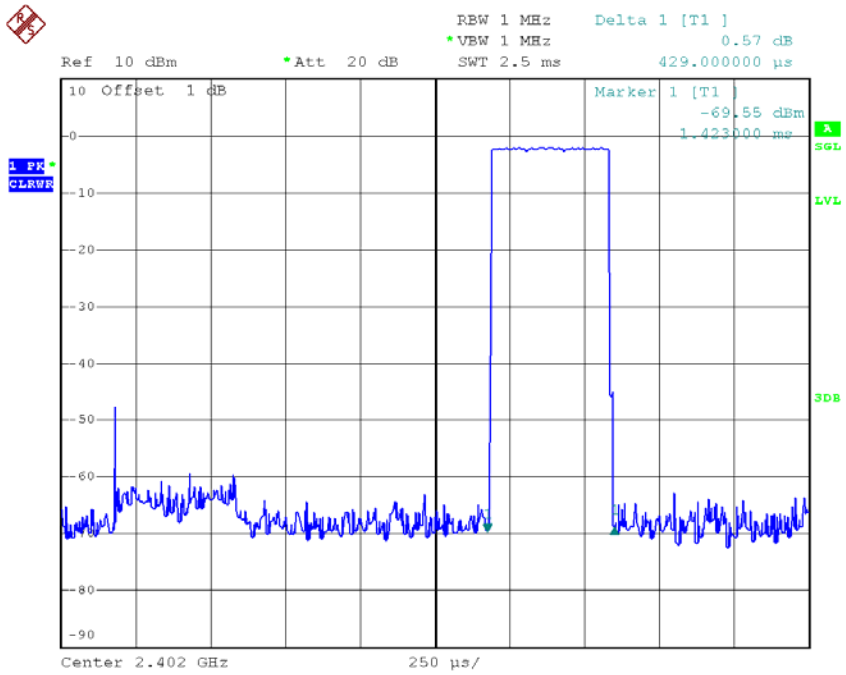

Date: 25.JUN.2015 16:35:35

### CH00-DH3

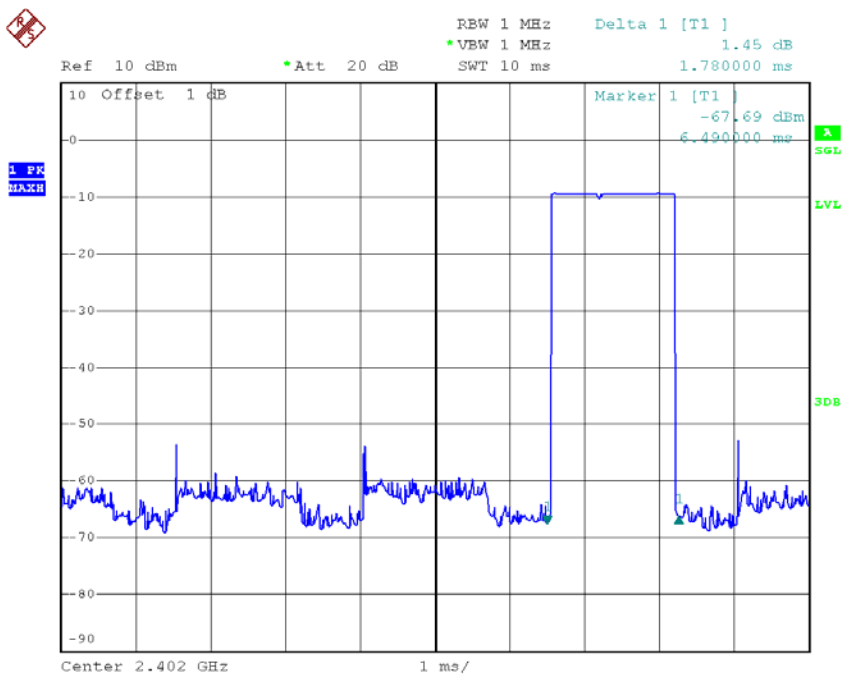

Date: 25.JUN.2015 16:43:00



### CH39-DH3

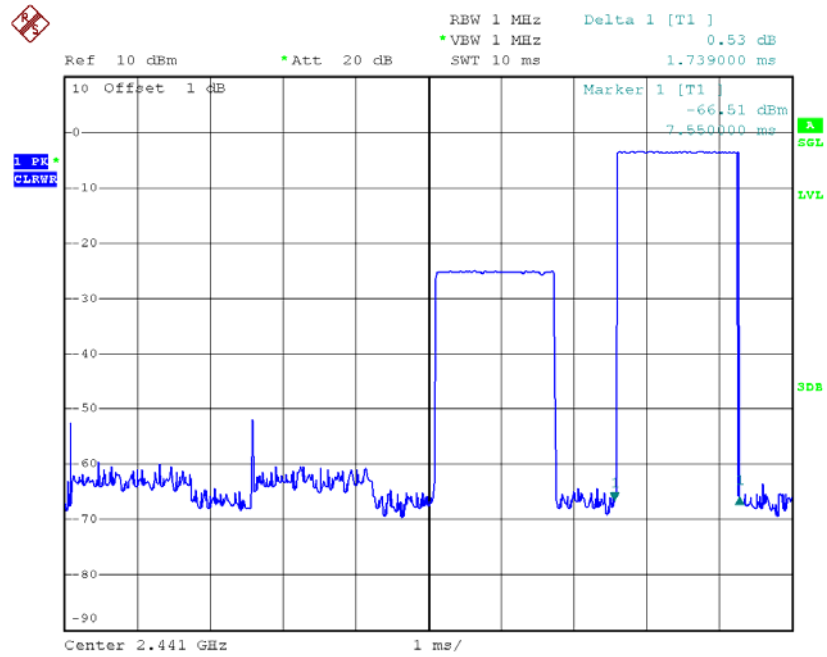

Date: 25.JUN.2015 16:43:11

### CH39-DH5

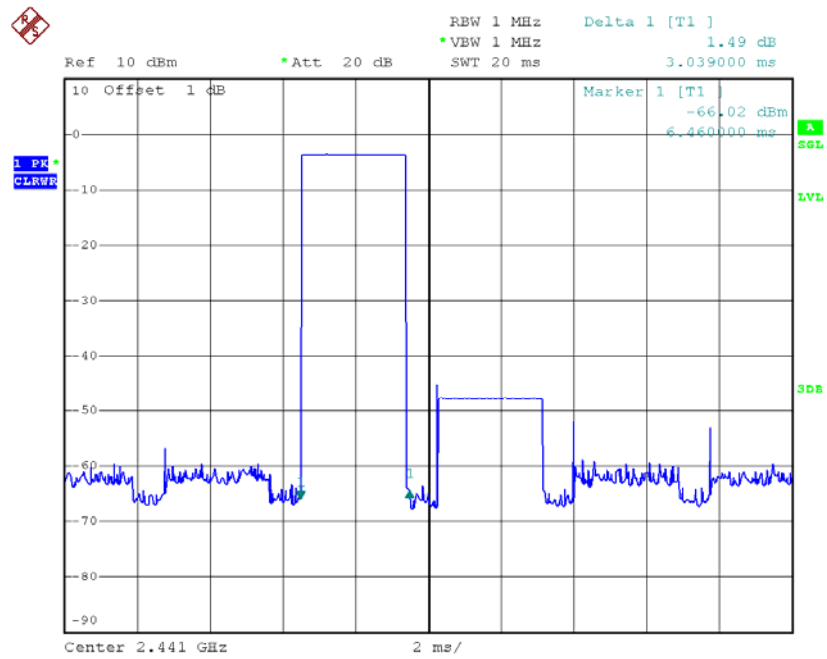

Date: 25.JUN.2015 16:44:04

### CH78-DH1

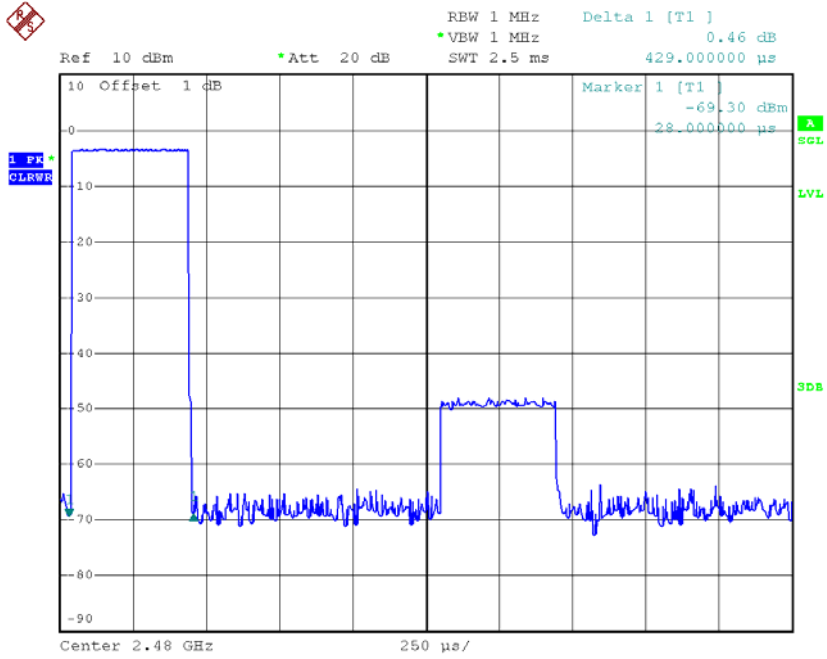

Date: 25.JUN.2015 16:36:03

### CH78-DH3

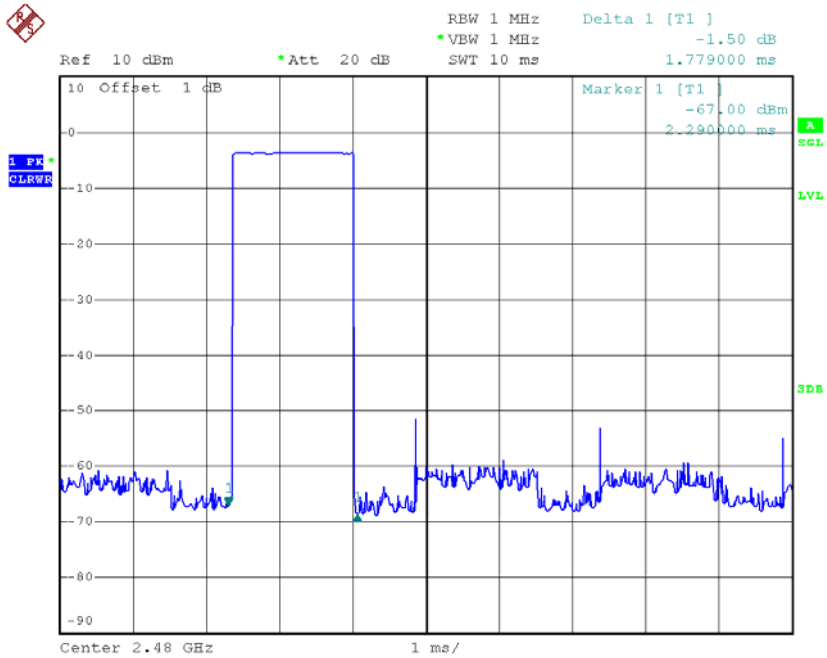

Date: 25.JUN.2015 16:43:27

### CH78-DH5

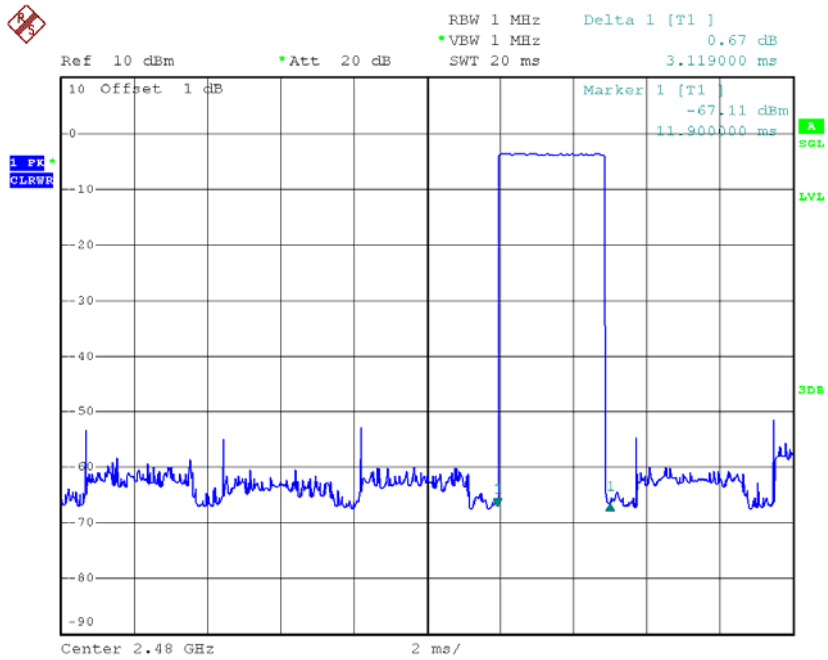

Date: 25.JUN.2015 16:44:22

Test Mode :	TX Mode_3Mbps
-------------	---------------

Data Packet	Frequency (MHz)	Pulse Duration (ms)	Dwell Time (s)	Limits (s)	Test Result
DH5	2402	3.1990	0.3412	0.4000	Complies
DH3	2402	1.7390	0.2782	0.4000	Complies
DH1	2402	0.4440	0.1421	0.4000	Complies
DH5	2441	3.0790	0.3284	0.4000	Complies
DH3	2441	1.7390	0.2782	0.4000	Complies
DH1	2441	0.4340	0.1389	0.4000	Complies
DH5	2480	3.0790	0.3284	0.4000	Complies
DH3	2480	1.7390	0.2782	0.4000	Complies
DH1	2480	0.4390	0.1405	0.4000	Complies

### CH00-DH1

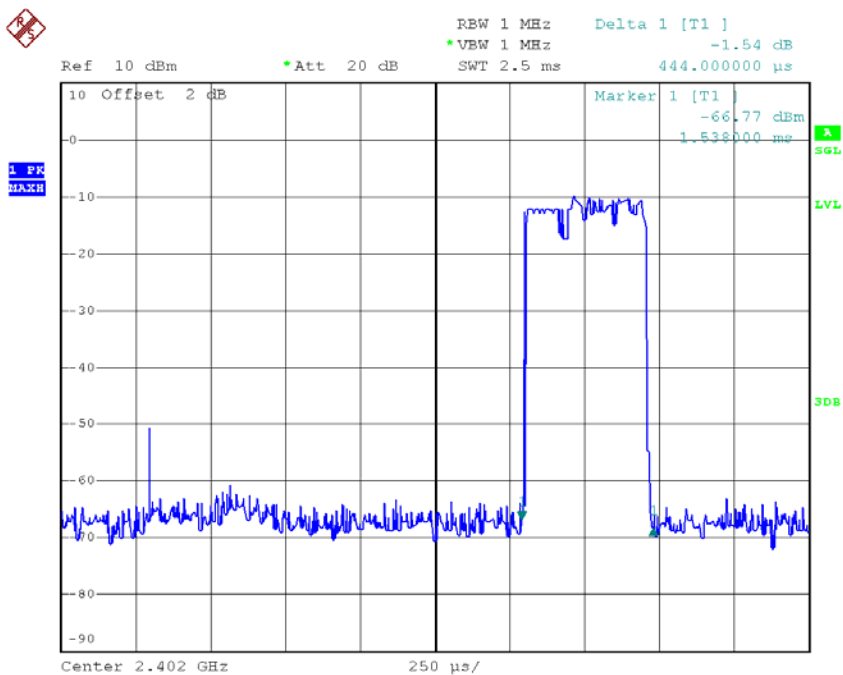

Date: 25.JUN.2015 16:53:10

### CH00-DH3

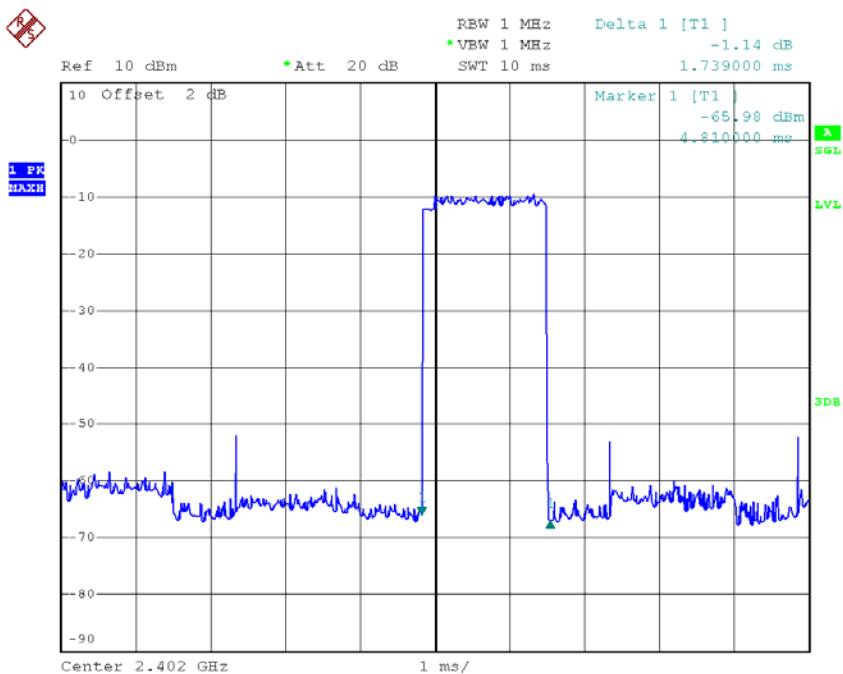

Date: 25.JUN.2015 17:00:33

### CH00-DH5

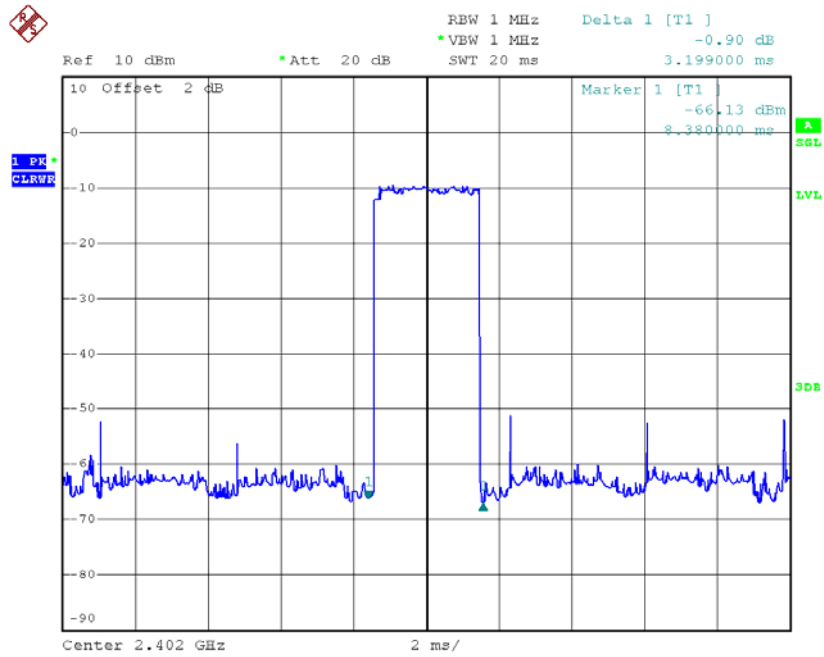

Date: 25.JUN.2015 17:01:36

### CH39-DH1

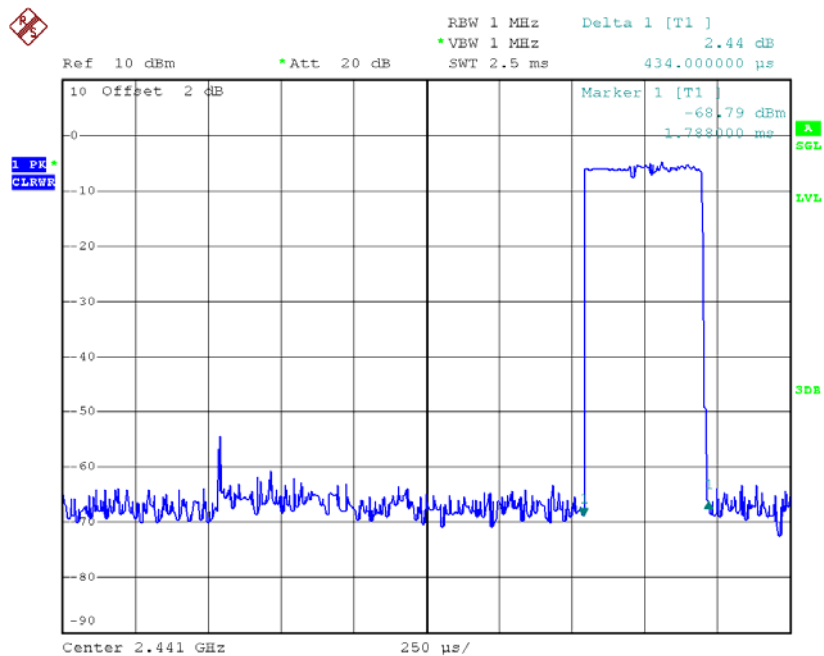

Date: 25.JUN.2015 16:53:27



### CH39-DH3

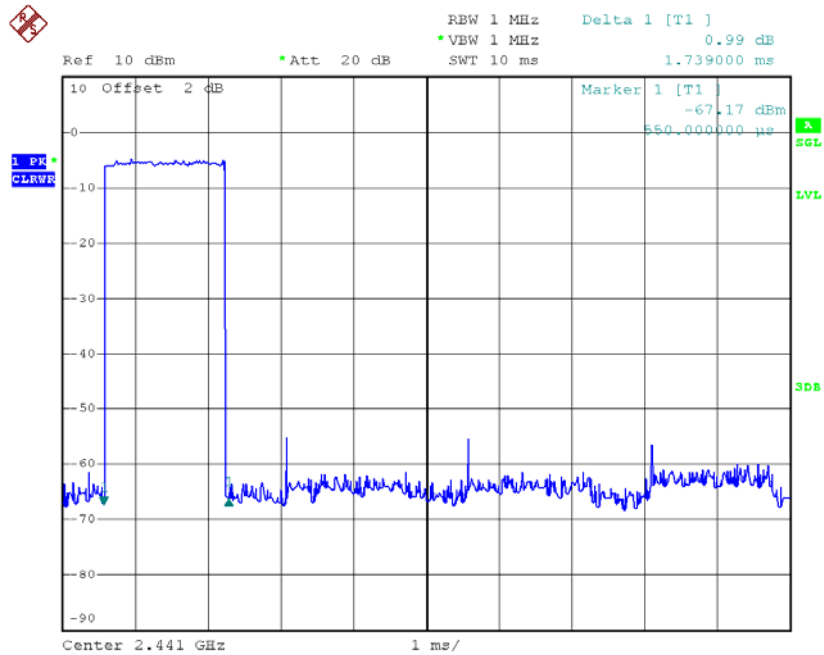

Date: 25.JUN.2015 17:00:43

### CH39-DH5

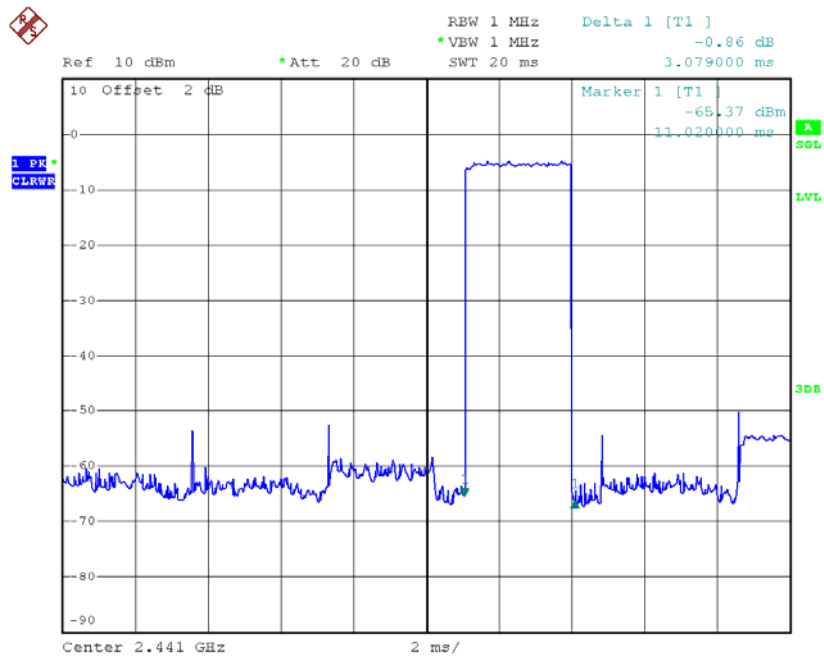

Date: 25.JUN.2015 17:01:48

### CH78-DH1

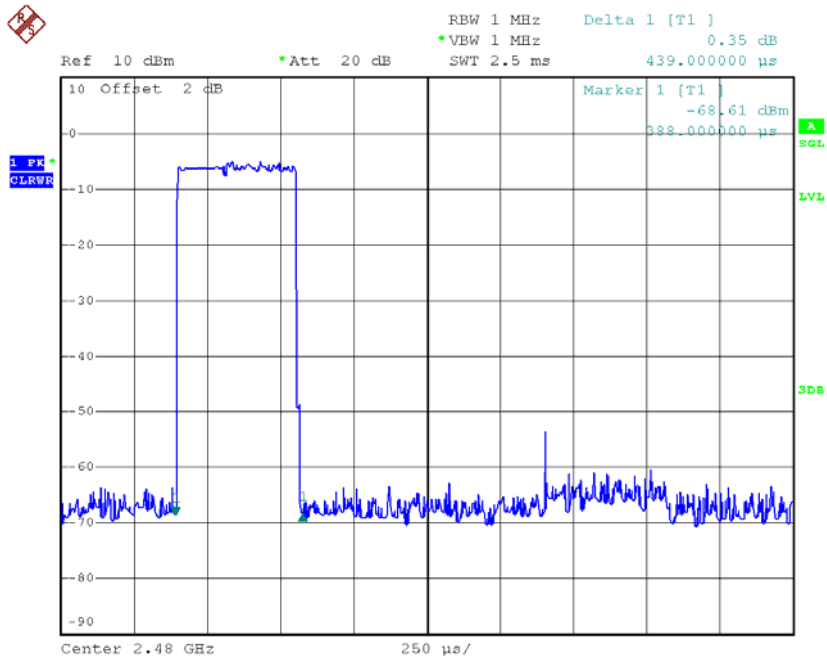

Date: 25.JUN.2015 16:53:35

### CH78-DH3

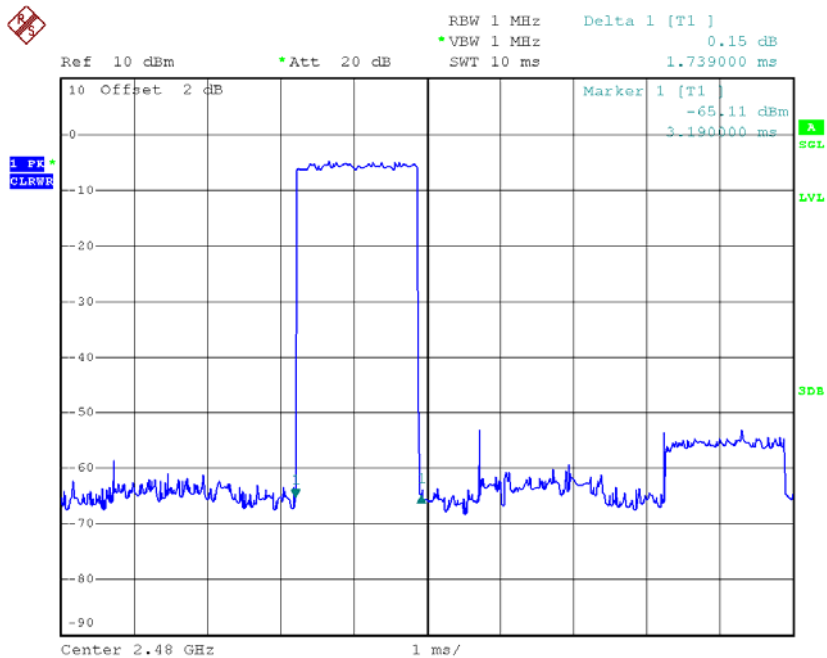

Date: 25.JUN.2015 17:01:02

### CH78-DH5

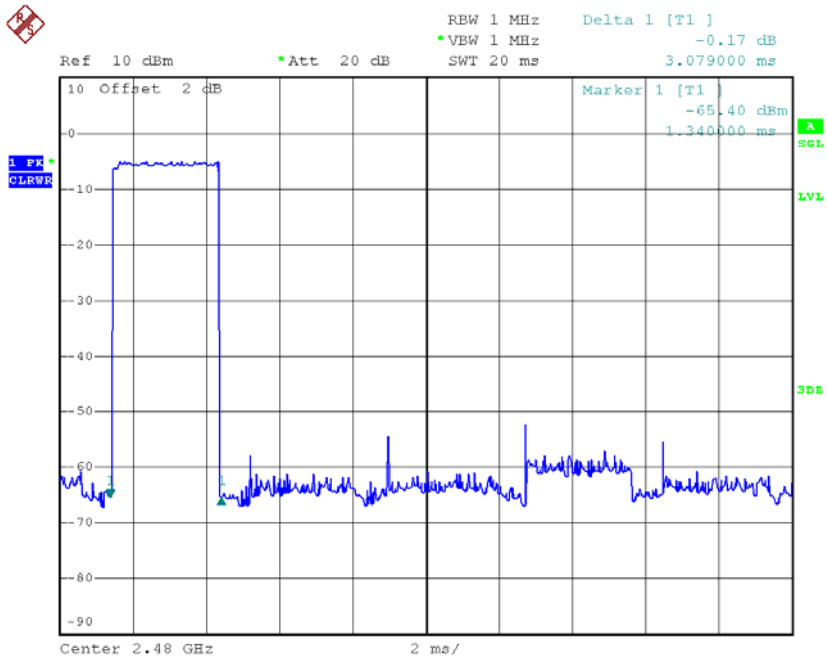

Date: 25.JUN.2015 17:02:03

## **ATTACHMENT G - HOPPING CHANNEL SEPARATION MEASUREMENT**

Test Mode : Hopping on \_1Mbps

Frequency (MHz)	Channel Separation (MHz)	2/3 of 20dB Bandwidth (MHz)	Test Result
2402	0.996	0.695	Complies
2441	0.996	0.693	Complies
2480	1.019	0.692	Complies

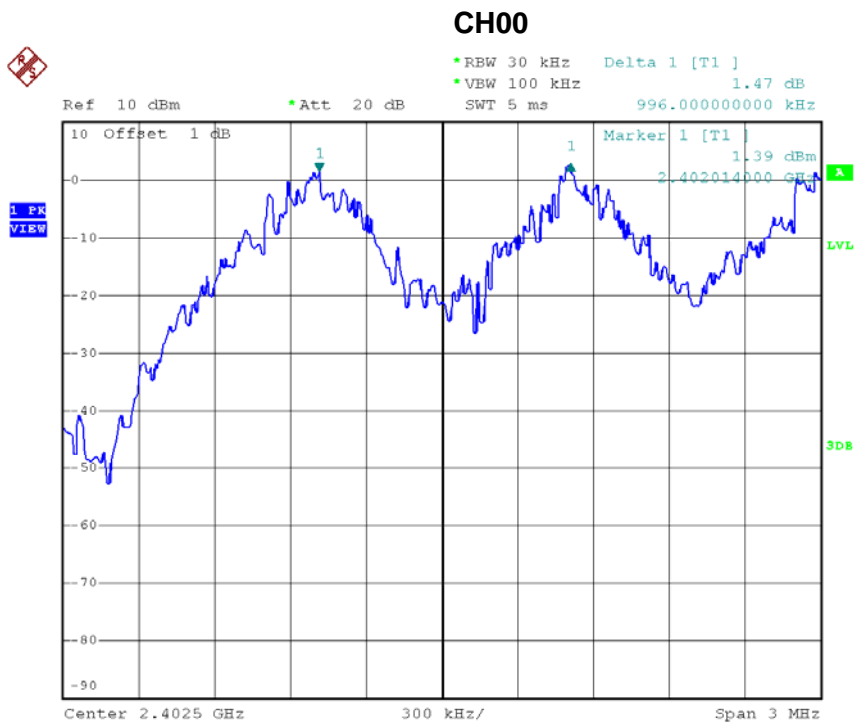

Date: 25.JUN.2015 16:27:06

### CH39

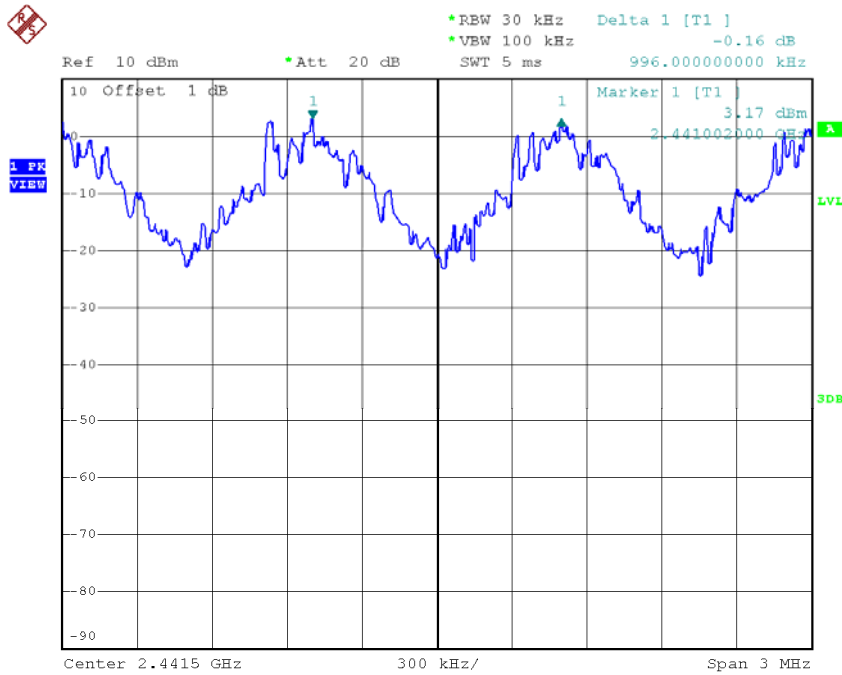

Date: 25.JUN.2015 16:27:06

### CH78

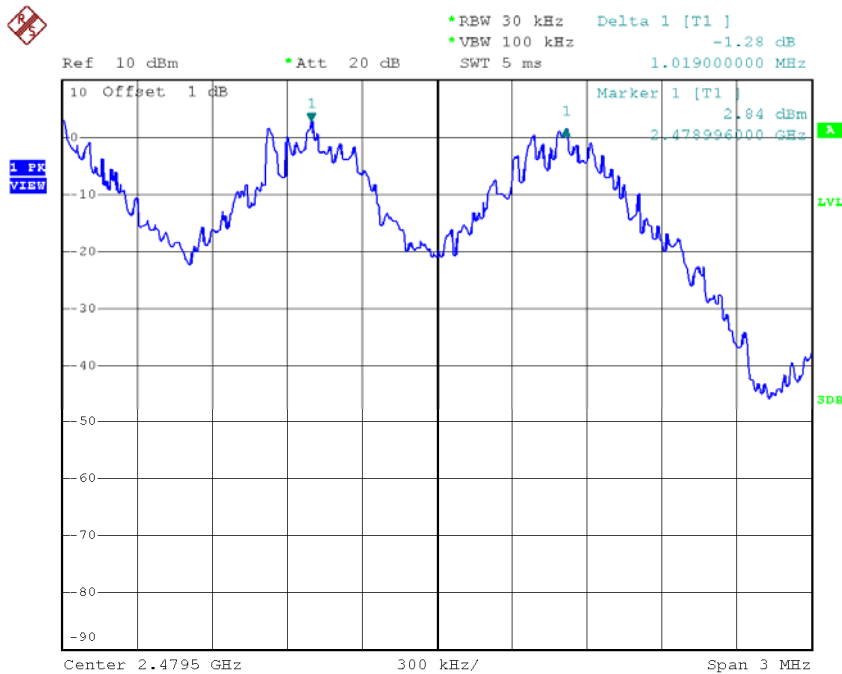

Date: 25.JUN.2015 16:27:06

Test Mode : Hopping on \_3Mbps

Frequency (MHz)	Channel Separation (MHz)	2/3 of 20dB Bandwidth (MHz)	Test Result
2402	0.843	0.913	Complies
2441	1.001	0.916	Complies
2480	1.002	0.916	Complies

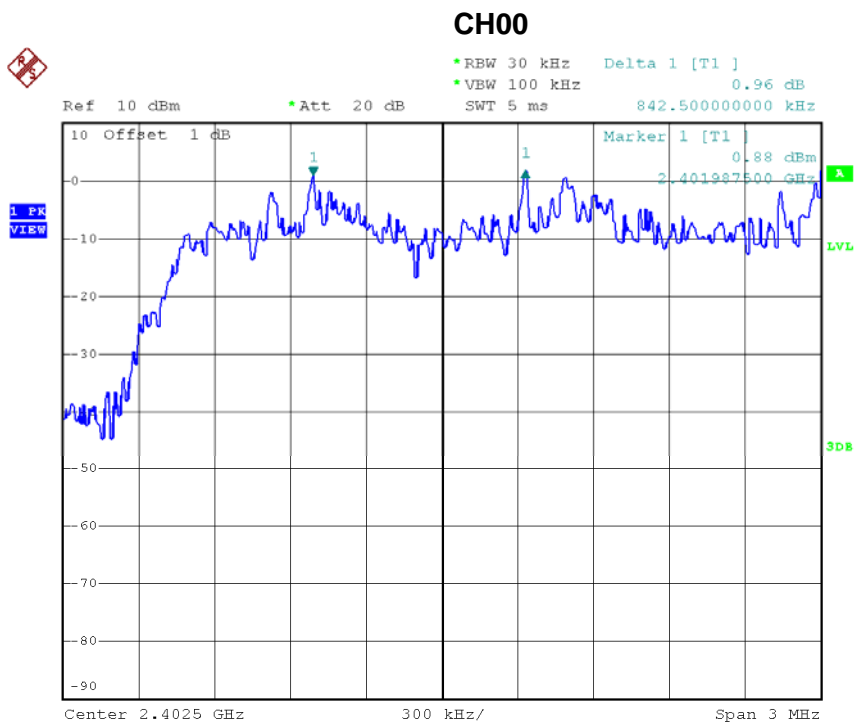

Date: 25.JUN.2015 16:27:06

### CH39

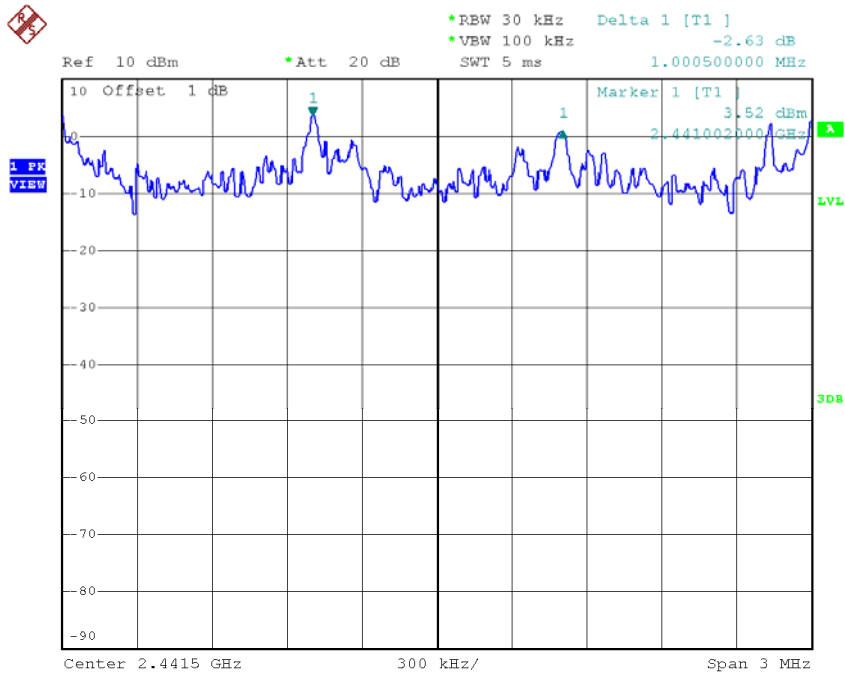

Date: 25.JUN.2015 16:27:06

### CH78

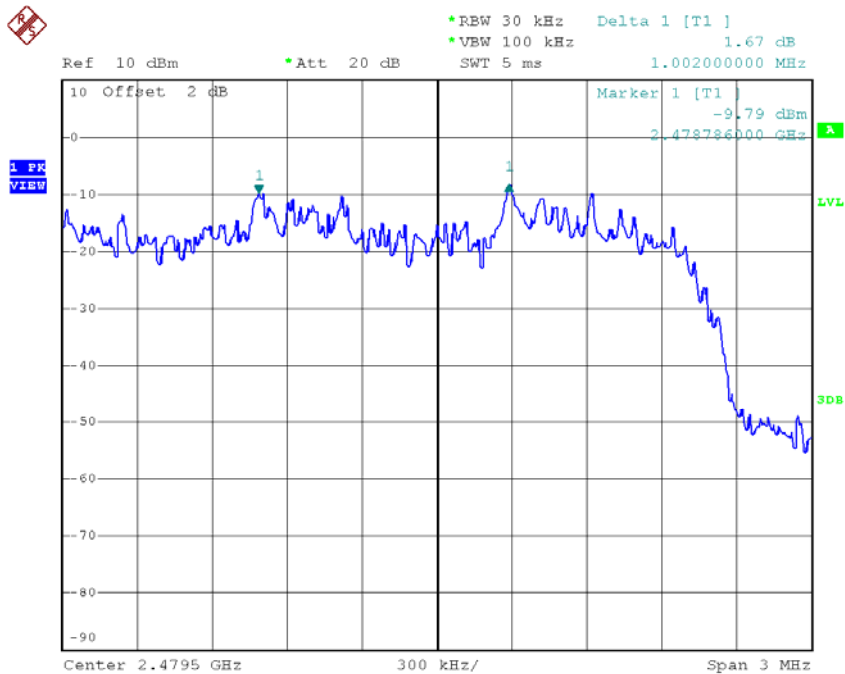

Date: 25.JUN.2015 16:56:57



## ATTACHMENT H - BANDWIDTH

Test Mode : TX Mode \_1Mbps

Frequency (MHz)	20dB Bandwidth (MHz)	99% Occupied BW (MHz)	Test Result
2402	1.042	0.916	Complies
2441	1.040	0.916	Complies
2480	1.038	0.912	Complies

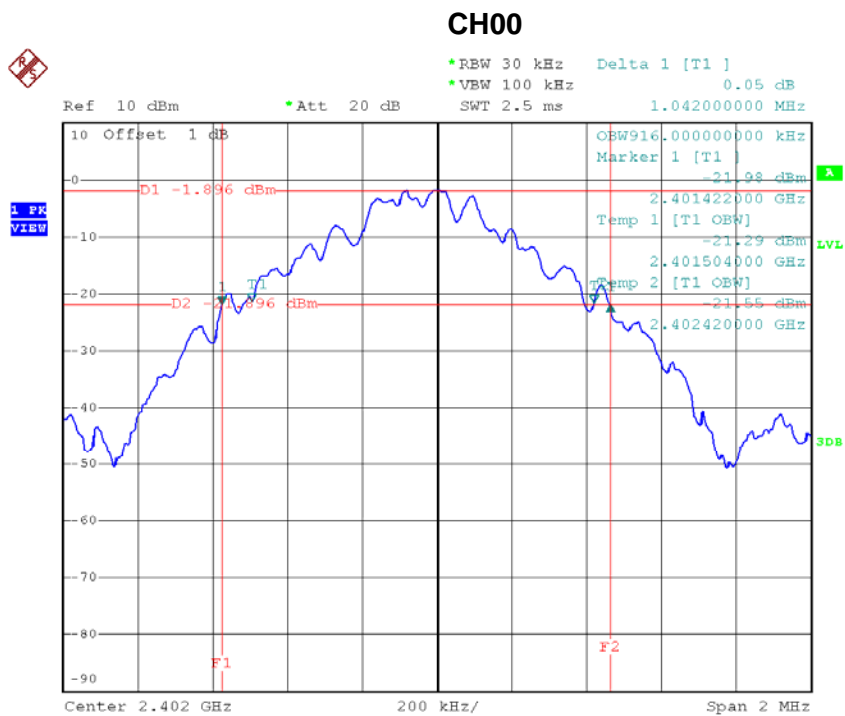

Date: 25.JUN.2015 16:26:52

### CH39

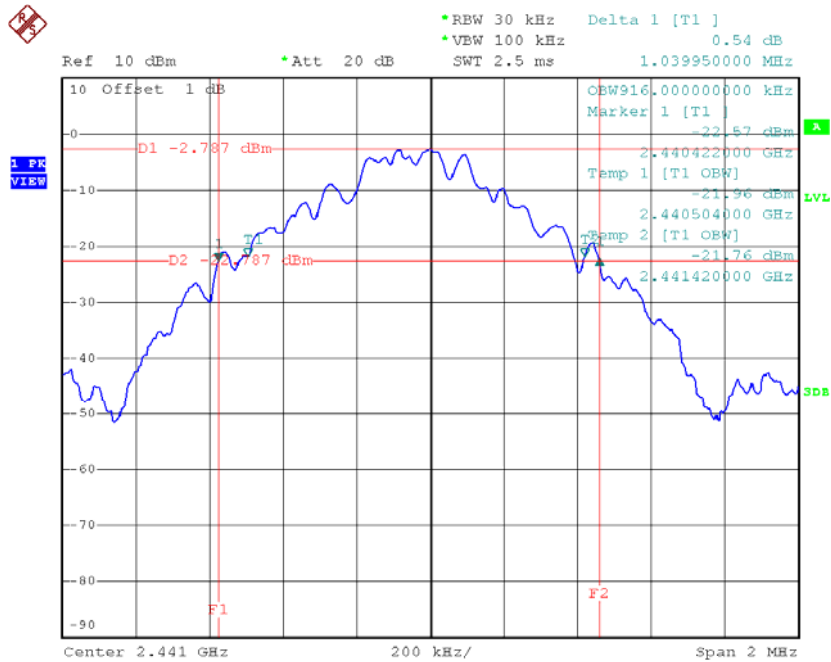

Date: 25.JUN.2015 16:28:02

### CH78

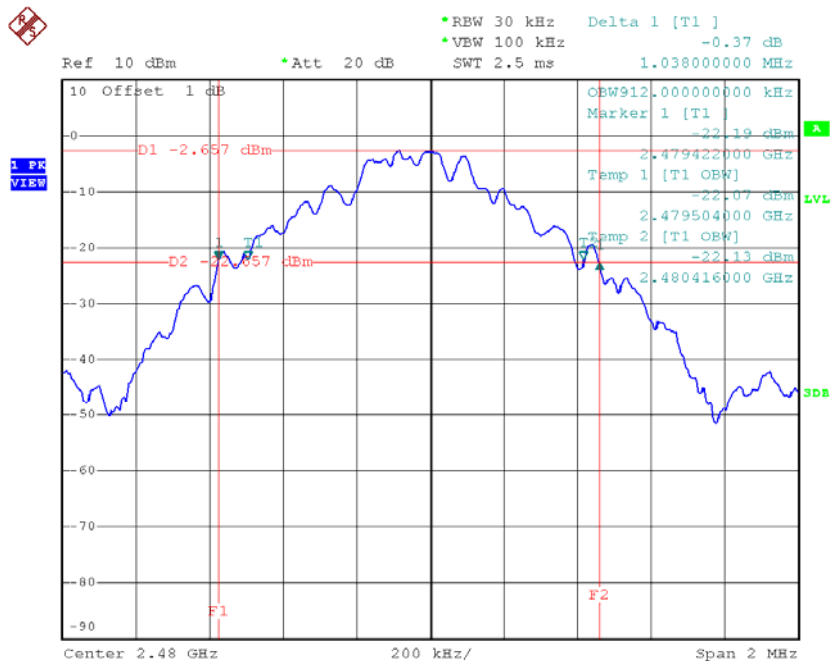

Date: 25.JUN.2015 16:28:51

Test Mode : TX Mode\_3Mbps

Frequency (MHz)	20dB Bandwidth (MHz)	99% Occupied BW (MHz)	Test Result
2402	1.370	1.236	Complies
2441	1.374	1.236	Complies
2480	1.374	1.236	Complies

### CH00

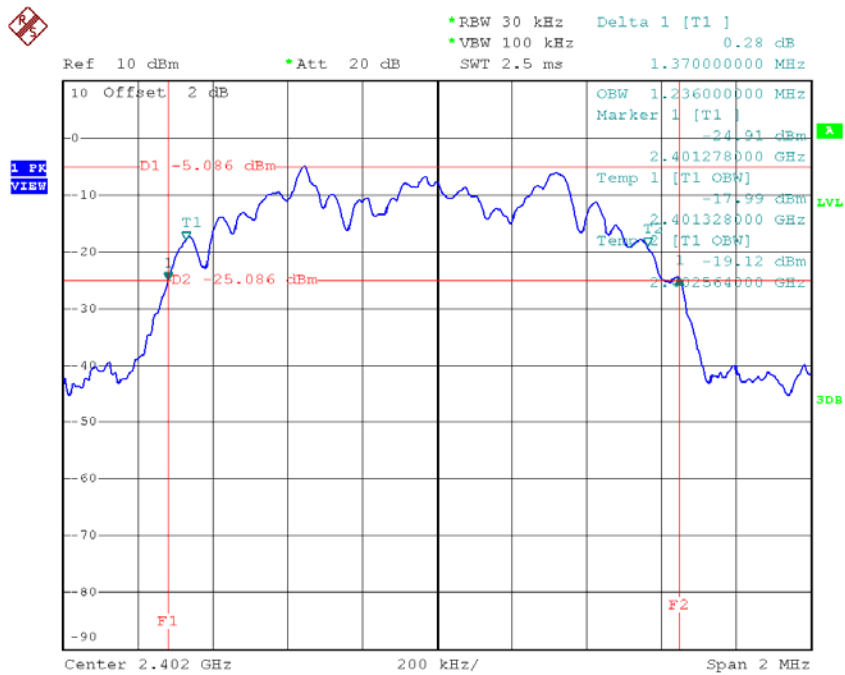

Date: 25.JUN.2015 16:49:30

### CH39

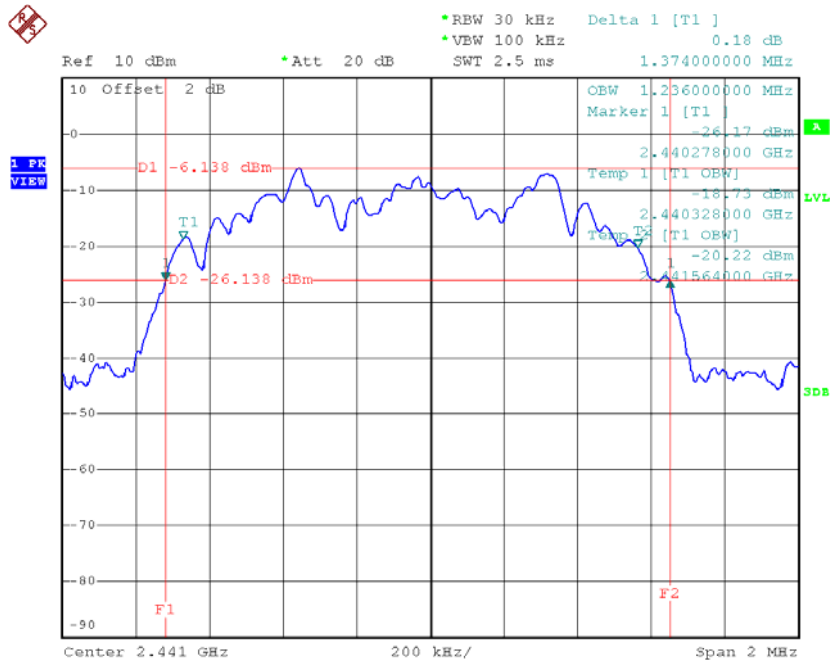

Date: 25.JUN.2015 16:50:45

### CH78

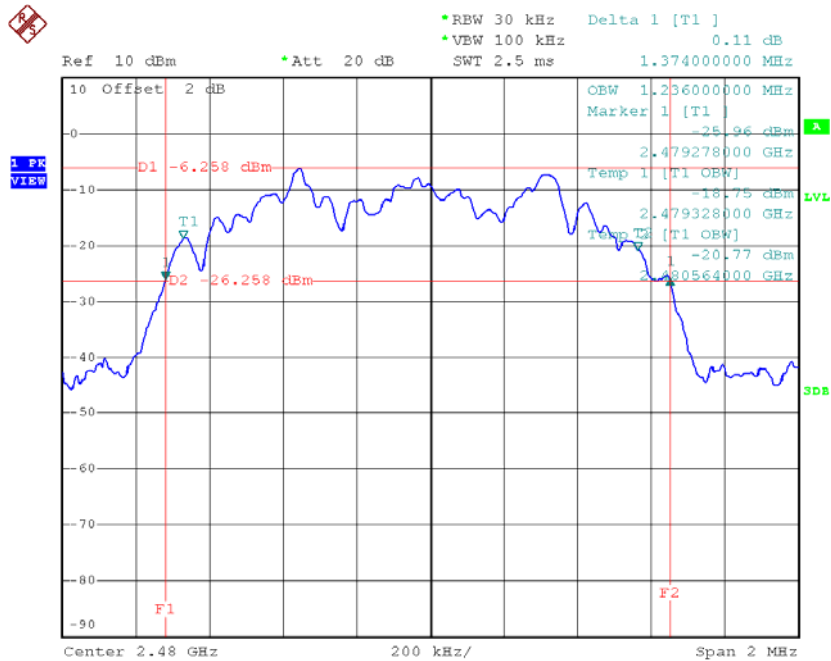

Date: 25.JUN.2015 16:51:56

## ATTACHMENT I - PEAK OUTPUT POWER

Test Mode : TX Mode \_1Mbps

Frequency (MHz)	Conducted Power (dBm)	Conducted Power (Watt)	Max. Limit (dBm)	Max. Limit (Watt)	Test Result
2402	1.77	0.0015	30.00	1.0000	Complies
2441	2.14	0.0016	30.00	1.0000	Complies
2480	2.08	0.0016	30.00	1.0000	Complies

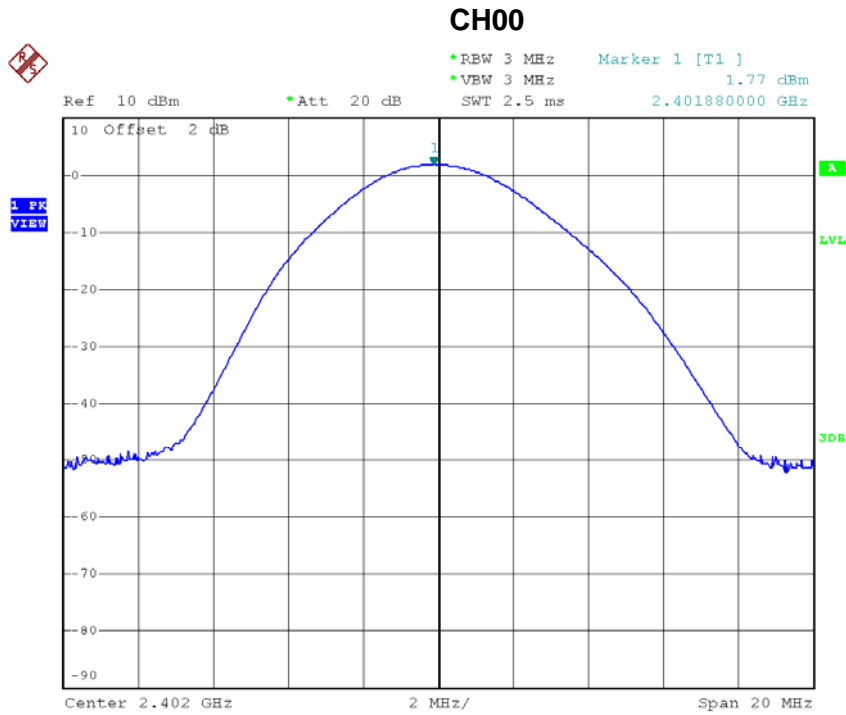

Date: 25.JUN.2015 16:21:42

### CH39

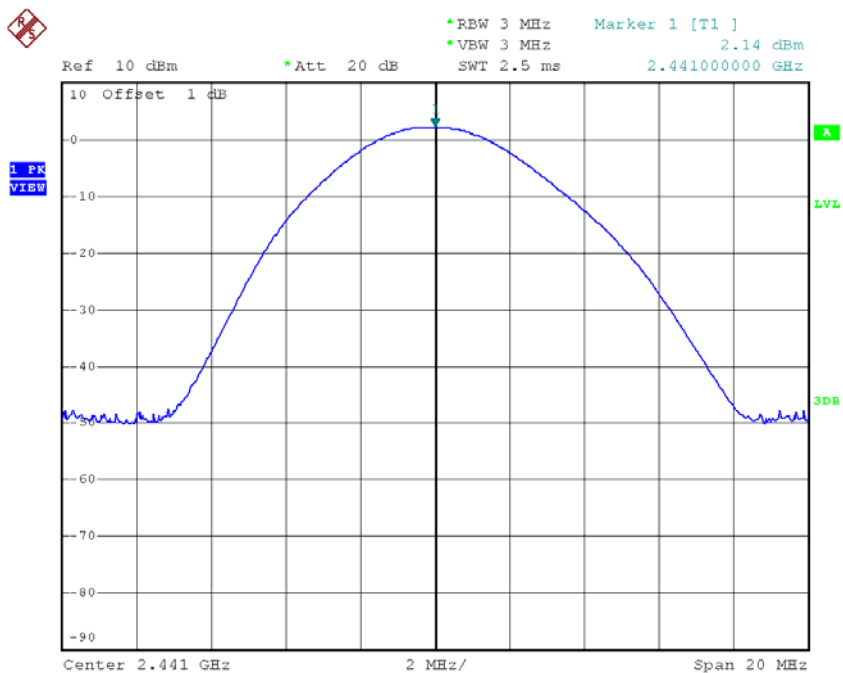

Date: 25.JUN.2015 16:24:18

### CH78

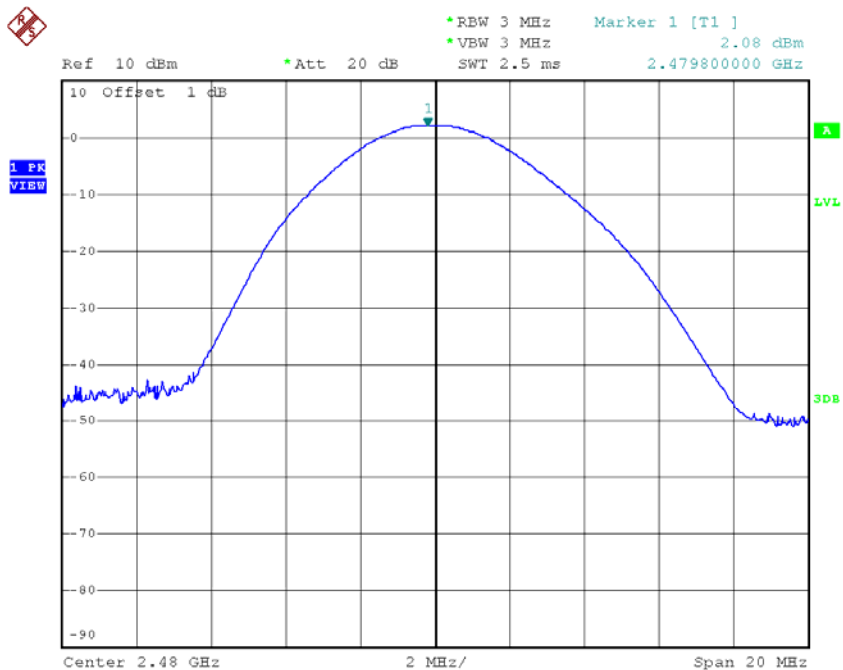

Date: 25.JUN.2015 16:24:55



Test Mode : TX Mode \_3Mbps

Frequency (MHz)	Conducted Power (dBm)	Conducted Power (Watt)	Max. Limit (dBm)	Max. Limit (Watt)	Test Result
2402	2.42	0.0017	30.00	1.0000	Complies
2441	2.30	0.0017	30.00	1.0000	Complies
2480	1.95	0.0016	30.00	1.0000	Complies

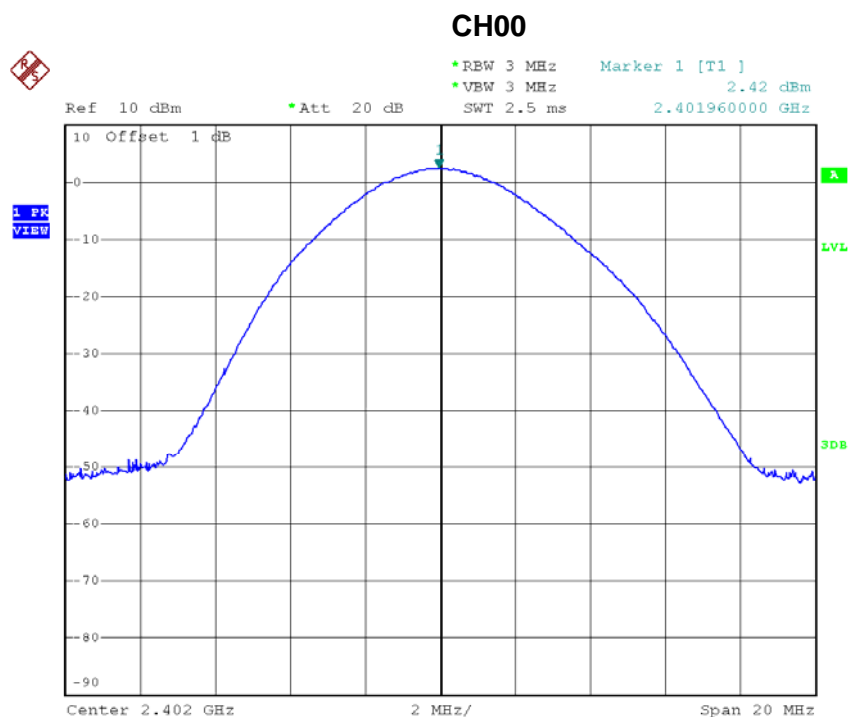

Date: 25.JUN.2015 16:45:54

### CH39

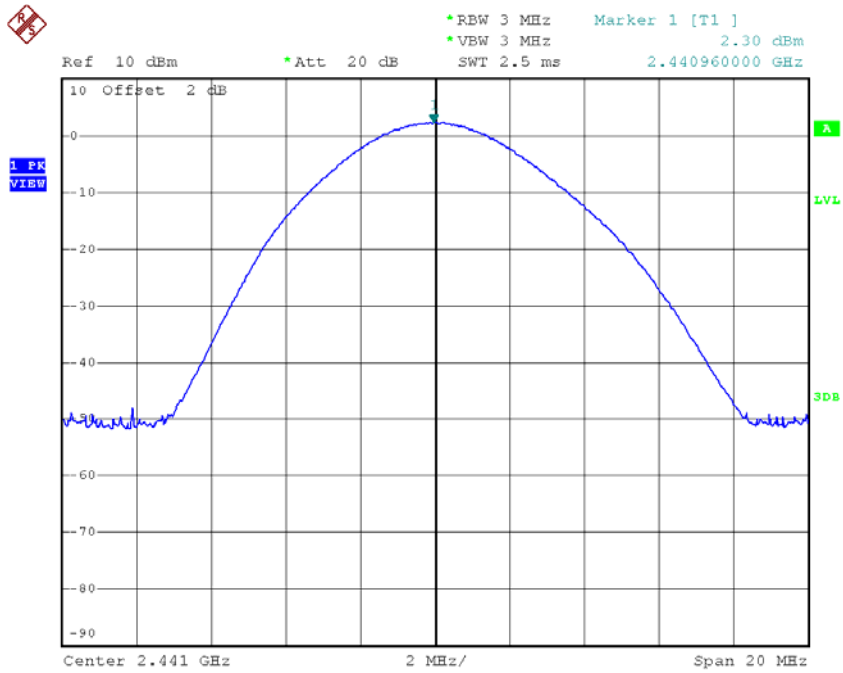

Date: 25.JUN.2015 16:46:47

### CH78

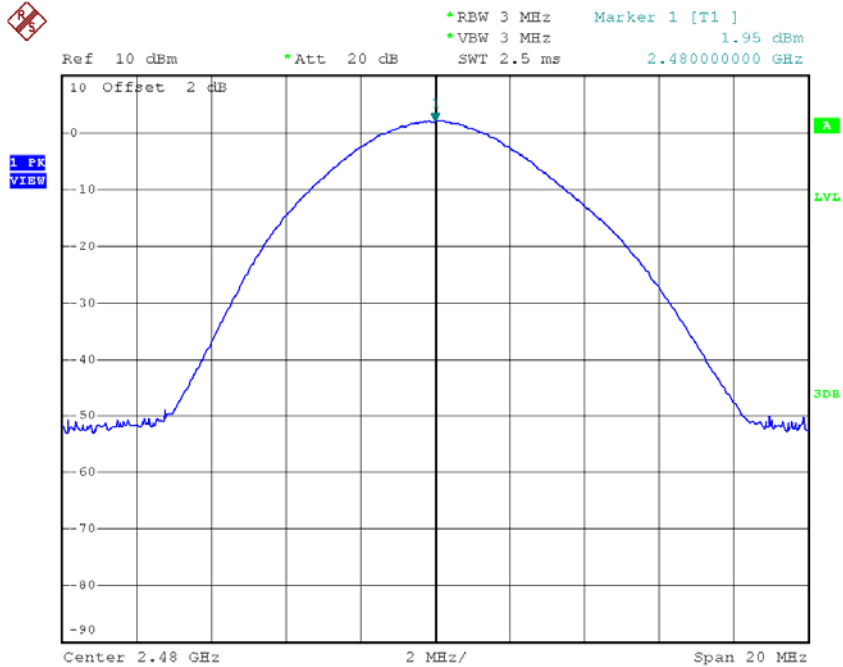

Date: 25.JUN.2015 16:47:41

## **ATTACHMENT J - ANTENNA CONDUCTED SPURIOUS EMISSION**

### CH00 (Lower)\_1Mbps

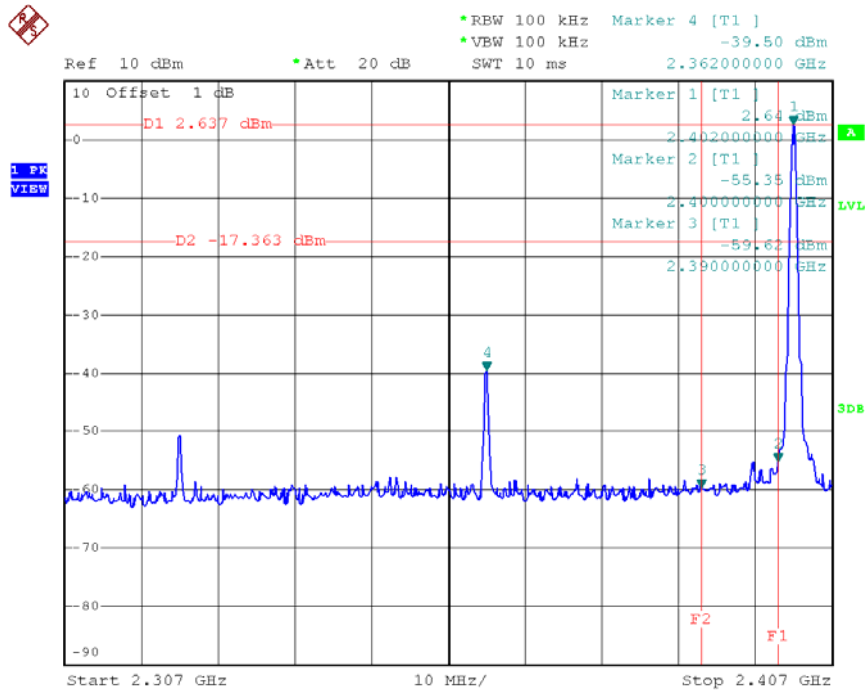

Date: 25.JUN.2015 16:26:25

### CH78 (Upper)\_1Mbps

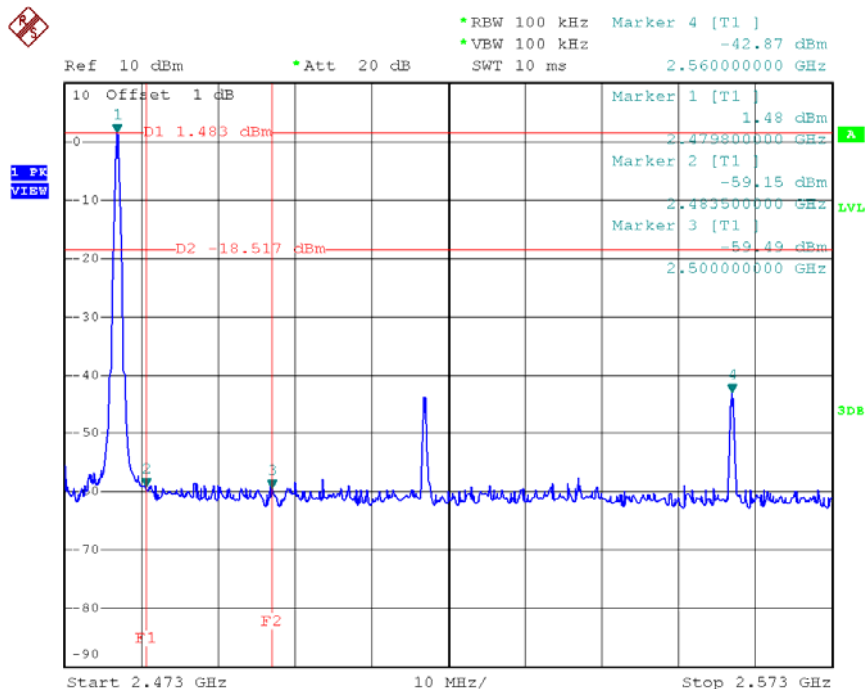

Date: 25.JUN.2015 16:28:26

### CH00 Hopping on mode (Lower)\_1Mbps

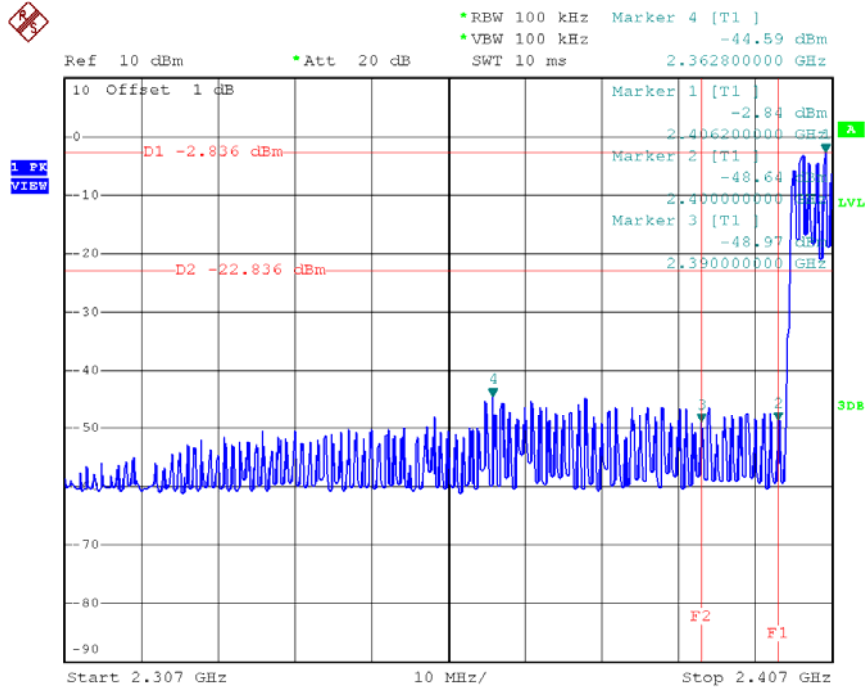

Date: 25.JUN.2015 16:41:53

### CH78 Hopping on mode (Upper)\_1Mbps

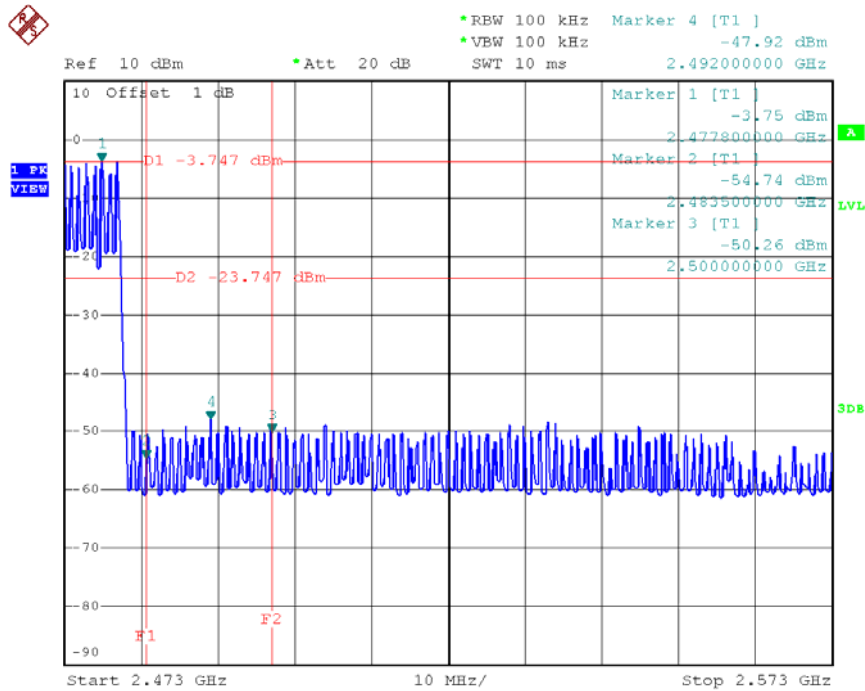

Date: 25.JUN.2015 16:42:34



### CH78 (10 Harmonic of the frequency) \_1Mbps

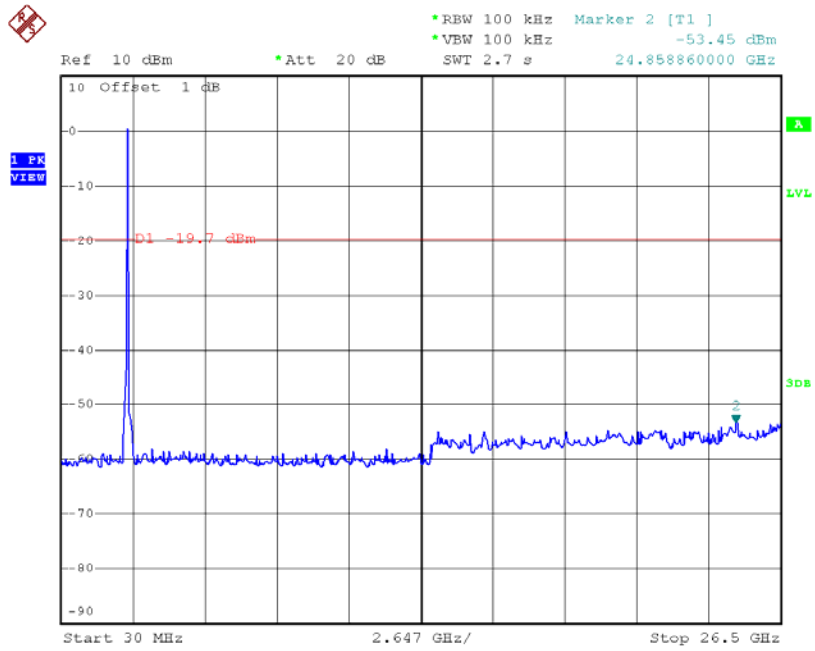

Date: 25.JUN.2015 16:29:05

### CH00 (Lower) \_3Mbps

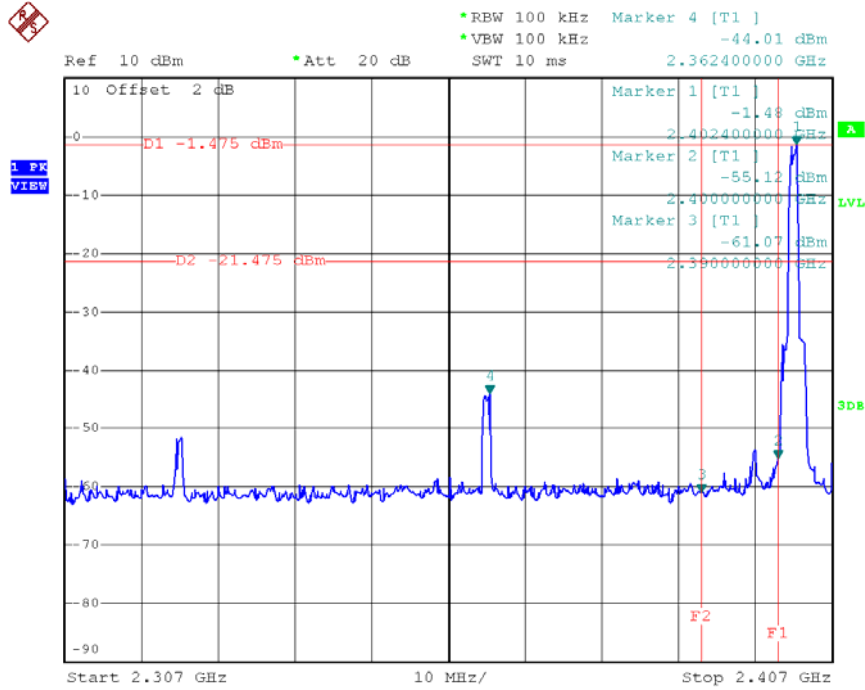

Date: 25.JUN.2015 16:49:11

### CH78 (Upper) \_3Mbps

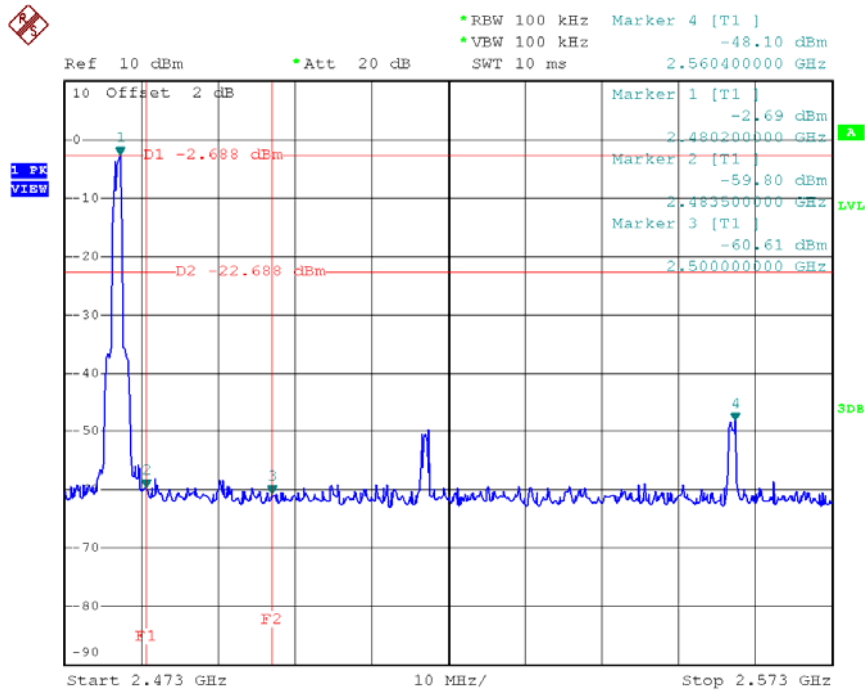

Date: 25.JUN.2015 16:51:37



### CH00 Hopping on mode (Lower)\_3Mbps

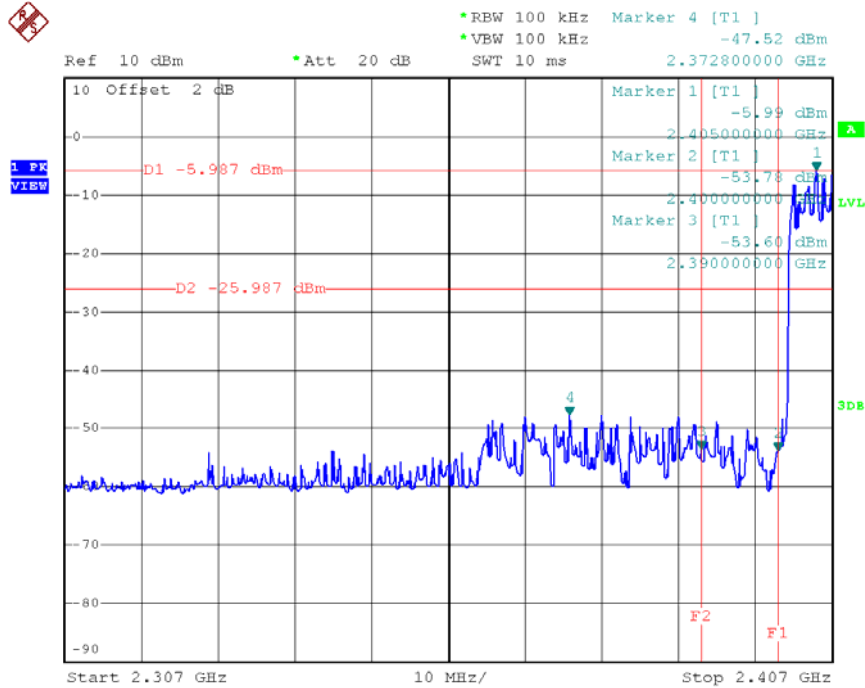

Date: 25.JUN.2015 16:59:22

### CH78 Hopping on mode (Upper)\_3Mbps

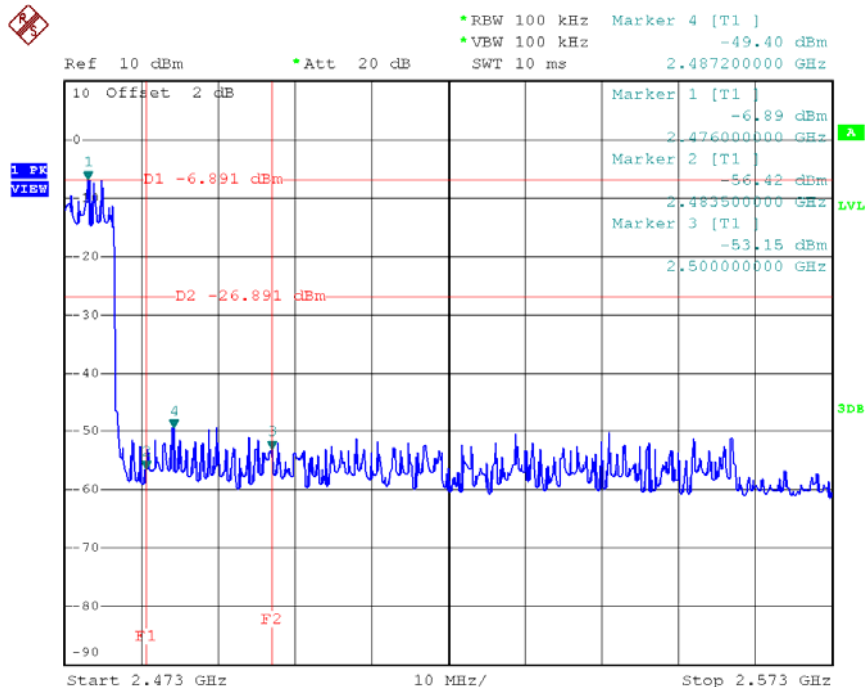

Date: 25.JUN.2015 17:03:02

### CH00 (10 Harmonic of the frequency) \_3Mbps

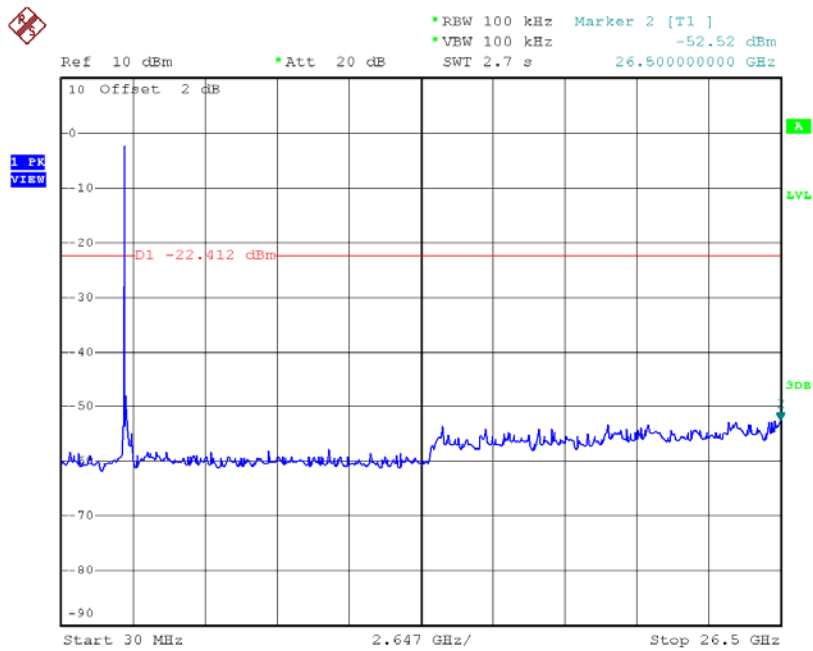

Date: 25.JUN.2015 16:49:43

### CH39 (10 Harmonic of the frequency) \_3Mbps

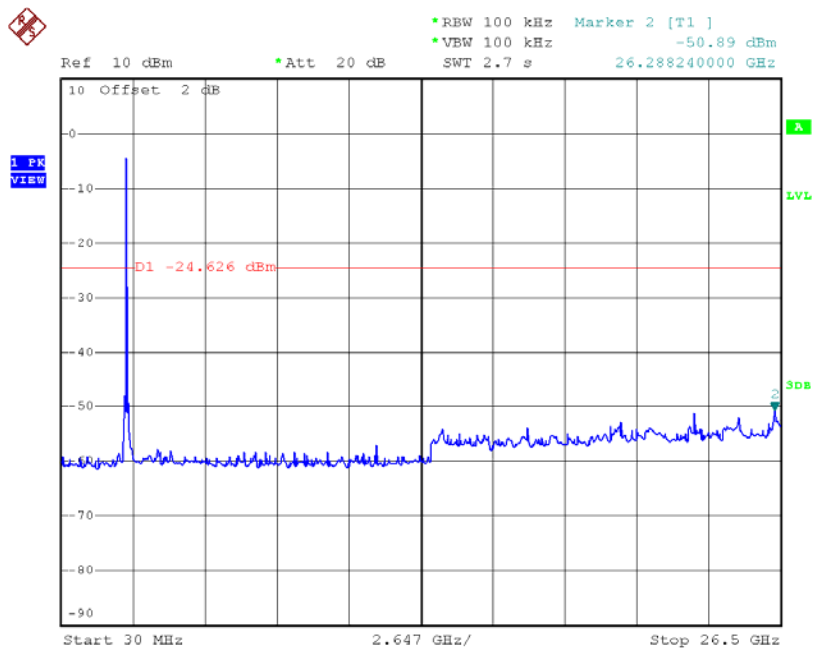

Date: 25.JUN.2015 16:50:25

### CH78 (10 Harmonic of the frequency) \_3Mbps

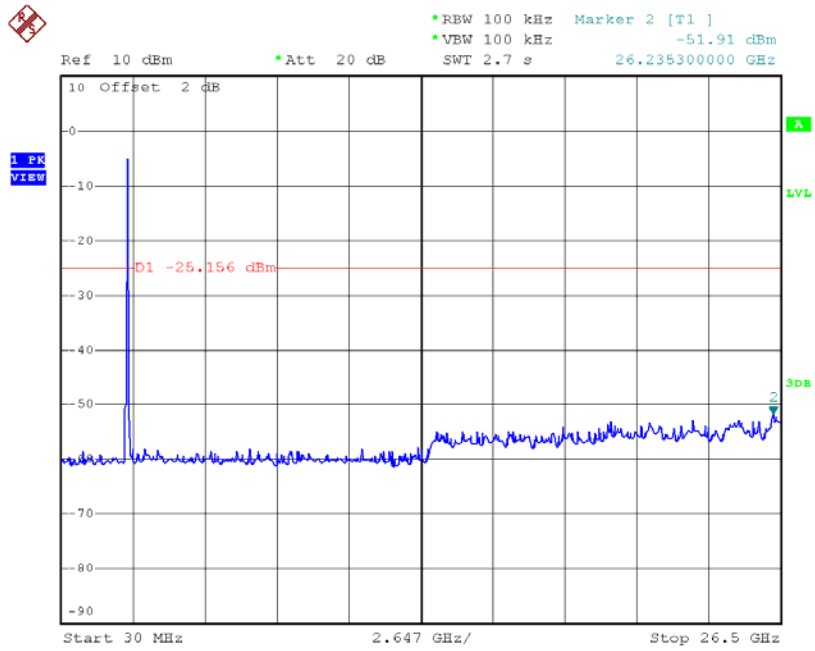

Date: 25.JUN.2015 16:52:10