



FCC RF Test Report

APPLICANT : Bandrich Inc.
EQUIPMENT : E600 Series LTE Outdoor cpe
BRAND NAME : BandLuxe
MODEL NAME : E600
FCC ID : UZIE6001801
STANDARD : FCC 47 CFR Part 2, and 90(S)
CLASSIFICATION : PCS Licensed Transmitter (PCB)

The product was received on Mar. 27, 2018 and testing was completed on Apr. 28, 2018. We, SPORTON INTERNATIONAL INC., would like to declare that the tested sample has been evaluated in accordance with the procedures given in ANSI / TIA-603-E and shown compliance with the applicable technical standards.

The test results in this report apply exclusively to the tested model / sample. Without written approval of SPORTON INTERNATIONAL INC., the test report shall not be reproduced except in full.

Reviewed by: Joseph Lin / Supervisor

Approved by: Jones Tsai / Manager



SPORTON INTERNATIONAL INC.

No. 52, Hwa Ya 1st Rd., Hwa Ya Technology Park, Kwei-Shan District, Tao Yuan City, Taiwan, R.O.C.



TABLE OF CONTENTS

REVISION HISTORY..... 3

SUMMARY OF TEST RESULT 4

1 GENERAL DESCRIPTION 5

 1.1 Applicant..... 5

 1.2 Manufacturer 5

 1.3 Feature of Equipment Under Test..... 5

 1.4 Modification of EUT 5

 1.5 Testing Site..... 6

 1.6 Applied Standards 7

2 TEST CONFIGURATION OF EQUIPMENT UNDER TEST 8

 2.1 Test Mode..... 8

 2.2 Connection Diagram of Test System 9

 2.3 Support Unit used in test configuration and system..... 9

 2.4 Measurement Results Explanation Example 9

 2.5 Frequency List of Low/Middle/High Channels..... 10

3 TEST RESULT 11

 3.1 Conducted Output Power Measurement..... 11

 3.2 99% Occupied Bandwidth and 26dB Bandwidth Measurement..... 12

 3.3 Emissions Mask Measurement 13

 3.4 Emissions Mask – Out Of Band Emissions Measurement..... 14

 3.5 Field Strength of Spurious Radiation Measurement 15

 3.6 Frequency Stability Measurement..... 17

4 LIST OF MEASURING EQUIPMENT 18

5 UNCERTAINTY OF EVALUATION 19

APPENDIX A. TEST RESULTS OF CONDUCTED TEST

APPENDIX B. TEST RESULTS OF ERP AND RADIATED TEST

APPENDIX C. TEST SETUP PHOTOGRAPHS



REVISION HISTORY

REPORT NO.	VERSION	DESCRIPTION	ISSUED DATE
FG832728C	Rev. 01	Initial issue of report	May 04, 2018



SUMMARY OF TEST RESULT

Report Section	FCC Rule	Description	Limit	Result	Remark
3.1	§2.1046	Conducted Output Power	Reporting only	PASS	-
3.2	§2.1049 §90.209	Occupied Bandwidth and 26dB Bandwidth	Reporting only	PASS	-
3.3	§2.1051 §90.691	Emission masks – In-band emissions	$< 50+10\log_{10}(P[\text{Watts}])$	PASS	-
3.4	§2.1051 §90.691	Emission masks – Out of band emissions	$< 43+10\log_{10}(P[\text{Watts}])$	PASS	-
3.5	§2.1053 §90.691	Field Strength of Spurious Radiation	$< 43+10\log_{10}(P[\text{Watts}])$	PASS	Under limit 30.34 dB at 2464.000 MHz
3.6	§2.1055 §90.213	Frequency Stability for Temperature & Voltage	$< 2.5 \text{ ppm}$	PASS	-



1 General Description

1.1 Applicant

Bandrich Inc.

6F-2., No.71, Zhouzi St., Neihu Dist., Taipei City 11493, Taiwan (R.O.C)

1.2 Manufacturer

FAIR GOAL ELECTRONIC CO.

1F., No.97-1, Haihu, Luzhu Township, Taoyuan County 338, Taiwan (R.O.C.)

1.3 Feature of Equipment Under Test

WCDMA/LTE

Product Specification subjective to this standard	
Antenna Type	WWAN: Fixed Internal Antenna

1.4 Modification of EUT

No modifications are made to the EUT during all test items.



1.5 Testing Site

Sporton Lab is accredited to ISO 17025 by Taiwan Accreditation Foundation (TAF code : 1190) and the FCC designation No. TW1190 and TW0007 under the FCC 2.948(e) by Mutual Recognition Agreement (MRA) in FCC Test.

Test Site	SPORTON INTERNATIONAL INC.
Test Site Location	No. 52, Hwa Ya 1 st Rd., Hwa Ya Technology Park, Kwei-Shan District, Taoyuan City, Taiwan, R.O.C. TEL: +886-3-327-3456 FAX: +886-3-328-4978
Test Site No.	Sporton Site No.
	TH05-HY

Note: The test site complies with ANSI C63.4 2014 requirement.

Test Site	SPORTON INTERNATIONAL INC.
Test Site Location	No.58, Aly. 75, Ln. 564, Wenhua 3rd Rd. Kwei-Shan District, Taoyuan City, Taiwan, R.O.C. TEL: +886-3-327-0868 FAX: +886-3-327-0855
Test Site No.	Sporton Site No.
	03CH11-HY

Note: The test site complies with ANSI C63.4 2014 requirement.



1.6 Applied Standards

According to the specifications of the manufacturer, the EUT must comply with the requirements of the following standards:

- ♦ FCC 47 CFR Part 2, 90
- ♦ ANSI / TIA-603-E
- ♦ FCC KDB 971168 D01 Power Meas. License Digital Systems v03
- ♦ Interim Guidance for Equipment Authorization of Devices with Channel Bandwidths Combined Across Two Contiguous Service Rule Allocations OET/Lab/EACB, June 6, 2013

Remark:

1. All test items were verified and recorded according to the standards and without any deviation during the test.
2. This EUT has also been tested and complied with the requirements of FCC Part 15, Subpart B, recorded in a separate test report.



2 Test Configuration of Equipment Under Test

2.1 Test Mode

During all testing, EUT is in link mode with base station emulator at maximum power level. The spurious emission measurements were carried out in semi-anechoic chamber with 3-meter test range, and EUT is rotated on three test planes to find out the worst emission.

Frequency range investigated for radiated emission is 30 MHz to 9000 MHz.

Test Items	Band	Bandwidth (MHz)						Modulation		RB #			Test Channel		
		1.4	3	5	10	15	20	QPSK	16QAM	1	Half	Full	L	M	H
Max. Output Power	26	v	v	v	v	v	-	v	v	v	v	v	v	v	v
26dB and 99% Bandwidth	26	v	v	v	v	v	-	v	v			v	v	v	v
Emission masks In-band emissions	26	v	v	v	v	v	-	v	v	v		v	v		v
Emission masks – Out of band emissions	26	v	v	v	v	v	-	v	v	v			v	v	v
Frequency Stability	26				v	v	-	v				v	v	v	
E.R.P.	26					v	-	v	v	v			v		
Radiated Spurious Emission	26	Worst Case										v	v	v	
Note	<ol style="list-style-type: none"> The mark "v" means that this configuration is chosen for testing The mark "-" means that this bandwidth is not supported. LTE Band26 transmit frequency for part22 rule is 824MHz-849MHz, for part90 rule is 814MHz-824MHz. ERP over 15MHz bandwidth complies the ERP limit line of part22 rule, therefore ERP of the partial frequency spectrum which falls within part 22 also complies. 														

2.2 Connection Diagram of Test System

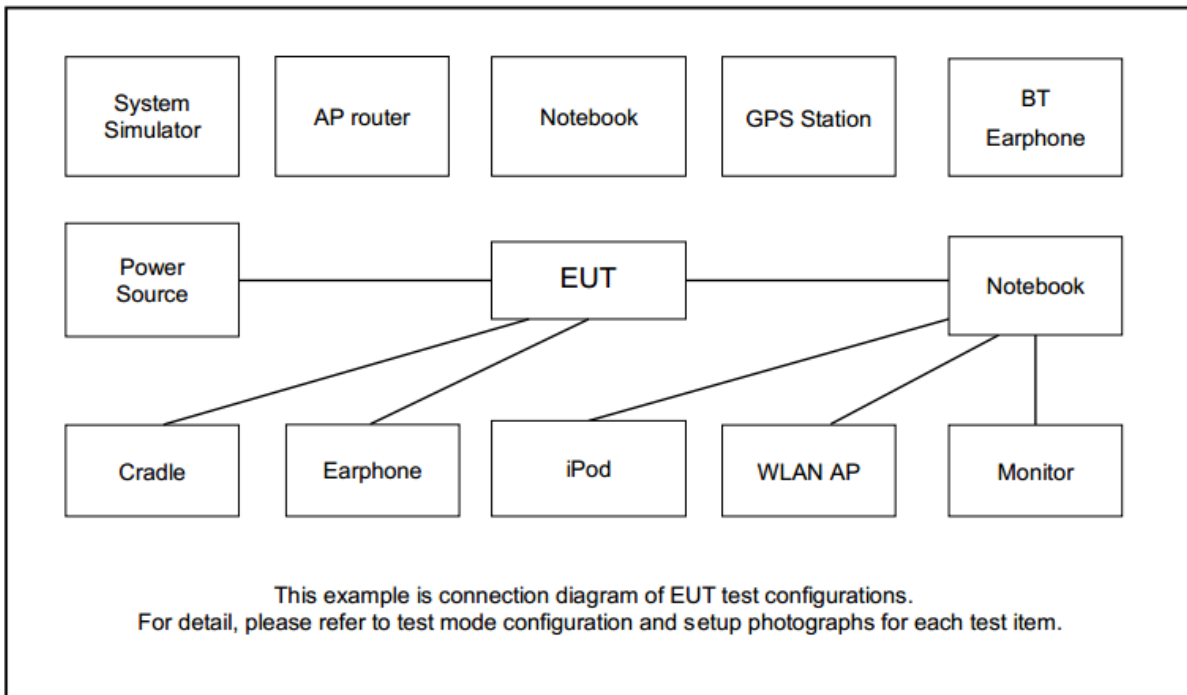

2.3 Support Unit used in test configuration and system

Item	Equipment	Trade Name	Model No.	FCC ID	Data Cable	Power Cord
1.	System Simulator	Anritsu	MT8820C	N/A	N/A	Unshielded, 1.8 m

2.4 Measurement Results Explanation Example

For all conducted test items:

The offset level is set in the spectrum analyzer to compensate the RF cable loss and attenuator factor between RF conducted output port and spectrum analyzer. With the offset compensation, the spectrum analyzer reading level will be exactly the RF output level.

The spectrum analyzer offset is derived from RF cable loss and attenuator factor.

Offset = RF cable loss + attenuator factor.

The following shows an offset computation example with RF cable loss 4.2 dB and a 10dB attenuator.

Example :

$$\begin{aligned} \text{Offset(dB)} &= \text{RF cable loss(dB)} + \text{attenuator factor(dB)}. \\ &= 4.2 + 10 = 14.2 \text{ (dB)} \end{aligned}$$



2.5 Frequency List of Low/Middle/High Channels

LTE Band 26 Channel and Frequency List				
BW [MHz]	Channel/Frequency(MHz)	Lowest	Middle	Highest
15	Channel	26765	-	-
	Frequency	821.5	-	-
10	Channel	-	26740	-
	Frequency	-	819	-
5	Channel	26715	26740	26765
	Frequency	816.5	819	821.5
3	Channel	26705	26740	26775
	Frequency	815.5	819	822.5
1.4	Channel	26697	26740	26783
	Frequency	814.7	819	823.3

3 Test Result

3.1 Conducted Output Power Measurement

3.1.1 Description of the Conducted Output Power Measurement

A system simulator was used to establish communication with the EUT. Its parameters were set to enforce EUT transmitting at the maximum power. The measured power in the radio frequency on the transmitter output terminals shall be reported.

3.1.2 Measuring Instruments

The measuring equipment is listed in the section 4 of this test report.

3.1.3 Test Procedures

1. The transmitter output port was connected to the system simulator.
2. Set EUT at maximum power through system simulator.
3. Select lowest, middle, and highest channels for each band and different modulation.
4. Measure and record the power level from the system simulator.

3.1.4 Test Setup



3.1.5 Test Result of Conducted Output Power

Please refer to Appendix A.

3.2 99% Occupied Bandwidth and 26dB Bandwidth Measurement

3.2.1 Description of (Occupied) Bandwidth Limitations Measurement

The 99% occupied bandwidth is the width of a frequency band such that, below the lower and above the upper frequency limits, the mean powers emitted are each equal to a specified percentage 0.5% of the total mean transmitted power.

The emission bandwidth is defined as the width of the signal between two points, located at the 2 sides of the carrier frequency, outside of which all emissions are attenuated at least 26 dB below the transmitter power.

3.2.2 Measuring Instruments

The measuring equipment is listed in the section 4 of this test report.

3.2.3 Test Procedures

1. The EUT was connected to spectrum analyzer and system simulator via a power divider.
2. The 26dB and 99% occupied bandwidth (BW) of the middle channel for the highest RF power with full RB sizes were measured.

3.2.4 Test Setup

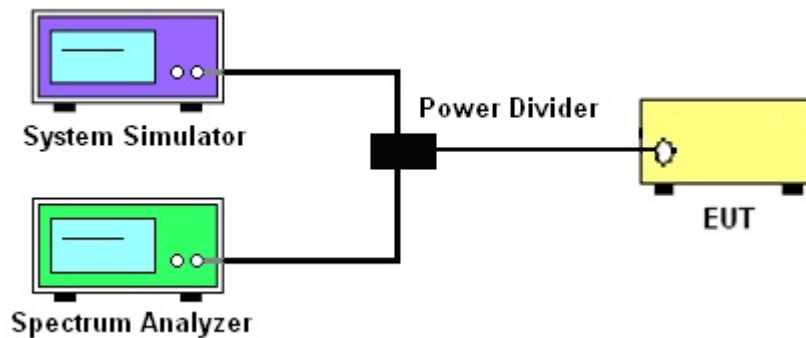

3.2.5 Test Result of 99% Occupied Bandwidth and 26dB Bandwidth

Please refer to Appendix A.

3.3 Emissions Mask Measurement

3.3.1 Description of Emissions Mask Measurement

Equipment used in this licensed to EA or non-EA systems shall comply with the emission mask provisions of FCC Part 90.691.(a)

(a) Out-of-band emission requirement shall apply only to the "outer" channels included in an EA license and to spectrum adjacent to interior channels used by incumbent licensees. The emission limits are as follows:

(1) For any frequency removed from the EA licensee's frequency block by up to and including 37.5 kHz, the power of any emission shall be attenuated below the transmitter power (P) in watts by at least $116 \text{Log}_{10}(f/6.1)$ decibels or $50 + 10 \text{Log}_{10}(P)$ decibels or 80 decibels, whichever is the lesser attenuation, where f is the frequency removed from the center of the outer channel in the block in kilohertz and where f is greater than 12.5 kHz.

(2) For any frequency removed from the EA licensee's frequency block greater than 37.5 kHz, the power of any emission shall be attenuated below the transmitter power (P) in watts by at least $43 + 10\text{Log}_{10}(P)$ decibels or 80 decibels, whichever is the lesser attenuation, where f is the frequency removed from the center of the outer channel in the block in kilohertz and where f is greater than 37.5 kHz.

3.3.2 Measuring Instruments

The measuring equipment is listed in the section 4 of this test report.

3.3.3 Test Procedures

1. The EUT was connected to spectrum analyzer and base station via power divider.
2. The emissions mask of low and high channels for the highest RF powers were measured.
3. The measured RBW and the VBW set 3 times of RBW are then set in spectrum analyzer, and the RBW correction factor $10\log(1\% \text{ of OBW/measured RBW})(\text{dB})$ was compensated, if required.
4. The test results were shown below plots with a correction offset factor including cable loss, insertion loss of power divider.

3.3.4 Test Setup

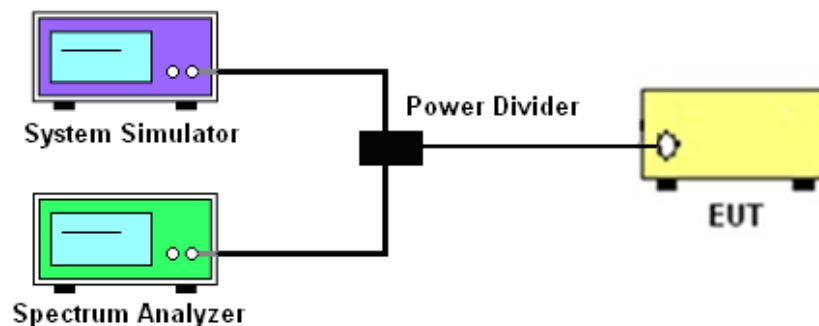

3.3.5 Test Result (Plots) of Conducted Emissions Mask

Please refer to Appendix A.

3.4 Emissions Mask – Out Of Band Emissions Measurement

3.4.1 Description of Conducted Emissions Out of band emissions measurement

The power of any emission FCC Part 90.691 (a)(2) on any frequency removed from the assigned frequency by out of the authorized bandwidth at least $43 + 10 \log (P)$ dB. It is measured by means of a calibrated spectrum analyzer and scanned from 30 MHz up to a frequency including its 10th harmonic.

3.4.2 Measuring Instruments

The measuring equipment is listed in the section 4 of this test report.

3.4.3 Test Procedures

1. The EUT was connected to spectrum analyzer and system simulator via a power divider.
2. The RF output of EUT was connected to the spectrum analyzer by RF cable and attenuator. The path loss was compensated to the results for each measurement.
3. The middle channel for the highest RF power within the transmitting frequency was measured.
4. The conducted spurious emission for the whole frequency range was taken.
5. Make the measurement with the spectrum analyzer's RBW = 1MHz, VBW = 3MHz, taking the record of maximum spurious emission.
6. The RF fundamental frequency should be excluded against the limit line in the operating frequency band.
7. The limit line is derived from $43 + 10\log(P)$ dB below the transmitter power P(Watts)

3.4.4 Test Setup

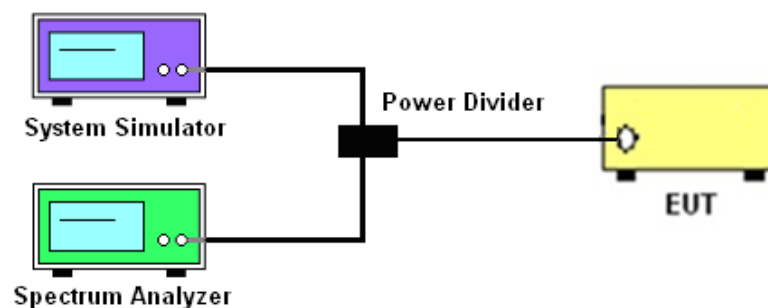

3.4.5 Test Result (Plots) of Conducted Emission

Please refer to Appendix A.



3.5 Field Strength of Spurious Radiation Measurement

3.5.1 Description of Field Strength of Spurious Radiated Measurement

The radiated spurious emission was measured by substitution method according to ANSI / TIA-603-E. The power of any emission FCC Part 90.691 on any frequency removed from the assigned frequency by more than 250 percent of the authorized bandwidth at least $43 + 10 \log (P)$ dB. The spectrum is scanned from 30 MHz up to a frequency including its 10th harmonic.

The power of any emission outside of the authorized operating frequency ranges must be attenuated below the transmitter power (P) by a factor of at least $43+10\log_{10}(P[\text{Watts}])$ dB. The spectrum is scanned from 30 MHz up to a frequency including its 10th harmonic.

3.5.2 Measuring Instruments

The measuring equipment is listed in the section 4 of this test report.

3.5.3 Test Procedures

1. The EUT was placed on a turntable with 0.8 meter for frequency below 1GHz and 1.5 meter for frequency above 1GHz respectively above ground.
2. The EUT was set 3 meters from the receiving antenna, which was mounted on the antenna tower.
3. The table was rotated 360 degrees to determine the position of the highest spurious emission.
4. The height of the receiving antenna is varied between one meter and four meters to search the maximum spurious emission for both horizontal and vertical polarizations.
5. Make the measurement with the spectrum analyzer's RBW = 1MHz, VBW = 3MHz, Sweep = 500ms, Taking the record of maximum spurious emission.
6. A horn antenna was substituted in place of the EUT and was driven by a signal generator.
7. Tune the output power of signal generator to the same emission level with EUT maximum spurious emission.
8. Taking the record of output power at antenna port.
9. Repeat step 7 to step 8 for another polarization.
10. $\text{EIRP (dBm)} = \text{S.G. Power} - \text{Tx Cable Loss} + \text{Tx Antenna Gain}$
11. $\text{ERP (dBm)} = \text{EIRP} - 2.15$
12. The RF fundamental frequency should be excluded against the limit line in the operating frequency band.
13. The limit line is derived from $43 + 10\log(P)$ dB below the transmitter power P(Watts)

3.5.4 Test Setup

For radiated test from 30MHz to 1GHz

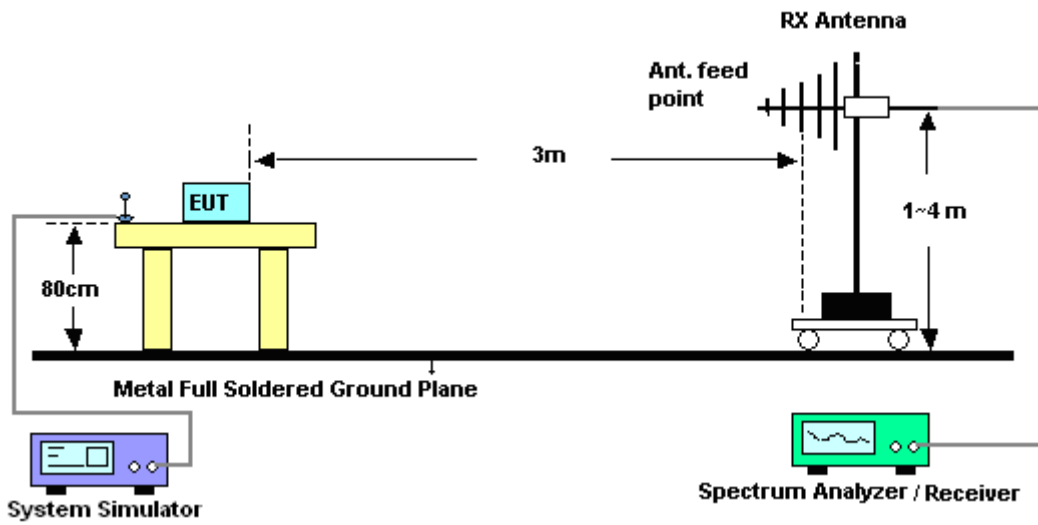

For radiated test above 1GHz

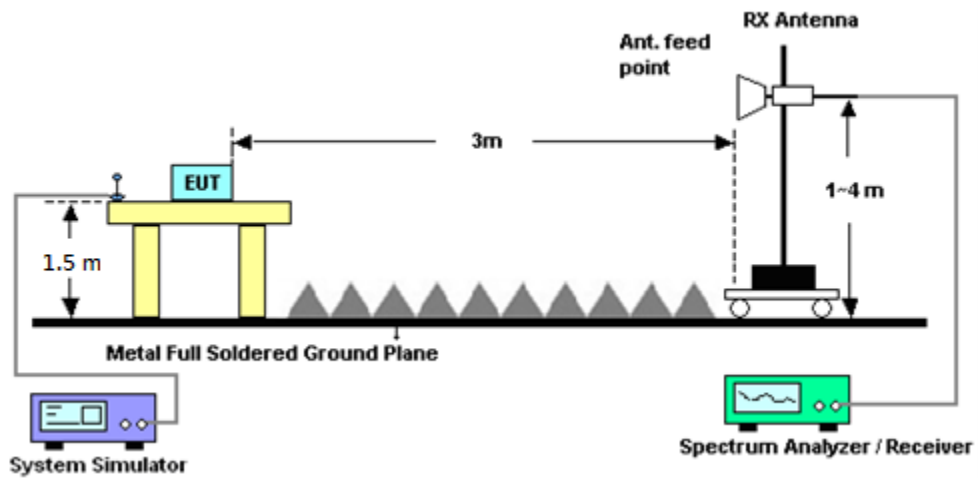

3.5.5 Test Result of Field Strength of Spurious Radiated

Please refer to Appendix B.

3.6 Frequency Stability Measurement

3.6.1 Description of Frequency Stability Measurement

The frequency stability shall be measured by variation of ambient temperature and variation of primary supply voltage to ensure that the fundamental emission stays within the authorized frequency block. The frequency stability of the transmitter shall be maintained within $\pm 0.00025\%$ ($\pm 2.5\text{ppm}$) of the center frequency according to FCC Part 90.213.

3.6.2 Measuring Instruments

The measuring equipment is listed in the section 4 of this test report.

3.6.3 Test Procedures for Temperature Variation

1. The EUT was set up in the thermal chamber and connected with the base station.
2. With power OFF, the temperature was decreased to -30°C and the EUT was stabilized for three hours. Power was applied and the maximum change in frequency was recorded within one minute.
3. With power OFF, the temperature was raised in 10°C step up to 50°C . The EUT was stabilized at each step for at least half an hour. Power was applied and the maximum frequency change was recorded within one minute.

3.6.4 Test Procedures for Voltage Variation

1. The EUT was placed in a temperature chamber at $20\pm 5^{\circ}\text{C}$ and connected with the base station.
2. The power supply voltage to the EUT was varied from BEP to 115% of the nominal value measured at the input to the EUT.
3. The variation in frequency was measured for the worst case.

3.6.5 Test Setup

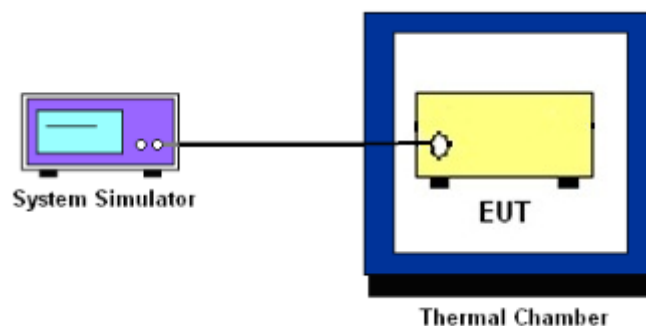

3.6.6 Test Result of Temperature Variation

Please refer to Appendix A.



4 List of Measuring Equipment

Instrument	Manufacturer	Model No.	Serial No.	Characteristics	Calibration Date	Test Date	Due Date	Remark
LTE Base Station	Anritsu	MT8820C	6201432821	GSM/GPRS /WCDMA/LTE	Oct. 13, 2017	Mar. 27, 2018~ Apr. 26, 2018	Oct. 12, 2018	Conducted (TH05-HY)
Spectrum Analyzer	Rohde & Schwarz	FSV40	101397	10Hz~40GHz	Nov. 07, 2017	Mar. 27, 2018~ Apr. 26, 2018	Nov. 06, 2018	Conducted (TH05-HY)
Temperature Chamber	ESPEC	SH-641	92013720	-30°C~70°C	Aug. 28, 2017	Mar. 27, 2018~ Apr. 26, 2018	Aug. 27, 2018	Conducted (TH05-HY)
Programmable Power Supply	GW Instek	PSS-2005	EL890001	1V~20V 0.5A~5A	Oct. 06, 2017	Mar. 27, 2018~ Apr. 26, 2018	Oct. 05, 2018	Conducted (TH05-HY)
Coupler	Warison	1-18GHz 20dB 25WSMA Directional Coupler	#B	1G~18GHz	Dec. 04, 2017	Mar. 27, 2018~ Apr. 26, 2018	Dec. 03, 2018	Conducted (TH05-HY)
Loop Antenna	Rohde & Schwarz	HFH2-Z2	100488	9 kHz~30 MHz	Nov. 23, 2017	Apr. 18, 2018~ Apr. 28, 2018	Nov. 22, 2019	Radiation (03CH11-HY)
Bilog Antenna	TESEQ	CBL 6111D&N-6-06	35414&AT-N0 602	30MHz~1GHz	Oct. 14, 2017	Apr. 18, 2018~ Apr. 28, 2018	Oct. 13, 2018	Radiation (03CH11-HY)
Horn Antenna	SCHWARZBECK	BBHA 9120 D	9120D-1326	1GHz ~ 18GHz	Oct. 16, 2017	Apr. 18, 2018~ Apr. 28, 2018	Oct. 15, 2018	Radiation (03CH11-HY)
Horn Antenna	SCHWARZBECK	BBHA 9120D	9120D-1328	1GHz ~ 18GHz	Oct. 20, 2017	Apr. 18, 2018~ Apr. 28, 2018	Oct. 19, 2018	Radiation (03CH11-HY)
SHF-EHF Horn Antenna	SCHWARZBECK	BBHA 9170	BBHA9170584	18GHz- 40GHz	Nov. 27, 2017	Apr. 18, 2018~ Apr. 28, 2018	Nov. 26, 2018	Radiation (03CH11-HY)
Amplifier	SONOMA	310N	187312	9kHz~1GHz	Nov. 10, 2016	Apr. 18, 2018~ Apr. 28, 2018	Nov. 09, 2018	Radiation (03CH11-HY)
Preamplifier	Keysight	83017A	MY53270080	1GHz~26.5GHz	Nov. 10, 2016	Apr. 18, 2018~ Apr. 28, 2018	Nov. 09, 2018	Radiation (03CH11-HY)
Amplifier	MITEQ	TTA1840-35-HG	1871923	18GHz~40GHz, VSWR : 2.5:1 max	Jul. 18, 2017	Apr. 18, 2018~ Apr. 28, 2018	Jul. 17, 2018	Radiation (03CH11-HY)
EMI Test Receiver	Keysight	N9038A (MXE)	MY57290111	3Hz~26.5GHz	Nov. 02, 2017	Apr. 18, 2018~ Apr. 28, 2018	Nov. 01, 2018	Radiation (03CH11-HY)
Spectrum Analyzer	Keysight	N9010A	MY54200486	10Hz ~ 44GHz	Oct. 19, 2017	Apr. 18, 2018~ Apr. 28, 2018	Oct. 18, 2018	Radiation (03CH11-HY)
Signal Generator	Rohde & Schwarz	SMF100A	101107	100kHz~40GHz	May 22, 2017	Apr. 18, 2018~ Apr. 28, 2018	May 21, 2018	Radiation (03CH11-HY)
Filter	Wainwright	WHKX12-1080-1 200-1500-60SS	SN2	1.2G High Pass	Sep. 18, 2017	Apr. 18, 2018~ Apr. 28, 2018	Sep. 17, 2018	Radiation (03CH11-HY)
Filter	Wainwright	WHKX12-2700-3 000-18000-60SS	SN3	2.7G High Pass	Sep. 18, 2017	Apr. 18, 2018~ Apr. 28, 2018	Sep. 17, 2018	Radiation (03CH11-HY)
Antenna Mast	EMEC	AM-BS-4500-B	N/A	1~4m	N/A	Apr. 18, 2018~ Apr. 28, 2018	N/A	Radiation (03CH11-HY)
Turn Table	EMEC	TT 2000	N/A	0~360 Degree	N/A	Apr. 18, 2018~ Apr. 28, 2018	N/A	Radiation (03CH11-HY)
Software	Audix	E3 6.2009-8-24	RK-001042	N/A	N/A	Apr. 18, 2018~ Apr. 28, 2018	N/A	Radiation (03CH11-HY)



5 Uncertainty of Evaluation

Uncertainty of Radiated Emission Measurement (30 MHz ~ 1000 MHz)

Measuring Uncertainty for a Level of Confidence of 95% ($U = 2Uc(y)$)	3.37
---	------

Uncertainty of Radiated Emission Measurement (1 GHz ~ 18 GHz)

Measuring Uncertainty for a Level of Confidence of 95% ($U = 2Uc(y)$)	3.67
---	------

Uncertainty of Radiated Emission Measurement (18 GHz ~ 40 GHz)

Measuring Uncertainty for a Level of Confidence of 95% ($U = 2Uc(y)$)	4.03
---	------



Appendix A. Test Results of Conducted Test

Conducted Output Power(Average power)

LTE Band 26 Maximum Average Power [dBm]						
BW [MHz]	RB Size	RB Offset	Mod	Lowest	Middle	Highest
15	1	0	QPSK	22.63	-	-
15	1	37		22.40	-	-
15	1	74		22.14	-	-
15	36	0		21.64	-	-
15	36	20		21.63	-	-
15	36	39		21.33	-	-
15	75	0		21.49	-	-
15	1	0	16-QAM	21.89	-	-
15	1	37		21.74	-	-
15	1	74		21.43	-	-
15	36	0		20.59	-	-
15	36	20		20.57	-	-
15	36	39		20.27	-	-
15	75	0		20.47	-	-
10	1	0	QPSK	-	22.28	-
10	1	25		-	22.34	-
10	1	49		-	22.10	-
10	25	0		-	21.14	-
10	25	12		-	21.08	-
10	25	25		-	21.00	-
10	50	0		-	21.07	-
10	1	0	16-QAM	-	21.59	-
10	1	25		-	21.48	-
10	1	49		-	21.43	-
10	25	0		-	20.13	-
10	25	12		-	20.02	-
10	25	25		-	20.00	-
10	50	0		-	20.06	-



LTE Band 26 Maximum Average Power [dBm]						
BW [MHz]	RB Size	RB Offset	Mod	Lowest	Middle	Highest
5	1	0	QPSK	22.37	22.17	22.22
5	1	12		22.55	22.12	22.11
5	1	24		22.58	22.09	22.12
5	12	0		21.46	21.12	21.15
5	12	7		21.58	21.19	21.11
5	12	13		21.44	21.16	21.14
5	25	0		21.50	21.03	21.12
5	1	0	16-QAM	21.62	21.48	21.48
5	1	12		21.94	21.50	21.50
5	1	24		21.90	21.47	21.49
5	12	0		20.48	20.10	20.12
5	12	7		20.54	20.15	20.12
5	12	13		20.45	20.08	20.11
5	25	0		20.49	20.02	20.02
3	1	0	QPSK	22.42	22.21	22.16
3	1	8		22.45	22.16	22.19
3	1	14		22.34	22.06	22.02
3	8	0		21.46	21.12	21.10
3	8	4		21.46	21.11	21.18
3	8	7		21.38	21.10	21.14
3	15	0		21.40	21.17	21.11
3	1	0	16-QAM	21.65	21.42	21.38
3	1	8		21.79	21.38	21.42
3	1	14		21.69	21.32	21.31
3	8	0		20.60	20.11	20.11
3	8	4		20.61	20.11	20.15
3	8	7		20.48	20.14	20.16
3	15	0		20.36	20.13	20.08



LTE Band 26 Maximum Average Power [dBm]						
BW [MHz]	RB Size	RB Offset	Mod	Lowest	Middle	Highest
1.4	1	0	QPSK	22.32	22.21	22.19
1.4	1	3		22.44	22.13	22.08
1.4	1	5		22.41	22.13	22.02
1.4	3	0		22.37	22.18	22.11
1.4	3	1		22.42	22.14	22.14
1.4	3	3		22.48	22.04	22.00
1.4	6	0		21.34	21.00	21.02
1.4	1	0	16-QAM	21.56	21.44	21.43
1.4	1	3		21.78	21.40	21.38
1.4	1	5		21.70	21.42	21.31
1.4	3	0		21.38	21.13	21.14
1.4	3	1		21.51	21.10	21.20
1.4	3	3		21.42	21.06	21.07
1.4	6	0		20.49	20.10	20.11



LTE Band 26_Part 90S

Peak-to-Average Ratio

Mode	LTE Band 26 / 10MHz				
Mod.	QPSK		16QAM		Limit: 13dB
RB Size	1RB	Full RB	1RB	Full RB	Result
Lowest CH	-	-	-	-	PASS
Middle CH	4.58	5.16	5.25	6.06	
Highest CH	-	-	-	-	



LTE Band 26 / 10MHz / QPSK

Middle Channel / 1RB

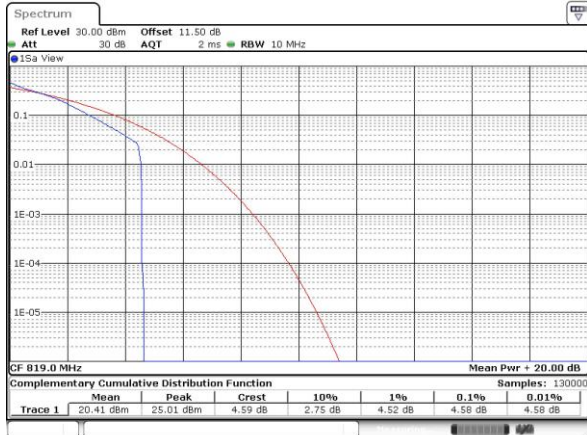

Date: 10 APR 2018 02:07:01

Middle Channel / Full RB

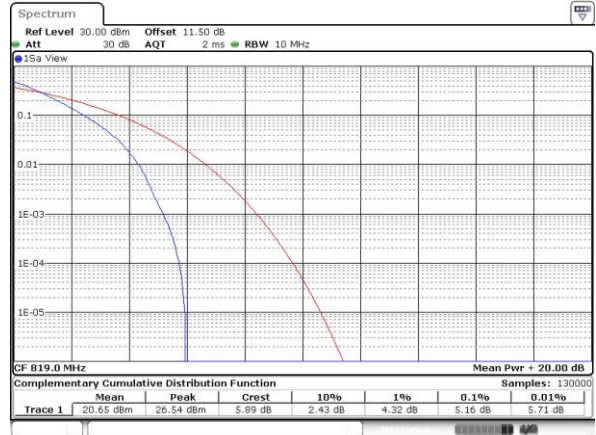

Date: 10 APR 2018 02:07:29

LTE Band 26 / 10MHz / 16QAM

Middle Channel / 1RB

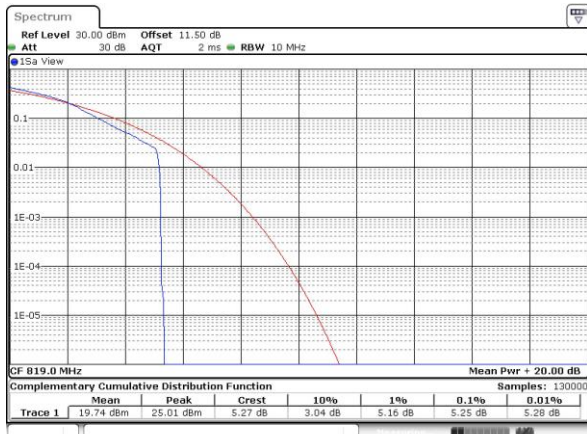

Date: 10 APR 2018 02:07:11

Middle Channel / Full RB



Date: 10 APR 2018 02:07:20



26dB Bandwidth

Mode	LTE Band 26 : 26dB BW(MHz)											
	1.4MHz		3MHz		5MHz		10MHz		15MHz		20MHz	
BW	QPSK	16QAM	QPSK	16QAM	QPSK	16QAM	QPSK	16QAM	QPSK	16QAM	QPSK	16QAM
Lowest CH	1.22	1.21	3.03	3.05	4.89	4.84	-	-	14.535	14.476	-	-
Middle CH	1.21	1.23	3.03	3.04	4.82	4.83	9.79	9.75	-	-	-	-
Highest CH	1.24	1.23	2.99	2.96	4.99	4.93	-	-	-	-	-	-



LTE Band 26

Lowest Channel / 1.4MHz / QPSK

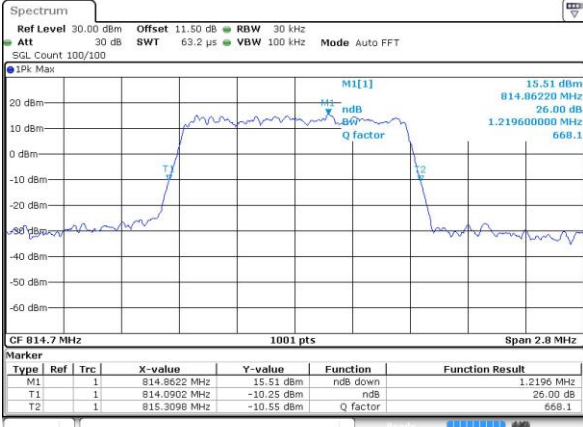

Date: 10 APR 2018 01:59:48

Lowest Channel / 1.4MHz / 16QAM

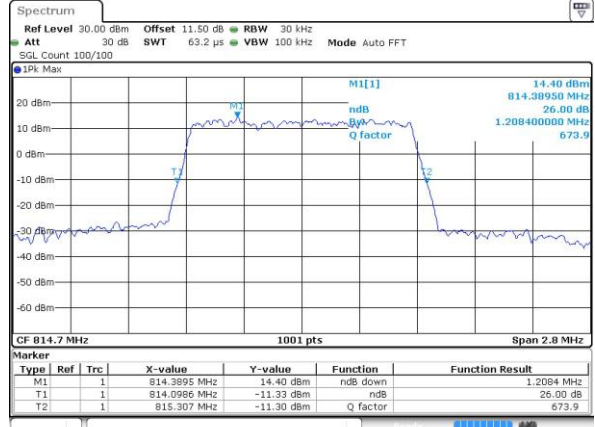

Date: 10 APR 2018 01:59:37

Middle Channel / 1.4MHz / QPSK

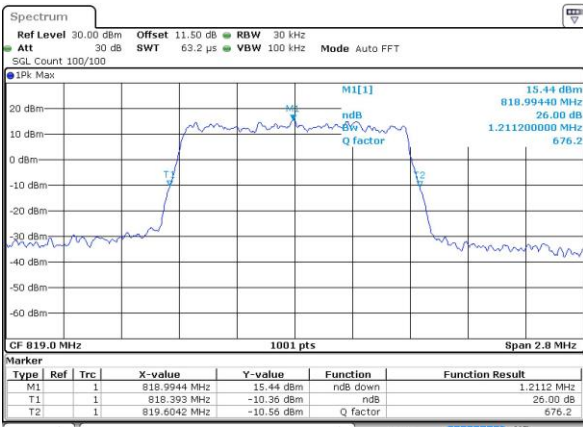

Date: 10 APR 2018 02:02:10

Middle Channel / 1.4MHz / 16QAM

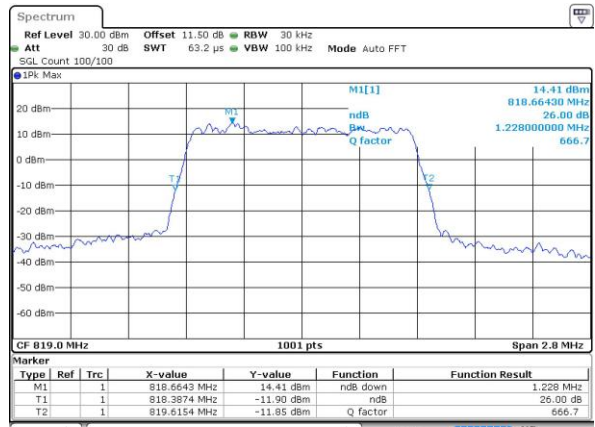

Date: 10 APR 2018 02:02:21

Highest Channel / 1.4MHz / QPSK

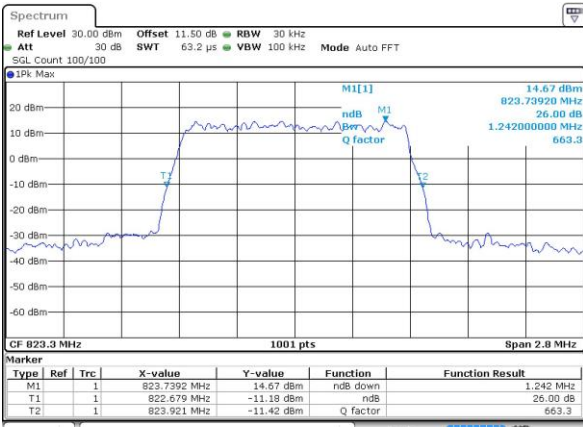

Date: 10 APR 2018 02:04:43

Highest Channel / 1.4MHz / 16QAM

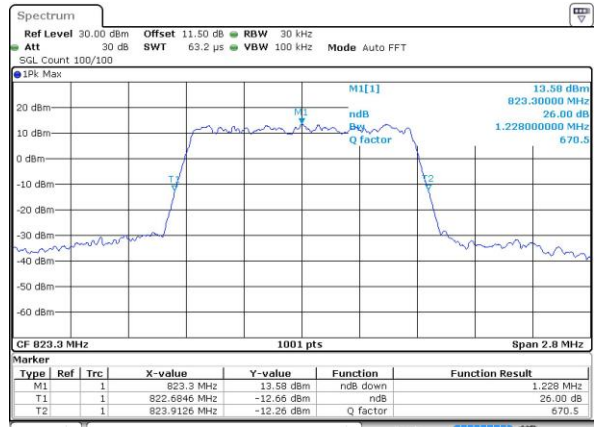

Date: 10 APR 2018 02:04:54



LTE Band 26

Lowest Channel / 3MHz / QPSK

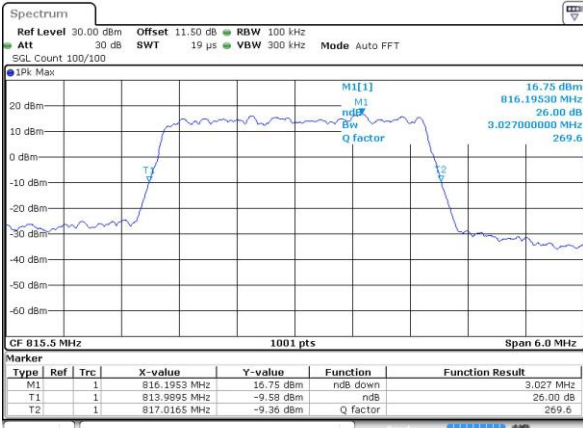

Date: 10 APR 2018 01:32:34

Lowest Channel / 3MHz / 16QAM

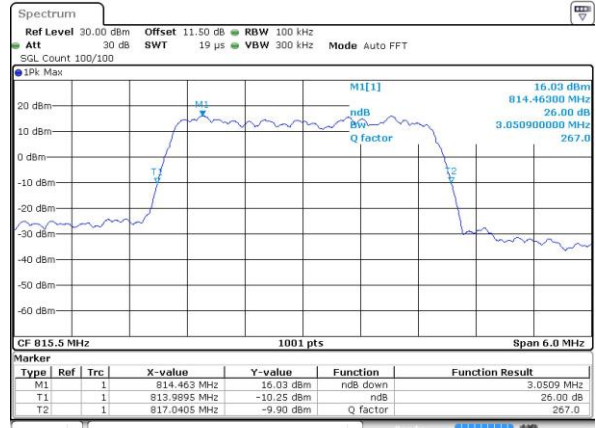

Date: 10 APR 2018 01:32:45

Middle Channel / 3MHz / QPSK

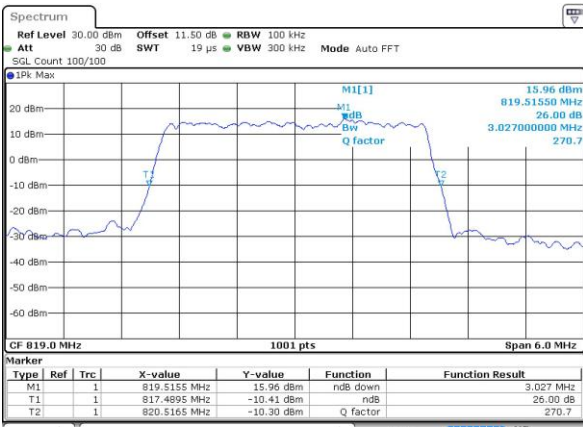

Date: 10 APR 2018 01:35:08

Middle Channel / 3MHz / 16QAM

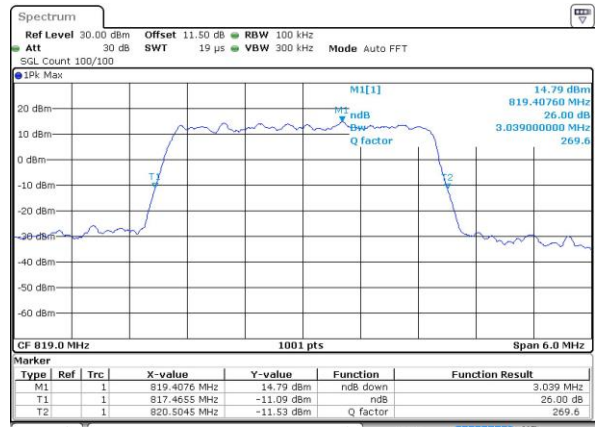

Date: 10 APR 2018 01:35:18

Highest Channel / 3MHz / QPSK

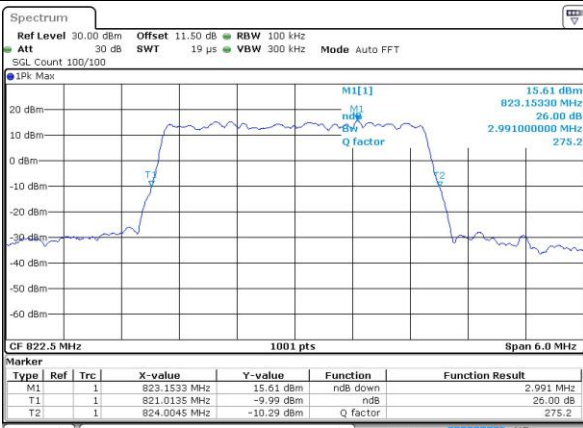

Date: 10 APR 2018 01:37:41

Highest Channel / 3MHz / 16QAM

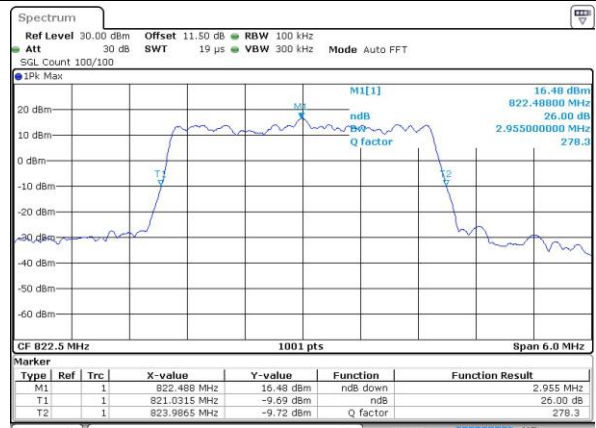

Date: 10 APR 2018 01:37:51



LTE Band 26

Lowest Channel / 5MHz / QPSK

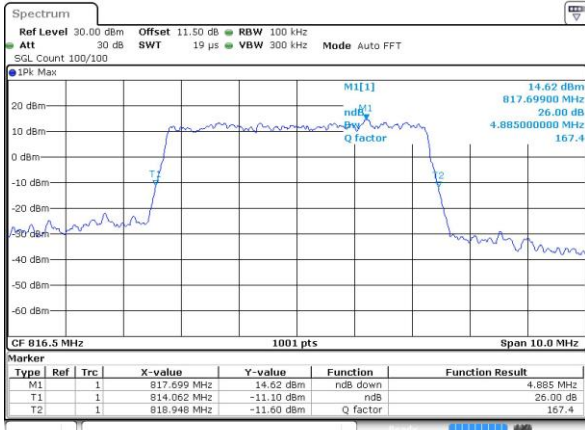

Date: 10 APR 2018 01:40:14

Lowest Channel / 5MHz / 16QAM

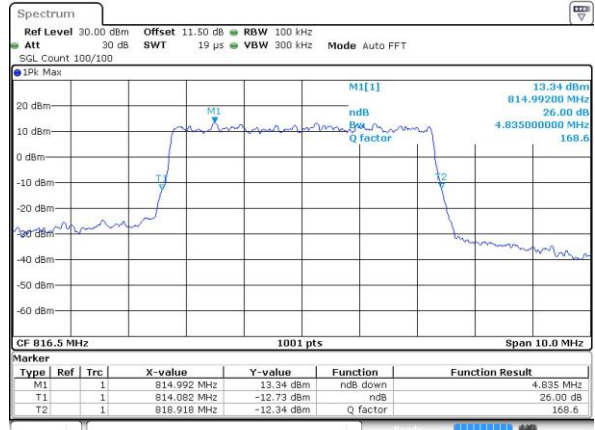

Date: 10 APR 2018 01:40:24

Middle Channel / 5MHz / QPSK

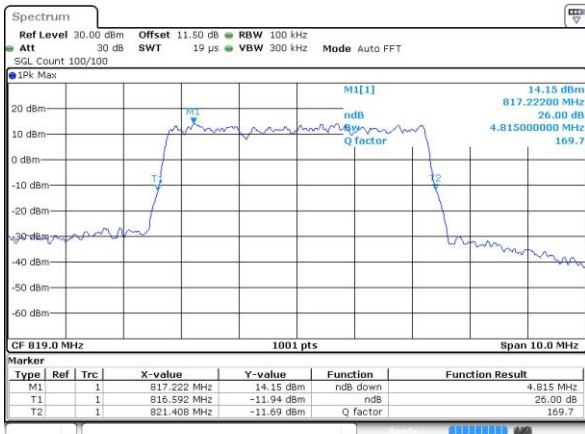

Date: 10 APR 2018 01:42:47

Middle Channel / 5MHz / 16QAM

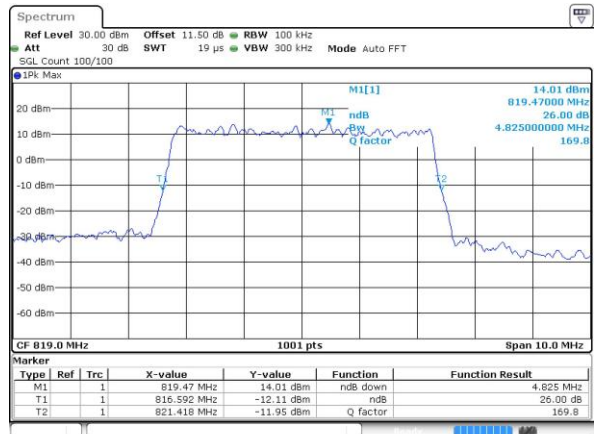

Date: 10 APR 2018 01:42:58

Highest Channel / 5MHz / QPSK

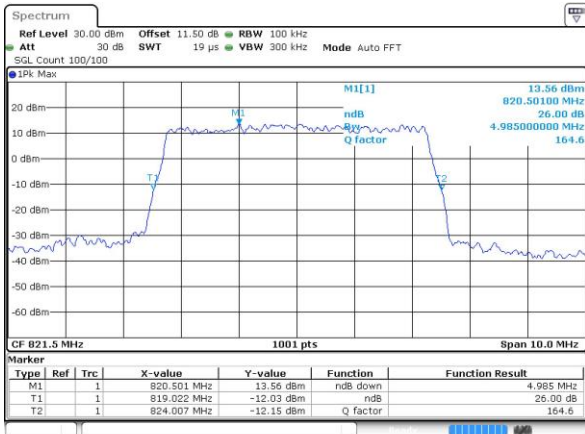

Date: 10 APR 2018 01:45:21

Highest Channel / 5MHz / 16QAM

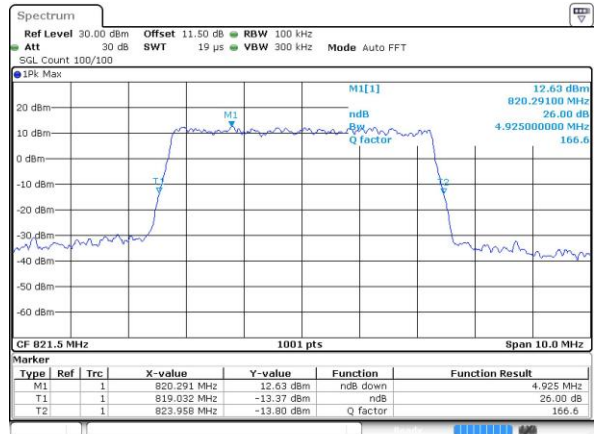

Date: 10 APR 2018 01:45:31



LTE Band 26

Middle Channel / 10MHz / QPSK

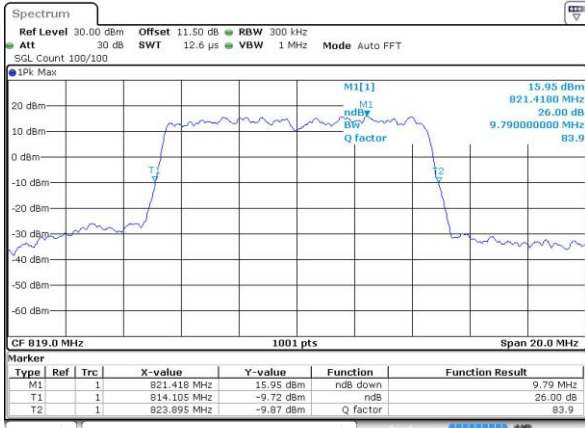

Date: 10 APR 2018 01:47:54

Middle Channel / 10MHz / 16QAM

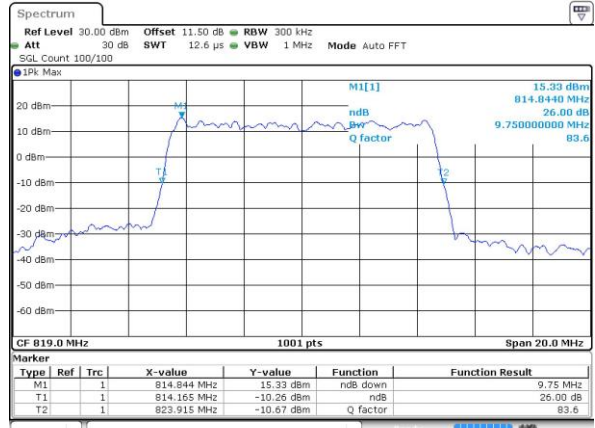

Date: 10 APR 2018 01:48:04

LTE Band 26

Lowest Channel / 15MHz / QPSK

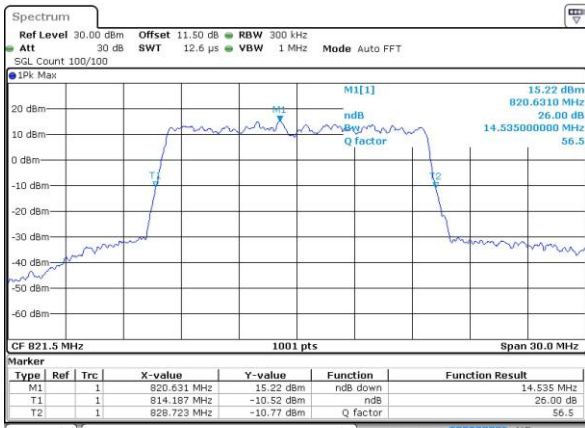

Date: 10 APR 2018 01:50:27

Lowest Channel / 15MHz / 16QAM

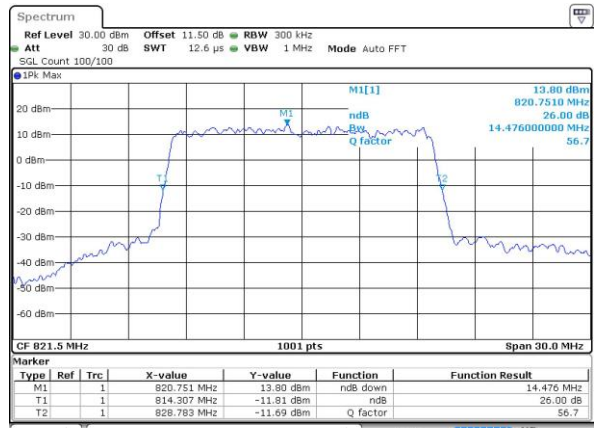

Date: 10 APR 2018 01:50:37



Occupied Bandwidth

Mode	LTE Band 26 : 99%OBW(MHz)											
	1.4MHz		3MHz		5MHz		10MHz		15MHz		20MHz	
BW	QPSK	16QAM	QPSK	16QAM	QPSK	16QAM	QPSK	16QAM	QPSK	16QAM	QPSK	16QAM
Lowest CH	1.09	1.09	2.72	2.71	4.48	4.49	-	-	13.49	13.43	-	-
Middle CH	1.09	1.09	2.73	2.72	4.48	4.51	8.99	9.05	-	-	-	-
Highest CH	1.09	1.09	2.71	2.7	4.5	4.5	-	-	-	-	-	-



LTE Band 26

Lowest Channel / 1.4MHz / QPSK

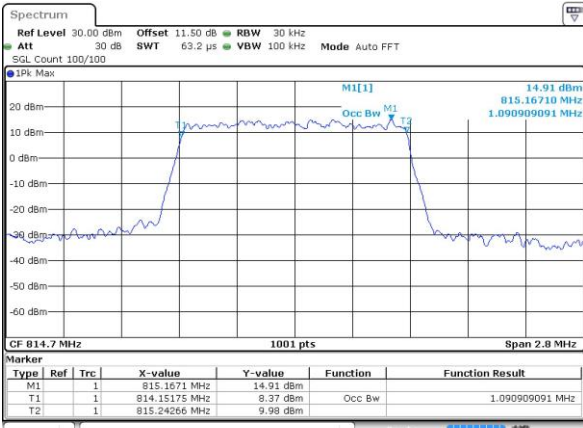

Date: 10 APR 2018 01:58:16

Lowest Channel / 1.4MHz / 16QAM

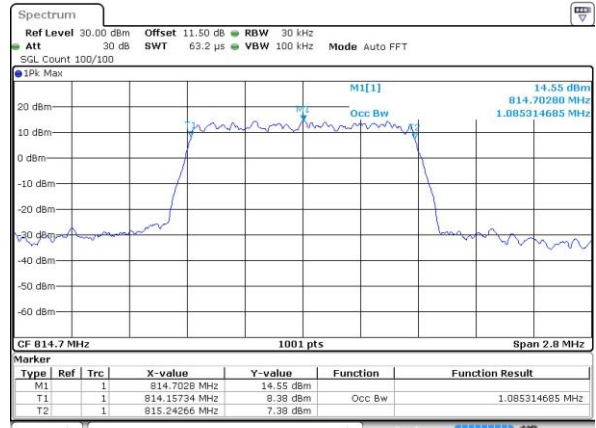

Date: 10 APR 2018 01:59:27

Middle Channel / 1.4MHz / QPSK

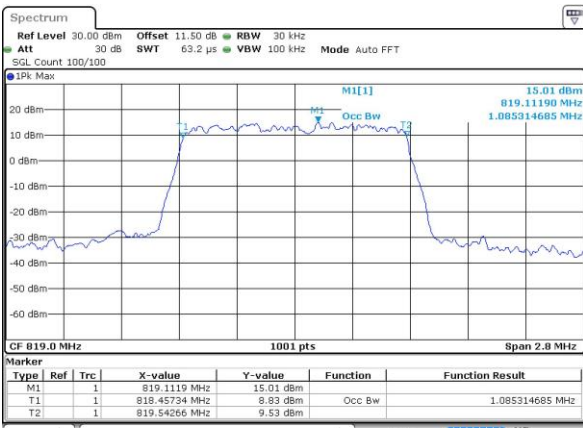

Date: 10 APR 2018 02:01:49

Middle Channel / 1.4MHz / 16QAM

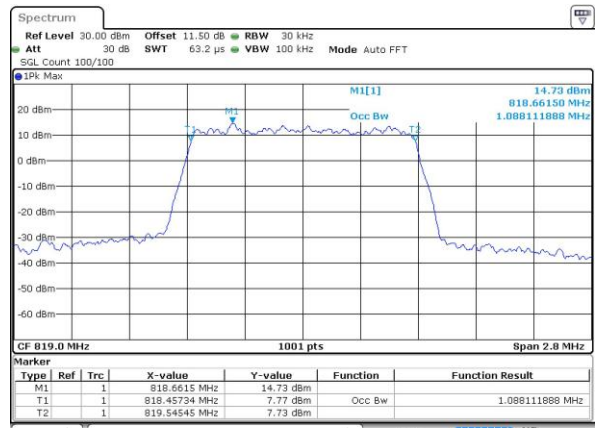

Date: 10 APR 2018 02:02:00

Highest Channel / 1.4MHz / QPSK

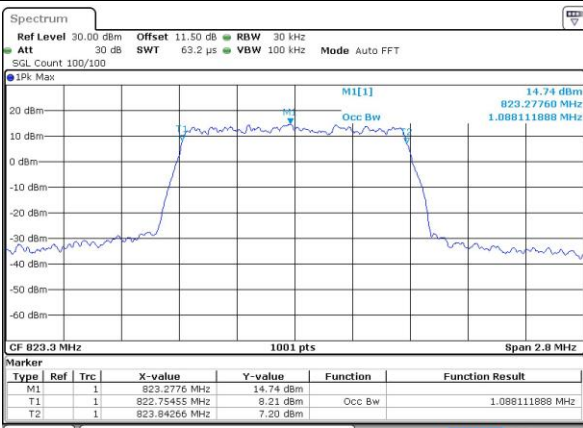

Date: 10 APR 2018 02:04:22

Highest Channel / 1.4MHz / 16QAM

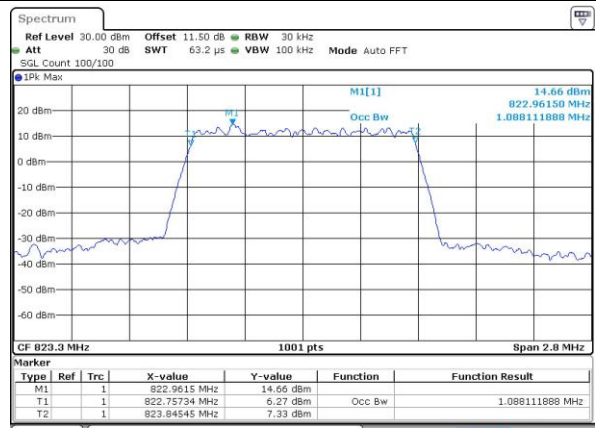

Date: 10 APR 2018 02:04:33



LTE Band 26

Lowest Channel / 3MHz / QPSK

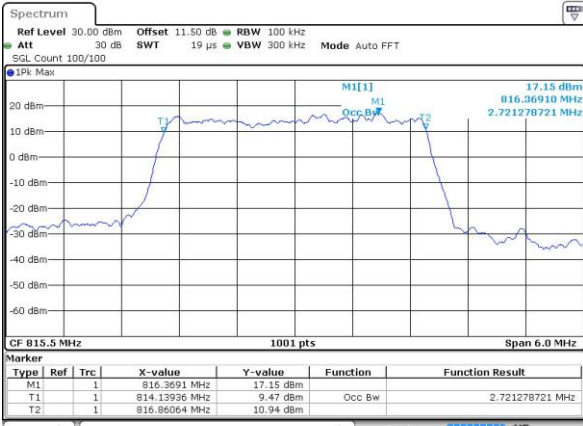

Date: 10 APR 2018 01:32:14

Lowest Channel / 3MHz / 16QAM

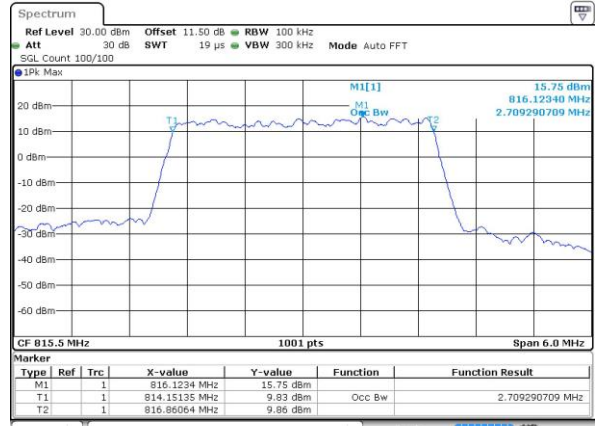

Date: 10 APR 2018 01:32:24

Middle Channel / 3MHz / QPSK

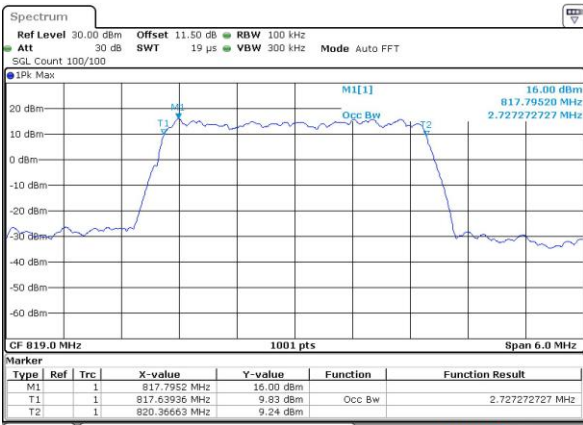

Date: 10 APR 2018 01:34:47

Middle Channel / 3MHz / 16QAM

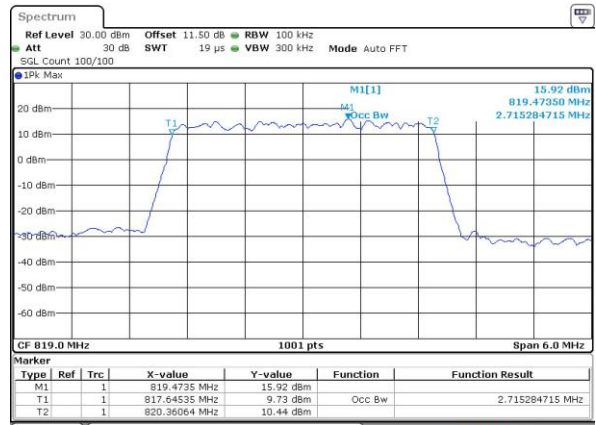

Date: 10 APR 2018 01:34:57

Highest Channel / 3MHz / QPSK

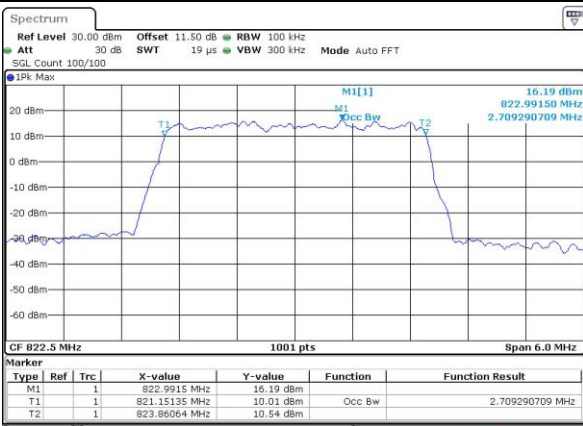

Date: 10 APR 2018 01:37:20

Highest Channel / 3MHz / 16QAM

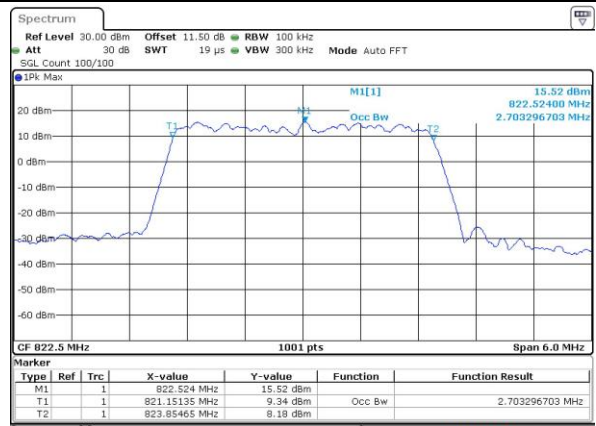

Date: 10 APR 2018 01:37:31



LTE Band 26

Lowest Channel / 5MHz / QPSK

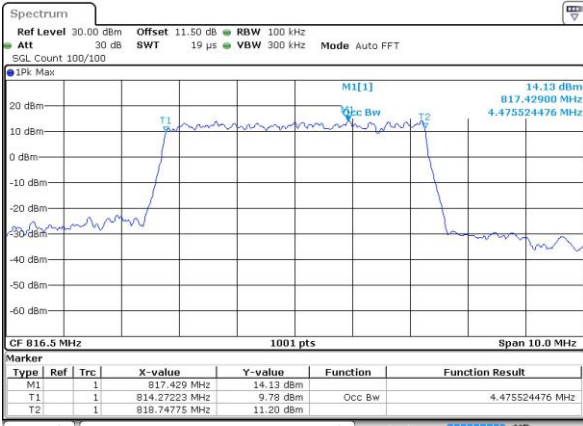

Date: 10 APR 2018 01:39:53

Lowest Channel / 5MHz / 16QAM

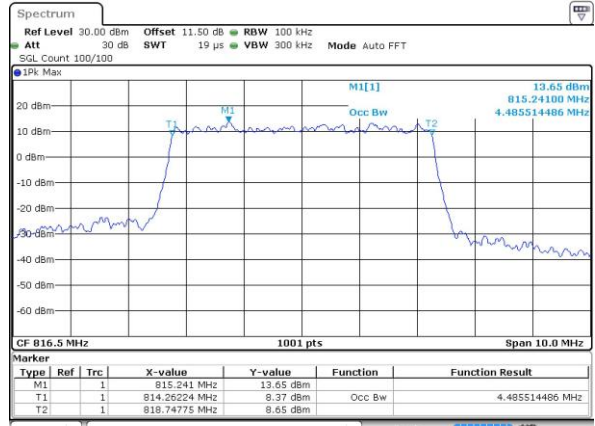

Date: 10 APR 2018 01:40:03

Middle Channel / 5MHz / QPSK

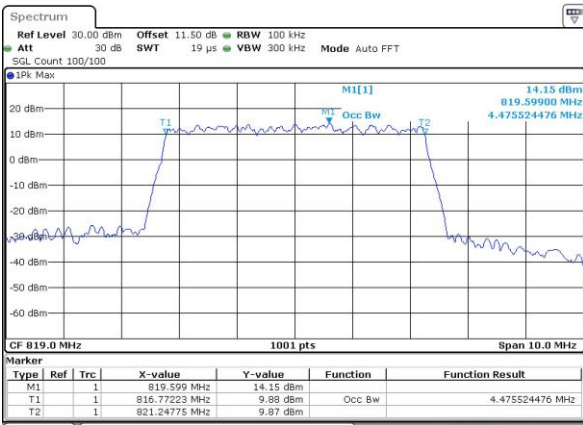

Date: 10 APR 2018 01:42:28

Middle Channel / 5MHz / 16QAM

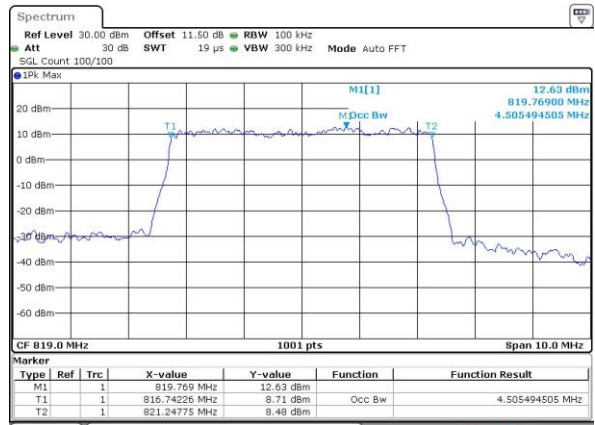

Date: 10 APR 2018 01:42:37

Highest Channel / 5MHz / QPSK

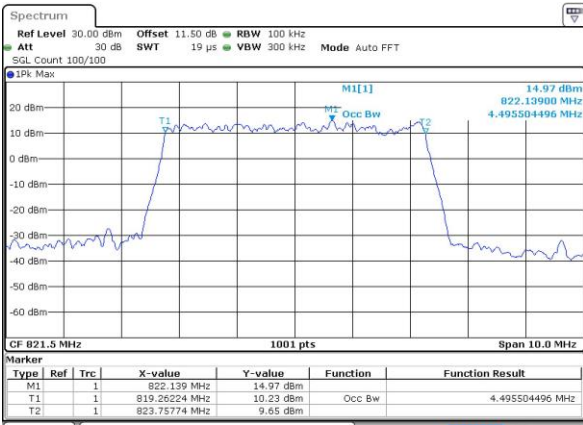

Date: 10 APR 2018 01:45:00

Highest Channel / 5MHz / 16QAM

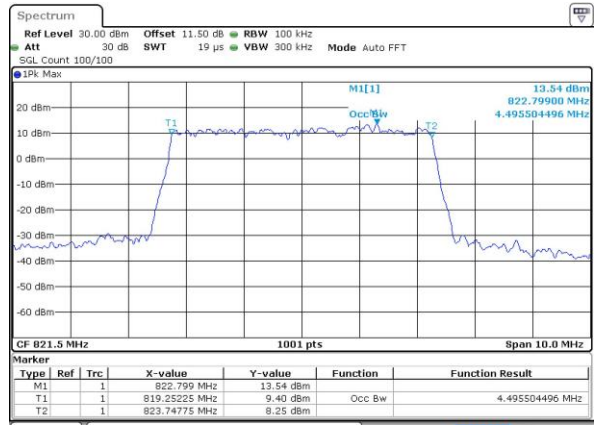

Date: 10 APR 2018 01:45:10



LTE Band 26

Middle Channel / 10MHz / QPSK

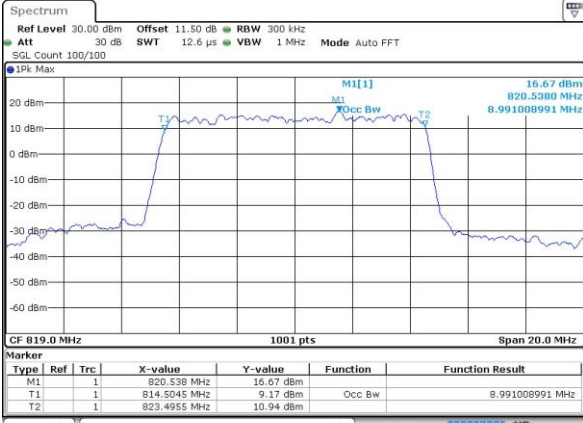

Date: 10 APR 2018 01:47:33

Middle Channel / 10MHz / 16QAM

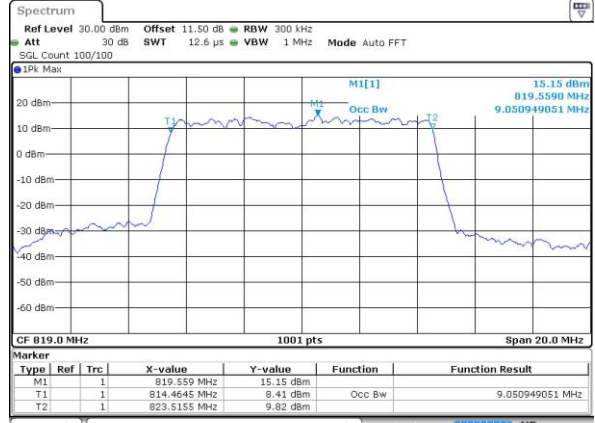

Date: 10 APR 2018 01:47:43

LTE Band 26

Lowest Channel / 15MHz / QPSK

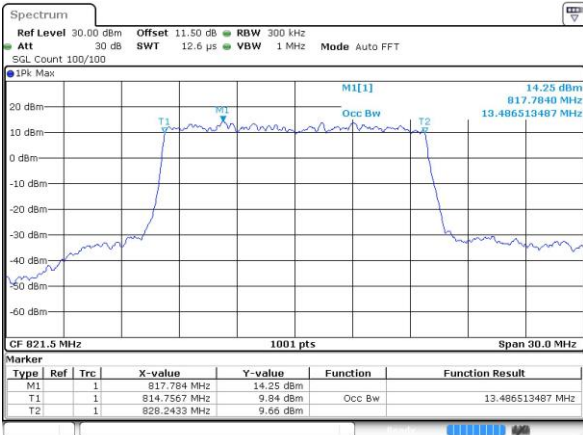

Date: 10 APR 2018 01:50:06

Lowest Channel / 15MHz / 16QAM

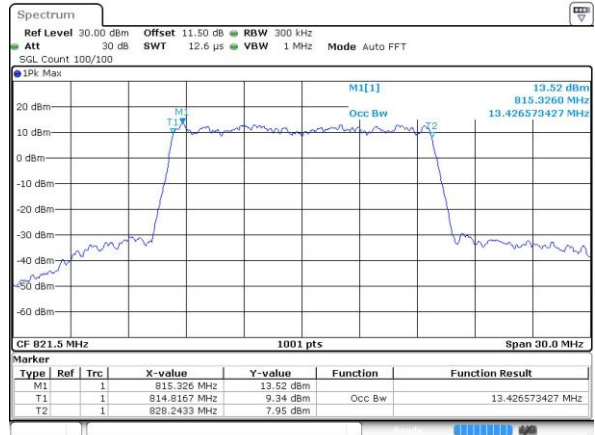

Date: 10 APR 2018 01:50:16



Conducted Band Edge

LTE Band 26 / 1.4MHz / QPSK

Lowest Band Edge / 1RB

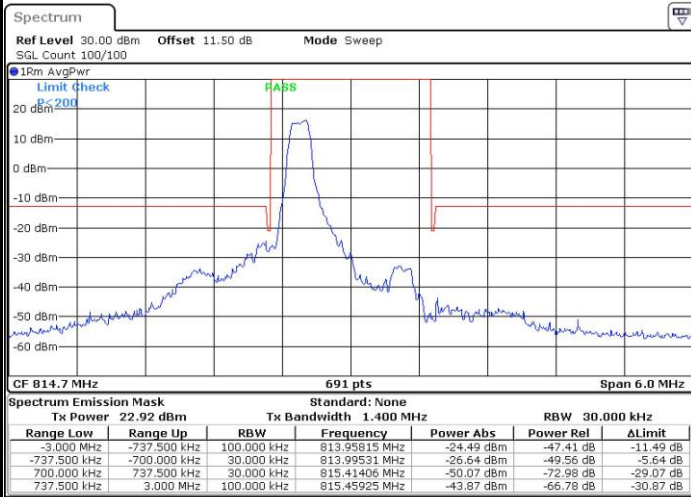

Date: 10 APR 2018 00:51:28

Highest Band Edge / 1RB

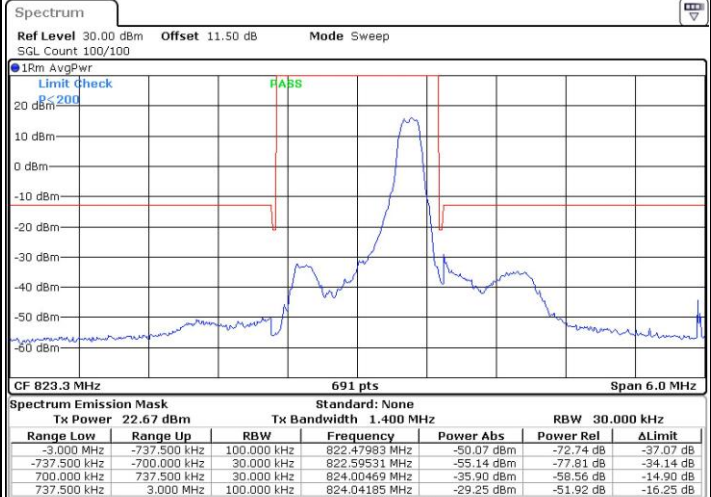

Date: 10 APR 2018 00:56:06

Lowest Band Edge / Full RB

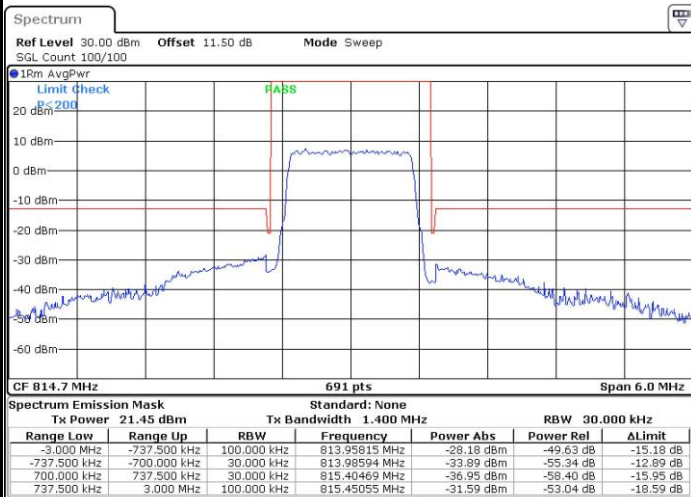

Date: 10 APR 2018 00:53:47

Highest Band Edge / Full RB

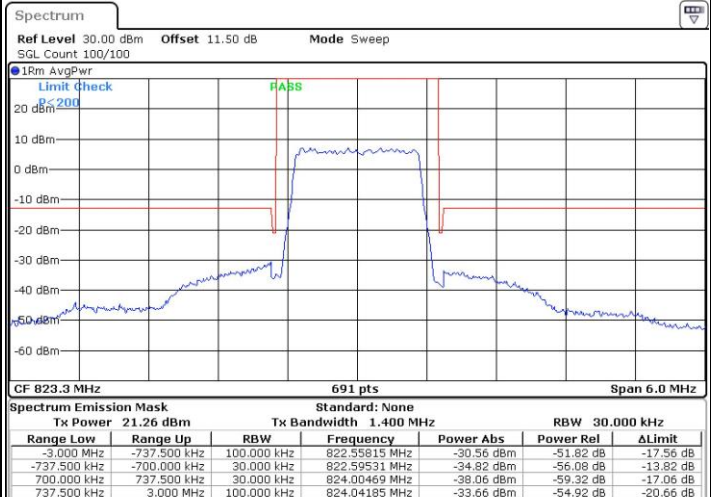

Date: 10 APR 2018 00:58:25



LTE Band 26 / 1.4MHz / 16QAM

Lowest Band Edge / 1 RB

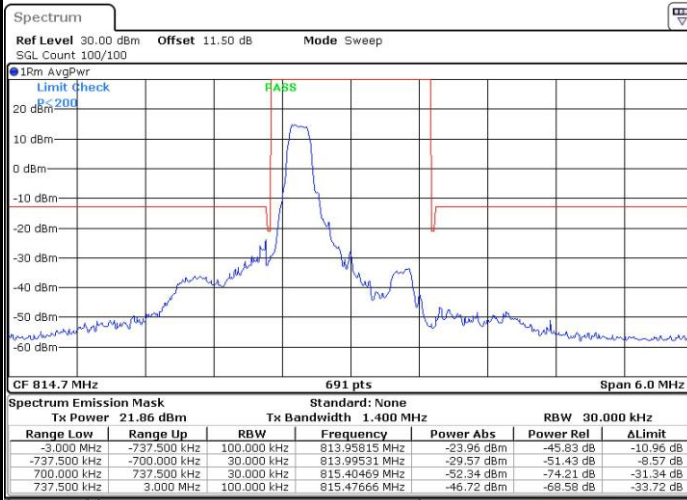

Date: 10 APR 2018 00:52:37

Highest Band Edge / 1 RB

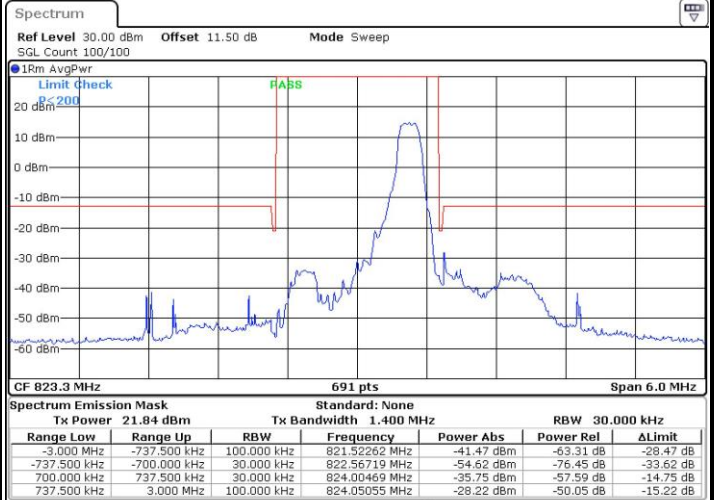

Date: 10 APR 2018 00:57:15

Lowest Band Edge / Full RB

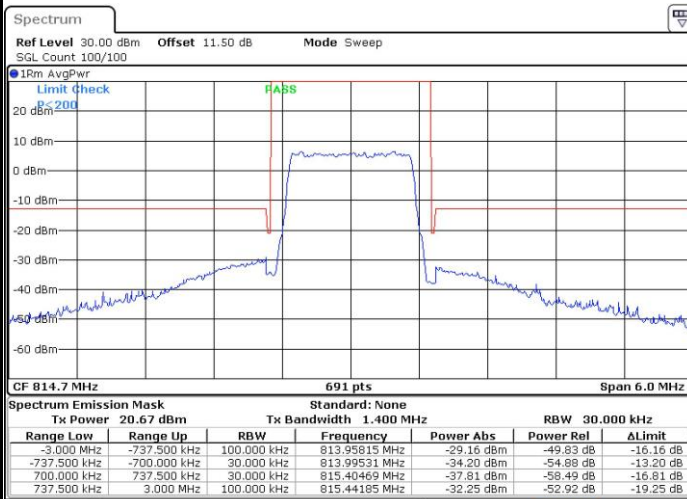

Date: 10 APR 2018 00:54:56

Highest Band Edge / Full RB

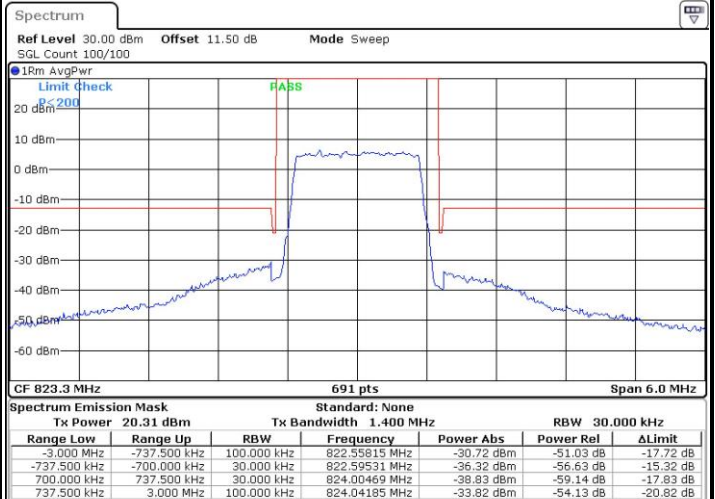

Date: 10 APR 2018 00:59:34