



FCC TEST REPORT

(PART 27)

REPORT NO.: RF121010C01B

MODEL NO.: E504

FCC ID: UZI-P04E68

RECEIVED: Jan. 21, 2013

TESTED: Jan. 29 ~ Jan. 30, 2013

ISSUED: Feb. 06, 2013

APPLICANT: BandRich Inc.

ADDRESS: 6F., No. 71, Zhouzi St., Neihu Dist., Taipei City
11493, Taiwan (R.O.C.)

ISSUED BY: Bureau Veritas Consumer Products Services
(H.K.) Ltd., Taoyuan Branch

LAB ADDRESS: No. 47, 14th Ling, Chia Pau Vil., Lin Kou Dist.,
New Taipei City, Taiwan, R.O.C.

TEST LOCATION: No. 19, Hwa Ya 2nd Rd, Wen Hwa Tsuen, Kwei
Shan Hsiang, Taoyuan Hsien 333, Taiwan, R.O.C.

This report should not be used by the client to claim product certification, approval, or endorsement by TAF or any government agencies.



This report is for your exclusive use. Any copying or replication of this report to or for any other person or entity, or use of our name or trademark, is permitted only with our prior written permission. This report sets forth our findings solely with respect to the test samples identified herein. The results set forth in this report are not indicative or representative of the quality or characteristics of the lot from which a test sample was taken or any similar or identical product unless specifically and expressly noted. Our report includes all of the tests requested by you and the results thereof based upon the information that you provided to us. You have 60 days from date of issuance of this report to notify us of any material error or omission caused by our negligence, provided, however, that such notice shall be in writing and shall specifically address the issue you wish to raise. A failure to raise such issue within the prescribed time shall constitute your unqualified acceptance of the completeness of this report, the tests conducted and the correctness of the report contents. Unless specific mention, the uncertainty of measurement has been explicitly taken into account to declare the compliance or non-compliance to the specification



A D T

TABLE OF CONTENTS

RELEASE CONTROL RECORD.....	3
1 CERTIFICATION	4
2 SUMMARY OF TEST RESULTS	5
2.1 MEASUREMENT UNCERTAINTY	5
2.2 TEST SITE AND INSTRUMENTS	6
3 GENERAL INFORMATION.....	7
3.1 GENERAL DESCRIPTION OF EUT.....	7
3.2 CONFIGURATION OF SYSTEM UNDER TEST	8
3.3 DESCRIPTION OF SUPPORT UNITS	8
3.4 DESCRIPTION OF TEST MODES.....	9
3.5 GENERAL DESCRIPTION OF APPLIED STANDARDS	11
4 TEST TYPES AND RESULTS	12
4.1 OUTPUT POWER MEASUREMENT	12
4.1.1 LIMITS OF OUTPUT POWER MEASUREMENT	12
4.1.2 TEST PROCEDURES	12
4.1.3 TEST SETUP	13
4.1.4 TEST RESULTS	14
4.2 FREQUENCY STABILITY MEASUREMENT	26
4.2.1 LIMITS OF FREQUENCY STABILITY MEASUREMENT	26
4.2.2 TEST PROCEDURE	26
4.2.3 TEST SETUP	26
4.2.4 TEST RESULTS	27
4.3 OCCUPIED BANDWIDTH MEASUREMENT.....	28
4.3.1 LIMITS OF OCCUPIED BANDWIDTH MEASUREMENT	28
4.3.2 TEST SETUP	28
4.3.3 TEST PROCEDURES	28
4.3.4 TEST RESULTS	29
4.4 PEAK TO AVERAGE RATIO	31
4.4.1 LIMITS OF PEAK TO AVERAGE RATIO MEASUREMENT	31
4.4.2 TEST SETUP	31
4.4.3 TEST PROCEDURES	31
4.4.4 TEST RESULTS	32
4.5 BAND EDGE MEASUREMENT	48
4.5.1 LIMITS OF BAND EDGE MEASUREMENT	48
4.5.2 TEST SETUP	48
4.5.3 TEST PROCEDURES	48
4.5.4 TEST RESULTS	49
4.6 CONDUCTED SPURIOUS EMISSIONS.....	57
4.6.1 LIMITS OF CONDUCTED SPURIOUS EMISSIONS MEASUREMENT	57
4.6.2 TEST PROCEDURE	57
4.6.3 TEST SETUP	57
4.6.4 TEST RESULTS	58
4.7 RADIATED EMISSION MEASUREMENT	82
4.7.1 LIMITS OF RADIATED EMISSION MEASUREMENT	82
4.7.2 TEST PROCEDURES	82
4.7.3 DEVIATION FROM TEST STANDARD	82
4.7.4 TEST SETUP	83
4.7.5 TEST RESULTS	84
5 INFORMATION ON THE TESTING LABORATORIES	104
6 APPENDIX A – MODIFICATIONS RECORDERS FOR ENGINEERING CHANGES TO THE EUT BY THE LAB.....	105



A D T

RELEASE CONTROL RECORD

ISSUE NO.	REASON FOR CHANGE	DATE ISSUED
RF121010C01B	Original release	Feb. 06, 2013



1 CERTIFICATION

PRODUCT: LTE Outdoor CPE
MODEL NO.: E504
BRAND: BandLuxe
APPLICANT: BandRich Inc.
TESTED: Jan. 29 ~ Jan. 30, 2013
TEST SAMPLE: ENGINEERING SAMPLE
TEST STANDARDS: **FCC Part 27, Subpart C, L**
FCC Part 2
ANSI C63.4-2009

The above equipment (model: E504) has been tested by **Bureau Veritas Consumer Products Services (H.K.) Ltd., Taoyuan Branch**, and found compliance with the requirement of the above standards. The test record, data evaluation & Equipment Under Test (EUT) configurations represented herein are true and accurate accounts of the measurements of the sample's EMC characteristics under the conditions specified in this report.

PREPARED BY : Ivy Lin , **DATE** : Feb. 06, 2013
Ivy Lin / Specialist

APPROVED BY : Anderson Chiu , **DATE** : Feb. 06, 2013
Anderson Chiu / Senior Engineer

2 SUMMARY OF TEST RESULTS

The EUT has been tested according to the following specifications:

OPERATING BAND: 1710~1755 MHz			
STANDARD SECTION	TEST TYPE AND LIMIT	RESULT	REMARK
2.1046 27.50(d)(4)	Maximum Peak Output Power	PASS	Meet the requirement of limit.
2.1055 27.54	Frequency Stability	PASS	Meet the requirement of limit.
2.1049 27.53(h)	Occupied Bandwidth	PASS	Meet the requirement of limit.
27.50(d)(5)	Peak to average ratio	PASS	Meet the requirement of limit.
27.53(h)	Band Edge Measurements	PASS	Meet the requirement of limit.
2.1051 27.53(h)	Conducted Spurious Emissions	PASS	Meet the requirement of limit.
2.1053 27.53(h)	Radiated Spurious Emissions	PASS	Meet the requirement of limit. Minimum passing margin is -16.01dB at 3490.00MHz.

2.1 MEASUREMENT UNCERTAINTY

Where relevant, the following measurement uncertainty levels have been estimated for tests performed on the EUT as specified in CISPR 16-4-2:

MEASUREMENT	FREQUENCY	UNCERTAINTY
Conducted emissions	150kHz~30MHz	2.44 dB
Radiated emissions	30MHz ~ 200MHz	3.34 dB
	200MHz ~1000MHz	3.35 dB
	1GHz ~ 18GHz	2.26 dB
	18GHz ~ 40GHz	1.94 dB

This uncertainty represents an expanded uncertainty expressed at approximately the 95% confidence level using a coverage factor of k=2.



2.2 TEST SITE AND INSTRUMENTS

DESCRIPTION & MANUFACTURER	MODEL NO.	SERIAL NO.	DATE OF CALIBRATION	DUE DATE OF CALIBRATION
Test Receiver ROHDE & SCHWARZ	ESIB7	100212	Aug. 06, 2012	Aug. 05, 2013
Spectrum Analyzer ROHDE & SCHWARZ	FSP40	100039	Feb. 03, 2012	Feb. 02, 2013
BILOG Antenna SCHWARZBECK	VULB9168	9168-160	Apr. 06, 2012	Apr. 05, 2013
HORN Antenna SCHWARZBECK	9120D	209	Sep. 03, 2012	Sep. 02, 2013
HORN Antenna SCHWARZBECK	BBHA 9170	148	Jul. 11, 2012	Jul. 10, 2013
Preamplifier Agilent	8447D	2944A10633	Oct. 25, 2012	Oct. 24, 2013
Preamplifier Agilent	8449B	3008A01964	Oct. 25, 2012	Oct. 24, 2013
RF signal cable HUBER+SUHNNER	SUCOFLEX 104	250723/4	Aug. 28, 2012	Aug. 27, 2013
RF signal cable HUBER+SUHNNER	SUCOFLEX 106	12738/6+309224/4	Aug. 28, 2012	Aug. 27, 2013
Software ADT.	ADT_Radiated_ V7.6.15.9.2	NA	NA	NA
Antenna Tower inn-co GmbH	MA 4000	013303	NA	NA
Antenna Tower Controller inn-co GmbH	CO2000	017303	NA	NA
Turn Table ADT.	TT100	TT93021703	NA	NA
Turn Table Controller ADT.	SC100	SC93021703	NA	NA

- NOTE:**
1. The calibration interval of the above test instruments is 12 months and the calibrations are traceable to NML/ROC and NIST/USA.
 2. The test was performed in HwaYa Chamber 3.
 3. The horn antenna and HP preamplifier (model: 8449B) are used only for the measurement of emission frequency above 1GHz if tested.
 4. The FCC Site Registration No. is 988962.
 5. The IC Site Registration No. is IC 7450F-3.

3 GENERAL INFORMATION

3.1 GENERAL DESCRIPTION OF EUT

EUT	LTE Outdoor CPE	
MODEL NO.	E504	
POWER SUPPLY	48Vdc (POE)	
MODULATION TECHNOLOGY	QPSK, 16QAM	
FREQUENCY RANGE	Channel Bandwidth: 5MHz	1712.5MHz ~1752.5MHz
	Channel Bandwidth: 10MHz	1715.0MHz ~1750.0MHz
	Channel Bandwidth: 15MHz	1717.5MHz ~ 1747.5MHz
	Channel Bandwidth: 20MHz	1720.0MHz ~ 1745.0MHz
MAX. EIRP POWER (mW)	Channel Bandwidth: 5MHz	633.87mW (28.02dBm)
	Channel Bandwidth: 10MHz	55.85mW (17.47dBm)
	Channel Bandwidth: 15MHz	42.07mW (16.24dBm)
	Channel Bandwidth: 20MHz	32.28mW (15.09dBm)
CATEGORY	LTE: 3	
ANTENNA TYPE	Loop antenna with 8dBi gain	
I/O PORTS	Refer to users' manual	
DATA CABLE	NA	
ACCESSORY DEVICES	POE, Adapter	

NOTE:

1. The EUT consumes power from POE which is powered by the following adapter.

ADAPTER	
BRAND:	DVE
MODEL:	DSA-42D-48 1
INPUT:	100-240Vac, 50-60Hz, 1.2A
OUTPUT:	48Vdc, 1A
POWER LINE:	AC: 1.5m non-shielded cable without core DC: 0.6m shielded cable with one core

2. The HW version is V01.
3. The SW version is R860_2 QC_0_00016749_1_001_0040.
4. The above EUT information is declared by manufacturer and for more detailed feature description, please refer to the manufacturer's specifications or user's manual.

3.2 CONFIGURATION OF SYSTEM UNDER TEST

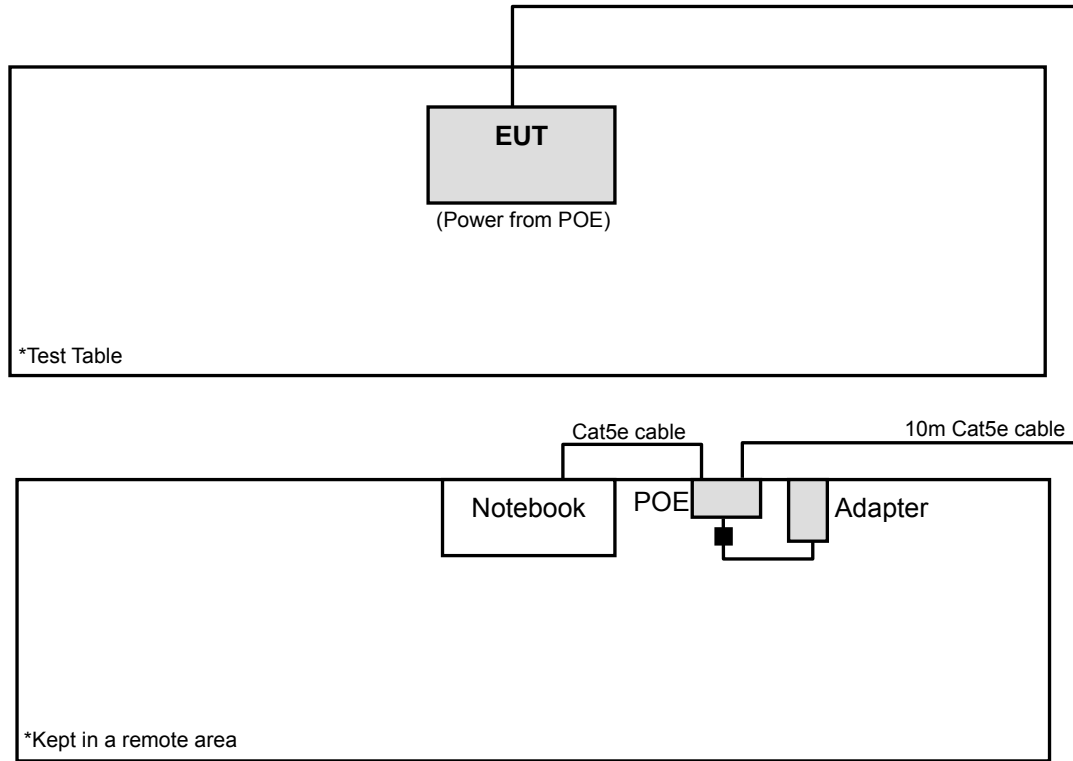

3.3 DESCRIPTION OF SUPPORT UNITS

The EUT has been tested as an independent unit together with other necessary accessories or support units. The following support units or accessories were used to form a representative test configuration during the tests.

NO.	PRODUCT	BRAND	MODEL NO.	SERIAL NO.	FCC ID
1	NOTEBOOK	DELL	D600	CN-0G5152-48643-4 7H-7677	N/A

NO.	SIGNAL CABLE DESCRIPTION OF THE ABOVE SUPPORT UNITS
1	10m cat.5e cable without core

NOTE: All power cords of the above support units are non shielded (1.8m).

3.4 DESCRIPTION OF TEST MODES

Pre-Scan has been conducted to determine the worst-case mode from all possible combinations between available modulations, data rates, XYZ axis and antenna ports. The worst case was found when positioned on Y-plane. Following channel(s) was (were) selected for the final test as listed below:

TEST ITEM	AVAILABLE CHANNEL	TESTED CHANNEL	CHANNEL BANDWIDTH	MODULATION	MODE
EIRP	19975 to 20375	19975, 20175, 20375	5MHz	QPSK,	1 RB / 0 RB Offset
				16QAM	1 RB / 0 RB Offset
	20000 to 20350	20000, 20175, 20350	10MHz	QPSK	1 RB / 0 RB Offset
				16QAM	1 RB / 0 RB Offset
	20025 to 20325	20025, 20175, 20325	15MHz	QPSK	1 RB / 0 RB Offset
				16QAM	1 RB / 0 RB Offset
	20050 to 20300	20050, 20175, 20300	20MHz	QPSK	1 RB / 0 RB Offset
				16QAM	1 RB / 0 RB Offset
FREQUENCY STABILITY	19975 to 20375	20175	5MHz	QPSK	1 RB / 0 RB Offset
	20000 to 20350	20175	10MHz	QPSK	1 RB / 0 RB Offset
	20025 to 20325	20175	15MHz	QPSK	1 RB / 0 RB Offset
	20050 to 20300	20175	20MHz	QPSK	1 RB / 0 RB Offset
OCCUPIED BANDWIDTH	19975 to 20375	19975, 20175, 20375	5MHz	QPSK, 16QAM	25 RB / 0 RB Offset
	20000 to 20350	20000, 20175, 20350	10MHz	QPSK, 16QAM	50 RB / 0 RB Offset
	20025 to 20325	20025, 20175, 20325	15MHz	QPSK, 16QAM	75RB / 0 RB Offset
	20050 to 20300	20050, 20175, 20300	20MHz	QPSK, 16QAM	100 RB / 0 RB Offset
PEAK TO AVERAGE RATIO	19975 to 20375	19975, 20175, 20375	5MHz	QPSK, 16QAM	1 RB / 0 RB Offset
					25 RB / 0 RB Offset
					100 RB / 0 RB Offset
	20000 to 20350	20000, 20175, 20350	10MHz	QPSK, 16QAM	1 RB / 0 RB Offset
					25 RB / 0 RB Offset
					100 RB / 0 RB Offset
	20025 to 20325	20025, 20175, 20325	15MHz	QPSK, 16QAM	1 RB / 0 RB Offset
					25 RB / 0 RB Offset
					100 RB / 0 RB Offset
	20050 to 20300	20050, 20175, 20300	20MHz	QPSK, 16QAM	1 RB / 0 RB Offset
					25 RB / 0 RB Offset
					100 RB / 0 RB Offset



A D T

TEST ITEM	AVAILABLE CHANNEL	TESTED CHANNEL	CHANNEL BANDWIDTH	MODULATION	MODE	
BAND EDGE	19975 to 20375	19975	5MHz	QPSK	1 RB / 0 RB Offset 25 RB / 0 RB Offset	
		20375	5MHz	QPSK	1 RB / 24 RB Offset 25 RB / 0 RB Offset	
	20000 to 20350	20000	10MHz	QPSK	1 RB / 0 RB Offset 50 RB / 0 RB Offset	
		20350	10MHz	QPSK	1 RB / 49 RB Offset 50RB / 0 RB Offset	
	20025 to 20325	20025	15MHz	QPSK	1 RB / 0 RB Offset 75 RB / 0 RB Offset	
		20325	15MHz	QPSK	1 RB / 74 RB Offset 75 RB / 0 RB Offset	
	20050 to 20300	20050	20MHz	QPSK	1 RB / 0 RB Offset 100 RB / 0 RB Offset	
		20300	20MHz	QPSK	1 RB / 99 RB Offset 100 RB / 0 RB Offset	
	CONDCUDED EMISSION	19975 to 20375	19975, 20175, 20375	5MHz	QPSK, 16QAM	1 RB / 0 RB Offset
		20000 to 20350	20000, 20175, 20350	10MHz	QPSK, 16QAM	1 RB / 0 RB Offset
		20025 to 20325	20025, 20175, 20325	15MHz	QPSK, 16QAM	1 RB / 0 RB Offset
		20050 to 20300	20050, 20175, 20300	20MHz	QPSK, 16QAM	1 RB / 0 RB Offset
RADIATED EMISSION BELOW 1GHz	19975 to 20375	19975	5MHz	QPSK, 16QAM	1 RB / 0 RB Offset	
	20000 to 20350	20000	10MHz	QPSK, 16QAM	1 RB / 0 RB Offset	
	20025 to 20325	20025	15MHz	QPSK, 16QAM	1 RB / 0 RB Offset	
	20050 to 20300	20050	20MHz	QPSK, 16QAM	1 RB / 0 RB Offset	
RADIATED EMISSION ABOVE 1GHz	19975 to 20375	19975, 20175, 20375	5MHz	QPSK	1 RB / 0 RB Offset	
	20000 to 20350	20000, 20175, 20350	10MHz	QPSK	1 RB / 0 RB Offset	
	20025 to 20325	20025, 20175, 20325	15MHz	QPSK	1 RB / 0 RB Offset	
	20050 to 20300	20050, 20175, 20300	20MHz	QPSK	1 RB / 0 RB Offset	

TEST CONDITION:

TEST ITEM	ENVIRONMENTAL CONDITIONS	INPUT POWER	TESTED BY
ERP/EIRP	25deg. C, 65%RH	120Vac, 60Hz	Chris Lin
FREQUENCY STABILITY	25deg. C, 65%RH	120Vac, 60Hz	Chris Lin
OCCUPIED BANDWIDTH	25deg. C, 65%RH	120Vac, 60Hz	Chris Lin
BAND EDGE	25deg. C, 65%RH	120Vac, 60Hz	Chris Lin
CONDCUDED EMISSION	25deg. C, 65%RH	120Vac, 60Hz	Chris Lin
RADIATED EMISSION	25deg. C, 65%RH	120Vac, 60Hz	Chris Lin

3.5 GENERAL DESCRIPTION OF APPLIED STANDARDS

The EUT is a RF product. According to the specifications of the manufacturer, it must comply with the requirements of the following standards:

FCC 47 CFR Part 2

FCC 47 CFR Part 27

ANSI C63.4-2009

ANSI/TIA/EIA-603-C 2004

NOTE: All test items have been performed and recorded as per the above standards.

4 TEST TYPES AND RESULTS

4.1 OUTPUT POWER MEASUREMENT

4.1.1 LIMITS OF OUTPUT POWER MEASUREMENT

Fixed, mobile, and portable (hand-held) stations operating in the 1710–1755 MHz band are limited to 1 watt EIRP.

4.1.2 TEST PROCEDURES

EIRP / ERP MEASUREMENT:

- a. The EUT was set up for the maximum power with LTE link data modulation. The power was measured with R&S Spectrum Analyzer. All measurements were done at 3 channels (low, middle and high operational frequency range). RBW and VBW is 10MHz for LTE.
- b. E.I.R.P power measurement. In the semi-anechoic chamber, EUT placed on the 0.8m height of Turn Table, rotated the table around 360 degrees to search the maximum radiation power and receiver antenna shall be rotated vertical and horizontal polarization and moved height from 1m to 4m to find the maximum polar radiated power. The “Read Value” is the spectrum reading the maximum power value.
- c. The substitution horn antenna is substituted for EUT at the same position and signals generator export the CW signal to the substitution antenna via a TX cable. Rotated the Turn Table and moved receiving antenna to find the maximum radiation power. Adjust output power level of S.G to get a Value of spectrum reading equal to “Read Value” of step a. Record the power level of S.G
- d. $EIRP = \text{Output power level of S.G} - \text{TX cable loss} + \text{Antenna gain of substitution horn}$
- e. $E.R.P = E.I.R.P - 2.15 \text{ dB}$

CONDUCTED POWER MEASUREMENT:

- a. The EUT was set up for the maximum power with LTE link data modulation and link up with simulator.
- b. Set the EUT to transmit under low, middle and high channel and record the power level shown on simulator.

4.1.3 TEST SETUP

EIRP / ERP MEASUREMENT:

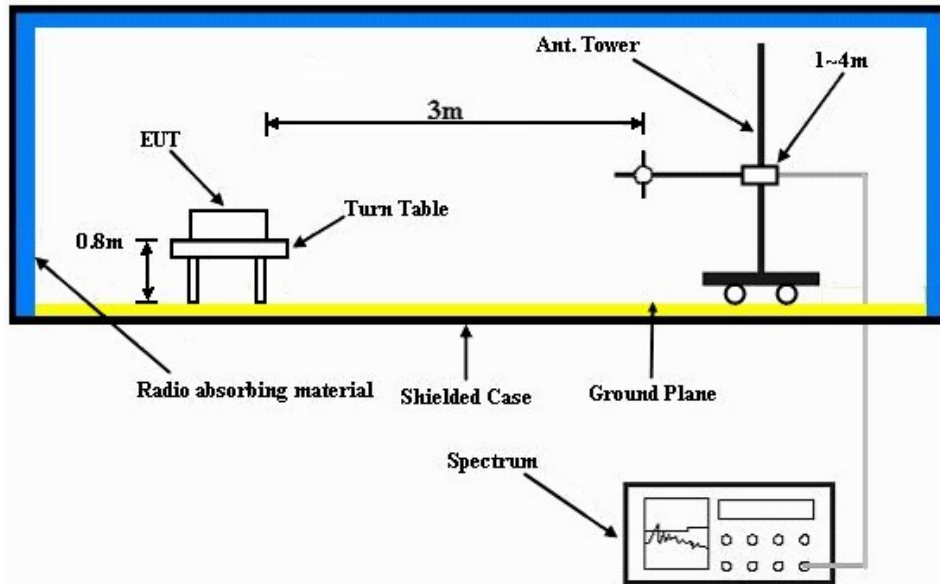

For the actual test configuration, please refer to the attached file (Test Setup Photo).

CONDUCTED POWER MEASUREMENT:

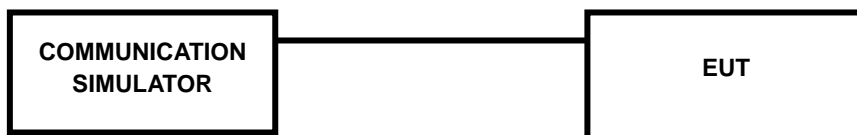

For the actual test configuration, please refer to the attached file (Test Setup Photo).

4.1.4 TEST RESULTS

CONDUCTED OUTPUT POWER (dBm)

LTE Band 4							
BW	Modulation	CH	Frequency	RB	RB Offset	MPR	Measured
			(MHz)				Power
5MHz	QPSK	19975	1712.5	1	0	0	25.15
		20175	1732.5	1	0	0	24.62
		20375	1752.5	1	0	0	24.78
		19975	1712.5	1	12	0	24.98
		20175	1732.5	1	12	0	24.58
		20375	1752.5	1	12	0	24.67
		19975	1712.5	1	24	0	24.81
		20175	1732.5	1	24	0	24.44
		20375	1752.5	1	24	0	24.68
		19975	1712.5	12	0	1	24.01
		20175	1732.5	12	0	1	23.66
		20375	1752.5	12	0	1	23.68
		19975	1712.5	12	6	1	24
		20175	1732.5	12	6	1	23.58
		20375	1752.5	12	6	1	23.74
		19975	1712.5	12	13	1	23.82
		20175	1732.5	12	13	1	23.48
		20375	1752.5	12	13	1	23.66
	19975	1712.5	25	0	1	23.92	
	20175	1732.5	25	0	1	23.55	
	20375	1752.5	25	0	1	23.66	
	19975	1712.5	1	0	1	24.02	
	20175	1732.5	1	0	1	23.82	
	20375	1752.5	1	0	1	24.00	
	19975	1712.5	1	12	1	23.87	
	20175	1732.5	1	12	1	23.54	
	20375	1752.5	1	12	1	23.72	
	19975	1712.5	1	24	1	23.74	
	20175	1732.5	1	24	1	23.49	
	20375	1752.5	1	24	1	23.64	
	19975	1712.5	12	0	2	23.04	
	20175	1732.5	12	0	2	22.89	
	20375	1752.5	12	0	2	22.97	
	19975	1712.5	12	6	2	23.01	
	20175	1732.5	12	6	2	22.94	
	20375	1752.5	12	6	2	23.00	
19975	1712.5	12	13	2	22.79		
20175	1732.5	12	13	2	22.79		
20375	1752.5	12	13	2	22.84		
19975	1712.5	25	0	2	22.59		
20175	1732.5	25	0	2	22.61		
20375	1752.5	25	0	2	22.63		



A D T

LTE Band 4							
BW	Modulation	CH	Frequency	RB	RB Offset	MPR	Measured
			(MHz)				Power
10MHz	QPSK	20000	1715	1	0	0	24.89
		20175	1732.5	1	0	0	24.32
		20350	1750	1	0	0	24.37
		20000	1715	1	24	0	24.71
		20175	1732.5	1	24	0	24.06
		20350	1750	1	24	0	24.09
		20000	1715	1	49	0	24.67
		20175	1732.5	1	49	0	23.94
		20350	1750	1	49	0	23.98
		20000	1715	25	0	1	23.84
		20175	1732.5	25	0	1	23.21
		20350	1750	25	0	1	23.24
		20000	1715	25	12	1	23.84
		20175	1732.5	25	12	1	23.19
		20350	1750	25	12	1	23.21
		20000	1715	25	25	1	23.67
		20175	1732.5	25	25	1	22.97
		20350	1750	25	25	1	23.04
	20000	1715	50	0	1	23.43	
	20175	1732.5	50	0	1	23.79	
	20350	1750	50	0	1	22.84	
	20000	1715	1	0	1	24	
	20175	1732.5	1	0	1	23.87	
	20350	1750	1	0	1	23.94	
	20000	1715	1	24	1	23.71	
	20175	1732.5	1	24	1	23.56	
	20350	1750	1	24	1	23.67	
	20000	1715	1	49	1	23.64	
	20175	1732.5	1	49	1	23.47	
	20350	1750	1	49	1	23.59	
	20000	1715	25	0	2	22.86	
	20175	1732.5	25	0	2	22.43	
	20350	1750	25	0	2	22.57	
	20000	1715	25	12	2	22.81	
	20175	1732.5	25	12	2	22.42	
	20350	1750	25	12	2	22.54	
20000	1715	25	25	2	22.67		
20175	1732.5	25	25	2	22.26		
20350	1750	25	25	2	22.34		
20000	1715	50	0	2	22.46		
20175	1732.5	50	0	2	22.01		
20350	1750	50	0	2	22.19		



A D T

LTE Band 4							
BW	Modulation	CH	Frequency	RB	RB Offset	MPR	Measured
			(MHz)				Power
15MHz	QPSK	20025	1717.5	1	0	0	24.82
		20175	1732.5	1	0	0	24.32
		20325	1747.5	1	0	0	24.26
		20025	1717.5	1	37	0	24.56
		20175	1732.5	1	37	0	24.03
		20325	1747.5	1	37	0	23.94
		20025	1717.5	1	74	0	24.47
		20175	1732.5	1	74	0	23.92
		20325	1747.5	1	74	0	23.86
		20025	1717.5	36	0	1	23.87
		20175	1732.5	36	0	1	23.19
		20325	1747.5	36	0	1	23.04
		20025	1717.5	36	19	1	23.84
		20175	1732.5	36	19	1	23.14
		20325	1747.5	36	19	1	23.01
		20025	1717.5	36	39	1	23.61
		20175	1732.5	36	39	1	22.98
		20325	1747.5	36	39	1	22.84
	20025	1717.5	75	0	1	23.46	
	20175	1732.5	75	0	1	22.75	
	20325	1747.5	75	0	1	22.61	
	20025	1717.5	1	0	1	24	
	20175	1732.5	1	0	1	23.87	
	20325	1747.5	1	0	1	23.64	
	20025	1717.5	1	37	1	23.65	
	20175	1732.5	1	37	1	23.54	
	20325	1747.5	1	37	1	23.37	
	20025	1717.5	1	74	1	23.54	
	20175	1732.5	1	74	1	23.47	
	20325	1747.5	1	74	1	23.24	
	20025	1717.5	36	0	2	22.79	
	20175	1732.5	36	0	2	22.86	
	20325	1747.5	36	0	2	22.64	
	20025	1717.5	36	19	2	22.75	
	20175	1732.5	36	19	2	22.84	
	20325	1747.5	36	19	2	22.64	
20025	1717.5	36	39	2	22.59		
20175	1732.5	36	39	2	22.68		
20325	1747.5	36	39	2	22.42		
20025	1717.5	75	0	2	22.34		
20175	1732.5	75	0	2	22.52		
20325	1747.5	75	0	2	22.31		



A D T

LTE Band 4							
BW	Modulation	CH	Frequency	RB	RB Offset	MPR	Measured
			(MHz)				Power
20MHz	QPSK	20050	1720	1	0	0	24.55
		20175	1732.5	1	0	0	24.41
		20300	1745	1	0	0	24.16
		20050	1720	1	50	0	24.24
		20175	1732.5	1	50	0	24.13
		20300	1745	1	50	0	23.84
		20050	1720	1	99	0	24.17
		20175	1732.5	1	99	0	24.06
		20300	1745	1	99	0	23.74
		20050	1720	50	0	1	23.39
		20175	1732.5	50	0	1	23.31
		20300	1745	50	0	1	22.96
		20050	1720	50	25	1	23.34
		20175	1732.5	50	25	1	23
		20300	1745	50	25	1	22.94
		20050	1720	50	50	1	23.17
		20175	1732.5	50	50	1	22.84
		20300	1745	50	50	1	22.76
	20050	1720	100	0	1	22.94	
	20175	1732.5	100	0	1	22.67	
	20300	1745	100	0	1	22.55	
	20050	1720	1	0	1	23.98	
	20175	1732.5	1	0	1	23.79	
	20300	1745	1	0	1	23.46	
	20050	1720	1	50	1	23.64	
	20175	1732.5	1	50	1	23.42	
	20300	1745	1	50	1	23.17	
	20050	1720	1	99	1	23.53	
	20175	1732.5	1	99	1	23.31	
	20300	1745	1	99	1	23.09	
	20050	1720	50	0	2	22.78	
	20175	1732.5	50	0	2	22.59	
	20300	1745	50	0	2	22.33	
	20050	1720	50	25	2	22.74	
	20175	1732.5	50	25	2	22.53	
	20300	1745	50	25	2	22.29	
20050	1720	50	50	2	22.53		
20175	1732.5	50	50	2	22.34		
20300	1745	50	50	2	22.04		
20050	1720	100	0	2	22.34		
20175	1732.5	100	0	2	22.17		
20300	1745	100	0	2	21.98		



A D T

EIRP (dBm)

CHANNEL BANDWIDTH: 5MHz QPSK

MODE		TX channel 19975					
ANTENNA POLARITY & TEST DISTANCE: HORIZONTAL AT 3 M							
No.	Freq. (MHz)	Reading (dBm)	S.G Power Value (dBm)	Correction Factor (dB)	EIRP (dBm)	Limit (dBm)	Margin (dB)
1	1712.5	-11.79	25.62	-0.83	24.79	30.00	-5.21
ANTENNA POLARITY & TEST DISTANCE: VERTICAL AT 3 M							
No.	Freq. (MHz)	Reading (dBm)	S.G Power Value (dBm)	Correction Factor (dB)	EIRP (dBm)	Limit (dBm)	Margin (dB)
1	1712.5	-8.95	27.56	-0.83	26.73	30.00	-3.27

MODE		TX channel 20175					
ANTENNA POLARITY & TEST DISTANCE: HORIZONTAL AT 3 M							
No.	Freq. (MHz)	Reading (dBm)	S.G Power Value (dBm)	Correction Factor (dB)	EIRP (dBm)	Limit (dBm)	Margin (dB)
1	1732.5	-10.94	26.55	-0.83	25.72	30.00	-4.28
ANTENNA POLARITY & TEST DISTANCE: VERTICAL AT 3 M							
No.	Freq. (MHz)	Reading (dBm)	S.G Power Value (dBm)	Correction Factor (dB)	EIRP (dBm)	Limit (dBm)	Margin (dB)
1	1732.5	-9.18	27.38	-0.83	26.55	30.00	-3.45

MODE		TX channel 20375					
ANTENNA POLARITY & TEST DISTANCE: HORIZONTAL AT 3 M							
No.	Freq. (MHz)	Reading (dBm)	S.G Power Value (dBm)	Correction Factor (dB)	EIRP (dBm)	Limit (dBm)	Margin (dB)
1	1752.5	-10.73	26.86	-0.84	26.02	30.00	-3.98
ANTENNA POLARITY & TEST DISTANCE: VERTICAL AT 3 M							
No.	Freq. (MHz)	Reading (dBm)	S.G Power Value (dBm)	Correction Factor (dB)	EIRP (dBm)	Limit (dBm)	Margin (dB)
1	1752.5	-7.76	28.86	-0.84	28.02	30.00	-1.98



A D T

CHANNEL BANDWIDTH: 5MHz 16QAM

MODE		TX channel 19975					
ANTENNA POLARITY & TEST DISTANCE: HORIZONTAL AT 3 M							
No.	Freq. (MHz)	Reading (dBm)	S.G Power Value (dBm)	Correction Factor (dB)	EIRP (dBm)	Limit (dBm)	Margin (dB)
1	1712.5	-11.80	25.61	-0.83	24.78	30.00	-5.22
ANTENNA POLARITY & TEST DISTANCE: VERTICAL AT 3 M							
No.	Freq. (MHz)	Reading (dBm)	S.G Power Value (dBm)	Correction Factor (dB)	EIRP (dBm)	Limit (dBm)	Margin (dB)
1	1712.5	-9.51	27.00	-0.83	26.17	30.00	-3.83

MODE		TX channel 20175					
ANTENNA POLARITY & TEST DISTANCE: HORIZONTAL AT 3 M							
No.	Freq. (MHz)	Reading (dBm)	S.G Power Value (dBm)	Correction Factor (dB)	EIRP (dBm)	Limit (dBm)	Margin (dB)
1	1732.5	-11.25	26.24	-0.83	25.41	30.00	-4.59
ANTENNA POLARITY & TEST DISTANCE: VERTICAL AT 3 M							
No.	Freq. (MHz)	Reading (dBm)	S.G Power Value (dBm)	Correction Factor (dB)	EIRP (dBm)	Limit (dBm)	Margin (dB)
1	1732.5	-7.74	28.82	-0.83	27.99	30.00	-2.01

MODE		TX channel 20375					
ANTENNA POLARITY & TEST DISTANCE: HORIZONTAL AT 3 M							
No.	Freq. (MHz)	Reading (dBm)	S.G Power Value (dBm)	Correction Factor (dB)	EIRP (dBm)	Limit (dBm)	Margin (dB)
1	1752.5	-10.23	27.36	-0.84	26.52	30.00	-3.48
ANTENNA POLARITY & TEST DISTANCE: VERTICAL AT 3 M							
No.	Freq. (MHz)	Reading (dBm)	S.G Power Value (dBm)	Correction Factor (dB)	EIRP (dBm)	Limit (dBm)	Margin (dB)
1	1752.5	-8.51	28.11	-0.84	27.27	30.00	-2.73



A D T

CHANNEL BANDWIDTH: 10MHz QPSK

MODE		TX channel 20000					
ANTENNA POLARITY & TEST DISTANCE: HORIZONTAL AT 3 M							
No.	Freq. (MHz)	Reading (dBm)	S.G Power Value (dBm)	Correction Factor (dB)	EIRP (dBm)	Limit (dBm)	Margin (dB)
1	1715.0	-20.55	16.87	-0.83	16.04	30.00	-13.96
ANTENNA POLARITY & TEST DISTANCE: VERTICAL AT 3 M							
No.	Freq. (MHz)	Reading (dBm)	S.G Power Value (dBm)	Correction Factor (dB)	EIRP (dBm)	Limit (dBm)	Margin (dB)
1	1715.0	-18.33	17.69	-0.83	16.89	30.00	-13.14

MODE		TX channel 20175					
ANTENNA POLARITY & TEST DISTANCE: HORIZONTAL AT 3 M							
No.	Freq. (MHz)	Reading (dBm)	S.G Power Value (dBm)	Correction Factor (dB)	EIRP (dBm)	Limit (dBm)	Margin (dB)
1	1732.5	-22.23	15.26	-0.83	14.43	30.00	-15.57
ANTENNA POLARITY & TEST DISTANCE: VERTICAL AT 3 M							
No.	Freq. (MHz)	Reading (dBm)	S.G Power Value (dBm)	Correction Factor (dB)	EIRP (dBm)	Limit (dBm)	Margin (dB)
1	1732.5	-19.30	17.26	-0.83	16.43	30.00	-13.57

MODE		TX channel 20350					
ANTENNA POLARITY & TEST DISTANCE: HORIZONTAL AT 3 M							
No.	Freq. (MHz)	Reading (dBm)	S.G Power Value (dBm)	Correction Factor (dB)	EIRP (dBm)	Limit (dBm)	Margin (dB)
1	1750.0	-21.07	16.51	-+0.84	15.67	30.00	-14.33
ANTENNA POLARITY & TEST DISTANCE: VERTICAL AT 3 M							
No.	Freq. (MHz)	Reading (dBm)	S.G Power Value (dBm)	Correction Factor (dB)	EIRP (dBm)	Limit (dBm)	Margin (dB)
1	1750.0	-18.56	18.06	-0.84	17.22	30.00	-12.78



A D T

CHANNEL BANDWIDTH: 10MHz 16QAM

MODE		TX channel 20000					
ANTENNA POLARITY & TEST DISTANCE: HORIZONTAL AT 3 M							
No.	Freq. (MHz)	Reading (dBm)	S.G Power Value (dBm)	Correction Factor (dB)	EIRP (dBm)	Limit (dBm)	Margin (dB)
1	1715.0	-21.52	15.90	-0.83	15.07	30.00	-14.93
ANTENNA POLARITY & TEST DISTANCE: VERTICAL AT 3 M							
No.	Freq. (MHz)	Reading (dBm)	S.G Power Value (dBm)	Correction Factor (dB)	EIRP (dBm)	Limit (dBm)	Margin (dB)
1	1715.0	-20.28	16.24	-0.83	15.41	30.00	-14.59

MODE		TX channel 20175					
ANTENNA POLARITY & TEST DISTANCE: HORIZONTAL AT 3 M							
No.	Freq. (MHz)	Reading (dBm)	S.G Power Value (dBm)	Correction Factor (dB)	EIRP (dBm)	Limit (dBm)	Margin (dB)
1	1732.5	-23.12	14.37	-0.83	13.54	30.00	-16.46
ANTENNA POLARITY & TEST DISTANCE: VERTICAL AT 3 M							
No.	Freq. (MHz)	Reading (dBm)	S.G Power Value (dBm)	Correction Factor (dB)	EIRP (dBm)	Limit (dBm)	Margin (dB)
1	1732.5	-19.38	17.18	-0.83	16.35	30.00	-13.65

MODE		TX channel 20350					
ANTENNA POLARITY & TEST DISTANCE: HORIZONTAL AT 3 M							
No.	Freq. (MHz)	Reading (dBm)	S.G Power Value (dBm)	Correction Factor (dB)	EIRP (dBm)	Limit (dBm)	Margin (dB)
1	1750.0	-20.96	16.62	-0.84	15.78	30.00	-14.22
ANTENNA POLARITY & TEST DISTANCE: VERTICAL AT 3 M							
No.	Freq. (MHz)	Reading (dBm)	S.G Power Value (dBm)	Correction Factor (dB)	EIRP (dBm)	Limit (dBm)	Margin (dB)
1	1750.0	-18.31	18.31	-0.84	17.47	30.00	-12.53



A D T

CHANNEL BANDWIDTH: 15MHz QPSK

MODE		TX channel 20025					
ANTENNA POLARITY & TEST DISTANCE: HORIZONTAL AT 3 M							
No.	Freq. (MHz)	Reading (dBm)	S.G Power Value (dBm)	Correction Factor (dB)	EIRP (dBm)	Limit (dBm)	Margin (dB)
1	1717.50	-21.58	15.85	-0.83	15.02	30.00	-14.98
ANTENNA POLARITY & TEST DISTANCE: VERTICAL AT 3 M							
No.	Freq. (MHz)	Reading (dBm)	S.G Power Value (dBm)	Correction Factor (dB)	EIRP (dBm)	Limit (dBm)	Margin (dB)
1	1717.50	-20.89	15.63	-0.83	14.80	30.00	-15.20

MODE		TX channel 20175					
ANTENNA POLARITY & TEST DISTANCE: HORIZONTAL AT 3 M							
No.	Freq. (MHz)	Reading (dBm)	S.G Power Value (dBm)	Correction Factor (dB)	EIRP (dBm)	Limit (dBm)	Margin (dB)
1	1732.50	-22.52	14.97	-0.83	14.14	30.00	-15.86
ANTENNA POLARITY & TEST DISTANCE: VERTICAL AT 3 M							
No.	Freq. (MHz)	Reading (dBm)	S.G Power Value (dBm)	Correction Factor (dB)	EIRP (dBm)	Limit (dBm)	Margin (dB)
1	1732.50	-20.54	16.02	-0.83	15.19	30.00	-14.81

MODE		TX channel 20325					
ANTENNA POLARITY & TEST DISTANCE: HORIZONTAL AT 3 M							
No.	Freq. (MHz)	Reading (dBm)	S.G Power Value (dBm)	Correction Factor (dB)	EIRP (dBm)	Limit (dBm)	Margin (dB)
1	1747.50	-23.53	14.04	-0.84	13.20	30.00	-16.80
ANTENNA POLARITY & TEST DISTANCE: VERTICAL AT 3 M							
No.	Freq. (MHz)	Reading (dBm)	S.G Power Value (dBm)	Correction Factor (dB)	EIRP (dBm)	Limit (dBm)	Margin (dB)
1	1747.50	-19.53	17.08	-0.84	16.24	30.00	-13.76



A D T

CHANNEL BANDWIDTH: 15MHz 16QAM

MODE		TX channel 20025					
ANTENNA POLARITY & TEST DISTANCE: HORIZONTAL AT 3 M							
No.	Freq. (MHz)	Reading (dBm)	S.G Power Value (dBm)	Correction Factor (dB)	EIRP (dBm)	Limit (dBm)	Margin (dB)
1	1717.50	-21.93	15.50	-0.83	14.67	30.00	-15.33
ANTENNA POLARITY & TEST DISTANCE: VERTICAL AT 3 M							
No.	Freq. (MHz)	Reading (dBm)	S.G Power Value (dBm)	Correction Factor (dB)	EIRP (dBm)	Limit (dBm)	Margin (dB)
1	1717.50	-21.48	15.04	-0.83	14.21	30.00	-15.79

MODE		TX channel 20175					
ANTENNA POLARITY & TEST DISTANCE: HORIZONTAL AT 3 M							
No.	Freq. (MHz)	Reading (dBm)	S.G Power Value (dBm)	Correction Factor (dB)	EIRP (dBm)	Limit (dBm)	Margin (dB)
1	1732.50	-23.57	13.92	-0.83	13.09	30.00	-16.91
ANTENNA POLARITY & TEST DISTANCE: VERTICAL AT 3 M							
No.	Freq. (MHz)	Reading (dBm)	S.G Power Value (dBm)	Correction Factor (dB)	EIRP (dBm)	Limit (dBm)	Margin (dB)
1	1732.50	-20.62	15.94	-0.83	15.11	30.00	-14.89

MODE		TX channel 20325					
ANTENNA POLARITY & TEST DISTANCE: HORIZONTAL AT 3 M							
No.	Freq. (MHz)	Reading (dBm)	S.G Power Value (dBm)	Correction Factor (dB)	EIRP (dBm)	Limit (dBm)	Margin (dB)
1	1747.50	-22.90	14.67	-0.84	13.83	30.00	-16.17
ANTENNA POLARITY & TEST DISTANCE: VERTICAL AT 3 M							
No.	Freq. (MHz)	Reading (dBm)	S.G Power Value (dBm)	Correction Factor (dB)	EIRP (dBm)	Limit (dBm)	Margin (dB)
1	1747.50	-21.23	15.38	-0.84	14.54	30.00	-15.46



A D T

CHANNEL BANDWIDTH: 20MHz QPSK

MODE		TX channel 20050					
ANTENNA POLARITY & TEST DISTANCE: HORIZONTAL AT 3 M							
No.	Freq. (MHz)	Reading (dBm)	S.G Power Value (dBm)	Correction Factor (dB)	EIRP (dBm)	Limit (dBm)	Margin (dB)
1	1720.00	-22.66	14.78	-0.83	13.95	30.00	-16.05
ANTENNA POLARITY & TEST DISTANCE: VERTICAL AT 3 M							
No.	Freq. (MHz)	Reading (dBm)	S.G Power Value (dBm)	Correction Factor (dB)	EIRP (dBm)	Limit (dBm)	Margin (dB)
1	1720.00	-20.61	15.92	-0.83	15.09	30.00	-14.91

MODE		TX channel 20175					
ANTENNA POLARITY & TEST DISTANCE: HORIZONTAL AT 3 M							
No.	Freq. (MHz)	Reading (dBm)	S.G Power Value (dBm)	Correction Factor (dB)	EIRP (dBm)	Limit (dBm)	Margin (dB)
1	1732.50	-23.90	13.59	-0.83	12.76	30.00	-17.24
ANTENNA POLARITY & TEST DISTANCE: VERTICAL AT 3 M							
No.	Freq. (MHz)	Reading (dBm)	S.G Power Value (dBm)	Correction Factor (dB)	EIRP (dBm)	Limit (dBm)	Margin (dB)
1	1732.50	-21.81	14.75	-0.83	13.92	30.00	-16.08

MODE		TX channel 20300					
ANTENNA POLARITY & TEST DISTANCE: HORIZONTAL AT 3 M							
No.	Freq. (MHz)	Reading (dBm)	S.G Power Value (dBm)	Correction Factor (dB)	EIRP (dBm)	Limit (dBm)	Margin (dB)
1	1745.00	-24.20	13.36	-0.84	12.52	30.00	-17.48
ANTENNA POLARITY & TEST DISTANCE: VERTICAL AT 3 M							
No.	Freq. (MHz)	Reading (dBm)	S.G Power Value (dBm)	Correction Factor (dB)	EIRP (dBm)	Limit (dBm)	Margin (dB)
1	1745.00	-21.03	15.57	-0.84	14.73	30.00	-15.27



A D T

CHANNEL BANDWIDTH: 20MHz 16QAM

MODE		TX channel 20050					
ANTENNA POLARITY & TEST DISTANCE: HORIZONTAL AT 3 M							
No.	Freq. (MHz)	Reading (dBm)	S.G Power Value (dBm)	Correction Factor (dB)	EIRP (dBm)	Limit (dBm)	Margin (dB)
1	1720.00	-23.33	14.11	-0.83	13.28	30.00	-16.72
ANTENNA POLARITY & TEST DISTANCE: VERTICAL AT 3 M							
No.	Freq. (MHz)	Reading (dBm)	S.G Power Value (dBm)	Correction Factor (dB)	EIRP (dBm)	Limit (dBm)	Margin (dB)
1	1720.00	-23.57	12.96	-0.83	12.13	30.00	-17.87

MODE		TX channel 20175					
ANTENNA POLARITY & TEST DISTANCE: HORIZONTAL AT 3 M							
No.	Freq. (MHz)	Reading (dBm)	S.G Power Value (dBm)	Correction Factor (dB)	EIRP (dBm)	Limit (dBm)	Margin (dB)
1	1732.50	-24.96	12.53	-0.83	11.70	30.00	-18.30
ANTENNA POLARITY & TEST DISTANCE: VERTICAL AT 3 M							
No.	Freq. (MHz)	Reading (dBm)	S.G Power Value (dBm)	Correction Factor (dB)	EIRP (dBm)	Limit (dBm)	Margin (dB)
1	1732.50	-21.70	14.86	-0.83	14.03	30.00	-15.97

MODE		TX channel 20300					
ANTENNA POLARITY & TEST DISTANCE: HORIZONTAL AT 3 M							
No.	Freq. (MHz)	Reading (dBm)	S.G Power Value (dBm)	Correction Factor (dB)	EIRP (dBm)	Limit (dBm)	Margin (dB)
1	1745.00	-24.22	13.34	-0.84	12.50	30.00	-17.50
ANTENNA POLARITY & TEST DISTANCE: VERTICAL AT 3 M							
No.	Freq. (MHz)	Reading (dBm)	S.G Power Value (dBm)	Correction Factor (dB)	EIRP (dBm)	Limit (dBm)	Margin (dB)
1	1745.00	-22.13	14.47	-0.84	13.63	30.00	-16.37

4.2 FREQUENCY STABILITY MEASUREMENT

4.2.1 LIMITS OF FREQUENCY STABILITY MEASUREMENT

The frequency stability shall be sufficient to ensure that the fundamental emissions stay within the authorized bands of operation.

4.2.2 TEST PROCEDURE

- a. Device is placed at the oven room. The oven room could control the temperatures and humidity. Power warm up is at least 15 min and power applied should perform before recording frequency error.
- b. EUT is connected the external power supply to control the DC input power. The test voltage range is from minimum to maximum working voltage. Each step shall be record the frequency error rate.
- c. The temperature range step is 10 degrees in this test items. All temperature levels shall be hold the $\pm 0.5^{\circ}\text{C}$ during the measurement testing. The each temperature step shall be at least 0.5 hours, consider the EUT could be test under the stability condition.

NOTE: The frequency error was recorded frequency error from the communication simulator.

4.2.3 TEST SETUP

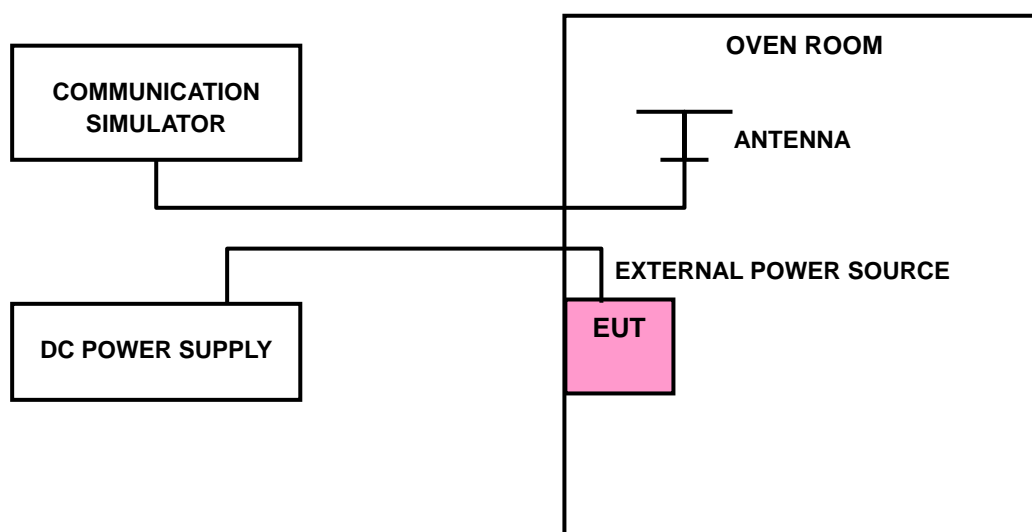

4.2.4 TEST RESULTS

VOLTAGE (Volts)	FREQUENCY ERROR (ppm)				LIMIT (ppm)
	LTE BAND 4				
	5MHz	10MHz	15MHz	20MHz	
93.5	-0.013	0.012	-0.006	-0.002	2.5
120.0	0.002	0.017	0.009	0.015	2.5
126.5	-0.017	-0.005	-0.005	-0.019	2.5

NOTE: The applicant defined the normal working voltage of the adapter is from 93.5Vac to 126.5Vac.

TEMP. (°C)	FREQUENCY ERROR (ppm)				LIMIT (ppm)
	LTE BAND 4				
	5MHz	10MHz	15MHz	20MHz	
55	0.010	-0.008	0.017	0.750	2.5
50	-0.006	0.012	-0.018	-0.008	2.5
40	-0.003	0.001	-0.008	-0.014	2.5
30	-0.002	0.008	-0.013	0.007	2.5
20	-0.019	0.015	0.214	0.012	2.5
10	-0.005	0.010	-0.018	0.008	2.5
0	0.016	0.012	0.006	0.004	2.5
-10	0.006	-0.007	0.008	0.010	2.5
-20	-0.003	0.006	-0.006	-0.010	2.5
-30	0.013	0.013	-0.016	0.008	2.5

4.3 OCCUPIED BANDWIDTH MEASUREMENT

4.3.1 LIMITS OF OCCUPIED BANDWIDTH MEASUREMENT

The width of a frequency band such that, below the lower and above the upper frequency limits, the mean powers emitted are each equal to a specified percentage 0.5 % of the total mean power of a given emission.

4.3.2 TEST SETUP

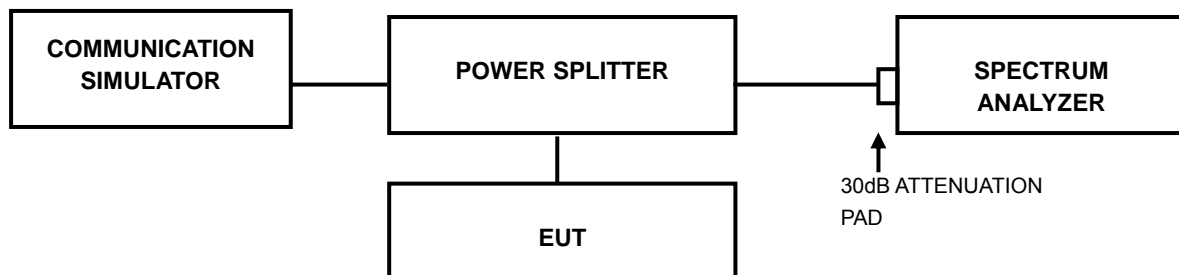

4.3.3 TEST PROCEDURES

- The conducted occupied bandwidth used the power splitter via EUT RF power connector between simulation base station and spectrum analyzer.
- Use OBW measurement function of Spectrum analyzer to measure 99 % occupied bandwidth.



A D T

4.3.4 TEST RESULTS

CHANNEL BANDWIDTH: 5MHz				CHANNEL BANDWIDTH: 10MHz			
CHANNEL	FREQUENCY (MHz)	99% OCCUPIED BANDWIDTH (MHz)		CHANNEL	FREQUENCY (MHz)	99% OCCUPIED BANDWIDTH (MHz)	
		QPSK	16QAM			QPSK	16QAM
19975	1712.5	4.5	4.5	20000	1715.0	8.97	8.97
20175	1732.5	4.5	4.5	20175	1732.5	8.97	9.00
20375	1752.5	4.5	4.48	20350	1750.0	9.00	9.00

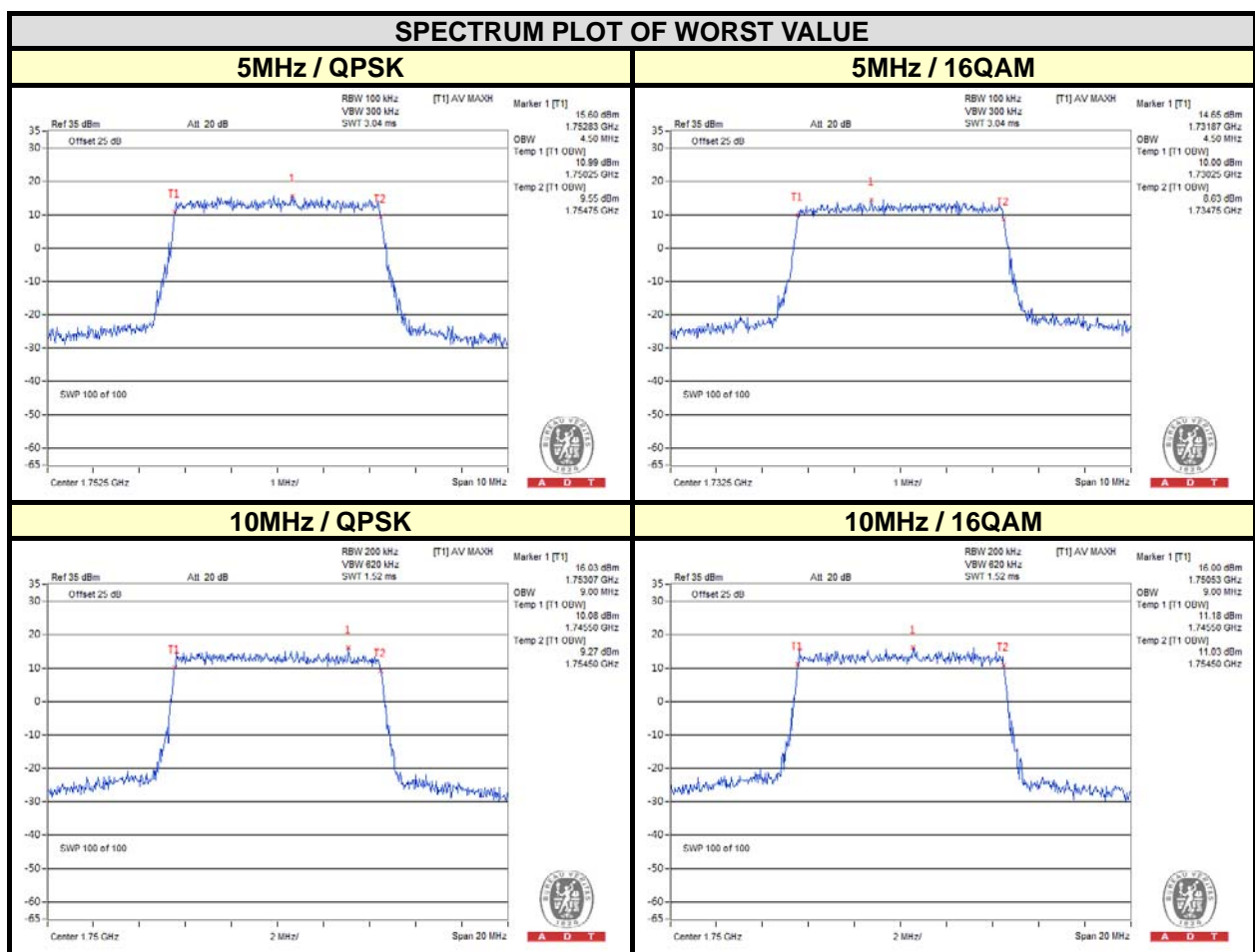



A D T

CHANNEL BANDWIDTH: 15MHz				CHANNEL BANDWIDTH: 20MHz			
CHANNEL	FREQUENCY (MHz)	99% OCCUPIED BANDWIDTH (MHz)		CHANNEL	FREQUENCY (MHz)	99% OCCUPIED BANDWIDTH (MHz)	
		QPSK	16QAM			QPSK	16QAM
20025	1717.5	13.4	13.4	20050	1720	17.87	17.87
20175	1732.5	13.4	13.4	20175	1732.5	17.87	17.80
20325	1747.5	13.45	13.4	20300	1745	17.87	17.87

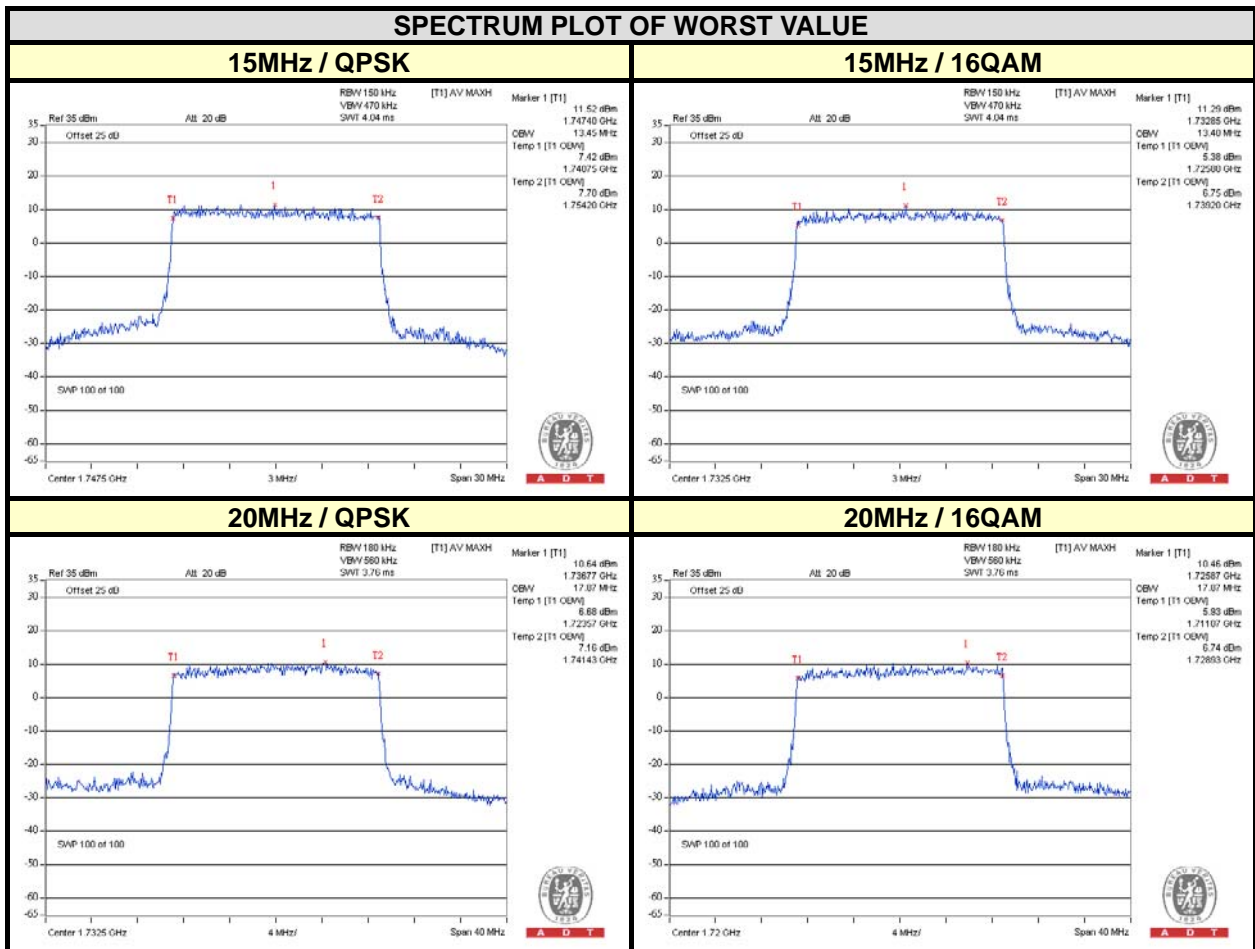

4.4 PEAK TO AVERAGE RATIO

4.4.1 LIMITS OF PEAK TO AVERAGE RATIO MEASUREMENT

In measuring transmissions in this band using an average power technique, the peak to-average ratio (PAR) of the transmission may not exceed 13 dB

4.4.2 TEST SETUP

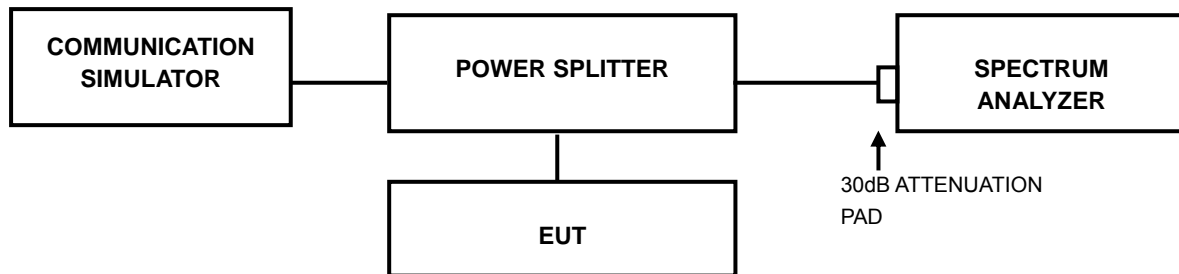

4.4.3 TEST PROCEDURES

1. Set resolution/measurement bandwidth \geq signal's occupied bandwidth;
2. Set the number of counts to a value that stabilizes the measured CCDF curve;
3. Record the maximum PAPR level associated with a probability of 0.1%.



A D T

4.4.4 TEST RESULTS

LTE BAND 4 CHANNEL BANDWIDTH: 5MHz / QPSK

FREQUENCY (MHz)	PEAK TO AVERAGE RATIO (dB)						
	1RB LOWER	1RB CENTER	1RB UPPER	50% RB LOWER	50% RB CENTER	50% RB UPPER	100% RB
1712.5	4.74	4.92	4.97	5.23	5.20	5.25	5.34
1732.5	5.11	5.12	5.13	5.31	5.36	5.34	5.44
1752.5	5.14	5.06	5.01	5.48	5.39	5.36	5.41

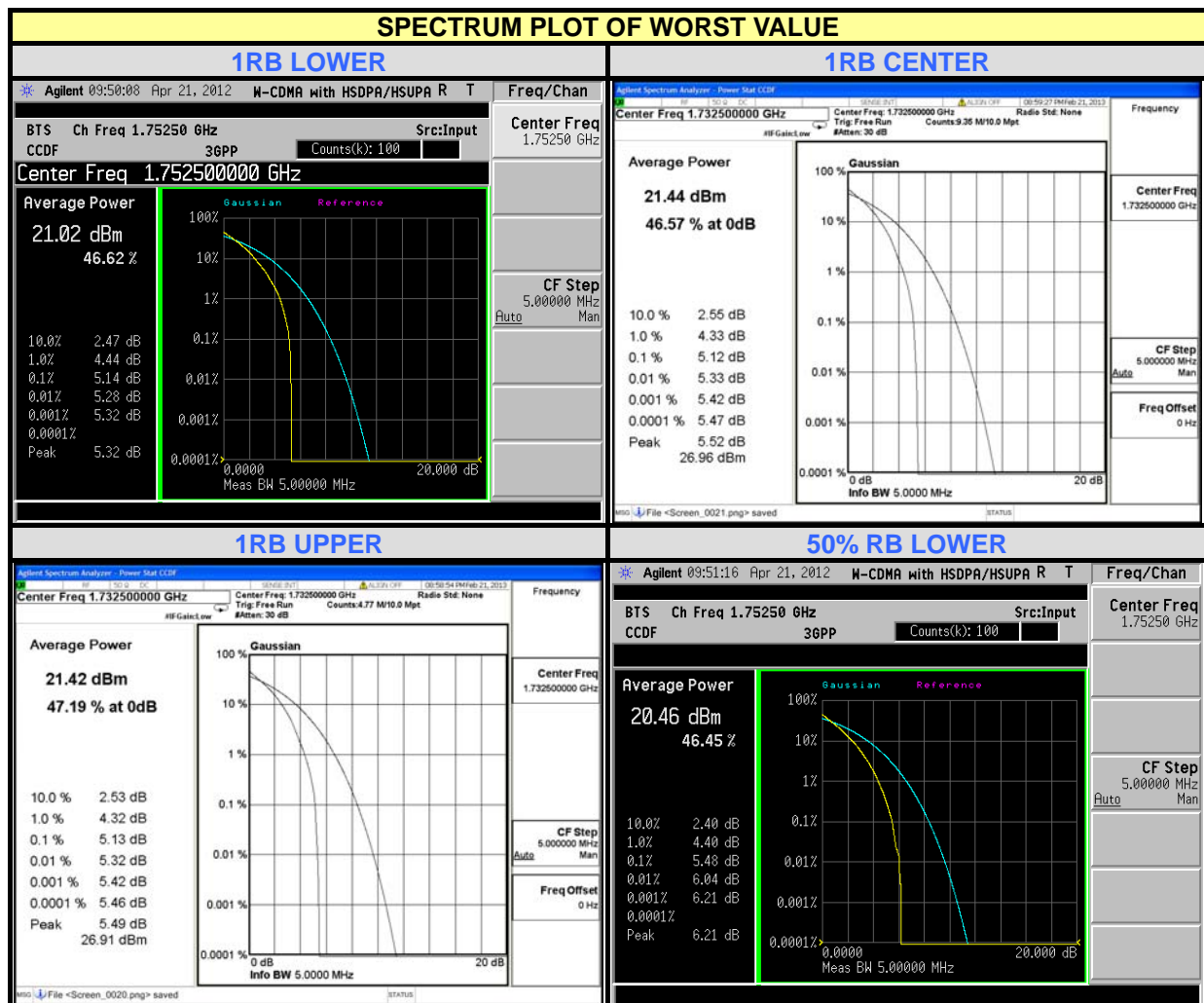



A D T

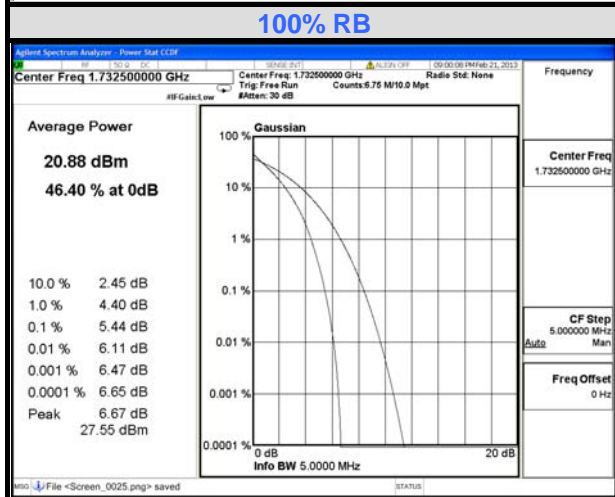
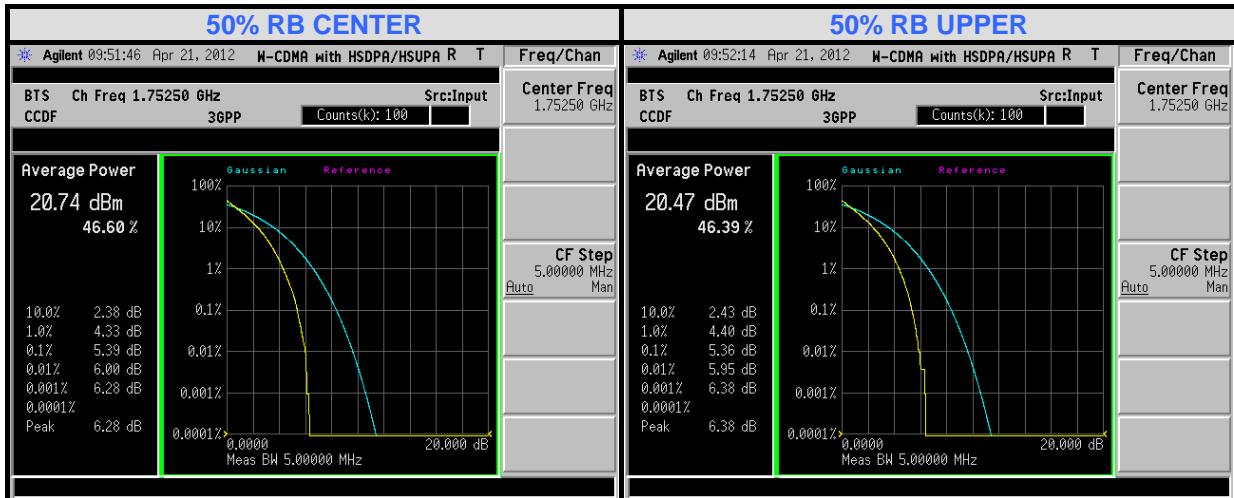



A D T

CHANNEL BANDWIDTH: 5MHz / 16QAM

FREQUENCY (MHz)	PEAK TO AVERAGE RATIO (dB)						
	1RB LOWER	1RB CENTER	1RB UPPER	50% RB LOWER	50% RB CENTER	50% RB UPPER	100% RB
1712.5	5.59	5.86	5.54	5.59	5.98	6.07	6.07
1732.5	6.04	6.01	5.54	6.15	6.12	6.14	6.03
1752.5	6.01	5.93	6.04	6.12	6.12	6.16	6.13

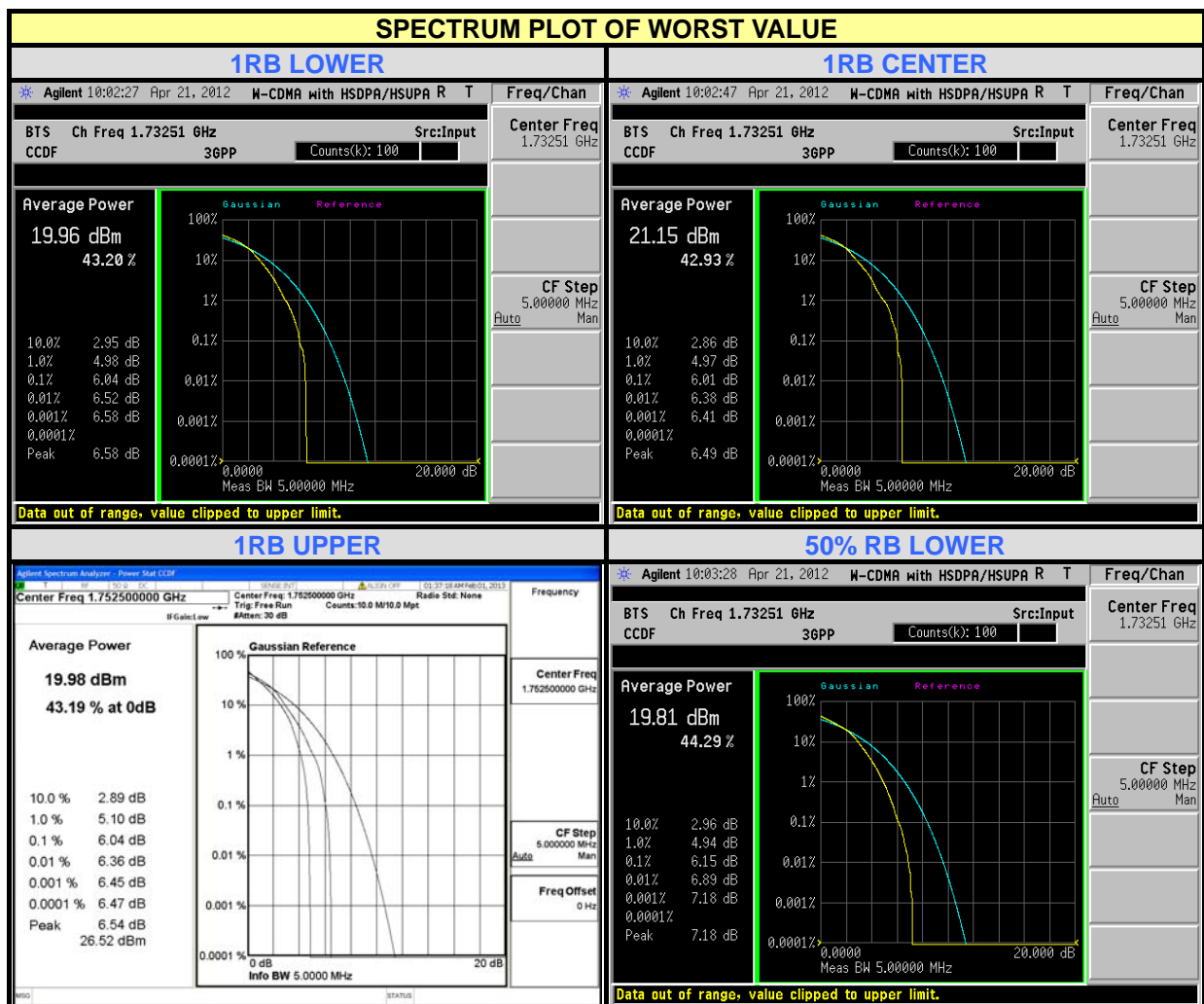



A D T

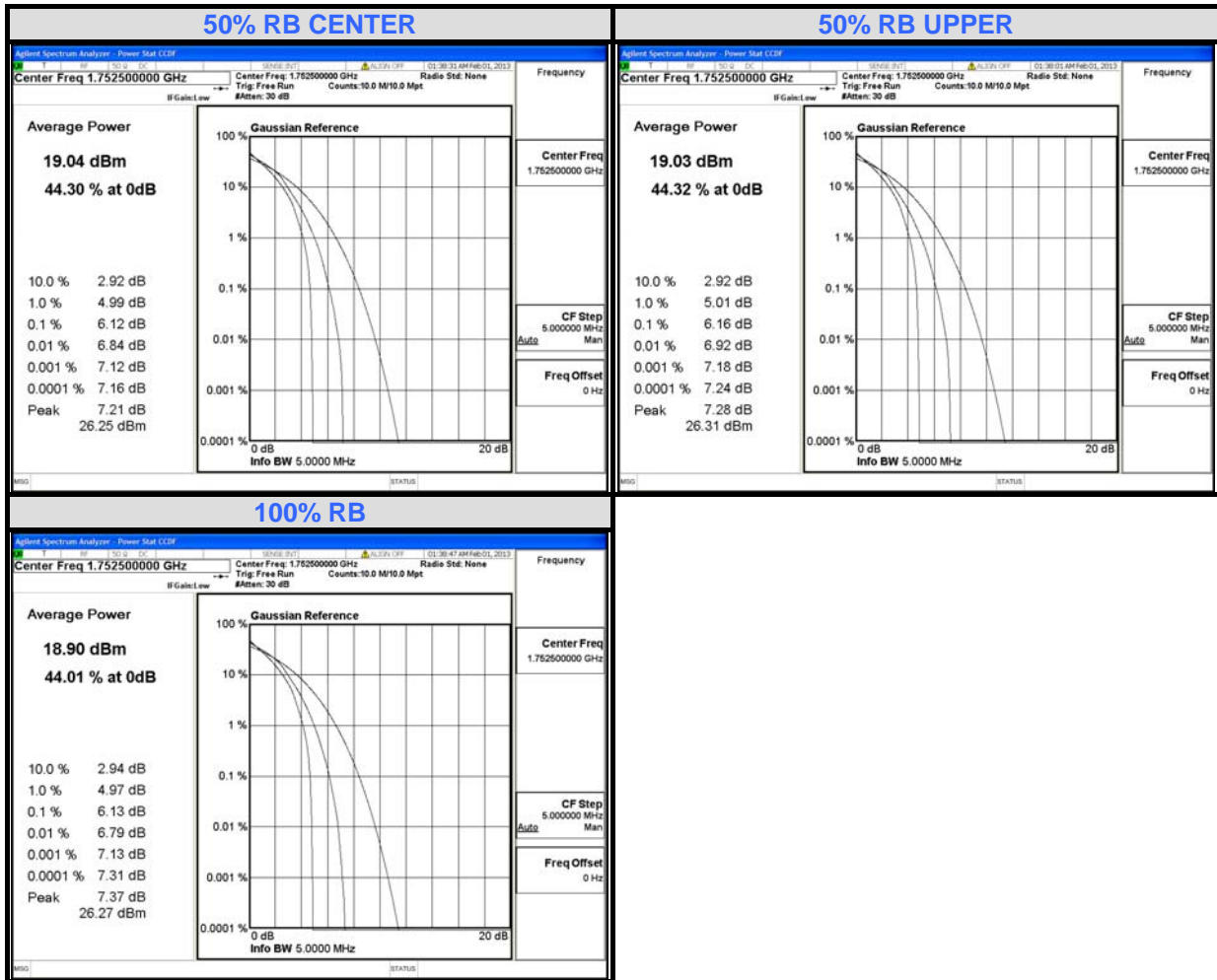



A D T

CHANNEL BANDWIDTH: 10MHz / QPSK

FREQUENCY (MHz)	PEAK TO AVERAGE RATIO (dB)						
	1RB LOWER	1RB CENTER	1RB UPPER	50% RB LOWER	50% RB CENTER	50% RB UPPER	100% RB
1715	4.63	4.69	4.56	5.22	5.14	5.12	5.39
1732.5	5.07	5.12	4.90	5.37	5.31	5.45	5.45
1750	4.80	5.09	5.03	5.29	5.33	5.52	5.51

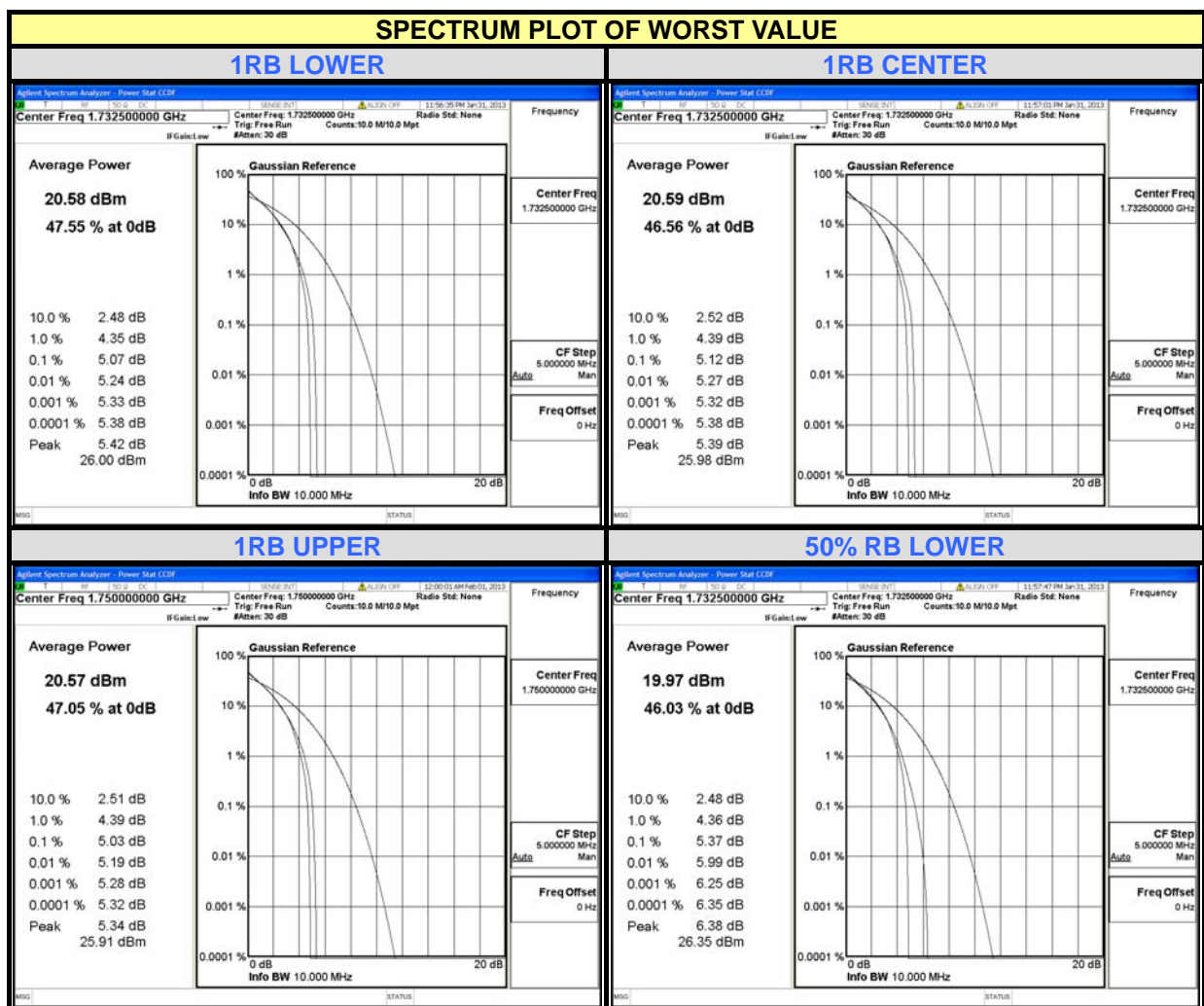



A D T

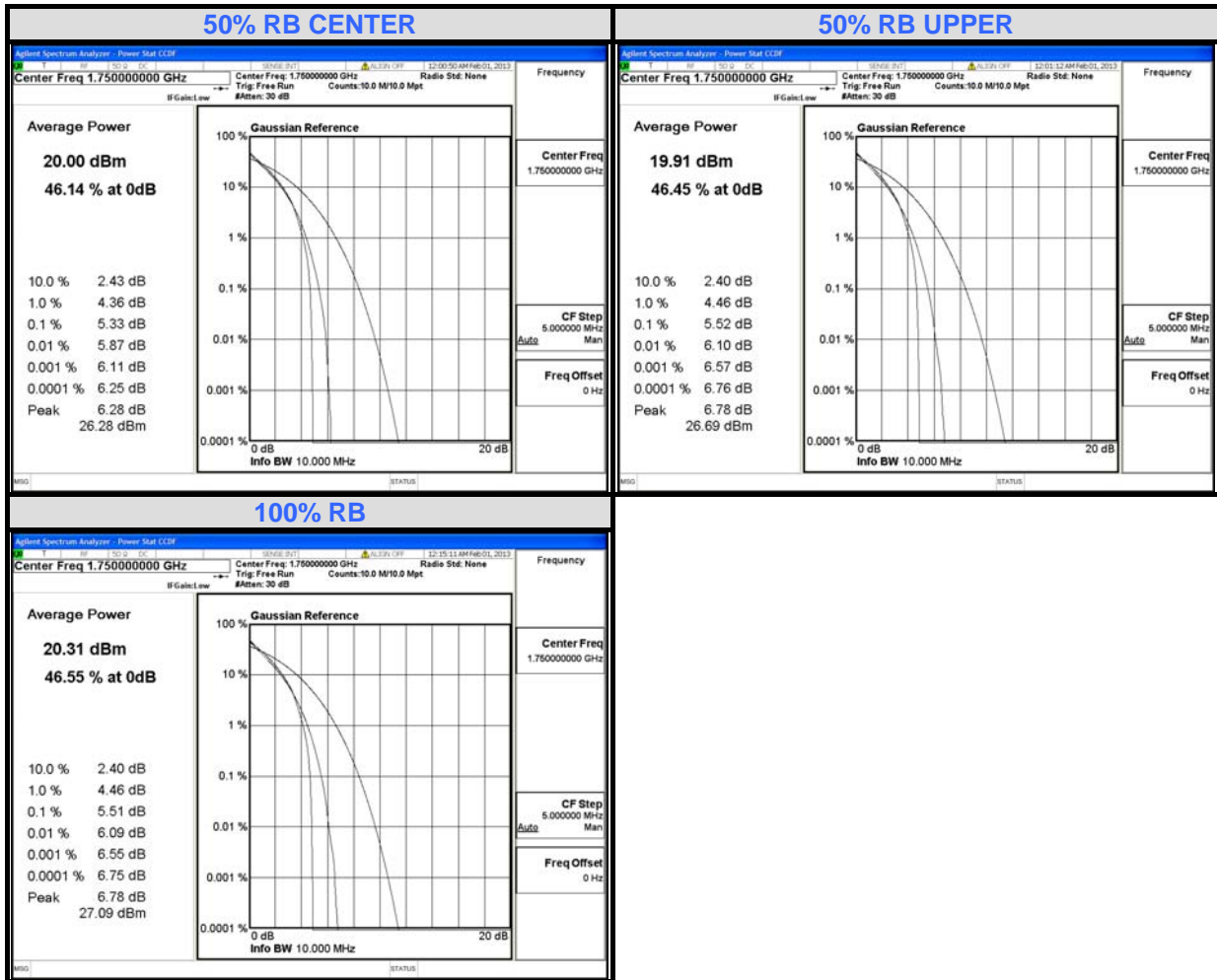



A D T

CHANNEL BANDWIDTH: 10MHz / 16QAM

FREQUENCY (MHz)	PEAK TO AVERAGE RATIO (dB)						
	1RB LOWER	1RB CENTER	1RB UPPER	50% RB LOWER	50% RB CENTER	50% RB UPPER	100% RB
1715	4.69	4.71	4.60	5.23	5.14	5.14	5.38
1732.5	5.99	6.07	5.80	6.01	6.02	6.05	6.11
1750	5.71	6.02	5.96	5.94	6.00	6.05	6.14

SPECTRUM PLOT OF WORST VALUE

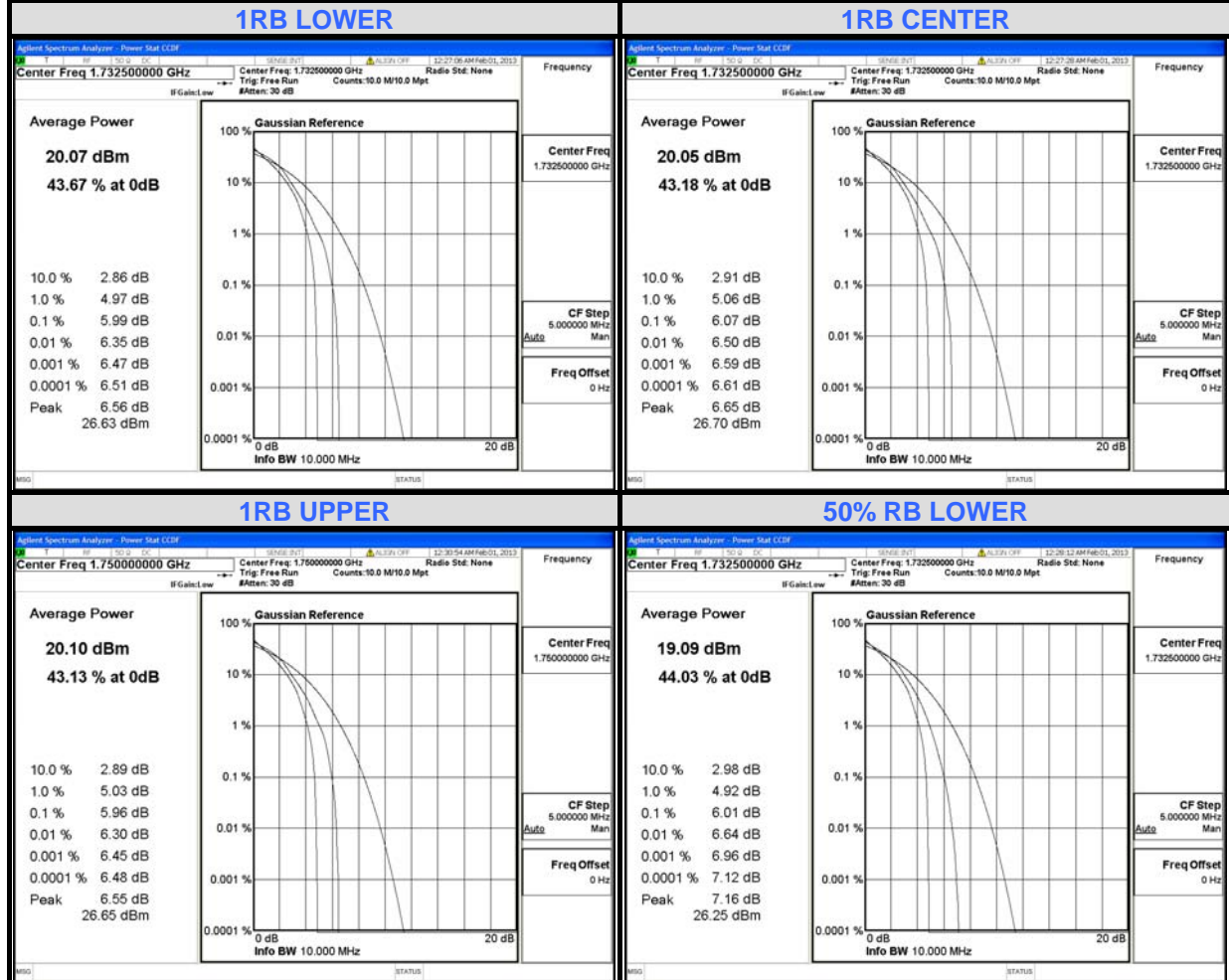



A D T

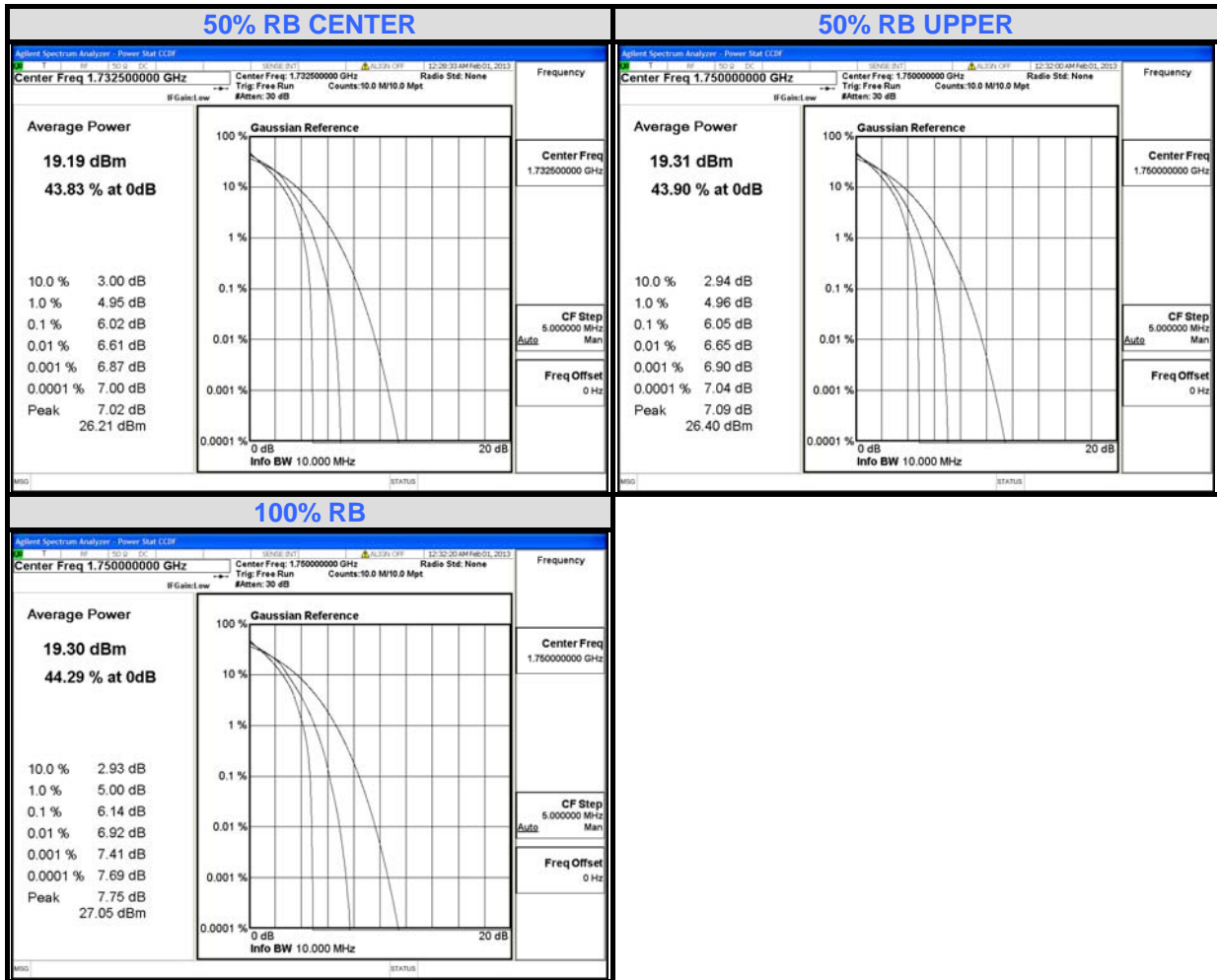



A D T

CHANNEL BANDWIDTH: 15MHz / QPSK

FREQUENCY (MHz)	PEAK TO AVERAGE RATIO (dB)						
	1RB LOWER	1RB CENTER	1RB UPPER	50% RB LOWER	50% RB CENTER	50% RB UPPER	100% RB
1717.5	4.83	4.75	4.85	5.14	5.00	4.96	5.15
1732.5	4.92	5.08	4.73	5.25	5.30	5.26	5.28
1747.5	4.64	4.94	5.02	4.95	5.14	5.33	5.24

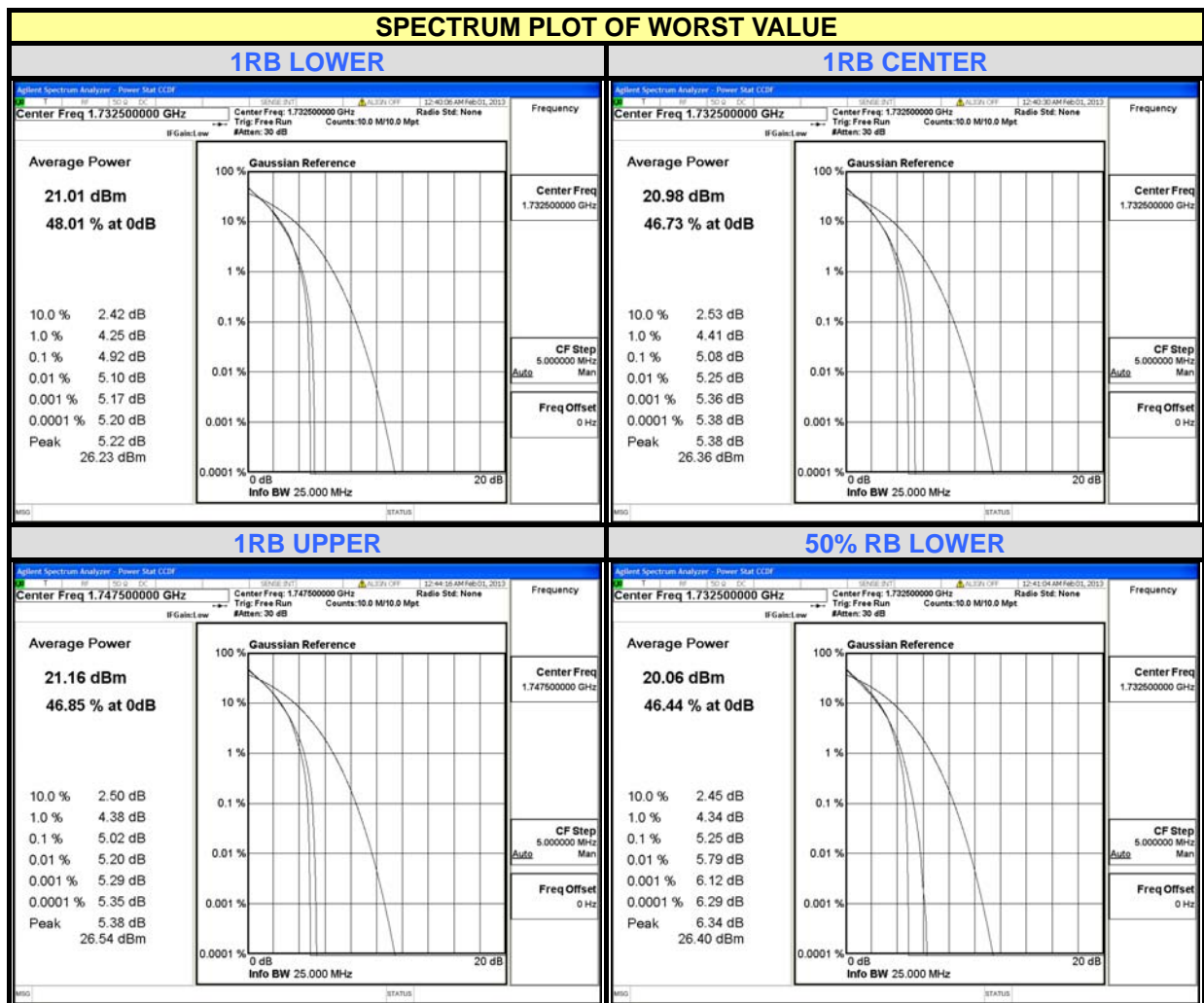



A D T

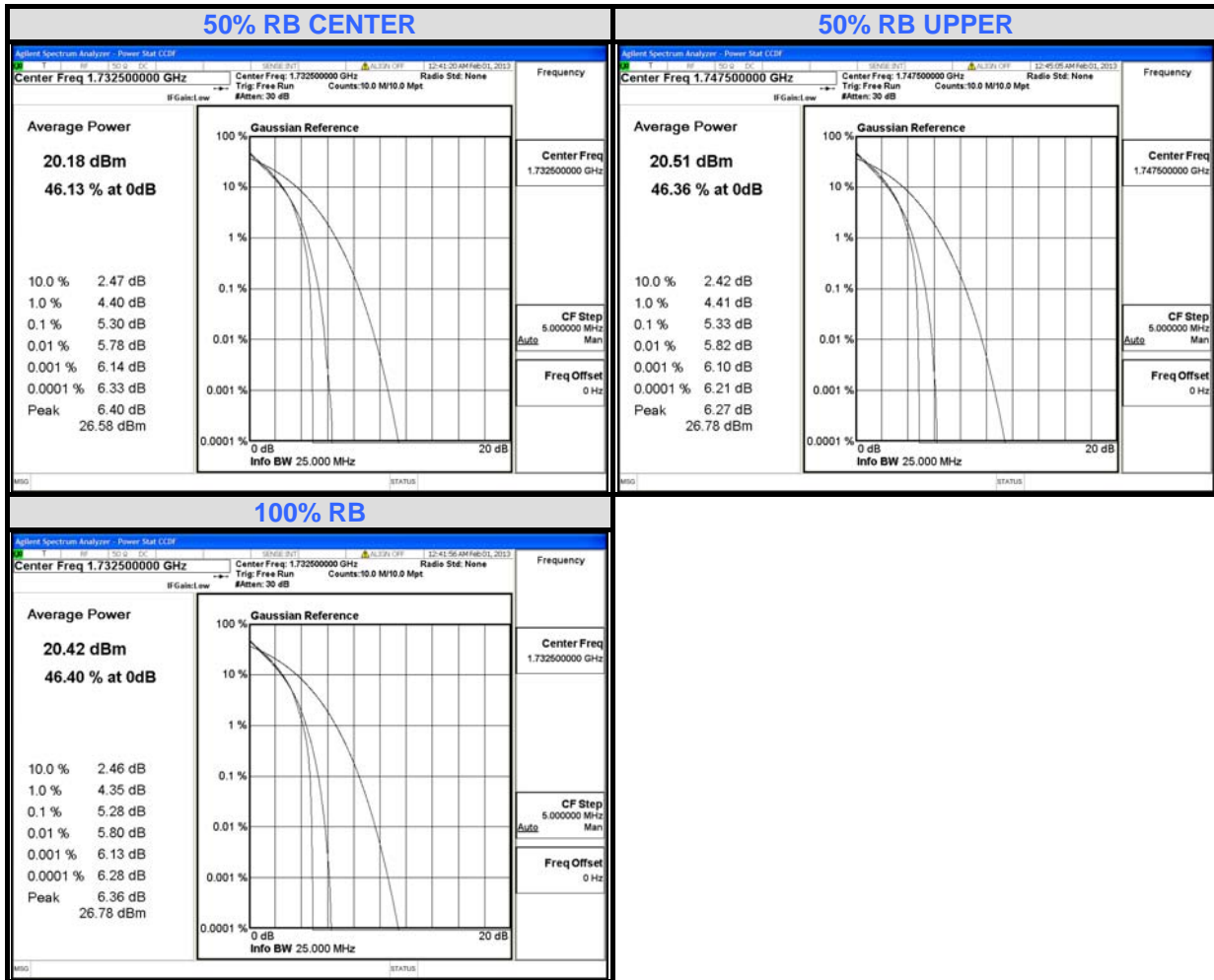



A D T

CHANNEL BANDWIDTH: 15MHz / 16QAM

FREQUENCY (MHz)	PEAK TO AVERAGE RATIO (dB)						
	1RB LOWER	1RB CENTER	1RB UPPER	50% RB LOWER	50% RB CENTER	50% RB UPPER	100% RB
1717.5	5.61	5.52	5.74	5.87	5.71	5.64	5.82
1732.5	5.84	5.99	5.58	5.91	5.97	5.94	6.00
1747.5	5.49	5.79	5.94	5.63	5.83	5.97	5.92

SPECTRUM PLOT OF WORST VALUE

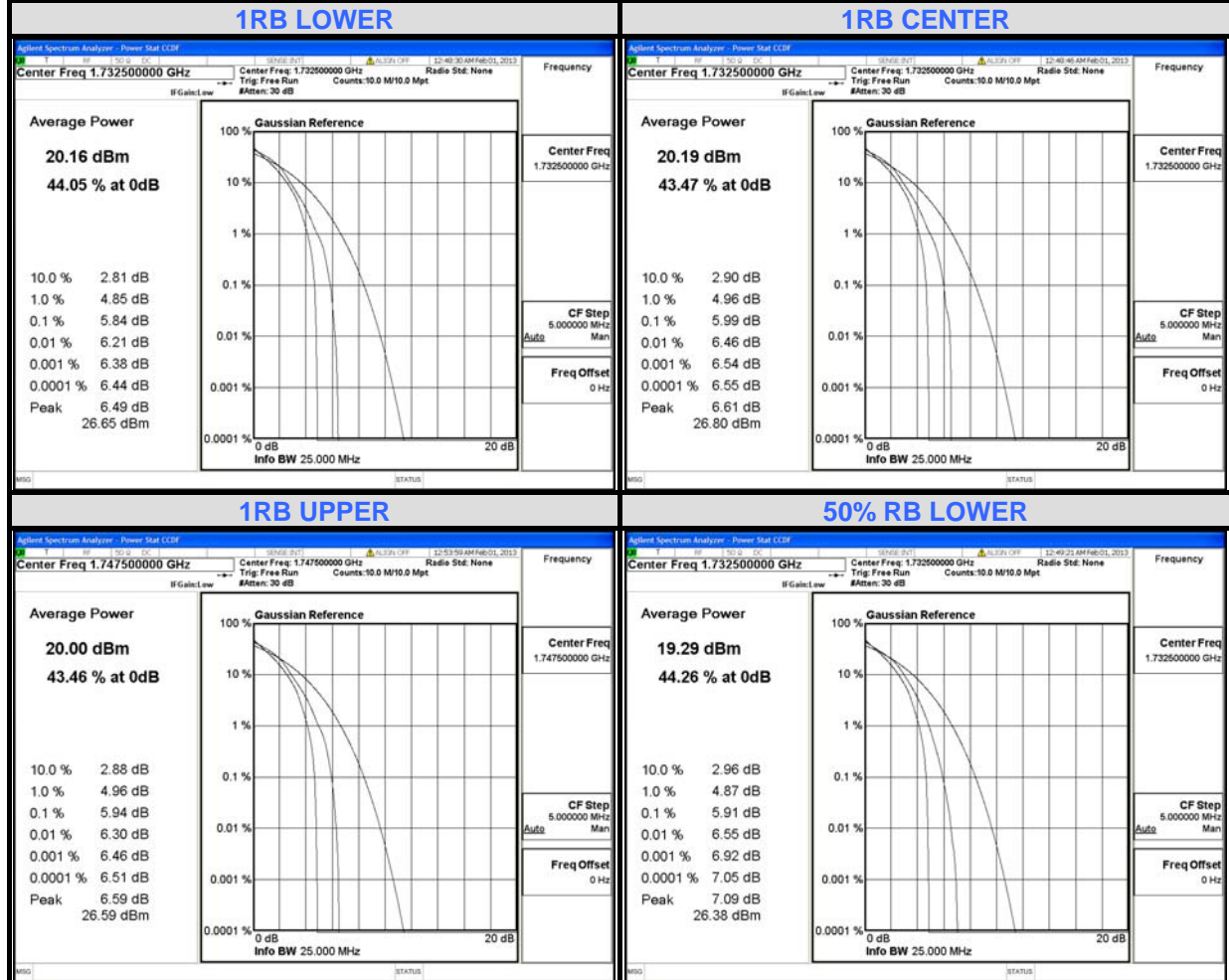



A D T

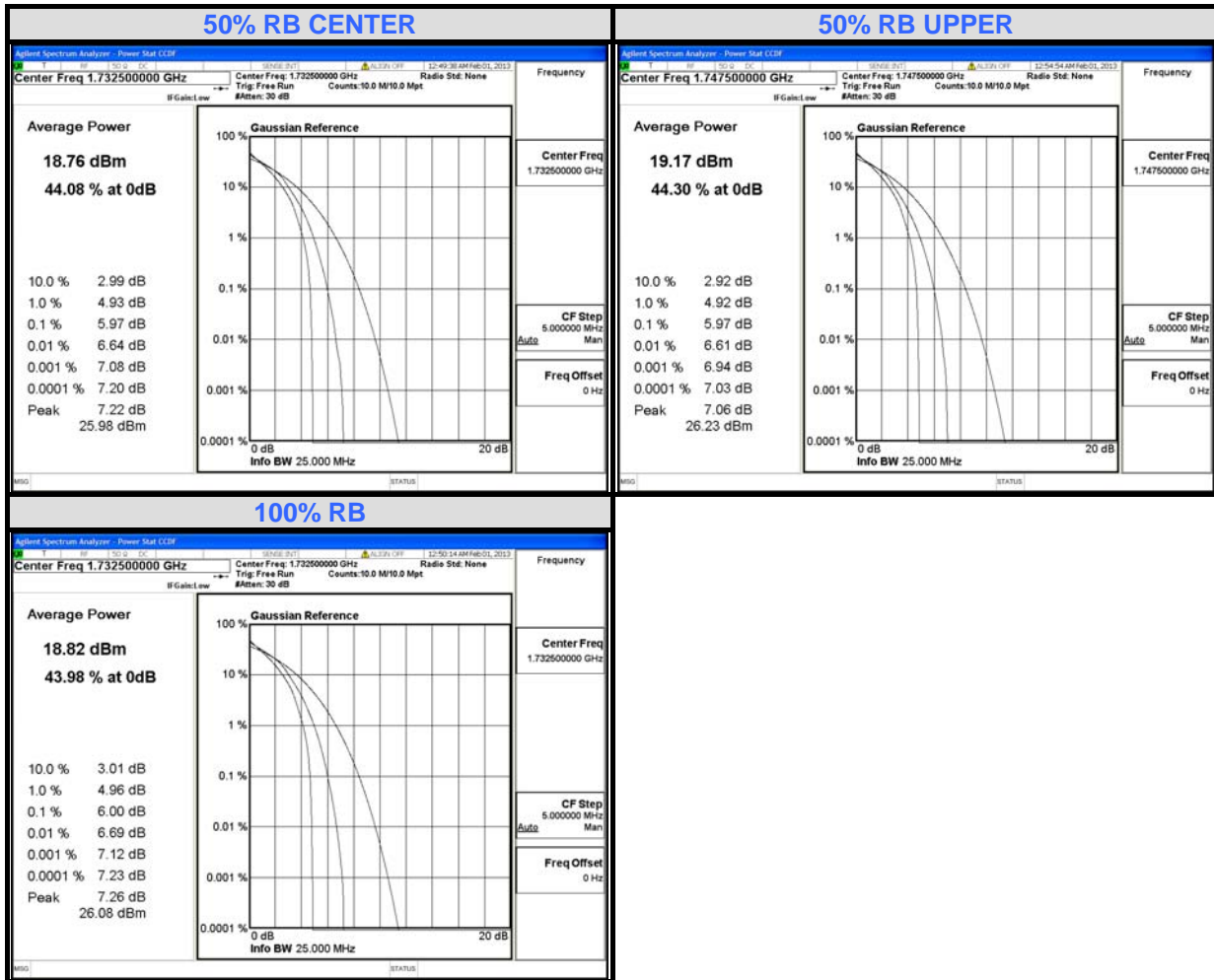



A D T

CHANNEL BANDWIDTH: 20MHz / QPSK

FREQUENCY (MHz)	PEAK TO AVERAGE RATIO (dB)						
	1RB LOWER	1RB CENTER	1RB UPPER	50% RB LOWER	50% RB CENTER	50% RB UPPER	100% RB
1720	4.84	4.76	5.10	5.17	5.00	5.15	5.20
1732.5	4.82	5.11	4.63	5.24	5.36	5.25	5.14
1745	4.98	4.78	5.09	5.10	5.05	5.31	5.22

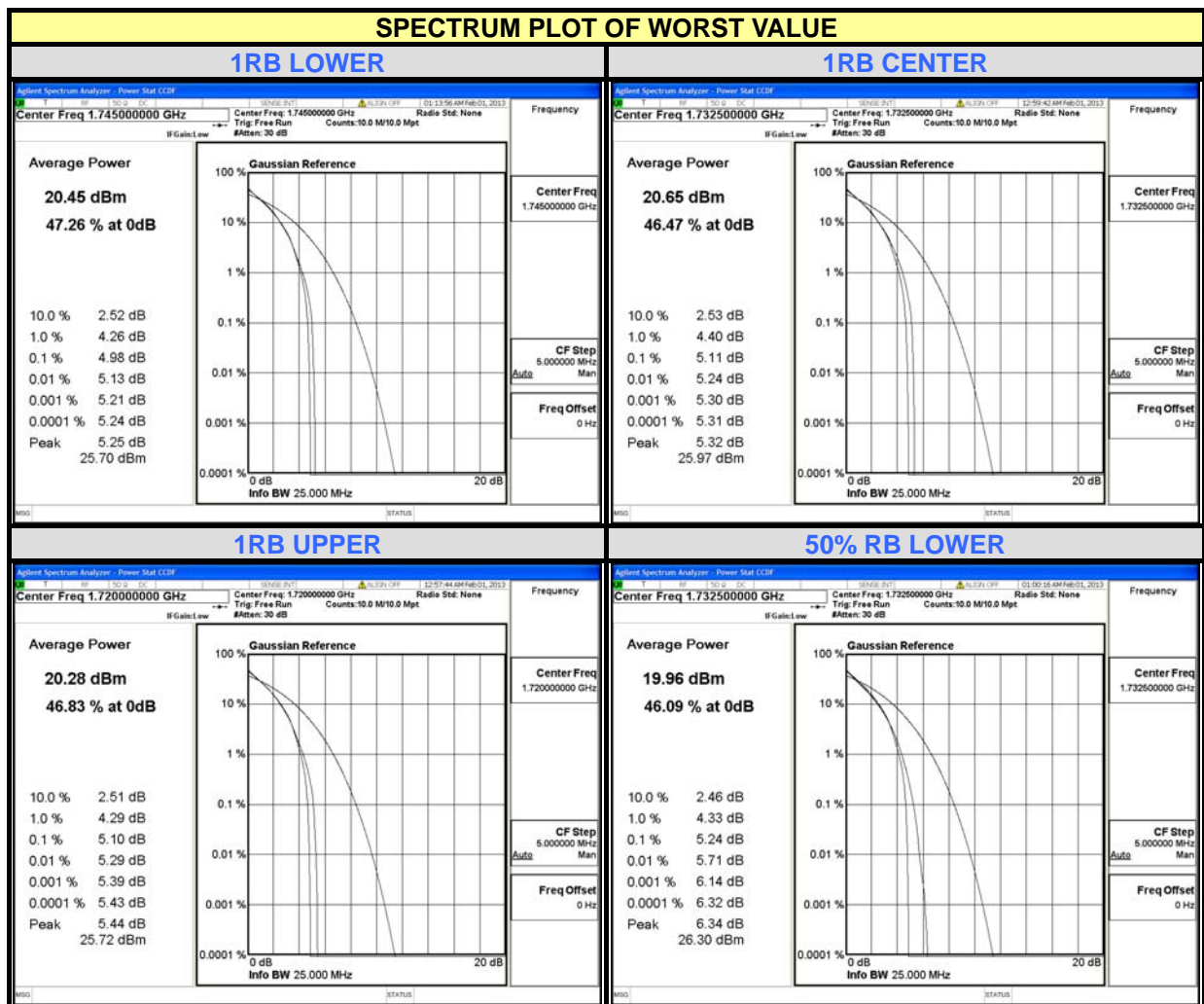



A D T

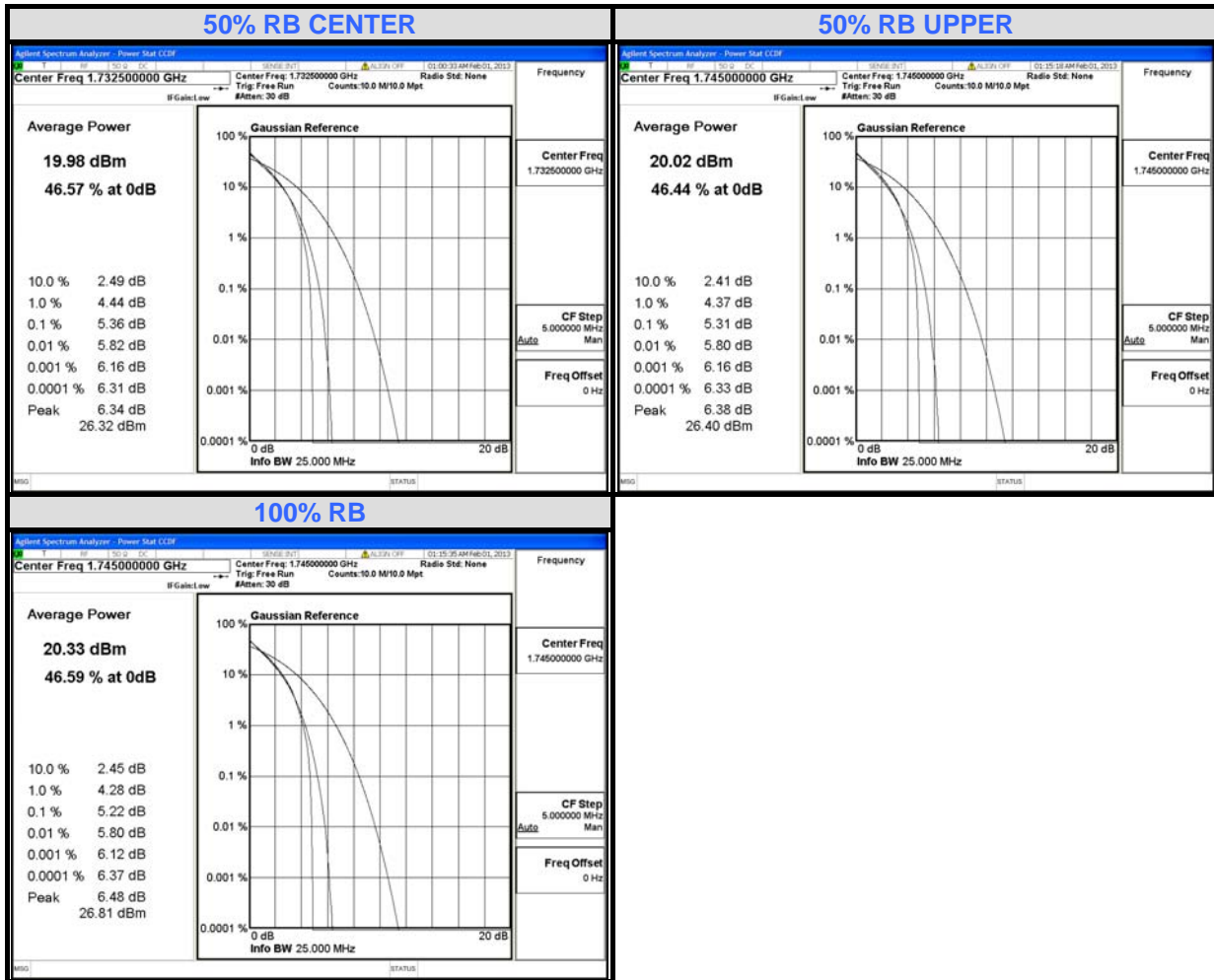



A D T

CHANNEL BANDWIDTH: 20MHz / 16QAM

FREQUENCY (MHz)	PEAK TO AVERAGE RATIO (dB)						
	1RB LOWER	1RB CENTER	1RB UPPER	50% RB LOWER	50% RB CENTER	50% RB UPPER	100% RB
1720	5.53	5.59	6.06	5.88	5.69	5.77	5.90
1732.5	5.74	6.06	5.46	5.91	5.99	5.94	5.97
1745	5.83	5.65	5.94	5.76	5.74	5.96	5.93

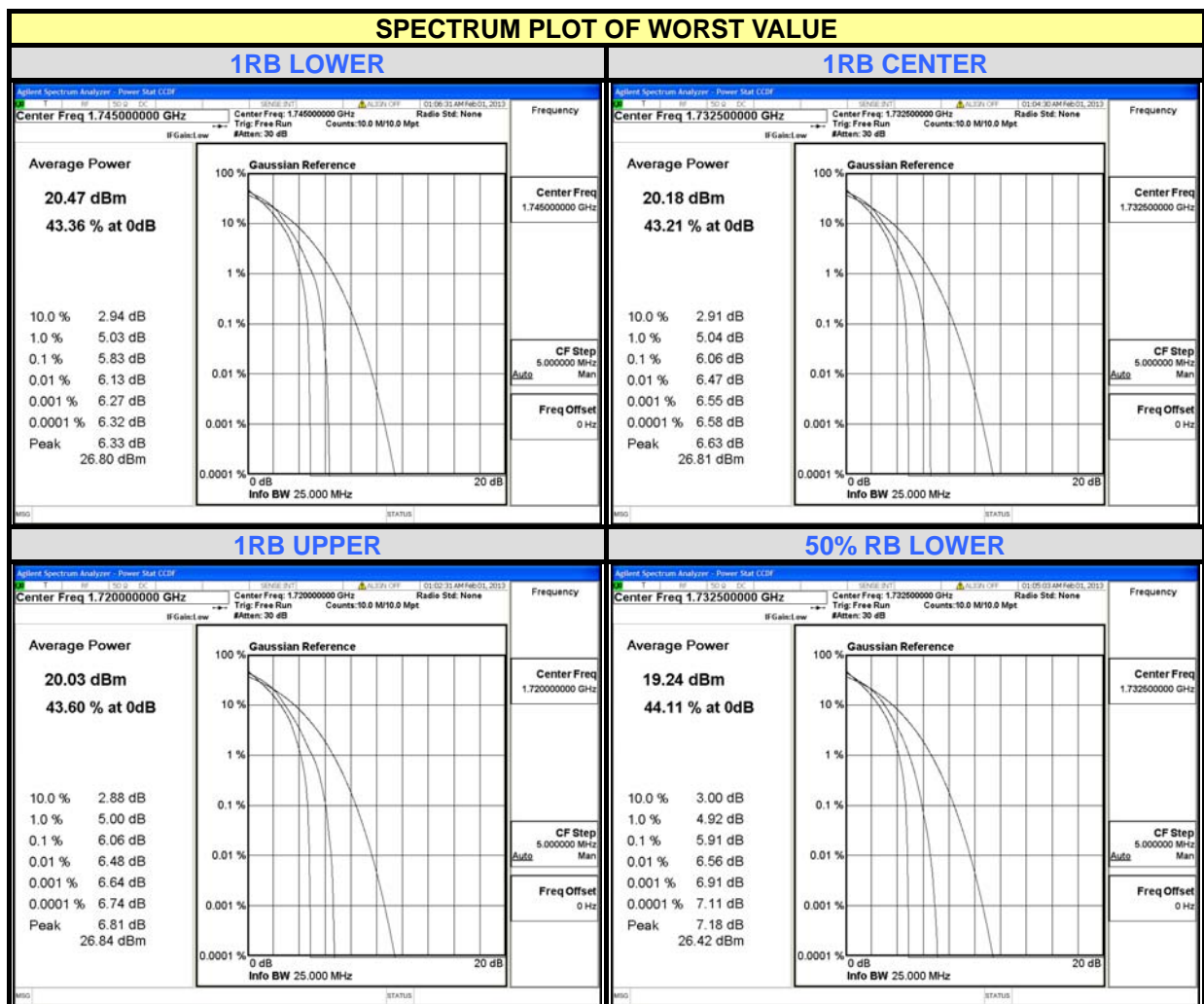



A D T

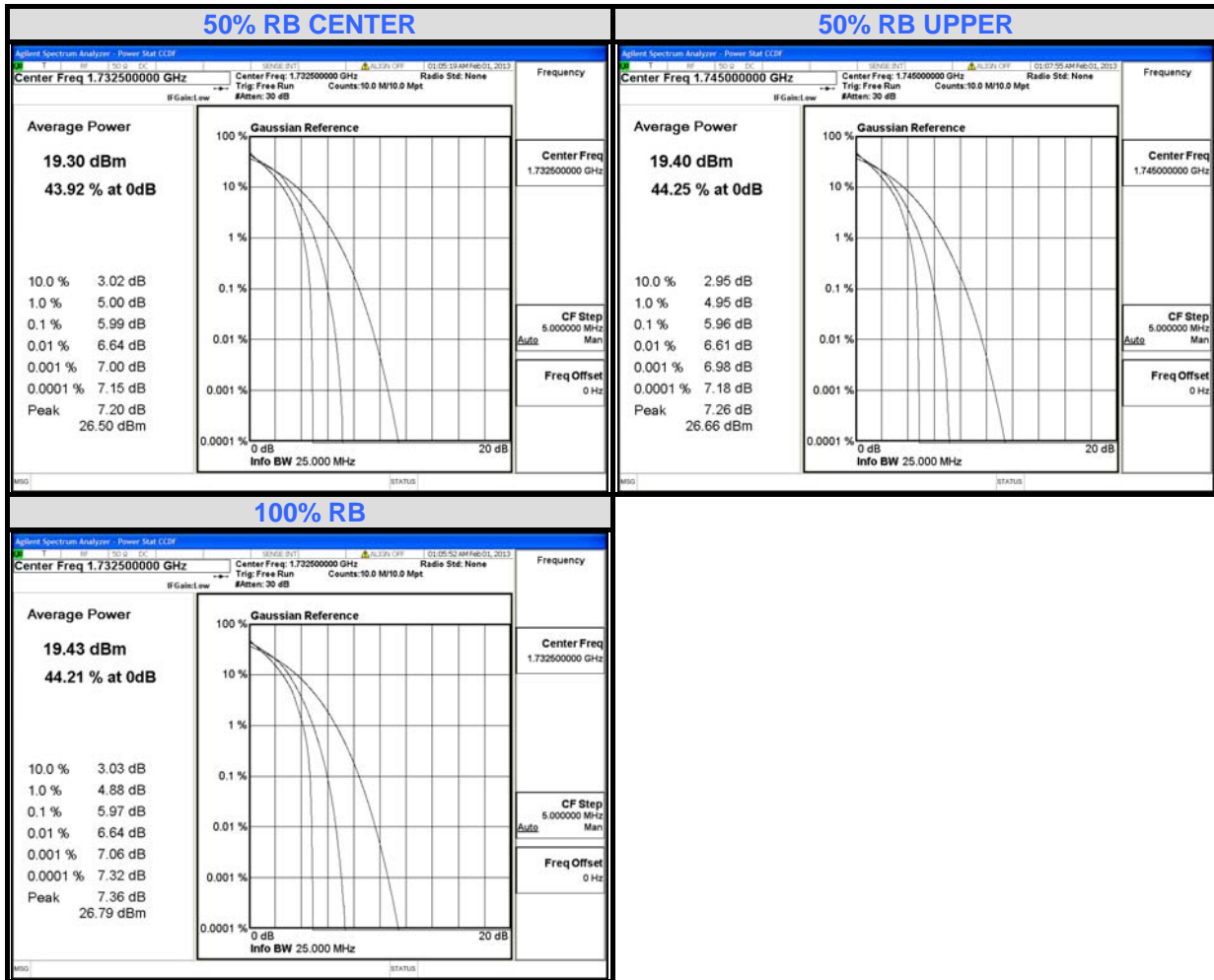

4.5 BAND EDGE MEASUREMENT

4.5.1 LIMITS OF BAND EDGE MEASUREMENT

For operations in the 704-716 MHz band, the power of any emission outside a licensee's frequency band(s) of operation shall be attenuated below the transmitter power (P) within the licensed band(s) of operation, measured in watts, by at least $43 + 10 \log(P)$ dB. Compliance with this provision is based on the use of measurement instrumentation employing a resolution bandwidth of 100 kilohertz or greater. However, in the 100 kilohertz bands immediately outside and adjacent to a licensee's frequency block, a resolution bandwidth of at least 30 kHz may be employed.

For operations in the 1710 – 1755 MHz MHz bands, the power of any emission outside a licensee's frequency block shall be attenuated below the transmitter power (P) by at least $43 + 10 \log_{10}(P)$ dB.

4.5.2 TEST SETUP

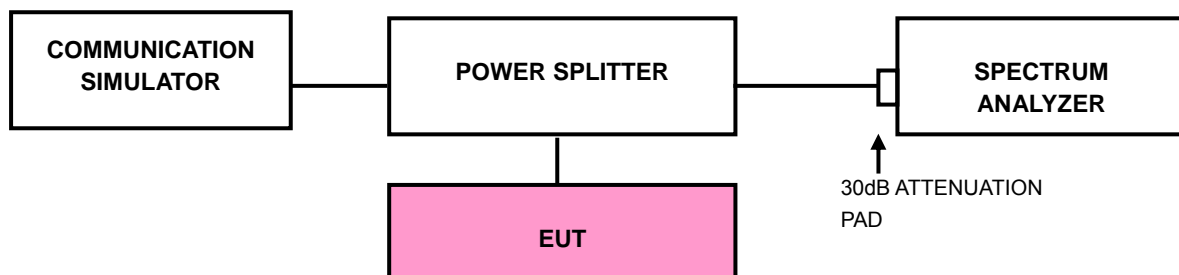

4.5.3 TEST PROCEDURES

- a. The EUT was set up for the maximum peak power with LTE link data modulation. The power was measured with R&S Spectrum Analyzer. All measurements were done at 2 channels (low and high operational frequency range.).
- b. The band edge measurement used the power splitter via EUT RF power connector between simulation base station and spectrum analyzer.
- c. The center frequency of spectrum is the band edge frequency and span is 2 MHz. RB of the spectrum is 100kHz and VB of the spectrum is 300kHz.
- d. Record the max trace plot into the test report.



A D T

4.5.4 TEST RESULTS

LTE BAND 4

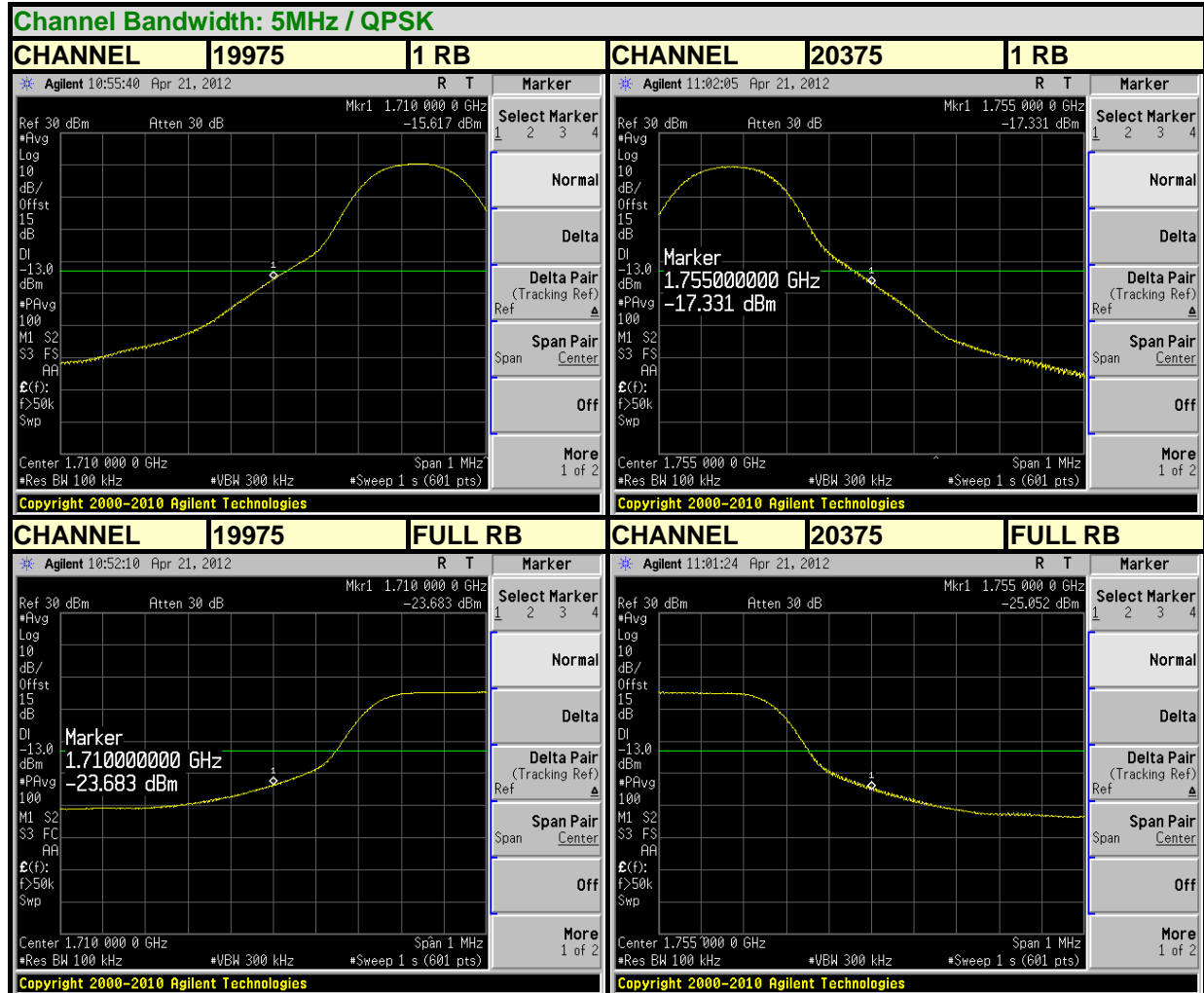



A D T

Channel Bandwidth: 5MHz / 16QAM

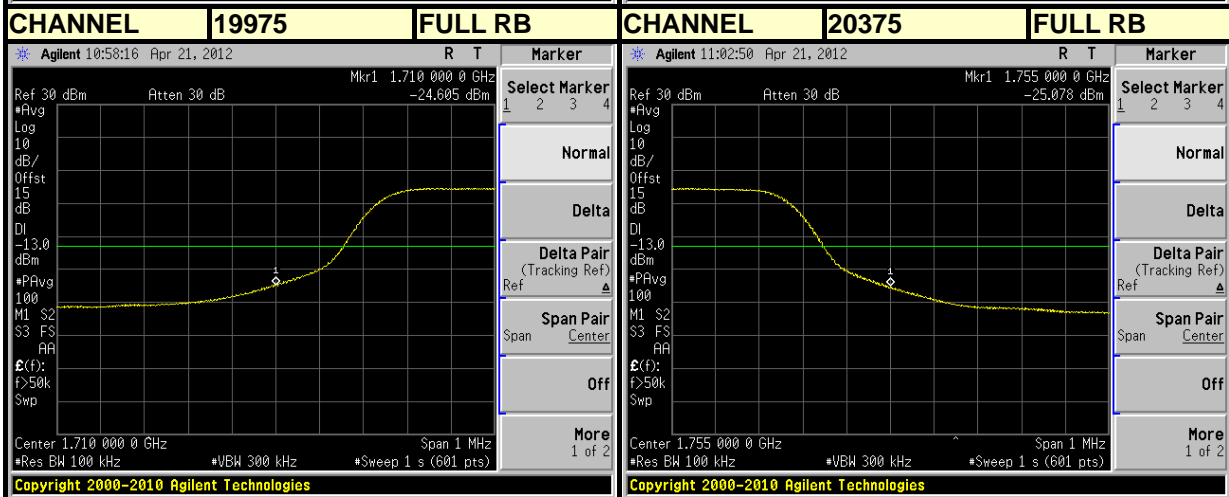
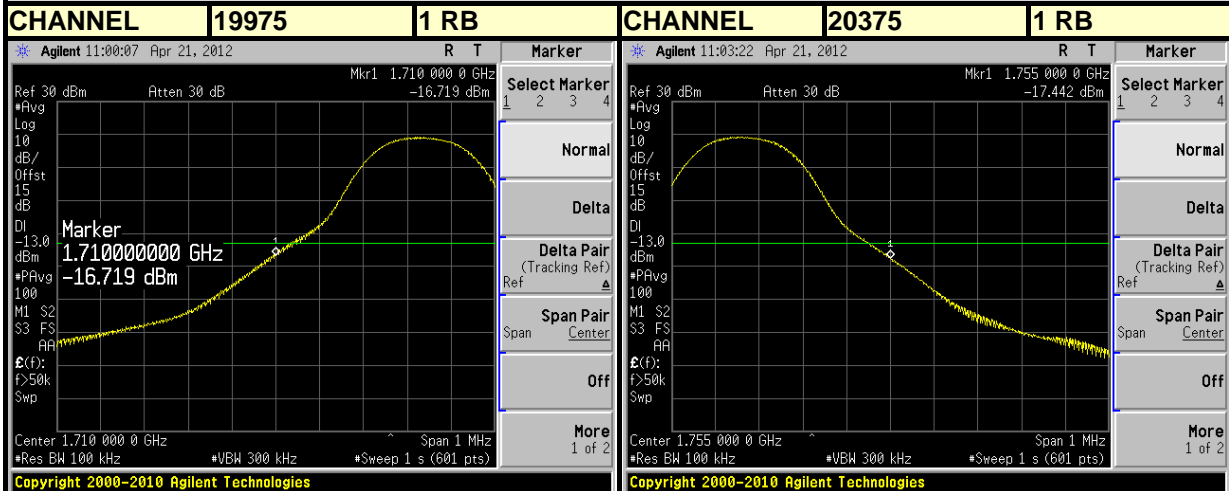



A D T

Channel Bandwidth: 10MHz / QPSK

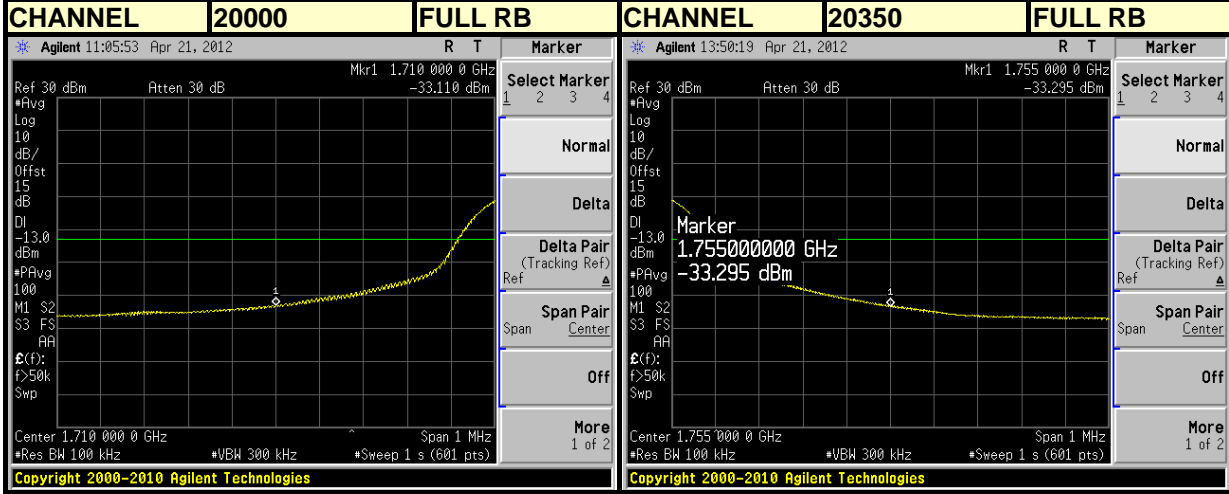
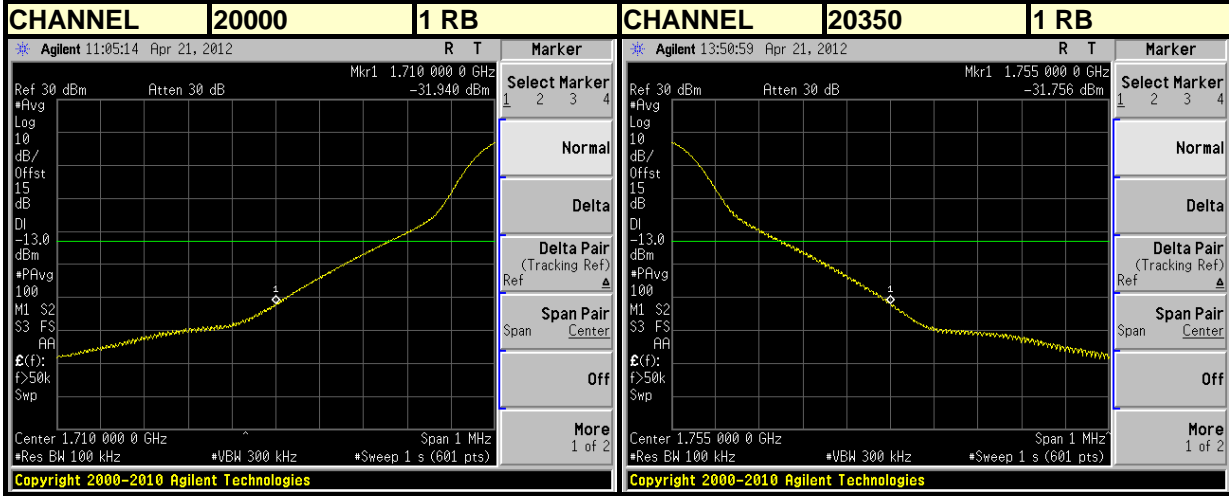



A D T

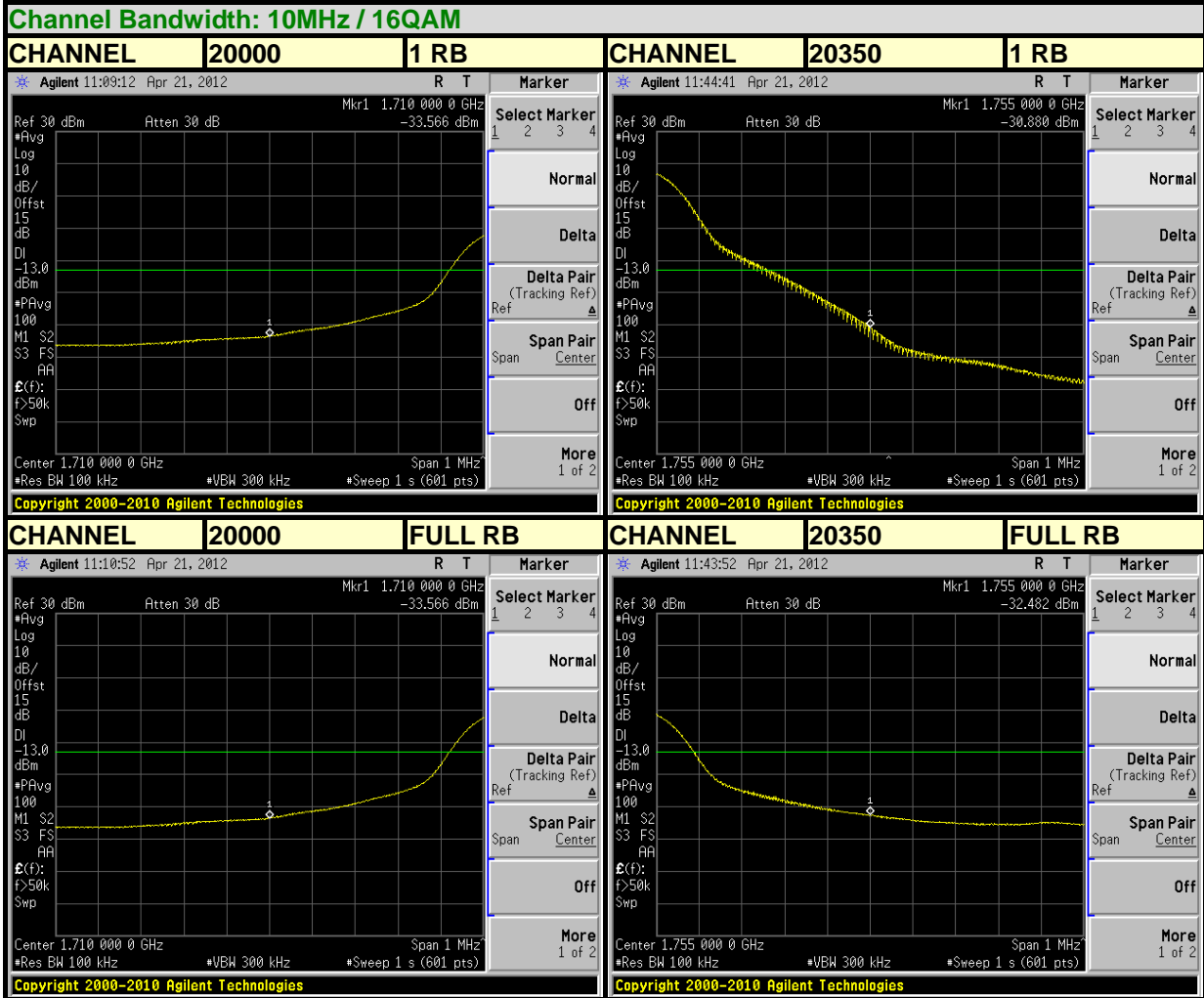



A D T

Channel Bandwidth: 15MHz / QPSK

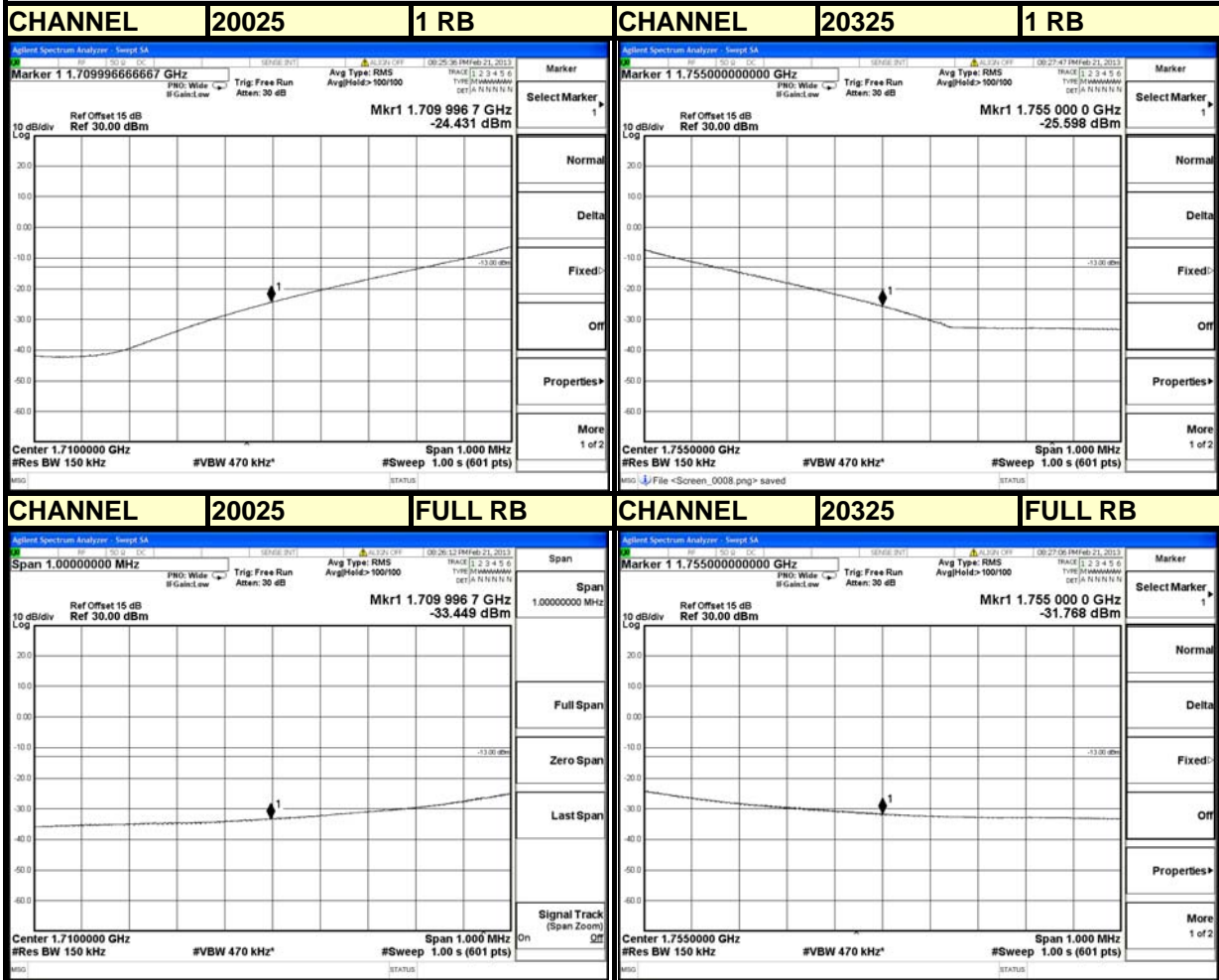



A D T

Channel Bandwidth: 15MHz / 16QAM

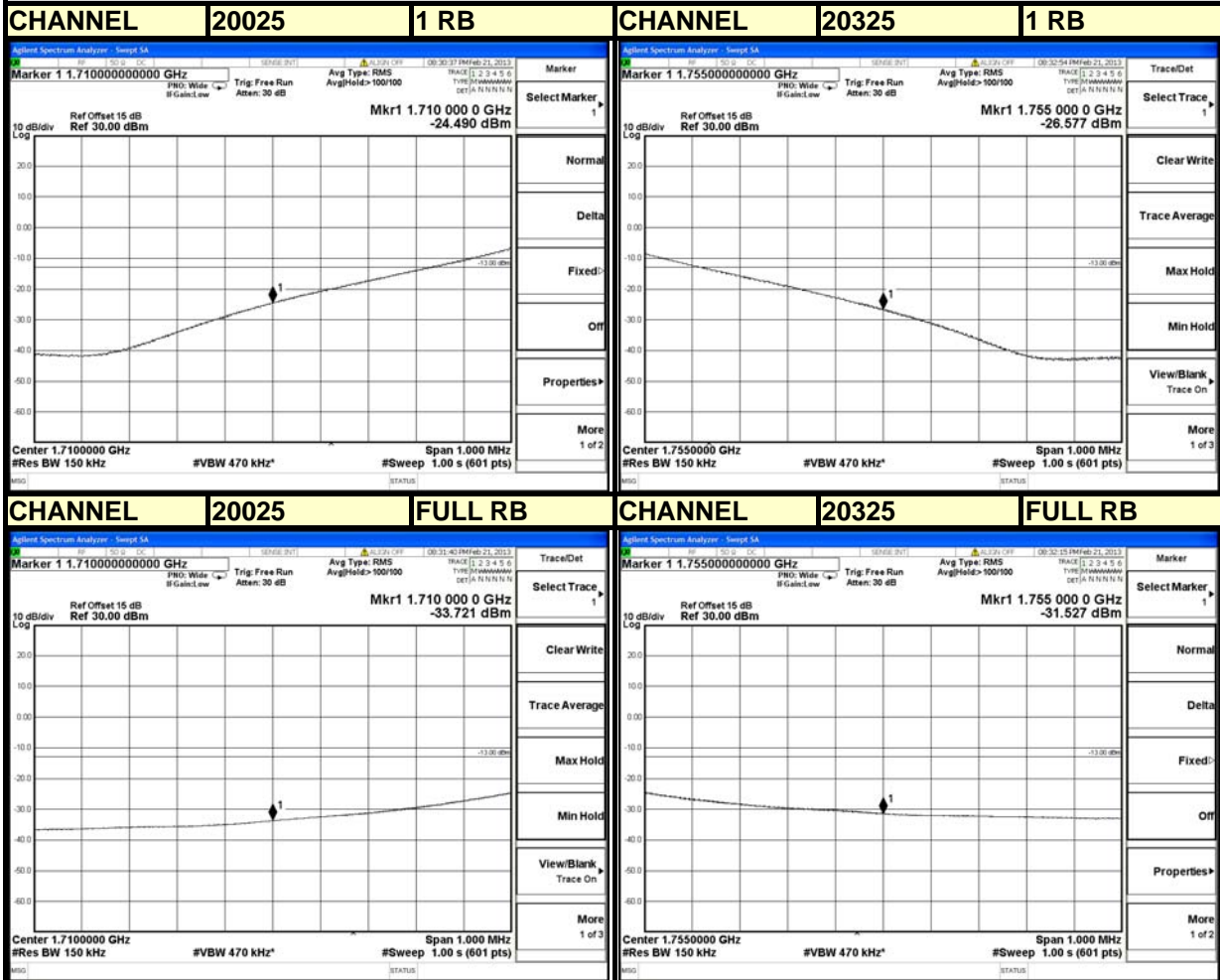



A D T

Channel Bandwidth: 20MHz / QPSK

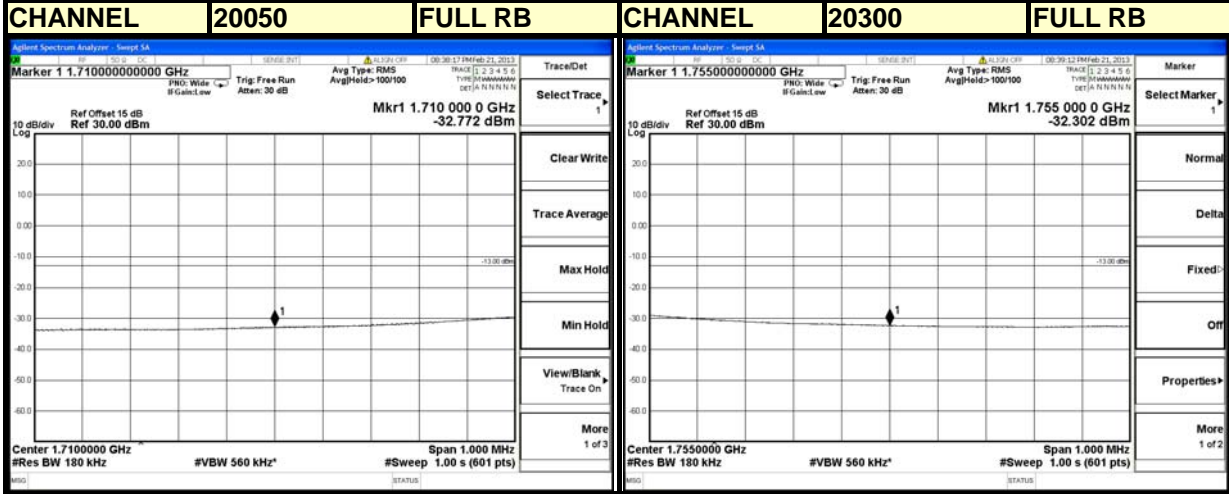
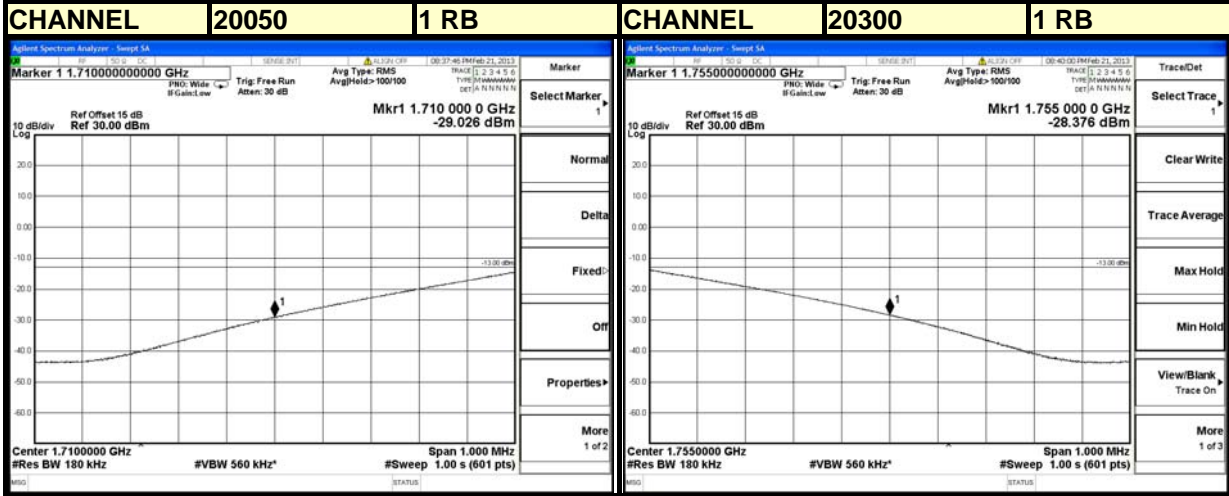



A D T

Channel Bandwidth: 20MHz / 16QAM

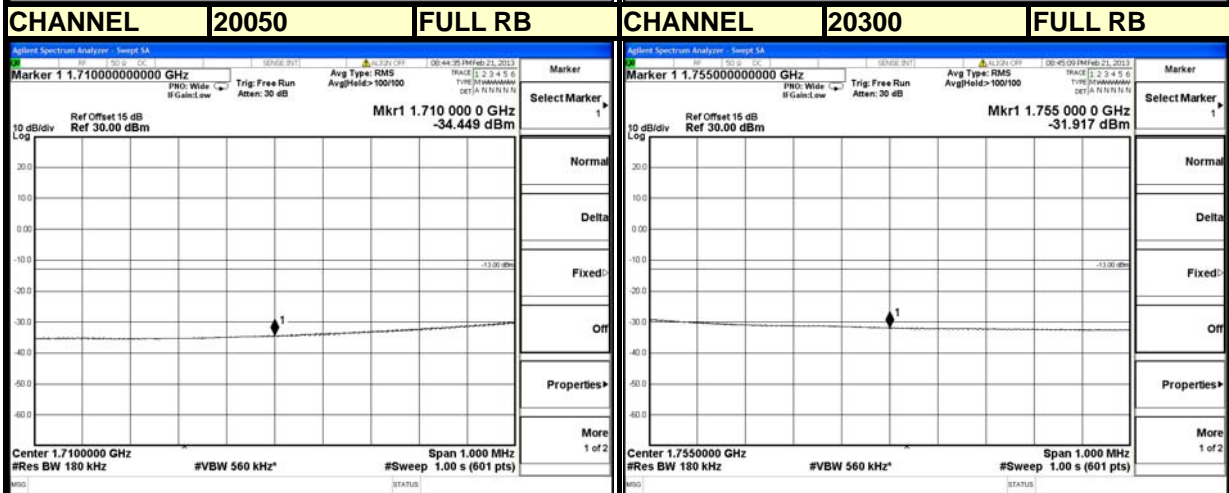
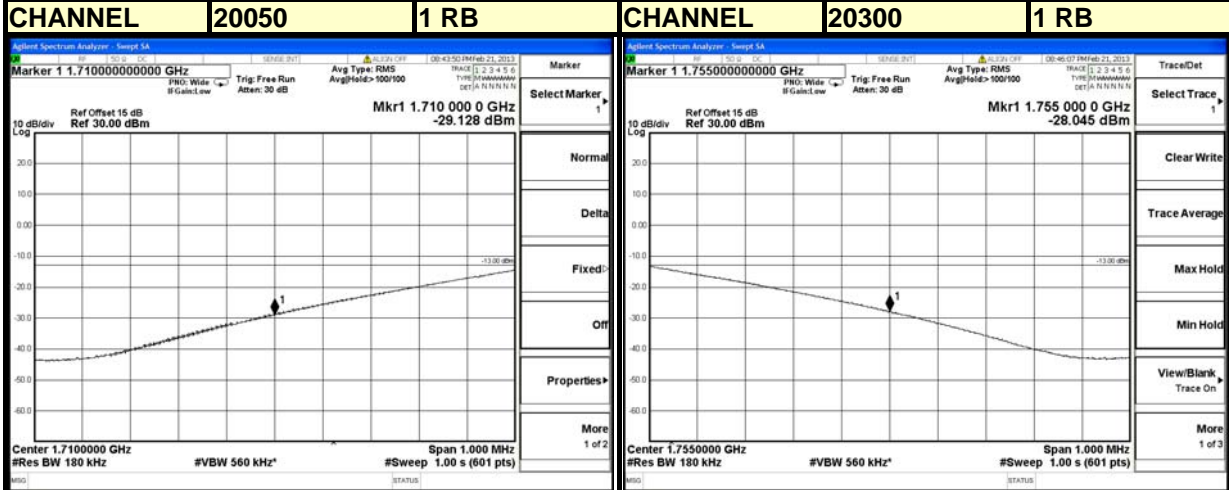

4.6 CONDUCTED SPURIOUS EMISSIONS

4.6.1 LIMITS OF CONDUCTED SPURIOUS EMISSIONS MEASUREMENT

The power of any emission outside a licensee's frequency block shall be attenuated below the transmitter power (P) by at least $43 + 10 \log_{10}(P)$ dB. The limit of emission equal to -13 dBm

4.6.2 TEST PROCEDURE

- a. The EUT makes a phone call to the communication simulator. All measurements were done at low, middle and high operational frequency range.
- b. Measuring frequency range is from 30 MHz to 7.2GHz for LTE Band 17 and from 30MHz to 18GHz for LTE Band 4. 10dB attenuation pad is connected with spectrum. RBW=1MHz and VBW=3MHz are used for conducted emission measurement.

4.6.3 TEST SETUP

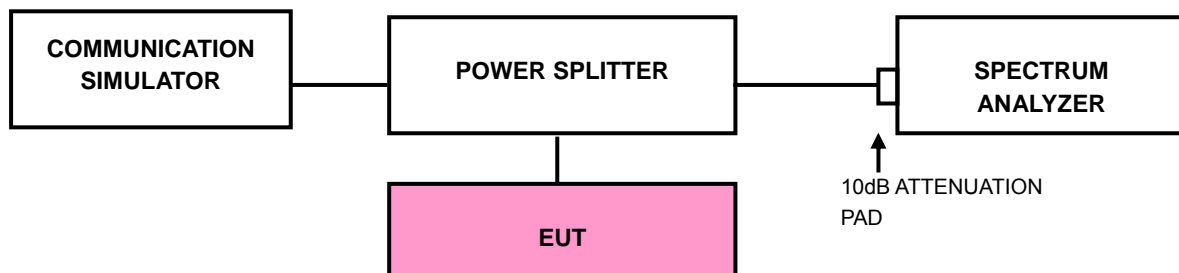



A D T

4.6.4 TEST RESULTS

CHANNEL BANDWIDTH: 5MHz / QPSK / 1 RB LOWER EDGE

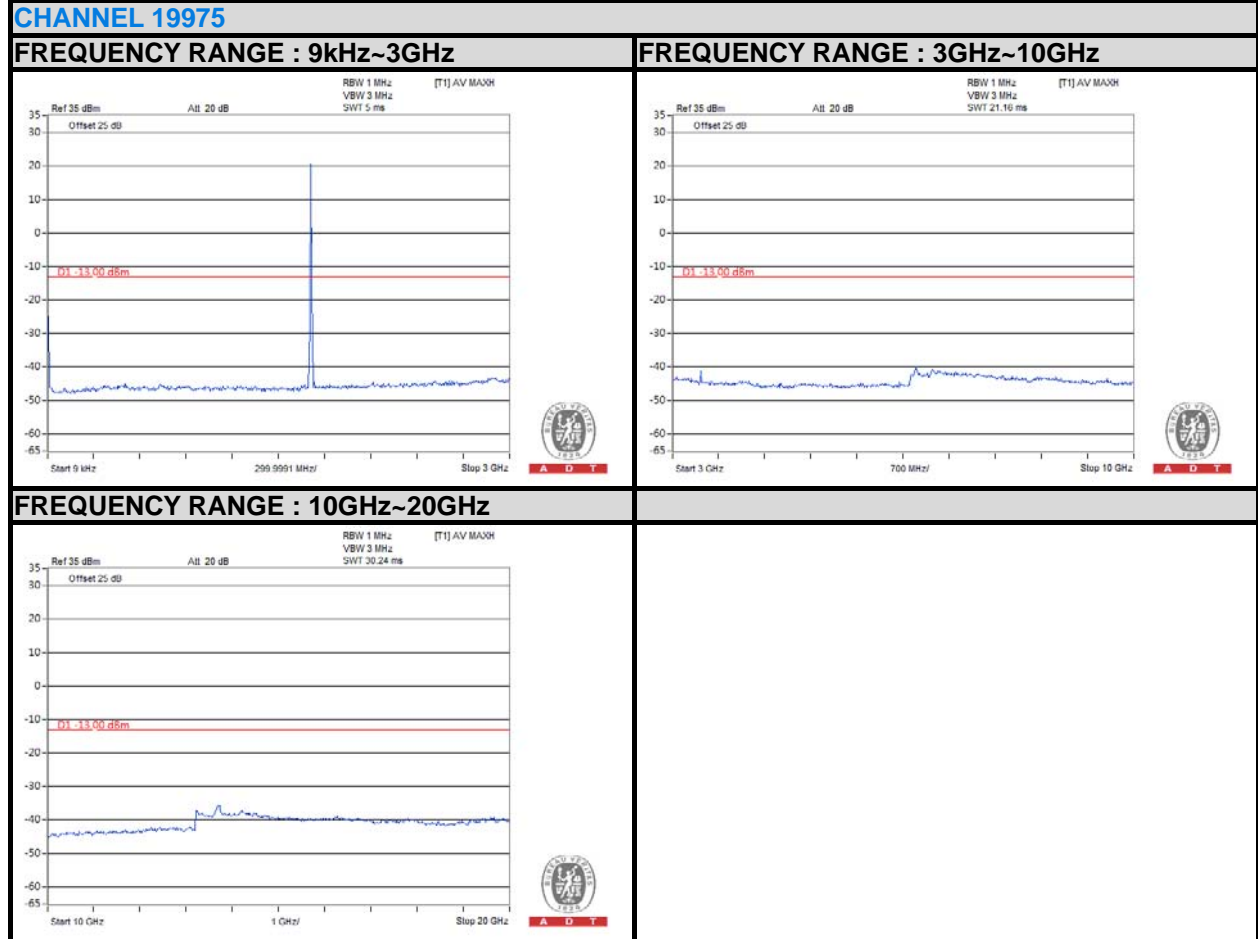



A D T

CHANNEL 20175

FREQUENCY RANGE : 9kHz~3GHz

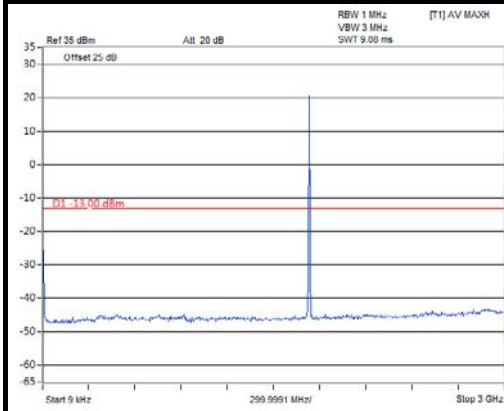

FREQUENCY RANGE : 3GHz~10GHz

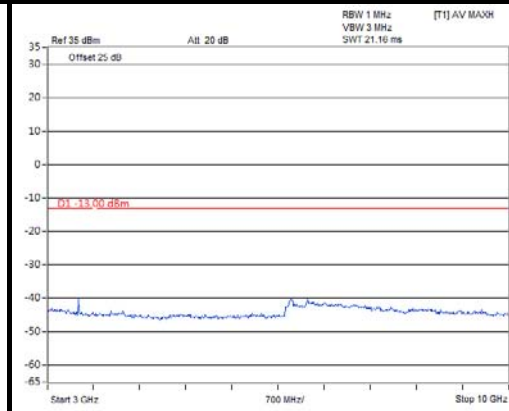

FREQUENCY RANGE : 10GHz~20GHz

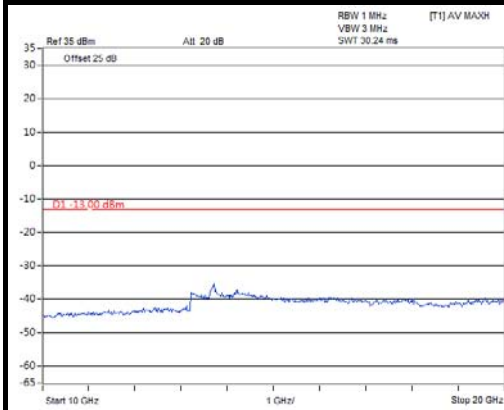



A D T

CHANNEL 20375

FREQUENCY RANGE : 9kHz~3GHz

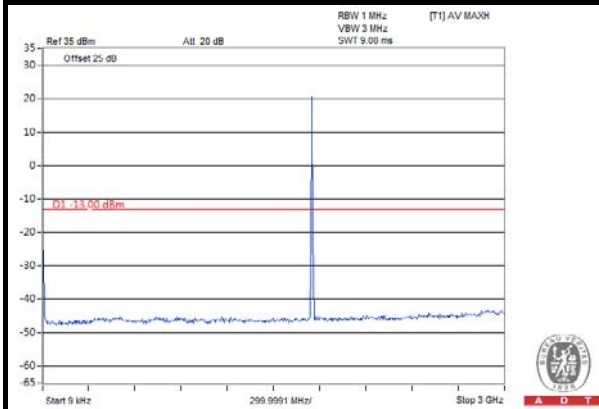

FREQUENCY RANGE : 3GHz~10GHz

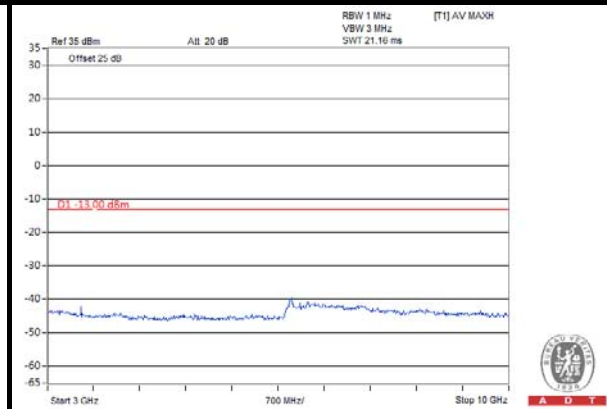

FREQUENCY RANGE : 10GHz~20GHz

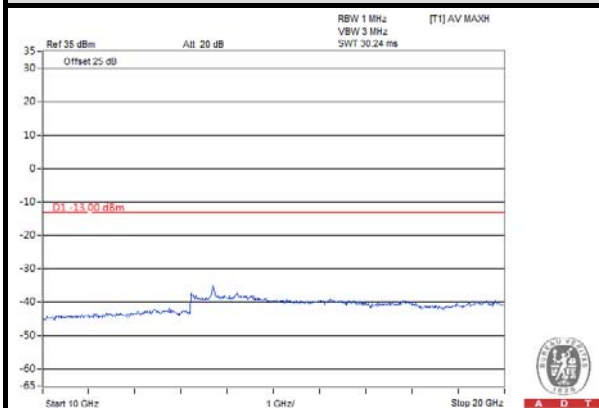



A D T

CHANNEL BANDWIDTH: 5MHz / 16QAM / 1 RB AT LOWER EDGE

CHANNEL 19975

FREQUENCY RANGE : 9kHz~3GHz

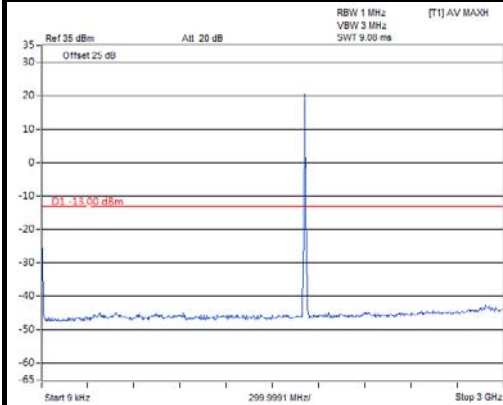

FREQUENCY RANGE : 3GHz~10GHz

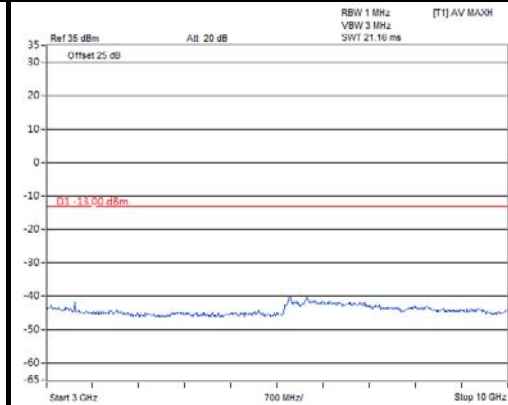

FREQUENCY RANGE : 10GHz~20GHz

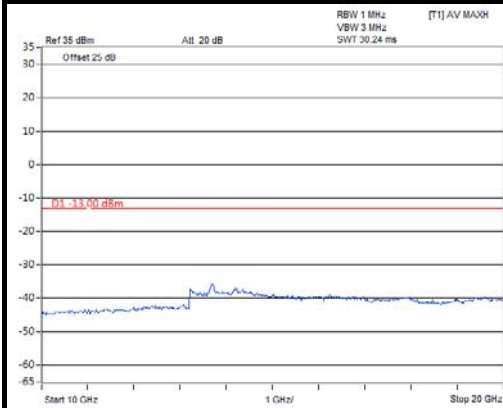



A D T

CHANNEL 20175

FREQUENCY RANGE : 9kHz~3GHz

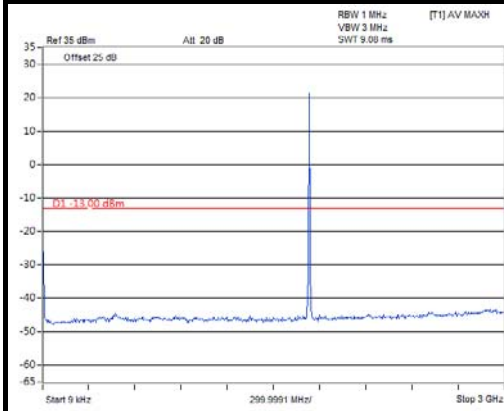

FREQUENCY RANGE : 3GHz~10GHz

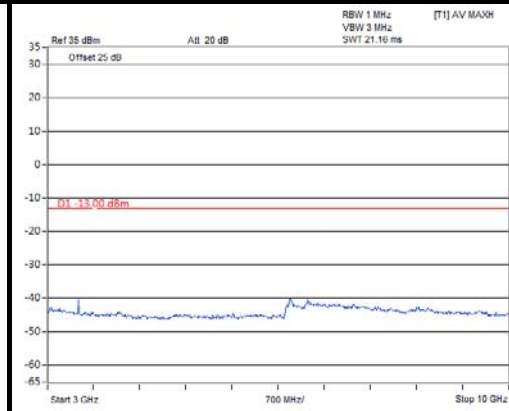

FREQUENCY RANGE : 10GHz~20GHz

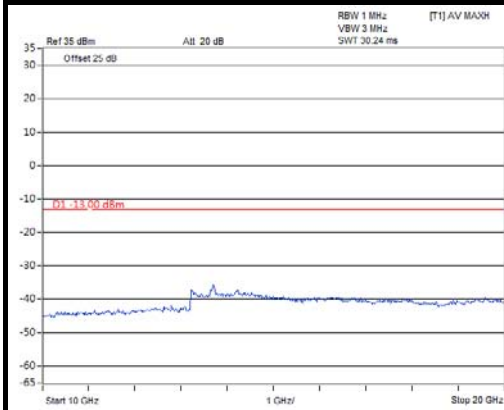



A D T

CHANNEL 20375

FREQUENCY RANGE : 9kHz~3GHz

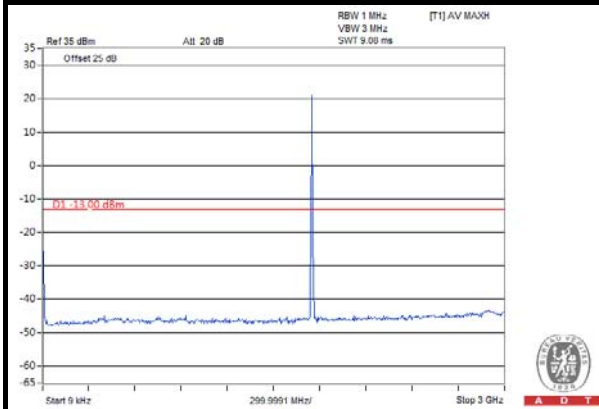

FREQUENCY RANGE : 3GHz~10GHz

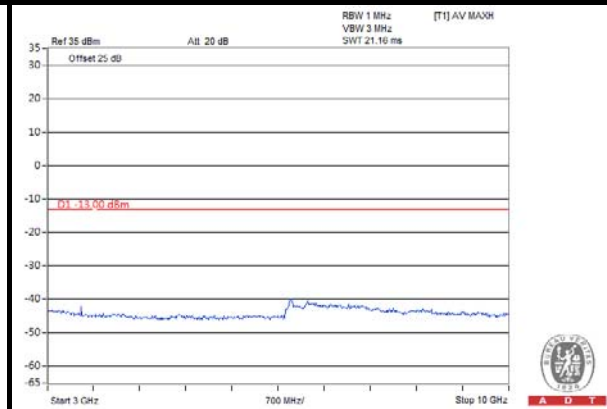

FREQUENCY RANGE : 10GHz~20GHz

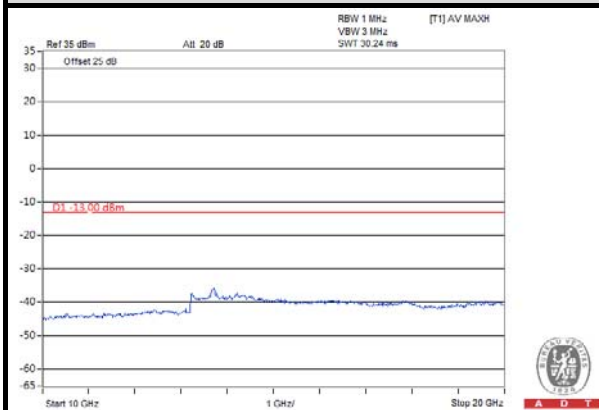



A D T

CHANNEL BANDWIDTH: 10MHz / QPSK / 1 RB AT LOWER EDGE

CHANNEL 2000

FREQUENCY RANGE : 9kHz~3GHz

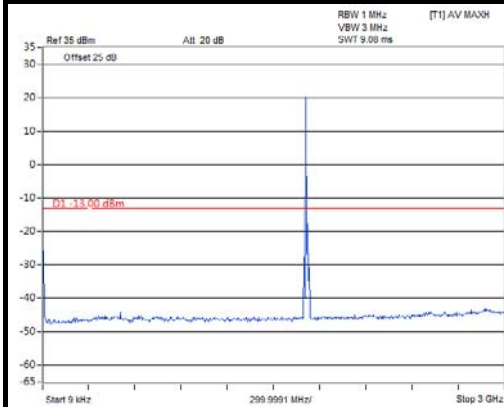

FREQUENCY RANGE : 3GHz~10GHz

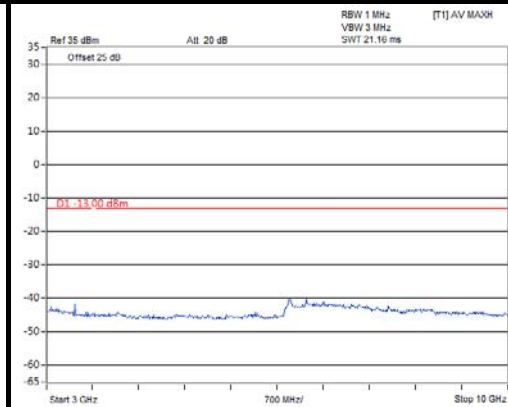

FREQUENCY RANGE : 10GHz~20GHz

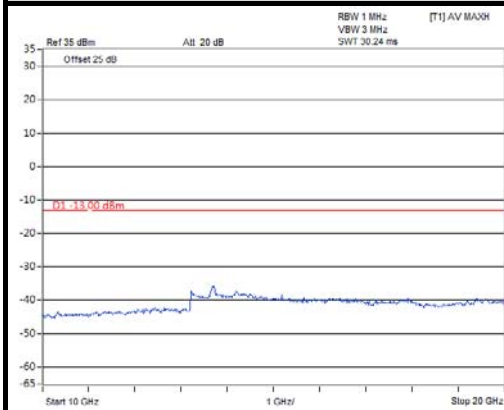



A D T

CHANNEL 20175

FREQUENCY RANGE : 9kHz~3GHz

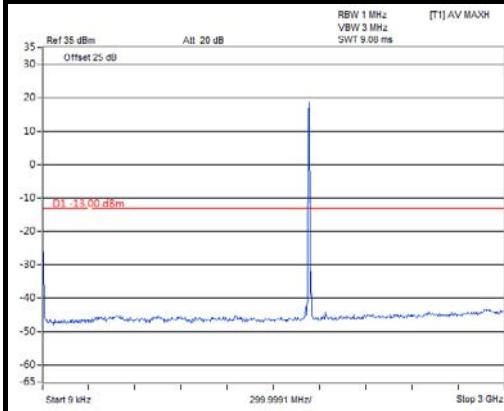

FREQUENCY RANGE : 3GHz~10GHz

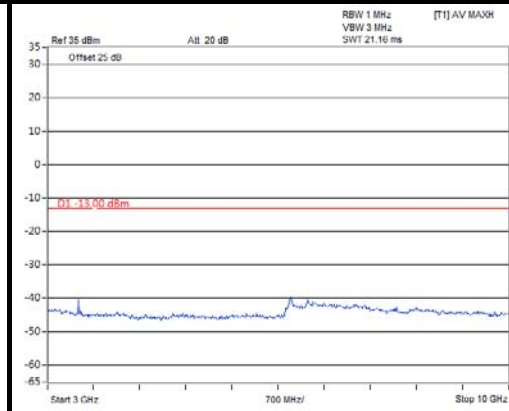

FREQUENCY RANGE : 10GHz~20GHz

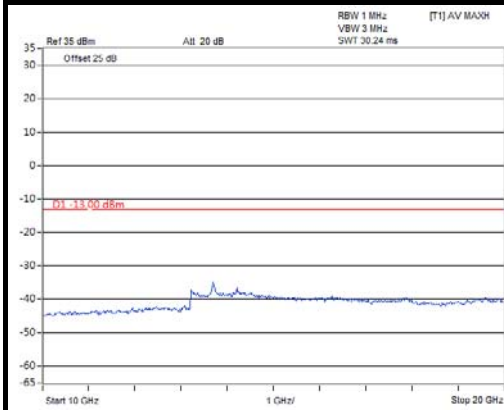



A D T

CHANNEL 20350

FREQUENCY RANGE : 9kHz~3GHz

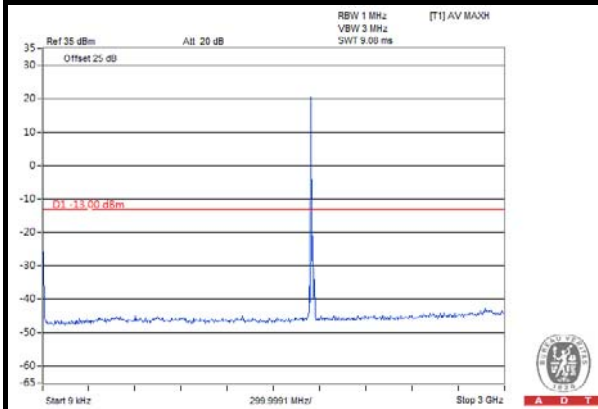

FREQUENCY RANGE : 3GHz~10GHz

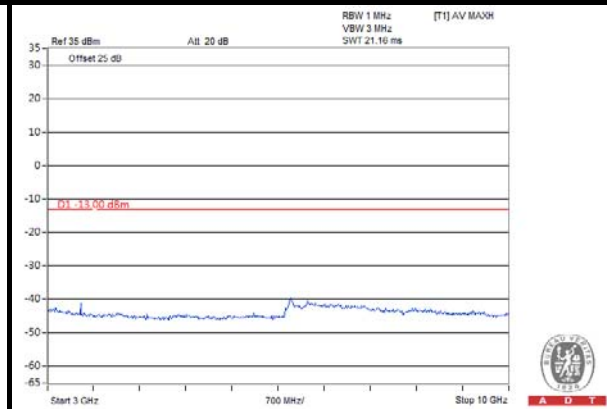

FREQUENCY RANGE : 10GHz~20GHz

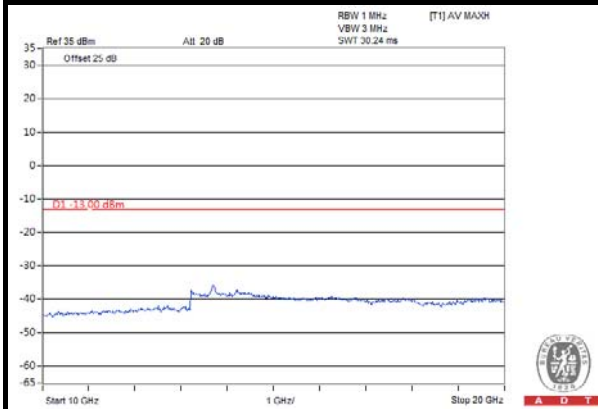



A D T

CHANNEL BANDWIDTH: 10MHz / 16QAM / 1 RB AT LOWER EDGE

CHANNEL 2000

FREQUENCY RANGE : 9kHz~3GHz

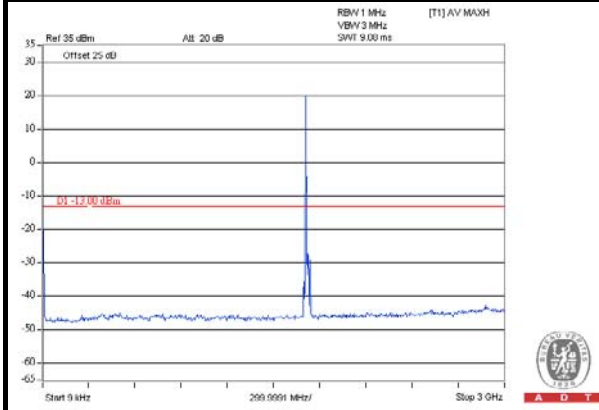

FREQUENCY RANGE : 3GHz~10GHz

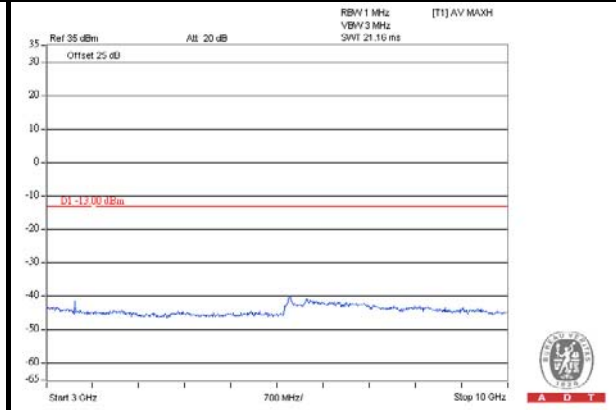

FREQUENCY RANGE : 10GHz~20GHz

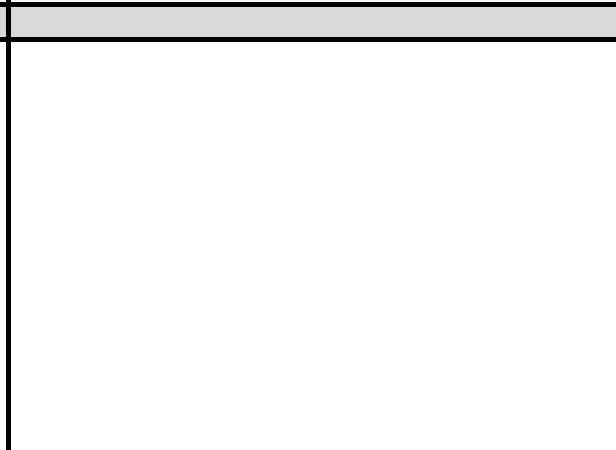
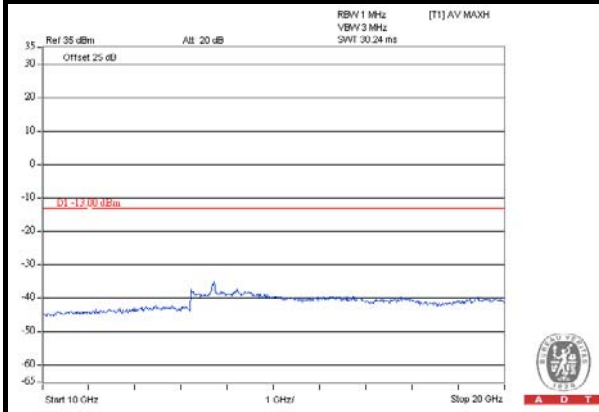



A D T

CHANNEL 20175

FREQUENCY RANGE : 9kHz~3GHz

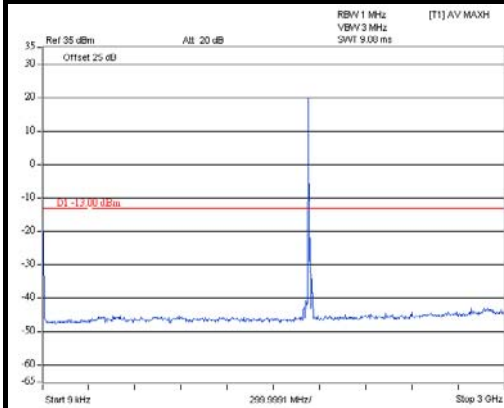

FREQUENCY RANGE : 3GHz~10GHz

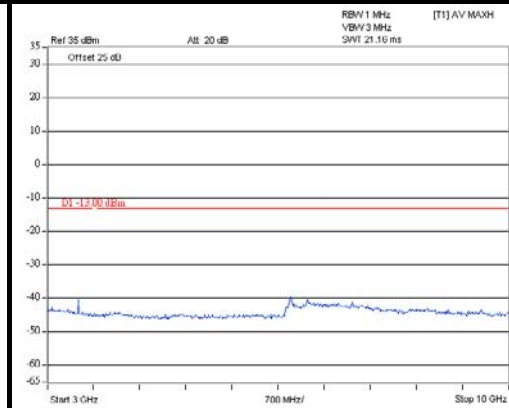

FREQUENCY RANGE : 10GHz~20GHz

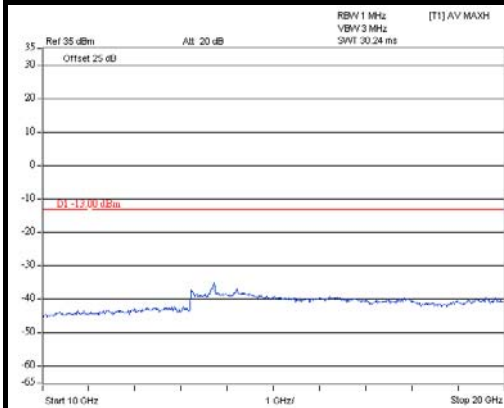



A D T

CHANNEL 20350

FREQUENCY RANGE : 9kHz~3GHz

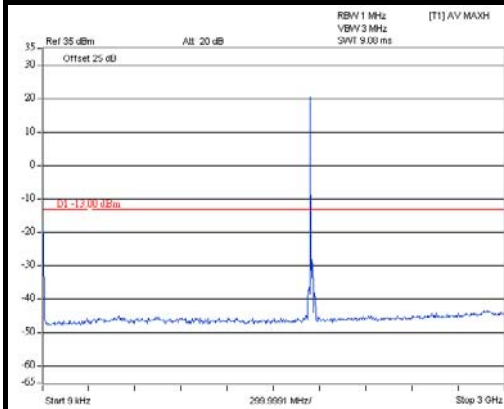

FREQUENCY RANGE : 3GHz~10GHz

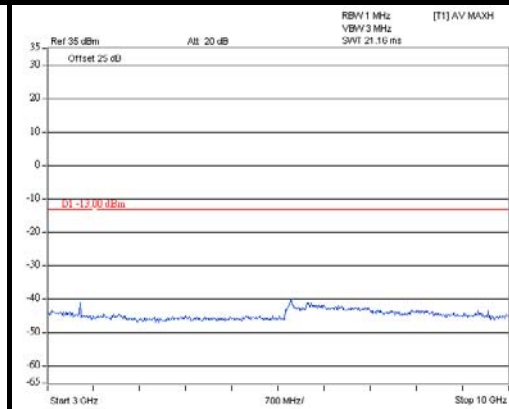

FREQUENCY RANGE : 10GHz~20GHz

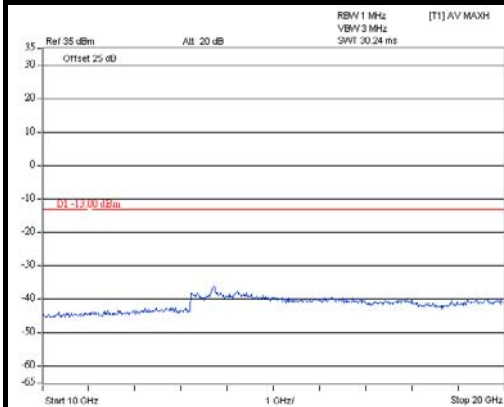



A D T

CHANNEL BANDWIDTH: 15MHz / QPSK / 1 RB AT LOWER EDGE

CHANNEL 20025

FREQUENCY RANGE : 9kHz~3GHz

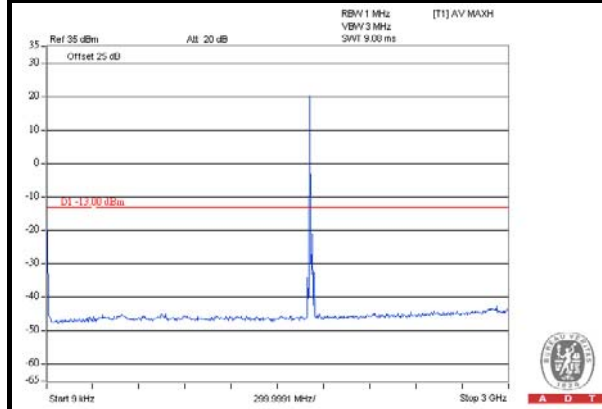

FREQUENCY RANGE : 3GHz~10GHz

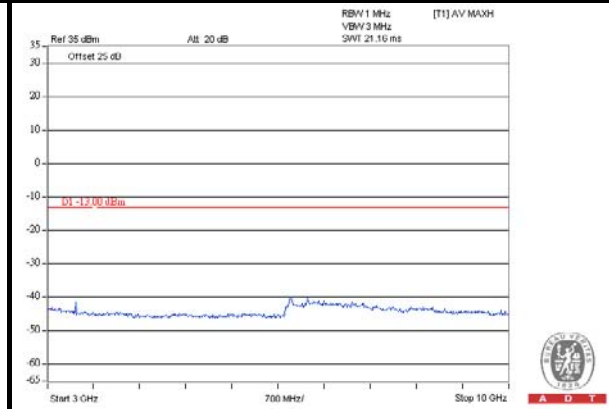

FREQUENCY RANGE : 10GHz~20GHz

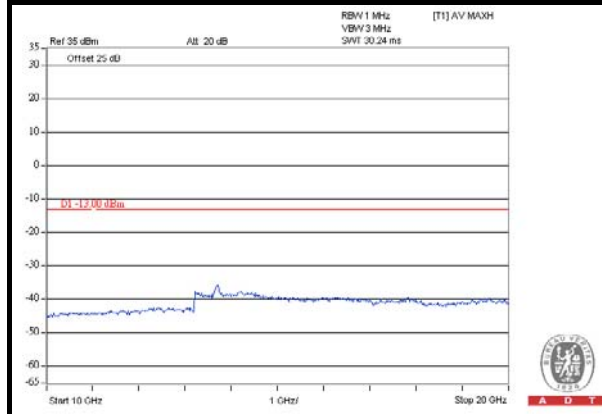



A D T

CHANNEL 20175

FREQUENCY RANGE : 9kHz~3GHz

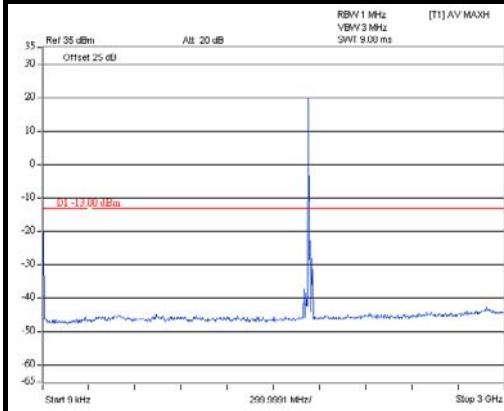

FREQUENCY RANGE : 3GHz~10GHz

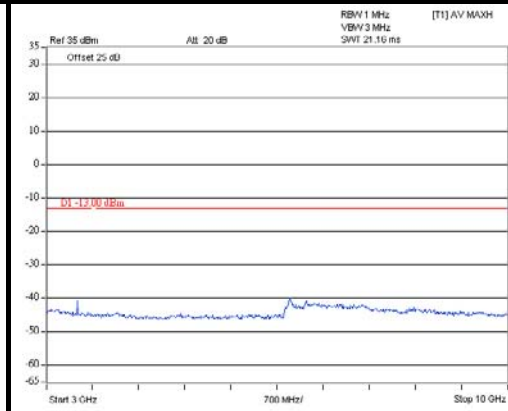

FREQUENCY RANGE : 10GHz~20GHz

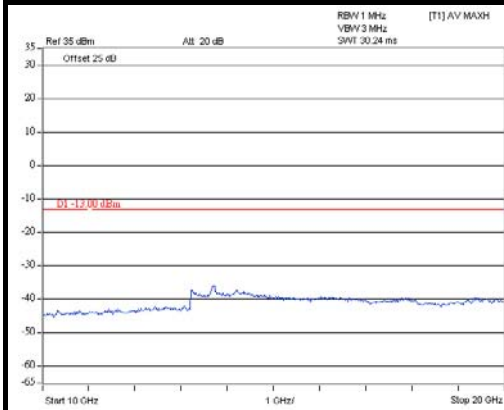



A D T

CHANNEL 20325

FREQUENCY RANGE : 9kHz~3GHz

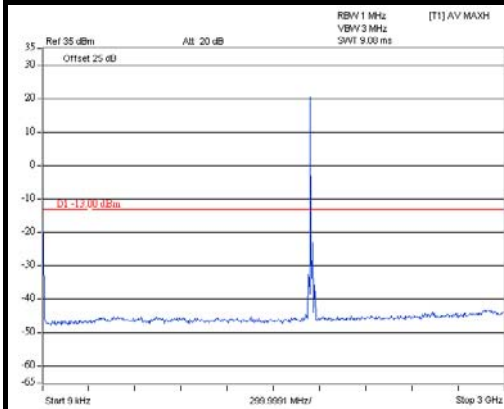

FREQUENCY RANGE : 3GHz~10GHz

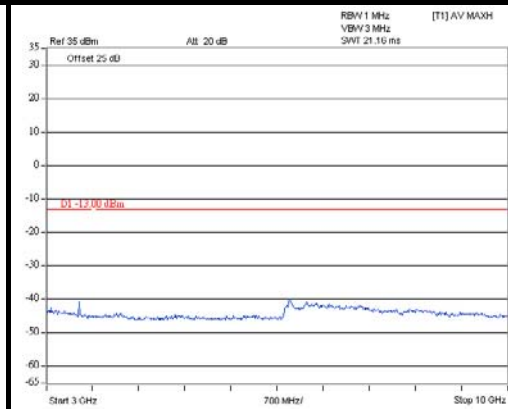

FREQUENCY RANGE : 10GHz~20GHz

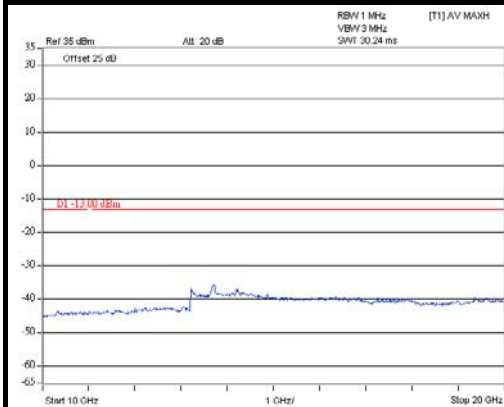



A D T

CHANNEL BANDWIDTH: 15MHz / 16QAM / 1 RB AT LOWER EDGE

CHANNEL 20025

FREQUENCY RANGE : 9kHz~3GHz

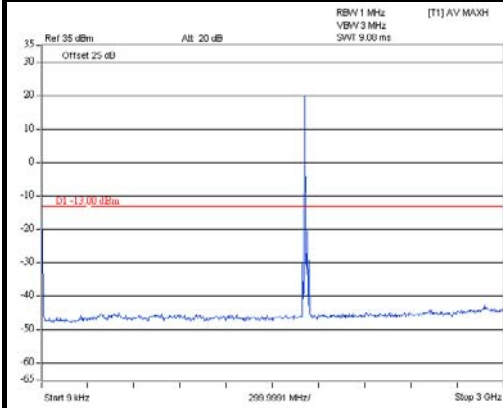

FREQUENCY RANGE : 3GHz~10GHz

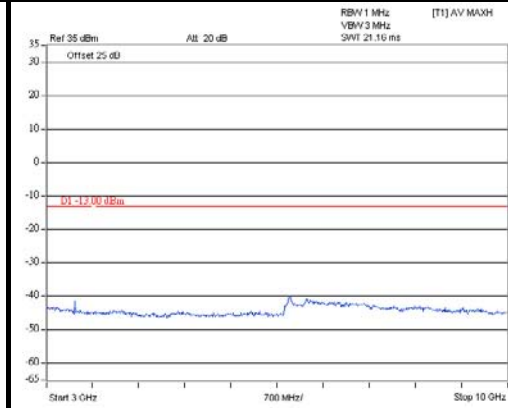

FREQUENCY RANGE : 10GHz~20GHz

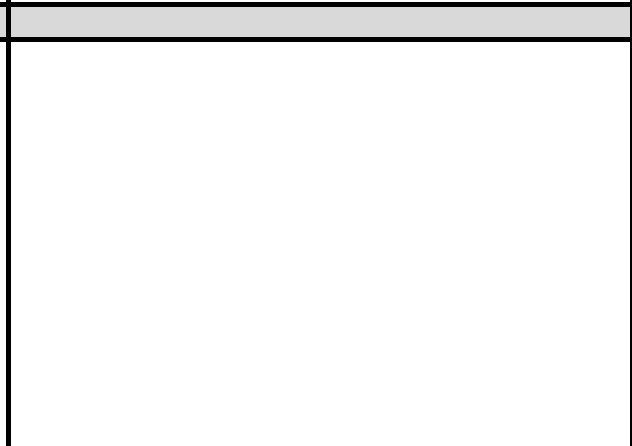
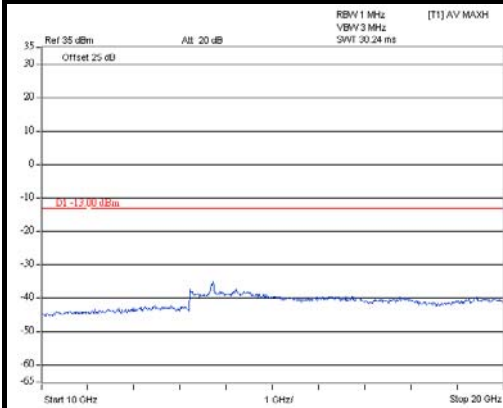



A D T

CHANNEL 20175

FREQUENCY RANGE : 9kHz~3GHz

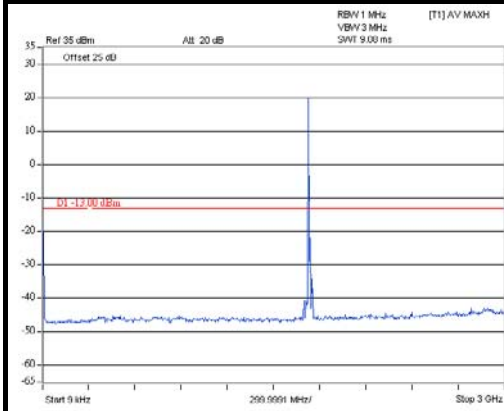

FREQUENCY RANGE : 3GHz~10GHz

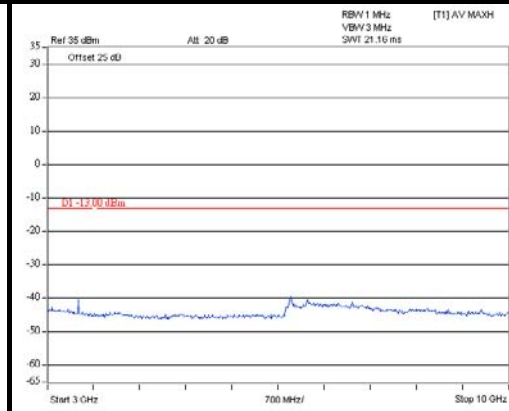

FREQUENCY RANGE : 10GHz~20GHz

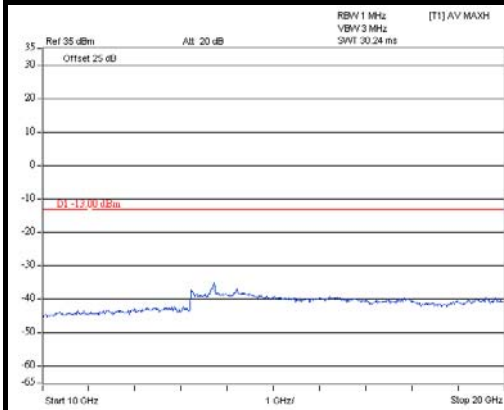



A D T

CHANNEL 20325

FREQUENCY RANGE : 9kHz~3GHz

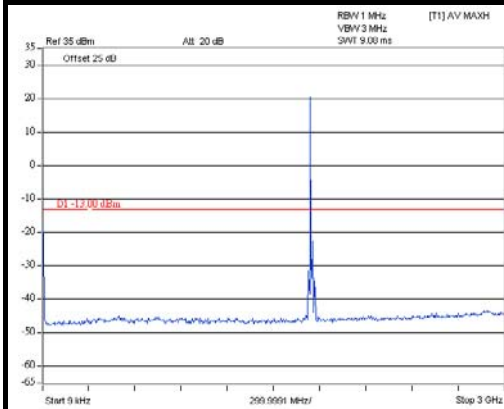

FREQUENCY RANGE : 3GHz~10GHz

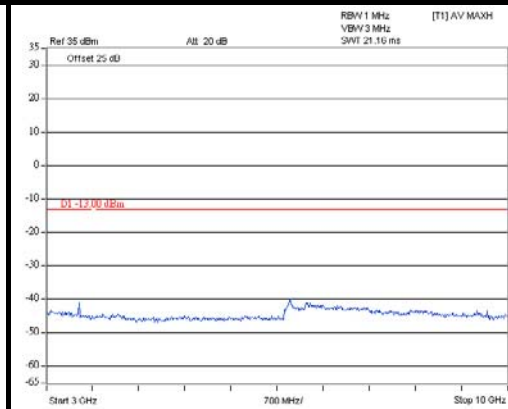

FREQUENCY RANGE : 10GHz~20GHz

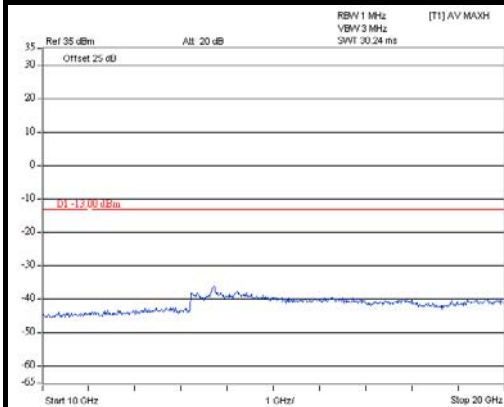



A D T

CHANNEL BANDWIDTH: 20MHz / QPSK / 1 RB AT LOWER EDGE

CHANNEL 20050

FREQUENCY RANGE : 9kHz~3GHz

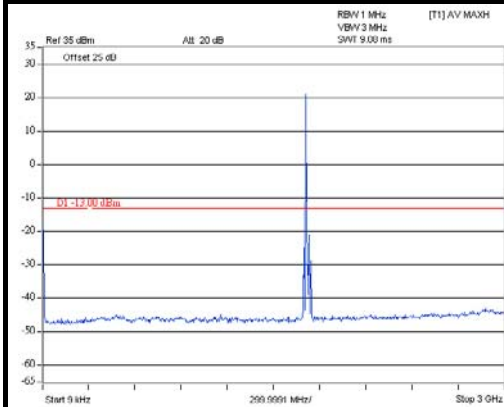

FREQUENCY RANGE : 3GHz~10GHz

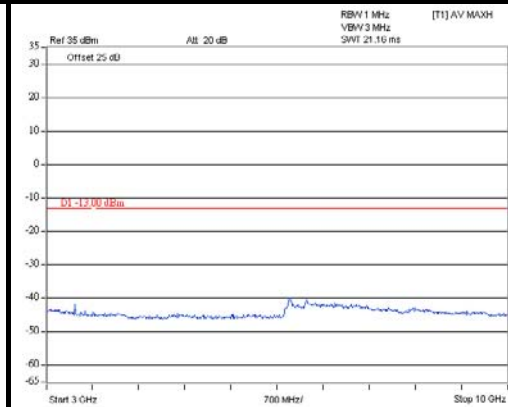

FREQUENCY RANGE : 10GHz~20GHz

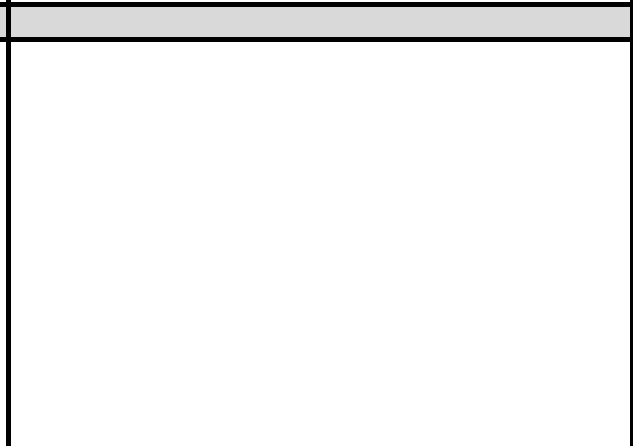
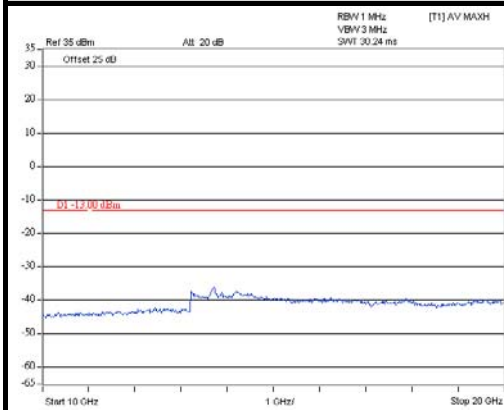



A D T

CHANNEL 20175

FREQUENCY RANGE : 9kHz~3GHz

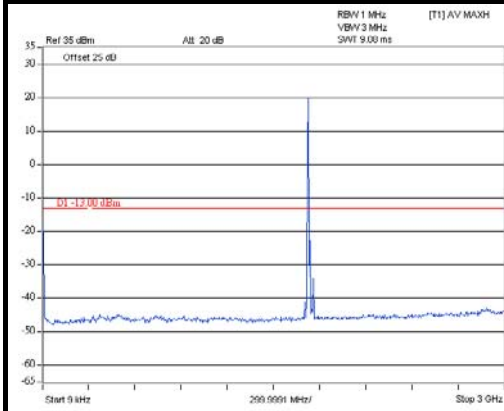

FREQUENCY RANGE : 3GHz~10GHz

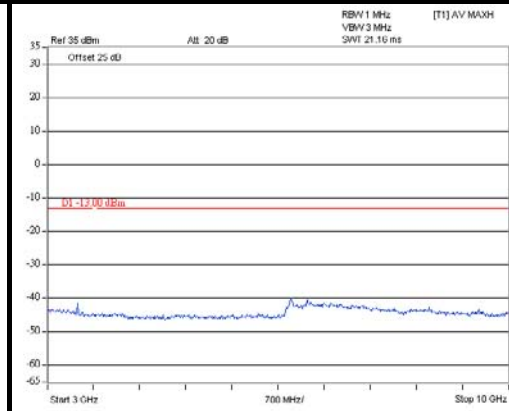

FREQUENCY RANGE : 10GHz~20GHz

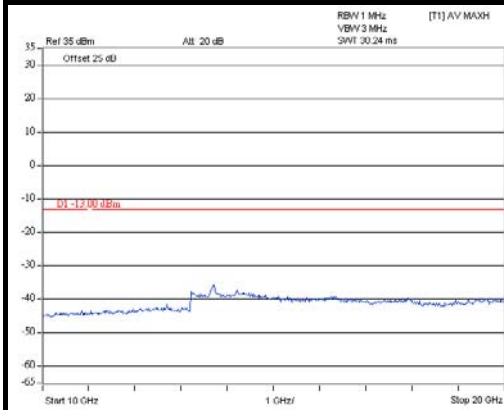



A D T

CHANNEL 20300

FREQUENCY RANGE : 9kHz~3GHz

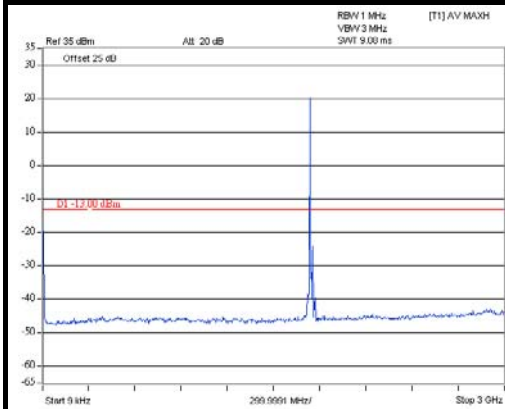

FREQUENCY RANGE : 3GHz~10GHz

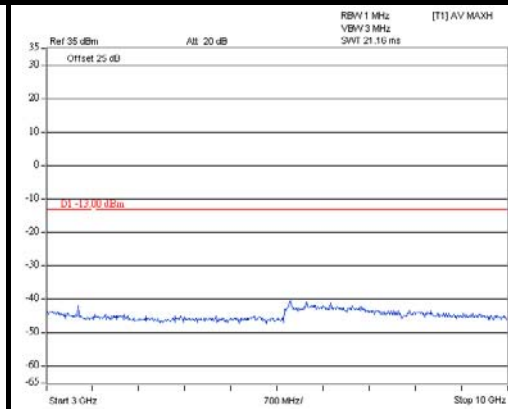

FREQUENCY RANGE : 10GHz~20GHz

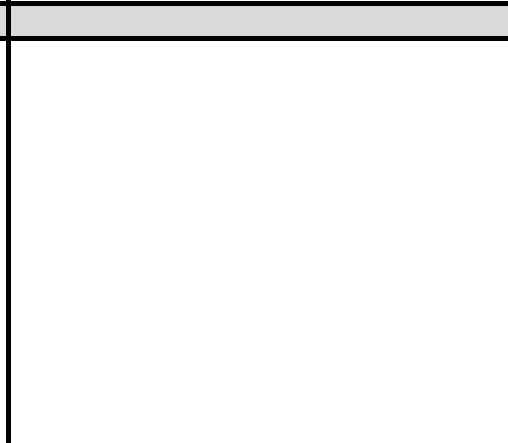
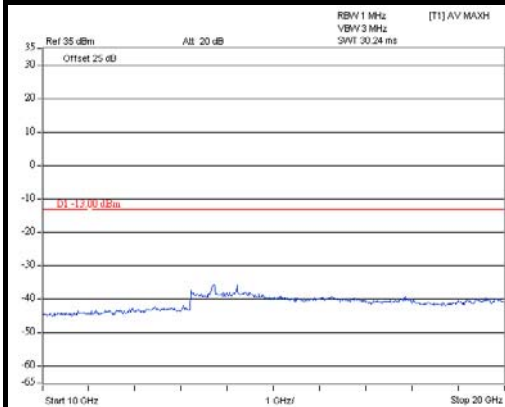



A D T

CHANNEL BANDWIDTH: 20MHz / 16QAM / 1 RB AT LOWER EDGE

CHANNEL 20050

FREQUENCY RANGE : 9kHz~3GHz

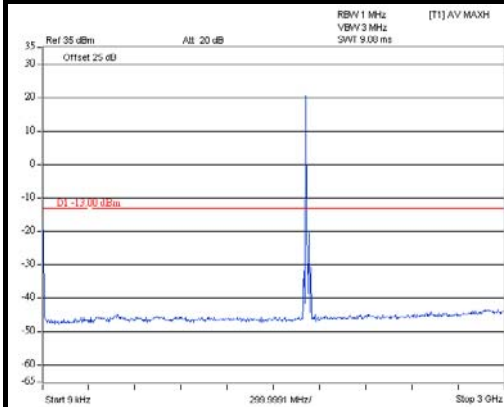

FREQUENCY RANGE : 3GHz~10GHz

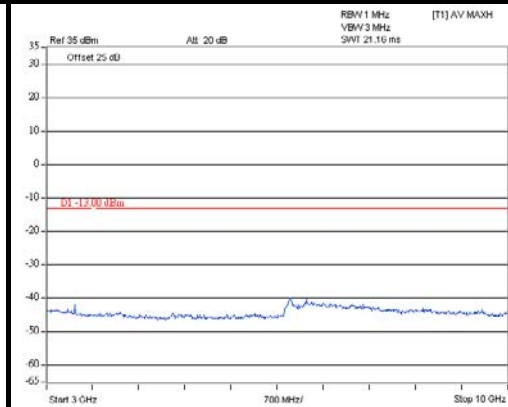

FREQUENCY RANGE : 10GHz~20GHz

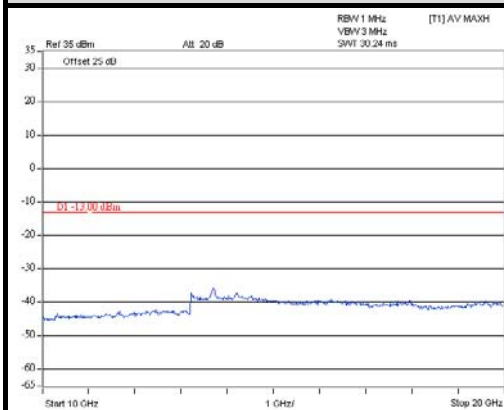



A D T

CHANNEL 20175

FREQUENCY RANGE : 9kHz~3GHz

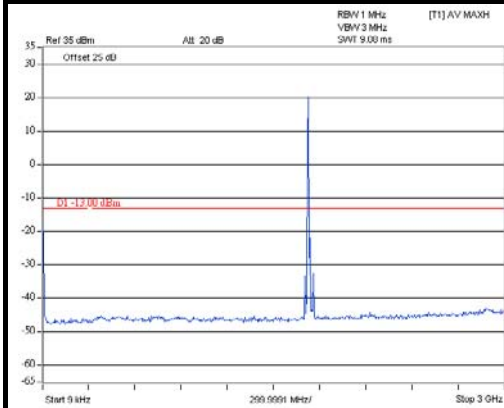

FREQUENCY RANGE : 3GHz~10GHz

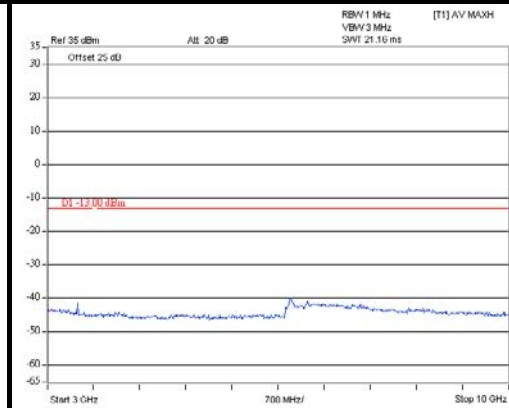

FREQUENCY RANGE : 10GHz~20GHz

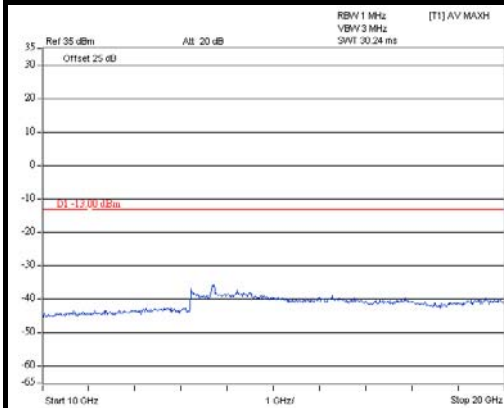



A D T

CHANNEL 20300

FREQUENCY RANGE : 9kHz~3GHz

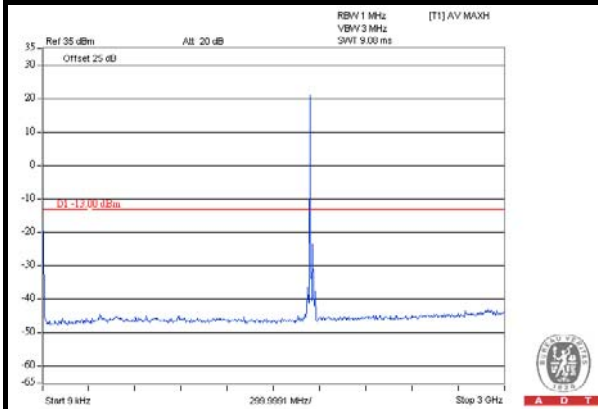

FREQUENCY RANGE : 3GHz~10GHz

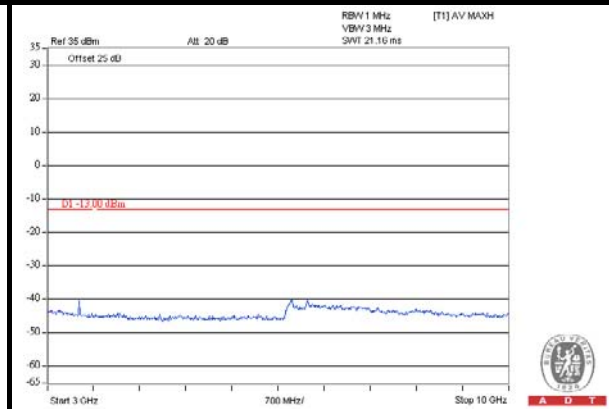

FREQUENCY RANGE : 10GHz~20GHz

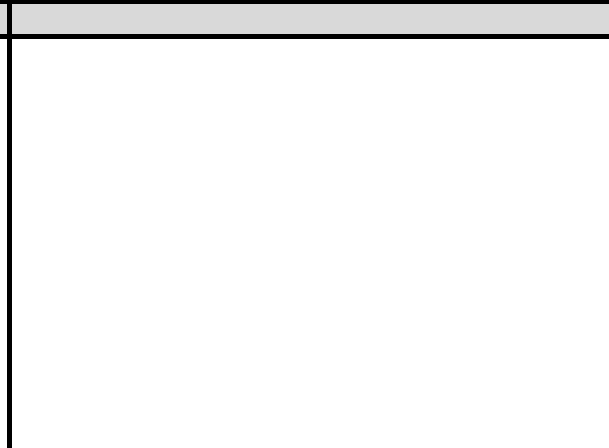
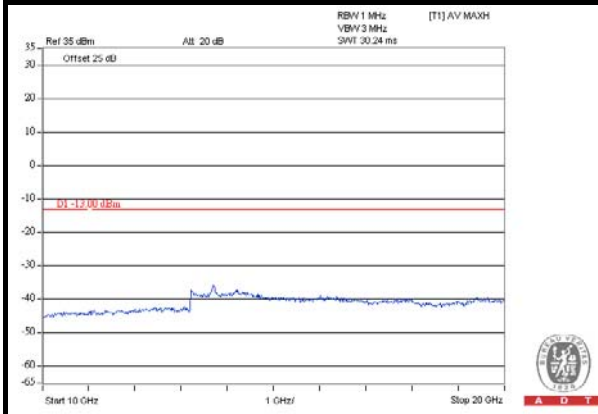

4.7 RADIATED EMISSION MEASUREMENT

4.7.1 LIMITS OF RADIATED EMISSION MEASUREMENT

The power of any emission outside a licensee's frequency block shall be attenuated below the transmitter power (P) by at least $43 + 10 \log_{10}(P)$ dB. The limit of emission equal to -13dBm

4.7.2 TEST PROCEDURES

- a. Substitution method is used for E.I.R.P measurement. In the semi-anechoic chamber, EUT placed on the 0.8m height of Turn Table, rotated the table around 360 degrees to search the maximum radiation power and receiver antenna shall be rotated vertical and horizontal polarization and moved height from 1m to 4m to find the maximum polar radiated power. The "Read Value" is the spectrum reading the maximum power value.
- b. The substitution horn antenna is substituted for EUT at the same position and signals generator export the CW signal to the substitution antenna via a TX cable. Rotated the Turn Table and moved receiving antenna to find the maximum radiation power. Adjust output power level of S.G to get a Value of spectrum reading equal to "Read Value" of step a. Record the power level of S.G
- c. $\text{EIRP} = \text{Output power level of S.G} - \text{TX cable loss} + \text{Antenna gain of substitution horn.}$
- d. E.R.P power can be calculated form E.I.R.P power by subtracting the gain of dipole, $\text{E.R.P power} = \text{E.I.R.P power} - 2.15\text{dBi.}$

NOTE: The resolution bandwidth of spectrum analyzer is 1 MHz and the video bandwidth is 3 MHz.

4.7.3 DEVIATION FROM TEST STANDARD

No deviation

4.7.4 TEST SETUP

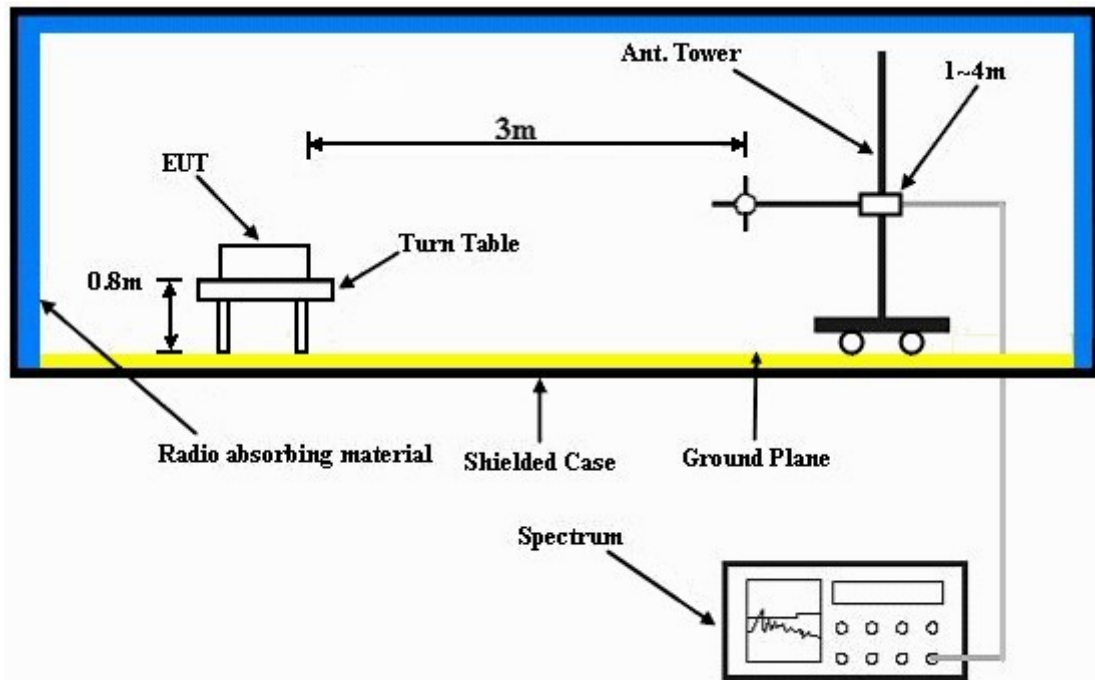

For the actual test configuration, please refer to the attached file (Test Setup Photo).

4.7.5 TEST RESULTS

Below 1GHz

CHANNEL BANDWIDTH: 5MHz / QPSK

MODE	TX channel 19975	FREQUENCY RANGE	Below 1000MHz
ENVIRONMENTAL CONDITIONS	25deg. C, 65%RH	INPUT POWER	120Vac, 60 Hz
TESTED BY	Chris Lin		

ANTENNA POLARITY & TEST DISTANCE: HORIZONTAL AT 3 M							
No.	Freq. (MHz)	Reading (dBm)	S.G Power Value (dBm)	Correction Factor (dB)	EIRP (dBm)	Limit (dBm)	Margin (dB)
1	152.46	-49.38	-52.40	-0.91	-53.31	-13.00	-40.31
2	236.05	-42.43	-46.74	-1.13	-47.87	-13.00	-34.87
3	376.01	-52.24	-51.55	-1.43	-52.98	-13.00	-39.98
4	500.42	-57.70	-55.78	-1.64	-57.42	-13.00	-44.42
5	599.56	-60.74	-57.63	-1.80	-59.43	-13.00	-46.43
6	758.96	-69.65	-62.15	-2.03	-64.18	-13.00	-51.18
ANTENNA POLARITY & TEST DISTANCE: VERTICAL AT 3 M							
No.	Freq. (MHz)	Reading (dBm)	S.G Power Value (dBm)	Correction Factor (dB)	EIRP (dBm)	Limit (dBm)	Margin (dB)
1	152.46	-50.30	-48.79	-0.91	-49.70	-13.00	-36.70
2	234.11	-43.17	-44.25	-1.12	-45.37	-13.00	-32.37
3	376.01	-57.14	-55.54	-1.43	-56.97	-13.00	-43.97
4	428.50	-60.35	-56.85	-1.53	-58.38	-13.00	-45.38
5	599.56	-64.52	-58.65	-1.80	-60.45	-13.00	-47.45
6	801.72	-60.87	-51.54	-2.10	-53.64	-13.00	-40.64

REMARKS:

1. Power Value (dBm) = S.G Power Value (dBm) + Correction Factor (dB).
2. Correction Factor (dB) = Substitution Antenna Gain (dB) + Cable Loss (dB).



A D T

CHANNEL BANDWIDTH: 5MHz / 16QAM

MODE	TX channel 19975	FREQUENCY RANGE	Below 1000MHz
ENVIRONMENTAL CONDITIONS	25deg. C, 65%RH	INPUT POWER	120Vac, 60 Hz
TESTED BY	Chris Lin		

ANTENNA POLARITY & TEST DISTANCE: HORIZONTAL AT 3 M

No.	Freq. (MHz)	Reading (dBm)	S.G Power Value (dBm)	Correction Factor (dB)	EIRP (dBm)	Limit (dBm)	Margin (dB)
1	154.41	-48.56	-51.55	-0.91	-52.46	-13.00	-39.46
2	236.05	-42.60	-46.91	-1.13	-48.04	-13.00	-35.04
3	376.01	-52.66	-51.97	-1.43	-53.40	-13.00	-40.40
4	438.22	-57.94	-56.00	-1.54	-57.54	-13.00	-44.54
5	601.50	-60.05	-56.89	-1.81	-58.70	-13.00	-45.70

ANTENNA POLARITY & TEST DISTANCE: VERTICAL AT 3 M

No.	Freq. (MHz)	Reading (dBm)	S.G Power Value (dBm)	Correction Factor (dB)	EIRP (dBm)	Limit (dBm)	Margin (dB)
1	154.41	-48.92	-47.04	-0.91	-47.95	-13.00	-34.95
2	234.11	-43.43	-44.51	-1.12	-45.63	-13.00	-32.63
3	376.01	-57.22	-55.62	-1.43	-57.05	-13.00	-44.05
4	494.59	-60.75	-57.48	-1.63	-59.11	-13.00	-46.11
5	601.50	-64.87	-58.95	-1.81	-60.76	-13.00	-47.76
6	801.72	-60.87	-51.54	-2.10	-53.64	-13.00	-40.64

REMARKS:

1. Power Value (dBm) = S.G Power Value (dBm) + Correction Factor (dB).
2. Correction Factor (dB) = Substitution Antenna Gain (dB) + Cable Loss (dB).



A D T

CHANNEL BANDWIDTH: 10MHz / QPSK

MODE	TX channel 20000	FREQUENCY RANGE	Below 1000MHz
ENVIRONMENTAL CONDITIONS	25deg. C, 65%RH	INPUT POWER	120Vac, 60 Hz
TESTED BY	Chris Lin		

ANTENNA POLARITY & TEST DISTANCE: HORIZONTAL AT 3 M							
No.	Freq. (MHz)	Reading (dBm)	S.G Power Value (dBm)	Correction Factor (dB)	EIRP (dBm)	Limit (dBm)	Margin (dB)
1	154.41	-48.40	-51.39	-0.91	-52.30	-13.00	-39.30
2	236.05	-43.23	-47.54	-1.13	-48.67	-13.00	-35.67
3	376.01	-52.57	-51.88	-1.43	-53.31	-13.00	-40.31
4	426.55	-58.98	-57.05	-1.52	-58.57	-13.00	-45.57
5	601.50	-60.09	-56.93	-1.81	-58.74	-13.00	-45.74
6	801.72	-66.56	-59.16	-2.10	-61.26	-13.00	-48.26
ANTENNA POLARITY & TEST DISTANCE: VERTICAL AT 3 M							
No.	Freq. (MHz)	Reading (dBm)	S.G Power Value (dBm)	Correction Factor (dB)	EIRP (dBm)	Limit (dBm)	Margin (dB)
1	152.46	-49.39	-47.88	-0.91	-48.79	-13.00	-35.79
2	234.11	-43.13	-44.21	-1.12	-45.33	-13.00	-32.33
3	376.01	-57.27	-55.67	-1.43	-57.10	-13.00	-44.10
4	494.59	-60.74	-57.47	-1.63	-59.10	-13.00	-46.10
5	601.50	-65.64	-59.72	-1.81	-61.53	-13.00	-48.53
6	801.72	-61.36	-52.03	-2.10	-54.13	-13.00	-41.13

REMARKS:

1. Power Value (dBm) = S.G Power Value (dBm) + Correction Factor (dB).
2. Correction Factor (dB) = Substitution Antenna Gain (dB) + Cable Loss (dB).



A D T

CHANNEL BANDWIDTH: 10MHz / 16QAM

MODE	TX channel 2000	FREQUENCY RANGE	Below 1000MHz
ENVIRONMENTAL CONDITIONS	25deg. C, 65%RH	INPUT POWER	120Vac, 60 Hz
TESTED BY	Chris Lin		

ANTENNA POLARITY & TEST DISTANCE: HORIZONTAL AT 3 M

No.	Freq. (MHz)	Reading (dBm)	S.G Power Value (dBm)	Correction Factor (dB)	EIRP (dBm)	Limit (dBm)	Margin (dB)
1	152.46	-48.47	-51.49	-0.91	-52.40	-13.00	-39.40
2	236.05	-42.98	-47.29	-1.13	-48.42	-13.00	-35.42
3	376.01	-52.57	-51.88	-1.43	-53.31	-13.00	-40.31
4	500.42	-59.01	-57.09	-1.64	-58.73	-13.00	-45.73
5	599.56	-60.93	-57.82	-1.80	-59.62	-13.00	-46.62
6	801.72	-66.94	-59.54	-2.10	-61.64	-13.00	-48.64

ANTENNA POLARITY & TEST DISTANCE: VERTICAL AT 3 M

No.	Freq. (MHz)	Reading (dBm)	S.G Power Value (dBm)	Correction Factor (dB)	EIRP (dBm)	Limit (dBm)	Margin (dB)
1	152.46	-50.42	-48.91	-0.91	-49.82	-13.00	-36.82
2	234.11	-43.23	-44.31	-1.12	-45.43	-13.00	-32.43
3	376.01	-56.94	-55.34	-1.43	-56.77	-13.00	-43.77
4	428.50	-60.88	-57.38	-1.53	-58.91	-13.00	-45.91
5	560.68	-63.60	-59.01	-1.74	-60.75	-13.00	-47.75
6	801.72	-61.62	-52.29	-2.10	-54.39	-13.00	-41.39

REMARKS:

1. Power Value (dBm) = S.G Power Value (dBm) + Correction Factor (dB).
2. Correction Factor (dB) = Substitution Antenna Gain (dB) + Cable Loss (dB).



A D T

CHANNEL BANDWIDTH: 15MHz / QPSK

MODE	TX channel 20025	FREQUENCY RANGE	Below 1000MHz
ENVIRONMENTAL CONDITIONS	25deg. C, 65%RH	INPUT POWER	120Vac, 60 Hz
TESTED BY	Chris Lin		

ANTENNA POLARITY & TEST DISTANCE: HORIZONTAL AT 3 M

No.	Freq. (MHz)	Reading (dBm)	S.G Power Value (dBm)	Correction Factor (dB)	EIRP (dBm)	Limit (dBm)	Margin (dB)
1	152.46	-49.37	-52.39	-0.91	-53.30	-13.00	-40.30
2	236.05	-43.20	-47.51	-1.13	-48.64	-13.00	-35.64
3	376.01	-52.77	-52.08	-1.43	-53.51	-13.00	-40.51
4	500.42	-57.60	-55.68	-1.64	-57.32	-13.00	-44.32
5	601.50	-61.75	-58.59	-1.81	-60.40	-13.00	-47.40
6	801.72	-67.21	-59.81	-2.10	-61.91	-13.00	-48.91

ANTENNA POLARITY & TEST DISTANCE: VERTICAL AT 3 M

No.	Freq. (MHz)	Reading (dBm)	S.G Power Value (dBm)	Correction Factor (dB)	EIRP (dBm)	Limit (dBm)	Margin (dB)
1	156.35	-52.17	-49.90	-0.92	-50.82	-13.00	-37.82
2	234.11	-43.29	-44.37	-1.12	-45.49	-13.00	-32.49
3	376.01	-57.60	-56.00	-1.43	-57.43	-13.00	-44.43
4	494.59	-60.77	-57.50	-1.63	-59.13	-13.00	-46.13
5	624.83	-65.76	-59.29	-1.84	-61.13	-13.00	-48.13
6	801.72	-61.38	-52.05	-2.10	-54.15	-13.00	-41.15

REMARKS:

1. Power Value (dBm) = S.G Power Value (dBm) + Correction Factor (dB).
2. Correction Factor (dB) = Substitution Antenna Gain (dB) + Cable Loss (dB).



A D T

CHANNEL BANDWIDTH: 15MHz / 16QAM

MODE	TX channel 20025	FREQUENCY RANGE	Below 1000MHz
ENVIRONMENTAL CONDITIONS	25deg. C, 65%RH	INPUT POWER	120Vac, 60 Hz
TESTED BY	Chris Lin		

ANTENNA POLARITY & TEST DISTANCE: HORIZONTAL AT 3 M

No.	Freq. (MHz)	Reading (dBm)	S.G Power Value (dBm)	Correction Factor (dB)	EIRP (dBm)	Limit (dBm)	Margin (dB)
1	152.46	-50.51	-53.53	-0.91	-54.44	-13.00	-41.44
2	236.05	-43.07	-47.38	-1.13	-48.51	-13.00	-35.51
3	376.01	-52.71	-52.02	-1.43	-53.45	-13.00	-40.45
4	500.42	-57.15	-55.23	-1.64	-56.87	-13.00	-43.87
5	601.50	-60.68	-57.52	-1.81	-59.33	-13.00	-46.33
6	801.72	-67.26	-59.86	-2.10	-61.96	-13.00	-48.96

ANTENNA POLARITY & TEST DISTANCE: VERTICAL AT 3 M

No.	Freq. (MHz)	Reading (dBm)	S.G Power Value (dBm)	Correction Factor (dB)	EIRP (dBm)	Limit (dBm)	Margin (dB)
1	152.46	-49.31	-47.80	-0.91	-48.71	-13.00	-35.71
2	234.11	-42.80	-43.88	-1.12	-45.00	-13.00	-32.00
3	296.31	-57.14	-57.38	-1.26	-58.64	-13.00	-45.64
4	376.01	-56.89	-55.29	-1.43	-56.72	-13.00	-43.72
5	494.59	-60.83	-57.56	-1.63	-59.19	-13.00	-46.19
6	801.72	-61.14	-51.81	-2.10	-53.91	-13.00	-40.91

REMARKS:

1. Power Value (dBm) = S.G Power Value (dBm) + Correction Factor (dB).
2. Correction Factor (dB) = Substitution Antenna Gain (dB) + Cable Loss (dB).



A D T

CHANNEL BANDWIDTH: 20MHz / QPSK

MODE	TX channel 20050	FREQUENCY RANGE	Below 1000MHz
ENVIRONMENTAL CONDITIONS	25deg. C, 65%RH	INPUT POWER	120Vac, 60 Hz
TESTED BY	Chris Lin		

ANTENNA POLARITY & TEST DISTANCE: HORIZONTAL AT 3 M

No.	Freq. (MHz)	Reading (dBm)	S.G Power Value (dBm)	Correction Factor (dB)	EIRP (dBm)	Limit (dBm)	Margin (dB)
1	150.52	-50.87	-53.92	-0.90	-54.82	-13.00	-41.82
2	236.05	-43.08	-47.39	-1.13	-48.52	-13.00	-35.52
3	376.01	-52.64	-51.95	-1.43	-53.38	-13.00	-40.38
4	418.78	-53.06	-50.95	-1.50	-52.45	-13.00	-39.45
5	500.42	-57.67	-55.75	-1.64	-57.39	-13.00	-44.39
6	599.56	-60.66	-57.55	-1.80	-59.35	-13.00	-46.35

ANTENNA POLARITY & TEST DISTANCE: VERTICAL AT 3 M

No.	Freq. (MHz)	Reading (dBm)	S.G Power Value (dBm)	Correction Factor (dB)	EIRP (dBm)	Limit (dBm)	Margin (dB)
1	152.46	-49.53	-48.02	-0.91	-48.93	-13.00	-35.93
2	234.11	-42.95	-44.03	-1.12	-45.15	-13.00	-32.15
3	376.01	-57.27	-55.67	-1.43	-57.10	-13.00	-44.10
4	428.50	-60.53	-57.03	-1.53	-58.56	-13.00	-45.56
5	599.56	-64.94	-59.07	-1.80	-60.87	-13.00	-47.87
6	801.72	-60.21	-50.88	-2.10	-52.98	-13.00	-39.98

REMARKS:

1. Power Value (dBm) = S.G Power Value (dBm) + Correction Factor (dB).
2. Correction Factor (dB) = Substitution Antenna Gain (dB) + Cable Loss (dB).



A D T

CHANNEL BANDWIDTH: 20MHz / 16QAM

MODE	TX channel 20050	FREQUENCY RANGE	Below 1000MHz
ENVIRONMENTAL CONDITIONS	25deg. C, 65%RH	INPUT POWER	120Vac, 60 Hz
TESTED BY	Chris Lin		

ANTENNA POLARITY & TEST DISTANCE: HORIZONTAL AT 3 M

No.	Freq. (MHz)	Reading (dBm)	S.G Power Value (dBm)	Correction Factor (dB)	EIRP (dBm)	Limit (dBm)	Margin (dB)
1	152.46	-50.37	-53.39	-0.91	-54.30	-13.00	-41.30
2	236.05	-42.84	-47.15	-1.13	-48.28	-13.00	-35.28
3	376.01	-52.50	-51.81	-1.43	-53.24	-13.00	-40.24
4	442.10	-57.18	-55.22	-1.54	-56.76	-13.00	-43.76
5	601.50	-62.14	-58.98	-1.81	-60.79	-13.00	-47.79
6	801.72	-66.46	-59.06	-2.10	-61.16	-13.00	-48.16

ANTENNA POLARITY & TEST DISTANCE: VERTICAL AT 3 M

No.	Freq. (MHz)	Reading (dBm)	S.G Power Value (dBm)	Correction Factor (dB)	EIRP (dBm)	Limit (dBm)	Margin (dB)
1	156.35	-51.58	-49.31	-0.92	-50.23	-13.00	-37.23
2	234.11	-42.90	-43.98	-1.12	-45.10	-13.00	-32.10
3	376.01	-57.27	-55.67	-1.43	-57.10	-13.00	-44.10
4	494.59	-60.34	-57.07	-1.63	-58.70	-13.00	-45.70
5	624.83	-65.01	-58.54	-1.84	-60.38	-13.00	-47.38
6	801.72	-61.03	-51.70	-2.10	-53.80	-13.00	-40.80

REMARKS:

1. Power Value (dBm) = S.G Power Value (dBm) + Correction Factor (dB).
2. Correction Factor (dB) = Substitution Antenna Gain (dB) + Cable Loss (dB).



A D T

Above 1GHz

CHANNEL BANDWIDTH: 5MHz / QPSK

MODE	Channel 19975	FREQUENCY RANGE	Above 1000MHz
ENVIRONMENTAL CONDITIONS	25deg. C, 65%RH	INPUT POWER	120Vac, 60 Hz
TESTED BY	Chris Lin		

ANTENNA POLARITY & TEST DISTANCE: HORIZONTAL AT 3 M							
No.	Freq. (MHz)	Reading (dBm)	S.G Power Value (dBm)	Correction Factor (dB)	EIRP (dBm)	Limit (dBm)	Margin (dB)
1	3425.00	-41.90	-26.87	-4.44	-31.31	-13.00	-18.31
2	5137.50	-57.59	-35.60	-5.50	-41.10	-13.00	-28.10

ANTENNA POLARITY & TEST DISTANCE: VERTICAL AT 3 M							
No.	Freq. (MHz)	Reading (dBm)	S.G Power Value (dBm)	Correction Factor (dB)	EIRP (dBm)	Limit (dBm)	Margin (dB)
1	3425.00	-41.74	-26.73	-4.44	-31.17	-13.00	-18.17
2	5137.50	-59.48	-38.75	-5.50	-44.25	-13.00	-31.25

REMARKS:

1. Power Value (dBm) = S.G Power Value (dBm) + Correction Factor (dB).
2. Correction Factor (dB) = Substitution Antenna Gain (dB) + Cable Loss (dB).



A D T

MODE	Channel 20175	FREQUENCY RANGE	Above 1000MHz
ENVIRONMENTAL CONDITIONS	25deg. C, 65%RH	INPUT POWER	120Vac, 60 Hz
TESTED BY	Chris Lin		

ANTENNA POLARITY & TEST DISTANCE: HORIZONTAL AT 3 M							
No.	Freq. (MHz)	Reading (dBm)	S.G Power Value (dBm)	Correction Factor (dB)	EIRP (dBm)	Limit (dBm)	Margin (dB)
1	3465.00	-39.99	-24.96	-4.46	-29.42	-13.00	-16.42
2	5197.50	-54.88	-32.66	-5.53	-38.19	-13.00	-25.19
ANTENNA POLARITY & TEST DISTANCE: VERTICAL AT 3 M							
No.	Freq. (MHz)	Reading (dBm)	S.G Power Value (dBm)	Correction Factor (dB)	EIRP (dBm)	Limit (dBm)	Margin (dB)
1	3465.00	-40.86	-25.73	-4.46	-30.19	-13.00	-17.19
2	5197.50	-57.26	-36.36	-5.53	-41.89	-13.00	-28.89

REMARKS:

1. Power Value (dBm) = S.G Power Value (dBm) + Correction Factor (dB).
2. Correction Factor (dB) = Substitution Antenna Gain (dB) + Cable Loss (dB).



A D T

MODE	Channel 20375	FREQUENCY RANGE	Above 1000MHz
ENVIRONMENTAL CONDITIONS	25deg. C, 65%RH	INPUT POWER	120Vac, 60 Hz
TESTED BY	Chris Lin		

ANTENNA POLARITY & TEST DISTANCE: HORIZONTAL AT 3 M							
No.	Freq. (MHz)	Reading (dBm)	S.G Power Value (dBm)	Correction Factor (dB)	EIRP (dBm)	Limit (dBm)	Margin (dB)
1	3505.00	-44.03	-28.96	-4.49	-33.45	-13.00	-20.45
2	5257.50	-60.44	-37.96	-5.58	-43.54	-13.00	-30.54
ANTENNA POLARITY & TEST DISTANCE: VERTICAL AT 3 M							
No.	Freq. (MHz)	Reading (dBm)	S.G Power Value (dBm)	Correction Factor (dB)	EIRP (dBm)	Limit (dBm)	Margin (dB)
1	3505.00	-43.46	-28.20	-4.49	-32.69	-13.00	-19.69
2	5257.50	-59.46	-38.38	-5.58	-43.96	-13.00	-30.96

REMARKS:

1. Power Value (dBm) = S.G Power Value (dBm) + Correction Factor (dB).
2. Correction Factor (dB) = Substitution Antenna Gain (dB) + Cable Loss (dB).



A D T

Above 1GHz

CHANNEL BANDWIDTH: 10MHz / QPSK

MODE	Channel 20000	FREQUENCY RANGE	Above 1000MHz
ENVIRONMENTAL CONDITIONS	25deg. C, 65%RH	INPUT POWER	120Vac, 60 Hz
TESTED BY	Chris Lin		

ANTENNA POLARITY & TEST DISTANCE: HORIZONTAL AT 3 M							
No.	Freq. (MHz)	Reading (dBm)	S.G Power Value (dBm)	Correction Factor (dB)	EIRP (dBm)	Limit (dBm)	Margin (dB)
1	3430.00	-45.89	-30.87	-4.44	-35.31	-13.00	-22.31
2	5145.00	-60.88	-38.85	-5.51	-44.36	-13.00	-31.36
ANTENNA POLARITY & TEST DISTANCE: VERTICAL AT 3 M							
No.	Freq. (MHz)	Reading (dBm)	S.G Power Value (dBm)	Correction Factor (dB)	EIRP (dBm)	Limit (dBm)	Margin (dB)
1	3430.00	-43.81	-28.79	-4.44	-33.23	-13.00	-20.23
2	5145.00	-61.52	-40.76	-5.51	-46.27	-13.00	-33.27

REMARKS:

1. Power Value (dBm) = S.G Power Value (dBm) + Correction Factor (dB).
2. Correction Factor (dB) = Substitution Antenna Gain (dB) + Cable Loss (dB).



A D T

MODE	Channel 20175	FREQUENCY RANGE	Above 1000MHz
ENVIRONMENTAL CONDITIONS	25deg. C, 65%RH	INPUT POWER	120Vac, 60 Hz
TESTED BY	Chris Lin		

ANTENNA POLARITY & TEST DISTANCE: HORIZONTAL AT 3 M							
No.	Freq. (MHz)	Reading (dBm)	S.G Power Value (dBm)	Correction Factor (dB)	EIRP (dBm)	Limit (dBm)	Margin (dB)
1	3465.00	-45.82	-30.79	-4.46	-35.25	-13.00	-22.25
2	5197.50	-60.40	-38.18	-5.53	-43.71	-13.00	-30.71
ANTENNA POLARITY & TEST DISTANCE: VERTICAL AT 3 M							
No.	Freq. (MHz)	Reading (dBm)	S.G Power Value (dBm)	Correction Factor (dB)	EIRP (dBm)	Limit (dBm)	Margin (dB)
1	3465.00	-43.52	-28.39	-4.46	-32.85	-13.00	-19.85
2	5197.50	-62.85	-41.95	-5.53	-47.48	-13.00	-34.48

REMARKS:

1. Power Value (dBm) = S.G Power Value (dBm) + Correction Factor (dB).
2. Correction Factor (dB) = Substitution Antenna Gain (dB) + Cable Loss (dB).



A D T

MODE	Channel 20350	FREQUENCY RANGE	Above 1000MHz
ENVIRONMENTAL CONDITIONS	25deg. C, 65%RH	INPUT POWER	120Vac, 60 Hz
TESTED BY	Chris Lin		

ANTENNA POLARITY & TEST DISTANCE: HORIZONTAL AT 3 M							
No.	Freq. (MHz)	Reading (dBm)	S.G Power Value (dBm)	Correction Factor (dB)	EIRP (dBm)	Limit (dBm)	Margin (dB)
1	3500.00	-45.26	-30.22	-4.48	-34.70	-13.00	-21.70
2	5250.00	-59.87	-37.43	-5.57	-43.00	-13.00	-30.00

ANTENNA POLARITY & TEST DISTANCE: VERTICAL AT 3 M							
No.	Freq. (MHz)	Reading (dBm)	S.G Power Value (dBm)	Correction Factor (dB)	EIRP (dBm)	Limit (dBm)	Margin (dB)
1	1750.00	-43.96	-37.27	-3.12	-40.39	-13.00	-27.39
2	5250.00	-59.85	-38.80	-5.57	-44.37	-13.00	-31.37

REMARKS:

1. Power Value (dBm) = S.G Power Value (dBm) + Correction Factor (dB).
2. Correction Factor (dB) = Substitution Antenna Gain (dB) + Cable Loss (dB).



A D T

CHANNEL BANDWIDTH: 15MHz / QPSK

MODE	Channel 20025	FREQUENCY RANGE	Above 1000MHz
ENVIRONMENTAL CONDITIONS	25deg. C, 65%RH	INPUT POWER	120Vac, 60 Hz
TESTED BY	Chris Lin		

ANTENNA POLARITY & TEST DISTANCE: HORIZONTAL AT 3 M							
No.	Freq. (MHz)	Reading (dBm)	S.G Power Value (dBm)	Correction Factor (dB)	EIRP (dBm)	Limit (dBm)	Margin (dB)
1	3435.00	-45.71	-30.68	-4.45	-35.13	-13.00	-22.13
2	5152.50	-61.74	-39.69	-5.51	-45.20	-13.00	-32.20
ANTENNA POLARITY & TEST DISTANCE: VERTICAL AT 3 M							
No.	Freq. (MHz)	Reading (dBm)	S.G Power Value (dBm)	Correction Factor (dB)	EIRP (dBm)	Limit (dBm)	Margin (dB)
1	3435.00	-42.56	-27.52	-4.45	-31.97	-13.00	-18.97
2	5152.50	-60.23	-39.46	-5.51	-44.97	-13.00	-31.97

REMARKS:

1. Power Value (dBm) = S.G Power Value (dBm) + Correction Factor (dB).
2. Correction Factor (dB) = Substitution Antenna Gain (dB) + Cable Loss (dB).



A D T

MODE	Channel 20175	FREQUENCY RANGE	Above 1000MHz
ENVIRONMENTAL CONDITIONS	25deg. C, 65%RH	INPUT POWER	120Vac, 60 Hz
TESTED BY	Chris Lin		

ANTENNA POLARITY & TEST DISTANCE: HORIZONTAL AT 3 M							
No.	Freq. (MHz)	Reading (dBm)	S.G Power Value (dBm)	Correction Factor (dB)	EIRP (dBm)	Limit (dBm)	Margin (dB)
1	3465.00	-42.37	-27.34	-4.46	-31.80	-13.00	-18.80
2	5197.50	-61.47	-39.25	-5.53	-44.78	-13.00	-31.78
ANTENNA POLARITY & TEST DISTANCE: VERTICAL AT 3 M							
No.	Freq. (MHz)	Reading (dBm)	S.G Power Value (dBm)	Correction Factor (dB)	EIRP (dBm)	Limit (dBm)	Margin (dB)
1	3465.00	-42.00	-26.87	-4.46	-31.33	-13.00	-18.33
2	5197.50	-58.98	-38.08	-5.53	-43.61	-13.00	-30.61

REMARKS:

1. Power Value (dBm) = S.G Power Value (dBm) + Correction Factor (dB).
2. Correction Factor (dB) = Substitution Antenna Gain (dB) + Cable Loss (dB).



A D T

MODE	Channel 20325	FREQUENCY RANGE	Above 1000MHz
ENVIRONMENTAL CONDITIONS	25deg. C, 65%RH	INPUT POWER	120Vac, 60 Hz
TESTED BY	Chris Lin		

ANTENNA POLARITY & TEST DISTANCE: HORIZONTAL AT 3 M							
No.	Freq. (MHz)	Reading (dBm)	S.G Power Value (dBm)	Correction Factor (dB)	EIRP (dBm)	Limit (dBm)	Margin (dB)
1	3495.00	-42.69	-27.65	-4.48	-32.13	-13.00	-19.13
2	5242.50	-62.74	-40.34	-5.56	-45.90	-13.00	-32.90

ANTENNA POLARITY & TEST DISTANCE: VERTICAL AT 3 M							
No.	Freq. (MHz)	Reading (dBm)	S.G Power Value (dBm)	Correction Factor (dB)	EIRP (dBm)	Limit (dBm)	Margin (dB)
1	3495.00	-41.85	-26.62	-4.48	-31.10	-13.00	-18.10
2	5242.50	-60.85	-39.82	-5.56	-45.38	-13.00	-32.38

REMARKS:

1. Power Value (dBm) = S.G Power Value (dBm) + Correction Factor (dB).
2. Correction Factor (dB) = Substitution Antenna Gain (dB) + Cable Loss (dB).



A D T

CHANNEL BANDWIDTH: 20MHz / QPSK

MODE	Channel 20050	FREQUENCY RANGE	Above 1000MHz
ENVIRONMENTAL CONDITIONS	25deg. C, 65%RH	INPUT POWER	120Vac, 60 Hz
TESTED BY	Chris Lin		

ANTENNA POLARITY & TEST DISTANCE: HORIZONTAL AT 3 M							
No.	Freq. (MHz)	Reading (dBm)	S.G Power Value (dBm)	Correction Factor (dB)	EIRP (dBm)	Limit (dBm)	Margin (dB)
1	3440.00	-42.65	-27.62	-4.45	-32.07	-13.00	-19.07
2	5160.00	-60.47	-38.39	-5.51	-43.90	-13.00	-30.90
ANTENNA POLARITY & TEST DISTANCE: VERTICAL AT 3 M							
No.	Freq. (MHz)	Reading (dBm)	S.G Power Value (dBm)	Correction Factor (dB)	EIRP (dBm)	Limit (dBm)	Margin (dB)
1	3440.00	-39.74	-24.69	-4.45	-29.14	-13.00	-16.14
2	5160.00	-57.96	-37.17	-5.51	-42.68	-13.00	-29.68

REMARKS:

1. Power Value (dBm) = S.G Power Value (dBm) + Correction Factor (dB).
2. Correction Factor (dB) = Substitution Antenna Gain (dB) + Cable Loss (dB).



A D T

MODE	Channel 20175	FREQUENCY RANGE	Above 1000MHz
ENVIRONMENTAL CONDITIONS	25deg. C, 65%RH	INPUT POWER	120Vac, 60 Hz
TESTED BY	Chris Lin		

ANTENNA POLARITY & TEST DISTANCE: HORIZONTAL AT 3 M							
No.	Freq. (MHz)	Reading (dBm)	S.G Power Value (dBm)	Correction Factor (dB)	EIRP (dBm)	Limit (dBm)	Margin (dB)
1	3465.00	-42.17	-27.14	-4.46	-31.60	-13.00	-18.60
2	5197.50	-63.70	-41.48	-5.53	-47.01	-13.00	-34.01
ANTENNA POLARITY & TEST DISTANCE: VERTICAL AT 3 M							
No.	Freq. (MHz)	Reading (dBm)	S.G Power Value (dBm)	Correction Factor (dB)	EIRP (dBm)	Limit (dBm)	Margin (dB)
1	3465.00	-40.52	-25.39	-4.46	-29.85	-13.00	-16.85
2	5197.50	-62.78	-41.88	-5.53	-47.41	-13.00	-34.41

REMARKS:

1. Power Value (dBm) = S.G Power Value (dBm) + Correction Factor (dB).
2. Correction Factor (dB) = Substitution Antenna Gain (dB) + Cable Loss (dB).



A D T

MODE	Channel 20300	FREQUENCY RANGE	Above 1000MHz
ENVIRONMENTAL CONDITIONS	25deg. C, 65%RH	INPUT POWER	120Vac, 60 Hz
TESTED BY	Chris Lin		

ANTENNA POLARITY & TEST DISTANCE: HORIZONTAL AT 3 M							
No.	Freq. (MHz)	Reading (dBm)	S.G Power Value (dBm)	Correction Factor (dB)	EIRP (dBm)	Limit (dBm)	Margin (dB)
1	3490.00	-42.88	-27.84	-4.48	-32.32	-13.00	-19.32
2	5235.00	-61.74	-39.36	-5.56	-44.92	-13.00	-31.92
ANTENNA POLARITY & TEST DISTANCE: VERTICAL AT 3 M							
No.	Freq. (MHz)	Reading (dBm)	S.G Power Value (dBm)	Correction Factor (dB)	EIRP (dBm)	Limit (dBm)	Margin (dB)
1	3490.00	-39.74	-24.53	-4.48	-29.01	-13.00	-16.01
2	5235.00	-58.43	-37.42	-5.56	-42.98	-13.00	-29.98

REMARKS:

1. Power Value (dBm) = S.G Power Value (dBm) + Correction Factor (dB).
2. Correction Factor (dB) = Substitution Antenna Gain (dB) + Cable Loss (dB).



5 INFORMATION ON THE TESTING LABORATORIES

We, Bureau Veritas Consumer Products Services (H.K.) Ltd., Taoyuan Branch, were founded in 1988 to provide our best service in EMC, Radio, Telecom and Safety consultation. Our laboratories are accredited and approved according to ISO/IEC 17025.

If you have any comments, please feel free to contact us at the following:

Linko EMC/RF Lab:

Tel: 886-2-26052180

Fax: 886-2-26051924

Hsin Chu EMC/RF Lab:

Tel: 886-3-5935343

Fax: 886-3-5935342

Hwa Ya EMC/RF/Safety/Telecom Lab:

Tel: 886-3-3183232

Fax: 886-3-3270892

Email: service.adt@tw.bureauveritas.com

Web Site: www.bureauveritas-adt.com

The address and road map of all our labs can be found in our web site also.



A D T

6 APPENDIX A – MODIFICATIONS RECORDERS FOR ENGINEERING CHANGES TO THE EUT BY THE LAB

No modifications were made to the EUT by the lab during the test.

---END---