

FCC RF Test Report

APPLICANT : BandRich Inc.
EQUIPMENT : LTE FDD&TDD WLAN VoIP Home Router
BRAND NAME : BandLuxe
MODEL NAME : R565
FCC ID : UZI-565R66
STANDARD : FCC Part 15 Subpart C §15.247
CLASSIFICATION : (DTS) Digital Transmission System

The product was received on May 19, 2014 and testing was completed on Jun. 04, 2014. We, SPORTON INTERNATIONAL INC., would like to declare that the tested sample has been evaluated in accordance with the test procedures and has been in compliance with the applicable technical standards.

The test results in this report apply exclusively to the tested model / sample. Without written approval of SPORTON INTERNATIONAL INC., the test report shall not be reproduced except in full.



Reviewed by: Joseph Lin / Supervisor



Approved by: Jones Tsai / Manager



SPORTON INTERNATIONAL INC.

No. 52, Hwa Ya 1st Rd., Hwa Ya Technology Park, Kwei-Shan Hsiang, Tao Yuan Hsien, Taiwan, R.O.C.

SPORTON INTERNATIONAL INC.

TEL : 886-3-327-3456

FAX : 886-3-328-4978

FCC ID : UZI-565R66

Page Number : 1 of 81

Report Issued Date : Jun. 17, 2014

Report Version : Rev. 01



TABLE OF CONTENTS

REVISION HISTORY.....3

SUMMARY OF TEST RESULT4

1 GENERAL DESCRIPTION.....5

1.1 Applicant.....5

1.2 Manufacturer.....5

1.3 Product Feature of Equipment Under Test.....5

1.4 Product Specification subjective to this standard6

1.5 Modification of EUT6

1.6 Testing Location7

1.7 Applicable Standards.....7

2 TEST CONFIGURATION OF EQUIPMENT UNDER TEST.....8

2.1 Carrier Frequency and Channel8

2.2 Pre-Scanned RF Power.....9

2.3 Test Mode.....10

2.4 Connection Diagram of Test System.....11

2.5 Support Unit used in test configuration and system.....12

2.6 EUT Operation Test Setup12

2.7 Measurement Results Explanation Example.....12

3 TEST RESULT.....13

3.1 6dB Bandwidth Measurement13

3.2 Peak Output Power Measurement16

3.3 Power Spectral Density Measurement19

3.4 Conducted Band Edges and Spurious Emission Measurement22

3.5 Radiated Band Edges and Spurious Emission Measurement47

3.6 AC Conducted Emission Measurement.....73

3.7 Antenna Requirements.....78

4 LIST OF MEASURING EQUIPMENT80

5 UNCERTAINTY OF EVALUATION.....81

APPENDIX A. SETUP PHOTOGRAPHS

**SUMMARY OF TEST RESULT**

Report Section	FCC Rule	IC Rule	Description	Limit	Result	Remark
3.1	15.247(a)(2)	RSS-210 A8.2(a)	6dB Bandwidth	$\geq 0.5\text{MHz}$	Pass	-
3.2	15.247(b)	RSS-210 A8.4	Power Output Measurement	$\leq 30\text{dBm}$	Pass	-
3.3	15.247(e)	RSS-210 A8.2(b)	Power Spectral Density	$\leq 8\text{dBm}/3\text{kHz}$	Pass	-
3.4	15.247(d)	RSS-210 A8.5	Conducted Band Edges	$\leq 20\text{dBc}$	Pass	-
			Conducted Spurious Emission		Pass	-
3.5	15.247(d)	RSS-210 A8.5	Radiated Band Edges and Radiated Spurious Emission	15.209(a) & 15.247(d)	Pass	Under limit 0.32 dB at 2483.650 MHz
3.6	15.207	RSS-Gen 7.2.4	AC Conducted Emission	15.207(a)	Pass	Under limit 8.60 dB at 0.262 MHz
3.7	15.203 & 15.247(b)	RSS-210 A8.4	Antenna Requirement	N/A	Pass	-



1 General Description

1.1 Applicant

BandRich Inc.

6F., No. 71, Zhouzi St., Neihu Dist., Taipei City 11493, Taiwan (R.O.C.)

1.2 Manufacturer

FAIR GOAL ELECTRONIC CO.

1F., No.97-1, Haihu, Luzhu Township, Taoyuan County 338, Taiwan (R.O.C.)

1.3 Product Feature of Equipment Under Test

Product Feature	
Equipment	LTE FDD&TDD WLAN VoIP Home Router
Brand Name	BandLuxe
Model Name	R565
FCC ID	UZI-565R66
EUT supports Radios application	LTE / WLAN 11b/g/n (HT20/HT40)
HW Version	1.0
SW Version	AR_1_00000000_2_001_9961
EUT Stage	Production Unit

Remark: The above EUT's information was declared by manufacturer. Please refer to the specifications or user's manual for more detailed description.

1.4 Product Specification subjective to this standard

Product Specification subjective to this standard			
Tx/Rx Channel Frequency Range	802.11b/g/n : 2412 MHz ~ 2462 MHz		
Maximum Output Power to antenna	<Ant 1+2> 802.11b : 23.58 dBm (0.2280 W) 802.11g : 26.97 dBm (0.4977 W) 802.11n HT20 : 26.27 dBm (0.4236 W) 802.11n HT40 : 26.77 dBm (0.4753 W)		
Antenna Type	<Ant 1> 802.11b/g/n : fixed internal Antenna type with gain 3.50 dBi <Ant 2> 802.11b/g/n : fixed internal Antenna type with gain 3.00 dBi		
Type of Modulation	802.11b : DSSS (DBPSK / DQPSK / CCK) 802.11g/n : OFDM (BPSK / QPSK / 16QAM / 64QAM)		
Antenna Function for Transmitter		Chain Port 0 Ant. 1	Chain Port 1 Ant. 2
	802.11 b MIMO	V	V
	802.11 g MIMO	V	V
	802.11 n MIMO	V	V

1.5 Modification of EUT

No modifications are made to the EUT during all test items.

1.6 Testing Location

Sporton Lab is accredited to ISO 17025 by Taiwan Accreditation Foundation (TAF code : 1190) and the FCC designation No. TW1022 under the FCC 2.948(e) by Mutual Recognition Agreement (MRA) in FCC Test.

Test Site	SPORTON INTERNATIONAL INC.		
Test Site Location	No. 52, Hwa Ya 1 st Rd., Hwa Ya Technology Park, Kwei-Shan Hsiang, Tao Yuan Hsien, Taiwan, R.O.C. TEL: +886-3-327-3456 FAX: +886-3-328-4978		
Test Site No.	Sporton Site No.		
	TH02-HY	CO05-HY	03CH07-HY

1.7 Applicable Standards

According to the specifications of the manufacturer, the EUT must comply with the requirements of the following standards:

- FCC Part 15 Subpart C §15.247
- FCC KDB Publication No. 558074 D01 DTS Meas. Guidance v03r02
- FCC KDB 662911 D01 Multiple Transmitter Output v02r01.
- ANSI C63.4-2003

Remark:

1. All test items were verified and recorded according to the standards and without any deviation during the test.
2. This EUT has also been tested and complied with the requirements of FCC Part 15, Subpart B, recorded in a separate test report.



2 Test Configuration of Equipment Under Test

The EUT has been associated with peripherals and configuration operated in a manner tended to maximize its emission characteristics in a typical application. Frequency range investigated: conducted emission (150 kHz to 30 MHz) and radiated emission (9 kHz to the 10th harmonic of the highest fundamental frequency or to 40 GHz, whichever is lower).

The final configuration from all the combinations and the worst-case data rates were investigated by measuring the maximum power across all the data rates and modulation modes under section 2.2.

Based on the worst configuration found above, the RF power setting is set individually to meet FCC compliance limit for the final conducted and radiated tests shown in section 2.3.

2.1 Carrier Frequency and Channel

Frequency Band	Channel	Freq. (MHz)	Channel	Freq. (MHz)
2400-2483.5 MHz	1	2412	7	2442
	2	2417	8	2447
	3	2422	9	2452
	4	2427	10	2457
	5	2432	11	2462
	6	2437		



2.2 Pre-Scanned RF Power

Preliminary tests were performed in different data rate and data rate associated with the highest power were chosen for full test shown in the following tables.

MIMO <Ant. 1+2>

802.11b				
Data Rate (MHz)	1M bps	2M bps	5.5M bps	11M bps
Peak Power (dBm)	23.58	23.51	23.49	23.55

802.11g								
Data Rate (MHz)	6M bps	9M bps	12M bps	18M bps	24M bps	36M bps	48M bps	54M bps
Peak Power (dBm)	26.97	26.92	26.85	26.88	26.92	26.85	26.92	26.93

2.4GHz 802.11n HT20								
Data Rate (MHz)	MCS0	MCS1	MCS2	MCS3	MCS4	MCS5	MCS6	MCS7
Peak Power (dBm)	26.27	26.22	26.22	26.18	26.14	26.22	26.20	26.23

2.4GHz 802.11n HT40								
Data Rate (MHz)	MCS0	MCS1	MCS2	MCS3	MCS4	MCS5	MCS6	MCS7
Peak Power (dBm)	26.77	25.99	26.07	26.25	26.21	26.15	26.41	26.53

Note: MIMO Ant. 1+2 is a calculated result from sum of the power MIMO Ant. 1 and MIMO Ant. 2.



2.3 Test Mode

Final results of test modes, data rates and test channels are shown as following table.

<2.4GHz>

Test Cases				
	Test Items	Mode	Data Rate	Test Channel
Conducted TCs	6dB BW Power Spectral Density	802.11b	1 Mbps	1/6/11
		802.11g	6 Mbps	1/6/11
		802.11n HT20	6.5 Mbps	1/6/11
		802.11n HT40	13.5 Mbps	3/6/9
	Output Power	802.11b	1 Mbps	1/6/11
		802.11g	6 Mbps	1/6/11
		802.11n HT20	6.5 Mbps	1/6/11
		802.11n HT40	13.5 Mbps	3/6/9
	Conducted Band Edge	802.11b	1 Mbps	1/11
		802.11g	6 Mbps	1/11
		802.11n HT20	6.5 Mbps	1/11
		802.11n HT40	13.5 Mbps	3/9
	Conducted Spurious Emission	802.11b	1 Mbps	1/6/11
		802.11g	6 Mbps	1/6/11
		802.11n HT20	6.5 Mbps	1/6/11
		802.11n HT40	13.5 Mbps	3/6/9
Radiated TCs	Radiated Band Edge	802.11b	1 Mbps	1/11
		802.11g	6 Mbps	1/11
		802.11n HT20	6.5 Mbps	1/11
		802.11n HT40	13.5 Mbps	3/9
	Radiated Spurious Emission	802.11b	1 Mbps	1/6/11
		802.11g	6 Mbps	1/6/11
		802.11n HT20	6.5 Mbps	1/6/11
		802.11n HT40	13.5 Mbps	3/6/9
Test Cases				
AC Conducted Emission	Mode 1 :LTE Band 4 Idle + VOIP + WLAN Idle + LAN Link + Adapter			

2.4 Connection Diagram of Test System

<WLAN Tx Mode>

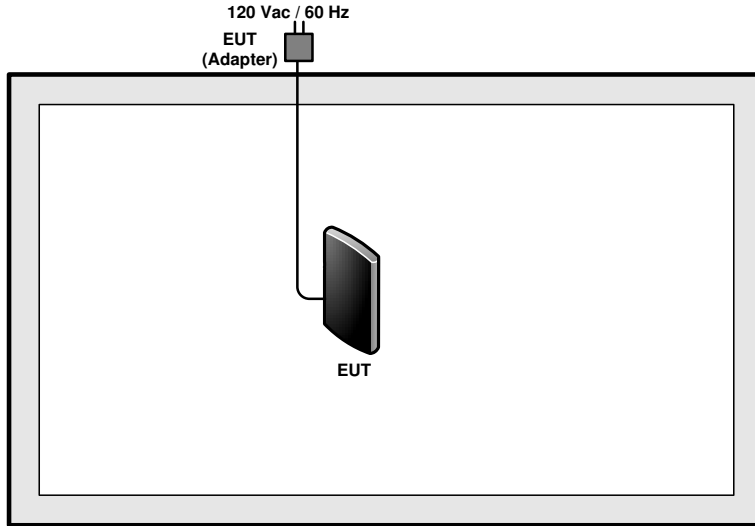

<AC Conducted Emission Mode>

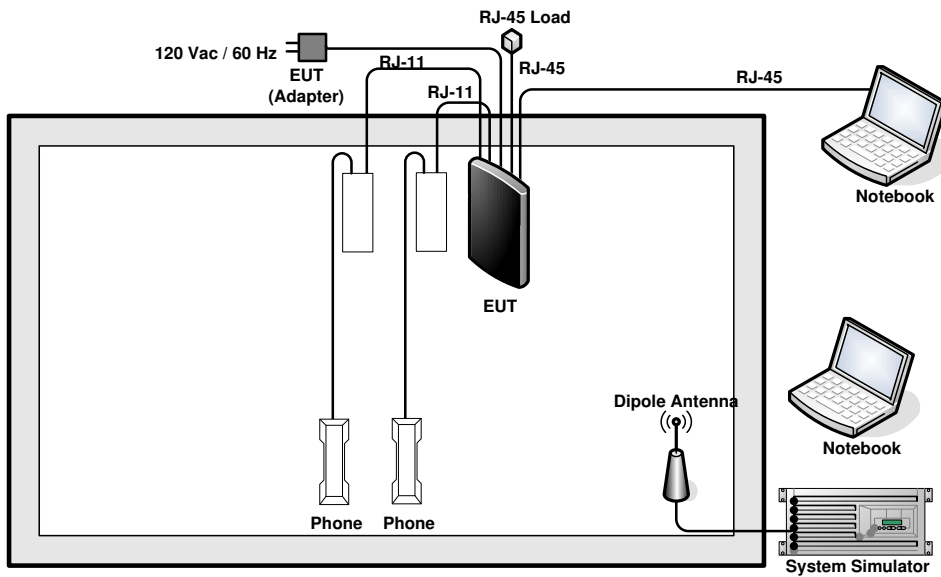

2.5 Support Unit used in test configuration and system

Item	Equipment	Trade Name	Model Name	FCC ID	Data Cable	Power Cord
1.	System Simulator	R&S	CMW 500	N/A	N/A	Unshielded, 1.8 m
2.	Phone	HTT-806	HTT-806	N/A	N/A	N/A
3.	Phone	WD-303	WD-303	N/A	N/A	N/A
4.	Notebook	DELL	Latitude E6320	FCC DoC/ Contains FCC ID: QDS-BRCM1054	N/A	AC I/P: Unshielded, 1.2 m DC O/P: Shielded, 1.8 m

2.6 EUT Operation Test Setup

For WLAN function, programmed RF utility, "artgui.exe" installed in the notebook make the EUT provides functions like channel selection and power level for continuous transmitting and receiving signals.

2.7 Measurement Results Explanation Example

For all conducted test items:

The offset level is set in the spectrum analyzer to compensate the RF cable loss and attenuator factor between EUT conducted output port and spectrum analyzer. With the offset compensation, the spectrum analyzer reading level is exactly the EUT RF output level.

Example:

The spectrum analyzer offset is derived from RF cable loss and attenuator factor.

Offset = RF cable loss + attenuator factor.

Following shows an offset computation example with cable loss 4.2 dB and 10dB attenuator.

$$\begin{aligned}
 \text{Offset(dB)} &= \text{RF cable loss(dB)} + \text{attenuator factor(dB)}. \\
 &= 4.2 + 10 = 14.2 \text{ (dB)}
 \end{aligned}$$

3 Test Result

3.1 6dB Bandwidth Measurement

3.1.1 Limit of 6dB Bandwidth

The minimum 6 dB bandwidth shall be at least 500 kHz.

3.1.2 Measuring Instruments

The measuring equipment is listed in the section 4 of this test report.

3.1.3 Test Procedures

1. The testing follows FCC KDB Publication No. 558074 DTS D01 Meas. Guidance v03r02.
2. The RF output of EUT was connected to the spectrum analyzer by RF cable and attenuator. The path loss was compensated to the results for each measurement.
3. Set to the maximum power setting and enable the EUT transmit continuously.
4. Make the measurement with the spectrum analyzer's resolution bandwidth (RBW) = 100 kHz. Set the Video bandwidth (VBW) = 300 kHz. In order to make an accurate measurement. The 6 dB bandwidth must be greater than 500 kHz.
5. Measure and record the results in the test report.

3.1.4 Test Setup

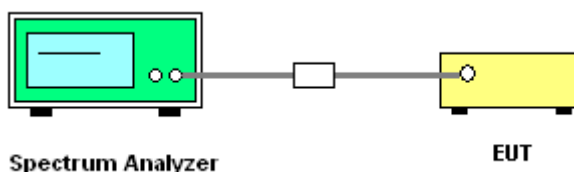



3.1.5 Test Result of 6dB Occupied Bandwidth

Test Band :	2.4GHz	Temperature :	21~26°C
Test Engineer :	Alex Lee	Relative Humidity :	45~54%

Mod.	Data Rate	N _{TX}	Channel	Freq. (MHz)	6dB Bandwidth (MHz)		6dB Bandwidth Min. Limit (MHz)	Pass/Fail
					Ant. 1	Ant. 2		
11b	1Mbps	2	1	2412	10.08	10.04	0.5	Pass
11b	1Mbps	2	6	2437	10.08	10.08	0.5	Pass
11b	1Mbps	2	11	2462	10.08	10.08	0.5	Pass
11g	6Mbps	2	1	2412	16.36	16.36	0.5	Pass
11g	6Mbps	2	6	2437	16.34	16.34	0.5	Pass
11g	6Mbps	2	11	2462	16.32	16.34	0.5	Pass
HT20	MCS0	2	1	2412	17.56	17.56	0.5	Pass
HT20	MCS0	2	6	2437	17.56	17.60	0.5	Pass
HT20	MCS0	2	11	2462	17.56	17.56	0.5	Pass
HT40	MCS0	2	3	2422	36.32	36.40	0.5	Pass
HT40	MCS0	2	6	2437	36.36	36.40	0.5	Pass
HT40	MCS0	2	9	2452	36.32	36.40	0.5	Pass

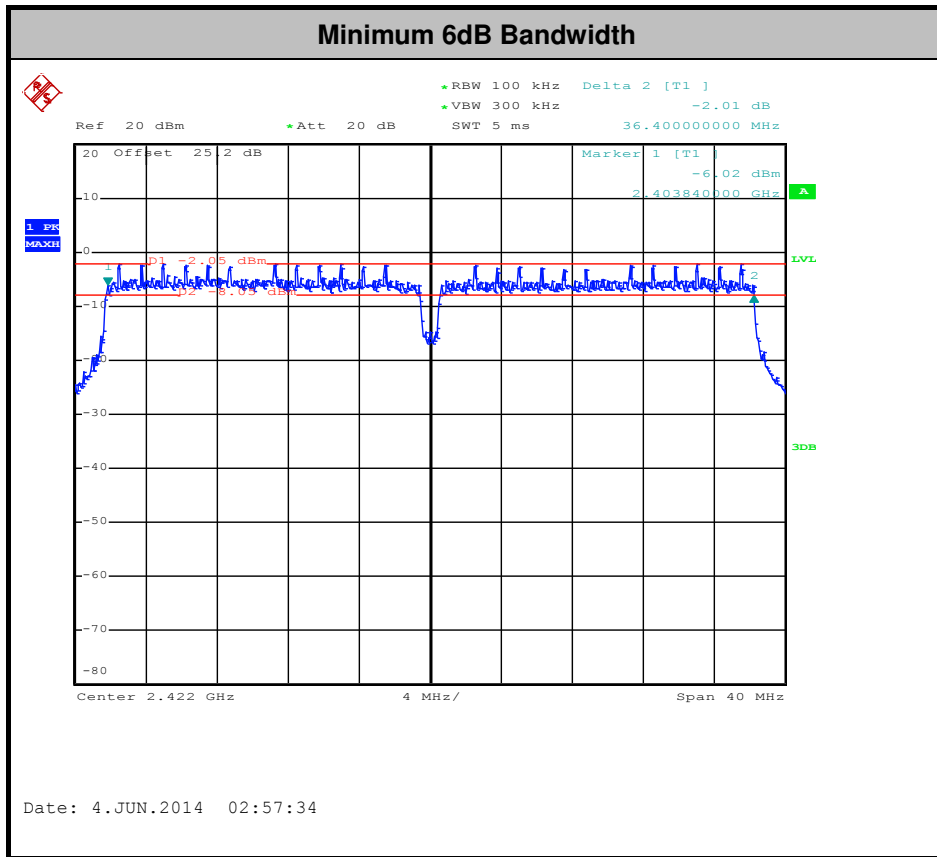

Note : The occupied channel bandwidth is maintained within the band of operation for all of the modulations.

3.2 Peak Output Power Measurement

3.2.1 Limit of Peak Output Power

For systems using digital modulation in the 2400-2483.5MHz, the limit for peak output power is 30dBm. If transmitting antenna with directional gain greater than 6dBi is used, the peak output power from the intentional radiator shall be reduced below the above stated value by the amount in dB that the directional gain of the antenna exceeds 6 dBi. In case of point-to-point operation, the limit has to be reduced by 1dB for every 3dB that the directional gain of the antenna exceeds 6dBi.

3.2.2 Measuring Instruments

The measuring equipment is listed in the section 4 of this test report.

3.2.3 Test Procedures

1. The testing follows the Measurement Procedure of FCC KDB No. 558074 DTS D01 Meas. Guidance v03r02.
2. The RF output of EUT was connected to the power meter by RF cable and attenuator. The path loss was compensated to the results for each measurement.
3. Set to the maximum power setting and enable the EUT transmit continuously.
4. Measure the conducted output power and record the results in the test report.
5. For MIMO mode, calculation method follows FCC KDB 662911 D01 Multiple Transmitter Output v02r01.

3.2.4 Test Setup

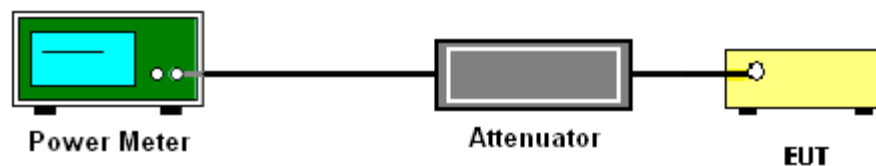



3.2.5 Test Result of Peak Output Power

Test Band :	2.4GHz	Temperature :	21~26°C
Test Engineer :	Alex Lee	Relative Humidity :	45~54%

Mod.	Data Rate	N _{TX}	CH.	Freq. (MHz)	Peak Conducted Power (dBm)			Max. Limit (dBm)		DG (dBi)		Pass/Fail
					Ant. 1	Ant. 2	SUM	Ant. 1	Ant. 2	Ant. 1	Ant. 2	
11b	1Mbps	2	1	2412	20.39	20.75	23.58	29.74	6.26	Pass		
11b	1Mbps	2	6	2437	19.43	20.57	23.05	29.74	6.26	Pass		
11b	1Mbps	2	11	2462	20.25	20.21	23.24	29.74	6.26	Pass		
11g	6Mbps	2	1	2412	23.41	23.35	26.39	29.74	6.26	Pass		
11g	6Mbps	2	6	2437	23.51	24.36	26.97	29.74	6.26	Pass		
11g	6Mbps	2	11	2462	23.47	22.93	26.22	29.74	6.26	Pass		
HT20	MCS0	2	1	2412	22.95	22.88	25.93	29.74	6.26	Pass		
HT20	MCS0	2	6	2437	22.73	23.74	26.27	29.74	6.26	Pass		
HT20	MCS0	2	11	2462	22.70	22.70	25.71	29.74	6.26	Pass		
HT40	MCS0	2	3	2422	23.41	24.05	26.75	29.74	6.26	Pass		
HT40	MCS0	2	6	2437	23.53	23.97	26.77	29.74	6.26	Pass		
HT40	MCS0	2	9	2452	22.27	22.44	25.37	29.74	6.26	Pass		

Note: Measured power (dBm) has offset with cable loss.



3.2.6 Test Result of Average output Power (Reporting Only)

Test Band :	2.4GHz	Temperature :	21~26°C
Test Engineer :	Alex Lee	Relative Humidity :	45~54%

Mod.	Data Rate	N _{TX}	Channel	Freq. (MHz)	Duty Factor (dB)		Average Conducted Power (dBm)		
					Ant. 1	Ant. 2	Ant. 1	Ant. 2	Sum Power
11b	1Mbps	2	1	2412	0.00	0.00	17.77	18.16	20.98
11b	1Mbps	2	6	2437	0.00	0.00	17.01	18.09	20.59
11b	1Mbps	2	11	2462	0.00	0.00	17.66	17.75	20.72
11g	6Mbps	2	1	2412	0.19	0.12	14.30	14.69	17.51
11g	6Mbps	2	6	2437	0.19	0.12	15.67	16.14	18.92
11g	6Mbps	2	11	2462	0.19	0.12	15.24	15.31	18.29
HT20	MCS0	2	1	2412	0.17	0.13	12.78	12.92	15.86
HT20	MCS0	2	6	2437	0.17	0.13	13.42	14.08	16.77
HT20	MCS0	2	11	2462	0.17	0.13	12.95	13.53	16.26
HT40	MCS0	2	3	2422	0.27	0.27	12.61	12.95	15.79
HT40	MCS0	2	6	2437	0.27	0.27	13.31	13.80	16.57
HT40	MCS0	2	9	2452	0.27	0.27	10.23	10.73	13.50

Note: Measured power (dBm) has offset with cable loss and duty factor.



3.3 Power Spectral Density Measurement

3.3.1 Limit of Power Spectral Density

The peak power spectral density shall not be greater than 8dBm in any 3kHz band at any time interval of continuous transmission.

3.3.2 Measuring Instruments

The measuring equipment is listed in the section 4 of this test report.

3.3.3 Test Procedures

1. The testing follows Measurement Procedure 10.2 Method PKPSD of FCC KDB Publication No. 558074 D01 DTS Meas. Guidance v03r02
2. The RF output of EUT was connected to the spectrum analyzer by RF cable and attenuator. The path loss was compensated to the results for each measurement.
3. Set to the maximum power setting and enable the EUT transmit continuously.
4. Make the measurement with the spectrum analyzer's resolution bandwidth (RBW) = 3 kHz. Video bandwidth VBW = 10 kHz In order to make an accurate measurement, set the span to 1.5 times DTS Channel Bandwidth. (6dB BW)
5. Detector = peak, Sweep time = auto couple, Trace mode = max hold, Allow trace to fully stabilize. Use the peak marker function to determine the maximum power level.
6. Measure and record the results in the test report.
7. For MIMO mode, calculation method follows FCC KDB 662911 D01 Multiple Transmitter Output v02r01.

If measurements performed using method (2) plus 10 log (N) exceeds the emission limit, the test should choose method (1) before declaring that the device fails the emission limit.

Method (1): Measure and sum the spectra across the outputs.

The total final Power Spectral Density is from a device with 2 transmitter outputs. The spectrum measurements of the individual outputs are all performed with the same span and number of points, the spectrum value in the first spectral bin of output 1 is summed with that in the first spectral bin of output 2 to obtain the value for the first frequency bin of the summed spectrum.

Method (2): Measure and add 10 log (N) dB, where N is the number of outputs. (N=2)

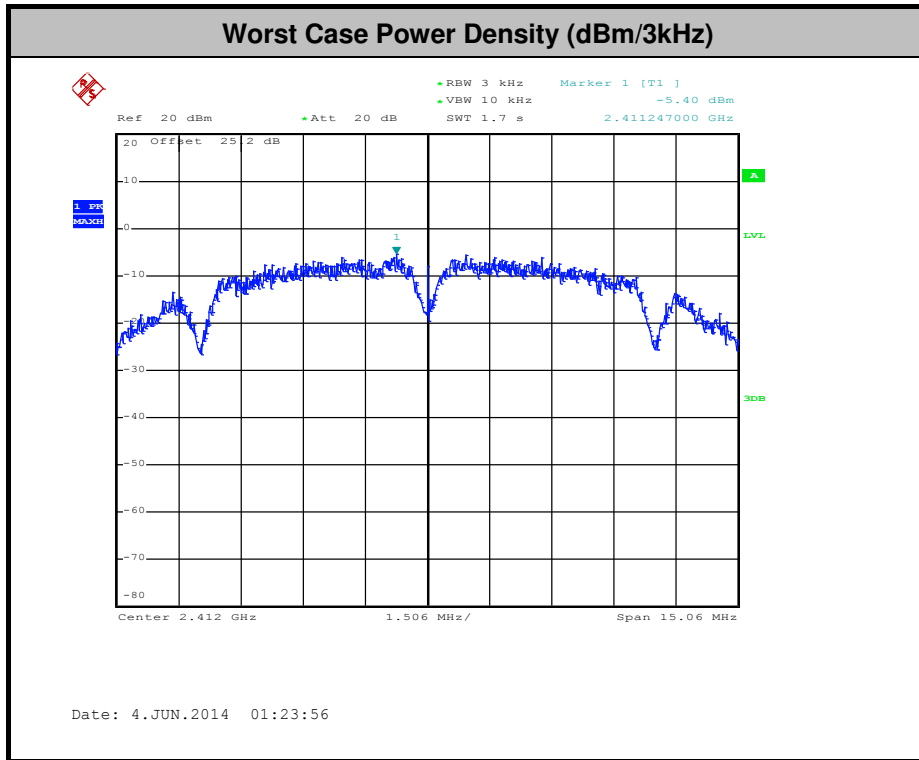

3.4 Conducted Band Edges and Spurious Emission Measurement

3.4.1 Limit of Conducted Band Edges and Spurious Emission Measurement

In any 100 kHz bandwidth outside of the authorized frequency band, the emissions which fall in the non-restricted bands shall be attenuated at least 20 dB / 30dB relative to the maximum PSD level in 100 kHz by RF conducted measurement and radiated emissions which fall in the restricted bands, as defined in Section 15.205(a), must also comply with the radiated emission limits specified in Section 15.209(a).

3.4.2 Measuring Instruments

The measuring equipment is listed in the section 4 of this test report.

3.4.3 Test Procedures

1. The testing follows FCC KDB Publication No. 558074 D01 DTS Meas. Guidance v03r02.
2. The RF output of EUT was connected to the spectrum analyzer by RF cable and attenuator. The path loss was compensated to the results for each measurement.
3. Set to the maximum power setting and enable the EUT transmit continuously.
4. Set RBW = 100 kHz, VBW=300 kHz, Peak Detector. Unwanted Emissions measured in any 100 kHz bandwidth outside of the authorized frequency band shall be attenuated by at least 20 dB relative to the maximum in-band peak PSD level in 100 kHz when maximum peak conducted output power procedure is used. If the transmitter complies with the conducted power limits based on the use of RMS averaging over a time interval, the attenuation required under this paragraph shall be 30 dB instead of 20 dB per 15.247(d).
5. Measure and record the results in the test report.
6. The RF fundamental frequency should be excluded against the limit line in the operating frequency band.

3.4.4 Test Setup

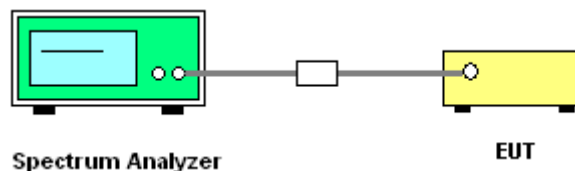



3.4.5 Test Result of Conducted Band Edges and Spurious Emission

Number of TX = 2, Ant. 1 (Measured)

Number of TX :	2	Ant. :	1
Test Mode :	802.11b	Temperature :	21~26°C
Test Band :	2.4GHz Low	Relative Humidity :	45~54%
Test Channel :	01	Test Engineer :	Alex Lee

WLAN 802.11b Channel 01

100kHz PSD reference Level

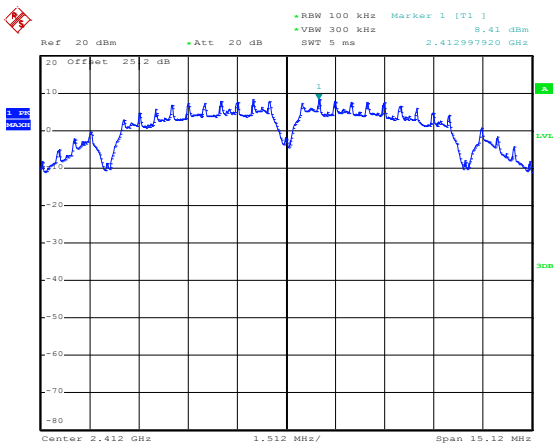

Date: 4.JUN.2014 01:19:42

Low Channel Plot

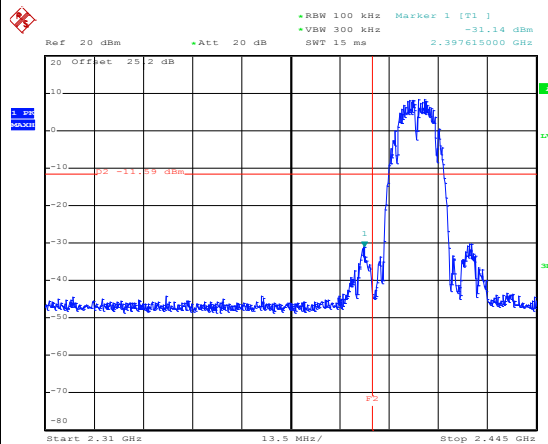

Date: 4.JUN.2014 01:19:56

Spurious Emission 30MHz~3GHz

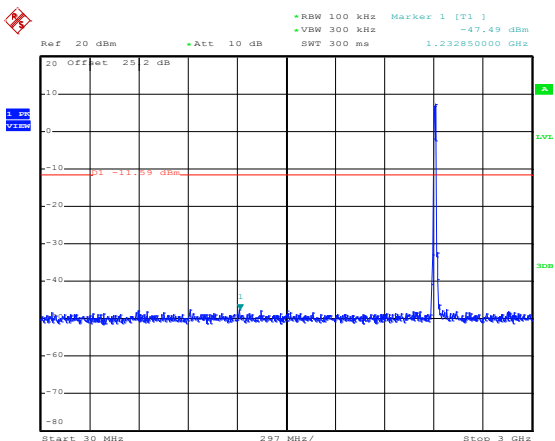

Date: 4.JUN.2014 01:21:19

Spurious Emission 2GHz~25GHz

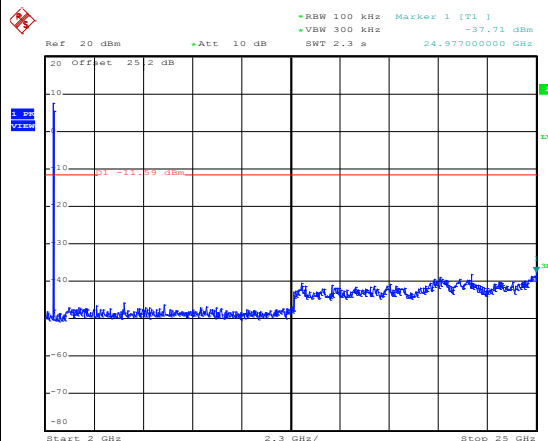

Date: 4.JUN.2014 01:21:38



Number of TX :	2	Ant. :	1
Test Mode :	802.11b	Temperature :	21~26°C
Test Band :	2.4GHz Mid	Relative Humidity :	45~54%
Test Channel :	06	Test Engineer :	Alex Lee

WLAN 802.11b Channel 06

100kHz PSD reference Level

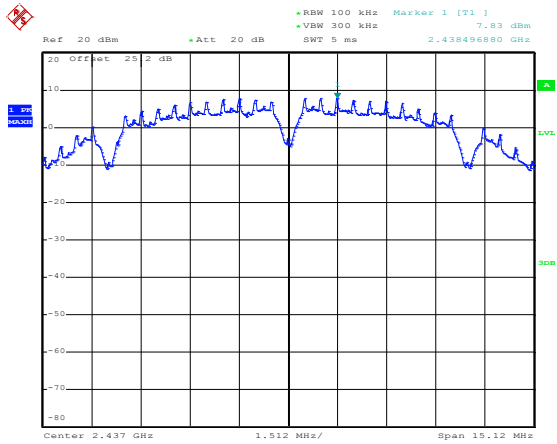

Date: 4.JUN.2014 01:51:14

Spurious Emission 30MHz~3GHz

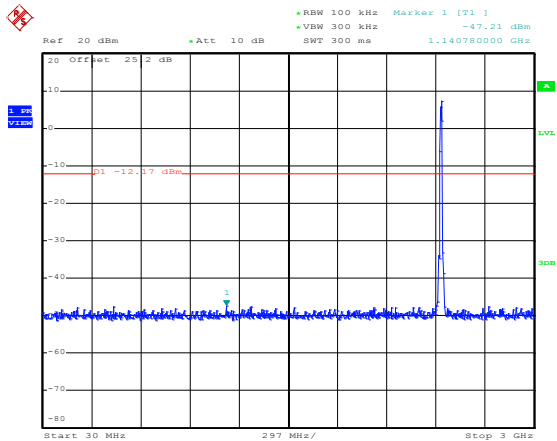

Date: 4.JUN.2014 01:54:44

Spurious Emission 2GHz~25GHz

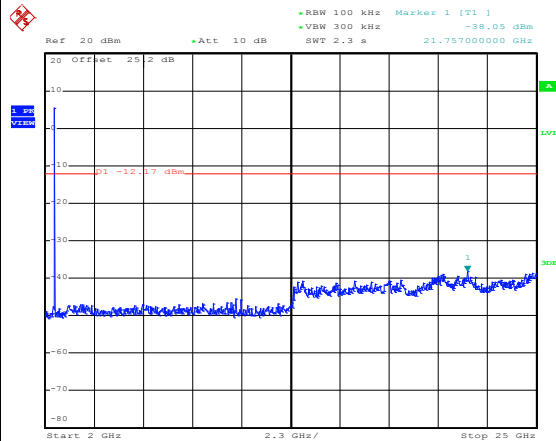

Date: 4.JUN.2014 01:55:02



Number of TX :	2	Ant. :	1
Test Mode :	802.11b	Temperature :	21~26°C
Test Band :	2.4GHz High	Relative Humidity :	45~54%
Test Channel :	11	Test Engineer :	Alex Lee

WLAN 802.11b Channel 11

100kHz PSD reference Level

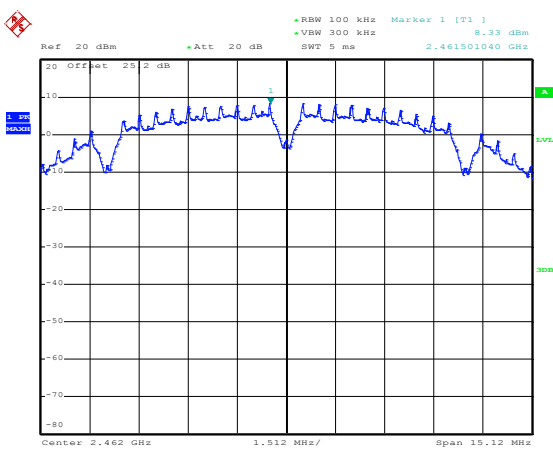

Date: 4.JUN.2014 01:57:30

High Channel Plot

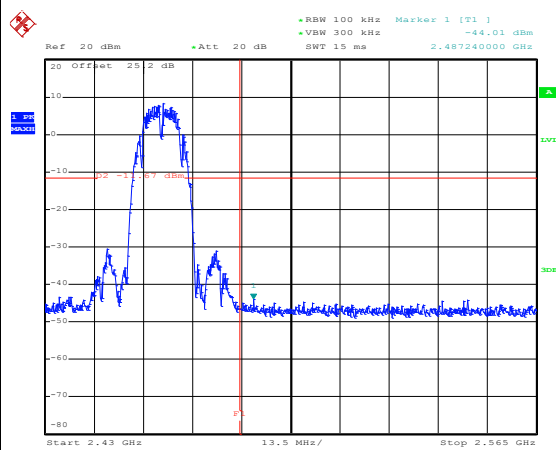

Date: 4.JUN.2014 01:57:44

Spurious Emission 30MHz~3GHz

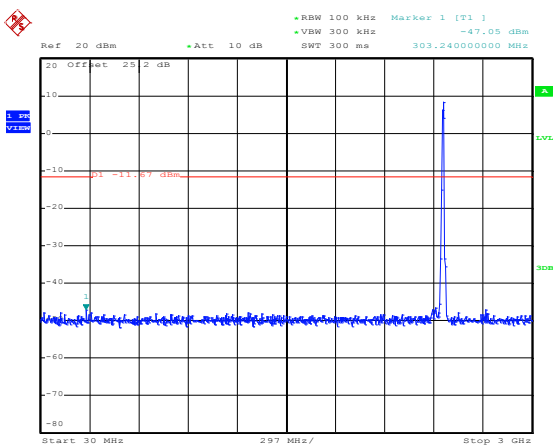

Date: 4.JUN.2014 01:59:34

Spurious Emission 2GHz~25GHz

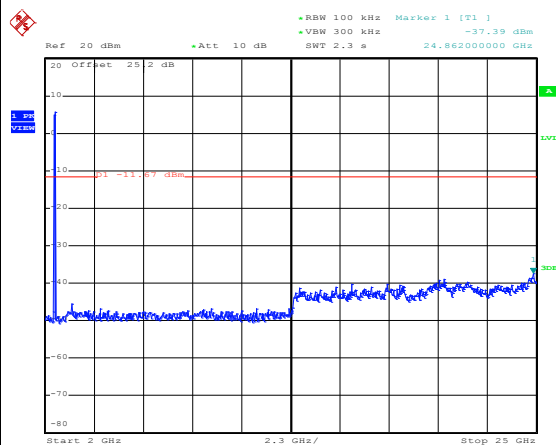

Date: 4.JUN.2014 01:59:52



Number of TX :	2	Ant. :	1
Test Mode :	802.11g	Temperature :	21~26°C
Test Band :	2.4GHz Low	Relative Humidity :	45~54%
Test Channel :	01	Test Engineer :	Alex Lee

WLAN 802.11g Channel 01

100kHz PSD reference Level

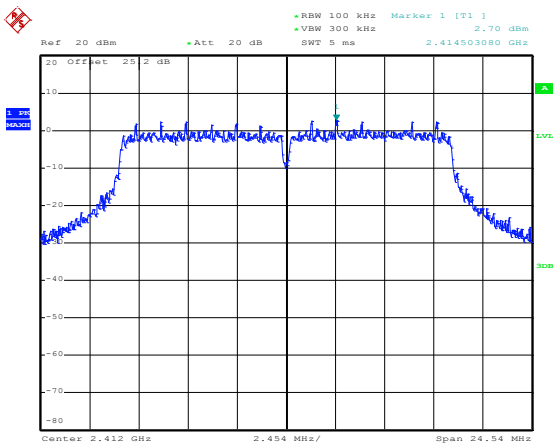

Date: 4.JUN.2014 02:13:53

Low Channel Plot

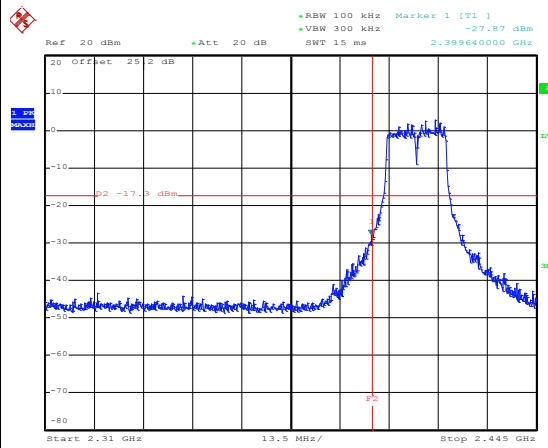

Date: 4.JUN.2014 02:14:06

Spurious Emission 30MHz~3GHz

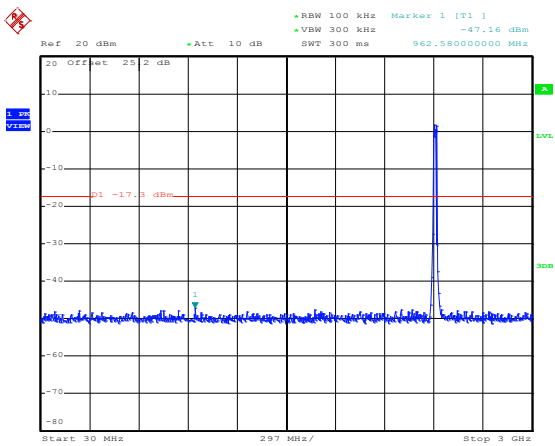

Date: 4.JUN.2014 02:14:26

Spurious Emission 2GHz~25GHz

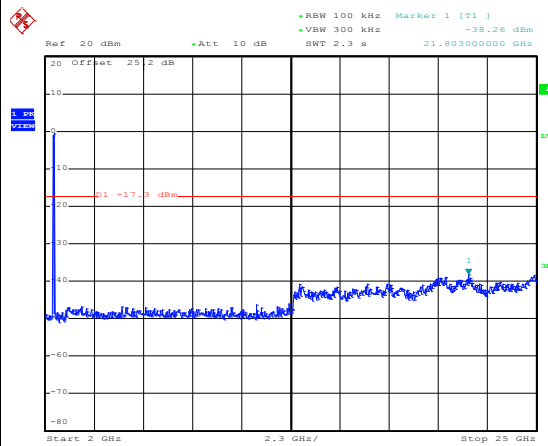

Date: 4.JUN.2014 02:14:44



Number of TX :	2	Ant. :	1
Test Mode :	802.11g	Temperature :	21~26°C
Test Band :	2.4GHz Mid	Relative Humidity :	45~54%
Test Channel :	06	Test Engineer :	Alex Lee

WLAN 802.11g Channel 06

100kHz PSD reference Level

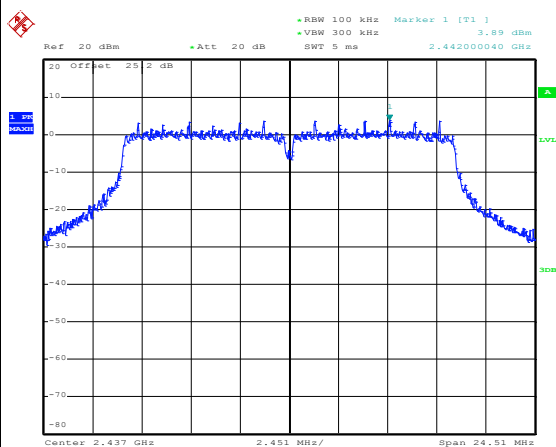

Date: 4.JUN.2014 02:21:51

Spurious Emission 30MHz~3GHz

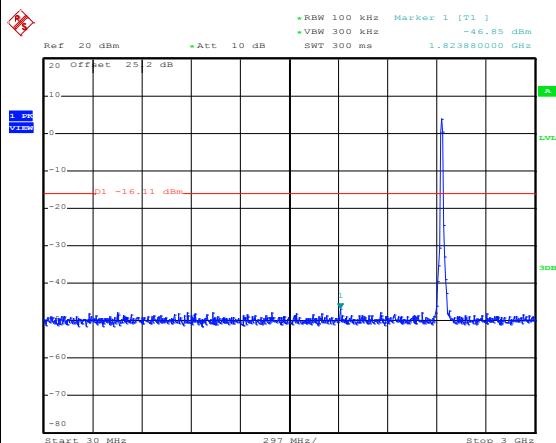

Date: 4.JUN.2014 02:22:11

Spurious Emission 2GHz~25GHz

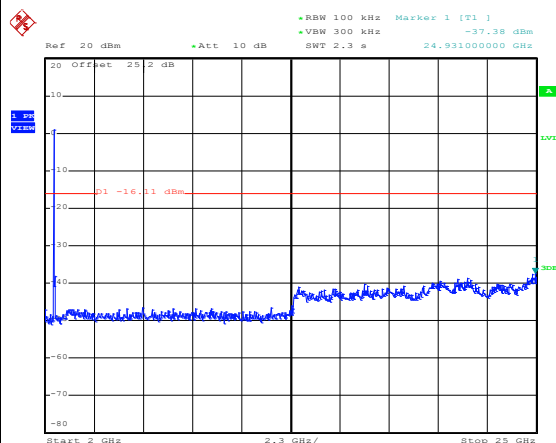

Date: 4.JUN.2014 02:22:30



Number of TX :	2	Ant. :	1
Test Mode :	802.11g	Temperature :	21~26°C
Test Band :	2.4GHz High	Relative Humidity :	45~54%
Test Channel :	11	Test Engineer :	Alex Lee

WLAN 802.11g Channel 11

100kHz PSD reference Level

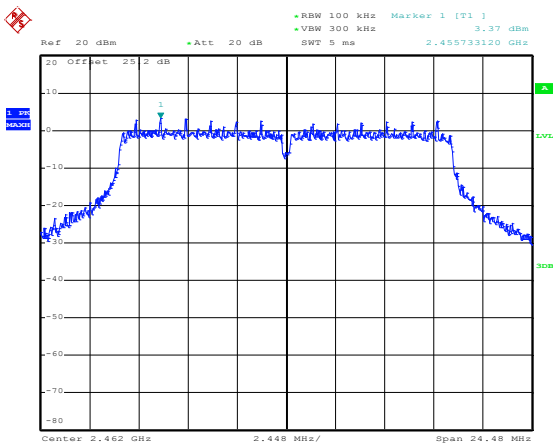

Date: 4.JUN.2014 02:24:42

High Channel Plot

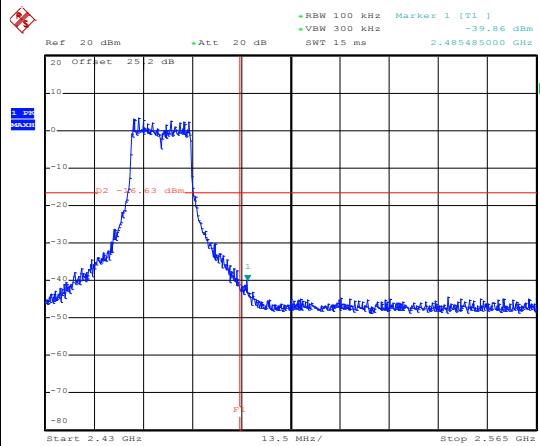

Date: 4.JUN.2014 02:24:56

Spurious Emission 30MHz~3GHz

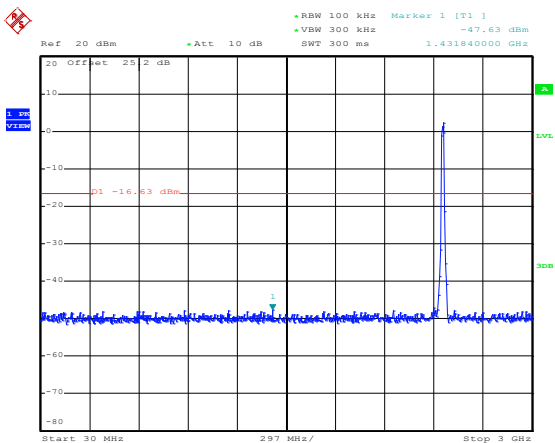

Date: 4.JUN.2014 02:26:17

Spurious Emission 2GHz~25GHz

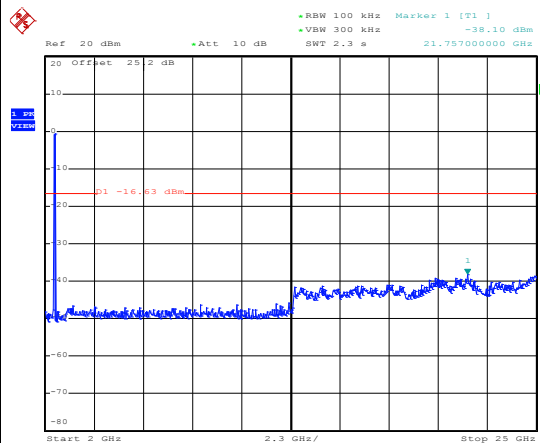

Date: 4.JUN.2014 02:26:35



Number of TX :	2	Ant. :	1
Test Mode :	802.11n HT20	Temperature :	21~26°C
Test Band :	2.4GHz Low	Relative Humidity :	45~54%
Test Channel :	01	Test Engineer :	Alex Lee

WLAN 802.11n HT20 Channel 01

100kHz PSD reference Level

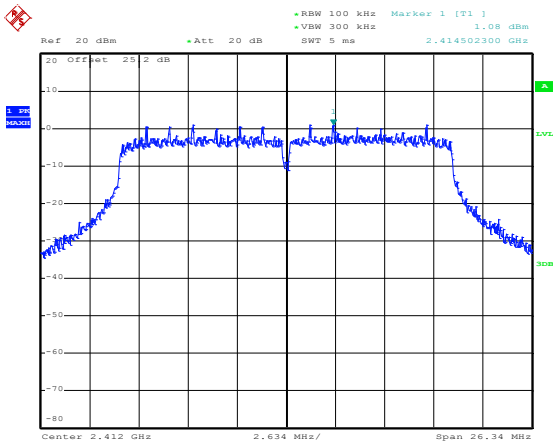

Date: 4.JUN.2014 02:31:33

Low Channel Plot

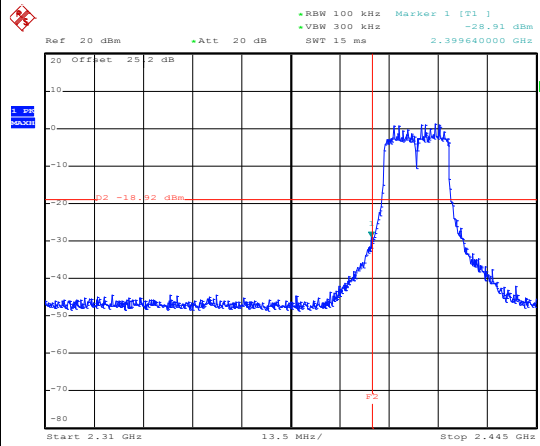

Date: 4.JUN.2014 02:32:50

Spurious Emission 30MHz~3GHz

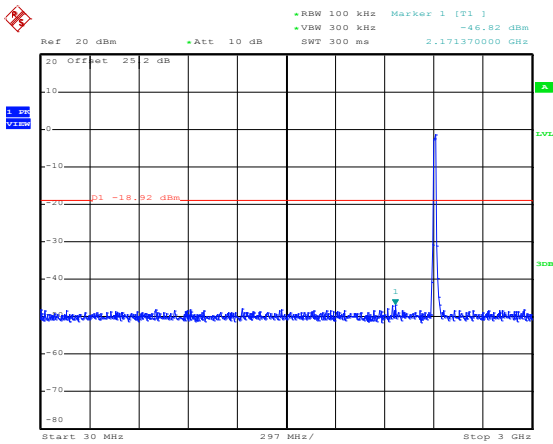

Date: 4.JUN.2014 02:33:47

Spurious Emission 2GHz~25GHz

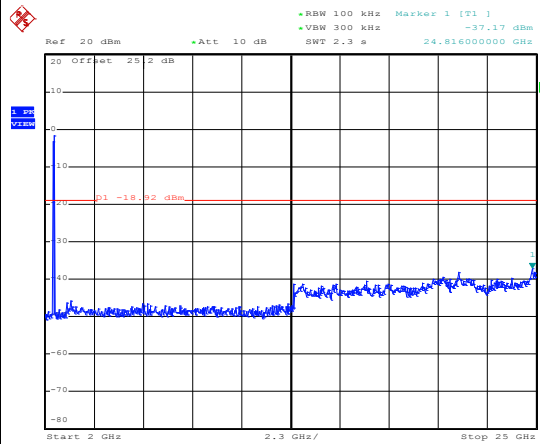

Date: 4.JUN.2014 02:34:06



Number of TX :	2	Ant. :	1
Test Mode :	802.11n HT20	Temperature :	21~26°C
Test Band :	2.4GHz Mid	Relative Humidity :	45~54%
Test Channel :	06	Test Engineer :	Alex Lee

WLAN 802.11n HT20 Channel 06

100kHz PSD reference Level

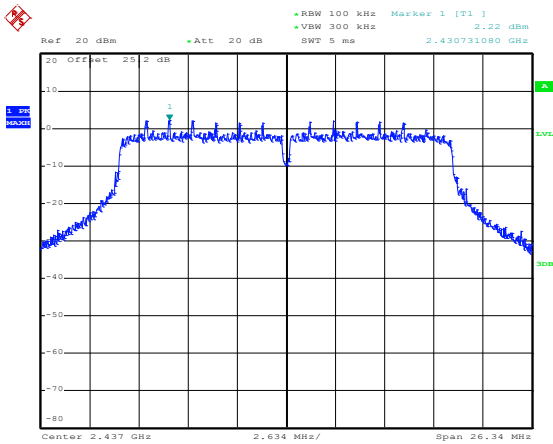

Date: 4.JUN.2014 02:42:51

Spurious Emission 30MHz~3GHz

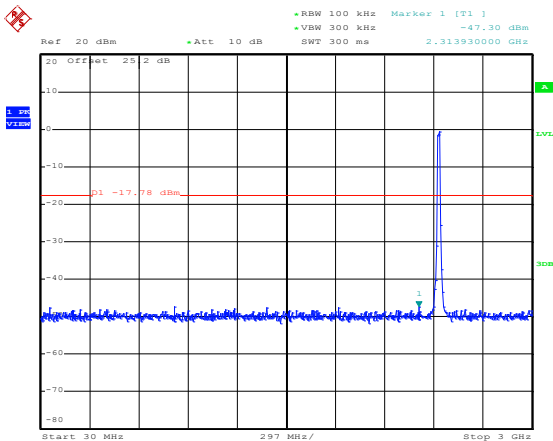

Date: 4.JUN.2014 02:43:11

Spurious Emission 2GHz~25GHz

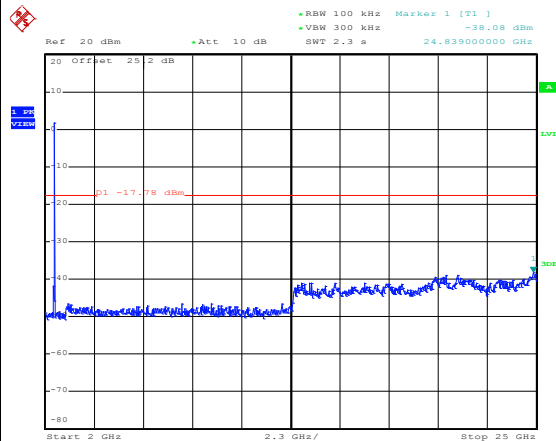

Date: 4.JUN.2014 02:43:30



Number of TX :	2	Ant. :	1
Test Mode :	802.11n HT20	Temperature :	21~26°C
Test Band :	2.4GHz High	Relative Humidity :	45~54%
Test Channel :	11	Test Engineer :	Alex Lee

WLAN 802.11n HT20 Channel 11

100kHz PSD reference Level

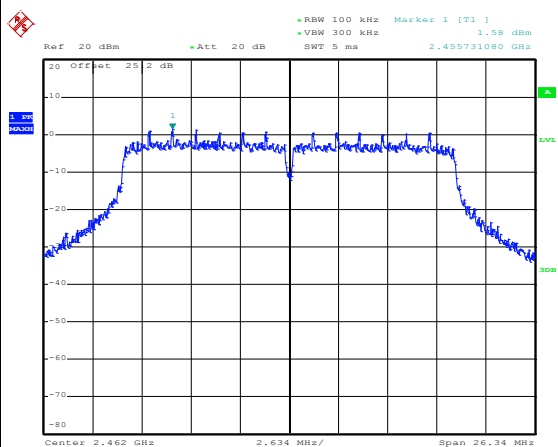

Date: 4.JUN.2014 02:45:47

High Channel Plot

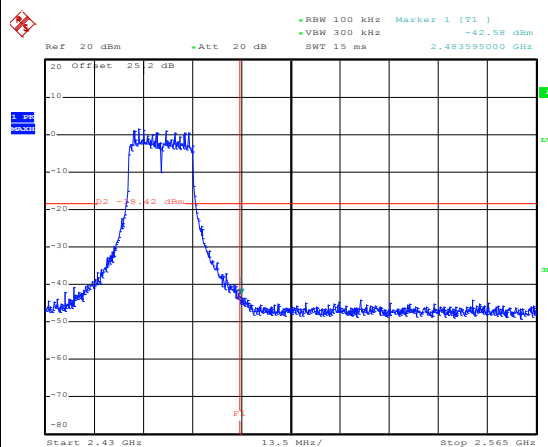

Date: 4.JUN.2014 02:48:00

Spurious Emission 30MHz~3GHz

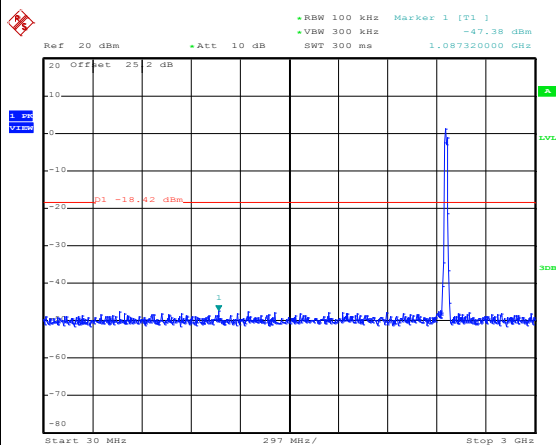

Date: 4.JUN.2014 02:47:26

Spurious Emission 2GHz~25GHz

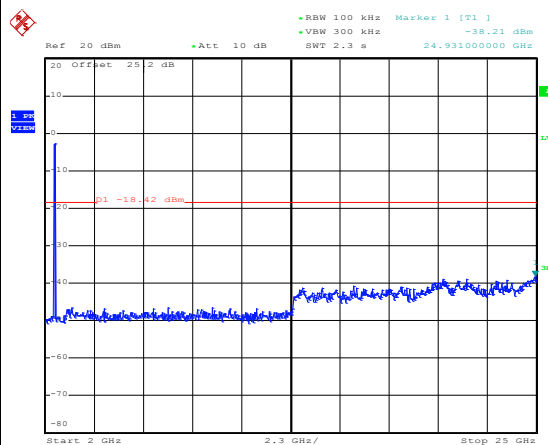

Date: 4.JUN.2014 02:47:44



Number of TX :	2	Ant. :	1
Test Mode :	802.11n HT40	Temperature :	21~26°C
Test Band :	2.4GHz Low	Relative Humidity :	45~54%
Test Channel :	03	Test Engineer :	Alex Lee

WLAN 802.11n HT40 Channel 03

100kHz PSD reference Level

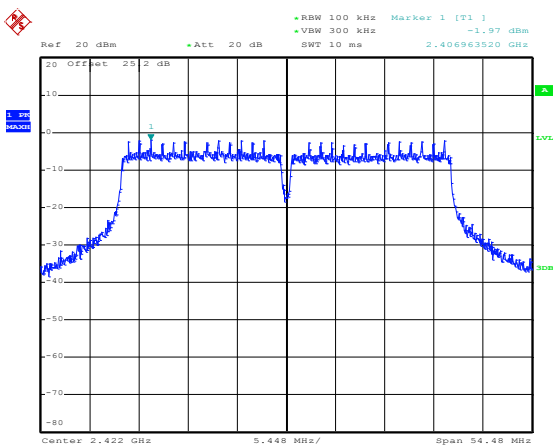

Date: 4.JUN.2014 02:54:01

Low Channel Plot

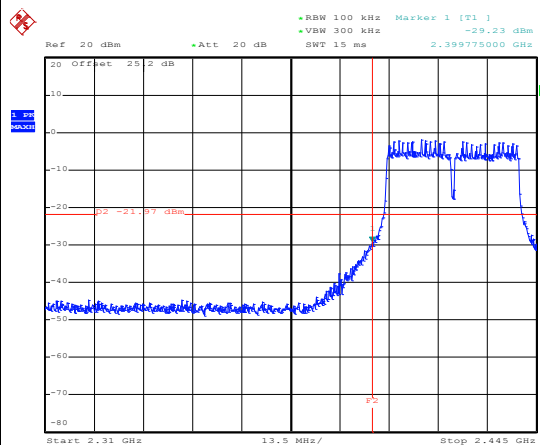

Date: 4.JUN.2014 02:54:15

Spurious Emission 30MHz~3GHz

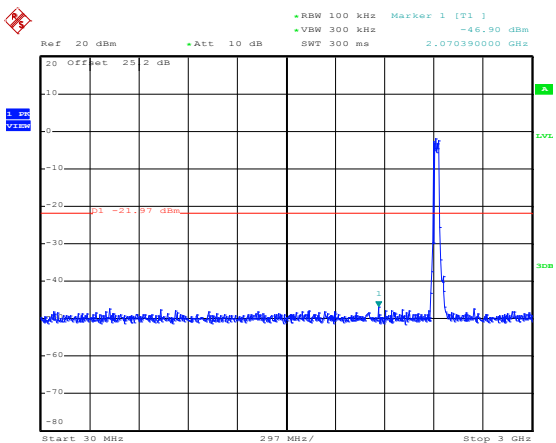

Date: 4.JUN.2014 02:56:17

Spurious Emission 2GHz~25GHz

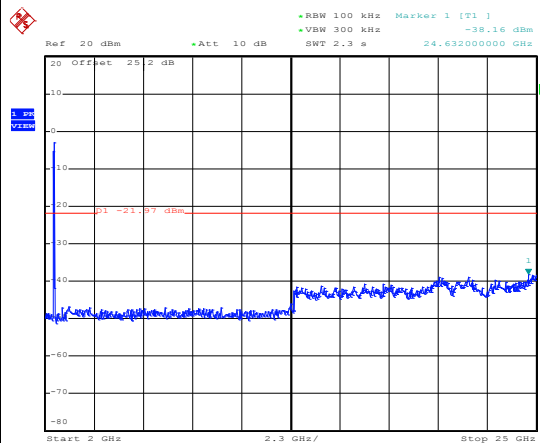

Date: 4.JUN.2014 02:55:42



Number of TX :	2	Ant. :	1
Test Mode :	802.11n HT40	Temperature :	21~26°C
Test Band :	2.4GHz Mid	Relative Humidity :	45~54%
Test Channel :	06	Test Engineer :	Alex Lee

WLAN 802.11n HT40 Channel 06

100kHz PSD reference Level

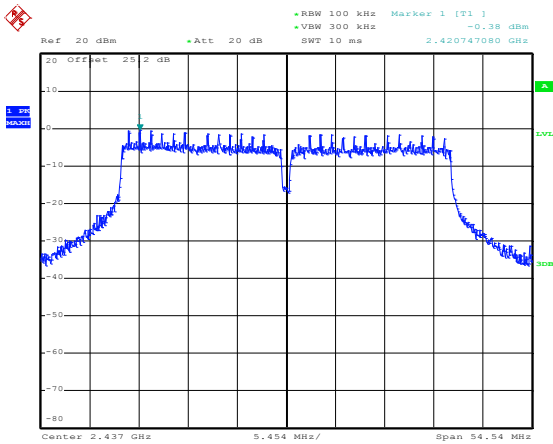

Date: 4.JUN.2014 03:06:46

Spurious Emission 30MHz~3GHz

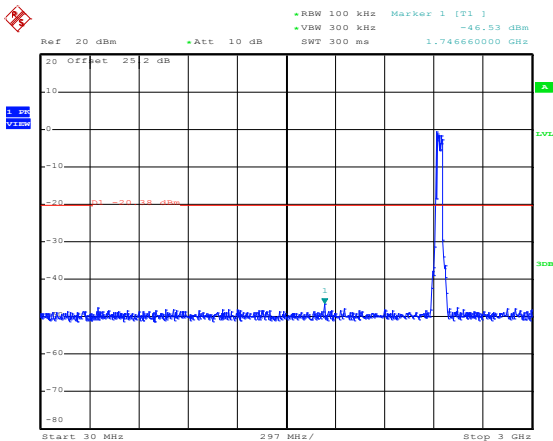

Date: 4.JUN.2014 03:08:48

Spurious Emission 2GHz~25GHz

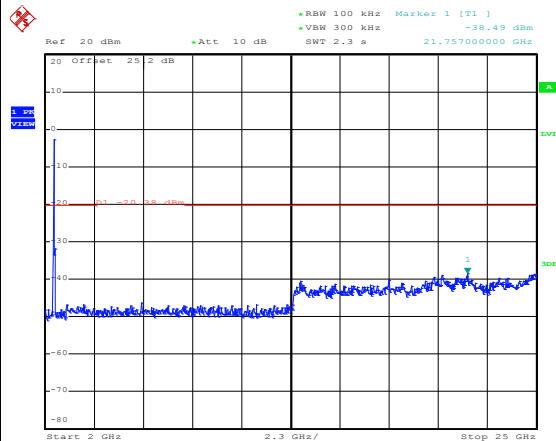

Date: 4.JUN.2014 03:08:14



Number of TX :	2	Ant. :	1
Test Mode :	802.11n HT40	Temperature :	21~26°C
Test Band :	2.4GHz High	Relative Humidity :	45~54%
Test Channel :	09	Test Engineer :	Alex Lee

WLAN 802.11n HT40 Channel 09

100kHz PSD reference Level

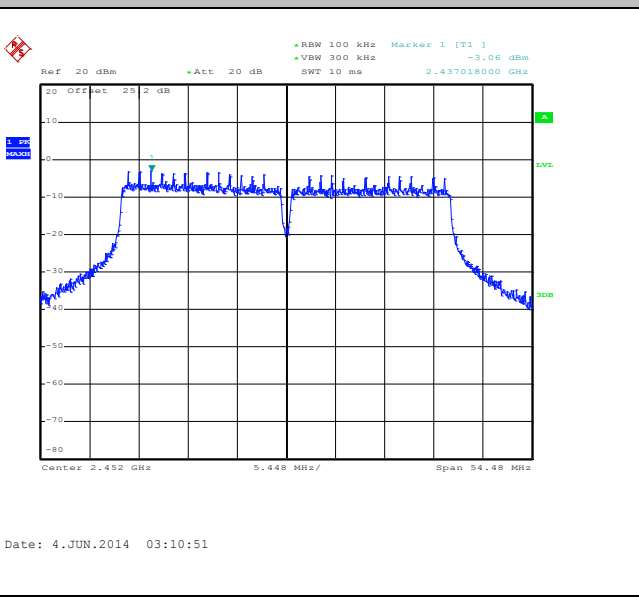

High Channel Plot

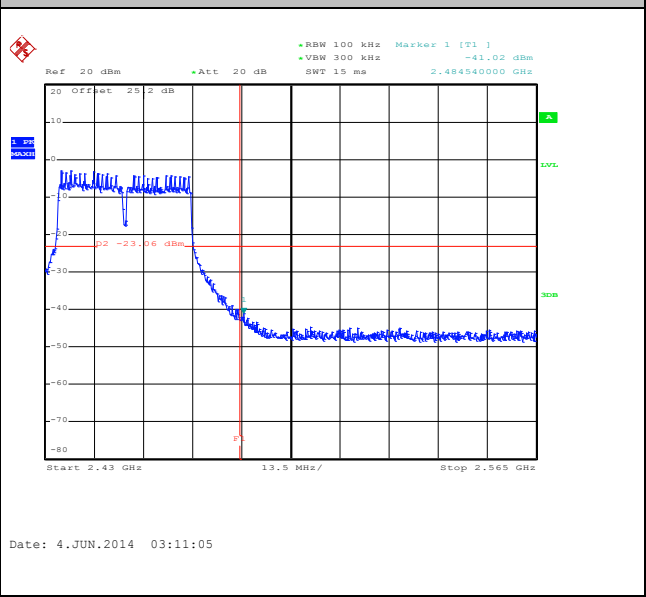

Spurious Emission 30MHz~3GHz

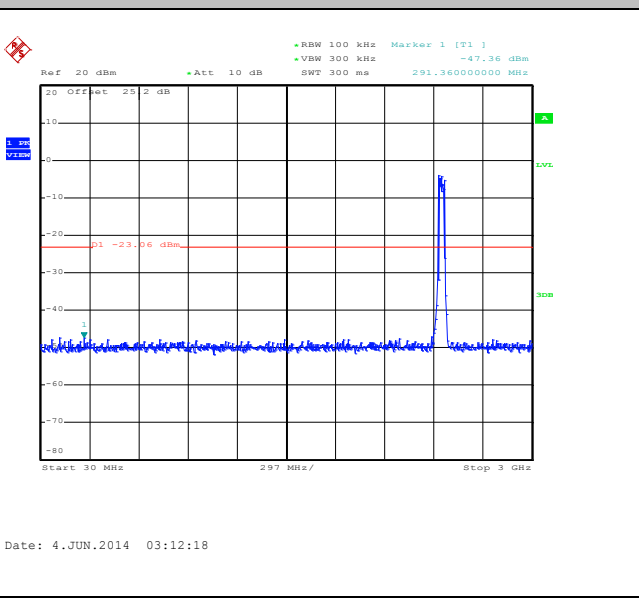

Spurious Emission 2GHz~25GHz

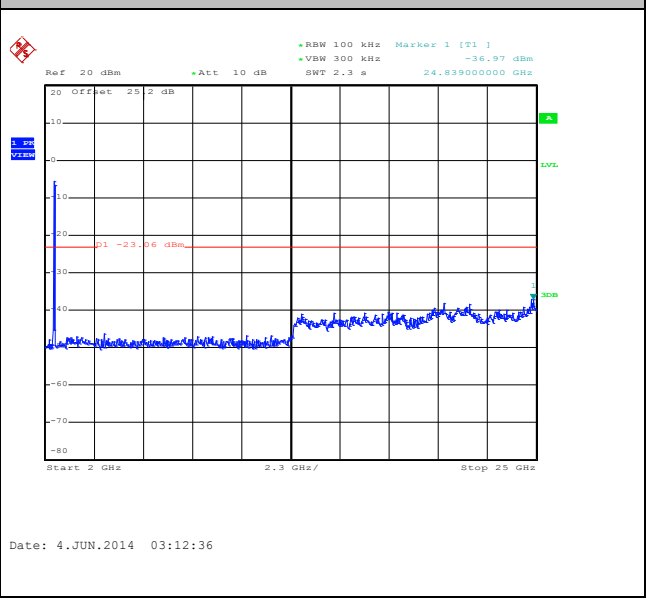



Number of TX = 2, Ant. 2 (Measured)

Number of TX :	2	Ant. :	2
Test Mode :	802.11b	Temperature :	21~26°C
Test Band :	2.4GHz Low	Relative Humidity :	45~54%
Test Channel :	01	Test Engineer :	Alex Lee

WLAN 802.11b Channel 01

100kHz PSD reference Level

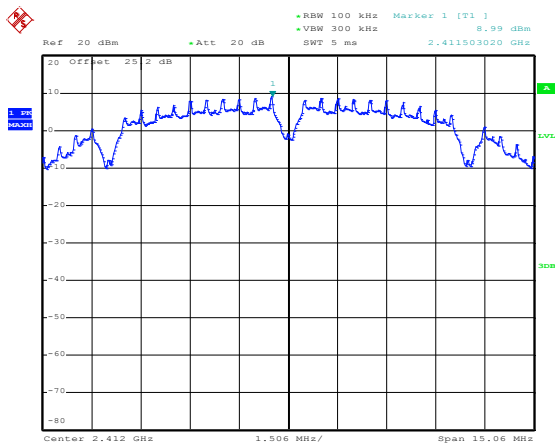

Date: 4.JUN.2014 01:24:05

Low Channel Plot

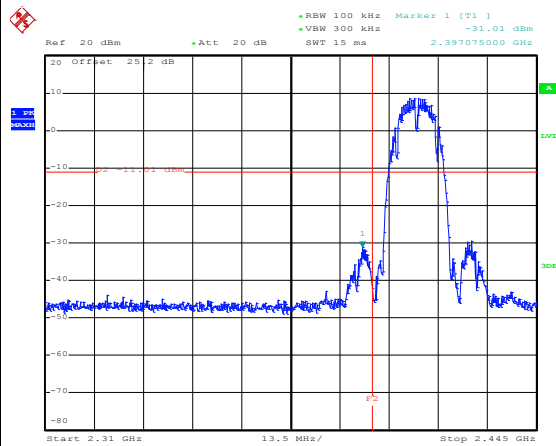

Date: 4.JUN.2014 01:24:18

Spurious Emission 30MHz~3GHz

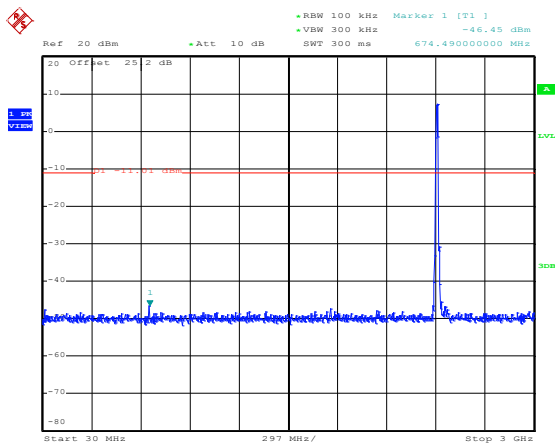

Date: 4.JUN.2014 01:25:30

Spurious Emission 2GHz~25GHz

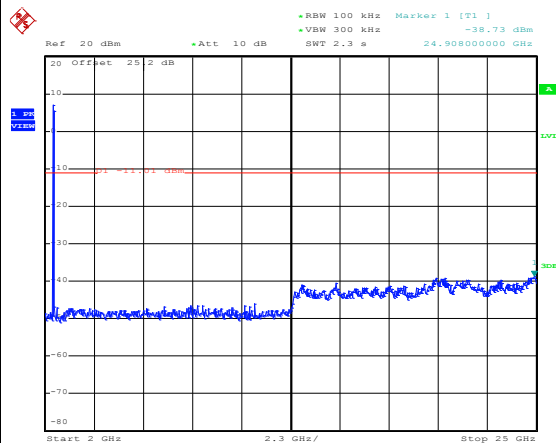

Date: 4.JUN.2014 01:25:49



Number of TX :	2	Ant. :	2
Test Mode :	802.11b	Temperature :	21~26°C
Test Band :	2.4GHz Mid	Relative Humidity :	45~54%
Test Channel :	06	Test Engineer :	Alex Lee

WLAN 802.11b Channel 06

100kHz PSD reference Level

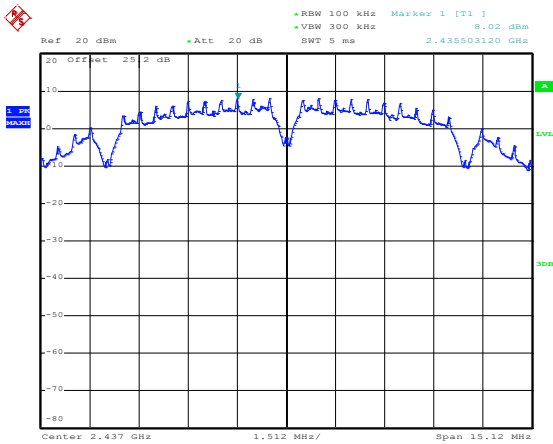

Date: 4.JUN.2014 01:46:06

Spurious Emission 30MHz~3GHz

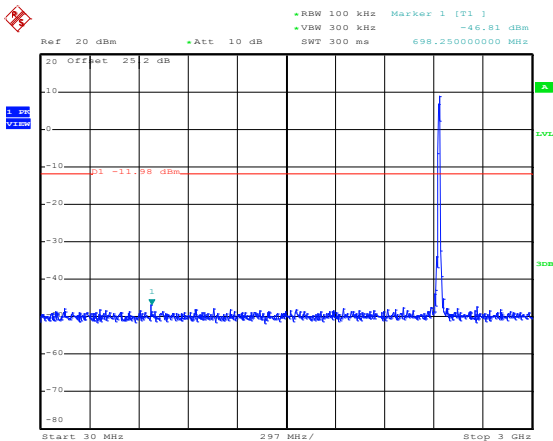

Date: 4.JUN.2014 01:49:31

Spurious Emission 2GHz~25GHz

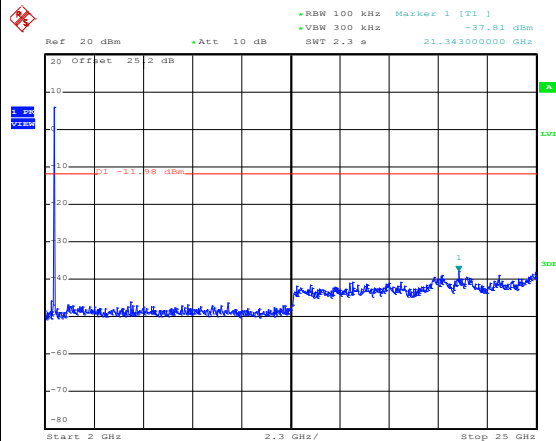

Date: 4.JUN.2014 01:49:50



Number of TX :	2	Ant. :	2
Test Mode :	802.11b	Temperature :	21~26°C
Test Band :	2.4GHz High	Relative Humidity :	45~54%
Test Channel :	11	Test Engineer :	Alex Lee

WLAN 802.11b Channel 11

100kHz PSD reference Level

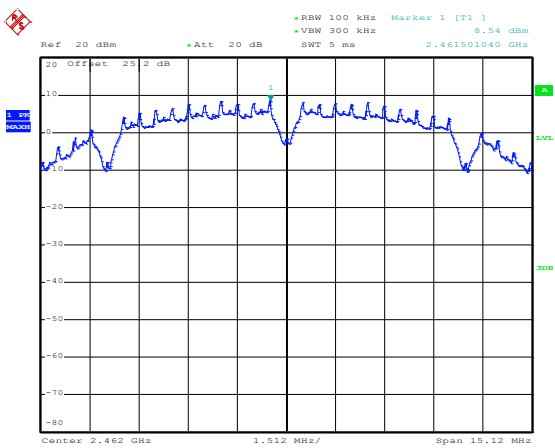

Date: 4.JUN.2014 02:01:53

High Channel Plot

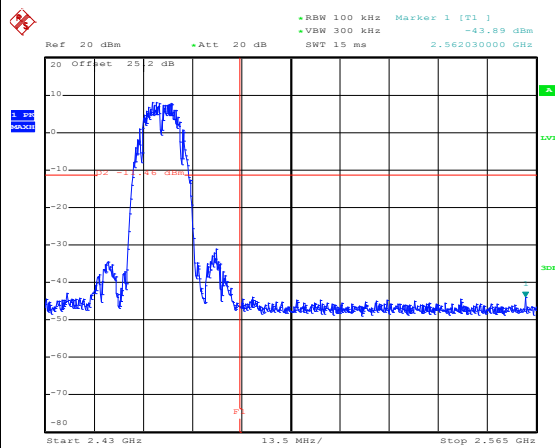

Date: 4.JUN.2014 02:02:07

Spurious Emission 30MHz~3GHz

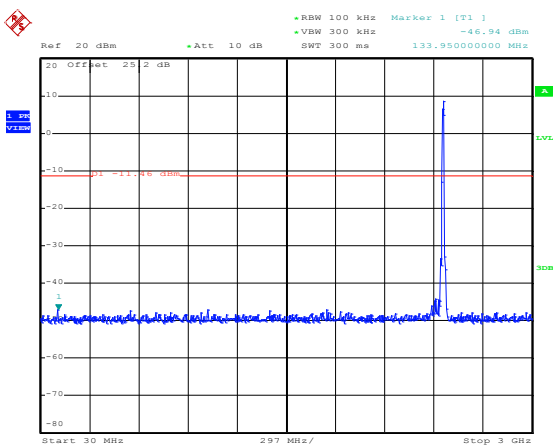

Date: 4.JUN.2014 02:08:46

Spurious Emission 2GHz~25GHz

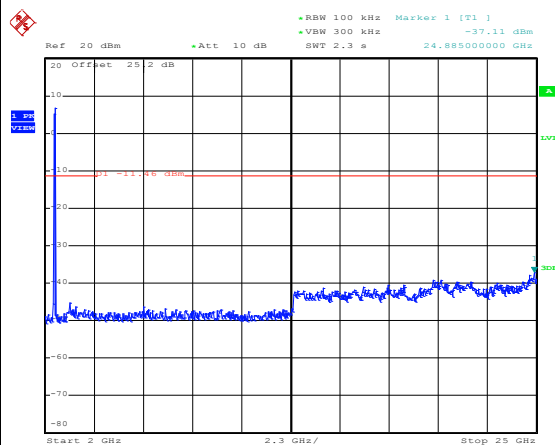

Date: 4.JUN.2014 02:07:53



Number of TX :	2	Ant. :	2
Test Mode :	802.11g	Temperature :	21~26°C
Test Band :	2.4GHz Low	Relative Humidity :	45~54%
Test Channel :	01	Test Engineer :	Alex Lee

WLAN 802.11g Channel 01

100kHz PSD reference Level

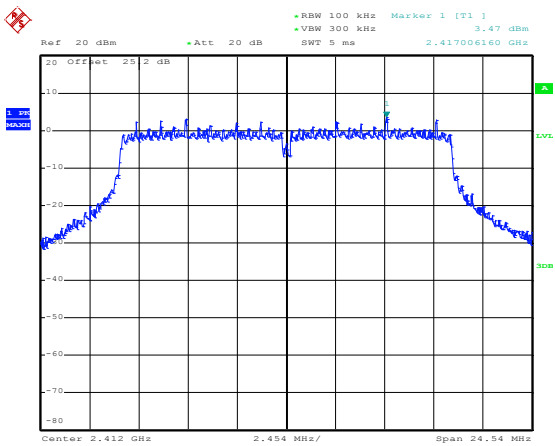

Low Channel Plot

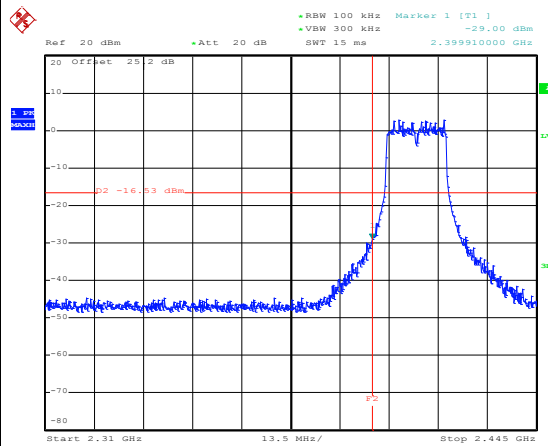

Spurious Emission 30MHz~3GHz

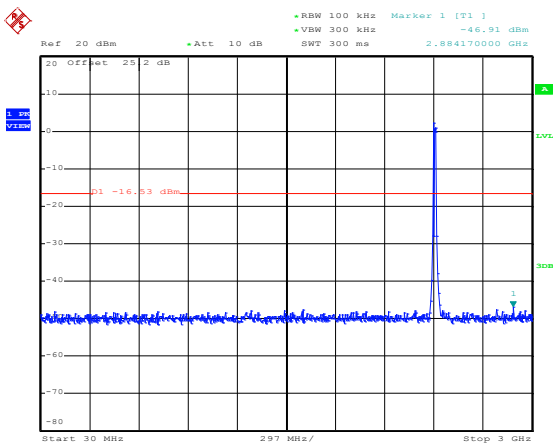

Spurious Emission 2GHz~25GHz

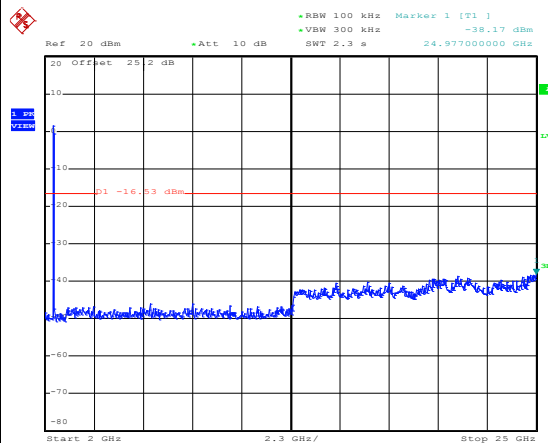



Number of TX :	2	Ant. :	2
Test Mode :	802.11g	Temperature :	21~26°C
Test Band :	2.4GHz Mid	Relative Humidity :	45~54%
Test Channel :	06	Test Engineer :	Alex Lee

WLAN 802.11g Channel 06

100kHz PSD reference Level

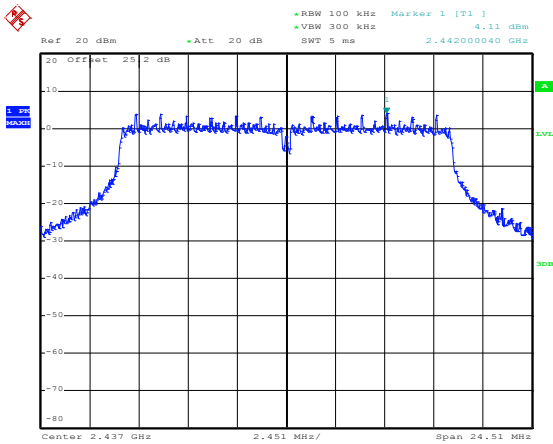

Date: 4.JUN.2014 02:19:25

Spurious Emission 30MHz~3GHz

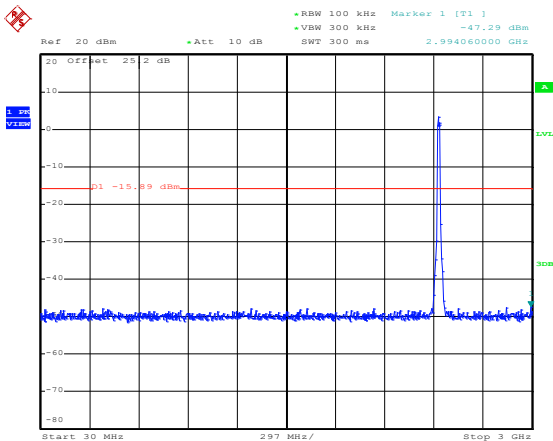

Date: 4.JUN.2014 02:19:45

Spurious Emission 2GHz~25GHz

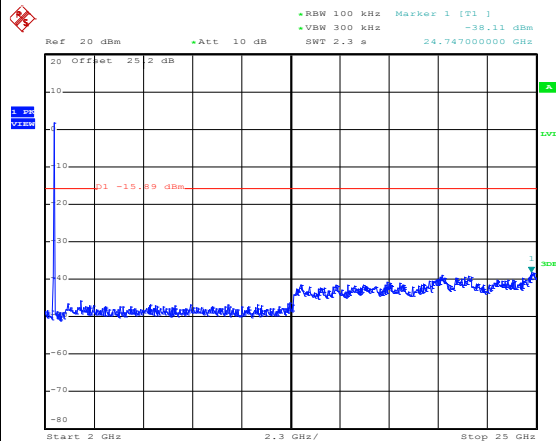

Date: 4.JUN.2014 02:20:03



Number of TX :	2	Ant. :	2
Test Mode :	802.11g	Temperature :	21~26°C
Test Band :	2.4GHz High	Relative Humidity :	45~54%
Test Channel :	11	Test Engineer :	Alex Lee

WLAN 802.11g Channel 11

100kHz PSD reference Level

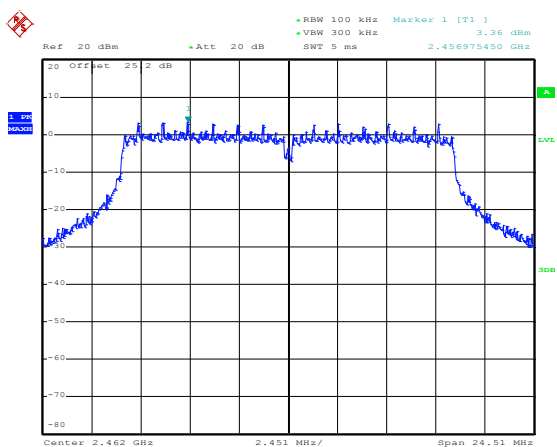

Date: 4.JUN.2014 02:28:05

High Channel Plot

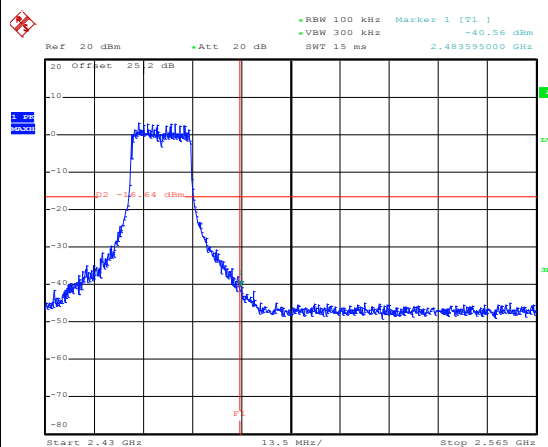

Date: 4.JUN.2014 02:28:19

Spurious Emission 30MHz~3GHz

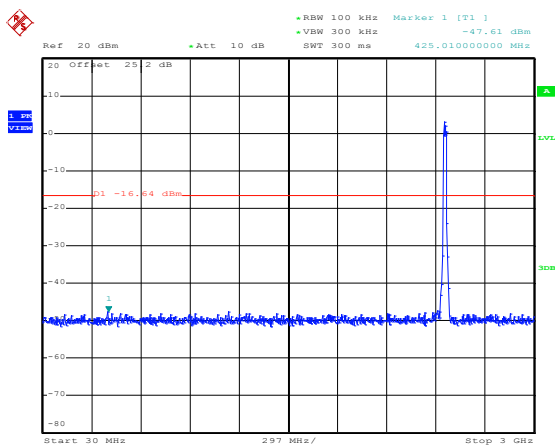

Date: 4.JUN.2014 02:28:38

Spurious Emission 2GHz~25GHz

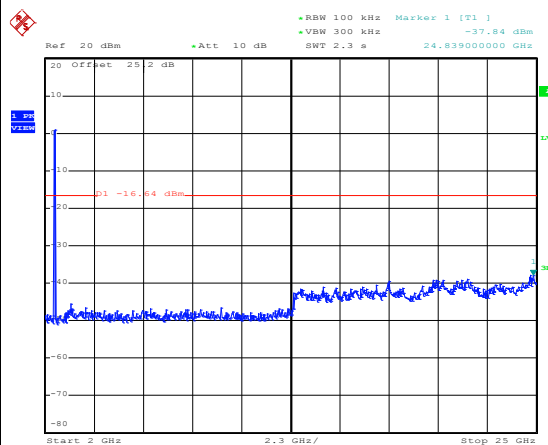

Date: 4.JUN.2014 02:28:57



Number of TX :	2	Ant. :	2
Test Mode :	802.11n HT20	Temperature :	21~26°C
Test Band :	2.4GHz Low	Relative Humidity :	45~54%
Test Channel :	01	Test Engineer :	Alex Lee

WLAN 802.11n HT20 Channel 01

100kHz PSD reference Level

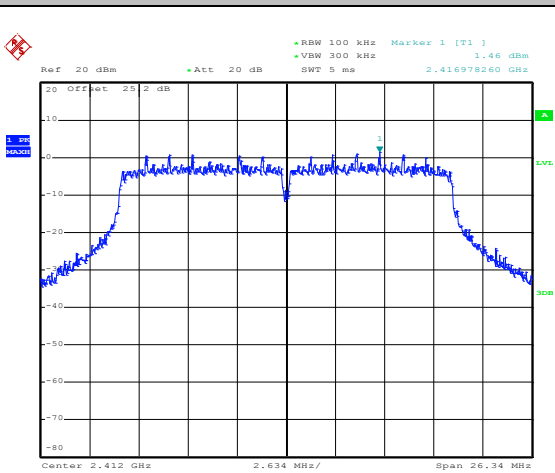

Date: 4.JUN.2014 02:36:42

Low Channel Plot

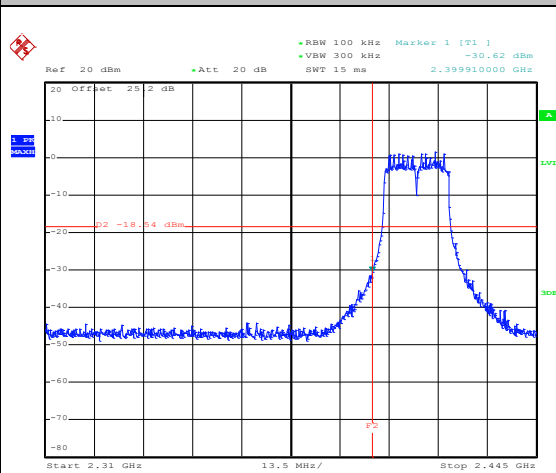

Date: 4.JUN.2014 02:36:56

Spurious Emission 30MHz~3GHz

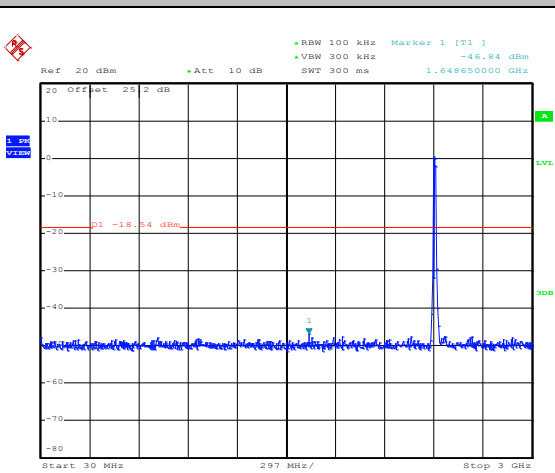

Date: 4.JUN.2014 02:37:15

Spurious Emission 2GHz~25GHz

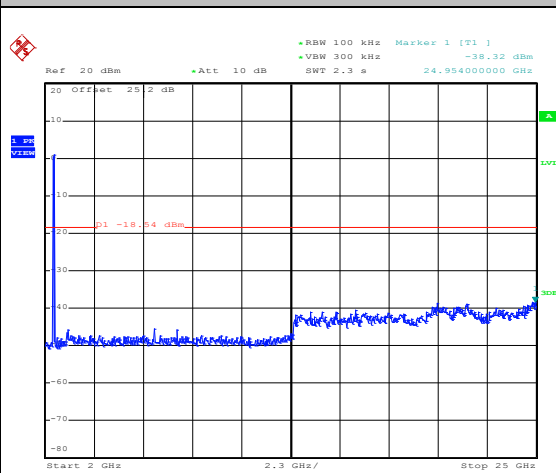

Date: 4.JUN.2014 02:37:34



Number of TX :	2	Ant. :	2
Test Mode :	802.11n HT20	Temperature :	21~26°C
Test Band :	2.4GHz Mid	Relative Humidity :	45~54%
Test Channel :	06	Test Engineer :	Alex Lee

WLAN 802.11n HT20 Channel 06

100kHz PSD reference Level

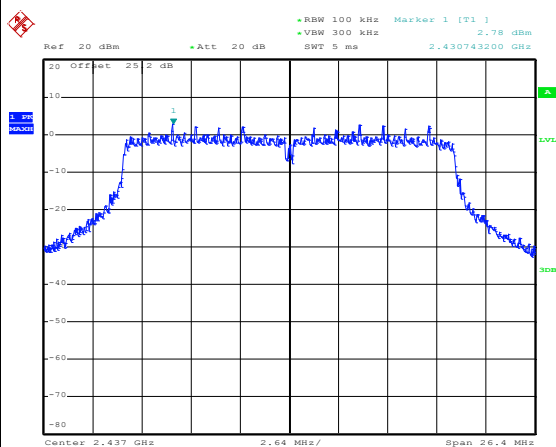

Date: 4.JUN.2014 02:40:14

Spurious Emission 30MHz~3GHz

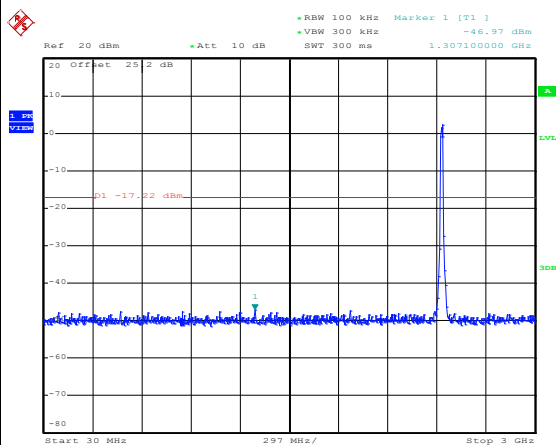

Date: 4.JUN.2014 02:40:34

Spurious Emission 2GHz~25GHz

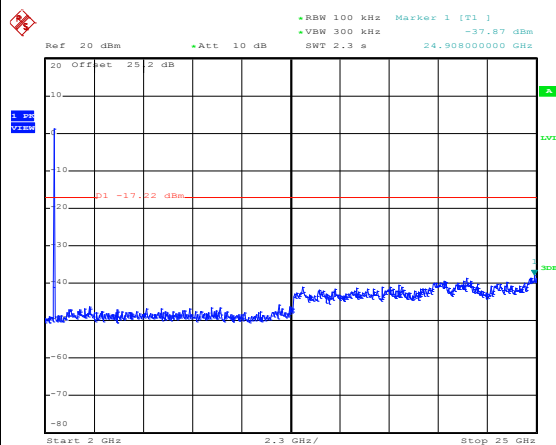

Date: 4.JUN.2014 02:40:53



Number of TX :	2	Ant. :	2
Test Mode :	802.11n HT20	Temperature :	21~26°C
Test Band :	2.4GHz High	Relative Humidity :	45~54%
Test Channel :	11	Test Engineer :	Alex Lee

WLAN 802.11n HT20 Channel 11

100kHz PSD reference Level

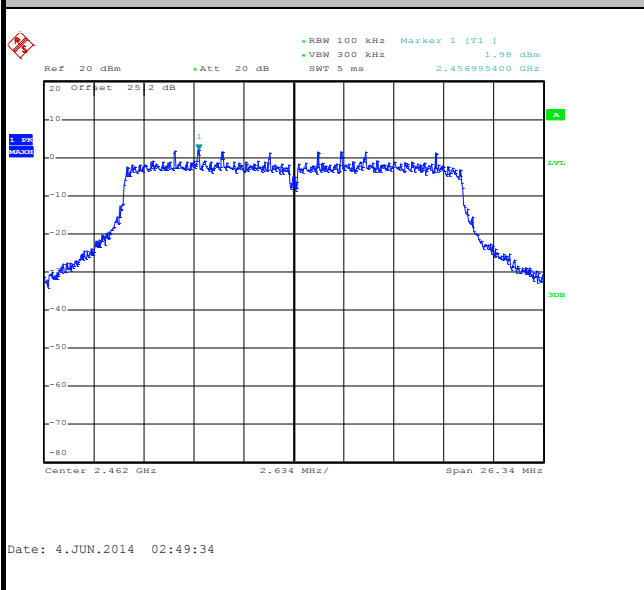

High Channel Plot

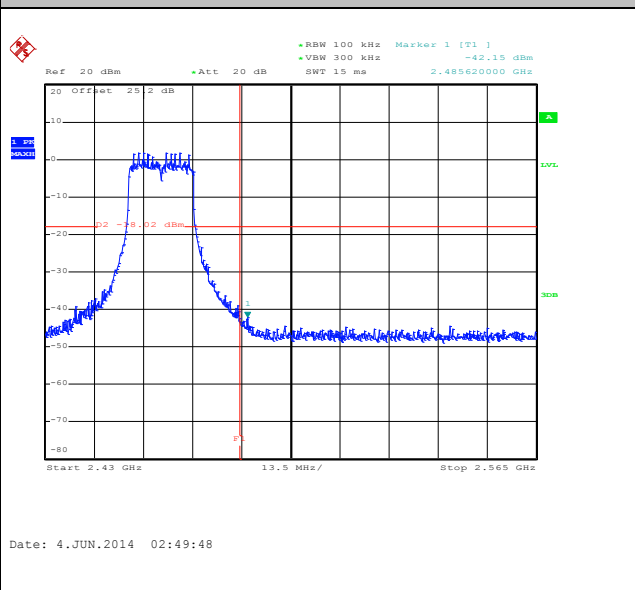

Spurious Emission 30MHz~3GHz

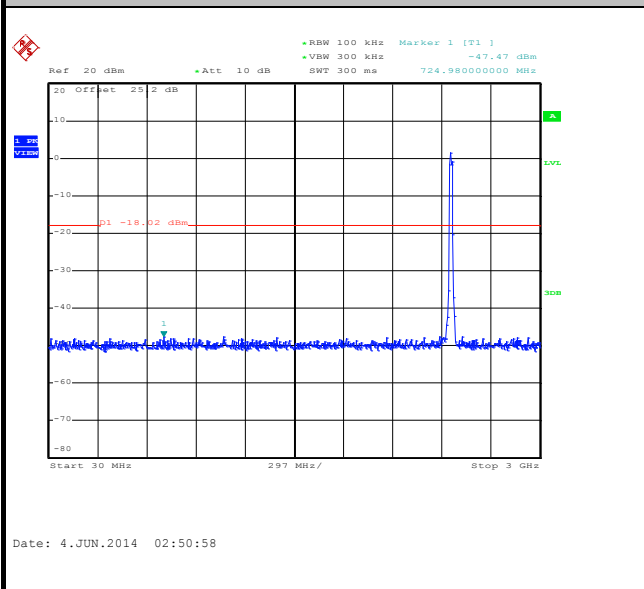

Spurious Emission 2GHz~25GHz

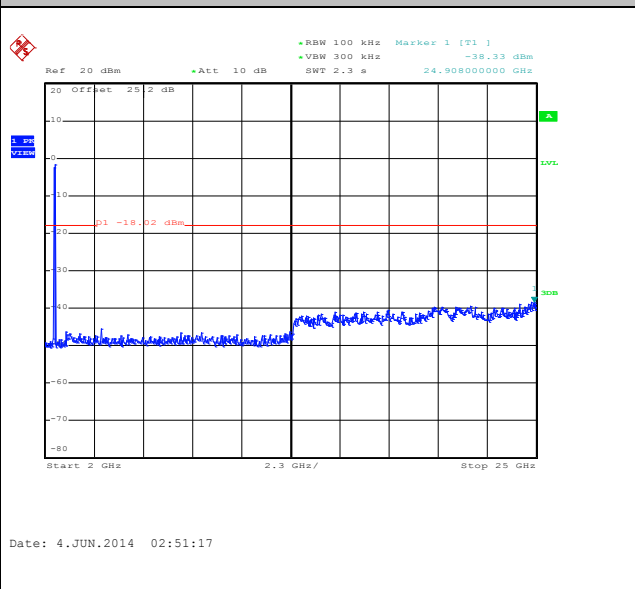



Number of TX :	2	Ant. :	2
Test Mode :	802.11n HT40	Temperature :	21~26°C
Test Band :	2.4GHz Low	Relative Humidity :	45~54%
Test Channel :	03	Test Engineer :	Alex Lee

WLAN 802.11n HT40 Channel 03

100kHz PSD reference Level

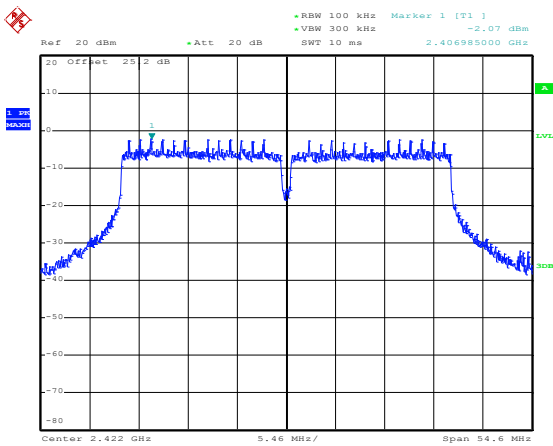

Low Channel Plot

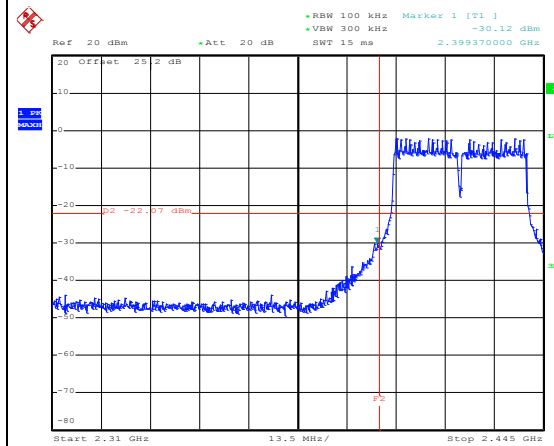

Spurious Emission 30MHz~3GHz

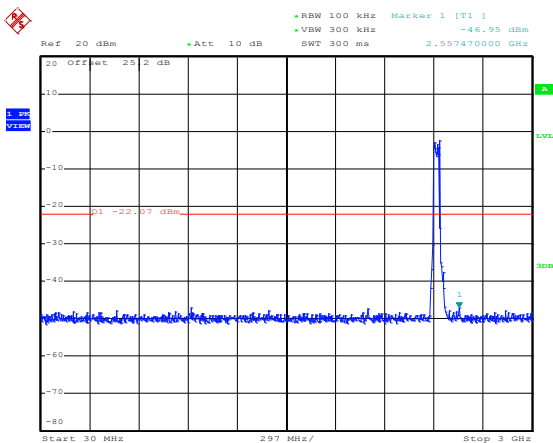

Spurious Emission 2GHz~25GHz

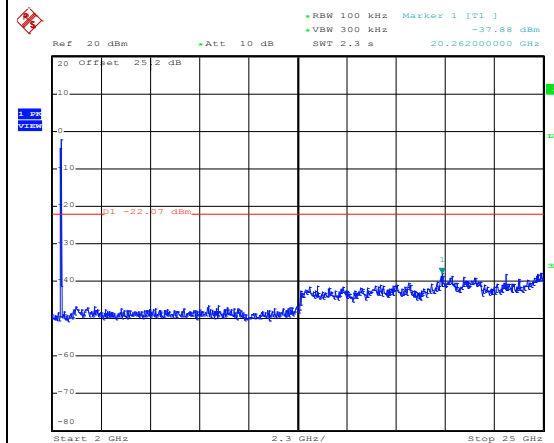



Number of TX :	2	Ant. :	2
Test Mode :	802.11n HT40	Temperature :	21~26°C
Test Band :	2.4GHz Mid	Relative Humidity :	45~54%
Test Channel :	06	Test Engineer :	Alex Lee

WLAN 802.11n HT40 Channel 06

100kHz PSD reference Level

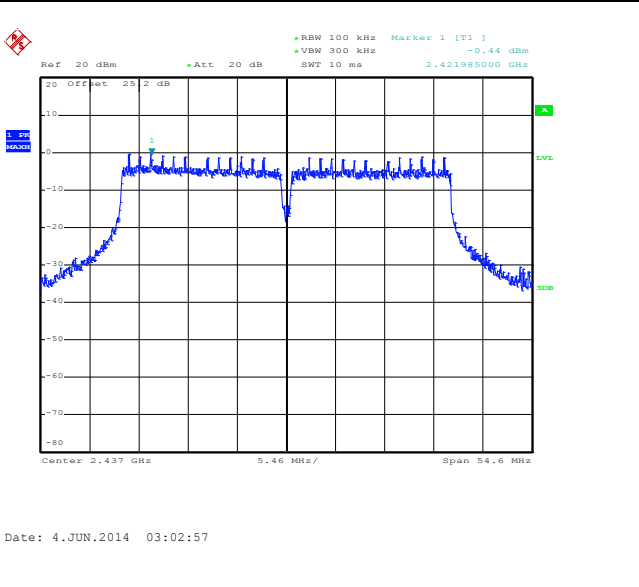

Spurious Emission 30MHz~3GHz

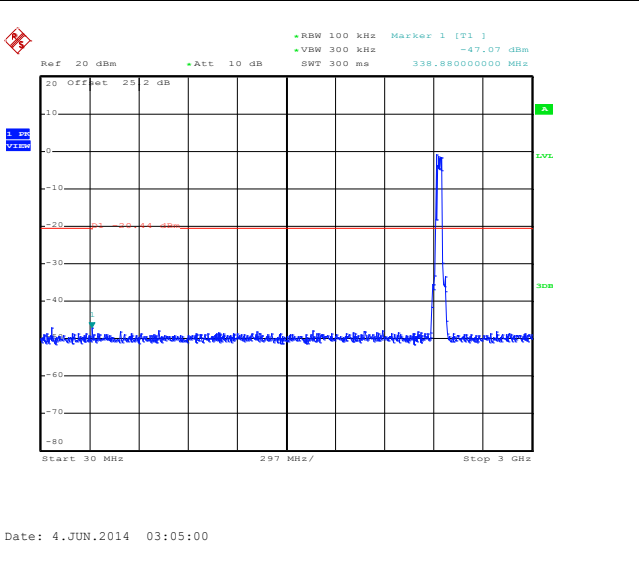

Spurious Emission 2GHz~25GHz

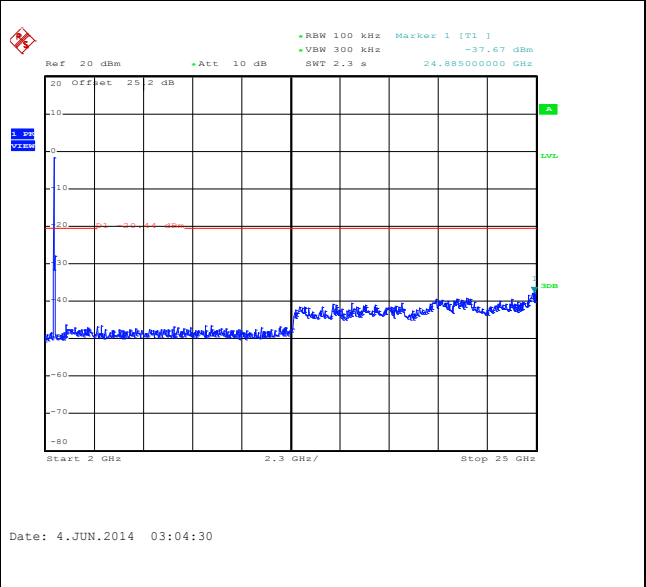



Number of TX :	2	Ant. :	2
Test Mode :	802.11n HT40	Temperature :	21~26°C
Test Band :	2.4GHz High	Relative Humidity :	45~54%
Test Channel :	09	Test Engineer :	Alex Lee

WLAN 802.11n HT40 Channel 09

100kHz PSD reference Level

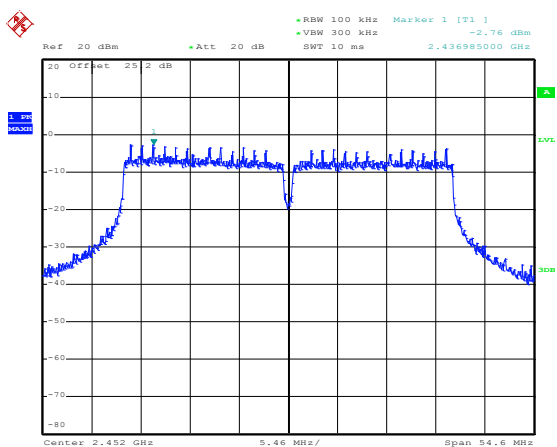

Date: 4.JUN.2014 03:14:12

High Channel Plot

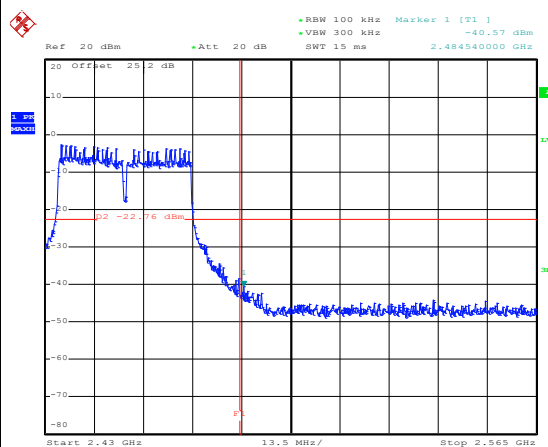

Date: 4.JUN.2014 03:14:25

Spurious Emission 30MHz~3GHz

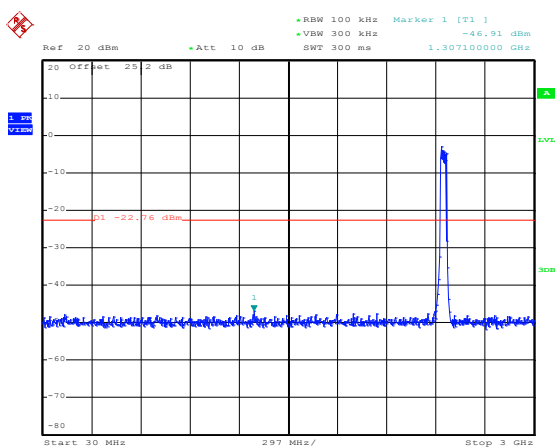

Date: 4.JUN.2014 03:14:45

Spurious Emission 2GHz~25GHz

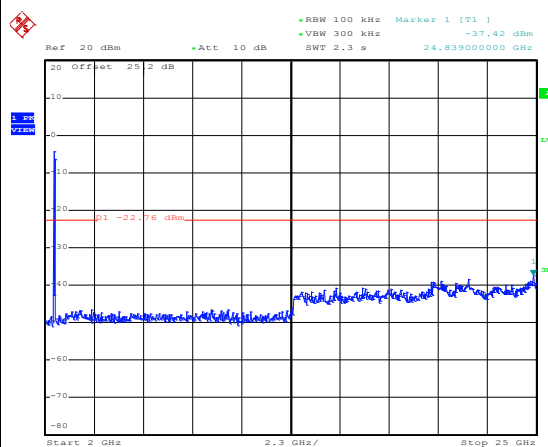

Date: 4.JUN.2014 03:15:03

3.5 Radiated Band Edges and Spurious Emission Measurement

3.5.1 Limit of Radiated band edge and Spurious Emission Measurement

In any 100 kHz bandwidth outside the intentional radiator frequency band, all harmonics/spurious must be at least 20 dB below the highest emission level within the authorized band. If the output power of this device was measured by spectrum analyzer, the attenuation under this paragraph shall be 30 dB instead of 20 dB. In addition, radiated emissions which fall in the restricted bands must also comply with the FCC section 15.209 limits as below.

Frequency (MHz)	Field Strength (microvolts/meter)	Measurement Distance (meters)
0.009 – 0.490	2400/F(kHz)	300
0.490 – 1.705	24000/F(kHz)	30
1.705 – 30.0	30	30
30 – 88	100	3
88 – 216	150	3
216 - 960	200	3
Above 960	500	3

3.5.2 Measuring Instruments

The measuring equipment is listed in the section 4 of this test report.



3.5.3 Test Procedure

1. The testing follows FCC KDB Publication No. 558074 D01 DTS Meas. Guidance v03r02.
2. The EUT was arranged to its worst case and then tune the antenna tower (from 1 m to 4 m) and turntable (from 0 degree to 360 degrees) to find the maximum reading. A pre-amp and a high pass filter are used for the test in order to get better signal level.
3. The EUT was placed on a turntable with 0.8 meter above ground.
4. The EUT was set 3 meters from the interference receiving antenna, which was mounted on the top of a variable height antenna tower.
5. Corrected Reading: Antenna Factor + Cable Loss + Read Level - Preamp Factor = Level
6. For measurement below 1GHz, If the emission level of the EUT measured by the peak detector is 3 dB lower than the applicable limit, the peak emission level will be reported. Otherwise, the emission measurement will be repeated using the quasi-peak detector and reported.
7. Use the following spectrum analyzer settings:
 - (1) Span shall wide enough to fully capture the emission being measured;
 - (2) Set RBW=100 kHz for $f < 1$ GHz; $VBW \geq RBW$; Sweep = auto; Detector function = peak; Trace = max hold;
 - (3) Set RBW = 1 MHz, VBW= 3MHz for $f \geq 1$ GHz for peak measurement.
For average measurement:
 - $VBW = 10$ Hz, when duty cycle is no less than 98 percent.
 - $VBW \geq 1/T$, when duty cycle is less than 98 percent where T is the minimum transmission duration over which the transmitter is on and is transmitting at its maximum power control level for the tested mode of operation.



Antenna	Band	Duty Cycle(%)	T(us)	1/T(kHz)	VBW Setting
1+2	802.11b for Ant 1	100	-	-	10Hz
1+2	802.11b for Ant 2	100	-	-	
1+2	802.11g for Ant 1	95.77	1360	0.74	1kHz
1+2	802.119 for Ant 2	97.18	1380	0.72	
1+2	2.4GHz 802.11n HT20 for Ant. 1	96.24	1280	0.78	
1+2	2.4GHz 802.11n HT20 for Ant. 2	96.97	1280	0.78	
1+2	2.4GHz 802.11n HT20 for Ant. 1	94.03	630	1.59	3kHz
1+2	2.4GHz 802.11n HT20 for Ant. 2	93.94	620	1.61	
1+2	5GHz 802.11n HT40 for Ant. 2	100	-	-	

3.5.4 Test Setup

For radiated emissions below 30MHz

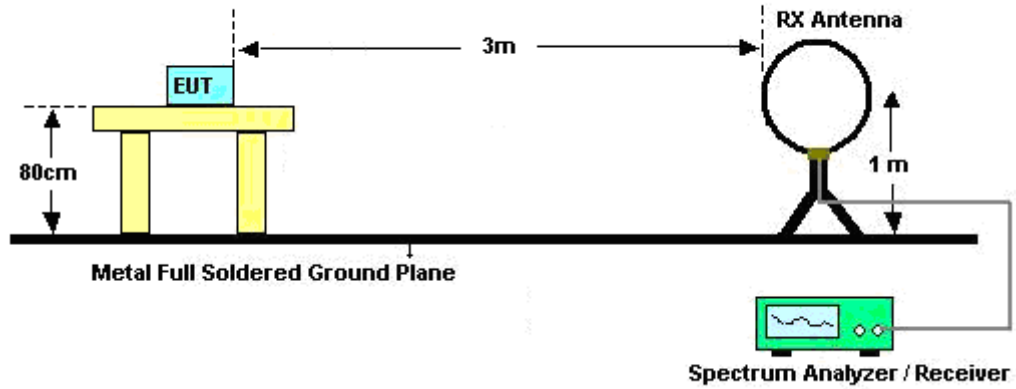

For radiated emissions from 30MHz to 1GHz

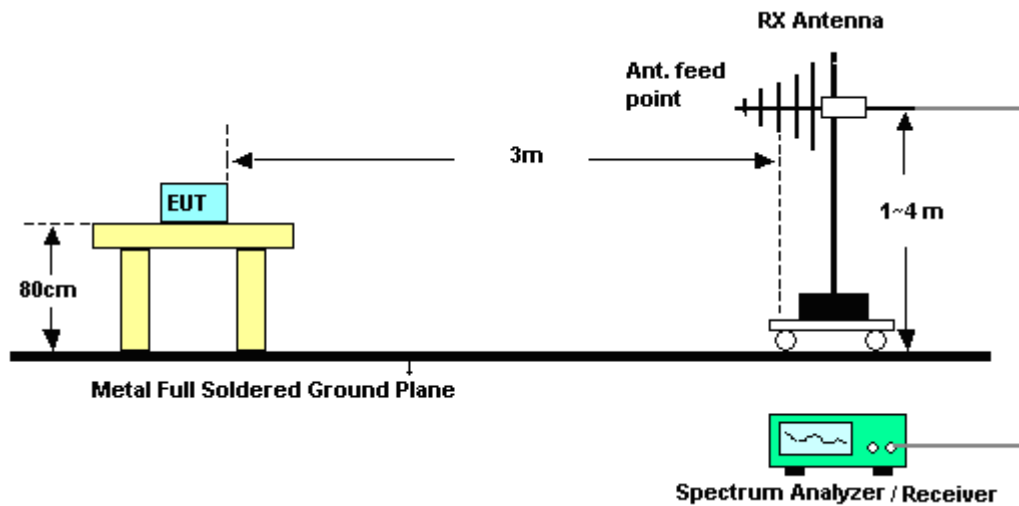

For radiated emissions above 1GHz

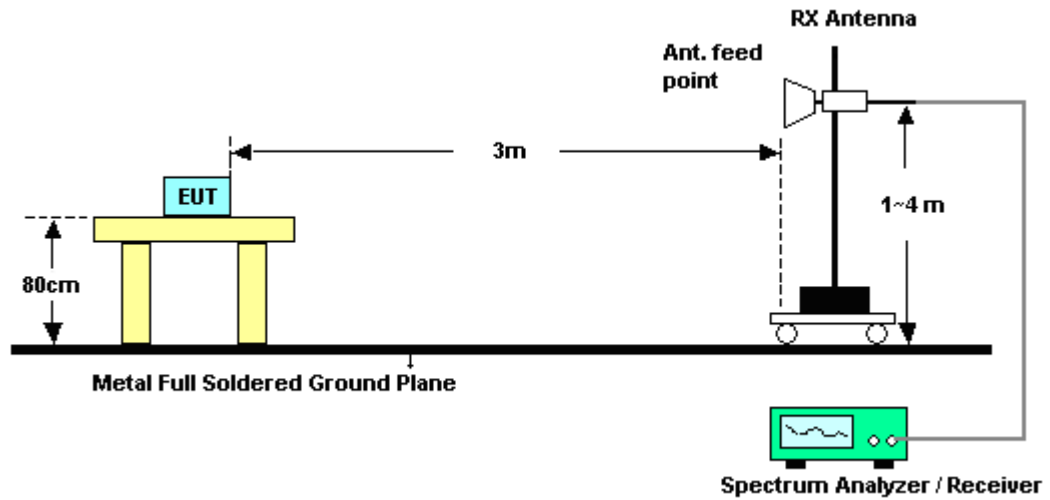

3.5.5 Test Results of Radiated Emissions (9kHz ~ 30MHz)

The low frequency, which started from 9 kHz to 30MHz, was pre-scanned and the result which was 20dB lower than the limit line per 15.31(o) was not reported.



3.5.6 Test Result of Radiated Spurious at Band Edges

<MIMO Ant. 1+2>

Test Mode :	802.11b	Temperature :	22~24°C
Test Band :	Low	Relative Humidity :	47~49%
Test Channel :	01	Test Engineer :	Marlboro Hsu

ANTENNA POLARITY : HORIZONTAL										
Frequency (MHz)	Level (dBμV/m)	Over Limit (dB)	Limit Line (dBμV/m)	Read Level (dBμV)	Antenna Factor (dB)	Cable Loss (dB)	Preamp Factor (dB)	Ant Pos (cm)	Table Pos (deg)	Remark
2388.39	54.96	-19.04	74	56.7	27.19	4.24	33.17	102	303	Peak
2387.13	45.95	-8.05	54	47.71	27.18	4.24	33.18	102	303	Average

ANTENNA POLARITY : VERTICAL										
Frequency (MHz)	Level (dBμV/m)	Over Limit (dB)	Limit Line (dBμV/m)	Read Level (dBμV)	Antenna Factor (dB)	Cable Loss (dB)	Preamp Factor (dB)	Ant Pos (cm)	Table Pos (deg)	Remark
2389.83	58.01	-15.99	74	59.75	27.19	4.24	33.17	101	205	Peak
2387.31	43.79	-10.21	54	45.55	27.18	4.24	33.18	101	205	Average

Test Mode :	802.11b	Temperature :	22~24°C
Test Band :	High	Relative Humidity :	47~49%
Test Channel :	11	Test Engineer :	Marlboro Hsu

ANTENNA POLARITY : HORIZONTAL										
Frequency (MHz)	Level (dBμV/m)	Over Limit (dB)	Limit Line (dBμV/m)	Read Level (dBμV)	Antenna Factor (dB)	Cable Loss (dB)	Preamp Factor (dB)	Ant Pos (cm)	Table Pos (deg)	Remark
2484.28	52.17	-21.83	74	53.56	27.46	4.29	33.14	100	304	Peak
2483.53	42.87	-11.13	54	44.27	27.45	4.29	33.14	100	304	Average

ANTENNA POLARITY : VERTICAL										
Frequency (MHz)	Level (dBμV/m)	Over Limit (dB)	Limit Line (dBμV/m)	Read Level (dBμV)	Antenna Factor (dB)	Cable Loss (dB)	Preamp Factor (dB)	Ant Pos (cm)	Table Pos (deg)	Remark
2484.79	55.76	-18.24	74	57.15	27.46	4.29	33.14	100	197	Peak
2483.5	42.51	-11.49	54	43.91	27.45	4.29	33.14	100	197	Average



Test Mode :	802.11g	Temperature :	22~24°C
Test Band :	Low	Relative Humidity :	47~49%
Test Channel :	01	Test Engineer :	Marlboro Hsu

ANTENNA POLARITY : HORIZONTAL										
Frequency (MHz)	Level (dBμV/m)	Over Limit (dB)	Limit Line (dBμV/m)	Read Level (dBμV)	Antenna Factor (dB)	Cable Loss (dB)	Preamp Factor (dB)	Ant Pos (cm)	Table Pos (deg)	Remark
2389.65	69.53	-4.47	74	71.27	27.19	4.24	33.17	103	302	Peak
2389.83	52.77	-1.23	54	54.51	27.19	4.24	33.17	103	302	Average

ANTENNA POLARITY : VERTICAL										
Frequency (MHz)	Level (dBμV/m)	Over Limit (dB)	Limit Line (dBμV/m)	Read Level (dBμV)	Antenna Factor (dB)	Cable Loss (dB)	Preamp Factor (dB)	Ant Pos (cm)	Table Pos (deg)	Remark
2389.11	68.14	-5.86	74	69.88	27.19	4.24	33.17	103	206	Peak
2389.83	52.32	-1.68	54	54.06	27.19	4.24	33.17	103	206	Average

Test Mode :	802.11g	Temperature :	22~24°C
Test Band :	High	Relative Humidity :	47~49%
Test Channel :	11	Test Engineer :	Marlboro Hsu

ANTENNA POLARITY : HORIZONTAL										
Frequency (MHz)	Level (dBμV/m)	Over Limit (dB)	Limit Line (dBμV/m)	Read Level (dBμV)	Antenna Factor (dB)	Cable Loss (dB)	Preamp Factor (dB)	Ant Pos (cm)	Table Pos (deg)	Remark
2483.89	69.39	-4.61	74	70.79	27.45	4.29	33.14	200	311	Peak
2483.56	52.61	-1.39	54	54.01	27.45	4.29	33.14	200	311	Average

ANTENNA POLARITY : VERTICAL										
Frequency (MHz)	Level (dBμV/m)	Over Limit (dB)	Limit Line (dBμV/m)	Read Level (dBμV)	Antenna Factor (dB)	Cable Loss (dB)	Preamp Factor (dB)	Ant Pos (cm)	Table Pos (deg)	Remark
2484.16	69.98	-4.02	74	71.37	27.46	4.29	33.14	102	206	Peak
2483.5	52.81	-1.19	54	54.21	27.45	4.29	33.14	102	206	Average



Test Mode :	802.11n HT20	Temperature :	22~24°C
Test Band :	Low	Relative Humidity :	47~49%
Test Channel :	01	Test Engineer :	Marlboro Hsu

ANTENNA POLARITY : HORIZONTAL										
Frequency (MHz)	Level (dBμV/m)	Over Limit (dB)	Limit Line (dBμV/m)	Read Level (dBμV)	Antenna Factor (dB)	Cable Loss (dB)	Preamp Factor (dB)	Ant Pos (cm)	Table Pos (deg)	Remark
2389.11	67.85	-6.15	74	69.59	27.19	4.24	33.17	104	301	Peak
2389.83	53.59	-0.41	54	55.33	27.19	4.24	33.17	104	301	Average

ANTENNA POLARITY : VERTICAL										
Frequency (MHz)	Level (dBμV/m)	Over Limit (dB)	Limit Line (dBμV/m)	Read Level (dBμV)	Antenna Factor (dB)	Cable Loss (dB)	Preamp Factor (dB)	Ant Pos (cm)	Table Pos (deg)	Remark
2389.02	66.09	-7.91	74	67.83	27.19	4.24	33.17	100	204	Peak
2389.92	49.7	-4.3	54	51.44	27.19	4.24	33.17	100	204	Average

Test Mode :	802.11n HT20	Temperature :	22~24°C
Test Band :	High	Relative Humidity :	47~49%
Test Channel :	11	Test Engineer :	Marlboro Hsu

ANTENNA POLARITY : HORIZONTAL										
Frequency (MHz)	Level (dBμV/m)	Over Limit (dB)	Limit Line (dBμV/m)	Read Level (dBμV)	Antenna Factor (dB)	Cable Loss (dB)	Preamp Factor (dB)	Ant Pos (cm)	Table Pos (deg)	Remark
2483.5	68.56	-5.44	74	69.96	27.45	4.29	33.14	100	305	Peak
2483.65	53.68	-0.32	54	55.08	27.45	4.29	33.14	100	305	Average

ANTENNA POLARITY : VERTICAL										
Frequency (MHz)	Level (dBμV/m)	Over Limit (dB)	Limit Line (dBμV/m)	Read Level (dBμV)	Antenna Factor (dB)	Cable Loss (dB)	Preamp Factor (dB)	Ant Pos (cm)	Table Pos (deg)	Remark
2484.16	67.95	-6.05	74	69.34	27.46	4.29	33.14	102	208	Peak
2483.5	53.1	-0.9	54	54.5	27.45	4.29	33.14	102	208	Average



Test Mode :	802.11n HT40	Temperature :	22~24°C
Test Band :	Low	Relative Humidity :	47~49%
Test Channel :	03	Test Engineer :	Marlboro Hsu

ANTENNA POLARITY : HORIZONTAL										
Frequency (MHz)	Level (dBμV/m)	Over Limit (dB)	Limit Line (dBμV/m)	Read Level (dBμV)	Antenna Factor (dB)	Cable Loss (dB)	Preamp Factor (dB)	Ant Pos (cm)	Table Pos (deg)	Remark
2389.83	65.02	-8.98	74	66.76	27.19	4.24	33.17	104	298	Peak
2389.92	53.48	-0.52	54	55.22	27.19	4.24	33.17	104	298	Average
2484.67	52.42	-21.58	74	53.81	27.46	4.29	33.14	104	298	Peak
2483.65	38.92	-15.08	54	40.32	27.45	4.29	33.14	104	298	Average

ANTENNA POLARITY : VERTICAL										
Frequency (MHz)	Level (dBμV/m)	Over Limit (dB)	Limit Line (dBμV/m)	Read Level (dBμV)	Antenna Factor (dB)	Cable Loss (dB)	Preamp Factor (dB)	Ant Pos (cm)	Table Pos (deg)	Remark
2389.83	65.74	-8.26	74	67.48	27.19	4.24	33.17	102	208	Peak
2389.92	52.74	-1.26	54	54.48	27.19	4.24	33.17	102	208	Average
2486.02	53.39	-20.61	74	54.78	27.46	4.29	33.14	102	208	Peak
2483.62	39.97	-14.03	54	41.37	27.45	4.29	33.14	102	208	Average



Test Mode :	802.11n HT40	Temperature :	22~24°C
Test Band :	High	Relative Humidity :	47~49%
Test Channel :	09	Test Engineer :	Marlboro Hsu

ANTENNA POLARITY : HORIZONTAL										
Frequency (MHz)	Level (dBμV/m)	Over Limit (dB)	Limit Line (dBμV/m)	Read Level (dBμV)	Antenna Factor (dB)	Cable Loss (dB)	Preamp Factor (dB)	Ant Pos (cm)	Table Pos (deg)	Remark
2389.38	58	-16	74	59.74	27.19	4.24	33.17	100	297	Peak
2389.47	42.51	-11.49	54	44.25	27.19	4.24	33.17	100	297	Average
2483.74	65.24	-8.76	74	66.64	27.45	4.29	33.14	100	297	Peak
2483.5	53.06	-0.94	54	54.46	27.45	4.29	33.14	100	297	Average

ANTENNA POLARITY : VERTICAL										
Frequency (MHz)	Level (dBμV/m)	Over Limit (dB)	Limit Line (dBμV/m)	Read Level (dBμV)	Antenna Factor (dB)	Cable Loss (dB)	Preamp Factor (dB)	Ant Pos (cm)	Table Pos (deg)	Remark
2389.92	56.05	-17.95	74	57.79	27.19	4.24	33.17	102	209	Peak
2388.48	41.18	-12.82	54	42.92	27.19	4.24	33.17	102	209	Average
2483.86	65.49	-8.51	74	66.89	27.45	4.29	33.14	102	209	Peak
2483.5	52.95	-1.05	54	54.35	27.45	4.29	33.14	102	209	Average

3.5.7 Test Result of Radiated Spurious Emission (30MHz ~ 10th Harmonic)

Note: Pre-scanned all test modes and only choose the worst case mode recorded in the test report for radiated spurious emission below 1GHz.

<MIMO Ant. 1+2>

Test Mode :	802.11b	Temperature :	22~24°C
Test Channel :	01	Relative Humidity :	47~49%
Test Engineer :	Marlboro Hsu	Polarization :	Horizontal
Remark :	1. 2411 MHz is fundamental signal which can be ignored. 2. Average measurement was not performed if peak level went lower than the average limit.		

Frequency (MHz)	Level (dBμV/m)	Over Limit (dB)	Limit Line (dBμV/m)	Read Level (dBμV)	Antenna Factor (dB)	Cable Loss (dB)	Preamp Factor (dB)	Ant Pos (cm)	Table Pos (deg)	Remark
44.85	28.06	-11.94	40	41.28	14.19	0.59	28	-	-	Peak
205.77	34.94	-8.56	43.5	51.22	10.72	1.16	28.16	100	51	Peak
276.78	37.28	-8.72	46	50.59	13.54	1.33	28.18	-	-	Peak
300	29.3	-16.7	46	41.98	14.1	1.4	28.18	-	-	Peak
600.3	31.01	-14.99	46	36.61	20.2	2.05	27.85	-	-	Peak
958	36.2	-9.8	46	35.95	24.53	2.63	26.91	-	-	Peak
2411	102.7	-	-	104.37	27.25	4.25	33.17	102	303	Average
2411	107.79	-	-	109.46	27.25	4.25	33.17	102	303	Peak
4824	42.09	-31.91	74	36.7	31.59	6.23	32.43	100	0	Peak



Test Mode :	802.11b	Temperature :	22~24°C
Test Channel :	01	Relative Humidity :	47~49%
Test Engineer :	Marlboro Hsu	Polarization :	Vertical
Remark :	1. 2413 MHz is fundamental signal which can be ignored. 2. Average measurement was not performed if peak level went lower than the average limit.		

Frequency (MHz)	Level (dBμV/m)	Over Limit (dB)	Limit Line (dBμV/m)	Read Level (dBμV)	Antenna Factor (dB)	Cable Loss (dB)	Preamp Factor (dB)	Ant Pos (cm)	Table Pos (deg)	Remark
45.93	41.31	1.31	40	54.48	14.24	0.59	28	100	314	Peak
45.93	33.38	-6.62	40	46.55	14.24	0.59	28	100	314	QP
70.77	30.61	-9.39	40	46.24	11.72	0.71	28.06	-	-	Peak
202.26	31.51	-11.99	43.5	47.87	10.65	1.15	28.16	-	-	Peak
600.3	31.37	-14.63	46	36.97	20.2	2.05	27.85	-	-	Peak
910.4	32.31	-13.69	46	32.88	23.95	2.57	27.09	-	-	Peak
957.3	35.63	-10.37	46	35.39	24.53	2.62	26.91	-	-	Peak
2413	102.58	-	-	104.22	27.26	4.26	33.16	101	205	Average
2413	107.37	-	-	109.01	27.26	4.26	33.16	101	205	Peak
4824	46.25	-27.75	74	40.86	31.59	6.23	32.43	100	0	Peak



Test Mode :	802.11b	Temperature :	22~24°C
Test Channel :	06	Relative Humidity :	47~49%
Test Engineer :	Marlboro Hsu	Polarization :	Horizontal
Remark :	1. 2438 MHz is fundamental signal which can be ignored. 2. Average measurement was not performed if peak level went lower than the average limit.		

Frequency (MHz)	Level (dBμV/m)	Over Limit (dB)	Limit Line (dBμV/m)	Read Level (dBμV)	Antenna Factor (dB)	Cable Loss (dB)	Preamp Factor (dB)	Ant Pos (cm)	Table Pos (deg)	Remark
2438	101.57	-	-	103.12	27.33	4.27	33.15	100	301	Average
2438	106.98	-	-	108.53	27.33	4.27	33.15	100	301	Peak
4875	45.82	-28.18	74	40.3	31.65	6.29	32.42	100	0	Peak
7311	48.36	-25.64	74	37.05	36.61	8.42	33.72	100	0	Peak

Test Mode :	802.11b	Temperature :	22~24°C
Test Channel :	06	Relative Humidity :	47~49%
Test Engineer :	Marlboro Hsu	Polarization :	Vertical
Remark :	1. 2438 MHz is fundamental signal which can be ignored. 2. Average measurement was not performed if peak level went lower than the average limit.		

Frequency (MHz)	Level (dBμV/m)	Over Limit (dB)	Limit Line (dBμV/m)	Read Level (dBμV)	Antenna Factor (dB)	Cable Loss (dB)	Preamp Factor (dB)	Ant Pos (cm)	Table Pos (deg)	Remark
2438	101.93	-	-	103.48	27.33	4.27	33.15	100	207	Average
2438	106.92	-	-	108.47	27.33	4.27	33.15	100	207	Peak
4875	48.37	-25.63	74	42.85	31.65	6.29	32.42	100	0	Peak
7311	50.69	-23.31	74	39.38	36.61	8.42	33.72	100	0	Peak



Test Mode :	802.11b	Temperature :	22~24°C
Test Channel :	11	Relative Humidity :	47~49%
Test Engineer :	Marlboro Hsu	Polarization :	Horizontal
Remark :	1. 2462 MHz is fundamental signal which can be ignored. 2. Average measurement was not performed if peak level went lower than the average limit.		

Frequency (MHz)	Level (dBμV/m)	Over Limit (dB)	Limit Line (dBμV/m)	Read Level (dBμV)	Antenna Factor (dB)	Cable Loss (dB)	Preamp Factor (dB)	Ant Pos (cm)	Table Pos (deg)	Remark
2462	101.89	-	-	103.37	27.39	4.28	33.15	100	304	Average
2462	106.78	-	-	108.26	27.39	4.28	33.15	100	304	Peak
4926	45.9	-28.1	74	40.25	31.71	6.34	32.4	100	0	Peak
7386	48.88	-25.12	74	37.54	36.8	8.32	33.78	100	0	Peak

Test Mode :	802.11b	Temperature :	22~24°C
Test Channel :	11	Relative Humidity :	47~49%
Test Engineer :	Marlboro Hsu	Polarization :	Vertical
Remark :	1. 2462 MHz is fundamental signal which can be ignored. 2. Average measurement was not performed if peak level went lower than the average limit.		

Frequency (MHz)	Level (dBμV/m)	Over Limit (dB)	Limit Line (dBμV/m)	Read Level (dBμV)	Antenna Factor (dB)	Cable Loss (dB)	Preamp Factor (dB)	Ant Pos (cm)	Table Pos (deg)	Remark
2462	101.79	-	-	103.27	27.39	4.28	33.15	100	197	Average
2462	106.38	-	-	107.86	27.39	4.28	33.15	100	197	Peak
4926	49.19	-24.81	74	43.54	31.71	6.34	32.4	100	0	Peak
7386	48.68	-25.32	74	37.34	36.8	8.32	33.78	100	0	Peak



Test Mode :	802.11g	Temperature :	22~24°C
Test Channel :	01	Relative Humidity :	47~49%
Test Engineer :	Marlboro Hsu	Polarization :	Horizontal
Remark :	1. 2413 MHz is fundamental signal which can be ignored. 2. Average measurement was not performed if peak level went lower than the average limit.		

Frequency (MHz)	Level (dBμV/m)	Over Limit (dB)	Limit Line (dBμV/m)	Read Level (dBμV)	Antenna Factor (dB)	Cable Loss (dB)	Preamp Factor (dB)	Ant Pos (cm)	Table Pos (deg)	Remark
2413	100.93	-	-	102.57	27.26	4.26	33.16	103	302	Average
2413	108.85	-	-	110.49	27.26	4.26	33.16	103	302	Peak
4824	42.05	-31.95	74	36.66	31.59	6.23	32.43	100	0	Peak

Test Mode :	802.11g	Temperature :	22~24°C
Test Channel :	01	Relative Humidity :	47~49%
Test Engineer :	Marlboro Hsu	Polarization :	Vertical
Remark :	1. 2413 MHz is fundamental signal which can be ignored. 2. Average measurement was not performed if peak level went lower than the average limit.		

Frequency (MHz)	Level (dBμV/m)	Over Limit (dB)	Limit Line (dBμV/m)	Read Level (dBμV)	Antenna Factor (dB)	Cable Loss (dB)	Preamp Factor (dB)	Ant Pos (cm)	Table Pos (deg)	Remark
2413	100.08	-	-	101.72	27.26	4.26	33.16	103	206	Average
2413	108.25	-	-	109.89	27.26	4.26	33.16	103	206	Peak
4825	47.84	-26.16	74	42.44	31.59	6.23	32.42	100	0	Peak



Test Mode :	802.11g	Temperature :	22~24°C
Test Channel :	06	Relative Humidity :	47~49%
Test Engineer :	Marlboro Hsu	Polarization :	Horizontal
Remark :	1. 2438 MHz is fundamental signal which can be ignored. 2. Average measurement was not performed if peak level went lower than the average limit.		

Frequency (MHz)	Level (dBμV/m)	Over Limit (dB)	Limit Line (dBμV/m)	Read Level (dBμV)	Antenna Factor (dB)	Cable Loss (dB)	Preamp Factor (dB)	Ant Pos (cm)	Table Pos (deg)	Remark
2438	101.7	-	-	103.25	27.33	4.27	33.15	102	298	Average
2438	109.9	-	-	111.45	27.33	4.27	33.15	102	298	Peak
4875	42.04	-31.96	74	36.52	31.65	6.29	32.42	100	0	Peak
7311	49.46	-24.54	74	38.15	36.61	8.42	33.72	100	0	Peak

Test Mode :	802.11g	Temperature :	22~24°C
Test Channel :	06	Relative Humidity :	47~49%
Test Engineer :	Marlboro Hsu	Polarization :	Vertical
Remark :	1. 2438 MHz is fundamental signal which can be ignored. 2. Average measurement was not performed if peak level went lower than the average limit.		

Frequency (MHz)	Level (dBμV/m)	Over Limit (dB)	Limit Line (dBμV/m)	Read Level (dBμV)	Antenna Factor (dB)	Cable Loss (dB)	Preamp Factor (dB)	Ant Pos (cm)	Table Pos (deg)	Remark
2438	101.33	-	-	102.88	27.33	4.27	33.15	102	208	Average
2438	109.65	-	-	111.2	27.33	4.27	33.15	102	208	Peak
4875	48.25	-25.75	74	42.73	31.65	6.29	32.42	100	0	Peak
7311	48.81	-25.19	74	37.5	36.61	8.42	33.72	100	0	Peak



Test Mode :	802.11g	Temperature :	22~24°C
Test Channel :	11	Relative Humidity :	47~49%
Test Engineer :	Marlboro Hsu	Polarization :	Horizontal
Remark :	1. 2461 MHz is fundamental signal which can be ignored. 2. Average measurement was not performed if peak level went lower than the average limit.		

Frequency (MHz)	Level (dBμV/m)	Over Limit (dB)	Limit Line (dBμV/m)	Read Level (dBμV)	Antenna Factor (dB)	Cable Loss (dB)	Preamp Factor (dB)	Ant Pos (cm)	Table Pos (deg)	Remark
45.93	29.14	-10.86	40	42.31	14.24	0.59	28	-	-	Peak
71.85	33.35	-6.65	40	49.22	11.47	0.72	28.06	100	12	Peak
209.01	33.45	-10.05	43.5	49.66	10.78	1.17	28.16	-	-	Peak
300	29.59	-16.41	46	42.27	14.1	1.4	28.18	-	-	Peak
600.3	31.09	-14.91	46	36.69	20.2	2.05	27.85	-	-	Peak
957.3	36.16	-9.84	46	35.92	24.53	2.62	26.91	-	-	Peak
2461	100.01	-	-	101.49	27.39	4.28	33.15	200	311	Average
2461	108.25	-	-	109.73	27.39	4.28	33.15	200	311	Peak
4925	46.46	-27.54	74	40.81	31.71	6.34	32.4	100	0	Peak
7386	48.47	-25.53	74	37.13	36.8	8.32	33.78	100	0	Peak



Test Mode :	802.11g	Temperature :	22~24°C
Test Channel :	11	Relative Humidity :	47~49%
Test Engineer :	Marlboro Hsu	Polarization :	Vertical
Remark :	1. 2463 MHz is fundamental signal which can be ignored. 2. Average measurement was not performed if peak level went lower than the average limit.		

Frequency (MHz)	Level (dBμV/m)	Over Limit (dB)	Limit Line (dBμV/m)	Read Level (dBμV)	Antenna Factor (dB)	Cable Loss (dB)	Preamp Factor (dB)	Ant Pos (cm)	Table Pos (deg)	Remark
39.72	36.72	-3.28	40	50.37	13.78	0.57	28	-	-	Peak
45.66	41.89	1.89	40	55.07	14.23	0.59	28	100	323	Peak
45.66	32.55	-7.45	40	45.73	14.23	0.59	28	100	323	QP
71.04	30.38	-9.62	40	46.07	11.66	0.71	28.06	-	-	Peak
304.9	26.04	-19.96	46	38.6	14.21	1.41	28.18	-	-	Peak
600.3	31.2	-14.8	46	36.8	20.2	2.05	27.85	-	-	Peak
957.3	36.72	-9.28	46	36.48	24.53	2.62	26.91	-	-	Peak
2463	100.46	-	-	101.92	27.4	4.28	33.14	102	206	Average
2463	108.41	-	-	109.87	27.4	4.28	33.14	102	206	Peak
4925	49.06	-24.94	74	43.41	31.71	6.34	32.4	100	0	Peak
7386	48.46	-25.54	74	37.12	36.8	8.32	33.78	100	0	Peak



Test Mode :	802.11n HT20	Temperature :	22~24°C
Test Channel :	01	Relative Humidity :	47~49%
Test Engineer :	Marlboro Hsu	Polarization :	Horizontal
Remark :	1. 2411 MHz is fundamental signal which can be ignored. 2. Average measurement was not performed if peak level went lower than the average limit.		

Frequency (MHz)	Level (dBμV/m)	Over Limit (dB)	Limit Line (dBμV/m)	Read Level (dBμV)	Antenna Factor (dB)	Cable Loss (dB)	Preamp Factor (dB)	Ant Pos (cm)	Table Pos (deg)	Remark
2411	99.07	-	-	100.74	27.25	4.25	33.17	104	301	Average
2411	107.36	-	-	109.03	27.25	4.25	33.17	104	301	Peak
4824	41.09	-32.91	74	35.7	31.59	6.23	32.43	100	0	Peak

Test Mode :	802.11n HT20	Temperature :	22~24°C
Test Channel :	01	Relative Humidity :	47~49%
Test Engineer :	Marlboro Hsu	Polarization :	Vertical
Remark :	1. 2411 MHz is fundamental signal which can be ignored. 2. Average measurement was not performed if peak level went lower than the average limit.		

Frequency (MHz)	Level (dBμV/m)	Over Limit (dB)	Limit Line (dBμV/m)	Read Level (dBμV)	Antenna Factor (dB)	Cable Loss (dB)	Preamp Factor (dB)	Ant Pos (cm)	Table Pos (deg)	Remark
2411	98.28	-	-	99.95	27.25	4.25	33.17	100	204	Average
2411	106.27	-	-	107.94	27.25	4.25	33.17	100	204	Peak
4824	42.57	-31.43	74	37.18	31.59	6.23	32.43	100	0	Peak



Test Mode :	802.11n HT20	Temperature :	22~24°C
Test Channel :	06	Relative Humidity :	47~49%
Test Engineer :	Marlboro Hsu	Polarization :	Horizontal
Remark :	1. 2438 MHz is fundamental signal which can be ignored. 2. Average measurement was not performed if peak level went lower than the average limit.		

Frequency (MHz)	Level (dBμV/m)	Over Limit (dB)	Limit Line (dBμV/m)	Read Level (dBμV)	Antenna Factor (dB)	Cable Loss (dB)	Preamp Factor (dB)	Ant Pos (cm)	Table Pos (deg)	Remark
2438	100.67	-	-	102.22	27.33	4.27	33.15	101	296	Average
2438	109.14	-	-	110.69	27.33	4.27	33.15	101	296	Peak
4875	41.91	-32.09	74	36.39	31.65	6.29	32.42	100	0	Peak
7311	49.37	-24.63	74	38.06	36.61	8.42	33.72	100	0	Peak

Test Mode :	802.11n HT20	Temperature :	22~24°C
Test Channel :	06	Relative Humidity :	47~49%
Test Engineer :	Marlboro Hsu	Polarization :	Vertical
Remark :	1. 2438 MHz is fundamental signal which can be ignored. 2. Average measurement was not performed if peak level went lower than the average limit.		

Frequency (MHz)	Level (dBμV/m)	Over Limit (dB)	Limit Line (dBμV/m)	Read Level (dBμV)	Antenna Factor (dB)	Cable Loss (dB)	Preamp Factor (dB)	Ant Pos (cm)	Table Pos (deg)	Remark
2438	100.16	-	-	101.71	27.33	4.27	33.15	102	207	Average
2438	108.84	-	-	110.39	27.33	4.27	33.15	102	207	Peak
4874	45.63	-28.37	74	40.11	31.65	6.29	32.42	100	0	Peak
7311	50.16	-23.84	74	38.85	36.61	8.42	33.72	100	0	Peak



Test Mode :	802.11n HT20	Temperature :	22~24°C
Test Channel :	11	Relative Humidity :	47~49%
Test Engineer :	Marlboro Hsu	Polarization :	Horizontal
Remark :	1. 2463 MHz is fundamental signal which can be ignored. 2. Average measurement was not performed if peak level went lower than the average limit.		

Frequency (MHz)	Level (dBμV/m)	Over Limit (dB)	Limit Line (dBμV/m)	Read Level (dBμV)	Antenna Factor (dB)	Cable Loss (dB)	Preamp Factor (dB)	Ant Pos (cm)	Table Pos (deg)	Remark
72.12	31.95	-8.05	40	47.88	11.41	0.72	28.06	100	141	Peak
209.01	33.31	-10.19	43.5	49.52	10.78	1.17	28.16	-	-	Peak
285.69	35.7	-10.3	46	48.71	13.81	1.36	28.18	-	-	Peak
300	29.54	-16.46	46	42.22	14.1	1.4	28.18	-	-	Peak
600.3	30.59	-15.41	46	36.19	20.2	2.05	27.85	-	-	Peak
957.3	36.34	-9.66	46	36.1	24.53	2.62	26.91	-	-	Peak
2463	98.66	-	-	100.12	27.4	4.28	33.14	100	305	Average
2463	106.68	-	-	108.14	27.4	4.28	33.14	100	305	Peak
4923	42.81	-31.19	74	37.17	31.71	6.34	32.41	100	0	Peak
7386	48.6	-25.4	74	37.26	36.8	8.32	33.78	100	0	Peak



Test Mode :	802.11n HT20	Temperature :	22~24°C
Test Channel :	11	Relative Humidity :	47~49%
Test Engineer :	Marlboro Hsu	Polarization :	Vertical
Remark :	1. 2463 MHz is fundamental signal which can be ignored. 2. Average measurement was not performed if peak level went lower than the average limit.		

Frequency (MHz)	Level (dBμV/m)	Over Limit (dB)	Limit Line (dBμV/m)	Read Level (dBμV)	Antenna Factor (dB)	Cable Loss (dB)	Preamp Factor (dB)	Ant Pos (cm)	Table Pos (deg)	Remark
39.45	37.3	-2.7	40	50.97	13.77	0.56	28	-	-	Peak
45.39	41.85	1.85	40	55.04	14.22	0.59	28	100	324	Peak
45.39	33.93	-6.07	40	47.12	14.22	0.59	28	100	324	QP
70.77	30.49	-9.51	40	46.12	11.72	0.71	28.06	-	-	Peak
302.8	28.43	-17.57	46	41.04	14.16	1.41	28.18	-	-	Peak
599.6	31.34	-14.66	46	36.95	20.19	2.05	27.85	-	-	Peak
957.3	35.81	-10.19	46	35.57	24.53	2.62	26.91	-	-	Peak
2463	98.88	-	-	100.34	27.4	4.28	33.14	102	208	Average
2463	106.97	-	-	108.43	27.4	4.28	33.14	102	208	Peak
4923	44.03	-29.97	74	38.39	31.71	6.34	32.41	100	0	Peak
7386	48.44	-25.56	74	37.1	36.8	8.32	33.78	100	0	Peak



Test Mode :	802.11n HT40	Temperature :	22~24°C
Test Channel :	03	Relative Humidity :	47~49%
Test Engineer :	Marlboro Hsu	Polarization :	Horizontal
Remark :	1. 2420 MHz is fundamental signal which can be ignored. 2. Average measurement was not performed if peak level went lower than the average limit.		

Frequency (MHz)	Level (dBμV/m)	Over Limit (dB)	Limit Line (dBμV/m)	Read Level (dBμV)	Antenna Factor (dB)	Cable Loss (dB)	Preamp Factor (dB)	Ant Pos (cm)	Table Pos (deg)	Remark
46.74	29.03	-10.97	40	42.17	14.27	0.59	28	-	-	Peak
70.77	30.69	-9.31	40	46.32	11.72	0.71	28.06	-	-	Peak
282.45	37.5	-8.5	46	50.58	13.75	1.35	28.18	-	-	Peak
304.9	31.25	-14.75	46	43.81	14.21	1.41	28.18	-	-	Peak
600.3	30.83	-15.17	46	36.43	20.2	2.05	27.85	-	-	Peak
958	37.52	-8.48	46	37.27	24.53	2.63	26.91	100	181	Peak
2420	96.51	-	-	98.13	27.28	4.26	33.16	104	298	Average
2420	104.47	-	-	106.09	27.28	4.26	33.16	104	298	Peak
4845	41.87	-32.13	74	36.43	31.61	6.25	32.42	100	0	Peak
7266	48.75	-25.25	74	37.46	36.49	8.48	33.68	100	0	Peak



Test Mode :	802.11n HT40	Temperature :	22~24°C
Test Channel :	03	Relative Humidity :	47~49%
Test Engineer :	Marlboro Hsu	Polarization :	Vertical
Remark :	1. 2424 MHz is fundamental signal which can be ignored. 2. Average measurement was not performed if peak level went lower than the average limit.		

Frequency (MHz)	Level (dBμV/m)	Over Limit (dB)	Limit Line (dBμV/m)	Read Level (dBμV)	Antenna Factor (dB)	Cable Loss (dB)	Preamp Factor (dB)	Ant Pos (cm)	Table Pos (deg)	Remark
39.72	35.33	-4.67	40	48.98	13.78	0.57	28	-	-	Peak
46.2	42.13	2.13	40	55.29	14.25	0.59	28	100	306	Peak
46.2	32.56	-7.44	40	45.72	14.25	0.59	28	100	306	QP
70.77	30.04	-9.96	40	45.67	11.72	0.71	28.06	-	-	Peak
301.4	25.36	-20.64	46	38.01	14.13	1.4	28.18	-	-	Peak
600.3	31.31	-14.69	46	36.91	20.2	2.05	27.85	-	-	Peak
957.3	36.9	-9.1	46	36.66	24.53	2.62	26.91	-	-	Peak
2424	95.95	-	-	97.56	27.29	4.26	33.16	102	208	Average
2424	103.31	-	-	104.92	27.29	4.26	33.16	102	208	Peak
4845	42.18	-31.82	74	36.74	31.61	6.25	32.42	100	0	Peak
7266	49.24	-24.76	74	37.95	36.49	8.48	33.68	100	0	Peak



Test Mode :	802.11n HT40	Temperature :	22~24°C
Test Channel :	06	Relative Humidity :	47~49%
Test Engineer :	Marlboro Hsu	Polarization :	Horizontal
Remark :	1. 2439 MHz is fundamental signal which can be ignored. 2. Average measurement was not performed if peak level went lower than the average limit.		

Frequency (MHz)	Level (dBμV/m)	Over Limit (dB)	Limit Line (dBμV/m)	Read Level (dBμV)	Antenna Factor (dB)	Cable Loss (dB)	Preamp Factor (dB)	Ant Pos (cm)	Table Pos (deg)	Remark
2439	98.38	-	-	99.93	27.33	4.27	33.15	102	299	Average
2439	106	-	-	107.55	27.33	4.27	33.15	102	299	Peak
4875	41.72	-32.28	74	36.2	31.65	6.29	32.42	100	0	Peak
7311	49.39	-24.61	74	38.08	36.61	8.42	33.72	100	0	Peak

Test Mode :	802.11n HT40	Temperature :	22~24°C
Test Channel :	06	Relative Humidity :	47~49%
Test Engineer :	Marlboro Hsu	Polarization :	Vertical
Remark :	1. 2439 MHz is fundamental signal which can be ignored. 2. Average measurement was not performed if peak level went lower than the average limit.		

Frequency (MHz)	Level (dBμV/m)	Over Limit (dB)	Limit Line (dBμV/m)	Read Level (dBμV)	Antenna Factor (dB)	Cable Loss (dB)	Preamp Factor (dB)	Ant Pos (cm)	Table Pos (deg)	Remark
2439	97.46	-	-	99.01	27.33	4.27	33.15	102	208	Average
2439	105.28	-	-	106.83	27.33	4.27	33.15	102	208	Peak
4875	43.42	-30.58	74	37.9	31.65	6.29	32.42	100	0	Peak
7311	49.19	-24.81	74	37.88	36.61	8.42	33.72	100	0	Peak



Test Mode :	802.11n HT40	Temperature :	22~24°C
Test Channel :	09	Relative Humidity :	47~49%
Test Engineer :	Marlboro Hsu	Polarization :	Horizontal
Remark :	1. 2450 MHz is fundamental signal which can be ignored. 2. Average measurement was not performed if peak level went lower than the average limit.		

Frequency (MHz)	Level (dBμV/m)	Over Limit (dB)	Limit Line (dBμV/m)	Read Level (dBμV)	Antenna Factor (dB)	Cable Loss (dB)	Preamp Factor (dB)	Ant Pos (cm)	Table Pos (deg)	Remark
2450	96.91	-	-	98.43	27.36	4.27	33.15	100	297	Average
2450	104.15	-	-	105.67	27.36	4.27	33.15	100	297	Peak
4905	41.25	-32.75	74	35.65	31.69	6.32	32.41	100	0	Peak
7356	48.49	-25.51	74	37.15	36.73	8.36	33.75	100	0	Peak

Test Mode :	802.11n HT40	Temperature :	22~24°C
Test Channel :	09	Relative Humidity :	47~49%
Test Engineer :	Marlboro Hsu	Polarization :	Vertical
Remark :	1. 2450 MHz is fundamental signal which can be ignored. 2. Average measurement was not performed if peak level went lower than the average limit.		

Frequency (MHz)	Level (dBμV/m)	Over Limit (dB)	Limit Line (dBμV/m)	Read Level (dBμV)	Antenna Factor (dB)	Cable Loss (dB)	Preamp Factor (dB)	Ant Pos (cm)	Table Pos (deg)	Remark
2450	95.71	-	-	97.23	27.36	4.27	33.15	102	209	Average
2450	103.54	29.54	74	105.06	27.36	4.27	33.15	102	209	Peak
4905	41.45	-32.55	74	35.85	31.69	6.32	32.41	100	0	Peak
7356	48.75	-25.25	74	37.41	36.73	8.36	33.75	100	0	Peak

3.6 AC Conducted Emission Measurement

3.6.1 Limit of AC Conducted Emission

For equipment that is designed to be connected to the public utility (AC) power line, the radio frequency voltage that is conducted back onto the AC power line on any frequency or frequencies within the band 150 kHz to 30 MHz shall not exceed the limits in the following table.

Frequency of Emission (MHz)	Conducted Limit (dB μ V)	
	Quasi-Peak	Average
0.15-0.5	66 to 56*	56 to 46*
0.5-5	56	46
5-30	60	50

*Decreases with the logarithm of the frequency.

3.6.2 Measuring Instruments

The measuring equipment is listed in the section 4 of this test report.

3.6.3 Test Procedures

1. The EUT was placed 0.4 meter from the conducting wall of the shielding room, and it was kept at least 80 centimeters from any other grounded conducting surface.
2. Connect EUT to the power mains through a line impedance stabilization network (LISN).
3. All the support units are connecting to the other LISN.
4. The LISN provides 50 ohm coupling impedance for the measuring instrument.
5. The FCC states that a 50 ohm, 50 microhenry LISN should be used.
6. Both sides of AC line were checked for maximum conducted interference.
7. The frequency range from 150 kHz to 30 MHz was searched.
8. Set the test-receiver system to Peak Detect Function and specified bandwidth with Maximum Hold Mode.

3.6.4 Test Setup

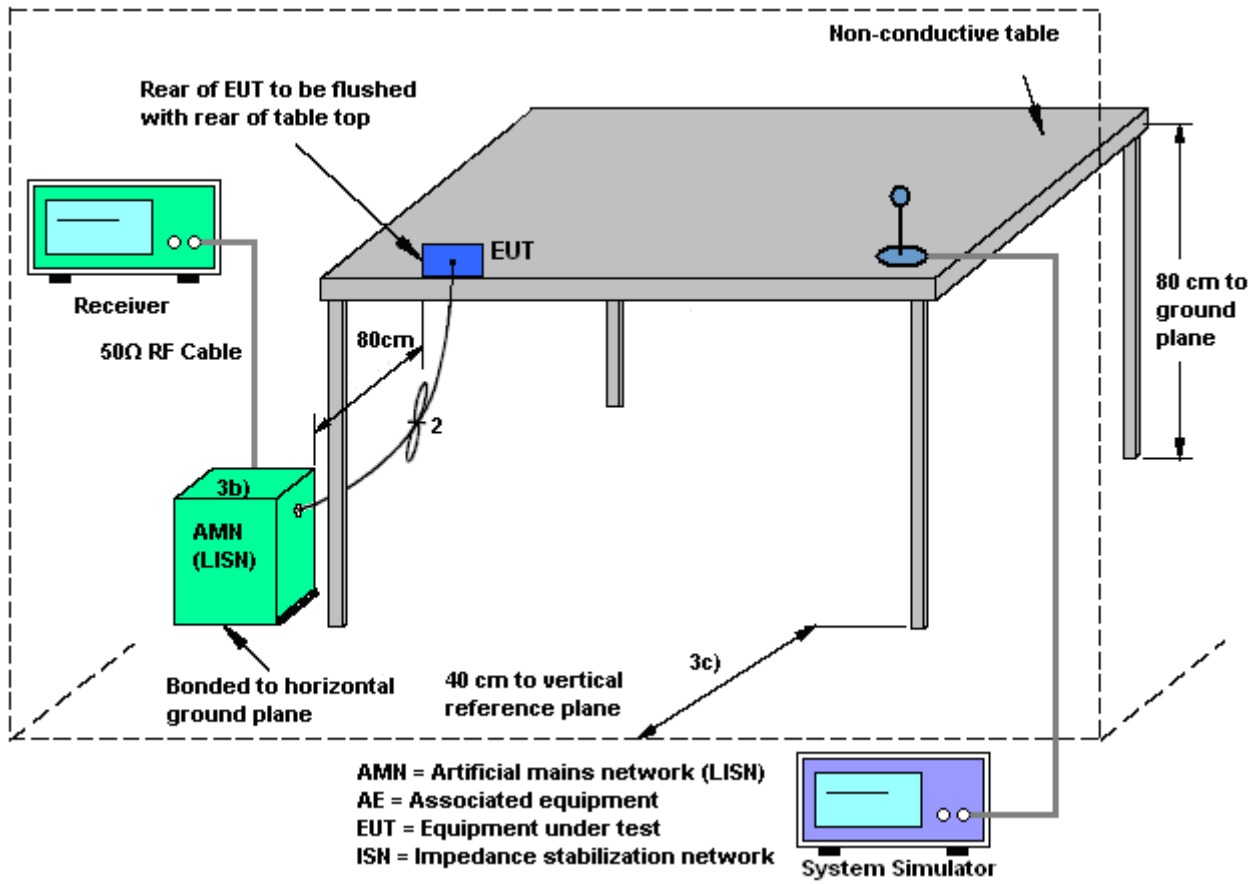

3.6.5 Test Result of AC Conducted Emission

Test Mode :	Mode 1	Temperature :	20~22°C
Test Engineer :	Cosmo Xu	Relative Humidity :	45~47%
Test Voltage :	120Vac / 60Hz	Phase :	Line
Function Type :	LTE Band 4 Idle + VOIP + WLAN Idle + LAN Link + Adapter		

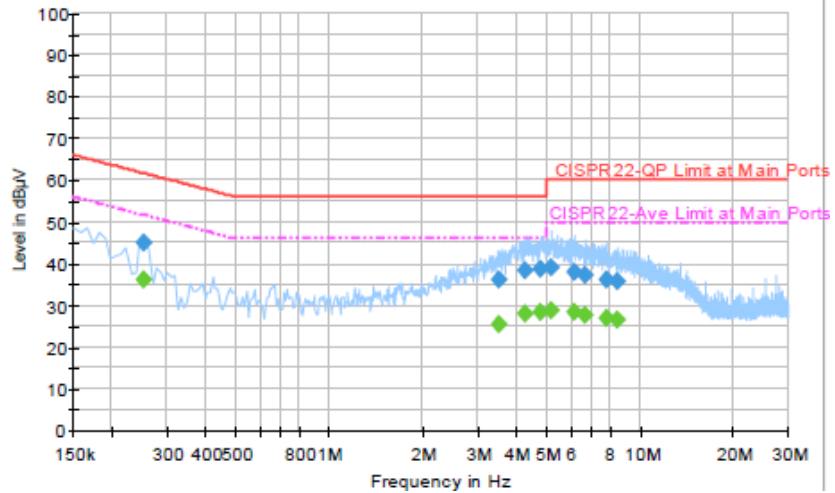

Final Result : QuasiPeak

Frequency (MHz)	QuasiPeak (dBµV)	Filter	Line	Corr. (dB)	Margin (dB)	Limit (dBµV)
0.254000	45.2	Off	L1	19.4	16.4	61.6
3.510000	36.1	Off	L1	19.6	19.9	56.0
4.278000	38.5	Off	L1	19.6	17.5	56.0
4.766000	38.8	Off	L1	19.6	17.2	56.0
5.174000	39.0	Off	L1	19.5	21.0	60.0
6.166000	37.9	Off	L1	19.6	22.1	60.0
6.670000	37.4	Off	L1	19.6	22.6	60.0
7.782000	36.2	Off	L1	19.5	23.8	60.0
8.470000	35.6	Off	L1	19.6	24.4	60.0

Final Result : Average

Frequency (MHz)	Average (dBµV)	Filter	Line	Corr. (dB)	Margin (dB)	Limit (dBµV)
0.254000	36.0	Off	L1	19.4	15.6	51.6
3.510000	25.3	Off	L1	19.6	20.7	46.0
4.278000	28.1	Off	L1	19.6	17.9	46.0
4.766000	28.4	Off	L1	19.6	17.6	46.0
5.174000	28.7	Off	L1	19.5	21.3	50.0
6.166000	28.3	Off	L1	19.6	21.7	50.0
6.670000	27.8	Off	L1	19.6	22.2	50.0
7.782000	27.0	Off	L1	19.5	23.0	50.0
8.470000	26.7	Off	L1	19.6	23.3	50.0



Test Mode :	Mode 1	Temperature :	20~22°C
Test Engineer :	Cosmo Xu	Relative Humidity :	45~47%
Test Voltage :	120Vac / 60Hz	Phase :	Neutral
Function Type :	LTE Band 4 Idle + VOIP + WLAN Idle + LAN Link + Adapter		

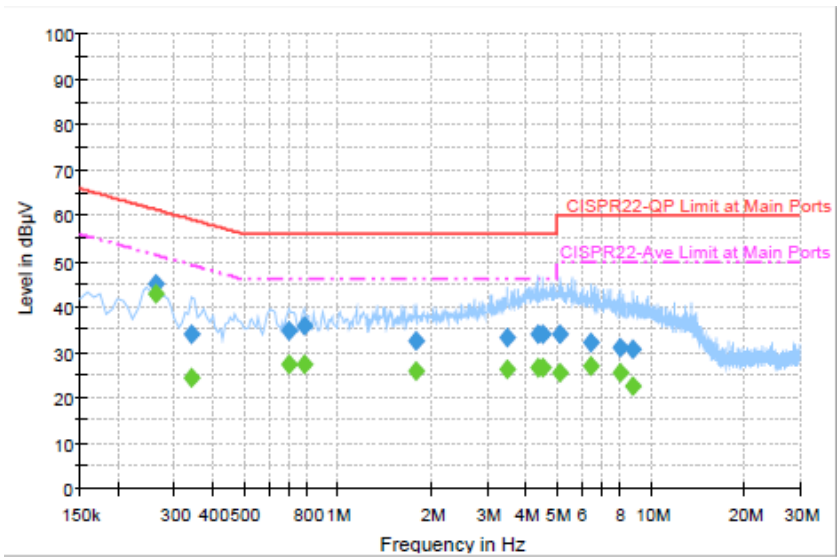

Final Result : QuasiPeak

Frequency (MHz)	QuasiPeak (dBµV)	Filter	Line	Corr. (dB)	Margin (dB)	Limit (dBµV)
0.262000	44.9	Off	N	19.4	16.5	61.4
0.342000	33.9	Off	N	19.4	25.3	59.2
0.702000	34.6	Off	N	19.5	21.4	56.0
0.782000	35.7	Off	N	19.5	20.3	56.0
1.782000	32.6	Off	N	19.6	23.4	56.0
3.486000	33.2	Off	N	19.6	22.8	56.0
4.366000	34.1	Off	N	19.6	21.9	56.0
4.542000	34.0	Off	N	19.6	22.0	56.0
5.118000	33.8	Off	N	19.6	26.2	60.0
6.478000	32.0	Off	N	19.6	28.0	60.0
7.982000	31.2	Off	N	19.7	28.8	60.0
8.798000	30.8	Off	N	19.8	29.2	60.0



Test Mode :	Mode 1	Temperature :	20~22°C
Test Engineer :	Cosmo Xu	Relative Humidity :	45~47%
Test Voltage :	120Vac / 60Hz	Phase :	Neutral
Function Type :	LTE Band 4 Idle + VOIP + WLAN Idle + LAN Link + Adapter		

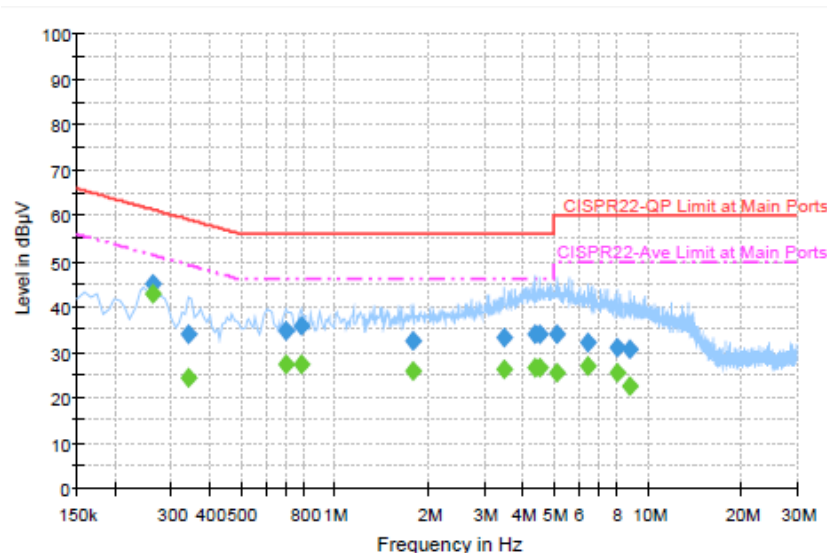

Final Result : Average

Frequency (MHz)	Average (dBµV)	Filter	Line	Corr. (dB)	Margin (dB)	Limit (dBµV)
0.262000	42.8	Off	N	19.4	8.6	51.4
0.342000	24.2	Off	N	19.4	25.0	49.2
0.702000	27.5	Off	N	19.5	18.5	46.0
0.782000	27.3	Off	N	19.5	18.7	46.0
1.782000	25.9	Off	N	19.6	20.1	46.0
3.486000	26.1	Off	N	19.6	19.9	46.0
4.366000	26.6	Off	N	19.6	19.4	46.0
4.542000	26.5	Off	N	19.6	19.5	46.0
5.118000	25.6	Off	N	19.6	24.4	50.0
6.478000	27.1	Off	N	19.6	22.9	50.0
7.982000	25.5	Off	N	19.7	24.5	50.0
8.798000	22.7	Off	N	19.8	27.3	50.0



3.7 Antenna Requirements

3.7.1 Standard Applicable

If directional gain of transmitting Antennas is greater than 6dBi, the power shall be reduced by the same level in dB comparing to gain minus 6dBi. For the fixed point-to-point operation, the power shall be reduced by one dB for every 3 dB that the directional gain of the Antenna exceeds 6 dBi. The use of a permanently attached Antenna or of an Antenna that uses a unique coupling to the intentional radiator shall be considered sufficient to comply with the FCC rule.

3.7.2 Antenna Anti-Replacement Construction

An embedded-in antenna design is used.

3.7.3 Antenna Gain

FCC KDB 662911 D01 Multiple Transmitter Output v02r01.

For CDD transmissions, directional gain is calculated as

$$DirectionalGain = 10 \cdot \log \left[\frac{\sum_{j=1}^{N_{SS}} \left\{ \sum_{k=1}^{N_{ANT}} g_{j,k} \right\}^2}{N_{ANT}} \right]$$

where

Each antenna is driven by no more than one spatial stream;

N_{SS} = the number of independent spatial streams of data;

N_{ANT} = the total number of antennas

$g_{j,k} = 10^{G_k / 20}$ if the k th antenna is being fed by spatial stream j , or zero if it is not;
 G_k is the gain in dBi of the k th antenna.

The EUT supports CDD mode.

The power and PSD limit should be modified if the directional gain of EUT is over 6 dBi,

The directional gain “DG” is calculated as following table.

			DG	DG	Power	PSD
	Ant. 1	Ant. 2	for	for	Limit	Limit
	(dBi)	(dBi)	Power	PSD	Reduction	Reduction
	(dBi)	(dBi)	(dBi)	(dBi)	(dB)	(dB)
2.4 GHz	3.50	3.00	6.26	6.26	0.26	0.26

Power Limit Reduction = $DG(\text{Power}) - 6\text{dBi}$, (min = 0)

PSD Limit Reduction = $DG(\text{PSD}) - 6\text{dBi}$, (min = 0)



4 List of Measuring Equipment

Instrument	Manufacturer	Model No.	Serial No.	Characteristics	Calibration Date	Test Date	Due Date	Remark
Spectrum Analyzer	Rohde & Schwarz	FSP40	100055	9kHz~40GHz	Jun. 07, 2013	May 26, 2014~ Jun. 04, 2014	Jun. 06, 2014	Conducted (TH02-HY)
Power Meter	Anritsu	ML2495A	1036004	300MHz~40GHz	Aug. 17, 2013	May 26, 2014~ Jun. 04, 2014	Aug. 16, 2014	Conducted (TH02-HY)
Power Sensor	Anritsu	MA2411B	1027253	300MHz~40GHz	Aug. 17, 2013	May 26, 2014~ Jun. 04, 2014	Aug. 16, 2014	Conducted (TH02-HY)
EMI Test Receiver	Rohde & Schwarz	ESCS 30	100356	9kHz ~ 2.75GHz	Nov. 15, 2013	Jun. 04, 2014	Nov. 14, 2014	Conduction (CO05-HY)
LISN (for auxiliary equipment)	Rohde & Schwarz	ENV216	100081	9kHz ~ 30MHz	Dec. 12, 2013	Jun. 04, 2014	Dec. 11, 2014	Conduction (CO05-HY)
LISN	Rohde & Schwarz	ENV216	100080	9kHz ~ 30MHz	Dec. 04, 2013	Jun. 04, 2014	Dec. 03, 2014	Conduction (CO05-HY)
AC Power Source	ChainTek	APC-1000W	N/A	N/A	N/A	Jun. 04, 2014	N/A	Conduction (CO05-HY)
EMI Test Receiver	Rohde & Schwarz	ESCI 7	100724	9 kHz~7 GHz	Sep. 06, 2013	May 27, 2014~ May 28, 2014	Sep. 05, 2014	Radiation (03CH07-HY)
Spectrum Analyzer	Rohde & Schwarz	FSV30	101749	10Hz ~ 30GHz	Feb. 10, 2014	May 27, 2014~ May 28, 2014	Feb. 09, 2015	Radiation (03CH07-HY)
Loop Antenna	Rohde & Schwarz	HFH2-Z2	860004/0001	9 kHz~30 MHz	Jul. 03, 2012	May 27, 2014~ May 28, 2014	Jul. 03, 2014	Radiation (03CH07-HY)
Bilog Antenna	Schaffner	CBL6111C	2726	30 MHz ~ 1 GHz	Oct. 10, 2013	May 27, 2014~ May 28, 2014	Oct. 09, 2014	Radiation (03CH07-HY)
Double Ridge Horn Antenna	ESCO	3117	75962	1 GHz~18 GHz	Aug. 22, 2013	May 27, 2014~ May 28, 2014	Aug. 21, 2014	Radiation (03CH07-HY)
SHF-EHF Horn Antenna	SCHWARZBECK	BBHA 9170	BBHA9170251	15 GHz- 40 GHz	Oct. 03, 2013	May 27, 2014~ May 28, 2014	Oct. 02, 2014	Radiation (03CH07-HY)
Preamplifier	COM-POWER	PA-103A	161241	10 MHz ~ 1000MHz 32dB GAIN	Mar. 17, 2014	May 27, 2014~ May 28, 2014	Mar. 16, 2015	Radiation (03CH07-HY)
Preamplifier	Agilent	8449B	3008A02362	1 GHz~26.5 GHz	Nov. 29, 2013	May 27, 2014~ May 28, 2014	Nov. 28, 2014	Radiation (03CH07-HY)
Preamplifier	MITEQ	AMF-7D-0010 1800-30-10P	1590074	DC~18 G High Gain	Jul. 09, 2013	May 27, 2014~ May 28, 2014	Jul. 08, 2014	Radiation (03CH07-HY)
Turn Table	ChainTek	ChainTek 3000	N/A	0 ~ 360 degree	N/A	May 27, 2014~ May 28, 2014	N/A	Radiation (03CH07-HY)
Antenna Mast	ChainTek	ChainTek 3000	N/A	N/A	N/A	May 27, 2014~ May 28, 2014	N/A	Radiation (03CH07-HY)



5 Uncertainty of Evaluation

Uncertainty of Conducted Emission Measurement (150kHz ~ 30MHz)

Measuring Uncertainty for a Level of Confidence of 95% ($U = 2Uc(y)$)	2.26
---	------

Uncertainty of Radiated Emission Measurement (30 MHz ~ 1000 MHz)

Measuring Uncertainty for a Level of Confidence of 95% ($U = 2Uc(y)$)	4.50
---	------