



3.5 Conducted Band Edge Measurement

3.5.1 Description of Conducted Band Edge Measurement

27.53 (f) and RSS – 130

For operations in the 698 -746 MHz band, the FCC limit is $43 + 10\log_{10}(P[\text{Watts}])$ dB below the transmitter power P(Watts) in a 100 kHz bandwidth. However, in the 100 kilohertz bands immediately outside and adjacent to a licensee's frequency block, a resolution bandwidth of at least 30 kHz may be employed.

27.53 (g) and RSS – 139

For operations in the 1710 – 1755 MHz band, the FCC limit is $43 + 10\log_{10}(P[\text{Watts}])$ dB below the transmitter power P(Watts) in a 1 MHz bandwidth. However, in the 1MHz bands immediately outside and adjacent to the licensee's frequency block, a resolution bandwidth of at least one percent of the emission bandwidth of the fundamental emission of the transmitter may be employed.

27.53 (l)(4) and RSS – 199

The emissions be operated in the 2496-2690 MHz band, the attenuation factor of transmitter Power (P) shall be not less than $55 + 10 \log (P)$ dB at the channel edge

3.5.2 Measuring Instruments

The measuring equipment is listed in the section 4 of this test report.

3.5.3 Test Procedures

1. The EUT was connected to spectrum analyzer and system simulator via a power divider.
2. The band edges of low and high channels for the highest RF powers were measured. Set RBW $\geq 1\%$ EBW in the 1MHz band immediately outside and adjacent to the band edge.
3. Set spectrum analyzer with RMS detector.
4. The RF fundamental frequency should be excluded against the limit line in the operating frequency band.
5. The limit line is derived from $43 + 10\log(P)$ dB below the transmitter power P(Watts)
= $P(W) - [43 + 10\log(P)]$ (dB)
= $[30 + 10\log(P)]$ (dBm) - $[43 + 10\log(P)]$ (dB)
= -13dBm.

3.5.4 Test Setup

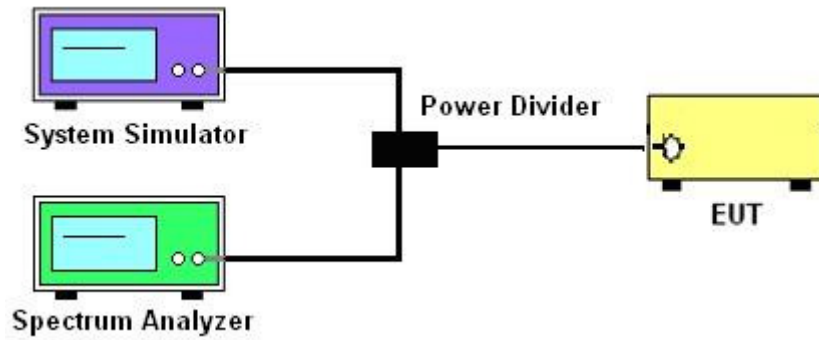



3.5.5 Test Result (Plots) of Conducted Band Edge

Band :	LTE Band 4	Band Width :	1.4MHz / QPSK
---------------	------------	---------------------	---------------

Lower Band Edge Plot for QPSK-RB Size 1, RB Offset 0

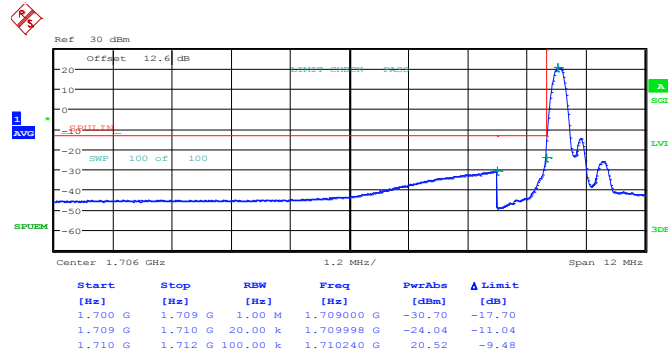

Date: 25.MAY.2014 07:41:55

Lower Band Edge Plot for QPSK-RB Size 6, RB Offset 0

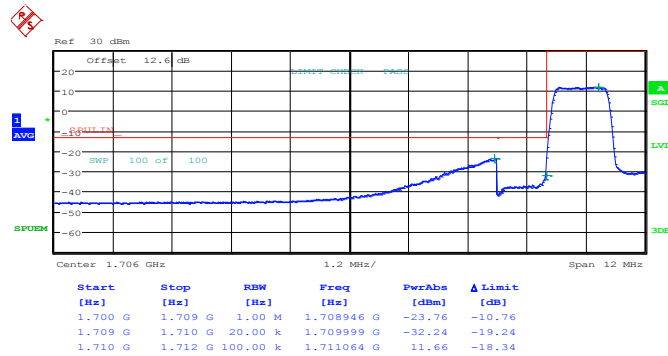

Date: 25.MAY.2014 07:43:30



Higher Band Edge Plot for QPSK-RB Size 1, RB Offset 5

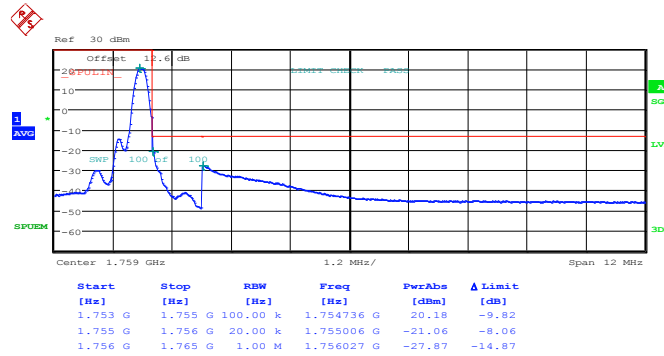

Date: 25.MAY.2014 07:51:23

Higher Band Edge Plot for QPSK-RB Size 6, RB Offset 0

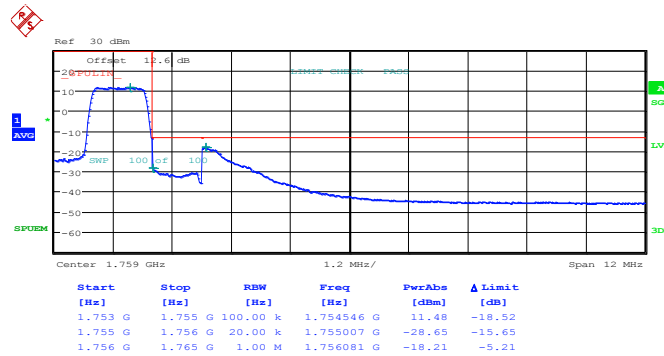

Date: 25.MAY.2014 07:52:57



Band :	LTE Band 4	Band Width :	1.4MHz / 16QAM
---------------	------------	---------------------	----------------

Lower Band Edge Plot for 16QAM-RB Size 1, RB Offset 0

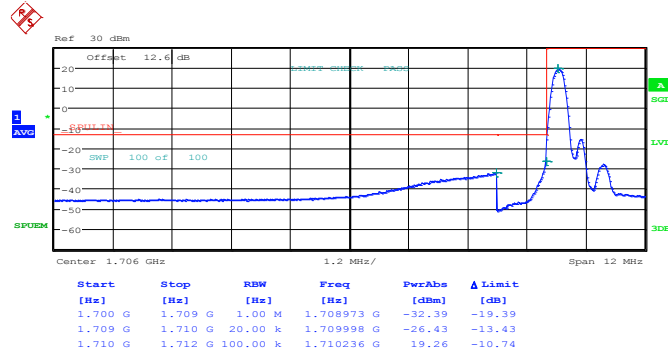

Date: 25.MAY.2014 07:42:42

Lower Band Edge Plot for 16QAM-RB Size 6, RB Offset 0

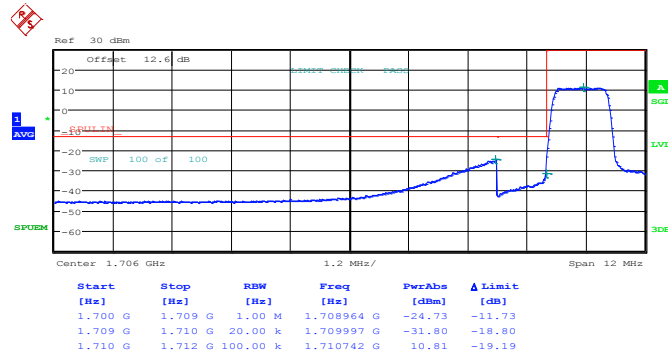

Date: 25.MAY.2014 07:44:17



Higher Band Edge Plot for 16QAM-RB Size 1, RB Offset 5

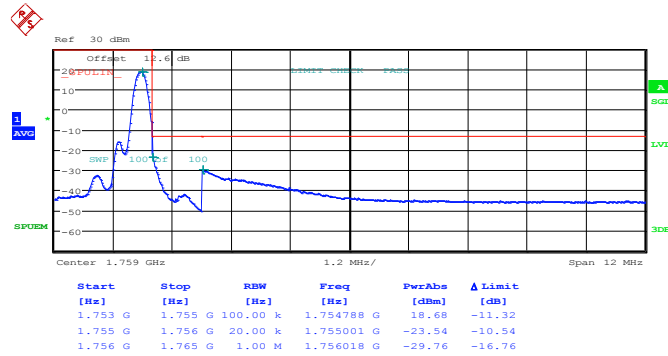

Date: 25.MAY.2014 07:52:10

Higher Band Edge Plot for 16QAM-RB Size 6, RB Offset 0

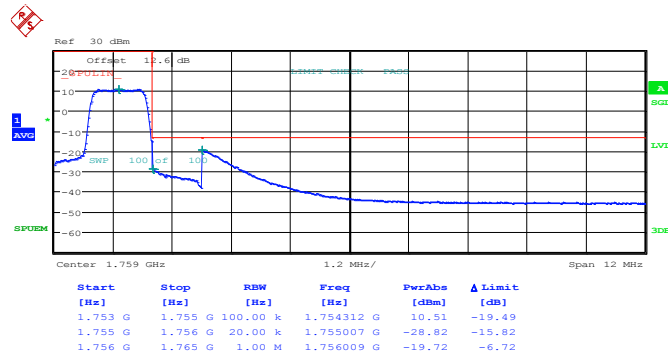

Date: 25.MAY.2014 07:53:45



Band :	LTE Band 4	Band Width :	3MHz / QPSK
---------------	------------	---------------------	-------------

Lower Band Edge Plot for QPSK-RB Size 1, RB Offset 0

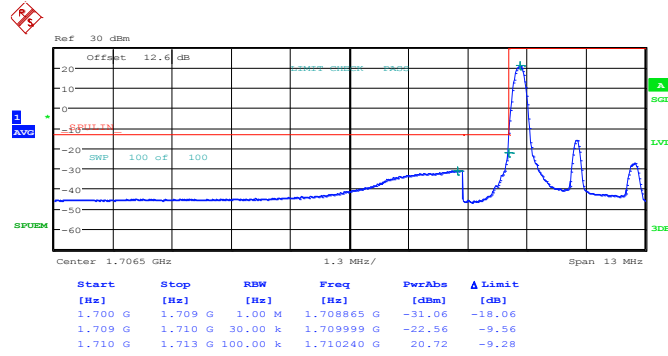

Date: 25.MAY.2014 07:57:45

Lower Band Edge Plot for QPSK-RB Size 15, RB Offset 0

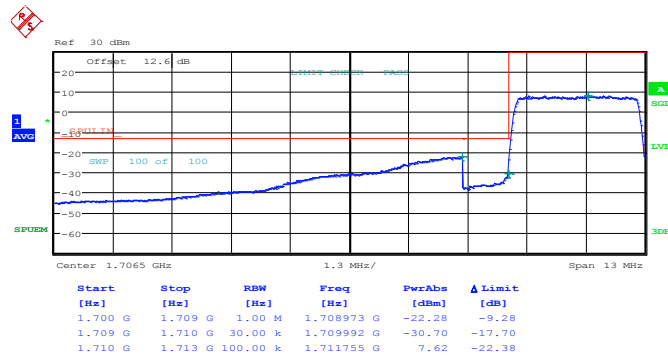

Date: 25.MAY.2014 07:59:20



Higher Band Edge Plot for QPSK-RB Size 1, RB Offset 14

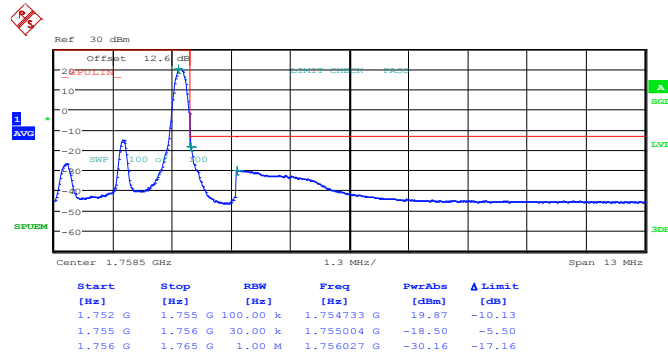

Date: 25.MAY.2014 08:07:16

Higher Band Edge Plot for QPSK-RB Size 15, RB Offset 0

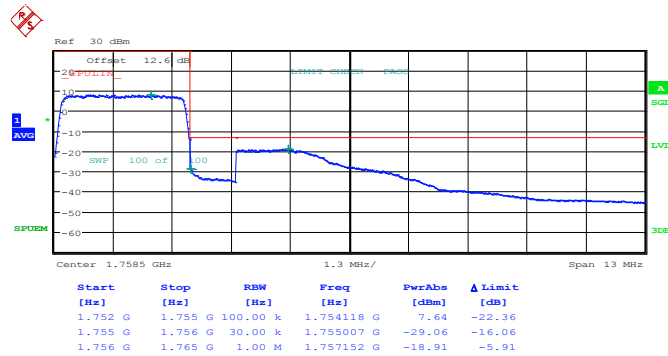

Date: 25.MAY.2014 08:08:50



Band :	LTE Band 4	Band Width :	3MHz / 16QAM
---------------	------------	---------------------	--------------

Lower Band Edge Plot for 16QAM-RB Size 1, RB Offset 0

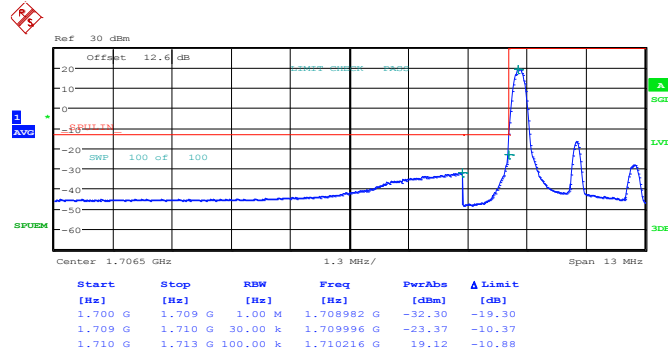

Date: 25.MAY.2014 07:58:33

Lower Band Edge Plot for 16QAM-RB Size 15, RB Offset 0

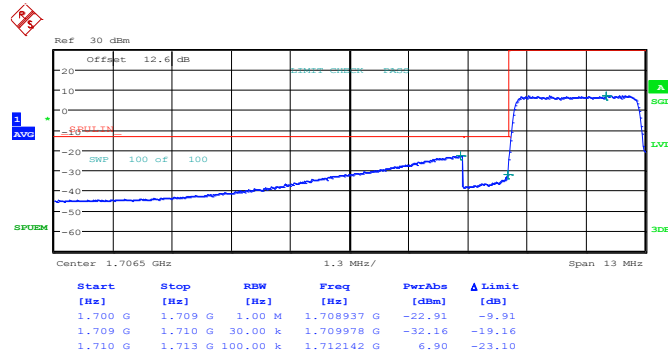

Date: 25.MAY.2014 08:00:07



Higher Band Edge Plot for 16QAM-RB Size 1, RB Offset 14

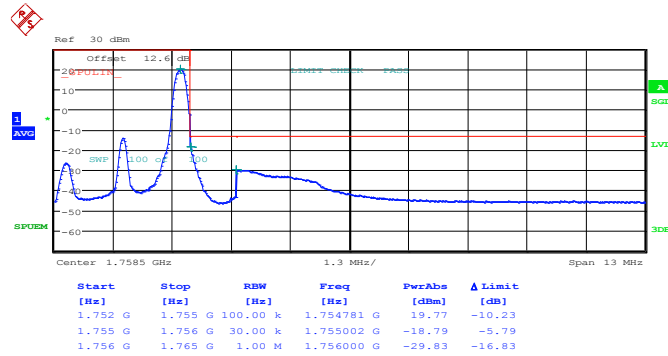

Date: 25.MAY.2014 08:08:03

Higher Band Edge Plot for 16QAM-RB Size 15, RB Offset 0

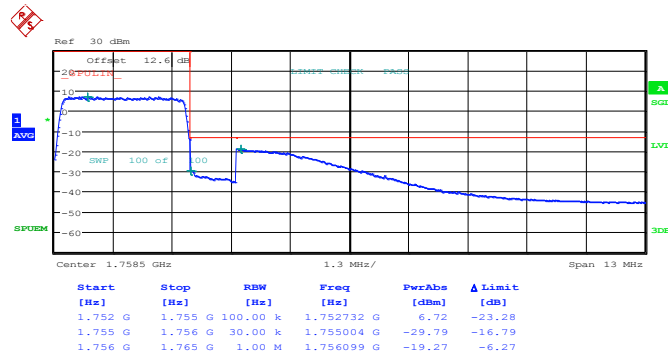

Date: 25.MAY.2014 08:09:38



Band :	LTE Band 4	Band Width :	5MHz / QPSK
---------------	------------	---------------------	-------------

Lower Band Edge Plot for QPSK-RB Size 1, RB Offset 0

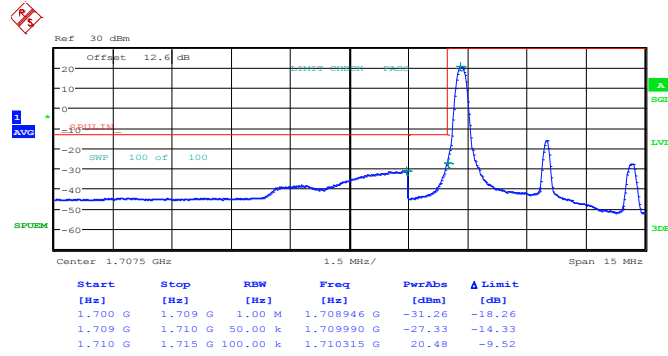

Date: 25.MAY.2014 08:13:39

Lower Band Edge Plot for QPSK-RB Size 25, RB Offset 0

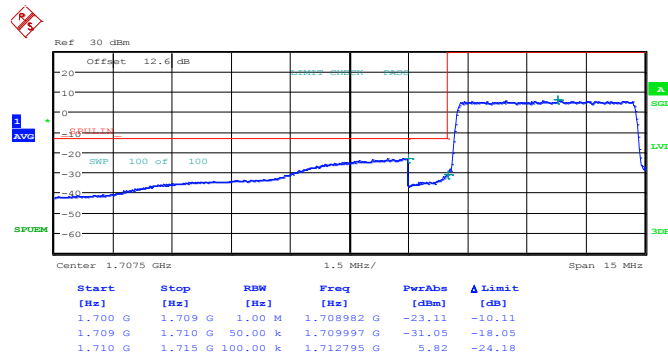

Date: 25.MAY.2014 08:15:14



Higher Band Edge Plot for QPSK-RB Size 1, RB Offset 24

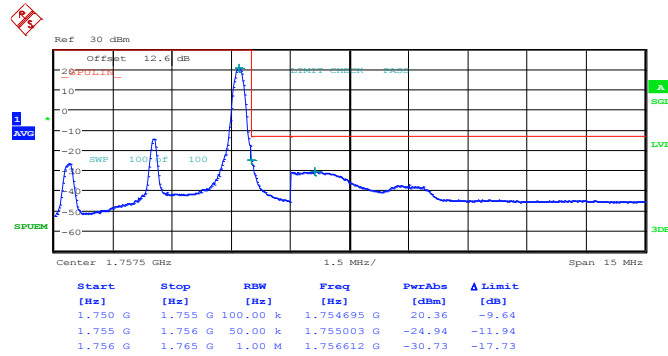

Date: 25.MAY.2014 08:23:07

Higher Band Edge Plot for QPSK-RB Size 25, RB Offset 0

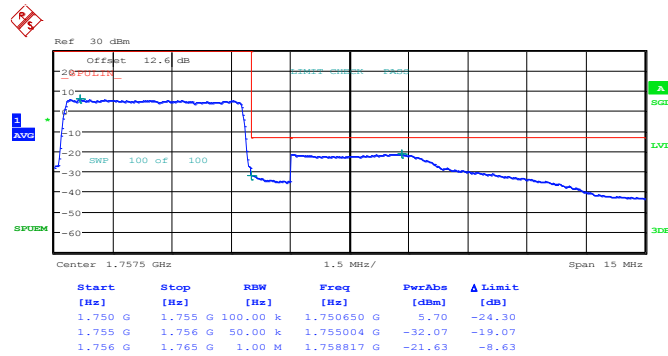

Date: 25.MAY.2014 08:24:42



Band :	LTE Band 4	Band Width :	5MHz / 16QAM
---------------	------------	---------------------	--------------

Lower Band Edge Plot for 16QAM-RB Size 1, RB Offset 0

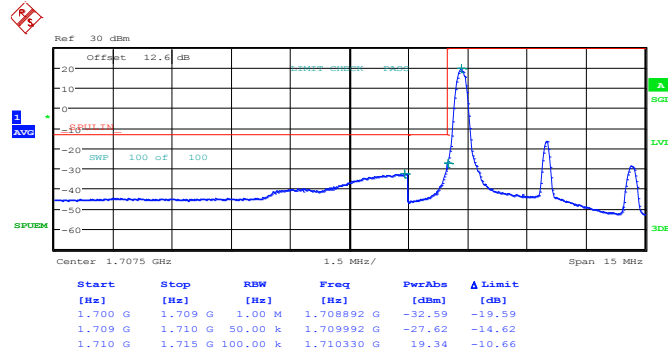

Date: 25.MAY.2014 08:14:26

Lower Band Edge Plot for 16QAM-RB Size 25, RB Offset 0

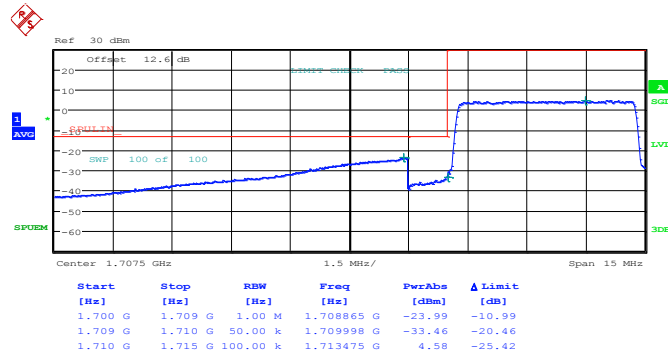

Date: 25.MAY.2014 08:16:01



Higher Band Edge Plot for 16QAM-RB Size 1, RB Offset 24

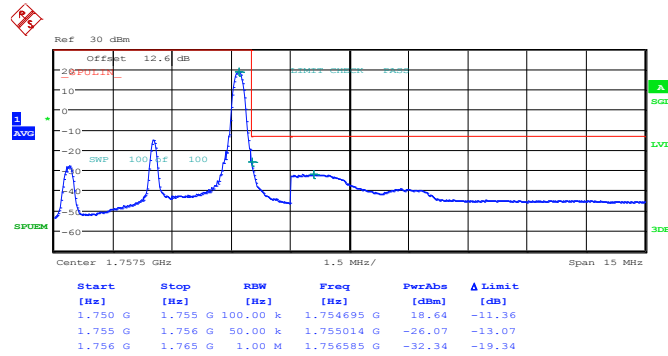

Date: 25.MAY.2014 08:23:55

Higher Band Edge Plot for 16QAM-RB Size 25, RB Offset 0

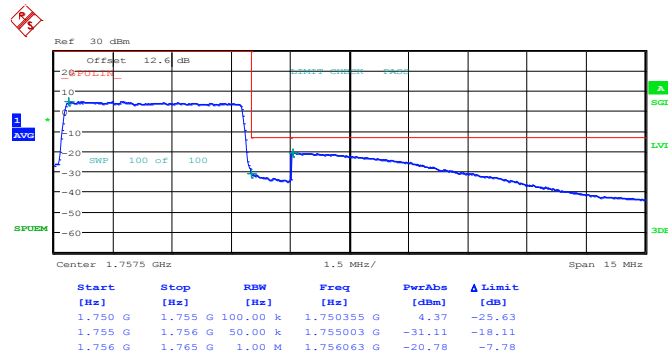

Date: 25.MAY.2014 08:25:30



Band :	LTE Band 4	Band Width :	10MHz / QPSK
---------------	------------	---------------------	--------------

Lower Band Edge Plot for QPSK-RB Size 1, RB Offset 0

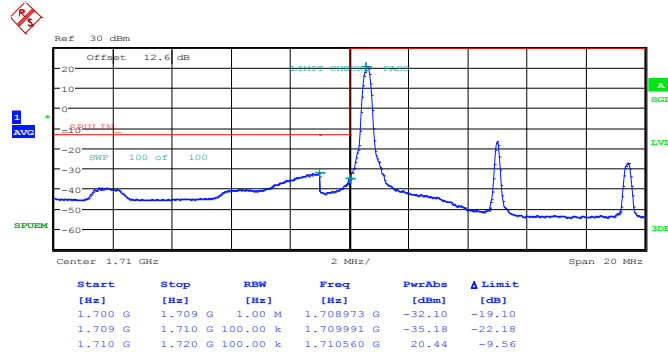

Date: 25.MAY.2014 08:29:31

Lower Band Edge Plot for QPSK-RB Size 50, RB Offset 0

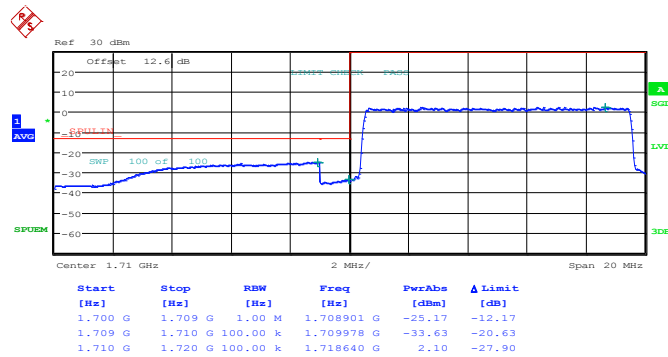

Date: 25.MAY.2014 08:31:06



Higher Band Edge Plot for QPSK-RB Size 1, RB Offset 49

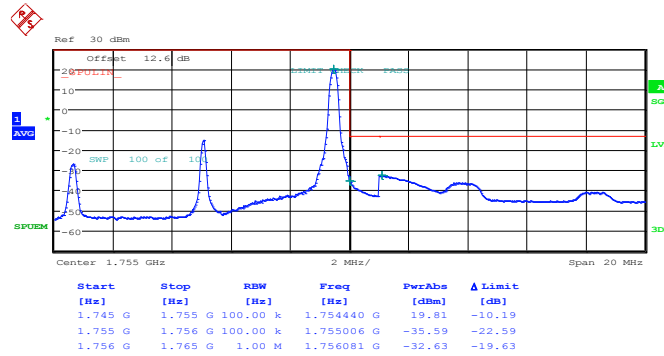

Date: 25.MAY.2014 08:38:59

Higher Band Edge Plot for QPSK-RB Size 50, RB Offset 0

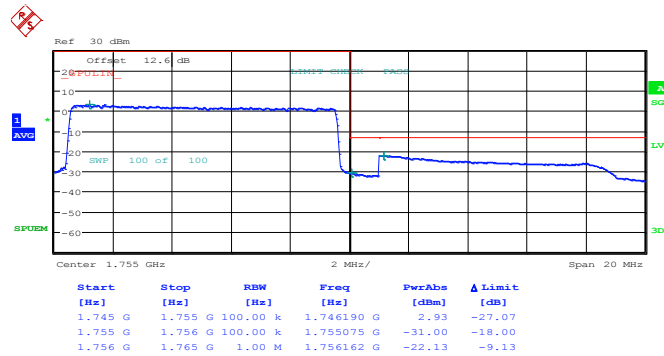

Date: 25.MAY.2014 08:40:33



Band :	LTE Band 4	Band Width :	10MHz / 16QAM
---------------	------------	---------------------	---------------

Lower Band Edge Plot for 16QAM-RB Size 1, RB Offset 0

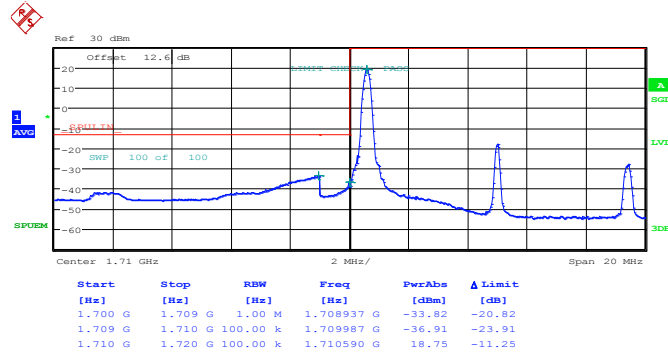

Date: 25.MAY.2014 08:30:18

Lower Band Edge Plot for 16QAM-RB Size 50, RB Offset 0

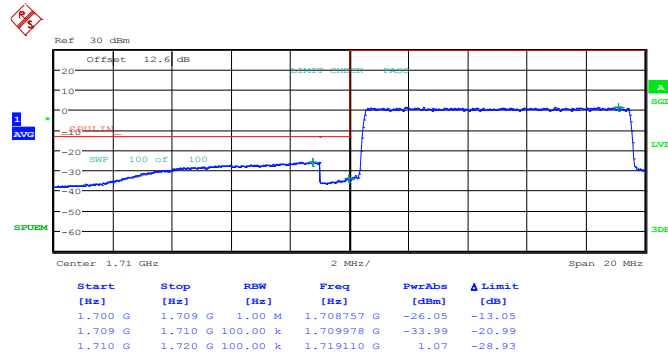

Date: 25.MAY.2014 08:31:53



Higher Band Edge Plot for 16QAM-RB Size 1, RB Offset 49

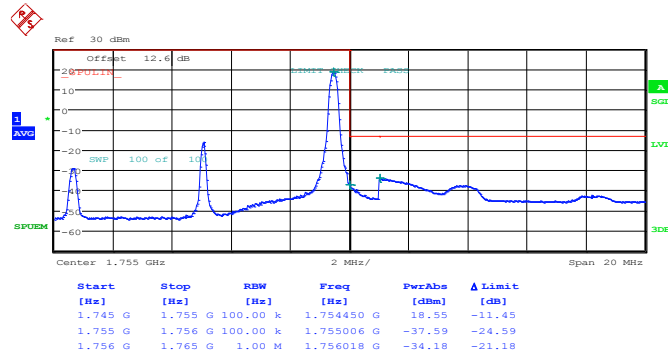

Date: 25.MAY.2014 08:39:46

Higher Band Edge Plot for 16QAM-RB Size 50, RB Offset 0

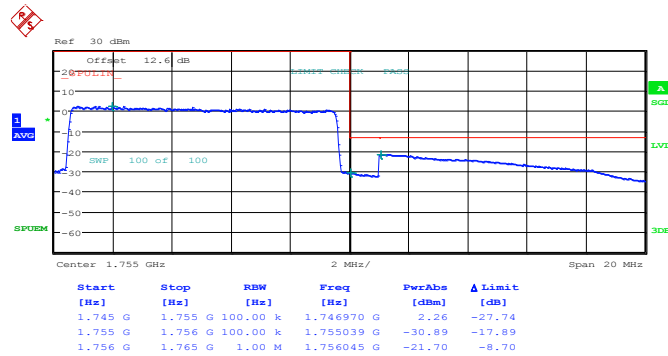

Date: 25.MAY.2014 08:41:21



Band :	LTE Band 4	Band Width :	15MHz / QPSK
---------------	------------	---------------------	--------------

Lower Band Edge Plot for QPSK-RB Size 1, RB Offset 0

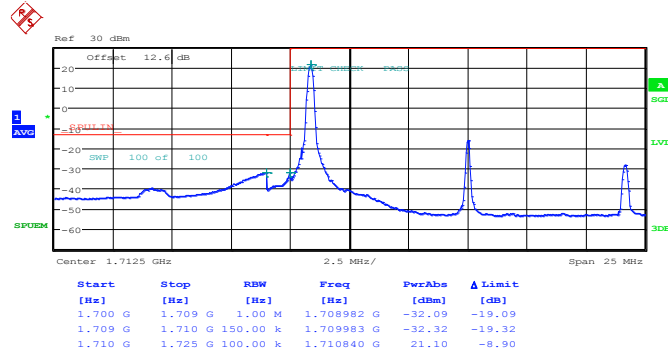

Date: 25.MAY.2014 08:45:23

Lower Band Edge Plot for QPSK-RB Size 75, RB Offset 0

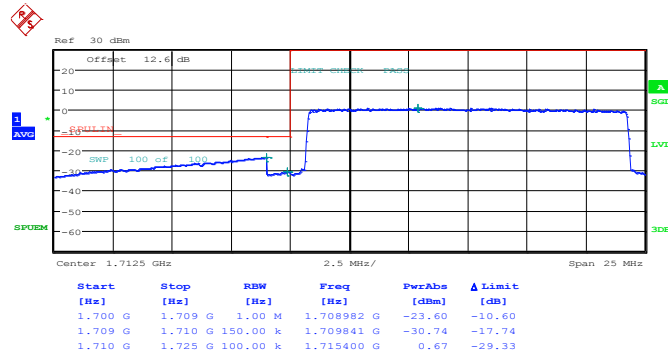

Date: 25.MAY.2014 08:46:58



Higher Band Edge Plot for QPSK-RB Size 1, RB Offset 74

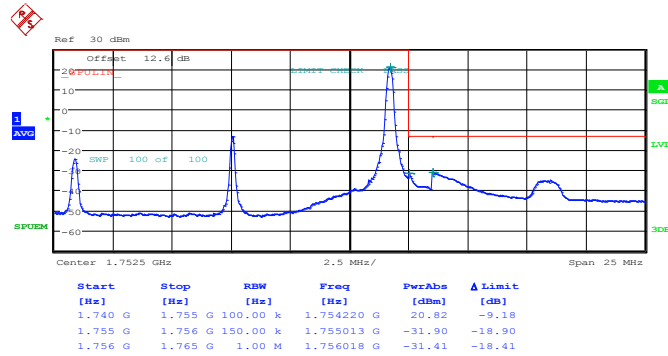

Date: 25.MAY.2014 08:54:52

Higher Band Edge Plot for QPSK-RB Size 75, RB Offset 0

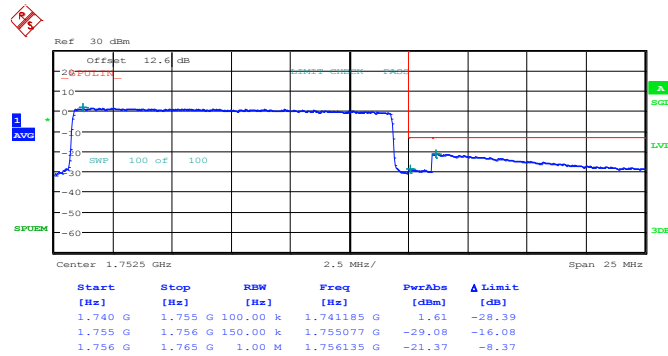

Date: 25.MAY.2014 08:56:27



Band :	LTE Band 4	Band Width :	15MHz / 16QAM
---------------	------------	---------------------	---------------

Lower Band Edge Plot for 16QAM-RB Size 1, RB Offset 0

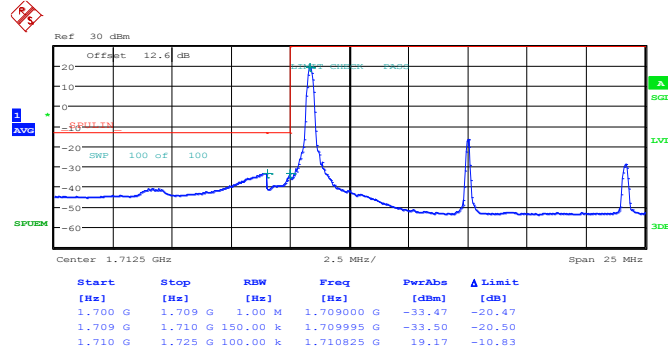

Date: 25.MAY.2014 08:46:10

Lower Band Edge Plot for 16QAM-RB Size 75, RB Offset 0

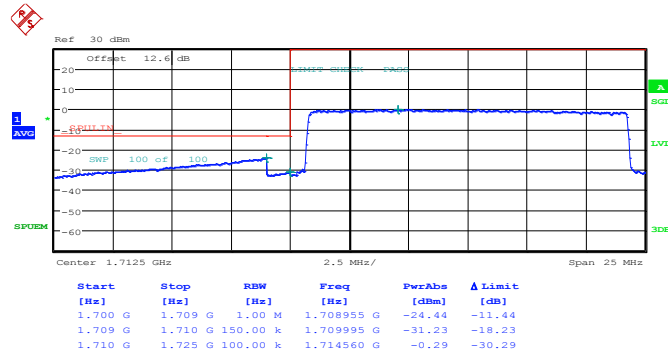

Date: 25.MAY.2014 08:47:45



Higher Band Edge Plot for 16QAM-RB Size 1, RB Offset 74

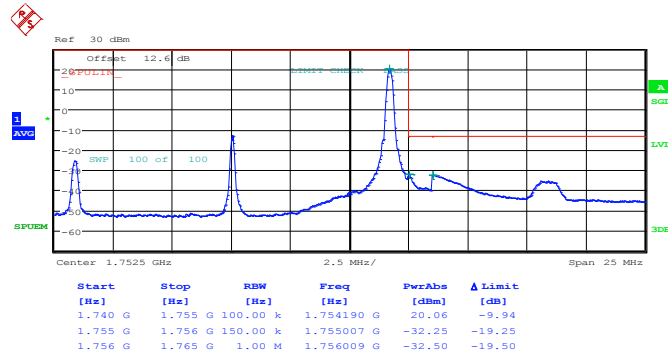

Date: 25.MAY.2014 08:55:39

Higher Band Edge Plot for 16QAM-RB Size 75, RB Offset 0

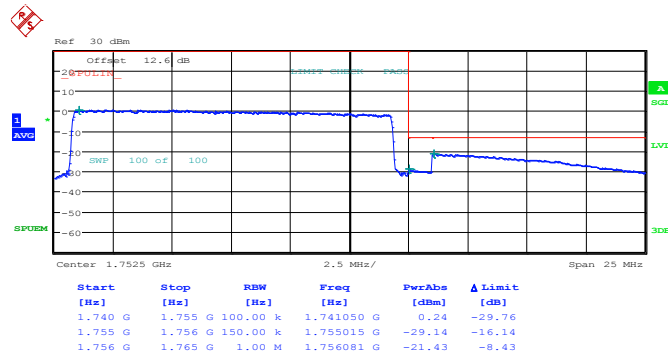

Date: 25.MAY.2014 08:57:14



Band :	LTE Band 4	Band Width :	20MHz / QPSK
---------------	------------	---------------------	--------------

Lower Band Edge Plot for QPSK-RB Size 1, RB Offset 0

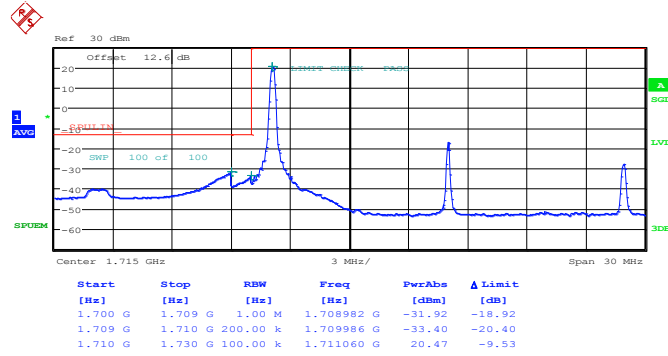

Date: 25.MAY.2014 09:01:15

Lower Band Edge Plot for QPSK-RB Size 100, RB Offset 0

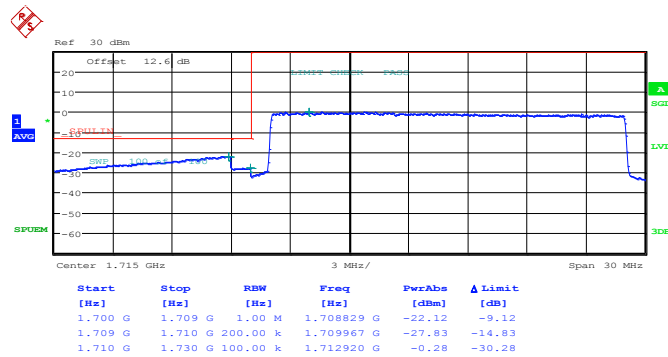

Date: 25.MAY.2014 09:02:50



Higher Band Edge Plot for QPSK-RB Size 1, RB Offset 99

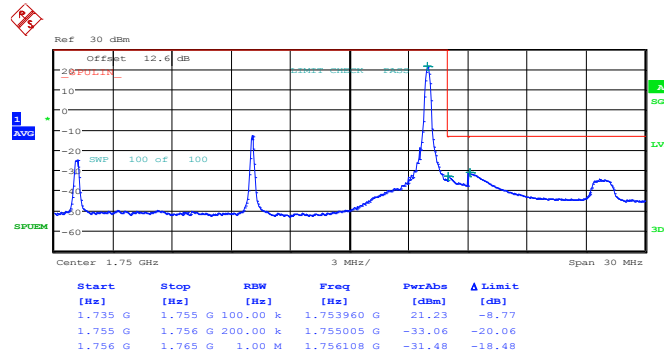

Date: 25.MAY.2014 09:10:44

Higher Band Edge Plot for QPSK-RB Size 100, RB Offset 0

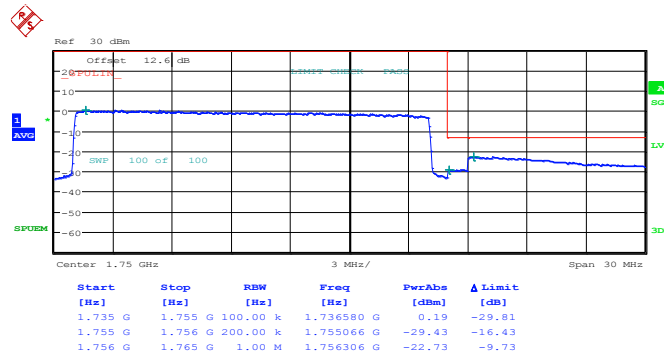

Date: 25.MAY.2014 09:12:19



Band :	LTE Band 4	Band Width :	20MHz / 16QAM
---------------	------------	---------------------	---------------

Lower Band Edge Plot for 16QAM-RB Size 1, RB Offset 0

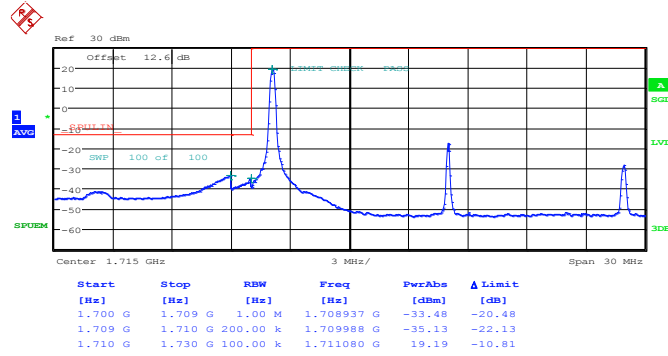

Date: 25.MAY.2014 09:02:03

Lower Band Edge Plot for 16QAM-RB Size 100, RB Offset 0

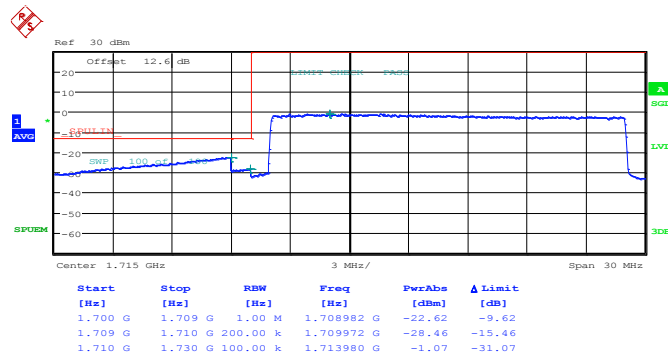

Date: 25.MAY.2014 09:03:37



Higher Band Edge Plot for 16QAM-RB Size 1, RB Offset 99

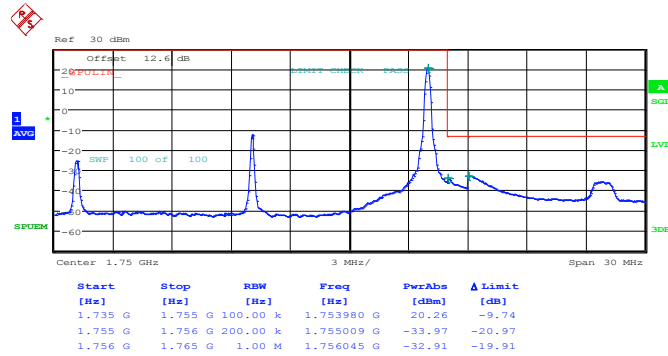

Date: 25.MAY.2014 09:11:31

Higher Band Edge Plot for 16QAM-RB Size 100, RB Offset 0

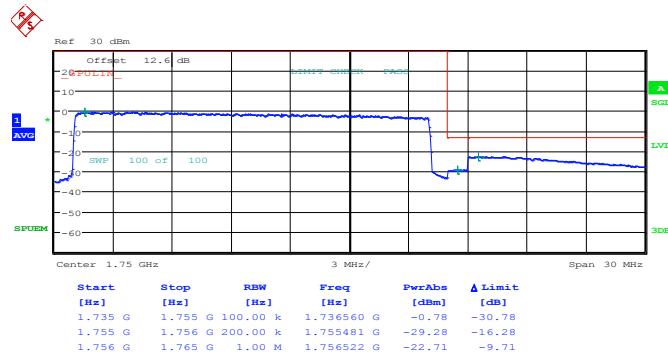

Date: 25.MAY.2014 09:13:06



Band :	LTE Band 12	Band Width :	1.4MHz / QPSK
---------------	-------------	---------------------	---------------

Lower Band Edge Plot for QPSK-RB Size 1, RB Offset 0

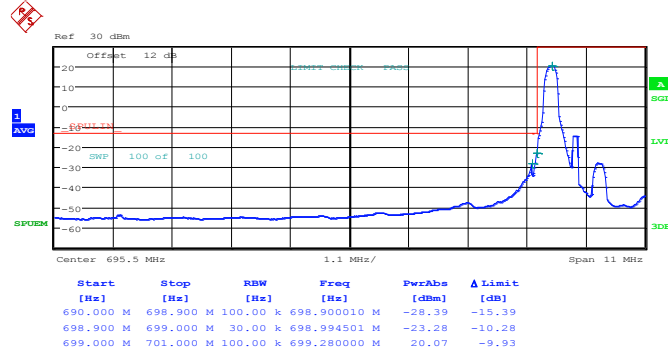

Date: 25.MAY.2014 10:03:34

Lower Band Edge Plot for QPSK-RB Size 6, RB Offset 0

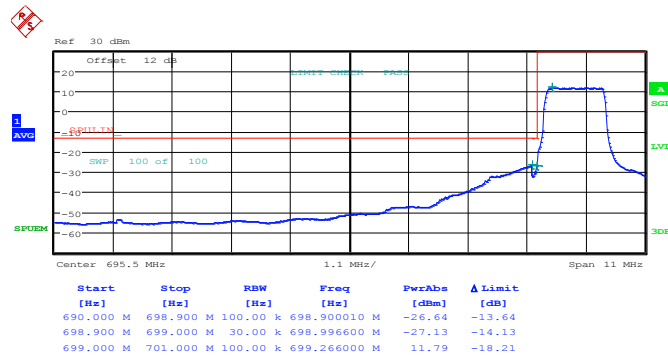

Date: 25.MAY.2014 10:01:11



Higher Band Edge Plot for QPSK-RB Size 1, RB Offset 5

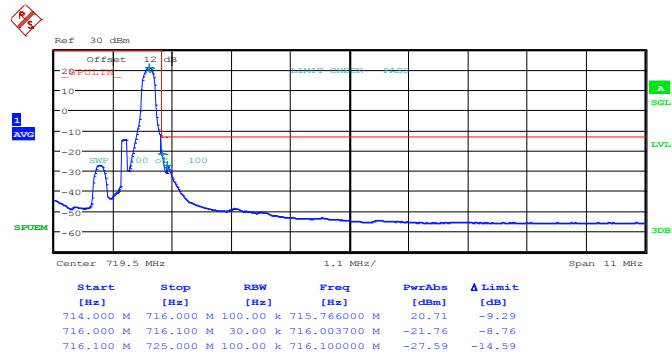

Date: 25.MAY.2014 10:35:54

Higher Band Edge Plot for QPSK-RB Size 6, RB Offset 0

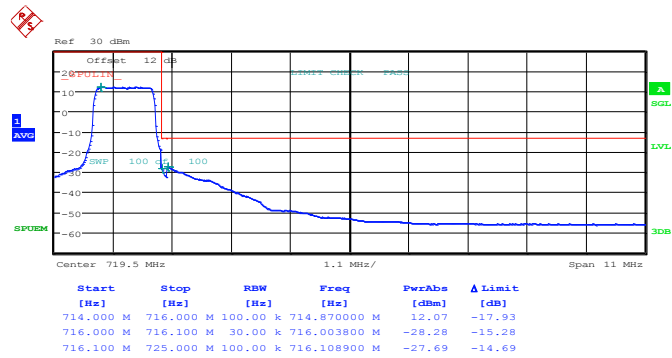

Date: 25.MAY.2014 10:33:31



Band :	LTE Band 12	Band Width :	1.4MHz / 16QAM
---------------	-------------	---------------------	----------------

Lower Band Edge Plot for 16QAM -RB Size 1, RB Offset 0

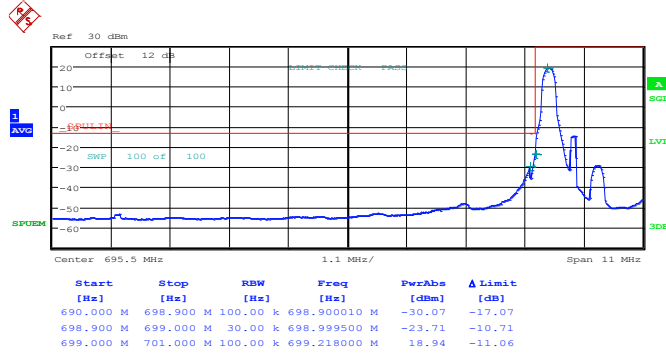

Date: 25.MAY.2014 10:02:46

Lower Band Edge Plot for 16QAM-RB Size 6, RB Offset 0

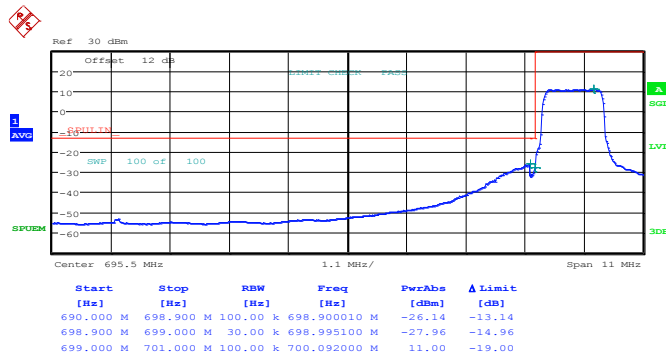

Date: 25.MAY.2014 10:01:58



Higher Band Edge Plot for 16QAM-RB Size 1, RB Offset 5

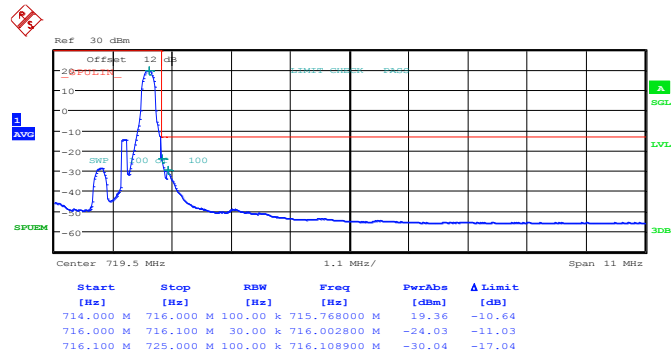

Date: 25.MAY.2014 10:35:06

Higher Band Edge Plot for 16QAM-RB Size 6, RB Offset 0

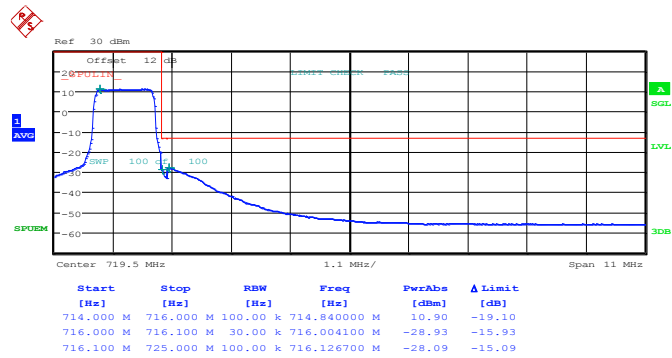

Date: 25.MAY.2014 10:34:18



Band :	LTE Band 12	Band Width :	3MHz / QPSK
---------------	-------------	---------------------	-------------

Lower Band Edge Plot for QPSK-RB Size 1, RB Offset 0

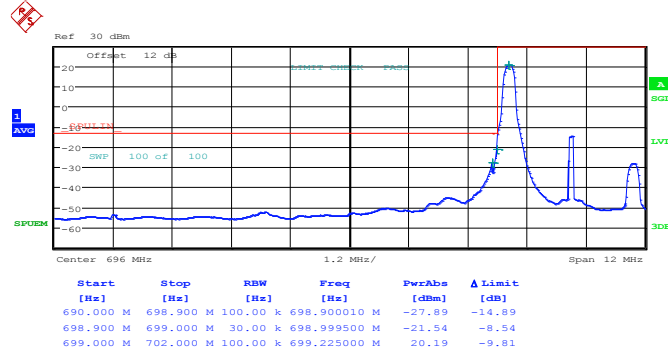

Date: 25.MAY.2014 10:42:32

Lower Band Edge Plot for QPSK-RB Size 15, RB Offset 0

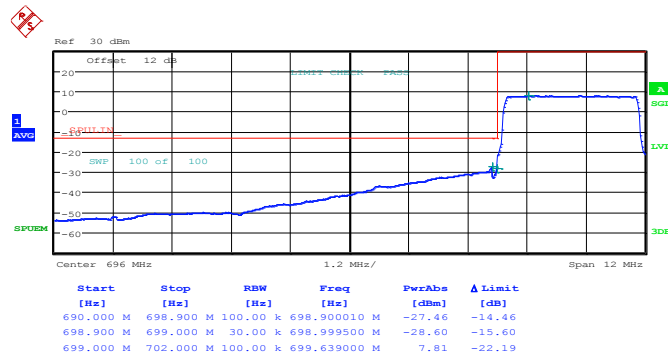

Date: 25.MAY.2014 10:39:59



Higher Band Edge Plot for QPSK-RB Size 1, RB Offset 14

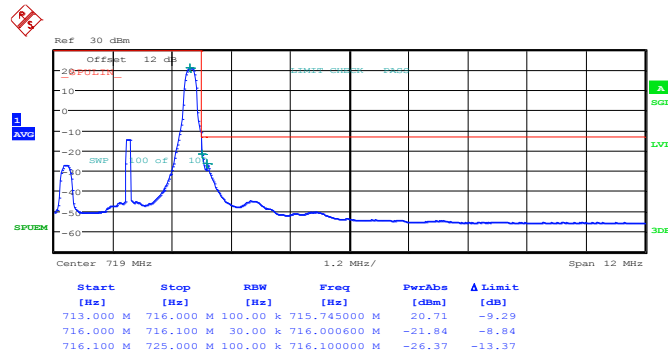

Date: 25.MAY.2014 10:52:58

Higher Band Edge Plot for QPSK-RB Size 15, RB Offset 0

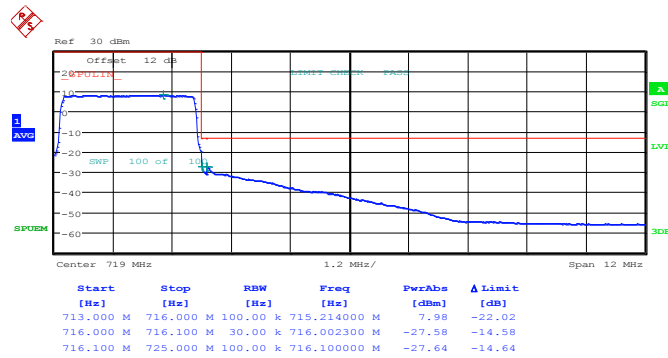

Date: 25.MAY.2014 10:50:32



Band :	LTE Band 12	Band Width :	3MHz / 16QAM
---------------	-------------	---------------------	--------------

Lower Band Edge Plot for 16QAM-RB Size 1, RB Offset 0

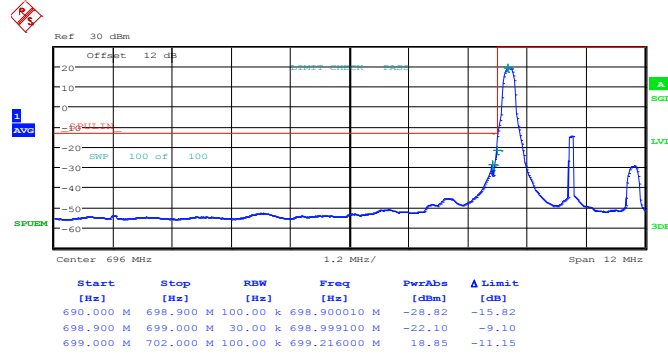

Date: 25.MAY.2014 10:41:41

Lower Band Edge Plot for 16QAM-RB Size 15, RB Offset 0

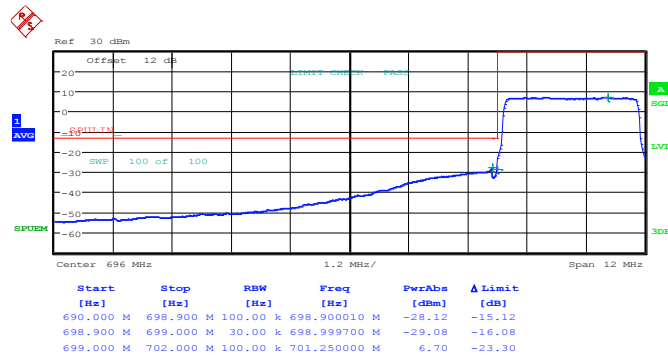

Date: 25.MAY.2014 10:40:50



Higher Band Edge Plot for 16QAM-RB Size 1, RB Offset 14

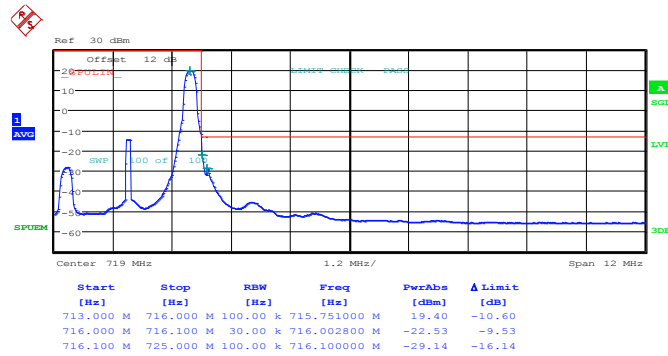

Date: 25.MAY.2014 10:52:10

Higher Band Edge Plot for 16QAM-RB Size 15, RB Offset 0

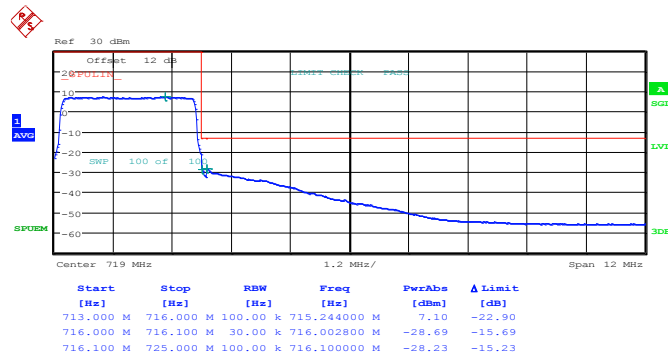

Date: 25.MAY.2014 10:51:21



Band :	LTE Band 12	Band Width :	5MHz / QPSK
---------------	-------------	---------------------	-------------

Lower Band Edge Plot for QPSK-RB Size 1, RB Offset 0

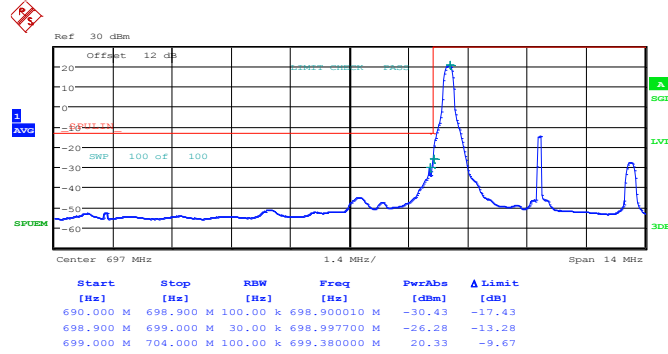

Date: 25.MAY.2014 10:59:53

Lower Band Edge Plot for QPSK-RB Size 25, RB Offset 0

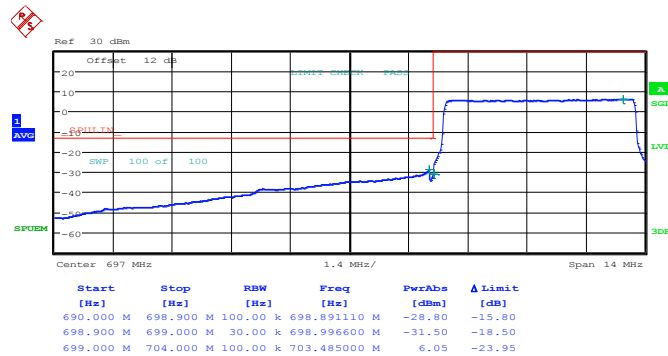

Date: 25.MAY.2014 10:57:08



Higher Band Edge Plot for QPSK-RB Size 1, RB Offset 24

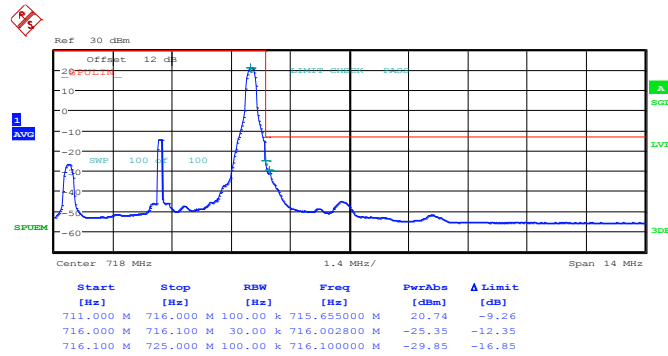

Date: 25.MAY.2014 11:08:50

Higher Band Edge Plot for QPSK-RB Size 25, RB Offset 0

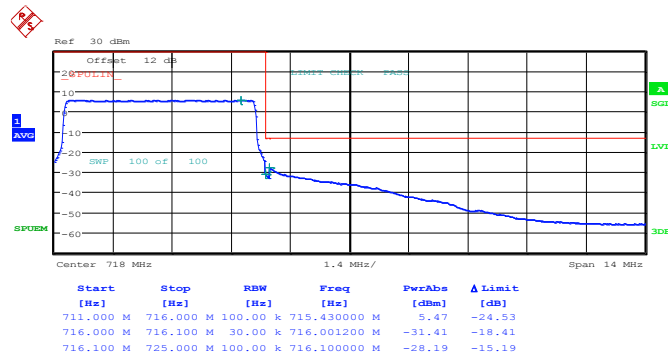

Date: 25.MAY.2014 11:07:05



Band :	LTE Band 12	Band Width :	5MHz / 16QAM
---------------	-------------	---------------------	--------------

Lower Band Edge Plot for 16QAM-RB Size 1, RB Offset 0

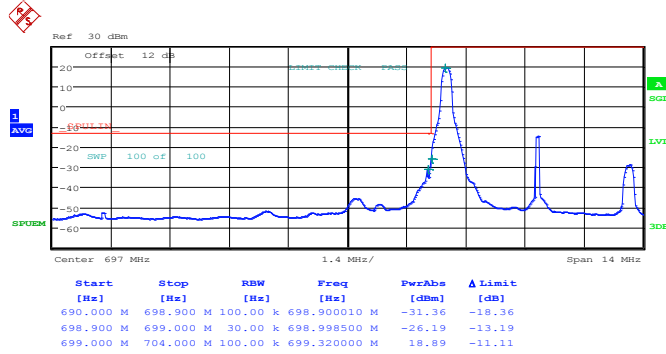

Date: 25.MAY.2014 10:58:58

Lower Band Edge Plot for 16QAM-RB Size 25, RB Offset 0

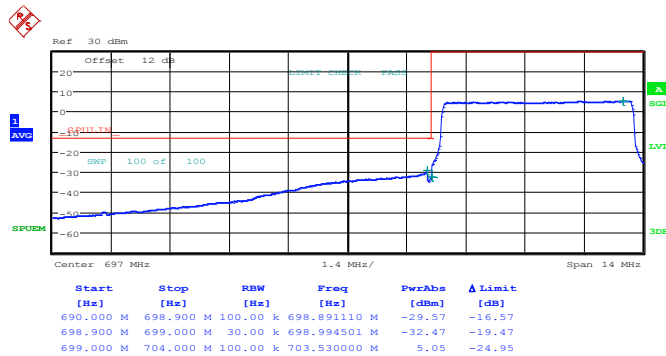

Date: 25.MAY.2014 10:58:03



Higher Band Edge Plot for 16QAM-RB Size 1, RB Offset 24

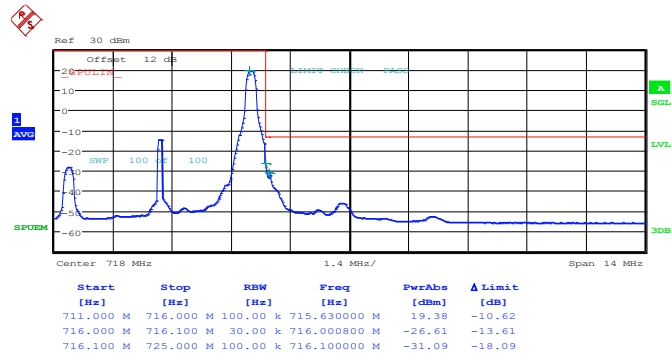

Date: 25.MAY.2014 11:09:43

Higher Band Edge Plot for 16QAM-RB Size 25, RB Offset 0

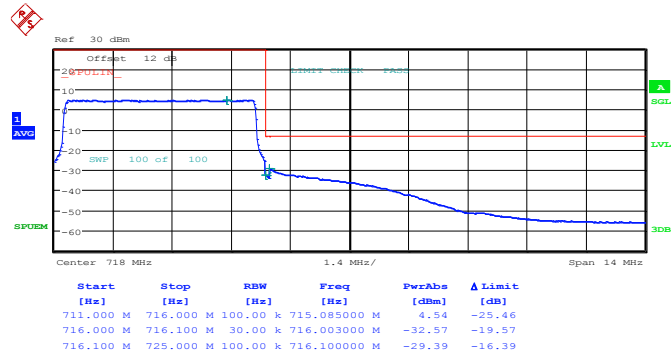

Date: 25.MAY.2014 11:07:57



Band :	LTE Band 12	Band Width :	10MHz / QPSK
---------------	-------------	---------------------	--------------

Lower Band Edge Plot for QPSK-RB Size 1, RB Offset 0

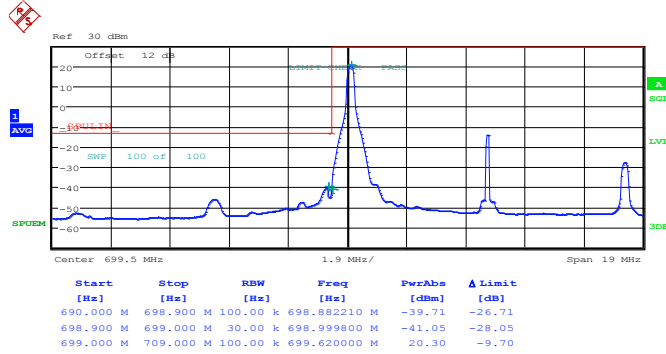

Date: 25.MAY.2014 11:52:56

Lower Band Edge Plot for QPSK-RB Size 50, RB Offset 0

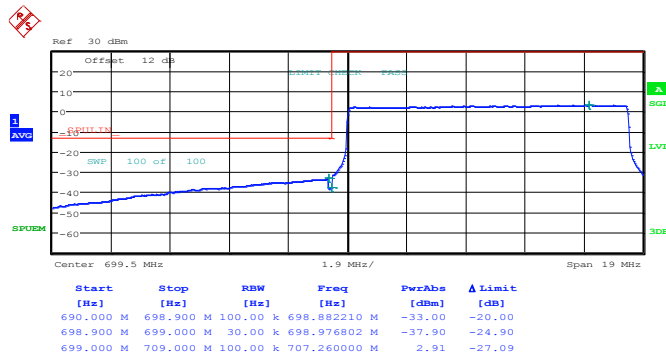

Date: 25.MAY.2014 11:48:12



Higher Band Edge Plot for QPSK-RB Size 1, RB Offset 49

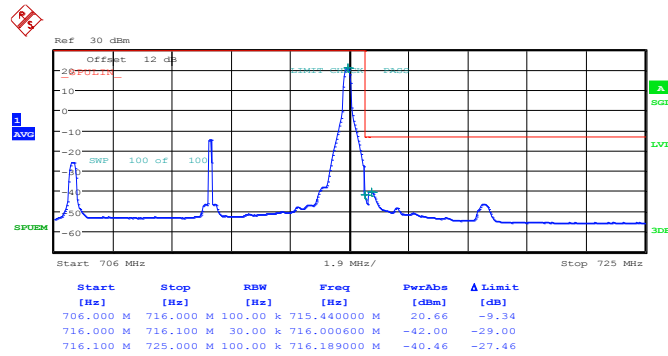

Date: 25.MAY.2014 12:09:34

Higher Band Edge Plot for QPSK-RB Size 50, RB Offset 0

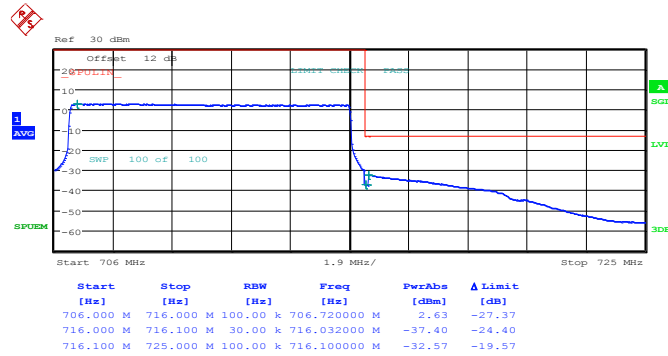

Date: 25.MAY.2014 12:10:51



Band :	LTE Band 12	Band Width :	10MHz / 16QAM
---------------	-------------	---------------------	---------------

Lower Band Edge Plot for 16QAM-RB Size 1, RB Offset 0

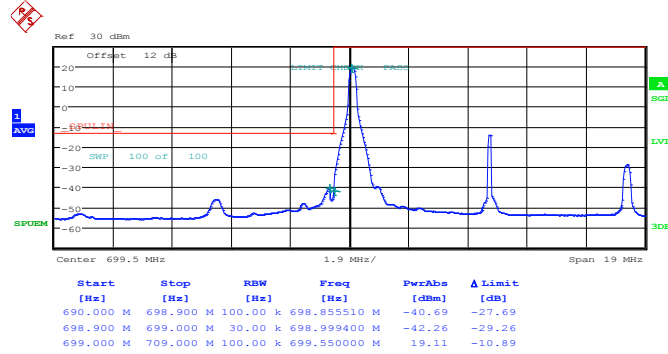

Date: 25.MAY.2014 11:51:31

Lower Band Edge Plot for 16QAM-RB Size 50, RB Offset 0

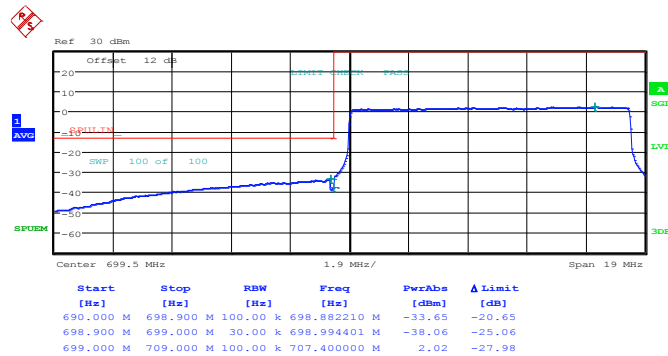

Date: 25.MAY.2014 11:49:55



Higher Band Edge Plot for 16QAM-RB Size 1, RB Offset 49

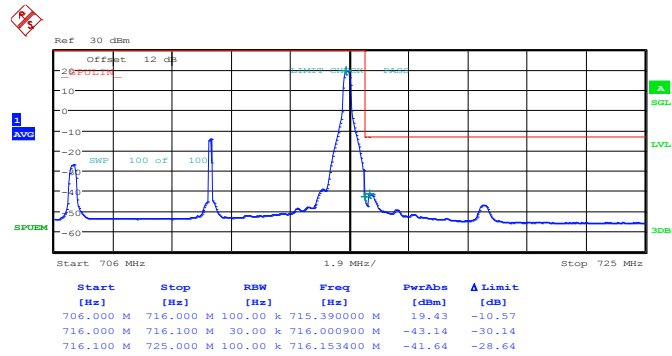

Date: 25.MAY.2014 12:07:58

Higher Band Edge Plot for 16QAM-RB Size 50, RB Offset 0

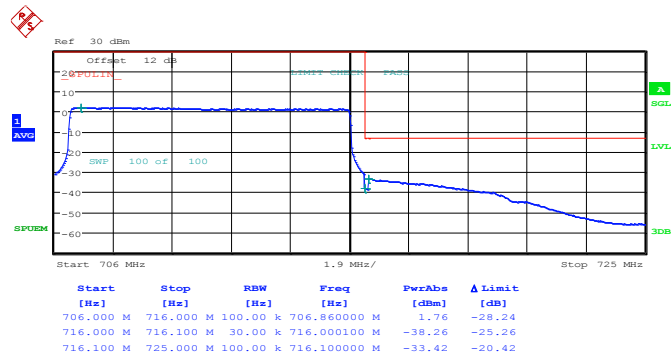

Date: 25.MAY.2014 12:12:03



Band :	LTE Band 17	Band Width :	5MHz / QPSK
---------------	-------------	---------------------	-------------

Lower Band Edge Plot for QPSK-RB Size 1, RB Offset 0

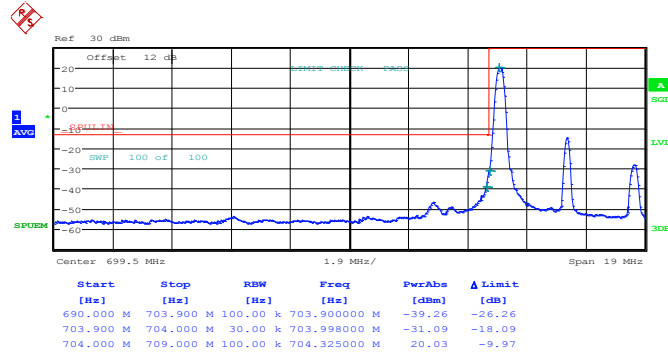

Date: 25.MAY.2014 09:24:56

Lower Band Edge Plot for QPSK-RB Size 25, RB Offset 0

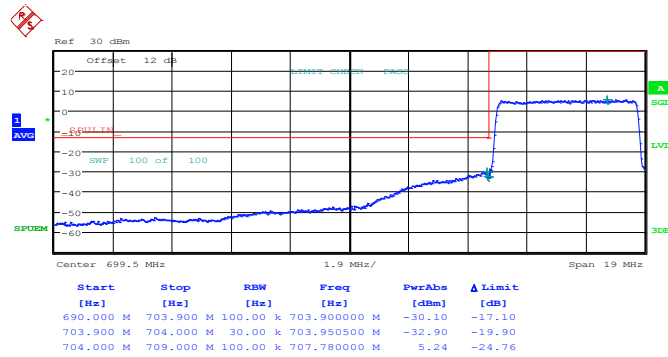

Date: 25.MAY.2014 09:26:31



Higher Band Edge Plot for QPSK-RB Size 1, RB Offset 24

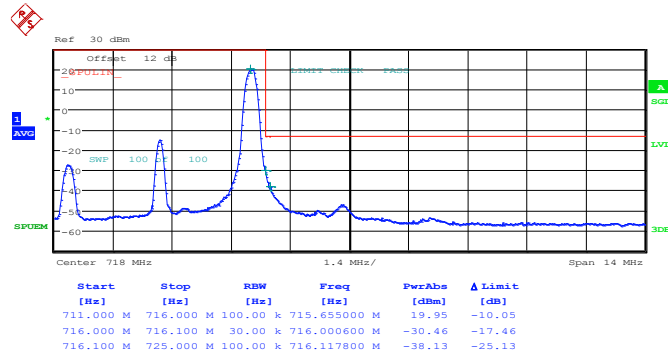

Date: 25.MAY.2014 09:34:25

Higher Band Edge Plot for QPSK-RB Size 25, RB Offset 0

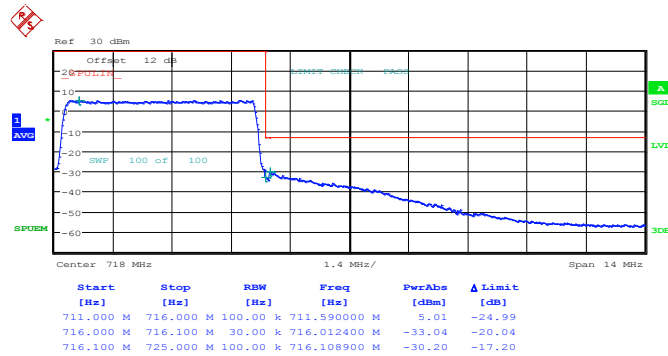

Date: 25.MAY.2014 09:36:00



Band :	LTE Band 17	Band Width :	5MHz / 16QAM
---------------	-------------	---------------------	--------------

Lower Band Edge Plot for 16QAM-RB Size 1, RB Offset 0

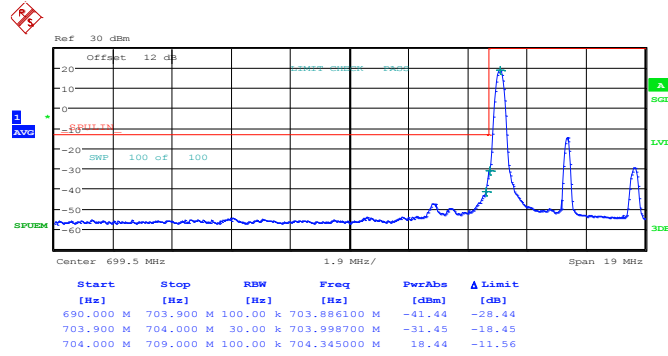

Date: 25.MAY.2014 09:25:44

Lower Band Edge Plot for 16QAM-RB Size 25, RB Offset 0

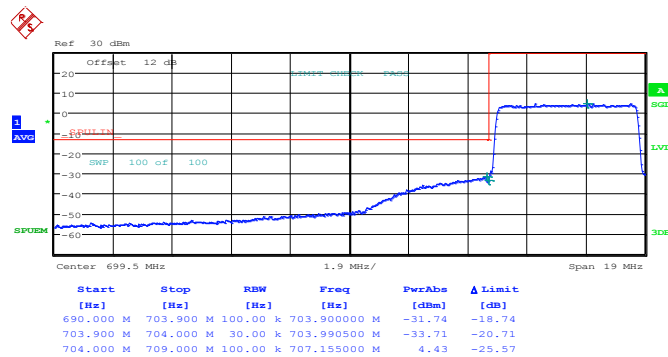

Date: 25.MAY.2014 09:27:19



Higher Band Edge Plot for 16QAM-RB Size 1, RB Offset 24

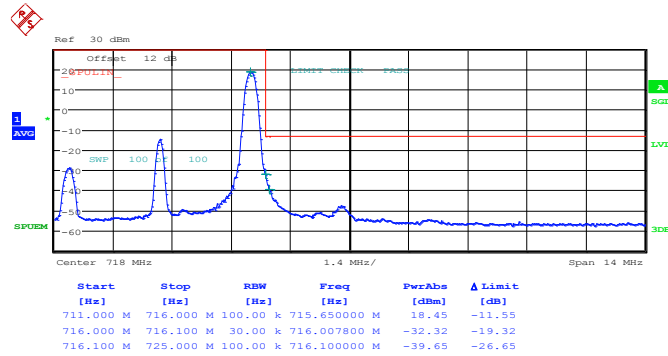

Date: 25.MAY.2014 09:35:12

Higher Band Edge Plot for 16QAM-RB Size 25, RB Offset 0

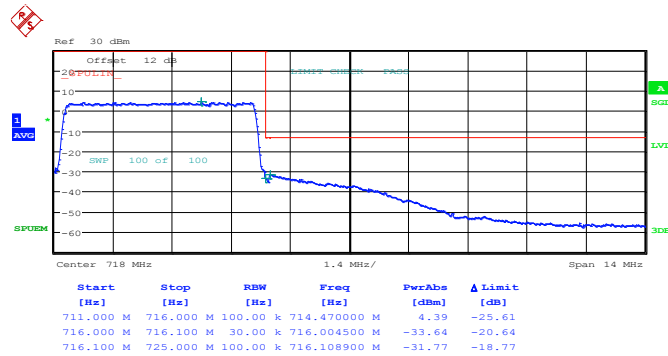

Date: 25.MAY.2014 09:36:47



Band :	LTE Band 17	Band Width :	10MHz / QPSK
---------------	-------------	---------------------	--------------

Lower Band Edge Plot for QPSK-RB Size 1, RB Offset 0

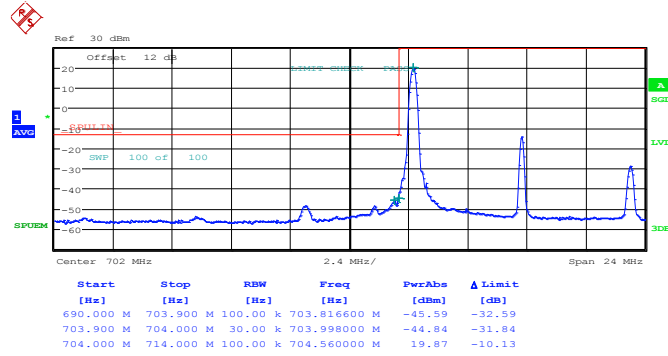

Date: 25.MAY.2014 09:40:49

Lower Band Edge Plot for QPSK-RB Size 50, RB Offset 0

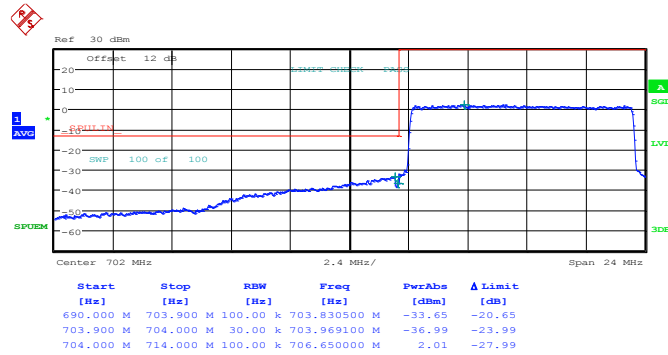

Date: 25.MAY.2014 09:42:24



Higher Band Edge Plot for QPSK-RB Size 1, RB Offset 49

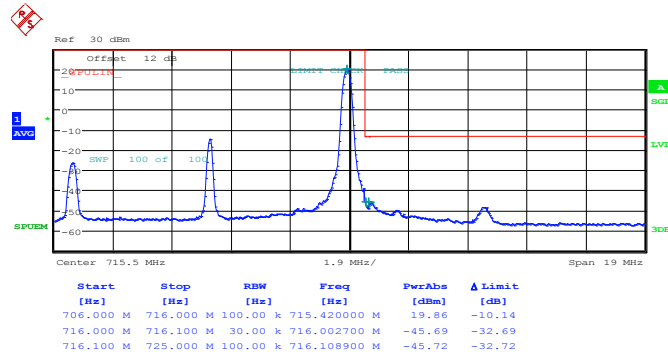

Date: 25.MAY.2014 09:50:18

Higher Band Edge Plot for QPSK-RB Size 50, RB Offset 0

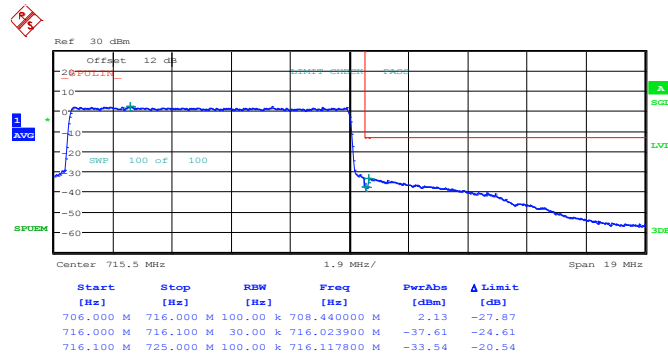

Date: 25.MAY.2014 09:51:53



Band :	LTE Band 17	Band Width :	10MHz / 16QAM
---------------	-------------	---------------------	---------------

Lower Band Edge Plot for 16QAM-RB Size 1, RB Offset 0

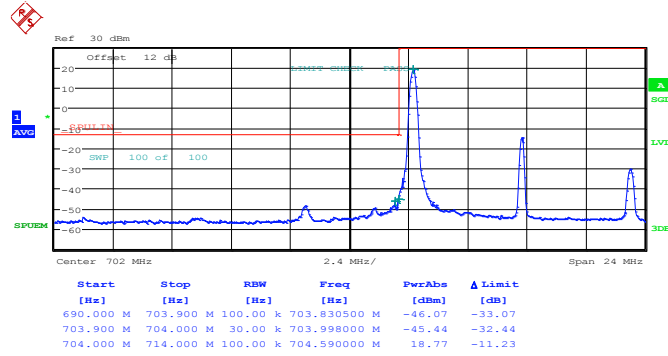

Date: 25.MAY.2014 09:41:36

Lower Band Edge Plot for 16QAM-RB Size 50, RB Offset 0

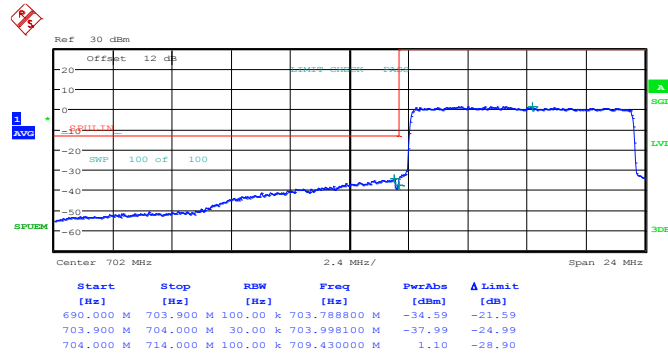

Date: 25.MAY.2014 09:43:11



Higher Band Edge Plot for 16QAM-RB Size 1, RB Offset 49

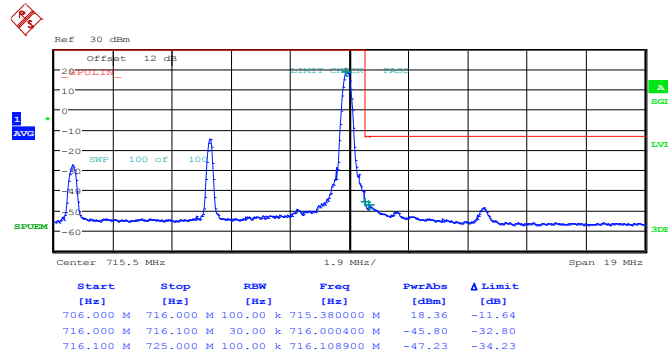

Date: 25.MAY.2014 09:51:06

Higher Band Edge Plot for 16QAM-RB Size 50, RB Offset 0

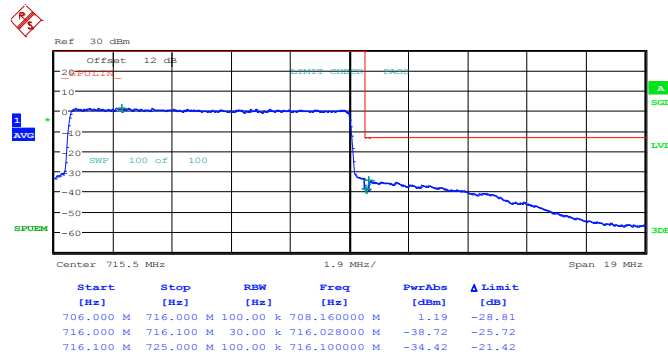

Date: 25.MAY.2014 09:52:41



Band :	LTE Band 41	Band Width :	5MHz / QPSK
---------------	-------------	---------------------	-------------

Lower Band Edge Plot for QPSK-RB Size 1, RB Offset 0

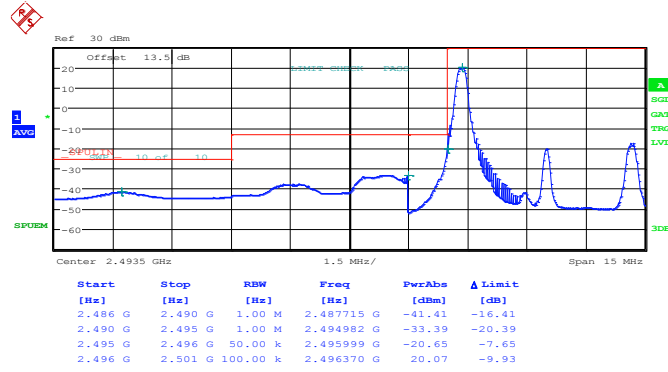

Date: 29.MAY.2014 10:10:58

Lower Band Edge Plot for QPSK-RB Size 25, RB Offset 0

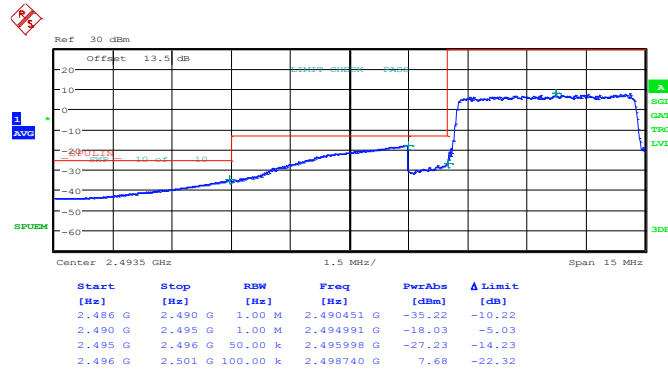

Date: 29.MAY.2014 10:04:31



Higher Band Edge Plot for QPSK-RB Size 1, RB Offset 24

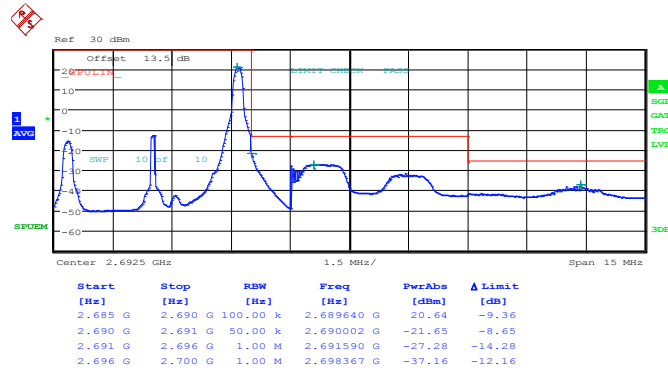

Date: 25.MAY.2014 15:24:54

Higher Band Edge Plot for QPSK-RB Size 25, RB Offset 0

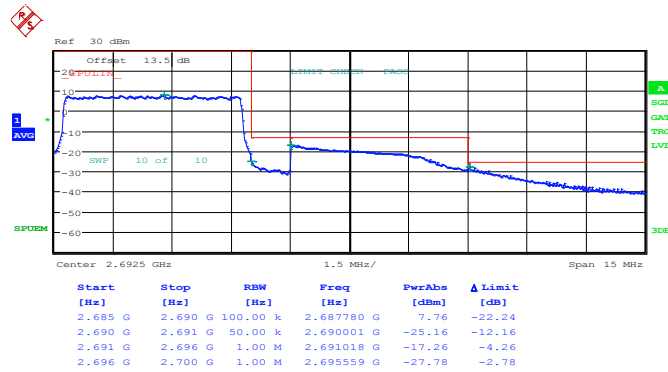

Date: 25.MAY.2014 15:19:07



Band :	LTE Band 41	Band Width :	5MHz / 16QAM
---------------	-------------	---------------------	--------------

Lower Band Edge Plot for 16QAM-RB Size 1, RB Offset 0

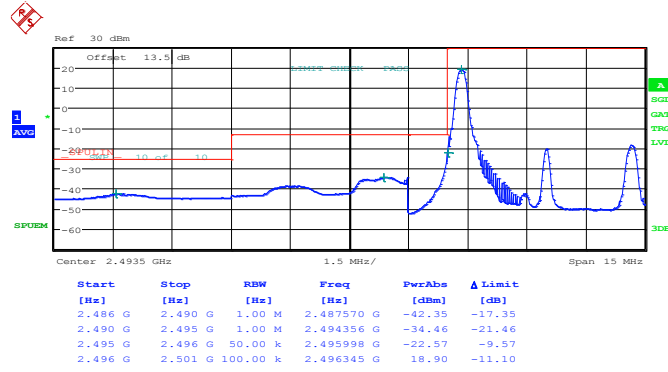

Date: 29.MAY.2014 10:09:23

Lower Band Edge Plot for 16QAM-RB Size 25, RB Offset 0

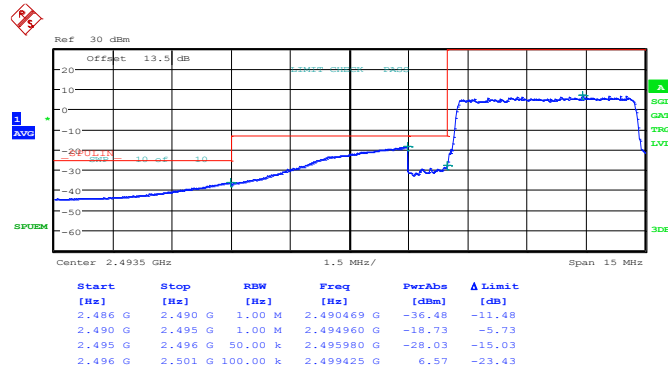

Date: 29.MAY.2014 10:06:13



Higher Band Edge Plot for 16QAM-RB Size 1, RB Offset 24

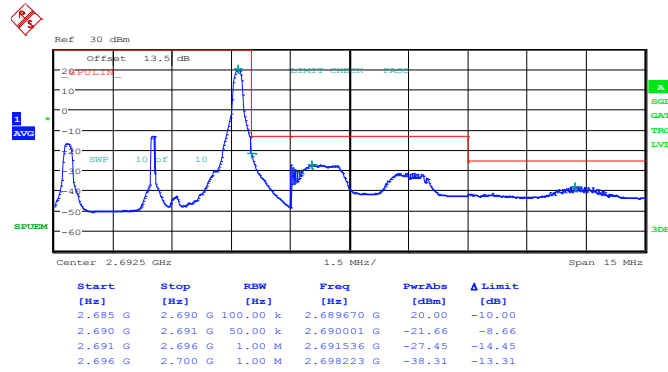

Date: 25.MAY.2014 15:22:57

Higher Band Edge Plot for 16QAM-RB Size 25, RB Offset 0

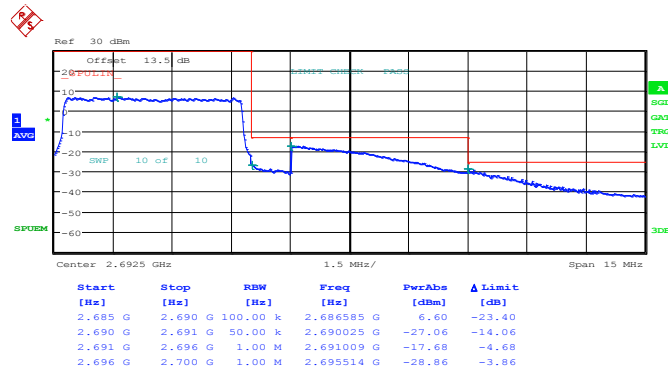

Date: 25.MAY.2014 15:21:08



Band :	LTE Band 41	Band Width :	10MHz / QPSK
---------------	-------------	---------------------	--------------

Lower Band Edge Plot for QPSK-RB Size 1, RB Offset 0

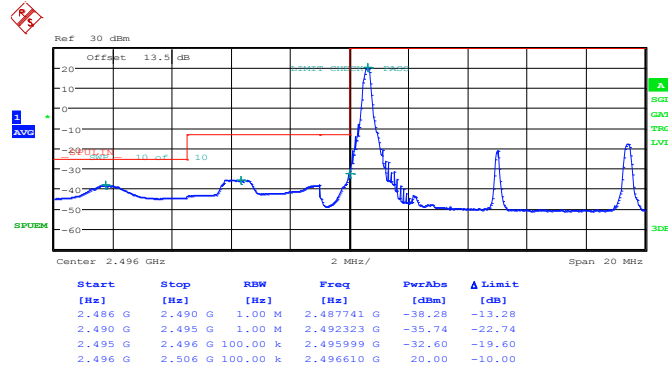

Date: 29.MAY.2014 20:03:31

Lower Band Edge Plot for QPSK-RB Size 50, RB Offset 0

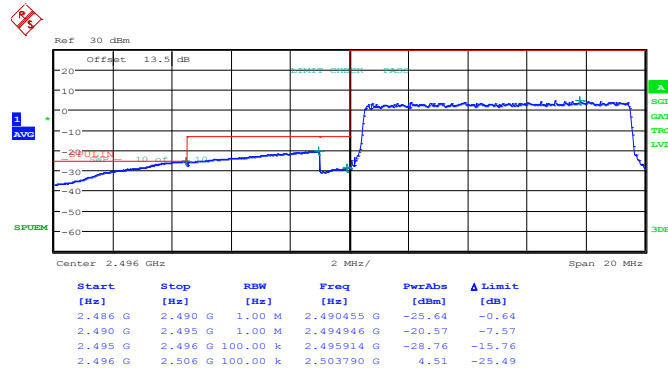

Date: 29.MAY.2014 20:06:11



Higher Band Edge Plot for QPSK-RB Size 1, RB Offset 49

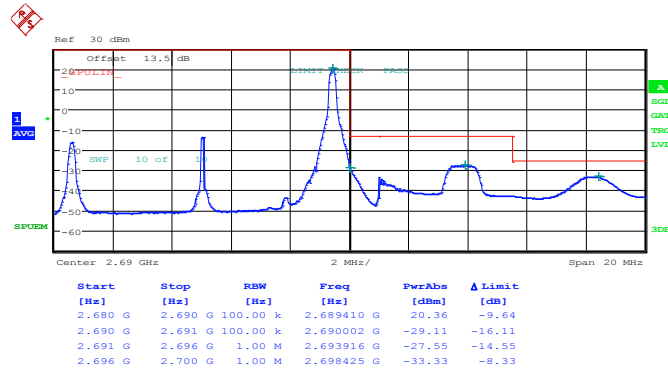

Date: 29.MAY.2014 20:31:42

Higher Band Edge Plot for QPSK-RB Size 50, RB Offset 0

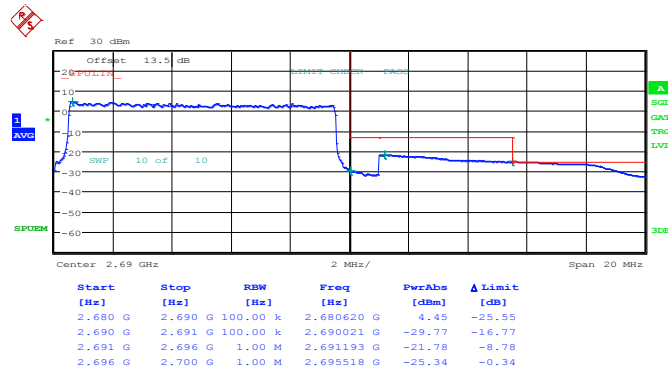

Date: 29.MAY.2014 20:28:23



Band :	LTE Band 41	Band Width :	10MHz / 16QAM
---------------	-------------	---------------------	---------------

Lower Band Edge Plot for 16QAM-RB Size 1, RB Offset 0

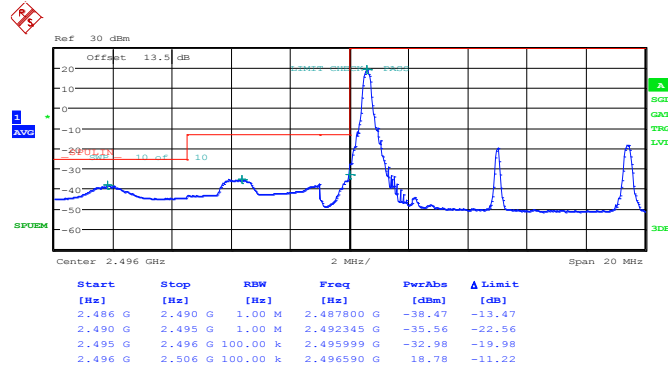

Date: 29.MAY.2014 20:02:01

Lower Band Edge Plot for 16QAM-RB Size 50, RB Offset 0

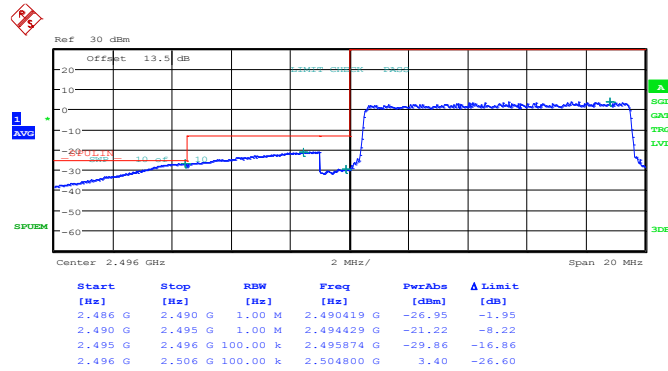

Date: 29.MAY.2014 20:08:27



Higher Band Edge Plot for 16QAM-RB Size 1, RB Offset 49

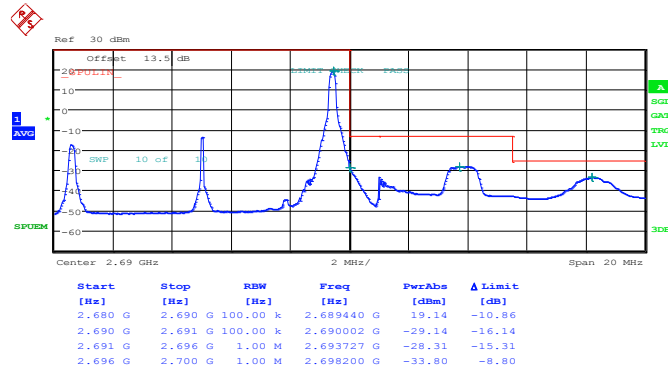

Date: 29.MAY.2014 20:35:10

Higher Band Edge Plot for 16QAM-RB Size 50, RB Offset 0

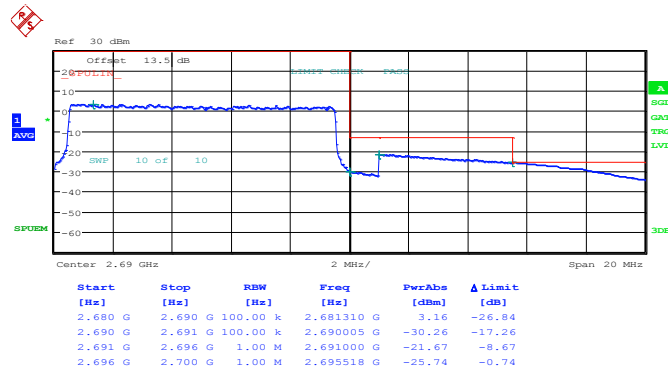

Date: 29.MAY.2014 20:25:33



Band :	LTE Band 41	Band Width :	15MHz / QPSK
---------------	-------------	---------------------	--------------

Lower Band Edge Plot for QPSK-RB Size 1, RB Offset 0

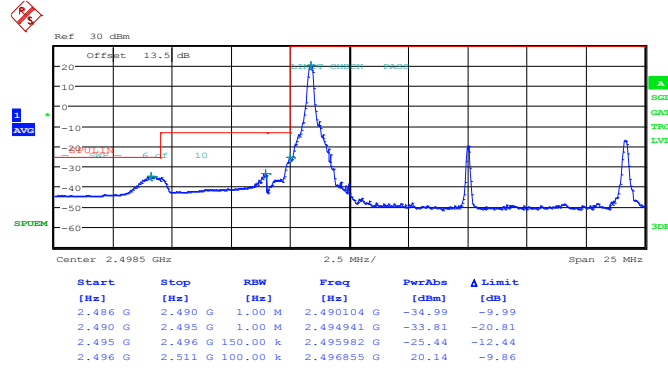

Date: 29.MAY.2014 21:05:29

Lower Band Edge Plot for QPSK-RB Size 75, RB Offset 0

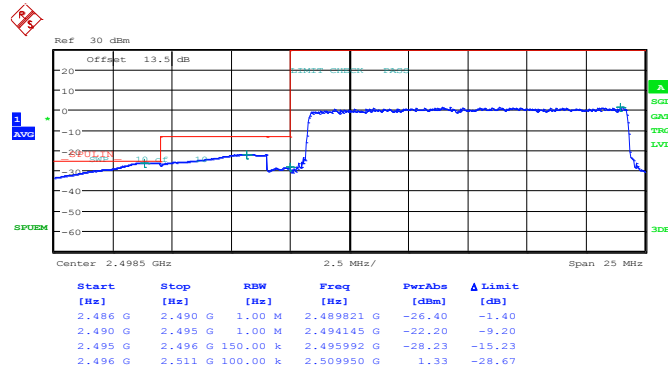

Date: 29.MAY.2014 21:12:03



Higher Band Edge Plot for QPSK-RB Size 1, RB Offset 74

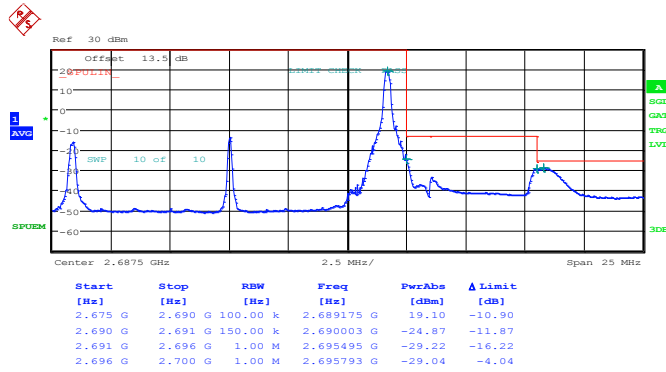

Date: 29.MAY.2014 21:21:25

Higher Band Edge Plot for QPSK-RB Size 75, RB Offset 0

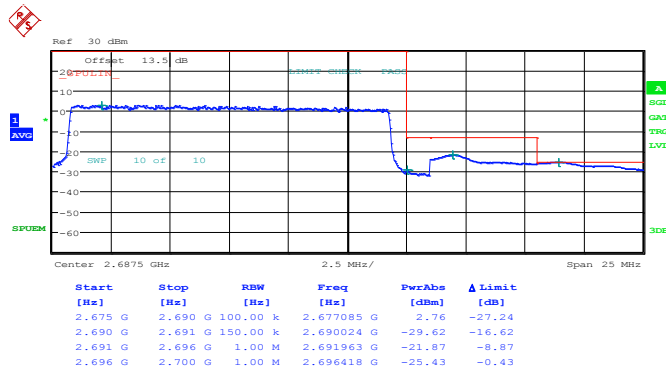

Date: 29.MAY.2014 21:14:48



Band :	LTE Band 41	Band Width :	15MHz / 16QAM
---------------	-------------	---------------------	---------------

Lower Band Edge Plot for 16QAM-RB Size 1, RB Offset 0

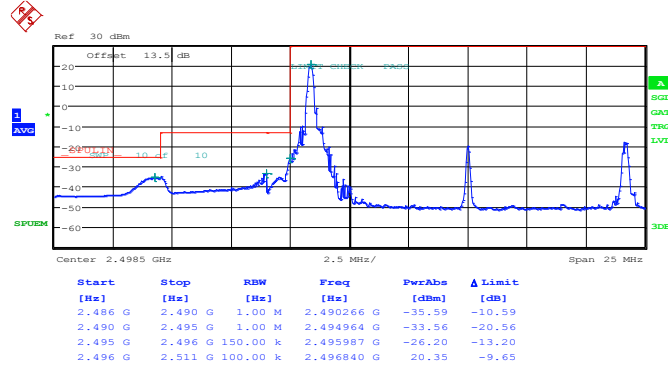

Date: 29.MAY.2014 21:07:29

Lower Band Edge Plot for 16QAM-RB Size 75, RB Offset 0

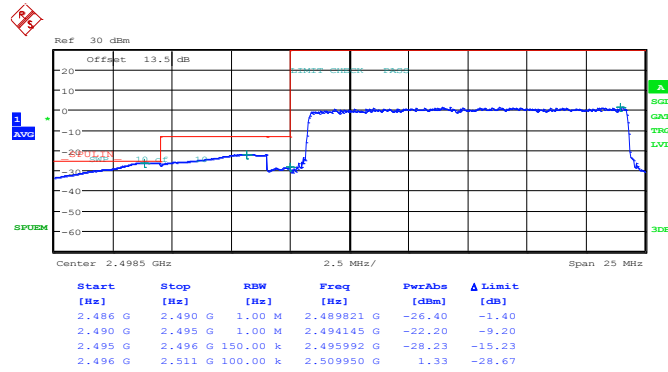

Date: 29.MAY.2014 21:11:07



Higher Band Edge Plot for 16QAM-RB Size 1, RB Offset 74

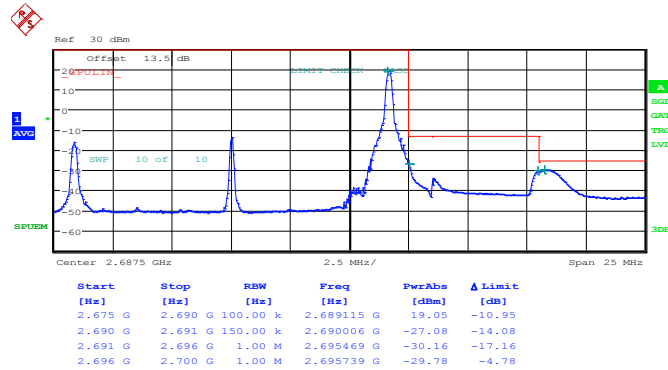

Date: 29.MAY.2014 21:19:53

Higher Band Edge Plot for 16QAM-RB Size 75, RB Offset 0

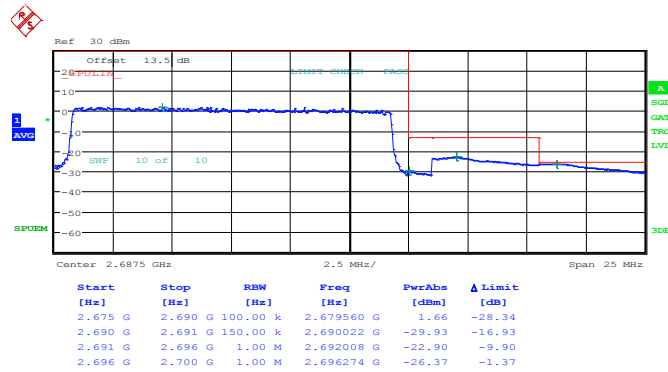

Date: 29.MAY.2014 21:16:04



Band :	LTE Band 41	Band Width :	20MHz / QPSK
---------------	-------------	---------------------	--------------

Lower Band Edge Plot for QPSK-RB Size 1, RB Offset 0

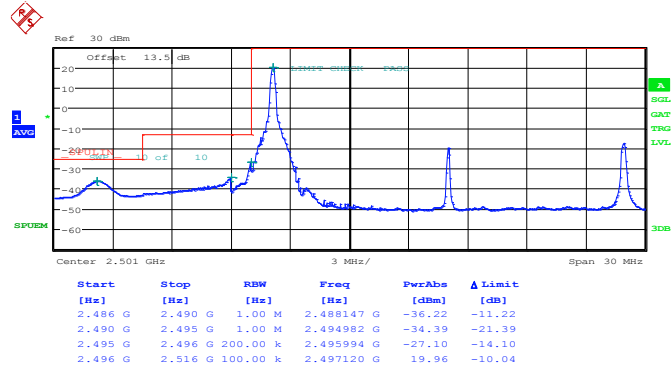

Date: 29.MAY.2014 21:31:12

Lower Band Edge Plot for QPSK-RB Size 100, RB Offset 0

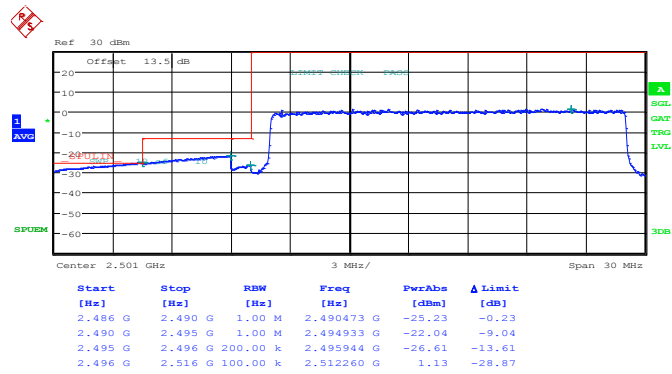

Date: 29.MAY.2014 21:26:35



Higher Band Edge Plot for QPSK-RB Size 1, RB Offset 99

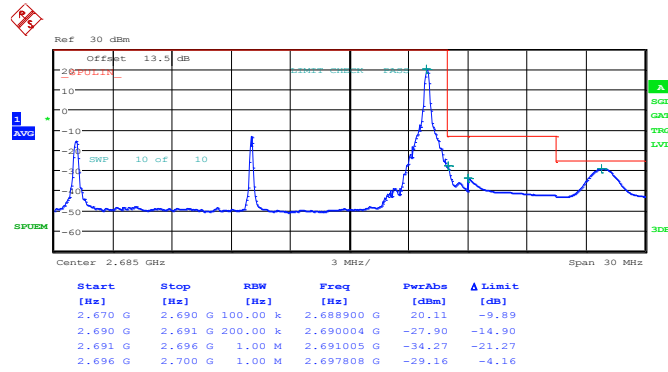

Date: 29.MAY.2014 21:36:44

Higher Band Edge Plot for QPSK-RB Size 100, RB Offset 0

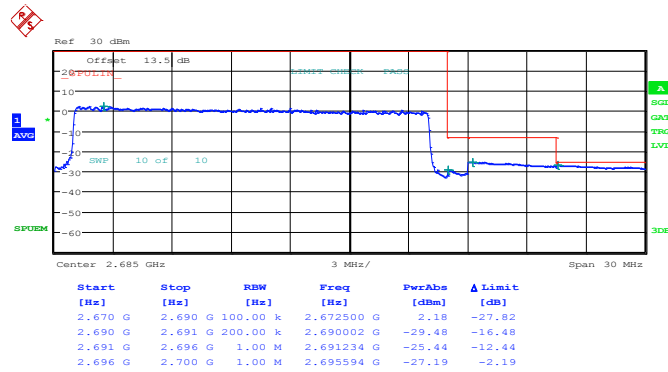

Date: 29.MAY.2014 21:47:29



Band :	LTE Band 41	Band Width :	20MHz / 16QAM
---------------	-------------	---------------------	---------------

Lower Band Edge Plot for 16QAM-RB Size 1, RB Offset 0

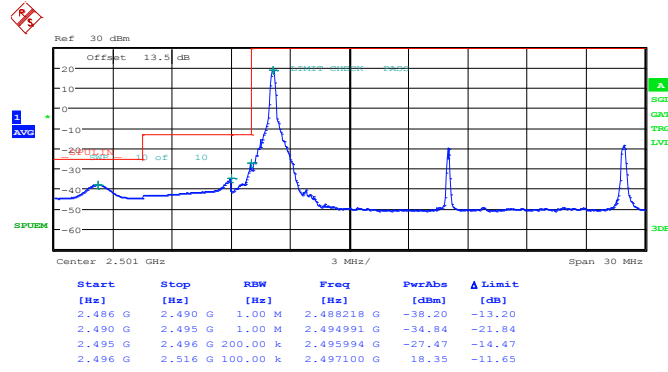

Date: 29.MAY.2014 21:29:43

Lower Band Edge Plot for 16QAM-RB Size 100, RB Offset 0

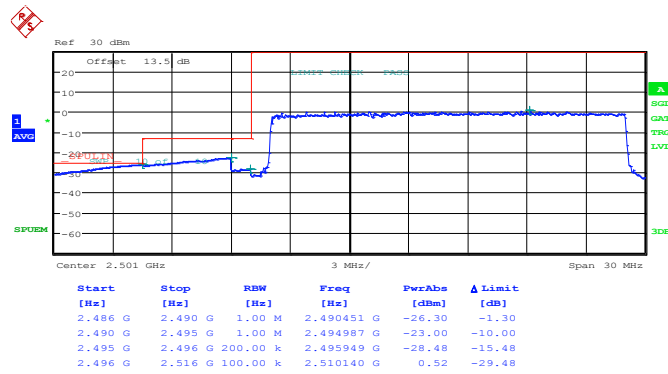

Date: 29.MAY.2014 21:27:53



Higher Band Edge Plot for 16QAM-RB Size 1, RB Offset 99

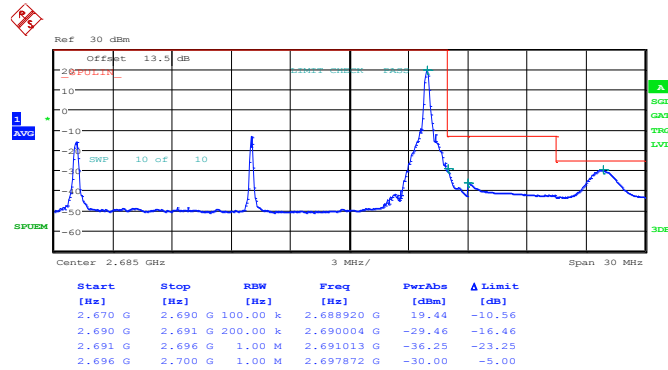

Date: 29.MAY.2014 21:38:23

Higher Band Edge Plot for 16QAM-RB Size 100, RB Offset 0

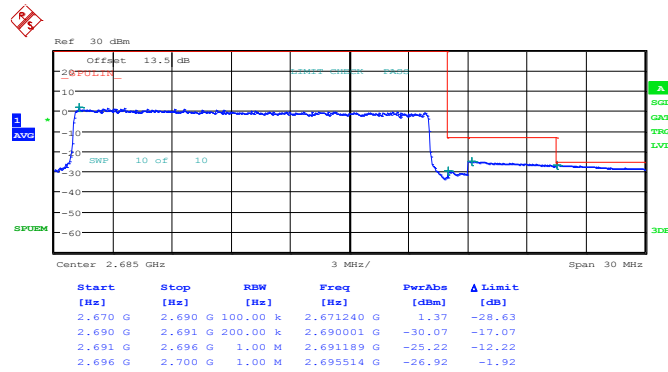

Date: 29.MAY.2014 21:41:24



3.6 Conducted Spurious Emission Measurement

3.6.1 Description of Conducted Spurious Emission Measurement

The power of any emission outside of the authorized operating frequency ranges must be lower than the transmitter power (P) by a factor of at least $43 + 10 \log (P)$ dB.

The power of any emission outside of the authorized operating frequency ranges must be lower than the transmitter power (P) by a factor of at least $55 + 10 \log (P)$ dB.

It is measured by means of a calibrated spectrum analyzer and scanned from 30MHz up to a frequency including its 10th harmonic.

3.6.2 Measuring Instruments

The measuring equipment is listed in the section 4 of this test report.

3.6.3 Test Procedures

1. The EUT was connected to spectrum analyzer and system simulator via a power divider.
2. The RF output of EUT was connected to the spectrum analyzer by RF cable and attenuator. The path loss was compensated to the results for each measurement.
3. The middle channel for the highest RF power within the transmitting frequency was measured.
4. The conducted spurious emission for the whole frequency range was taken.
5. Make the measurement with the spectrum analyzer's RBW = 1MHz, VBW = 3MHz, taking the record of maximum spurious emission.
6. The RF fundamental frequency should be excluded against the limit line in the operating frequency band.
7. The limit line is derived from $43 + 10\log(P)$ dB below the transmitter power P(Watts)
= $P(W) - [43 + 10\log(P)]$ (dB)
= $[30 + 10\log(P)]$ (dBm) - $[43 + 10\log(P)]$ (dB)
= -13dBm.
8. The limit line is derived from $55 + 10\log(P)$ dB below the transmitter power P(Watts)

3.6.4 Test Setup

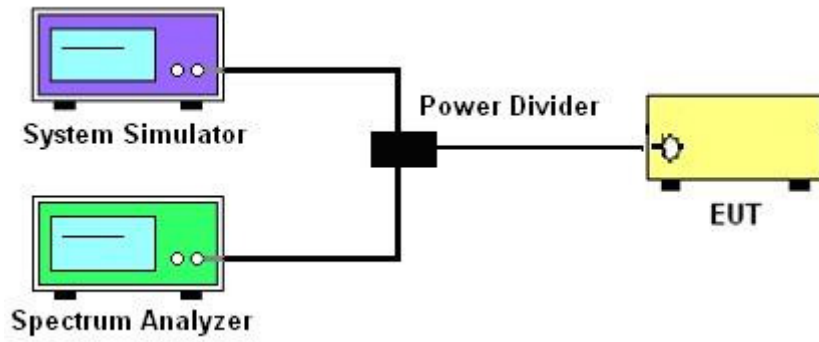



3.6.5 Test Result (Plots) of Conducted Spurious Emission

Band :	LTE Band 4	Channel :	CH20175
Band Width :	1.4MHz		

QPSK (RB Size 1, RB Offset 0)

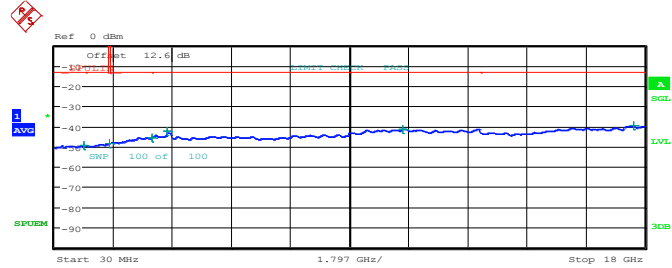

Start [Hz]	Stop [Hz]	RBW [Hz]	Freq [Hz]	PwrAbs [dBm]	Δ Limit [dB]
30.000 M	1.000 G	1.00 M	925.310000 M	-49.48	-36.48
1.000 G	1.700 G	1.00 M	1.697200 G	-48.47	-35.47
1.765 G	3.000 G	1.00 M	2.992590 G	-45.66	-32.66
3.000 G	9.000 G	1.00 M	3.462000 G	-42.44	-29.44
9.000 G	13.000 G	1.00 M	10.624000 G	-41.54	-28.54
13.000 G	18.000 G	1.00 M	17.660000 G	-39.88	-26.88

Date: 25.MAY.2014 07:48:27

16QAM (RB Size 1, RB Offset 0)

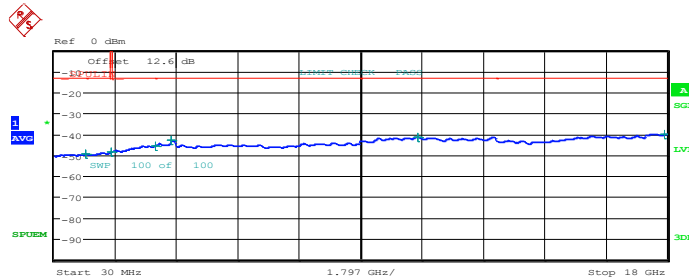

Start [Hz]	Stop [Hz]	RBW [Hz]	Freq [Hz]	PwrAbs [dBm]	Δ Limit [dB]
30.000 M	1.000 G	1.00 M	950.530000 M	-49.66	-36.66
1.000 G	1.700 G	1.00 M	1.695800 G	-48.45	-35.45
1.765 G	3.000 G	1.00 M	2.998765 G	-45.73	-32.73
3.000 G	9.000 G	1.00 M	3.462000 G	-42.85	-29.85
9.000 G	13.000 G	1.00 M	10.680000 G	-41.51	-28.51
13.000 G	18.000 G	1.00 M	17.920000 G	-39.96	-26.96

Date: 25.MAY.2014 07:49:27



Band :	LTE Band 4	Channel :	CH20175
Band Width :	3MHz		

QPSK (RB Size 1, RB Offset 0)

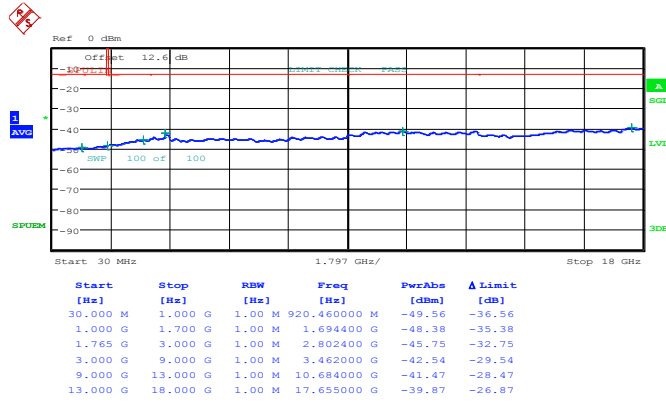

Date: 25.MAY.2014 08:04:17

16QAM (RB Size 1, RB Offset 0)

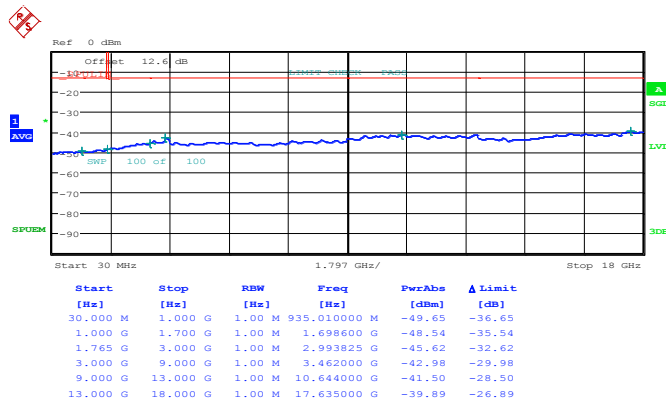

Date: 25.MAY.2014 08:05:17



Band :	LTE Band 4	Channel :	CH20175
Band Width :	5MHz		

QPSK (RB Size 1, RB Offset 0)

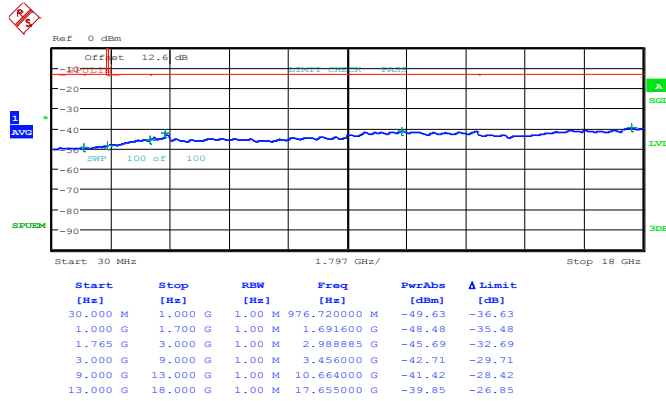

Date: 25.MAY.2014 08:20:11

16QAM (RB Size 1, RB Offset 0)

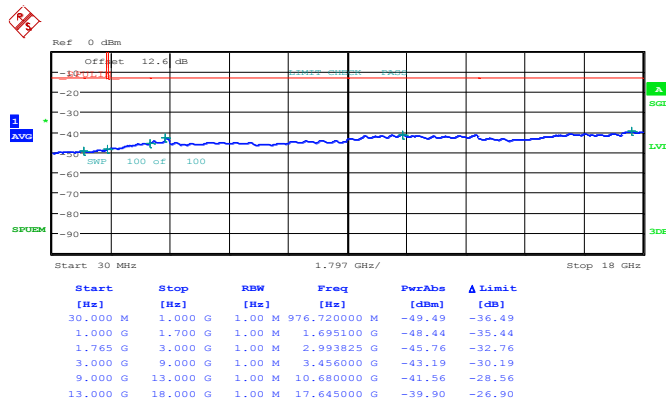

Date: 25.MAY.2014 08:21:11



Band :	LTE Band 4	Channel :	CH20175
Band Width :	10MHz		

QPSK (RB Size 1, RB Offset 0)

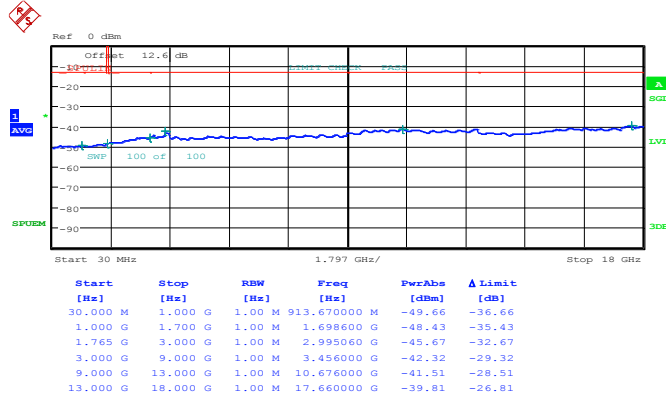

Date: 25.MAY.2014 08:36:03

16QAM (RB Size 1, RB Offset 0)

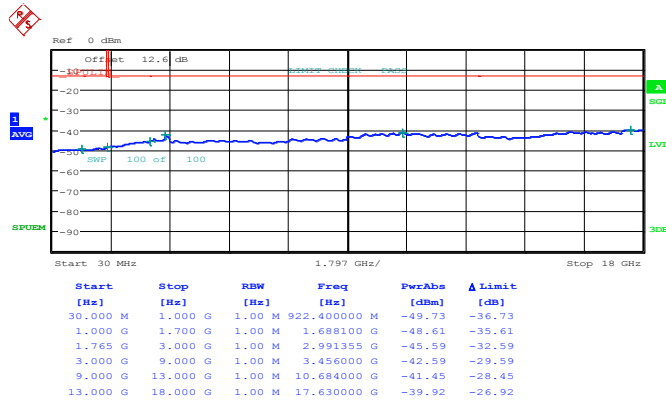

Date: 25.MAY.2014 08:37:03



Band :	LTE Band 4	Channel :	CH20175
Band Width :	15MHz		

QPSK (RB Size 1, RB Offset 0)

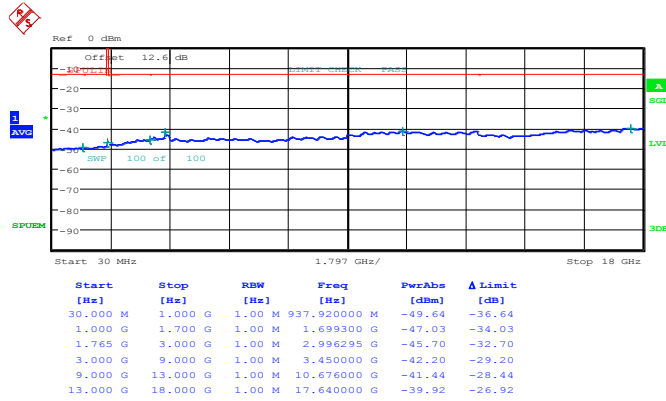

Date: 25.MAY.2014 08:51:55

16QAM (RB Size 1, RB Offset 0)

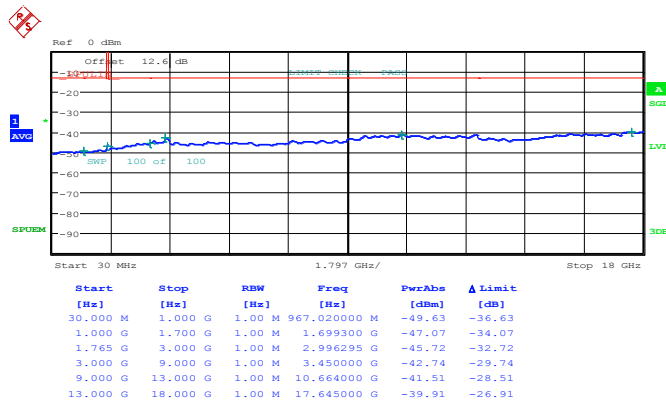

Date: 25.MAY.2014 08:52:56



Band :	LTE Band 4	Channel :	CH20175
Band Width :	20MHz		

QPSK (RB Size 1, RB Offset 0)

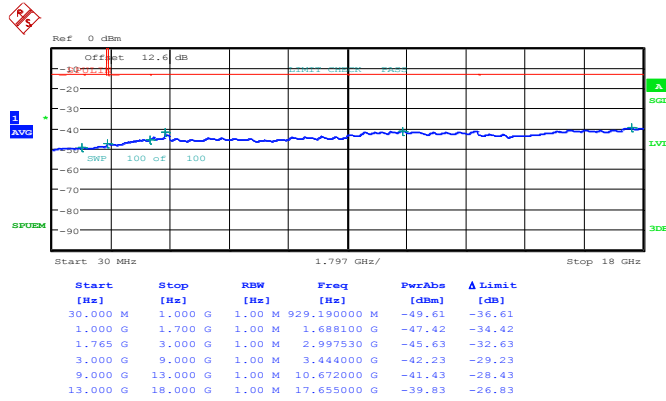

Date: 25.MAY.2014 09:07:47

16QAM (RB Size 1, RB Offset 0)

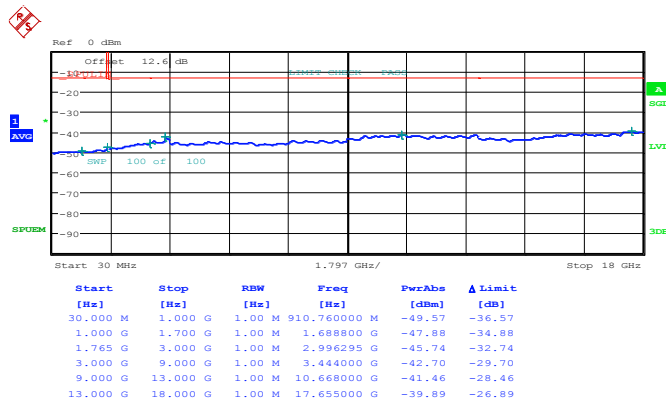

Date: 25.MAY.2014 09:08:48



Band :	LTE Band 12	Channel :	CH23095
Band Width :	1.4MHz		

QPSK (RB Size 1, RB Offset 0)

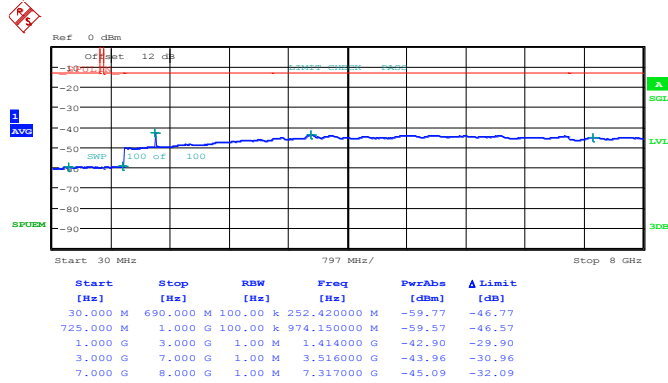

Date: 25.MAY.2014 10:31:35

16QAM (RB Size 1, RB Offset 0)

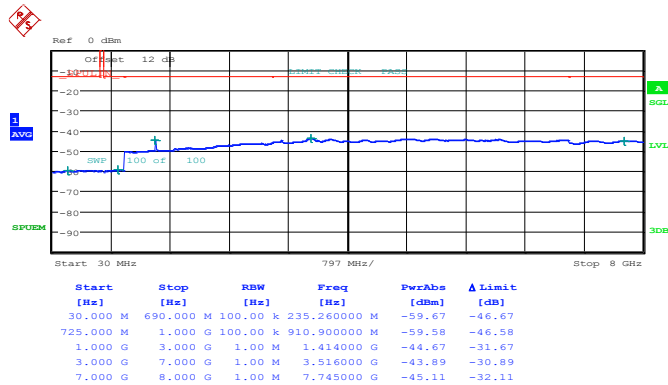

Date: 25.MAY.2014 10:30:34



Band :	LTE Band 12	Channel :	CH23095
Band Width :	3MHz		

QPSK (RB Size 1, RB Offset 0)

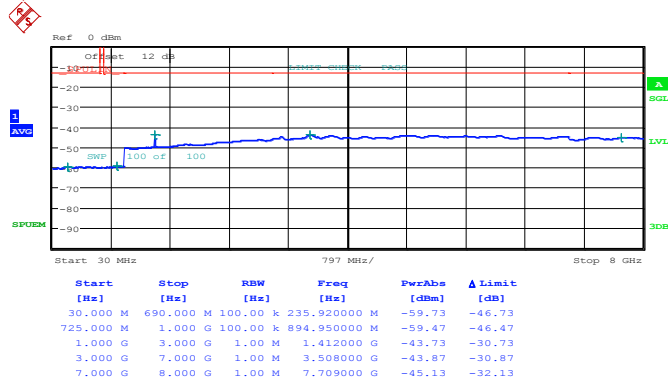

Date: 25.MAY.2014 10:48:36

16QAM (RB Size 1, RB Offset 0)

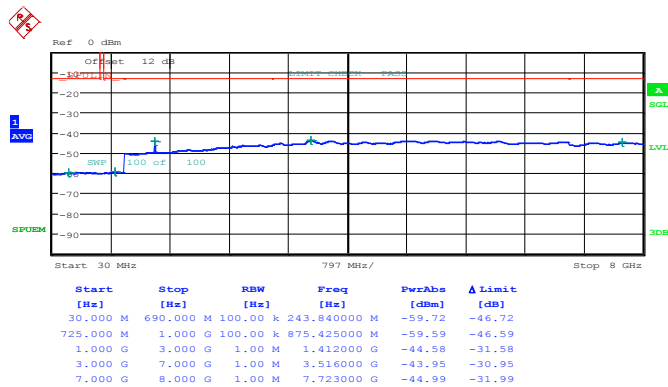

Date: 25.MAY.2014 10:47:35



Band :	LTE Band 12	Channel :	CH23095
Band Width :	5MHz		

QPSK (RB Size 1, RB Offset 0)

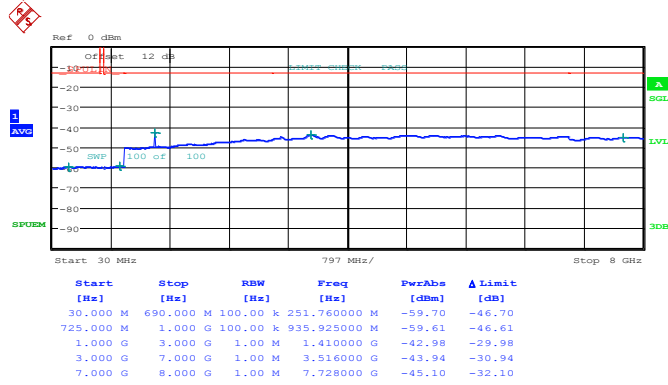

Date: 25.MAY.2014 11:05:04

16QAM (RB Size 1, RB Offset 0)

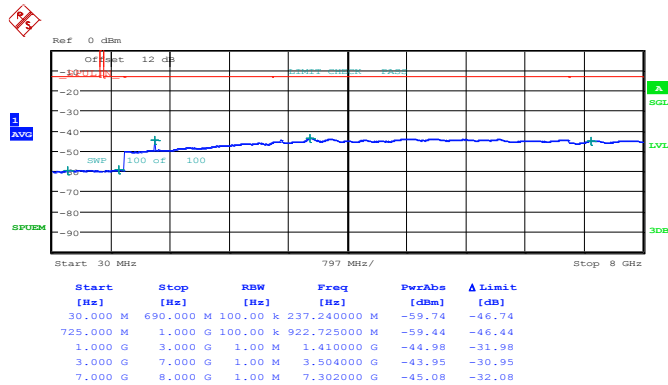

Date: 25.MAY.2014 11:04:04



Band :	LTE Band 12	Channel :	CH23095
Band Width :	10MHz		

QPSK (RB Size 1, RB Offset 0)

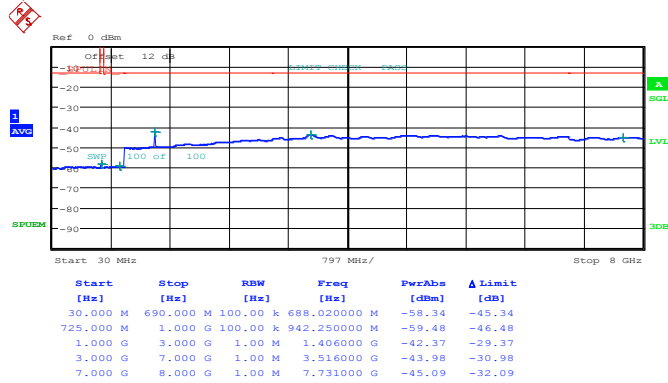

Date: 25.MAY.2014 11:59:50

16QAM (RB Size 1, RB Offset 0)

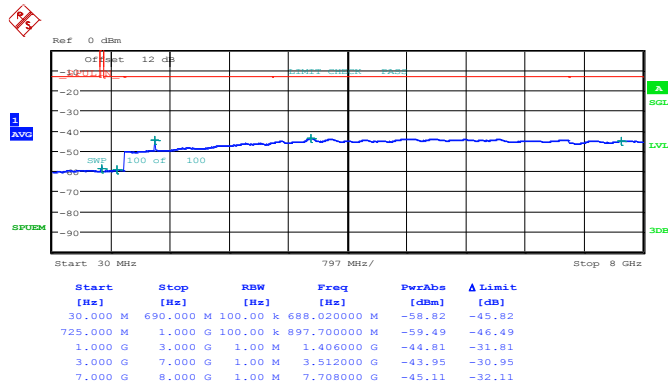

Date: 25.MAY.2014 11:56:29



Band :	LTE Band 17	Channel :	CH23790
Band Width :	5MHz		

QPSK (RB Size 1, RB Offset 0)

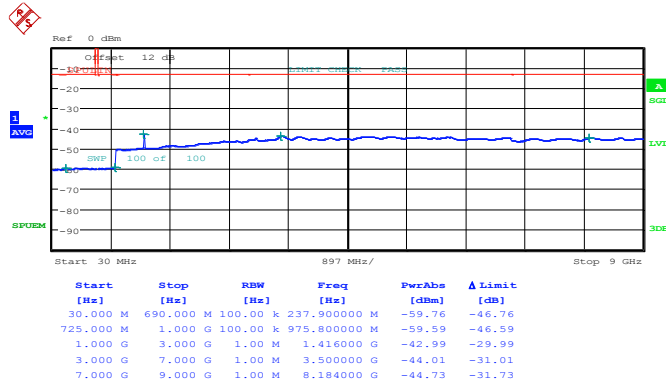

Date: 25.MAY.2014 09:31:28

16QAM (RB Size 1, RB Offset 0)

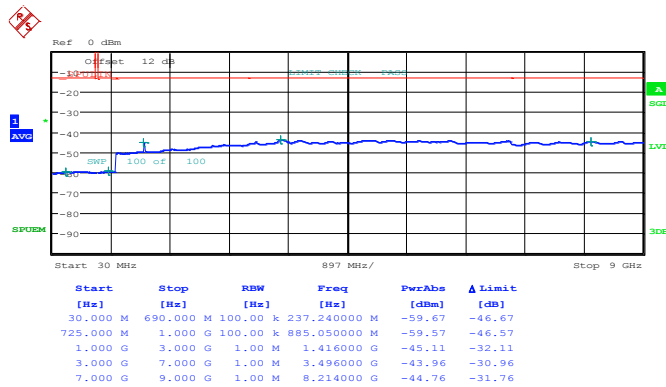

Date: 25.MAY.2014 09:32:29



Band :	LTE Band 17	Channel :	CH23790
Band Width :	10MHz		

QPSK (RB Size 1, RB Offset 0)

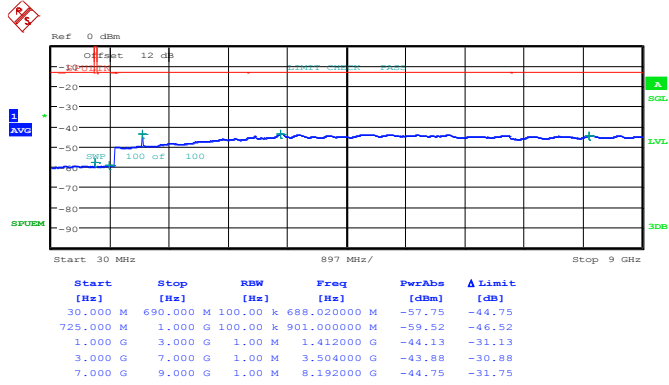

Date: 25.MAY.2014 09:47:22

16QAM (RB Size 1, RB Offset 0)

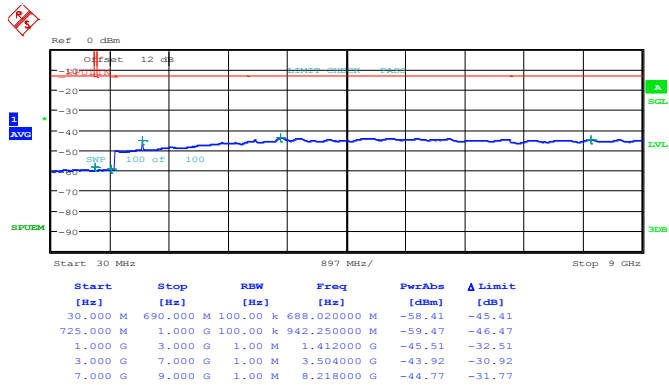

Date: 25.MAY.2014 09:48:23



Band :	LTE Band 41	Channel :	CH40620
Band Width :	5MHz		

QPSK (RB Size 1, RB Offset 0)

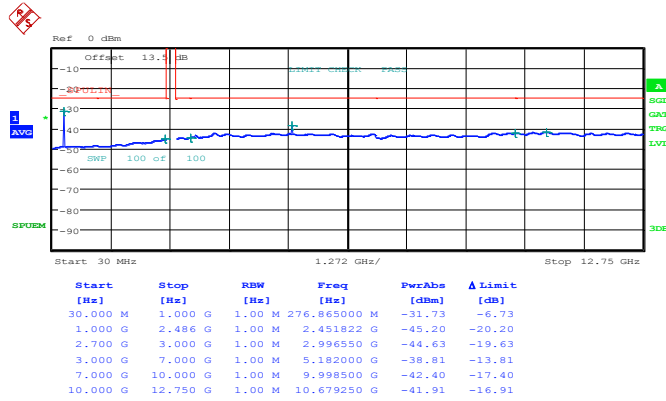

Date: 25.MAY.2014 14:56:56

16QAM (RB Size 1, RB Offset 0)

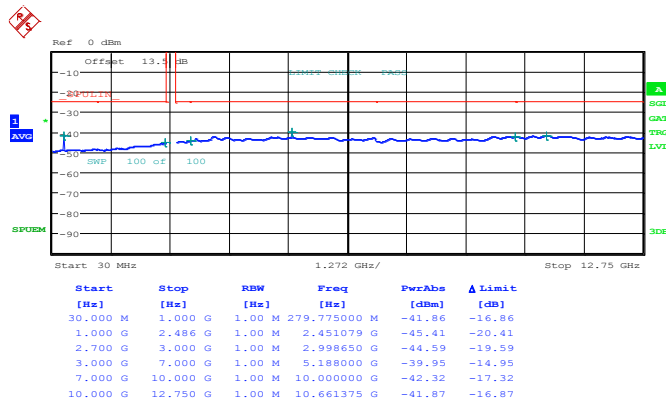

Date: 25.MAY.2014 14:54:27



Band :	LTE Band 41	Channel :	CH40620
Band Width :	10MHz		

QPSK (RB Size 1, RB Offset 0)

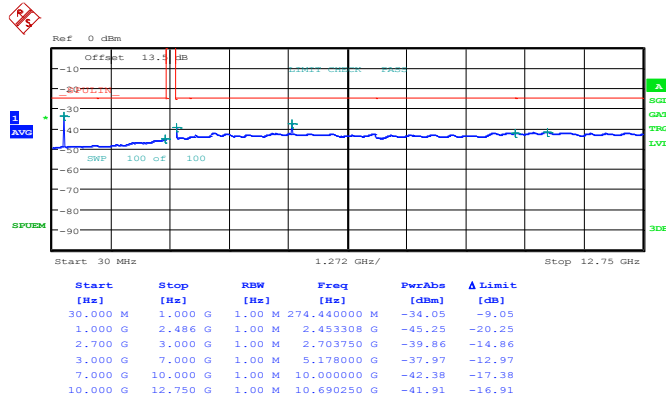

Date: 25.MAY.2014 14:36:39

16QAM (RB Size 1, RB Offset 0)

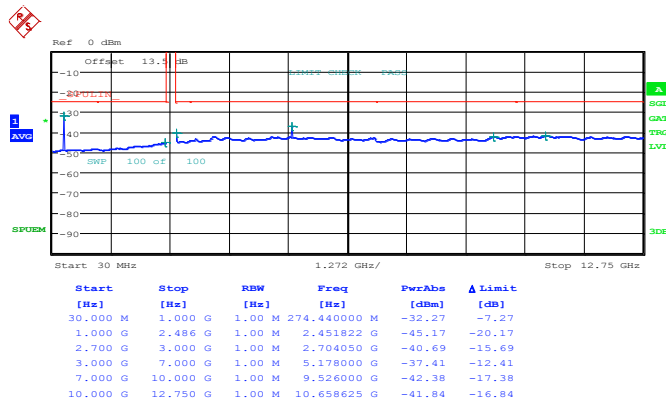

Date: 25.MAY.2014 14:34:20



Band :	LTE Band 41	Channel :	CH40620
Band Width :	15MHz		

QPSK (RB Size 1, RB Offset 0)

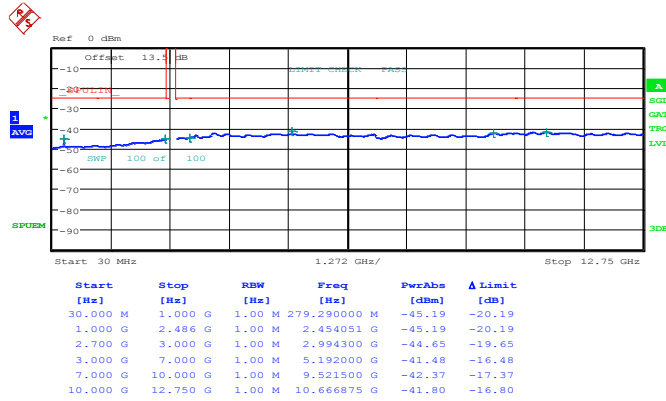

Date: 25.MAY.2014 14:29:46

16QAM (RB Size 1, RB Offset 0)

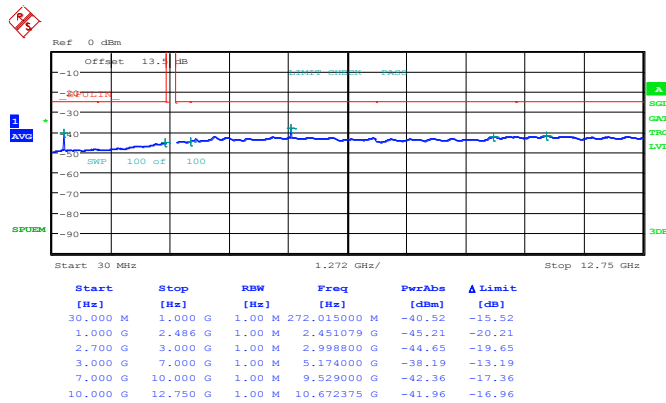

Date: 25.MAY.2014 14:32:00



Band :	LTE Band 41	Channel :	CH40620
Band Width :	20MHz		

QPSK (RB Size 1, RB Offset 0)

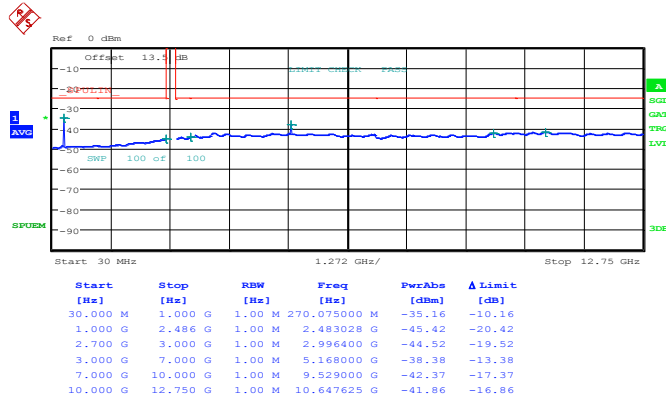

Date: 25.MAY.2014 14:00:51

16QAM (RB Size 1, RB Offset 0)

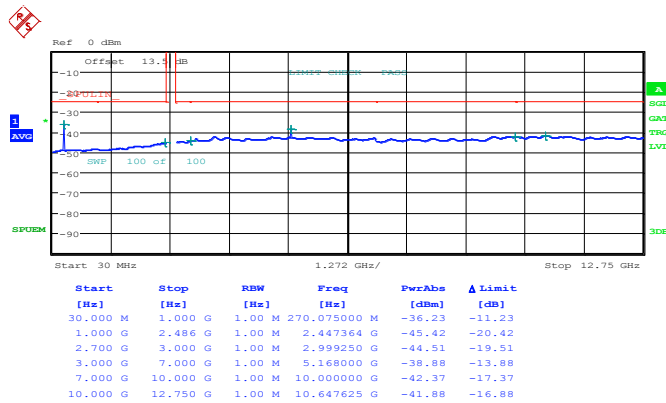

Date: 25.MAY.2014 14:03:08



3.7 Radiated Spurious Emission Measurement

3.7.1 Description of Radiated Spurious Emission

The radiated spurious emission was measured by substitution method according to ANSI / TIA / EIA-603-C-2004. The power of any emission outside of the authorized operating frequency ranges must be attenuated below the transmitter power (P) by a factor of at least $43 + 10 \log (P)$ dB.

The power of any emission outside of the authorized operating frequency ranges must be attenuated below the transmitter power (P) by a factor of at least $55 + 10 \log (P)$ dB.

The spectrum is scanned from 30 MHz up to a frequency including its 10th harmonic.

3.7.2 Measuring Instruments

The measuring equipment is listed in the section 4 of this test report.

3.7.3 Test Procedures

1. The EUT was placed on a rotatable wooden table with 0.8 meter above ground.
2. The EUT was set 3 meters from the receiving antenna, which was mounted on the antenna tower.
3. The table was rotated 360 degrees to determine the position of the highest spurious emission.
4. The height of the receiving antenna is varied between one meter and four meters to search the maximum spurious emission for both horizontal and vertical polarizations.
5. Make the measurement with the spectrum analyzer's RBW = 1MHz, VBW = 3MHz, taking the record of maximum spurious emission.
6. A horn antenna was substituted in place of the EUT and was driven by a signal generator.
7. Tune the output power of signal generator to the same emission level with EUT maximum spurious emission.
8. Taking the record of output power at antenna port.
9. Repeat step 7 to step 8 for another polarization.
10. The RF fundamental frequency should be excluded against the limit line in the operating frequency band.

$$\begin{aligned} & \text{The limit line is derived from } 43 + 10\log(P)\text{dB below the transmitter power P(Watts)} \\ & = P(W) - [43 + 10\log(P)] \text{ (dB)} \\ & = [30 + 10\log(P)] \text{ (dBm)} - [43 + 10\log(P)] \text{ (dB)} \\ & = -13\text{dBm}. \end{aligned}$$

$$\text{The limit line is derived from } 55 + 10\log(P)\text{dB below the transmitter power P(Watts)}$$

11. $\text{EIRP (dBm)} = \text{S.G. Power} - \text{Tx Cable Loss} + \text{Tx Antenna Gain}$
12. $\text{ERP (dBm)} = \text{EIRP} - 2.15$

3.7.4 Test Setup

For radiated emissions from 30MHz to 1GHz

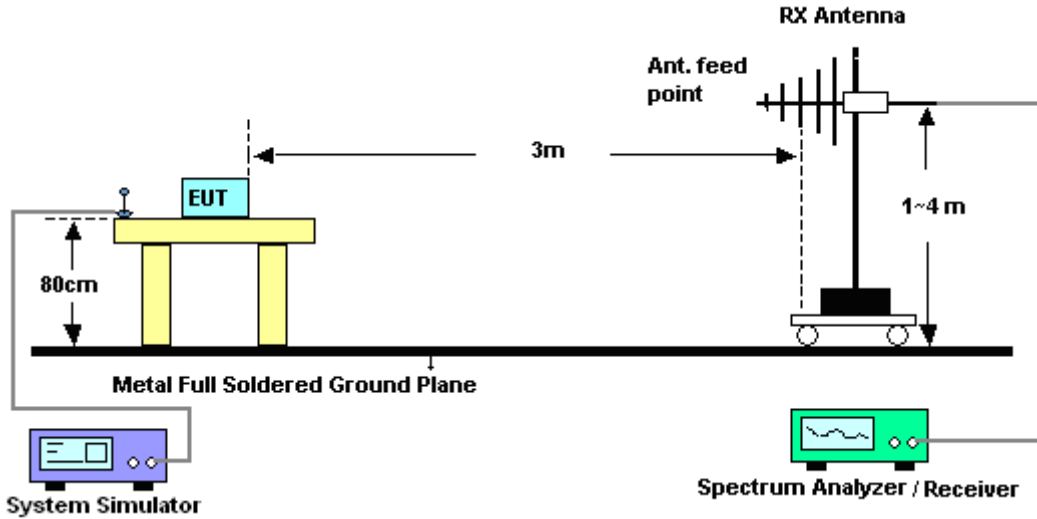

For radiated emissions above 1GHz

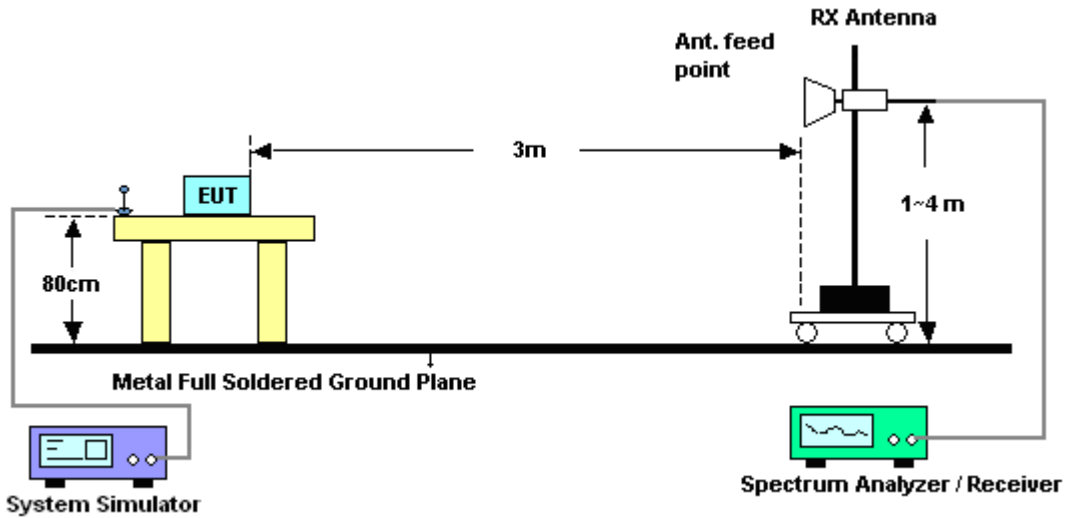



3.7.5 Test Result of Field Strength of Spurious Radiated

Band :	LTE Band 4				Temperature :	21~24°C			
Test Mode :	1.4MHz QPSK RB Size 1 Offset 0				Relative Humidity :	44~48%			
Test Engineer :	Kyle Jhuang				Polarization :	Horizontal			
Remark :	Spurious emissions within 30-10th harmonic were found more than 20dB below limit line.								
Frequency (MHz)	EIRP (dBm)	Limit (dBm)	Over Limit (dB)	SPA Reading (dBm)	S.G. Power (dBm)	TX Cable loss (dB)	TX Antenna Gain (dBi)	Polarization (H/V)	Result
3464	-39.20	-13	-26.20	-51.79	-43.03	4.48	8.31	H	Pass
5196	-37.22	-13	-24.22	-56.45	-41.86	5.332	9.98	H	Pass
6928	-31.15	-13	-18.15	-54.67	-36.39	6.1	11.34	H	Pass
8659	-33.59	-13	-20.59	-59.31	-38.51	8.25	13.17	H	Pass
10391	-35.83	-13	-22.83	-62.32	-40.12	8.65	12.94	H	Pass
12123	-32.74	-13	-19.74	-62.81	-37.05	8.59	12.90	H	Pass
13855	-30.29	-13	-17.29	-57.31	-36.34	8.14	14.19	H	Pass
15587	-27.07	-13	-14.07	-58.08	-31.56	9.45	13.94	H	Pass

Band :	LTE Band 4				Temperature :	21~24°C			
Test Mode :	1.4MHz QPSK RB Size 1 Offset 0				Relative Humidity :	44~48%			
Test Engineer :	Kyle Jhuang				Polarization :	Vertical			
Remark :	Spurious emissions within 30-10th harmonic were found more than 20dB below limit line.								
Frequency (MHz)	EIRP (dBm)	Limit (dBm)	Over Limit (dB)	SPA Reading (dBm)	S.G. Power (dBm)	TX Cable loss (dB)	TX Antenna Gain (dBi)	Polarization (H/V)	Result
3464	-41.99	-13	-28.99	-55.46	-45.82	4.48	8.31	V	Pass
5196	-40.64	-13	-27.64	-59.27	-45.28	5.332	9.98	V	Pass
6928	-31.70	-13	-18.70	-54.23	-36.94	6.1	11.34	V	Pass
8659	-40.67	-13	-27.67	-65.59	-45.59	8.25	13.17	V	Pass
10391	-37.88	-13	-24.88	-63.56	-42.17	8.65	12.94	V	Pass
12123	-35.17	-13	-22.17	-63.06	-39.48	8.59	12.90	V	Pass
13855	-31.46	-13	-18.46	-58.29	-37.51	8.14	14.19	V	Pass
15587	-30.54	-13	-17.54	-59.72	-35.03	9.45	13.94	V	Pass



Band :	LTE Band 4		Temperature :	21~24°C					
Test Mode :	3MHz QPSK RB Size 1 Offset 0		Relative Humidity :	44~48%					
Test Engineer :	Kyle Jhuang		Polarization :	Horizontal					
Remark :	Spurious emissions within 30-10th harmonic were found more than 20dB below limit line.								
Frequency (MHz)	EIRP (dBm)	Limit (dBm)	Over Limit (dB)	SPA Reading (dBm)	S.G. Power (dBm)	TX Cable loss (dB)	TX Antenna Gain (dBi)	Polarization (H/V)	Result
3462	-39.36	-13	-26.36	-40.49	-43.19	4.48	8.31	H	Pass
5191	-37.24	-13	-24.24	-38.35	-41.88	5.332	9.98	H	Pass
6927	-32.17	-13	-19.17	-33.32	-37.41	6.1	11.34	H	Pass
8656	-33.07	-13	-20.07	-34.03	-37.99	8.25	13.17	H	Pass
10378	-39.60	-13	-26.60	-65.9	-43.89	8.65	12.94	H	Pass
12115	-34.16	-13	-21.16	-64.28	-38.47	8.59	12.90	H	Pass
13852	-31.51	-13	-18.51	-58.55	-37.56	8.14	14.19	H	Pass
15580	-25.33	-13	-12.33	-56.34	-29.82	9.45	13.94	H	Pass

Band :	LTE Band 4		Temperature :	21~24°C					
Test Mode :	3MHz QPSK RB Size 1 Offset 0		Relative Humidity :	44~48%					
Test Engineer :	Kyle Jhuang		Polarization :	Vertical					
Remark :	Spurious emissions within 30-10th harmonic were found more than 20dB below limit line.								
Frequency (MHz)	EIRP (dBm)	Limit (dBm)	Over Limit (dB)	SPA Reading (dBm)	S.G. Power (dBm)	TX Cable loss (dB)	TX Antenna Gain (dBi)	Polarization (H/V)	Result
3462	-42.19	-13	-29.19	-55.81	-46.02	4.48	8.31	V	Pass
5191	-42.54	-13	-29.54	-61.15	-47.18	5.332	9.98	V	Pass
6927	-32.10	-13	-19.10	-54.68	-37.34	6.1	11.34	V	Pass
8628	-41.09	-13	-28.09	-66.33	-46.01	8.25	13.17	V	Pass
10351	-39.60	-13	-26.60	-65.34	-43.89	8.65	12.94	V	Pass
12079	-37.57	-13	-24.57	-65.37	-41.88	8.59	12.90	V	Pass
13852	-29.61	-13	-16.61	-56.34	-35.66	8.14	14.19	V	Pass
15580	-30.32	-13	-17.32	-59.57	-34.81	9.45	13.94	V	Pass



Band :	LTE Band 4		Temperature :	21~24°C					
Test Mode :	5MHz QPSK RB Size 1 Offset 0		Relative Humidity :	44~48%					
Test Engineer :	Kyle Jhuang		Polarization :	Horizontal					
Remark :	Spurious emissions within 30-10th harmonic were found more than 20dB below limit line.								
Frequency (MHz)	EIRP (dBm)	Limit (dBm)	Over Limit (dB)	SPA Reading (dBm)	S.G. Power (dBm)	TX Cable loss (dB)	TX Antenna Gain (dBi)	Polarization (H/V)	Result
3462	-39.19	-13	-26.19	-52.01	-43.02	4.48	8.31	H	Pass
5191	-34.25	-13	-21.25	-53.6	-38.89	5.332	9.98	H	Pass
6920	-31.82	-13	-18.82	-55.14	-37.06	6.1	11.34	H	Pass
8649	-33.87	-13	-20.87	-59.83	-38.79	8.25	13.17	H	Pass
10378	-37.22	-13	-24.22	-63.67	-41.51	8.65	12.94	H	Pass
12115	-33.21	-13	-20.21	-63.65	-37.52	8.59	12.90	H	Pass
13843	-28.23	-13	-15.23	-55.47	-34.28	8.14	14.19	H	Pass
15571	-24.19	-13	-11.19	-55.64	-28.68	9.45	13.94	H	Pass
17302	-30.72	-13	-17.72	-61.68	-34.86	10.08	14.23	H	Pass

Band :	LTE Band 4		Temperature :	21~24°C					
Test Mode :	5MHz QPSK RB Size 1 Offset 0		Relative Humidity :	44~48%					
Test Engineer :	Kyle Jhuang		Polarization :	Vertical					
Remark :	Spurious emissions within 30-10th harmonic were found more than 20dB below limit line.								
Frequency (MHz)	EIRP (dBm)	Limit (dBm)	Over Limit (dB)	SPA Reading (dBm)	S.G. Power (dBm)	TX Cable loss (dB)	TX Antenna Gain (dBi)	Polarization (H/V)	Result
3462	-42.19	-13	-29.19	-55.65	-46.02	4.48	8.31	V	Pass
5191	-39.38	-13	-26.38	-58.24	-44.02	5.332	9.98	V	Pass
6920	-30.31	-13	-17.31	-53.05	-35.55	6.1	11.34	V	Pass
8649	-38.19	-13	-25.19	-63.2	-43.11	8.25	13.17	V	Pass
10378	-36.19	-13	-23.19	-62.08	-40.48	8.65	12.94	V	Pass
12106	-37.74	-13	-24.74	-65.6	-42.05	8.59	12.90	V	Pass
13843	-29.81	-13	-16.81	-56.5	-35.86	8.14	14.19	V	Pass
15571	-29.69	-13	-16.69	-58.84	-34.18	9.45	13.94	V	Pass
17299	-32.08	-13	-19.08	-63.67	-36.22	10.08	14.23	V	Pass



Band :	LTE Band 4					Temperature :	21~24°C		
Test Mode :	10MHz QPSK RB Size 1 Offset 0					Relative Humidity :	44~48%		
Test Engineer :	Kyle Jhuang					Polarization :	Horizontal		
Remark :	Spurious emissions within 30-10th harmonic were found more than 20dB below limit line.								
Frequency (MHz)	EIRP (dBm)	Limit (dBm)	Over Limit (dB)	SPA Reading (dBm)	S.G. Power (dBm)	TX Cable loss (dB)	TX Antenna Gain (dBi)	Polarization (H/V)	Result
3455	-37.30	-13	-24.30	-49.95	-41.13	4.48	8.31	H	Pass
5183	-37.37	-13	-24.37	-56.56	-42.01	5.332	9.98	H	Pass
6910	-31.68	-13	-18.68	-55.01	-36.92	6.1	11.34	H	Pass
8638	-34.45	-13	-21.45	-60.09	-39.37	8.25	13.17	H	Pass
10365	-36.57	-13	-23.57	-63.13	-40.86	8.65	12.94	H	Pass
12093	-31.83	-13	-18.83	-61.91	-36.14	8.59	12.90	H	Pass
13820	-29.98	-13	-16.98	-57.1	-36.03	8.14	14.19	H	Pass
15548	-26.80	-13	-13.80	-57.94	-31.29	9.45	13.94	H	Pass
17275	-29.60	-13	-16.60	-60.46	-33.74	10.08	14.23	H	Pass

Band :	LTE Band 4					Temperature :	21~24°C		
Test Mode :	10MHz QPSK RB Size 1 Offset 0					Relative Humidity :	44~48%		
Test Engineer :	Kyle Jhuang					Polarization :	Vertical		
Remark :	Spurious emissions within 30-10th harmonic were found more than 20dB below limit line.								
Frequency (MHz)	EIRP (dBm)	Limit (dBm)	Over Limit (dB)	SPA Reading (dBm)	S.G. Power (dBm)	TX Cable loss (dB)	TX Antenna Gain (dBi)	Polarization (H/V)	Result
3455	-39.58	-13	-26.58	-52.84	-43.41	4.48	8.31	V	Pass
5183	-39.38	-13	-26.38	-58.04	-44.02	5.332	9.98	V	Pass
6910	-32.04	-13	-19.04	-54.69	-37.28	6.1	11.34	V	Pass
8638	-39.77	-13	-26.77	-64.72	-44.69	8.25	13.17	V	Pass
10365	-34.72	-13	-21.72	-60.42	-39.01	8.65	12.94	V	Pass
12093	-38.93	-13	-25.93	-66.74	-43.24	8.59	12.90	V	Pass
13820	-29.37	-13	-16.37	-56.26	-35.42	8.14	14.19	V	Pass
15548	-29.32	-13	-16.32	-58.67	-33.81	9.45	13.94	V	Pass
17275	-32.22	-13	-19.22	-63.49	-36.36	10.08	14.23	V	Pass



Band :	LTE Band 4	Temperature :	21~24°C						
Test Mode :	15MHz QPSK RB Size 1 Offset 0	Relative Humidity :	44~48%						
Test Engineer :	Kyle Jhuang	Polarization :	Horizontal						
Remark :	Spurious emissions within 30-10th harmonic were found more than 20dB below limit line.								
Frequency (MHz)	EIRP (dBm)	Limit (dBm)	Over Limit (dB)	SPA Reading (dBm)	S.G. Power (dBm)	TX Cable loss (dB)	TX Antenna Gain (dBi)	Polarization (H/V)	Result
3450	-38.50	-13	-25.50	-51.43	-42.33	4.48	8.31	H	Pass
5177	-36.35	-13	-23.35	-55.55	-40.99	5.332	9.98	H	Pass
6906	-34.43	-13	-21.43	-57.85	-39.67	6.1	11.34	H	Pass
8628	-36.83	-13	-23.83	-62.59	-41.75	8.25	13.17	H	Pass
10351	-36.76	-13	-23.76	-63.28	-41.05	8.65	12.94	H	Pass
12079	-32.37	-13	-19.37	-62.36	-36.68	8.59	12.90	H	Pass
13807	-28.31	-13	-15.31	-55.74	-34.36	8.14	14.19	H	Pass
15535	-28.39	-13	-15.39	-59.24	-32.88	9.45	13.94	H	Pass
17254	-30.88	-13	-17.88	-61.69	-35.02	10.08	14.23	H	Pass

Band :	LTE Band 4	Temperature :	21~24°C						
Test Mode :	15MHz QPSK RB Size 1 Offset 0	Relative Humidity :	44~48%						
Test Engineer :	Kyle Jhuang	Polarization :	Vertical						
Remark :	Spurious emissions within 30-10th harmonic were found more than 20dB below limit line.								
Frequency (MHz)	EIRP (dBm)	Limit (dBm)	Over Limit (dB)	SPA Reading (dBm)	S.G. Power (dBm)	TX Cable loss (dB)	TX Antenna Gain (dBi)	Polarization (H/V)	Result
3450	-41.20	-13	-28.20	-54.72	-45.03	4.48	8.31	V	Pass
5177	-43.02	-13	-30.02	-61.65	-47.66	5.332	9.98	V	Pass
6906	-33.17	-13	-20.17	-55.76	-38.41	6.1	11.34	V	Pass
8628	-40.26	-13	-27.26	-65.27	-45.18	8.25	13.17	V	Pass
10360	-37.27	-13	-24.27	-63.15	-41.56	8.65	12.94	V	Pass
12079	-35.53	-13	-22.53	-63.48	-39.84	8.59	12.90	V	Pass
13807	-30.07	-13	-17.07	-56.94	-36.12	8.14	14.19	V	Pass
15535	-30.37	-13	-17.37	-59.72	-34.86	9.45	13.94	V	Pass
17254	-32.40	-13	-19.40	-63.42	-36.54	10.08	14.23	V	Pass



Band :	LTE Band 4	Temperature :	21~24°C						
Test Mode :	20MHz QPSK RB Size 1 Offset 0	Relative Humidity :	44~48%						
Test Engineer :	Kyle Jhuang	Polarization :	Horizontal						
Remark :	Spurious emissions within 30-10th harmonic were found more than 20dB below limit line.								
Frequency (MHz)	EIRP (dBm)	Limit (dBm)	Over Limit (dB)	SPA Reading (dBm)	S.G. Power (dBm)	TX Cable loss (dB)	TX Antenna Gain (dBi)	Polarization (H/V)	Result
3446	-38.03	-13	-25.03	-50.68	-41.86	4.48	8.31	H	Pass
5168	-39.11	-13	-26.11	-58.38	-43.75	5.332	9.98	H	Pass
6891	-34.10	-13	-21.10	-57.22	-39.34	6.1	11.34	H	Pass
8613	-37.09	-13	-24.09	-62.63	-42.01	8.25	13.17	H	Pass
10335	-35.46	-13	-22.46	-61.9	-39.75	8.65	12.94	H	Pass
12058	-34.45	-13	-21.45	-64.38	-38.76	8.59	12.90	H	Pass
13780	-31.03	-13	-18.03	-58.42	-37.08	8.14	14.19	H	Pass
15503	-28.20	-13	-15.20	-59.31	-32.69	9.45	13.94	H	Pass

Band :	LTE Band 4	Temperature :	21~24°C						
Test Mode :	20MHz QPSK RB Size 1 Offset 0	Relative Humidity :	44~48%						
Test Engineer :	Kyle Jhuang	Polarization :	Vertical						
Remark :	Spurious emissions within 30-10th harmonic were found more than 20dB below limit line.								
Frequency (MHz)	EIRP (dBm)	Limit (dBm)	Over Limit (dB)	SPA Reading (dBm)	S.G. Power (dBm)	TX Cable loss (dB)	TX Antenna Gain (dBi)	Polarization (H/V)	Result
3446	-41.18	-13	-28.18	-54.35	-45.01	4.48	8.31	V	Pass
5168	-43.85	-13	-30.85	-62.42	-48.49	5.332	9.98	V	Pass
6890	-34.79	-13	-21.79	-57.12	-40.03	6.1	11.34	V	Pass
8613	-39.20	-13	-26.20	-64.26	-44.12	8.25	13.17	V	Pass
10335	-40.02	-13	-27.02	-65.71	-44.31	8.65	12.94	V	Pass
12058	-37.97	-13	-24.97	-65.67	-42.28	8.59	12.90	V	Pass
13780	-33.09	-13	-20.09	-59.9	-39.14	8.14	14.19	V	Pass
15503	-34.96	-13	-21.96	-64.15	-39.45	9.45	13.94	V	Pass



Band :	LTE Band 12				Temperature :	21~24°C			
Test Mode :	1.4MHz QPSK RB Size 1 Offset 0				Relative Humidity :	44~48%			
Test Engineer :	Kyle Jhuang				Polarization :	Horizontal			
Remark :	Spurious emissions within 30-10th harmonic were found more than 20dB below limit line.								
Frequency (MHz)	ERP (dBm)	Limit (dBm)	Over Limit (dB)	SPA Reading (dBm)	S.G. Power (dBm)	TX Cable loss (dB)	TX Antenna Gain (dBi)	Polarization (H/V)	Result
1416	-56.82	-13	-43.82	-63.13	-58.52	1.47	5.32	H	Pass
2120	-53.25	-13	-40.25	-64.07	-55.22	1.86	5.98	H	Pass
2824	-53.81	-13	-40.81	-65.12	-56.88	2.21	7.43	H	Pass

Band :	LTE Band 12				Temperature :	21~24°C			
Test Mode :	1.4MHz QPSK RB Size 1 Offset 0				Relative Humidity :	44~48%			
Test Engineer :	Kyle Jhuang				Polarization :	Vertical			
Remark :	Spurious emissions within 30-10th harmonic were found more than 20dB below limit line.								
Frequency (MHz)	ERP (dBm)	Limit (dBm)	Over Limit (dB)	SPA Reading (dBm)	S.G. Power (dBm)	TX Cable loss (dB)	TX Antenna Gain (dBi)	Polarization (H/V)	Result
1416	-56.96	-13	-43.96	-62.89	-58.66	1.47	5.32	V	Pass
2120	-54.15	-13	-41.15	-65.12	-56.12	1.86	5.98	V	Pass
2824	-51.69	-13	-38.69	-64.98	-54.76	2.21	7.43	V	Pass



Band :	LTE Band 12	Temperature :	21~24°C						
Test Mode :	3MHz QPSK RB Size 1 Offset 0	Relative Humidity :	44~48%						
Test Engineer :	Kyle Jhuang	Polarization :	Horizontal						
Remark :	Spurious emissions within 30-10th harmonic were found more than 20dB below limit line.								
Frequency (MHz)	ERP (dBm)	Limit (dBm)	Over Limit (dB)	SPA Reading (dBm)	S.G. Power (dBm)	TX Cable loss (dB)	TX Antenna Gain (dBi)	Polarization (H/V)	Result
1416	-57.37	-13	-44.37	-63.47	-59.07	1.47	5.32	H	Pass
2120	-53.25	-13	-40.25	-63.65	-55.22	1.86	5.98	H	Pass
2824	-52.95	-13	-39.95	-64.27	-56.02	2.21	7.43	H	Pass

Band :	LTE Band 12	Temperature :	21~24°C						
Test Mode :	3MHz QPSK RB Size 1 Offset 0	Relative Humidity :	44~48%						
Test Engineer :	Kyle Jhuang	Polarization :	Vertical						
Remark :	Spurious emissions within 30-10th harmonic were found more than 20dB below limit line.								
Frequency (MHz)	ERP (dBm)	Limit (dBm)	Over Limit (dB)	SPA Reading (dBm)	S.G. Power (dBm)	TX Cable loss (dB)	TX Antenna Gain (dBi)	Polarization (H/V)	Result
1416	-57.42	-13	-44.42	-63.09	-59.12	1.47	5.32	V	Pass
2120	-52.30	-13	-39.30	-63.13	-54.27	1.86	5.98	V	Pass
2824	-52.28	-13	-39.28	-65.43	-55.35	2.21	7.43	V	Pass



Band :	LTE Band 12	Temperature :	21~24°C						
Test Mode :	5MHz QPSK RB Size 1 Offset 0	Relative Humidity :	44~48%						
Test Engineer :	Kyle Jhuang	Polarization :	Horizontal						
Remark :	Spurious emissions within 30-10th harmonic were found more than 20dB below limit line.								
Frequency (MHz)	ERP (dBm)	Limit (dBm)	Over Limit (dB)	SPA Reading (dBm)	S.G. Power (dBm)	TX Cable loss (dB)	TX Antenna Gain (dBi)	Polarization (H/V)	Result
1408	-57.40	-13	-44.40	-63.48	-59.1	1.47	5.32	H	Pass
2120	-50.16	-13	-37.16	-61.08	-52.13	1.86	5.98	H	Pass
2824	-53.34	-13	-40.34	-64.72	-56.41	2.21	7.43	H	Pass

Band :	LTE Band 12	Temperature :	21~24°C						
Test Mode :	5MHz QPSK RB Size 1 Offset 0	Relative Humidity :	44~48%						
Test Engineer :	Kyle Jhuang	Polarization :	Vertical						
Remark :	Spurious emissions within 30-10th harmonic were found more than 20dB below limit line.								
Frequency (MHz)	ERP (dBm)	Limit (dBm)	Over Limit (dB)	SPA Reading (dBm)	S.G. Power (dBm)	TX Cable loss (dB)	TX Antenna Gain (dBi)	Polarization (H/V)	Result
1408	-57.71	-13	-44.71	-63.58	-59.41	1.47	5.32	V	Pass
2120	-50.31	-13	-37.31	-61.3	-52.28	1.86	5.98	V	Pass
2824	-52.17	-13	-39.17	-65.49	-55.24	2.21	7.43	V	Pass



Band :	LTE Band 12	Temperature :	21~24°C						
Test Mode :	10MHz QPSK RB Size 1 Offset 0	Relative Humidity :	44~48%						
Test Engineer :	Kyle Jhuang	Polarization :	Horizontal						
Remark :	Spurious emissions within 30-10th harmonic were found more than 20dB below limit line.								
Frequency (MHz)	ERP (dBm)	Limit (dBm)	Over Limit (dB)	SPA Reading (dBm)	S.G. Power (dBm)	TX Cable loss (dB)	TX Antenna Gain (dBi)	Polarization (H/V)	Result
1408	-57.41	-13	-44.41	-63.58	-59.11	1.47	5.32	H	Pass
2104	-55.05	-13	-42.05	-65.1	-57.02	1.86	5.98	H	Pass
2808	-53.02	-13	-40.02	-64.64	-56.09	2.21	7.43	H	Pass

Band :	LTE Band 12	Temperature :	21~24°C						
Test Mode :	10MHz QPSK RB Size 1 Offset 0	Relative Humidity :	44~48%						
Test Engineer :	Kyle Jhuang	Polarization :	Vertical						
Remark :	Spurious emissions within 30-10th harmonic were found more than 20dB below limit line.								
Frequency (MHz)	ERP (dBm)	Limit (dBm)	Over Limit (dB)	SPA Reading (dBm)	S.G. Power (dBm)	TX Cable loss (dB)	TX Antenna Gain (dBi)	Polarization (H/V)	Result
1408	-56.35	-13	-43.35	-62.09	-58.05	1.47	5.32	V	Pass
2104	-54.54	-13	-41.54	-65.24	-56.51	1.86	5.98	V	Pass
2808	-51.20	-13	-38.20	-64.54	-54.27	2.21	7.43	V	Pass



Band :	LTE Band 17	Temperature :	21~24°C						
Test Mode :	5MHz QPSK RB Size 1 Offset 0	Relative Humidity :	44~48%						
Test Engineer :	Kyle Jhuang	Polarization :	Horizontal						
Remark :	Spurious emissions within 30-10th harmonic were found more than 20dB below limit line.								
Frequency (MHz)	ERP (dBm)	Limit (dBm)	Over Limit (dB)	SPA Reading (dBm)	S.G. Power (dBm)	TX Cable loss (dB)	TX Antenna Gain (dBi)	Polarization (H/V)	Result
1416	-57.25	-13	-44.25	-63.31	-61.33	1.53	5.61	H	Pass
2120	-54.05	-13	-41.05	-65.25	-58.22	1.85	6.02	H	Pass
2832	-53.27	-13	-40.27	-64.6	-58.03	2.24	7.00	H	Pass

Band :	LTE Band 17	Temperature :	21~24°C						
Test Mode :	5MHz QPSK RB Size 1 Offset 0	Relative Humidity :	44~48%						
Test Engineer :	Kyle Jhuang	Polarization :	Vertical						
Remark :	Spurious emissions within 30-10th harmonic were found more than 20dB below limit line.								
Frequency (MHz)	ERP (dBm)	Limit (dBm)	Over Limit (dB)	SPA Reading (dBm)	S.G. Power (dBm)	TX Cable loss (dB)	TX Antenna Gain (dBi)	Polarization (H/V)	Result
1416	-57.10	-13	-44.10	-62.8	-61.18	1.53	5.61	V	Pass
2120	-54.05	-13	-41.05	-64.94	-58.22	1.85	6.02	V	Pass
2832	-52.03	-13	-39.03	-65.18	-56.79	2.24	7.00	V	Pass



Band :	LTE Band 17	Temperature :	21~24°C						
Test Mode :	10MHz QPSK RB Size 1 Offset 0	Relative Humidity :	44~48%						
Test Engineer :	Kyle Jhuang	Polarization :	Horizontal						
Remark :	Spurious emissions within 30-10th harmonic were found more than 20dB below limit line.								
Frequency (MHz)	ERP (dBm)	Limit (dBm)	Over Limit (dB)	SPA Reading (dBm)	S.G. Power (dBm)	TX Cable loss (dB)	TX Antenna Gain (dBi)	Polarization (H/V)	Result
1408	-56.03	-13	-43.03	-62.28	-60.11	1.53	5.61	H	Pass
2112	-55.08	-13	-42.08	-65.23	-59.25	1.85	6.02	H	Pass
2824	-53.86	-13	-40.86	-65.29	-58.62	2.24	7.00	H	Pass

Band :	LTE Band 17	Temperature :	21~24°C						
Test Mode :	10MHz QPSK RB Size 1 Offset 0	Relative Humidity :	44~48%						
Test Engineer :	Kyle Jhuang	Polarization :	Vertical						
Remark :	Spurious emissions within 30-10th harmonic were found more than 20dB below limit line.								
Frequency (MHz)	ERP (dBm)	Limit (dBm)	Over Limit (dB)	SPA Reading (dBm)	S.G. Power (dBm)	TX Cable loss (dB)	TX Antenna Gain (dBi)	Polarization (H/V)	Result
1408	-56.77	-13	-43.77	-62.65	-60.85	1.53	5.61	V	Pass
2112	-54.55	-13	-41.55	-65.19	-58.72	1.85	6.02	V	Pass
2824	-52.57	-13	-39.57	-65.6	-57.33	2.24	7.00	V	Pass



Band :	LTE Band 41	Temperature :	21~24°C						
Test Mode :	5MHz QPSK RB Size 1 Offset 0	Relative Humidity :	44~48%						
Test Engineer :	Kyle Jhuang	Polarization :	Horizontal						
Remark :	Spurious emissions within 30-10th harmonic were found more than 20dB below limit line.								
Frequency (MHz)	EIRP (dBm)	Limit (dBm)	Over Limit (dB)	SPA Reading (dBm)	S.G. Power (dBm)	TX Cable loss (dB)	TX Antenna Gain (dBi)	Polarization (H/V)	Result
5184	-36.12	-25	-11.12	-55.28	-39.58	6.89	10.35	H	Pass
7774	-30.10	-25	-5.10	-53.04	-31.02	9.34	10.26	H	Pass
10360	-39.17	-25	-14.17	-65.56	-43.21	8.68	12.72	H	Pass

Band :	LTE Band 41	Temperature :	21~24°C						
Test Mode :	5MHz QPSK RB Size 1 Offset 0	Relative Humidity :	44~48%						
Test Engineer :	Kyle Jhuang	Polarization :	Vertical						
Remark :	Spurious emissions within 30-10th harmonic were found more than 20dB below limit line.								
Frequency (MHz)	EIRP (dBm)	Limit (dBm)	Over Limit (dB)	SPA Reading (dBm)	S.G. Power (dBm)	TX Cable loss (dB)	TX Antenna Gain (dBi)	Polarization (H/V)	Result
5184	-39.77	-25	-14.77	-58.46	-43.23	6.89	10.35	V	Pass
7774	-35.36	-25	-10.36	-58.24	-36.28	9.34	10.26	V	Pass
10360	-41.21	-25	-16.21	-66.75	-45.25	8.68	12.72	V	Pass



Band :	LTE Band 41	Temperature :	21~24°C						
Test Mode :	10MHz QPSK RB Size 1 Offset 0	Relative Humidity :	44~48%						
Test Engineer :	Kyle Jhuang	Polarization :	Horizontal						
Remark :	Spurious emissions within 30-10th harmonic were found more than 20dB below limit line.								
Frequency (MHz)	EIRP (dBm)	Limit (dBm)	Over Limit (dB)	SPA Reading (dBm)	S.G. Power (dBm)	TX Cable loss (dB)	TX Antenna Gain (dBi)	Polarization (H/V)	Result
5177	-35.22	-25	-10.22	-54.41	-38.68	6.89	10.35	H	Pass
7767	-29.76	-25	-4.76	-52.34	-30.68	9.34	10.26	H	Pass
10351	-39.99	-25	-14.99	-66.29	-44.03	8.68	12.72	H	Pass

Band :	LTE Band 41	Temperature :	21~24°C						
Test Mode :	10MHz QPSK RB Size 1 Offset 0	Relative Humidity :	44~48%						
Test Engineer :	Kyle Jhuang	Polarization :	Vertical						
Remark :	Spurious emissions within 30-10th harmonic were found more than 20dB below limit line.								
Frequency (MHz)	EIRP (dBm)	Limit (dBm)	Over Limit (dB)	SPA Reading (dBm)	S.G. Power (dBm)	TX Cable loss (dB)	TX Antenna Gain (dBi)	Polarization (H/V)	Result
5177	-38.60	-25	-13.60	-56.98	-42.06	6.89	10.35	V	Pass
7767	-34.41	-25	-9.41	-56.96	-35.33	9.34	10.26	V	Pass
10351	-41.07	-25	-16.07	-66.4	-45.11	8.68	12.72	V	Pass



Band :	LTE Band 41	Temperature :	21~24°C						
Test Mode :	15MHz QPSK RB Size 1 Offset 0	Relative Humidity :	44~48%						
Test Engineer :	Kyle Jhuang	Polarization :	Horizontal						
Remark :	Spurious emissions within 30-10th harmonic were found more than 20dB below limit line.								
Frequency (MHz)	EIRP (dBm)	Limit (dBm)	Over Limit (dB)	SPA Reading (dBm)	S.G. Power (dBm)	TX Cable loss (dB)	TX Antenna Gain (dBi)	Polarization (H/V)	Result
5170	-33.79	-25	-8.79	-52.88	-37.25	6.89	10.35	H	Pass
7760	-28.63	-25	-3.63	-51.45	-29.55	9.34	10.26	H	Pass
10342	-39.18	-25	-14.18	-65.34	-43.22	8.68	12.72	H	Pass

Band :	LTE Band 41	Temperature :	21~24°C						
Test Mode :	15MHz QPSK RB Size 1 Offset 0	Relative Humidity :	44~48%						
Test Engineer :	Kyle Jhuang	Polarization :	Vertical						
Remark :	Spurious emissions within 30-10th harmonic were found more than 20dB below limit line.								
Frequency (MHz)	EIRP (dBm)	Limit (dBm)	Over Limit (dB)	SPA Reading (dBm)	S.G. Power (dBm)	TX Cable loss (dB)	TX Antenna Gain (dBi)	Polarization (H/V)	Result
5170	-37.76	-25	-12.76	-56.07	-41.22	6.89	10.35	V	Pass
7760	-30.60	-25	-5.60	-52.98	-31.52	9.34	10.26	V	Pass
10342	-40.62	-25	-15.62	-65.89	-44.66	8.68	12.72	V	Pass



Band :	LTE Band 41	Temperature :	21~24°C						
Test Mode :	20MHz QPSK RB Size 1 Offset 0	Relative Humidity :	44~48%						
Test Engineer :	Kyle Jhuang	Polarization :	Horizontal						
Remark :	Spurious emissions within 30-10th harmonic were found more than 20dB below limit line.								
Frequency (MHz)	EIRP (dBm)	Limit (dBm)	Over Limit (dB)	SPA Reading (dBm)	S.G. Power (dBm)	TX Cable loss (dB)	TX Antenna Gain (dBi)	Polarization (H/V)	Result
5170	-33.76	-25	-8.76	-53.01	-37.22	6.89	10.35	H	Pass
7753	-28.74	-25	-3.74	-51.59	-29.66	9.34	10.26	H	Pass
10333	-39.47	-25	-14.47	-65.54	-43.51	8.68	12.72	H	Pass

Band :	LTE Band 41	Temperature :	21~24°C						
Test Mode :	20MHz QPSK RB Size 1 Offset 0	Relative Humidity :	44~48%						
Test Engineer :	Kyle Jhuang	Polarization :	Vertical						
Remark :	Spurious emissions within 30-10th harmonic were found more than 20dB below limit line.								
Frequency (MHz)	EIRP (dBm)	Limit (dBm)	Over Limit (dB)	SPA Reading (dBm)	S.G. Power (dBm)	TX Cable loss (dB)	TX Antenna Gain (dBi)	Polarization (H/V)	Result
5170	-37.76	-25	-12.76	-55.93	-41.22	6.89	10.35	V	Pass
7753	-33.74	-25	-8.74	-56.37	-34.66	9.34	10.26	V	Pass
10333	-40.31	-25	-15.31	-65.8	-44.35	8.68	12.72	V	Pass



3.8 Frequency Stability Measurement

3.8.1 Description of Frequency Stability Measurement

The frequency stability shall be measured by variation of ambient temperature and variation of primary supply voltage to ensure that the fundamental emission stays within the authorized frequency block. The frequency stability of the transmitter shall be maintained within $\pm 0.00025\%$ ($\pm 2.5\text{ppm}$) of the center frequency.

3.8.2 Measuring Instruments

The measuring equipment is listed in the section 4 of this test report.

3.8.3 Test Procedures for Temperature Variation

1. The EUT was set up in the thermal chamber and connected with the system simulator.
2. With power OFF, the temperature was decreased to -30°C and the EUT was stabilized before testing. Power was applied and the maximum change in frequency was recorded within one minute.
3. With power OFF, the temperature was raised in 10°C step up to 50°C . The EUT was stabilized at each step for at least half an hour. Power was applied and the maximum frequency change was recorded within one minute.

3.8.4 Test Procedures for Voltage Variation

1. The EUT was placed in a temperature chamber at $25\pm 5^{\circ}\text{C}$ and connected with the system simulator.
2. The power supply voltage to the EUT was varied from 85% to 115% of the nominal value measured at the input to the EUT.
3. The variation in frequency was measured for the worst case.

3.8.5 Test Setup

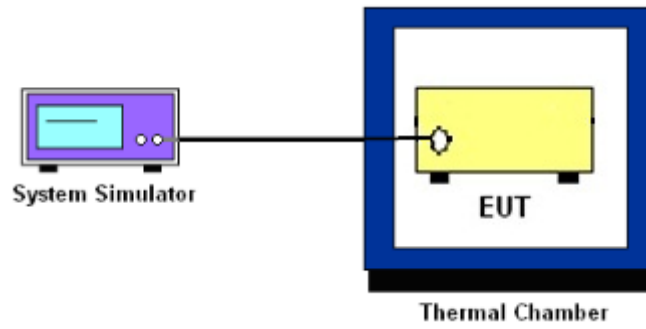



3.8.6 Test Result of Temperature Variation

Band :	LTE Band 4 (QPSK)	Limit (ppm) :	2.5
Temperature (°C)	BW 10MHz		Result
	Deviation (ppm)		
50	0.0052		PASS
40	0.0009		
30	0.0014		
20(Ref.)	0.0015		
10	0.0008		
0	0.0006		
-10	0.0028		
-20	0.0012		
-30	0.0018		



Band :	LTE Band 12 (QPSK)	Limit (ppm) :	2.5
Temperature (°C)	BW 10MHz		Result
	Deviation (ppm)		
50	0.0083		PASS
40	0.0061		
30	0.0033		
20(Ref.)	0.0038		
10	0.0033		
0	0.0088		
-10	0.0021		
-20	0.0047		
-30	0.0025		

Band :	LTE Band 17 (QPSK)	Limit (ppm) :	2.5
Temperature (°C)	BW 10MHz		Result
	Deviation (ppm)		
50	0.0042		PASS
40	0.0025		
30	0.0017		
20(Ref.)	0.0021		
10	0.0030		
0	0.0070		
-10	0.0063		
-20	0.0068		
-30	0.0013		



Band :	LTE Band 41 (QPSK)	Limit (ppm) :	2.5
Temperature (°C)	BW 10MHz	Result	
	Deviation (ppm)		
50	0.0052	PASS	
40	0.0049		
30	0.0042		
20(Ref.)	0.0044		
10	0.0056		
0	0.0051		
-10	0.0061		
-20	0.0049		
-30	0.0046		



3.8.7 Test Result of Voltage Variation (FCC)

Band	Bandwidth	Voltage (Volt)	Deviation (ppm)	Limit (ppm)	Result
LTE Band 4	10M	12.20	0.0010	2.5	PASS
		Normal	0.0017		
		11.80	0.0013		
LTE Band 12	10M	12.20	0.0085	2.5	PASS
		Normal	0.0085		
		11.80	0.0016		
LTE Band 17	10M	12.20	0.0007	2.5	PASS
		Normal	0.0027		
		11.80	0.0052		
LTE Band 41	10M	12.20	0.0052	2.5	PASS
		Normal	0.0048		
		11.80	0.0046		

Remark:

1. Normal Voltage = 12.00V.
2. The manufacturer declared that the EUT could work properly between voltage 11.80V ~ 12.20V.



4 List of Measuring Equipment

Instrument	Manufacturer	Model No.	Serial No.	Characteristics	Calibration Date	Test Date	Due Date	Remark
Spectrum Analyzer	Rohde & Schwarz	FSP40	100055	9kHz~40GHz	Jun. 07, 2013	May 25, 2014~ Jun. 03, 2014	Jun. 06, 2014	Conducted (TH02-HY)
Thermal Chamber	Ten Billion	TTH-D3SP	TBN-930701	N/A	Jul. 19, 2013	May 25, 2014~ Jun. 03, 2014	Jul. 18, 2014	Conducted (TH02-HY)
LTE Base Station	Anritsu	MT8820C	6201026480	30MHz~2.7GHz SISO	Jan. 07, 2014	May 25, 2014~ Jun. 03, 2014	Jan. 06, 2015	Conducted (TH02-HY)
Spectrum Analyzer	Rohde & Schwarz	FSV30	101749	10Hz ~ 30GHz	Feb. 10, 2014	Jun. 03, 2014~ Jun. 12, 2014	Feb. 09, 2015	Radiation (03CH07-HY)
Bilog Antenna	Schaffner	CBL6111C	2726	30MHz ~ 1GHz	Oct. 10, 2013	Jun. 03, 2014~ Jun. 12, 2014	Oct. 09, 2014	Radiation (03CH07-HY)
Double Ridge Horn Antenna	ESCO	3117	75962	1GHz~18GHz	Aug. 22, 2013	Jun. 03, 2014~ Jun. 12, 2014	Aug. 21, 2014	Radiation (03CH07-HY)
Preamplifier	COM-POWER	PA-103A	161241	10 MHz ~ 1000MHz	Mar. 17, 2014	Jun. 03, 2014~ Jun. 12, 2014	Mar. 16, 2015	Radiation (03CH07-HY)
Preamplifier	Agilent	8449B	3008A02362	1 GHz~26.5 GHz	Nov. 29, 2013	Jun. 03, 2014~ Jun. 12, 2014	Nov. 28, 2014	Radiation (03CH07-HY)
Turn Table	ChainTek	ChainTek 3000	N/A	0 ~ 360 degree	N/A	Jun. 03, 2014~ Jun. 12, 2014	N/A	Radiation (03CH07-HY)
Antenna Mast	ChainTek	M-400-0	114/8000604	N/A	N/A	Jun. 03, 2014~ Jun. 12, 2014	N/A	Radiation (03CH07-HY)
SHF-EHF Horn Antenna	SCHWARZBEC K	BBHA 9170	BBHA91702 51	15GHz- 40GHz	Oct. 03, 2013	Jun. 03, 2014~ Jun. 12, 2014	Oct. 02, 2014	Radiation (03CH07-HY)



5 Uncertainty of Evaluation

Uncertainty of Radiated Emission Measurement (30 MHz ~ 1000 MHz)

Measuring Uncertainty for a Level of Confidence of 95% ($U = 2Uc(y)$)	4.50
---	------