



FCC RF Test Report

APPLICANT : BandRich Inc.
EQUIPMENT : Ruggedized 4G LTE M2M & Vehicle Mount Router
BRAND NAME : BandLuxe
MODEL NAME : K535U
FCC ID : UZI-35K899
STANDARD : FCC Part 15 Subpart C §15.247
CLASSIFICATION : (DTS) Digital Transmission System

The product was received on Feb. 11, 2014 and testing was completed on Apr. 10, 2014. We, SPORTON INTERNATIONAL INC., would like to declare that the tested sample has been evaluated in accordance with the procedures and shown to be compliant with the applicable technical standards.

The test results in this report apply exclusively to the tested model / sample. Without written approval of SPORTON INTERNATIONAL INC., the test report shall not be reproduced except in full.

Reviewed by: Joseph Lin / Supervisor

Approved by: Jones Tsai / Manager



SPORTON INTERNATIONAL INC.

No. 52, Hwa Ya 1st Rd., Hwa Ya Technology Park, Kwei-Shan Hsiang, Tao Yuan Hsien, Taiwan, R.O.C.

SPORTON INTERNATIONAL INC.

TEL : 886-3-327-3456

FAX : 886-3-328-4978

FCC ID : UZI-35K899

Page Number : 1 of 92

Report Issued Date : Apr. 11, 2014

Report Version : Rev. 01



TABLE OF CONTENTS

REVISION HISTORY 3

SUMMARY OF TEST RESULT 4

1 GENERAL DESCRIPTION 5

 1.1 Applicant 5

 1.2 Manufacturer 5

 1.3 Feature of Equipment Under Test 5

 1.4 Product Specification of Equipment Under Test 6

 1.5 Modification of EUT 6

 1.6 Testing Site 7

 1.7 Applied Standards 7

2 TEST CONFIGURATION OF EQUIPMENT UNDER TEST 8

 2.1 Carrier Frequency and Channel 8

 2.2 Pre-Scanned RF Power 9

 2.3 Test Mode 11

 2.4 Connection Diagram of Test System 12

 2.5 Support Unit used in test configuration and system 13

 2.6 EUT Operation Test Setup 13

 2.7 Measurement Results Explanation Example 14

3 TEST RESULT 15

 3.1 6dB Bandwidth Measurement 15

 3.2 Peak Output Power Measurement 18

 3.3 Power Spectral Density Measurement 21

 3.4 Conducted Band Edges and Spurious Emission Measurement 25

 3.5 Radiated Band Edges and Spurious Emission Measurement 62

 3.6 AC Conducted Emission Measurement 84

 3.7 Antenna Requirements 90

4 LIST OF MEASURING EQUIPMENT 91

5 UNCERTAINTY OF EVALUATION 92

APPENDIX A. SETUP PHOTOGRAPHS



REVISION HISTORY

REPORT NO.	VERSION	DESCRIPTION	ISSUED DATE
FR421184	Rev. 01	Initial issue of report	Apr. 11, 2014

**SUMMARY OF TEST RESULT**

Report Section	FCC Rule	IC Rule	Description	Limit	Result	Remark
3.1	15.247(a)(2)	RSS-210 A8.2(a)	6dB Bandwidth	$\geq 0.5\text{MHz}$	Pass	-
3.2	15.247(b)	RSS-210 A8.4	Power Output Measurement	$\leq 30\text{dBm}$	Pass	-
3.3	15.247(e)	RSS-210 A8.2(b)	Power Spectral Density	$\leq 8\text{dBm}/3\text{kHz}$	Pass	-
3.4	15.247(d)	RSS-210 A8.5	Conducted Band Edges	$\leq 20\text{dBc}$	Pass	-
			Conducted Spurious Emission		Pass	-
3.5	15.247(d)	RSS-210 A8.5	Radiated Band Edges and Radiated Spurious Emission	15.209(a) & 15.247(d)	Pass	Under limit 0.62 dB at 2483.860 MHz
3.6	15.207	RSS-Gen 7.2.4	AC Conducted Emission	15.207(a)	Pass	Under limit 12.30 dB at 4.094 MHz
3.7	15.203 & 15.247(b)	RSS-210 A8.4	Antenna Requirement	N/A	Pass	-



1 General Description

1.1 Applicant

BandRich Inc.

6F., No. 71, Zhouzi St., Neihu Dist., Taipei City 11493, Taiwan (R.O.C.)

1.2 Manufacturer

FAIR GOAL ELECTRONIC CO.

1F., No. 97-1, Haihu, Luzhu Township, Taoyuan County 338, Taiwan (R.O.C.)

1.3 Feature of Equipment Under Test

Product Feature	
Equipment	Ruggedized 4G LTE M2M & Vehicle Mount Router
Brand Name	BandLuxe
Model Name	K535U
FCC ID	UZI-35K899
EUT supports Radios application	CDMA/EV-DO/LTE WLAN 11b/g/n (HT20/HT40)
HW Version	K1813ME01
EUT Stage	Identical Prototype

Remark: The above EUT's information was declared by manufacturer. Please refer to the specifications or user's manual for more detailed description.

1.4 Product Specification of Equipment Under Test

Product Specification subjective to this standard																						
Tx/Rx Channel Frequency Range	2412 MHz ~ 2462 MHz																					
Maximum Output Power to antenna	<p><SISO Ant. 1> 802.11b : 20.25 dBm (0.1059 W) 802.11g : 25.02 dBm (0.3177 W) 802.11n HT20 : 24.51 dBm (0.2825 W) 802.11n HT40 : 24.78 dBm (0.3006 W)</p> <p><SISO Ant. 2> 802.11b : 20.18 dBm (0.1042 W) 802.11g : 24.81 dBm (0.3027 W) 802.11n HT20 : 24.42 dBm (0.2767 W) 802.11n HT40 : 24.65 dBm (0.2917 W)</p> <p><MIMO Ant. 1+2> 802.11b : 23.40 dBm (0.2188 W) 802.11g : 27.73 dBm (0.5929 W) 802.11n HT20 : 27.26 dBm (0.5321 W) 802.11n HT40 : 27.55 dBm (0.5689 W)</p>																					
Antenna Type	<p><Ant 1> 802.11b/g/n : Fixed External Antenna with gain 4.50 dBi</p> <p><Ant 2> 802.11b/g/n : Fixed External Antenna with gain 4.50 dBi</p>																					
Type of Modulation	802.11b : DSSS (DBPSK / DQPSK / CCK) 802.11g/n : OFDM (BPSK / QPSK / 16QAM / 64QAM)																					
Antenna Function for Transmitter	<table border="1"> <thead> <tr> <th></th> <th>Chain Port 0 Ant. 1</th> <th>Chain Port 1 Ant. 2</th> </tr> </thead> <tbody> <tr> <td>802.11 b SISO</td> <td>V</td> <td>V</td> </tr> <tr> <td>802.11 b MIMO</td> <td>V</td> <td>V</td> </tr> <tr> <td>802.11 g SISO</td> <td>V</td> <td>V</td> </tr> <tr> <td>802.11 g MIMO</td> <td>V</td> <td>V</td> </tr> <tr> <td>802.11 n SISO</td> <td>V</td> <td>V</td> </tr> <tr> <td>802.11 n MIMO</td> <td>V</td> <td>V</td> </tr> </tbody> </table>		Chain Port 0 Ant. 1	Chain Port 1 Ant. 2	802.11 b SISO	V	V	802.11 b MIMO	V	V	802.11 g SISO	V	V	802.11 g MIMO	V	V	802.11 n SISO	V	V	802.11 n MIMO	V	V
	Chain Port 0 Ant. 1	Chain Port 1 Ant. 2																				
802.11 b SISO	V	V																				
802.11 b MIMO	V	V																				
802.11 g SISO	V	V																				
802.11 g MIMO	V	V																				
802.11 n SISO	V	V																				
802.11 n MIMO	V	V																				

1.5 Modification of EUT

No modifications are made to the EUT during all test items.

1.6 Testing Site

Test Site	SPORTON INTERNATIONAL INC.			
Test Site Location	No. 52, Hwa Ya 1 st Rd., Hwa Ya Technology Park, Kwei-Shan Hsiang, Tao Yuan Hsien, Taiwan, R.O.C. TEL: +886-3-3273456 / FAX: +886-3-3284978			
Test Site No.	Sporton Site No.			FCC/IC Registration No.
	TH02-HY	CO05-HY	03CH08-HY	636805/4086B-1

Note: The test site complies with ANSI C63.4 2003 requirement.

1.7 Applied Standards

According to the specifications of the manufacturer, the EUT must comply with the requirements of the following standards:

- ♦ FCC Part 15 Subpart C §15.247
- ♦ FCC KDB Publication No. 558074 D01 DTS Meas. Guidance v03r01
- ♦ FCC KDB 662911 D01 Multiple Transmitter Output v02r01.
- ♦ ANSI C63.4-2003

Remark:

1. All test items were verified and recorded according to the standards and without any deviation during the test.
2. This EUT has also been tested and complied with the requirements of FCC Part 15, Subpart B, recorded in a separate test report.



2 Test Configuration of Equipment Under Test

The EUT has been associated with peripherals and configuration operated in a manner tended to maximize its emission characteristics in a typical application. Frequency range investigated: conducted emission (150 kHz to 30 MHz) and radiated emission (9 kHz to the 10th harmonic of the highest fundamental frequency or to 40 GHz, whichever is lower).

The final configuration from all the combinations and the worst-case data rates were investigated by measuring the maximum power across all the data rates and modulation modes under section 2.2.

Based on the worst configuration found above, the RF power setting is set individually to meet FCC compliance limit for the final conducted and radiated tests shown in section 2.3.

2.1 Carrier Frequency and Channel

Frequency Band	Channel	Freq. (MHz)	Channel	Freq. (MHz)
2400-2483.5 MHz	1	2412	7	2442
	2	2417	8	2447
	3	2422	9	2452
	4	2427	10	2457
	5	2432	11	2462
	6	2437	-	-



2.2 Pre-Scanned RF Power

Preliminary tests were performed in different data rate and data rate associated with the highest power were chosen for full test shown in the following tables.

SISO <Ant. 1>

802.11b				
Data Rate (MHz)	1M bps	2M bps	5.5M bps	11M bps
Peak Power (dBm)	20.25	20.23	20.21	20.24

802.11g								
Data Rate (MHz)	6M bps	9M bps	12M bps	18M bps	24M bps	36M bps	48M bps	54M bps
Peak Power (dBm)	25.02	24.88	24.99	24.97	24.95	24.91	24.89	24.97

2.4GHz 802.11n HT20								
Data Rate (MHz)	MCS0	MCS1	MCS2	MCS3	MCS4	MCS5	MCS6	MCS7
Peak Power (dBm)	24.51	24.43	24.49	24.38	24.44	24.47	24.33	24.46

2.4GHz 802.11n HT40								
Data Rate (MHz)	MCS0	MCS1	MCS2	MCS3	MCS4	MCS5	MCS6	MCS7
Peak Power (dBm)	24.78	24.71	24.69	24.65	24.68	24.59	24.73	24.76

SISO <Ant. 2>

802.11b				
Data Rate (MHz)	1M bps	2M bps	5.5M bps	11M bps
Peak Power (dBm)	20.18	20.17	20.14	20.13

802.11g								
Data Rate (MHz)	6M bps	9M bps	12M bps	18M bps	24M bps	36M bps	48M bps	54M bps
Peak Power (dBm)	24.81	24.69	24.70	24.65	24.79	24.78	24.68	24.77

2.4GHz 802.11n HT20								
Data Rate (MHz)	MCS0	MCS1	MCS2	MCS3	MCS4	MCS5	MCS6	MCS7
Peak Power (dBm)	24.42	24.37	24.28	24.30	24.28	24.36	24.25	24.25

2.4GHz 802.11n HT40								
Data Rate (MHz)	MCS0	MCS1	MCS2	MCS3	MCS4	MCS5	MCS6	MCS7
Peak Power (dBm)	24.65	24.62	24.48	24.53	14.57	24.43	24.36	24.22



MIMO <Ant. 1+2>

802.11b				
Data Rate (MHz)	1M bps	2M bps	5.5M bps	11M bps
Peak Power (dBm)	23.40	23.34	23.23	23.34

802.11g								
Data Rate (MHz)	6M bps	9M bps	12M bps	18M bps	24M bps	36M bps	48M bps	54M bps
Peak Power (dBm)	27.73	27.54	27.43	27.49	27.51	27.41	27.48	27.54

2.4GHz 802.11n HT20								
Data Rate (MHz)	MCS0	MCS1	MCS2	MCS3	MCS4	MCS5	MCS6	MCS7
Peak Power (dBm)	27.26	27.17	27.08	27.06	27.04	27.06	27.09	27.06

2.4GHz 802.11n HT40								
Data Rate (MHz)	MCS0	MCS1	MCS2	MCS3	MCS4	MCS5	MCS6	MCS7
Peak Power (dBm)	27.55	27.08	27.08	26.94	26.75	26.75	26.71	26.80

Note: MIMO Ant. 1+2 is a calculated result from sum of the power MIMO Ant. 1 and MIMO Ant. 2.

2.3 Test Mode

Final results of test modes, data rates and test channels are shown as following table.

Test Cases				
	Test Items	Mode	Data Rate	Test Channel
Conducted TCs	6dB BW Power Spectral Density	802.11b	1 Mbps	1/6/11
		802.11g	6 Mbps	1/6/11
		802.11n HT20	MCS0	1/6/11
		802.11n HT40	MCS0	3/6/9
	Output Power	802.11b	1 Mbps	1/6/11
		802.11g	6 Mbps	1/6/11
		802.11n HT20	MCS0	1/6/11
		802.11n HT40	MCS0	3/6/9
	Conducted Band Edge	802.11b	1 Mbps	1/11
		802.11g	6 Mbps	1/11
		802.11n HT20	MCS0	1/11
		802.11n HT40	MCS0	3/9
	Conducted Spurious Emission	802.11b	1 Mbps	1/6/11
		802.11g	6 Mbps	1/6/11
		802.11n HT20	MCS0	1/6/11
		802.11n HT40	MCS0	3/6/9
Radiated TCs	Radiated Band Edge	802.11b	1 Mbps	1/11
		802.11g	6 Mbps	1/11
		802.11n HT20	MCS0	1/11
		802.11n HT40	MCS0	3/9
	Radiated Spurious Emission	802.11b	1 Mbps	1/6/11
		802.11g	6 Mbps	1/6/11
		802.11n HT20	MCS0	1/6/11
		802.11n HT40	MCS0	3/6/9
AC Conducted Emission	Mode 1 : LTE Band 2 Idle + WLAN Link + GPS Rx + RJ-45 Link + USB Cable (Data Link with Notebook) + Adapter			

2.4 Connection Diagram of Test System

<WLAN Tx Mode>

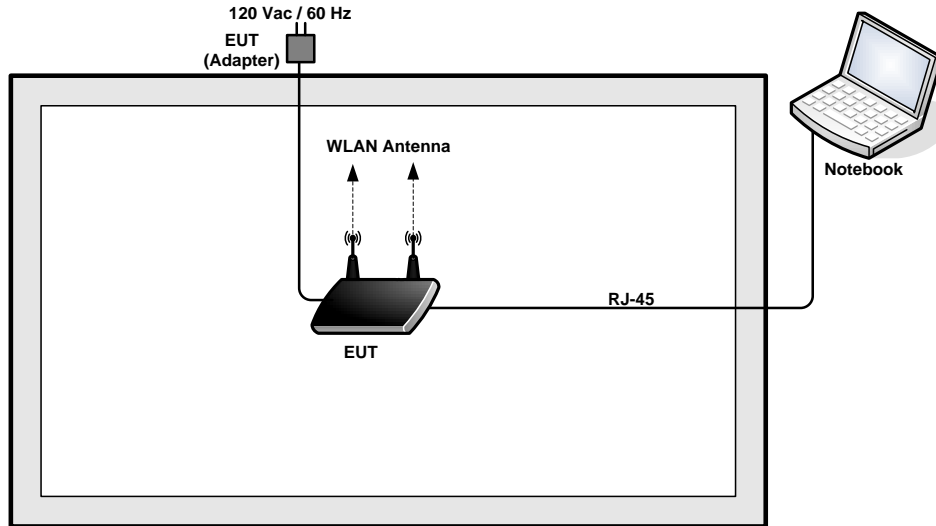

<AC Conducted Emission Mode>

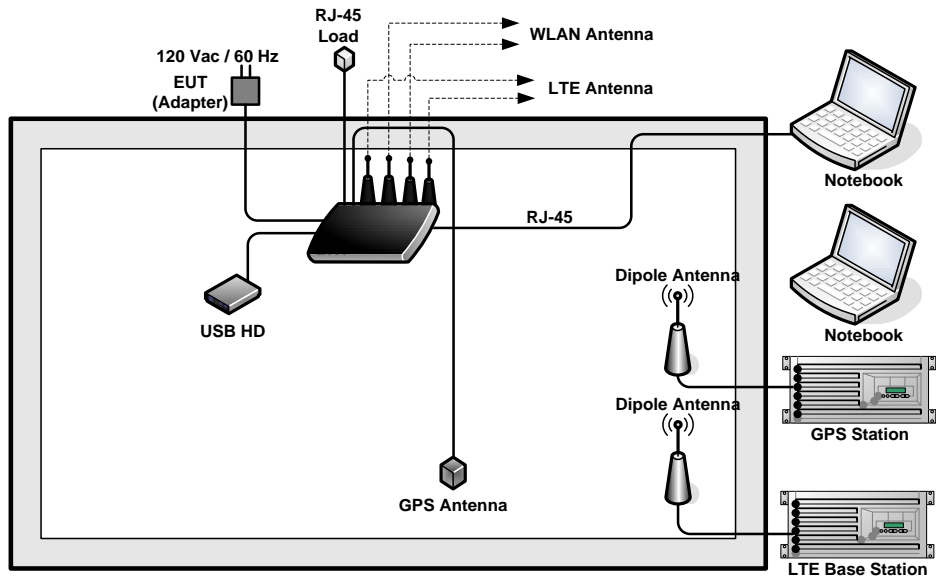

2.5 Support Unit used in test configuration and system

Item	Equipment	Trade Name	Model Name	FCC ID	Data Cable	Power Cord
1.	LTE Base Station	Anritsu	MT8820C	N/A	N/A	Unshielded, 1.8 m
2.	GPS Station	Pendulum	GSG-54	N/A	N/A	Unshielded, 1.8 m
3.	Notebook	DELL	Latitude E6320	FCC DoC	N/A	AC I/P: Unshielded, 1.2 m DC O/P: Shielded, 1.8 m
4.	Notebook	TOSHIBA	PORTEGE M600	FCC DoC	N/A	AC I/P: Unshielded, 1.2 m DC O/P: Shielded, 1.8 m
5.	USB HD	WD	WDBAAR3200ABK-PESN	FCC DoC	Unshielded, 0.5 m	N/A
6.	WWAN Antenna	JOYCELL	YAF-6462SAXX-997	NA	NA	NA
7.	WLAN Antenna	VICMOORE	CY2400-10109LM-03A	NA	NA	NA
8.	GPS Antenna	NA	NA	NA	NA	NA

2.6 EUT Operation Test Setup

For WLAN function, programmed RF utility, “artgui.exe” installed in the notebook make the EUT provides functions like channel selection and power level for continuous transmitting and receiving signals.



2.7 Measurement Results Explanation Example

For all conducted test items:

The offset level is set in the spectrum analyzer to compensate the RF cable loss and attenuator factor between EUT conducted output port and spectrum analyzer. With the offset compensation, the spectrum analyzer reading level is exactly the EUT RF output level.

Example:

The spectrum analyzer offset is derived from RF cable loss and attenuator factor.

Offset = RF cable loss + attenuator factor.

Following shows an offset computation example with cable loss 4.2 dB and 10dB attenuator.

$$\begin{aligned} \text{Offset(dB)} &= \text{RF cable loss(dB)} + \text{attenuator factor(dB)}. \\ &= 4.2 + 10 = 14.2 \text{ (dB)} \end{aligned}$$

3 Test Result

3.1 6dB Bandwidth Measurement

3.1.1 Limit of 6dB Bandwidth

The minimum 6 dB bandwidth shall be at least 500 kHz.

3.1.2 Measuring Instruments

The measuring equipment is listed in the section 4 of this test report.

3.1.3 Test Procedures

1. The testing follows FCC KDB Publication No. 558074 DTS D01 Meas. Guidance v03r01.
2. The RF output of EUT was connected to the spectrum analyzer by RF cable and attenuator. The path loss was compensated to the results for each measurement.
3. Set to the maximum power setting and enable the EUT transmit continuously.
4. Make the measurement with the spectrum analyzer's resolution bandwidth (RBW) = 100 kHz. Set the Video bandwidth (VBW) = 300 kHz. In order to make an accurate measurement. The 6 dB bandwidth must be greater than 500 kHz.
5. Measure and record the results in the test report.

3.1.4 Test Setup

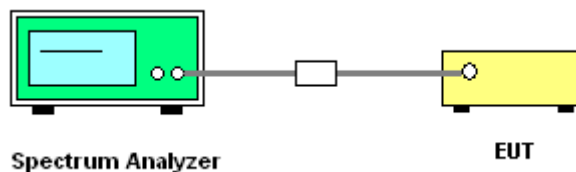



3.1.5 Test Result of 6dB and 99% Occupied Bandwidth

Test Band :	2.4GHz	Temperature :	21~26°C
Test Engineer :	Alex Lee and Bill Kuo	Relative Humidity :	45~54%

Mod.	Data Rate	N _{TX}	Channel	Freq. (MHz)	99% Bandwidth (MHz)		6dB Bandwidth (MHz)		6dB Bandwidth Min. Limit (MHz)	Pass/Fail
					Ant. 1	Ant. 2	Ant. 1	Ant. 2		
11b	1Mbps	1	1	2412	14.10	-	10.08	-	0.5	Pass
11b	1Mbps	1	6	2437	14.05	-	10.04	-	0.5	Pass
11b	1Mbps	1	11	2462	14.15	-	10.04	-	0.5	Pass
11g	6Mbps	1	1	2412	18.70	-	16.32	-	0.5	Pass
11g	6Mbps	1	6	2437	18.35	-	16.08	-	0.5	Pass
11g	6Mbps	1	11	2462	19.25	-	16.04	-	0.5	Pass
HT20	MCS0	1	1	2412	19.25	-	17.32	-	0.5	Pass
HT20	MCS0	1	6	2437	19.30	-	17.32	-	0.5	Pass
HT20	MCS0	1	11	2462	19.50	-	17.56	-	0.5	Pass
HT40	MCS0	1	3	2422	38.50		36.32		0.5	Pass
HT40	MCS0	1	6	2437	37.70		36.12		0.5	Pass
HT40	MCS0	1	9	2452	37.60		35.92		0.5	Pass
11b	1Mbps	2	1	2412	14.10	14.05	10.04	10.08	0.5	Pass
11b	1Mbps	2	6	2437	14.05	14.00	10.04	10.08	0.5	Pass
11b	1Mbps	2	11	2462	14.20	14.05	10.04	10.08	0.5	Pass
11g	6Mbps	2	1	2412	18.50	18.15	16.34	16.36	0.5	Pass
11g	6Mbps	2	6	2437	18.25	18.20	16.00	16.32	0.5	Pass
11g	6Mbps	2	11	2462	18.70	18.25	16.02	16.36	0.5	Pass
HT20	MCS0	2	1	2412	19.00	18.95	17.68	17.62	0.5	Pass
HT20	MCS0	2	6	2437	19.30	19.10	17.32	17.32	0.5	Pass
HT20	MCS0	2	11	2462	19.15	19.10	17.70	17.60	0.5	Pass
HT40	MCS0	2	3	2422	38.70	38.00	36.32	36.40	0.5	Pass
HT40	MCS0	2	6	2437	37.80	37.70	36.08	36.32	0.5	Pass
HT40	MCS0	2	9	2452	37.40	37.50	36.00	36.32	0.5	Pass

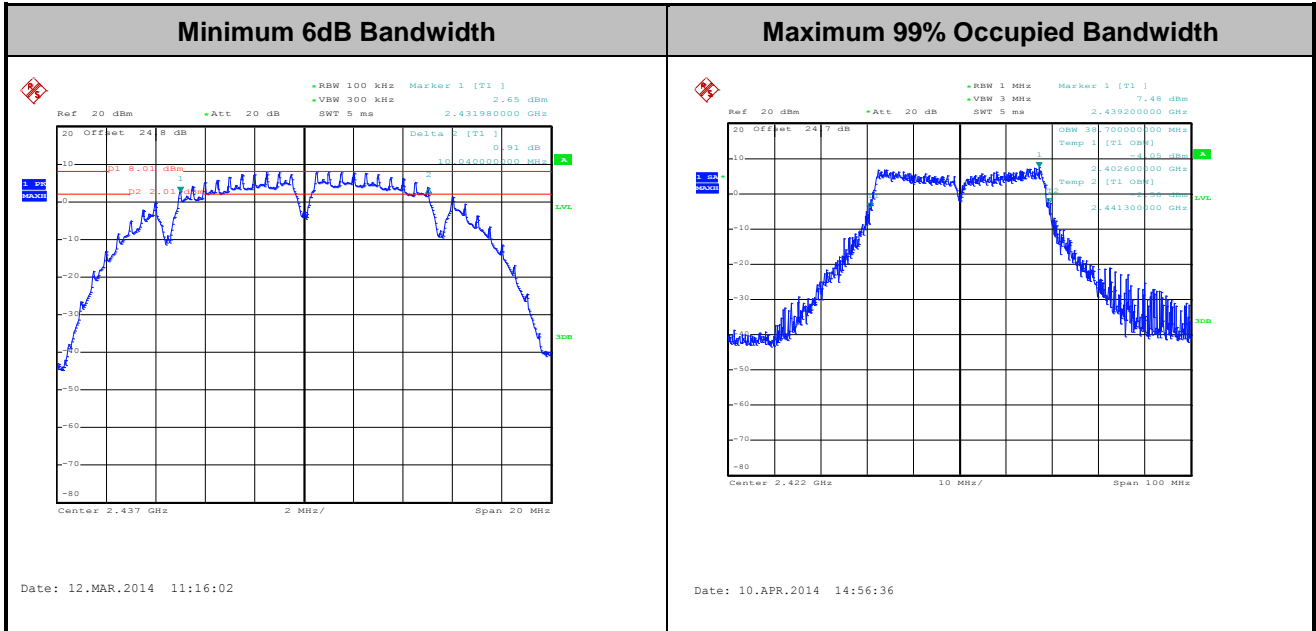

Note : The occupied channel bandwidth is maintained within the band of operation for all of the modulations.

3.2 Peak Output Power Measurement

3.2.1 Limit of Peak Output Power

For systems using digital modulation in the 2400-2483.5MHz, the limit for peak output power is 30dBm. If transmitting antenna with directional gain greater than 6dBi is used, the peak output power from the intentional radiator shall be reduced below the above stated value by the amount in dB that the directional gain of the antenna exceeds 6 dBi. In case of point-to-point operation, the limit has to be reduced by 1dB for every 3dB that the directional gain of the antenna exceeds 6dBi.

3.2.2 Measuring Instruments

The measuring equipment is listed in the section 4 of this test report.

3.2.3 Test Procedures

1. The testing follows the Measurement Procedure of FCC KDB No. 558074 DTS D01 Meas. Guidance v03r01.
2. The RF output of EUT was connected to the power meter by RF cable and attenuator. The path loss was compensated to the results for each measurement.
3. Set to the maximum power setting and enable the EUT transmit continuously.
4. Measure the conducted output power and record the results in the test report.
5. For MIMO mode, calculation method follows FCC KDB 662911 D01 Multiple Transmitter Output v02r01.

3.2.4 Test Setup

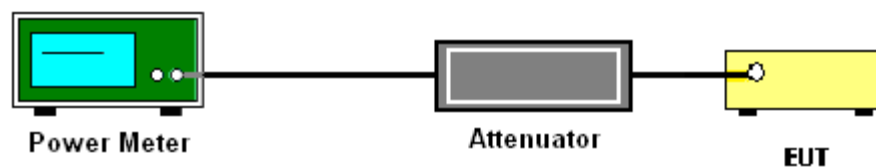



3.2.5 Test Result of Peak Output Power

Test Band :	2.4GHz	Temperature :	21~26°C
Test Engineer :	Alex Lee and Bill Kuo	Relative Humidity :	45~54%

Mod.	Data Rate	N _{TX}	CH.	Freq. (MHz)	Peak Conducted Power (dBm)			Max. Limit (dBm)		DG (dBi)		Pass/Fail
					Ant. 1	Ant. 2	SUM	Ant. 1	Ant. 2	Ant. 1	Ant. 2	
11b	1Mbps	1	1	2412	20.20	20.18		30.00	30.00	4.50	4.50	Pass
11b	1Mbps	1	6	2437	20.12	20.06		30.00	30.00	4.50	4.50	Pass
11b	1Mbps	1	11	2462	20.25	19.90		30.00	30.00	4.50	4.50	Pass
11g	6Mbps	1	1	2412	25.02	24.81		30.00	30.00	4.50	4.50	Pass
11g	6Mbps	1	6	2437	25.00	24.72		30.00	30.00	4.50	4.50	Pass
11g	6Mbps	1	11	2462	24.16	24.19		30.00	30.00	4.50	4.50	Pass
HT20	MCS0	1	1	2412	24.38	24.42		30.00	30.00	4.50	4.50	Pass
HT20	MCS0	1	6	2437	24.51	24.36		30.00	30.00	4.50	4.50	Pass
HT20	MCS0	1	11	2462	23.51	23.79		30.00	30.00	4.50	4.50	Pass
HT40	MCS0	1	3	2422	24.44	24.63		30.00	30.00	4.50	4.50	Pass
HT40	MCS0	1	6	2437	24.78	24.65		30.00	30.00	4.50	4.50	Pass
HT40	MCS0	1	9	2452	24.60	24.62		30.00	30.00	4.50	4.50	Pass
11b	1Mbps	2	1	2412	19.95	20.79	23.40	30.00		4.50		Pass
11b	1Mbps	2	6	2437	20.16	19.94	23.06	30.00		4.50		Pass
11b	1Mbps	2	11	2462	19.71	20.83	23.32	30.00		4.50		Pass
11g	6Mbps	2	1	2412	23.52	23.89	26.72	30.00		4.50		Pass
11g	6Mbps	2	6	2437	24.85	24.59	27.73	30.00		4.50		Pass
11g	6Mbps	2	11	2462	22.38	22.82	25.62	30.00		4.50		Pass
HT20	MCS0	2	1	2412	23.44	23.94	26.71	30.00		4.50		Pass
HT20	MCS0	2	6	2437	24.21	24.28	27.26	30.00		4.50		Pass
HT20	MCS0	2	11	2462	21.68	21.82	24.76	30.00		4.50		Pass
HT40	MCS0	2	3	2422	23.87	23.73	26.81	30.00		4.50		Pass
HT40	MCS0	2	6	2437	24.52	24.55	27.55	30.00		4.50		Pass
HT40	MCS0	2	9	2452	23.81	23.68	26.76	30.00		4.50		Pass

Note: Measured power (dBm) has offset with cable loss.



3.2.6 Test Result of Average output Power (Reporting Only)

Test Band :	2.4GHz	Temperature :	21~26°C
Test Engineer :	Alex Lee and Bill Kuo	Relative Humidity :	45~54%

Mod.	Data Rate	N _{TX}	Channel	Freq. (MHz)	Duty Factor (dB)		Average Conducted Power (dBm)		
					Ant. 1	Ant. 2	Ant. 1	Ant. 2	Sum Power
11b	1Mbps	1	1	2412	0.00	0.00	17.77	17.77	
11b	1Mbps	1	6	2437	0.00	0.00	17.76	17.68	
11b	1Mbps	1	11	2462	0.00	0.00	17.95	17.58	
11g	6Mbps	1	1	2412	0.15	0.16	17.87	17.86	
11g	6Mbps	1	6	2437	0.15	0.16	17.66	17.82	
11g	6Mbps	1	11	2462	0.15	0.16	17.74	17.69	
HT20	MCS0	1	1	2412	0.16	0.16	15.86	15.89	
HT20	MCS0	1	6	2437	0.16	0.16	15.91	15.50	
HT20	MCS0	1	11	2462	0.16	0.16	15.71	15.76	
HT40	MCS0	1	3	2422	0.24	0.24	14.92	14.68	
HT40	MCS0	1	6	2437	0.24	0.24	14.95	14.93	
HT40	MCS0	1	9	2452	0.24	0.24	14.76	14.85	
11b	1Mbps	2	1	2412	0.00	0.00	17.48	18.43	20.99
11b	1Mbps	2	6	2437	0.00	0.00	17.81	17.54	20.69
11b	1Mbps	2	11	2462	0.00	0.00	17.47	18.41	20.98
11g	6Mbps	2	1	2412	0.18	0.19	14.63	15.04	17.85
11g	6Mbps	2	6	2437	0.18	0.19	17.76	17.71	20.74
11g	6Mbps	2	11	2462	0.18	0.19	13.71	14.27	17.01
HT20	MCS0	2	1	2412	0.17	0.16	14.24	14.77	17.52
HT20	MCS0	2	6	2437	0.17	0.16	15.35	15.76	18.57
HT20	MCS0	2	11	2462	0.17	0.16	11.61	11.62	14.62
HT40	MCS0	2	3	2422	0.24	0.24	12.92	12.70	15.82
HT40	MCS0	2	6	2437	0.24	0.24	14.87	14.83	17.86
HT40	MCS0	2	9	2452	0.24	0.24	12.80	12.56	15.69

Note: Measured power (dBm) has offset with cable loss and duty factor.

3.3 Power Spectral Density Measurement

3.3.1 Limit of Power Spectral Density

The peak power spectral density shall not be greater than 8dBm in any 3kHz band at any time interval of continuous transmission.

3.3.2 Measuring Instruments

The measuring equipment is listed in the section 4 of this test report.

3.3.3 Test Procedures

1. The testing follows Measurement Procedure 10.2 Method PKPSD of FCC KDB Publication No. 558074 D01 DTS Meas. Guidance v03r01
2. The RF output of EUT was connected to the spectrum analyzer by RF cable and attenuator. The path loss was compensated to the results for each measurement.
3. Set to the maximum power setting and enable the EUT transmit continuously.
4. Make the measurement with the spectrum analyzer's resolution bandwidth (RBW) = 3 kHz. Video bandwidth VBW = 10 kHz In order to make an accurate measurement, set the span to 1.5 times DTS Channel Bandwidth. (6dB BW)
5. Detector = peak, Sweep time = auto couple, Trace mode = max hold, Allow trace to fully stabilize. Use the peak marker function to determine the maximum power level.
6. Measure and record the results in the test report.
7. For MIMO mode, calculation method follows FCC KDB 662911 D01 Multiple Transmitter Output v02r01.

If measurements performed using method (2) plus $10 \log(N)$ exceeds the emission limit, the test should choose method (1) before declaring that the device fails the emission limit.

Method (1): Measure and sum the spectra across the outputs.

The total final Power Spectral Density is from a device with 2 transmitter outputs. The spectrum measurements of the individual outputs are all performed with the same span and number of points, the spectrum value in the first spectral bin of output 1 is summed with that in the first spectral bin of output 2 to obtain the value for the first frequency bin of the summed spectrum.

Method (2): Measure and add $10 \log(N)$ dB, where N is the number of outputs. (N=2)

3.3.4 Test Setup

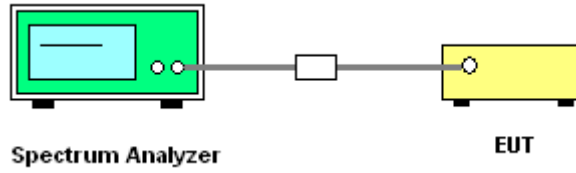



3.3.5 Test Result of Power Spectral Density

Test Band :	2.4GHz	Temperature :	21~26°C
Test Engineer :	Alex Lee and Bill Kuo	Relative Humidity :	45~54%

Mod.	Data Rate	N _{TX}	CH.	Freq. (MHz)	Peak Power Density (dBm/3kHz)			Max. Limit (dBm/3kHz)		DG (dBi)		Pass/Fail
					Ant. 1	Ant. 2	Worst +10log(2)	Ant. 1	Ant. 2	Ant. 1	Ant. 2	
11b	1Mbps	1	1	2412	-6.46	-	-	8.00	8.00	4.50	4.50	Pass
11b	1Mbps	1	6	2437	-6.13	-		8.00	8.00	4.50	4.50	Pass
11b	1Mbps	1	11	2462	-6.50	-		8.00	8.00	4.50	4.50	Pass
11g	6Mbps	1	1	2412	-3.12	-		8.00	8.00	4.50	4.50	Pass
11g	6Mbps	1	6	2437	-3.76	-		8.00	8.00	4.50	4.50	Pass
11g	6Mbps	1	11	2462	-4.46	-		8.00	8.00	4.50	4.50	Pass
HT20	MCS0	1	1	2412	-10.77	-		8.00	8.00	4.50	4.50	Pass
HT20	MCS0	1	6	2437	-9.85	-		8.00	8.00	4.50	4.50	Pass
HT20	MCS0	1	11	2462	-10.18	-		8.00	8.00	4.50	4.50	Pass
HT40	MCS0	1	3	2422	-12.71	-		8.00	8.00	4.50	4.50	Pass
HT40	MCS0	1	6	2437	-13.75	-		8.00	8.00	4.50	4.50	Pass
HT40	MCS0	1	9	2452	-11.44	-	8.00	8.00	4.50	4.50	Pass	
11b	1Mbps	2	1	2412	-5.74	-5.75	-2.73	6.49	6.49	7.51	7.51	Pass
11b	1Mbps	2	6	2437	-6.42	-5.99	-2.98	6.49	6.49	7.51	7.51	Pass
11b	1Mbps	2	11	2462	-7.28	-5.66	-2.65	6.49	6.49	7.51	7.51	Pass
11g	6Mbps	2	1	2412	-10.82	-10.72	-7.71	6.49	6.49	7.51	7.51	Pass
11g	6Mbps	2	6	2437	-4.54	-8.09	-1.53	6.49	6.49	7.51	7.51	Pass
11g	6Mbps	2	11	2462	-10.10	-10.88	-7.09	6.49	6.49	7.51	7.51	Pass
HT20	MCS0	2	1	2412	-11.51	-10.85	-7.84	6.49	6.49	7.51	7.51	Pass
HT20	MCS0	2	6	2437	-10.02	-9.95	-6.94	6.49	6.49	7.51	7.51	Pass
HT20	MCS0	2	11	2462	-13.75	-13.78	-10.74	6.49	6.49	7.51	7.51	Pass
HT40	MCS0	2	3	2422	-15.37	-15.22	-12.21	6.49	6.49	7.51	7.51	Pass
HT40	MCS0	2	6	2437	-13.94	-13.67	-10.66	6.49	6.49	7.51	7.51	Pass
HT40	MCS0	2	9	2452	-15.37	-15.85	-12.36	6.49	6.49	7.51	7.51	Pass

Note: Measured power density (dBm) has offset with cable loss.

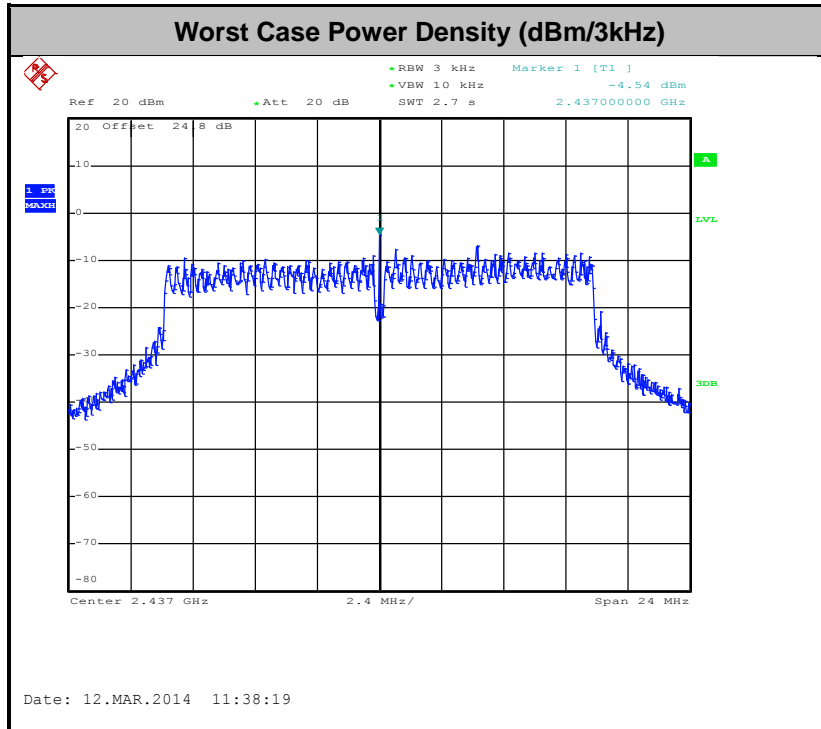

3.4 Conducted Band Edges and Spurious Emission Measurement

3.4.1 Limit of Conducted Band Edges and Spurious Emission Measurement

In any 100 kHz bandwidth outside of the authorized frequency band, the emissions which fall in the non-restricted bands shall be attenuated at least 20 dB / 30dB relative to the maximum PSD level in 100 kHz by RF conducted measurement and radiated emissions which fall in the restricted bands, as defined in Section 15.205(a), must also comply with the radiated emission limits specified in Section 15.209(a).

3.4.2 Measuring Instruments

The measuring equipment is listed in the section 4 of this test report.

3.4.3 Test Procedures

1. The testing follows FCC KDB Publication No. 558074 D01 DTS Meas. Guidance v03r01.
2. The RF output of EUT was connected to the spectrum analyzer by RF cable and attenuator. The path loss was compensated to the results for each measurement.
3. Set to the maximum power setting and enable the EUT transmit continuously.
4. Set RBW = 100 kHz, VBW=300 kHz, Peak Detector. Unwanted Emissions measured in any 100 kHz bandwidth outside of the authorized frequency band shall be attenuated by at least 20 dB relative to the maximum in-band peak PSD level in 100 kHz when maximum peak conducted output power procedure is used. If the transmitter complies with the conducted power limits based on the use of RMS averaging over a time interval, the attenuation required under this paragraph shall be 30 dB instead of 20 dB per 15.247(d).
5. Measure and record the results in the test report.
6. The RF fundamental frequency should be excluded against the limit line in the operating frequency band.

3.4.4 Test Setup





3.4.5 Test Result of Conducted Band Edges and Spurious Emission

Number of TX = 1, Ant. 1 (Measured)

Number of TX	1	Ant. :	1
Test Mode :	802.11b	Temperature :	21~26°C
Test Band :	2.4GHz Low	Relative Humidity :	45~54%
Test Channel :	01	Test Engineer :	Alex Lee and Bill Kuo

WLAN 802.11b Channel 01

100kHz PSD reference Level

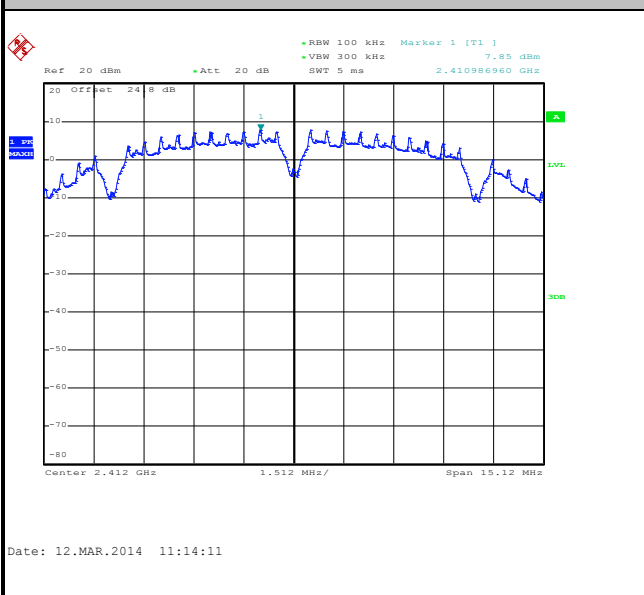

Low Channel Plot

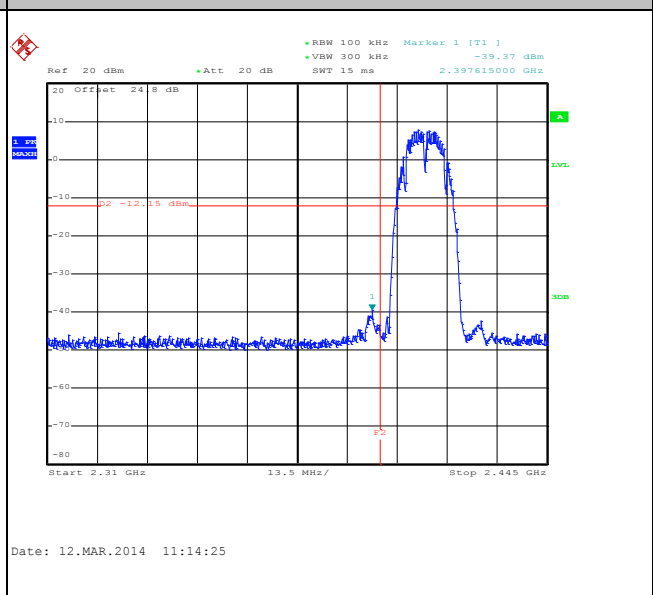

Spurious Emission 30MHz~3GHz

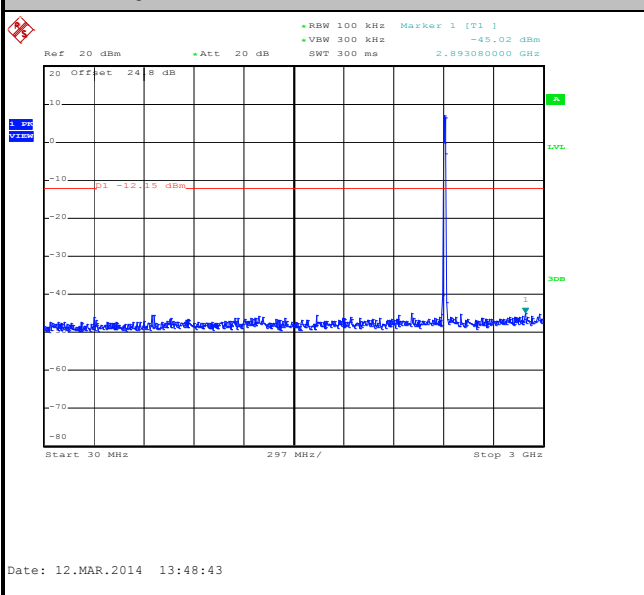

Spurious Emission 2GHz~25GHz

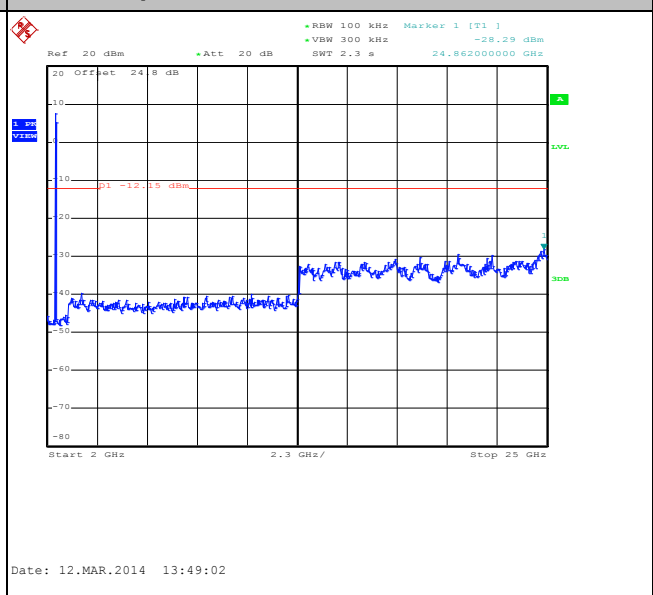



Number of TX :	1	Ant. :	1
Test Mode :	802.11b	Temperature :	21~26°C
Test Band :	2.4GHz Mid	Relative Humidity :	45~54%
Test Channel :	06	Test Engineer :	Alex Lee and Bill Kuo

WLAN 802.11b Channel 06

100kHz PSD reference Level

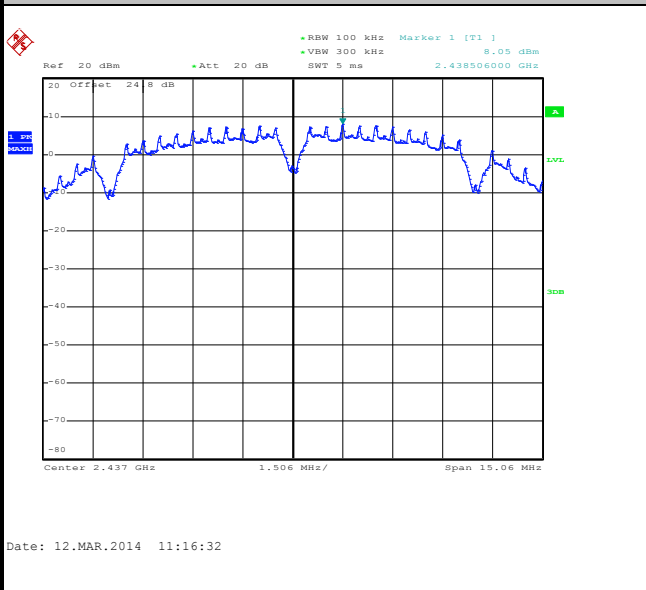

Spurious Emission 30MHz~3GHz

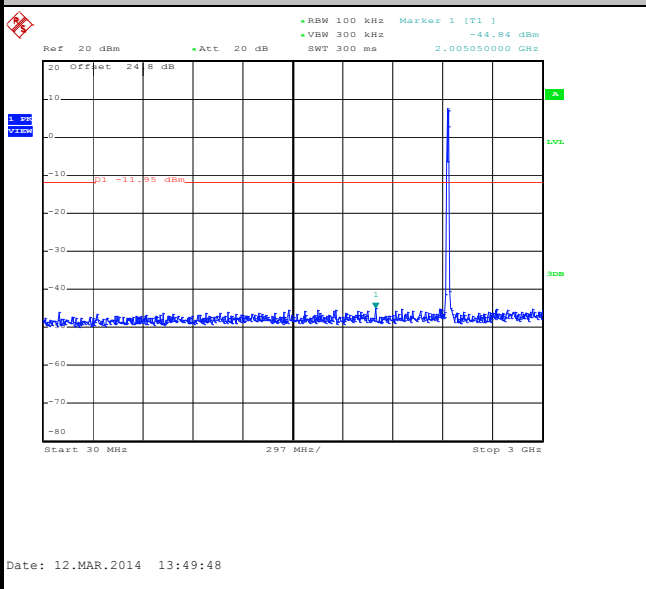

Spurious Emission 2GHz~25GHz

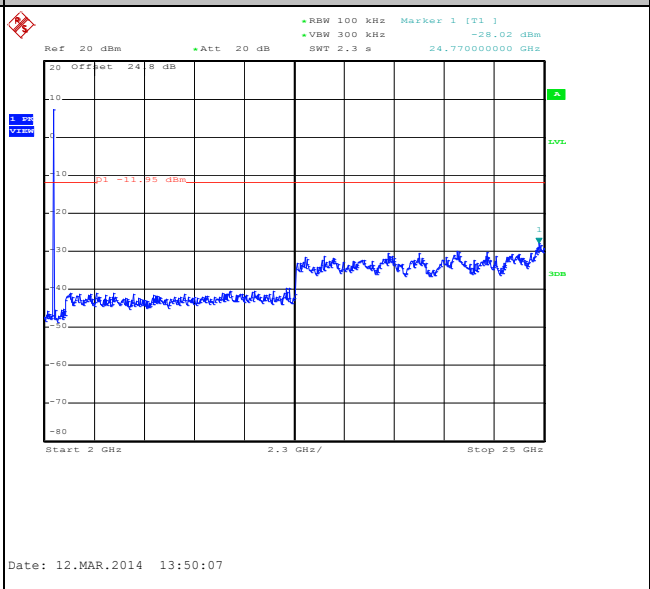



Number of TX :	1	Ant. :	1
Test Mode :	802.11b	Temperature :	21~26°C
Test Band :	2.4GHz High	Relative Humidity :	45~54%
Test Channel :	11	Test Engineer :	Alex Lee and Bill Kuo

WLAN 802.11b Channel 11

100kHz PSD reference Level

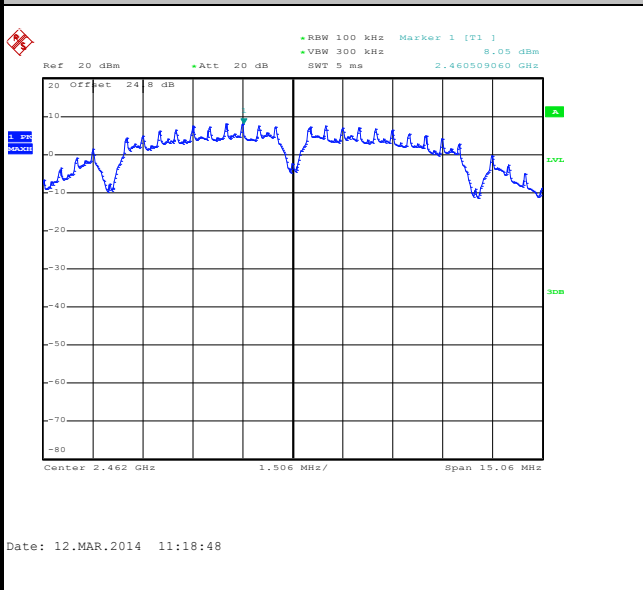

High Channel Plot

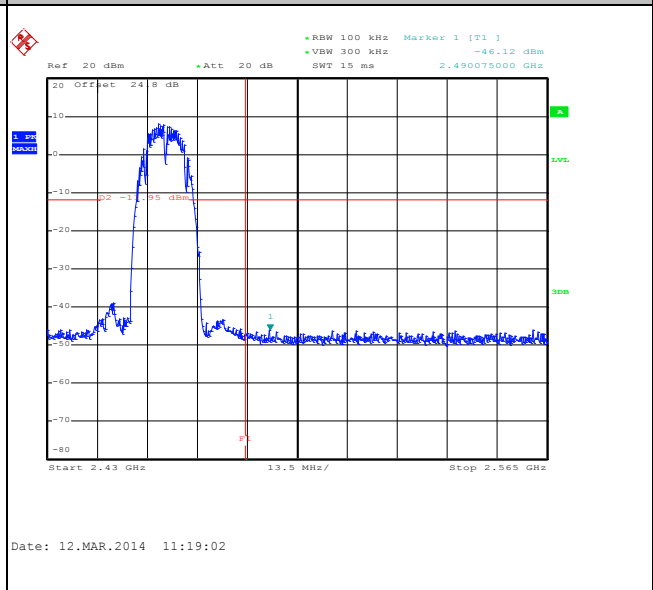

Spurious Emission 30MHz~3GHz

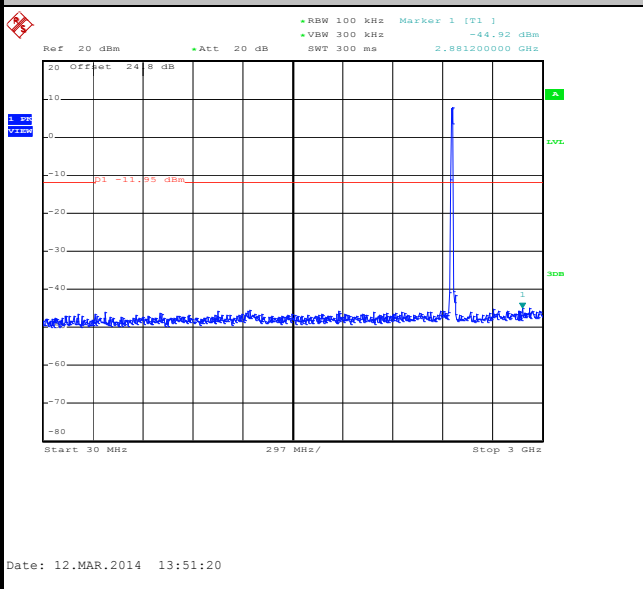

Spurious Emission 2GHz~25GHz

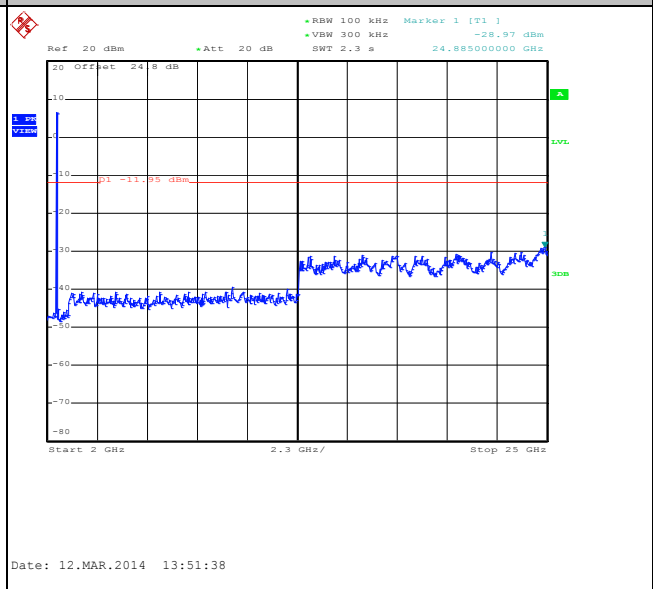



Number of TX :	1	Ant. :	1
Test Mode :	802.11g	Temperature :	21~26°C
Test Band :	2.4GHz Low	Relative Humidity :	45~54%
Test Channel :	01	Test Engineer :	Alex Lee and Bill Kuo

WLAN 802.11g Channel 01

100kHz PSD reference Level

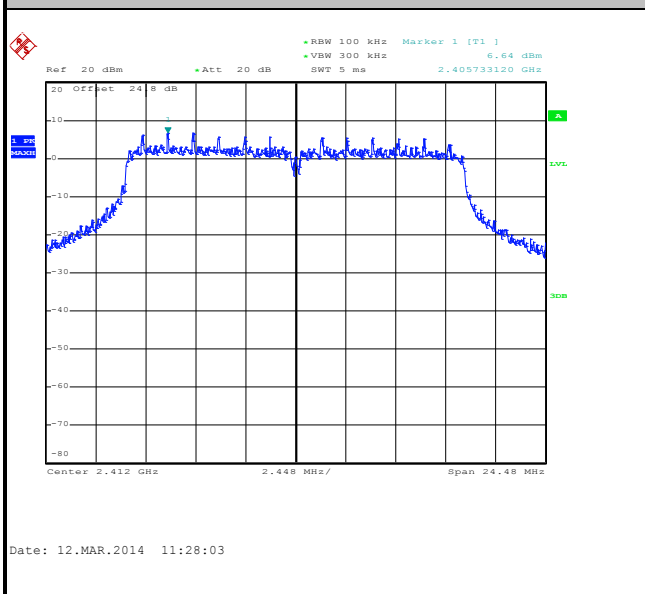

Low Channel Plot

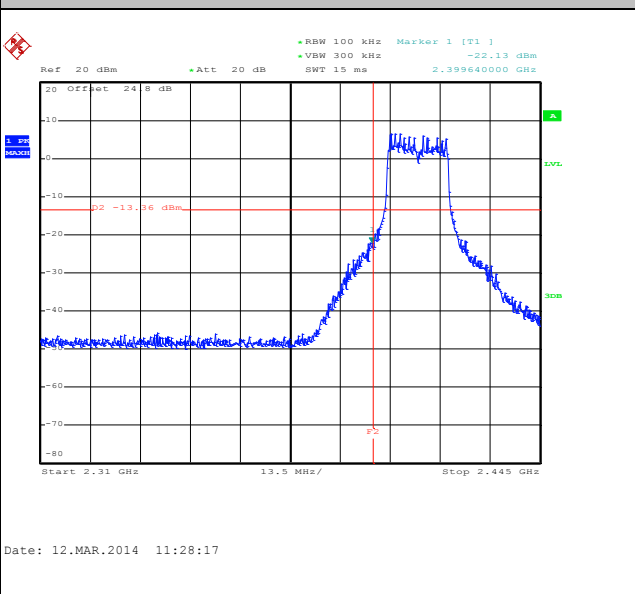

Spurious Emission 30MHz~3GHz

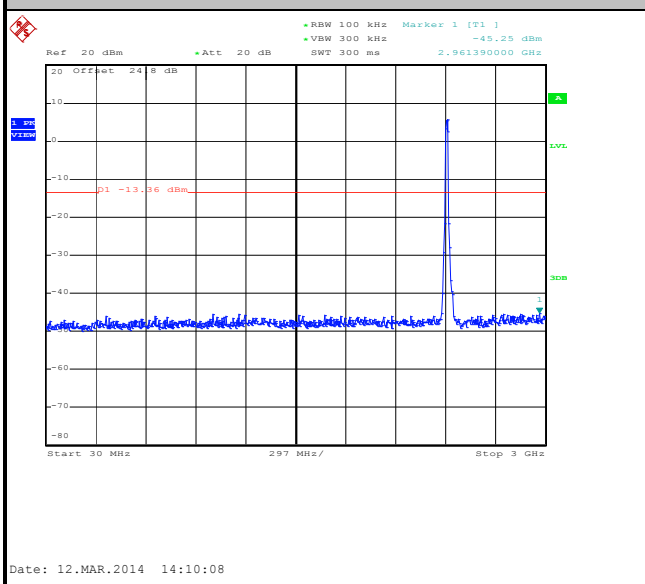

Spurious Emission 2GHz~25GHz

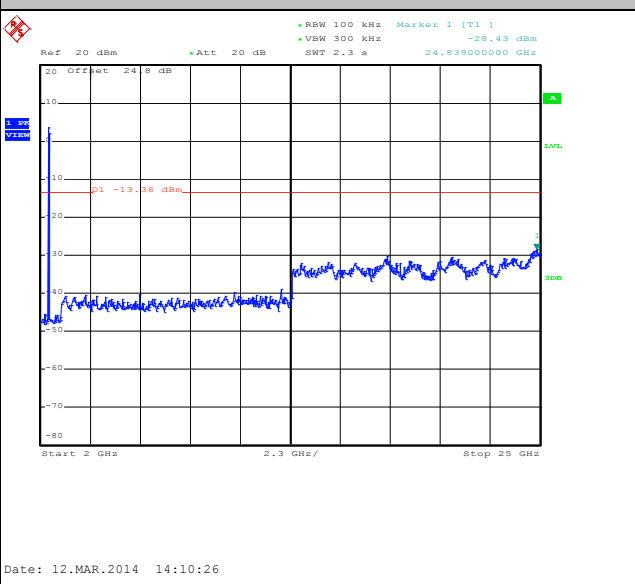



Number of TX :	1	Ant. :	1
Test Mode :	802.11g	Temperature :	21~26°C
Test Band :	2.4GHz Mid	Relative Humidity :	45~54%
Test Channel :	06	Test Engineer :	Alex Lee and Bill Kuo

WLAN 802.11g Channel 06

100kHz PSD reference Level

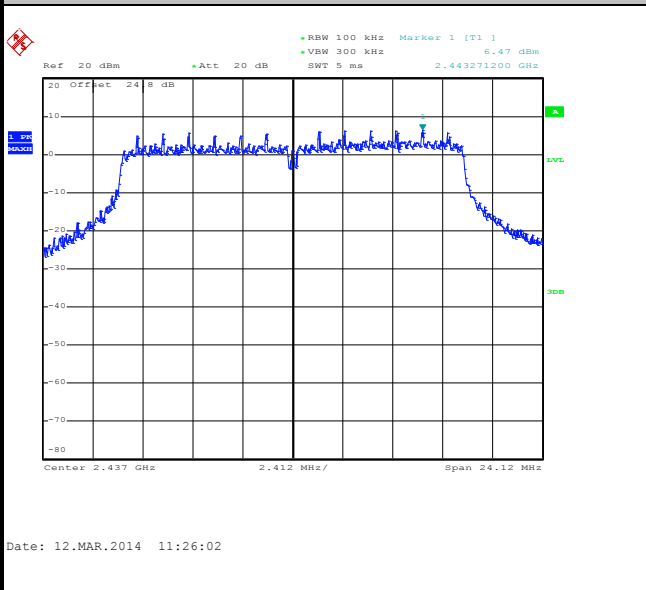

Spurious Emission 30MHz~3GHz

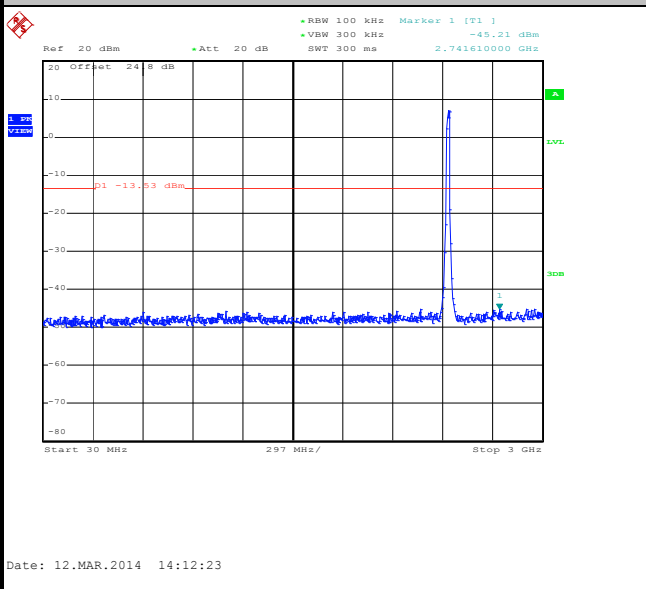

Spurious Emission 2GHz~25GHz

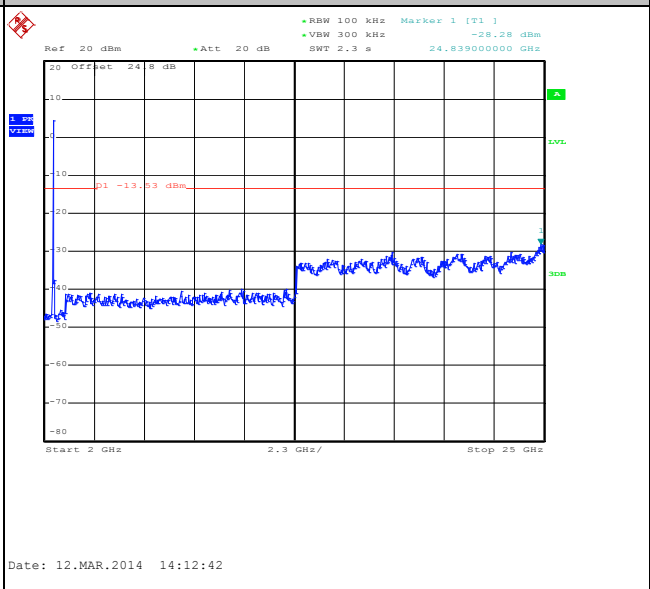



Number of TX :	1	Ant. :	1
Test Mode :	802.11g	Temperature :	21~26°C
Test Band :	2.4GHz High	Relative Humidity :	45~54%
Test Channel :	11	Test Engineer :	Alex Lee and Bill Kuo

WLAN 802.11g Channel 11

100kHz PSD reference Level

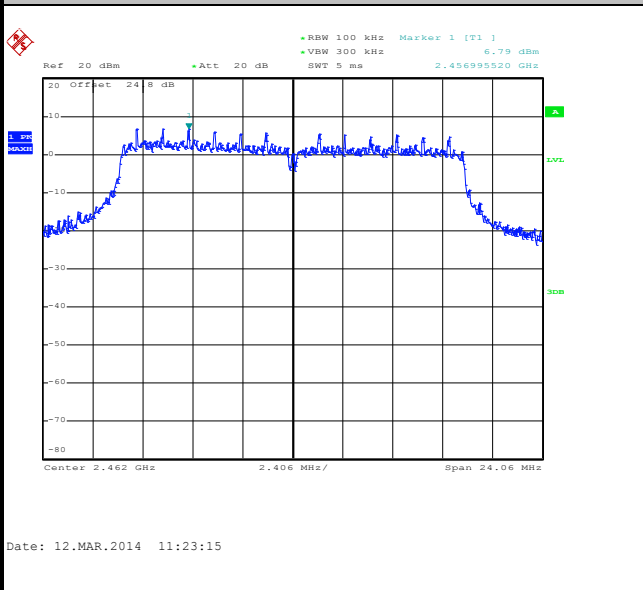

High Channel Plot

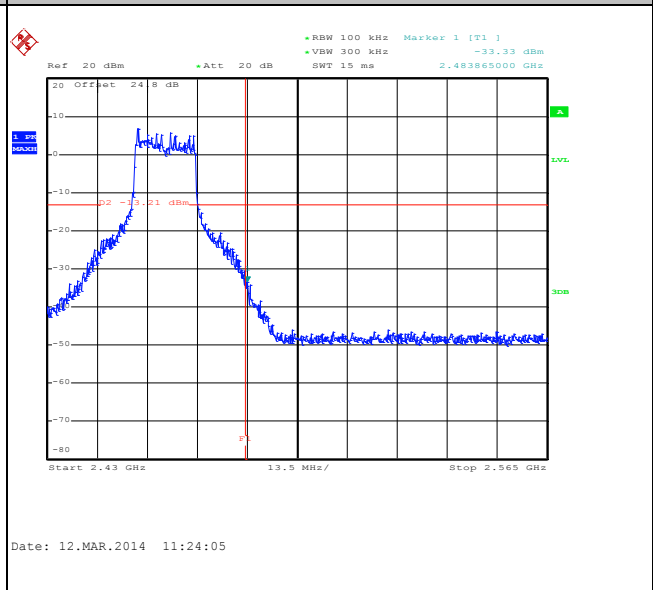

Spurious Emission 30MHz~3GHz

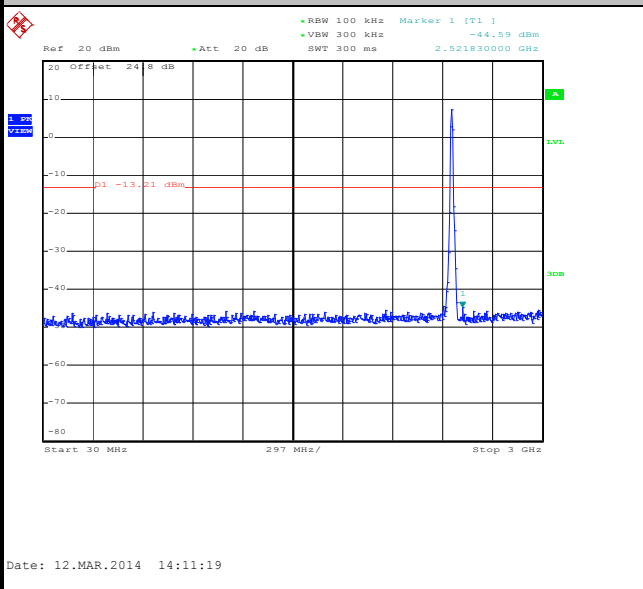

Spurious Emission 2GHz~25GHz

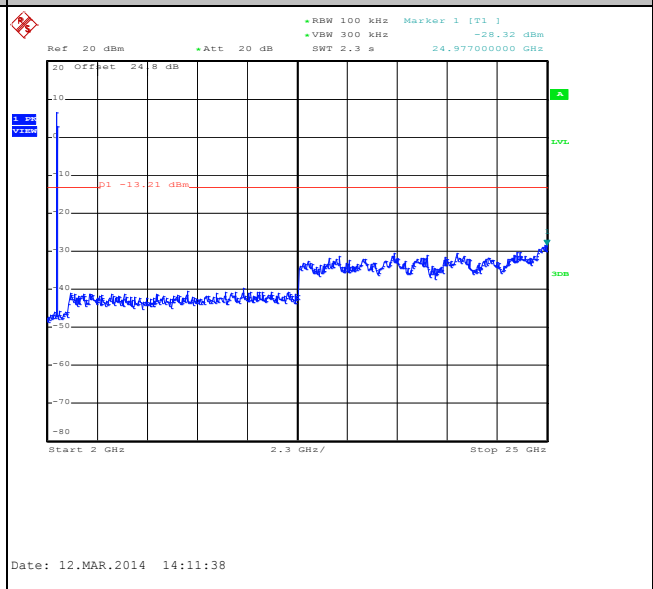



Number of TX :	1	Ant. :	1
Test Mode :	802.11n HT20	Temperature :	21~26°C
Test Band :	2.4GHz Low	Relative Humidity :	45~54%
Test Channel :	01	Test Engineer :	Alex Lee and Bill Kuo

WLAN 802.11n HT20 Channel 01

100kHz PSD reference Level

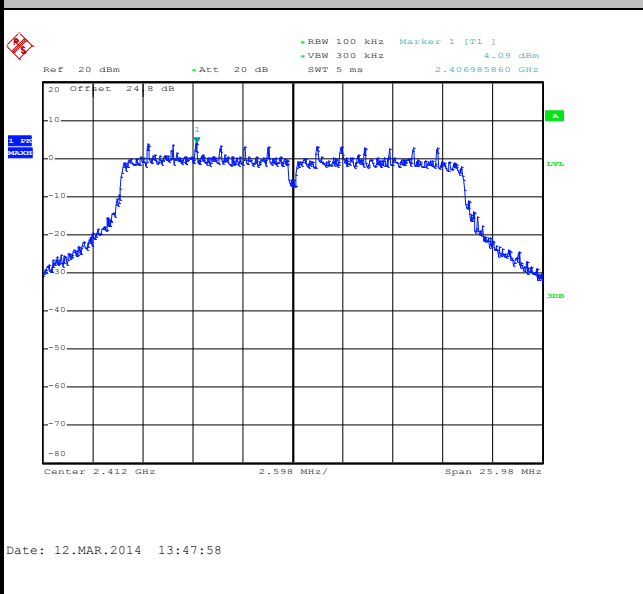

Low Channel Plot

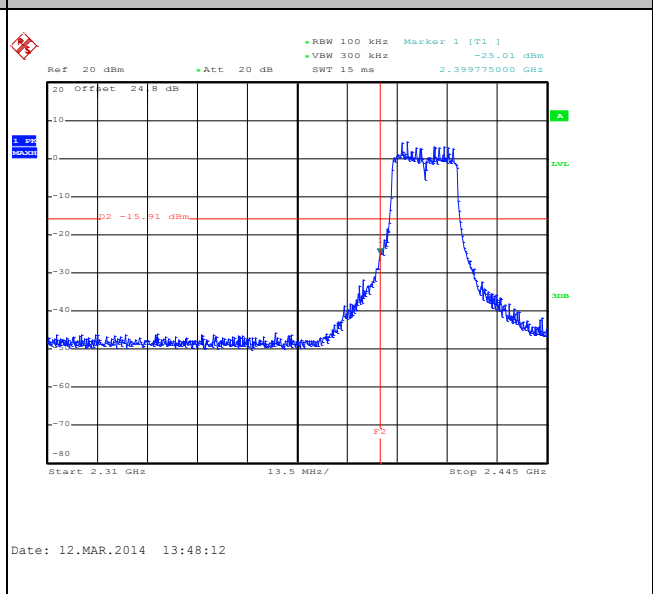

Spurious Emission 30MHz~3GHz

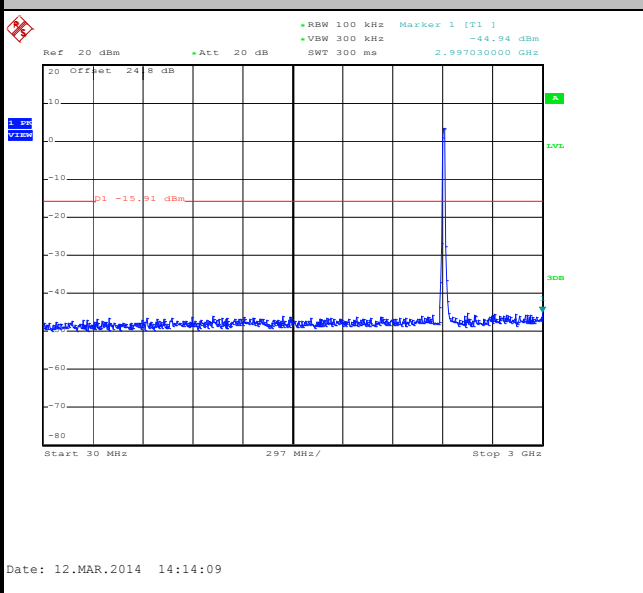

Spurious Emission 2GHz~25GHz

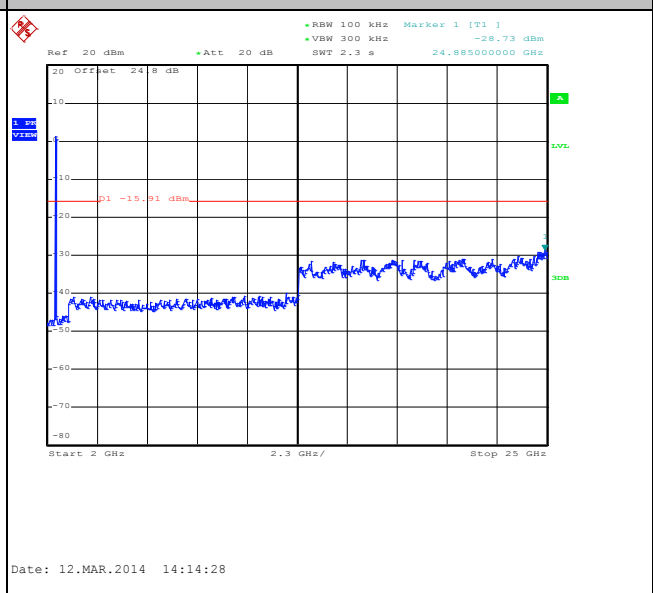



Number of TX :	1	Ant. :	1
Test Mode :	802.11n HT20	Temperature :	21~26°C
Test Band :	2.4GHz Mid	Relative Humidity :	45~54%
Test Channel :	06	Test Engineer :	Alex Lee and Bill Kuo

WLAN 802.11n HT20 Channel 06

100kHz PSD reference Level

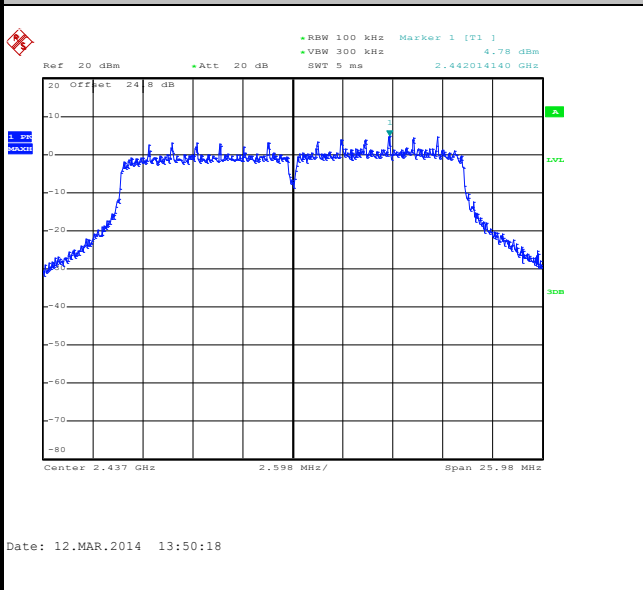

Spurious Emission 30MHz~3GHz

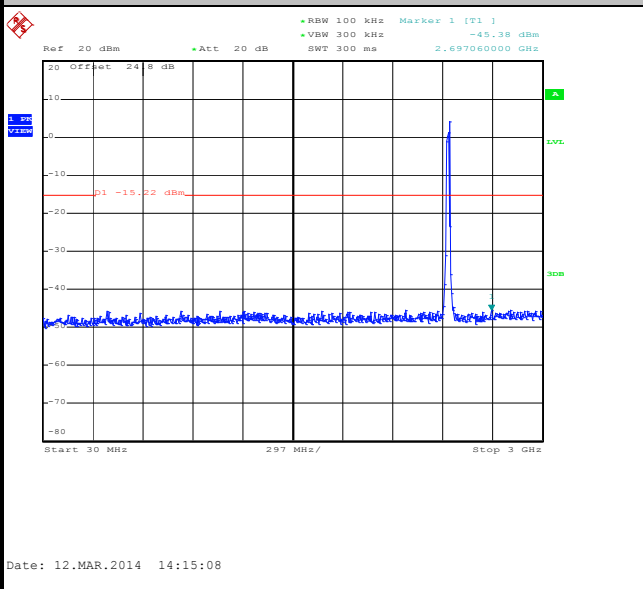

Spurious Emission 2GHz~25GHz

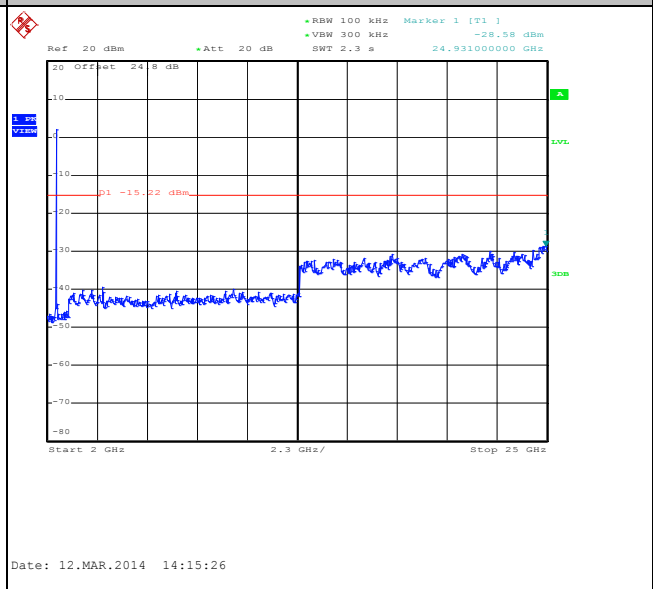



Number of TX :	1	Ant. :	1
Test Mode :	802.11n HT20	Temperature :	21~26°C
Test Band :	2.4GHz High	Relative Humidity :	45~54%
Test Channel :	11	Test Engineer :	Alex Lee and Bill Kuo

WLAN 802.11n HT20 Channel 11

100kHz PSD reference Level

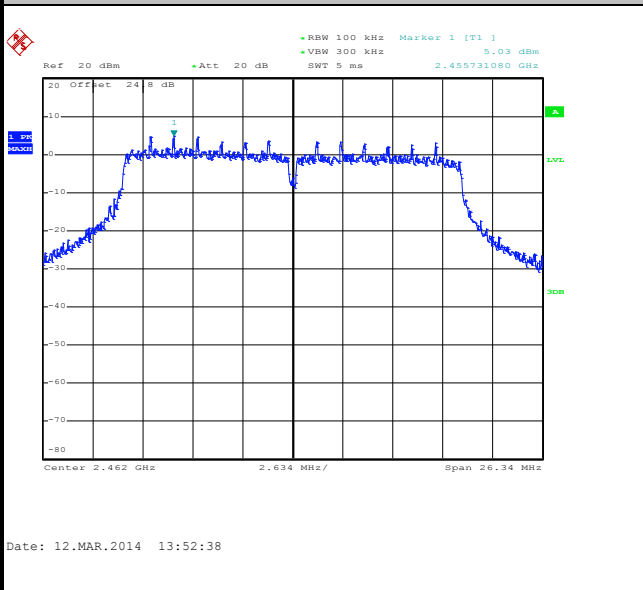

High Channel Plot

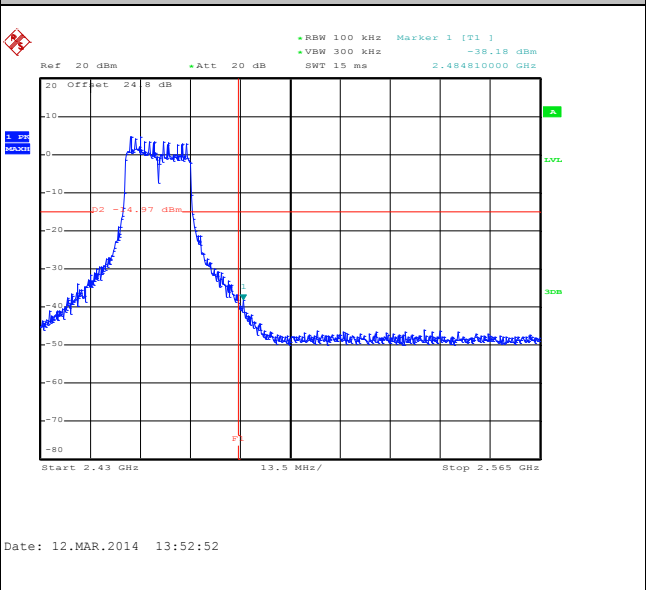

Spurious Emission 30MHz~3GHz

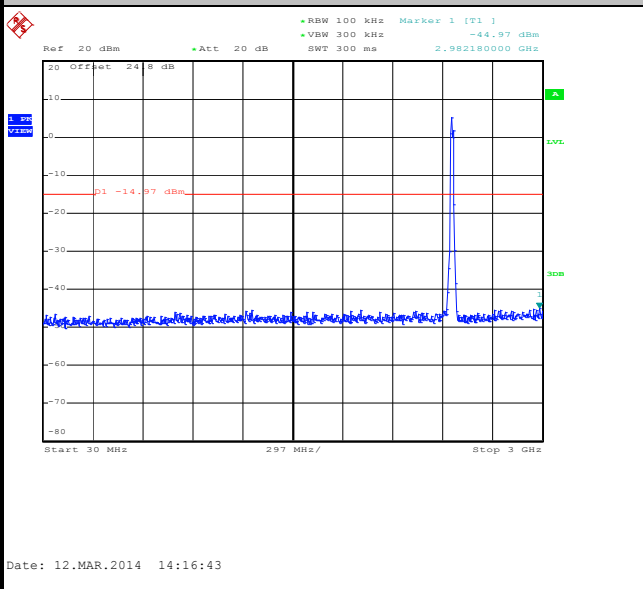

Spurious Emission 2GHz~25GHz

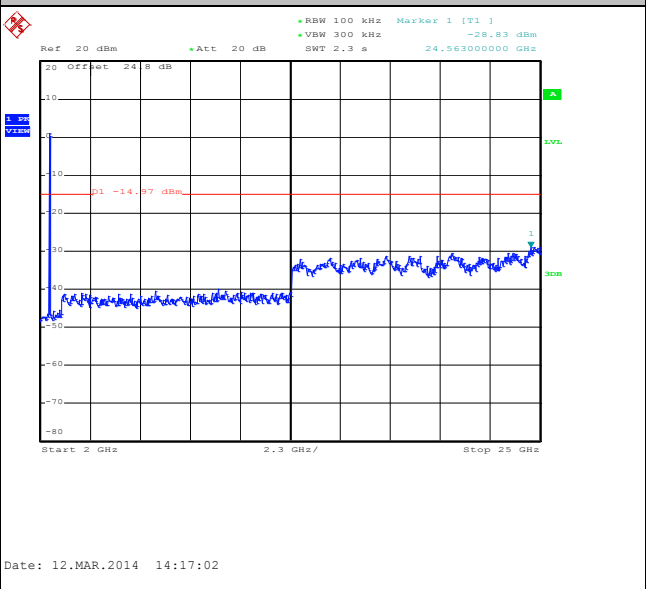



Number of TX :	1	Ant. :	1
Test Mode :	802.11n HT40	Temperature :	21~26°C
Test Band :	2.4GHz Low	Relative Humidity :	45~54%
Test Channel :	03	Test Engineer :	Alex Lee and Bill Kuo

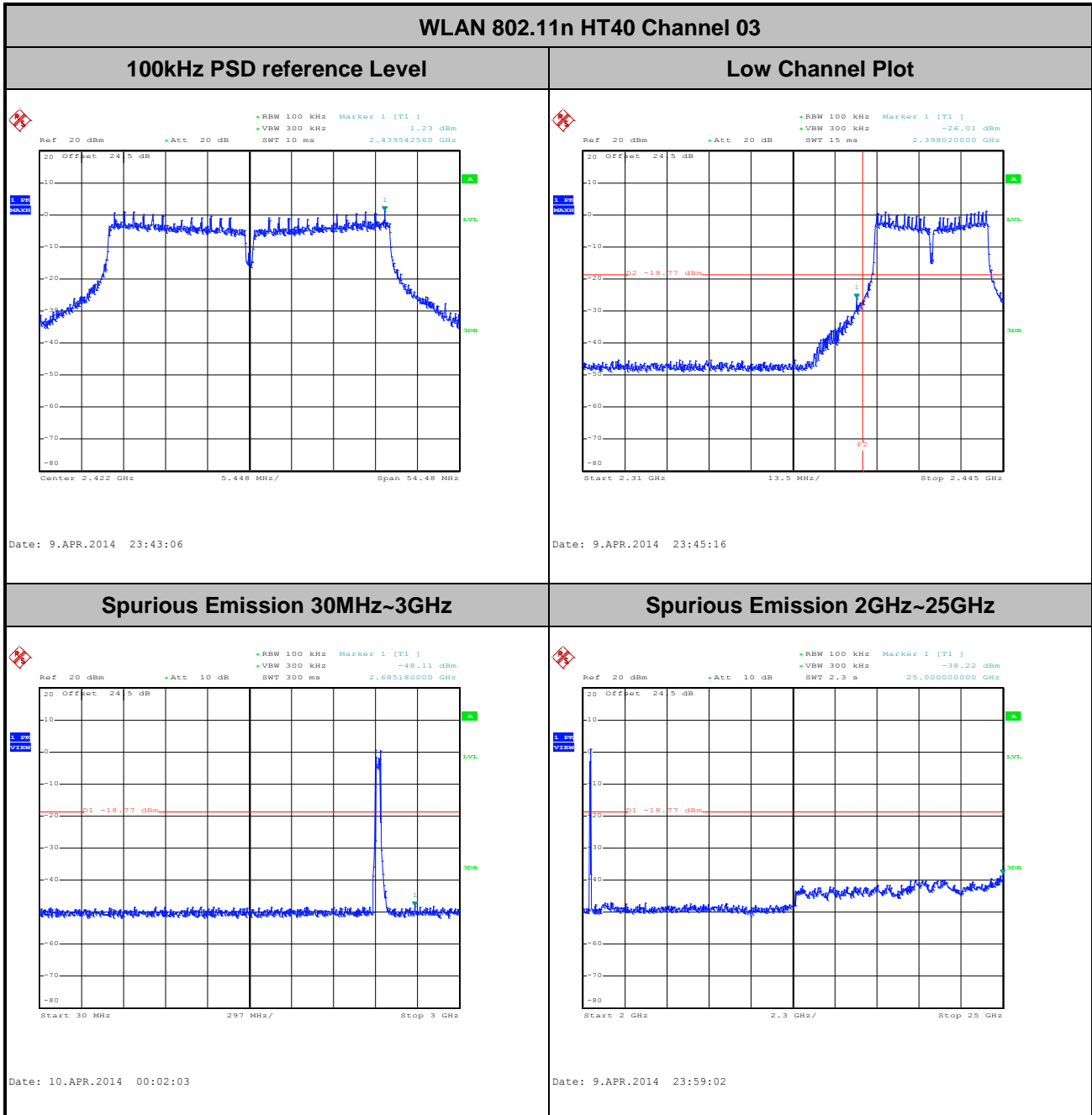



Number of TX :	1	Ant. :	1
Test Mode :	802.11n HT40	Temperature :	21~26°C
Test Band :	2.4GHz Mid	Relative Humidity :	45~54%
Test Channel :	06	Test Engineer :	Alex Lee and Bill Kuo

WLAN 802.11n HT40 Channel 06

100kHz PSD reference Level

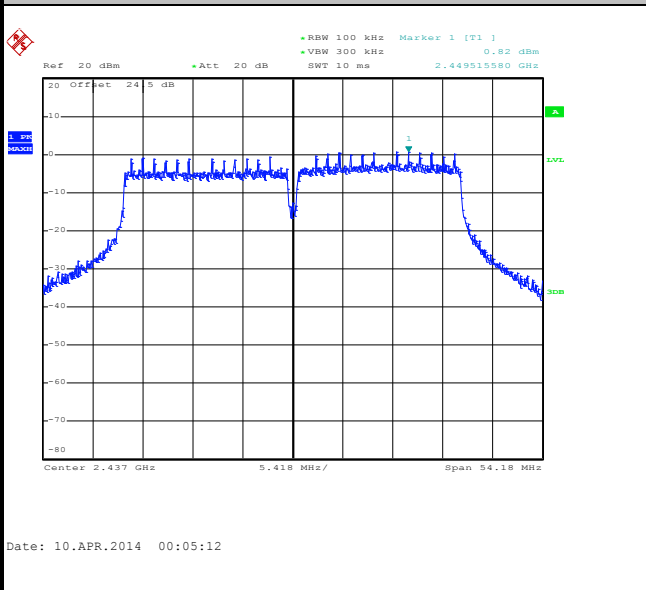

Spurious Emission 30MHz~3GHz

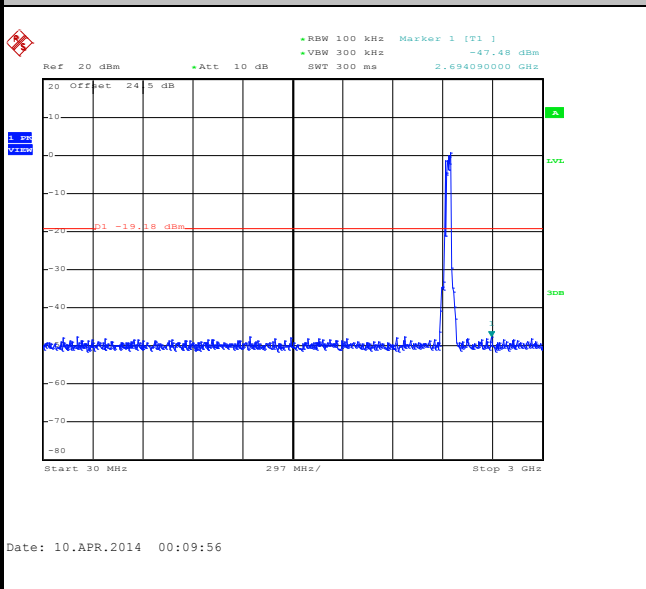

Spurious Emission 2GHz~25GHz

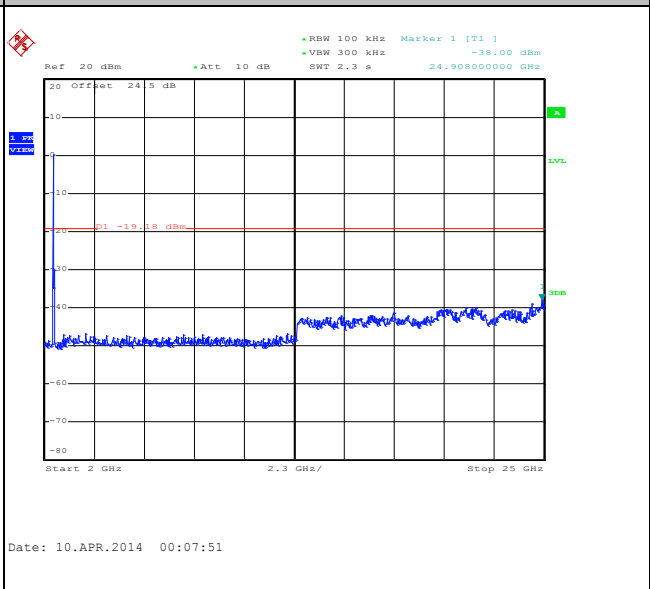



Number of TX :	1	Ant. :	1
Test Mode :	802.11n HT40	Temperature :	21~26°C
Test Band :	2.4GHz High	Relative Humidity :	45~54%
Test Channel :	09	Test Engineer :	Alex Lee and Bill Kuo

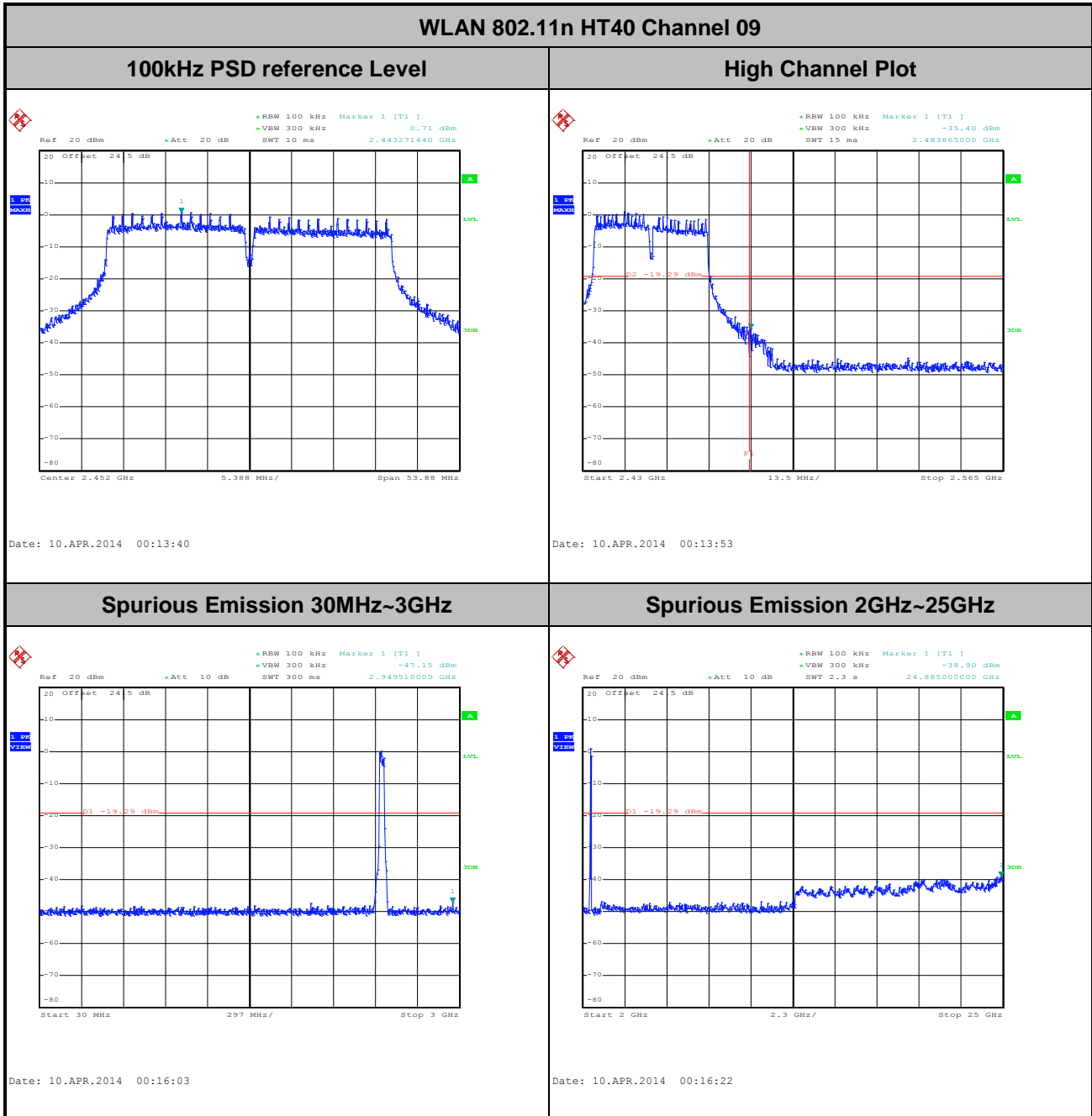



Number of TX = 2, Ant. 1 (Measured)

Number of TX :	2	Ant. :	1
Test Mode :	802.11b	Temperature :	21~26°C
Test Band :	2.4GHz Low	Relative Humidity :	45~54%
Test Channel :	01	Test Engineer :	Alex Lee and Bill Kuo

WLAN 802.11b Channel 01

100kHz PSD reference Level

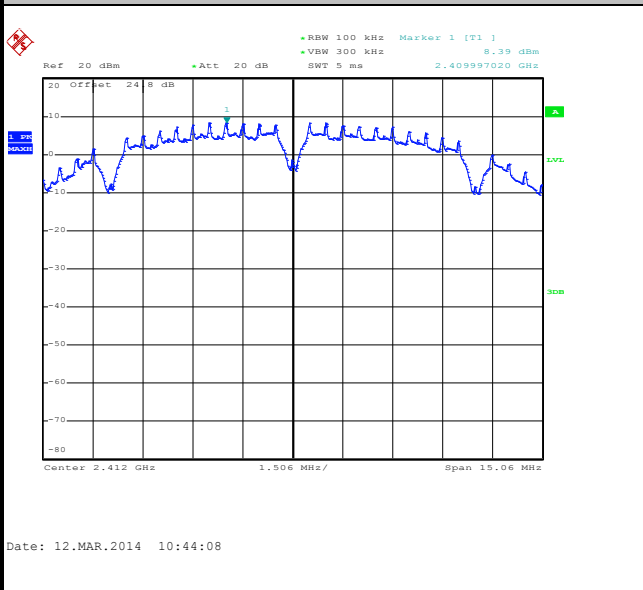

Low Channel Plot

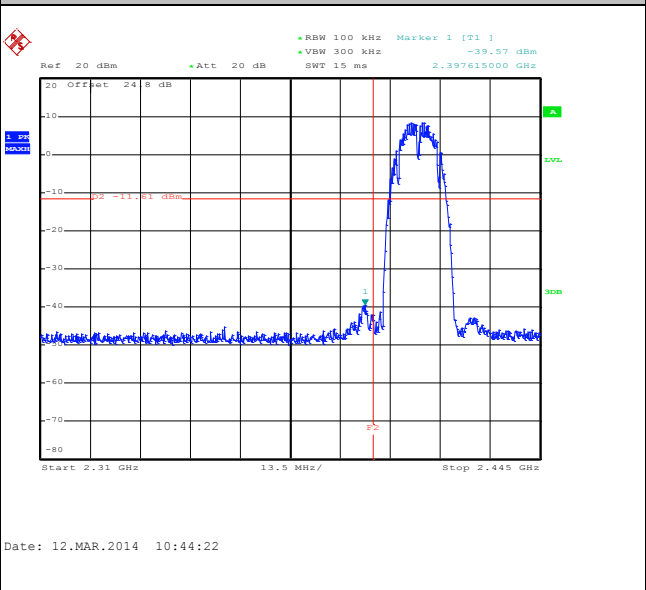

Spurious Emission 30MHz~3GHz

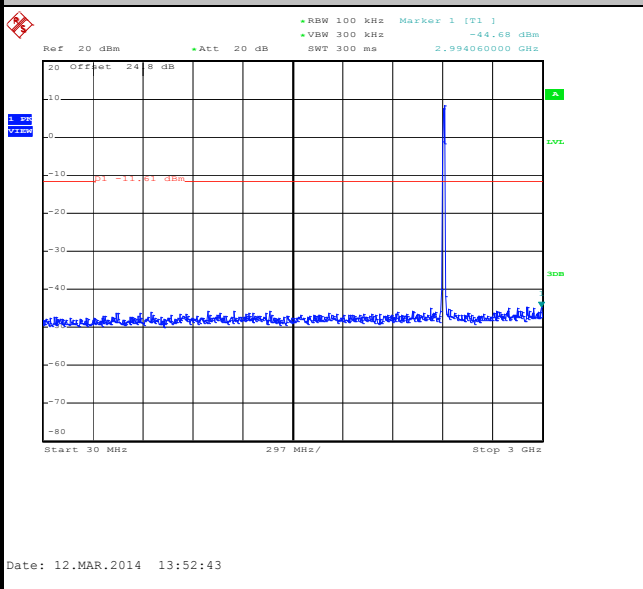

Spurious Emission 2GHz~25GHz

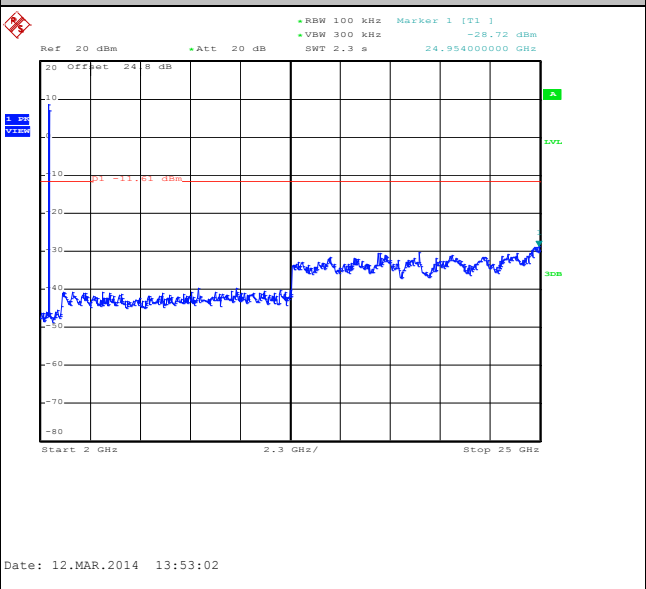



Number of TX :	2	Ant. :	1
Test Mode :	802.11b	Temperature :	21~26°C
Test Band :	2.4GHz Mid	Relative Humidity :	45~54%
Test Channel :	06	Test Engineer :	Alex Lee and Bill Kuo

WLAN 802.11b Channel 06

100kHz PSD reference Level

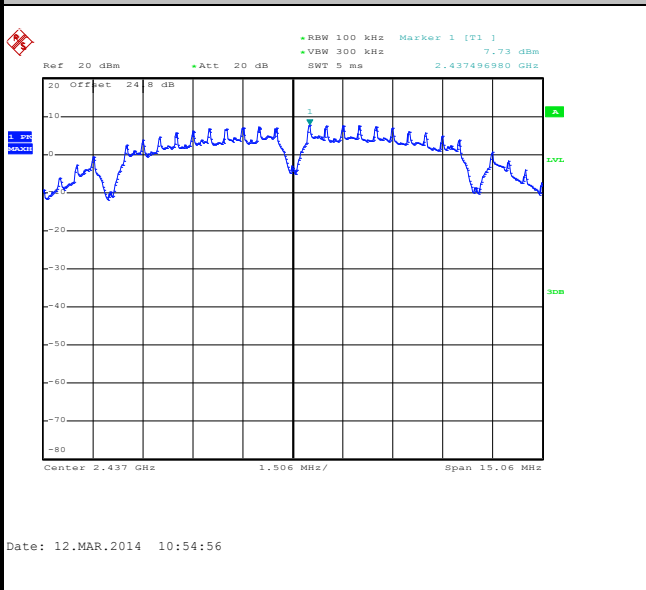

Spurious Emission 30MHz~3GHz

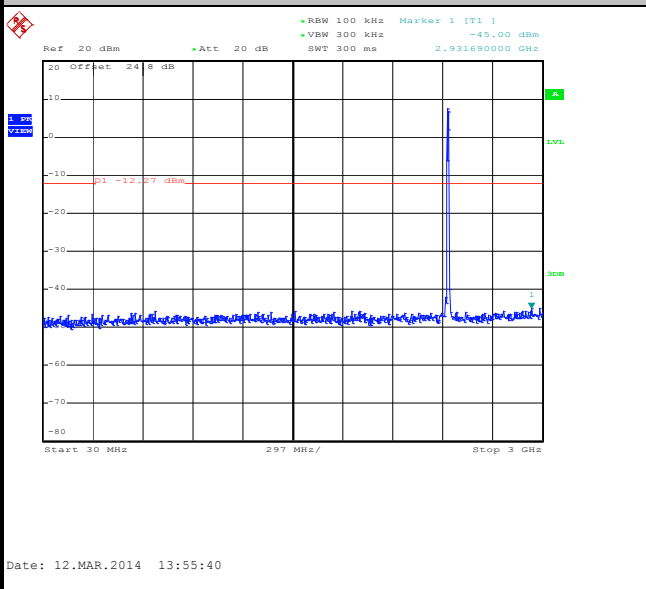

Spurious Emission 2GHz~25GHz

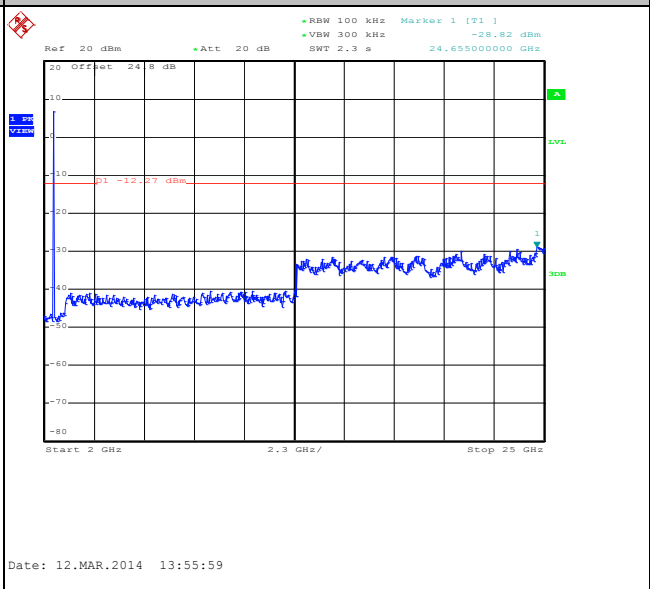



Number of TX :	2	Ant. :	1
Test Mode :	802.11b	Temperature :	21~26°C
Test Band :	2.4GHz High	Relative Humidity :	45~54%
Test Channel :	11	Test Engineer :	Alex Lee and Bill Kuo

WLAN 802.11b Channel 11

100kHz PSD reference Level

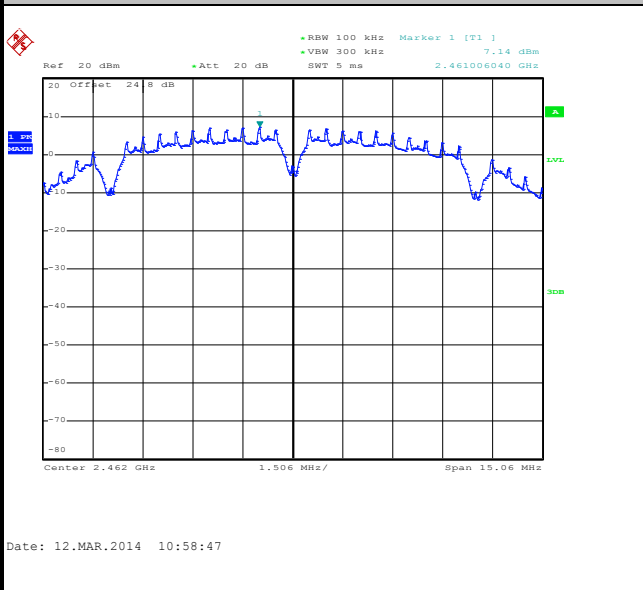

High Channel Plot

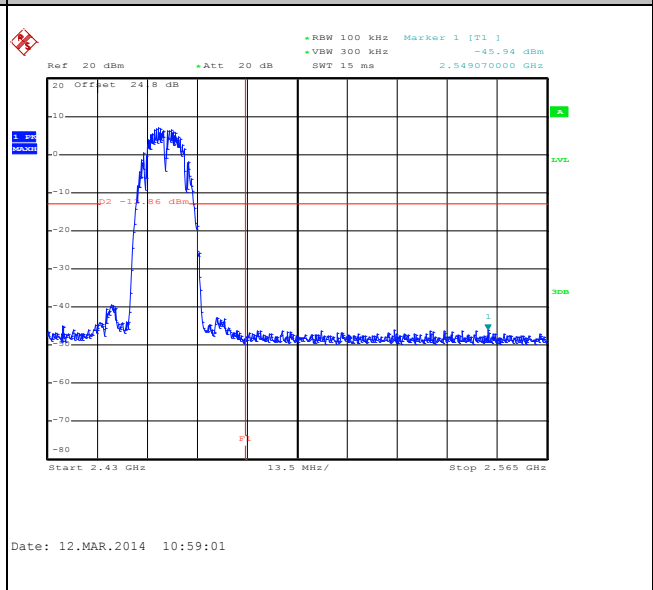

Spurious Emission 30MHz~3GHz

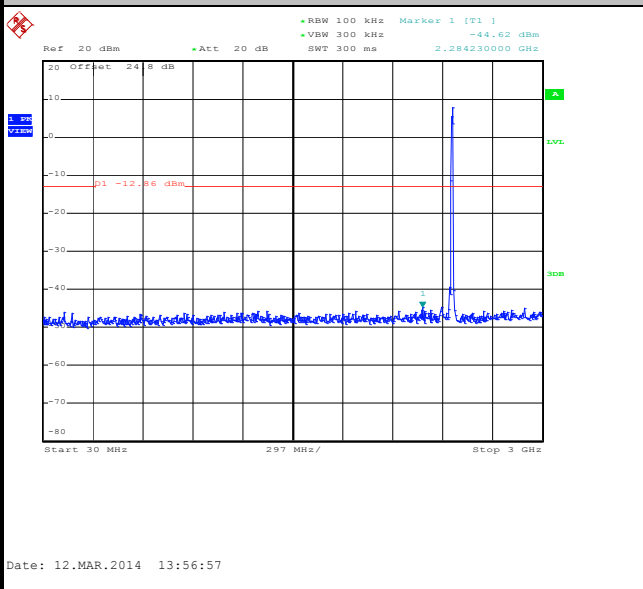

Spurious Emission 2GHz~25GHz

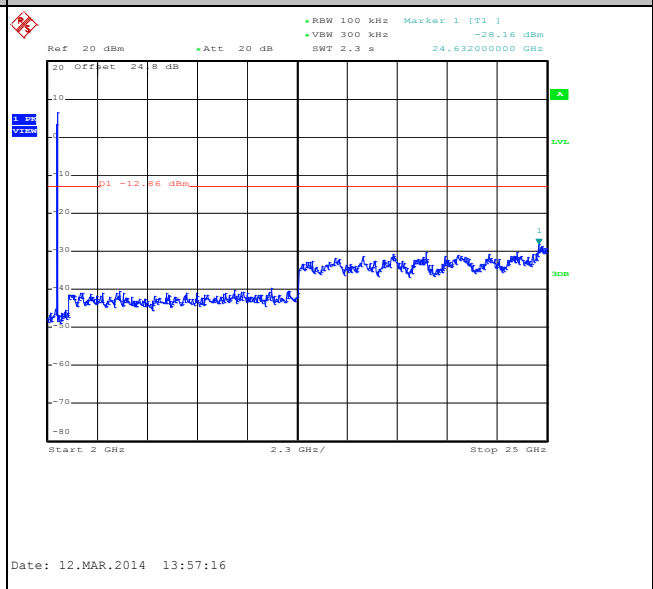



Number of TX :	2	Ant. :	1
Test Mode :	802.11g	Temperature :	21~26°C
Test Band :	2.4GHz Low	Relative Humidity :	45~54%
Test Channel :	01	Test Engineer :	Alex Lee and Bill Kuo

WLAN 802.11g Channel 01

100kHz PSD reference Level

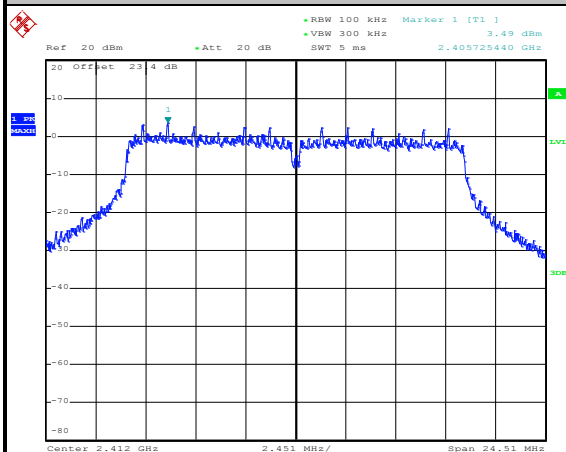

Date: 17.MAR.2014 16:27:13

Low Channel Plot

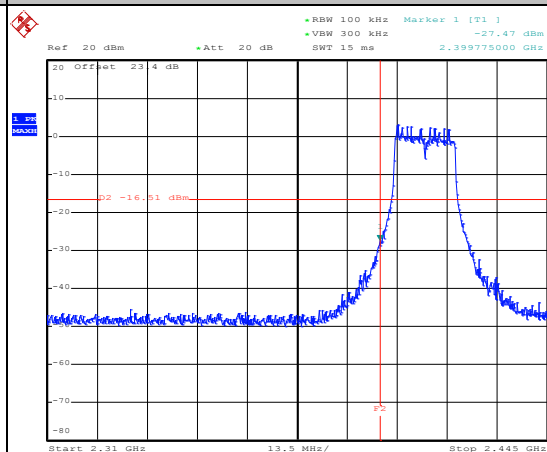

Date: 17.MAR.2014 16:28:48

Spurious Emission 30MHz~3GHz

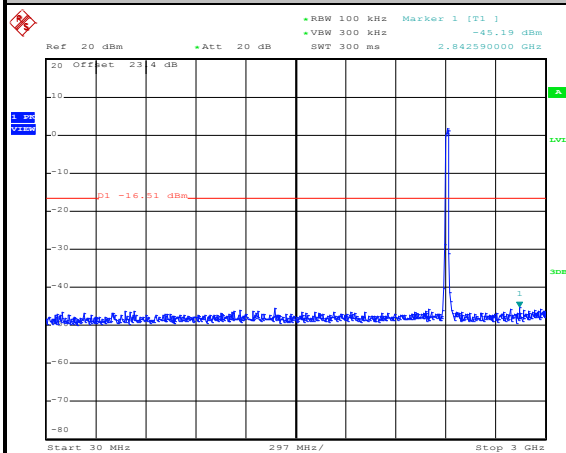

Date: 17.MAR.2014 16:27:46

Spurious Emission 2GHz~25GHz

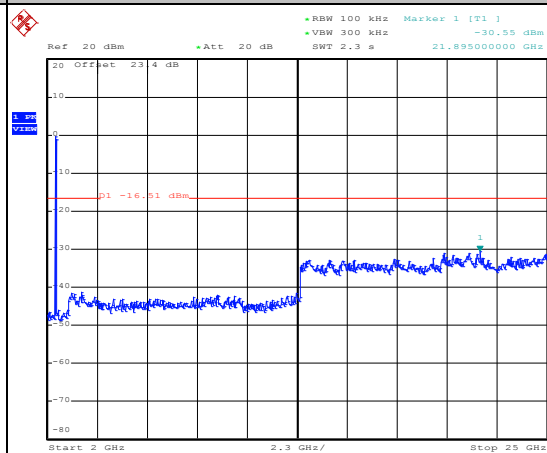

Date: 17.MAR.2014 16:28:05



Number of TX :	2	Ant. :	1
Test Mode :	802.11g	Temperature :	21~26°C
Test Band :	2.4GHz Mid	Relative Humidity :	45~54%
Test Channel :	06	Test Engineer :	Alex Lee and Bill Kuo

WLAN 802.11g Channel 06

100kHz PSD reference Level

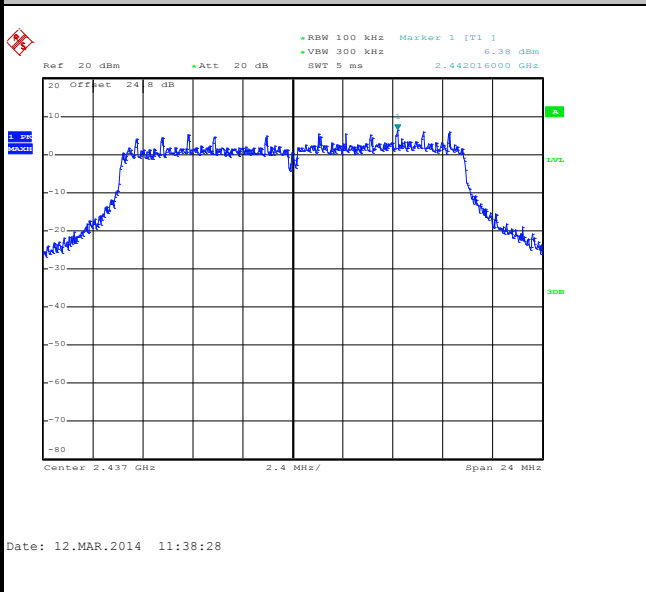

Spurious Emission 30MHz~3GHz

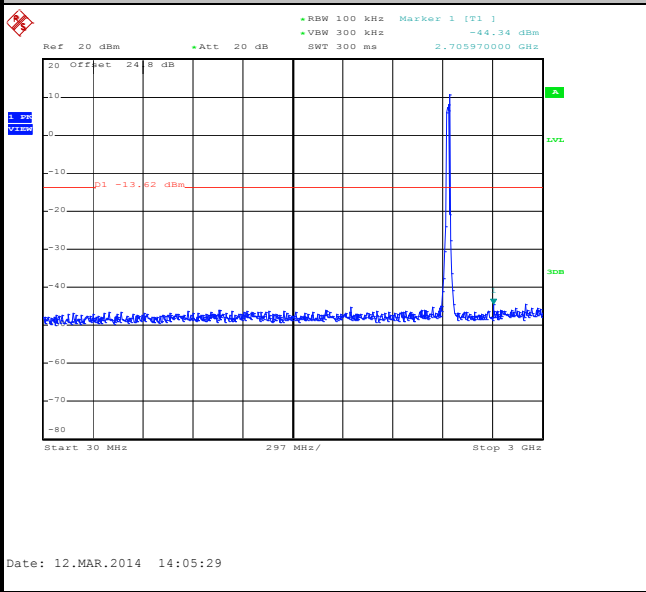

Spurious Emission 2GHz~25GHz

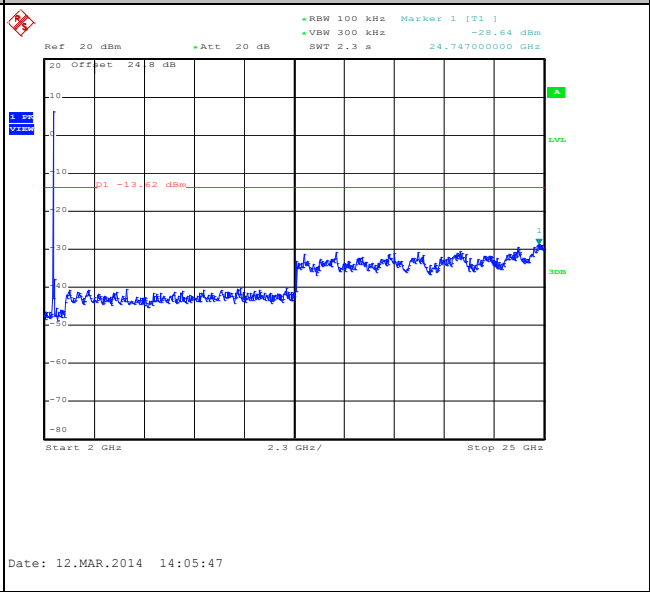



Number of TX :	2	Ant. :	1
Test Mode :	802.11g	Temperature :	21~26°C
Test Band :	2.4GHz High	Relative Humidity :	45~54%
Test Channel :	11	Test Engineer :	Alex Lee and Bill Kuo

WLAN 802.11g Channel 11

100kHz PSD reference Level

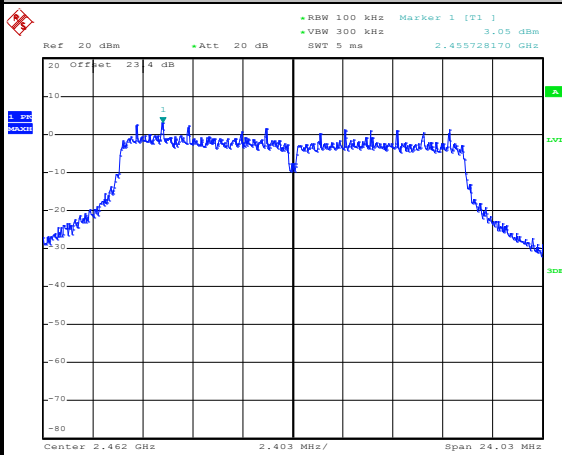

Date: 17.MAR.2014 16:31:28

High Channel Plot

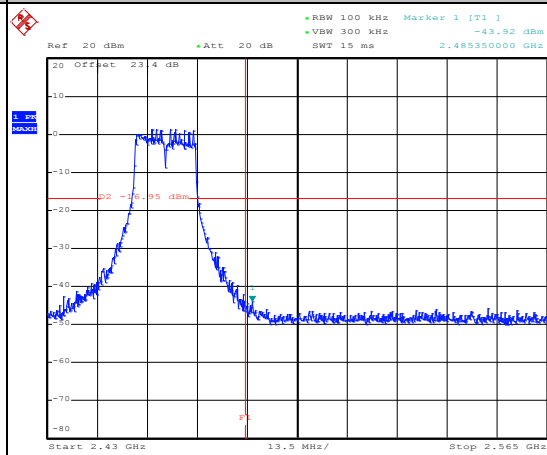

Date: 17.MAR.2014 16:31:42

Spurious Emission 30MHz~3GHz

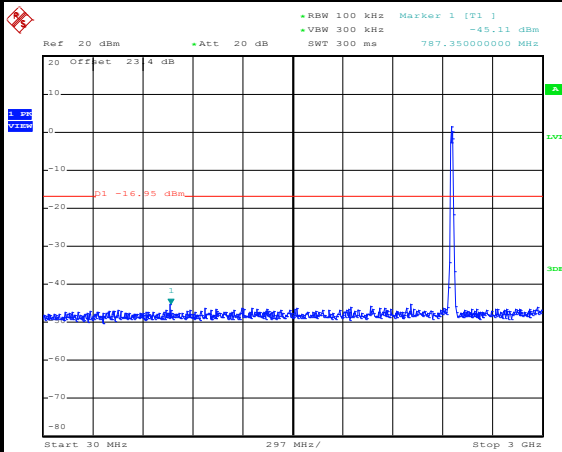

Date: 17.MAR.2014 16:32:01

Spurious Emission 2GHz~25GHz

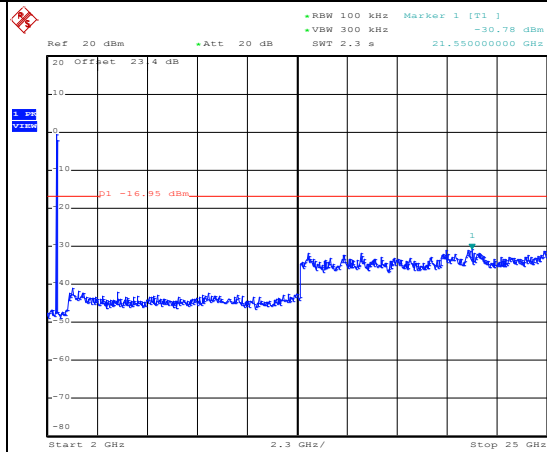

Date: 17.MAR.2014 16:32:20



Number of TX :	2	Ant. :	1
Test Mode :	802.11n HT20	Temperature :	21~26°C
Test Band :	2.4GHz Low	Relative Humidity :	45~54%
Test Channel :	01	Test Engineer :	Alex Lee and Bill Kuo

WLAN 802.11n HT20 Channel 01

100kHz PSD reference Level

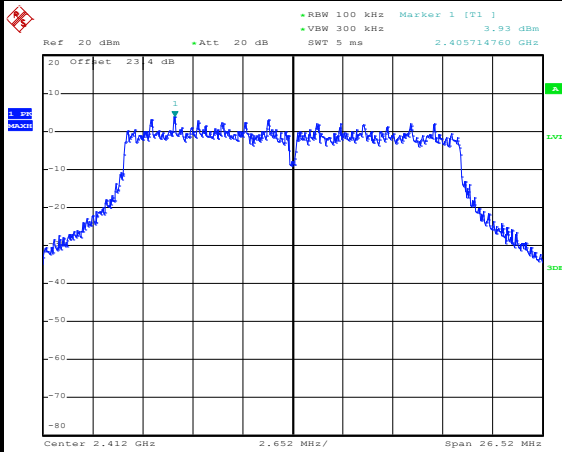

Date: 17.MAR.2014 16:42:29

Low Channel Plot

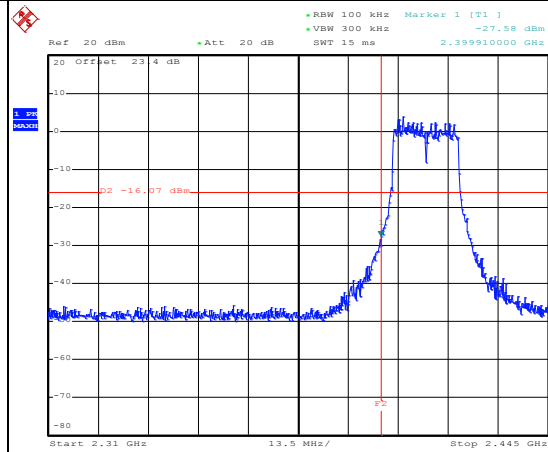

Date: 17.MAR.2014 16:42:42

Spurious Emission 30MHz~3GHz

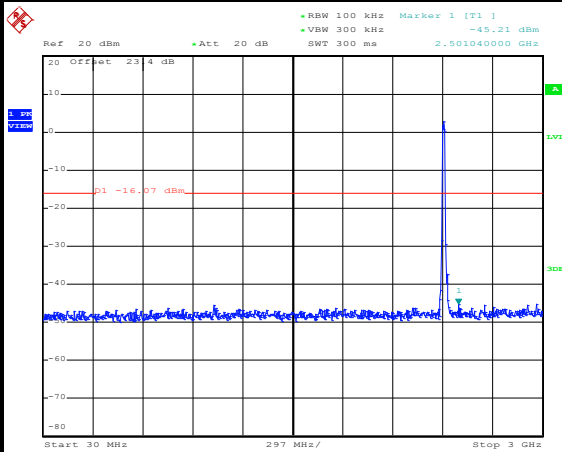

Date: 17.MAR.2014 16:43:02

Spurious Emission 2GHz~25GHz

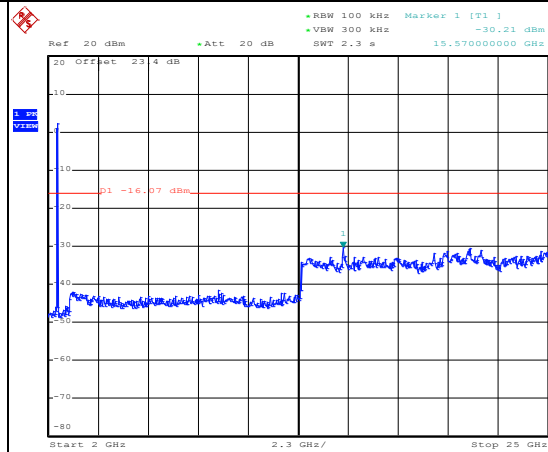

Date: 17.MAR.2014 16:43:20



Number of TX :	2	Ant. :	1
Test Mode :	802.11n HT20	Temperature :	21~26°C
Test Band :	2.4GHz Mid	Relative Humidity :	45~54%
Test Channel :	06	Test Engineer :	Alex Lee and Bill Kuo

WLAN 802.11n HT20 Channel 06

100kHz PSD reference Level

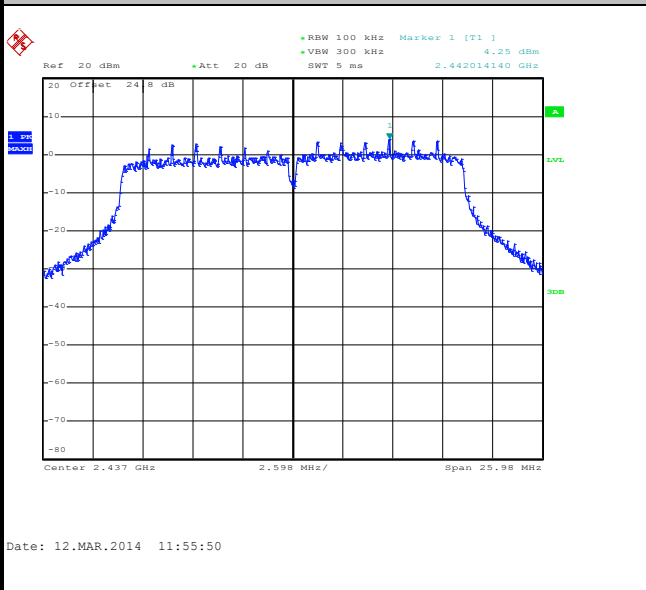

Spurious Emission 30MHz~3GHz

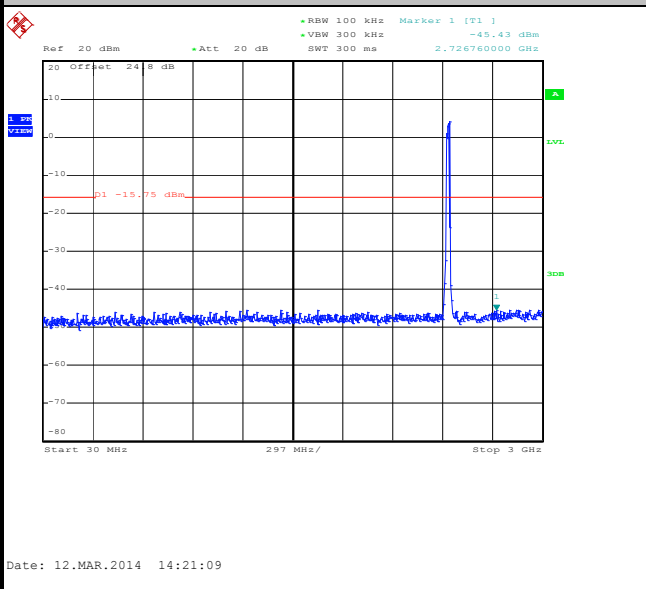

Spurious Emission 2GHz~25GHz

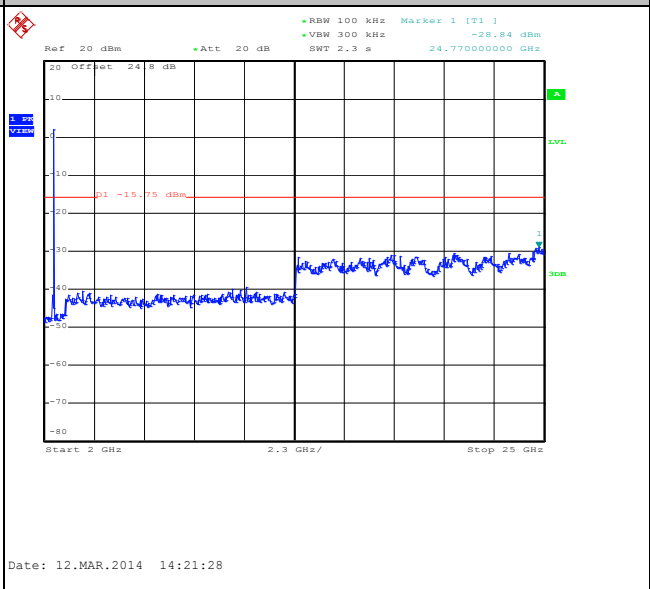



Number of TX :	2	Ant. :	1
Test Mode :	802.11n HT20	Temperature :	21~26°C
Test Band :	2.4GHz High	Relative Humidity :	45~54%
Test Channel :	11	Test Engineer :	Alex Lee and Bill Kuo

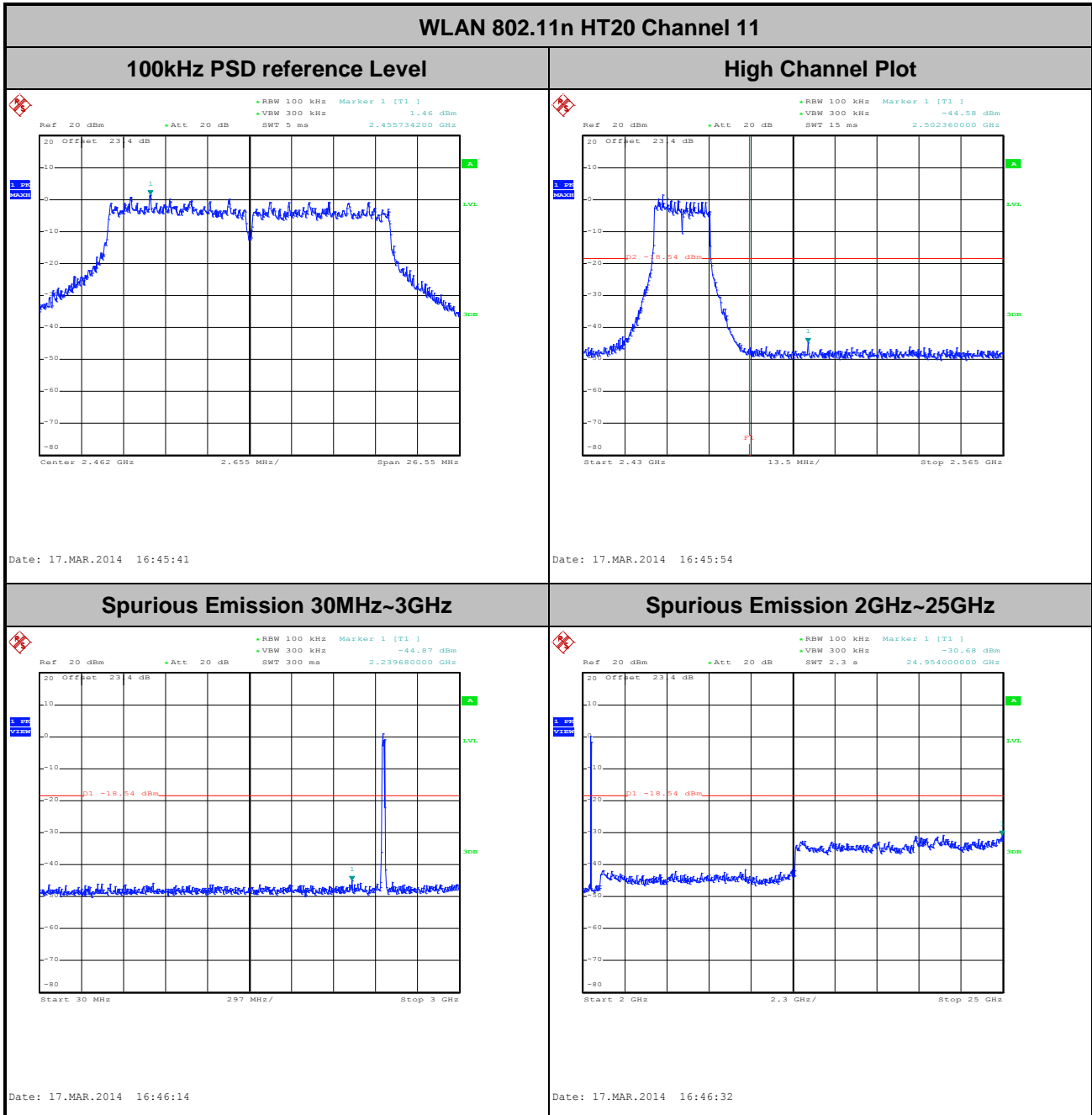



Number of TX :	2	Ant. :	1
Test Mode :	802.11n HT40	Temperature :	21~26°C
Test Band :	2.4GHz Low	Relative Humidity :	45~54%
Test Channel :	03	Test Engineer :	Alex Lee and Bill Kuo

WLAN 802.11n HT40 Channel 03

100kHz PSD reference Level

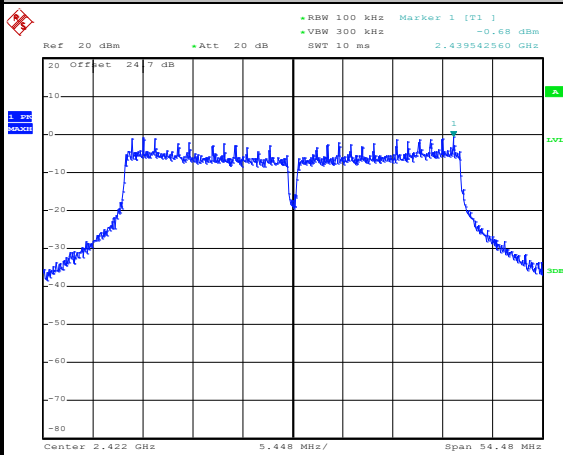

Date: 10.APR.2014 14:54:20

Low Channel Plot

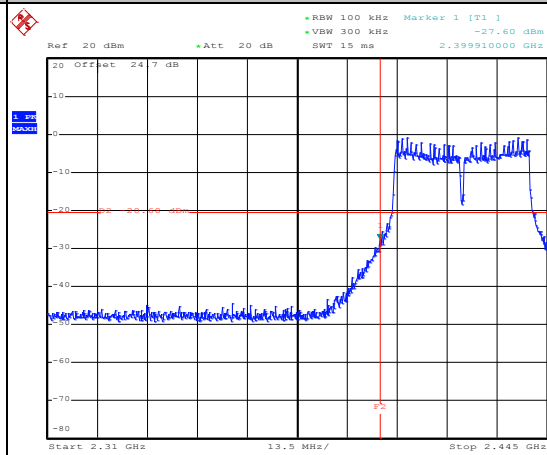

Date: 10.APR.2014 14:54:43

Spurious Emission 30MHz~3GHz

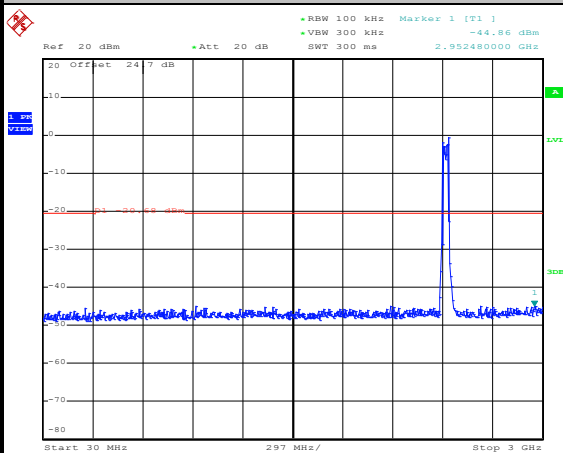

Date: 10.APR.2014 14:56:17

Spurious Emission 2GHz~25GHz

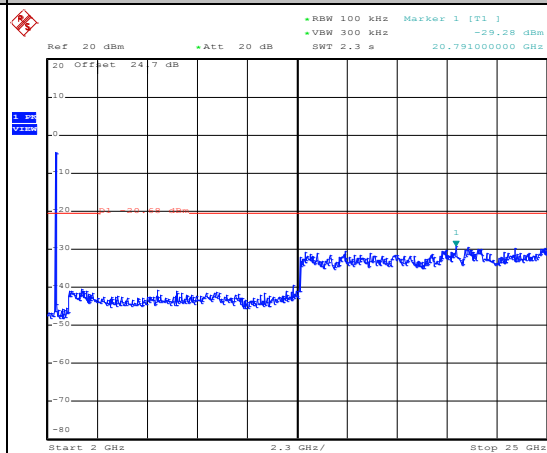

Date: 10.APR.2014 14:55:24



Number of TX :	2	Ant. :	1
Test Mode :	802.11n HT40	Temperature :	21~26°C
Test Band :	2.4GHz Mid	Relative Humidity :	45~54%
Test Channel :	06	Test Engineer :	Alex Lee and Bill Kuo

WLAN 802.11n HT40 Channel 06

100kHz PSD reference Level

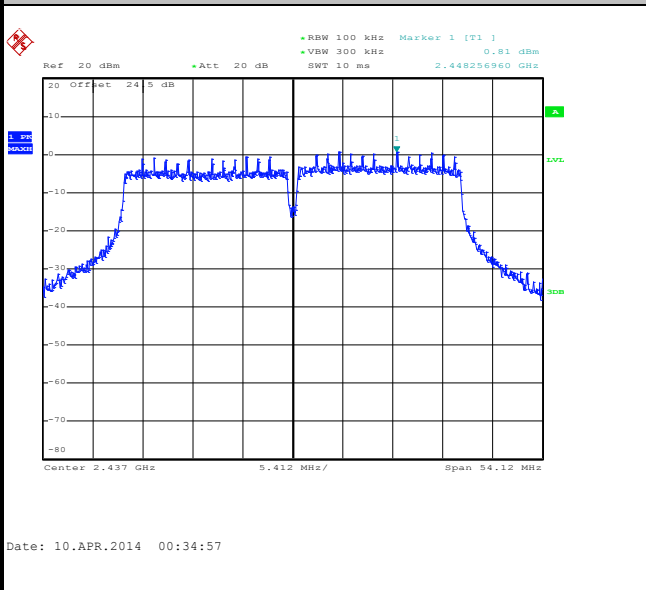

Spurious Emission 30MHz~3GHz

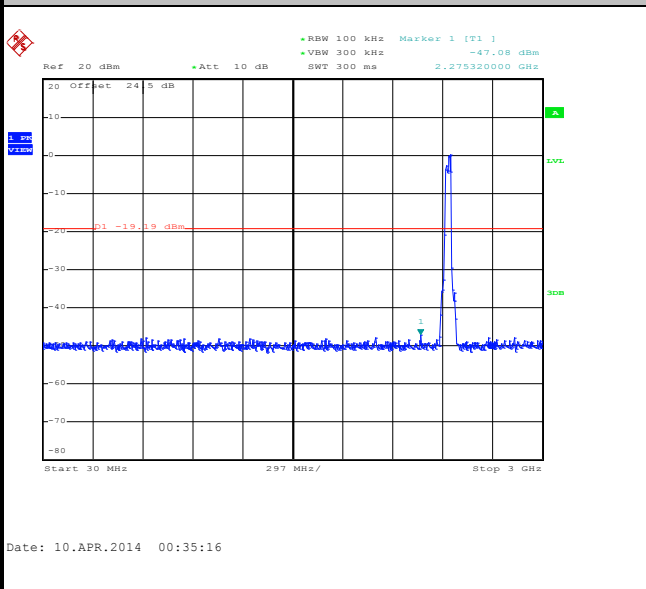

Spurious Emission 2GHz~25GHz

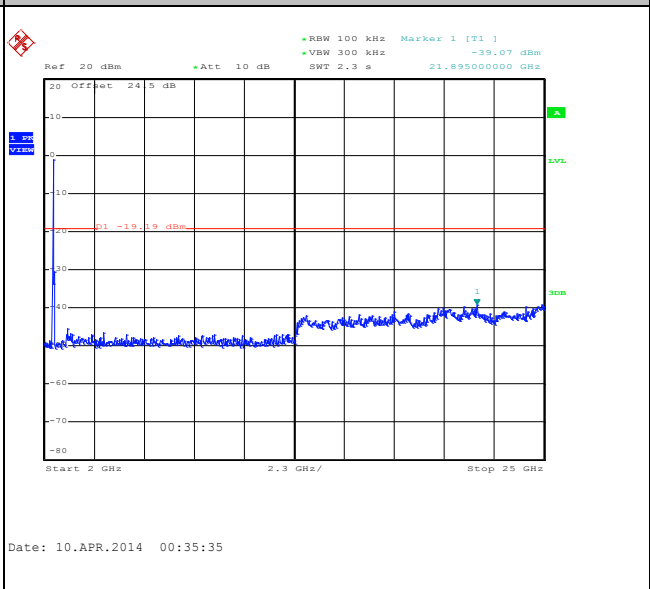



Number of TX :	2	Ant. :	1
Test Mode :	802.11n HT40	Temperature :	21~26°C
Test Band :	2.4GHz High	Relative Humidity :	45~54%
Test Channel :	09	Test Engineer :	Alex Lee and Bill Kuo

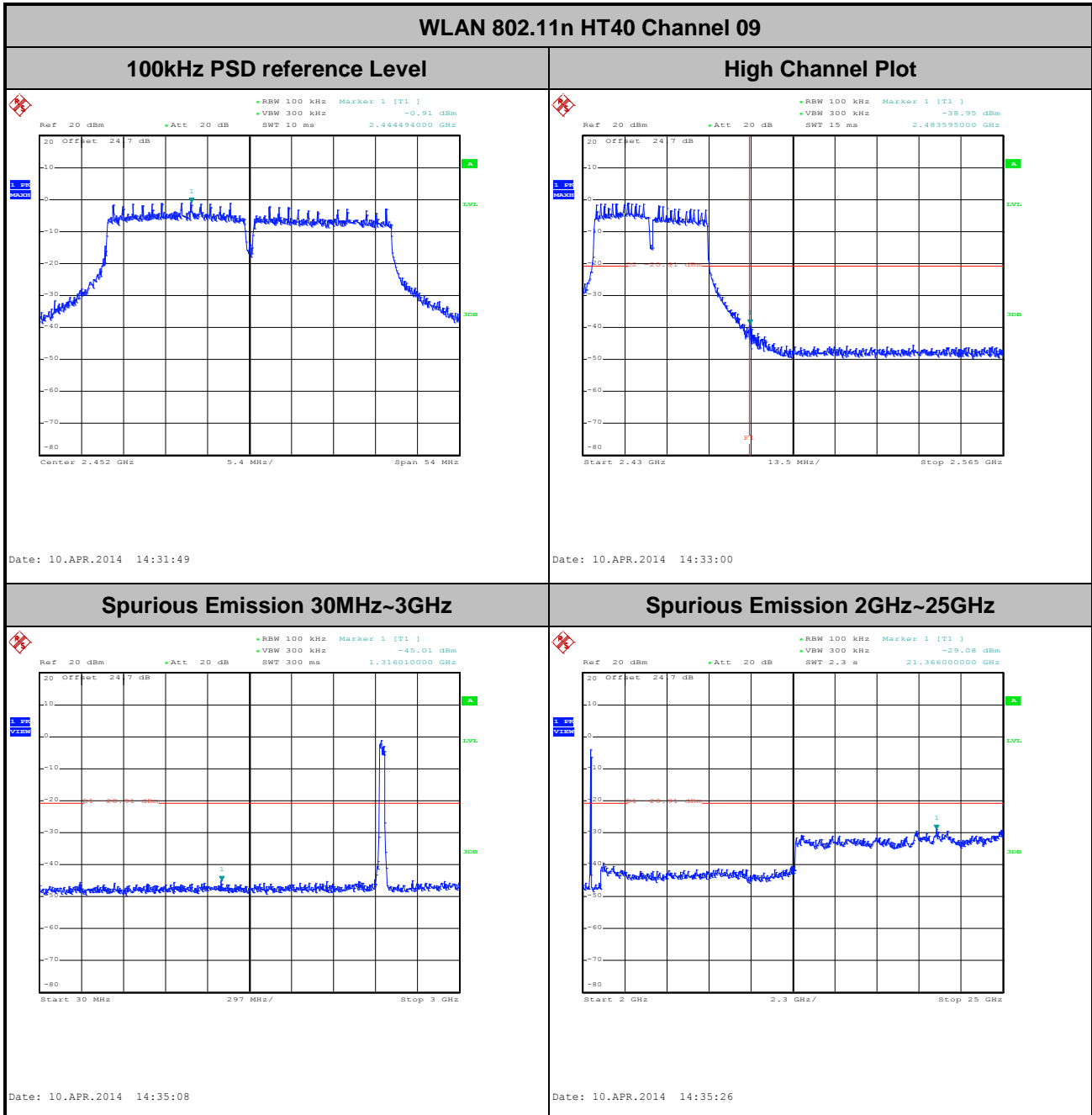



Number of TX = 2, Ant. 2 (Measured)

Number of TX :	2	Ant. :	2
Test Mode :	802.11b	Temperature :	21~26°C
Test Band :	2.4GHz Low	Relative Humidity :	45~54%
Test Channel :	01	Test Engineer :	Alex Lee and Bill Kuo

WLAN 802.11b Channel 01

100kHz PSD reference Level

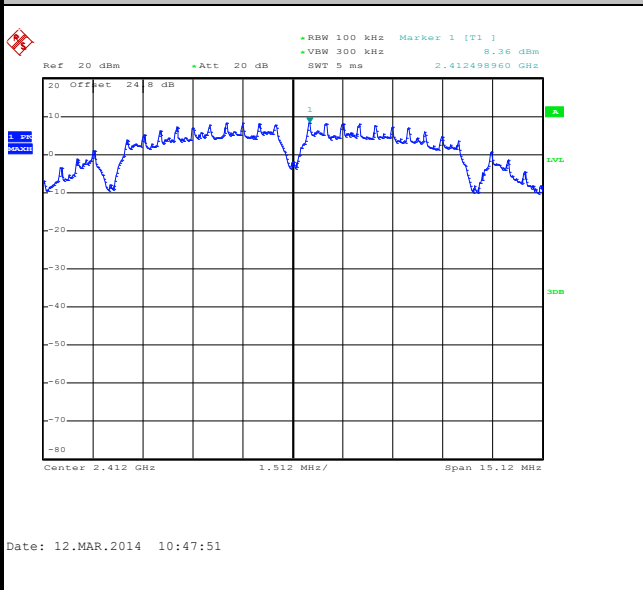

Low Channel Plot

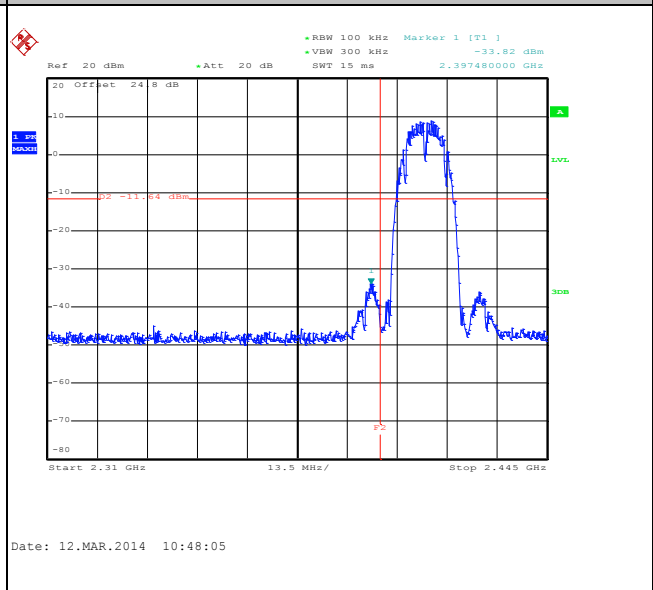

Spurious Emission 30MHz~3GHz

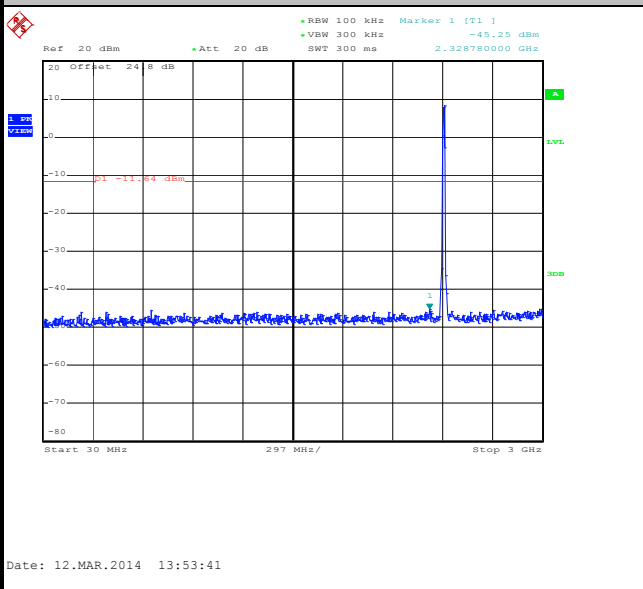

Spurious Emission 2GHz~25GHz

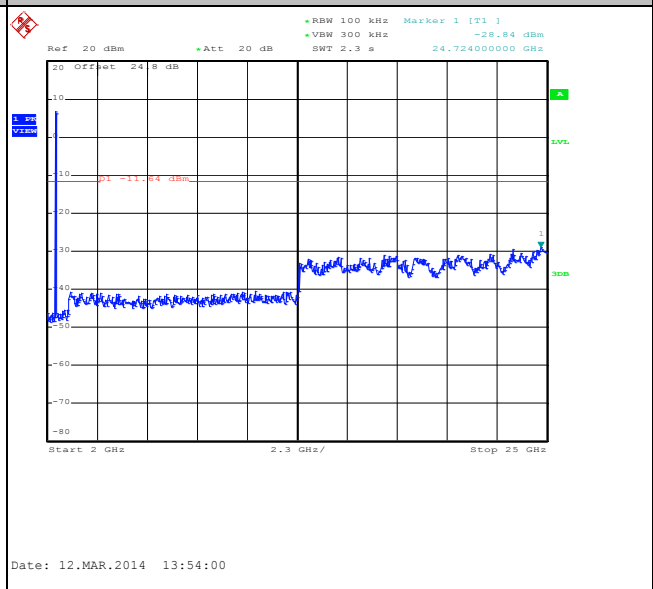



Number of TX :	2	Ant. :	2
Test Mode :	802.11b	Temperature :	21~26°C
Test Band :	2.4GHz Mid	Relative Humidity :	45~54%
Test Channel :	06	Test Engineer :	Alex Lee and Bill Kuo

WLAN 802.11b Channel 06

100kHz PSD reference Level

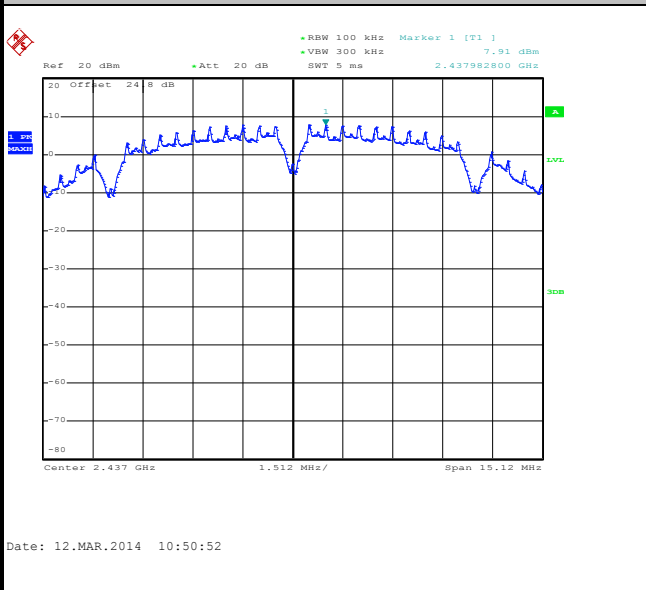

Spurious Emission 30MHz~3GHz

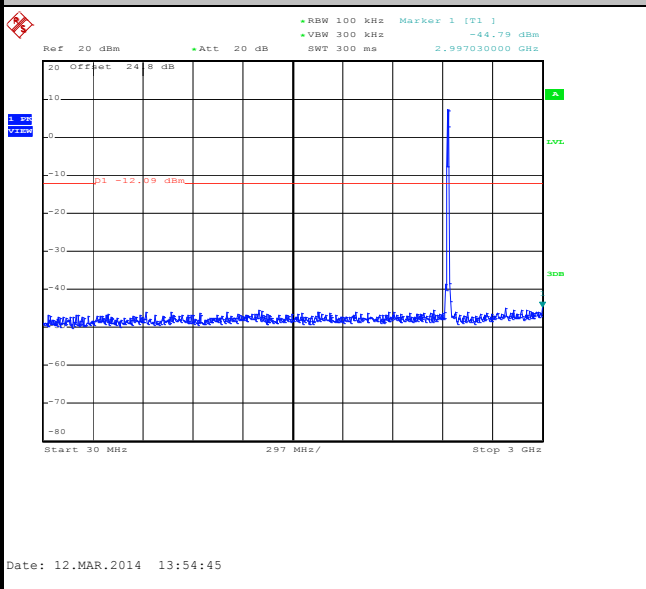

Spurious Emission 2GHz~25GHz

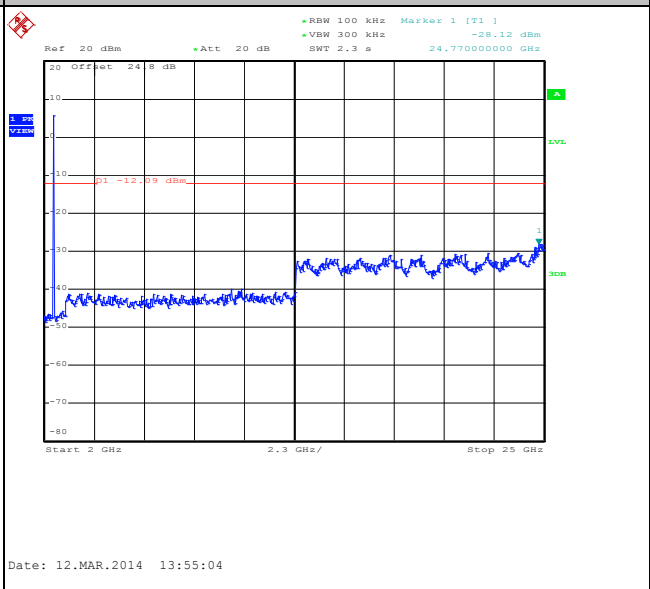



Number of TX :	2	Ant. :	2
Test Mode :	802.11b	Temperature :	21~26°C
Test Band :	2.4GHz High	Relative Humidity :	45~54%
Test Channel :	11	Test Engineer :	Alex Lee and Bill Kuo

WLAN 802.11b Channel 11

100kHz PSD reference Level

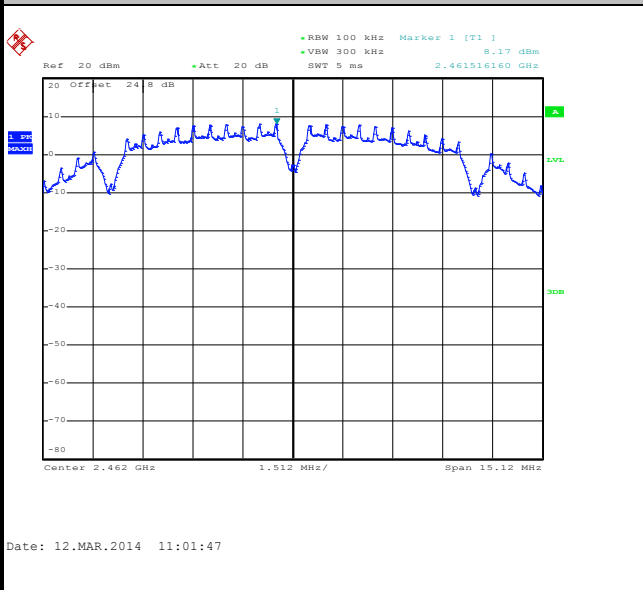

High Channel Plot

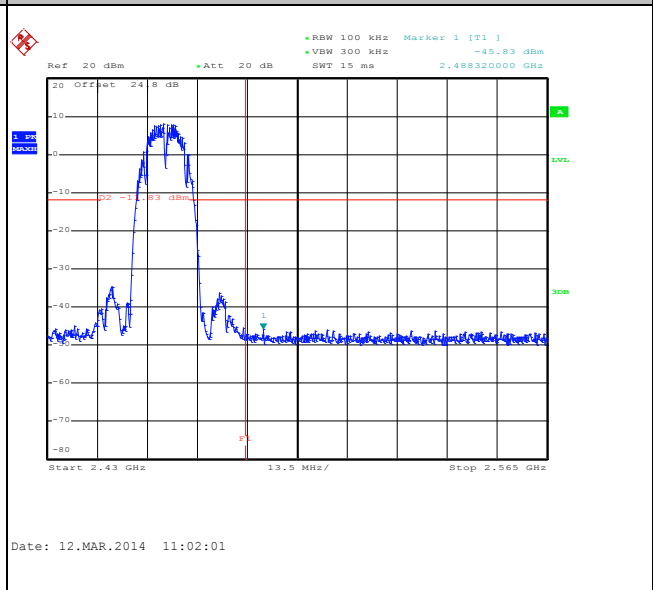

Spurious Emission 30MHz~3GHz

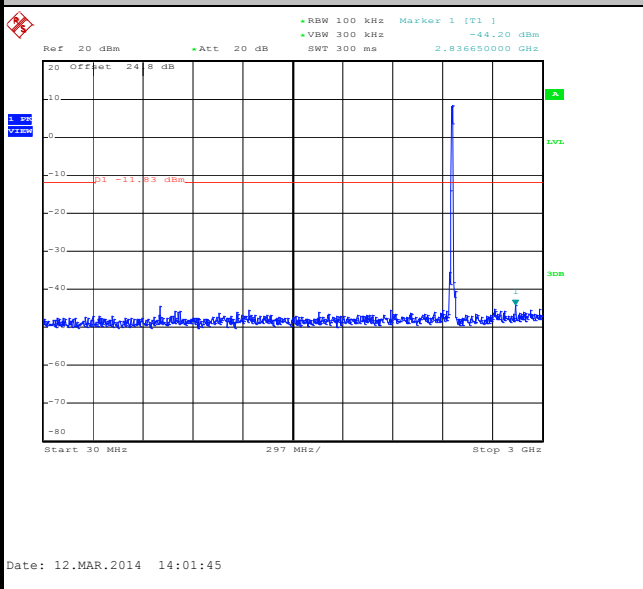

Spurious Emission 2GHz~25GHz

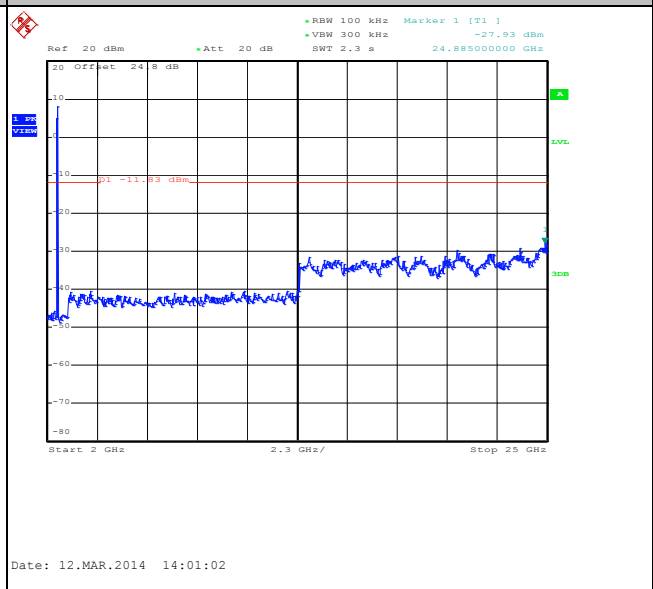



Number of TX :	2	Ant. :	2
Test Mode :	802.11g	Temperature :	21~26°C
Test Band :	2.4GHz Low	Relative Humidity :	45~54%
Test Channel :	01	Test Engineer :	Alex Lee and Bill Kuo

WLAN 802.11g Channel 01

100kHz PSD reference Level

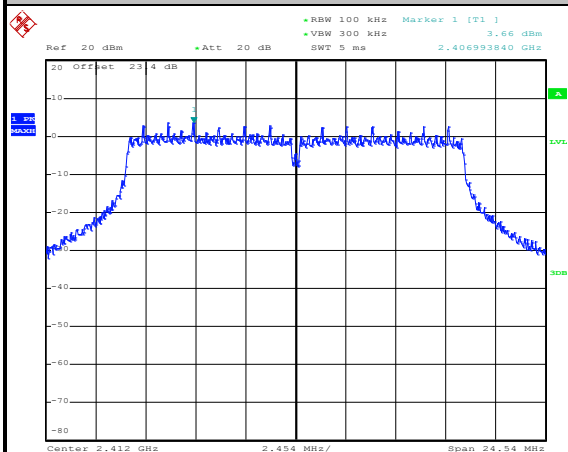

Date: 17.MAR.2014 16:23:08

Low Channel Plot

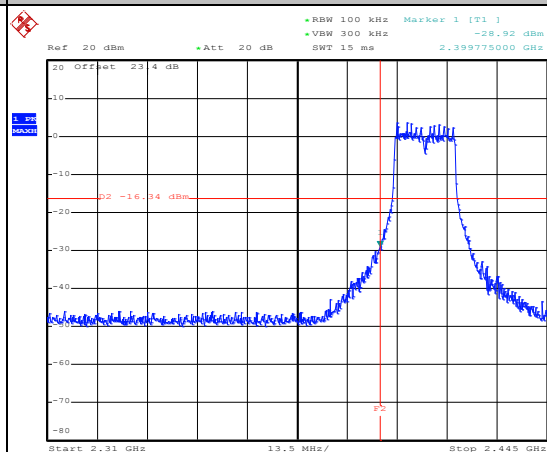

Date: 17.MAR.2014 16:23:22

Spurious Emission 30MHz~3GHz

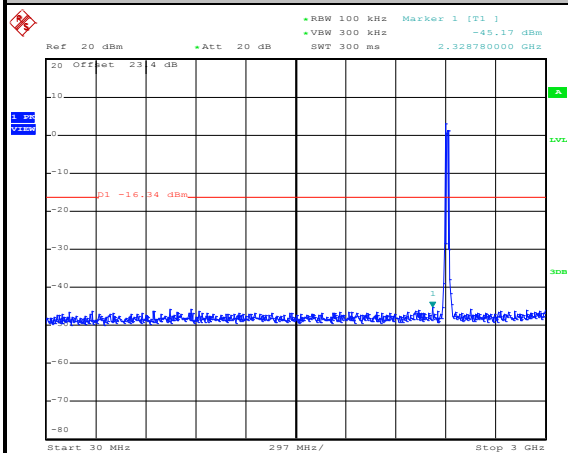

Date: 17.MAR.2014 16:23:41

Spurious Emission 2GHz~25GHz

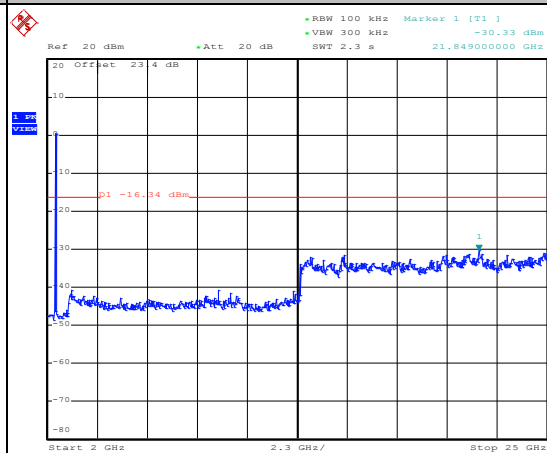

Date: 17.MAR.2014 16:24:00



Number of TX :	2	Ant. :	2
Test Mode :	802.11g	Temperature :	21~26°C
Test Band :	2.4GHz Mid	Relative Humidity :	45~54%
Test Channel :	06	Test Engineer :	Alex Lee and Bill Kuo

WLAN 802.11g Channel 06

100kHz PSD reference Level

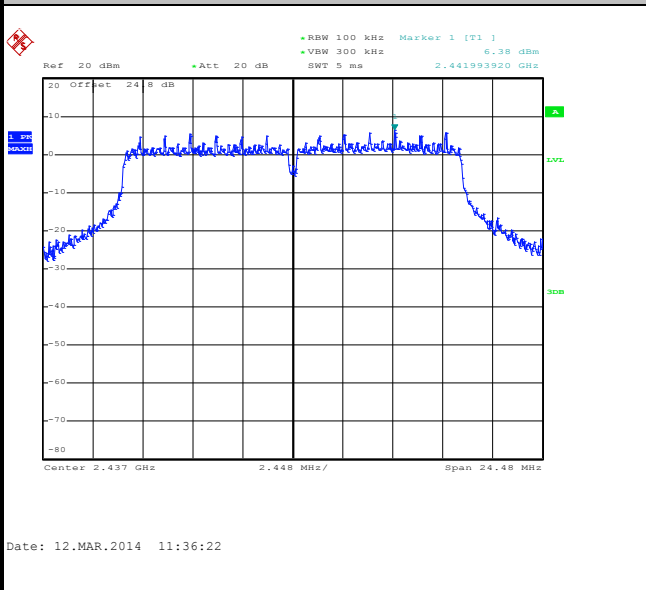

Spurious Emission 30MHz~3GHz

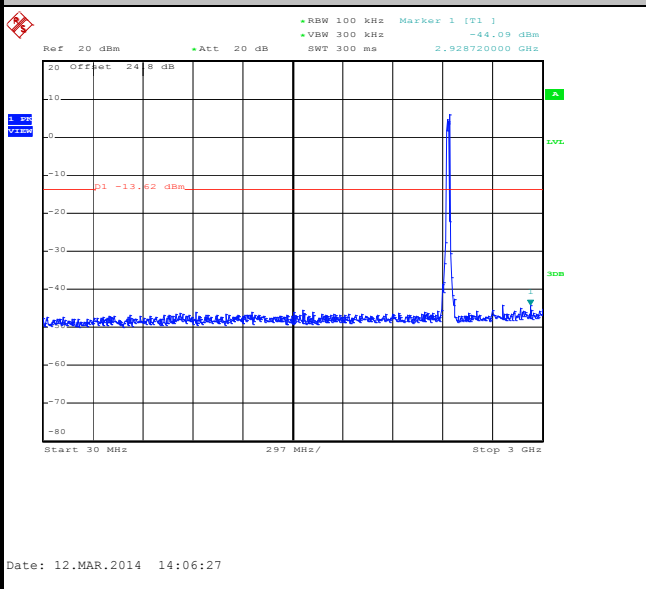

Spurious Emission 2GHz~25GHz

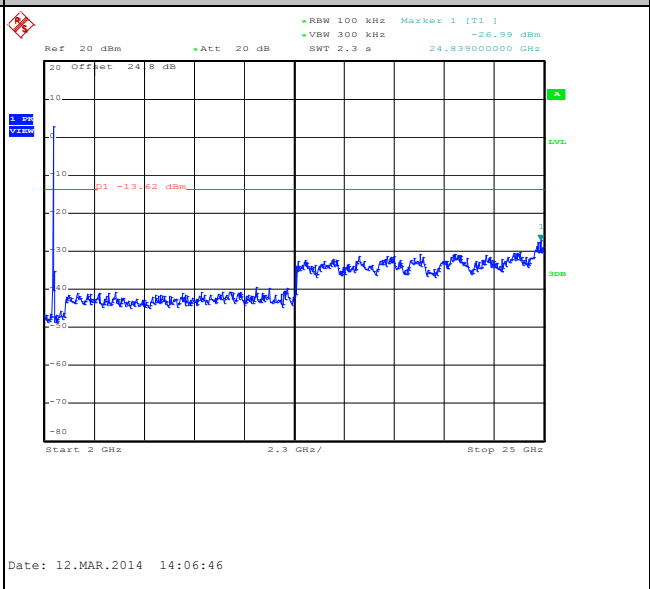



Number of TX :	2	Ant. :	2
Test Mode :	802.11g	Temperature :	21~26°C
Test Band :	2.4GHz High	Relative Humidity :	45~54%
Test Channel :	11	Test Engineer :	Alex Lee and Bill Kuo

WLAN 802.11g Channel 11

100kHz PSD reference Level

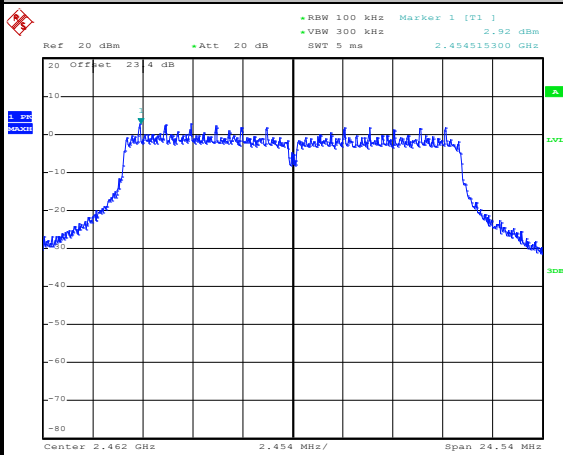

Date: 17.MAR.2014 16:34:09

High Channel Plot

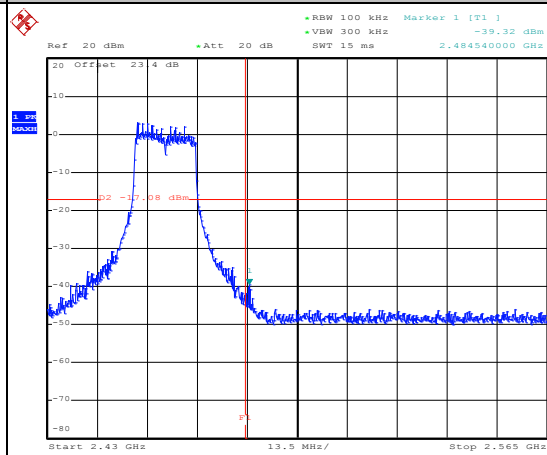

Date: 17.MAR.2014 16:35:34

Spurious Emission 30MHz~3GHz

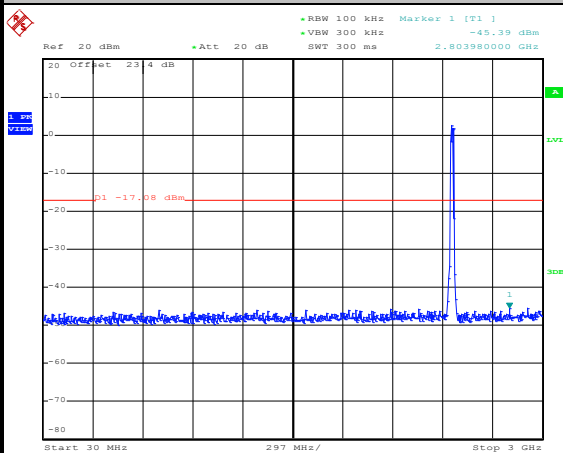

Date: 17.MAR.2014 16:34:42

Spurious Emission 2GHz~25GHz

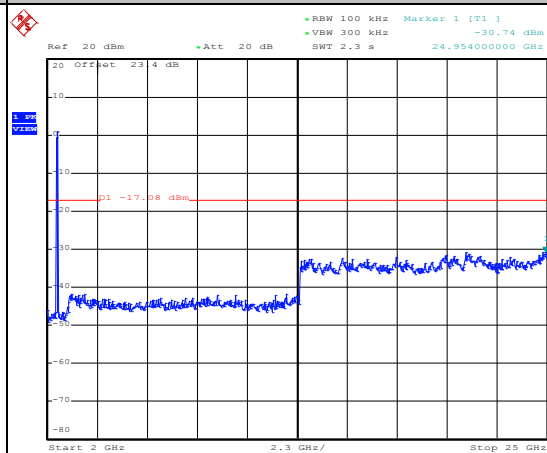

Date: 17.MAR.2014 16:35:01



Number of TX :	2	Ant. :	2
Test Mode :	802.11n HT20	Temperature :	21~26°C
Test Band :	2.4GHz Low	Relative Humidity :	45~54%
Test Channel :	01	Test Engineer :	Alex Lee and Bill Kuo

WLAN 802.11n HT20 Channel 01

100kHz PSD reference Level

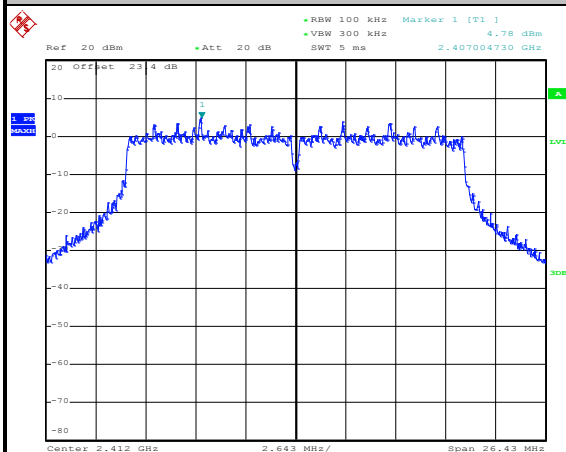

Date: 17.MAR.2014 16:39:08

Low Channel Plot

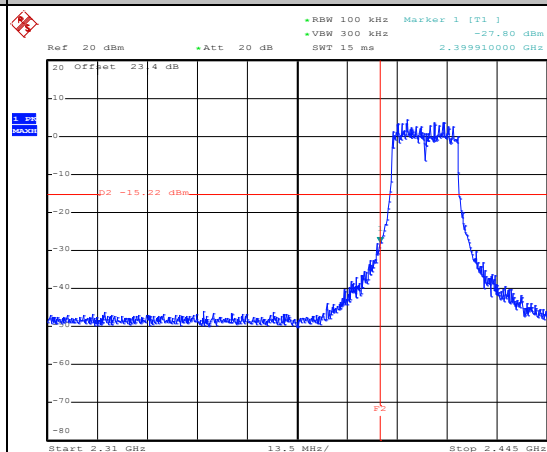

Date: 17.MAR.2014 16:40:27

Spurious Emission 30MHz~3GHz

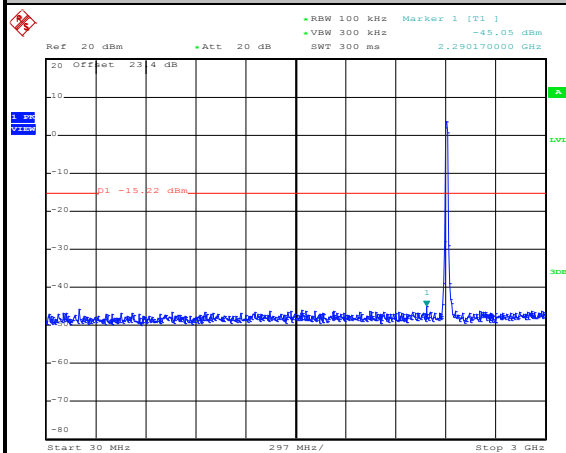

Date: 17.MAR.2014 16:39:41

Spurious Emission 2GHz~25GHz

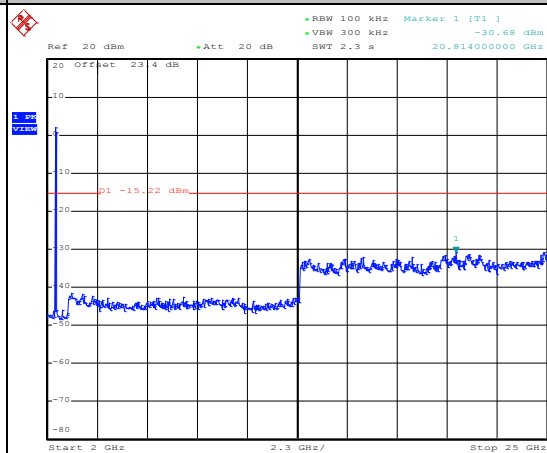

Date: 17.MAR.2014 16:40:00



Number of TX :	2	Ant. :	2
Test Mode :	802.11n HT20	Temperature :	21~26°C
Test Band :	2.4GHz Mid	Relative Humidity :	45~54%
Test Channel :	06	Test Engineer :	Alex Lee and Bill Kuo

WLAN 802.11n HT20 Channel 06

100kHz PSD reference Level

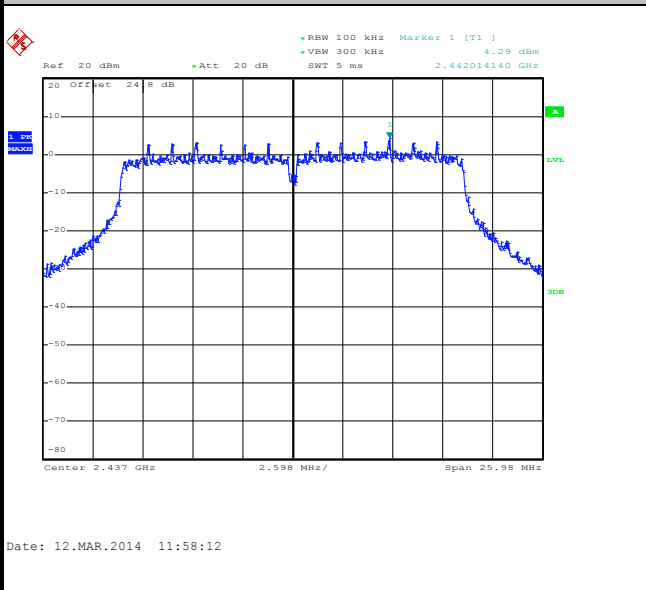

Spurious Emission 30MHz~3GHz

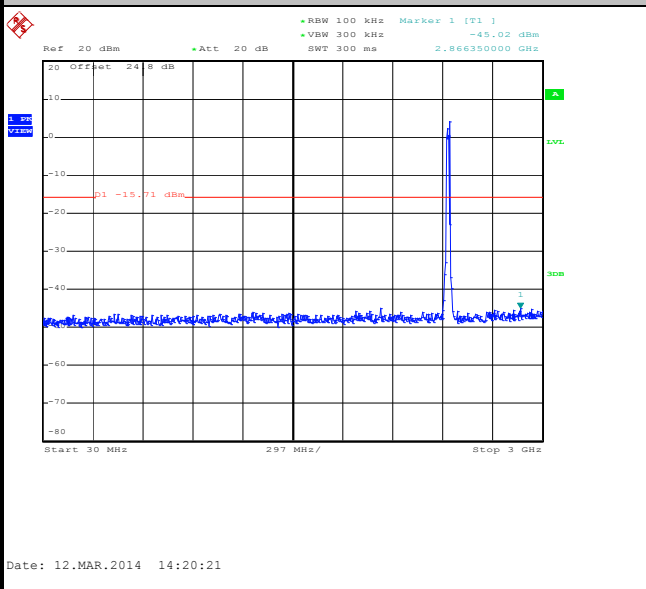

Spurious Emission 2GHz~25GHz

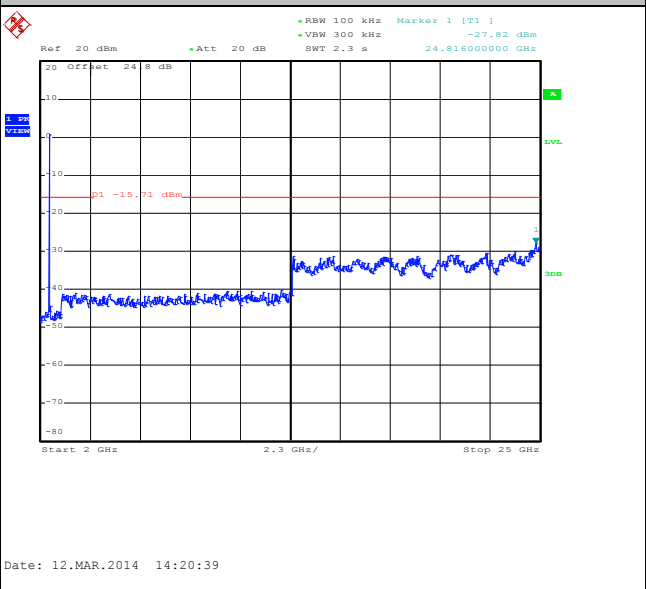



Number of TX :	2	Ant. :	2
Test Mode :	802.11n HT20	Temperature :	21~26°C
Test Band :	2.4GHz High	Relative Humidity :	45~54%
Test Channel :	11	Test Engineer :	Alex Lee and Bill Kuo

WLAN 802.11n HT20 Channel 11

100kHz PSD reference Level

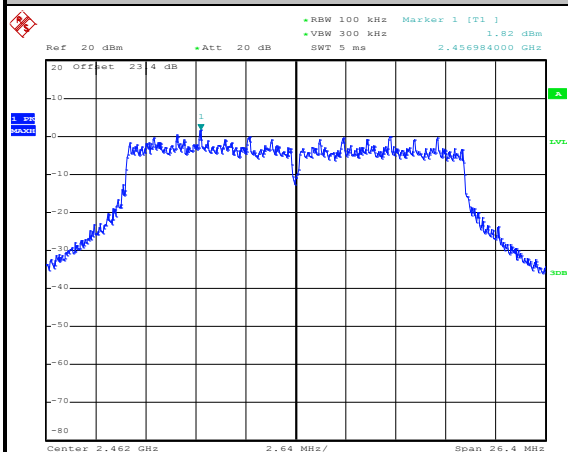

Date: 17.MAR.2014 16:48:46

High Channel Plot

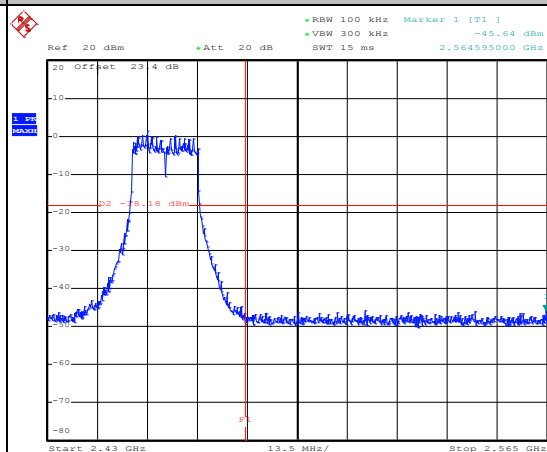

Date: 17.MAR.2014 16:49:00

Spurious Emission 30MHz~3GHz

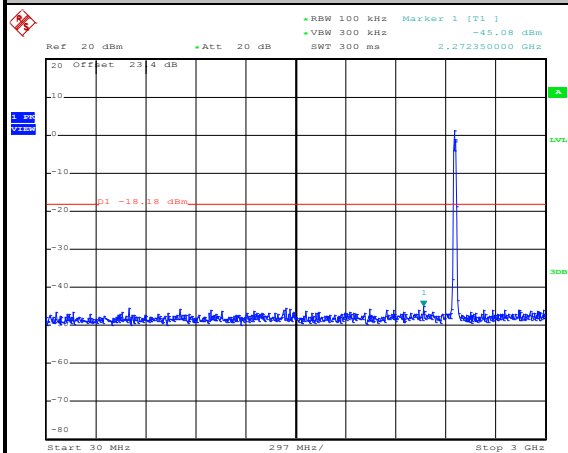

Date: 17.MAR.2014 16:49:19

Spurious Emission 2GHz~25GHz

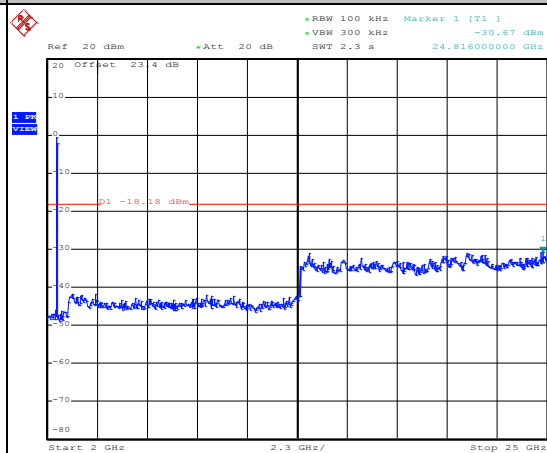

Date: 17.MAR.2014 16:49:37



Number of TX :	2	Ant. :	2
Test Mode :	802.11n HT40	Temperature :	21~26°C
Test Band :	2.4GHz Low	Relative Humidity :	45~54%
Test Channel :	03	Test Engineer :	Alex Lee and Bill Kuo

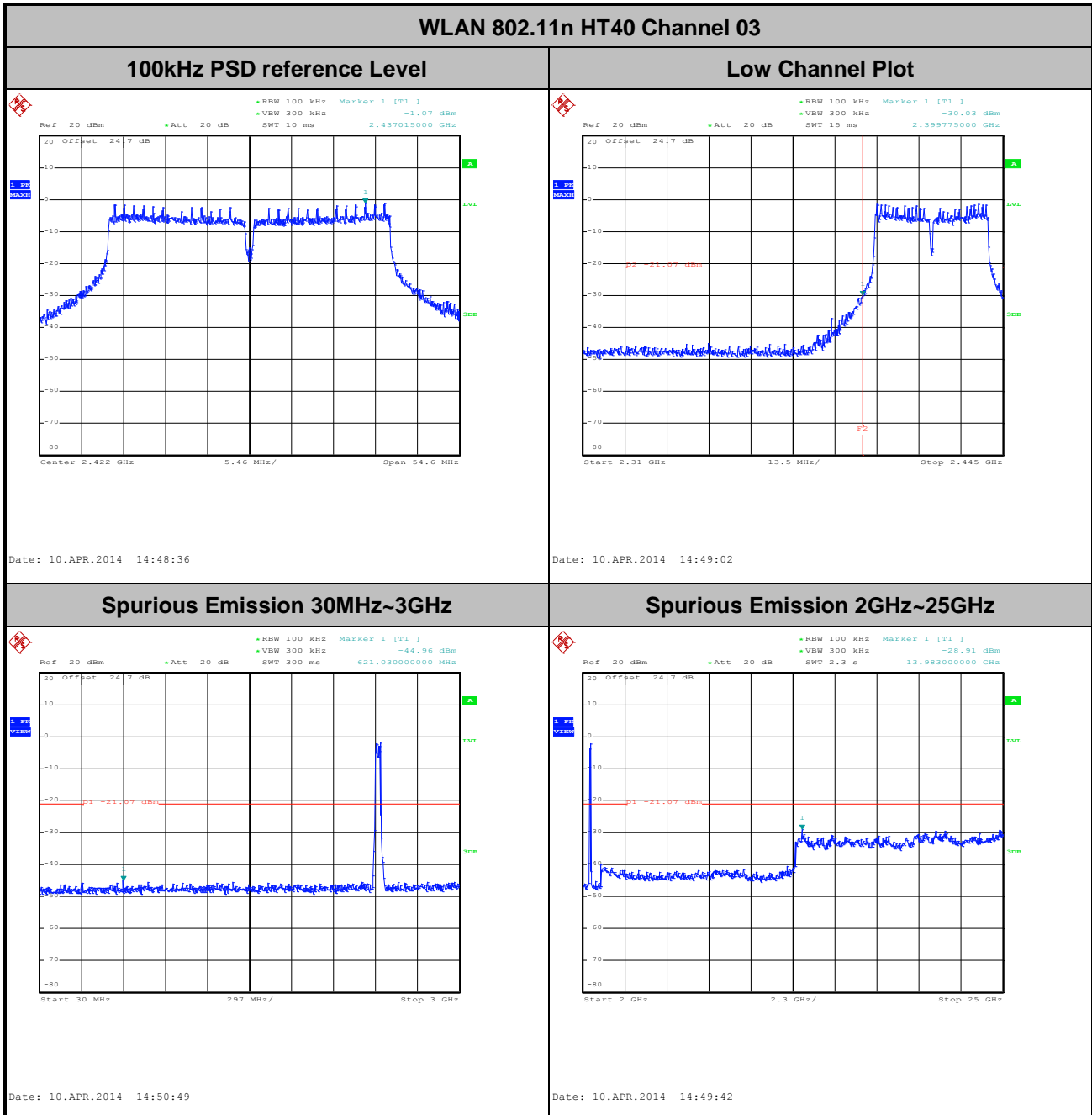



Number of TX :	2	Ant. :	2
Test Mode :	802.11n HT40	Temperature :	21~26°C
Test Band :	2.4GHz Mid	Relative Humidity :	45~54%
Test Channel :	06	Test Engineer :	Alex Lee and Bill Kuo

WLAN 802.11n HT40 Channel 06

100kHz PSD reference Level

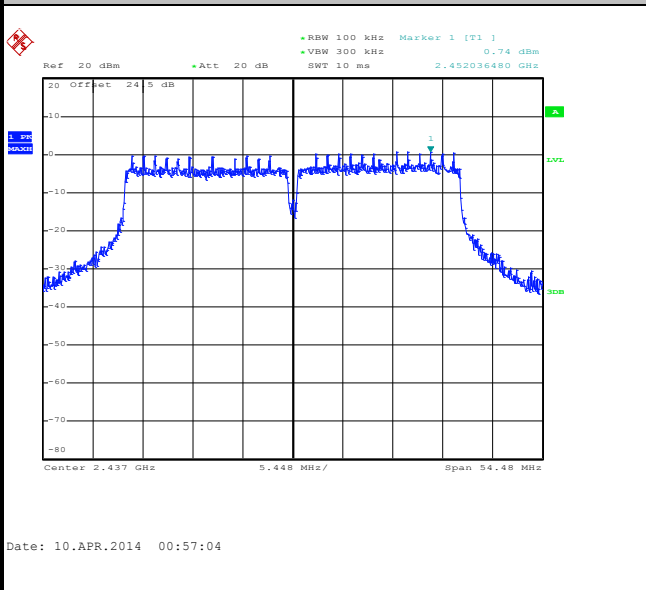

Spurious Emission 30MHz~3GHz

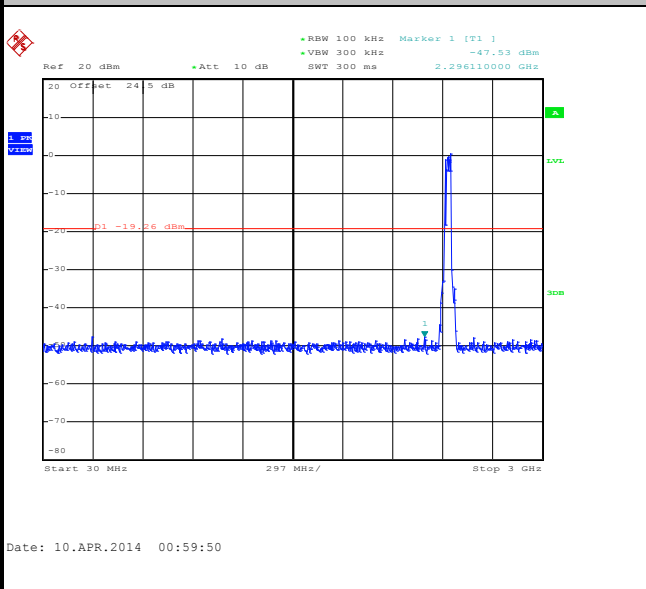

Spurious Emission 2GHz~25GHz

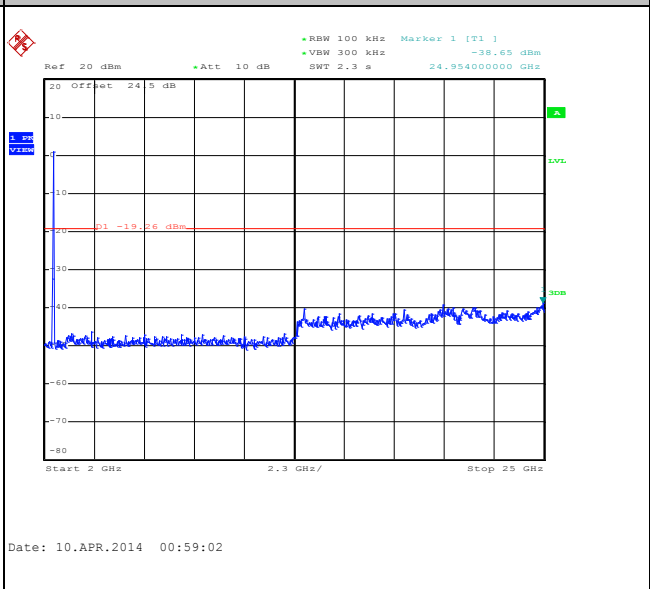



Number of TX :	2	Ant. :	2
Test Mode :	802.11n HT40	Temperature :	21~26°C
Test Band :	2.4GHz High	Relative Humidity :	45~54%
Test Channel :	09	Test Engineer :	Alex Lee and Bill Kuo

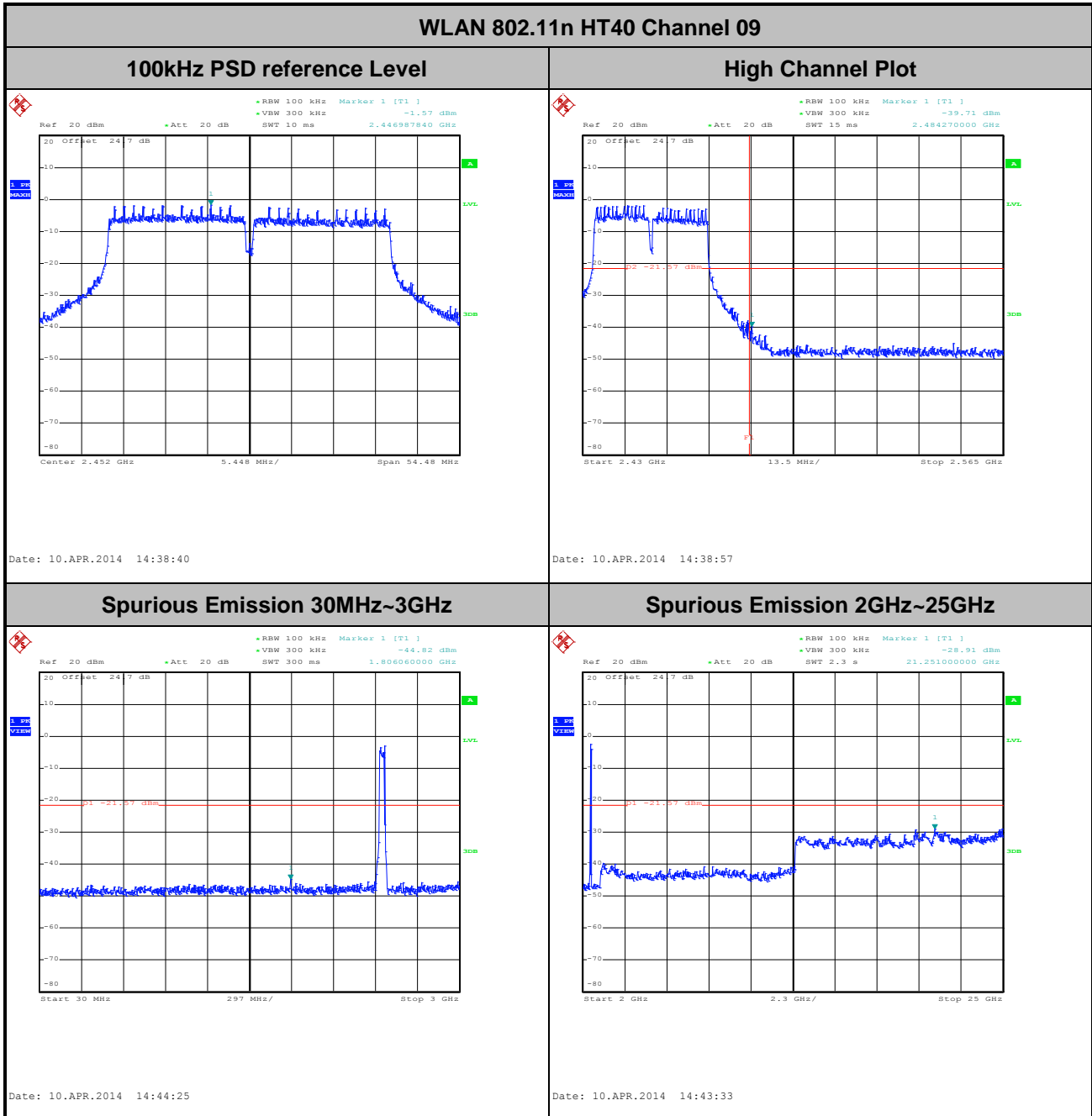

3.5 Radiated Band Edges and Spurious Emission Measurement

3.5.1 Limit of Radiated band edge and Spurious Emission Measurement

In any 100 kHz bandwidth outside the intentional radiator frequency band, all harmonics/spurious must be at least 20 dB below the highest emission level within the authorized band. If the output power of this device was measured by spectrum analyzer, the attenuation under this paragraph shall be 30 dB instead of 20 dB. In addition, radiated emissions which fall in the restricted bands must also comply with the FCC section 15.209 limits as below.

Frequency (MHz)	Field Strength (microvolts/meter)	Measurement Distance (meters)
0.009 – 0.490	2400/F(kHz)	300
0.490 – 1.705	24000/F(kHz)	30
1.705 – 30.0	30	30
30 – 88	100	3
88 – 216	150	3
216 - 960	200	3
Above 960	500	3

3.5.2 Measuring Instruments

The measuring equipment is listed in the section 4 of this test report.



3.5.3 Test Procedure

1. The testing follows FCC KDB Publication No. 558074 D01 DTS Meas. Guidance v03r01.
2. The EUT was arranged to its worst case and then tune the antenna tower (from 1 m to 4 m) and turntable (from 0 degree to 360 degrees) to find the maximum reading. A pre-amp and a high pass filter are used for the test in order to get better signal level.
3. The EUT was placed on a turntable with 0.8 meter above ground.
4. The EUT was set 3 meters from the interference receiving antenna, which was mounted on the top of a variable height antenna tower.
5. Corrected Reading: Antenna Factor + Cable Loss + Read Level - Preamp Factor = Level
6. For measurement below 1GHz, If the emission level of the EUT measured by the peak detector is 3 dB lower than the applicable limit, the peak emission level will be reported. Otherwise, the emission measurement will be repeated using the quasi-peak detector and reported.
7. Use the following spectrum analyzer settings:
 - (1) Span shall wide enough to fully capture the emission being measured;
 - (2) Set RBW=100 kHz for $f < 1$ GHz; $VBW \geq RBW$; Sweep = auto; Detector function = peak; Trace = max hold;
 - (3) Set RBW = 1 MHz, VBW= 3MHz for $f \geq 1$ GHz for peak measurement.
For average measurement:
 - $VBW = 10$ Hz, when duty cycle is no less than 98 percent.
 - $VBW \geq 1/T$, when duty cycle is less than 98 percent where T is the minimum transmission duration over which the transmitter is on and is transmitting at its maximum power control level for the tested mode of operation.

Antenna	Band	Duty Cycle(%)	T(us)	1/T(kHz)	VBW Setting
1	802.11b	100.00	-	-	10Hz
2	802.11b	100.00	-	-	
1+2	802.11b for Ant. 1	100.00	-	-	
1+2	802.11b for Ant. 2	100.00	-	-	
1	802.11g	96.59	1358	0.74	1kHz
2	802.11g	96.45	1360	0.74	
1+2	802.11g for Ant. 1	96.05	1360	0.74	
1+2	802.11g for Ant. 2	95.77	1360	0.74	
1	2.4GHz 802.11n HT20	96.39	1280	0.78	
2	2.4GHz 802.11n HT20	96.36	1272	0.79	
1+2	2.4GHz 802.11n HT20 for Ant. 1	96.24	1280	0.78	
1+2	2.4GHz 802.11n HT20 for Ant. 2	96.39	1280	0.78	
1	2.4GHz 802.11n HT40	94.64	636	1.57	3kHz
2	2.4GHz 802.11n HT40	94.64	636	1.57	
1+2	2.4GHz 802.11n HT40 for Ant 1	94.64	636	1.57	
1+2	2.4GHz 802.11n HT40 for Ant 2	94.64	636	1.57	

3.5.4 Test Setup

For radiated emissions below 30MHz

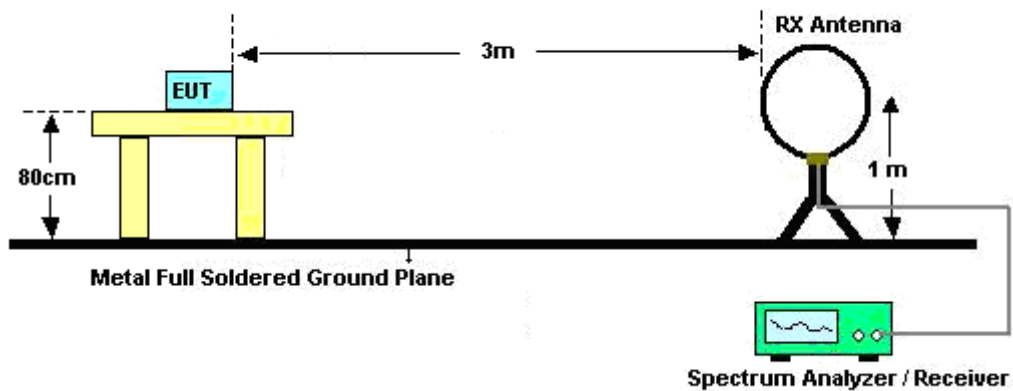

For radiated emissions from 30MHz to 1GHz

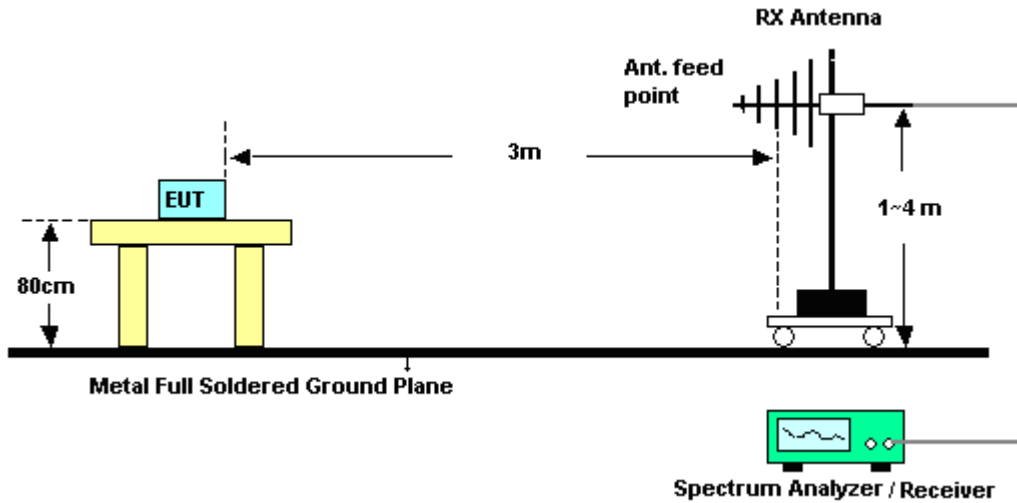

For radiated emissions above 1GHz

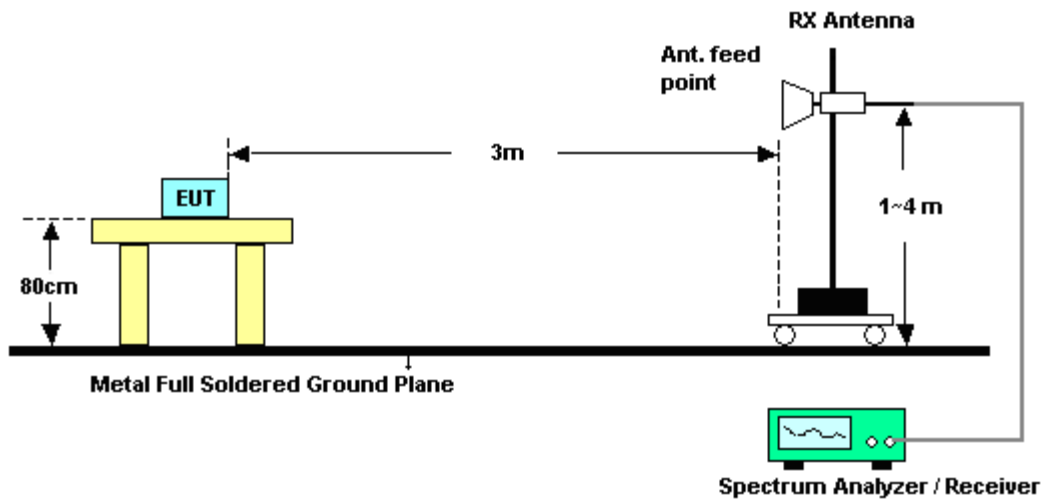

3.5.5 Test Results of Radiated Emissions (9kHz ~ 30MHz)

The low frequency, which started from 9 kHz to 30MHz, was pre-scanned and the result which was 20dB lower than the limit line per 15.31(o) was not reported.



3.5.6 Test Result of Radiated Spurious at Band Edges

<MIMO Ant. 1+2>

Test Mode :	802.11b	Temperature :	22~24°C
Test Band :	Low	Relative Humidity :	50~52%
Test Channel :	01	Test Engineer :	Kyle Jhuang

ANTENNA POLARITY : HORIZONTAL										
Frequency (MHz)	Level (dBμV/m)	Over Limit (dB)	Limit Line (dBμV/m)	Read Level (dBμV)	Antenna Factor (dB)	Cable Loss (dB)	Preamp Factor (dB)	Ant Pos (cm)	Table Pos (deg)	Remark
2387.04	49.91	-24.09	74	45.73	32.29	6.22	34.33	104	218	Peak
2389.83	38.41	-15.59	54	34.23	32.29	6.22	34.33	104	218	Average

ANTENNA POLARITY : VERTICAL										
Frequency (MHz)	Level (dBμV/m)	Over Limit (dB)	Limit Line (dBμV/m)	Read Level (dBμV)	Antenna Factor (dB)	Cable Loss (dB)	Preamp Factor (dB)	Ant Pos (cm)	Table Pos (deg)	Remark
2390	58.26	-15.74	74	54.08	32.29	6.22	34.33	116	66	Peak
2390	47.52	-6.48	54	43.34	32.29	6.22	34.33	116	66	Average

Test Mode :	802.11b	Temperature :	22~24°C
Test Band :	High	Relative Humidity :	50~52%
Test Channel :	11	Test Engineer :	Kyle Jhuang

ANTENNA POLARITY : HORIZONTAL										
Frequency (MHz)	Level (dBμV/m)	Over Limit (dB)	Limit Line (dBμV/m)	Read Level (dBμV)	Antenna Factor (dB)	Cable Loss (dB)	Preamp Factor (dB)	Ant Pos (cm)	Table Pos (deg)	Remark
2484.25	51.89	-22.11	74	47.27	32.47	6.45	34.3	102	180	Peak
2483.5	42.47	-11.53	54	37.85	32.47	6.45	34.3	102	180	Average

ANTENNA POLARITY : VERTICAL										
Frequency (MHz)	Level (dBμV/m)	Over Limit (dB)	Limit Line (dBμV/m)	Read Level (dBμV)	Antenna Factor (dB)	Cable Loss (dB)	Preamp Factor (dB)	Ant Pos (cm)	Table Pos (deg)	Remark
2483.89	58.35	-15.65	74	53.73	32.47	6.45	34.3	165	110	Peak
2483.5	48.57	-5.43	54	43.95	32.47	6.45	34.3	165	110	Average



Test Mode :	802.11g	Temperature :	22~24°C
Test Band :	Low	Relative Humidity :	50~52%
Test Channel :	01	Test Engineer :	Kyle Jhuang

ANTENNA POLARITY : HORIZONTAL										
Frequency (MHz)	Level (dBμV/m)	Over Limit (dB)	Limit Line (dBμV/m)	Read Level (dBμV)	Antenna Factor (dB)	Cable Loss (dB)	Preamp Factor (dB)	Ant Pos (cm)	Table Pos (deg)	Remark
2389.92	67.65	-6.35	74	63.47	32.29	6.22	34.33	136	335	Peak
2389.92	46.95	-7.05	54	42.77	32.29	6.22	34.33	136	335	Average

ANTENNA POLARITY : VERTICAL										
Frequency (MHz)	Level (dBμV/m)	Over Limit (dB)	Limit Line (dBμV/m)	Read Level (dBμV)	Antenna Factor (dB)	Cable Loss (dB)	Preamp Factor (dB)	Ant Pos (cm)	Table Pos (deg)	Remark
2389.92	73.16	-0.84	74	68.98	32.29	6.22	34.33	120	349	Peak
2389.74	50.03	-3.97	54	45.85	32.29	6.22	34.33	120	349	Average

Test Mode :	802.11g	Temperature :	22~24°C
Test Band :	High	Relative Humidity :	50~52%
Test Channel :	11	Test Engineer :	Kyle Jhuang

ANTENNA POLARITY : HORIZONTAL										
Frequency (MHz)	Level (dBμV/m)	Over Limit (dB)	Limit Line (dBμV/m)	Read Level (dBμV)	Antenna Factor (dB)	Cable Loss (dB)	Preamp Factor (dB)	Ant Pos (cm)	Table Pos (deg)	Remark
2483.56	67.94	-6.06	74	63.32	32.47	6.45	34.3	102	180	Peak
2483.5	46.53	-7.47	54	41.91	32.47	6.45	34.3	102	180	Average

ANTENNA POLARITY : VERTICAL										
Frequency (MHz)	Level (dBμV/m)	Over Limit (dB)	Limit Line (dBμV/m)	Read Level (dBμV)	Antenna Factor (dB)	Cable Loss (dB)	Preamp Factor (dB)	Ant Pos (cm)	Table Pos (deg)	Remark
2485.48	72.63	-1.37	74	68.01	32.47	6.45	34.3	118	349	Peak
2483.5	50.56	-3.44	54	45.94	32.47	6.45	34.3	118	349	Average



Test Mode :	802.11n HT20	Temperature :	22~24°C
Test Band :	Low	Relative Humidity :	50~52%
Test Channel :	01	Test Engineer :	Kyle Jhuang

ANTENNA POLARITY : HORIZONTAL										
Frequency (MHz)	Level (dBμV/m)	Over Limit (dB)	Limit Line (dBμV/m)	Read Level (dBμV)	Antenna Factor (dB)	Cable Loss (dB)	Preamp Factor (dB)	Ant Pos (cm)	Table Pos (deg)	Remark
2389.92	66.42	-7.58	74	62.24	32.29	6.22	34.33	138	328	Peak
2390	46.3	-7.7	54	42.12	32.29	6.22	34.33	138	328	Average

ANTENNA POLARITY : VERTICAL										
Frequency (MHz)	Level (dBμV/m)	Over Limit (dB)	Limit Line (dBμV/m)	Read Level (dBμV)	Antenna Factor (dB)	Cable Loss (dB)	Preamp Factor (dB)	Ant Pos (cm)	Table Pos (deg)	Remark
2389.83	72.37	-1.63	74	68.19	32.29	6.22	34.33	121	5	Peak
2389.92	51.17	-2.83	54	46.99	32.29	6.22	34.33	121	5	Average

Test Mode :	802.11n HT20	Temperature :	22~24°C
Test Band :	High	Relative Humidity :	50~52%
Test Channel :	11	Test Engineer :	Kyle Jhuang

ANTENNA POLARITY : HORIZONTAL										
Frequency (MHz)	Level (dBμV/m)	Over Limit (dB)	Limit Line (dBμV/m)	Read Level (dBμV)	Antenna Factor (dB)	Cable Loss (dB)	Preamp Factor (dB)	Ant Pos (cm)	Table Pos (deg)	Remark
2483.53	63.27	-10.73	74	58.65	32.47	6.45	34.3	101	332	Peak
2483.53	45.16	-8.84	54	40.54	32.47	6.45	34.3	101	332	Average

ANTENNA POLARITY : VERTICAL										
Frequency (MHz)	Level (dBμV/m)	Over Limit (dB)	Limit Line (dBμV/m)	Read Level (dBμV)	Antenna Factor (dB)	Cable Loss (dB)	Preamp Factor (dB)	Ant Pos (cm)	Table Pos (deg)	Remark
2483.86	73.38	-0.62	74	68.76	32.47	6.45	34.3	114	304	Peak
2483.56	47.3	-6.7	54	42.68	32.47	6.45	34.3	114	304	Average



Test Mode :	802.11n HT40	Temperature :	22~24°C
Test Band :	Low	Relative Humidity :	50~52%
Test Channel :	03	Test Engineer :	Kyle Jhuang

ANTENNA POLARITY : HORIZONTAL										
Frequency (MHz)	Level (dBμV/m)	Over Limit (dB)	Limit Line (dBμV/m)	Read Level (dBμV)	Antenna Factor (dB)	Cable Loss (dB)	Preamp Factor (dB)	Ant Pos (cm)	Table Pos (deg)	Remark
2389.65	67.17	-6.83	74	62.23	32.3	6.91	34.27	102	10	Peak
2389.83	47.47	-6.53	54	42.56	32.3	6.91	34.3	102	10	Average
2486.02	57.7	-16.3	74	52.69	32.38	7.06	34.43	102	10	Peak
2485.54	44.75	-9.25	54	39.74	32.38	7.06	34.43	102	10	Average

ANTENNA POLARITY : VERTICAL										
Frequency (MHz)	Level (dBμV/m)	Over Limit (dB)	Limit Line (dBμV/m)	Read Level (dBμV)	Antenna Factor (dB)	Cable Loss (dB)	Preamp Factor (dB)	Ant Pos (cm)	Table Pos (deg)	Remark
2389.92	72.77	-1.23	74	67.86	32.3	6.91	34.3	100	360	Peak
2389.92	51.88	-2.12	54	46.97	32.3	6.91	34.3	100	360	Average
2483.98	60.92	-13.08	74	55.91	32.38	7.06	34.43	100	360	Peak
2483.62	45.69	-8.31	54	40.68	32.38	7.06	34.43	100	360	Average



Test Mode :	802.11n HT40	Temperature :	22~24°C
Test Band :	High	Relative Humidity :	50~52%
Test Channel :	09	Test Engineer :	Kyle Jhuang

ANTENNA POLARITY : HORIZONTAL										
Frequency (MHz)	Level (dBμV/m)	Over Limit (dB)	Limit Line (dBμV/m)	Read Level (dBμV)	Antenna Factor (dB)	Cable Loss (dB)	Preamp Factor (dB)	Ant Pos (cm)	Table Pos (deg)	Remark
2323.41	57.26	-16.74	74	52.45	32.23	6.8	34.22	103	11	Peak
2370.03	44.64	-9.36	54	39.75	32.28	6.88	34.27	103	11	Average
2485.27	69.27	-4.73	74	64.26	32.38	7.06	34.43	103	11	Peak
2483.56	47.4	-6.6	54	42.39	32.38	7.06	34.43	103	11	Average

ANTENNA POLARITY : VERTICAL										
Frequency (MHz)	Level (dBμV/m)	Over Limit (dB)	Limit Line (dBμV/m)	Read Level (dBμV)	Antenna Factor (dB)	Cable Loss (dB)	Preamp Factor (dB)	Ant Pos (cm)	Table Pos (deg)	Remark
2389.83	60.74	-13.26	74	55.83	32.3	6.91	34.3	100	4	Peak
2389.83	45.8	-8.2	54	40.89	32.3	6.91	34.3	100	4	Average
2485.81	72.8	-1.2	74	67.79	32.38	7.06	34.43	100	4	Peak
2483.56	49.98	-4.02	54	44.97	32.38	7.06	34.43	100	4	Average

3.5.7 Test Result of Radiated Spurious Emission (30MHz ~ 10th Harmonic)

Note: Pre-scanned all test modes and only choose the worst case mode recorded in the test report for radiated spurious emission below 1GHz.

<MIMO Ant. 1+2>

Test Mode :	802.11b	Temperature :	22~24°C
Test Channel :	01	Relative Humidity :	50~52%
Test Engineer :	Kyle Jhuang	Polarization :	Horizontal
Remark :	1. 2412 MHz is fundamental signal which can be ignored. 2. Average measurement was not performed if peak level went lower than the average limit.		

Frequency (MHz)	Level (dBμV/m)	Over Limit (dB)	Limit Line (dBμV/m)	Read Level (dBμV)	Antenna Factor (dB)	Cable Loss (dB)	Preamp Factor (dB)	Ant Pos (cm)	Table Pos (deg)	Remark
2412	102.56	-	-	98.28	32.33	6.28	34.33	104	218	Average
2412	107.56	-	-	103.28	32.33	6.28	34.33	104	218	Peak
4824	38.86	-35.14	74	54.86	34.9	8.04	58.94	100	0	Peak

Test Mode :	802.11b	Temperature :	22~24°C
Test Channel :	01	Relative Humidity :	50~52%
Test Engineer :	Kyle Jhuang	Polarization :	Vertical
Remark :	1. 2412 MHz is Fundamental signal which can be ignored. 2. Average measurement was not performed if peak level went lower than the average limit.		

Frequency (MHz)	Level (dBμV/m)	Over Limit (dB)	Limit Line (dBμV/m)	Read Level (dBμV)	Antenna Factor (dB)	Cable Loss (dB)	Preamp Factor (dB)	Ant Pos (cm)	Table Pos (deg)	Remark
2412	111.11	-	-	106.83	32.33	6.28	34.33	116	66	Average
2412	116.66	-	-	112.38	32.33	6.28	34.33	116	66	Peak
4824	39.66	-34.34	74	55.66	34.9	8.04	58.94	100	0	Peak



Test Mode :	802.11b	Temperature :	22~24°C
Test Channel :	06	Relative Humidity :	50~52%
Test Engineer :	Kyle Jhuang	Polarization :	Horizontal
Remark :	1. 2436 MHz is Fundamental signal which can be ignored. 2. Average measurement was not performed if peak level went lower than the average limit.		

Frequency (MHz)	Level (dBμV/m)	Over Limit (dB)	Limit Line (dBμV/m)	Read Level (dBμV)	Antenna Factor (dB)	Cable Loss (dB)	Preamp Factor (dB)	Ant Pos (cm)	Table Pos (deg)	Remark
2436	103.78	-	-	99.4	32.36	6.34	34.32	135	336	Average
2436	108.95	-	-	104.57	32.36	6.34	34.32	135	336	Peak
4875	41.66	-32.34	74	57.49	34.93	8.11	58.87	100	0	Peak
7311	44.21	-29.79	74	55.56	36.64	10.47	58.46	100	0	Peak

Test Mode :	802.11b	Temperature :	22~24°C
Test Channel :	06	Relative Humidity :	50~52%
Test Engineer :	Kyle Jhuang	Polarization :	Vertical
Remark :	1. 2438 MHz is Fundamental signal which can be ignored. 2. Average measurement was not performed if peak level went lower than the average limit.		

Frequency (MHz)	Level (dBμV/m)	Over Limit (dB)	Limit Line (dBμV/m)	Read Level (dBμV)	Antenna Factor (dB)	Cable Loss (dB)	Preamp Factor (dB)	Ant Pos (cm)	Table Pos (deg)	Remark
2438	112.27	-	-	107.85	32.4	6.34	34.32	116	349	Average
2438	117.61	-	-	113.19	32.4	6.34	34.32	116	349	Peak
4875	44.72	-29.28	74	60.55	34.93	8.11	58.87	100	0	Peak
7313	47.29	-26.71	74	58.64	36.64	10.47	58.46	100	0	Peak



Test Mode :	802.11b	Temperature :	22~24°C
Test Channel :	11	Relative Humidity :	50~52%
Test Engineer :	Kyle Jhuang	Polarization :	Horizontal
Remark :	1. 2464 MHz is fundamental signal which can be ignored. 2. Average measurement was not performed if peak level went lower than the average limit.		

Frequency (MHz)	Level (dBμV/m)	Over Limit (dB)	Limit Line (dBμV/m)	Read Level (dBμV)	Antenna Factor (dB)	Cable Loss (dB)	Preamp Factor (dB)	Ant Pos (cm)	Table Pos (deg)	Remark
2464	102.06	-	-	97.55	32.43	6.39	34.31	102	180	Average
2464	107.18	-	-	102.67	32.43	6.39	34.31	102	180	Peak
4923	40.99	-33.01	74	56.65	34.96	8.18	58.8	100	0	Peak
7386	49.67	-24.33	74	61.21	36.62	10.45	58.61	100	0	Peak

Test Mode :	802.11b	Temperature :	22~24°C
Test Channel :	11	Relative Humidity :	50~52%
Test Engineer :	Kyle Jhuang	Polarization :	Vertical
Remark :	1. 2462 MHz is fundamental signal which can be ignored. 2. Average measurement was not performed if peak level went lower than the average limit.		

Frequency (MHz)	Level (dBμV/m)	Over Limit (dB)	Limit Line (dBμV/m)	Read Level (dBμV)	Antenna Factor (dB)	Cable Loss (dB)	Preamp Factor (dB)	Ant Pos (cm)	Table Pos (deg)	Remark
2462	111.02	-	-	106.51	32.43	6.39	34.31	165	110	Average
2462	116.33	-	-	111.82	32.43	6.39	34.31	165	110	Peak
4923	43.53	-30.47	74	59.19	34.96	8.18	58.8	100	0	Peak
7386	52.34	-21.66	74	63.88	36.62	10.45	58.61	100	0	Peak



Test Mode :	802.11g	Temperature :	22~24°C
Test Channel :	01	Relative Humidity :	50~52%
Test Engineer :	Kyle Jhuang	Polarization :	Horizontal
Remark :	1. 2414 MHz is fundamental signal which can be ignored. 2. Average measurement was not performed if peak level went lower than the average limit.		

Frequency (MHz)	Level (dBμV/m)	Over Limit (dB)	Limit Line (dBμV/m)	Read Level (dBμV)	Antenna Factor (dB)	Cable Loss (dB)	Preamp Factor (dB)	Ant Pos (cm)	Table Pos (deg)	Remark
2414	95.69	-	-	91.41	32.33	6.28	34.33	136	335	Average
2414	107.39	-	-	103.11	32.33	6.28	34.33	136	335	Peak
4824	39.98	-34.02	74	55.98	34.9	8.04	58.94	100	0	Peak

Test Mode :	802.11g	Temperature :	22~24°C
Test Channel :	01	Relative Humidity :	50~52%
Test Engineer :	Kyle Jhuang	Polarization :	Vertical
Remark :	1. 2410 MHz is fundamental signal which can be ignored. 2. Average measurement was not performed if peak level went lower than the average limit.		

Frequency (MHz)	Level (dBμV/m)	Over Limit (dB)	Limit Line (dBμV/m)	Read Level (dBμV)	Antenna Factor (dB)	Cable Loss (dB)	Preamp Factor (dB)	Ant Pos (cm)	Table Pos (deg)	Remark
2410	102.86	-	-	98.58	32.33	6.28	34.33	120	349	Average
2410	112.87	-	-	108.59	32.33	6.28	34.33	120	349	Peak
4824	42.8	-31.2	74	58.8	34.9	8.04	58.94	100	0	Peak



Test Mode :	802.11g	Temperature :	22~24°C
Test Channel :	06	Relative Humidity :	50~52%
Test Engineer :	Kyle Jhuang	Polarization :	Horizontal
Remark :	1. 2438 MHz is fundamental signal which can be ignored. 2. Average measurement was not performed if peak level went lower than the average limit.		

Frequency (MHz)	Level (dBμV/m)	Over Limit (dB)	Limit Line (dBμV/m)	Read Level (dBμV)	Antenna Factor (dB)	Cable Loss (dB)	Preamp Factor (dB)	Ant Pos (cm)	Table Pos (deg)	Remark
2438	100.62	-	-	96.2	32.4	6.34	34.32	137	336	Average
2438	110.94	-	-	106.52	32.4	6.34	34.32	137	336	Peak
4875	40.33	-33.67	74	56.16	34.93	8.11	58.87	100	0	Peak
7313	51.67	-22.33	74	63.02	36.64	10.47	58.46	100	0	Peak

Test Mode :	802.11g	Temperature :	22~24°C
Test Channel :	06	Relative Humidity :	50~52%
Test Engineer :	Kyle Jhuang	Polarization :	Vertical
Remark :	1. 2436 MHz is fundamental signal which can be ignored. 2. Average measurement was not performed if peak level went lower than the average limit.		

Frequency (MHz)	Level (dBμV/m)	Over Limit (dB)	Limit Line (dBμV/m)	Read Level (dBμV)	Antenna Factor (dB)	Cable Loss (dB)	Preamp Factor (dB)	Ant Pos (cm)	Table Pos (deg)	Remark
2436	108.8	-	-	104.42	32.36	6.34	34.32	117	348	Average
2436	119.01	-	-	114.63	32.36	6.34	34.32	117	348	Peak
4872	49.71	-24.29	74	65.54	34.93	8.11	58.87	100	0	Peak
7313	53.94	-20.06	74	65.29	36.64	10.47	58.46	100	0	Peak



Test Mode :	802.11g	Temperature :	22~24°C
Test Channel :	11	Relative Humidity :	50~52%
Test Engineer :	Kyle Jhuang	Polarization :	Horizontal
Remark :	1. 2462 MHz is fundamental signal which can be ignored. 2. Average measurement was not performed if peak level went lower than the average limit.		

Frequency (MHz)	Level (dBμV/m)	Over Limit (dB)	Limit Line (dBμV/m)	Read Level (dBμV)	Antenna Factor (dB)	Cable Loss (dB)	Preamp Factor (dB)	Ant Pos (cm)	Table Pos (deg)	Remark
2462	95.91	-	-	91.4	32.43	6.39	34.31	102	180	Average
2462	105.51	-	-	101	32.43	6.39	34.31	102	180	Peak
4923	40.13	-33.87	74	55.79	34.96	8.18	58.8	100	0	Peak
7386	46.64	-27.36	74	58.18	36.62	10.45	58.61	100	0	Peak

Test Mode :	802.11g	Temperature :	22~24°C
Test Channel :	11	Relative Humidity :	50~52%
Test Engineer :	Kyle Jhuang	Polarization :	Vertical
Remark :	1. 2460 MHz is fundamental signal which can be ignored. 2. Average measurement was not performed if peak level went lower than the average limit.		

Frequency (MHz)	Level (dBμV/m)	Over Limit (dB)	Limit Line (dBμV/m)	Read Level (dBμV)	Antenna Factor (dB)	Cable Loss (dB)	Preamp Factor (dB)	Ant Pos (cm)	Table Pos (deg)	Remark
2460	103.74	-	-	99.23	32.43	6.39	34.31	118	349	Average
2460	113.8	-	-	109.29	32.43	6.39	34.31	118	349	Peak
4923	41.19	-32.81	74	56.85	34.96	8.18	58.8	100	0	Peak
7386	49.79	-24.21	74	61.33	36.62	10.45	58.61	100	0	Peak



Test Mode :	802.11n HT20	Temperature :	22~24°C
Test Channel :	01	Relative Humidity :	50~52%
Test Engineer :	Kyle Jhuang	Polarization :	Horizontal
Remark :	1. 2414 MHz is fundamental signal which can be ignored. 2. Average measurement was not performed if peak level went lower than the average limit.		

Frequency (MHz)	Level (dBμV/m)	Over Limit (dB)	Limit Line (dBμV/m)	Read Level (dBμV)	Antenna Factor (dB)	Cable Loss (dB)	Preamp Factor (dB)	Ant Pos (cm)	Table Pos (deg)	Remark
2414	94.64	-	-	90.36	32.33	6.28	34.33	138	328	Average
2414	105.02	-	-	100.74	32.33	6.28	34.33	138	328	Peak
4824	39.58	-34.42	74	55.58	34.9	8.04	58.94	100	0	Peak

Test Mode :	802.11n HT20	Temperature :	22~24°C
Test Channel :	01	Relative Humidity :	50~52%
Test Engineer :	Kyle Jhuang	Polarization :	Vertical
Remark :	1. 2410 MHz is fundamental signal which can be ignored. 2. Average measurement was not performed if peak level went lower than the average limit.		

Frequency (MHz)	Level (dBμV/m)	Over Limit (dB)	Limit Line (dBμV/m)	Read Level (dBμV)	Antenna Factor (dB)	Cable Loss (dB)	Preamp Factor (dB)	Ant Pos (cm)	Table Pos (deg)	Remark
2410	103.67	-	-	99.39	32.33	6.28	34.33	121	5	Average
2410	114.13	-	-	109.85	32.33	6.28	34.33	121	5	Peak
4824	39.23	-34.77	74	55.23	34.9	8.04	58.94	100	0	Peak



Test Mode :	802.11n HT20	Temperature :	22~24°C
Test Channel :	06	Relative Humidity :	50~52%
Test Engineer :	Kyle Jhuang	Polarization :	Horizontal
Remark :	1. 2438 MHz is fundamental signal which can be ignored. 2. Average measurement was not performed if peak level went lower than the average limit.		

Frequency (MHz)	Level (dBμV/m)	Over Limit (dB)	Limit Line (dBμV/m)	Read Level (dBμV)	Antenna Factor (dB)	Cable Loss (dB)	Preamp Factor (dB)	Ant Pos (cm)	Table Pos (deg)	Remark
2438	97.83	-	-	93.41	32.4	6.34	34.32	110	345	Average
2438	108.31	-	-	103.89	32.4	6.34	34.32	110	345	Peak
4875	40.18	-33.82	74	56.01	34.93	8.11	58.87	100	0	Peak
7311	42.29	-31.71	74	53.64	36.64	10.47	58.46	100	0	Peak

Test Mode :	802.11n HT20	Temperature :	22~24°C
Test Channel :	06	Relative Humidity :	50~52%
Test Engineer :	Kyle Jhuang	Polarization :	Vertical
Remark :	1. 2436 MHz is fundamental signal which can be ignored. 2. Average measurement was not performed if peak level went lower than the average limit.		

Frequency (MHz)	Level (dBμV/m)	Over Limit (dB)	Limit Line (dBμV/m)	Read Level (dBμV)	Antenna Factor (dB)	Cable Loss (dB)	Preamp Factor (dB)	Ant Pos (cm)	Table Pos (deg)	Remark
2436	106.19	-	-	101.81	32.36	6.34	34.32	117	6	Average
2436	116.51	-	-	112.13	32.36	6.34	34.32	117	6	Peak
4875	41.71	-32.29	74	57.54	34.93	8.11	58.87	100	0	Peak
7311	48.43	-25.57	74	59.78	36.64	10.47	58.46	100	0	Peak



Test Mode :	802.11n HT20	Temperature :	22~24°C
Test Channel :	11	Relative Humidity :	50~52%
Test Engineer :	Kyle Jhuang	Polarization :	Horizontal
Remark :	1. 2464 MHz is fundamental signal which can be ignored. 2. Average measurement was not performed if peak level went lower than the average limit.		

Frequency (MHz)	Level (dBμV/m)	Over Limit (dB)	Limit Line (dBμV/m)	Read Level (dBμV)	Antenna Factor (dB)	Cable Loss (dB)	Preamp Factor (dB)	Ant Pos (cm)	Table Pos (deg)	Remark
71.85	34.77	-5.23	40	59.95	5.59	1	31.77	-	-	Peak
119.91	38.38	-5.12	43.5	57.32	11.53	1.28	31.75	100	13	Peak
199.56	38.1	-5.4	43.5	59.39	8.82	1.64	31.75	-	-	Peak
366.5	36.89	-9.11	46	51.65	14.82	2.21	31.79	-	-	Peak
624.1	38.05	-7.95	46	48.57	18.65	2.88	32.05	-	-	Peak
708.1	32.92	-13.08	46	42.71	19.15	3.07	32.01	-	-	Peak
2464	92.84	-	-	88.33	32.43	6.39	34.31	101	332	Average
2464	103.43	-	-	98.92	32.43	6.39	34.31	101	332	Peak
4923	40.71	-33.29	74	56.37	34.96	8.18	58.8	100	0	Peak
7386	41.65	-32.35	74	53.19	36.62	10.45	58.61	100	0	Peak



Test Mode :	802.11n HT20	Temperature :	22~24°C
Test Channel :	11	Relative Humidity :	50~52%
Test Engineer :	Kyle Jhuang	Polarization :	Vertical
Remark :	1. 2460 MHz is fundamental signal which can be ignored. 2. Average measurement was not performed if peak level went lower than the average limit.		

Frequency (MHz)	Level (dBμV/m)	Over Limit (dB)	Limit Line (dBμV/m)	Read Level (dBμV)	Antenna Factor (dB)	Cable Loss (dB)	Preamp Factor (dB)	Ant Pos (cm)	Table Pos (deg)	Remark
71.85	35.78	-4.22	40	60.8	5.75	1	31.77	100	52	Peak
119.91	38.89	-4.61	43.5	58.68	10.68	1.28	31.75	-	-	Peak
192	31.14	-12.36	43.5	52.57	8.71	1.61	31.75	-	-	Peak
388.9	33.23	-12.77	46	47.4	15.36	2.28	31.81	-	-	Peak
499.5	34.21	-11.79	46	46.47	17.08	2.59	31.93	-	-	Peak
927.9	35.63	-10.37	46	42.7	20.67	3.53	31.27	-	-	Peak
2460	99.8	-	-	95.29	32.43	6.39	34.31	114	304	Average
2460	110.63	-	-	106.12	32.43	6.39	34.31	114	304	Peak
4923	40.78	-33.22	74	56.44	34.96	8.18	58.8	100	0	Peak
7386	41.99	-32.01	74	53.53	36.62	10.45	58.61	100	0	Peak



Test Mode :	802.11n HT40	Temperature :	22~24°C
Test Channel :	03	Relative Humidity :	50~52%
Test Engineer :	Kyle Jhuang	Polarization :	Horizontal
Remark :	1. 2424 MHz is fundamental signal which can be ignored. 2. Average measurement was not performed if peak level went lower than the average limit.		

Frequency (MHz)	Level (dBμV/m)	Over Limit (dB)	Limit Line (dBμV/m)	Read Level (dBμV)	Antenna Factor (dB)	Cable Loss (dB)	Preamp Factor (dB)	Ant Pos (cm)	Table Pos (deg)	Remark
2424	91.76	-	-	86.83	32.33	6.95	34.35	102	10	Average
2424	101.05	-	-	96.12	32.33	6.95	34.35	102	10	Peak
4845	39.69	-34.31	74	55.82	33.96	8.8	58.89	100	0	Peak
7266	41.12	-32.88	74	52.41	35.54	10.86	57.69	100	0	Peak

Test Mode :	802.11n HT40	Temperature :	22~24°C
Test Channel :	03	Relative Humidity :	50~52%
Test Engineer :	Kyle Jhuang	Polarization :	Vertical
Remark :	1. 2424 MHz is fundamental signal which can be ignored. 2. Average measurement was not performed if peak level went lower than the average limit.		

Frequency (MHz)	Level (dBμV/m)	Over Limit (dB)	Limit Line (dBμV/m)	Read Level (dBμV)	Antenna Factor (dB)	Cable Loss (dB)	Preamp Factor (dB)	Ant Pos (cm)	Table Pos (deg)	Remark
2424	99.33	-	-	94.4	32.33	6.95	34.35	100	360	Average
2424	108.87	-	-	103.94	32.33	6.95	34.35	100	360	Peak
4845	39.85	-34.15	74	55.98	33.96	8.8	58.89	100	0	Peak
7266	42.15	-31.85	74	53.44	35.54	10.86	57.69	100	0	Peak



Test Mode :	802.11n HT40	Temperature :	22~24°C
Test Channel :	06	Relative Humidity :	50~52%
Test Engineer :	Kyle Jhuang	Polarization :	Horizontal
Remark :	1. 2439 MHz is fundamental signal which can be ignored. 2. Average measurement was not performed if peak level went lower than the average limit.		

Frequency (MHz)	Level (dBμV/m)	Over Limit (dB)	Limit Line (dBμV/m)	Read Level (dBμV)	Antenna Factor (dB)	Cable Loss (dB)	Preamp Factor (dB)	Ant Pos (cm)	Table Pos (deg)	Remark
2439	94.81	-	-	89.82	32.35	6.99	34.35	104	12	Average
2439	104.02	-	-	99.03	32.35	6.99	34.35	104	12	Peak
4875	39.55	-34.45	74	55.61	33.95	8.82	58.83	100	0	Peak
7311	42.56	-31.44	74	53.84	35.54	10.91	57.73	100	0	Peak

Test Mode :	802.11n HT40	Temperature :	22~24°C
Test Channel :	06	Relative Humidity :	50~52%
Test Engineer :	Kyle Jhuang	Polarization :	Vertical
Remark :	1. 2436 MHz is fundamental signal which can be ignored. 2. Average measurement was not performed if peak level went lower than the average limit.		

Frequency (MHz)	Level (dBμV/m)	Over Limit (dB)	Limit Line (dBμV/m)	Read Level (dBμV)	Antenna Factor (dB)	Cable Loss (dB)	Preamp Factor (dB)	Ant Pos (cm)	Table Pos (deg)	Remark
2436	101.08	-	-	96.11	32.33	6.99	34.35	100	360	Average
2436	110.31	-	-	105.34	32.33	6.99	34.35	100	360	Peak
4875	43.18	-30.82	74	59.24	33.95	8.82	58.83	100	0	Peak
7311	44.17	-29.83	74	55.45	35.54	10.91	57.73	100	0	Peak



Test Mode :	802.11n HT40	Temperature :	22~24°C
Test Channel :	09	Relative Humidity :	50~52%
Test Engineer :	Kyle Jhuang	Polarization :	Horizontal
Remark :	1. 2450 MHz is fundamental signal which can be ignored. 2. Average measurement was not performed if peak level went lower than the average limit.		

Frequency (MHz)	Level (dBμV/m)	Over Limit (dB)	Limit Line (dBμV/m)	Read Level (dBμV)	Antenna Factor (dB)	Cable Loss (dB)	Preamp Factor (dB)	Ant Pos (cm)	Table Pos (deg)	Remark
2450	92.75	-	-	87.8	32.35	6.99	34.39	103	11	Average
2450	101.92	-	-	96.97	32.35	6.99	34.39	103	11	Peak
4905	39.72	-34.28	74	55.68	33.93	8.87	58.76	100	0	Peak
7356	42.85	-31.15	74	54.13	35.53	10.96	57.77	100	0	Peak

Test Mode :	802.11n HT40	Temperature :	22~24°C
Test Channel :	09	Relative Humidity :	50~52%
Test Engineer :	Kyle Jhuang	Polarization :	Vertical
Remark :	1. 2452 MHz is fundamental signal which can be ignored. 2. Average measurement was not performed if peak level went lower than the average limit.		

Frequency (MHz)	Level (dBμV/m)	Over Limit (dB)	Limit Line (dBμV/m)	Read Level (dBμV)	Antenna Factor (dB)	Cable Loss (dB)	Preamp Factor (dB)	Ant Pos (cm)	Table Pos (deg)	Remark
2452	98.81	-	-	93.86	32.35	6.99	34.39	100	4	Average
2452	107.87	-	-	102.92	32.35	6.99	34.39	100	4	Peak
4905	40.25	-33.75	74	56.21	33.93	8.87	58.76	100	0	Peak
7356	44.06	-29.94	74	55.34	35.53	10.96	57.77	100	0	Peak

3.6 AC Conducted Emission Measurement

3.6.1 Limit of AC Conducted Emission

For equipment that is designed to be connected to the public utility (AC) power line, the radio frequency voltage that is conducted back onto the AC power line on any frequency or frequencies within the band 150 kHz to 30 MHz shall not exceed the limits in the following table.

Frequency of Emission (MHz)	Conducted Limit (dB μ V)	
	Quasi-Peak	Average
0.15-0.5	66 to 56*	56 to 46*
0.5-5	56	46
5-30	60	50

*Decreases with the logarithm of the frequency.

3.6.2 Measuring Instruments

The measuring equipment is listed in the section 4 of this test report.

3.6.3 Test Procedures

1. The EUT was placed 0.4 meter from the conducting wall of the shielding room, and it was kept at least 80 centimeters from any other grounded conducting surface.
2. Connect EUT to the power mains through a line impedance stabilization network (LISN).
3. All the support units are connecting to the other LISN.
4. The LISN provides 50 ohm coupling impedance for the measuring instrument.
5. The FCC states that a 50 ohm, 50 microhenry LISN should be used.
6. Both sides of AC line were checked for maximum conducted interference.
7. The frequency range from 150 kHz to 30 MHz was searched.
8. Set the test-receiver system to Peak Detect Function and specified bandwidth with Maximum Hold Mode.

3.6.4 Test Setup

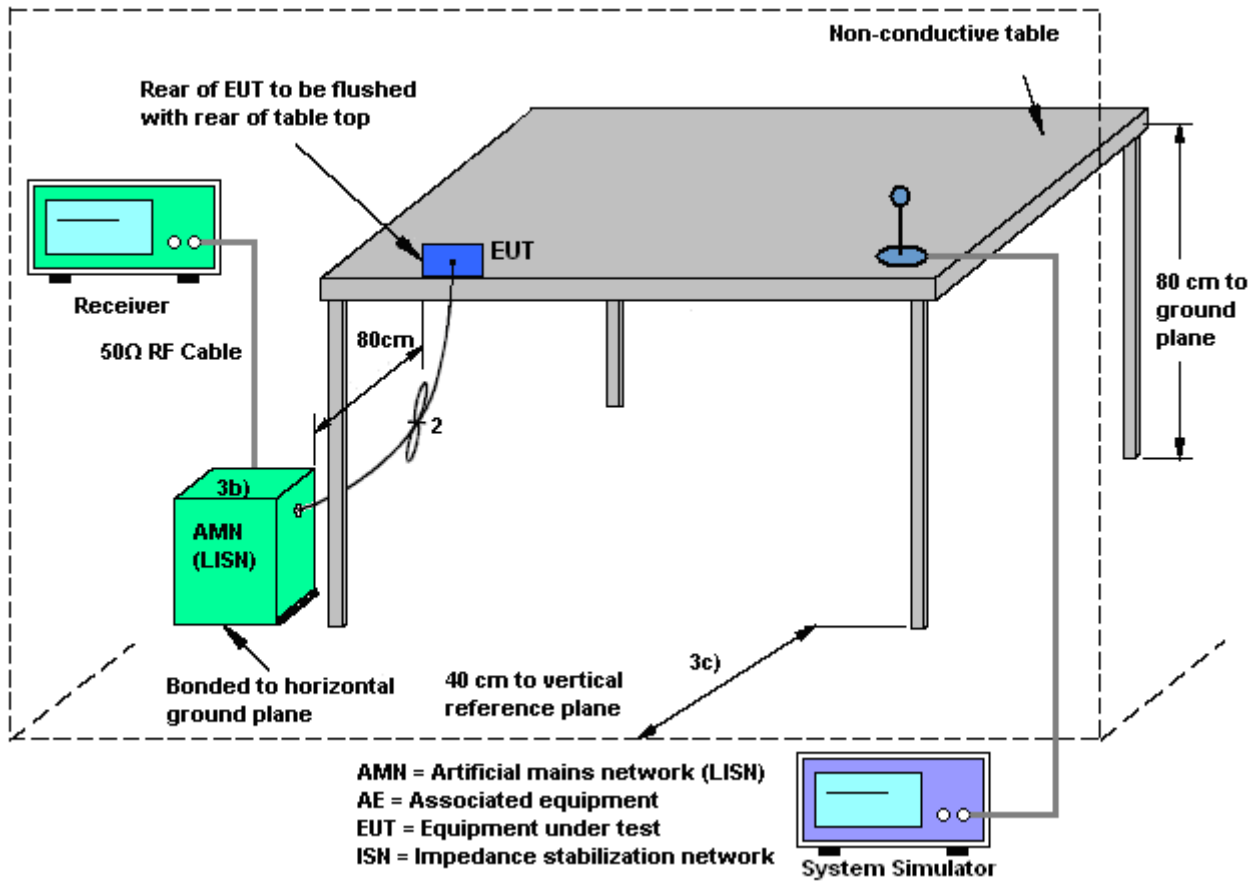

3.6.5 Test Result of AC Conducted Emission

Test Mode :	Mode 1	Temperature :	20~22°C
Test Engineer :	Cosmo Xu	Relative Humidity :	45~47%
Test Voltage :	120Vac / 60Hz	Phase :	Line
Function Type :	LTE Band 2 Idle + WLAN Link + GPS Rx + RJ-45 Link + USB Cable (Data Link with Notebook) + Adapter		

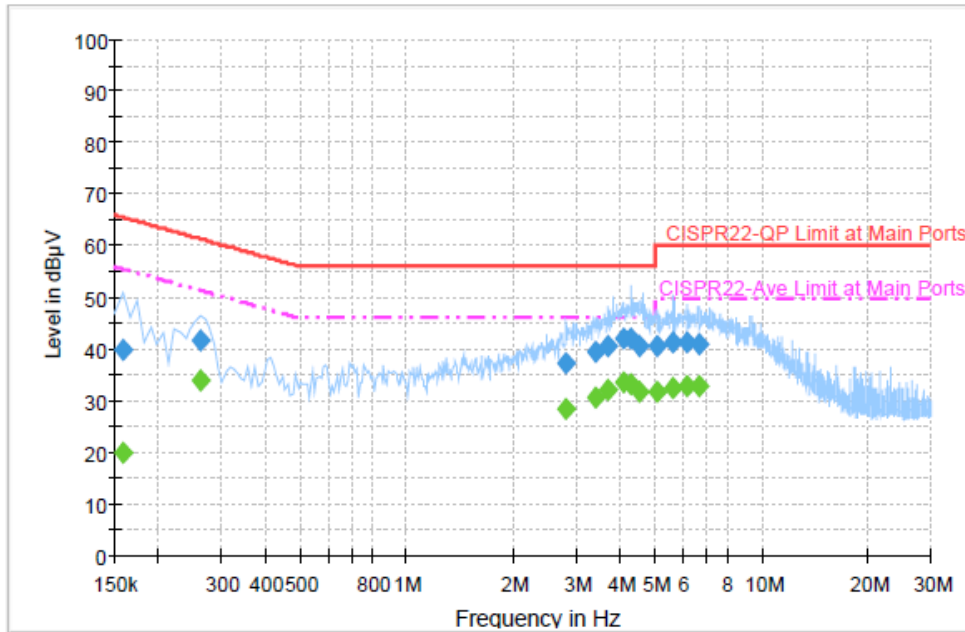

Final Result : QuasiPeak

Frequency (MHz)	QuasiPeak (dBµV)	Filter	Line	Corr. (dB)	Margin (dB)	Limit (dBµV)
0.158000	40.0	Off	L1	19.3	25.6	65.6
0.262000	41.5	Off	L1	19.3	19.9	61.4
2.814000	37.3	Off	L1	19.6	18.7	56.0
3.414000	39.4	Off	L1	19.6	16.6	56.0
3.694000	40.7	Off	L1	19.6	15.3	56.0
4.094000	42.2	Off	L1	19.6	13.8	56.0
4.262000	42.1	Off	L1	19.6	13.9	56.0
4.502000	40.8	Off	L1	19.6	15.2	56.0
5.070000	40.7	Off	L1	19.6	19.3	60.0
5.622000	41.4	Off	L1	19.6	18.6	60.0
6.166000	41.3	Off	L1	19.6	18.7	60.0
6.638000	41.0	Off	L1	19.6	19.0	60.0

Test Mode :	Mode 1	Temperature :	20~22°C
Test Engineer :	Cosmo Xu	Relative Humidity :	45~47%
Test Voltage :	120Vac / 60Hz	Phase :	Line
Function Type :	LTE Band 2 Idle + WLAN Link + GPS Rx + RJ-45 Link + USB Cable (Data Link with Notebook) + Adapter		

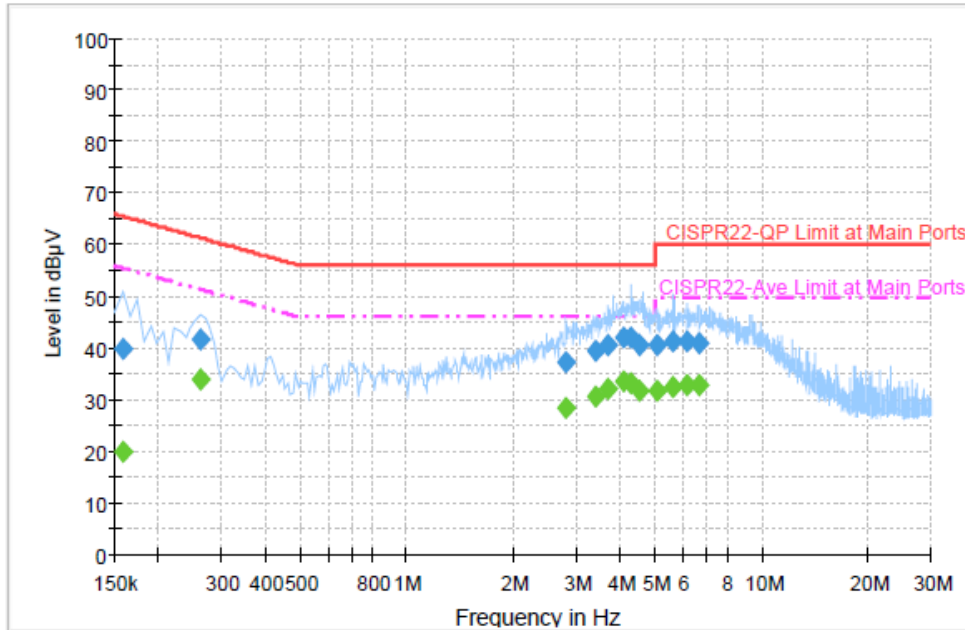

Final Result : Average

Frequency (MHz)	Average (dBµV)	Filter	Line	Corr. (dB)	Margin (dB)	Limit (dBµV)
0.158000	20.0	Off	L1	19.3	35.6	55.6
0.262000	34.0	Off	L1	19.3	17.4	51.4
2.814000	28.4	Off	L1	19.6	17.6	46.0
3.414000	30.7	Off	L1	19.6	15.3	46.0
3.694000	31.9	Off	L1	19.6	14.1	46.0
4.094000	33.7	Off	L1	19.6	12.3	46.0
4.262000	33.4	Off	L1	19.6	12.6	46.0
4.502000	31.8	Off	L1	19.6	14.2	46.0
5.070000	31.7	Off	L1	19.6	18.3	50.0
5.622000	32.5	Off	L1	19.6	17.5	50.0
6.166000	32.7	Off	L1	19.6	17.3	50.0
6.638000	32.8	Off	L1	19.6	17.2	50.0



Test Mode :	Mode 1	Temperature :	20~22°C
Test Engineer :	Cosmo Xu	Relative Humidity :	45~47%
Test Voltage :	120Vac / 60Hz	Phase :	Neutral
Function Type :	LTE Band 2 Idle + WLAN Link + GPS Rx + RJ-45 Link + USB Cable (Data Link with Notebook) + Adapter		

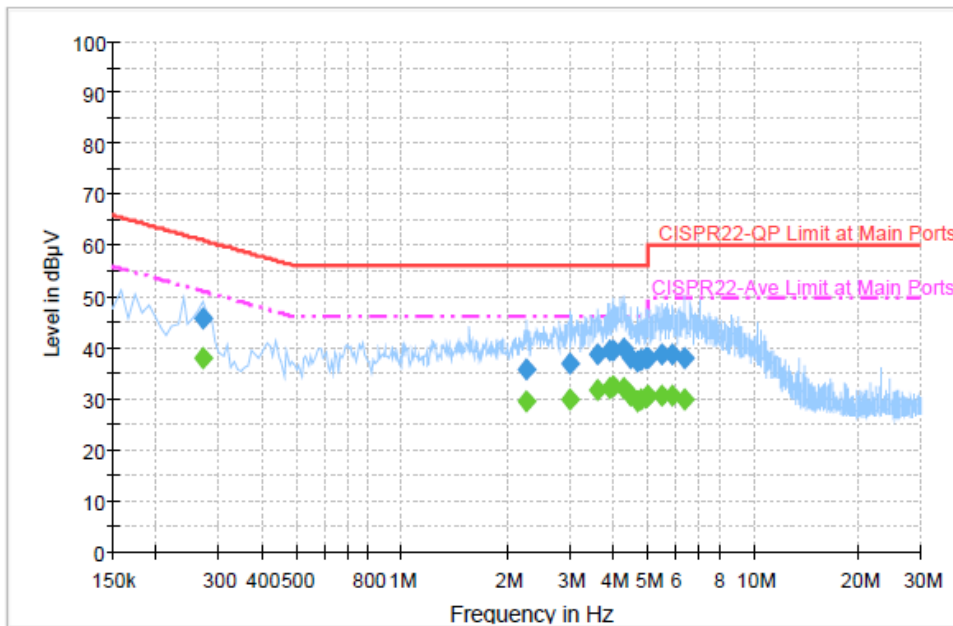

Final Result : QuasiPeak

Frequency (MHz)	QuasiPeak (dBµV)	Filter	Line	Corr. (dB)	Margin (dB)	Limit (dBµV)
0.270000	45.7	Off	N	19.3	15.4	61.1
2.254000	35.6	Off	N	19.6	20.4	56.0
2.998000	36.8	Off	N	19.6	19.2	56.0
3.606000	38.7	Off	N	19.6	17.3	56.0
3.902000	39.6	Off	N	19.6	16.4	56.0
3.990000	39.5	Off	N	19.6	16.5	56.0
4.254000	39.7	Off	N	19.6	16.3	56.0
4.478000	38.1	Off	N	19.6	17.9	56.0
4.702000	37.4	Off	N	19.6	18.6	56.0
4.774000	37.7	Off	N	19.6	18.3	56.0
4.942000	37.9	Off	N	19.7	18.1	56.0
4.990000	38.0	Off	N	19.7	18.0	56.0
5.462000	38.6	Off	N	19.6	21.4	60.0
5.886000	38.6	Off	N	19.6	21.4	60.0
6.398000	38.1	Off	N	19.6	21.9	60.0



Test Mode :	Mode 1	Temperature :	20~22°C
Test Engineer :	Cosmo Xu	Relative Humidity :	45~47%
Test Voltage :	120Vac / 60Hz	Phase :	Neutral
Function Type :	LTE Band 2 Idle + WLAN Link + GPS Rx + RJ-45 Link + USB Cable (Data Link with Notebook) + Adapter		

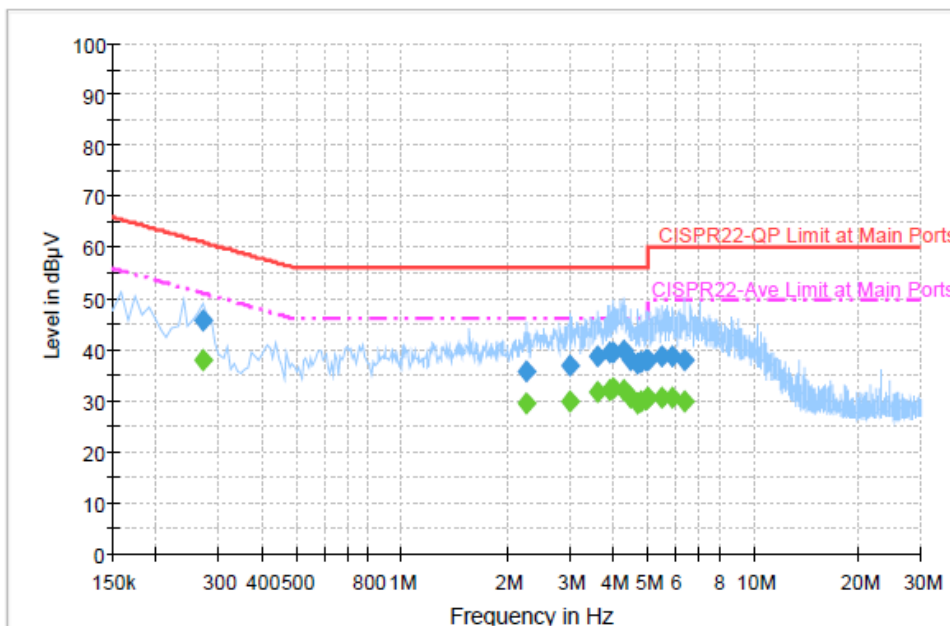

Final Result : Average

Frequency (MHz)	Average (dBµV)	Filter	Line	Corr. (dB)	Margin (dB)	Limit (dBµV)
0.270000	38.0	Off	N	19.3	13.1	51.1
2.254000	29.5	Off	N	19.6	16.5	46.0
2.998000	29.8	Off	N	19.6	16.2	46.0
3.606000	31.6	Off	N	19.6	14.4	46.0
3.902000	31.9	Off	N	19.6	14.1	46.0
3.990000	32.5	Off	N	19.6	13.5	46.0
4.254000	32.2	Off	N	19.6	13.8	46.0
4.478000	30.8	Off	N	19.6	15.2	46.0
4.702000	29.4	Off	N	19.6	16.6	46.0
4.774000	29.7	Off	N	19.6	16.3	46.0
4.942000	30.3	Off	N	19.7	15.7	46.0
4.990000	30.5	Off	N	19.7	15.5	46.0
5.462000	30.6	Off	N	19.6	19.4	50.0
5.886000	30.6	Off	N	19.6	19.4	50.0
6.398000	30.0	Off	N	19.6	20.0	50.0

3.7 Antenna Requirements

3.7.1 Standard Applicable

If directional gain of transmitting Antennas is greater than 6dBi, the power shall be reduced by the same level in dB comparing to gain minus 6dBi. For the fixed point-to-point operation, the power shall be reduced by one dB for every 3 dB that the directional gain of the Antenna exceeds 6 dBi. The use of a permanently attached Antenna or of an Antenna that uses a unique coupling to the intentional radiator shall be considered sufficient to comply with the FCC rule.

3.7.2 Antenna Anti-Replacement Construction

SMA antenna connector is used.

3.7.3 Antenna Gain

FCC KDB 662911 D01 Multiple Transmitter Output v02r01.

For CDD transmissions, directional gain is calculated as

Directional gain = $G_{ANT} + \text{Array Gain}$, where Array Gain is as follows.

For power spectral density (PSD) measurements on all devices,

Array Gain = $10 \log(N_{ANT}/N_{SS}=1)$ dB.

For power measurements on IEEE 802.11 devices,

Array Gain = 0 dB (i.e., no array gain) for $N_{ANT} \leq 4$.

The EUT supports CDD mode.

The power and PSD limit should be modified if the directional gain of EUT is over 6 dBi,

The directional gain “DG” is calculated as following table.

			DG for Power (dBi)	DG for PSD (dBi)	Power Limit Reduction (dB)	PSD Limit Reduction (dB)
	Ant. 1 (dBi)	Ant. 2 (dBi)				
2.4 GHz	4.50	4.50	4.50	7.51	0.00	1.51

$Power\ Limit\ Reduction = DG(Power) - 6dBi, (min = 0)$

$PSD\ Limit\ Reduction = DG(PSD) - 6dBi, (min = 0)$



4 List of Measuring Equipment

Instrument	Manufacturer	Model No.	Serial No.	Characteristics	Calibration Date	Test Date	Due Date	Remark
Spectrum Analyzer	Rohde & Schwarz	FSP40	100055	9kHz~40GHz	Jun. 07, 2013	Mar. 07, 2014 ~ Apr. 10, 2014	Jun. 06, 2014	Conducted (TH02-HY)
Power Meter	Anritsu	ML2495A	1036004	300MHz~40GHz	Aug. 17, 2013	Mar. 07, 2014 ~ Apr. 10, 2014	Aug. 16, 2014	Conducted (TH02-HY)
Power Sensor	Anritsu	MA2411B	1027253	300MHz~40GHz	Aug. 17, 2013	Mar. 07, 2014 ~ Apr. 10, 2014	Aug. 16, 2014	Conducted (TH02-HY)
EMI Test Receiver	Rohde & Schwarz	ESCS 30	100356	9kHz ~ 2.75GHz	Nov. 15, 2013	Mar. 10, 2014	Nov. 14, 2014	Conduction (CO05-HY)
LISN (for auxiliary equipment)	Rohde & Schwarz	ENV216	100081	9kHz ~ 30MHz	Dec. 12, 2013	Mar. 10, 2014	Dec. 11, 2014	Conduction (CO05-HY)
LISN	Rohde & Schwarz	ENV216	100080	9kHz ~ 30MHz	Dec. 04, 2013	Mar. 10, 2014	Dec. 03, 2014	Conduction (CO05-HY)
AC Power Source	ChainTek	APC-1000W	N/A	N/A	N/A	Mar. 10, 2014	N/A	Conduction (CO05-HY)
EMI Test Receiver	Rohde & Schwarz	ESU26	100472	20Hz ~ 26.5GHz	Jan. 15, 2014	Mar. 12, 2014 ~ Apr. 10, 2014	Jan. 14, 2015	Radiation (03CH08-HY)
Bilog Antenna	Teseq GmbH	CBL6112D	35379	30MHz~2GHz	Oct. 10, 2013	Mar. 12, 2014 ~ Apr. 10, 2014	Oct. 09, 2014	Radiation (03CH08-HY)
Horn Antenna	ESCO	3117	000143261	1GHz~18GHz	Jan. 16, 2014	Mar. 12, 2014 ~ Apr. 10, 2014	Jan. 15, 2015	Radiation (03CH08-HY)
SHF-EHF Horn Antenna	SCHWARZBECK	BBHA 9170	BBHA9170251	15GHz~40GHz	Oct. 03, 2013	Mar. 12, 2014 ~ Apr. 10, 2014	Oct. 02, 2014	Radiation (03CH08-HY)
Amplifier	SONOMA	310N	187231	9kHz~1GHz	May 15, 2013	Mar. 12, 2014 ~ Apr. 10, 2014	May 14, 2014	Radiation (03CH08-HY)
Preamplifier	MITEQ	AMF-7D-0010 1800-30-10P	1590074	1GHz~18GHz	Jul. 09, 2013	Mar. 12, 2014 ~ Apr. 10, 2014	Jul. 08, 2014	Radiation (03CH08-HY)
Pre Amplifier	Agilent	8449B	3008A02665	1GHz~26.5GHz	Sep. 04, 2013	Mar. 12, 2014 ~ Apr. 10, 2014	Sep. 03, 2014	Radiation (03CH08-HY)
Turn Table	Chaintek	Chaintek 3000	N/A	0~360 Degree	N/A	Mar. 12, 2014 ~ Apr. 10, 2014	N/A	Radiation (03CH08-HY)
Antenna Mast	MF	MFA520BS	N/A	1m~4m	N/A	Mar. 12, 2014 ~ Apr. 10, 2014	N/A	Radiation (03CH08-HY)
Loop Antenna	Rohde & Schwarz	HFH2-Z2	860004/0001	9 kHz~30 MHz	Jul. 03, 2012	Mar. 12, 2014 ~ Apr. 10, 2014	Jul. 03, 2014	Radiation (03CH08-HY)



5 Uncertainty of Evaluation

Uncertainty of Conducted Emission Measurement (150kHz ~ 30MHz)

Measuring Uncertainty for a Level of Confidence of 95% ($U = 2Uc(y)$)	2.26
---	------

Uncertainty of Radiated Emission Measurement (30 MHz ~ 1000 MHz)

Measuring Uncertainty for a Level of Confidence of 95% ($U = 2Uc(y)$)	4.30
---	------