



FCC TEST REPORT (15.407)

REPORT NO.: RF110408E05-2

MODEL NO.: XWING1

FCC ID: UZ7XWING1

RECEIVED: Apr. 08, 2011

TESTED: Apr. 28 to June 16, 2011

ISSUED: July 28, 2011

APPLICANT: Motorola Solutions, Inc.

ADDRESS: One Motorola Plaza, Holtsville, NY 11742-1300
USA

ISSUED BY: Bureau Veritas Consumer Products Services (H.K.)
Ltd., Taoyuan Branch Hsin Chu Laboratory

LAB ADDRESS: No. 81-1, Lu Liao Keng, 9th Ling, Wu Lung Tsuen,
Chiung Lin Hsiang, Hsin Chu Hsien 307, Taiwan

TEST LOCATION (1): No. 81-1, Lu Liao Keng, 9th Ling, Wu Lung Tsuen,
Chiung Lin Hsiang, Hsin Chu Hsien 307, Taiwan

TEST LOCATION (2): No.49, Ln. 206, Wende Rd., Shangshan Tsuen,
Chiung Lin Hsiang, Hsin Chu Hsien 307, Taiwan

This test report consists of 140 pages in total. It may be duplicated completely for legal use with the approval of the applicant. It should not be reproduced except in full, without the written approval of our laboratory. The client should not use it to claim product endorsement by TAF or any government agencies. The test results in the report only apply to the tested sample.





A D T

Table of Contents

RELEASE CONTROL RECORD.....	4
1. CERTIFICATION.....	5
2. SUMMARY OF TEST RESULTS.....	6
2.1 MEASUREMENT UNCERTAINTY	7
3. GENERAL INFORMATION	8
3.1 GENERAL DESCRIPTION OF EUT.....	8
3.2 DESCRIPTION OF TEST MODES.....	10
3.2.1 TEST MODE APPLICABILITY AND TESTED CHANNEL DETAIL:	11
3.3 GENERAL DESCRIPTION OF APPLIED STANDARDS	14
3.4 DESCRIPTION OF SUPPORT UNITS.....	15
3.5 CONFIGURATION OF SYSTEM UNDER TEST	15
4. TEST TYPES AND RESULTS.....	17
4.1 CONDUCTED EMISSION MEASUREMENT	17
4.1.1 LIMITS OF CONDUCTED EMISSION MEASUREMENT.....	17
4.1.2 TEST INSTRUMENTS	17
4.1.3 TEST PROCEDURES.....	18
4.1.4 DEVIATION FROM TEST STANDARD	18
4.1.5 TEST SETUP	19
4.1.6 EUT OPERATING CONDITIONS.....	19
4.1.7 TEST RESULTS.....	20
4.2 RADIATED EMISSION MEASUREMENT	22
4.2.1 LIMITS OF RADIATED EMISSION MEASUREMENT.....	22
4.2.2 LIMITS OF UNWANTED EMISSION OUT OF THE RESTRICTED BANDS.....	23
4.2.3 TEST INSTRUMENTS	24
4.2.4 TEST PROCEDURES.....	26
4.2.5 DEVIATION FROM TEST STANDARD	26
4.2.6 TEST SETUP	27
4.2.7 EUT OPERATING CONDITION	27
4.2.8 TEST RESULTS.....	28
4.3 OUTPUT TRANSMIT POWER MEASUREMENT	63
4.3.1 LIMITS OF OUTPUT TRANSMIT POWER MEASUREMENT.....	63
4.3.2 TEST INSTRUMENTS	63
4.3.3 TEST PROCEDURE	63
4.3.4 DEVIATION FROM TEST STANDARD	63
4.3.5 TEST SETUP	64
4.3.6 EUT OPERATING CONDITIONS.....	64
4.3.7 TEST RESULTS(MODE A).....	65
4.3.8 TEST RESULTS(MODE B)	91
4.4 PEAK POWER EXCURSION MEASUREMENT	93
4.4.1 LIMITS OF PEAK POWER EXCURSION MEASUREMENT.....	93
4.4.2 TEST INSTRUMENTS	93
4.4.3 TEST PROCEDURE	93
4.4.4 DEVIATION FROM TEST STANDARD	94
4.4.5 TEST SETUP	94
4.4.6 EUT OPERATING CONDITIONS.....	94
4.4.7 TEST RESULTS.....	95



A D T

4.5	PEAK POWER SPECTRAL DENSITY MEASUREMENT	109
4.5.1	LIMITS OF PEAK POWER SPECTRAL DENSITY MEASUREMENT	109
4.5.2	TEST INSTRUMENTS	109
4.5.3	TEST PROCEDURES	109
4.5.4	DEVIATION FROM TEST STANDARD	109
4.5.5	TEST SETUP	109
4.5.6	EUT OPERATING CONDITIONS	109
4.5.7	TEST RESULTS(MODE A).....	110
4.5.8	TEST RESULTS(MODE B)	124
4.6	FREQUENCY STABILITY	126
4.6.1	LIMITS OF FREQUENCY STABILITY MEASUREMENT	126
4.6.2	TEST INSTRUMENTS	126
4.6.3	TEST PROCEDURE	126
4.6.4	DEVIATION FROM TEST STANDARD	127
4.6.5	TEST SETUP	127
4.6.6	EUT OPERATING CONDITION	127
4.6.7	TEST RESULTS.....	128
4.7	CONDUCTED OUT-BAND EMISSION MEASUREMENT	129
4.7.1	TEST INSTRUMENTS	129
4.7.2	TEST PROCEDURE	129
4.7.3	EUT OPERATING CONDITION	129
4.7.4	TEST RESULTS.....	129
5.	INFORMATION ON THE TESTING LABORATORIES	139
6.	APPENDIX A - MODIFICATIONS RECORDERS FOR ENGINEERING CHANGES TO THE EUT BY THE LAB.....	140



A D T

RELEASE CONTROL RECORD

ISSUE NO.	REASON FOR CHANGE	DATE ISSUED
RF110408E05-2	Original release	July 28, 2011



1. CERTIFICATION

PRODUCT: XWING1
BRAND NAME: MOTOROLA
MODEL NO.: XWING1
TEST SAMPLE: ENGINEERING SAMPLE
TESTED: Apr. 28 to June 16, 2011
APPLICANT: Motorola Solutions, Inc.
STANDARDS: FCC Part 15, Subpart E (Section 15.407)
ANSI C63.4-2003
ANSI C63.10-2009

The above equipment (Model: XWING1) has been tested by **Bureau Veritas Consumer Products Services (H.K.) Ltd., Taoyuan Branch**, and found compliance with the requirement of the above standards. The test record, data evaluation & Equipment Under Test (EUT) configurations represented herein are true and accurate accounts of the measurements of the sample's EMC characteristics under the conditions specified in this report.

PREPARED BY :  , **DATE:** July 28, 2011
(Claire Kuan, Specialist)

APPROVED BY :  , **DATE:** June 28, 2011
(May Chen, Deputy Manager)

2. SUMMARY OF TEST RESULTS

The EUT has been tested according to the following specifications:

APPLIED STANDARD: FCC Part 15, Subpart E (Section 15.407)			
Standard Section	Test Type	Result	Remark
15.407(b)(5)	AC Power Conducted Emission	PASS	Meet the requirement of limit. Minimum passing margin is -15.66dB at 0.205MHz
15.407(b/1/2/3) (b)(5)	Electric Field Strength Spurious Emissions, 30MHz ~ 40000MHz	PASS	Meet the requirement of limit. Minimum passing margin is -1.1dB at 5350.00MHz & 5725.00MHz
15.407(a/1/2/3)	Output Transmit Power	PASS	Meet the requirement of limit.
15.407(a)(6)	Peak Power Excursion	PASS	Meet the requirement of limit.
15.407(a/1/2/3)	Peak Power Spectral Density	PASS	Meet the requirement of limit.
15.407(g)	Frequency Stability	PASS	Meet the requirement of limit.
15.203	Antenna Requirement	PASS	Antenna connector is SMA Female connector.

NOTE:

1. The EUT was operating in 2400 ~ 2483.5MHz, 5.15~5.35GHz, 5.47~5.725GHz and 5.725~5.850GHz frequencies band. This report was recorded the RF parameters including 5.15~5.35GHz and 5.47~5.725GHz. For the 2400 ~ 2483.5MHz and 5.725~5.850GHz RF parameters was recorded in another test report.
2. The "Dynamic Frequency Selection" was recorded in Report No.: RF110408E05.



A D T

2.1 MEASUREMENT UNCERTAINTY

Where relevant, the following measurement uncertainty levels have been estimated for tests performed on the EUT as specified in CISPR 16-4-2:

This uncertainty represents an expanded uncertainty expressed at approximately the 95% confidence level using a coverage factor of $k=2$.

Measurement	Value
Conducted emissions	2.45 dB
Radiated emissions (30MHz-1GHz)-Chamber G	3.81 dB
Radiated emissions (1GHz -18GHz)-Chamber G	2.19 dB
Radiated emissions (18GHz -40GHz)-Chamber G	2.56 dB
Radiated emissions (1GHz -18GHz)-Chamber H	2.19 dB
Radiated emissions (18GHz -40GHz)-Chamber H	2.56 dB



A D T

3. GENERAL INFORMATION

3.1 GENERAL DESCRIPTION OF EUT

PRODUCT	XWING1
MODEL NO.	XWING1
FCC ID	UZ7XWING1
POWER SUPPLY	DC 3.3V from host equipment
MODULATION TYPE	CCK, DQPSK, DBPSK for DSSS 64QAM, 16QAM, QPSK, BPSK for OFDM
MODULATION TECHNOLOGY	DSSS, OFDM
TRANSFER RATE	802.11b: 11 / 5.5 / 2 / 1Mbps 802.11a/g: 54 / 48 / 36 / 24 / 18 / 12 / 9 / 6Mbps 802.11n (20MHz, 800ns GI): 6.5/13.0/19.5/26.0/39.0/52.0/58.5/65.0(for one stream) 802.11n (20MHz, 400ns GI): 7.2/14.4/21.7/28.9/43.3/57.8/65.0/72.2Mbps(for one stream)
FREQUENCY RANGE	15.247: 802.11b/g & 802.11n (20MHz): 2.412 ~ 2.472GHz 802.11a, 802.11n (20MHz): 5.745 ~ 5.825GHz 15.407: 802.11a, 802.11n (20MHz): 5.18 ~ 5.24GHz, 5.26 ~ 5.32GHz, 5.50 ~ 5.7GHz
NUMBER OF CHANNEL	15.247(2.4GHz) 13 for 802.11b/g, 802.11n (20MHz) 15.247(5GHz) 5 for 802.11a, 802.11n (20MHz) 15.407: 19 for 802.11a, 802.11n (20MHz)
CHANNEL SPACING	802.11b/g, 802.11n (20MHz): 5MHz 802.11a, 802.11n (20MHz): 20MHz



A D T

MAXIMUM OUTPUT POWER	15.247(2.4GHz) 802.11b: 269.2mW 802.11g: 257.0mW 802.11n (20MHz): 257.0mW
	15.247(5GHz) 802.11a: 166.0mW 802.11n (20MHz): 158.5mW
	15.407 802.11a: 67.6mW 802.11n (20MHz): 72.4mW
ANTENNA TYPE	Please see note
ANTENNA CONNECTOR	Please see note
DATA CABLE	NA
I/O PORTS	NA
ASSOCIATED DEVICES	NA

NOTE:

1. There is antenna provided to this EUT, please refer to the following table:

Antenna Model	Antenna Type	Antenna Gain(dBi)	cable loss (dBi)	Net Gain (dBi)	Connecter Type	Frequency range (MHz)
ML-2452-APA2-01	Dipole	3 dBi (2.4GHz) 5 dBi (5GHz)	0.4 dBi (2.4GHz) 0.8 dBi (5GHz)	2.6 dBi (2.4GHz) 4.2 dBi (5GHz)	SMA Female	2400 ~ 2500 5150 ~ 5850

2. The EUT is 1 * 1 spatial SISO (1Tx & 1Rx) without beam forming function.
3. 2.4GHz and 5GHz technology cannot transmit at same time.
4. The above EUT information was declared by the manufacturer and for more detailed feature descriptions, please refer to the manufacturer's specifications or User's Manual.

3.2 DESCRIPTION OF TEST MODES

Operated in 5150MHz ~ 5350MHz bands:

Eight channels are provided for 802.11a and 802.11n (20MHz):

CHANNEL	FREQUENCY
36	5180 MHz
40	5200 MHz
44	5220 MHz
48	5240 MHz
52	5260 MHz
56	5280 MHz
60	5300 MHz
64	5320 MHz

Operated in 5470MHz ~ 5725MHz bands:

Eleven channels are provided for 802.11a and 802.11n (20MHz):

CHANNEL	FREQUENCY
100	5500 MHz
104	5520 MHz
108	5540 MHz
112	5560 MHz
116	5580 MHz
120	5600 MHz
124	5620 MHz
128	5640 MHz
132	5660 MHz
136	5680 MHz
140	5700 MHz

3.2.1 TEST MODE APPLICABILITY AND TESTED CHANNEL DETAIL:

EUT CONFIGURE MODE	APPLICABLE TO				DESCRIPTION
	PLC	RE < 1G	RE ≥ 1G	APCM	
A	√	√	√	√	The output power of module connector end
B	-	-	-	√	The output power of sip RF chip end (The output power of module connector end offset micro-strip trace loss*)

Where **PLC**: Power Line Conducted Emission

RE < 1G: Radiated Emission below 1GHz

RE ≥ 1G: Radiated Emission above 1GHz

APCM: Antenna Port Conducted Measurement

*Trace loss: 2.4GHz is 0.4dB, 5GHz is 0.8dB.

POWER LINE CONDUCTED EMISSION TEST:

- Pre-Scan has been conducted to determine the worst-case mode from all possible combinations between available modulations, data rates and antenna ports (if EUT with antenna diversity architecture).
- Following channel(s) was (were) selected for the final test as listed below.

MODE	AVAILABLE CHANNEL	TESTED CHANNEL	MODULATION TECHNOLOGY	MODULATION TYPE	DATA RATE (Mbps)	EUT CONFIGURE MODE
802.11n (20MHz)	36 to 140	60	OFDM	BPSK	7.2	A

RADIATED EMISSION TEST (BELOW 1 GHz):

- Pre-Scan has been conducted to determine the worst-case mode from all possible combinations between available modulations, data rates and antenna ports (if EUT with antenna diversity architecture).
- Following channel(s) was (were) selected for the final test as listed below.

MODE	AVAILABLE CHANNEL	TESTED CHANNEL	MODULATION TECHNOLOGY	MODULATION TYPE	DATA RATE (Mbps)	EUT CONFIGURE MODE
802.11n (20MHz)	36 to 140	60	OFDM	BPSK	7.2	A

RADIATED EMISSION TEST (ABOVE 1 GHz):

- Pre-Scan has been conducted to determine the worst-case mode from all possible combinations between available modulations, data rates and antenna ports (if EUT with antenna diversity architecture).
- Following channel(s) was (were) selected for the final test as listed below.

MODE	AVAILABLE CHANNEL	TESTED CHANNEL	MODULATION TECHNOLOGY	MODULATION TYPE	DATA RATE (Mbps)	EUT CONFIGURE MODE
802.11a	36 to 140	36, 40, 48, 52, 60, 64, 100, 116, 120, 132, 140	OFDM	BPSK	6	A
802.11n (20MHz)	36 to 140	36, 40, 48, 52, 60, 64, 100, 116, 120, 132, 140	OFDM	BPSK	7.2	A

CONDUCTED OUT-BAND EMISSION MEASUREMENT:

- Pre-Scan has been conducted to determine the worst-case mode from all possible combinations between available modulations, data rates and antenna ports (if EUT with antenna diversity architecture).
- Following channel(s) was (were) selected for the final test as listed below.

MODE	AVAILABLE CHANNEL	TESTED CHANNEL	MODULATION TECHNOLOGY	MODULATION TYPE	DATA RATE (Mbps)	EUT CONFIGURE MODE
802.11a	36 to 140	36, 64, 100, 140	OFDM	BPSK	6	A
802.11n (20MHz)	36 to 140	36, 64, 100, 140	OFDM	BPSK	7.2	A

ANTENNA PORT CONDUCTED MEASUREMENT:

- This item includes all test value of each mode, but only includes spectrum plot of worst value of each mode.
- Pre-Scan has been conducted to determine the worst-case mode from all possible combinations between available modulations, data rates and antenna ports (if EUT with antenna diversity architecture).
- Following channel(s) was (were) selected for the final test as listed below.

MODE	AVAILABLE CHANNEL	TESTED CHANNEL	MODULATION TECHNOLOGY	MODULATION TYPE	DATA RATE (Mbps)	EUT CONFIGURE MODE
802.11a	36 to 140	36, 64, 100, 116, 132, 140	OFDM	BPSK	6	A, B
802.11n (20MHz)	36 to 140	36, 64, 100, 116, 132, 140	OFDM	BPSK	7.2	A, B



A D T

TEST CONDITION:

APPLICABLE TO	ENVIRONMENTAL CONDITIONS	INPUT POWER (SYSTEM)	TESTED BY
RE ³ 1G	22deg. C, 64%RH, 1002 hPa	120Vac, 60Hz	Frank Liu
	25deg. C, 68%RH, 1002 hPa	120Vac, 60Hz	Rex Huang
RE<1G	23deg. C, 68%RH, 1002 hPa	120Vac, 60Hz	Wen Yu
PLC	26deg. C, 68%RH, 1002 hPa	120Vac, 60Hz	Timmy Hu
APCM	22deg. C, 66%RH, 1002 hPa	120Vac, 60Hz	Kent Liu

3.3 GENERAL DESCRIPTION OF APPLIED STANDARDS

The EUT is a RF product. According to the specifications of the manufacturer, it must comply with the requirements of the following standards:

FCC Part 15, Subpart E (15.407)

ANSI C63.4-2003

ANSI C63.10-2009

All test items have been performed and recorded as per the above standards.

NOTE: The EUT has been verified to comply with the requirements of FCC Part 15, Subpart B, Class B (DoC). The test report has been issued separately.



A D T

3.4 DESCRIPTION OF SUPPORT UNITS

The EUT has been tested as an independent unit together with other necessary accessories or support units. The following support units or accessories were used to form a representative test configuration during the tests.

No.	Product	Brand	Model No.	Serial No.	FCC ID
1	NOTEBOOK COMPUTER	ASUS	A8M	75N0AS180287	MSQBT183
2	DC POWER SUPPLY	Topward	6603D	795558	NA

No.	Signal cable description
1	1m USB to 1394 cable
2	2m DC line

Note: 1. All power cords of the above support units are unshielded (1.8m).

3.5 CONFIGURATION OF SYSTEM UNDER TEST

For conducted test

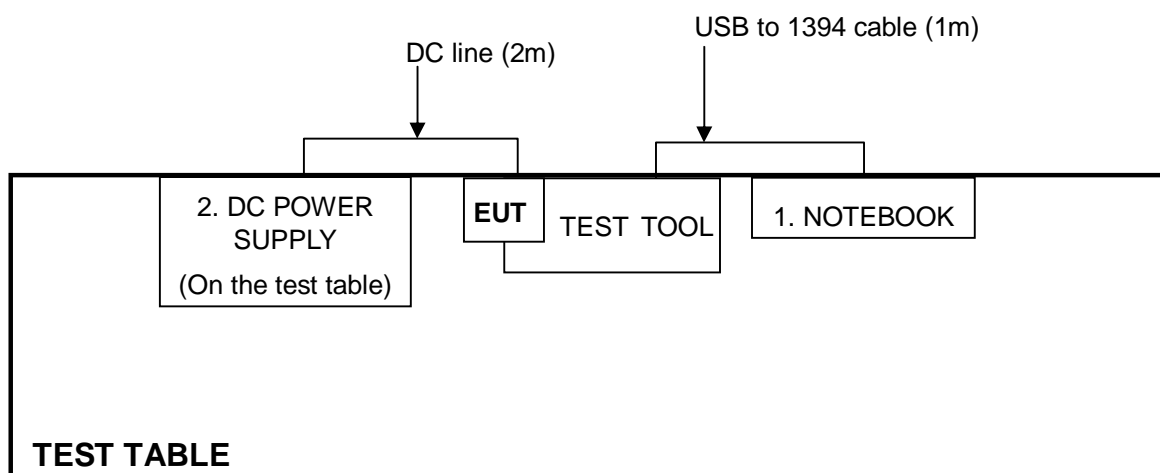

For other test items:

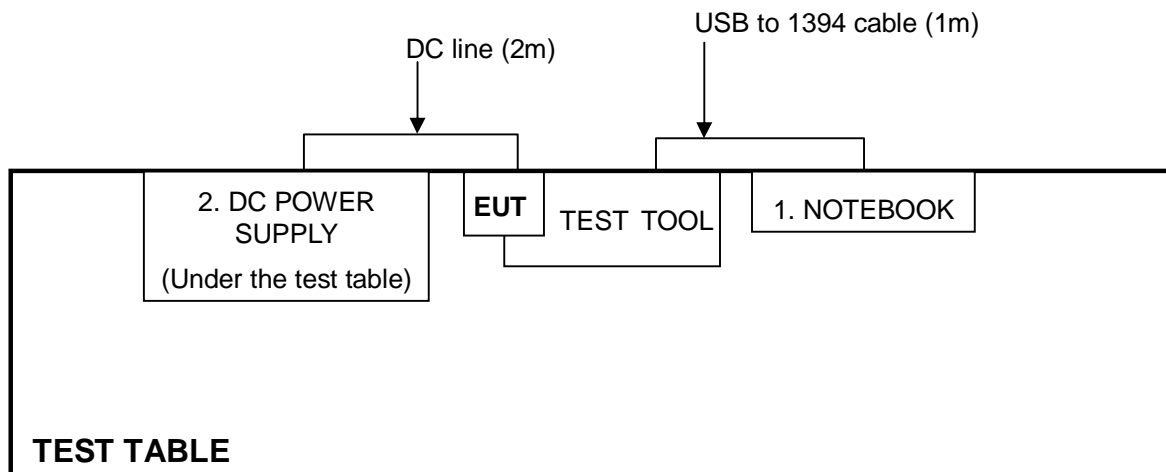



A D T

4. TEST TYPES AND RESULTS

4.1 CONDUCTED EMISSION MEASUREMENT

4.1.1 LIMITS OF CONDUCTED EMISSION MEASUREMENT

FREQUENCY OF EMISSION (MHz)	CONDUCTED LIMIT (dBµV)	
	Quasi-peak	Average
0.15-0.5	66 to 56	56 to 46
0.5-5	56	46
5-30	60	50

- NOTE:**
1. The lower limit shall apply at the transition frequencies.
 2. The limit decreases in line with the logarithm of the frequency in the range of 0.15 to 0.50 MHz.
 3. All emanations from a class A/B digital device or system, including any network of conductors and apparatus connected thereto, shall not exceed the level of field strengths specified above.

4.1.2 TEST INSTRUMENTS

DESCRIPTION & MANUFACTURER	MODEL NO.	SERIAL NO.	CALIBRATED DATE	CALIBRATED UNTIL
ROHDE & SCHWARZ Test Receiver	ESCS 30	100287	Mar. 02, 2011	Mar. 01, 2012
Line-Impedance Stabilization Network (for EUT)	NSLK 8127	8127-523	Sep. 17, 2010	Sep. 16, 2011
Line-Impedance Stabilization Network (for Peripheral)	ENV-216	100072	June 11, 2010	June 10, 2011
RF Cable (JYEBAO)	5DFB	CONCAB-003	Aug. 06, 2010	Aug. 05, 2011
50 ohms Terminator	50	3	Nov. 03, 2010	Nov. 02, 2011
Software	BV ADT_Cond_V7.3.7	NA	NA	NA

Note:

1. The calibration interval of the above test instruments is 12 months and the calibrations are traceable to NML/ROC and NIST/USA.
2. The test was performed in Shielded Room No. A.
3. The VCCI Con A Registration No. is C-817.

4.1.3 TEST PROCEDURES

- a. The EUT was placed 0.4 meters from the conducting wall of the shielded room with EUT being connected to the power mains through a line impedance stabilization network (LISN). Other support units were connected to the power mains through another LISN. The two LISNs
- b. provide 50 ohm/ 50uH of coupling impedance for the measuring instrument.
- c. Both lines of the power mains connected to the EUT were checked for maximum conducted interference.
- d. The frequency range from 150kHz to 30MHz was searched. Emission level under (Limit – 20dB) was not recorded.

4.1.4 DEVIATION FROM TEST STANDARD

No deviation

4.1.5 TEST SETUP

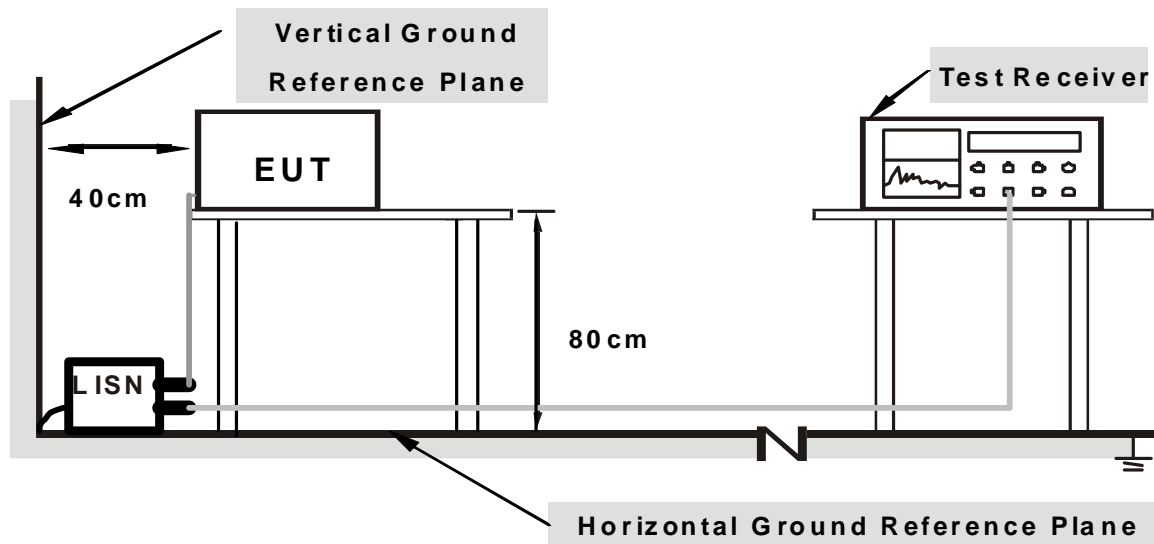

Note: 1. Support units were connected to second LISN.

2. Both of LISNs (AMN) are 80 cm from EUT and at least 80 cm from other units and other metal planes

For the actual test configuration, please refer to the related item – Photographs of the Test Configuration.

4.1.6 EUT OPERATING CONDITIONS

1. Turn on the power of EUT.
2. The support unit 1 (Notebook computer) run test program “TrioScopeMFC.exe” to enable EUT under transmission / receiver condition continuously at specific channel frequency.

4.1.7 TEST RESULTS

PHASE	Line (L)	6dB BANDWIDTH	9 kHz
--------------	----------	----------------------	-------

No	Freq. [MHz]	Corr. Factor (dB)	Reading Value [dB (uV)]		Emission Level [dB (uV)]		Limit [dB (uV)]		Margin (dB)	
			Q.P.	AV.	Q.P.	AV.	Q.P.	AV.	Q.P.	AV.
			1	0.205	0.36	45.31	-	45.67	-	63.42
2	0.275	0.36	38.44	-	38.80	-	60.97	50.97	-22.17	-
3	0.345	0.36	35.19	-	35.55	-	59.07	49.07	-23.52	-
4	0.478	0.37	34.24	-	34.61	-	56.37	46.37	-21.76	-
5	2.531	0.47	33.33	-	33.80	-	56.00	46.00	-22.20	-
6	17.863	1.02	30.61	-	31.63	-	60.00	50.00	-28.37	-

- REMARKS:**
1. Q.P. and AV. are abbreviations of quasi-peak and average individually.
 2. "-": The Quasi-peak reading value also meets average limit and measurement with the average detector is unnecessary.
 3. The emission levels of other frequencies were very low against the limit.
 4. Margin value = Emission level - Limit value
 5. Correction factor = Insertion loss + Cable loss
 6. Emission Level = Correction Factor + Reading Value.

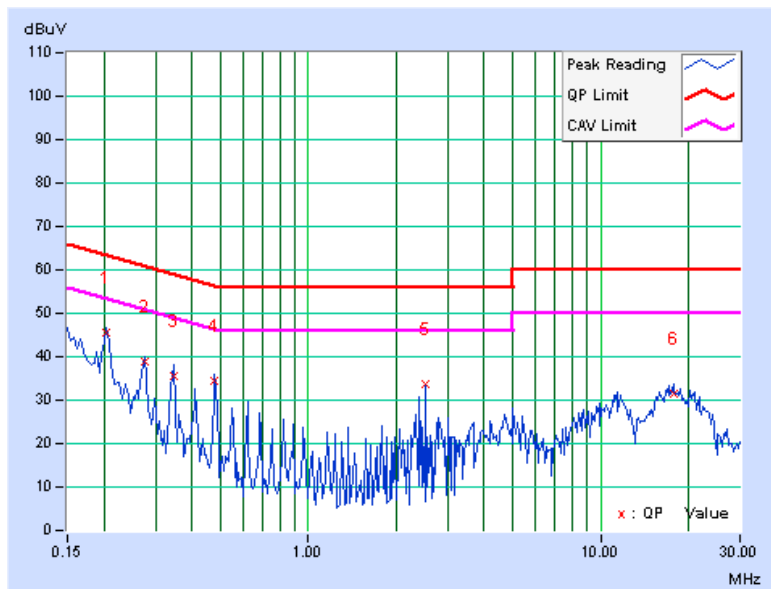

PHASE	Neutral (N)	6dB BANDWIDTH	9 kHz
--------------	-------------	----------------------	-------

No	Freq. [MHz]	Corr. Factor (dB)	Reading Value		Emission Level		Limit		Margin	
			[dB (uV)]		[dB (uV)]		[dB (uV)]		(dB)	
			Q.P.	AV.	Q.P.	AV.	Q.P.	AV.	Q.P.	AV.
1	0.205	0.10	47.66	-	47.76	-	63.42	53.42	-15.66	-
2	0.275	0.10	40.63	-	40.73	-	60.97	50.97	-20.23	-
3	0.341	0.11	38.79	-	38.90	-	59.17	49.17	-20.27	-
4	0.482	0.12	34.20	-	34.32	-	56.30	46.30	-21.99	-
5	2.395	0.21	31.78	-	31.99	-	56.00	46.00	-24.01	-
6	2.531	0.21	33.99	-	34.20	-	56.00	46.00	-21.80	-
7	5.332	0.29	28.36	-	28.65	-	60.00	50.00	-31.35	-

- REMARKS:**
1. Q.P. and AV. are abbreviations of quasi-peak and average individually.
 2. "-": The Quasi-peak reading value also meets average limit and measurement with the average detector is unnecessary.
 3. The emission levels of other frequencies were very low against the limit.
 4. Margin value = Emission level - Limit value
 5. Correction factor = Insertion loss + Cable loss
 6. Emission Level = Correction Factor + Reading Value.

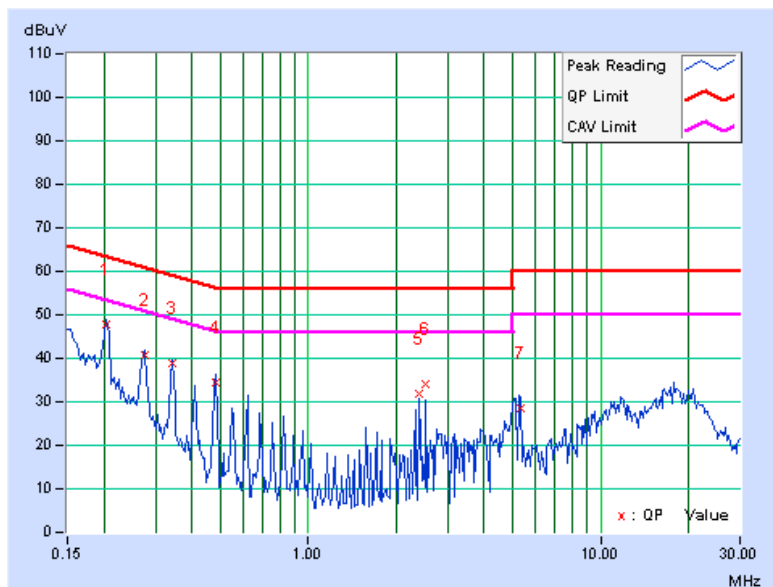

4.2 RADIATED EMISSION MEASUREMENT

4.2.1 LIMITS OF RADIATED EMISSION MEASUREMENT

Emissions radiated outside of the specified bands, shall be according to the general radiated limits in 15.209 as following:

Frequencies (MHz)	Field strength (microvolts/meter)	Measurement distance (meters)
0.009-0.490	2400/F(kHz)	300
0.490-1.705	24000/F(kHz)	30
1.705-30.0	30	30
30-88	100	3
88-216	150	3
216-960	200	3
Above 960	500	3

NOTE:

1. The lower limit shall apply at the transition frequencies.
2. Emission level (dBuV/m) = 20 log Emission level (uV/m).
3. As shown in 15.35(b), for frequencies above 1000MHz, the field strength limits are based on average detector, however, the peak field strength of any emission shall not exceed the maximum permitted average limits, specified above by more than 20dB under any condition of modulation.
4. Section 15.205 restricted bands of operation shall compliance with the limits in Section 15.209.



A D T

4.2.2 LIMITS OF UNWANTED EMISSION OUT OF THE RESTRICTED BANDS

Frequencies (MHz)	EIRP Limit (dBm)	Equivalent Field Strength at 3m (dB μ V/m) *note 3
5150~5250	-27	68.3
5250~5350	-27	68.3
5470~5725	-27	68.3
5725~5825	-27 *note 1	68.3
	-17 *note 2	78.3

NOTE:

1. For frequencies 10MHz or greater above or below the band edge.
2. All emissions within the frequency range from the band edge to 10MHz above or below the band edge.
3. The following formula is used to convert the equipment isotropic radiated power (eirp) to field strength

$$E = \frac{1000000\sqrt{30P}}{3} \mu\text{V/m, where P is the eirp (Watts)}$$

4.2.3 TEST INSTRUMENTS

For above 1GHz test channel 5660MHz (Test date: June 14, 2011):

DESCRIPTION & MANUFACTURER	MODEL NO.	SERIAL NO.	CALIBRATED DATE	CALIBRATED UNTIL
Agilent Spectrum Analyzer	E4446A	MY48250253	Aug. 23, 2010	Aug. 22, 2011
Agilent Pre-Selector	N9039A	MY46520310	Aug. 23, 2010	Aug. 22, 2011
Agilent Signal Generator	N5181A	MY49060347	July 30, 2010	July 29, 2011
Mini-Circuits Pre-Amplifier	ZFL-1000VH2B	AMP-ZFL-04	Nov. 16, 2010	Nov. 15, 2011
Agilent Pre-Amplifier	8449B	3008A02465	Feb. 28, 2011	Feb. 27, 2012
Miteq Pre-Amplifier	AFS33-1800265 0-30-8P-44	881786	NA	NA
SCHWARZBECK Trilog Broadband Antenna	VULB 9168	9168-361	Apr. 14, 2011	Apr. 13, 2012
AISI Horn_Antenna	AIH.8018	0000220091110	Nov. 22, 2010	Nov. 21, 2011
SCHWARZBECK Horn_Antenna	BBHA 9170	9170-424	Oct. 08, 2010	Oct. 07, 2011
RF CABLE	NA	RF104-205 RF104-207 RF104-202	Dec. 28, 2010	Dec. 27, 2011
RF Cable	NA	CHHCAB_001	NA	NA
Software	ADT_Radiated_V8.7.05	NA	NA	NA
CT Antenna Tower & Turn Table	NA	NA	NA	NA

- Note: 1. The calibration interval of the above test instruments is 12 months and the calibrations are traceable to NML/ROC and NIST/USA.
 2. The horn antenna, preamplifier (model: 8449B) are used only for the measurement of emission frequency above 1GHz if tested.
 3. The test was performed in 966 Chamber No. H.
 4. The FCC Site Registration No. is 797305.
 5. The CANADA Site Registration No. is IC 7450H-3.



A D T

For below 1GHz and above 1GHz other test channels (Test date: Apr. 28 to June 10, 2011):

DESCRIPTION & MANUFACTURER	MODEL NO.	SERIAL NO.	CALIBRATED DATE	CALIBRATED UNTIL
Agilent Spectrum Analyzer	E4446A	MY48250254	July 14, 2010	July 13, 2011
Agilent Pre-Selector	N9039A	MY46520311	July 14, 2010	July 13, 2011
Agilent Signal Generator	N5181A	MY49060517	July 14, 2010	July 13, 2011
Mini-Circuits Pre-Amplifier	ZFL-1000VH2B	AMP-ZFL-03	Nov. 16, 2010	Nov. 15, 2011
Agilent Pre-Amplifier	8449B	3008A02578	July 05, 2010	July 04, 2011
Miteq Pre-Amplifier	AFS33-1800265 0-30-8P-44	881786	NA	NA
SCHWARZBECK Trilog Broadband Antenna	VULB 9168	9168-360	Apr. 14, 2011	Apr. 13, 2012
AISI Horn_Antenna	AIH.8018	0000320091110	Nov. 12, 2010	Nov. 11, 2011
SCHWARZBECK Horn_Antenna	BBHA 9170	9170-424	Oct. 08, 2010	Oct. 07, 2011
RF CABLE	NA	RF104-201 RF104-203 RF104-204	Dec. 27, 2010	Dec. 26, 2011
RF Cable	NA	CHGCAB_001	NA	NA
Software	ADT_Radiated_V8.7.05	NA	NA	NA
CT Antenna Tower & Turn Table	NA	NA	NA	NA

- Note: 1. The calibration interval of the above test instruments is 12 months and the calibrations are traceable to NML/ROC and NIST/USA.
2. The horn antenna, preamplifier (model: 8449B) are used only for the measurement of emission frequency above 1GHz if tested.
3. The test was performed in 966 Chamber No. G.
4. The FCC Site Registration No. is 966073.
5. The VCCI Site Registration No. is G-137.
6. The CANADA Site Registration No. is IC 7450H-2.

4.2.4 TEST PROCEDURES

- a. The EUT was placed on the top of a rotating table 0.8 meters above the ground at a 3 meter chamber room. The table was rotated 360 degrees to determine the position of the highest radiation.
- b. The EUT was set 3 meters away from the interference-receiving antenna, which was mounted on the top of a variable-height antenna tower.
- c. The height of antenna is varied from one meter to four meters above the ground to determine the maximum value of the field strength. Both horizontal and vertical polarizations of the antenna are set to make the measurement.
- d. For each suspected emission, the EUT was arranged to its worst case and then the antenna was tuned to heights from 1 meter to 4 meters and the rotatable table was turned from 0 degrees to 360 degrees to find the maximum reading.
- e. The test-receiver system was set to quasi-peak detect function and specified bandwidth with maximum hold mode when the test frequency is below 1 GHz.
- f. The test-receiver system was set to peak and average detect function and specified bandwidth with maximum hold mode when the test frequency is above 1 GHz. If the peak reading value also meets average limit, measurement with the average detector is unnecessary.

NOTE:

1. The resolution bandwidth and video bandwidth of test receiver/spectrum analyzer is 120kHz for Quasi-peak detection (QP) at frequency below 1GHz.
2. The resolution bandwidth of test receiver/spectrum analyzer is 1 MHz and the video bandwidth is 3 MHz for Peak detection (PK) at frequency above 1GHz.
3. The resolution bandwidth of test receiver/spectrum analyzer is 1 MHz and the video bandwidth is 10 Hz for Average detection (AV) at frequency above 1GHz.

4.2.5 DEVIATION FROM TEST STANDARD

No deviation

4.2.6 TEST SETUP

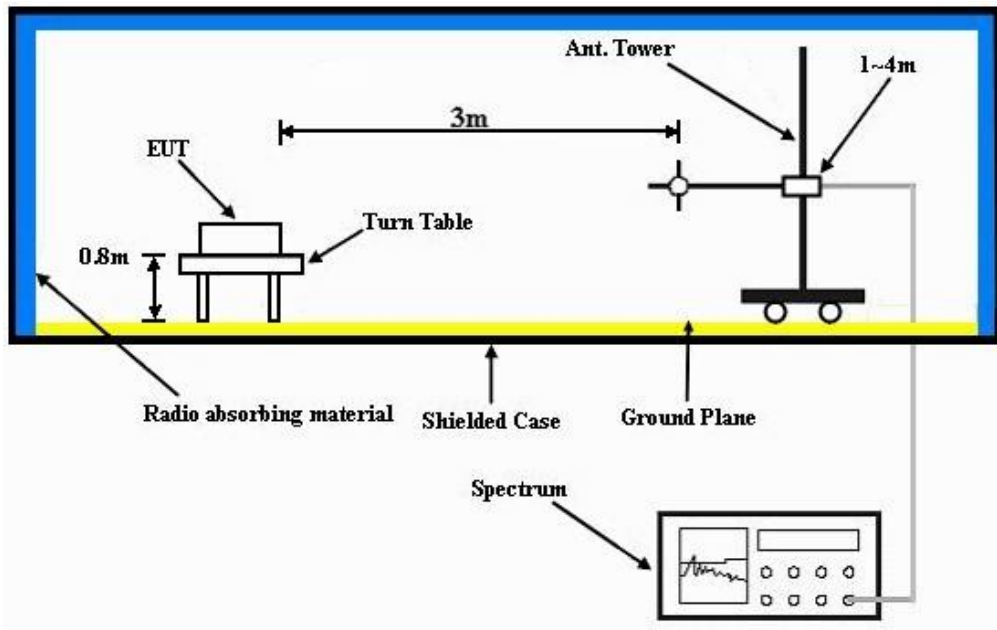

For the actual test configuration, please refer to the related item – Photographs of the Test Configuration.

4.2.7 EUT OPERATING CONDITION

Same as 4.1.6

4.2.8 TEST RESULTS

BELOW 1GHz WORST-CASE DATA : 802.11n (20MHz) OFDM MODULATION

EUT TEST CONDITION		MEASUREMENT DETAIL	
CHANNEL	Channel 60	FREQUENCY RANGE	Below 1000MHz
INPUT POWER (SYSTEM)	120Vac, 60 Hz	DETECTOR FUNCTION	Quasi-Peak
ENVIRONMENTAL CONDITIONS	23deg. C, 68%RH 1002 hPa	TESTED BY	Wen Yu

ANTENNA POLARITY & TEST DISTANCE: HORIZONTAL AT 3 M								
NO.	FREQ. (MHz)	EMISSION LEVEL (dBuV/m)	LIMIT (dBuV/m)	MARGIN (dB)	ANTENNA HEIGHT (m)	TABLE ANGLE (Degree)	RAW VALUE (dBuV)	CORRECTION FACTOR (dB/m)
1	93.60	33.3 QP	43.5	-10.2	1.25 H	223	24.33	8.98
2	131.90	37.4 QP	43.5	-6.1	1.58 H	64	23.97	13.47
3	167.32	37.4 QP	43.5	-6.1	1.54 H	247	23.65	13.74
4	180.00	37.2 QP	43.5	-6.3	1.00 H	25	25.25	11.95
5	192.00	35.9 QP	43.5	-7.6	1.25 H	302	24.62	11.27
6	300.00	39.9 QP	46.0	-6.1	1.50 H	336	24.40	15.46
7	313.00	37.2 QP	46.0	-8.8	1.12 H	225	21.50	15.74
8	903.10	39.9 QP	46.0	-6.1	1.50 H	258	13.07	26.83
ANTENNA POLARITY & TEST DISTANCE: VERTICAL AT 3 M								
NO.	FREQ. (MHz)	EMISSION LEVEL (dBuV/m)	LIMIT (dBuV/m)	MARGIN (dB)	ANTENNA HEIGHT (m)	TABLE ANGLE (Degree)	RAW VALUE (dBuV)	CORRECTION FACTOR (dB/m)
1	43.90	34.0 QP	40.0	-6.0	1.25 V	245	19.67	14.31
2	55.90	33.9 QP	40.0	-6.1	1.00 V	124	20.16	13.74
3	167.10	37.2 QP	43.5	-6.3	1.15 V	208	23.45	13.77
4	180.01	37.5 QP	43.5	-6.1	1.25 V	261	25.50	11.95
5	301.10	33.8 QP	46.0	-12.2	1.50 V	124	18.32	15.48
6	563.00	31.2 QP	46.0	-14.8	1.25 V	225	9.71	21.53
7	903.98	39.9 QP	46.0	-6.1	1.21 V	339	13.05	26.83

- REMARKS:**
1. Emission level (dBuV/m) = Raw Value (dBuV) + Correction Factor (dB/m).
 2. Correction Factor (dB/m) = Antenna Factor (dB/m) + Cable Factor (dB).
 3. The other emission levels were very low against the limit.
 4. Margin value = Emission level – Limit value.



A D T

ABOVE 1GHz WORST-CASE DATA

802.11a OFDM MODULATION

EUT TEST CONDITION		MEASUREMENT DETAIL	
CHANNEL	Channel 36	FREQUENCY RANGE	1 ~ 40GHz
INPUT POWER (SYSTEM)	120Vac, 60 Hz	DETECTOR FUNCTION	Peak (PK) Average (AV)
ENVIRONMENTAL CONDITIONS	22deg. C, 64%RH 1002 hPa	TESTED BY	Frank Liu

ANTENNA POLARITY & TEST DISTANCE: HORIZONTAL AT 3 M								
NO.	FREQ. (MHz)	EMISSION LEVEL (dBuV/m)	LIMIT (dBuV/m)	MARGIN (dB)	ANTENNA HEIGHT (m)	TABLE ANGLE (Degree)	RAW VALUE (dBuV)	CORRECTION FACTOR (dB/m)
1	5150.00	57.6 PK	74.0	-16.4	1.00 H	173	17.66	39.94
2	5150.00	45.2 AV	54.0	-8.8	1.00 H	173	5.26	39.94
3	*5180.00	97.5 PK			1.00 H	173	57.48	40.02
4	*5180.00	87.5 AV			1.00 H	173	47.48	40.02
5	#10360.00	54.7 PK	68.3	-13.6	1.00 H	64	8.17	46.53
6	15540.00	57.1 PK	74.0	-16.9	1.10 H	34	5.73	51.37
7	15540.00	47.4 AV	54.0	-6.6	1.10 H	34	-3.97	51.37
ANTENNA POLARITY & TEST DISTANCE: VERTICAL AT 3 M								
NO.	FREQ. (MHz)	EMISSION LEVEL (dBuV/m)	LIMIT (dBuV/m)	MARGIN (dB)	ANTENNA HEIGHT (m)	TABLE ANGLE (Degree)	RAW VALUE (dBuV)	CORRECTION FACTOR (dB/m)
1	5150.00	63.0 PK	74.0	-11.0	1.00 V	246	23.06	39.94
2	5150.00	52.6 AV	54.0	-1.4	1.00 V	246	12.66	39.94
3	*5180.00	108.1 PK			1.00 V	247	68.08	40.02
4	*5180.00	98.2 AV			1.00 V	247	58.18	40.02
5	#10360.00	54.6 PK	68.3	-13.7	1.00 V	37	8.07	46.53
6	15540.00	56.8 PK	74.0	-17.2	1.21 V	24	5.43	51.37
7	15540.00	47.2 AV	54.0	-6.8	1.21 V	24	-4.17	51.37

- REMARKS:**
1. Emission level (dBuV/m) = Raw Value (dBuV) + Correction Factor (dB/m).
 2. Correction Factor (dB/m) = Antenna Factor (dB/m) + Cable Factor (dB).
 3. The other emission levels were very low against the limit.
 4. Margin value = Emission level – Limit value.
 5. “ * “: Fundamental frequency.
 6. "#":The radiated frequency is out the restricted band.



A D T

EUT TEST CONDITION		MEASUREMENT DETAIL	
CHANNEL	Channel 40	FREQUENCY RANGE	1 ~ 40GHz
INPUT POWER (SYSTEM)	120Vac, 60 Hz	DETECTOR FUNCTION	Peak (PK) Average (AV)
ENVIRONMENTAL CONDITIONS	22deg. C, 64%RH 1002 hPa	TESTED BY	Frank Liu

ANTENNA POLARITY & TEST DISTANCE: HORIZONTAL AT 3 M								
NO.	FREQ. (MHz)	EMISSION LEVEL (dBuV/m)	LIMIT (dBuV/m)	MARGIN (dB)	ANTENNA HEIGHT (m)	TABLE ANGLE (Degree)	RAW VALUE (dBuV)	CORRECTION FACTOR (dB/m)
1	*5200.00	99.2 PK			1.05 H	166	59.13	40.07
2	*5200.00	89.0 AV			1.05 H	166	48.93	40.07
3	#10400.00	54.3 PK	68.3	-14.0	1.00 H	23	7.73	46.57
4	15600.00	56.9 PK	74.0	-17.1	1.15 H	21	5.43	51.47
5	15600.00	47.5 AV	54.0	-6.5	1.15 H	21	-3.97	51.47
ANTENNA POLARITY & TEST DISTANCE: VERTICAL AT 3 M								
NO.	FREQ. (MHz)	EMISSION LEVEL (dBuV/m)	LIMIT (dBuV/m)	MARGIN (dB)	ANTENNA HEIGHT (m)	TABLE ANGLE (Degree)	RAW VALUE (dBuV)	CORRECTION FACTOR (dB/m)
1	*5200.00	109.4 PK			1.00 V	350	69.33	40.07
2	*5200.00	99.3 AV			1.00 V	350	59.23	40.07
3	#10400.00	54.4 PK	68.3	-13.9	1.00 V	32	7.83	46.57
4	15600.00	56.4 PK	74.0	-17.6	1.20 V	31	4.93	51.47
5	15600.00	47.1 AV	54.0	-6.9	1.20 V	31	-4.37	51.47

- REMARKS:**
1. Emission level (dBuV/m) = Raw Value (dBuV) + Correction Factor (dB/m).
 2. Correction Factor (dB/m) = Antenna Factor (dB/m) + Cable Factor (dB).
 3. The other emission levels were very low against the limit.
 4. Margin value = Emission level – Limit value.
 5. “ * “: Fundamental frequency.
 6. “ # “: The radiated frequency is out the restricted band.



A D T

EUT TEST CONDITION		MEASUREMENT DETAIL	
CHANNEL	Channel 48	FREQUENCY RANGE	1 ~ 40GHz
INPUT POWER (SYSTEM)	120Vac, 60 Hz	DETECTOR FUNCTION	Peak (PK) Average (AV)
ENVIRONMENTAL CONDITIONS	22deg. C, 64%RH 1002 hPa	TESTED BY	Frank Liu

ANTENNA POLARITY & TEST DISTANCE: HORIZONTAL AT 3 M								
NO.	FREQ. (MHz)	EMISSION LEVEL (dBuV/m)	LIMIT (dBuV/m)	MARGIN (dB)	ANTENNA HEIGHT (m)	TABLE ANGLE (Degree)	RAW VALUE (dBuV)	CORRECTION FACTOR (dB/m)
1	*5240.00	98.8 PK			1.04 H	178	58.63	40.17
2	*5240.00	88.9 AV			1.04 H	178	48.73	40.17
3	#10480.00	54.6 PK	68.3	-13.7	1.00 H	21	7.93	46.67
4	15720.00	57.1 PK	74.0	-16.9	1.15 H	16	5.59	51.51
5	15720.00	47.7 AV	54.0	-6.3	1.15 H	16	-3.81	51.51
ANTENNA POLARITY & TEST DISTANCE: VERTICAL AT 3 M								
NO.	FREQ. (MHz)	EMISSION LEVEL (dBuV/m)	LIMIT (dBuV/m)	MARGIN (dB)	ANTENNA HEIGHT (m)	TABLE ANGLE (Degree)	RAW VALUE (dBuV)	CORRECTION FACTOR (dB/m)
1	*5240.00	109.2 PK			1.00 V	360	69.03	40.17
2	*5240.00	99.1 AV			1.00 V	360	58.93	40.17
3	#10480.00	54.6 PK	68.3	-13.7	1.00 V	26	7.93	46.67
4	15720.00	58.4 PK	74.0	-15.6	1.00 V	54	6.89	51.51
5	15720.00	47.3 AV	54.0	-6.7	1.00 V	54	-4.21	51.51

- REMARKS:**
1. Emission level (dBuV/m) = Raw Value (dBuV) + Correction Factor (dB/m).
 2. Correction Factor (dB/m) = Antenna Factor (dB/m) + Cable Factor (dB).
 3. The other emission levels were very low against the limit.
 4. Margin value = Emission level – Limit value.
 5. “ * “: Fundamental frequency.
 6. “ # “: The radiated frequency is out the restricted band.



A D T

EUT TEST CONDITION		MEASUREMENT DETAIL	
CHANNEL	Channel 52	FREQUENCY RANGE	1 ~ 40GHz
INPUT POWER (SYSTEM)	120Vac, 60 Hz	DETECTOR FUNCTION	Peak (PK) Average (AV)
ENVIRONMENTAL CONDITIONS	22deg. C, 64%RH 1002 hPa	TESTED BY	Frank Liu

ANTENNA POLARITY & TEST DISTANCE: HORIZONTAL AT 3 M								
NO.	FREQ. (MHz)	EMISSION LEVEL (dBuV/m)	LIMIT (dBuV/m)	MARGIN (dB)	ANTENNA HEIGHT (m)	TABLE ANGLE (Degree)	RAW VALUE (dBuV)	CORRECTION FACTOR (dB/m)
1	*5260.00	100.6 PK			1.00 H	166	60.37	40.23
2	*5260.00	90.6 AV			1.00 H	166	50.37	40.23
3	#10520.00	54.1 PK	68.3	-14.2	1.00 H	22	7.38	46.72
4	15780.00	56.9 PK	74.0	-17.1	1.13 H	12	5.32	51.58
5	15780.00	47.6 AV	54.0	-6.4	1.13 H	12	-3.98	51.58
ANTENNA POLARITY & TEST DISTANCE: VERTICAL AT 3 M								
NO.	FREQ. (MHz)	EMISSION LEVEL (dBuV/m)	LIMIT (dBuV/m)	MARGIN (dB)	ANTENNA HEIGHT (m)	TABLE ANGLE (Degree)	RAW VALUE (dBuV)	CORRECTION FACTOR (dB/m)
1	*5260.00	111.5 PK			1.00 V	244	71.27	40.23
2	*5260.00	101.6 AV			1.00 V	244	61.37	40.23
3	#10520.00	54.7 PK	68.3	-13.6	1.00 V	29	7.98	46.72
4	15780.00	58.2 PK	74.0	-15.8	1.00 V	62	6.62	51.58
5	15780.00	47.1 AV	54.0	-6.9	1.00 V	62	-4.48	51.58

- REMARKS:**
1. Emission level (dBuV/m) = Raw Value (dBuV) + Correction Factor (dB/m).
 2. Correction Factor (dB/m) = Antenna Factor (dB/m) + Cable Factor (dB).
 3. The other emission levels were very low against the limit.
 4. Margin value = Emission level – Limit value.
 5. “ * “: Fundamental frequency.
 6. “ # “: The radiated frequency is out the restricted band.



A D T

EUT TEST CONDITION		MEASUREMENT DETAIL	
CHANNEL	Channel 60	FREQUENCY RANGE	1 ~ 40GHz
INPUT POWER (SYSTEM)	120Vac, 60 Hz	DETECTOR FUNCTION	Peak (PK) Average (AV)
ENVIRONMENTAL CONDITIONS	22deg. C, 64%RH 1002 hPa	TESTED BY	Frank Liu

ANTENNA POLARITY & TEST DISTANCE: HORIZONTAL AT 3 M								
NO.	FREQ. (MHz)	EMISSION LEVEL (dBuV/m)	LIMIT (dBuV/m)	MARGIN (dB)	ANTENNA HEIGHT (m)	TABLE ANGLE (Degree)	RAW VALUE (dBuV)	CORRECTION FACTOR (dB/m)
1	*5300.00	101.0 PK			1.03 H	160	60.67	40.33
2	*5300.00	91.2 AV			1.03 H	160	50.87	40.33
3	10600.00	55.4 PK	74.0	-18.6	1.02 H	28	8.58	46.82
4	10600.00	43.9 AV	54.0	-10.1	1.02 H	28	-2.92	46.82
5	15900.00	57.7 PK	74.0	-16.3	1.11 H	22	6.04	51.66
6	15900.00	47.5 AV	54.0	-6.5	1.11 H	22	-4.16	51.66
ANTENNA POLARITY & TEST DISTANCE: VERTICAL AT 3 M								
NO.	FREQ. (MHz)	EMISSION LEVEL (dBuV/m)	LIMIT (dBuV/m)	MARGIN (dB)	ANTENNA HEIGHT (m)	TABLE ANGLE (Degree)	RAW VALUE (dBuV)	CORRECTION FACTOR (dB/m)
1	*5300.00	112.0 PK			1.00 V	253	71.67	40.33
2	*5300.00	102.1 AV			1.00 V	253	61.77	40.33
3	10600.00	54.9 PK	74.0	-19.1	1.00 V	32	8.08	46.82
4	10600.00	43.6 AV	54.0	-10.4	1.00 V	32	-3.22	46.82
5	15900.00	57.9 PK	74.0	-16.1	1.00 V	104	6.24	51.66
6	15900.00	47.5 AV	54.0	-6.5	1.00 V	104	-4.16	51.66

- REMARKS:**
1. Emission level (dBuV/m) = Raw Value (dBuV) + Correction Factor (dB/m).
 2. Correction Factor (dB/m) = Antenna Factor (dB/m) + Cable Factor (dB).
 3. The other emission levels were very low against the limit.
 4. Margin value = Emission level – Limit value.
 5. “ * “: Fundamental frequency.



A D T

EUT TEST CONDITION		MEASUREMENT DETAIL	
CHANNEL	Channel 64	FREQUENCY RANGE	1 ~ 40GHz
INPUT POWER (SYSTEM)	120Vac, 60 Hz	DETECTOR FUNCTION	Peak (PK) Average (AV)
ENVIRONMENTAL CONDITIONS	22deg. C, 64%RH 1002 hPa	TESTED BY	Frank Liu

ANTENNA POLARITY & TEST DISTANCE: HORIZONTAL AT 3 M								
NO.	FREQ. (MHz)	EMISSION LEVEL (dBuV/m)	LIMIT (dBuV/m)	MARGIN (dB)	ANTENNA HEIGHT (m)	TABLE ANGLE (Degree)	RAW VALUE (dBuV)	CORRECTION FACTOR (dB/m)
1	*5320.00	99.7 PK			1.05 H	340	59.31	40.39
2	*5320.00	90.2 AV			1.05 H	340	49.81	40.39
3	5350.00	58.7 PK	74.0	-15.3	1.05 H	340	18.23	40.47
4	5350.00	46.2 AV	54.0	-7.8	1.05 H	340	5.73	40.47
5	10640.00	55.7 PK	74.0	-18.3	1.00 H	26	8.83	46.87
6	10640.00	44.5 AV	54.0	-9.5	1.00 H	26	-2.37	46.87
7	15960.00	57.6 PK	74.0	-16.4	1.09 H	17	5.87	51.73
8	15960.00	47.5 AV	54.0	-6.5	1.09 H	17	-4.23	51.73
ANTENNA POLARITY & TEST DISTANCE: VERTICAL AT 3 M								
NO.	FREQ. (MHz)	EMISSION LEVEL (dBuV/m)	LIMIT (dBuV/m)	MARGIN (dB)	ANTENNA HEIGHT (m)	TABLE ANGLE (Degree)	RAW VALUE (dBuV)	CORRECTION FACTOR (dB/m)
1	*5320.00	109.7 PK			1.00 V	304	69.31	40.39
2	*5320.00	100.1 AV			1.00 V	304	59.71	40.39
3	5350.00	67.6 PK	74.0	-6.4	1.00 V	241	27.13	40.47
4	5350.00	52.9 AV	54.0	-1.1	1.00 V	241	12.43	40.47
5	10640.00	55.1 PK	74.0	-18.9	1.05 V	34	8.23	46.87
6	10640.00	44.0 AV	54.0	-10.0	1.05 V	34	-2.87	46.87
7	15960.00	58.6 PK	74.0	-15.4	1.02 V	96	6.87	51.73
8	15960.00	47.5 AV	54.0	-6.5	1.02 V	96	-4.23	51.73

- REMARKS:**
1. Emission level (dBuV/m) = Raw Value (dBuV) + Correction Factor (dB/m).
 2. Correction Factor (dB/m) = Antenna Factor (dB/m) + Cable Factor (dB).
 3. The other emission levels were very low against the limit.
 4. Margin value = Emission level – Limit value.
 5. “ * “: Fundamental frequency.



A D T

EUT TEST CONDITION		MEASUREMENT DETAIL	
CHANNEL	Channel 100	FREQUENCY RANGE	1 ~ 40GHz
INPUT POWER (SYSTEM)	120Vac, 60 Hz	DETECTOR FUNCTION	Peak (PK) Average (AV)
ENVIRONMENTAL CONDITIONS	22deg. C, 64%RH 1002 hPa	TESTED BY	Frank Liu

ANTENNA POLARITY & TEST DISTANCE: HORIZONTAL AT 3 M								
NO.	FREQ. (MHz)	EMISSION LEVEL (dBuV/m)	LIMIT (dBuV/m)	MARGIN (dB)	ANTENNA HEIGHT (m)	TABLE ANGLE (Degree)	RAW VALUE (dBuV)	CORRECTION FACTOR (dB/m)
1	5460.00	59.4 PK	74.0	-14.6	1.00 H	352	18.64	40.76
2	5460.00	46.6 AV	54.0	-7.4	1.00 H	352	5.84	40.76
3	#5470.00	61.2 PK	68.3	-7.1	1.00 H	352	20.42	40.78
4	*5500.00	99.4 PK			1.00 H	352	58.54	40.86
5	*5500.00	90.1 AV			1.00 H	352	49.24	40.86
6	11000.00	55.6 PK	74.0	-18.4	1.00 H	23	8.32	47.28
7	11000.00	44.3 AV	54.0	-9.7	1.00 H	23	-2.98	47.28
8	#16500.00	59.6 PK	68.3	-8.7	1.04 H	20	6.57	53.03
ANTENNA POLARITY & TEST DISTANCE: VERTICAL AT 3 M								
NO.	FREQ. (MHz)	EMISSION LEVEL (dBuV/m)	LIMIT (dBuV/m)	MARGIN (dB)	ANTENNA HEIGHT (m)	TABLE ANGLE (Degree)	RAW VALUE (dBuV)	CORRECTION FACTOR (dB/m)
1	5460.00	66.0 PK	74.0	-8.0	1.49 V	177	25.24	40.76
2	5460.00	47.4 AV	54.0	-6.6	1.49 V	177	6.64	40.76
3	#5470.00	67.1 PK	68.3	-1.2	1.49 V	177	26.32	40.78
4	*5500.00	110.8 PK			1.00 V	250	69.94	40.86
5	*5500.00	101.1 AV			1.00 V	250	60.24	40.86
6	11000.00	55.8 PK	74.0	-18.2	1.00 V	21	8.52	47.28
7	11000.00	44.5 AV	54.0	-9.5	1.00 V	21	-2.78	47.28
8	#16500.00	59.7 PK	68.3	-8.6	1.04 V	104	6.67	53.03

- REMARKS:**
1. Emission level (dBuV/m) = Raw Value (dBuV) + Correction Factor (dB/m).
 2. Correction Factor (dB/m) = Antenna Factor (dB/m) + Cable Factor (dB).
 3. The other emission levels were very low against the limit.
 4. Margin value = Emission level – Limit value.
 5. “ * “: Fundamental frequency.
 6. “#”:The radiated frequency is out the restricted band.



A D T

EUT TEST CONDITION		MEASUREMENT DETAIL	
CHANNEL	Channel 116	FREQUENCY RANGE	1 ~ 40GHz
INPUT POWER (SYSTEM)	120Vac, 60 Hz	DETECTOR FUNCTION	Peak (PK) Average (AV)
ENVIRONMENTAL CONDITIONS	27deg. C, 61%RH 1002 hPa	TESTED BY	Frank Liu

ANTENNA POLARITY & TEST DISTANCE: HORIZONTAL AT 3 M								
NO.	FREQ. (MHz)	EMISSION LEVEL (dBuV/m)	LIMIT (dBuV/m)	MARGIN (dB)	ANTENNA HEIGHT (m)	TABLE ANGLE (Degree)	RAW VALUE (dBuV)	CORRECTION FACTOR (dB/m)
1	*5580.00	99.0 PK			1.08 H	345	57.91	41.09
2	*5580.00	89.2 AV			1.08 H	345	48.11	41.09
3	11160.00	56.3 PK	74.0	-17.7	1.00 H	33	8.91	47.39
4	11160.00	44.5 AV	54.0	-9.5	1.00 H	33	-2.89	47.39
5	#16740.00	61.2 PK	68.3	-7.1	1.05 H	6	7.71	53.49
ANTENNA POLARITY & TEST DISTANCE: VERTICAL AT 3 M								
NO.	FREQ. (MHz)	EMISSION LEVEL (dBuV/m)	LIMIT (dBuV/m)	MARGIN (dB)	ANTENNA HEIGHT (m)	TABLE ANGLE (Degree)	RAW VALUE (dBuV)	CORRECTION FACTOR (dB/m)
1	*5580.00	110.4 PK			1.00 V	255	69.31	41.09
2	*5580.00	100.2 AV			1.00 V	255	59.11	41.09
3	11160.00	56.0 PK	74.0	-18.0	1.00 V	41	8.61	47.39
4	11160.00	44.2 AV	54.0	-9.8	1.00 V	41	-3.19	47.39
5	#16740.00	59.8 PK	68.3	-8.5	1.06 V	48	6.31	53.49

- REMARKS:**
1. Emission level (dBuV/m) = Raw Value (dBuV) + Correction Factor (dB/m).
 2. Correction Factor (dB/m) = Antenna Factor (dB/m) + Cable Factor (dB).
 3. The other emission levels were very low against the limit.
 4. Margin value = Emission level – Limit value.
 5. " * ": Fundamental frequency.
 6. "#": The radiated frequency is out the restricted band.



A D T

EUT TEST CONDITION		MEASUREMENT DETAIL	
CHANNEL	Channel 120	FREQUENCY RANGE	1 ~ 40GHz
INPUT POWER (SYSTEM)	120Vac, 60 Hz	DETECTOR FUNCTION	Peak (PK) Average (AV)
ENVIRONMENTAL CONDITIONS	22deg. C, 64%RH 1002 hPa	TESTED BY	Frank Liu

ANTENNA POLARITY & TEST DISTANCE: HORIZONTAL AT 3 M								
NO.	FREQ. (MHz)	EMISSION LEVEL (dBuV/m)	LIMIT (dBuV/m)	MARGIN (dB)	ANTENNA HEIGHT (m)	TABLE ANGLE (Degree)	RAW VALUE (dBuV)	CORRECTION FACTOR (dB/m)
1	*5600.00	99.3 PK			1.09 H	349	58.15	41.15
2	*5600.00	89.9 AV			1.09 H	349	48.75	41.15
3	11200.00	55.8 PK	74.0	-18.2	1.00 H	31	8.38	47.42
4	11200.00	44.3 AV	54.0	-9.7	1.00 H	31	-3.12	47.42
5	#16800.00	61.1 PK	68.3	-7.2	1.01 H	7	7.47	53.63
ANTENNA POLARITY & TEST DISTANCE: VERTICAL AT 3 M								
NO.	FREQ. (MHz)	EMISSION LEVEL (dBuV/m)	LIMIT (dBuV/m)	MARGIN (dB)	ANTENNA HEIGHT (m)	TABLE ANGLE (Degree)	RAW VALUE (dBuV)	CORRECTION FACTOR (dB/m)
1	*5600.00	111.4 PK			1.00 V	264	70.25	41.15
2	*5600.00	101.8 AV			1.00 V	264	60.65	41.15
3	11200.00	54.9 PK	74.0	-19.1	1.00 V	37	7.48	47.42
4	11200.00	43.6 AV	54.0	-10.4	1.00 V	37	-3.82	47.42
5	#16800.00	60.2 PK	68.3	-8.1	1.00 V	46	6.57	53.63

- REMARKS:**
1. Emission level (dBuV/m) = Raw Value (dBuV) + Correction Factor (dB/m).
 2. Correction Factor (dB/m) = Antenna Factor (dB/m) + Cable Factor (dB).
 3. The other emission levels were very low against the limit.
 4. Margin value = Emission level – Limit value.
 5. " * ": Fundamental frequency.
 6. "#": The radiated frequency is out the restricted band.



A D T

EUT TEST CONDITION		MEASUREMENT DETAIL	
CHANNEL	Channel 132	FREQUENCY RANGE	1 ~ 40GHz
INPUT POWER (SYSTEM)	120Vac, 60 Hz	DETECTOR FUNCTION	Peak (PK) Average (AV)
ENVIRONMENTAL CONDITIONS	25deg. C, 68%RH 1002 hPa	TESTED BY	Rex Huang

ANTENNA POLARITY & TEST DISTANCE: HORIZONTAL AT 3 M								
NO.	FREQ. (MHz)	EMISSION LEVEL (dBuV/m)	LIMIT (dBuV/m)	MARGIN (dB)	ANTENNA HEIGHT (m)	TABLE ANGLE (Degree)	RAW VALUE (dBuV)	CORRECTION FACTOR (dB/m)
1	*5660.00	97.5 PK			1.11 H	352	56.27	41.23
2	*5660.00	87.4 AV			1.11 H	352	46.17	41.23
3	11320.00	55.8 PK	74.0	-18.2	1.00 H	24	8.45	47.35
4	11320.00	44.2 AV	54.0	-9.8	1.00 H	24	-3.15	47.35
5	#16980.00	61.2 PK	68.3	-7.1	1.06 H	9	7.12	54.08
ANTENNA POLARITY & TEST DISTANCE: VERTICAL AT 3 M								
NO.	FREQ. (MHz)	EMISSION LEVEL (dBuV/m)	LIMIT (dBuV/m)	MARGIN (dB)	ANTENNA HEIGHT (m)	TABLE ANGLE (Degree)	RAW VALUE (dBuV)	CORRECTION FACTOR (dB/m)
1	*5660.00	110.0 PK			1.00 V	277	68.77	41.23
2	*5660.00	100.4 AV			1.00 V	277	59.17	41.23
3	11320.00	55.3 PK	74.0	-18.7	1.04 V	44	7.95	47.35
4	11320.00	43.9 AV	54.0	-10.1	1.04 V	44	-3.45	47.35
5	#16980.00	60.2 PK	68.3	-8.1	1.03 V	28	6.12	54.08

- REMARKS:**
1. Emission level (dBuV/m) = Raw Value (dBuV) + Correction Factor (dB/m).
 2. Correction Factor (dB/m) = Antenna Factor (dB/m) + Cable Factor (dB).
 3. The other emission levels were very low against the limit.
 4. Margin value = Emission level – Limit value.
 5. “ * “: Fundamental frequency.
 6. "#":The radiated frequency is out the restricted band.



A D T

EUT TEST CONDITION		MEASUREMENT DETAIL	
CHANNEL	Channel 140	FREQUENCY RANGE	1 ~ 40GHz
INPUT POWER (SYSTEM)	120Vac, 60 Hz	DETECTOR FUNCTION	Peak (PK) Average (AV)
ENVIRONMENTAL CONDITIONS	22deg. C, 64%RH 1002 hPa	TESTED BY	Frank Liu

ANTENNA POLARITY & TEST DISTANCE: HORIZONTAL AT 3 M								
NO.	FREQ. (MHz)	EMISSION LEVEL (dBuV/m)	LIMIT (dBuV/m)	MARGIN (dB)	ANTENNA HEIGHT (m)	TABLE ANGLE (Degree)	RAW VALUE (dBuV)	CORRECTION FACTOR (dB/m)
1	*5700.00	97.6 PK			1.11 H	7	56.18	41.42
2	*5700.00	88.1 AV			1.11 H	7	46.68	41.42
3	#5725.00	60.4 PK	68.3	-7.9	1.11 H	7	18.91	41.49
4	11400.00	55.2 PK	74.0	-18.8	1.03 H	49	7.58	47.62
5	11400.00	43.8 AV	54.0	-10.2	1.03 H	49	-3.82	47.62
6	#17100.00	61.3 PK	68.3	-7.0	1.02 H	3	7.10	54.20
ANTENNA POLARITY & TEST DISTANCE: VERTICAL AT 3 M								
NO.	FREQ. (MHz)	EMISSION LEVEL (dBuV/m)	LIMIT (dBuV/m)	MARGIN (dB)	ANTENNA HEIGHT (m)	TABLE ANGLE (Degree)	RAW VALUE (dBuV)	CORRECTION FACTOR (dB/m)
1	*5700.00	108.6 PK			1.69 V	0	67.18	41.42
2	*5700.00	99.5 AV			1.69 V	0	58.08	41.42
3	#5725.00	66.8 PK	68.3	-1.5	1.49 V	225	25.31	41.49
4	11400.00	55.0 PK	74.0	-19.0	1.00 V	42	7.38	47.62
5	11400.00	43.7 AV	54.0	-10.3	1.00 V	42	-3.92	47.62
6	#17100.00	61.8 PK	68.3	-6.5	1.06 V	34	7.60	54.20

- REMARKS:**
1. Emission level (dBuV/m) = Raw Value (dBuV) + Correction Factor (dB/m).
 2. Correction Factor (dB/m) = Antenna Factor (dB/m) + Cable Factor (dB).
 3. The other PK emission levels were very low against the limit.
 4. Margin value = Emission level – Limit value.
 5. “ * “: Fundamental frequency.
 6. “#”:The radiated frequency is out the restricted band.



A D T

RESTRICTED BANDEDGE (802.11a MODE, CH36, HORIZONTAL)

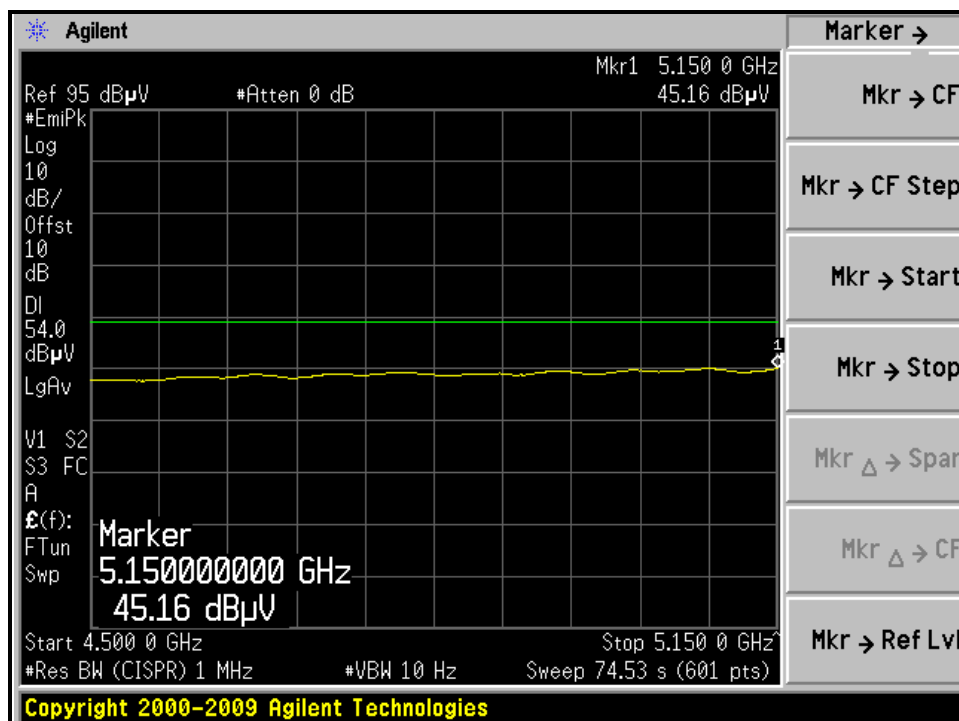
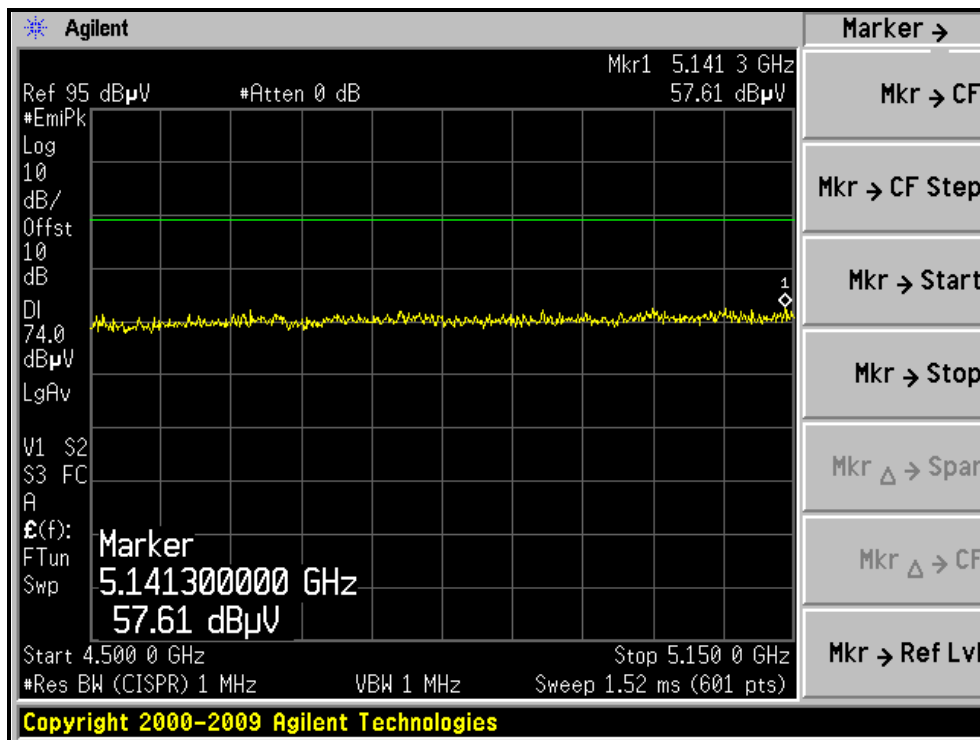



A D T

RESTRICTED BANDEDGE (802.11a MODE, CH36, VERTICAL)

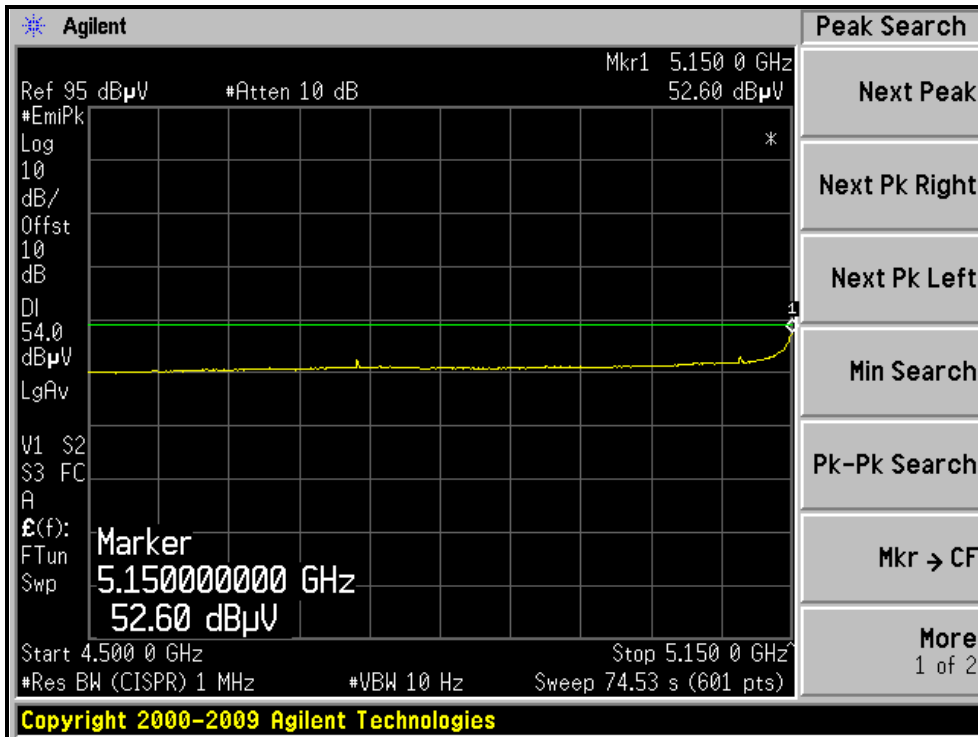
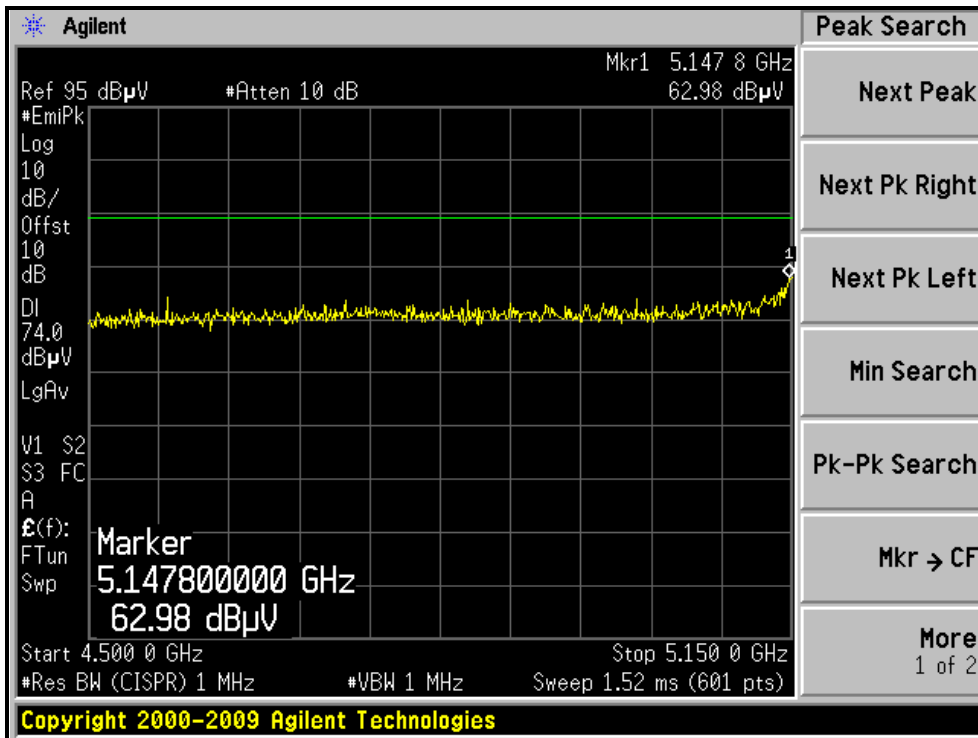



A D T

RESTRICTED BANDEDGE (802.11a MODE, CH64, HORIZONTAL)

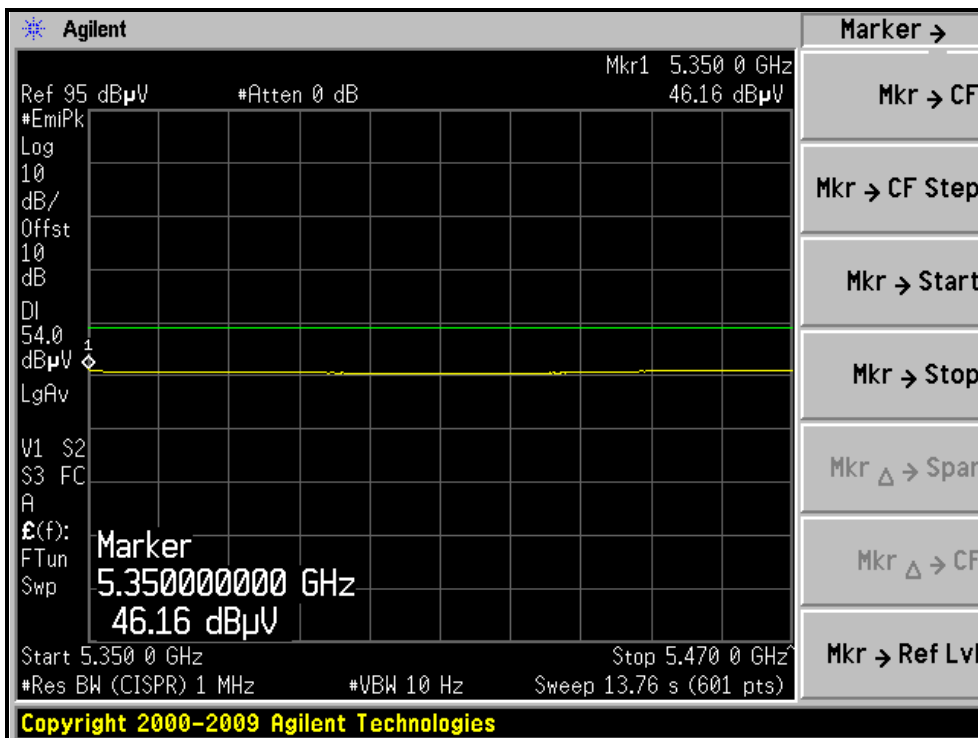
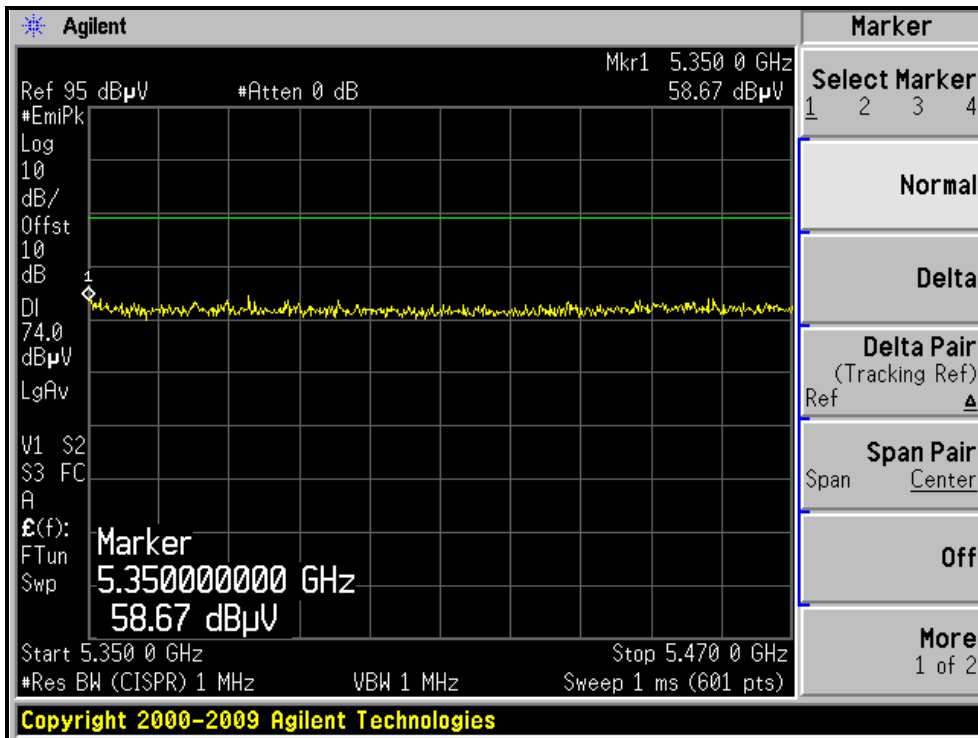



A D T

RESTRICTED BANDEDGE (802.11a MODE, CH64, VERTICAL)

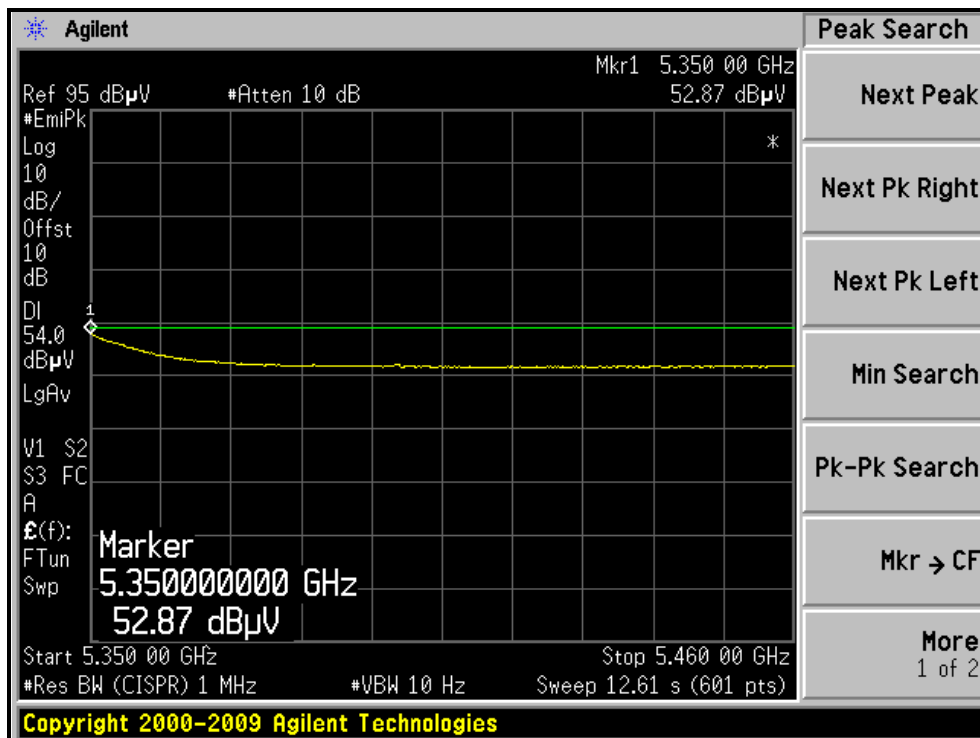
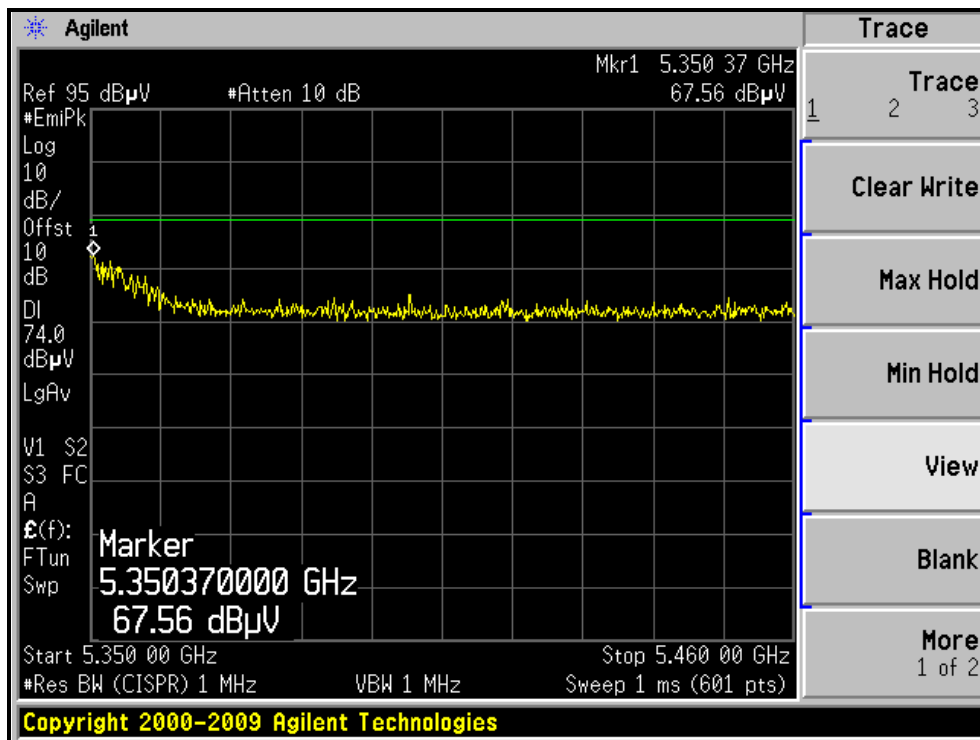



A D T

RESTRICTED BANDEDGE (802.11a MODE, CH100, HORIZONTAL)

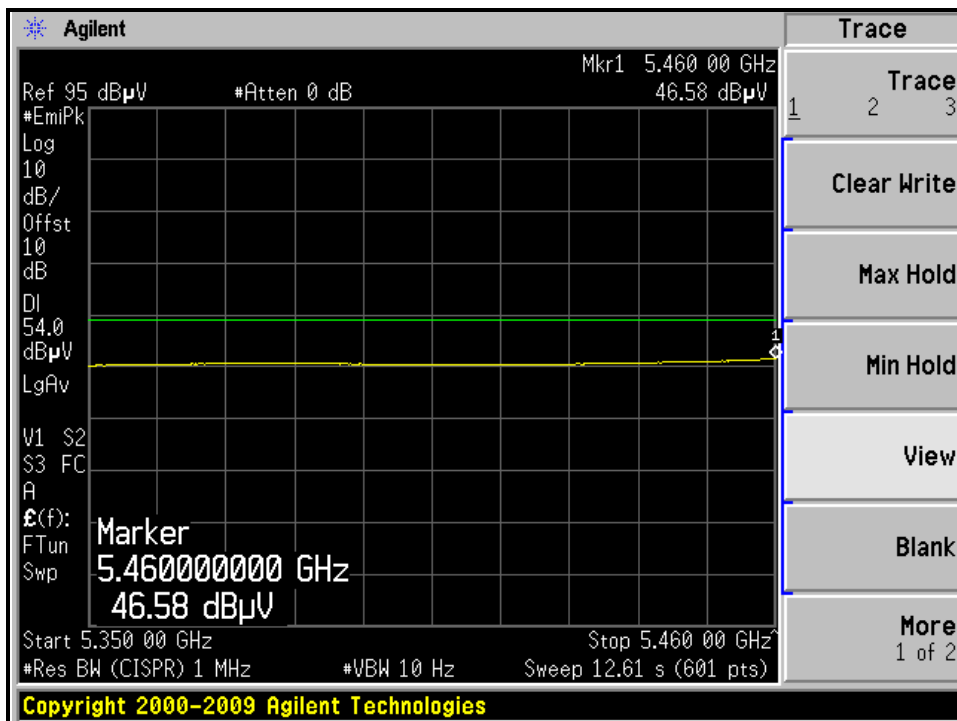
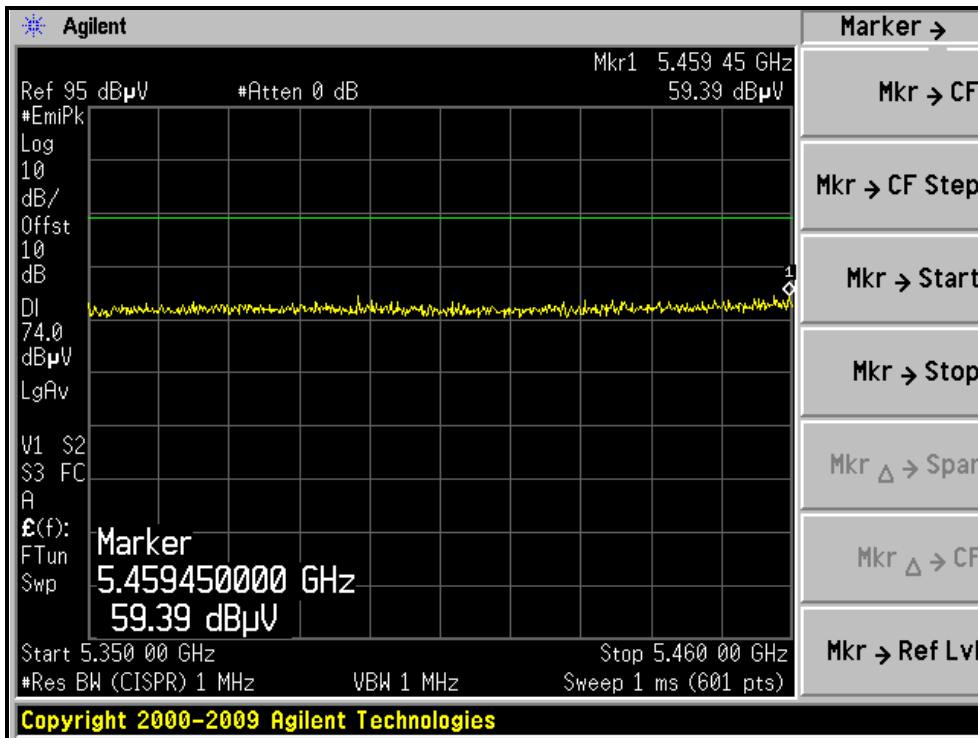



A D T

RESTRICTED BANDEDGE (802.11a MODE, CH100, VERTICAL)

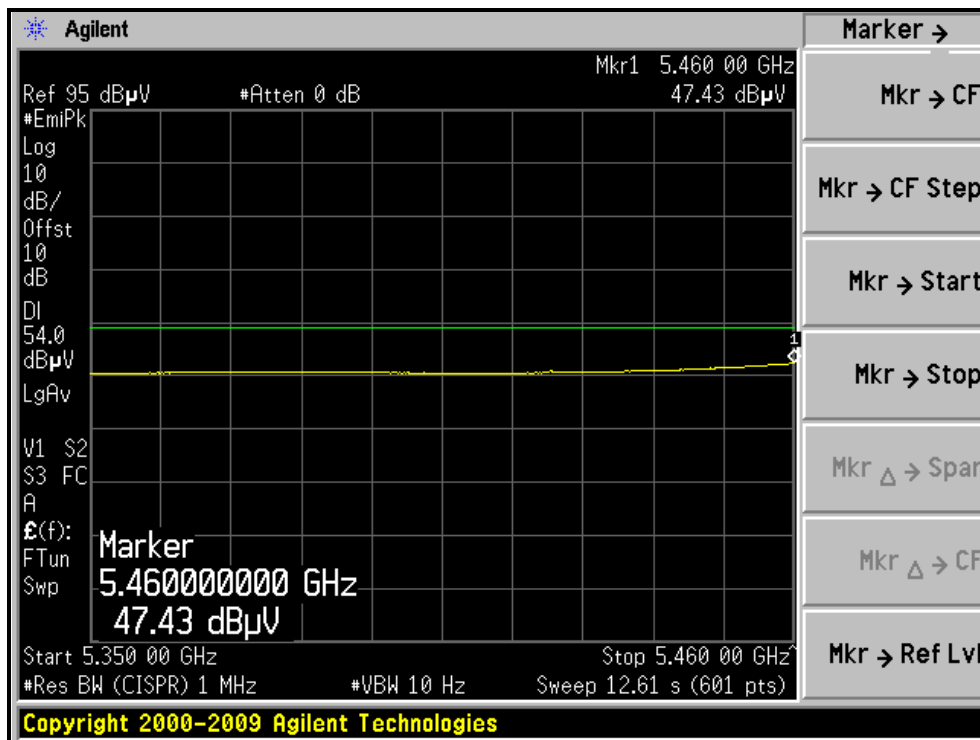
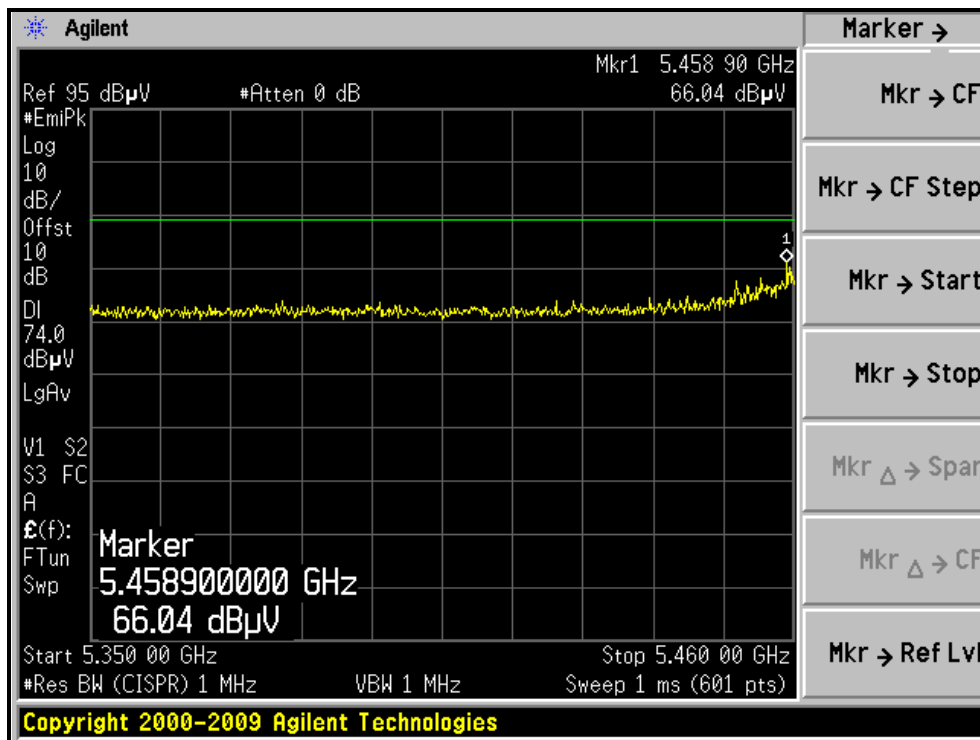



A D T

802.11n (20MHz) OFDM MODULATION

EUT TEST CONDITION		MEASUREMENT DETAIL	
CHANNEL	Channel 36	FREQUENCY RANGE	1 ~ 40GHz
INPUT POWER (SYSTEM)	120Vac, 60 Hz	DETECTOR FUNCTION	Peak (PK) Average (AV)
ENVIRONMENTAL CONDITIONS	22deg. C, 64%RH 1002 hPa	TESTED BY	Frank Liu

ANTENNA POLARITY & TEST DISTANCE: HORIZONTAL AT 3 M								
NO.	FREQ. (MHz)	EMISSION LEVEL (dBuV/m)	LIMIT (dBuV/m)	MARGIN (dB)	ANTENNA HEIGHT (m)	TABLE ANGLE (Degree)	RAW VALUE (dBuV)	CORRECTION FACTOR (dB/m)
1	5150.00	57.2 PK	74.0	-16.8	1.11 H	10	17.26	39.94
2	5150.00	45.1 AV	54.0	-8.9	1.11 H	10	5.16	39.94
3	*5180.00	97.5 PK			1.11 H	10	57.48	40.02
4	*5180.00	87.9 AV			1.11 H	10	47.88	40.02
5	#10360.00	55.1 PK	68.3	-13.2	1.05 H	65	8.57	46.53
6	15540.00	57.9 PK	74.0	-16.1	1.15 H	47	6.53	51.37
7	15540.00	47.9 AV	54.0	-6.1	1.15 H	47	-3.47	51.37

ANTENNA POLARITY & TEST DISTANCE: VERTICAL AT 3 M								
NO.	FREQ. (MHz)	EMISSION LEVEL (dBuV/m)	LIMIT (dBuV/m)	MARGIN (dB)	ANTENNA HEIGHT (m)	TABLE ANGLE (Degree)	RAW VALUE (dBuV)	CORRECTION FACTOR (dB/m)
1	5150.00	65.9 PK	74.0	-8.1	1.00 V	201	25.96	39.94
2	5150.00	52.4 AV	54.0	-1.6	1.00 V	201	12.46	39.94
3	*5180.00	108.4 PK			1.00 V	246	68.38	40.02
4	*5180.00	98.5 AV			1.00 V	246	58.48	40.02
5	#10360.00	54.4 PK	68.3	-13.9	1.00 V	26	7.87	46.53
6	15540.00	56.5 PK	74.0	-17.5	1.16 V	15	5.13	51.37
7	15540.00	47.2 AV	54.0	-6.8	1.16 V	15	-4.17	51.37

- REMARKS:**
1. Emission level (dBuV/m) = Raw Value (dBuV) + Correction Factor (dB/m).
 2. Correction Factor (dB/m) = Antenna Factor (dB/m) + Cable Factor (dB).
 3. The other emission levels were very low against the limit.
 4. Margin value = Emission level – Limit value.
 5. “ * “: Fundamental frequency.
 6. “#“:The radiated frequency is out the restricted band.



A D T

EUT TEST CONDITION		MEASUREMENT DETAIL	
CHANNEL	Channel 40	FREQUENCY RANGE	1 ~ 40GHz
INPUT POWER (SYSTEM)	120Vac, 60 Hz	DETECTOR FUNCTION	Peak (PK) Average (AV)
ENVIRONMENTAL CONDITIONS	22deg. C, 64%RH 1002 hPa	TESTED BY	Frank Liu

ANTENNA POLARITY & TEST DISTANCE: HORIZONTAL AT 3 M								
NO.	FREQ. (MHz)	EMISSION LEVEL (dBuV/m)	LIMIT (dBuV/m)	MARGIN (dB)	ANTENNA HEIGHT (m)	TABLE ANGLE (Degree)	RAW VALUE (dBuV)	CORRECTION FACTOR (dB/m)
1	*5200.00	98.3 PK			1.11 H	155	58.23	40.07
2	*5200.00	87.8 AV			1.11 H	155	47.73	40.07
3	#10400.00	54.3 PK	68.3	-14.0	1.00 H	31	7.73	46.57
4	15600.00	56.7 PK	74.0	-17.3	1.19 H	28	5.23	51.47
5	15600.00	47.4 AV	54.0	-6.6	1.19 H	28	-4.07	51.47
ANTENNA POLARITY & TEST DISTANCE: VERTICAL AT 3 M								
NO.	FREQ. (MHz)	EMISSION LEVEL (dBuV/m)	LIMIT (dBuV/m)	MARGIN (dB)	ANTENNA HEIGHT (m)	TABLE ANGLE (Degree)	RAW VALUE (dBuV)	CORRECTION FACTOR (dB/m)
1	*5200.00	108.4 PK			1.01 V	343	68.33	40.07
2	*5200.00	98.2 AV			1.01 V	343	58.13	40.07
3	#10400.00	55.1 PK	68.3	-13.2	1.00 V	44	8.53	46.57
4	15600.00	56.5 PK	74.0	-17.5	1.18 V	34	5.03	51.47
5	15600.00	47.0 AV	54.0	-7.0	1.18 V	34	-4.47	51.47

- REMARKS:**
1. Emission level (dBuV/m) = Raw Value (dBuV) + Correction Factor (dB/m).
 2. Correction Factor (dB/m) = Antenna Factor (dB/m) + Cable Factor (dB).
 3. The other emission levels were very low against the limit.
 4. Margin value = Emission level – Limit value.
 5. “ * “: Fundamental frequency.
 6. “ # “: The radiated frequency is out the restricted band.



A D T

EUT TEST CONDITION		MEASUREMENT DETAIL	
CHANNEL	Channel 48	FREQUENCY RANGE	1 ~ 40GHz
INPUT POWER (SYSTEM)	120Vac, 60 Hz	DETECTOR FUNCTION	Peak (PK) Average (AV)
ENVIRONMENTAL CONDITIONS	22deg. C, 64%RH 1002 hPa	TESTED BY	Frank Liu

ANTENNA POLARITY & TEST DISTANCE: HORIZONTAL AT 3 M								
NO.	FREQ. (MHz)	EMISSION LEVEL (dBuV/m)	LIMIT (dBuV/m)	MARGIN (dB)	ANTENNA HEIGHT (m)	TABLE ANGLE (Degree)	RAW VALUE (dBuV)	CORRECTION FACTOR (dB/m)
1	*5240.00	98.0 PK			1.10 H	171	57.83	40.17
2	*5240.00	88.3 AV			1.10 H	171	48.13	40.17
3	#10480.00	54.9 PK	68.3	-13.4	1.01 H	34	8.23	46.67
4	15720.00	57.1 PK	74.0	-16.9	1.11 H	25	5.59	51.51
5	15720.00	47.8 AV	54.0	-6.2	1.11 H	25	-3.71	51.51
ANTENNA POLARITY & TEST DISTANCE: VERTICAL AT 3 M								
NO.	FREQ. (MHz)	EMISSION LEVEL (dBuV/m)	LIMIT (dBuV/m)	MARGIN (dB)	ANTENNA HEIGHT (m)	TABLE ANGLE (Degree)	RAW VALUE (dBuV)	CORRECTION FACTOR (dB/m)
1	*5240.00	108.8 PK			1.00 V	360	68.63	40.17
2	*5240.00	98.4 AV			1.00 V	360	58.23	40.17
3	#10480.00	55.2 PK	68.3	-13.1	1.02 V	29	8.53	46.67
4	15720.00	59.0 PK	74.0	-15.0	1.00 V	41	7.49	51.51
5	15720.00	47.9 AV	54.0	-6.1	1.00 V	41	-3.61	51.51

- REMARKS:**
1. Emission level (dBuV/m) = Raw Value (dBuV) + Correction Factor (dB/m).
 2. Correction Factor (dB/m) = Antenna Factor (dB/m) + Cable Factor (dB).
 3. The other emission levels were very low against the limit.
 4. Margin value = Emission level – Limit value.
 5. “ * “: Fundamental frequency.
 6. “#”:The radiated frequency is out the restricted band.



A D T

EUT TEST CONDITION		MEASUREMENT DETAIL	
CHANNEL	Channel 52	FREQUENCY RANGE	1 ~ 40GHz
INPUT POWER (SYSTEM)	120Vac, 60 Hz	DETECTOR FUNCTION	Peak (PK) Average (AV)
ENVIRONMENTAL CONDITIONS	22deg. C, 64%RH 1002 hPa	TESTED BY	Frank Liu

ANTENNA POLARITY & TEST DISTANCE: HORIZONTAL AT 3 M								
NO.	FREQ. (MHz)	EMISSION LEVEL (dBuV/m)	LIMIT (dBuV/m)	MARGIN (dB)	ANTENNA HEIGHT (m)	TABLE ANGLE (Degree)	RAW VALUE (dBuV)	CORRECTION FACTOR (dB/m)
1	*5260.00	100.0 PK			1.00 H	169	59.77	40.23
2	*5260.00	89.9 AV			1.00 H	169	49.67	40.23
3	#10520.00	54.7 PK	68.3	-13.6	1.00 H	8	7.98	46.72
4	15780.00	57.2 PK	74.0	-16.8	1.08 H	20	5.62	51.58
5	15780.00	47.8 AV	54.0	-6.2	1.08 H	20	-3.78	51.58
ANTENNA POLARITY & TEST DISTANCE: VERTICAL AT 3 M								
NO.	FREQ. (MHz)	EMISSION LEVEL (dBuV/m)	LIMIT (dBuV/m)	MARGIN (dB)	ANTENNA HEIGHT (m)	TABLE ANGLE (Degree)	RAW VALUE (dBuV)	CORRECTION FACTOR (dB/m)
1	*5260.00	111.0 PK			1.00 V	237	70.77	40.23
2	*5260.00	100.9 AV			1.00 V	237	60.67	40.23
3	#10520.00	54.7 PK	68.3	-13.6	1.00 V	22	7.98	46.72
4	15780.00	60.2 PK	74.0	-13.8	1.05 V	52	8.62	51.58
5	15780.00	47.7 AV	54.0	-6.3	1.05 V	52	-3.88	51.58

- REMARKS:**
1. Emission level (dBuV/m) = Raw Value (dBuV) + Correction Factor (dB/m).
 2. Correction Factor (dB/m) = Antenna Factor (dB/m) + Cable Factor (dB).
 3. The other emission levels were very low against the limit.
 4. Margin value = Emission level – Limit value.
 5. “ * “: Fundamental frequency.
 6. “ # “: The radiated frequency is out the restricted band.



A D T

EUT TEST CONDITION		MEASUREMENT DETAIL	
CHANNEL	Channel 60	FREQUENCY RANGE	1 ~ 40GHz
INPUT POWER (SYSTEM)	120Vac, 60 Hz	DETECTOR FUNCTION	Peak (PK) Average (AV)
ENVIRONMENTAL CONDITIONS	22deg. C, 64%RH 1002 hPa	TESTED BY	Frank Liu

ANTENNA POLARITY & TEST DISTANCE: HORIZONTAL AT 3 M								
NO.	FREQ. (MHz)	EMISSION LEVEL (dBuV/m)	LIMIT (dBuV/m)	MARGIN (dB)	ANTENNA HEIGHT (m)	TABLE ANGLE (Degree)	RAW VALUE (dBuV)	CORRECTION FACTOR (dB/m)
1	*5300.00	99.8 PK			1.09 H	163	59.47	40.33
2	*5300.00	90.0 AV			1.09 H	163	49.67	40.33
3	10600.00	55.9 PK	74.0	-18.1	1.00 H	32	9.08	46.82
4	10600.00	44.3 AV	54.0	-9.7	1.00 H	32	-2.52	46.82
5	15900.00	57.6 PK	74.0	-16.4	1.14 H	32	5.94	51.66
6	15900.00	47.6 AV	54.0	-6.4	1.14 H	32	-4.06	51.66
ANTENNA POLARITY & TEST DISTANCE: VERTICAL AT 3 M								
NO.	FREQ. (MHz)	EMISSION LEVEL (dBuV/m)	LIMIT (dBuV/m)	MARGIN (dB)	ANTENNA HEIGHT (m)	TABLE ANGLE (Degree)	RAW VALUE (dBuV)	CORRECTION FACTOR (dB/m)
1	*5300.00	110.5 PK			1.00 V	253	70.17	40.33
2	*5300.00	100.4 AV			1.00 V	253	60.07	40.33
3	10600.00	54.4 PK	74.0	-19.6	1.00 V	37	7.58	46.82
4	10600.00	43.1 AV	54.0	-10.9	1.00 V	37	-3.72	46.82
5	15900.00	61.2 PK	74.0	-12.8	1.00 V	32	9.54	51.66
6	15900.00	47.1 AV	54.0	-6.9	1.00 V	32	-4.56	51.66

- REMARKS:**
1. Emission level (dBuV/m) = Raw Value (dBuV) + Correction Factor (dB/m).
 2. Correction Factor (dB/m) = Antenna Factor (dB/m) + Cable Factor (dB).
 3. The other emission levels were very low against the limit.
 4. Margin value = Emission level – Limit value.
 5. “ * “: Fundamental frequency.



A D T

EUT TEST CONDITION		MEASUREMENT DETAIL	
CHANNEL	Channel 64	FREQUENCY RANGE	1 ~ 40GHz
INPUT POWER (SYSTEM)	120Vac, 60 Hz	DETECTOR FUNCTION	Peak (PK) Average (AV)
ENVIRONMENTAL CONDITIONS	22deg. C, 64%RH 1002 hPa	TESTED BY	Frank Liu

ANTENNA POLARITY & TEST DISTANCE: HORIZONTAL AT 3 M								
NO.	FREQ. (MHz)	EMISSION LEVEL (dBuV/m)	LIMIT (dBuV/m)	MARGIN (dB)	ANTENNA HEIGHT (m)	TABLE ANGLE (Degree)	RAW VALUE (dBuV)	CORRECTION FACTOR (dB/m)
1	*5320.00	99.5 PK			1.02 H	342	59.11	40.39
2	*5320.00	90.0 AV			1.02 H	342	49.61	40.39
3	5350.00	58.7 PK	74.0	-15.3	1.12 H	14	18.23	40.47
4	5350.00	46.0 AV	54.0	-8.0	1.12 H	14	5.53	40.47
5	10640.00	55.5 PK	74.0	-18.5	1.00 H	21	8.63	46.87
6	10640.00	44.1 AV	54.0	-9.9	1.00 H	21	-2.77	46.87
7	15960.00	57.5 PK	74.0	-16.5	1.06 H	27	5.77	51.73
8	15960.00	47.4 AV	54.0	-6.6	1.06 H	27	-4.33	51.73
ANTENNA POLARITY & TEST DISTANCE: VERTICAL AT 3 M								
NO.	FREQ. (MHz)	EMISSION LEVEL (dBuV/m)	LIMIT (dBuV/m)	MARGIN (dB)	ANTENNA HEIGHT (m)	TABLE ANGLE (Degree)	RAW VALUE (dBuV)	CORRECTION FACTOR (dB/m)
1	*5320.00	110.1 PK			1.00 V	303	69.71	40.39
2	*5320.00	100.4 AV			1.00 V	303	60.01	40.39
3	5350.00	68.7 PK	74.0	-5.3	1.00 V	187	28.23	40.47
4	5350.00	52.8 AV	54.0	-1.2	1.00 V	187	12.3	40.47
5	10640.00	54.6 PK	74.0	-19.4	1.00 V	29	7.73	46.87
6	10640.00	43.4 AV	54.0	-10.6	1.00 V	29	-3.47	46.87
7	15960.00	58.4 PK	74.0	-15.6	1.02 V	96	6.67	51.73
8	15960.00	47.5 AV	54.0	-6.5	1.02 V	96	-4.23	51.73

- REMARKS:**
1. Emission level (dBuV/m) = Raw Value (dBuV) + Correction Factor (dB/m).
 2. Correction Factor (dB/m) = Antenna Factor (dB/m) + Cable Factor (dB).
 3. The other emission levels were very low against the limit.
 4. Margin value = Emission level – Limit value.
 5. “ * “: Fundamental frequency.



A D T

EUT TEST CONDITION		MEASUREMENT DETAIL	
CHANNEL	Channel 100	FREQUENCY RANGE	1 ~ 40GHz
INPUT POWER (SYSTEM)	120Vac, 60 Hz	DETECTOR FUNCTION	Peak (PK) Average (AV)
ENVIRONMENTAL CONDITIONS	22deg. C, 64%RH 1002 hPa	TESTED BY	Frank Liu

ANTENNA POLARITY & TEST DISTANCE: HORIZONTAL AT 3 M								
NO.	FREQ. (MHz)	EMISSION LEVEL (dBuV/m)	LIMIT (dBuV/m)	MARGIN (dB)	ANTENNA HEIGHT (m)	TABLE ANGLE (Degree)	RAW VALUE (dBuV)	CORRECTION FACTOR (dB/m)
1	5460.00	58.2 PK	74.0	-15.8	1.11 H	10	17.44	40.76
2	5460.00	46.3 AV	54.0	-7.7	1.11 H	10	5.54	40.76
3	#5470.00	60.7 PK	68.3	-7.6	1.09 H	8	19.92	40.78
4	*5500.00	98.7 PK			1.00 H	345	57.84	40.86
5	*5500.00	89.4 AV			1.00 H	345	48.54	40.86
6	11000.00	55.9 PK	74.0	-18.1	1.00 H	33	8.62	47.28
7	11000.00	44.3 AV	54.0	-9.7	1.00 H	33	-2.98	47.28
8	#16500.00	60.3 PK	68.3	-8.0	1.00 H	28	7.27	53.03
ANTENNA POLARITY & TEST DISTANCE: VERTICAL AT 3 M								
NO.	FREQ. (MHz)	EMISSION LEVEL (dBuV/m)	LIMIT (dBuV/m)	MARGIN (dB)	ANTENNA HEIGHT (m)	TABLE ANGLE (Degree)	RAW VALUE (dBuV)	CORRECTION FACTOR (dB/m)
1	5460.00	65.7 PK	74.0	-8.3	1.00 V	310	24.94	40.76
2	5460.00	49.3 AV	54.0	-4.7	1.00 V	310	8.54	40.76
3	#5470.00	66.8 PK	68.3	-1.5	1.00 V	310	26.02	40.78
4	*5500.00	110.2 PK			1.00 V	240	69.34	40.86
5	*5500.00	100.7 AV			1.00 V	240	59.84	40.86
6	11000.00	54.7 PK	74.0	-19.3	1.00 V	36	7.42	47.28
7	11000.00	43.9 AV	54.0	-10.1	1.00 V	36	-3.38	47.28
8	#16500.00	61.8 PK	68.3	-6.5	1.00 V	30	8.77	53.03

- REMARKS:**
1. Emission level (dBuV/m) = Raw Value (dBuV) + Correction Factor (dB/m).
 2. Correction Factor (dB/m) = Antenna Factor (dB/m) + Cable Factor (dB).
 3. The other emission levels were very low against the limit.
 4. Margin value = Emission level – Limit value.
 5. “ * “: Fundamental frequency.
 6. “#”:The radiated frequency is out the restricted band.



A D T

EUT TEST CONDITION		MEASUREMENT DETAIL	
CHANNEL	Channel 116	FREQUENCY RANGE	1 ~ 40GHz
INPUT POWER (SYSTEM)	120Vac, 60 Hz	DETECTOR FUNCTION	Peak (PK) Average (AV)
ENVIRONMENTAL CONDITIONS	27deg. C, 61%RH 1002 hPa	TESTED BY	Frank Liu

ANTENNA POLARITY & TEST DISTANCE: HORIZONTAL AT 3 M								
NO.	FREQ. (MHz)	EMISSION LEVEL (dBuV/m)	LIMIT (dBuV/m)	MARGIN (dB)	ANTENNA HEIGHT (m)	TABLE ANGLE (Degree)	RAW VALUE (dBuV)	CORRECTION FACTOR (dB/m)
1	*5580.00	99.0 PK			1.10 H	350	57.91	41.09
2	*5580.00	89.8 AV			1.10 H	350	48.71	41.09
3	11160.00	56.1 PK	74.0	-17.9	1.00 H	28	8.71	47.39
4	11160.00	44.7 AV	54.0	-9.3	1.00 H	28	-2.69	47.39
5	#16740.00	61.6 PK	68.3	-6.7	1.00 H	0	8.11	53.49

ANTENNA POLARITY & TEST DISTANCE: VERTICAL AT 3 M								
NO.	FREQ. (MHz)	EMISSION LEVEL (dBuV/m)	LIMIT (dBuV/m)	MARGIN (dB)	ANTENNA HEIGHT (m)	TABLE ANGLE (Degree)	RAW VALUE (dBuV)	CORRECTION FACTOR (dB/m)
1	*5580.00	110.8 PK			1.01 V	271	69.71	41.09
2	*5580.00	101.1 AV			1.01 V	271	60.01	41.09
3	11160.00	55.1 PK	74.0	-18.9	1.01 V	43	7.71	47.39
4	11160.00	44.0 AV	54.0	-10.0	1.01 V	43	-3.39	47.39
5	#16740.00	62.2 PK	68.3	-6.1	1.11 V	31	8.71	53.49

- REMARKS:**
1. Emission level (dBuV/m) = Raw Value (dBuV) + Correction Factor (dB/m).
 2. Correction Factor (dB/m) = Antenna Factor (dB/m) + Cable Factor (dB).
 3. The other emission levels were very low against the limit.
 4. Margin value = Emission level – Limit value.
 5. “ * “: Fundamental frequency.
 6. “ # “: The radiated frequency is out the restricted band.



A D T

EUT TEST CONDITION		MEASUREMENT DETAIL	
CHANNEL	Channel 120	FREQUENCY RANGE	1 ~ 40GHz
INPUT POWER (SYSTEM)	120Vac, 60 Hz	DETECTOR FUNCTION	Peak (PK) Average (AV)
ENVIRONMENTAL CONDITIONS	22deg. C, 64%RH 1002 hPa	TESTED BY	Frank Liu

ANTENNA POLARITY & TEST DISTANCE: HORIZONTAL AT 3 M								
NO.	FREQ. (MHz)	EMISSION LEVEL (dBuV/m)	LIMIT (dBuV/m)	MARGIN (dB)	ANTENNA HEIGHT (m)	TABLE ANGLE (Degree)	RAW VALUE (dBuV)	CORRECTION FACTOR (dB/m)
1	*5600.00	99.4 PK			1.10 H	348	58.25	41.15
2	*5600.00	90.5 AV			1.10 H	348	49.35	41.15
3	11200.00	55.8 PK	74.0	-18.2	1.00 H	38	8.38	47.42
4	11200.00	44.6 AV	54.0	-9.4	1.00 H	38	-2.82	47.42
5	#16800.00	61.7 PK	68.3	-6.6	1.00 H	8	8.07	53.63

ANTENNA POLARITY & TEST DISTANCE: VERTICAL AT 3 M								
NO.	FREQ. (MHz)	EMISSION LEVEL (dBuV/m)	LIMIT (dBuV/m)	MARGIN (dB)	ANTENNA HEIGHT (m)	TABLE ANGLE (Degree)	RAW VALUE (dBuV)	CORRECTION FACTOR (dB/m)
1	*5600.00	111.2 PK			1.00 V	258	70.05	41.15
2	*5600.00	101.3 AV			1.00 V	258	60.15	41.15
3	11200.00	54.8 PK	74.0	-19.2	1.00 V	39	7.38	47.42
4	11200.00	43.6 AV	54.0	-10.4	1.00 V	39	-3.82	47.42
5	#16800.00	62.2 PK	68.3	-6.1	1.10 V	36	8.57	53.63

- REMARKS:**
1. Emission level (dBuV/m) = Raw Value (dBuV) + Correction Factor (dB/m).
 2. Correction Factor (dB/m) = Antenna Factor (dB/m) + Cable Factor (dB).
 3. The other emission levels were very low against the limit.
 4. Margin value = Emission level – Limit value.
 5. “ * “: Fundamental frequency.
 6. “#”:The radiated frequency is out the restricted band.



A D T

EUT TEST CONDITION		MEASUREMENT DETAIL	
CHANNEL	Channel 132	FREQUENCY RANGE	1 ~ 40GHz
INPUT POWER (SYSTEM)	120Vac, 60 Hz	DETECTOR FUNCTION	Peak (PK) Average (AV)
ENVIRONMENTAL CONDITIONS	27deg. C, 61%RH 1002 hPa	TESTED BY	Rex Huang

ANTENNA POLARITY & TEST DISTANCE: HORIZONTAL AT 3 M								
NO.	FREQ. (MHz)	EMISSION LEVEL (dBuV/m)	LIMIT (dBuV/m)	MARGIN (dB)	ANTENNA HEIGHT (m)	TABLE ANGLE (Degree)	RAW VALUE (dBuV)	CORRECTION FACTOR (dB/m)
1	*5660.00	97.2 PK			1.15 H	341	55.97	41.23
2	*5660.00	88.5 AV			1.15 H	341	47.27	41.23
3	11320.00	56.5 PK	74.0	-17.5	1.00 H	28	9.15	47.35
4	11320.00	44.7 AV	54.0	-9.3	1.00 H	28	-2.65	47.35
5	#16980.00	61.7 PK	68.3	-6.6	1.01 H	6	7.62	54.08
ANTENNA POLARITY & TEST DISTANCE: VERTICAL AT 3 M								
NO.	FREQ. (MHz)	EMISSION LEVEL (dBuV/m)	LIMIT (dBuV/m)	MARGIN (dB)	ANTENNA HEIGHT (m)	TABLE ANGLE (Degree)	RAW VALUE (dBuV)	CORRECTION FACTOR (dB/m)
1	*5660.00	110.1 PK			1.00 V	268	68.87	41.23
2	*5660.00	100.2 AV			1.00 V	268	58.97	41.23
3	11320.00	55.3 PK	74.0	-18.7	1.00 V	44	7.95	47.35
4	11320.00	43.8 AV	54.0	-10.2	1.00 V	44	-3.55	47.35
5	#16980.00	59.70 PK	68.3	-8.6	1.01 V	35	5.62	54.08

- REMARKS:**
1. Emission level (dBuV/m) = Raw Value (dBuV) + Correction Factor (dB/m).
 2. Correction Factor (dB/m) = Antenna Factor (dB/m) + Cable Factor (dB).
 3. The other emission levels were very low against the limit.
 4. Margin value = Emission level – Limit value.
 5. “ * “: Fundamental frequency.
 6. "#":The radiated frequency is out the restricted band.



A D T

EUT TEST CONDITION		MEASUREMENT DETAIL	
CHANNEL	Channel 140	FREQUENCY RANGE	1 ~ 40GHz
INPUT POWER (SYSTEM)	120Vac, 60 Hz	DETECTOR FUNCTION	Peak (PK) Average (AV)
ENVIRONMENTAL CONDITIONS	22deg. C, 64%RH 1002 hPa	TESTED BY	Frank Liu

ANTENNA POLARITY & TEST DISTANCE: HORIZONTAL AT 3 M								
NO.	FREQ. (MHz)	EMISSION LEVEL (dBuV/m)	LIMIT (dBuV/m)	MARGIN (dB)	ANTENNA HEIGHT (m)	TABLE ANGLE (Degree)	RAW VALUE (dBuV)	CORRECTION FACTOR (dB/m)
1	*5700.00	98.2 PK			1.09 H	17	56.78	41.42
2	*5700.00	88.5 AV			1.09 H	17	47.08	41.42
3	#5725.00	61.4 PK	68.3	-6.9	1.08 H	11	19.91	41.49
4	11400.00	55.2 PK	74.0	-18.8	1.05 H	44	7.58	47.62
5	11400.00	44.1 AV	54.0	-9.9	1.05 H	44	-3.52	47.62
6	#17100.00	61.3 PK	68.3	-7.0	1.00 H	11	7.10	54.20
ANTENNA POLARITY & TEST DISTANCE: VERTICAL AT 3 M								
NO.	FREQ. (MHz)	EMISSION LEVEL (dBuV/m)	LIMIT (dBuV/m)	MARGIN (dB)	ANTENNA HEIGHT (m)	TABLE ANGLE (Degree)	RAW VALUE (dBuV)	CORRECTION FACTOR (dB/m)
1	*5700.00	109.0 PK			1.64 V	12	67.58	41.42
2	*5700.00	99.8 AV			1.64 V	12	58.38	41.42
3	#5725.00	67.2 PK	68.3	-1.1	1.00 V	344	25.71	41.49
4	11400.00	54.6 PK	74.0	-19.4	1.00 V	41	6.98	47.62
5	11400.00	43.2 AV	54.0	-10.8	1.00 V	41	-4.42	47.62
6	#17100.00	61.6 PK	68.3	-6.7	1.07 V	26	7.40	54.20

- REMARKS:**
1. Emission level (dBuV/m) = Raw Value (dBuV) + Correction Factor (dB/m).
 2. Correction Factor (dB/m) = Antenna Factor (dB/m) + Cable Factor (dB).
 3. The other PK emission levels were very low against the limit.
 4. Margin value = Emission level – Limit value.
 5. “ * “: Fundamental frequency.
 6. “ # “: The radiated frequency is out the restricted band.



A D T

RESTRICTED BANDEDGE (802.11n(20MHz) MODE, CH36, HORIZONTAL)

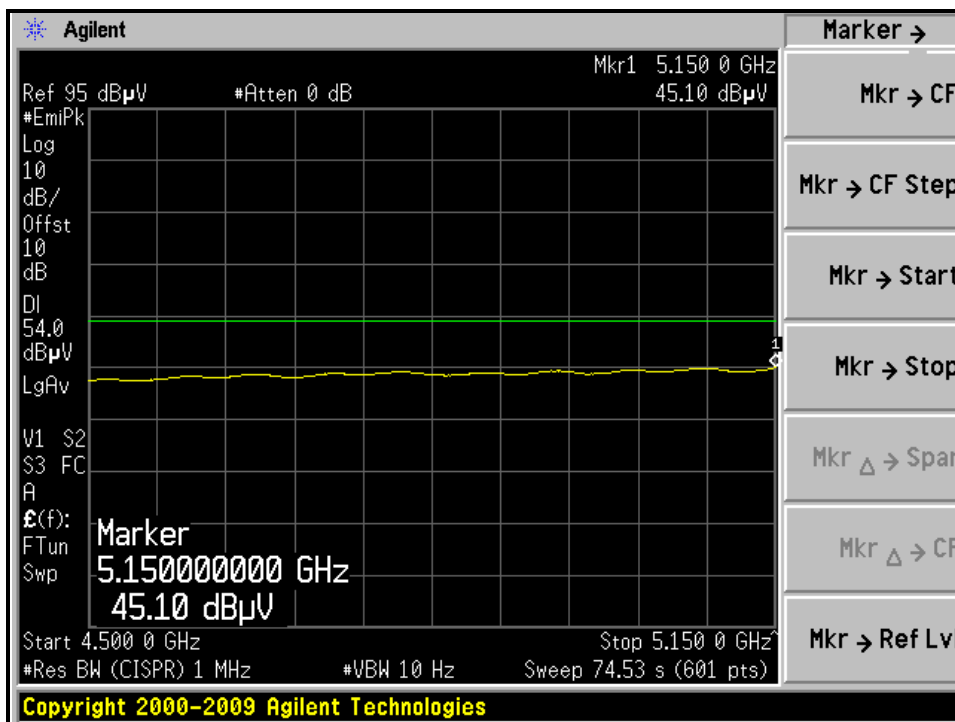
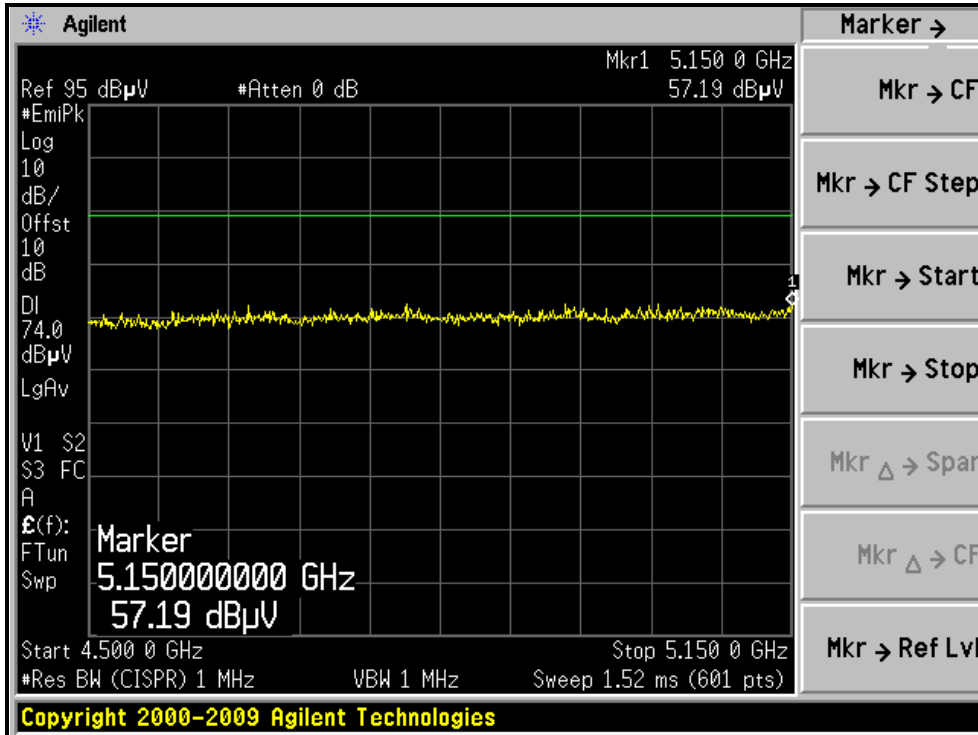



A D T

RESTRICTED BANDEDGE (802.11n(20MHz) MODE, CH36, VERTICAL)

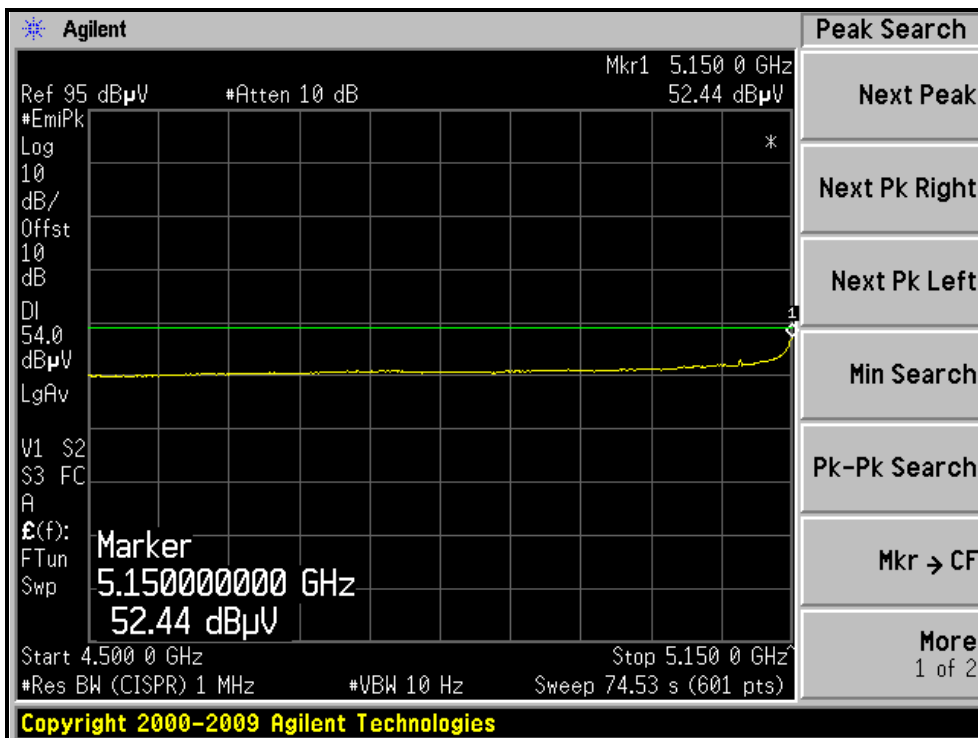
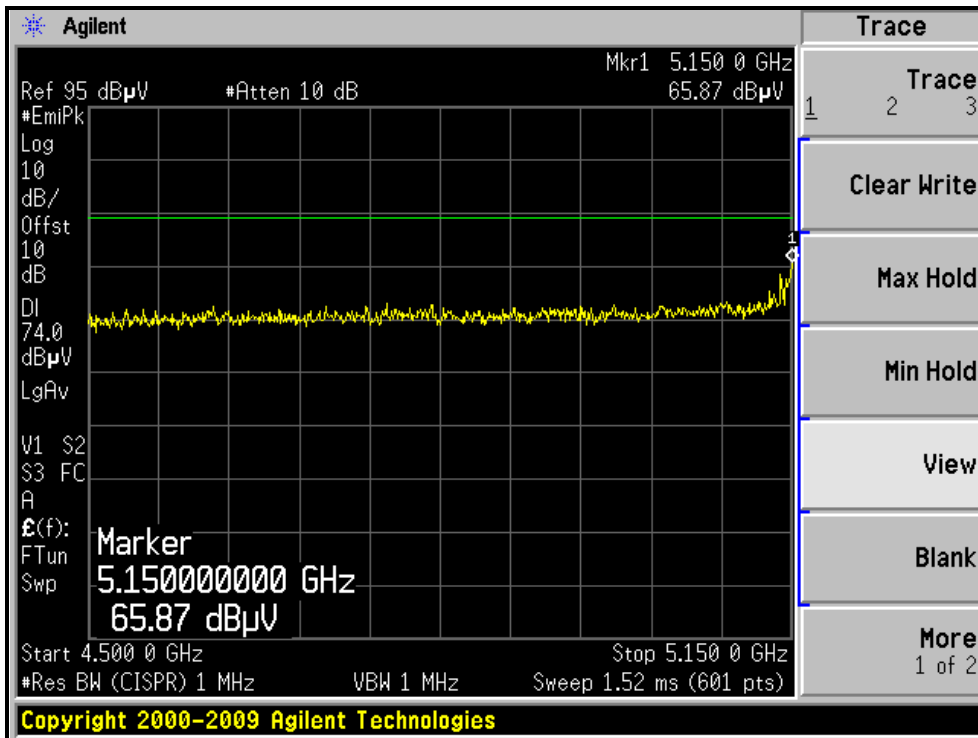



A D T

RESTRICTED BANDEDGE (802.11n(20MHz) MODE, CH64, HORIZONTAL)

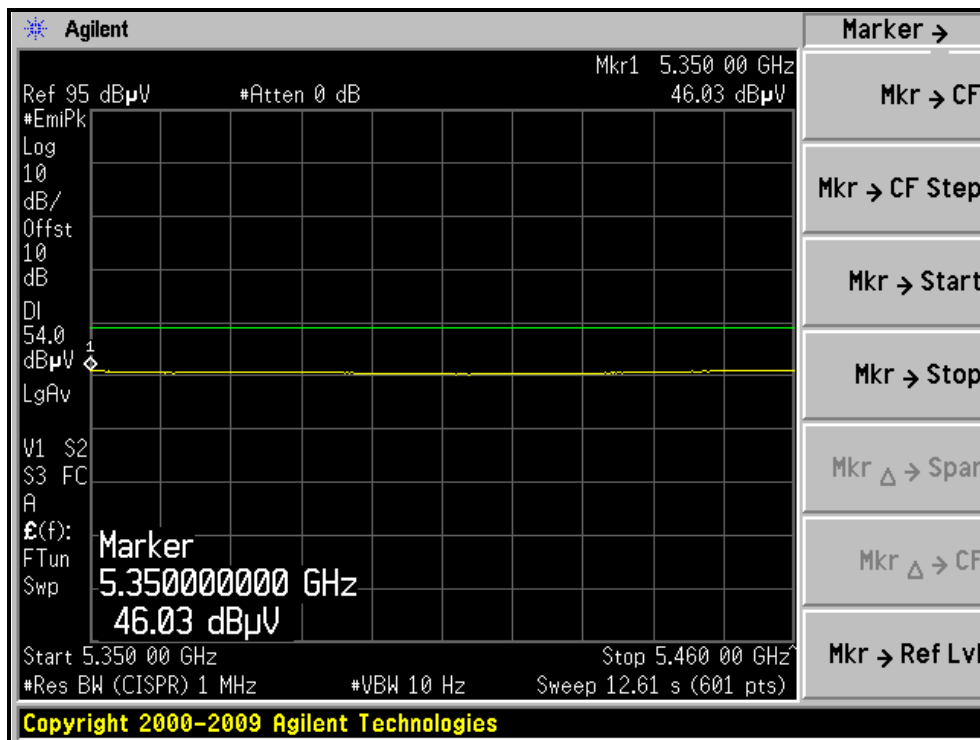
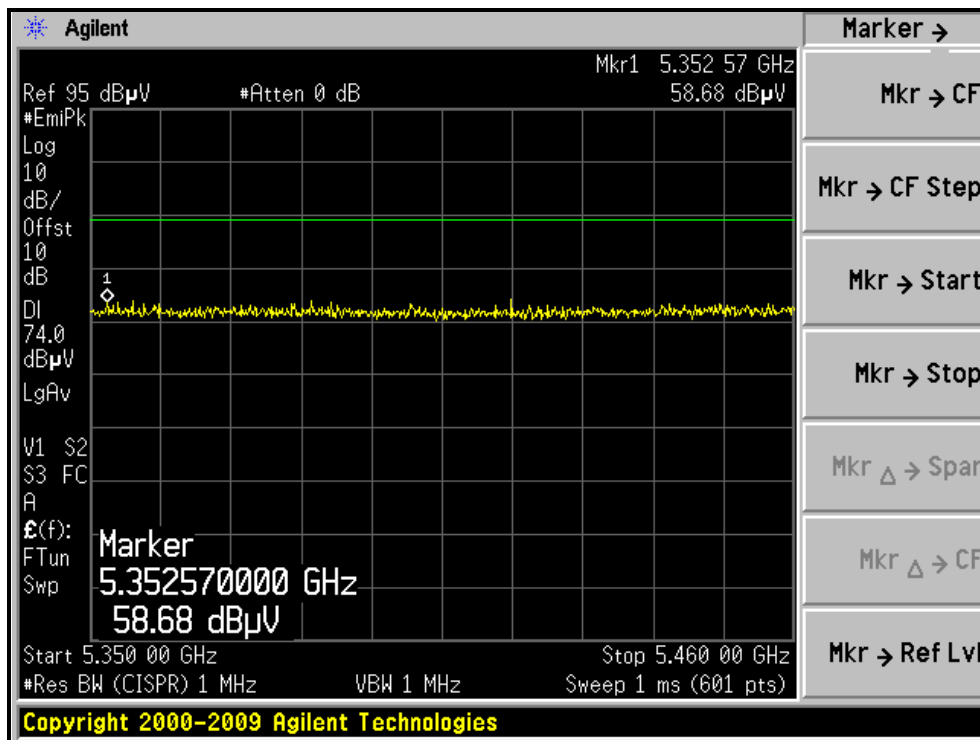



A D T

RESTRICTED BANDEDGE (802.11n(20MHz) MODE, CH64, VERTICAL)

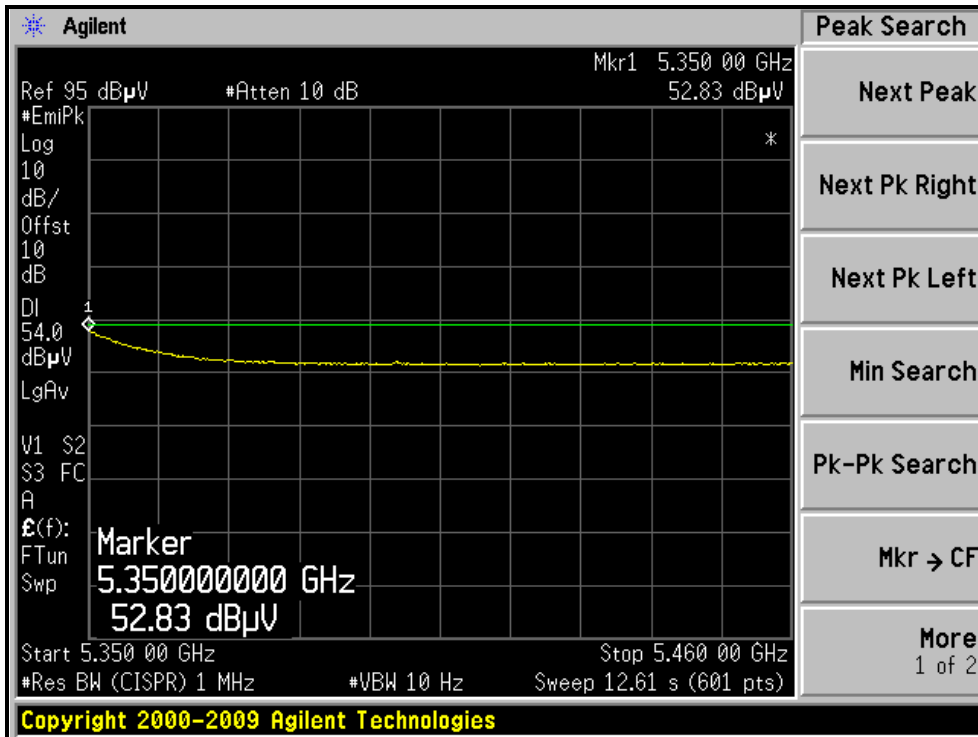
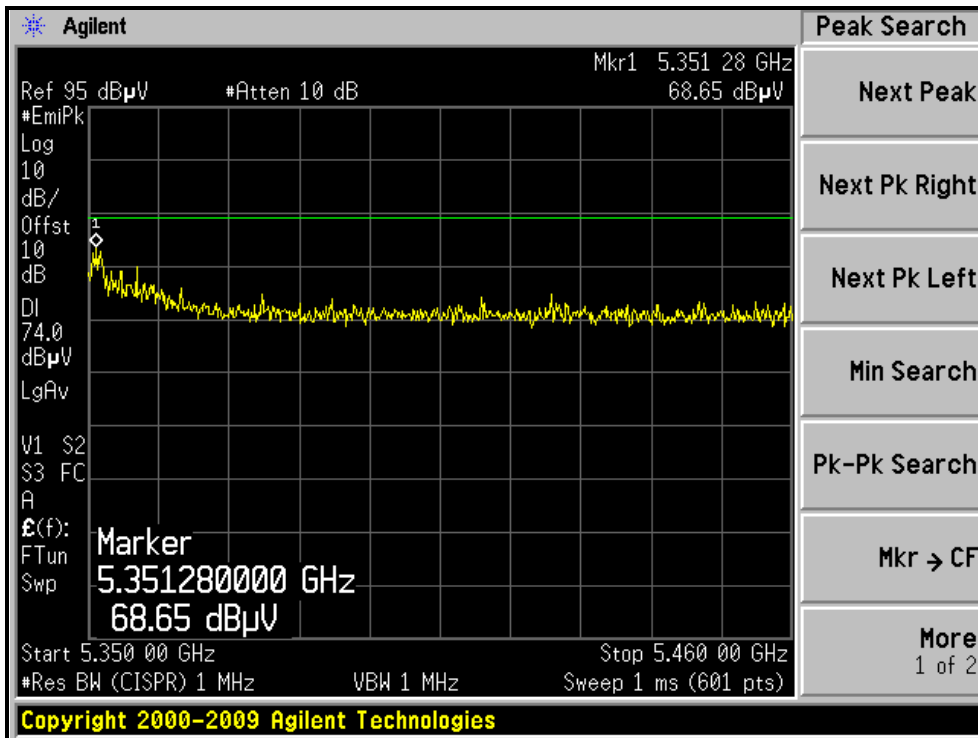



A D T

RESTRICTED BANDEDGE (802.11n(20MHz) MODE, CH100, HORIZONTAL)

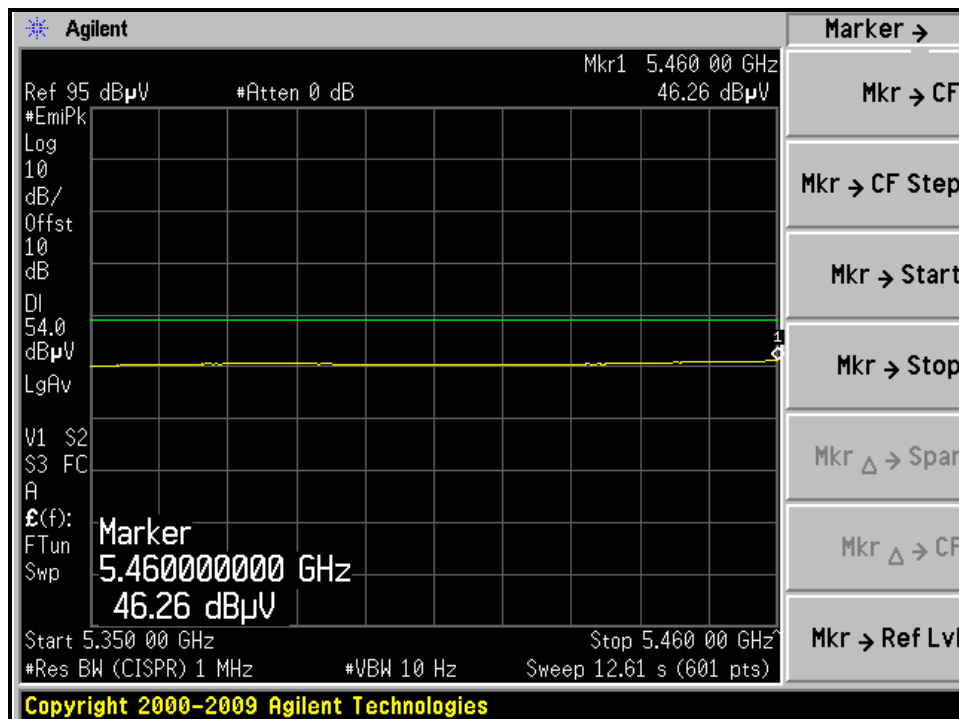
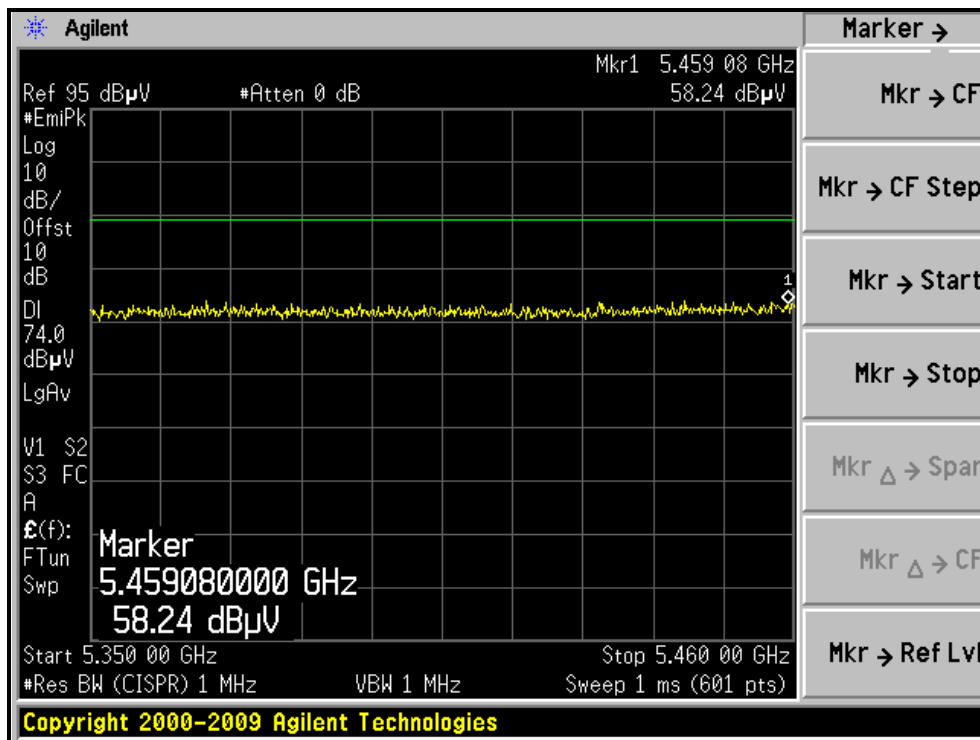



A D T

RESTRICTED BANDEDGE (802.11n(20MHz) MODE, CH100, VERTICAL)

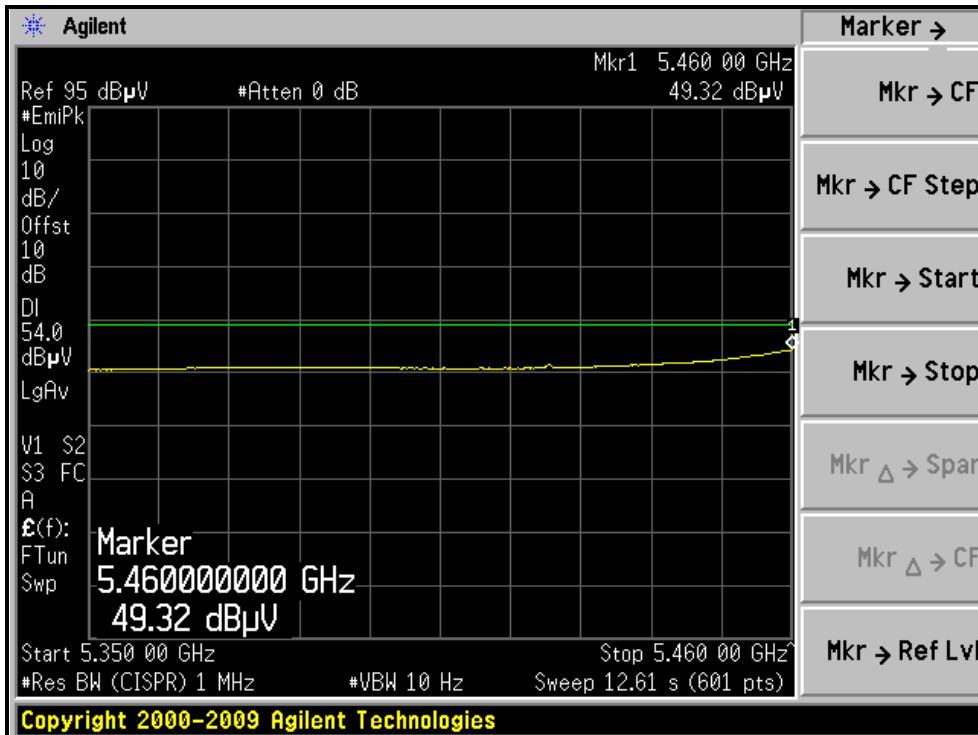
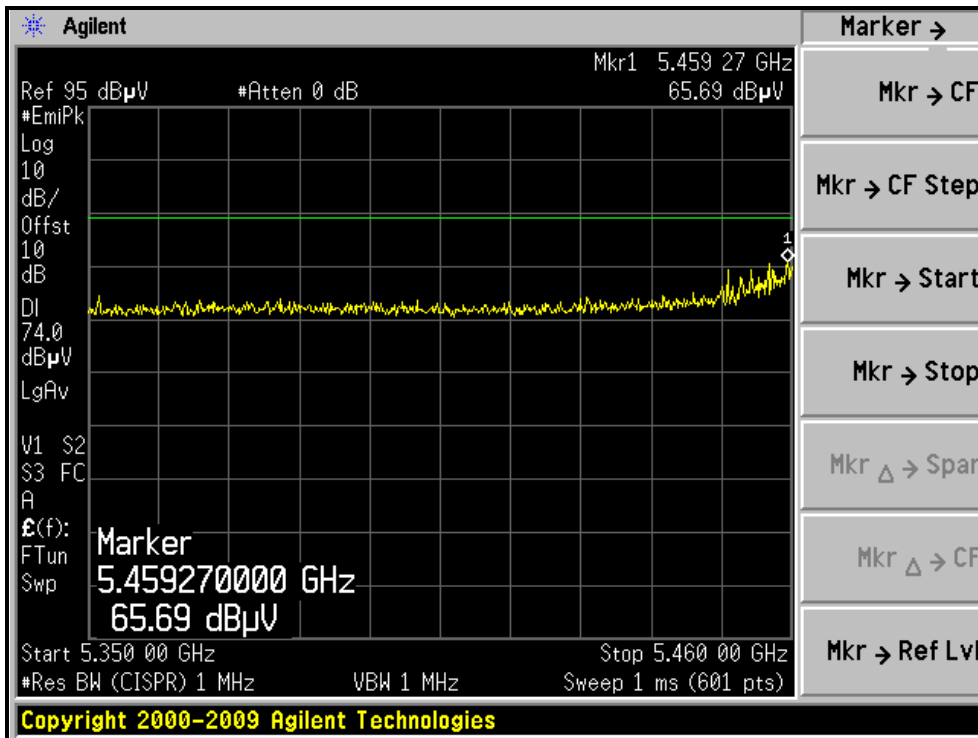

4.3 OUTPUT TRANSMIT POWER MEASUREMENT

4.3.1 LIMITS OF OUTPUT TRANSMIT POWER MEASUREMENT

Frequency Band	Limit
5.15 – 5.25GHz	The lesser of 50mW (17dBm) or 4dBm + 10logB
5.25 – 5.35GHz	The lesser of 250mW (24dBm) or 11dBm + 10logB
5.47 – 5.725GHz	The lesser of 250mW (24dBm) or 11dBm + 10logB
5.725 – 5.825GHz	The lesser of 1W (30dBm) or 17dBm + 10logB

NOTE: Where B is the 26dB emission bandwidth in MHz.

4.3.2 TEST INSTRUMENTS

DESCRIPTION & MANUFACTURER	MODEL NO.	SERIAL NO.	CALIBRATED DATE	CALIBRATED UNTIL
Spectrum Analyzer	E4446A	MY48250254	July 14, 2010	July 13, 2011

NOTE:

1. The calibration interval of the above test instruments is 12 months and the calibrations are traceable to NML/ROC and NIST/USA.

4.3.3 TEST PROCEDURE

1. The transmitter output was connected to the spectrum analyzer.
2. Set span to encompass the entire emission bandwidth of the signal.
3. Set RBW to 1MHz, VBW to 3MHz.
4. Using the spectrum analyzer's channel power measurement function to measure the output power.

The transmitter output operates continuously therefore Method # 1 is used.

4.3.4 DEVIATION FROM TEST STANDARD

No deviation

4.3.5 TEST SETUP

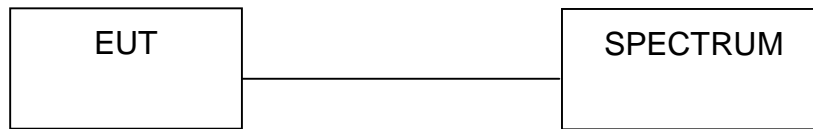

4.3.6 EUT OPERATING CONDITIONS

The software provided by client to enable the EUT under transmission condition continuously at specific channel frequencies individually.



A D T

4.3.7 TEST RESULTS(MODE A)

802.11a OFDM MODULATION:

CHANNEL	CHANNEL FREQUENCY (MHz)	OUTPUT POWER (mW)	OUTPUT POWER (dBm)	OUTPUT POWER LIMIT (dBm)	26dBc Occupied Bandwidth (MHz)	PASS/ FAIL
36	5180	22.4	13.5	17.0	20.75	PASS
40	5200	22.4	13.5	17.0	20.58	PASS
48	5240	20.4	13.1	17.0	19.58	PASS
52	5260	55.0	17.4	24.0	28.42	PASS
60	5300	55.0	17.4	24.0	26.83	PASS
64	5320	38.0	15.8	24.0	21.58	PASS
100	5500	50.1	17.0	24.0	26.92	PASS
116	5580	56.2	17.5	24.0	27.92	PASS
120	5600	45.7	16.6	24.0	25.67	PASS
132	5660	46.8	16.7	24.0	27.75	PASS
140	5700	49.0	16.9	24.0	22.42	PASS

NOTE: The 26dBc Occupied Bandwidth plot, please refer to the following pages.



A D T

Power Output: CH36

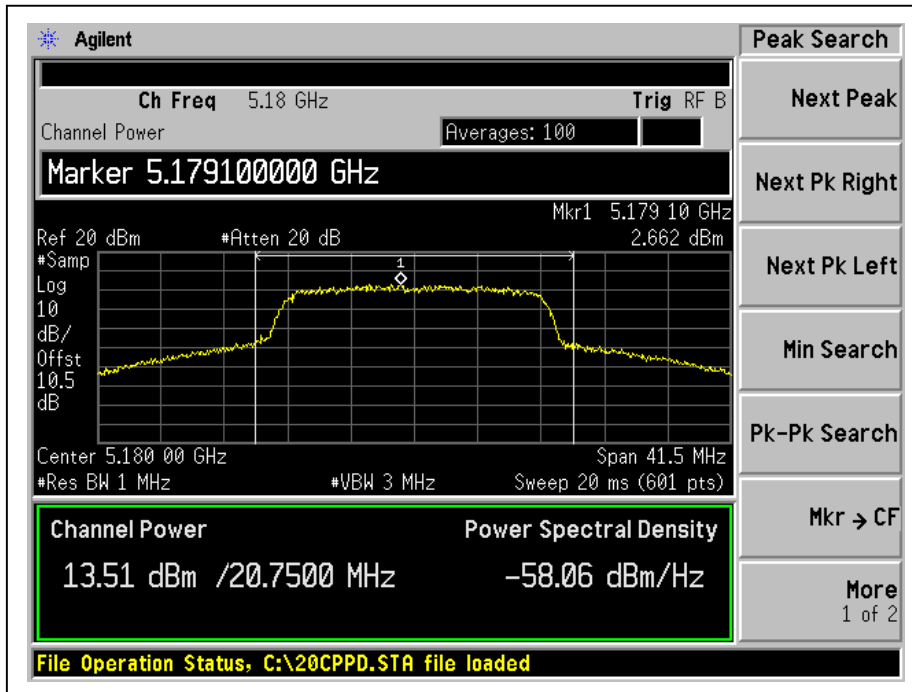

CH40

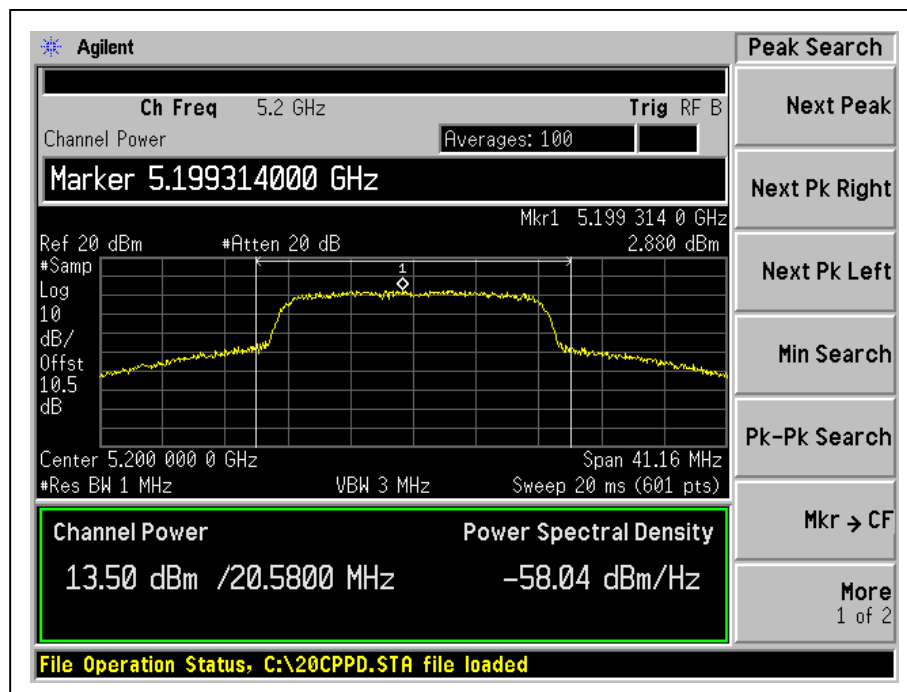



A D T

CH48

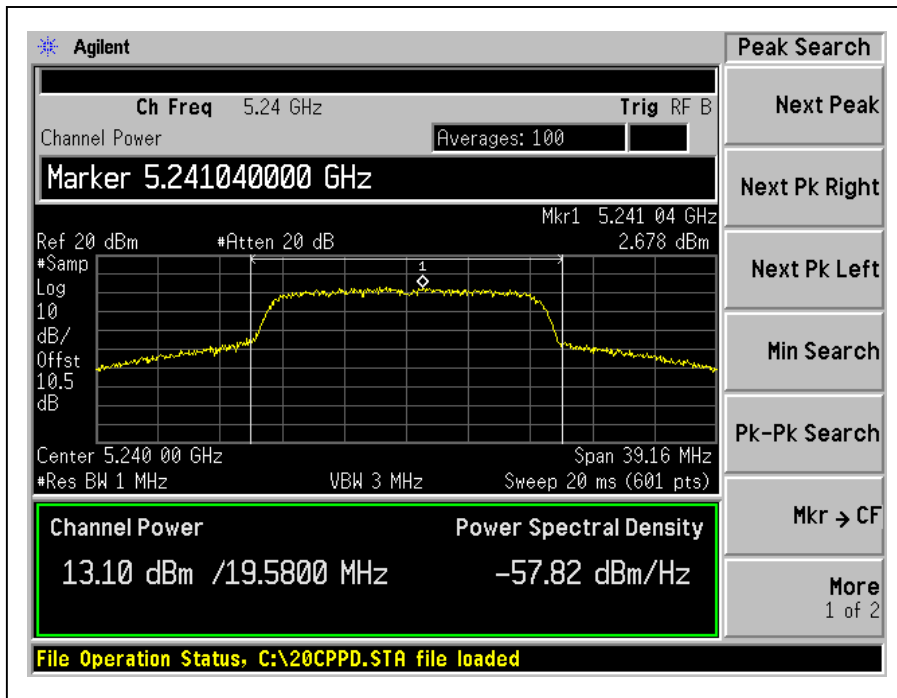

CH52

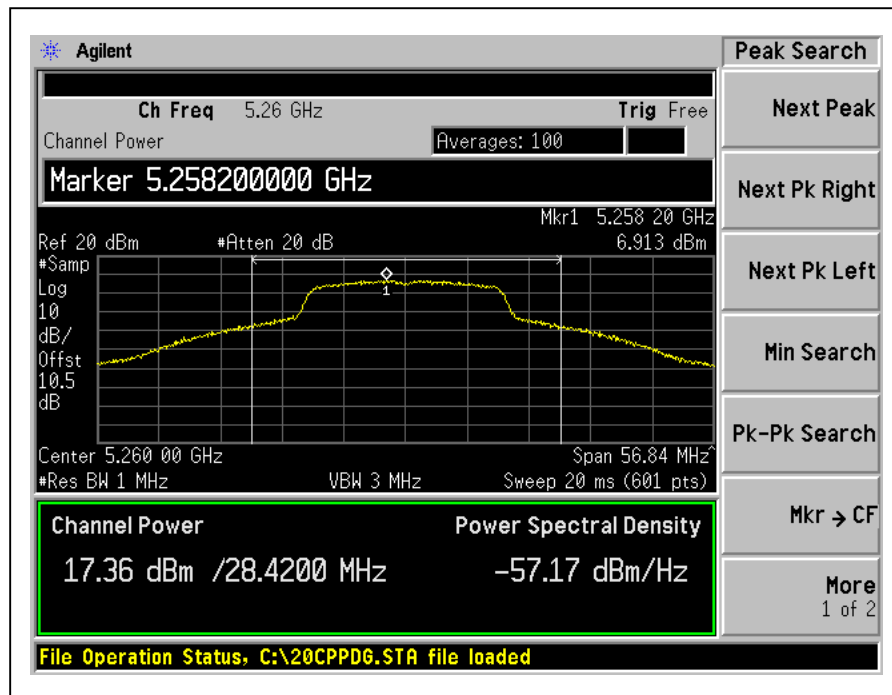



A D T

CH60

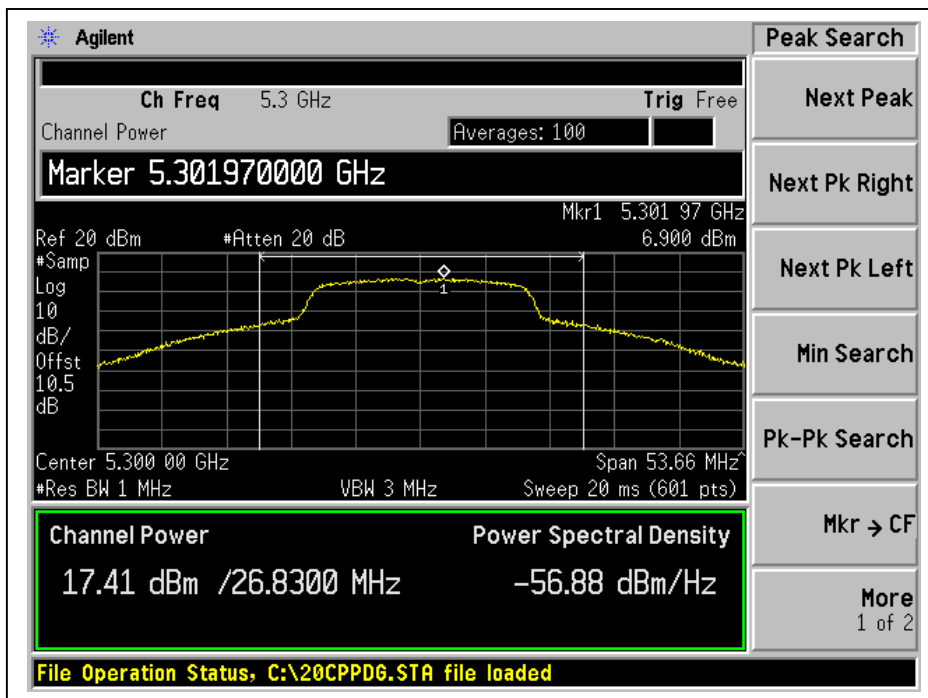

CH64

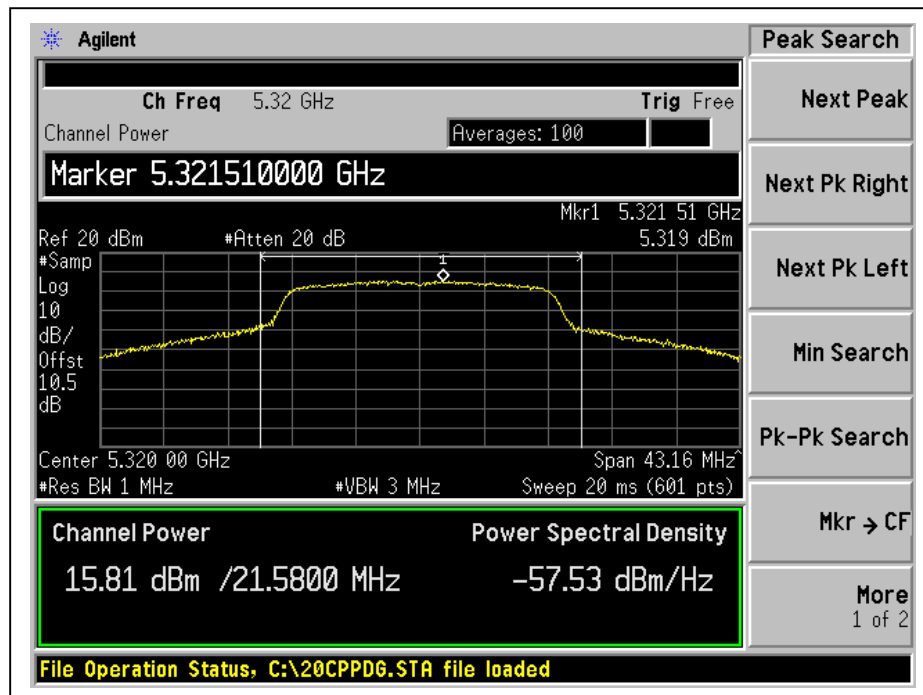



A D T

CH100

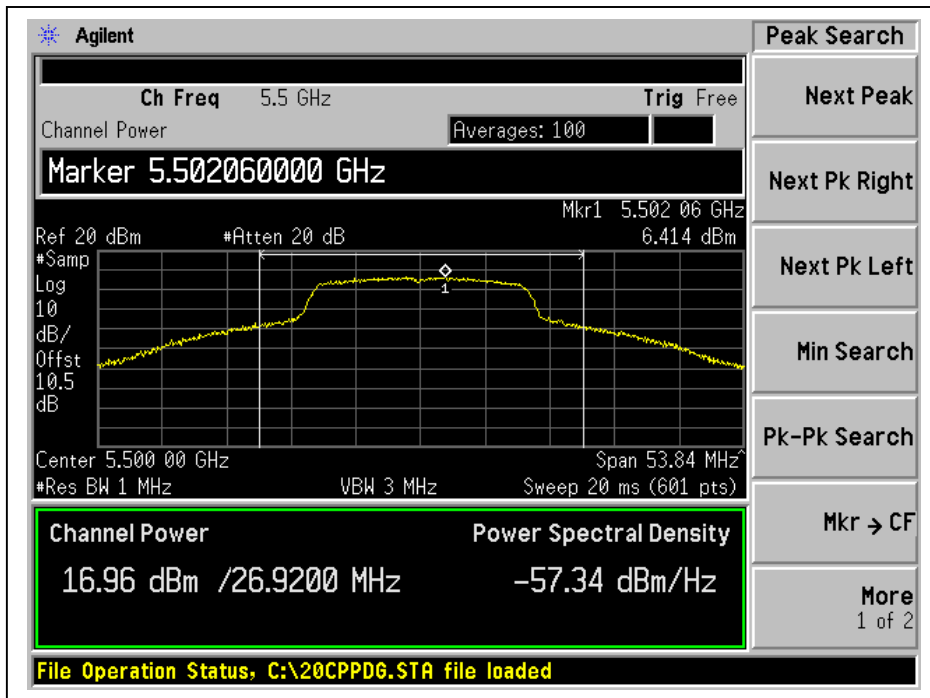

CH116

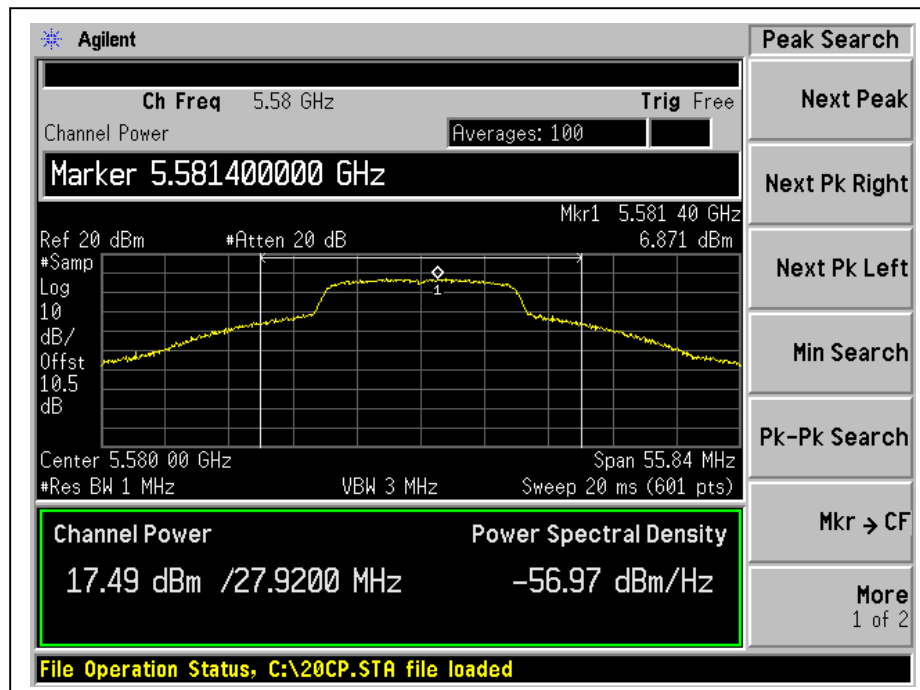



A D T

CH120

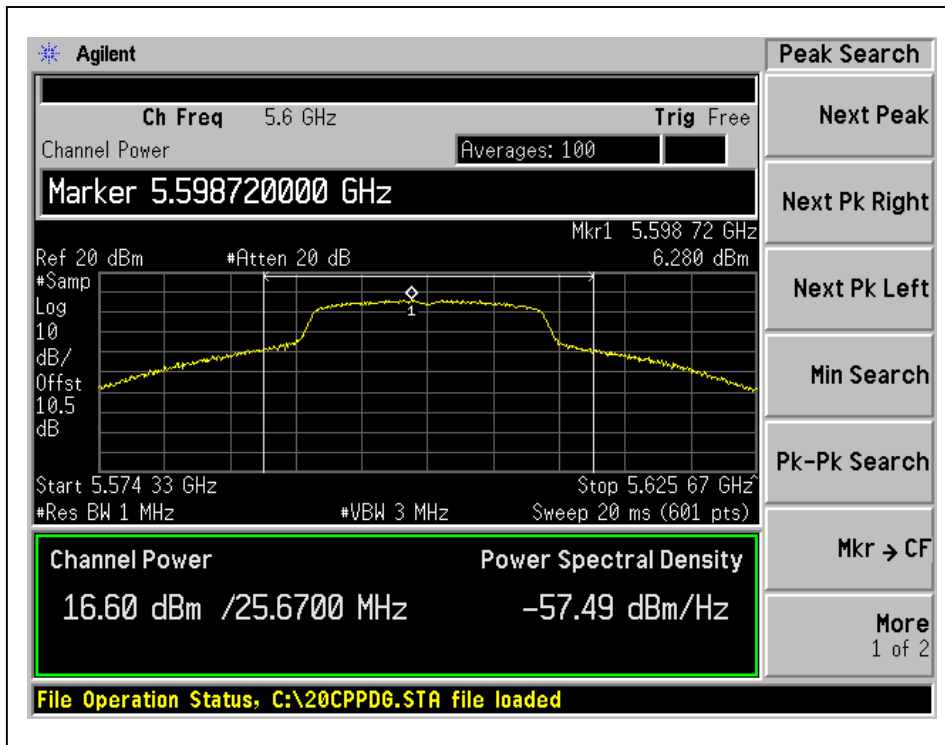

CH132

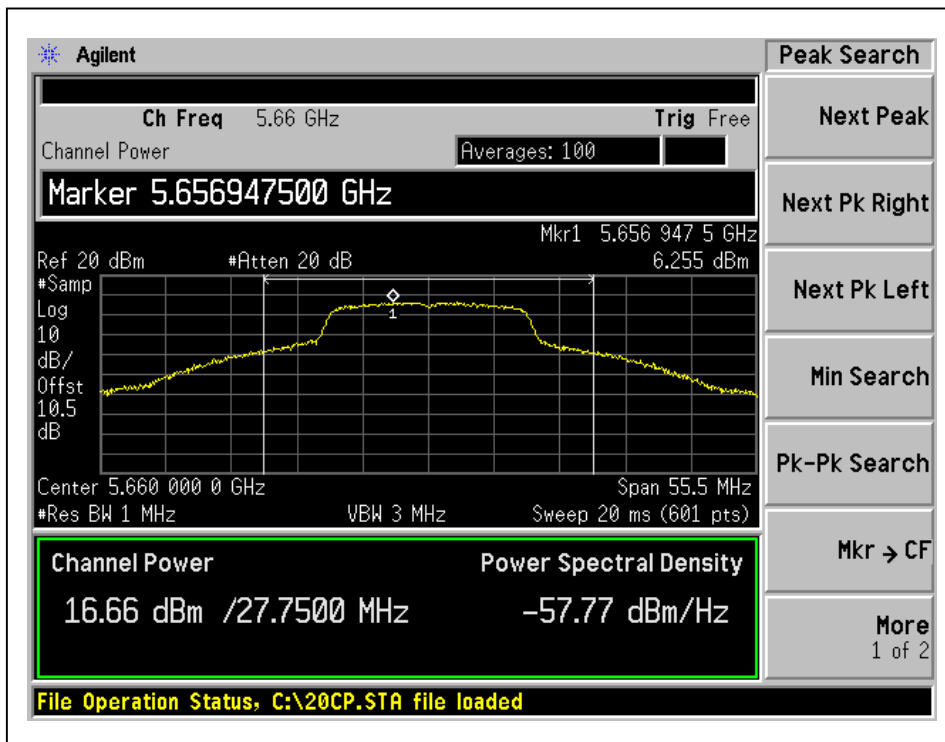



A D T

CH140

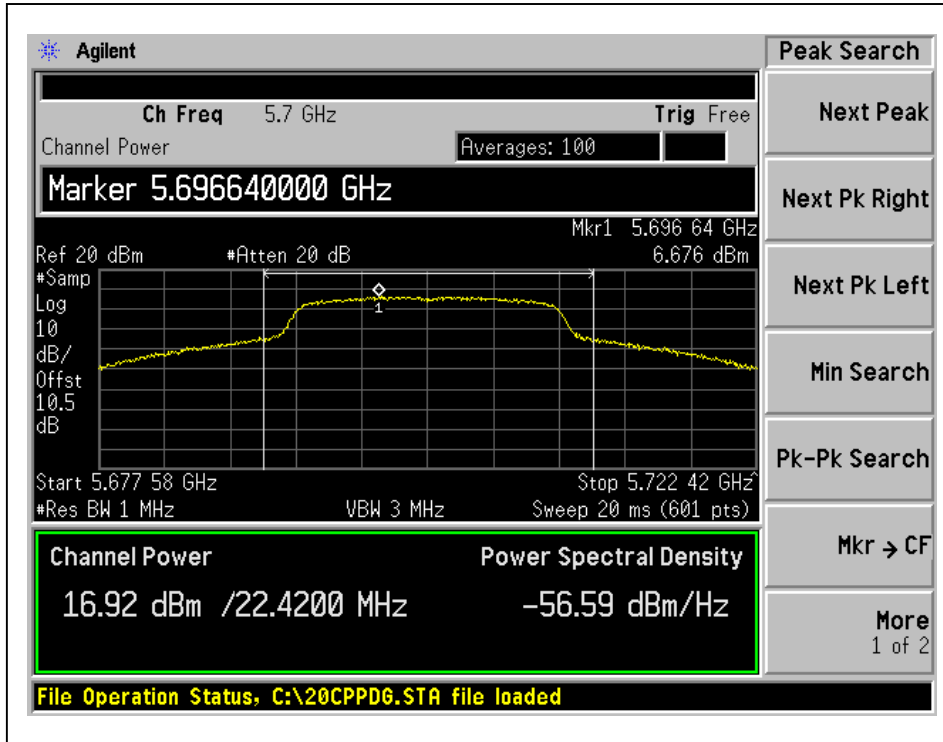



A D T

26dB Occupied Bandwidth: CH36

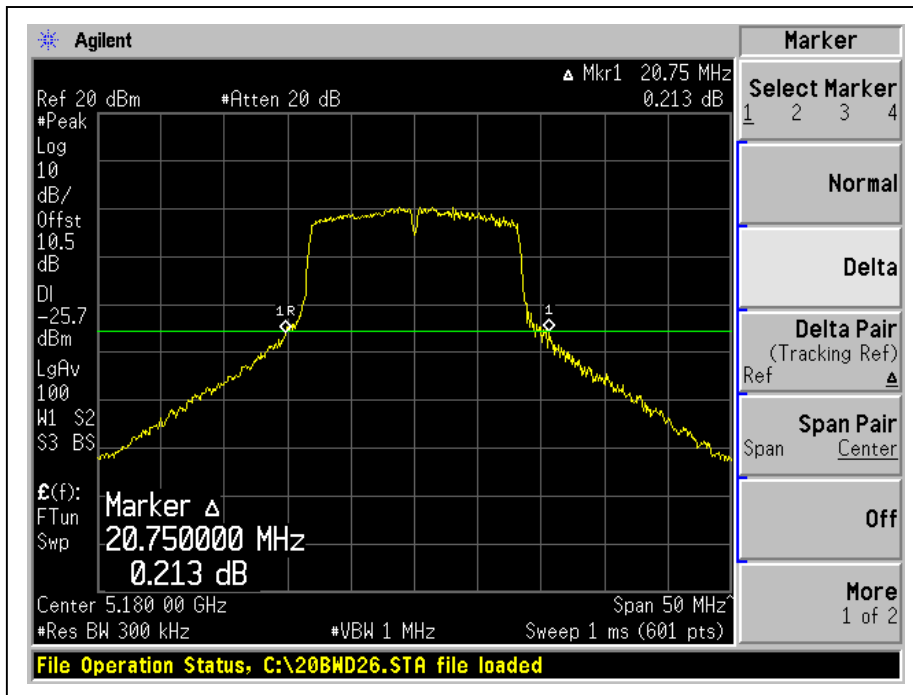

CH40

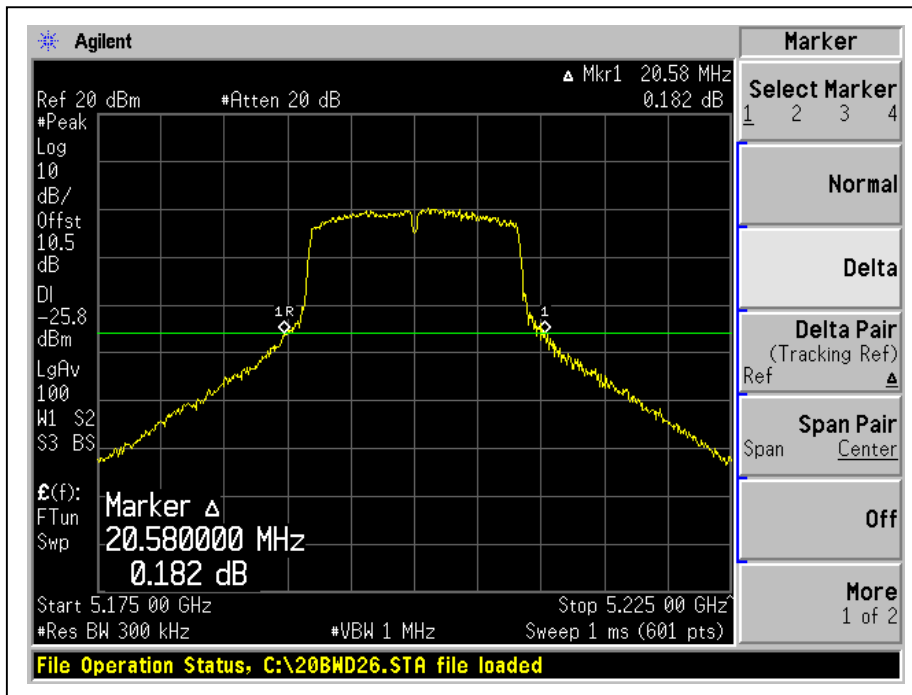



A D T

CH48

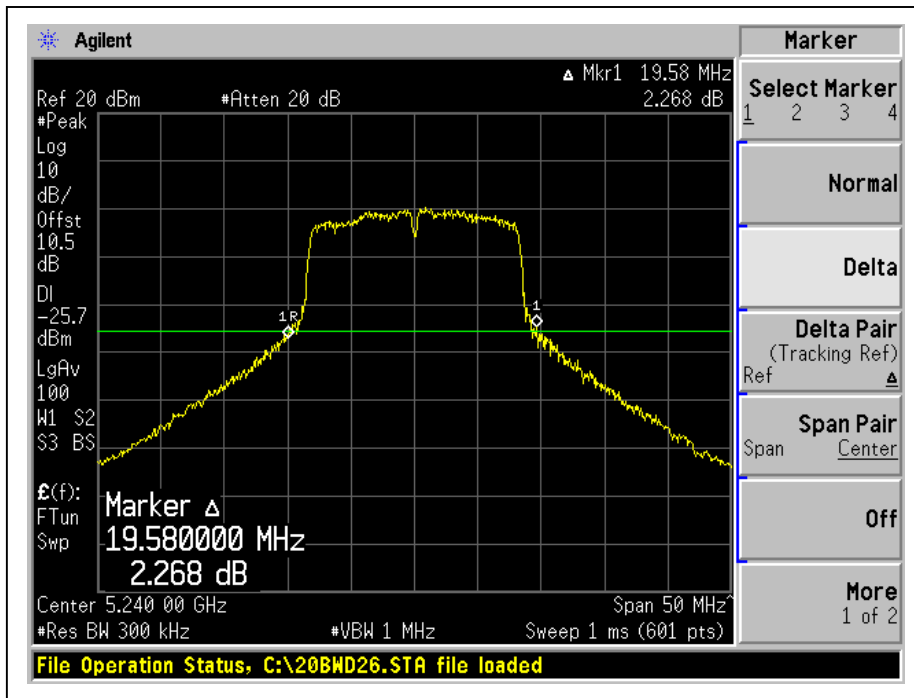

CH52

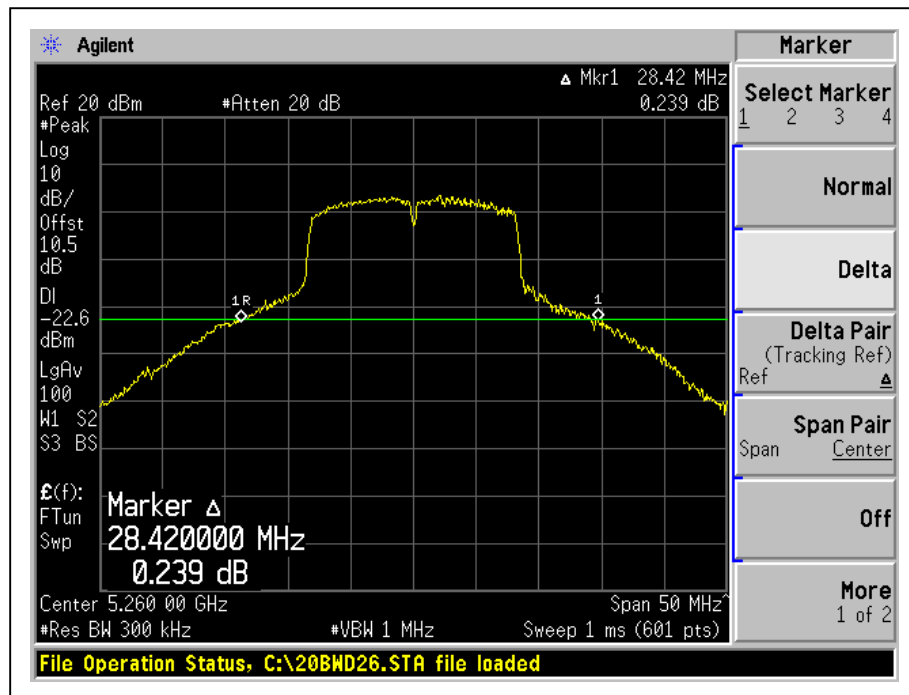



A D T

CH60

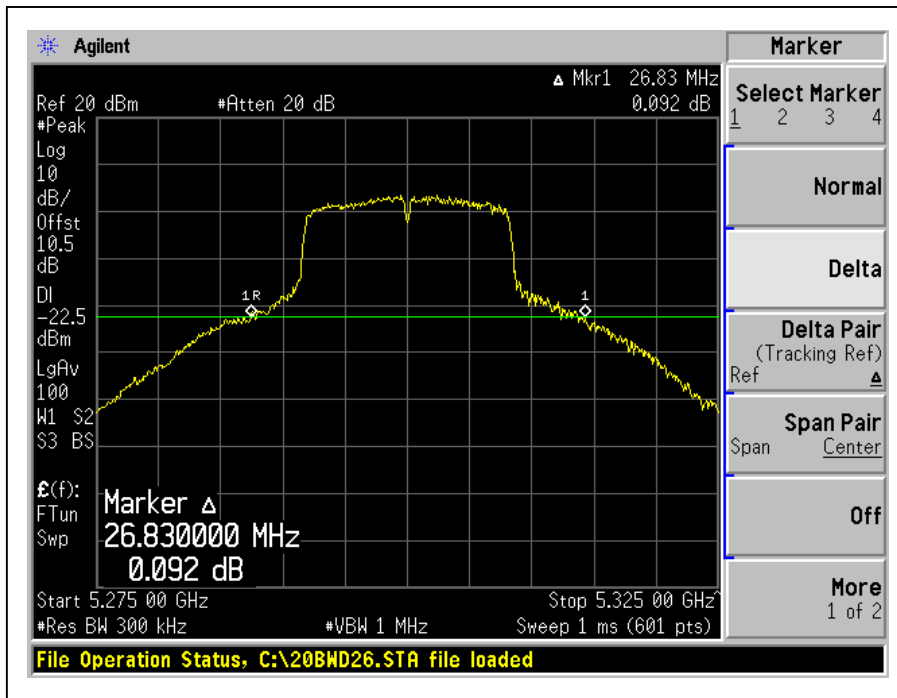

CH64

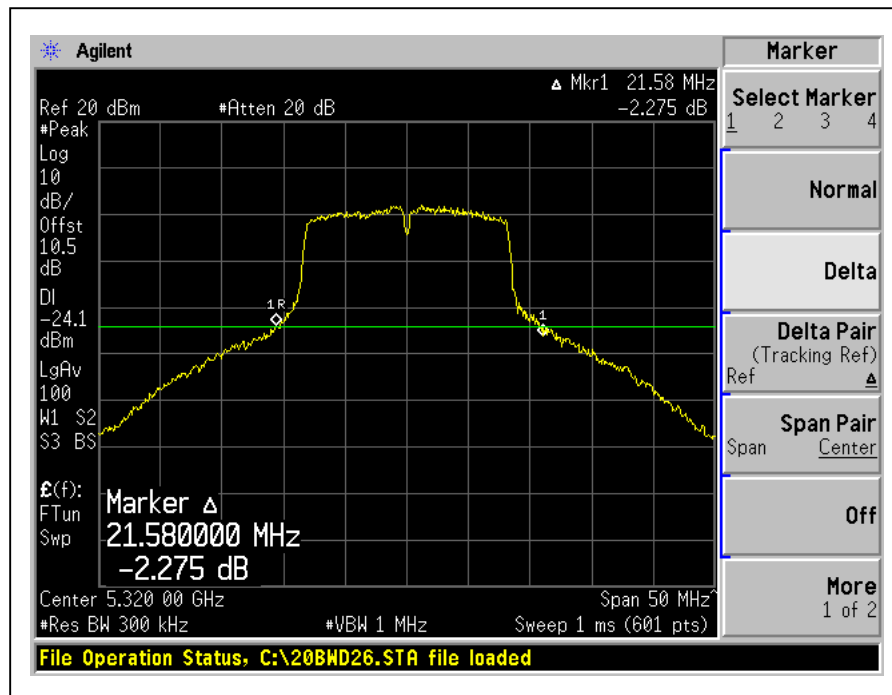



A D T

CH100

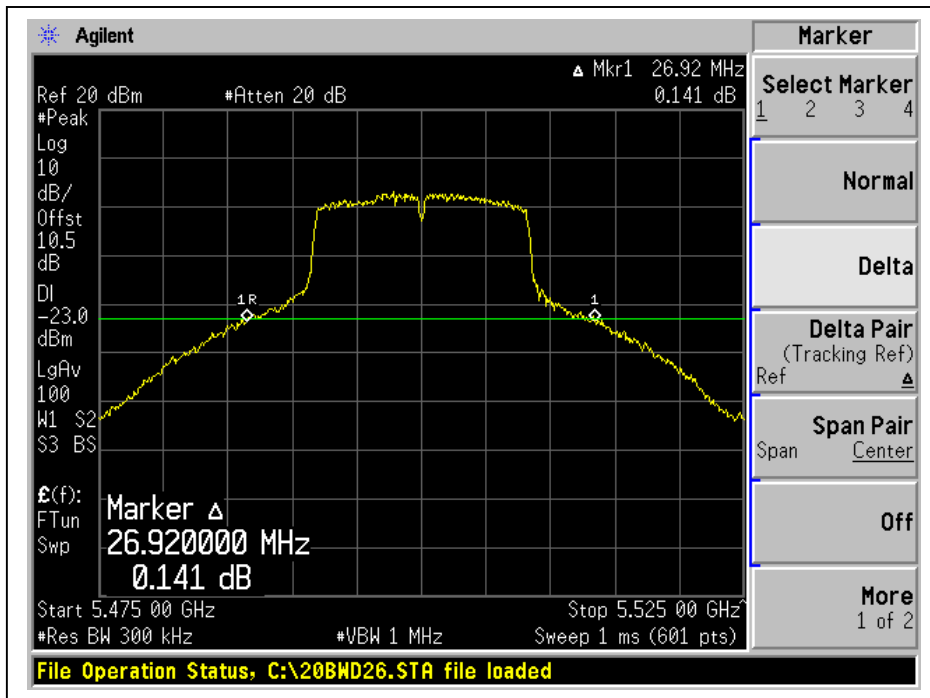

CH116

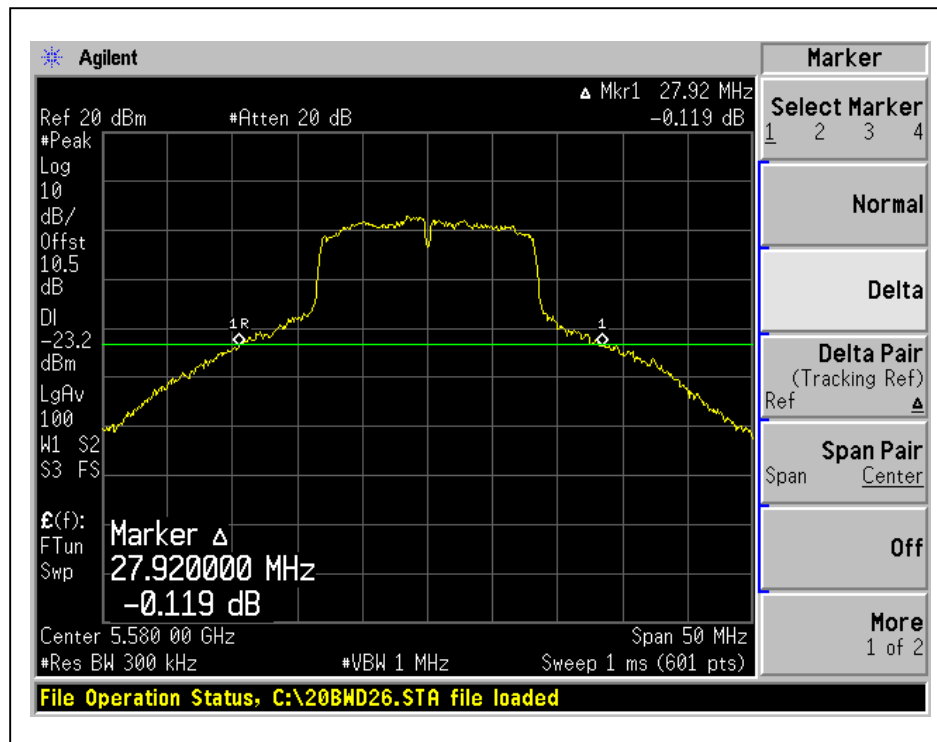



A D T

CH120

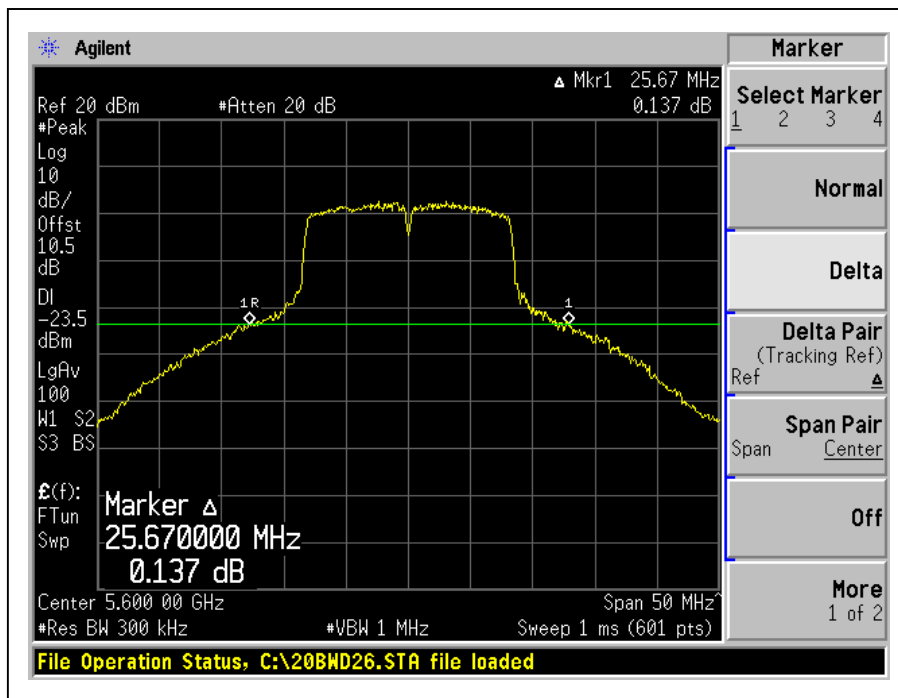

CH132

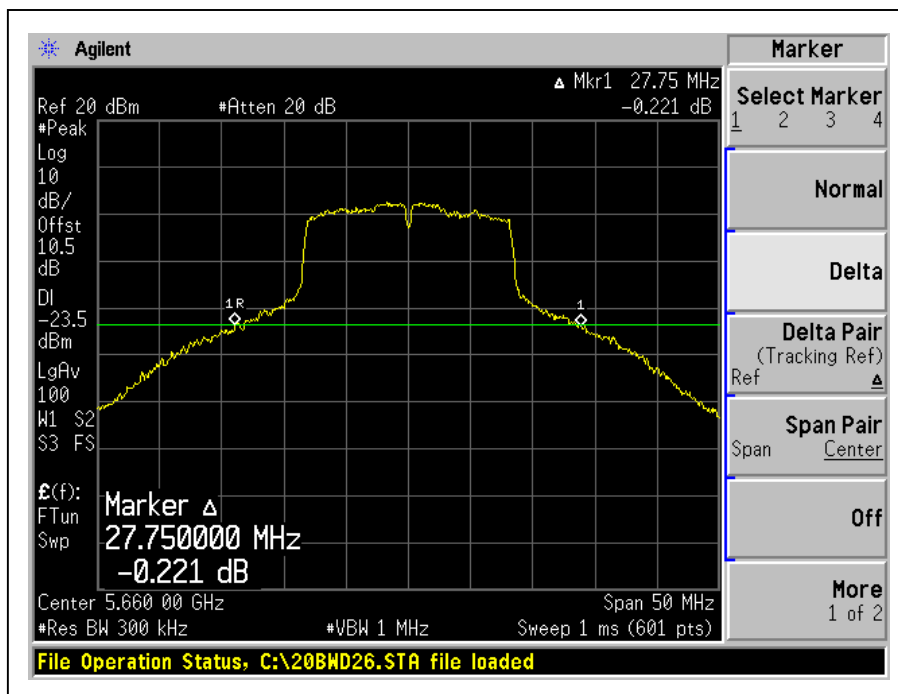



A D T

CH140

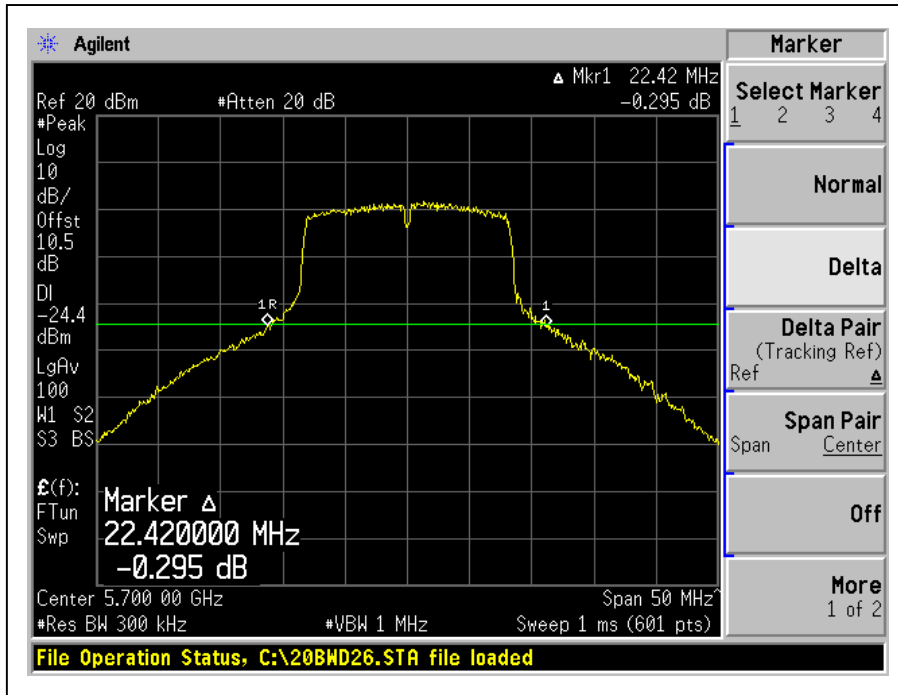



A D T

802.11n(20MHz) OFDM MODULATION:

CHANNEL	CHANNEL FREQUENCY (MHz)	OUTPUT POWER (mW)	OUTPUT POWER (dBm)	OUTPUT POWER LIMIT (dBm)	26dBc Occupied Bandwidth (MHz)	PASS/ FAIL
36	5180	20.9	13.2	17.0	21.33	PASS
40	5200	20.0	13.0	17.0	21.75	PASS
48	5240	21.4	13.3	17.0	21.08	PASS
52	5260	56.2	17.5	24.0	29.83	PASS
60	5300	57.5	17.6	24.0	29.50	PASS
64	5320	33.1	15.2	24.0	22.75	PASS
100	5500	49.0	16.9	24.0	24.92	PASS
116	5580	60.3	17.8	24.0	30.40	PASS
120	5600	45.7	16.6	24.0	26.42	PASS
132	5660	41.7	16.2	24.0	28.33	PASS
140	5700	44.7	16.5	24.0	22.25	PASS

NOTE: The 26dBc Occupied Bandwidth plot, please refer to the following pages.



A D T

Power Output: CH36

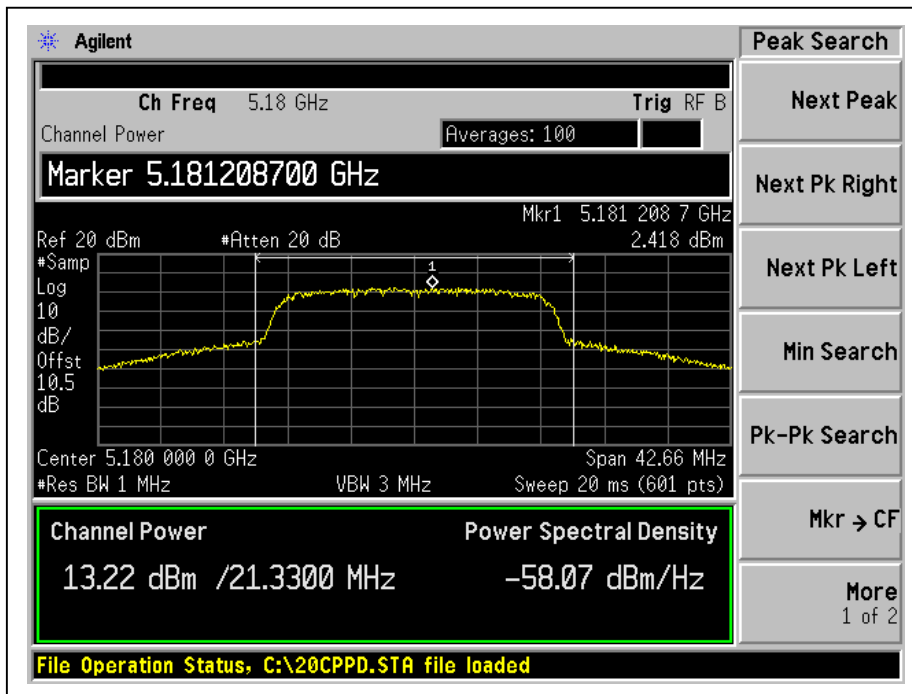

CH40

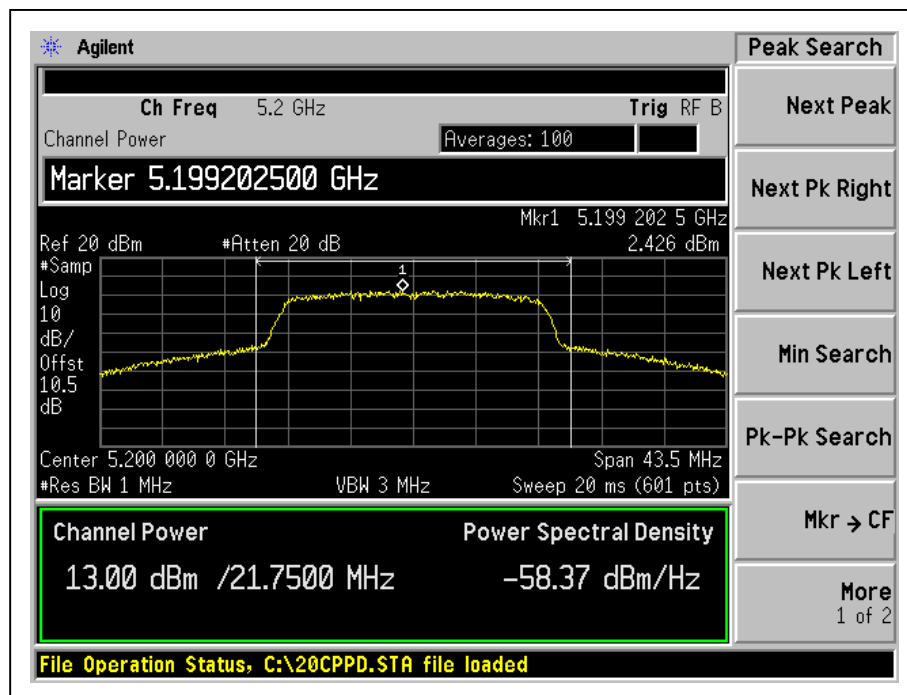



A D T

CH48

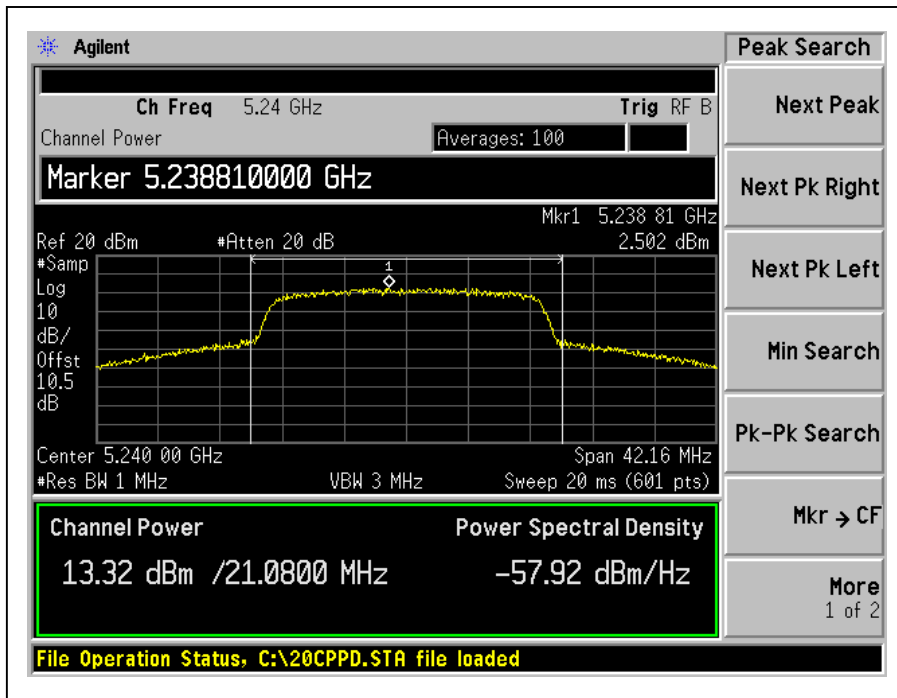

CH52

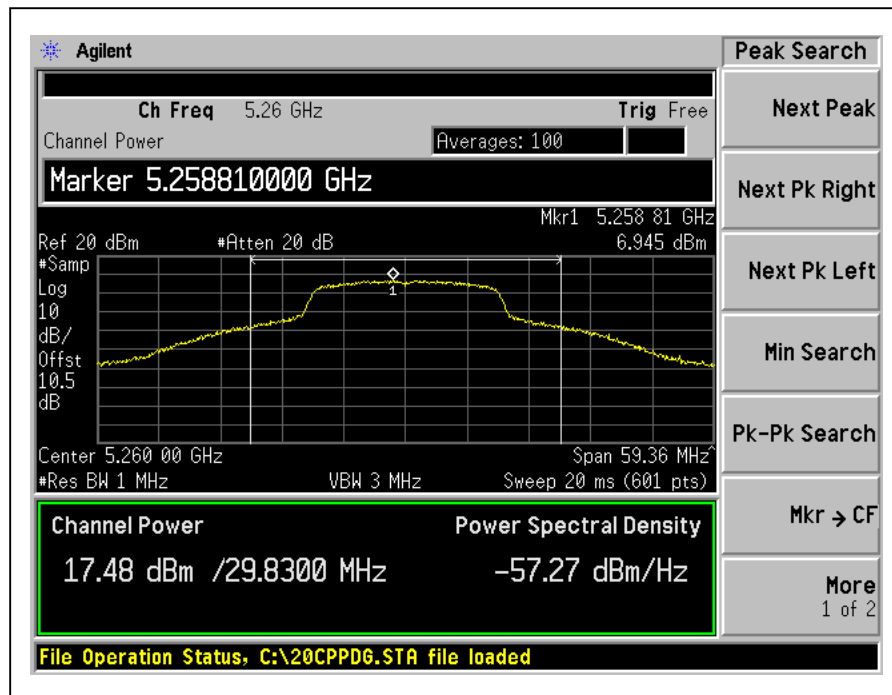



A D T

CH60

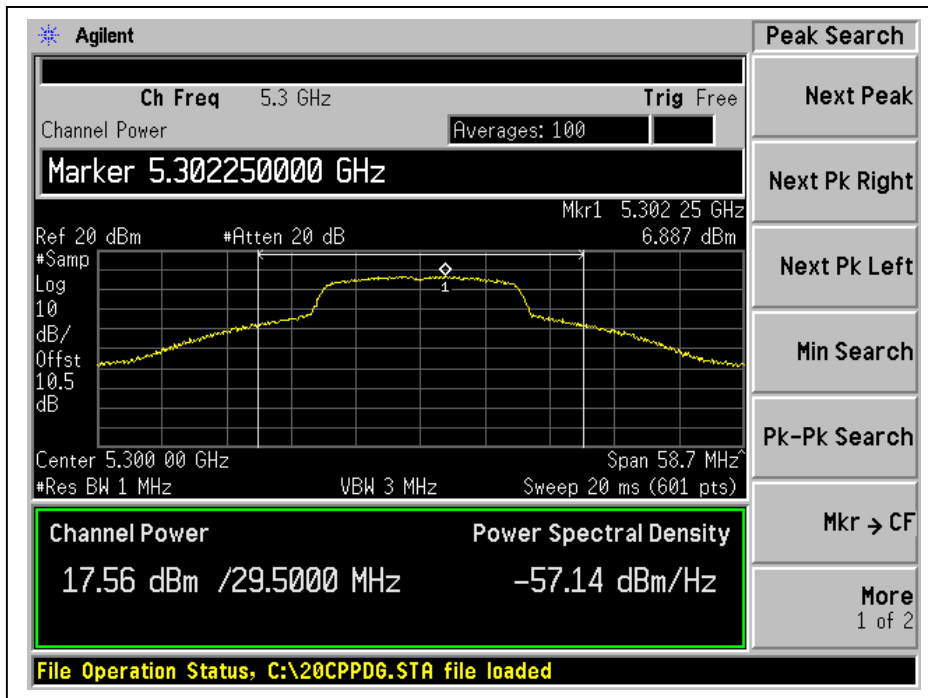

CH64

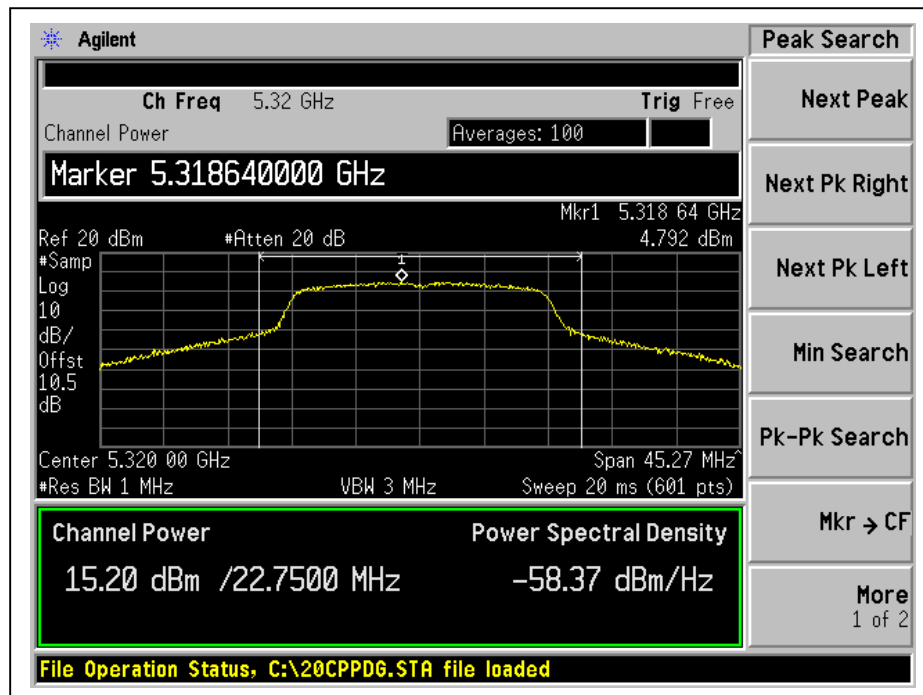



A D T

CH100

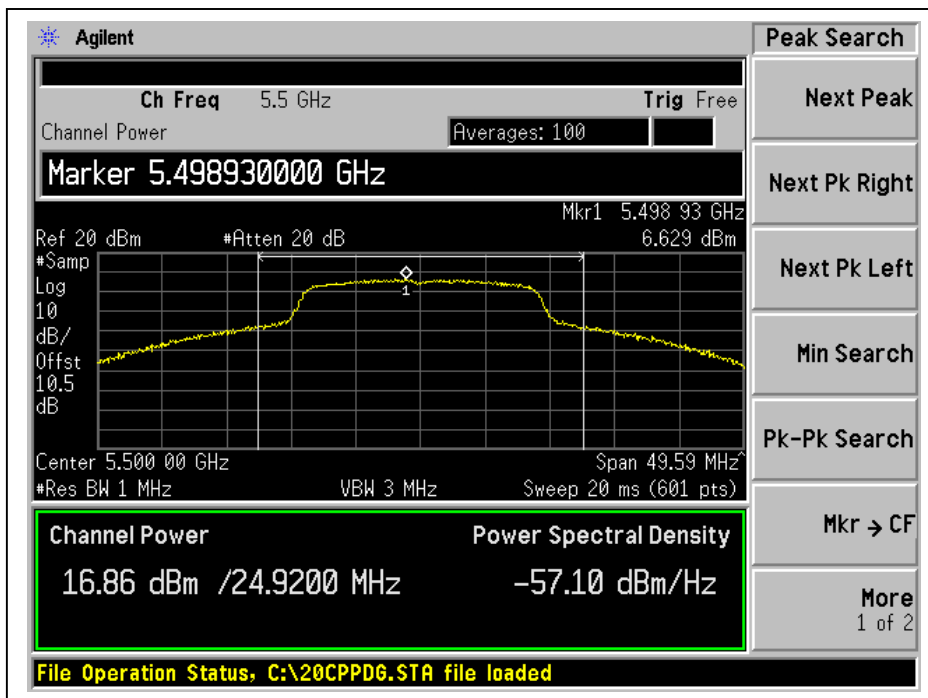

CH116

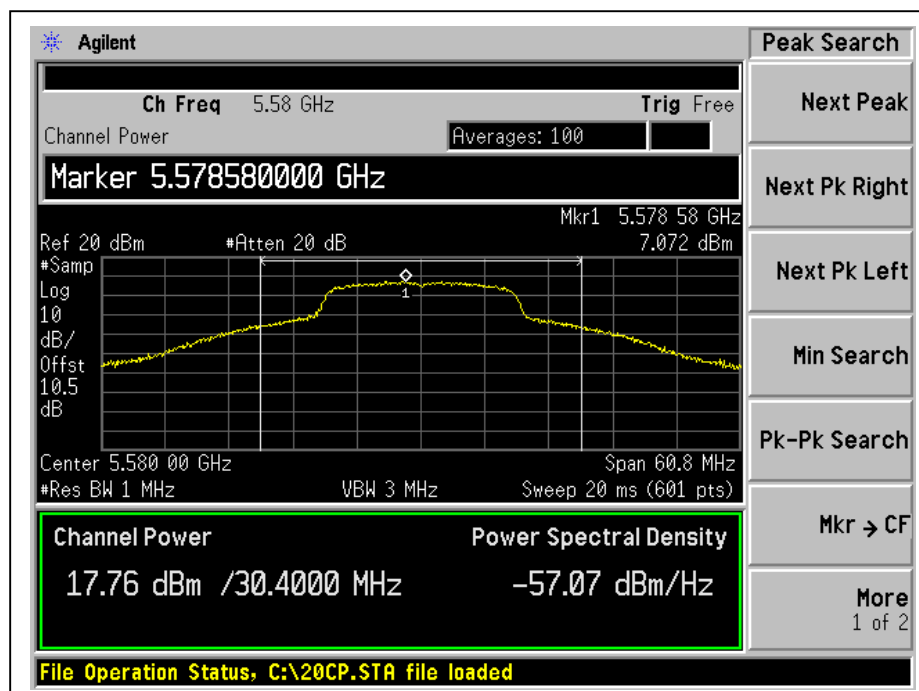



A D T

CH120

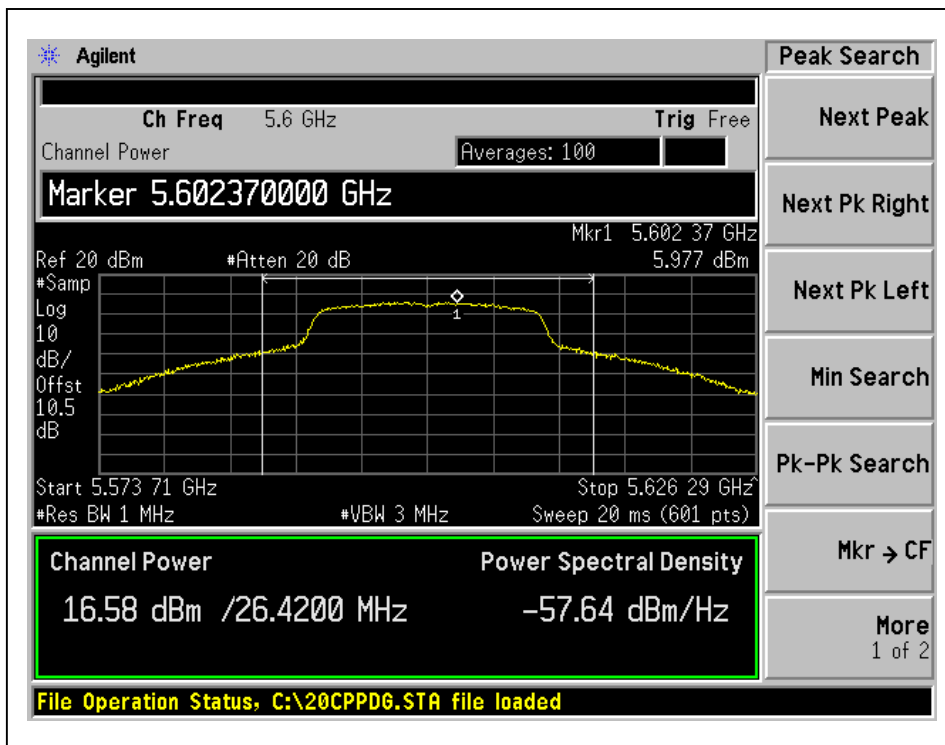

CH132

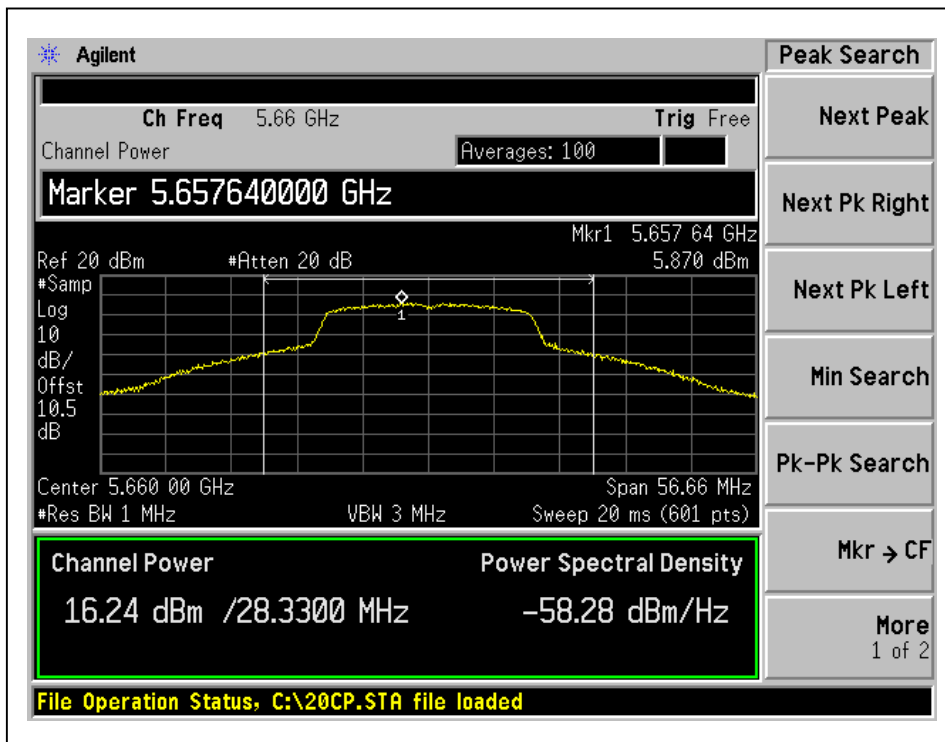



A D T

CH140

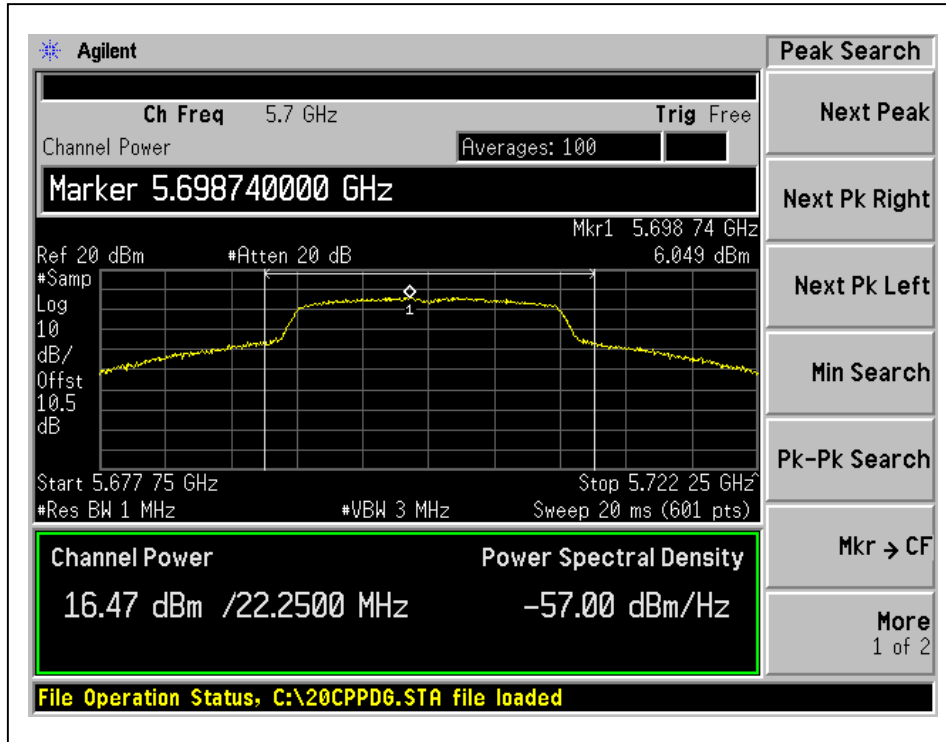



A D T

26dB Occupied Bandwidth: CH36

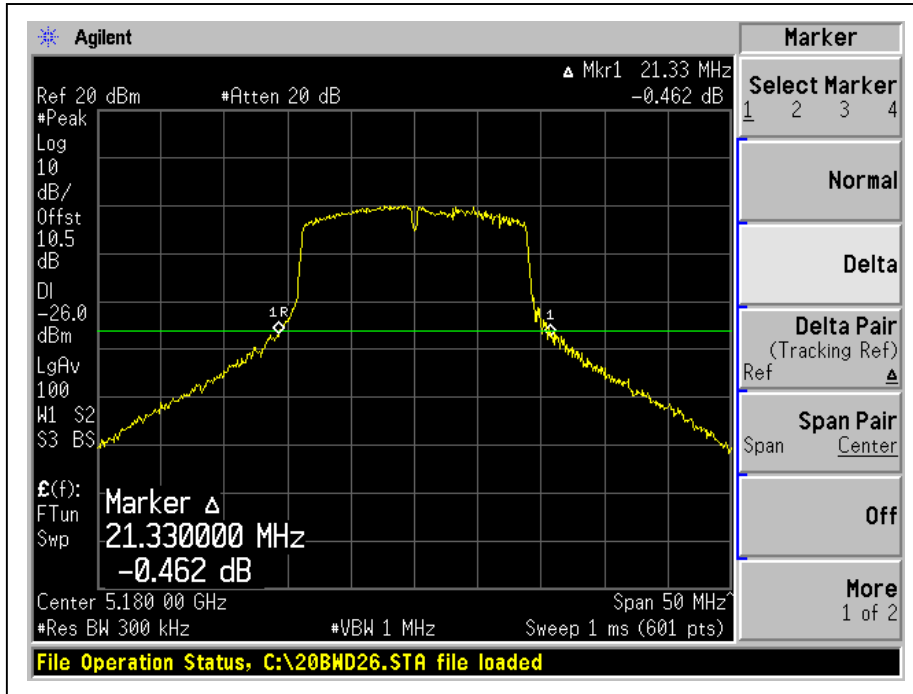

CH40

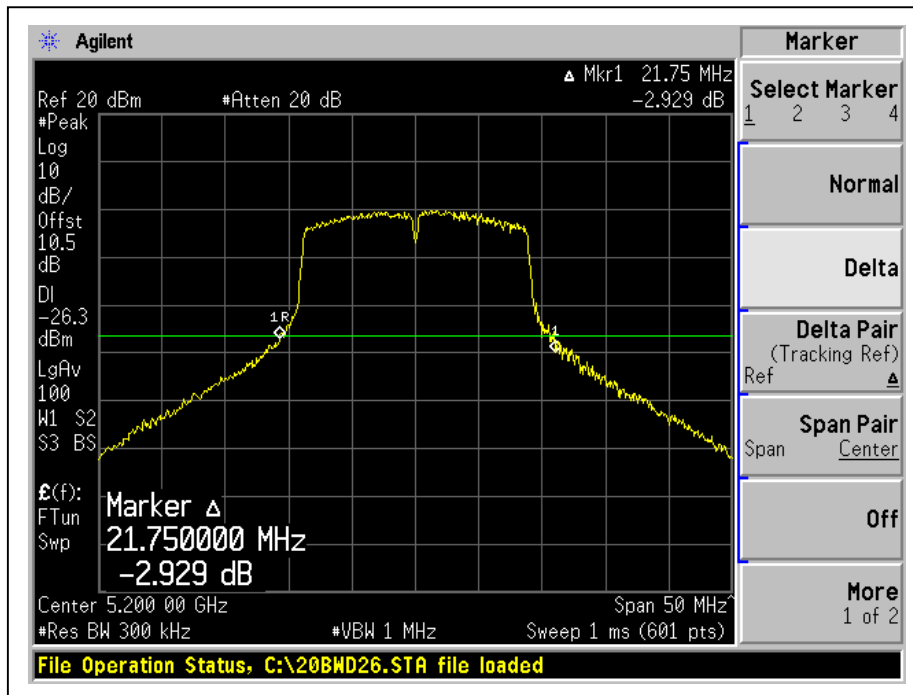



A D T

CH48

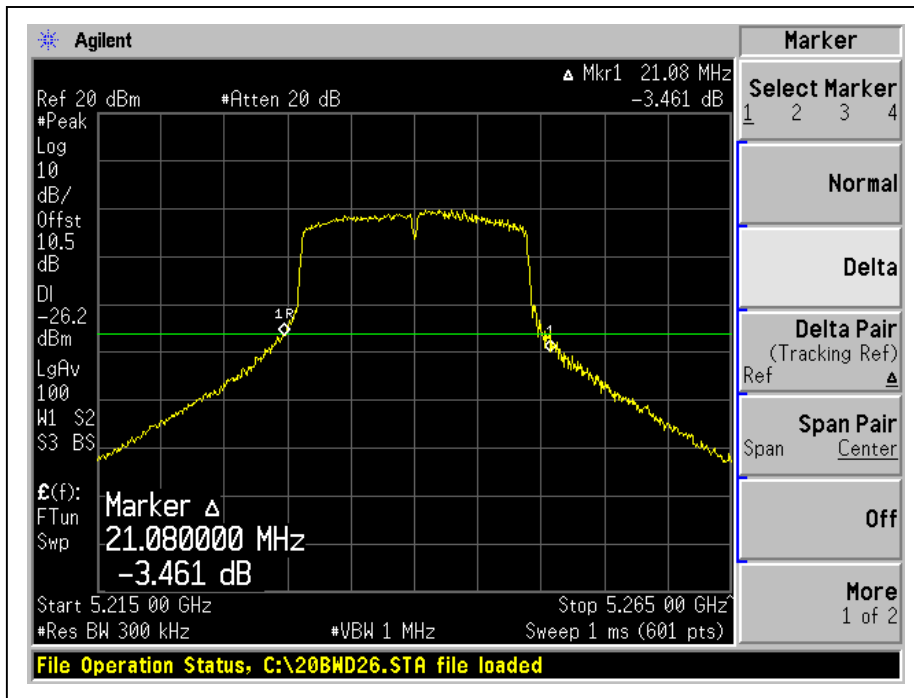

CH52

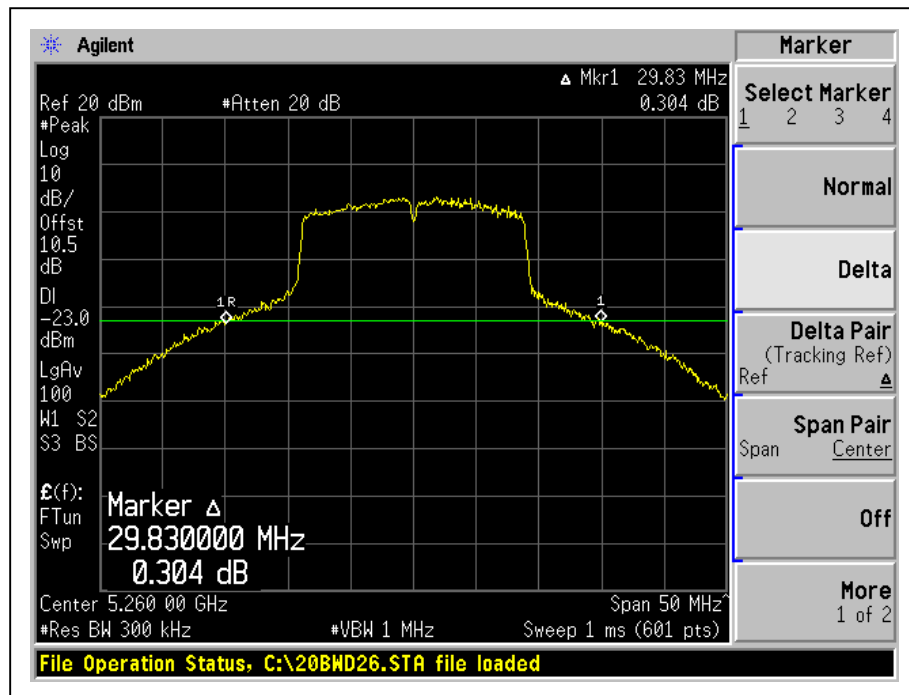

CH60

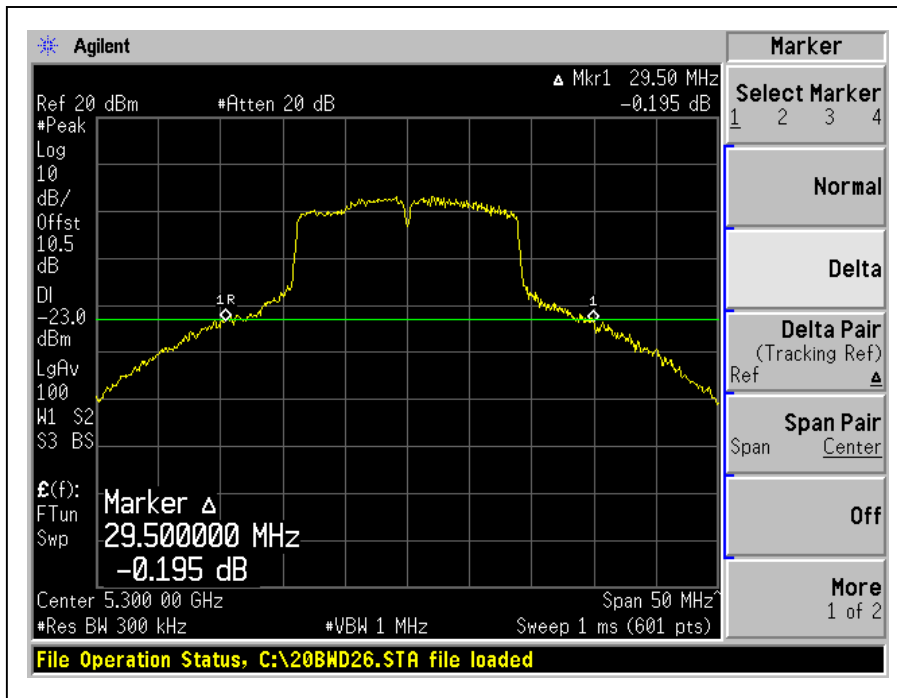

CH64

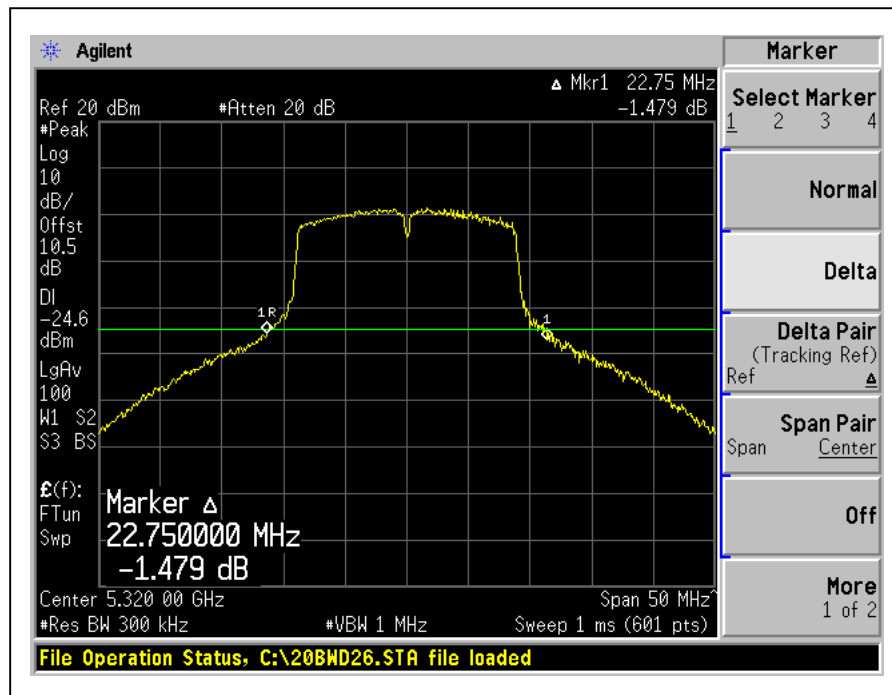



A D T

CH100

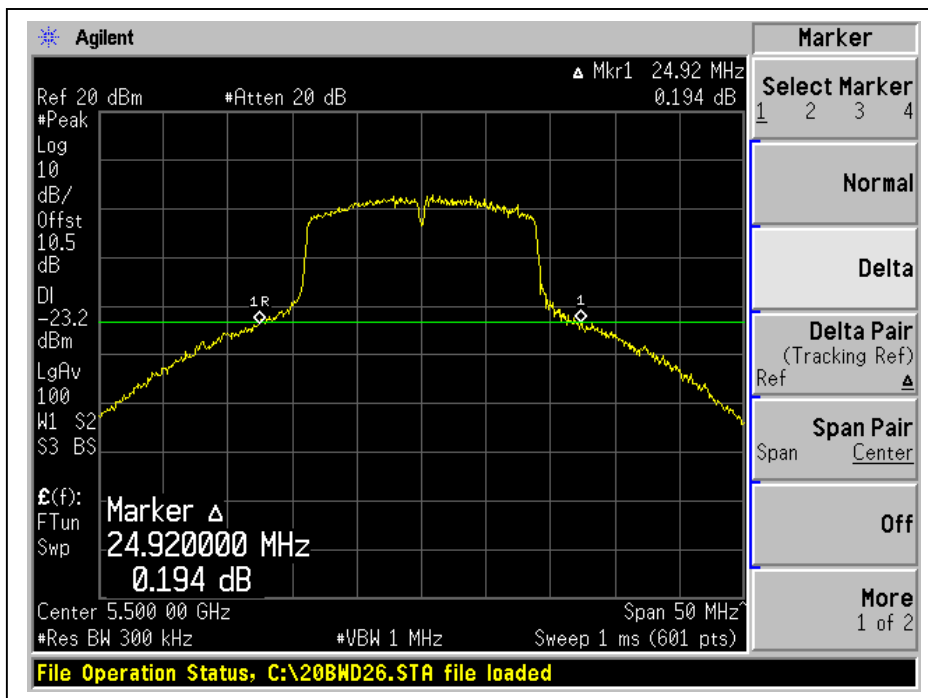

CH116

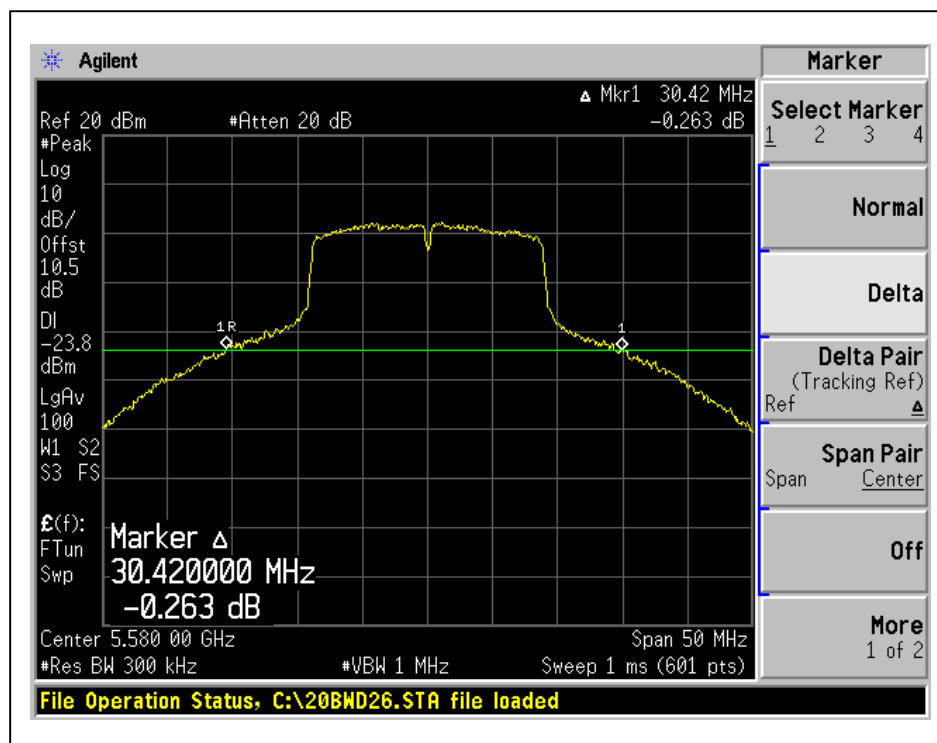



A D T

CH120

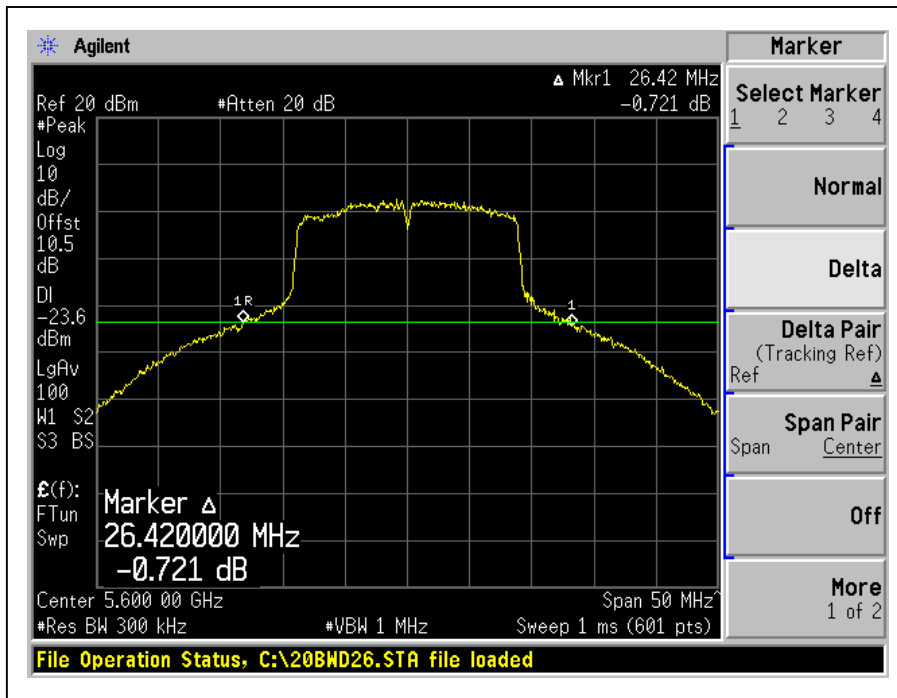

CH132

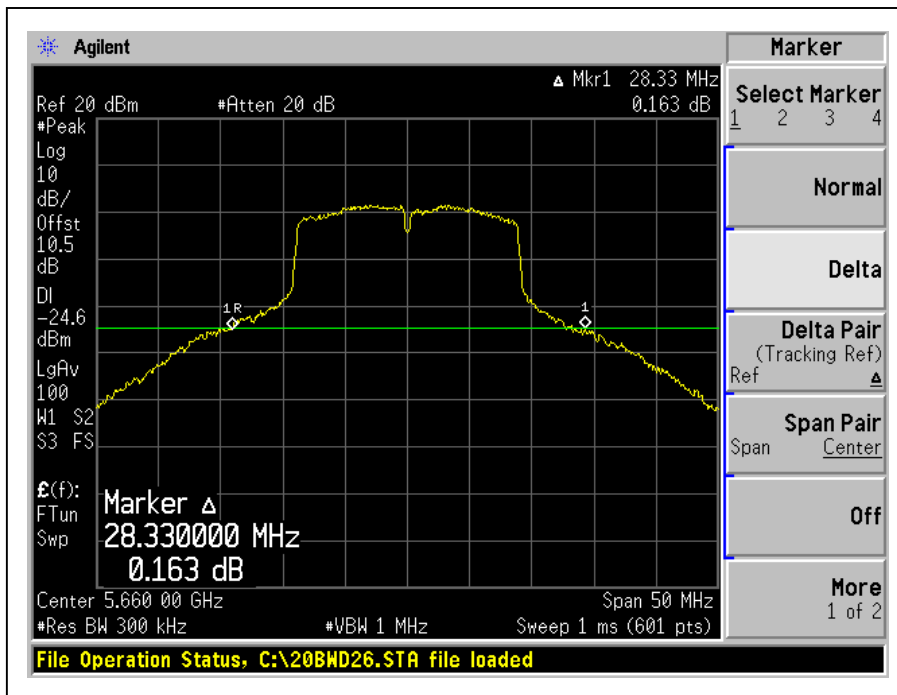



A D T

CH140

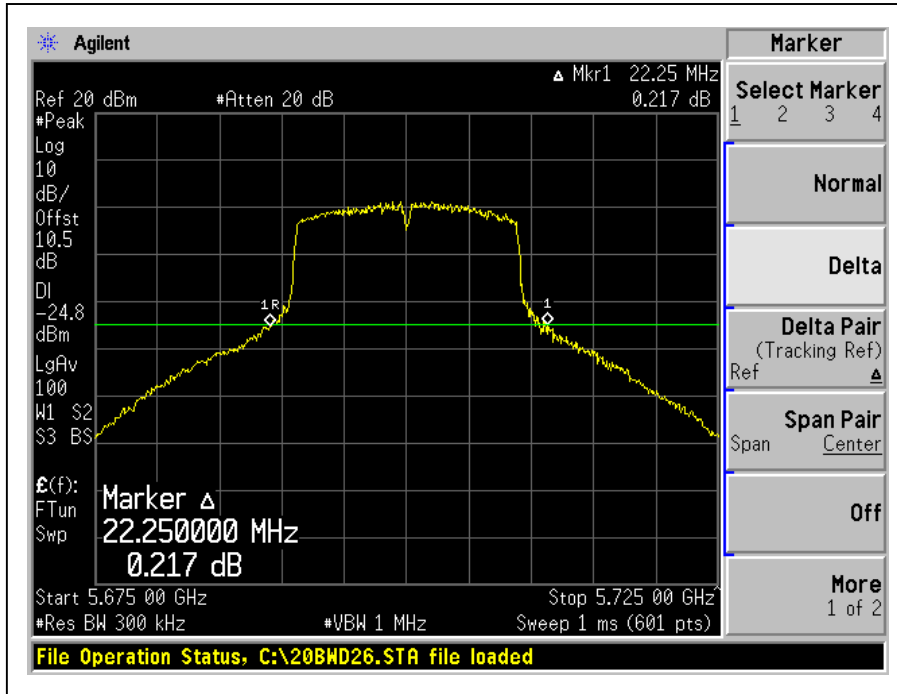



A D T

4.3.8 TEST RESULTS(MODE B)

802.11a OFDM MODULATION:

CHANNEL	CHANNEL FREQUENCY (MHz)	OUTPUT POWER (mW)	OUTPUT POWER (dBm)	OUTPUT POWER LIMIT (dBm)	PASS/ FAIL
36	5180	26.9	14.3	17.0	PASS
40	5200	26.9	14.3	17.0	PASS
48	5240	24.5	13.9	17.0	PASS
52	5260	66.1	18.2	24.0	PASS
60	5300	66.1	18.2	24.0	PASS
64	5320	45.7	16.6	24.0	PASS
100	5500	60.3	17.8	24.0	PASS
116	5580	67.6	18.3	24.0	PASS
120	5600	55.0	17.4	24.0	PASS
132	5660	56.2	17.5	24.0	PASS
140	5700	58.9	17.7	24.0	PASS



A D T

802.11n(20MHz) OFDM MODULATION:

CHANNEL	CHANNEL FREQUENCY (MHz)	OUTPUT POWER (mW)	OUTPUT POWER (dBm)	OUTPUT POWER LIMIT (dBm)	PASS/ FAIL
36	5180	25.1	14.0	17.0	PASS
40	5200	24.0	13.8	17.0	PASS
48	5240	25.7	14.1	17.0	PASS
52	5260	67.6	18.3	24.0	PASS
60	5300	69.2	18.4	24.0	PASS
64	5320	39.8	16.0	24.0	PASS
100	5500	58.9	17.7	24.0	PASS
116	5580	72.4	18.6	24.0	PASS
120	5600	55.0	17.4	24.0	PASS
132	5660	50.1	17.0	24.0	PASS
140	5700	53.7	17.3	24.0	PASS

4.4 PEAK POWER EXCURSION MEASUREMENT

4.4.1 LIMITS OF PEAK POWER EXCURSION MEASUREMENT

Frequency Band	Limit
5.15 – 5.25 GHz	13dB
5.25 – 5.35 GHz	13dB
5.47 – 5.725GHz	13dB
5.725 – 5.825 GHz	13dB

4.4.2 TEST INSTRUMENTS

DESCRIPTION & MANUFACTURER	MODEL NO.	SERIAL NO.	CALIBRATED DATE	CALIBRATED UNTIL
Spectrum Analyzer	E4446A	MY48250254	July 14, 2010	July 13, 2011

NOTE:

1. The calibration interval of the above test instruments is 12 months and the calibrations are traceable to NML/ROC and NIST/USA.

4.4.3 TEST PROCEDURE

1. Connect the cable from the spectrum analyzer to the EUT antenna port using an appropriate RF attenuator.
2. Verify the antenna port selected is the active one if the system has more than one antenna.
3. Verify the unlicensed wireless device is set to operate at 100 % duty cycle at the maximum allowed power for operation.
4. Testing shall be done on the center frequency of each U-NII band.
5. Set the spectrum analyzer span to view the entire emission bandwidth. The largest difference between the following two traces must be 13 dB for all frequencies across the emission bandwidth.
6. First trace: set RBW = 1 MHz, VBW = 3 MHz with peak detector and max hold settings.
7. Second trace: set RBW = 1 MHz, VBW = 3 MHz with sample detector and trace average across 100 traces in power averaging mode.

4.4.4 DEVIATION FROM TEST STANDARD

No deviation

4.4.5 TEST SETUP

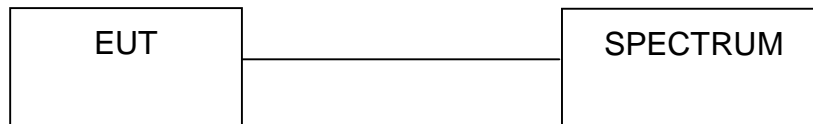

4.4.6 EUT OPERATING CONDITIONS

The software provided by client to enable the EUT under transmission condition continuously at specific channel frequencies individually.



A D T

4.4.7 TEST RESULTS

802.11a OFDM modulation

CHANNEL	CHANNEL FREQUENCY (MHz)	PEAK POWER EXCURSION (dB)	PEAK to AVERAGE EXCURSION LIMIT (dB)	PASS/FAIL
36	5180	7.5	13	PASS
40	5200	7.6	13	PASS
48	5240	7.4	13	PASS
52	5260	7.5	13	PASS
60	5300	8.0	13	PASS
64	5320	7.5	13	PASS
100	5500	8.0	13	PASS
116	5580	8.3	13	PASS
120	5600	7.6	13	PASS
132	5660	8.0	13	PASS
140	5700	7.3	13	PASS

CH36

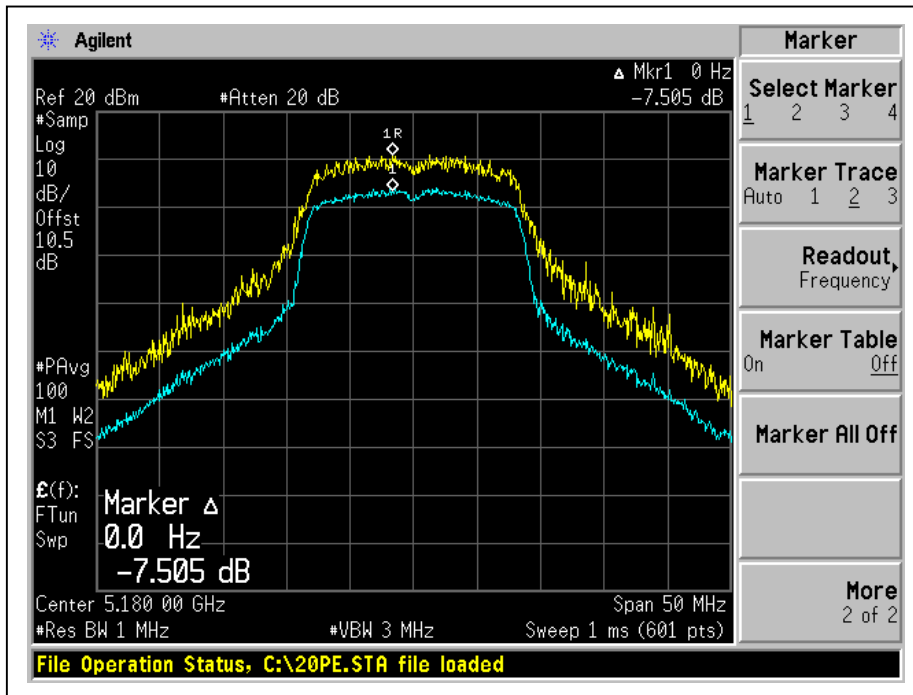

CH40

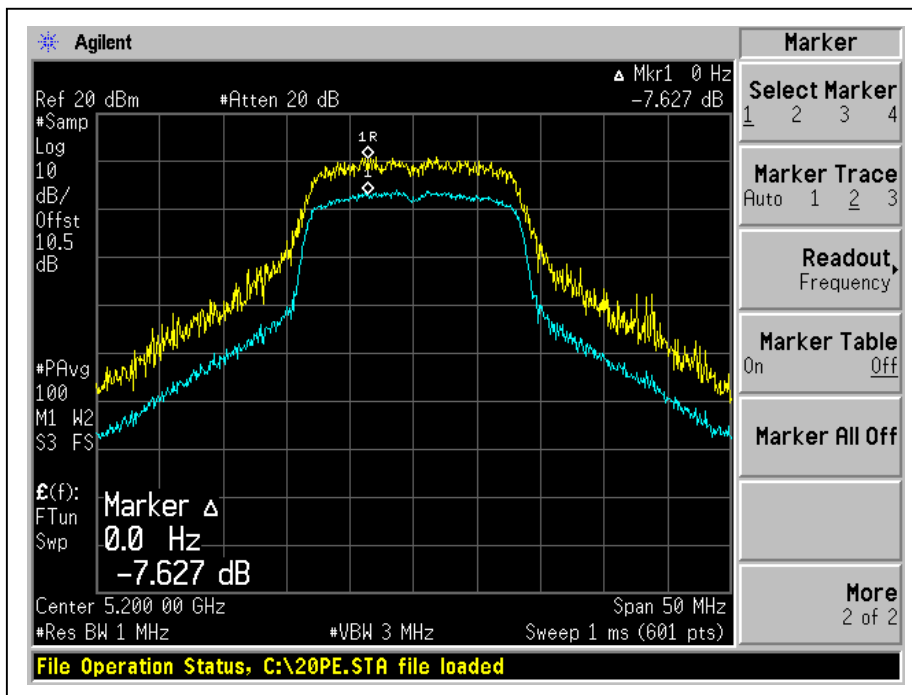



A D T

CH48

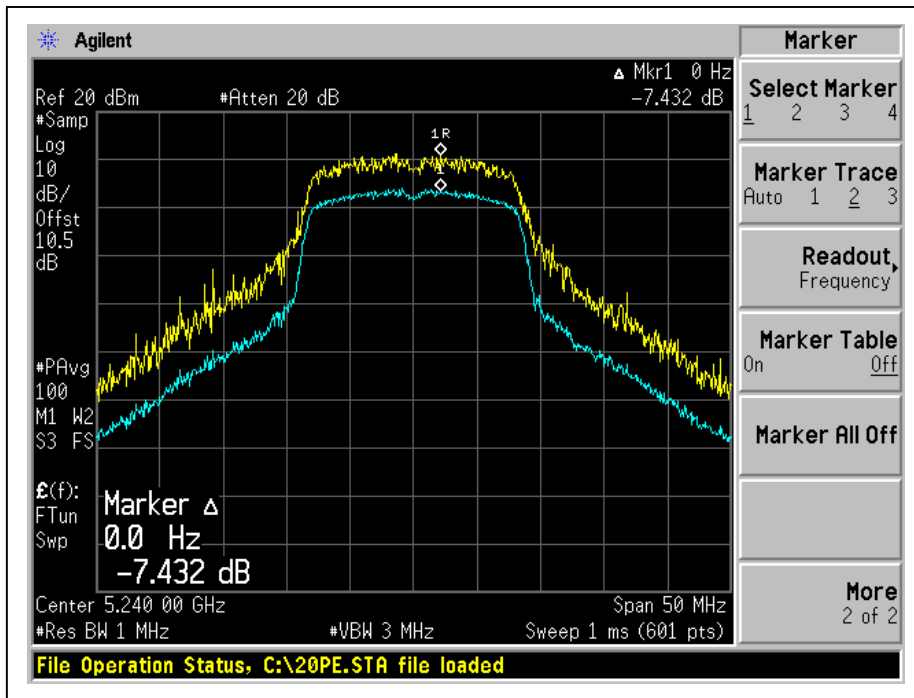

CH52

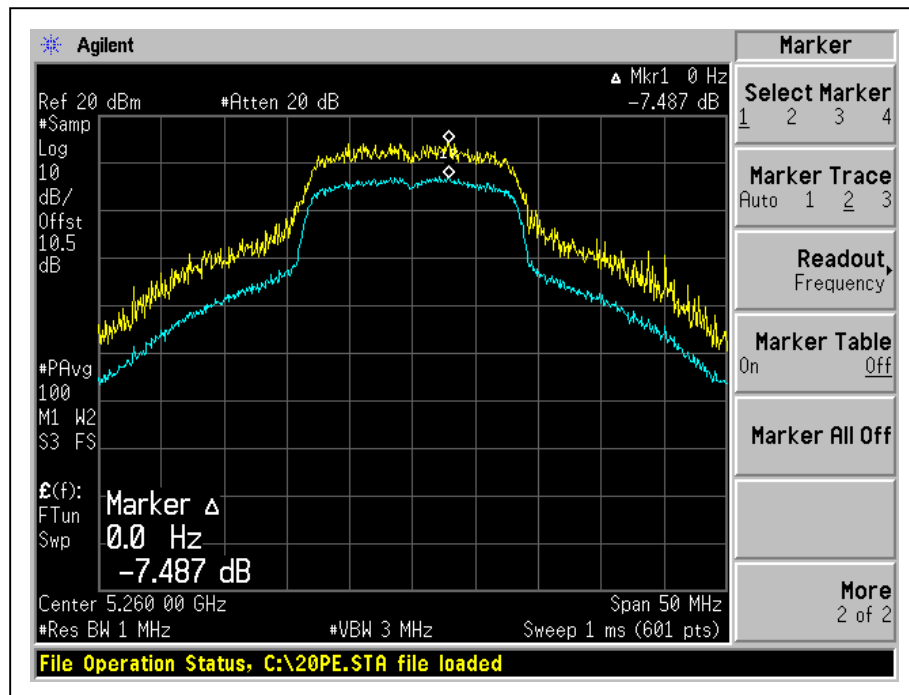



A D T

CH60

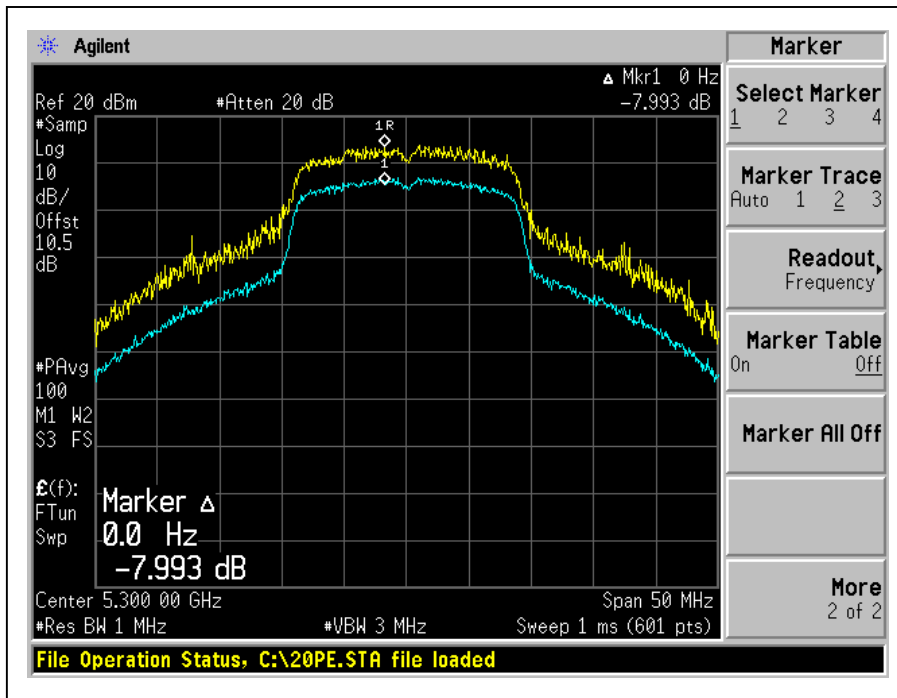

CH64

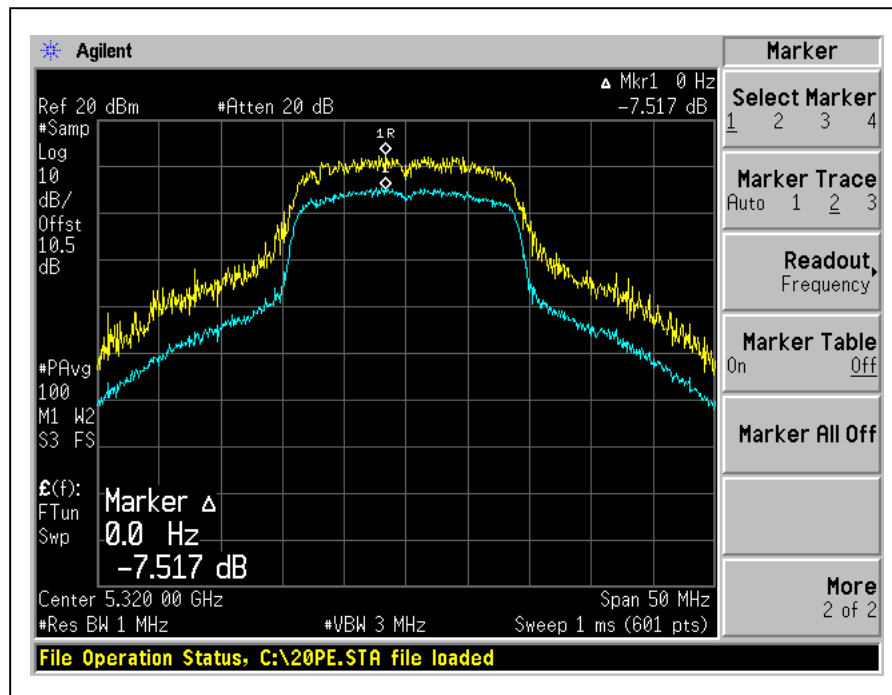



A D T

CH100

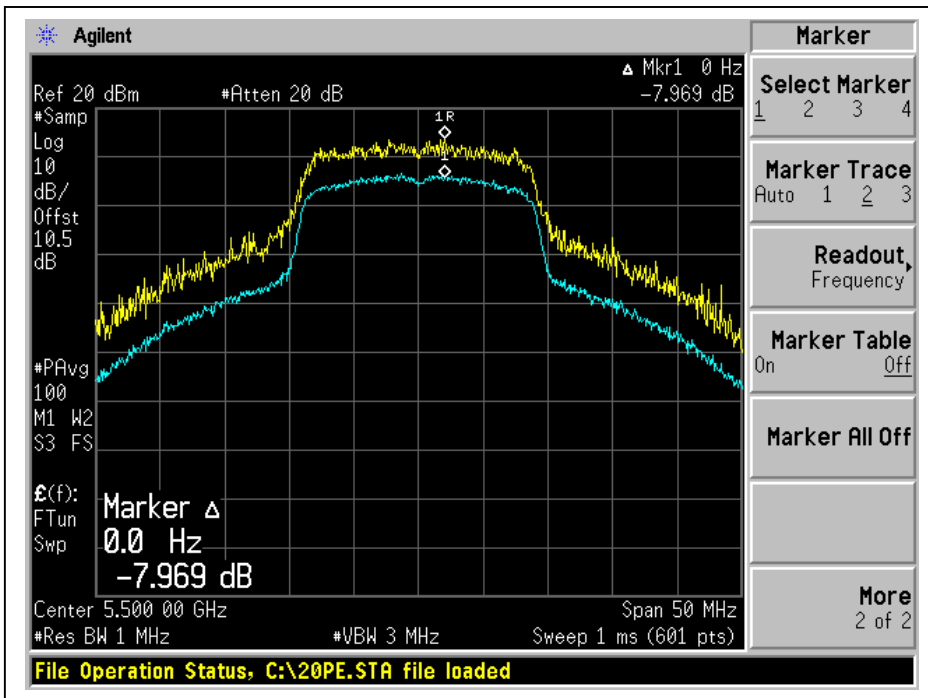

CH116

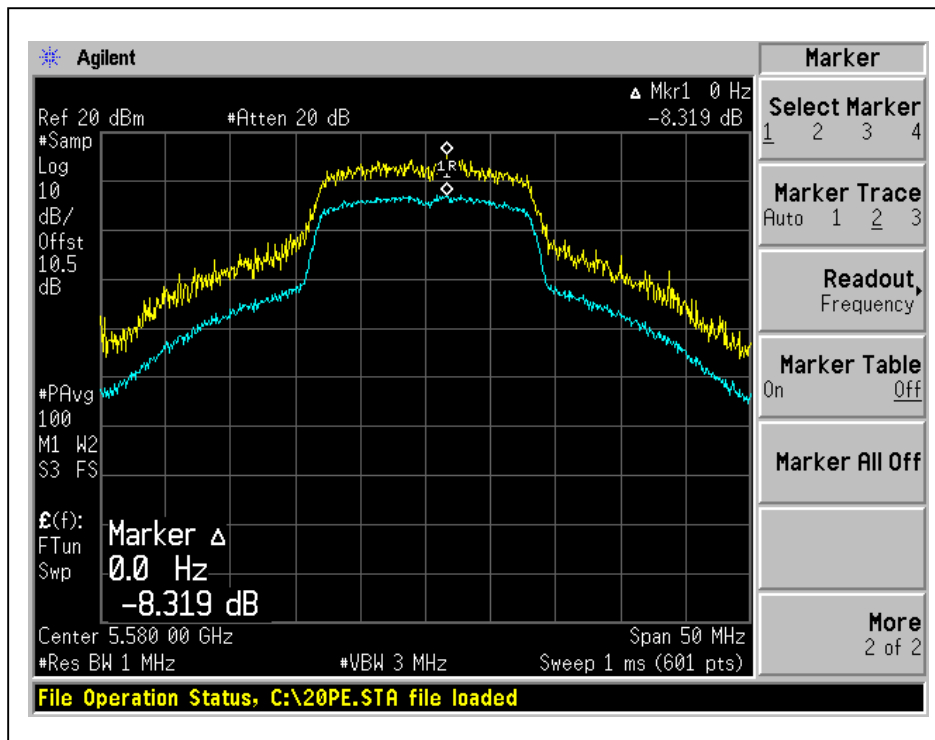



A D T

CH120

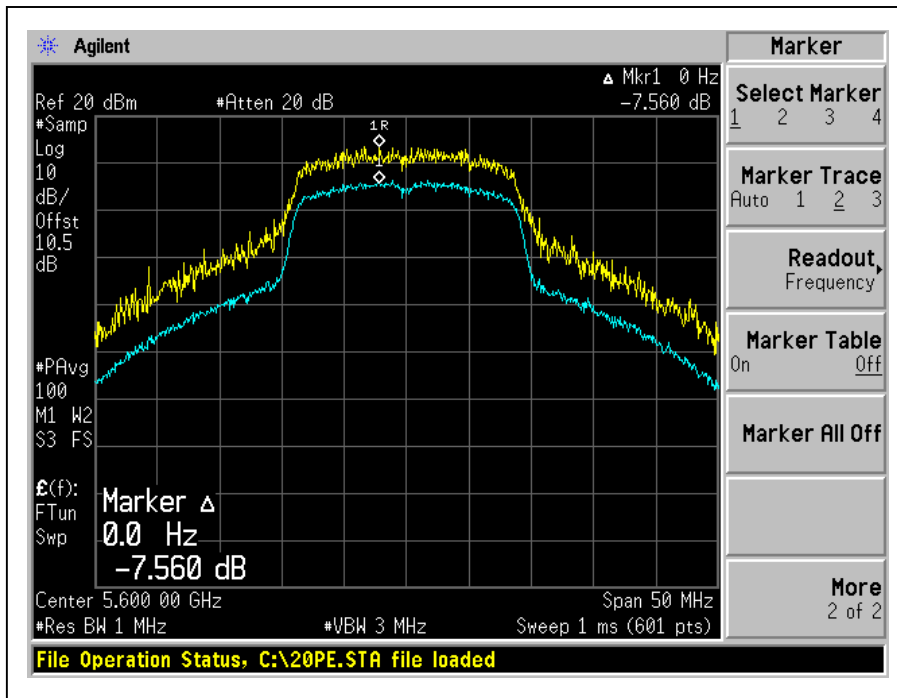

CH132

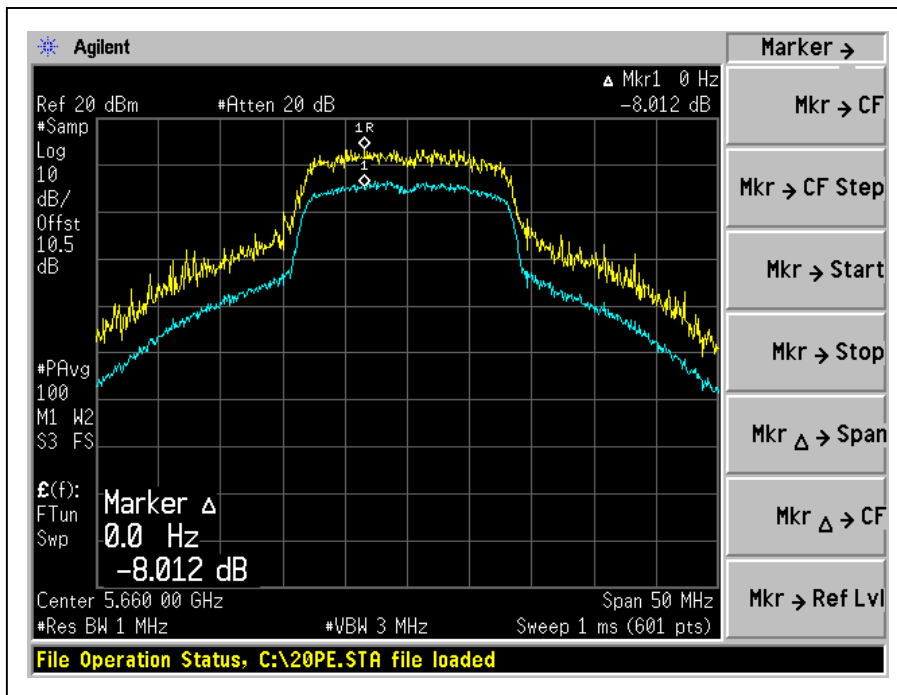



A D T

CH140

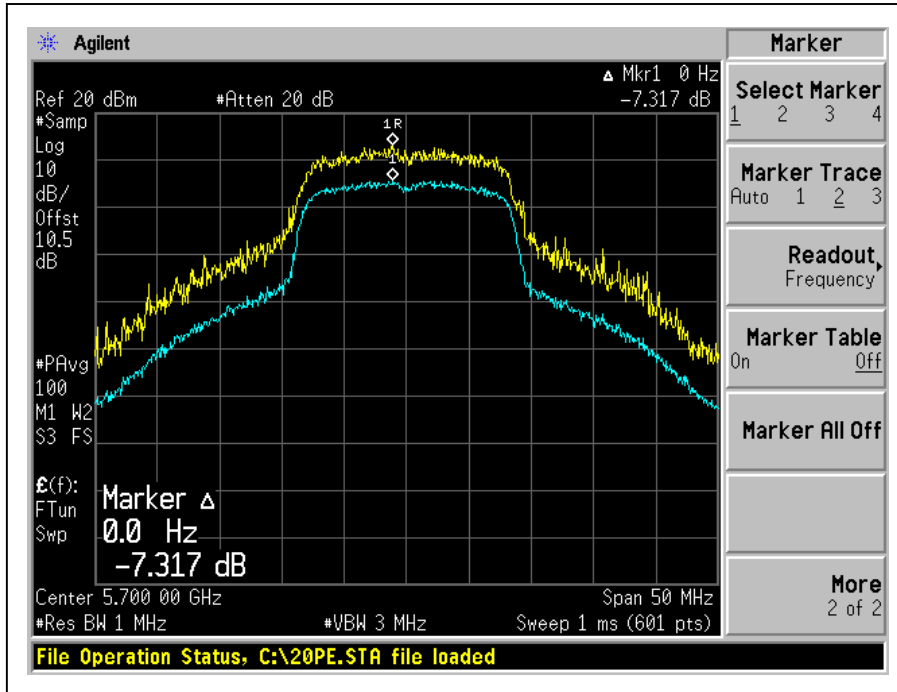



A D T

802.11n(20MHz) OFDM modulation

CHANNEL	CHANNEL FREQUENCY (MHz)	PEAK POWER EXCURSION (dB)	PEAK to AVERAGE EXCURSION LIMIT (dB)	PASS/FAIL
36	5180	8.1	13	PASS
40	5200	8.1	13	PASS
48	5240	8.7	13	PASS
52	5260	8.4	13	PASS
60	5300	8.5	13	PASS
64	5320	8.1	13	PASS
100	5500	8.0	13	PASS
116	5580	7.6	13	PASS
120	5600	7.9	13	PASS
132	5660	8.0	13	PASS
140	5700	8.1	13	PASS

CH36

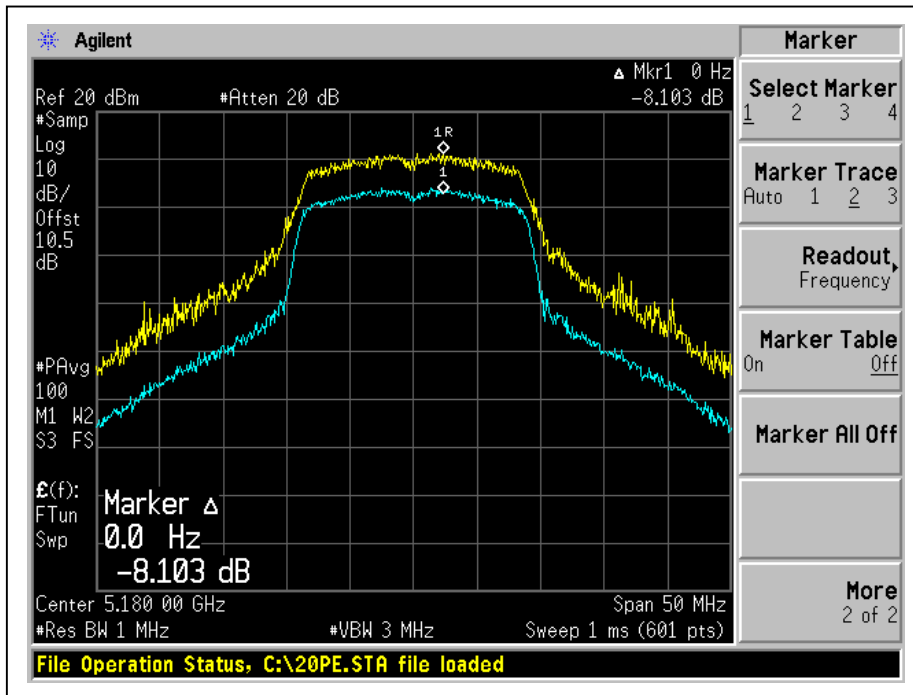

CH40

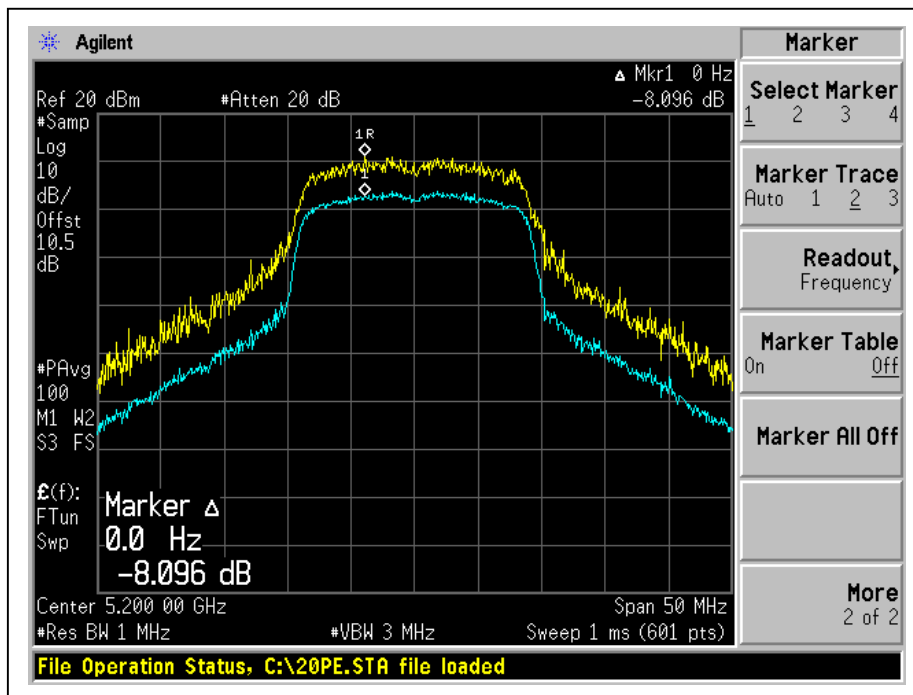

CH48

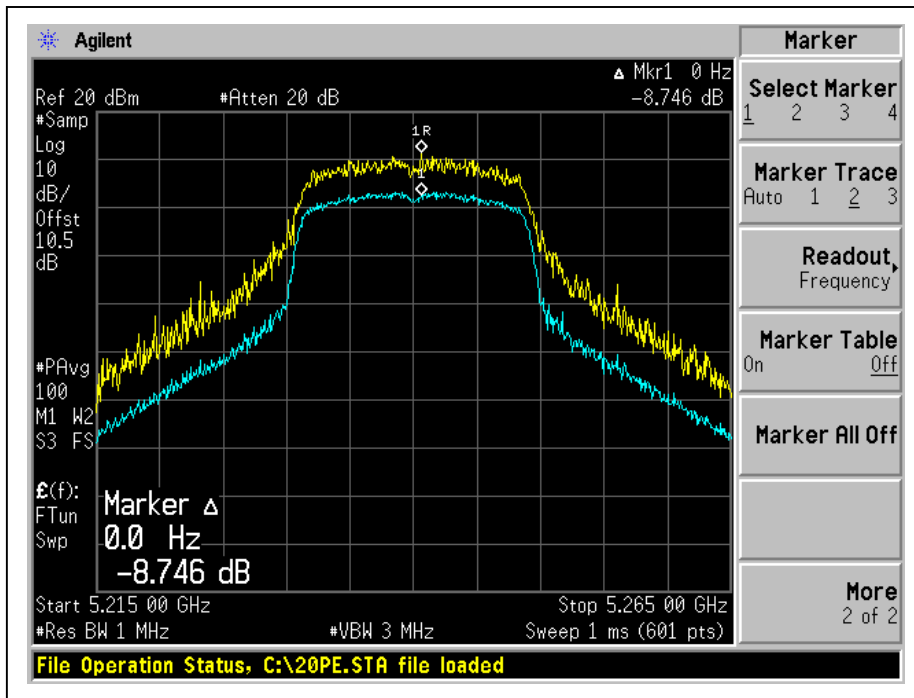

CH52

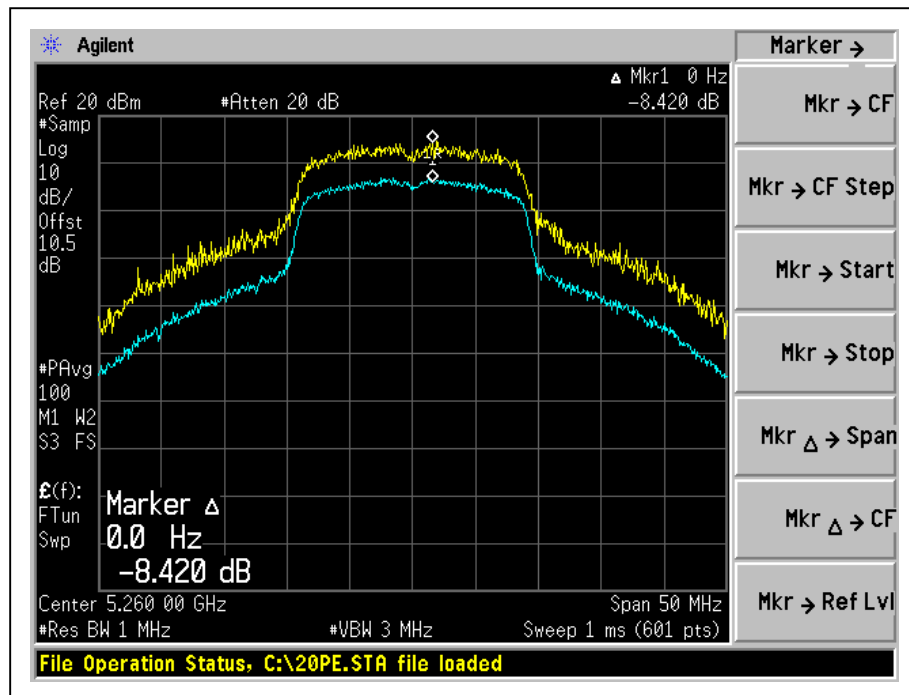



A D T

CH60

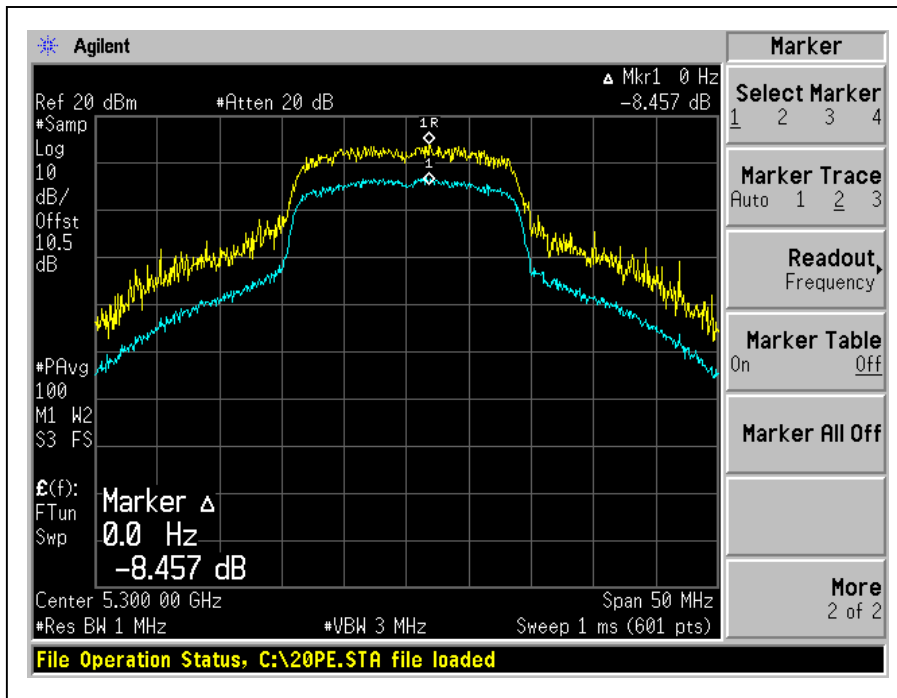

CH64

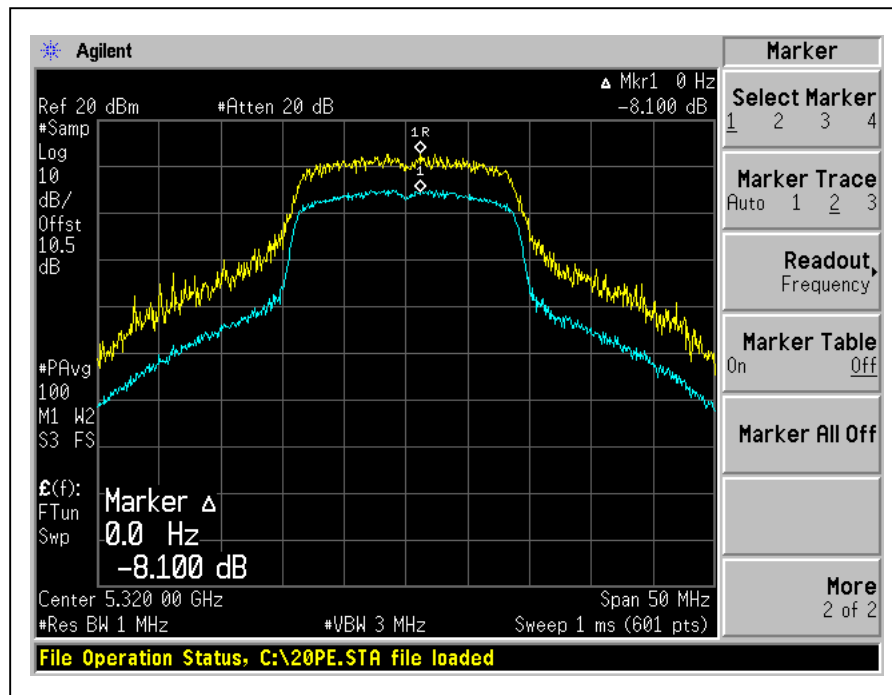



A D T

CH100

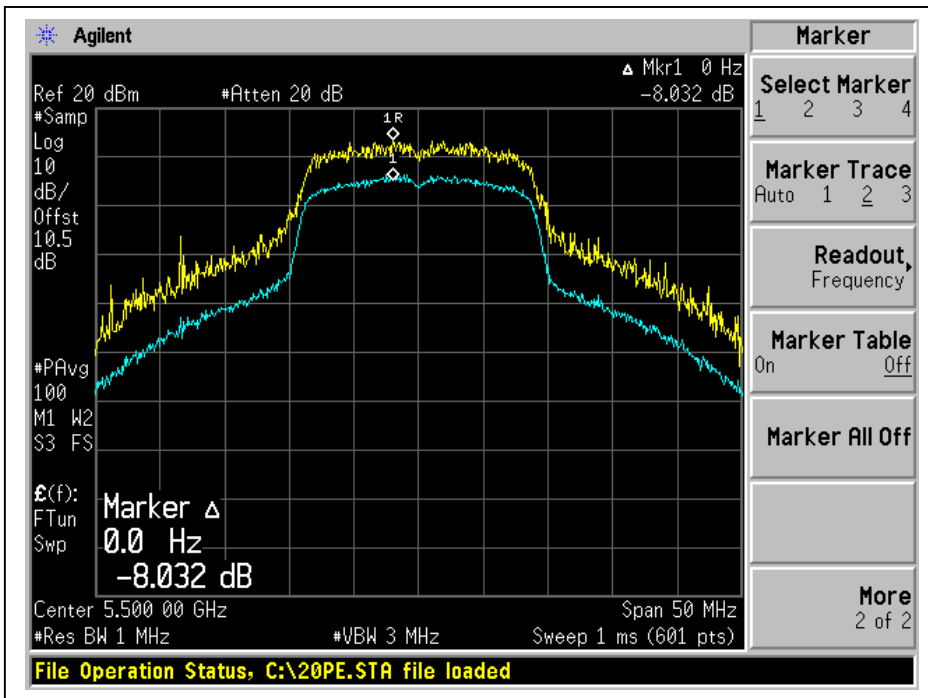

CH116

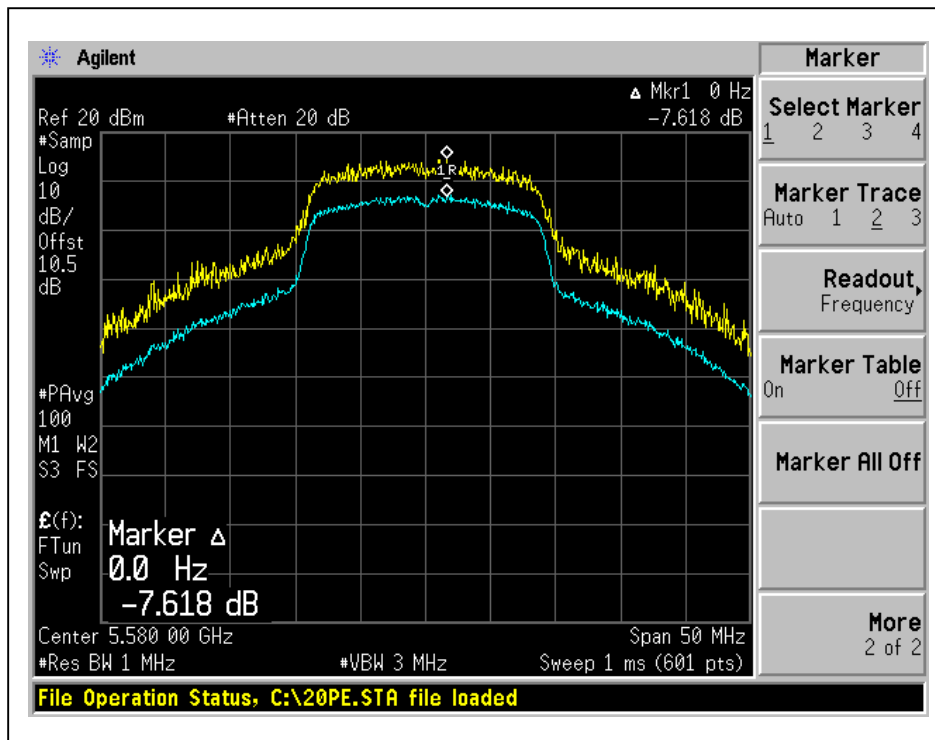



A D T

CH120

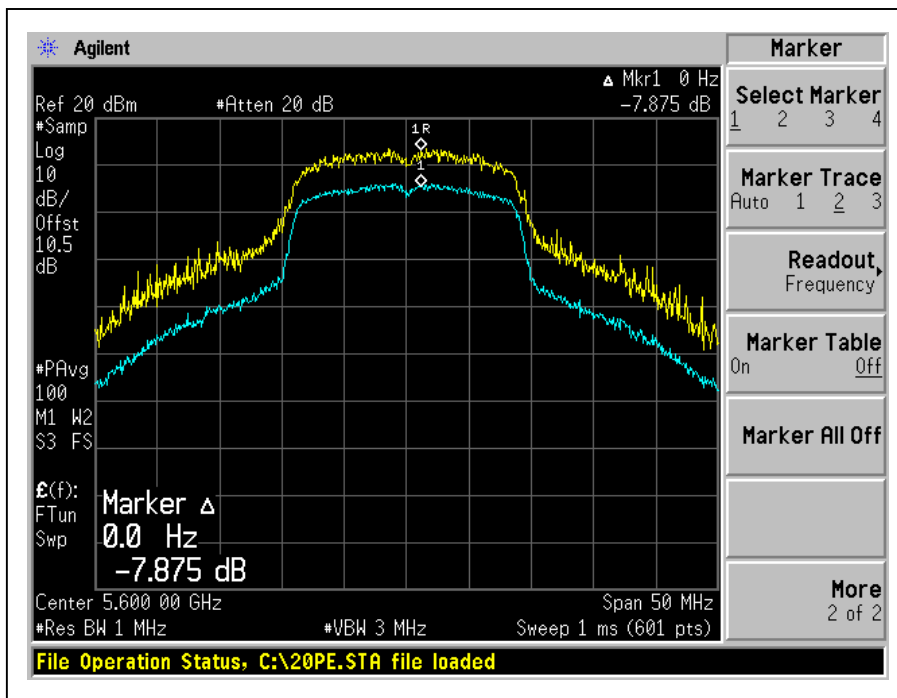

CH132

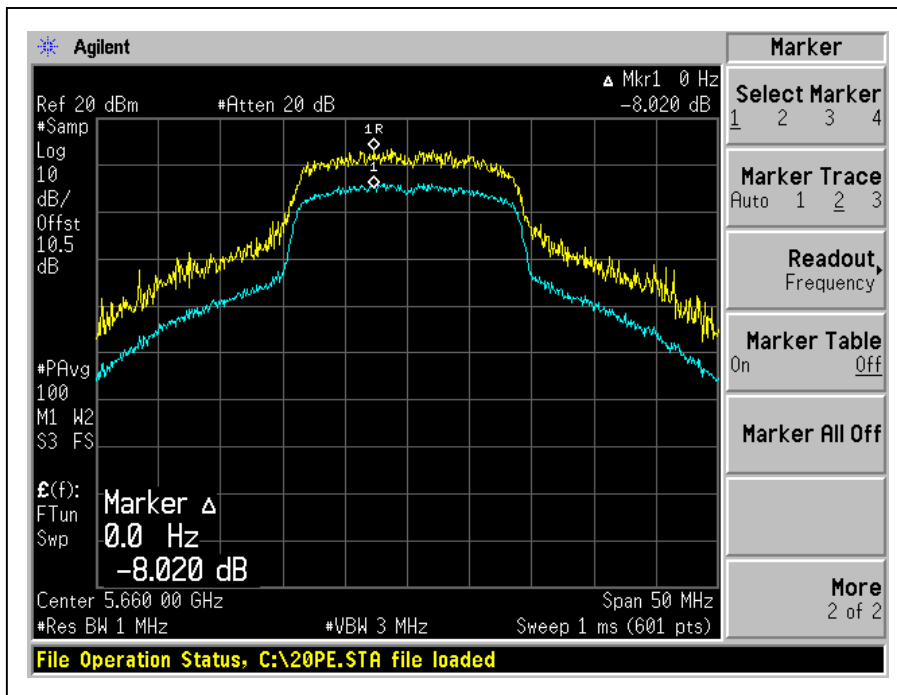



A D T

CH140

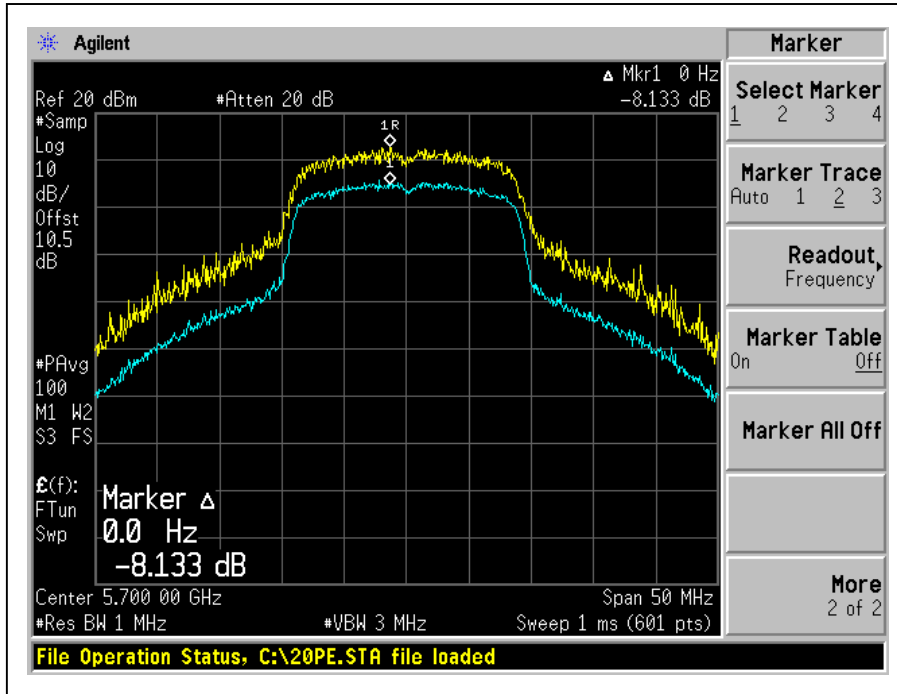



A D T

4.5 PEAK POWER SPECTRAL DENSITY MEASUREMENT

4.5.1 LIMITS OF PEAK POWER SPECTRAL DENSITY MEASUREMENT

Frequency Band	Limit
5.15 ~ 5.25GHz	4dBm
5.25 ~ 5.35GHz	11dBm
5.47 ~ 5.725GHz	11dBm
5.725 ~ 5.825GHz	17dBm

4.5.2 TEST INSTRUMENTS

DESCRIPTION & MANUFACTURER	MODEL NO.	SERIAL NO.	CALIBRATED DATE	CALIBRATED UNTIL
Spectrum Analyzer	E4446A	MY48250254	July 14, 2010	July 13, 2011

NOTE:

1. The calibration interval of the above test instruments is 12 months and the calibrations are traceable to NML/ROC and NIST/USA.

4.5.3 TEST PROCEDURES

1. The transmitter output was connected to the spectrum analyzer.
2. Set RBW=1MHz, VBW=3MHz. The PPSD is the highest level found across the emission in any 1MHz band.

4.5.4 DEVIATION FROM TEST STANDARD

No deviation

4.5.5 TEST SETUP



4.5.6 EUT OPERATING CONDITIONS

Same as 4.3.6



A D T

4.5.7 TEST RESULTS(MODE A)

802.11a OFDM modulation

CHANNEL	CHANNEL FREQUENCY (MHz)	RF POWER LEVEL IN 1MHz BW (dBm)	MAXIMUM LIMIT (dBm)	PASS/FAIL
36	5180	2.7	4	PASS
40	5200	2.9	4	PASS
48	5240	2.7	4	PASS
52	5260	6.9	11	PASS
60	5300	6.9	11	PASS
64	5320	5.3	11	PASS
100	5500	6.4	11	PASS
116	5580	6.9	11	PASS
120	5600	6.3	11	PASS
132	5660	6.3	11	PASS
140	5700	6.7	11	PASS



A D T

CH36

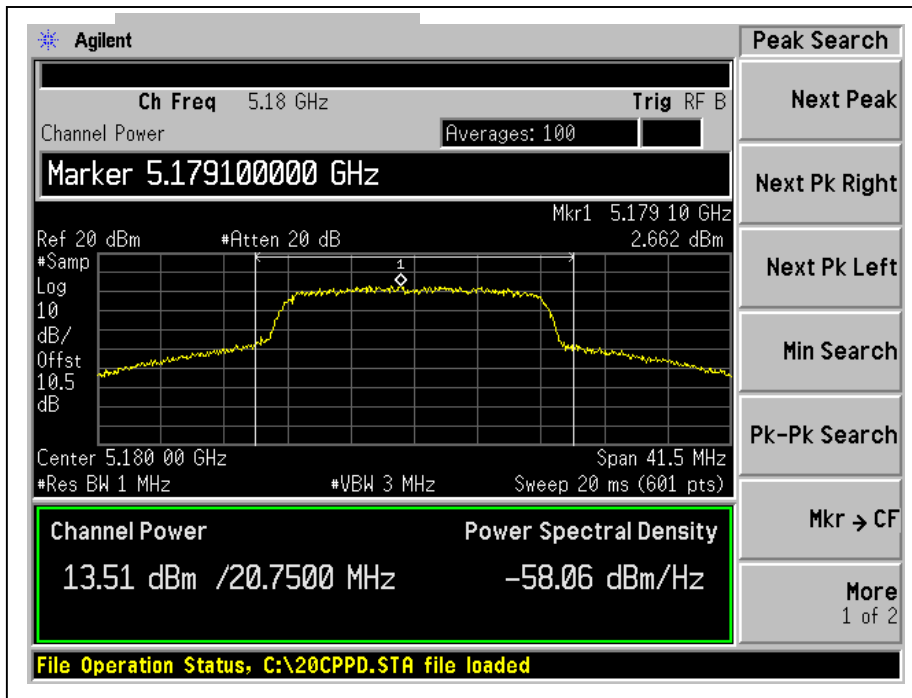

CH40

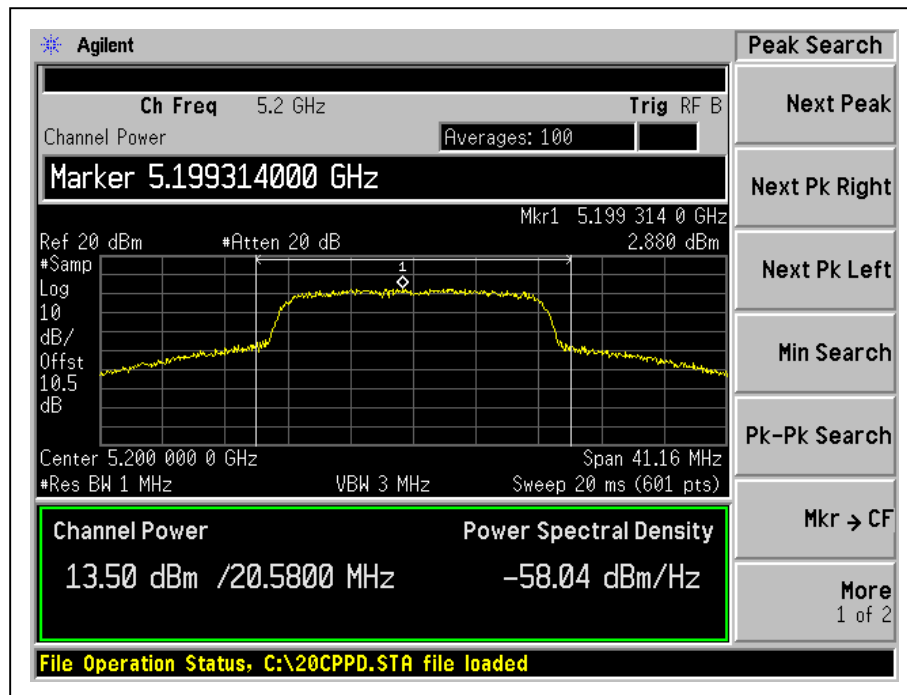



A D T

CH48

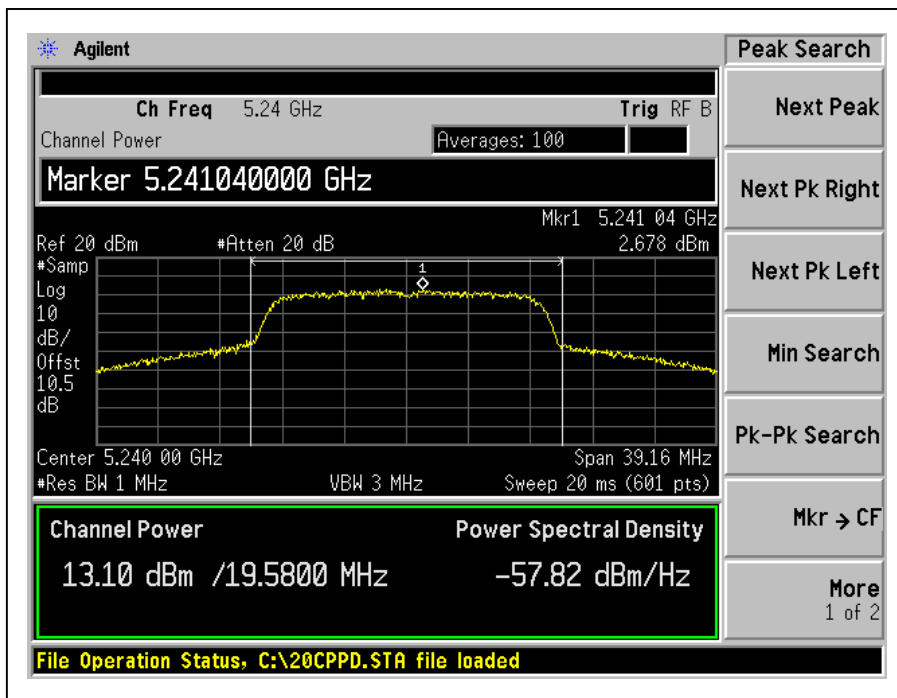

CH52

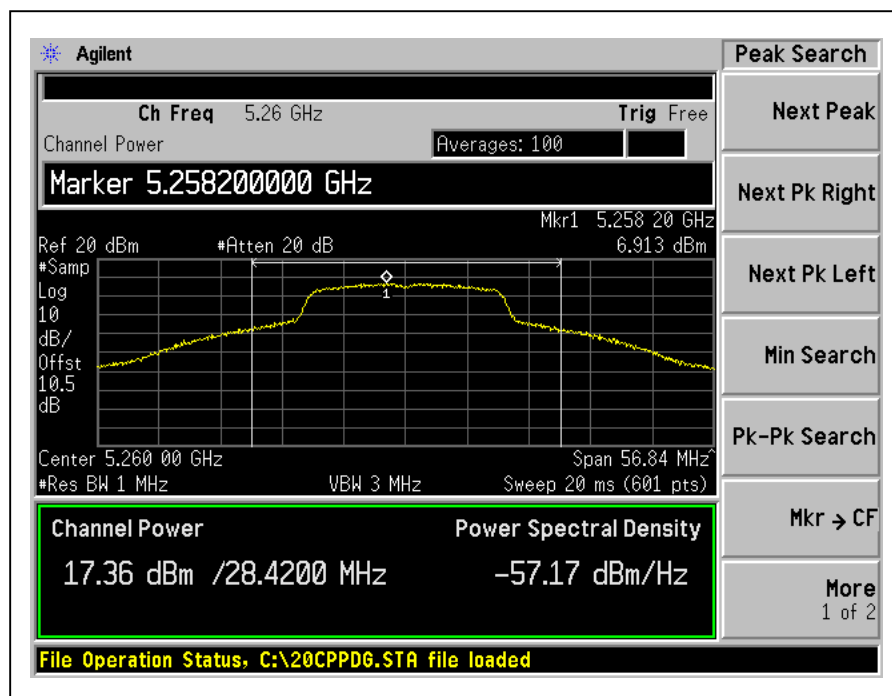

CH60

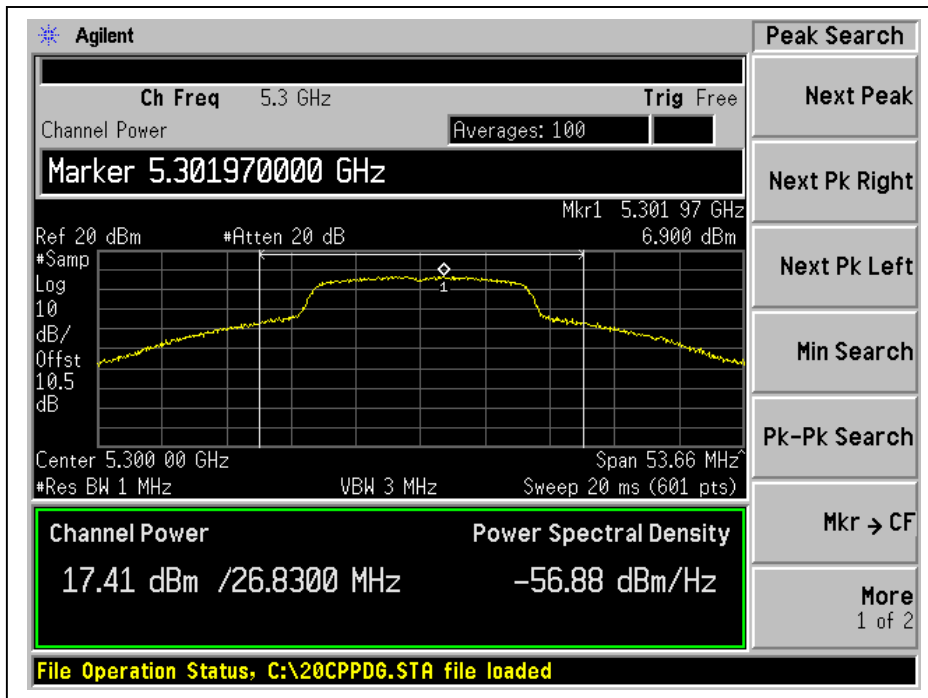

CH64

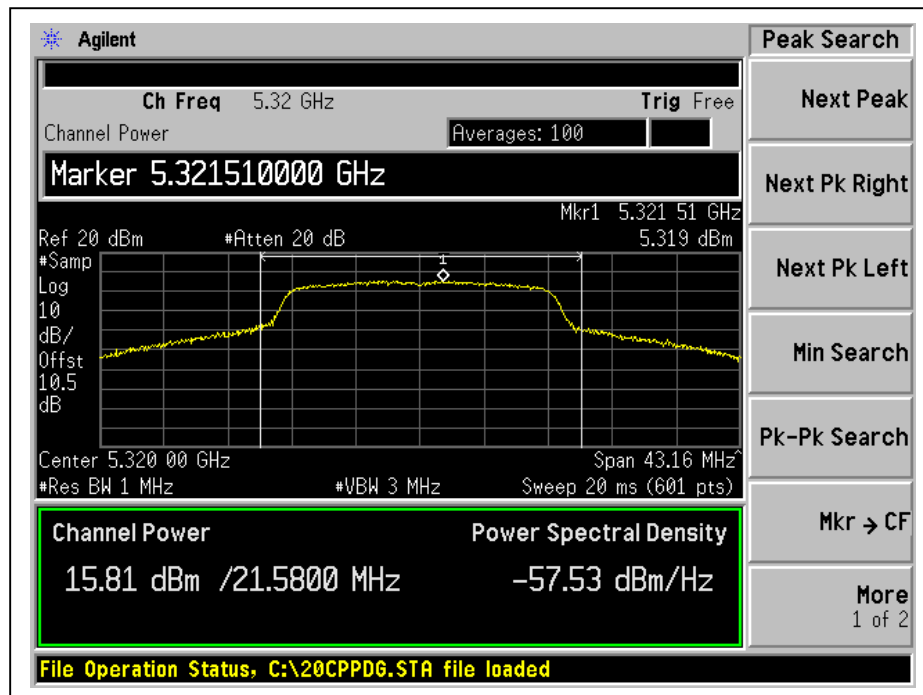



A D T

CH100

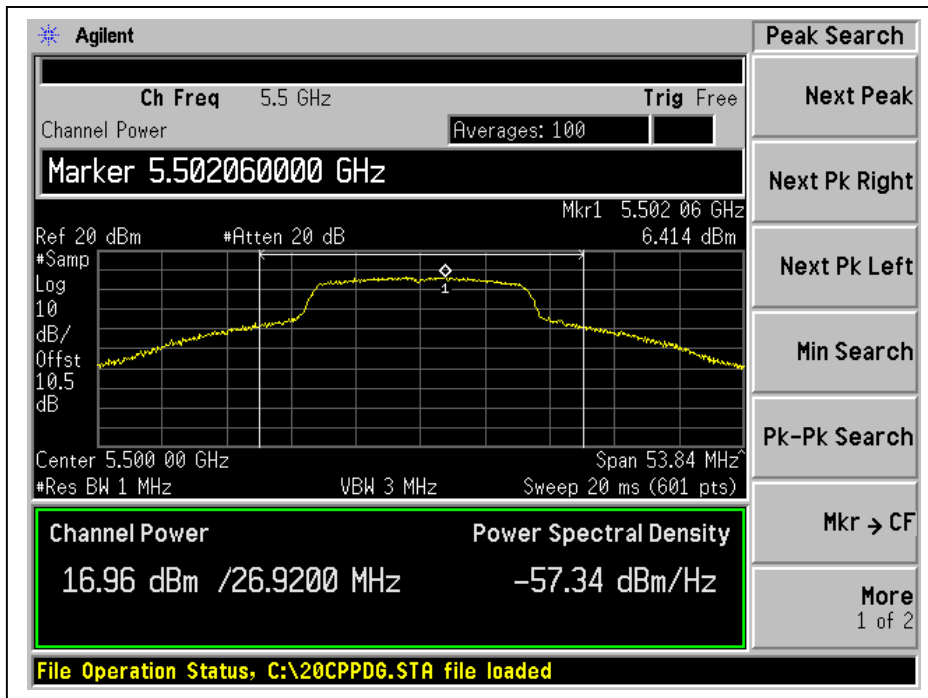

CH116

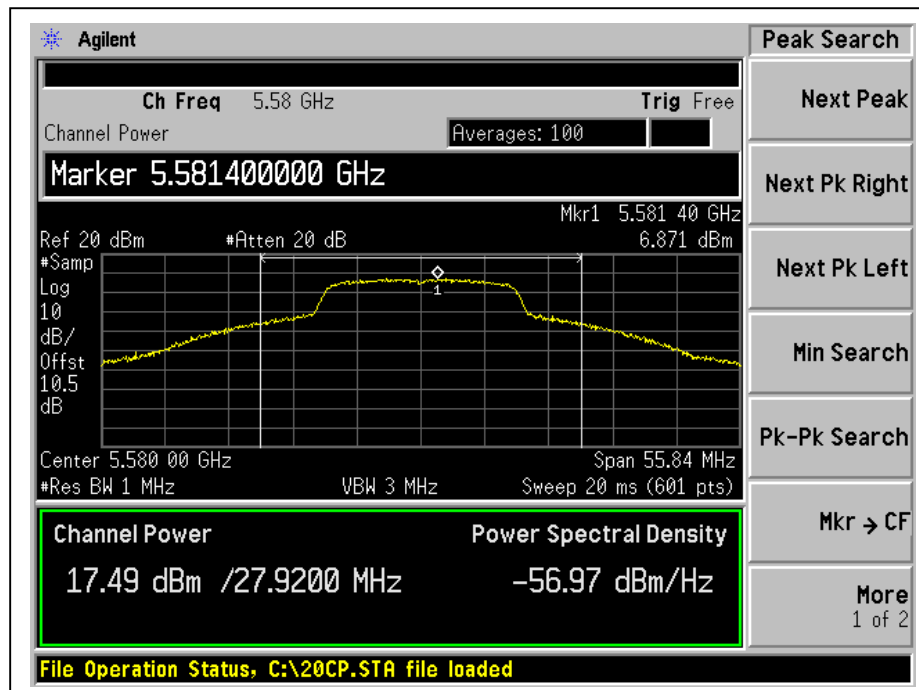



A D T

CH120

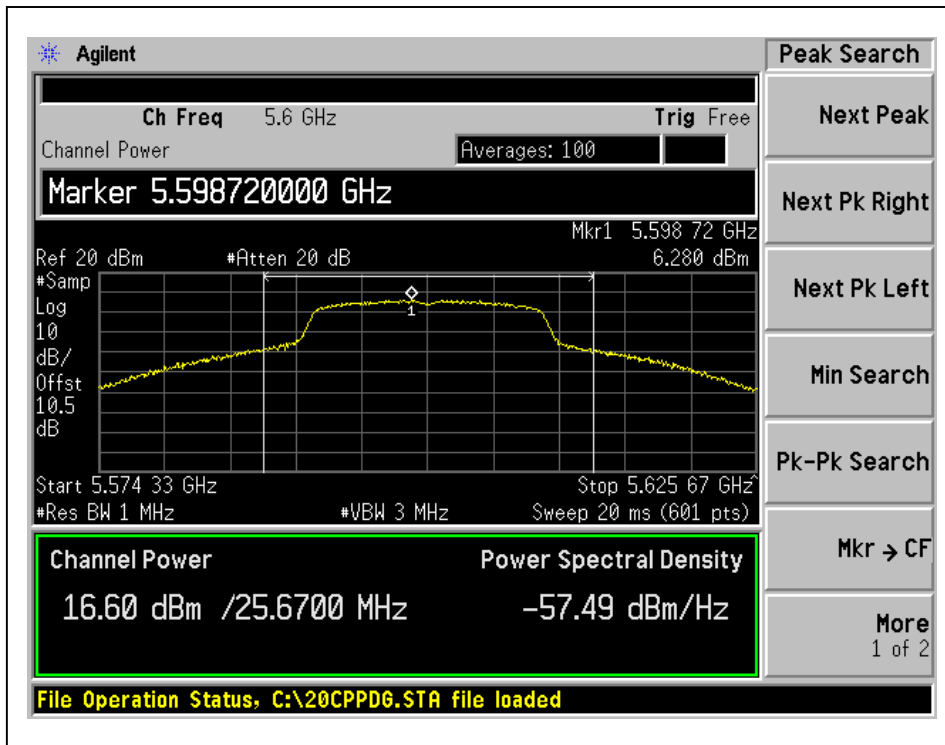

CH132

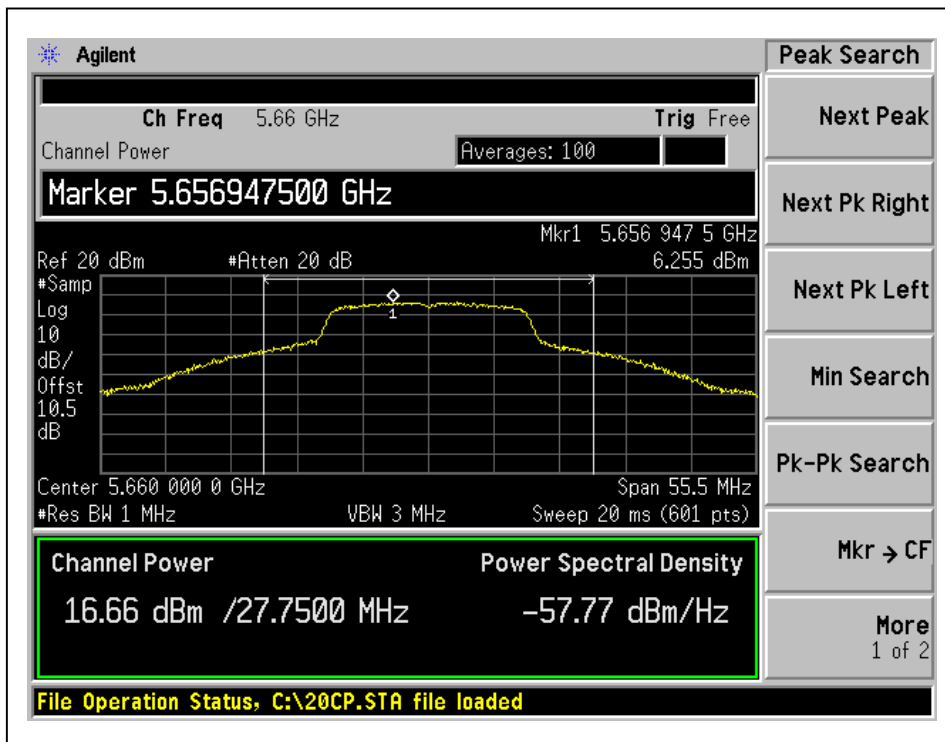



A D T

CH140

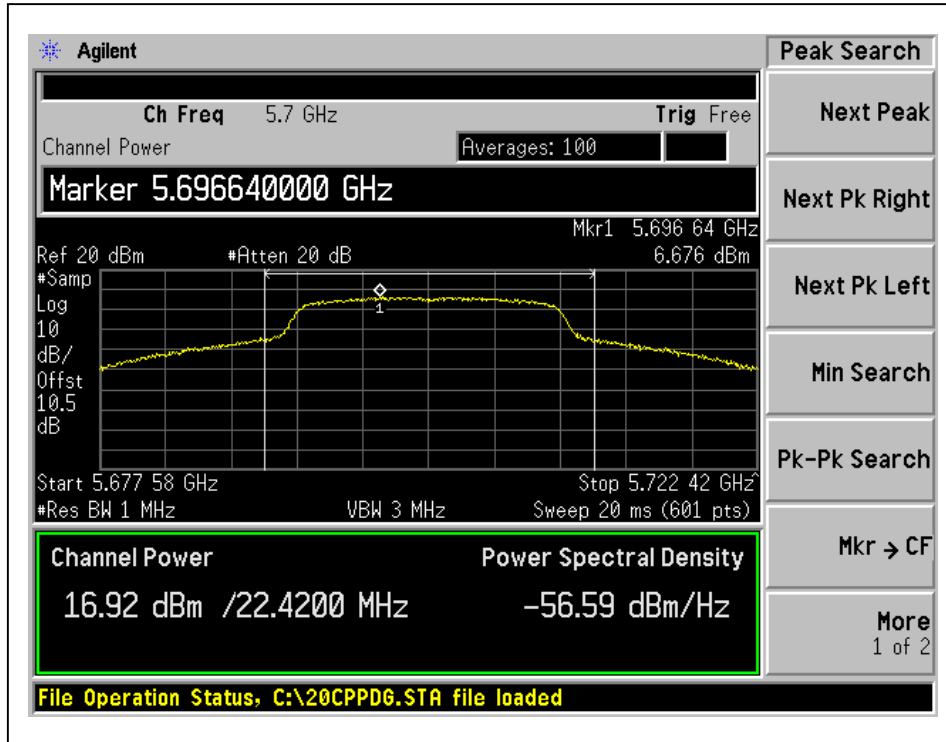



A D T

802.11n(20MHz) OFDM modulation

CHANNEL	CHANNEL FREQUENCY (MHz)	RF POWER LEVEL IN 1MHz BW (dBm)	MAXIMUM LIMIT (dBm)	PASS/FAIL
36	5180	2.4	4	PASS
40	5200	2.4	4	PASS
48	5240	2.5	4	PASS
52	5260	6.9	11	PASS
60	5300	6.9	11	PASS
64	5320	4.8	11	PASS
100	5500	6.6	11	PASS
116	5580	7.1	11	PASS
120	5600	6.0	11	PASS
132	5660	5.9	11	PASS
140	5700	6.0	11	PASS



A D T

CH36

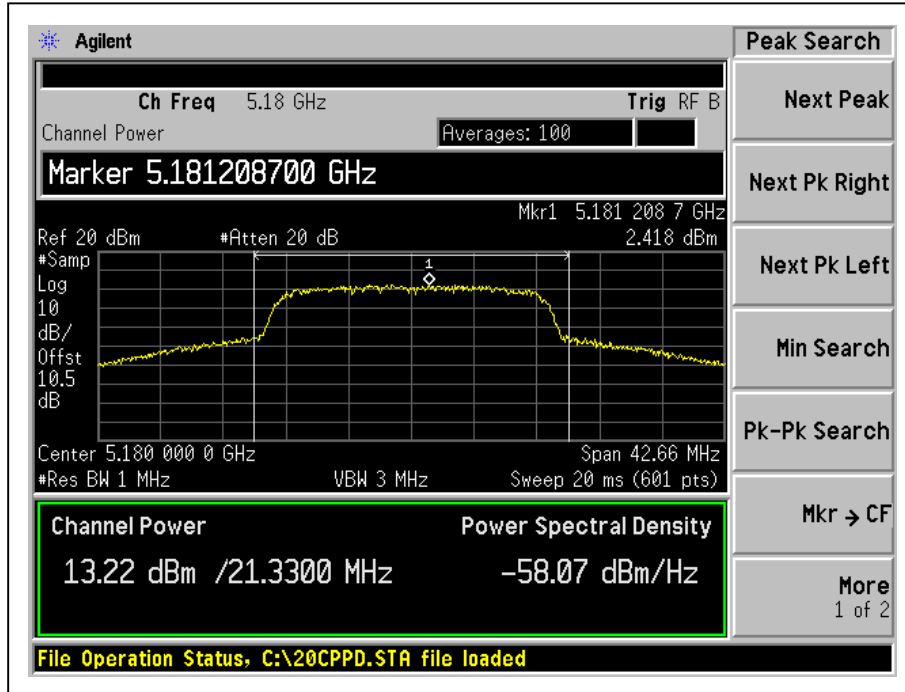

CH40

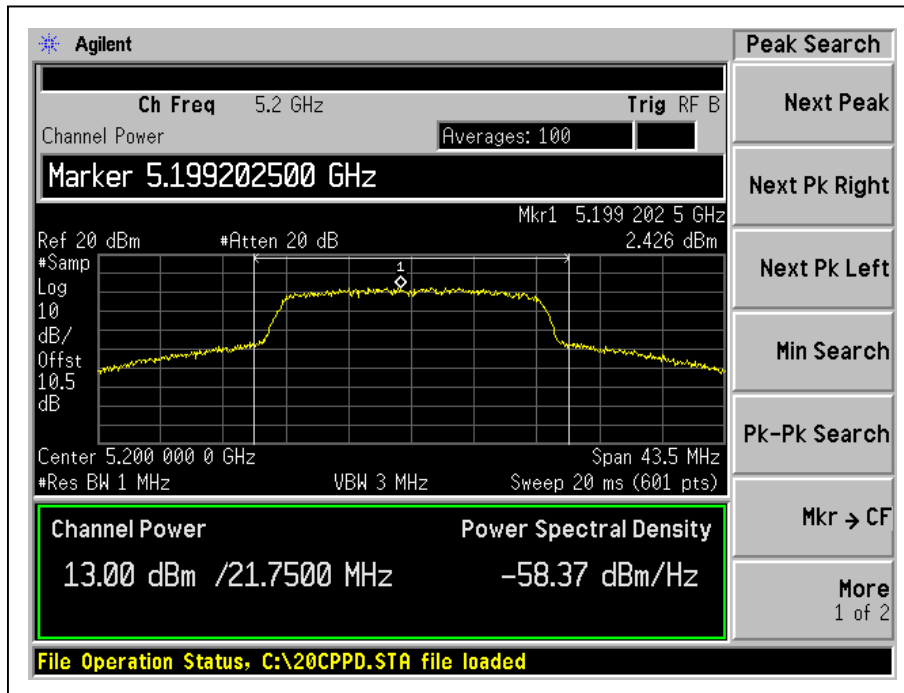



A D T

CH48

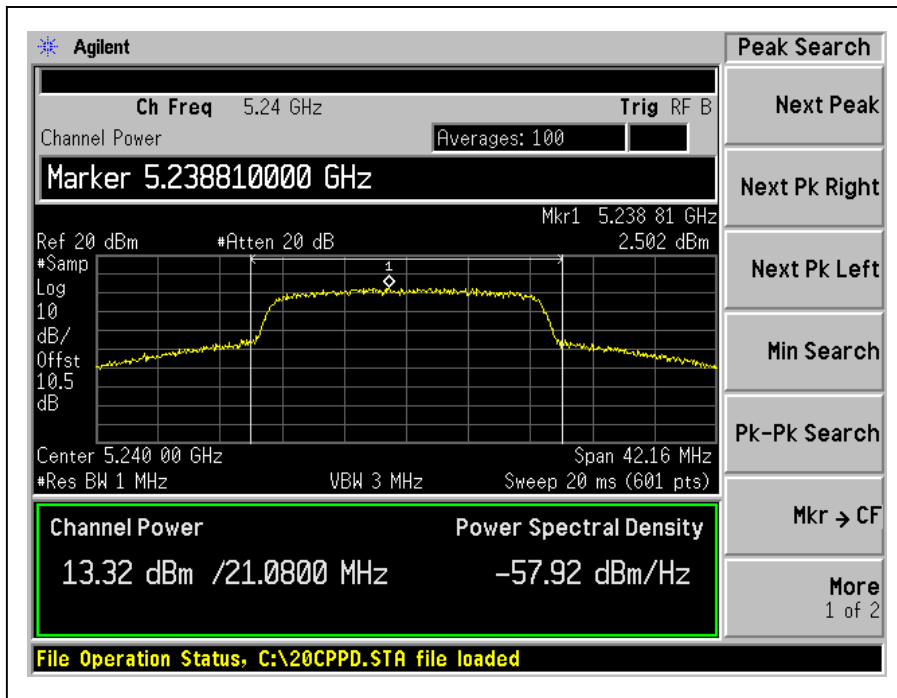

CH52

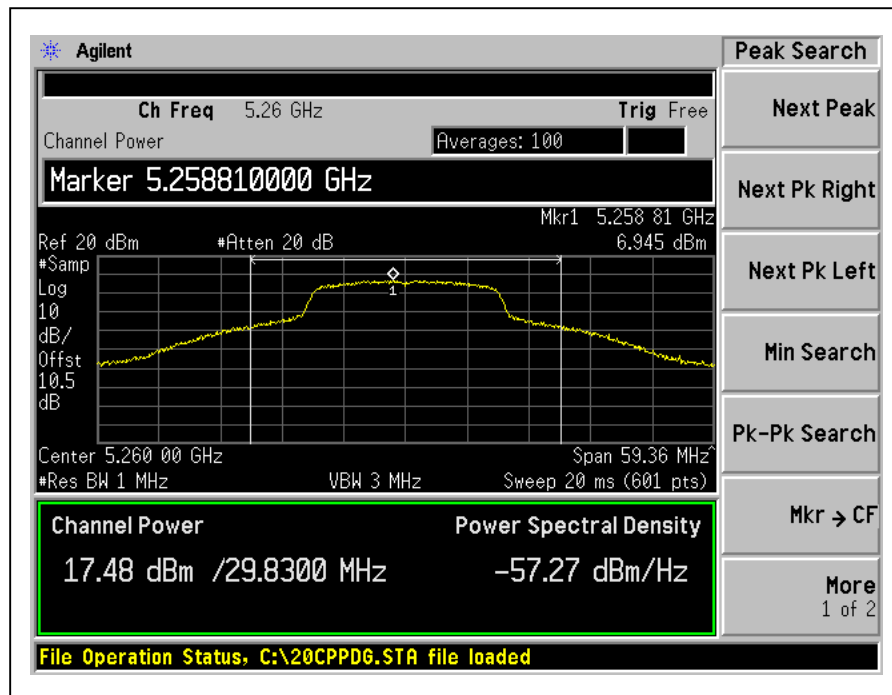



A D T

CH60

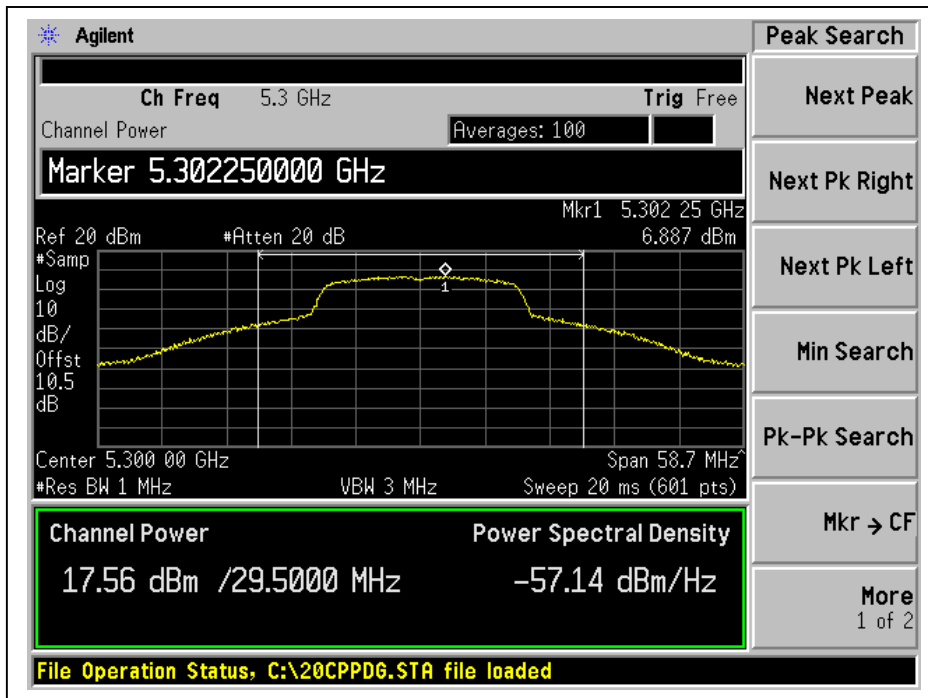

CH64

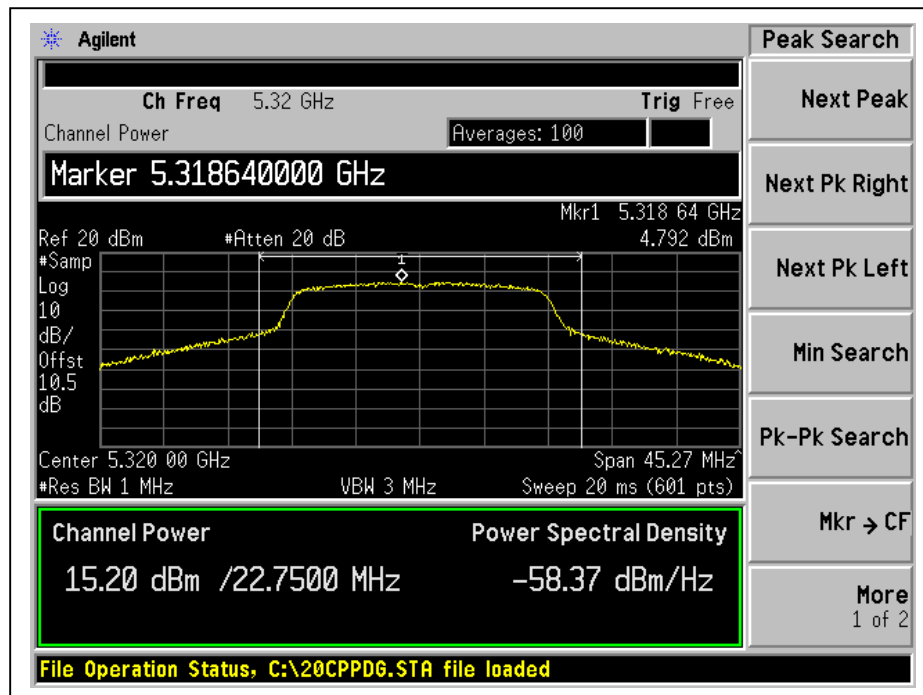



A D T

CH100

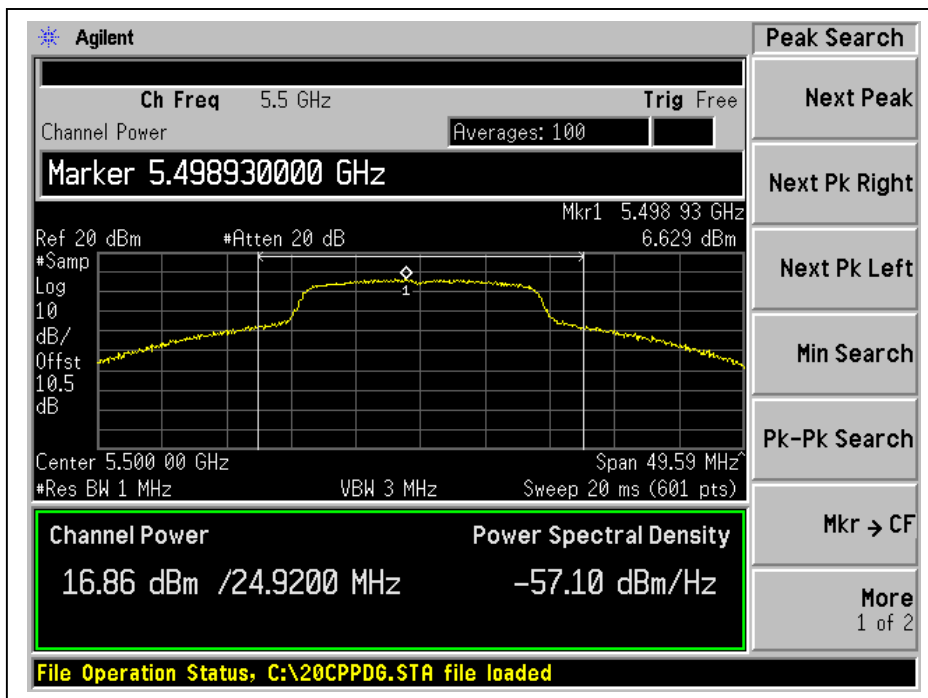

CH116

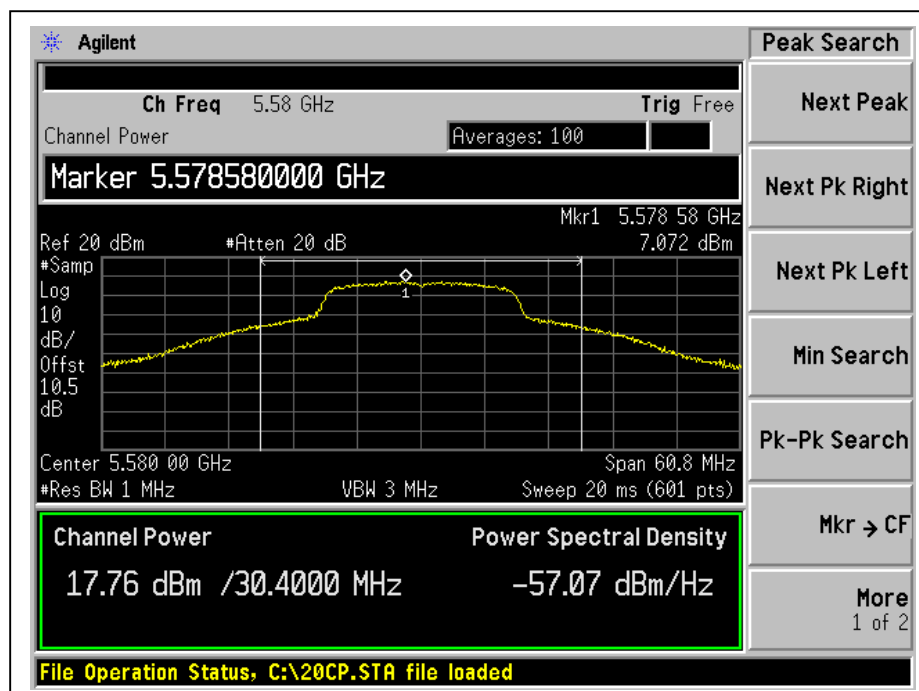



A D T

CH120

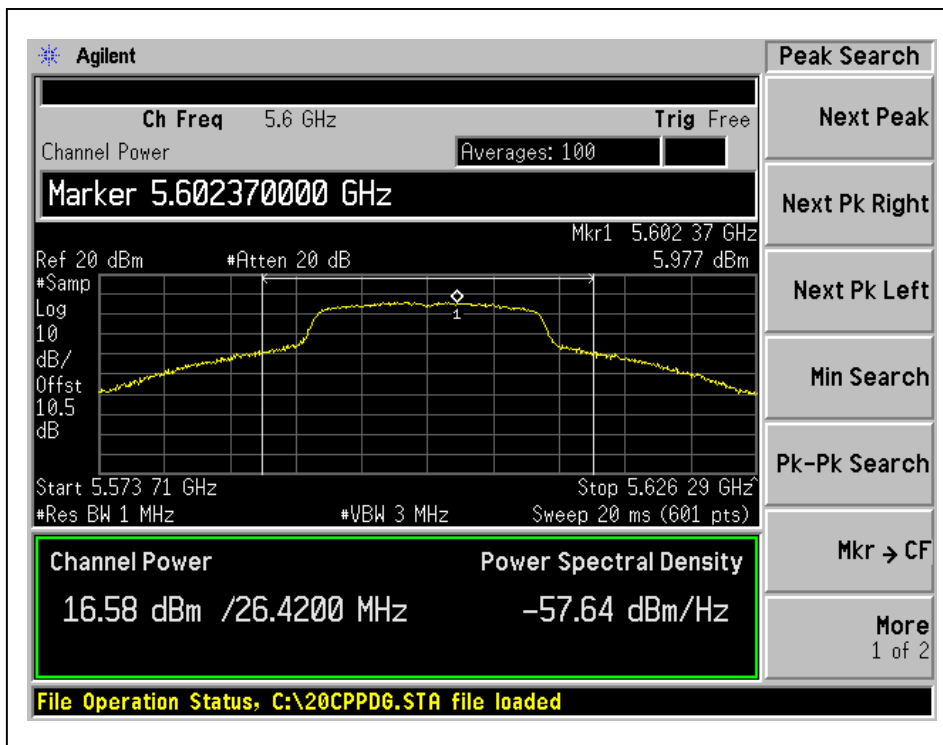

CH132

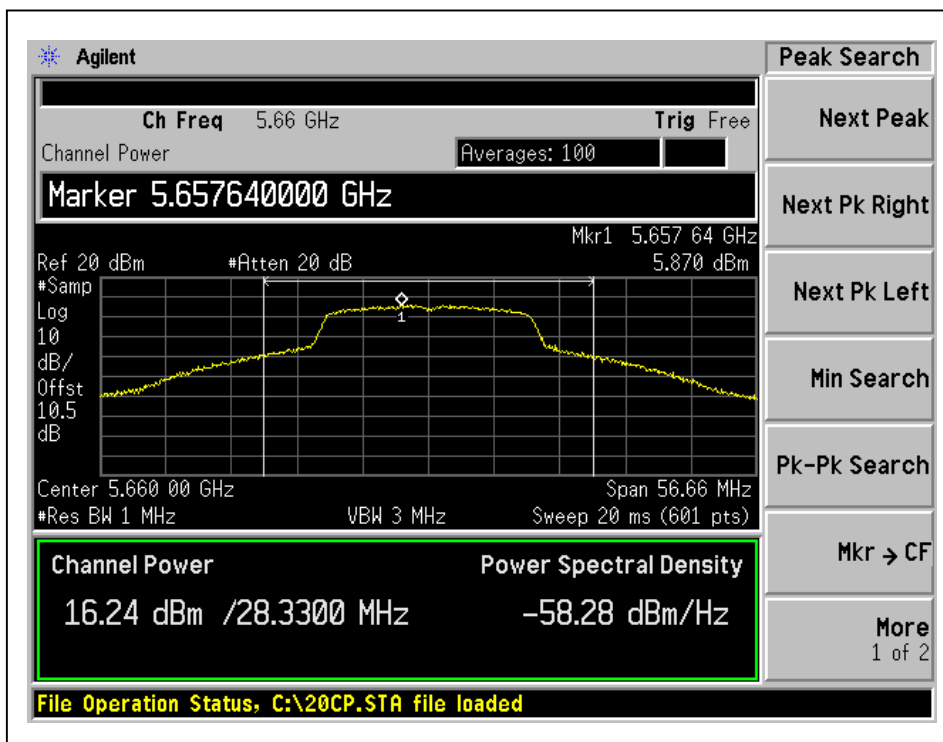



A D T

CH140

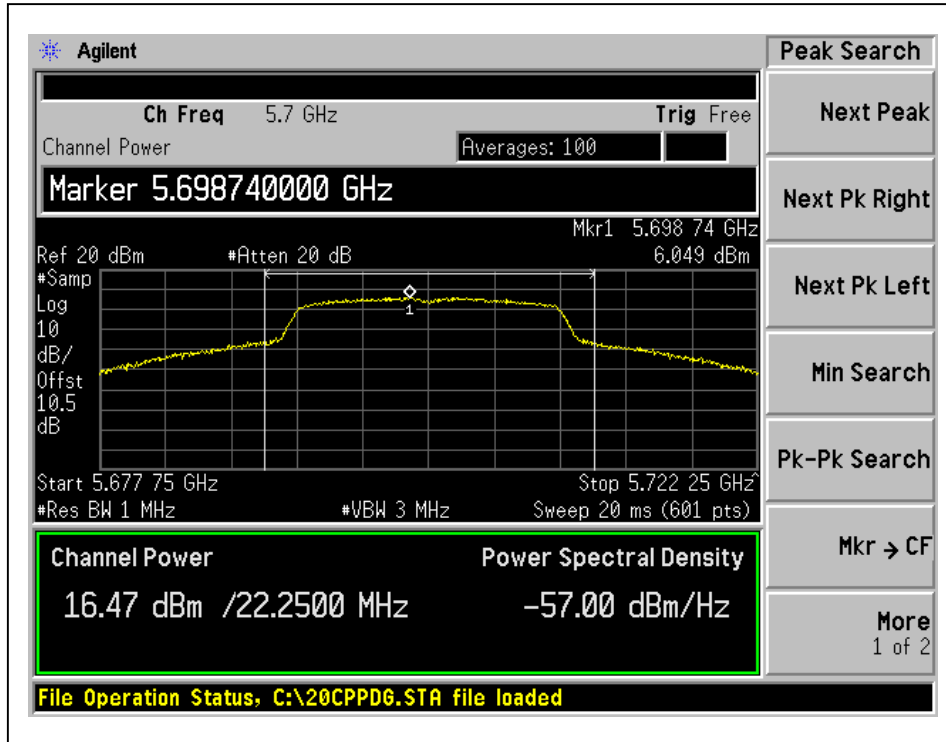



A D T

4.5.8 TEST RESULTS(MODE B)

802.11a OFDM modulation

CHANNEL	CHANNEL FREQUENCY (MHz)	RF POWER LEVEL IN 1MHz BW (dBm)	MAXIMUM LIMIT (dBm)	PASS/FAIL
36	5180	3.5	4	PASS
40	5200	3.7	4	PASS
48	5240	3.5	4	PASS
52	5260	7.7	11	PASS
60	5300	7.7	11	PASS
64	5320	6.1	11	PASS
100	5500	7.2	11	PASS
116	5580	7.7	11	PASS
120	5600	7.1	11	PASS
132	5660	7.1	11	PASS
140	5700	7.5	11	PASS



A D T

802.11n(20MHz) OFDM modulation

CHANNEL	CHANNEL FREQUENCY (MHz)	RF POWER LEVEL IN 1MHz BW (dBm)	MAXIMUM LIMIT (dBm)	PASS/FAIL
36	5180	3.2	4	PASS
40	5200	3.2	4	PASS
48	5240	3.3	4	PASS
52	5260	7.7	11	PASS
60	5300	7.7	11	PASS
64	5320	5.6	11	PASS
100	5500	7.4	11	PASS
116	5580	7.9	11	PASS
120	5600	6.8	11	PASS
132	5660	6.7	11	PASS
140	5700	6.8	11	PASS

4.6 FREQUENCY STABILITY

4.6.1 LIMITS OF FREQUENCY STABILITY MEASUREMENT

The frequency tolerance of the carrier signal shall be maintained within the band of the operating frequency over a temperature variation of –30 degrees to 50 degrees C at normal supply voltage, and for a variation in the primary supply voltage from 85% to 115% of the rated supply voltage at a temperature of 20 degrees C.

4.6.2 TEST INSTRUMENTS

DESCRIPTION & MANUFACTURER	MODEL NO.	SERIAL NO.	CALIBRATED DATE	CALIBRATED UNTIL
Spectrum Analyzer	E4446A	MY48250254	July 14, 2010	July 13, 2011

NOTE:

1. The calibration interval of the above test instruments is 12 months and the calibrations are traceable to NML/ROC and NIST/USA.

4.6.3 TEST PROCEDURE

1. The EUT was placed inside the environmental test chamber and powered by nominal DC voltage.
2. Turn the EUT on and couple its output to a spectrum analyzer.
3. Turn the EUT off and set the chamber to the highest temperature specified.
4. Allow sufficient time (approximately 30 min) for the temperature of the chamber to stabilize, turn the EUT on and measure the operating frequency after 2, 5, and 10 minutes.
5. Repeat step 2 and 3 with the temperature chamber set to the lowest temperature.
6. The test chamber was allowed to stabilize at +20 degree C for a minimum of 30 minutes. The supply voltage was then adjusted on the EUT from 85% to 115% and the frequency record.

4.6.4 DEVIATION FROM TEST STANDARD

No deviation

4.6.5 TEST SETUP

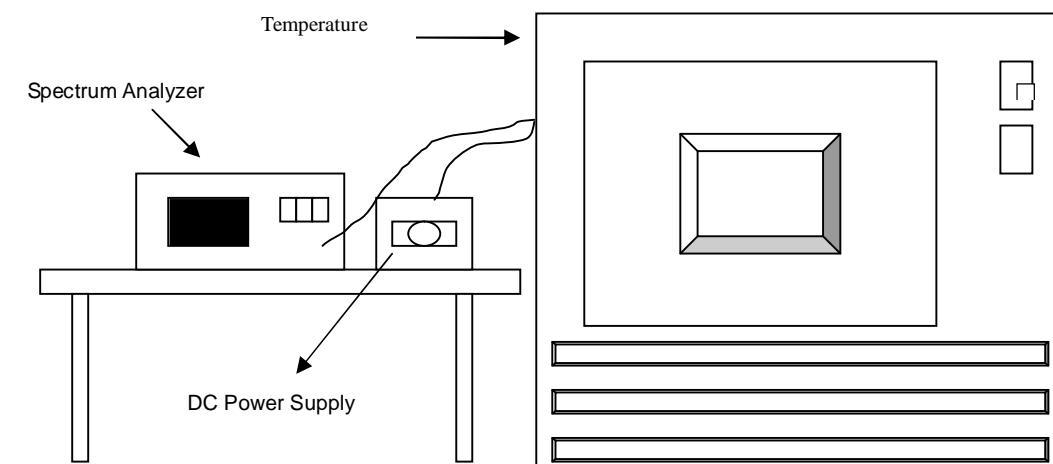

4.6.6 EUT OPERATING CONDITION

The software provided by client to enable the EUT under transmission condition continuously at specific channel frequencies individually.



A D T

4.6.7 TEST RESULTS

Operating frequency: 5180MHz									
Temp. (°C)	Power supply (Vdc)	0 minute		2 minute		5 minute		10 minute	
		(MHz)	ppm	(MHz)	ppm	(MHz)	ppm	(MHz)	ppm
50	3.465	5179.9999	-0.0193	5180.0025	0.4826	5180.0007	0.1351	5180.004	0.7722
	3.3	5179.9996	-0.0772	5180.0019	0.3668	5179.9995	-0.0965	5180.0044	0.8494
	3.135	5179.9992	-0.1544	5180.003	0.5792	5180.0013	0.2510	5180.0042	0.8108
40	3.465	5179.9844	-3.0116	5179.9865	-2.6062	5179.9873	-2.4517	5179.9873	-2.4517
	3.3	5179.9839	-3.1081	5179.9864	-2.6255	5179.988	-2.3166	5179.9865	-2.6062
	3.135	5179.9837	-3.1467	5179.986	-2.7027	5179.987	-2.5097	5179.9864	-2.6255
30	3.465	5180.0069	1.3320	5180.01	1.9305	5180.0114	2.2008	5180.0135	2.6062
	3.3	5180.0085	1.6409	5180.0088	1.6988	5180.0123	2.3745	5180.0128	2.4710
	3.135	5180.0072	1.3900	5180.0087	1.6795	5180.0114	2.2008	5180.013	2.5097
20	3.465	5180.0102	1.9691	5180.0073	1.4093	5180.0049	0.9459	5180.0024	0.4633
	3.3	5180.0101	1.9498	5180.008	1.5444	5180.0038	0.7336	5180.0014	0.2703
	3.135	5180.0101	1.9498	5180.0073	1.4093	5180.0034	0.6564	5180.0016	0.3089
10	3.465	5179.983	-3.2819	5179.9808	-3.7066	5179.9836	-3.1660	5179.9834	-3.2046
	3.3	5179.983	-3.2819	5179.9802	-3.8224	5179.9837	-3.1467	5179.9848	-2.9344
	3.135	5179.9834	-3.2046	5179.981	-3.6680	5179.9846	-2.9730	5179.9836	-3.1660
0	3.465	5180.0095	1.8340	5180.0117	2.2587	5180.0097	1.8726	5180.0115	2.2201
	3.3	5180.0089	1.7181	5180.0119	2.2973	5180.0102	1.9691	5180.0106	2.0463
	3.135	5180.0085	1.6409	5180.0121	2.3359	5180.0113	2.1815	5180.0102	1.9691
-10	3.465	5179.99	-1.9305	5179.9916	-1.6216	5179.993	-1.3514	5179.9933	-1.2934
	3.3	5179.9892	-2.0849	5179.9911	-1.7181	5179.9933	-1.2934	5179.9948	-1.0039
	3.135	5179.9888	-2.1622	5179.9909	-1.7568	5179.9946	-1.0425	5179.9945	-1.0618
-20	3.465	5180.017	3.2819	5180.0121	2.3359	5180.0154	2.9730	5180.0125	2.4131
	3.3	5180.0156	3.0116	5180.0128	2.4710	5180.0152	2.9344	5180.0122	2.3552
	3.135	5180.0166	3.2046	5180.0115	2.2201	5180.0149	2.8764	5180.0125	2.4131
-30	3.465	5179.9854	-2.8185	5179.9828	-3.3205	5179.9836	-3.1660	5179.9889	-2.1429
	3.3	5179.9859	-2.7220	5179.9822	-3.4363	5179.9849	-2.9151	5179.9888	-2.1622
	3.135	5179.986	-2.7027	5179.9818	-3.5135	5179.9839	-3.1081	5179.988	-2.3166

4.7 CONDUCTED OUT-BAND EMISSION MEASUREMENT

4.7.1 TEST INSTRUMENTS

DESCRIPTION & MANUFACTURER	MODEL NO.	SERIAL NO.	CALIBRATED DATE	CALIBRATED UNTIL
R&S SPECTRUM ANALYZER	FSP40	100036	Dec. 08, 2010	Dec. 07, 2011

NOTE:

1. The calibration interval of the above test instruments is 12 months and the calibrations are traceable to NML/ROC and NIST/USA.

4.7.2 TEST PROCEDURE

The transmitter output was connected to the spectrum analyzer via a low loss cable. Set RBW of spectrum analyzer to 1MHz with suitable frequency span including 100 MHz bandwidth from band edge. The band edges was measured and recorded.

4.7.3 EUT OPERATING CONDITION

The software provided by client to enable the EUT under transmission condition continuously at specific channel frequencies individually.

4.7.4 TEST RESULTS

For 5.15 to 5.35GHz band:

The spectrum plots (Peak RBW=1MHz, VBW=3MHz) are attached on the following pages.

802.11a OFDM modulation

CH 36

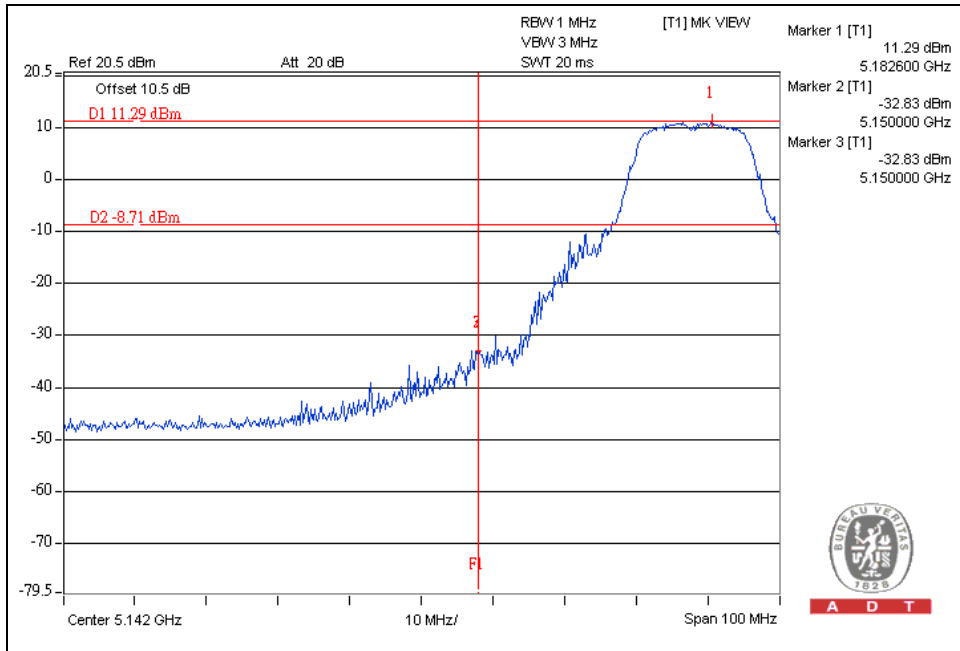

CH 64

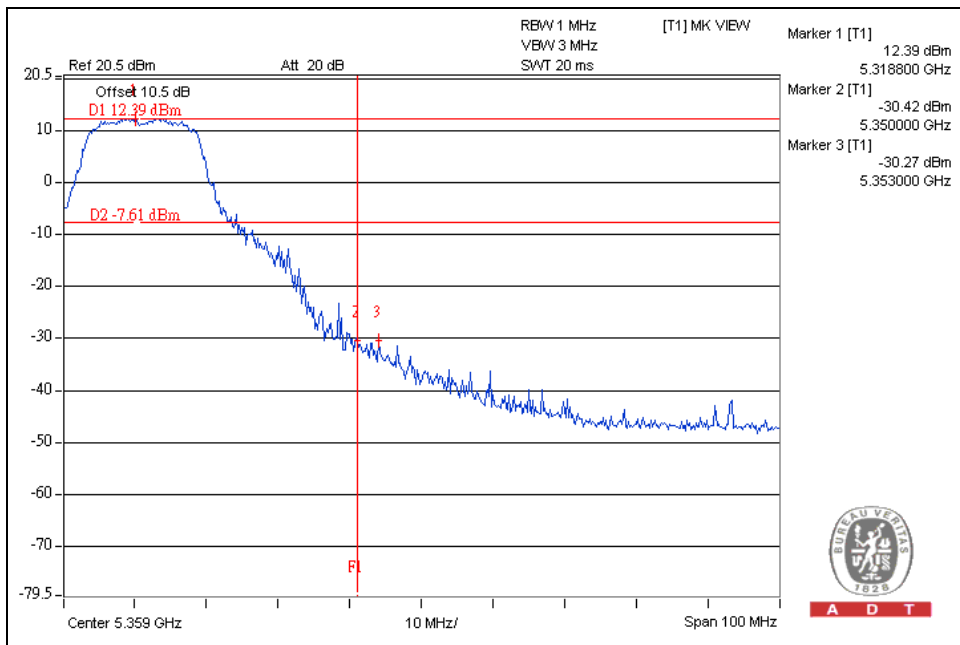



A D T

CH 36

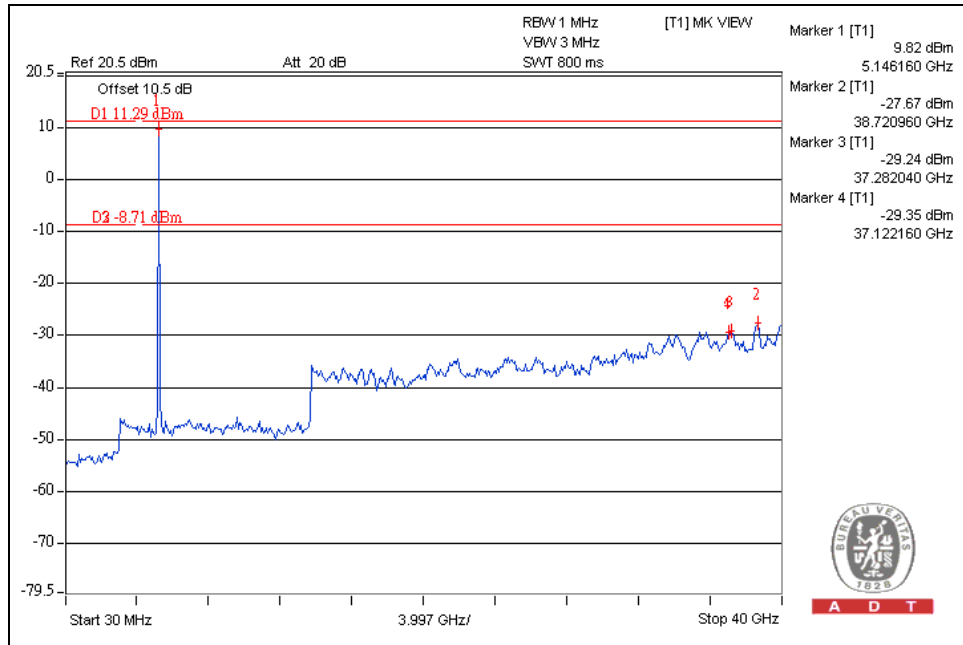

A D T

CH 64

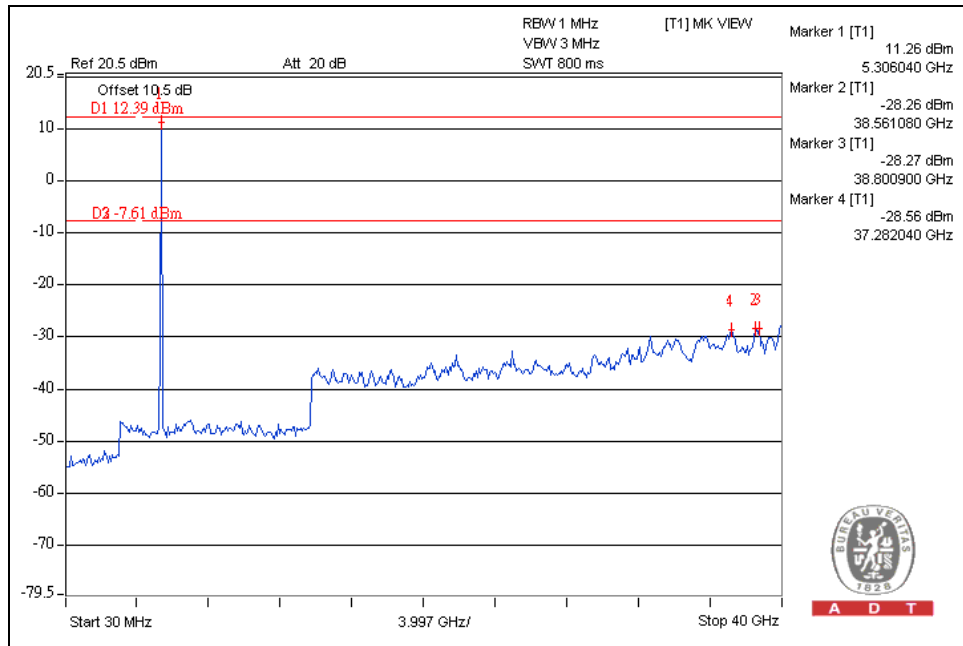

A D T



A D T

802.11n(20MHz) OFDM modulation

CH 36

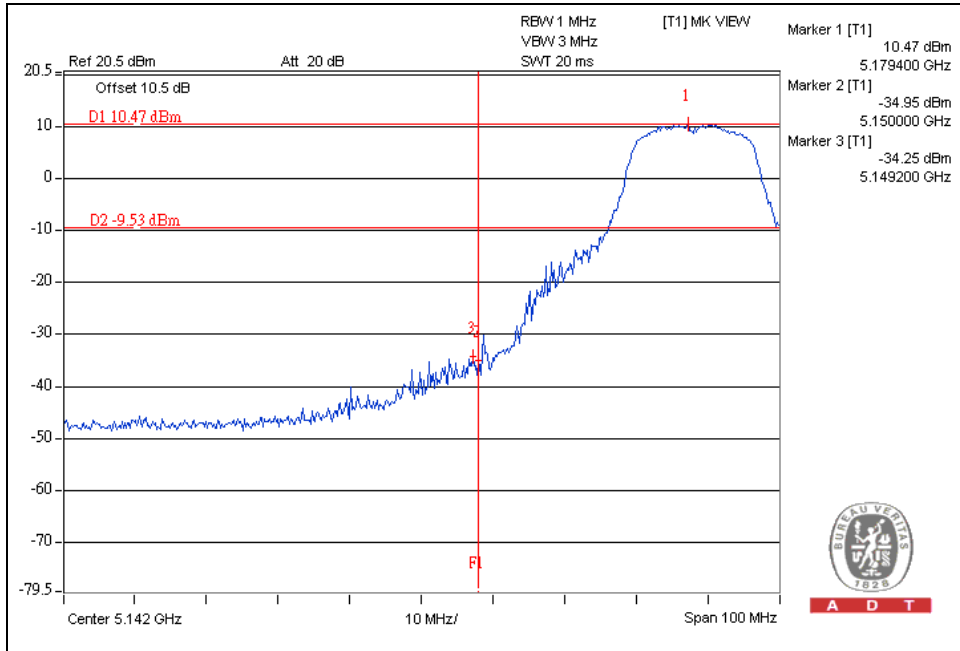

CH 64

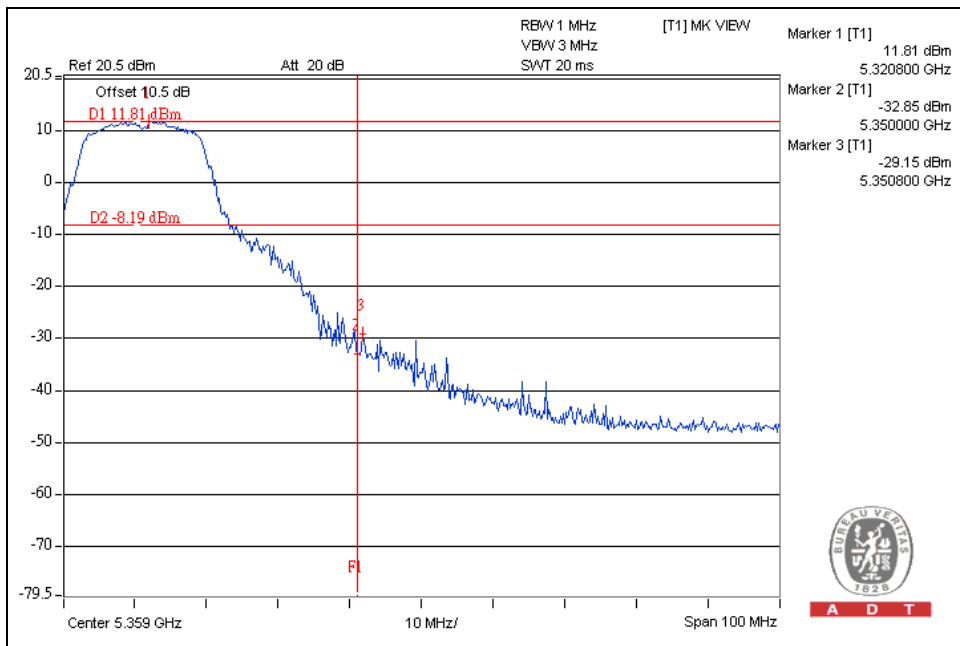



A D T

CH 36

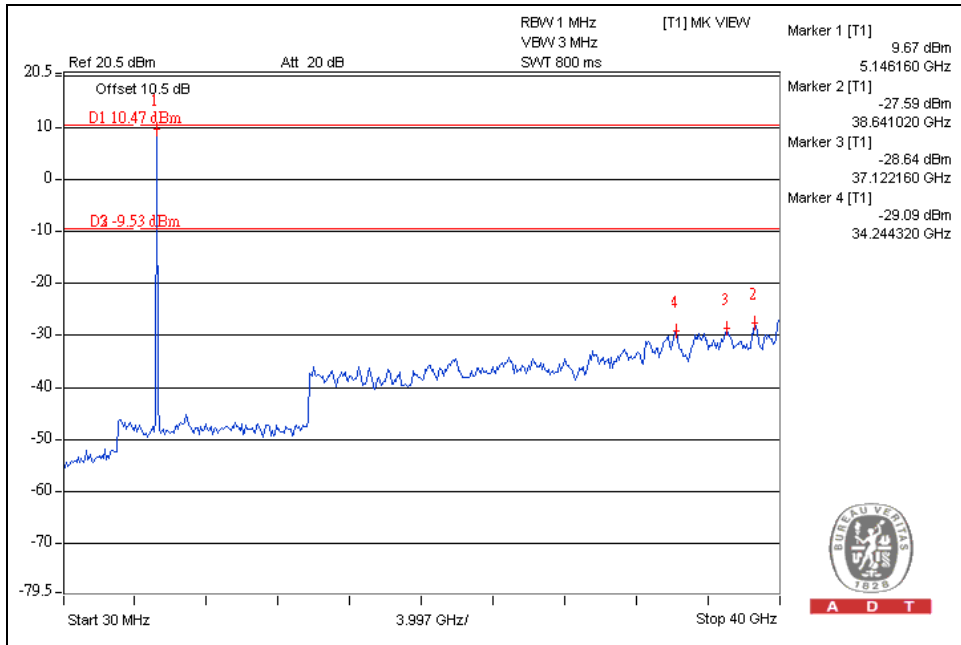

CH 64

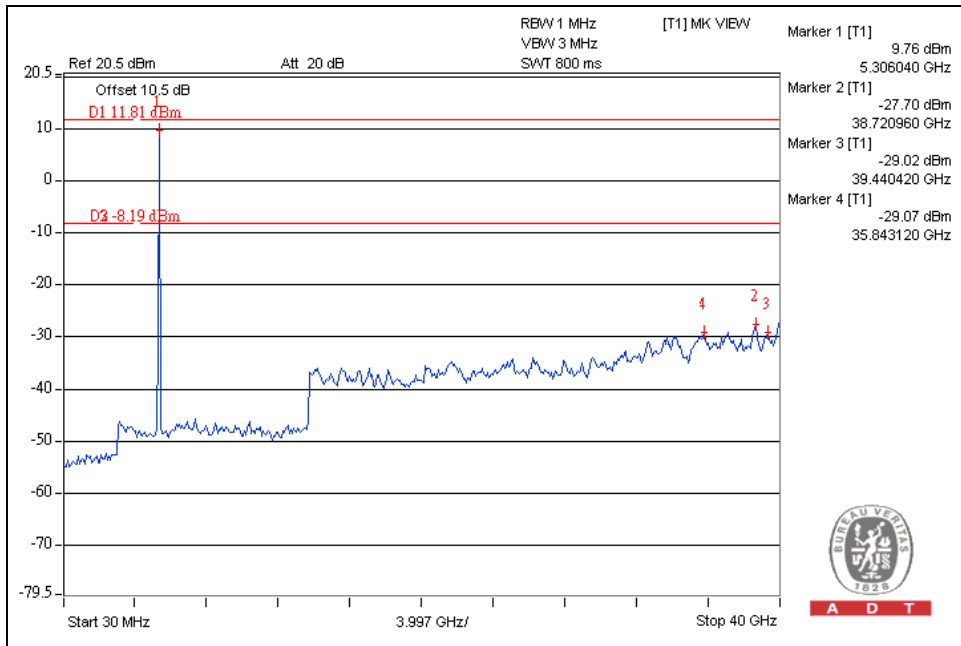

For 5.47 to 5.725GHz band:

The spectrum plots (Peak RBW=1MHz, VBW=3MHz) are attached on the following pages.



A D T

802.11a OFDM modulation

CH 100

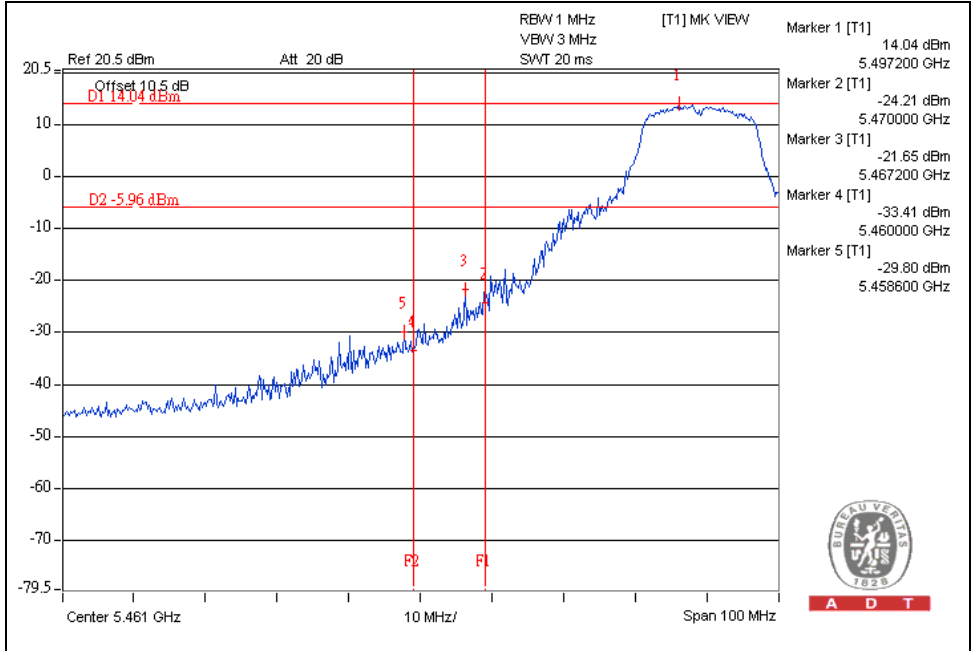

CH 140

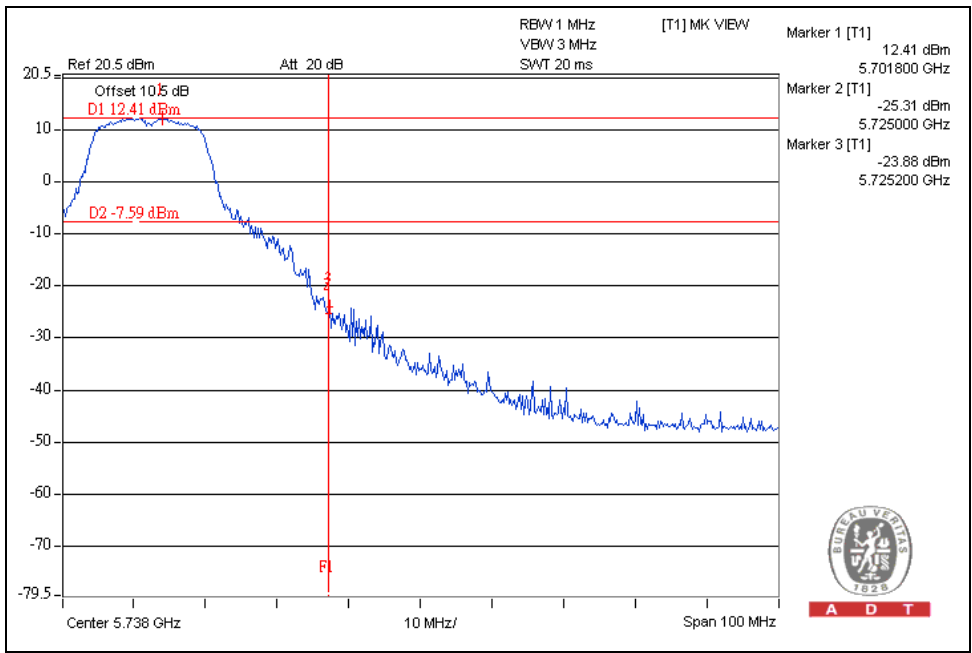



A D T

CH 100

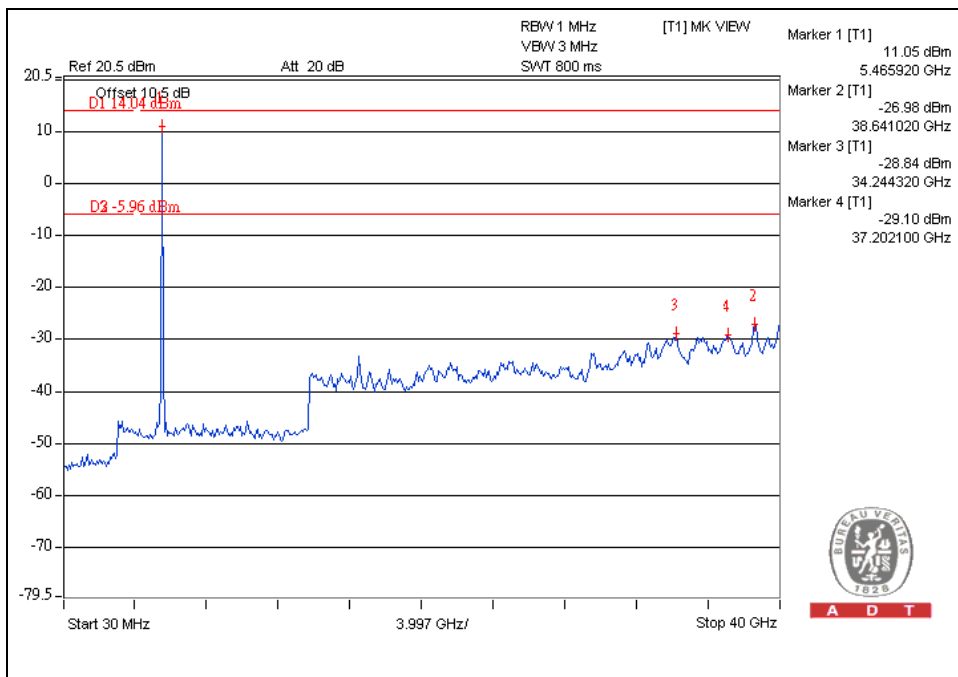

CH 140

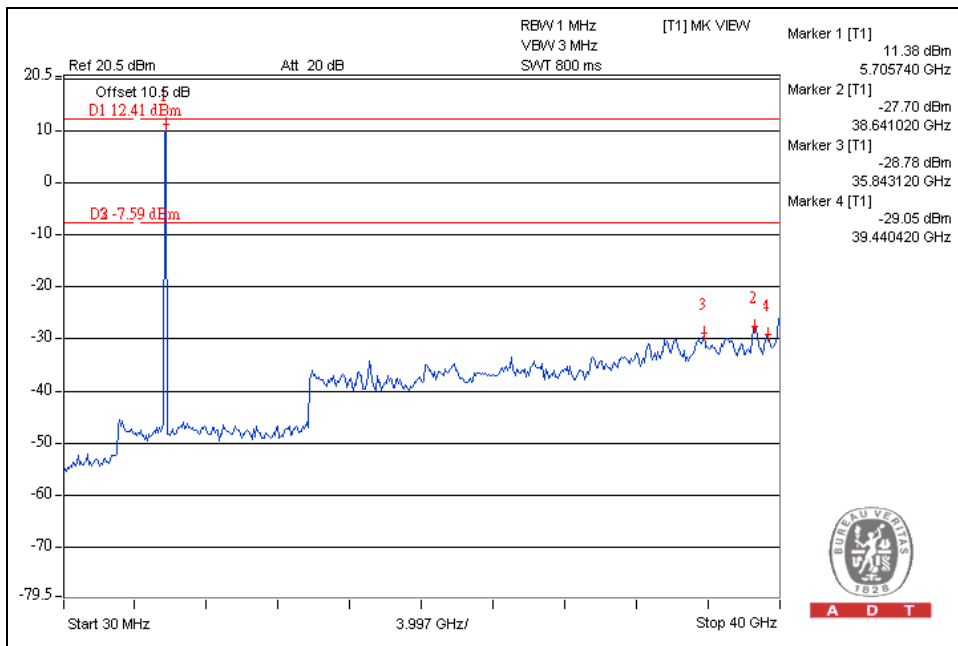



A D T

802.11n(20MHz) OFDM modulation

CH 100

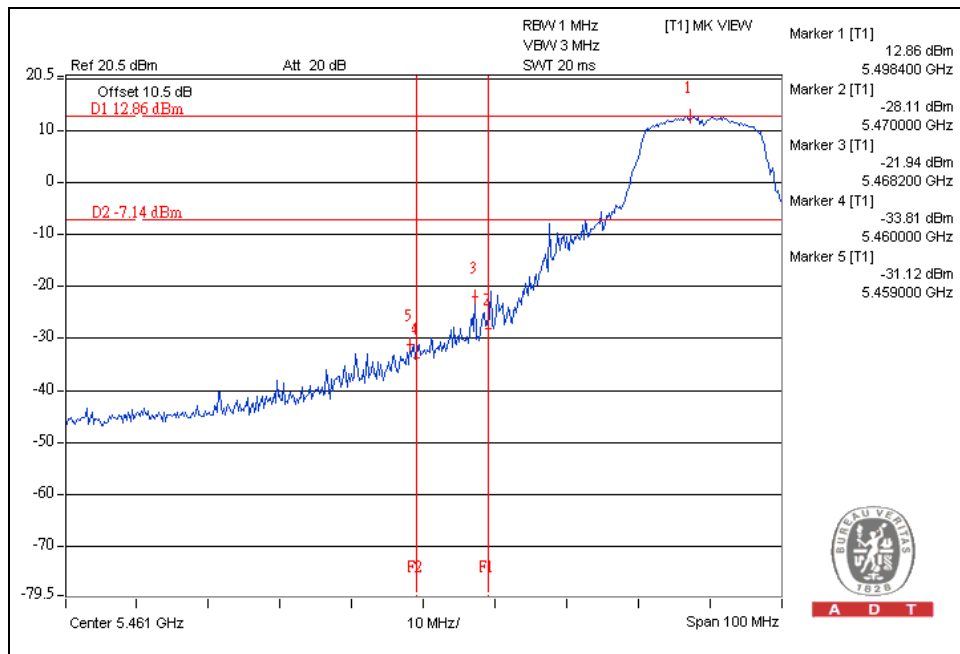

CH 140

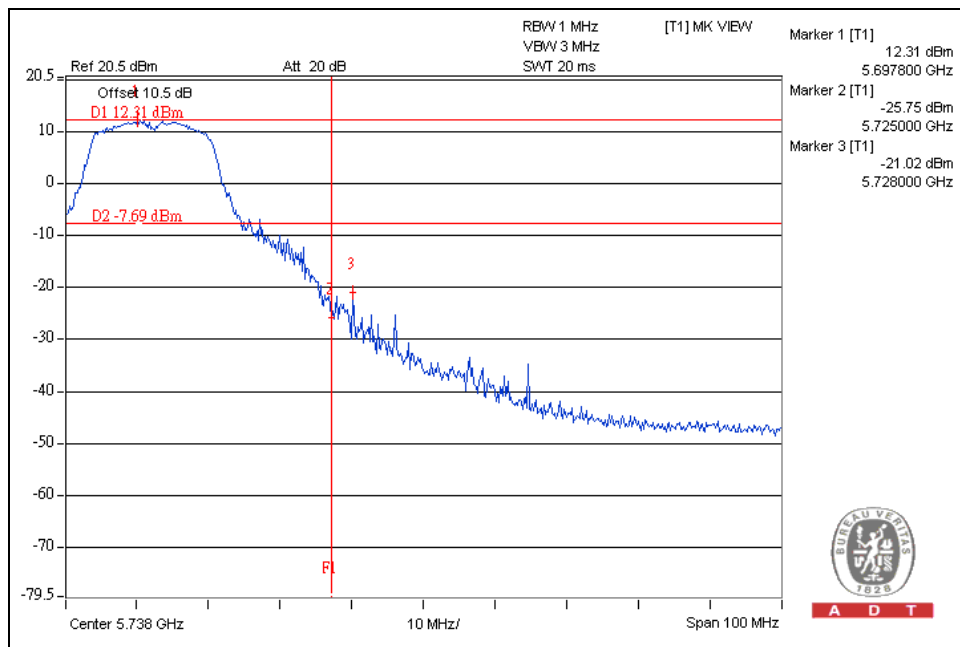



A D T

CH 100

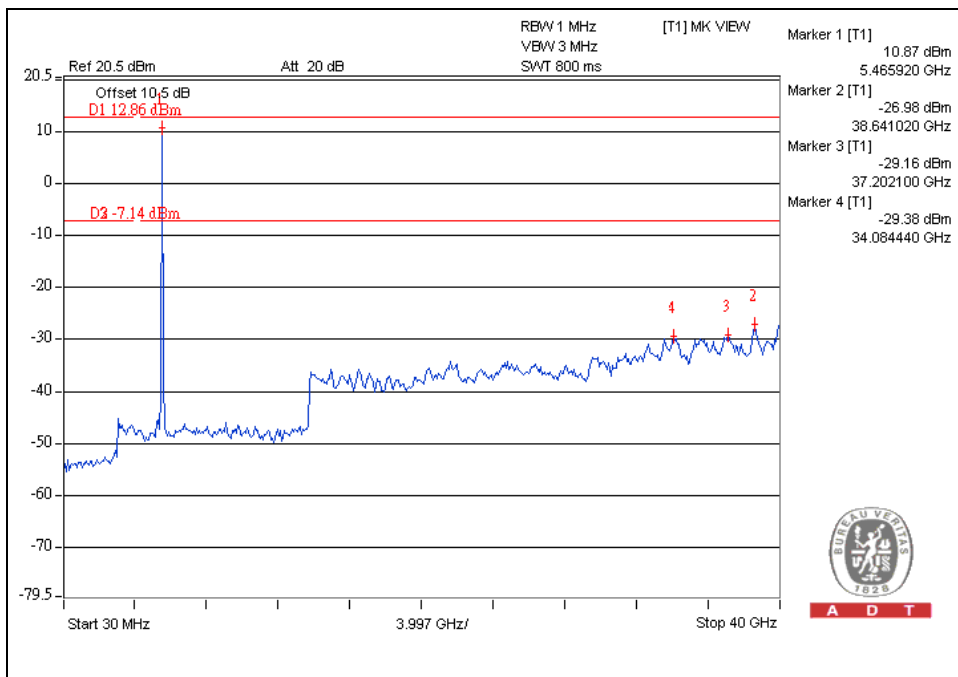

CH 140

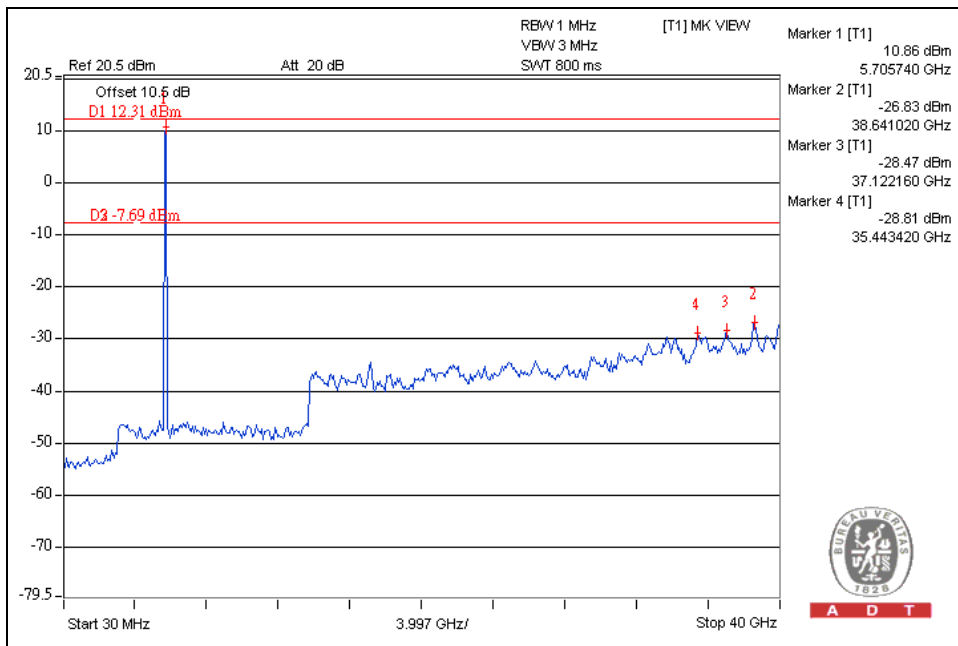



5. INFORMATION ON THE TESTING LABORATORIES

We, Bureau Veritas Consumer Products Services (H.K.) Ltd., Taoyuan Branch, were founded in 1988 to provide our best service in EMC, Radio, Telecom and Safety consultation. Our laboratories are accredited and approved according to ISO/IEC 17025:

Copies of accreditation certificates of our laboratories obtained from approval agencies can be downloaded from our web site: www.adt.com.tw/index.5.phtml.

If you have any comments, please feel free to contact us at the following:

Linko EMC/RF Lab:

Tel: 886-2-26052180

Fax: 886-2-26052943

Hsin Chu EMC/RF Lab:

Tel: 886-3-5935343

Fax: 886-3-5935342

Hwa Ya EMC/RF/Safety/Telecom Lab:

Tel: 886-3-3183232

Fax: 886-3-3185050

Email: service.adt@tw.bureauveritas.com

Web Site: www.adt.com.tw

The address and road map of all our labs can be found in our web site also.



A D T

6.APPENDIX A - MODIFICATIONS RECORDERS FOR ENGINEERING CHANGES TO THE EUT BY THE LAB

No any modifications are made to the EUT by the lab during the test.