



A D T

FCC TEST REPORT (15.247)

REPORT NO.: RF110408E05-1

MODEL NO.: XWING1

FCC ID: UZ7XWING1

RECEIVED: Apr. 08, 2011

TESTED: Apr. 28 to May 26, 2011

ISSUED: July 28, 2011

APPLICANT: Motorola Solutions, Inc.

ADDRESS: One Motorola Plaza, Holtsville, NY 11742-1300
USA

ISSUED BY: Bureau Veritas Consumer Products Services (H.K.)
Ltd., Taoyuan Branch Hsin Chu Laboratory

LAB ADDRESS: No. 81-1, Lu Liao Keng, 9th Ling, Wu Lung Tsuen,
Chiung Lin Hsiang, Hsin Chu Hsien 307, Taiwan

TEST LOCATION (1): No. 81-1, Lu Liao Keng, 9th Ling, Wu Lung Tsuen,
Chiung Lin Hsiang, Hsin Chu Hsien 307, Taiwan

TEST LOCATION (2): No.49, Ln. 206, Wende Rd., Shangshan Tsuen,
Chiung Lin Hsiang, Hsin Chu Hsien 307, Taiwan

This test report consists of 141 pages in total. It may be duplicated completely for legal use with the approval of the applicant. It should not be reproduced except in full, without the written approval of our laboratory. The client should not use it to claim product endorsement by TAF or any government agencies. The test results in the report only apply to the tested sample.





Table of Contents

RELEASE CONTROL RECORD.....	5
1. CERTIFICATION.....	6
2. SUMMARY OF TEST RESULTS.....	7
2.1 MEASUREMENT UNCERTAINTY	9
3. GENERAL INFORMATION	10
3.1 GENERAL DESCRIPTION OF EUT.....	10
3.2 DESCRIPTION OF TEST MODES.....	12
3.2.1 TEST MODE APPLICABILITY AND TESTED CHANNEL DETAIL	13
3.3 GENERAL DESCRIPTION OF APPLIED STANDARDS	16
3.4 DESCRIPTION OF SUPPORT UNITS.....	17
3.5 CONFIGURATION OF SYSTEM UNDER TEST	17
4. TEST TYPES AND RESULTS (For 2.4GHz, 2412~2462MHz Band)	19
4.1 CONDUCTED EMISSION MEASUREMENT	19
4.1.1 LIMITS OF CONDUCTED EMISSION MEASUREMENT.....	19
4.1.2 TEST INSTRUMENTS	19
4.1.3 TEST PROCEDURES.....	20
4.1.4 DEVIATION FROM TEST STANDARD	20
4.1.5 TEST SETUP	21
4.1.6 EUT OPERATING CONDITIONS.....	21
4.1.7 TEST RESULTS.....	22
4.2 RADIATED EMISSION MEASUREMENT	24
4.2.1 LIMITS OF RADIATED EMISSION MEASUREMENT.....	24
4.2.2 TEST INSTRUMENTS	25
4.2.3 TEST PROCEDURES.....	26
4.2.4 DEVIATION FROM TEST STANDARD	26
4.2.5 TEST SETUP	27
4.2.6 EUT OPERATING CONDITIONS.....	27
4.2.7 TEST RESULTS.....	28
4.3 6dB BANDWIDTH MEASUREMENT	68
4.3.1 LIMITS OF 6dB BANDWIDTH MEASUREMENT	68
4.3.2 TEST INSTRUMENTS	68
4.3.3 TEST PROCEDURE	68
4.3.4 DEVIATION FROM TEST STANDARD	68
4.3.5 TEST SETUP	68
4.3.6 EUT OPERATING CONDITIONS.....	68
4.3.7 TEST RESULTS.....	69
4.4 MAXIMUM PEAK OUTPUT POWER	78



4.4.1	LIMITS OF MAXIMUM PEAK OUTPUT POWER MEASUREMENT	78
4.4.2	INSTRUMENTS	78
4.4.3	TEST PROCEDURES.....	78
4.4.4	DEVIATION FROM TEST STANDARD	78
4.4.5	TEST SETUP	78
4.4.6	EUT OPERATING CONDITIONS.....	78
4.4.7	TEST RESULTS(MODE A).....	79
4.4.8	TEST RESULTS(MODE B)	81
4.5	POWER SPECTRAL DENSITY MEASUREMENT.....	83
4.5.1	LIMITS OF POWER SPECTRAL DENSITY MEASUREMENT	83
4.5.2	TEST INSTRUMENTS	83
4.5.3	TEST PROCEDURE	83
4.5.4	DEVIATION FROM TEST STANDARD	83
4.5.5	TEST SETUP	83
4.5.6	EUT OPERATING CONDITION	84
4.5.7	TEST RESULTS(MODE A).....	85
4.5.8	TEST RESULTS(MODE B)	94
4.6	CONDUCTED OUT-BAND EMISSION MEASUREMENT.....	96
4.6.1	LIMITS OF CONDUCTED OUT-BAND EMISSION MEASUREMENT	96
4.6.2	TEST INSTRUMENTS	96
4.6.3	TEST PROCEDURE	96
4.6.4	DEVIATION FROM TEST STANDARD	96
4.6.5	EUT OPERATING CONDITION	96
4.6.6	TEST RESULTS.....	96
5.	TEST TYPES AND RESULTS (For 5GHz, 5725~5850MHz Band)	105
5.1	CONDUCTED EMISSION MEASUREMENT	105
5.1.1	LIMITS OF CONDUCTED EMISSION MEASUREMENT.....	105
5.1.2	TEST INSTRUMENTS	105
5.1.3	TEST PROCEDURES.....	106
5.1.4	DEVIATION FROM TEST STANDARD	106
5.1.5	TEST SETUP	107
5.1.6	EUT OPERATING CONDITIONS.....	107
5.1.7	TEST RESULTS.....	108
5.2	RADIATED EMISSION MEASUREMENT	110
5.2.1	LIMITS OF RADIATED EMISSION MEASUREMENT.....	110
5.2.2	TEST INSTRUMENTS	111
5.2.3	TEST PROCEDURES.....	112
5.2.4	DEVIATION FROM TEST STANDARD	112
5.2.5	TEST SETUP	113



A D T

5.2.6	EUT OPERATING CONDITIONS.....	113
5.2.7	TEST RESULTS.....	114
5.3	6dB BANDWIDTH MEASUREMENT	121
5.3.1	LIMITS OF 6dB BANDWIDTH MEASUREMENT	121
5.3.2	TEST INSTRUMENTS	121
5.3.3	TEST PROCEDURE	121
5.3.4	DEVIATION FROM TEST STANDARD	121
5.3.5	TEST SETUP	121
5.3.6	EUT OPERATING CONDITIONS.....	121
5.3.7	TEST RESULTS.....	122
5.4	MAXIMUM PEAK OUTPUT POWER	126
5.4.1	LIMITS OF MAXIMUM PEAK OUTPUT POWER MEASUREMENT	126
5.4.2	INSTRUMENTS	126
5.4.3	TEST PROCEDURES.....	126
5.4.4	DEVIATION FROM TEST STANDARD	126
5.4.5	TEST SETUP	126
5.4.6	EUT OPERATING CONDITIONS.....	126
5.4.7	TEST RESULTS(MODE A).....	127
5.4.8	TEST RESULTS(MODE B)	128
5.5	POWER SPECTRAL DENSITY MEASUREMENT.....	129
5.5.1	LIMITS OF POWER SPECTRAL DENSITY MEASUREMENT	129
5.5.2	TEST INSTRUMENTS	129
5.5.3	TEST PROCEDURE	129
5.5.4	DEVIATION FROM TEST STANDARD	129
5.5.5	TEST SETUP	129
5.5.6	EUT OPERATING CONDITION	129
5.5.7	TEST RESULTS(MODE A).....	130
5.5.8	TEST RESULTS(MODE B)	134
5.6	CONDUCTED OUT-BAND EMISSION MEASUREMENT.....	135
5.6.1	LIMITS OF CONDUCTED OUT-BAND EMISSION MEASUREMENT	135
5.6.2	TEST INSTRUMENTS	135
5.6.3	TEST PROCEDURE	135
5.6.4	DEVIATION FROM TEST STANDARD	135
5.6.5	EUT OPERATING CONDITION	135
5.6.6	TEST RESULTS.....	135
6.	INFORMATION ON THE TESTING LABORATORIES	140
7.	APPENDIX A - MODIFICATIONS RECORDERS FOR ENGINEERING CHANGES TO THE EUT BY THE LAB.....	141



A D T

RELEASE CONTROL RECORD

ISSUE NO.	REASON FOR CHANGE	DATE ISSUED
RF110408E05-1	Original release	July 28, 2011



1. CERTIFICATION

PRODUCT: XWING1
BRAND: MOTOROLA
MODEL NO.: XWING1
TEST SAMPLE: ENGINEERING SAMPLE
TESTED: Apr. 28 to May 26, 2011
APPLICANT: Motorola Solutions, Inc.
STANDARDS: FCC Part 15, Subpart C (Section 15.247)
ANSI C63.4-2003
ANSI C63.10-2009

The above equipment (Model: XWING1) has been tested by **Bureau Veritas Consumer Products Services (H.K.) Ltd., Taoyuan Branch**, and found compliance with the requirement of the above standards. The test record, data evaluation & Equipment Under Test (EUT) configurations represented herein are true and accurate accounts of the measurements of the sample's EMC characteristics under the conditions specified in this report.

PREPARED BY :  , **DATE:** July 28, 2011
(Claire Kuan, Specialist)

APPROVED BY :  , **DATE:** June 28, 2011
(May Chen, Deputy Manager)

2. SUMMARY OF TEST RESULTS

The EUT has been tested according to the following specifications:

For 2.4GHz, 2412~2462MHz Band

APPLIED STANDARD: FCC Part 15, Subpart C (Section 15.247)			
Standard Section	Test Type and Limit	Result	Remark
15.207	AC Power Conducted Emission	PASS	Meet the requirement of limit. Minimum passing margin is -17.00dB at 0.209MHz
15.247(a)(2)	Spectrum Bandwidth of a Direct Sequence Spread Spectrum System Limit: min. 500kHz	PASS	Meet the requirement of limit.
15.247(b)	Maximum Peak Output Power Limit: max. 30dBm	PASS	Meet the requirement of limit.
15.247(d)	Radiated Emissions Limit: Table 15.209	PASS	Meet the requirement of limit. Minimum passing margin is -1.2dB at 2386.70MHz
15.247(e)	Power Spectral Density Limit: max. 8dBm	PASS	Meet the requirement of limit.
15.247(d)	Conducted Out-Band Emission Measurement Limit: 20dB less than the peak value of fundamental frequency	PASS	Meet the requirement of limit.
15.203	Antenna Requirement	PASS	Antenna connector is SMA Female not a standard connector.



A D T

For 5G, 5725~5850MHz Band

APPLIED STANDARD: FCC Part 15, Subpart C (Section 15.247)			
Standard Section	Test Type and Limit	Result	Remark
15.207	AC Power Conducted Emission	PASS	Meet the requirement of limit. Minimum passing margin is -15.16dB at 0.205MHz
15.247(a)(2)	Spectrum Bandwidth of a Direct Sequence Spread Spectrum System Limit: min. 500kHz	PASS	Meet the requirement of limit.
15.247(b)	Maximum Peak Output Power Limit: max. 30dBm	PASS	Meet the requirement of limit.
15.247(d)	Radiated Emissions Limit: Table 15.209	PASS	Meet the requirement of limit. Minimum passing margin is -6.0dB at 903.30MHz
15.247(e)	Power Spectral Density Limit: max. 8dBm	PASS	Meet the requirement of limit.
15.247(d)	Conducted Out-Band Emission Measurement Limit: 20dB less than the peak value of fundamental frequency	PASS	Meet the requirement of limit.
15.203	Antenna Requirement	PASS	Antenna connector is SMA Female not a standard connector.

NOTE:

1. The EUT was operating in 2400 ~ 2483.5MHz, 5.15~5.35GHz, 5.47~5.725GHz and 5.725~5.850GHz frequencies band. This report was recorded the RF parameters including 2400 ~ 2483.5MHz and 5.725~5.850GHz. For the 5.15~5.35GHz and 5.47~5.725GHz RF parameters was recorded in another test report.



A D T

2.1 MEASUREMENT UNCERTAINTY

Where relevant, the following measurement uncertainty levels have been estimated for tests performed on the EUT as specified in CISPR 16-4-2:

This uncertainty represents an expanded uncertainty expressed at approximately the 95% confidence level using a coverage factor of $k=2$.

Measurement	Value
Conducted emissions	2.45 dB
Radiated emissions (30MHz-1GHz)-Chamber G	3.81 dB
Radiated emissions (1GHz -18GHz)-Chamber G	2.19 dB
Radiated emissions (18GHz -40GHz)-Chamber G	2.56 dB



A D T

3. GENERAL INFORMATION

3.1 GENERAL DESCRIPTION OF EUT

PRODUCT	XWING1
MODEL NO.	XWING1
FCC ID	UZ7XWING1
POWER SUPPLY	DC 3.3V from host equipment
MODULATION TYPE	CCK, DQPSK, DBPSK for DSSS 64QAM, 16QAM, QPSK, BPSK for OFDM
MODULATION TECHNOLOGY	DSSS, OFDM
TRANSFER RATE	802.11b: 11 / 5.5 / 2 / 1Mbps 802.11a/g: 54 / 48 / 36 / 24 / 18 / 12 / 9 / 6Mbps 802.11n (20MHz, 800ns GI): 6.5/13.0/19.5/26.0/39.0/52.0/58.5/65.0(for one stream) 802.11n (20MHz, 400ns GI): 7.2/14.4/21.7/28.9/43.3/57.8/65.0/72.2Mbps(for one stream)
FREQUENCY RANGE	15.247: 802.11b/g & 802.11n (20MHz): 2.412 ~ 2.472GHz 802.11a, 802.11n (20MHz): 5.745 ~ 5.825GHz
	15.407: 802.11a, 802.11n (20MHz): 5.18 ~ 5.24GHz, 5.26 ~ 5.32GHz, 5.50 ~ 5.7GHz
NUMBER OF CHANNEL	15.247(2.4GHz) 13 for 802.11b/g, 802.11n (20MHz) 15.247(5GHz) 5 for 802.11a, 802.11n (20MHz)
	15.407: 19 for 802.11a, 802.11n (20MHz)
CHANNEL SPACING	802.11b/g, 802.11n (20MHz): 5MHz 802.11a, 802.11n (20MHz): 20MHz



A D T

MAXIMUM OUTPUT POWER	15.247(2.4GHz) 802.11b: 269.2mW 802.11g: 257.0mW 802.11n (20MHz): 257.0mW
	15.247(5GHz) 802.11a: 166.0mW 802.11n (20MHz): 158.5mW
	15.407 802.11a: 67.6mW 802.11n (20MHz): 72.4mW
ANTENNA TYPE	Please see note
ANTENNA CONNECTOR	Please see note
DATA CABLE	NA
I/O PORTS	NA
ASSOCIATED DEVICES	NA

NOTE:

1. There is antenna provided to this EUT, please refer to the following table:

Antenna Model	Antenna Type	Antenna Gain(dBi)	cable loss (dBi)	Net Gain (dBi)	Connecter Type	Frequency range (MHz)
ML-2452-APA2-01	Dipole	3 dBi (2.4GHz) 5 dBi (5GHz)	0.4 dBi (2.4GHz) 0.8 dBi (5GHz)	2.6 dBi (2.4GHz) 4.2 dBi (5GHz)	SMA Female	2400 ~ 2500 5150 ~ 5850

2. The EUT is 1 * 1 spatial SISO (1Tx & 1Rx) without beam forming function.

3. 2.4GHz and 5GHz technology cannot transmit at same time.

4. The above EUT information was declared by the manufacturer and for more detailed feature descriptions, please refer to the manufacturer's specifications or User's Manual.

3.2 DESCRIPTION OF TEST MODES

Operated in 2400 ~ 2483.5MHz band:

Thirteen channels are provided for 802.11b, 802.11g, 802.11n (20MHz):

CHANNEL	FREQUENCY	CHANNEL	FREQUENCY
1	2412MHz	8	2447MHz
2	2417MHz	9	2452MHz
3	2422MHz	10	2457MHz
4	2427MHz	11	2462MHz
5	2432MHz	12	2467MHz
6	2437MHz	13	2472MHz
7	2442MHz		

Operated in 5725 ~ 5850MHz band:

Five channels are provided for 802.11a, 802.11n (20MHz):

CHANNEL	FREQUENCY	CHANNEL	FREQUENCY
149	5745 MHz	161	5805 MHz
153	5765 MHz	165	5825 MHz
157	5785 MHz		



A D T

3.2.1 TEST MODE APPLICABILITY AND TESTED CHANNEL DETAIL

EUT CONFIGURE MODE	APPLICABLE TO				DESCRIPTION
	PLC	RE < 1G	RE ≥ 1G	APCM	
A	√	√	√	√	The output power of module connector end
B	-	-	-	√	The output power of sip RF chip end (The output power of module connector end offset micro-strip trace loss*)

Where **PLC**: Power Line Conducted Emission **RE < 1G**: Radiated Emission below 1GHz
RE ≥ 1G: Radiated Emission above 1GHz **APCM**: Antenna Port Conducted Measurement
 *Trace loss: 2.4GHz is 0.4dB, 5GHz is 0.8dB.

POWER LINE CONDUCTED EMISSION TEST:

- Pre-Scan has been conducted to determine the worst-case mode from all possible combinations between available modulations, data rates and antenna ports (if EUT with antenna diversity architecture).
- Following channel(s) was (were) selected for the final test as listed below.

MODE	AVAILABLE CHANNEL	TESTED CHANNEL	MODULATION TECHNOLOGY	MODULATION TYPE	DATA RATE (Mbps)	EUT CONFIGURE MODE
802.11b	1 to 13	6	DSSS	DBPSK	1	A
802.11a	149 to 165	157	OFDM	BPSK	6	A

RADIATED EMISSION TEST (BELOW 1 GHz):

- Pre-Scan has been conducted to determine the worst-case mode from all possible combinations between available modulations, data rates and antenna ports (if EUT with antenna diversity architecture).
- Following channel(s) was (were) selected for the final test as listed below.

MODE	AVAILABLE CHANNEL	TESTED CHANNEL	MODULATION TECHNOLOGY	MODULATION TYPE	DATA RATE (Mbps)	EUT CONFIGURE MODE
802.11b	1 to 13	6	DSSS	DBPSK	1	A
802.11a	149 to 165	157	OFDM	BPSK	6	A



A D T

RADIATED EMISSION TEST (ABOVE 1 GHz):

- Pre-Scan has been conducted to determine the worst-case mode from all possible combinations between available modulations, data rates and antenna ports (if EUT with antenna diversity architecture).
- Following channel(s) was (were) selected for the final test as listed below.

MODE	AVAILABLE CHANNEL	TESTED CHANNEL	MODULATION TECHNOLOGY	MODULATION TYPE	DATA RATE (Mbps)	EUT CONFIGURE MODE
802.11b	1 to 13	1, 6, 11, 12, 13	DSSS	DBPSK	1	A
802.11g	1 to 13	1, 6, 11, 12, 13	OFDM	BPSK	6	A
For 2.4 GHz 802.11n (20MHz)	1 to 13	1, 6, 11, 12, 13	OFDM	BPSK	7.2	A
802.11a	149 to 165	149, 157, 165	OFDM	BPSK	6	A
For 5 GHz 802.11n (20MHz)	149 to 165	149, 157, 165	OFDM	BPSK	7.2	A

CONDUCTED OUT-BAND EMISSION MEASUREMENT:

- Pre-Scan has been conducted to determine the worst-case mode from all possible combinations between available modulations, data rates and antenna ports (if EUT with antenna diversity architecture).
- Following channel(s) was (were) selected for the final test as listed below.

MODE	AVAILABLE CHANNEL	TESTED CHANNEL	MODULATION TECHNOLOGY	MODULATION TYPE	DATA RATE (Mbps)	EUT CONFIGURE MODE
802.11b	1 to 13	1, 11, 12, 13	DSSS	DBPSK	1	A
802.11g	1 to 13	1, 11, 12, 13	OFDM	BPSK	6	A
For 2.4 GHz 802.11n (20MHz)	1 to 13	1, 11, 12, 13	OFDM	BPSK	7.2	A
802.11a	149 to 165	149, 165	OFDM	BPSK	6	A
For 5 GHz 802.11n (20MHz)	149 to 165	149, 165	OFDM	BPSK	7.2	A

ANTENNA PORT CONDUCTED MEASUREMENT:

- This item includes all test value of each mode, but only includes spectrum plot of worst value of each mode.
- Pre-Scan has been conducted to determine the worst-case mode from all possible combinations between available modulations, data rates and antenna ports (if EUT with antenna diversity architecture).
- Following channel(s) was (were) selected for the final test as listed below.

MODE	AVAILABLE CHANNEL	TESTED CHANNEL	MODULATION TECHNOLOGY	MODULATION TYPE	DATA RATE (Mbps)	EUT CONFIGURE MODE
802.11b	1 to 13	1, 6, 11, 12, 13	DSSS	DBPSK	1	A, B
802.11g	1 to 13	1, 6, 11, 12, 13	OFDM	BPSK	6	A, B
For 2.4 GHz 802.11n (20MHz)	1 to 13	1, 11, 12, 13	OFDM	BPSK	7.2	A, B
802.11a	149 to 165	149, 157, 165	OFDM	BPSK	6	A, B
For 5 GHz 802.11n (20MHz)	149 to 165	149, 157, 165	OFDM	BPSK	7.2	A, B

TEST CONDITION:

APPLICABLE TO	ENVIRONMENTAL CONDITIONS	INPUT POWER (SYSTEM)	TESTED BY
RE³1G	20deg. C, 63%RH, 1002 hPa	120Vac, 60Hz	Kent Liu
	22deg. C, 64%RH, 1002 hPa	120Vac, 60Hz	Frank Liu
RE<1G	23deg. C, 68%RH, 1002 hPa	120Vac, 60Hz	Wen Yu
PLC	26deg. C, 68%RH, 1002 hPa	120Vac, 60Hz	Timmy Hu
APCM	22deg. C, 66%RH, 1002 hPa	120Vac, 60Hz	Rex Huang
	22deg. C, 66%RH, 1002 hPa	120Vac, 60Hz	Kent Liu



3.3 GENERAL DESCRIPTION OF APPLIED STANDARDS

The EUT is a RF product. According to the specifications of the manufacturer, it must comply with the requirements of the following standards:

FCC Part 15, Subpart C. (15.247)

ANSI C63.4-2003

ANSI C63.10-2009

All test items have been performed and recorded as per the above standards.

NOTE: The EUT has been verified to comply with the requirements of FCC Part 15, Subpart B, Class B (DoC). The test report has been issued separately.



A D T

3.4 DESCRIPTION OF SUPPORT UNITS

The EUT has been tested as an independent unit together with other necessary accessories or support units. The following support units or accessories were used to form a representative test configuration during the tests.

No.	Product	Brand	Model No.	Serial No.	FCC ID
1	NOTEBOOK COMPUTER	ASUS	A8M	75N0AS180287	MSQBT183
2	DC POWER SUPPLY	Topward	6603D	795558	NA

No.	Signal cable description
1	1m USB to 1394 cable
2	2m DC line

Note: 1. All power cords of the above support units are unshielded (1.8m).

3.5 CONFIGURATION OF SYSTEM UNDER TEST

For conducted test

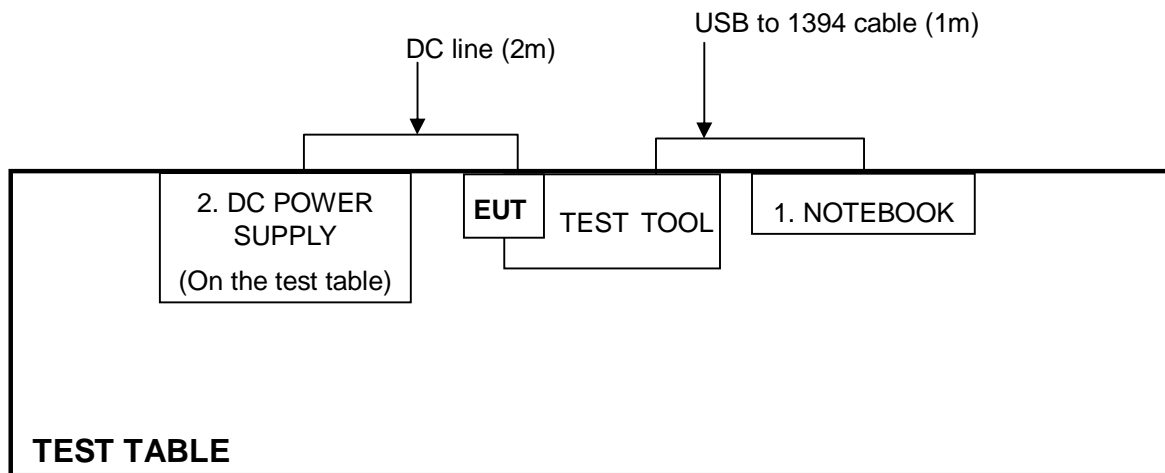



A D T

For other test items:

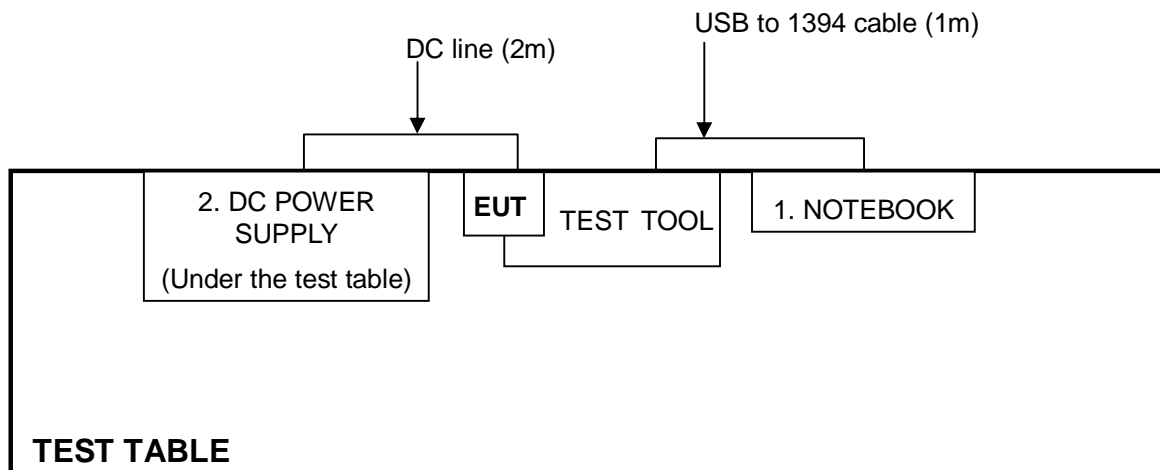

4. TEST TYPES AND RESULTS (FOR 2.4GHZ, 2412~2462MHZ BAND)

4.1 CONDUCTED EMISSION MEASUREMENT

4.1.1 LIMITS OF CONDUCTED EMISSION MEASUREMENT

FREQUENCY OF EMISSION (MHz)	CONDUCTED LIMIT (dB μ V)	
	Quasi-peak	Average
0.15-0.5	66 to 56	56 to 46
0.5-5	56	46
5-30	60	50

- NOTE:**
1. The lower limit shall apply at the transition frequencies.
 2. The limit decreases in line with the logarithm of the frequency in the range of 0.15 to 0.50 MHz.
 3. All emanations from a class A/B digital device or system, including any network of conductors and apparatus connected thereto, shall not exceed the level of field strengths specified above.

4.1.2 TEST INSTRUMENTS

DESCRIPTION & MANUFACTURER	MODEL NO.	SERIAL NO.	CALIBRATED DATE	CALIBRATED UNTIL
ROHDE & SCHWARZ Test Receiver	ESCS 30	100287	Mar. 02, 2011	Mar. 01, 2012
Line-Impedance Stabilization Network (for EUT)	NSLK 8127	8127-523	Sep. 17, 2010	Sep. 16, 2011
Line-Impedance Stabilization Network (for Peripheral)	ENV-216	100072	June 11, 2010	June 10, 2011
RF Cable (JYEBAO)	5DFB	CONCAB-003	Aug. 06, 2010	Aug. 05, 2011
50 ohms Terminator	50	3	Nov. 03, 2010	Nov. 02, 2011
Software	BV ADT_Cond_V7.3.7	NA	NA	NA

Note:

1. The calibration interval of the above test instruments is 12 months and the calibrations are traceable to NML/ROC and NIST/USA.
2. The test was performed in Shielded Room No. A.
3. The VCCI Con A Registration No. is C-817.

4.1.3 TEST PROCEDURES

- a. The EUT was placed 0.4 meters from the conducting wall of the shielded room with EUT being connected to the power mains through a line impedance stabilization network (LISN). Other support units were connected to the power mains through another LISN. The two LISNs provide 50 ohm/ 50uH of coupling impedance for the measuring instrument.
- b. Both lines of the power mains connected to the EUT were checked for maximum conducted interference.
- c. The frequency range from 150kHz to 30MHz was searched. Emission levels under (Limit - 20dB) were not recorded.

4.1.4 DEVIATION FROM TEST STANDARD

No deviation

4.1.5 TEST SETUP

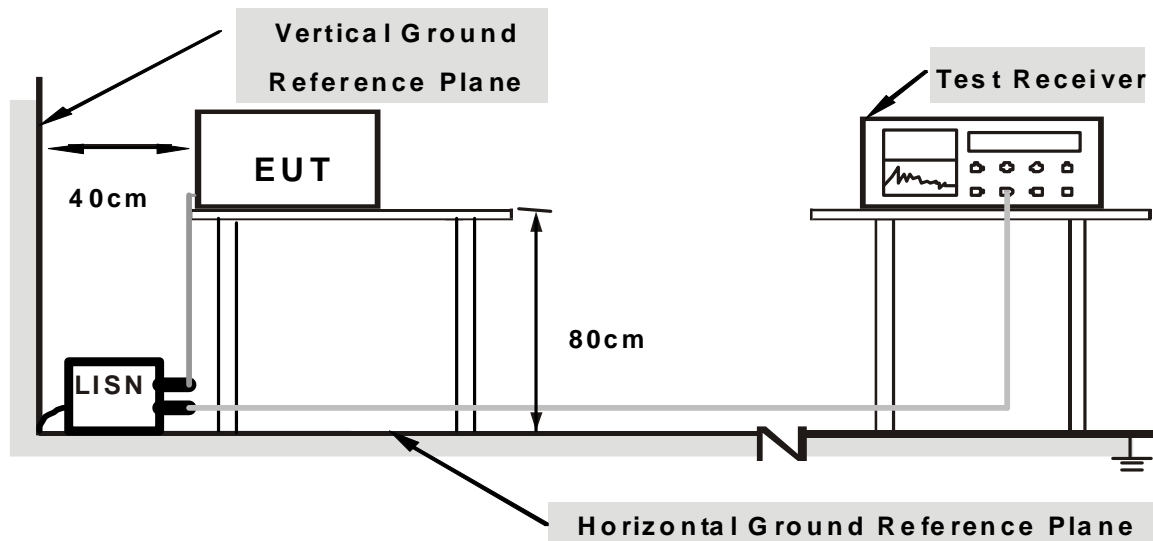

Note: 1.Support units were connected to second LISN.

2.Both of LISNs (AMN) are 80 cm from EUT and at least 80 cm from other units and other metal planes

For the actual test configuration, please refer to the related item – Photographs of the Test Configuration.

4.1.6 EUT OPERATING CONDITIONS

1. Turn on the power of EUT.
2. The support unit 1(Notebook computer) run test program “TrioScopeMFC.exe” to enable EUT under transmission / receiver condition continuously at specific channel frequency.

4.1.7 TEST RESULTS

PHASE	Line (L)	6dB BANDWIDTH	9 kHz
-------	----------	---------------	-------

No	Freq. [MHz]	Corr. Factor (dB)	Reading Value [dB (uV)]		Emission Level [dB (uV)]		Limit [dB (uV)]		Margin (dB)	
			Q.P.	AV.	Q.P.	AV.	Q.P.	AV.	Q.P.	AV.
			1	0.205	0.36	46.04	-	46.40	-	63.42
2	0.275	0.36	39.22	-	39.58	-	60.97	50.97	-21.39	-
3	0.482	0.37	33.96	-	34.33	-	56.30	46.30	-21.98	-
4	1.164	0.42	31.78	-	32.20	-	56.00	46.00	-23.80	-
5	5.063	0.54	31.16	-	31.70	-	60.00	50.00	-28.30	-
6	17.801	1.02	29.47	-	30.49	-	60.00	50.00	-29.51	-

- REMARKS:**
1. Q.P. and AV. are abbreviations of quasi-peak and average individually.
 2. "-": The Quasi-peak reading value also meets average limit and measurement with the average detector is unnecessary.
 3. The emission levels of other frequencies were very low against the limit.
 4. Margin value = Emission level - Limit value
 5. Correction factor = Insertion loss + Cable loss
 6. Emission Level = Correction Factor + Reading Value.

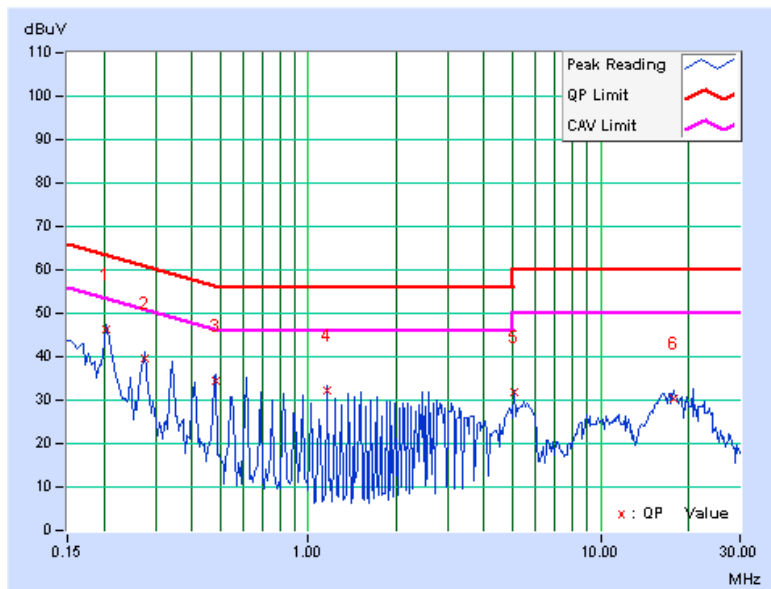

PHASE	Neutral (N)	6dB BANDWIDTH	9 kHz
-------	-------------	---------------	-------

No	Freq. [MHz]	Corr. Factor (dB)	Reading Value		Emission Level		Limit		Margin	
			[dB (uV)]		[dB (uV)]		[dB (uV)]		(dB)	
			Q.P.	AV.	Q.P.	AV.	Q.P.	AV.	Q.P.	AV.
1	0.209	0.10	46.16	-	46.26	-	63.26	53.26	-17.00	-
2	0.271	0.10	40.09	-	40.19	-	61.08	51.08	-20.89	-
3	0.478	0.12	36.42	-	36.54	-	56.37	46.37	-19.83	-
4	0.615	0.13	33.63	-	33.76	-	56.00	46.00	-22.24	-
5	2.395	0.21	33.24	-	33.45	-	56.00	46.00	-22.55	-
6	5.199	0.29	32.13	-	32.42	-	60.00	50.00	-27.58	-

- REMARKS:**
1. Q.P. and AV. are abbreviations of quasi-peak and average individually.
 2. "-": The Quasi-peak reading value also meets average limit and measurement with the average detector is unnecessary.
 3. The emission levels of other frequencies were very low against the limit.
 4. Margin value = Emission level - Limit value
 5. Correction factor = Insertion loss + Cable loss
 6. Emission Level = Correction Factor + Reading Value.

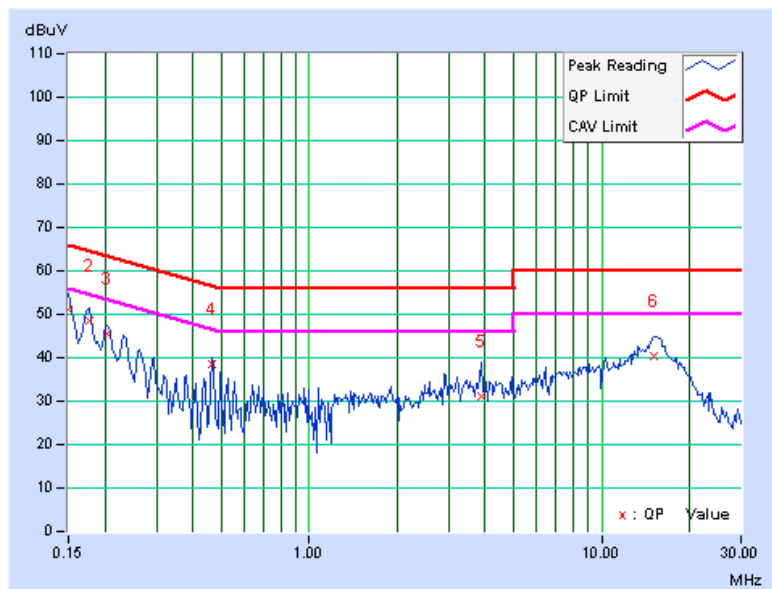

4.2 RADIATED EMISSION MEASUREMENT

4.2.1 LIMITS OF RADIATED EMISSION MEASUREMENT

Emissions radiated outside of the specified bands, shall be according to the general radiated limits in 15.209 as following:

Frequencies (MHz)	Field strength (microvolts/meter)	Measurement distance (meters)
0.009-0.490	2400/F(kHz)	300
0.490-1.705	24000/F(kHz)	30
1.705-30.0	30	30
30-88	100	3
88-216	150	3
216-960	200	3
Above 960	500	3

NOTE:

1. The lower limit shall apply at the transition frequencies.
2. Emission level (dBuV/m) = 20 log Emission level (uV/m).
3. As shown in 15.35(b), for frequencies above 1000MHz, the field strength limits are based on average detector, however, the peak field strength of any emission shall not exceed the maximum permitted average limits, specified above by more than 20dB under any condition of modulation.
4. Section 15.205 restricted bands of operation shall compliance with the limits in Section 15.209.



A D T

4.2.2 TEST INSTRUMENTS

DESCRIPTION & MANUFACTURER	MODEL NO.	SERIAL NO.	CALIBRATED DATE	CALIBRATED UNTIL
Agilent Spectrum Analyzer	E4446A	MY48250254	July 14, 2010	July 13, 2011
Agilent Pre-Selector	N9039A	MY46520311	July 14, 2010	July 13, 2011
Agilent Signal Generator	N5181A	MY49060517	July 14, 2010	July 13, 2011
Mini-Circuits Pre-Amplifier	ZFL-1000VH2B	AMP-ZFL-03	Nov. 16, 2010	Nov. 15, 2011
Agilent Pre-Amplifier	8449B	3008A02578	July 05, 2010	July 04, 2011
Miteq Pre-Amplifier	AFS33-1800265 0-30-8P-44	881786	NA	NA
SCHWARZBECK Trilog Broadband Antenna	VULB 9168	9168-360	Apr. 14, 2011	Apr. 13, 2012
AISI Horn_Antenna	AIH.8018	0000320091110	Nov. 12, 2010	Nov. 11, 2011
SCHWARZBECK Horn_Antenna	BBHA 9170	9170-424	Oct. 08, 2010	Oct. 07, 2011
RF CABLE	NA	RF104-201 RF104-203 RF104-204	Dec. 27, 2010	Dec. 26, 2011
RF Cable	NA	CHGCAB_001	NA	NA
Software	ADT_Radiated_ V8.7.05	NA	NA	NA
CT Antenna Tower & Turn Table	NA	NA	NA	NA

- Note: 1. The calibration interval of the above test instruments is 12 months and the calibrations are traceable to NML/ROC and NIST/USA.
2. The horn antenna, preamplifier (model: 8449B) are used only for the measurement of emission frequency above 1GHz if tested.
3. The test was performed in 966 Chamber No. G.
4. The FCC Site Registration No. is 966073.
5. The VCCI Site Registration No. is G-137.
6. The CANADA Site Registration No. is IC 7450H-2.

4.2.3 TEST PROCEDURES

- a. The EUT was placed on the top of a rotating table 0.8 meters above the ground at a 3 meters chamber room. The table was rotated 360 degrees to determine the position of the highest radiation.
- b. The EUT was set 3 meters away from the interference-receiving antenna, which was mounted on the top of a variable-height antenna tower.
- c. The height of antenna is varied from one meter to four meters above the ground to determine the maximum value of the field strength. Both horizontal and vertical polarizations of the antenna are set to make the measurement.
- d. For each suspected emission, the EUT was arranged to its worst case and then the antenna was tuned to heights from 1 meter to 4 meters and the rotatable table was turned from 0 degrees to 360 degrees to find the maximum reading.
- e. The test-receiver system was set to quasi-peak detect function and specified bandwidth with maximum hold mode when the test frequency is below 1 GHz.
- f. The test-receiver system was set to peak and average detect function and specified bandwidth with maximum hold mode when the test frequency is above 1 GHz. If the peak reading value also meets average limit, measurement with the average detector is unnecessary.

NOTE:

1. The resolution bandwidth and video bandwidth of test receiver/spectrum analyzer is 120kHz for Quasi-peak detection (QP) at frequency below 1GHz.
2. The resolution bandwidth of test receiver/spectrum analyzer is 1 MHz and the video bandwidth is 3 MHz for Peak detection (PK) at frequency above 1GHz.
3. The resolution bandwidth of test receiver/spectrum analyzer is 1 MHz and the video bandwidth is 10 Hz for Average detection (AV) at frequency above 1GHz.

4.2.4 DEVIATION FROM TEST STANDARD

No deviation

4.2.5 TEST SETUP

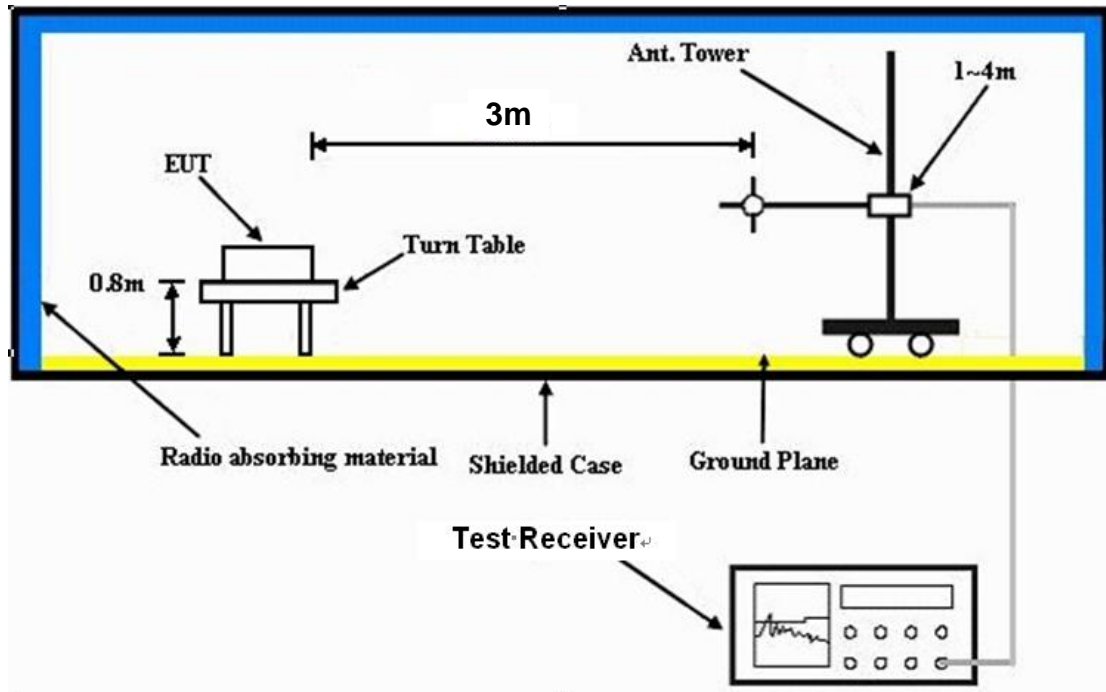

For the actual test configuration, please refer to the related item – Photographs of the Test Configuration.

4.2.6 EUT OPERATING CONDITIONS

Same as the 4.1.6



A D T

4.2.7 TEST RESULTS

BELOW 1GHz WORST-CASE DATA : 802.11b DSSS MODULATION

EUT TEST CONDITION		MEASUREMENT DETAIL	
CHANNEL	Channel 6	FREQUENCY RANGE	Below 1000MHz
INPUT POWER (SYSTEM)	120Vac, 60 Hz	DETECTOR FUNCTION	Quasi-Peak
ENVIRONMENTAL CONDITIONS	23deg. C, 68%RH 1002 hPa	TESTED BY	Wen Yu

ANTENNA POLARITY & TEST DISTANCE: HORIZONTAL AT 3 M								
NO.	FREQ. (MHz)	EMISSION LEVEL (dBuV/m)	LIMIT (dBuV/m)	MARGIN (dB)	ANTENNA HEIGHT (m)	TABLE ANGLE (Degree)	RAW VALUE (dBuV)	CORRECTION FACTOR (dB/m)
1	93.59	33.4 QP	43.5	-10.1	2.00 H	324	24.45	8.98
2	131.98	37.2 QP	43.5	-6.4	2.00 H	64	23.68	13.47
3	167.36	37.3 QP	43.5	-6.2	1.57 H	297	23.58	13.73
4	180.01	37.1 QP	43.5	-6.4	1.25 H	33	25.13	11.95
5	192.00	36.2 QP	43.5	-7.3	2.00 H	360	24.97	11.27
6	301.42	40.0 QP	46.0	-6.0	1.00 H	349	24.47	15.49
7	313.62	37.7 QP	46.0	-8.3	1.00 H	322	21.91	15.76
8	903.60	39.4 QP	46.0	-6.6	1.25 H	284	12.58	26.83
ANTENNA POLARITY & TEST DISTANCE: VERTICAL AT 3 M								
NO.	FREQ. (MHz)	EMISSION LEVEL (dBuV/m)	LIMIT (dBuV/m)	MARGIN (dB)	ANTENNA HEIGHT (m)	TABLE ANGLE (Degree)	RAW VALUE (dBuV)	CORRECTION FACTOR (dB/m)
1	43.79	33.8 QP	40.0	-6.2	1.25 V	160	19.49	14.30
2	55.85	34.0 QP	40.0	-6.0	1.00 V	114	20.25	13.75
3	167.49	37.4 QP	43.5	-6.1	1.00 V	152	23.67	13.72
4	180.04	37.5 QP	43.5	-6.1	1.00 V	267	25.50	11.95
5	301.42	32.2 QP	46.0	-13.9	1.75 V	106	16.66	15.49
6	563.14	30.9 QP	46.0	-15.1	1.00 V	121	9.33	21.54
7	904.08	40.0 QP	46.0	-6.0	1.00 V	349	13.14	26.84

- REMARKS:**
1. Emission level (dBuV/m) = Raw Value (dBuV) + Correction Factor (dB/m).
 2. Correction Factor (dB/m) = Antenna Factor (dB/m) + Cable Factor (dB).
 3. The other emission levels were very low against the limit.
 4. Margin value = Emission level – Limit value.



A D T

ABOVE 1GHz WORST-CASE DATA

802.11b DSSS MODULATION

EUT TEST CONDITION		MEASUREMENT DETAIL	
CHANNEL	Channel 1	FREQUENCY RANGE	1 ~ 25GHz
INPUT POWER (SYSTEM)	120Vac, 60 Hz	DETECTOR FUNCTION	Peak (PK) Average (AV)
ENVIRONMENTAL CONDITIONS	20deg. C, 63%RH 1002 hPa	TESTED BY	Kent Liu

ANTENNA POLARITY & TEST DISTANCE: HORIZONTAL AT 3 M

NO.	FREQ. (MHz)	EMISSION LEVEL (dBuV/m)	LIMIT (dBuV/m)	MARGIN (dB)	ANTENNA HEIGHT (m)	TABLE ANGLE (Degree)	RAW VALUE (dBuV)	CORRECTION FACTOR (dB/m)
1	2386.90	57.4 PK	74.0	-16.6	1.51 H	275	25.75	31.65
2	2386.90	45.9 AV	54.0	-8.1	1.51 H	275	14.25	31.65
3	*2412.00	101.9 PK			1.50 H	274	70.17	31.73
4	*2412.00	99.4 AV			1.50 H	274	67.67	31.73
5	4824.00	46.3 PK	74.0	-27.7	1.00 H	300	7.33	38.97
6	4824.00	34.7 AV	54.0	-19.3	1.00 H	300	-4.27	38.97

ANTENNA POLARITY & TEST DISTANCE: VERTICAL AT 3 M

NO.	FREQ. (MHz)	EMISSION LEVEL (dBuV/m)	LIMIT (dBuV/m)	MARGIN (dB)	ANTENNA HEIGHT (m)	TABLE ANGLE (Degree)	RAW VALUE (dBuV)	CORRECTION FACTOR (dB/m)
1	2386.70	59.4 PK	74.0	-14.6	1.50 V	276	27.75	31.65
2	2386.70	52.8 AV	54.0	-1.2	1.50 V	276	21.15	31.65
3	*2412.00	111.2 PK			1.50 V	276	79.47	31.73
4	*2412.00	108.9 AV			1.50 V	276	77.17	31.73
5	4824.00	49.5 PK	74.0	-24.5	1.00 V	273	10.53	38.97
6	4824.00	42.3 AV	54.0	-11.7	1.00 V	273	3.33	38.97

- REMARKS:**
1. Emission level (dBuV/m) = Raw Value (dBuV) + Correction Factor (dB/m).
 2. Correction Factor (dB/m) = Antenna Factor (dB/m) + Cable Factor (dB).
 3. The other emission levels were very low against the limit.
 4. Margin value = Emission level – Limit value.
 5. “ * “: Fundamental frequency.



A D T

EUT TEST CONDITION		MEASUREMENT DETAIL	
CHANNEL	Channel 6	FREQUENCY RANGE	1 ~ 25GHz
INPUT POWER (SYSTEM)	120Vac, 60 Hz	DETECTOR FUNCTION	Peak (PK) Average (AV)
ENVIRONMENTAL CONDITIONS	20deg. C, 63%RH 1002 hPa	TESTED BY	Kent Liu

ANTENNA POLARITY & TEST DISTANCE: HORIZONTAL AT 3 M								
NO.	FREQ. (MHz)	EMISSION LEVEL (dBuV/m)	LIMIT (dBuV/m)	MARGIN (dB)	ANTENNA HEIGHT (m)	TABLE ANGLE (Degree)	RAW VALUE (dBuV)	CORRECTION FACTOR (dB/m)
1	*2437.00	104.0 PK			1.48 H	237	72.19	31.81
2	*2437.00	101.5 AV			1.48 H	237	69.69	31.81
3	4874.00	46.9 PK	74.0	-27.1	1.00 H	315	7.76	39.14
4	4874.00	34.8 AV	54.0	-19.2	1.00 H	315	-4.34	39.14
5	7311.00	51.0 PK	74.0	-23.0	1.54 H	283	4.37	46.63
6	7311.00	39.5 AV	54.0	-14.5	1.54 H	283	-7.13	46.63
ANTENNA POLARITY & TEST DISTANCE: VERTICAL AT 3 M								
NO.	FREQ. (MHz)	EMISSION LEVEL (dBuV/m)	LIMIT (dBuV/m)	MARGIN (dB)	ANTENNA HEIGHT (m)	TABLE ANGLE (Degree)	RAW VALUE (dBuV)	CORRECTION FACTOR (dB/m)
1	*2437.00	113.0 PK			1.50 V	278	81.19	31.81
2	*2437.00	110.4 AV			1.50 V	278	78.59	31.81
3	4874.00	51.8 PK	74.0	-22.2	1.00 V	291	12.66	39.14
4	4874.00	47.2 AV	54.0	-6.8	1.00 V	291	8.06	39.14
5	7311.00	53.2 PK	74.0	-20.8	1.42 V	327	6.57	46.63
6	7311.00	41.6 AV	54.0	-12.4	1.42 V	327	-5.03	46.63

- REMARKS:**
1. Emission level (dBuV/m) = Raw Value (dBuV) + Correction Factor (dB/m).
 2. Correction Factor (dB/m) = Antenna Factor (dB/m) + Cable Factor (dB).
 3. The other emission levels were very low against the limit.
 4. Margin value = Emission level – Limit value.
 5. “ * “: Fundamental frequency.



A D T

EUT TEST CONDITION		MEASUREMENT DETAIL	
CHANNEL	Channel 11	FREQUENCY RANGE	1 ~ 25GHz
INPUT POWER (SYSTEM)	120Vac, 60 Hz	DETECTOR FUNCTION	Peak (PK) Average (AV)
ENVIRONMENTAL CONDITIONS	20deg. C, 63%RH 1002 hPa	TESTED BY	Kent Liu

ANTENNA POLARITY & TEST DISTANCE: HORIZONTAL AT 3 M								
NO.	FREQ. (MHz)	EMISSION LEVEL (dBuV/m)	LIMIT (dBuV/m)	MARGIN (dB)	ANTENNA HEIGHT (m)	TABLE ANGLE (Degree)	RAW VALUE (dBuV)	CORRECTION FACTOR (dB/m)
1	*2462.00	103.1 PK			1.42 H	273	71.25	31.89
2	*2462.00	100.6 AV			1.42 H	273	68.71	31.89
3	2486.60	57.1 PK	74.0	-16.9	1.42 H	273	25.12	31.98
4	2486.60	45.1 AV	54.0	-8.9	1.42 H	273	13.12	31.98
5	4924.00	46.9 PK	74.0	-27.1	1.02 H	325	7.59	39.31
6	4924.00	34.6 AV	54.0	-19.4	1.02 H	325	-4.71	39.31
7	7386.00	51.1 PK	74.0	-22.9	1.53 H	281	4.50	46.60
8	7386.00	39.5 AV	54.0	-14.5	1.53 H	281	-7.10	46.60
ANTENNA POLARITY & TEST DISTANCE: VERTICAL AT 3 M								
NO.	FREQ. (MHz)	EMISSION LEVEL (dBuV/m)	LIMIT (dBuV/m)	MARGIN (dB)	ANTENNA HEIGHT (m)	TABLE ANGLE (Degree)	RAW VALUE (dBuV)	CORRECTION FACTOR (dB/m)
1	*2462.00	111.5 PK			1.47 V	276	79.61	31.89
2	*2462.00	109.1 AV			1.47 V	276	77.21	31.89
3	2486.70	60.5 PK	74.0	-13.5	1.44 V	277	28.52	31.98
4	2486.70	52.1 AV	54.0	-1.9	1.44 V	277	20.12	31.98
5	4924.00	51.6 PK	74.0	-22.4	1.02 V	342	12.29	39.31
6	4924.00	46.8 AV	54.0	-7.2	1.02 V	342	7.49	39.31
7	7386.00	53.5 PK	74.0	-20.5	1.46 V	329	6.90	46.60
8	7386.00	41.7 AV	54.0	-12.3	1.46 V	329	-4.90	46.60

- REMARKS:**
1. Emission level (dBuV/m) = Raw Value (dBuV) + Correction Factor (dB/m).
 2. Correction Factor (dB/m) = Antenna Factor (dB/m) + Cable Factor (dB).
 3. The other emission levels were very low against the limit.
 4. Margin value = Emission level – Limit value.
 5. “ * “: Fundamental frequency.



A D T

EUT TEST CONDITION		MEASUREMENT DETAIL	
CHANNEL	Channel 12	FREQUENCY RANGE	1 ~ 25GHz
INPUT POWER (SYSTEM)	120Vac, 60 Hz	DETECTOR FUNCTION	Peak (PK) Average (AV)
ENVIRONMENTAL CONDITIONS	20deg. C, 63%RH 1002 hPa	TESTED BY	Kent Liu

ANTENNA POLARITY & TEST DISTANCE: HORIZONTAL AT 3 M

NO.	FREQ. (MHz)	EMISSION LEVEL (dBuV/m)	LIMIT (dBuV/m)	MARGIN (dB)	ANTENNA HEIGHT (m)	TABLE ANGLE (Degree)	RAW VALUE (dBuV)	CORRECTION FACTOR (dB/m)
1	*2467.00	100.1 PK			1.42 H	272	68.19	31.91
2	*2467.00	97.6 AV			1.42 H	272	65.69	31.91
3	2484.05	56.5 PK	74.0	-17.5	1.42 H	272	24.53	31.97
4	2484.05	45.6 AV	54.0	-8.4	1.42 H	272	13.63	31.97
5	4934.00	46.7 PK	74.0	-27.3	1.00 H	308	7.36	39.34
6	4934.00	34.9 AV	54.0	-19.1	1.00 H	308	-4.44	39.34
7	7401.00	51.2 PK	74.0	-22.8	1.54 H	278	4.61	46.59
8	7401.00	39.8 AV	54.0	-14.2	1.54 H	278	-6.79	46.59

ANTENNA POLARITY & TEST DISTANCE: VERTICAL AT 3 M

NO.	FREQ. (MHz)	EMISSION LEVEL (dBuV/m)	LIMIT (dBuV/m)	MARGIN (dB)	ANTENNA HEIGHT (m)	TABLE ANGLE (Degree)	RAW VALUE (dBuV)	CORRECTION FACTOR (dB/m)
1	*2467.00	107.7 PK			1.45 V	303	75.79	31.91
2	*2467.00	105.1 AV			1.45 V	303	73.19	31.91
3	2484.16	60.9 PK	74.0	-13.1	1.45 V	303	28.93	31.97
4	2484.16	52.3 AV	54.0	-1.7	1.45 V	303	20.33	31.97
5	4934.00	51.7 PK	74.0	-22.3	1.00 V	284	12.36	39.34
6	4934.00	47.1 AV	54.0	-6.9	1.00 V	284	7.76	39.34
7	7401.00	53.3 PK	74.0	-20.7	1.43 V	323	6.71	46.59
8	7401.00	41.5 AV	54.0	-12.5	1.43 V	323	-5.09	46.59

- REMARKS:**
1. Emission level (dBuV/m) = Raw Value (dBuV) + Correction Factor (dB/m).
 2. Correction Factor (dB/m) = Antenna Factor (dB/m) + Cable Factor (dB).
 3. The other emission levels were very low against the limit.
 4. Margin value = Emission level – Limit value.
 5. “ * “: Fundamental frequency.



A D T

EUT TEST CONDITION		MEASUREMENT DETAIL	
CHANNEL	Channel 13	FREQUENCY RANGE	1 ~ 25GHz
INPUT POWER (SYSTEM)	120Vac, 60 Hz	DETECTOR FUNCTION	Peak (PK) Average (AV)
ENVIRONMENTAL CONDITIONS	20deg. C, 63%RH 1002 hPa	TESTED BY	Kent Liu

ANTENNA POLARITY & TEST DISTANCE: HORIZONTAL AT 3 M								
NO.	FREQ. (MHz)	EMISSION LEVEL (dBuV/m)	LIMIT (dBuV/m)	MARGIN (dB)	ANTENNA HEIGHT (m)	TABLE ANGLE (Degree)	RAW VALUE (dBuV)	CORRECTION FACTOR (dB/m)
1	*2472.00	98.6 PK			1.42 H	272	66.67	31.93
2	*2472.00	95.9 AV			1.42 H	272	63.97	31.93
3	2486.50	57.0 PK	74.0	-17.0	1.42 H	272	25.02	31.98
4	2486.50	45.2 AV	54.0	-8.8	1.42 H	272	13.22	31.98
5	4944.00	46.9 PK	74.0	-27.1	1.00 H	303	7.53	39.37
6	4944.00	34.9 AV	54.0	-19.1	1.00 H	303	-4.47	39.37
7	7416.00	51.2 PK	74.0	-22.8	1.52 H	280	4.62	46.58
8	7416.00	39.5 AV	54.0	-14.5	1.52 H	280	-7.08	46.58
ANTENNA POLARITY & TEST DISTANCE: VERTICAL AT 3 M								
NO.	FREQ. (MHz)	EMISSION LEVEL (dBuV/m)	LIMIT (dBuV/m)	MARGIN (dB)	ANTENNA HEIGHT (m)	TABLE ANGLE (Degree)	RAW VALUE (dBuV)	CORRECTION FACTOR (dB/m)
1	*2472.00	107.0 PK			1.47 V	277	75.07	31.93
2	*2472.00	103.9 AV			1.47 V	277	71.97	31.93
3	2486.25	60.0 PK	74.0	-14.0	1.47 V	277	28.03	31.97
4	2486.25	51.6 AV	54.0	-2.4	1.47 V	277	19.63	31.97
5	4944.00	51.7 PK	74.0	-22.3	1.00 V	288	12.33	39.37
6	4944.00	47.0 AV	54.0	-7.0	1.00 V	288	7.63	39.37
7	7416.00	53.2 PK	74.0	-20.8	1.42 V	320	6.62	46.58
8	7416.00	41.7 AV	54.0	-12.3	1.42 V	320	-4.88	46.58

- REMARKS:**
1. Emission level (dBuV/m) = Raw Value (dBuV) + Correction Factor (dB/m).
 2. Correction Factor (dB/m) = Antenna Factor (dB/m) + Cable Factor (dB).
 3. The other emission levels were very low against the limit.
 4. Margin value = Emission level – Limit value.
 5. “ * “: Fundamental frequency.



A D T

RESTRICTED BANDEDGE (802.11b MODE,CH1, HORIZONTAL)

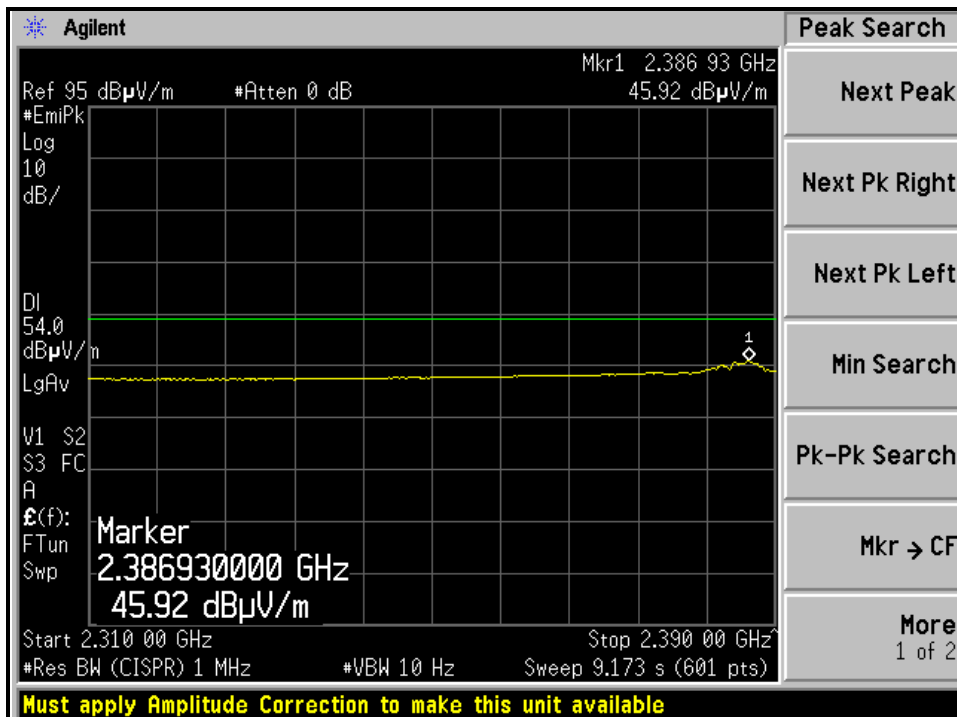
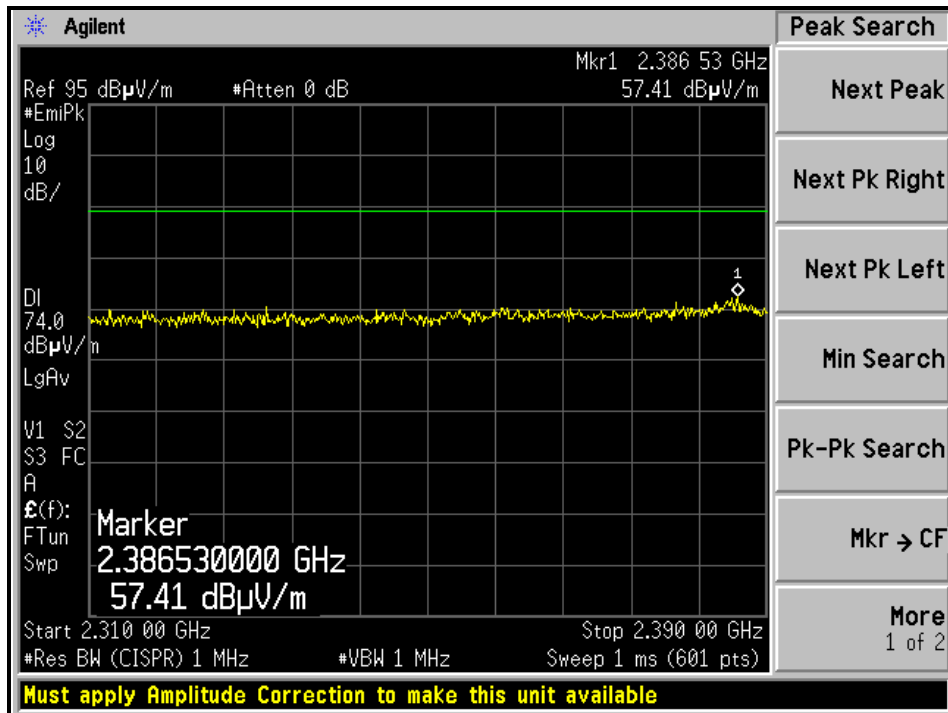



A D T

RESTRICTED BANDEDGE (802.11b MODE, CH1, VERTICAL)

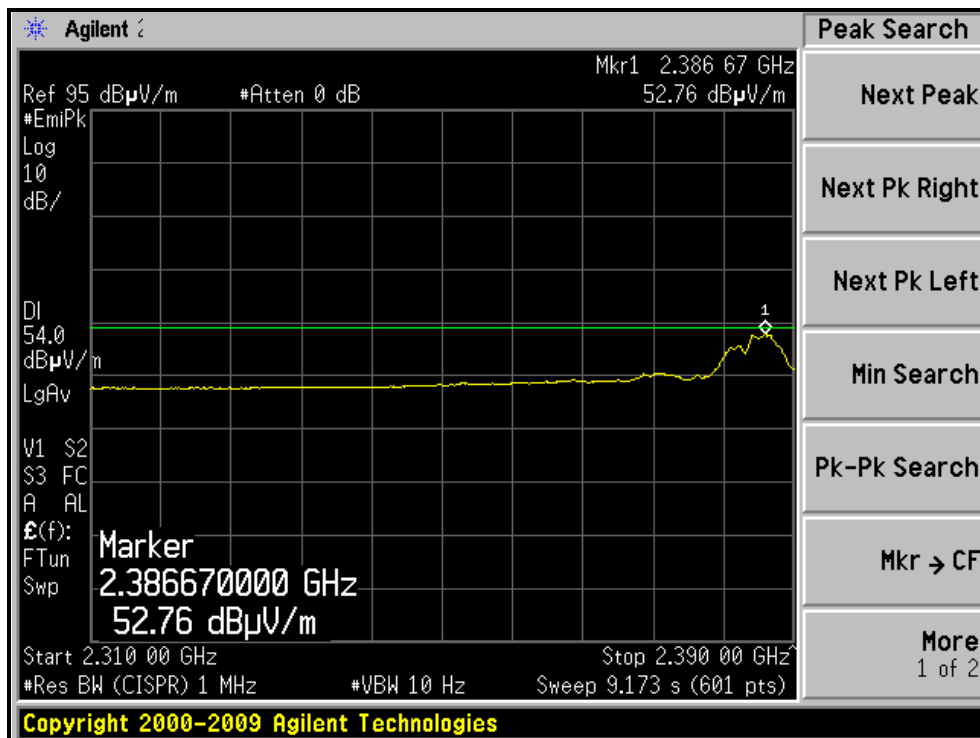
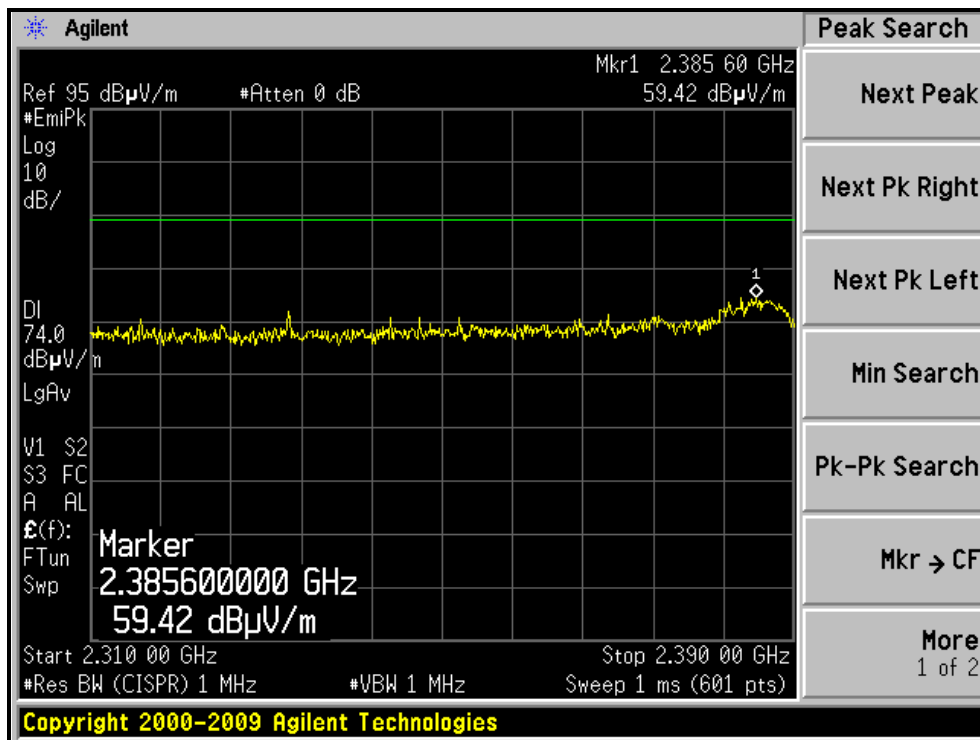



A D T

RESTRICTED BANDEDGE (802.11b MODE,CH11, HORIZONTAL)

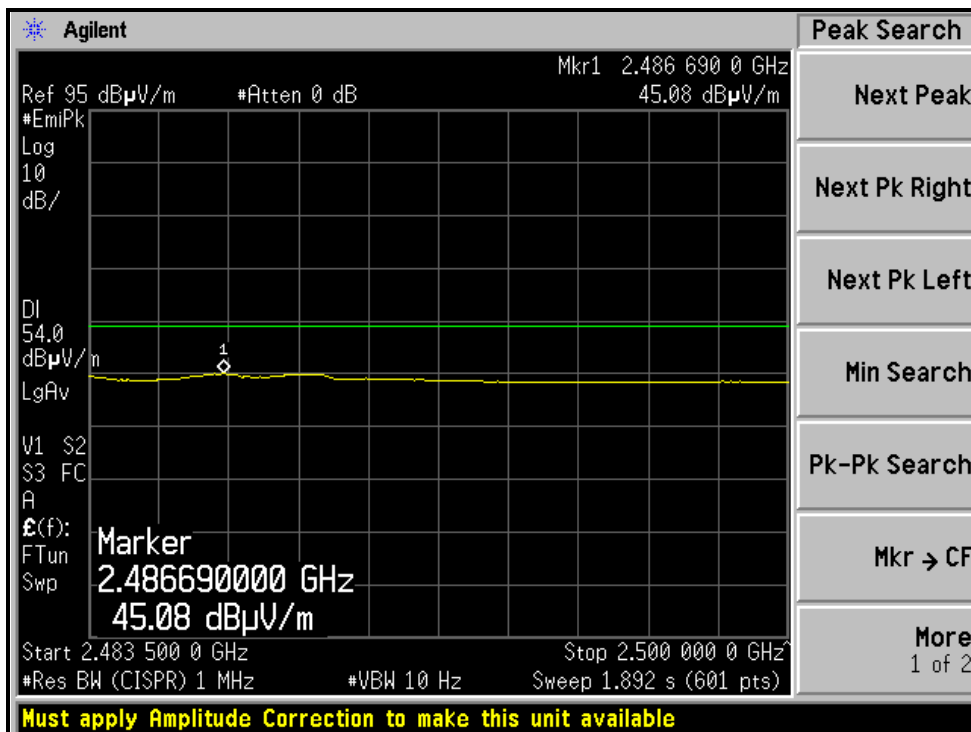
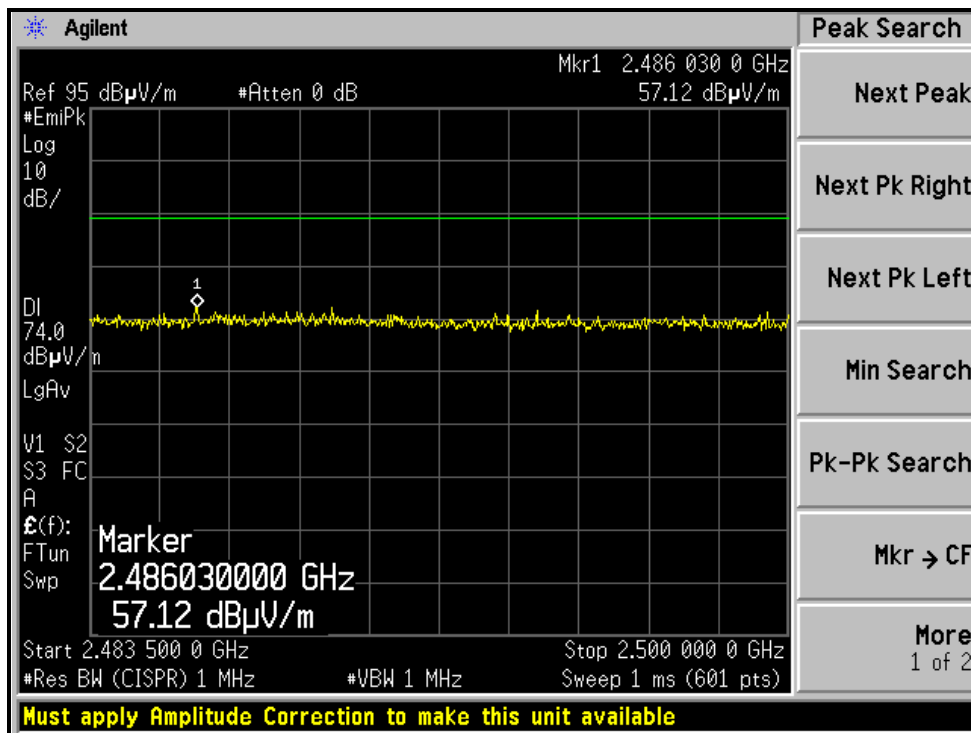



A D T

RESTRICTED BANDEDGE (802.11b MODE, CH11, VERTICAL)

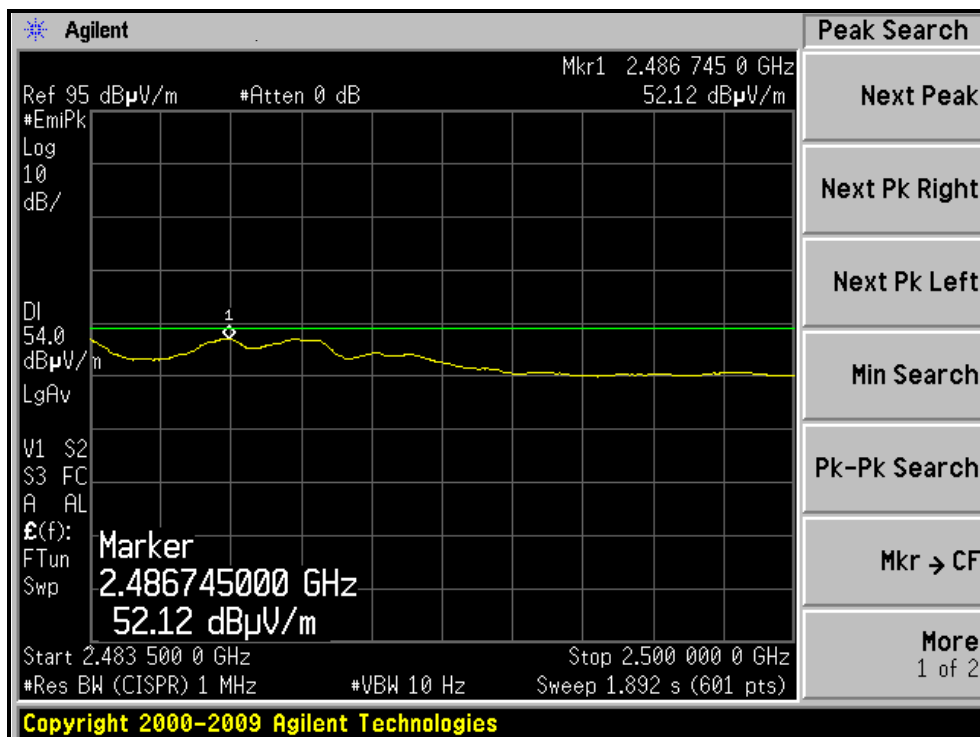
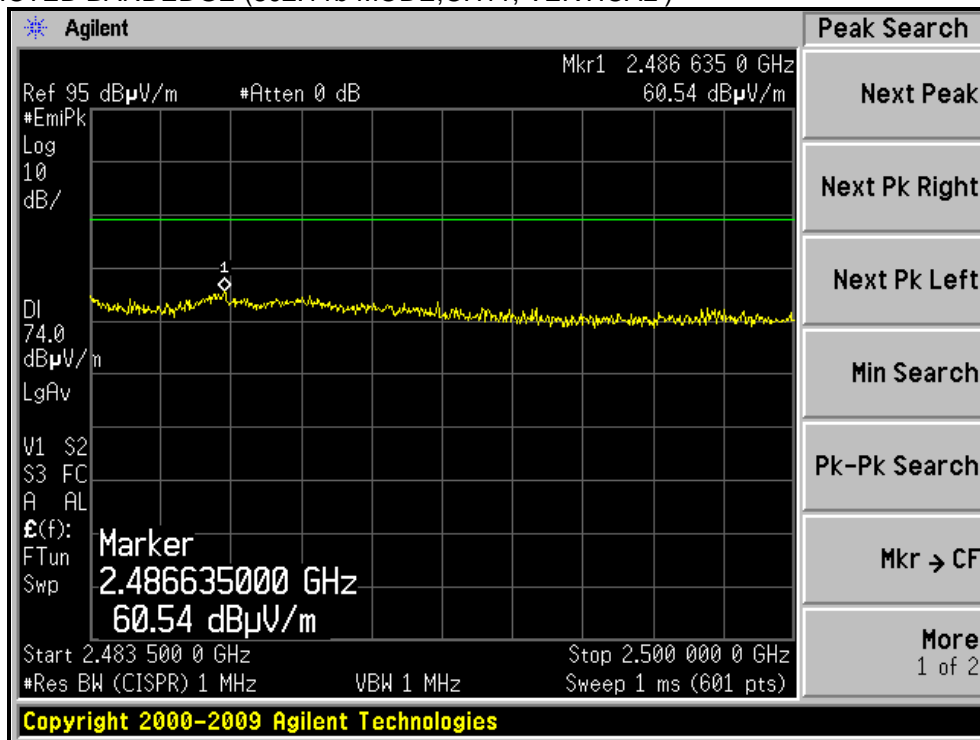



A D T

RESTRICTED BANDEDGE (802.11b MODE, CH12, HORIZONTAL)

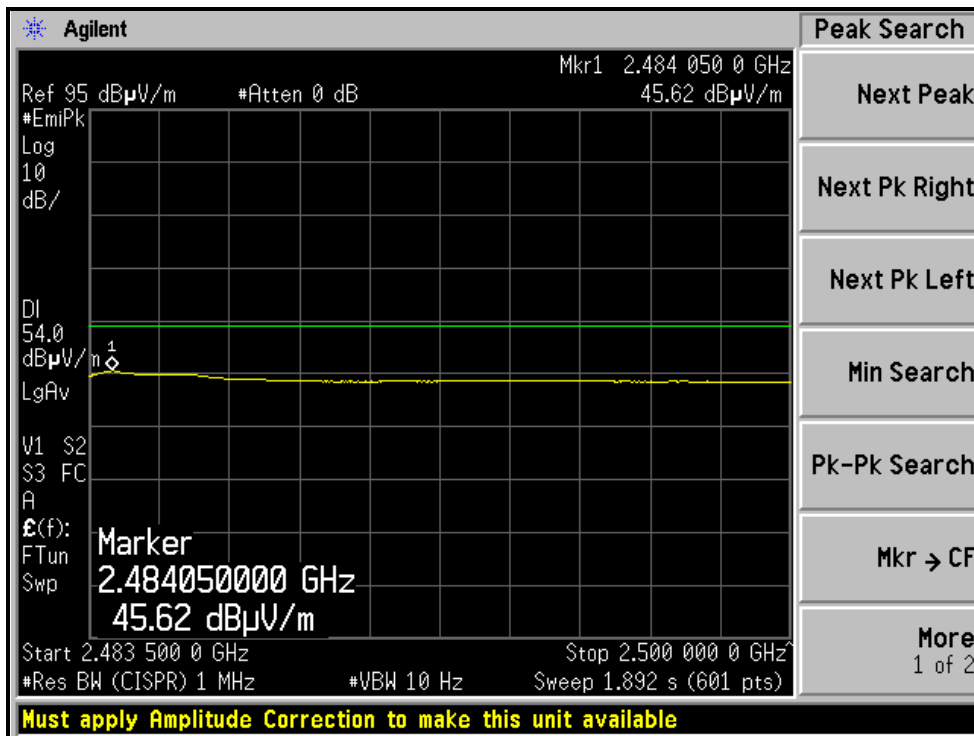
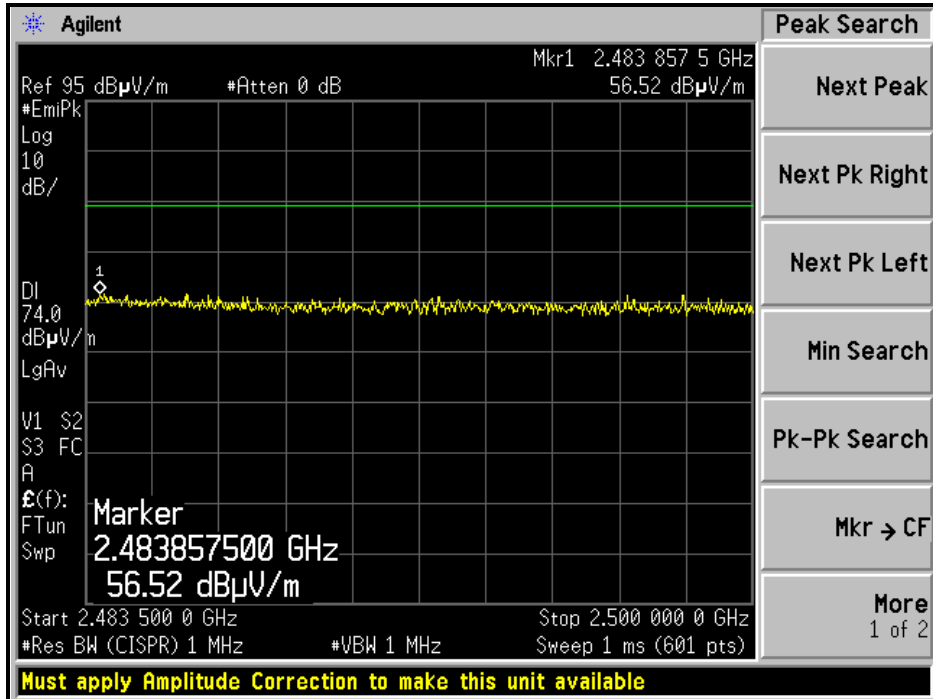



A D T

RESTRICTED BANDEDGE (802.11b MODE, CH12, VERTICAL)

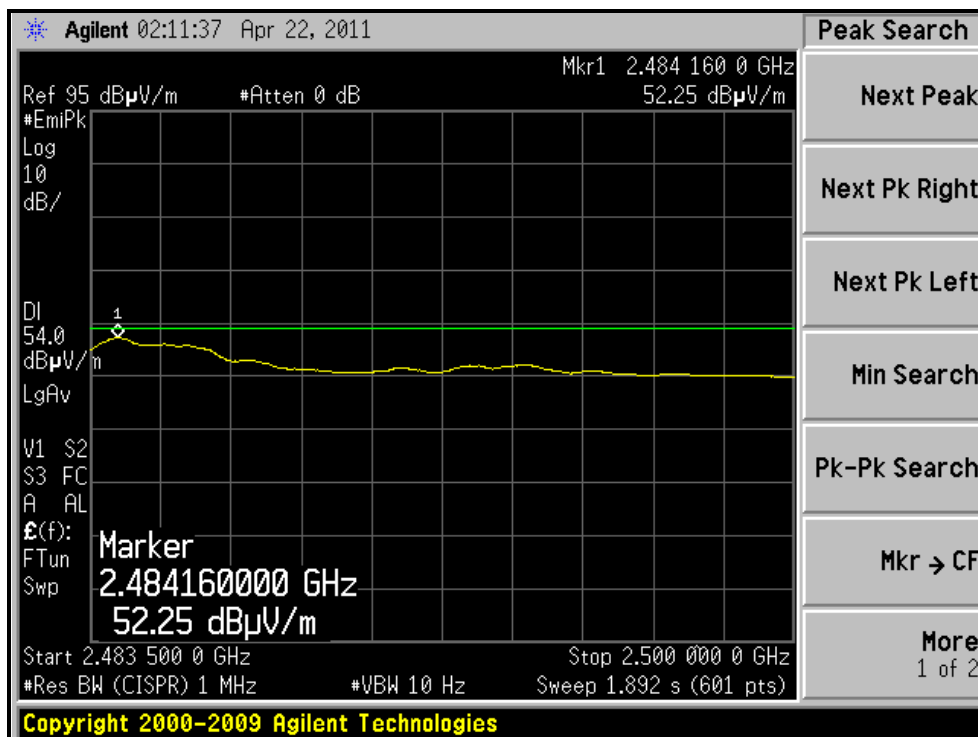
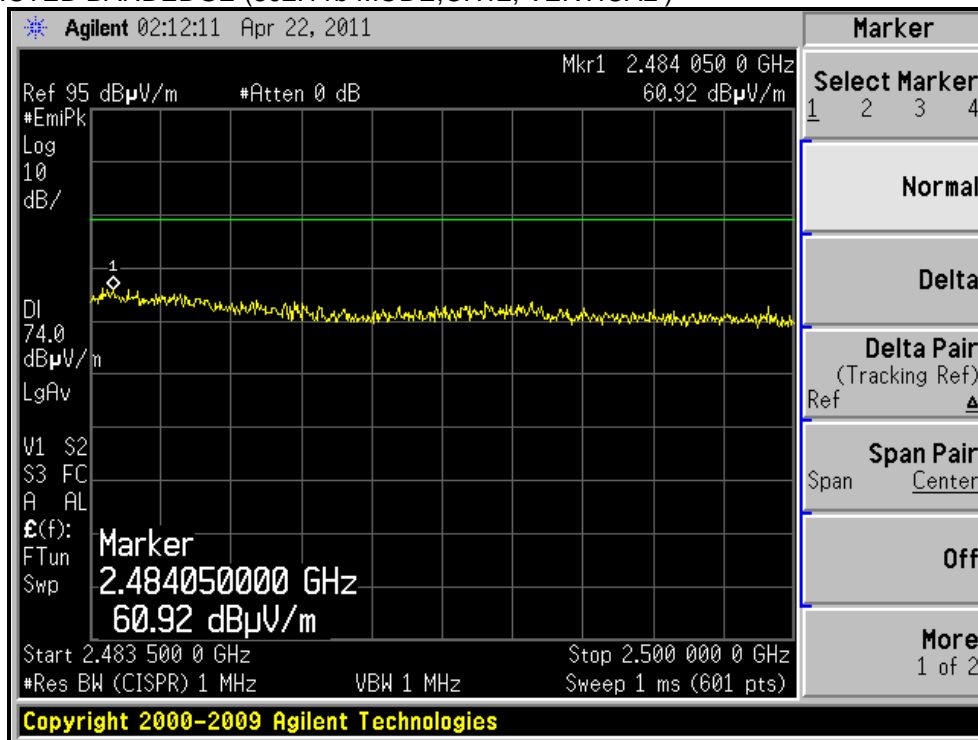



A D T

RESTRICTED BANDEDGE (802.11b MODE, CH13, HORIZONTAL)

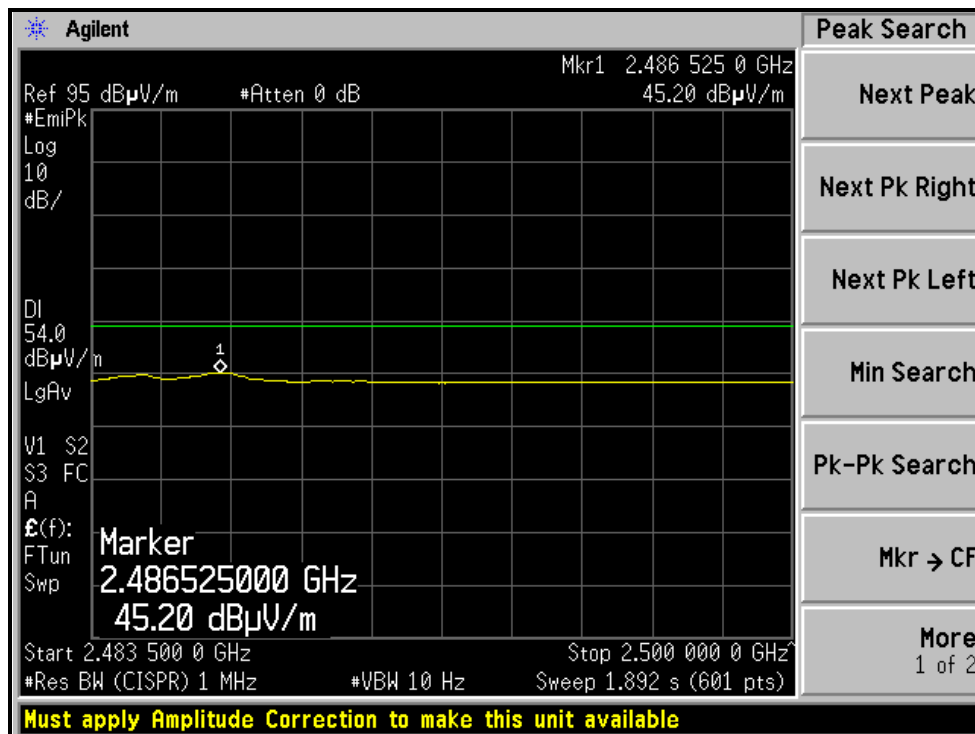
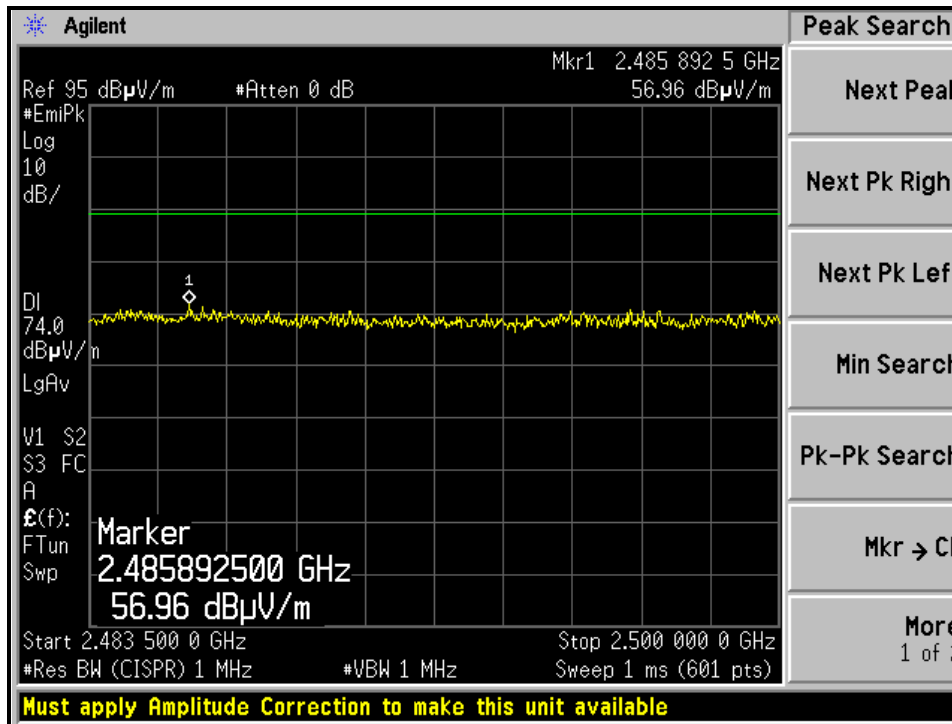



A D T

RESTRICTED BANDEDGE (802.11b MODE, CH13, VERTICAL)

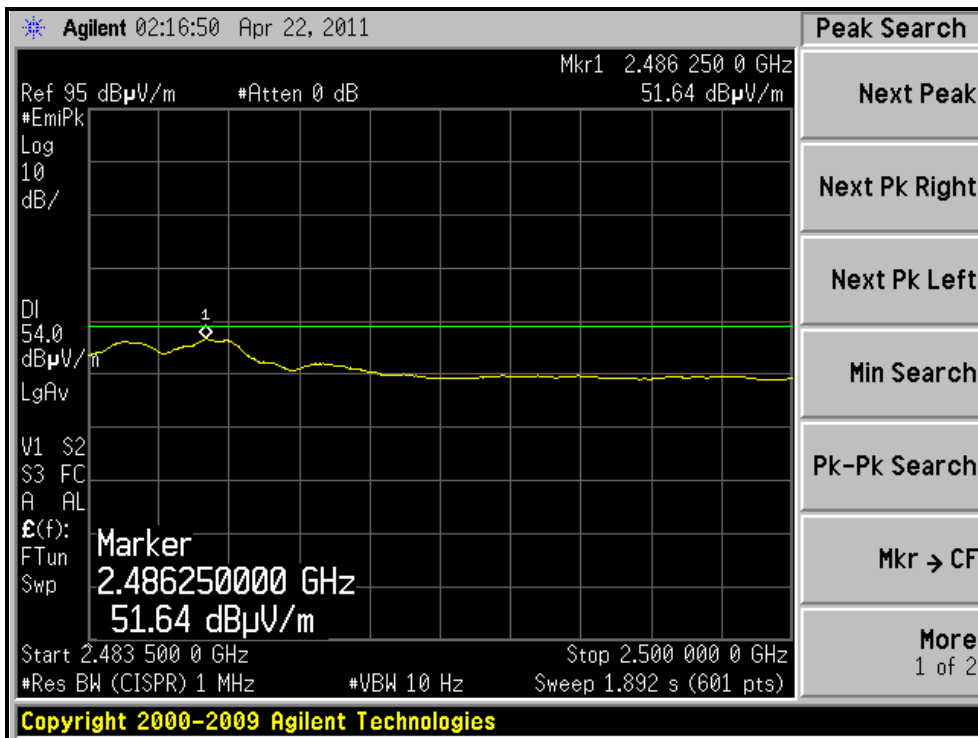
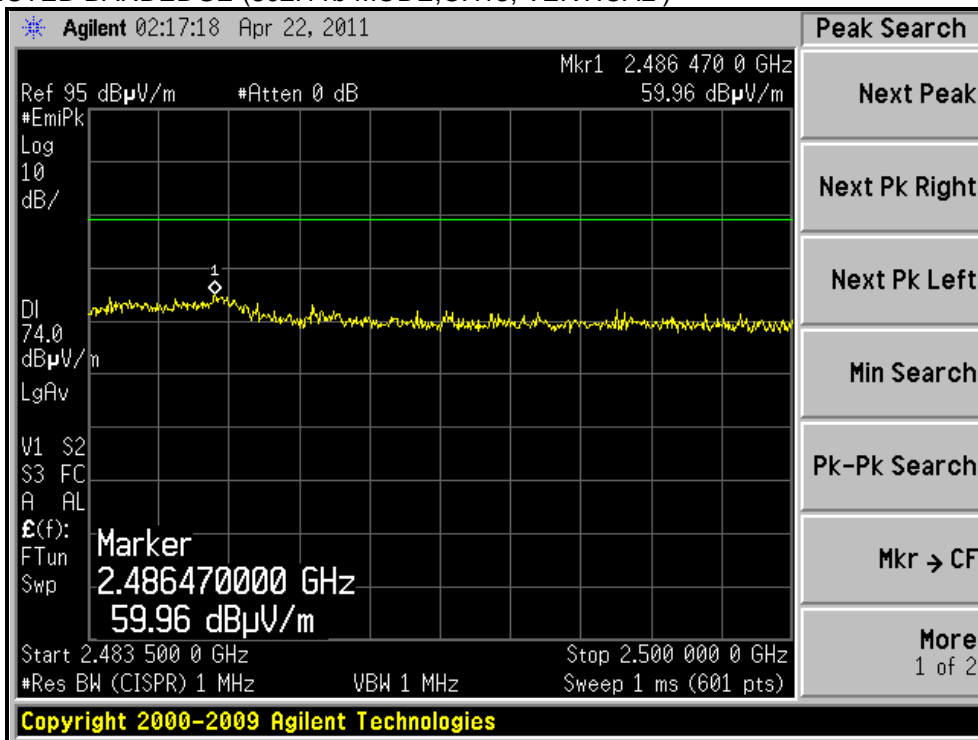



A D T

802.11g OFDM MODULATION

EUT TEST CONDITION		MEASUREMENT DETAIL	
CHANNEL	Channel 1	FREQUENCY RANGE	1 ~ 25GHz
INPUT POWER (SYSTEM)	120Vac, 60 Hz	DETECTOR FUNCTION	Peak (PK) Average (AV)
ENVIRONMENTAL CONDITIONS	20deg. C, 63%RH 1002 hPa	TESTED BY	Kent Liu

ANTENNA POLARITY & TEST DISTANCE: HORIZONTAL AT 3 M								
NO.	FREQ. (MHz)	EMISSION LEVEL (dBuV/m)	LIMIT (dBuV/m)	MARGIN (dB)	ANTENNA HEIGHT (m)	TABLE ANGLE (Degree)	RAW VALUE (dBuV)	CORRECTION FACTOR (dB/m)
1	2390.00	60.0 PK	74.0	-14.0	1.49 H	272	28.34	31.66
2	2390.00	45.8 AV	54.0	-8.2	1.49 H	272	14.14	31.66
3	*2412.00	101.7 PK			1.49 H	271	69.97	31.73
4	*2412.00	91.5 AV			1.49 H	271	59.77	31.73
5	4824.00	45.2 PK	74.0	-28.8	1.00 H	312	6.23	38.97
6	4824.00	33.8 AV	54.0	-20.2	1.00 H	312	-5.17	38.97
ANTENNA POLARITY & TEST DISTANCE: VERTICAL AT 3 M								
NO.	FREQ. (MHz)	EMISSION LEVEL (dBuV/m)	LIMIT (dBuV/m)	MARGIN (dB)	ANTENNA HEIGHT (m)	TABLE ANGLE (Degree)	RAW VALUE (dBuV)	CORRECTION FACTOR (dB/m)
1	2390.00	72.8 PK	74.0	-1.2	1.48 V	248	41.14	31.66
2	2390.00	50.9 AV	54.0	-3.1	1.48 V	248	19.24	31.66
3	*2412.00	110.4 PK			1.49 V	272	78.67	31.73
4	*2412.00	100.0 AV			1.49 V	272	68.27	31.73
5	4824.00	46.8 PK	74.0	-27.2	1.05 V	281	7.83	38.97
6	4824.00	35.1 AV	54.0	-18.9	1.05 V	281	-3.87	38.97

- REMARKS:**
1. Emission level (dBuV/m) = Raw Value (dBuV) + Correction Factor (dB/m).
 2. Correction Factor (dB/m) = Antenna Factor (dB/m) + Cable Factor (dB).
 3. The other emission levels were very low against the limit.
 4. Margin value = Emission level – Limit value.
 5. “ * “: Fundamental frequency.



A D T

EUT TEST CONDITION		MEASUREMENT DETAIL	
CHANNEL	Channel 6	FREQUENCY RANGE	1 ~ 25GHz
INPUT POWER (SYSTEM)	120Vac, 60 Hz	DETECTOR FUNCTION	Peak (PK) Average (AV)
ENVIRONMENTAL CONDITIONS	20deg. C, 63%RH 1002 hPa	TESTED BY	Kent Liu

ANTENNA POLARITY & TEST DISTANCE: HORIZONTAL AT 3 M								
NO.	FREQ. (MHz)	EMISSION LEVEL (dBuV/m)	LIMIT (dBuV/m)	MARGIN (dB)	ANTENNA HEIGHT (m)	TABLE ANGLE (Degree)	RAW VALUE (dBuV)	CORRECTION FACTOR (dB/m)
1	*2437.00	103.4 PK			1.46 H	271	71.59	31.81
2	*2437.00	92.9 AV			1.46 H	271	61.09	31.81
3	4874.00	45.0 PK	74.0	-29.0	1.00 H	308	5.86	39.14
4	4874.00	33.8 AV	54.0	-20.2	1.00 H	308	-5.34	39.14
5	7311.00	51.0 PK	74.0	-23.0	1.47 H	285	4.37	46.63
6	7311.00	39.5 AV	54.0	-14.5	1.47 H	285	-7.13	46.63
ANTENNA POLARITY & TEST DISTANCE: VERTICAL AT 3 M								
NO.	FREQ. (MHz)	EMISSION LEVEL (dBuV/m)	LIMIT (dBuV/m)	MARGIN (dB)	ANTENNA HEIGHT (m)	TABLE ANGLE (Degree)	RAW VALUE (dBuV)	CORRECTION FACTOR (dB/m)
1	2390.00	60.4 PK	74.0	-13.6	1.47 V	293	28.74	31.66
2	2390.00	45.9 AV	54.0	-8.1	1.47 V	293	14.24	31.66
3	*2437.00	113.5 PK			1.47 V	293	81.69	31.81
4	*2437.00	103.1 AV			1.47 V	293	71.29	31.81
5	2483.50	67.6 PK	74.0	-6.4	1.47 V	293	35.63	31.97
6	2483.50	46.6 AV	54.0	-7.4	1.47 V	293	14.63	31.97
7	4874.00	46.6 PK	74.0	-27.4	1.01 V	293	7.46	39.14
8	4874.00	35.0 AV	54.0	-19.0	1.01 V	293	-4.14	39.14
9	7311.00	53.2 PK	74.0	-20.8	1.42 V	313	6.57	46.63
10	7311.00	41.7 AV	54.0	-12.3	1.42 V	313	-4.93	46.63

- REMARKS:**
1. Emission level (dBuV/m) = Raw Value (dBuV) + Correction Factor (dB/m).
 2. Correction Factor (dB/m) = Antenna Factor (dB/m) + Cable Factor (dB).
 3. The other emission levels were very low against the limit.
 4. Margin value = Emission level – Limit value.
 5. “ * “: Fundamental frequency.



A D T

EUT TEST CONDITION		MEASUREMENT DETAIL	
CHANNEL	Channel 11	FREQUENCY RANGE	1 ~ 25GHz
INPUT POWER (SYSTEM)	120Vac, 60 Hz	DETECTOR FUNCTION	Peak (PK) Average (AV)
ENVIRONMENTAL CONDITIONS	20deg. C, 63%RH 1002 hPa	TESTED BY	Kent Liu

ANTENNA POLARITY & TEST DISTANCE: HORIZONTAL AT 3 M								
NO.	FREQ. (MHz)	EMISSION LEVEL (dBuV/m)	LIMIT (dBuV/m)	MARGIN (dB)	ANTENNA HEIGHT (m)	TABLE ANGLE (Degree)	RAW VALUE (dBuV)	CORRECTION FACTOR (dB/m)
1	*2462.00	101.3 PK			1.43 H	272	69.41	31.89
2	*2462.00	90.8 AV			1.43 H	272	58.91	31.89
3	2483.52	59.7 PK	74.0	-14.3	1.43 H	272	27.73	31.97
4	2483.52	44.8 AV	54.0	-9.2	1.43 H	272	12.83	31.97
5	4924.00	44.9 PK	74.0	-29.1	1.04 H	303	5.59	39.31
6	4924.00	33.7 AV	54.0	-20.3	1.04 H	303	-5.61	39.31
7	7386.00	50.9 PK	74.0	-23.1	1.42 H	281	4.30	46.60
8	7386.00	39.4 AV	54.0	-14.6	1.42 H	281	-7.20	46.60
ANTENNA POLARITY & TEST DISTANCE: VERTICAL AT 3 M								
NO.	FREQ. (MHz)	EMISSION LEVEL (dBuV/m)	LIMIT (dBuV/m)	MARGIN (dB)	ANTENNA HEIGHT (m)	TABLE ANGLE (Degree)	RAW VALUE (dBuV)	CORRECTION FACTOR (dB/m)
1	*2462.00	108.1 PK			1.48 V	277	76.21	31.89
2	*2462.00	99.0 AV			1.48 V	277	67.11	31.89
3	2483.52	72.3 PK	74.0	-1.7	1.46 V	274	40.33	31.97
4	2483.52	49.6 AV	54.0	-4.4	1.46 V	274	17.63	31.97
5	4924.00	46.2 PK	74.0	-27.8	1.00 V	292	6.89	39.31
6	4924.00	34.8 AV	54.0	-19.2	1.00 V	292	-4.51	39.31
7	7386.00	53.1 PK	74.0	-20.9	1.38 V	311	6.50	46.60
8	7386.00	41.7 AV	54.0	-12.3	1.38 V	311	-4.90	46.60

- REMARKS:**
1. Emission level (dBuV/m) = Raw Value (dBuV) + Correction Factor (dB/m).
 2. Correction Factor (dB/m) = Antenna Factor (dB/m) + Cable Factor (dB).
 3. The other emission levels were very low against the limit.
 4. Margin value = Emission level – Limit value.
 5. “ * “: Fundamental frequency.



A D T

EUT TEST CONDITION		MEASUREMENT DETAIL	
CHANNEL	Channel 12	FREQUENCY RANGE	1 ~ 25GHz
INPUT POWER (SYSTEM)	120Vac, 60 Hz	DETECTOR FUNCTION	Peak (PK) Average (AV)
ENVIRONMENTAL CONDITIONS	20deg. C, 63%RH 1002 hPa	TESTED BY	Kent Liu

ANTENNA POLARITY & TEST DISTANCE: HORIZONTAL AT 3 M								
NO.	FREQ. (MHz)	EMISSION LEVEL (dBuV/m)	LIMIT (dBuV/m)	MARGIN (dB)	ANTENNA HEIGHT (m)	TABLE ANGLE (Degree)	RAW VALUE (dBuV)	CORRECTION FACTOR (dB/m)
1	*2467.00	97.7 PK			1.43 H	272	65.79	31.91
2	*2467.00	87.7 AV			1.43 H	272	55.79	31.91
3	2483.50	61.5 PK	74.0	-12.5	1.43 H	272	29.53	31.97
4	2483.50	46.3 AV	54.0	-7.7	1.43 H	272	14.33	31.97
5	4934.00	45.1 PK	74.0	-28.9	1.02 H	297	5.76	39.34
6	4934.00	33.7 AV	54.0	-20.3	1.02 H	297	-5.64	39.34
7	7401.00	51.2 PK	74.0	-22.8	1.48 H	287	4.61	46.59
8	7401.00	39.5 AV	54.0	-14.5	1.48 H	287	-7.09	46.59
ANTENNA POLARITY & TEST DISTANCE: VERTICAL AT 3 M								
NO.	FREQ. (MHz)	EMISSION LEVEL (dBuV/m)	LIMIT (dBuV/m)	MARGIN (dB)	ANTENNA HEIGHT (m)	TABLE ANGLE (Degree)	RAW VALUE (dBuV)	CORRECTION FACTOR (dB/m)
1	*2467.00	104.1 PK			1.44 V	279	72.19	31.91
2	*2467.00	94.1 AV			1.44 V	279	62.19	31.91
3	2483.50	69.6 PK	74.0	-4.4	1.44 V	279	37.63	31.97
4	2483.50	52.4 AV	54.0	-1.6	1.44 V	279	20.43	31.97
5	4934.00	46.7 PK	74.0	-27.3	1.03 V	290	7.36	39.34
6	4934.00	35.1 AV	54.0	-18.9	1.03 V	290	-4.24	39.34
7	7401.00	53.4 PK	74.0	-20.6	1.48 V	326	6.81	46.59
8	7401.00	41.9 AV	54.0	-12.1	1.48 V	326	-4.69	46.59

- REMARKS:**
1. Emission level (dBuV/m) = Raw Value (dBuV) + Correction Factor (dB/m).
 2. Correction Factor (dB/m) = Antenna Factor (dB/m) + Cable Factor (dB).
 3. The other emission levels were very low against the limit.
 4. Margin value = Emission level – Limit value.
 5. “ * “: Fundamental frequency.



A D T

EUT TEST CONDITION		MEASUREMENT DETAIL	
CHANNEL	Channel 13	FREQUENCY RANGE	1 ~ 25GHz
INPUT POWER (SYSTEM)	120Vac, 60 Hz	DETECTOR FUNCTION	Peak (PK) Average (AV)
ENVIRONMENTAL CONDITIONS	20deg. C, 63%RH 1002 hPa	TESTED BY	Kent Liu

ANTENNA POLARITY & TEST DISTANCE: HORIZONTAL AT 3 M								
NO.	FREQ. (MHz)	EMISSION LEVEL (dBuV/m)	LIMIT (dBuV/m)	MARGIN (dB)	ANTENNA HEIGHT (m)	TABLE ANGLE (Degree)	RAW VALUE (dBuV)	CORRECTION FACTOR (dB/m)
1	*2472.00	86.6 PK			1.43 H	273	54.67	31.93
2	*2472.00	76.2 AV			1.43 H	273	44.27	31.93
3	2483.50	64.5 PK	74.0	-9.5	1.43 H	273	32.53	31.97
4	2483.50	45.7 AV	54.0	-8.3	1.43 H	273	13.73	31.97
5	4944.00	45.2 PK	74.0	-28.8	1.01 H	297	5.83	39.37
6	4944.00	33.9 AV	54.0	-20.1	1.01 H	297	-5.47	39.37
7	7416.00	50.9 PK	74.0	-23.1	1.47 H	287	4.32	46.58
8	7416.00	39.6 AV	54.0	-14.4	1.47 H	287	-6.98	46.58
ANTENNA POLARITY & TEST DISTANCE: VERTICAL AT 3 M								
NO.	FREQ. (MHz)	EMISSION LEVEL (dBuV/m)	LIMIT (dBuV/m)	MARGIN (dB)	ANTENNA HEIGHT (m)	TABLE ANGLE (Degree)	RAW VALUE (dBuV)	CORRECTION FACTOR (dB/m)
1	*2472.00	94.1 PK			1.45 V	278	62.17	31.93
2	*2472.00	84.3 AV			1.45 V	278	52.37	31.93
3	2483.50	72.6 PK	74.0	-1.4	1.45 V	278	40.63	31.97
4	2483.50	49.2 AV	54.0	-4.8	1.45 V	278	17.23	31.97
5	4944.00	46.6 PK	74.0	-27.4	1.06 V	299	7.23	39.37
6	4944.00	35.0 AV	54.0	-19.0	1.06 V	299	-4.37	39.37
7	7416.00	53.0 PK	74.0	-21.0	1.39 V	318	6.42	46.58
8	7416.00	41.5 AV	54.0	-12.5	1.39 V	318	-5.08	46.58

- REMARKS:**
1. Emission level (dBuV/m) = Raw Value (dBuV) + Correction Factor (dB/m).
 2. Correction Factor (dB/m) = Antenna Factor (dB/m) + Cable Factor (dB).
 3. The other emission levels were very low against the limit.
 4. Margin value = Emission level – Limit value.
 5. “ * “: Fundamental frequency.



A D T

RESTRICTED BANDEDGE (802.11g MODE, CH1, HORIZONTAL)

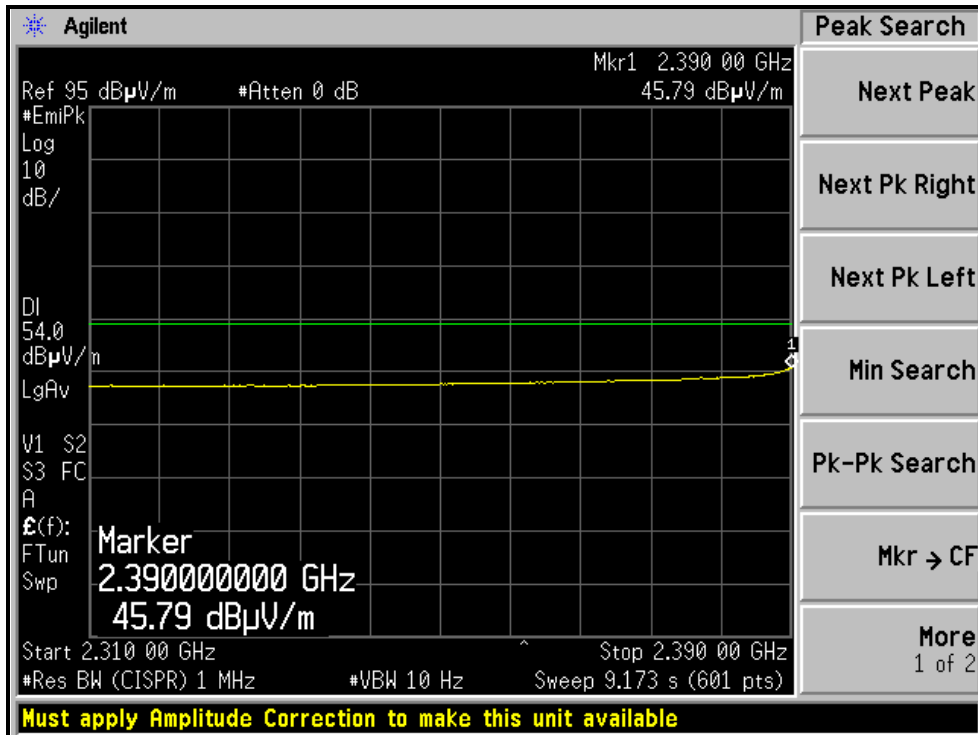
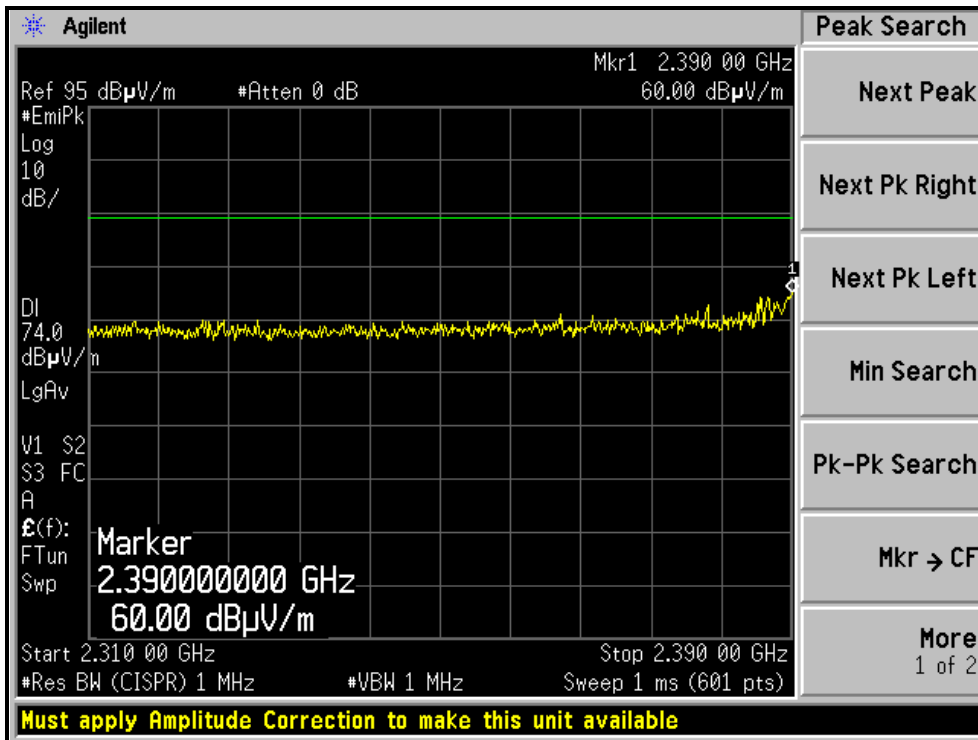



A D T

RESTRICTED BANDEDGE (802.11g MODE, CH1, VERTICAL)

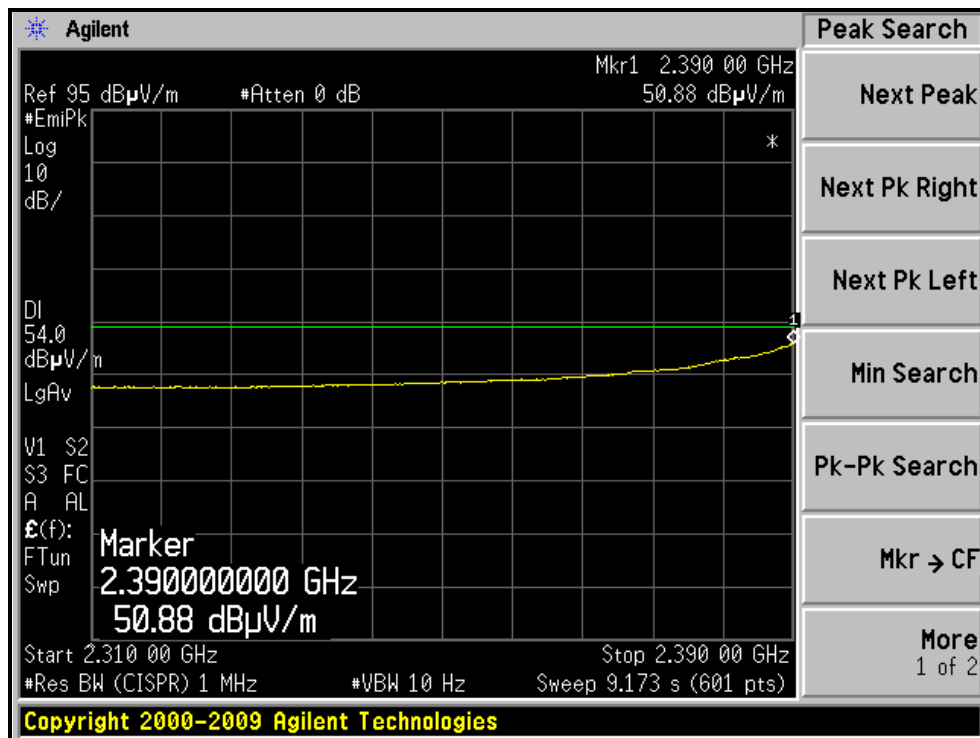
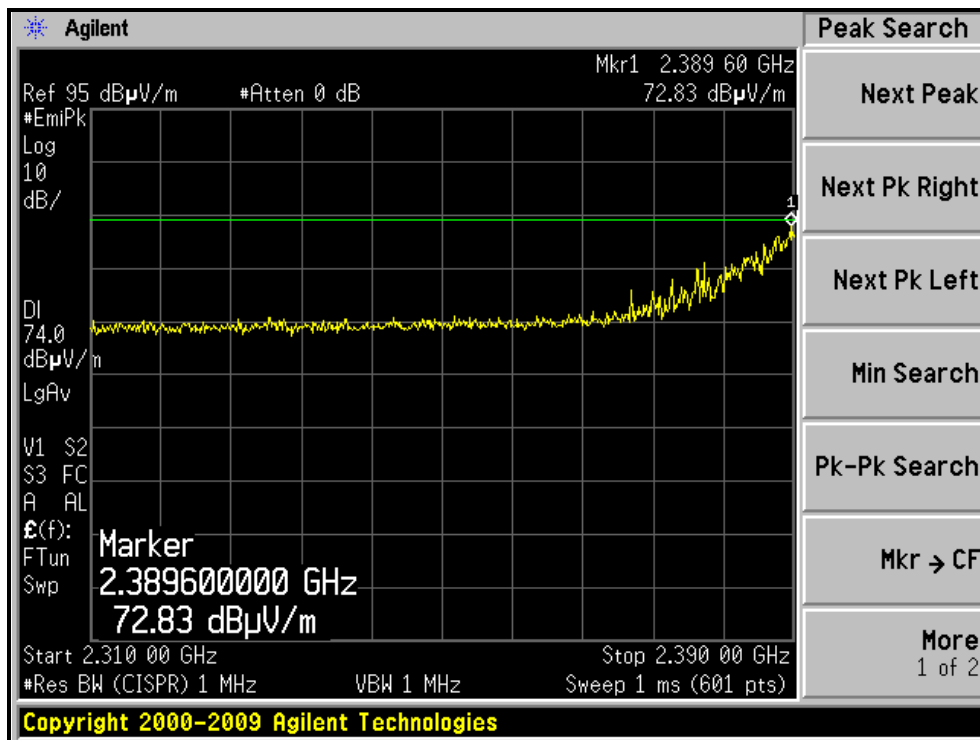



A D T

RESTRICTED BANDEDGE (802.11g MODE,CH11, HORIZONTAL)

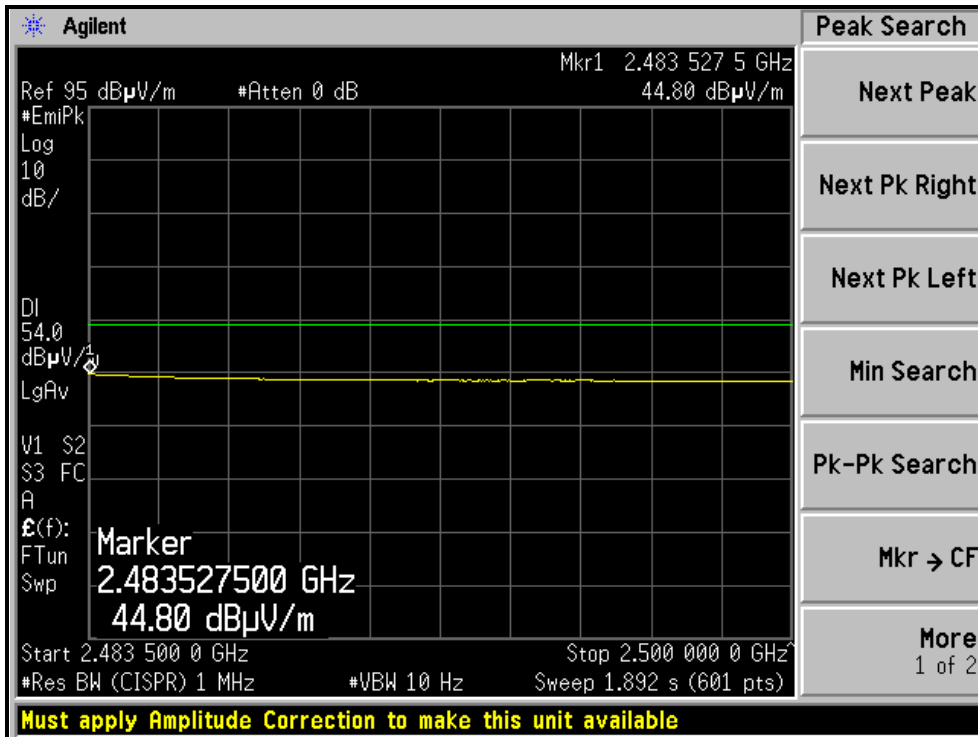
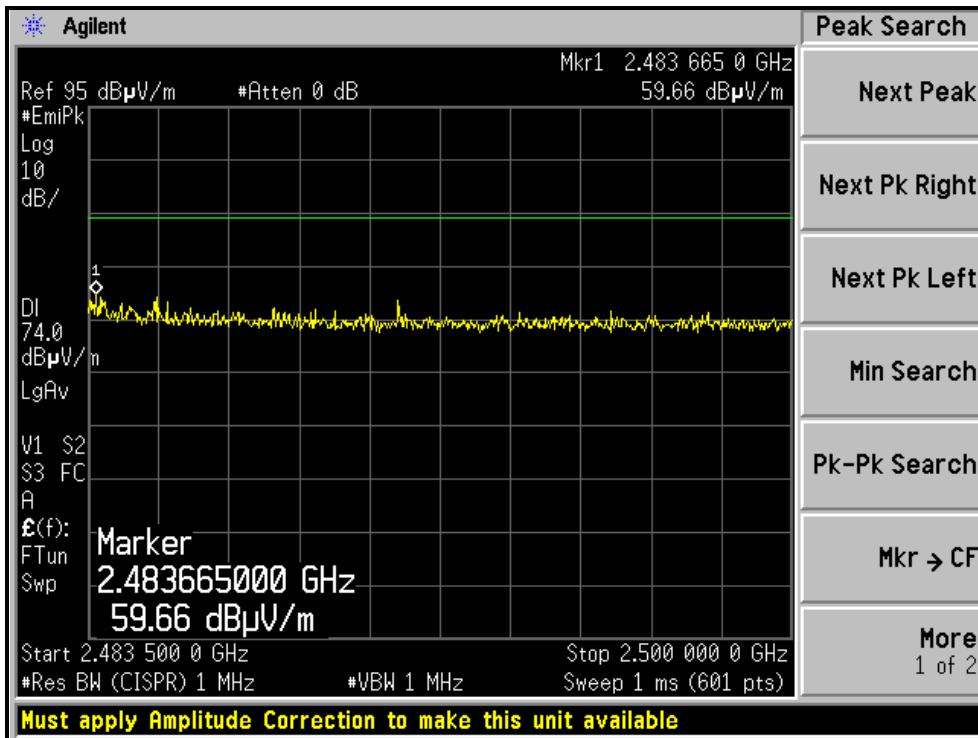



A D T

RESTRICTED BANDEDGE (802.11g MODE,CH11, VERTICAL)

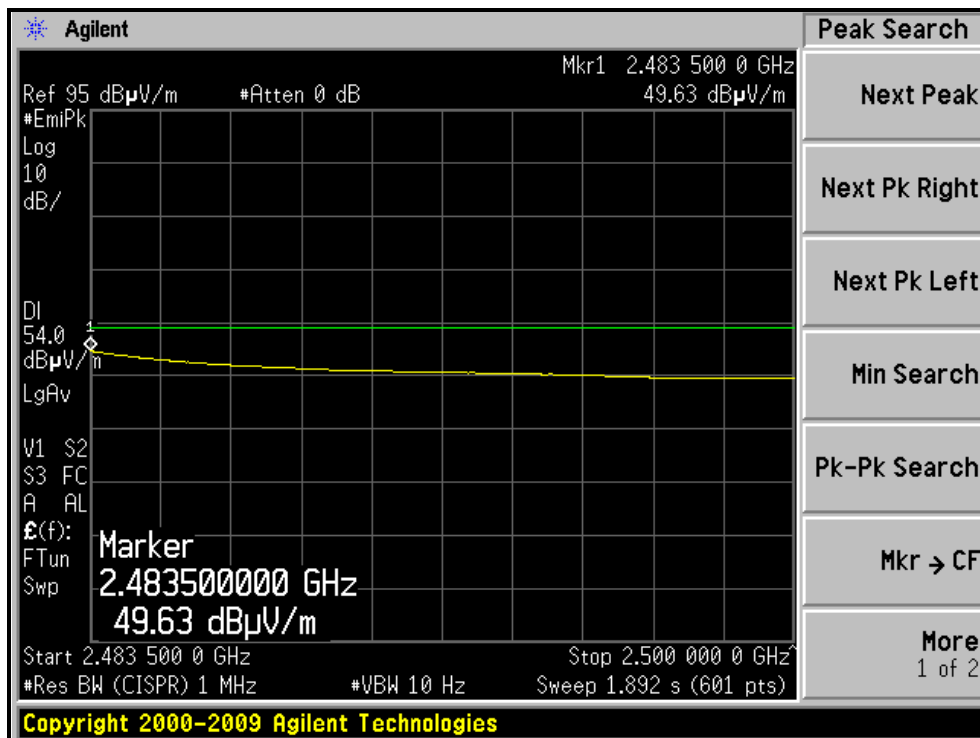
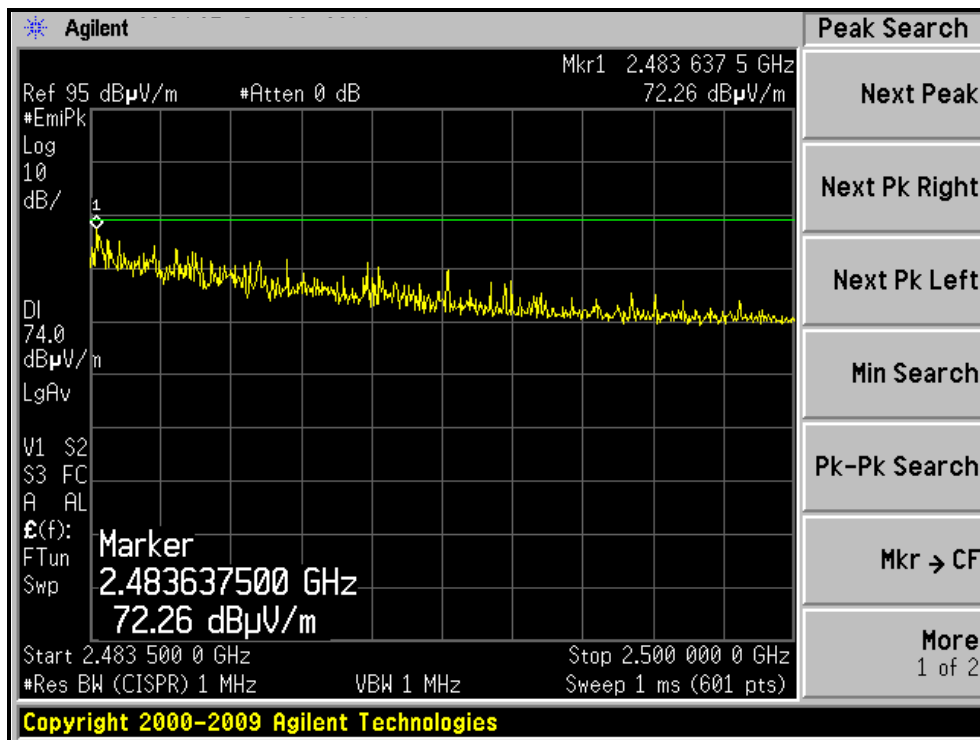



A D T

RESTRICTED BANDEDGE (802.11g MODE, CH12, HORIZONTAL)

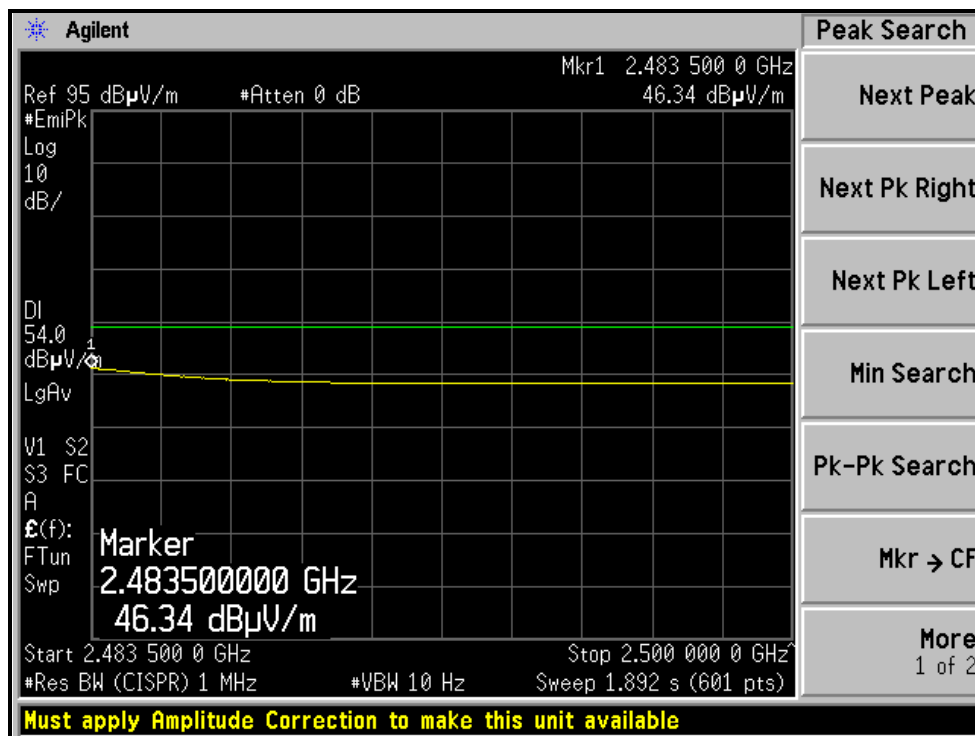
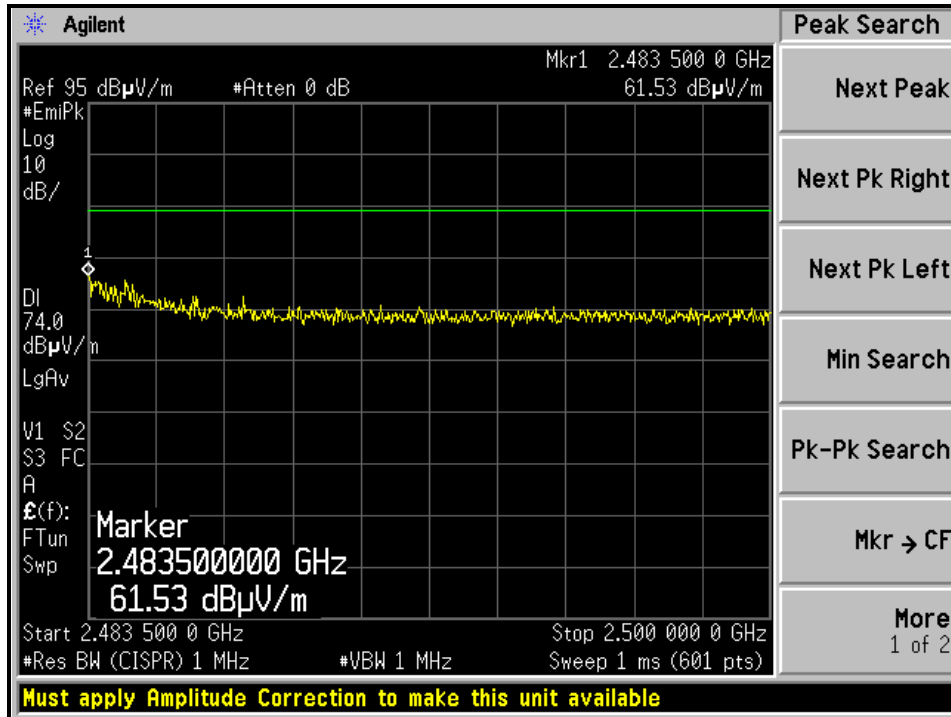



A D T

RESTRICTED BANDEDGE (802.11g MODE, CH12, VERTICAL)

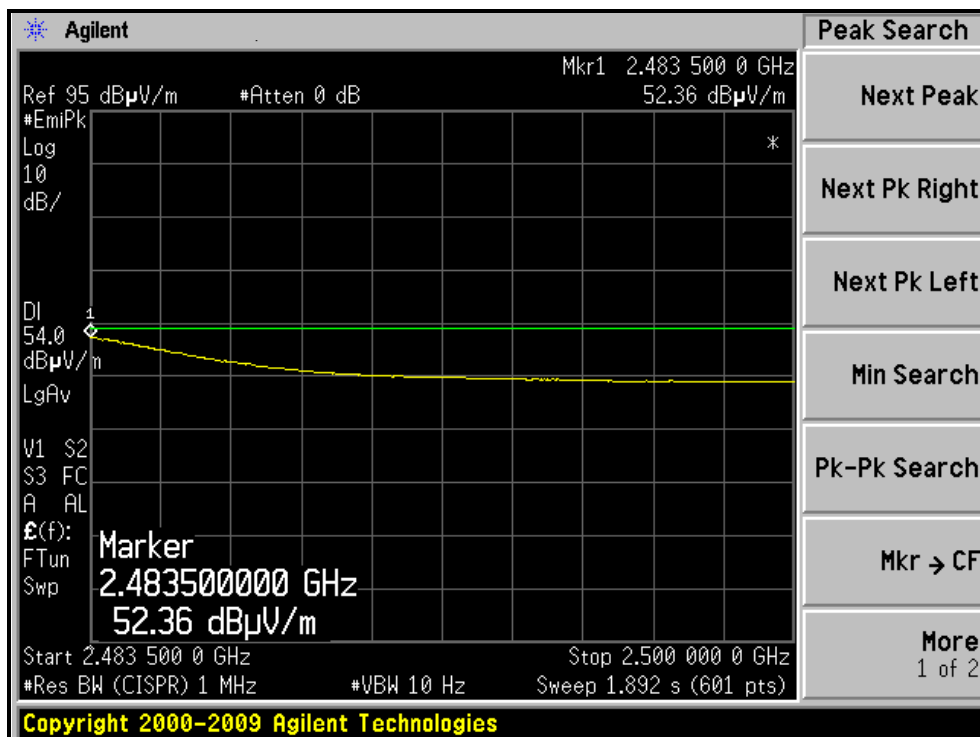
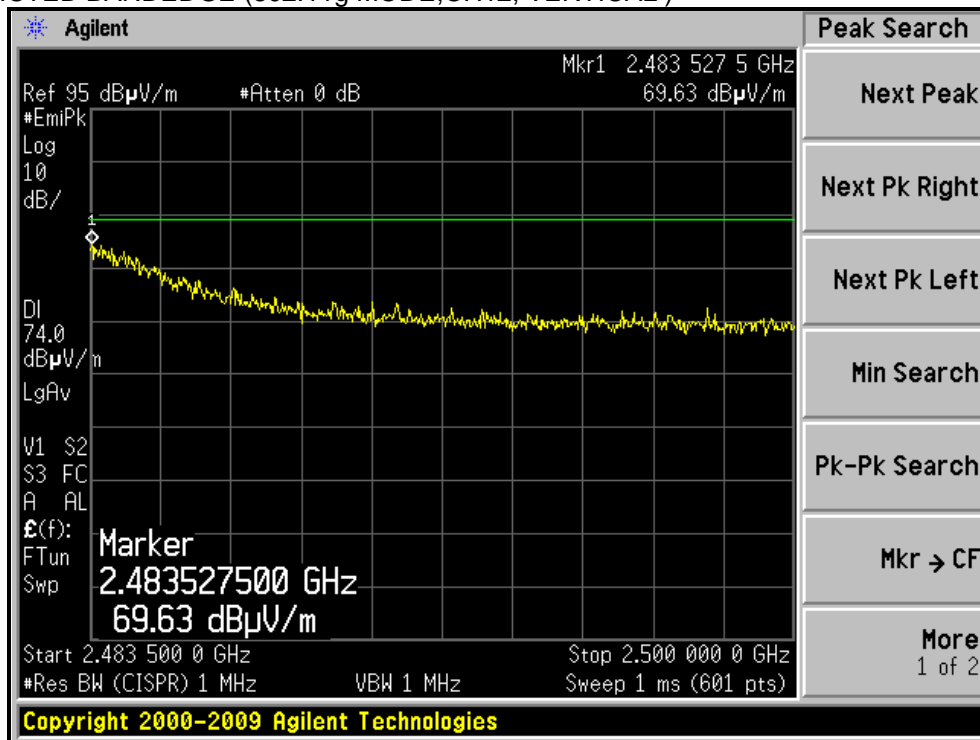

RESTRICTED BANDEDGE (802.11g MODE, CH13, HORIZONTAL)

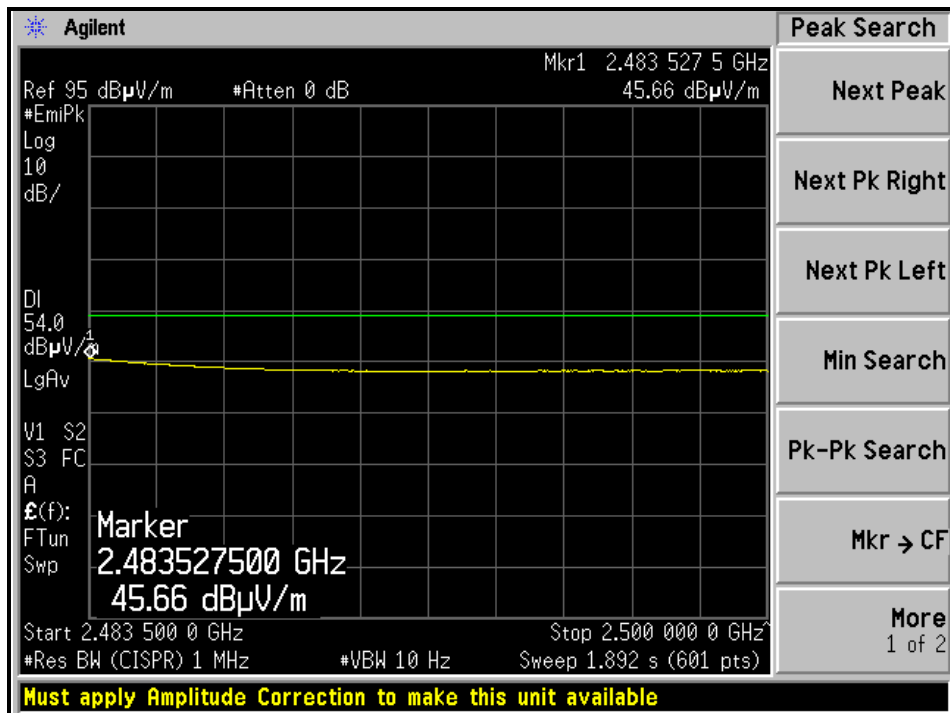
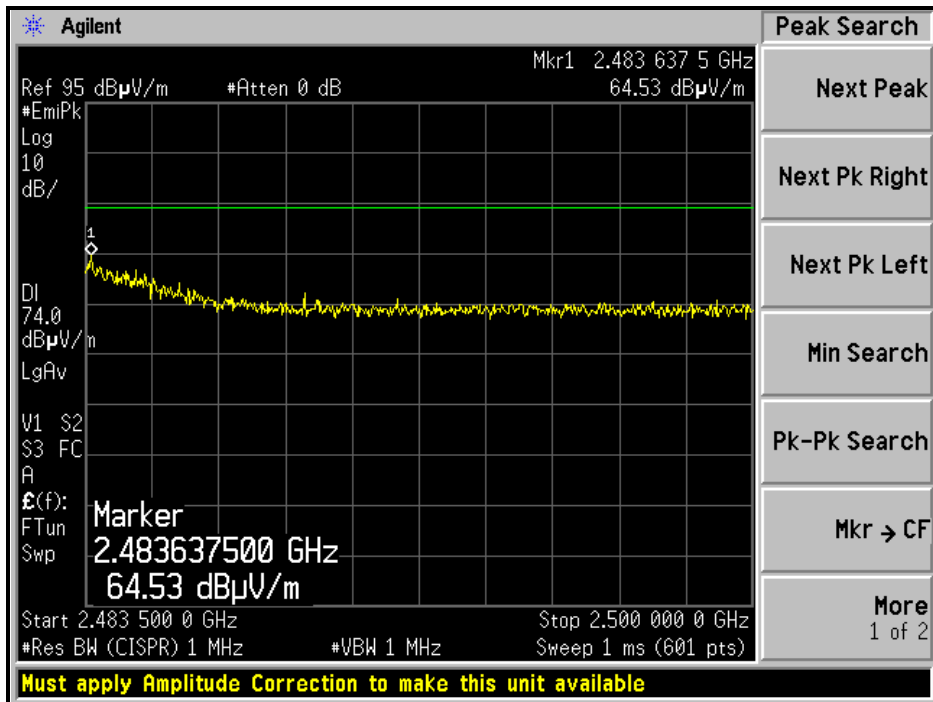



A D T

RESTRICTED BANDEDGE (802.11g MODE, CH13, VERTICAL)

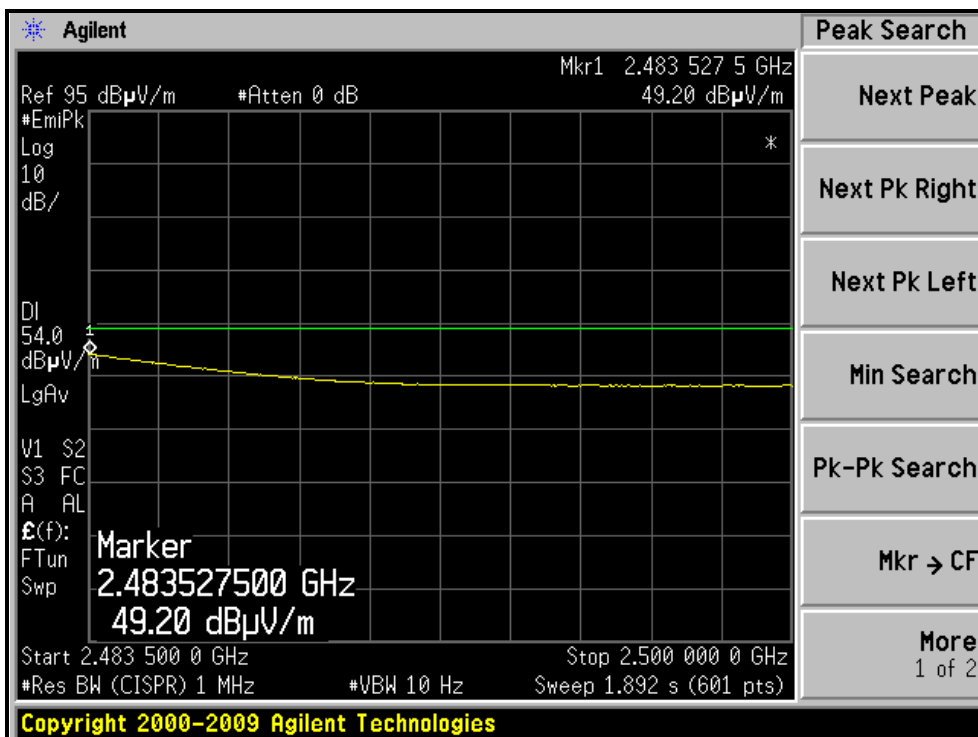
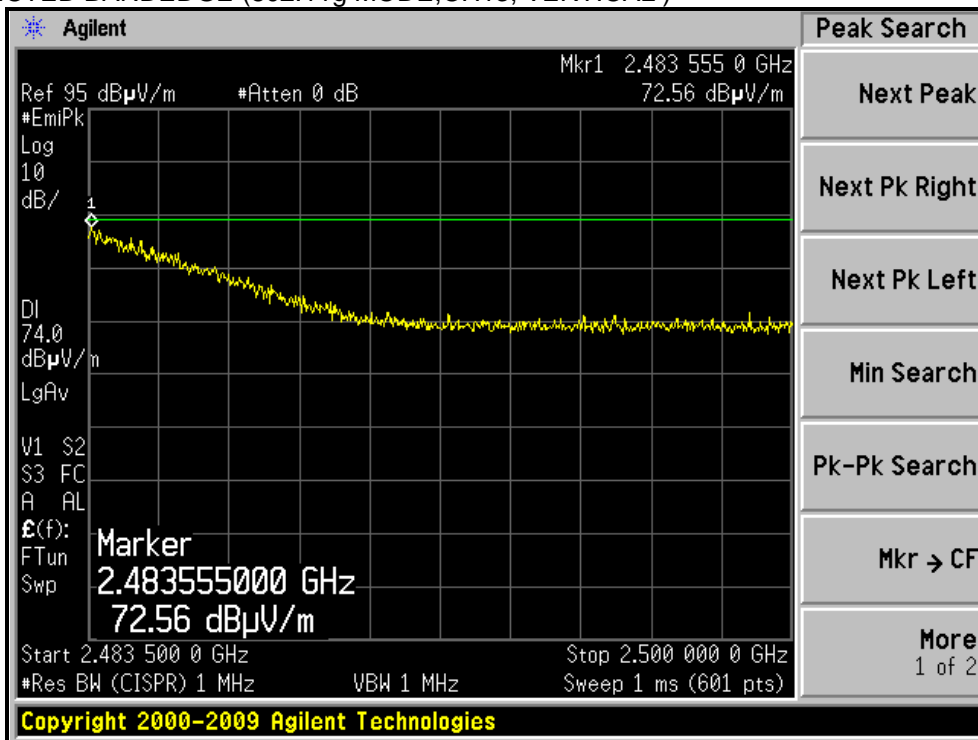



A D T

802.11n (20MHz) OFDM MODULATION

EUT TEST CONDITION		MEASUREMENT DETAIL	
CHANNEL	Channel 1	FREQUENCY RANGE	1 ~ 25GHz
INPUT POWER (SYSTEM)	120Vac, 60 Hz	DETECTOR FUNCTION	Peak (PK) Average (AV)
ENVIRONMENTAL CONDITIONS	20deg. C, 63%RH 1002 hPa	TESTED BY	Kent Liu

ANTENNA POLARITY & TEST DISTANCE: HORIZONTAL AT 3 M								
NO.	FREQ. (MHz)	EMISSION LEVEL (dBuV/m)	LIMIT (dBuV/m)	MARGIN (dB)	ANTENNA HEIGHT (m)	TABLE ANGLE (Degree)	RAW VALUE (dBuV)	CORRECTION FACTOR (dB/m)
1	2390.00	61.8 PK	74.0	-12.2	1.43 H	272	30.14	31.66
2	2390.00	46.1 AV	54.0	-7.9	1.43 H	272	14.44	31.66
3	*2412.00	100.7 PK			1.43 H	272	68.97	31.73
4	*2412.00	90.4 AV			1.43 H	272	58.67	31.73
5	4824.00	45.0 PK	74.0	-29.0	1.00 H	284	6.03	38.97
6	4824.00	33.6 AV	54.0	-20.4	1.00 H	284	-5.37	38.97
ANTENNA POLARITY & TEST DISTANCE: VERTICAL AT 3 M								
NO.	FREQ. (MHz)	EMISSION LEVEL (dBuV/m)	LIMIT (dBuV/m)	MARGIN (dB)	ANTENNA HEIGHT (m)	TABLE ANGLE (Degree)	RAW VALUE (dBuV)	CORRECTION FACTOR (dB/m)
1	2390.00	72.0 PK	74.0	-2.0	1.52 V	296	40.34	31.66
2	2390.00	52.8 AV	54.0	-1.2	1.52 V	296	21.14	31.66
3	*2412.00	109.4 PK			1.51 V	276	77.68	31.73
4	*2412.00	99.3 AV			1.51 V	276	67.57	31.73
5	4824.00	46.6 PK	74.0	-27.4	1.05 V	286	7.63	38.97
6	4824.00	34.9 AV	54.0	-19.1	1.05 V	286	-4.07	38.97

- REMARKS:**
1. Emission level (dBuV/m) = Raw Value (dBuV) + Correction Factor (dB/m).
 2. Correction Factor (dB/m) = Antenna Factor (dB/m) + Cable Factor (dB).
 3. The other emission levels were very low against the limit.
 4. Margin value = Emission level – Limit value.
 5. “ * “: Fundamental frequency.



A D T

EUT TEST CONDITION		MEASUREMENT DETAIL	
CHANNEL	Channel 6	FREQUENCY RANGE	1 ~ 25GHz
INPUT POWER (SYSTEM)	120Vac, 60 Hz	DETECTOR FUNCTION	Peak (PK) Average (AV)
ENVIRONMENTAL CONDITIONS	20deg. C, 63%RH 1002 hPa	TESTED BY	Kent Liu

ANTENNA POLARITY & TEST DISTANCE: HORIZONTAL AT 3 M								
NO.	FREQ. (MHz)	EMISSION LEVEL (dBuV/m)	LIMIT (dBuV/m)	MARGIN (dB)	ANTENNA HEIGHT (m)	TABLE ANGLE (Degree)	RAW VALUE (dBuV)	CORRECTION FACTOR (dB/m)
1	*2437.00	103.1 PK			1.43 H	272	71.29	31.81
2	*2437.00	92.8 AV			1.43 H	272	60.99	31.81
3	4874.00	45.2 PK	74.0	-28.8	1.00 H	284	6.06	39.14
4	4874.00	34.2 AV	54.0	-19.8	1.00 H	284	-4.94	39.14
5	7311.00	51.3 PK	74.0	-22.7	1.47 H	285	4.67	46.63
6	7311.00	39.8 AV	54.0	-14.2	1.47 H	285	-6.83	46.63
ANTENNA POLARITY & TEST DISTANCE: VERTICAL AT 3 M								
NO.	FREQ. (MHz)	EMISSION LEVEL (dBuV/m)	LIMIT (dBuV/m)	MARGIN (dB)	ANTENNA HEIGHT (m)	TABLE ANGLE (Degree)	RAW VALUE (dBuV)	CORRECTION FACTOR (dB/m)
1	2390.00	67.3 PK	74.0	-6.7	1.51 V	289	35.64	31.66
2	2390.00	46.2 AV	54.0	-7.8	1.51 V	289	14.54	31.66
3	*2437.00	112.7 PK			1.54 V	291	80.89	31.81
4	*2437.00	102.4 AV			1.54 V	291	70.59	31.81
5	2483.50	60.1 PK	74.0	-13.9	1.54 V	271	28.13	31.97
6	2483.50	45.4 AV	54.0	-8.6	1.54 V	271	13.43	31.97
7	4874.00	46.1 PK	74.0	-27.9	1.08 V	301	6.96	39.14
8	4874.00	34.8 AV	54.0	-19.2	1.08 V	301	-4.34	39.14
9	7311.00	52.8 PK	74.0	-21.2	1.45 V	326	6.17	46.63
10	7311.00	41.4 AV	54.0	-12.6	1.45 V	326	-5.23	46.63

- REMARKS:**
1. Emission level (dBuV/m) = Raw Value (dBuV) + Correction Factor (dB/m).
 2. Correction Factor (dB/m) = Antenna Factor (dB/m) + Cable Factor (dB).
 3. The other emission levels were very low against the limit.
 4. Margin value = Emission level – Limit value.
 5. “ * “: Fundamental frequency.



A D T

EUT TEST CONDITION		MEASUREMENT DETAIL	
CHANNEL	Channel 11	FREQUENCY RANGE	1 ~ 25GHz
INPUT POWER (SYSTEM)	120Vac, 60 Hz	DETECTOR FUNCTION	Peak (PK) Average (AV)
ENVIRONMENTAL CONDITIONS	20deg. C, 63%RH 1002 hPa	TESTED BY	Kent Liu

ANTENNA POLARITY & TEST DISTANCE: HORIZONTAL AT 3 M								
NO.	FREQ. (MHz)	EMISSION LEVEL (dBuV/m)	LIMIT (dBuV/m)	MARGIN (dB)	ANTENNA HEIGHT (m)	TABLE ANGLE (Degree)	RAW VALUE (dBuV)	CORRECTION FACTOR (dB/m)
1	*2462.00	100.1 PK			1.43 H	272	68.21	31.89
2	*2462.00	89.7 AV			1.43 H	272	57.81	31.89
3	2483.50	58.9 PK	74.0	-15.1	1.43 H	272	26.93	31.97
4	2483.50	44.7 AV	54.0	-9.3	1.43 H	272	12.73	31.97
5	4924.00	45.5 PK	74.0	-28.5	1.01 H	290	6.19	39.31
6	4924.00	34.0 AV	54.0	-20.0	1.01 H	290	-5.31	39.31
7	7386.00	50.8 PK	74.0	-23.2	1.43 H	300	4.20	46.60
8	7386.00	39.5 AV	54.0	-14.5	1.43 H	300	-7.10	46.60
ANTENNA POLARITY & TEST DISTANCE: VERTICAL AT 3 M								
NO.	FREQ. (MHz)	EMISSION LEVEL (dBuV/m)	LIMIT (dBuV/m)	MARGIN (dB)	ANTENNA HEIGHT (m)	TABLE ANGLE (Degree)	RAW VALUE (dBuV)	CORRECTION FACTOR (dB/m)
1	*2462.00	107.4 PK			1.44 V	295	75.51	31.89
2	*2462.00	97.6 AV			1.44 V	295	65.71	31.89
3	2483.50	72.3 PK	74.0	-1.7	1.45 V	302	40.33	31.97
4	2483.50	49.6 AV	54.0	-4.4	1.45 V	302	17.63	31.97
5	4924.00	46.7 PK	74.0	-27.3	1.11 V	302	7.39	39.31
6	4924.00	35.2 AV	54.0	-18.8	1.11 V	302	-4.11	39.31
7	7386.00	53.0 PK	74.0	-21.0	1.44 V	317	6.40	46.60
8	7386.00	41.3 AV	54.0	-12.7	1.44 V	317	-5.30	46.60

- REMARKS:**
1. Emission level (dBuV/m) = Raw Value (dBuV) + Correction Factor (dB/m).
 2. Correction Factor (dB/m) = Antenna Factor (dB/m) + Cable Factor (dB).
 3. The other emission levels were very low against the limit.
 4. Margin value = Emission level – Limit value.
 5. “ * “: Fundamental frequency.



A D T

EUT TEST CONDITION		MEASUREMENT DETAIL	
CHANNEL	Channel 12	FREQUENCY RANGE	1 ~ 25GHz
INPUT POWER (SYSTEM)	120Vac, 60 Hz	DETECTOR FUNCTION	Peak (PK) Average (AV)
ENVIRONMENTAL CONDITIONS	20deg. C, 63%RH 1002 hPa	TESTED BY	Kent Liu

ANTENNA POLARITY & TEST DISTANCE: HORIZONTAL AT 3 M

NO.	FREQ. (MHz)	EMISSION LEVEL (dBuV/m)	LIMIT (dBuV/m)	MARGIN (dB)	ANTENNA HEIGHT (m)	TABLE ANGLE (Degree)	RAW VALUE (dBuV)	CORRECTION FACTOR (dB/m)
1	*2467.00	97.3 PK			1.43 H	272	65.39	31.91
2	*2467.00	86.9 AV			1.43 H	272	54.99	31.91
3	2483.50	60.9 PK	74.0	-13.1	1.43 H	272	28.93	31.97
4	2483.50	46.5 AV	54.0	-7.5	1.43 H	272	14.53	31.97
5	4934.00	45.3 PK	74.0	-28.7	1.02 H	280	5.96	39.34
6	4934.00	34.0 AV	54.0	-20.0	1.02 H	280	-5.34	39.34
7	7401.00	51.4 PK	74.0	-22.6	1.40 H	295	4.81	46.59
8	7401.00	39.8 AV	54.0	-14.2	1.40 H	295	-6.79	46.59

ANTENNA POLARITY & TEST DISTANCE: VERTICAL AT 3 M

NO.	FREQ. (MHz)	EMISSION LEVEL (dBuV/m)	LIMIT (dBuV/m)	MARGIN (dB)	ANTENNA HEIGHT (m)	TABLE ANGLE (Degree)	RAW VALUE (dBuV)	CORRECTION FACTOR (dB/m)
1	*2467.00	103.4 PK			1.44 V	279	71.49	31.91
2	*2467.00	93.2 AV			1.44 V	279	61.29	31.91
3	2483.50	71.5 PK	74.0	-2.5	1.44 V	279	39.53	31.97
4	2483.50	52.6 AV	54.0	-1.4	1.44 V	279	20.63	31.97
5	4934.00	46.8 PK	74.0	-27.2	1.07 V	301	7.46	39.34
6	4934.00	35.4 AV	54.0	-18.6	1.07 V	301	-3.94	39.34
7	7401.00	53.2 PK	74.0	-20.8	1.44 V	311	6.61	46.59
8	7401.00	41.5 AV	54.0	-12.5	1.44 V	311	-5.09	46.59

- REMARKS:**
1. Emission level (dBuV/m) = Raw Value (dBuV) + Correction Factor (dB/m).
 2. Correction Factor (dB/m) = Antenna Factor (dB/m) + Cable Factor (dB).
 3. The other emission levels were very low against the limit.
 4. Margin value = Emission level – Limit value.
 5. “ * “: Fundamental frequency.



A D T

EUT TEST CONDITION		MEASUREMENT DETAIL	
CHANNEL	Channel 13	FREQUENCY RANGE	1 ~ 25GHz
INPUT POWER (SYSTEM)	120Vac, 60 Hz	DETECTOR FUNCTION	Peak (PK) Average (AV)
ENVIRONMENTAL CONDITIONS	20deg. C, 63%RH 1002 hPa	TESTED BY	Kent Liu

ANTENNA POLARITY & TEST DISTANCE: HORIZONTAL AT 3 M

NO.	FREQ. (MHz)	EMISSION LEVEL (dBuV/m)	LIMIT (dBuV/m)	MARGIN (dB)	ANTENNA HEIGHT (m)	TABLE ANGLE (Degree)	RAW VALUE (dBuV)	CORRECTION FACTOR (dB/m)
1	*2472.00	85.9 PK			1.43 H	272	53.97	31.93
2	*2472.00	75.0 AV			1.43 H	272	43.07	31.93
3	2483.50	64.3 PK	74.0	-9.7	1.43 H	272	32.33	31.97
4	2483.50	45.7 AV	54.0	-8.3	1.43 H	272	13.73	31.97
5	4944.00	46.0 PK	74.0	-28.0	1.06 H	303	6.63	39.37
6	4944.00	34.2 AV	54.0	-19.8	1.06 H	303	-5.17	39.37
7	7416.00	51.3 PK	74.0	-22.7	1.48 H	291	4.72	46.58
8	7416.00	39.7 AV	54.0	-14.3	1.48 H	291	-6.88	46.58

ANTENNA POLARITY & TEST DISTANCE: VERTICAL AT 3 M

NO.	FREQ. (MHz)	EMISSION LEVEL (dBuV/m)	LIMIT (dBuV/m)	MARGIN (dB)	ANTENNA HEIGHT (m)	TABLE ANGLE (Degree)	RAW VALUE (dBuV)	CORRECTION FACTOR (dB/m)
1	*2472.00	93.4 PK			1.45 V	279	61.47	31.93
2	*2472.00	83.1 AV			1.45 V	279	51.17	31.93
3	2483.50	72.6 PK	74.0	-1.4	1.45 V	279	40.63	31.97
4	2483.50	49.1 AV	54.0	-4.9	1.45 V	279	17.13	31.97
5	4944.00	46.6 PK	74.0	-27.4	1.13 V	313	7.23	39.37
6	4944.00	35.1 AV	54.0	-18.9	1.13 V	313	-4.27	39.37
7	7416.00	52.9 PK	74.0	-21.1	1.38 V	321	6.32	46.58
8	7416.00	41.4 AV	54.0	-12.6	1.38 V	321	-5.18	46.58

- REMARKS:**
1. Emission level (dBuV/m) = Raw Value (dBuV) + Correction Factor (dB/m).
 2. Correction Factor (dB/m) = Antenna Factor (dB/m) + Cable Factor (dB).
 3. The other emission levels were very low against the limit.
 4. Margin value = Emission level – Limit value.
 5. “ * “: Fundamental frequency.



A D T

RESTRICTED BANDEDGE (802.11n (20MHz) MODE,CH1, HORIZONTAL)

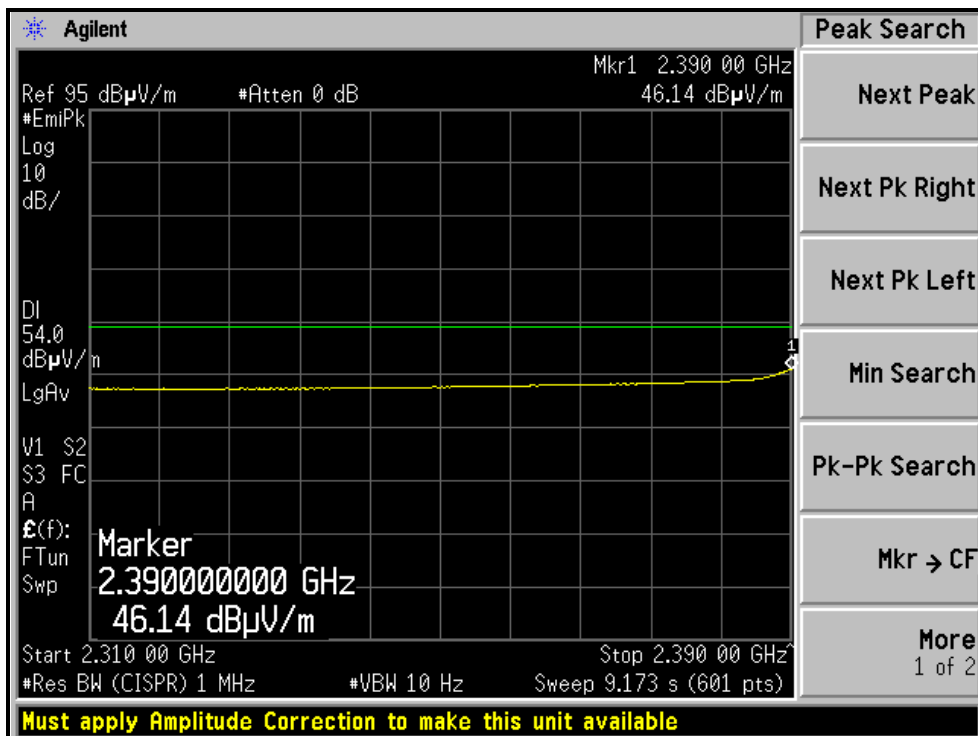
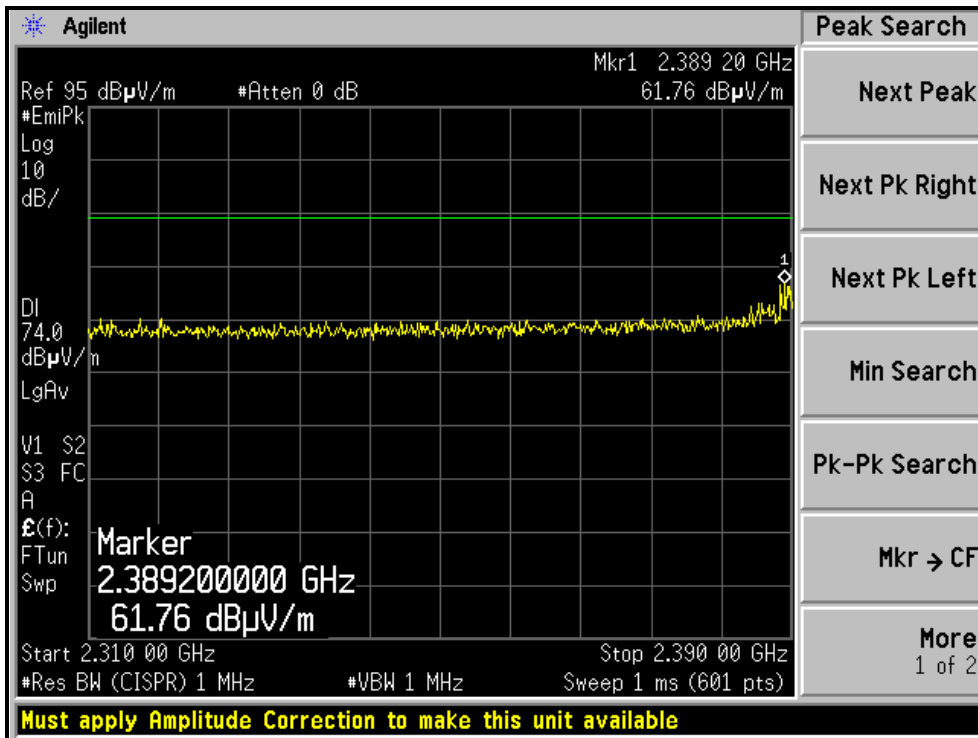



A D T

RESTRICTED BANDEDGE (802.11n (20MHz) MODE,CH1, VERTICAL)

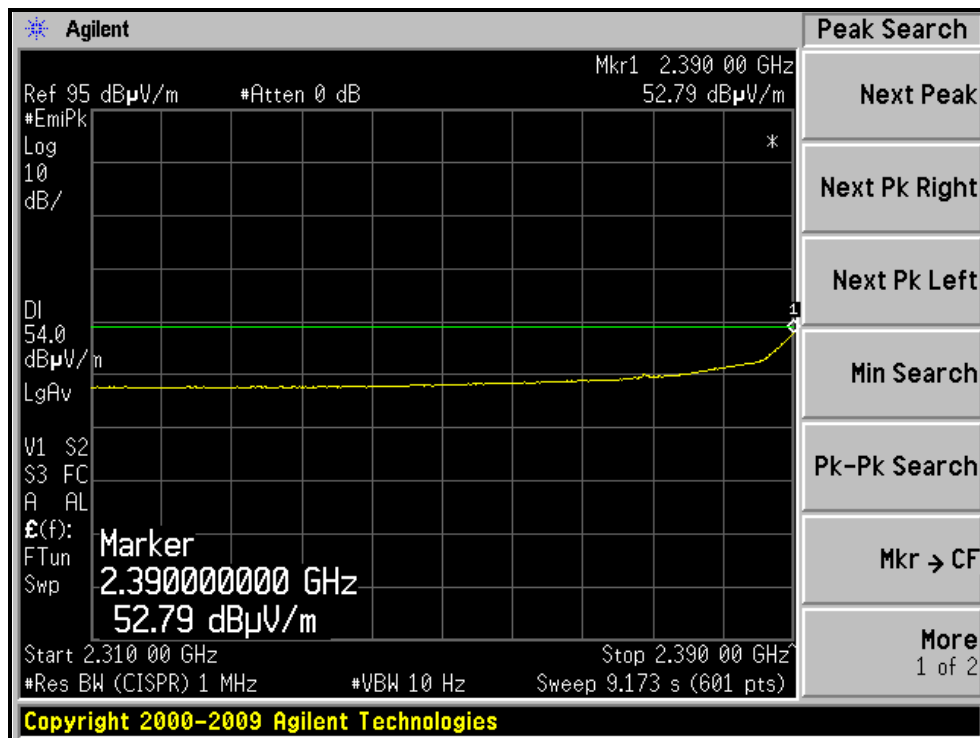
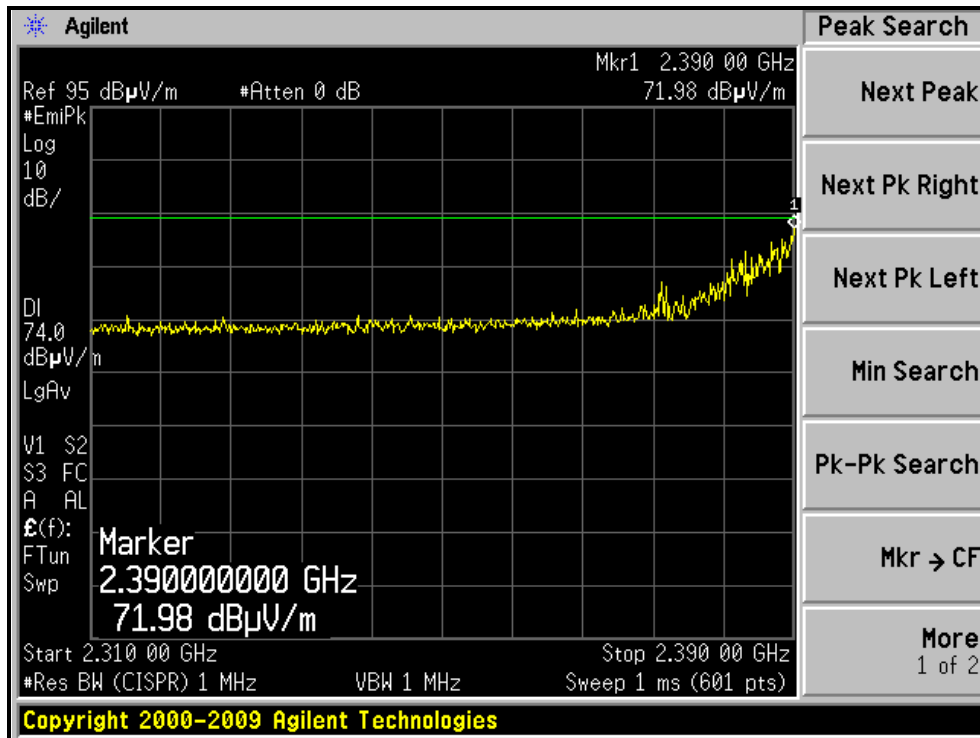



A D T

RESTRICTED BANDEDGE (802.11n (20MHz) MODE,CH11, HORIZONTAL)

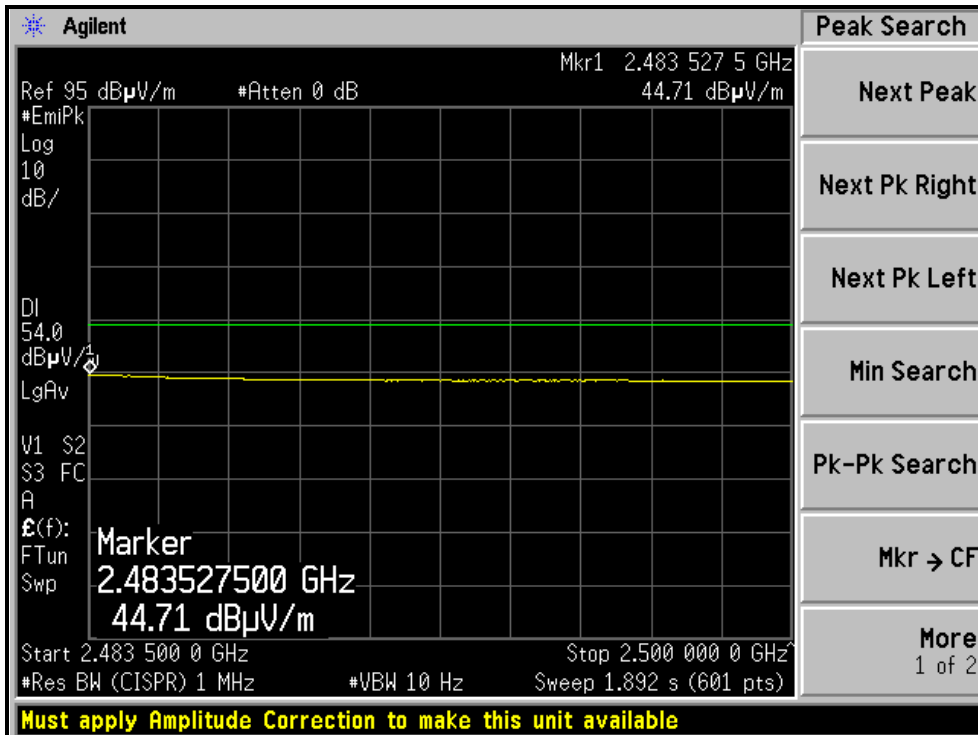
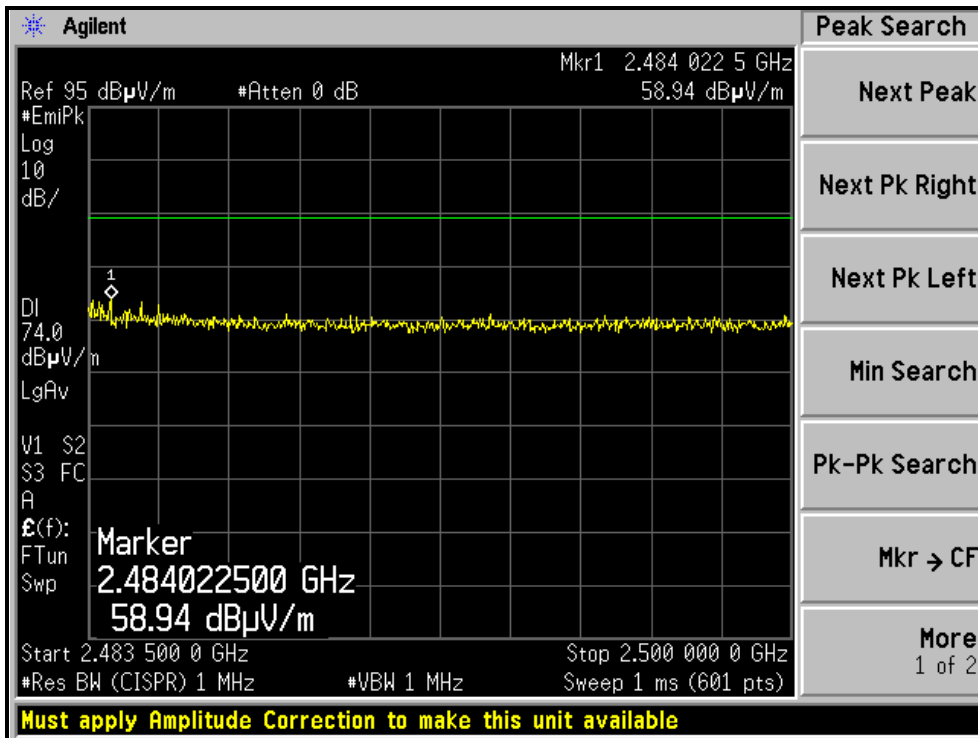



A D T

RESTRICTED BANDEDGE (802.11n (20MHz) MODE,CH11, VERTICAL)

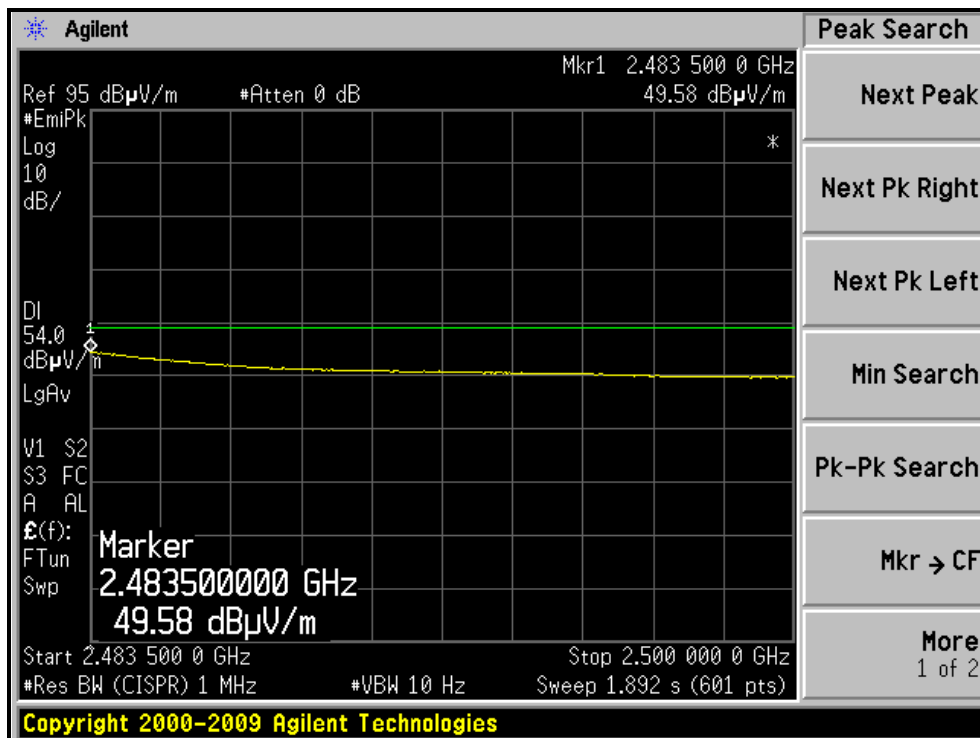
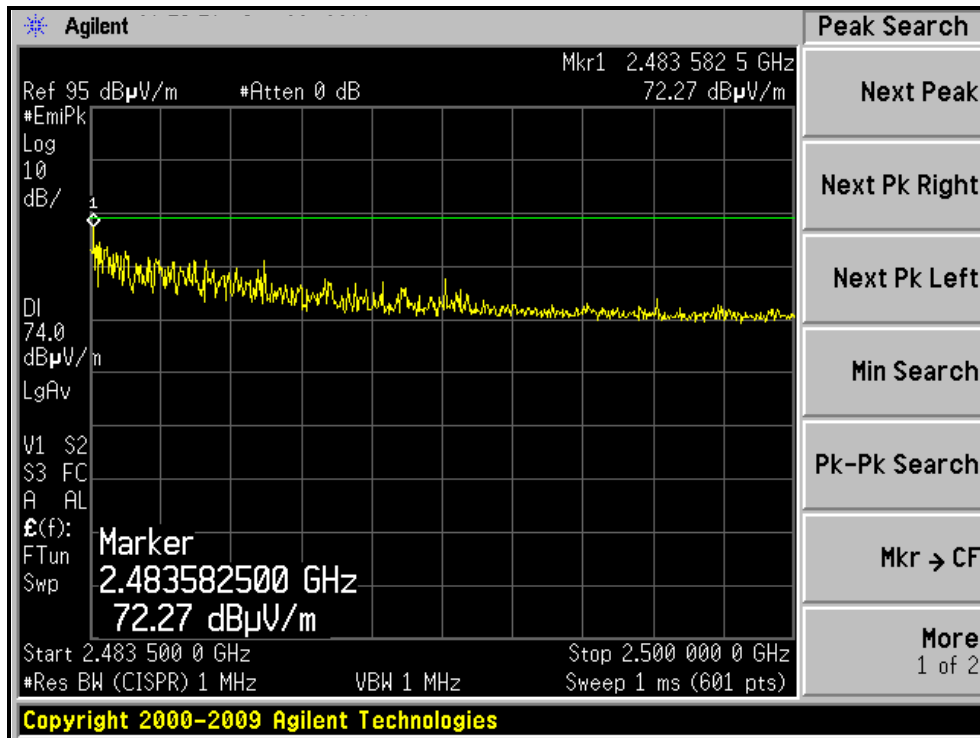

RESTRICTED BANDEDGE (802.11n (20MHz) MODE,CH12, HORIZONTAL)

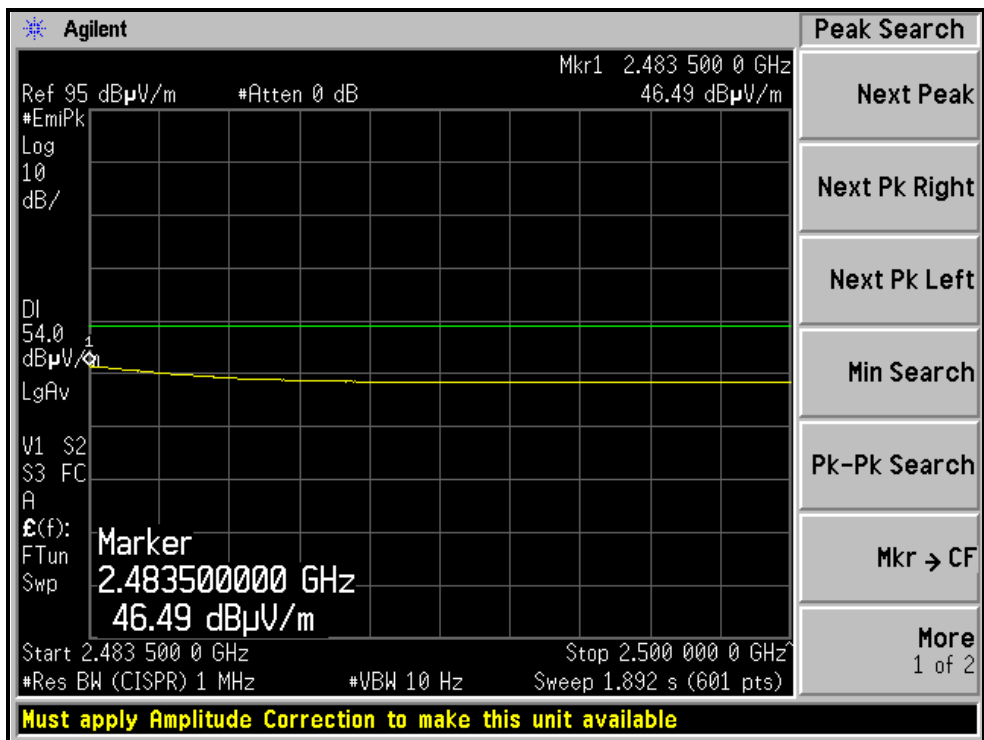
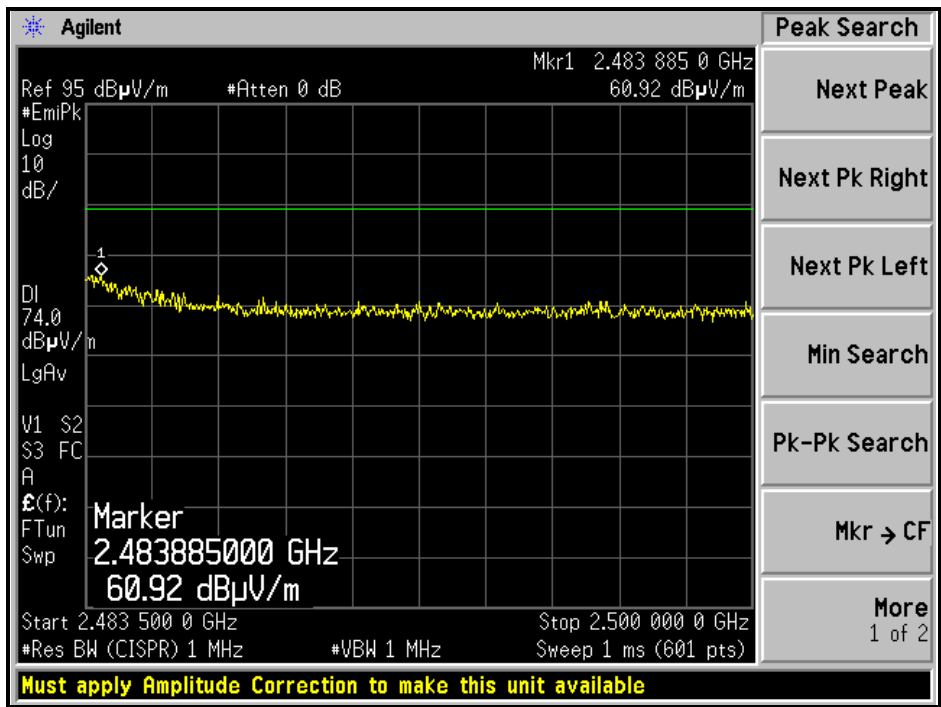



A D T

RESTRICTED BANDEDGE (802.11n (20MHz) MODE,CH12, VERTICAL)

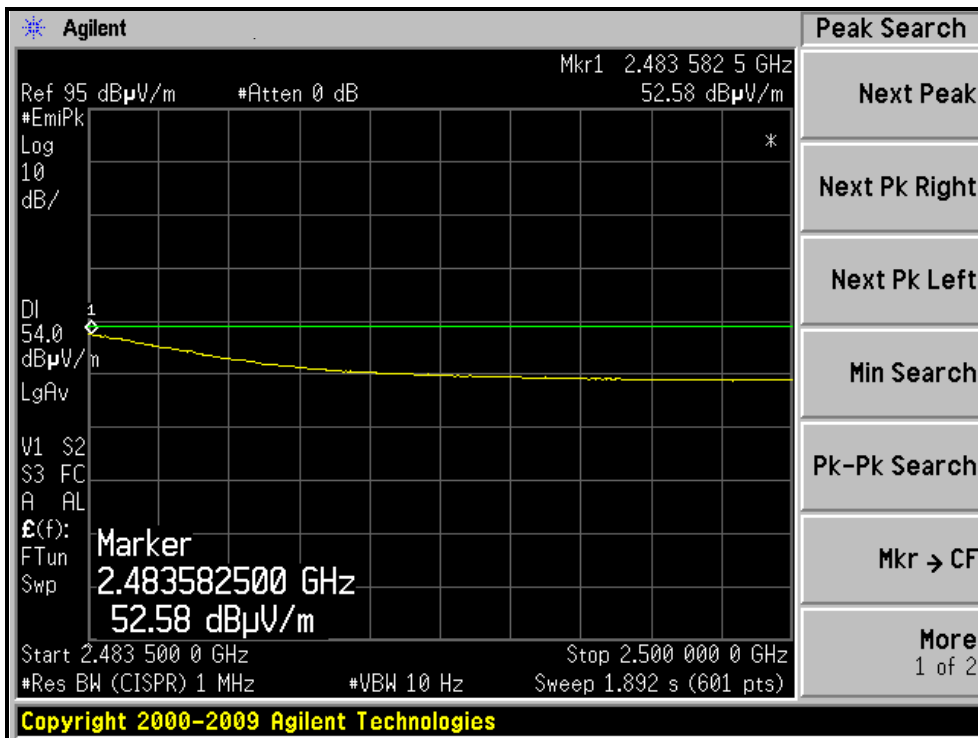
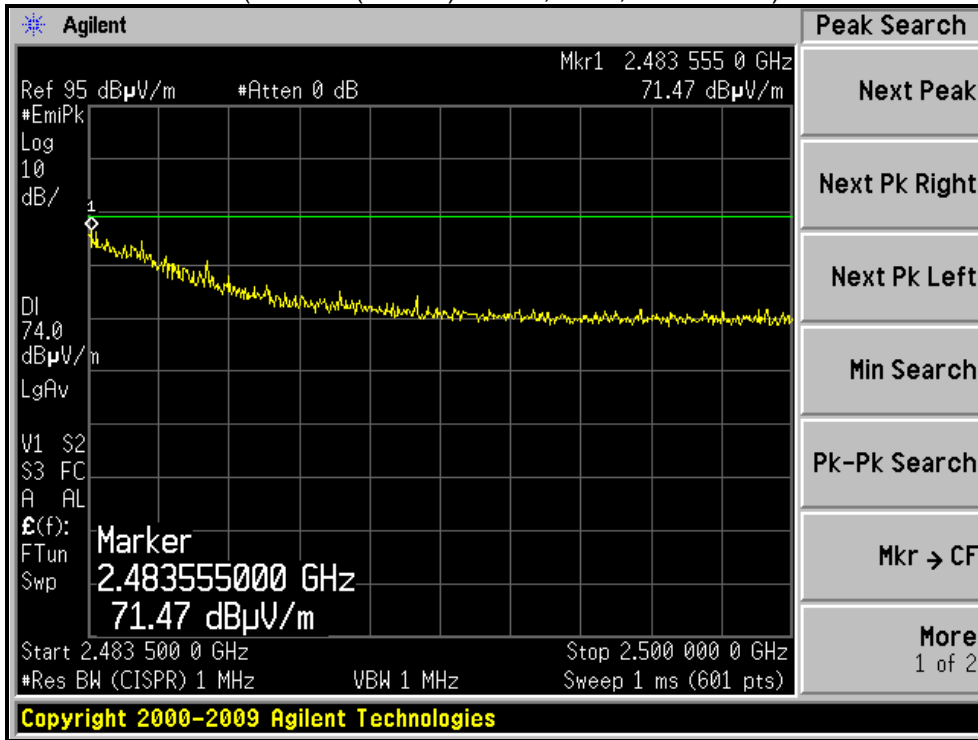



A D T

RESTRICTED BANDEDGE (802.11n (20MHz) MODE,CH13, HORIZONTAL)

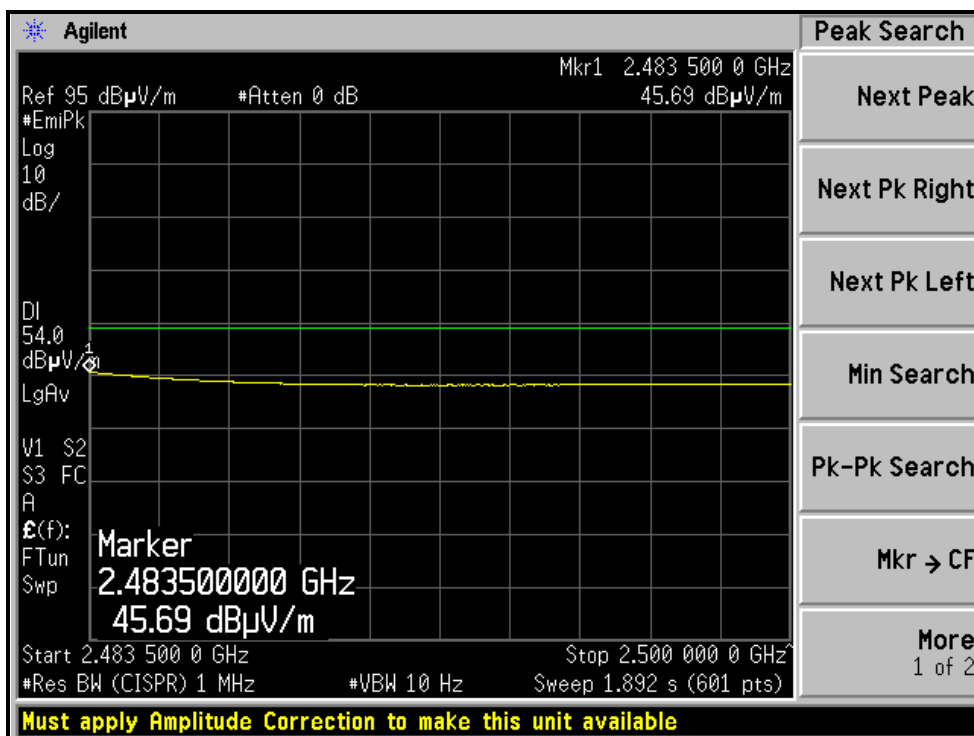
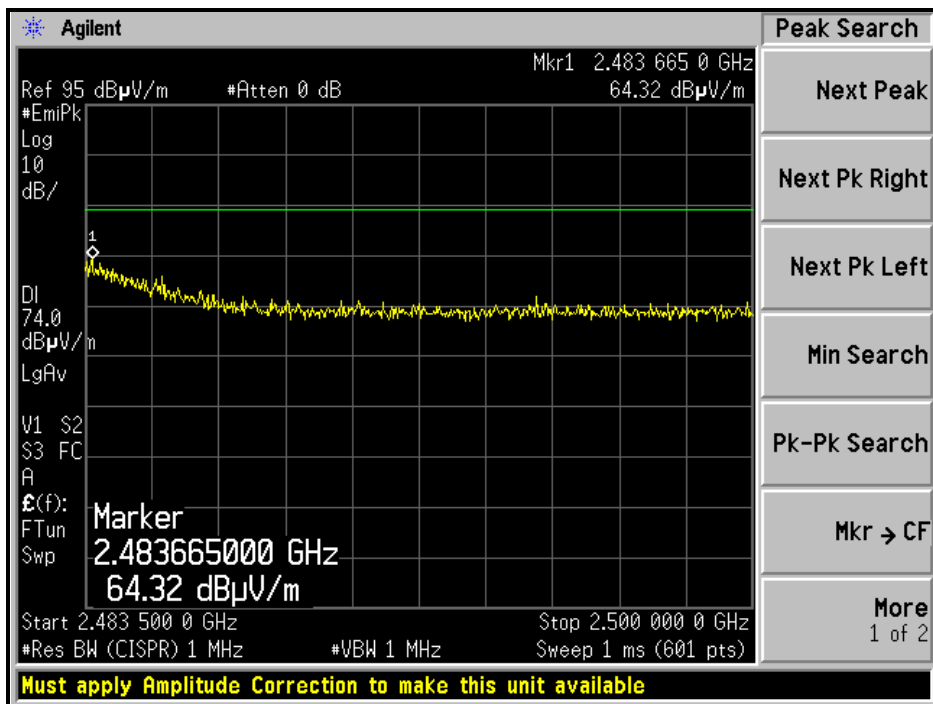



A D T

RESTRICTED BANDEDGE (802.11n (20MHz) MODE,CH13, VERTICAL)

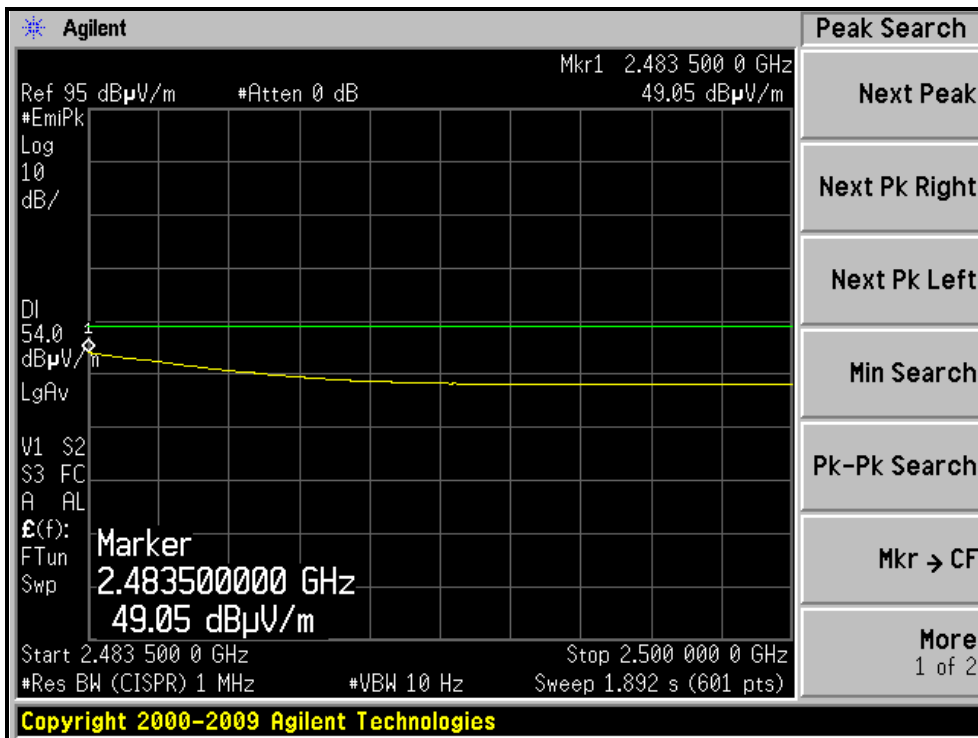
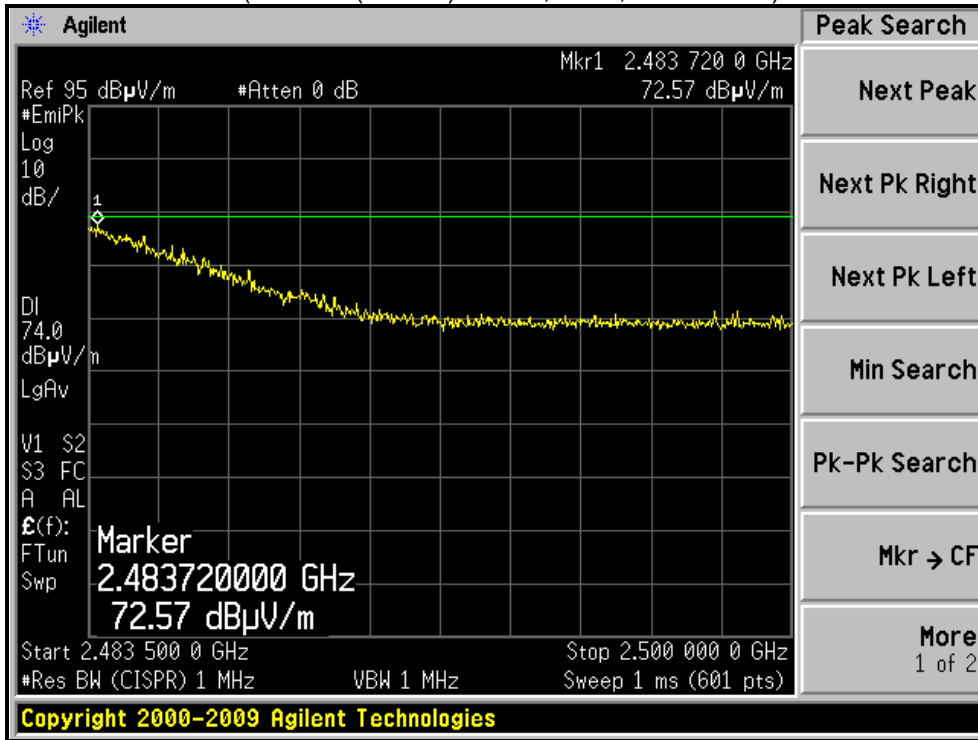

4.3 6dB BANDWIDTH MEASUREMENT

4.3.1 LIMITS OF 6dB BANDWIDTH MEASUREMENT

The minimum of 6dB Bandwidth Measurement is 0.5 MHz.

4.3.2 TEST INSTRUMENTS

DESCRIPTION & MANUFACTURER	MODEL NO.	SERIAL NO.	CALIBRATED DATE	CALIBRATED UNTIL
SPECTRUM ANALYZER R&S	FSP 40	100060	May 11, 2011	May 10, 2012

NOTE:

1. The calibration interval of the above test instruments is 12 months and the calibrations are traceable to NML/ROC and NIST/USA.

4.3.3 TEST PROCEDURE

The transmitter output was connected to the spectrum analyzer through an attenuator. The bandwidth of the fundamental frequency was measured by spectrum analyzer with 100kHz RBW and 300kHz VBW. The 6dB bandwidth is defined as the total spectrum the power of which is higher than peak power minus 6dB.

4.3.4 DEVIATION FROM TEST STANDARD

No deviation

4.3.5 TEST SETUP

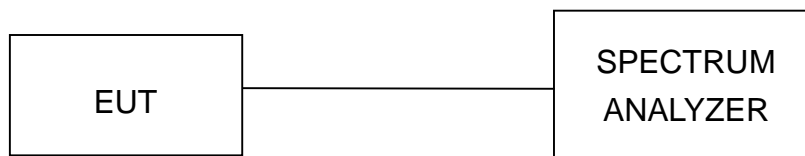

4.3.6 EUT OPERATING CONDITIONS

The software provided by client to enable the EUT under transmission condition continuously at lowest, middle and highest channel frequencies individually.



A D T

4.3.7 TEST RESULTS

802.11b DSSS MODULATION:

CHANNEL	CHANNEL FREQUENCY (MHz)	6dB BANDWIDTH (MHz)	MINIMUM LIMIT (MHz)	PASS / FAIL
1	2412	10.24	0.5	PASS
6	2437	9.88	0.5	PASS
11	2462	10.22	0.5	PASS
12	2467	9.93	0.5	PASS
13	2472	9.86	0.5	PASS

CH1

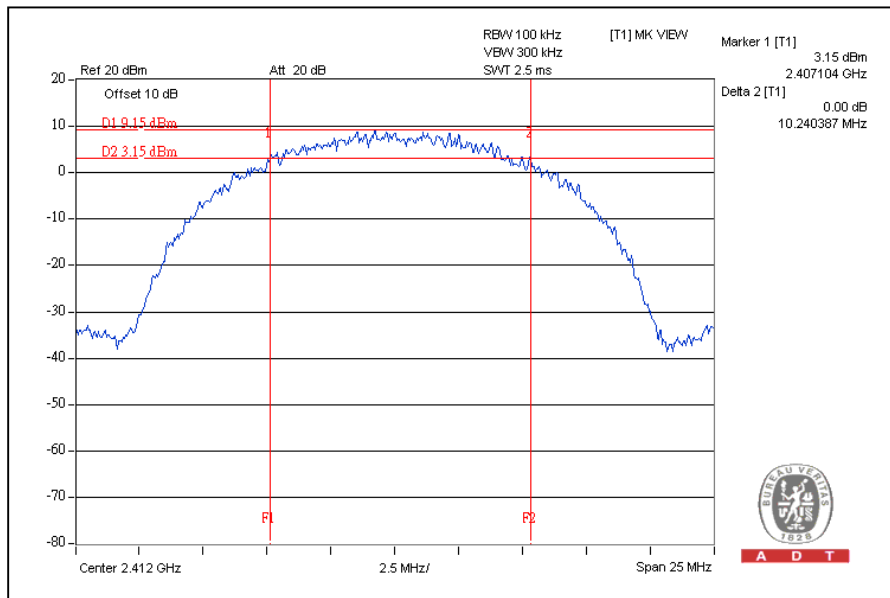



A D T

CH6

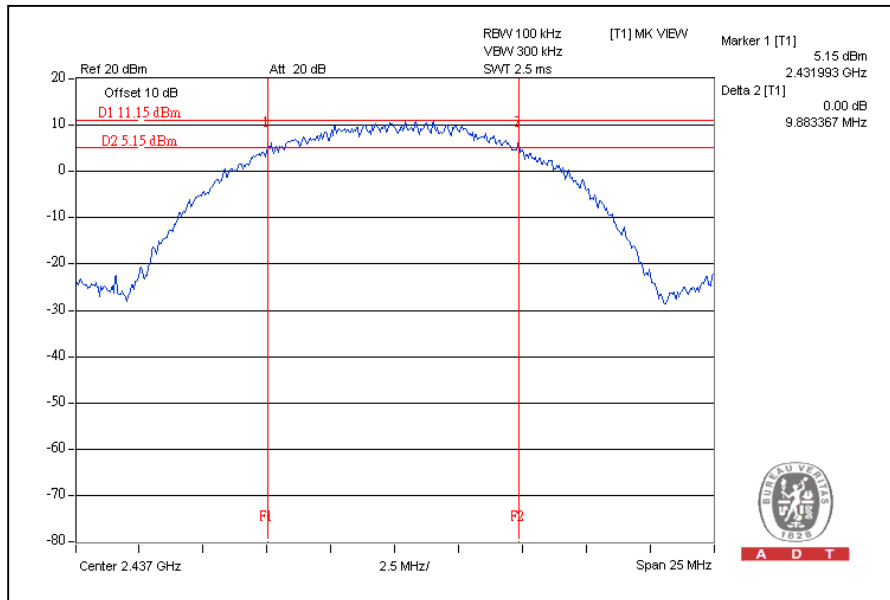

CH11

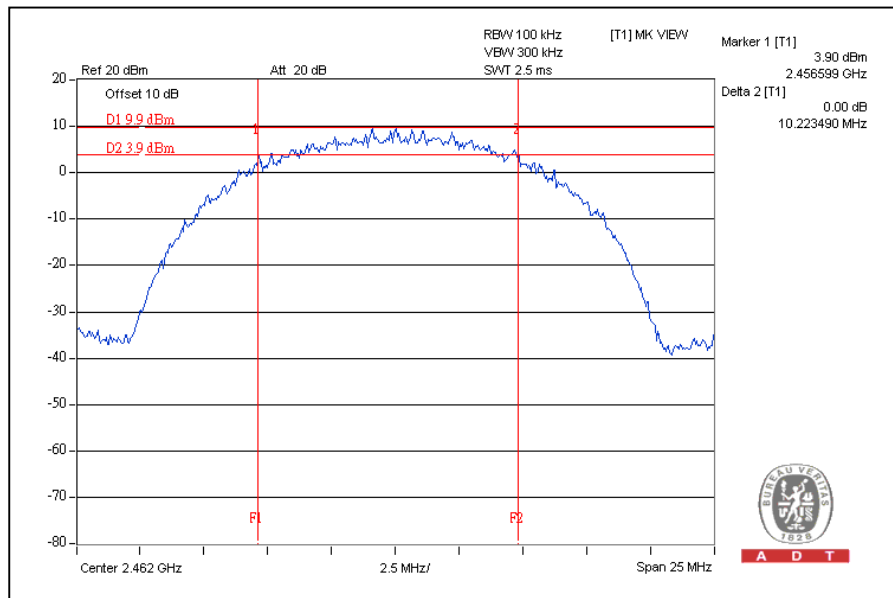



A D T

CH12

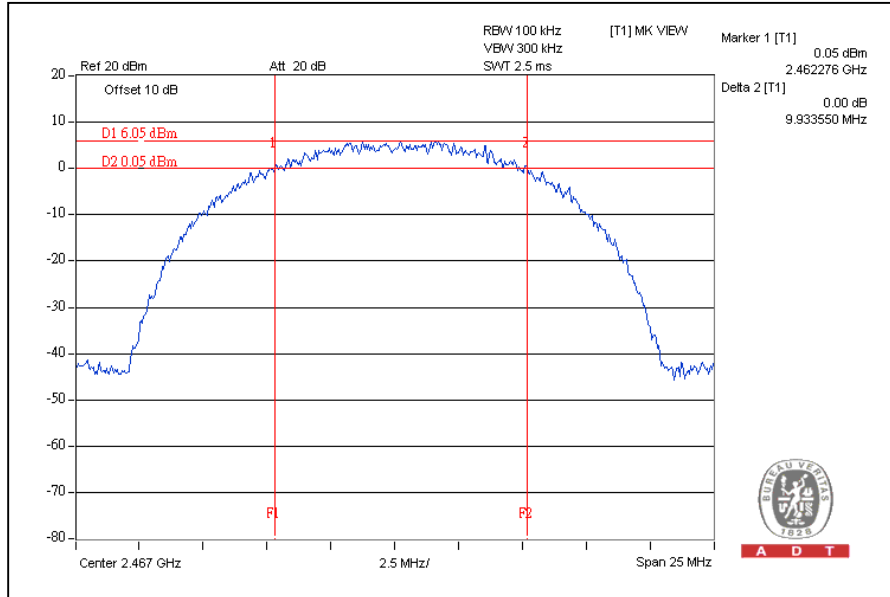

CH13

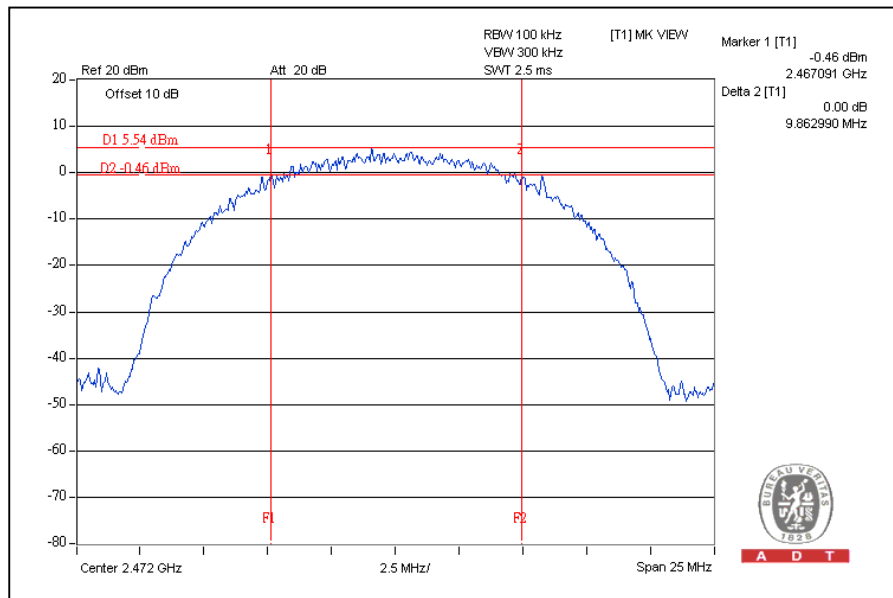



A D T

802.11g OFDM MODULATION:

CHANNEL	CHANNEL FREQUENCY (MHz)	6dB BANDWIDTH (MHz)	MINIMUM LIMIT (MHz)	PASS / FAIL
1	2412	15.72	0.5	PASS
6	2437	15.12	0.5	PASS
11	2462	16.37	0.5	PASS
12	2467	15.16	0.5	PASS
13	2472	16.37	0.5	PASS

CH1

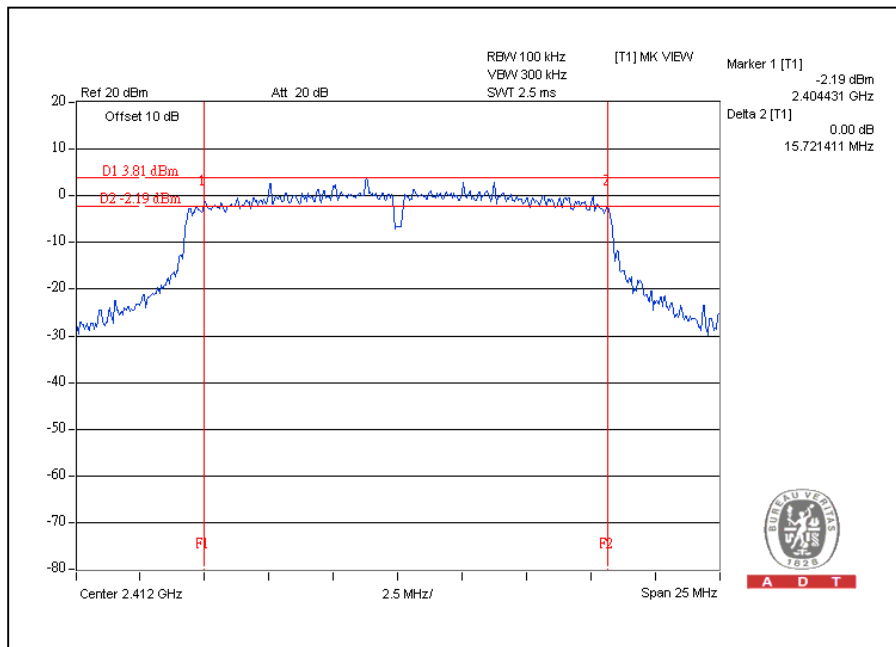



A D T

CH6

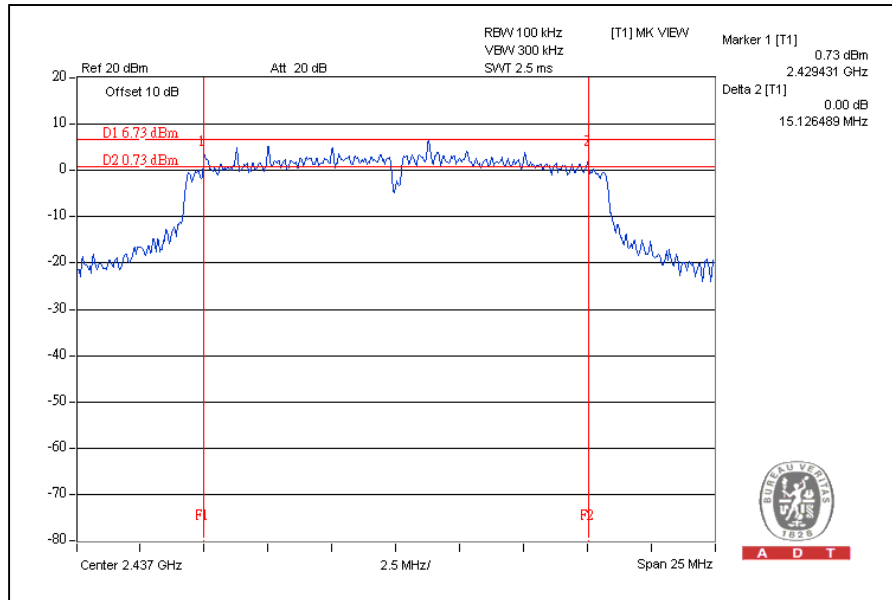

CH11

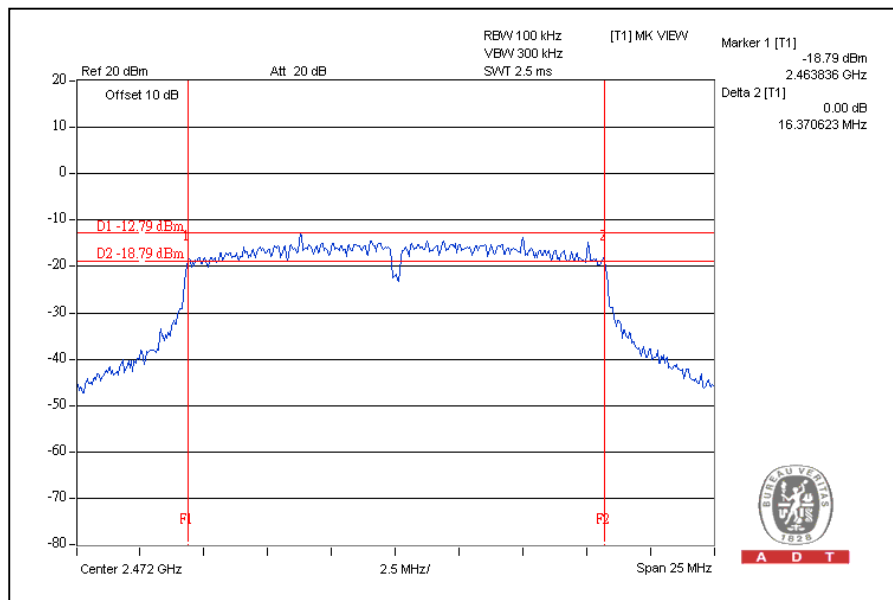



A D T

CH12

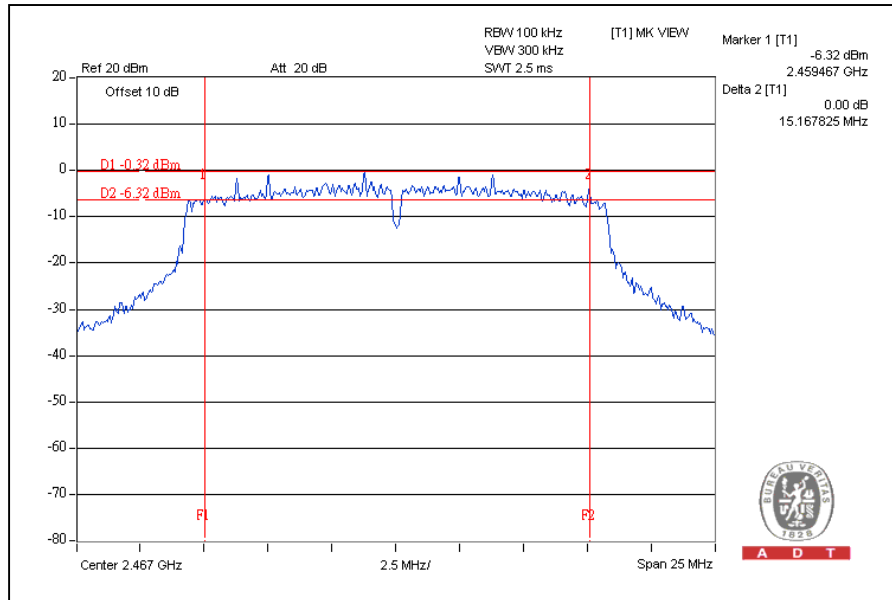

CH13

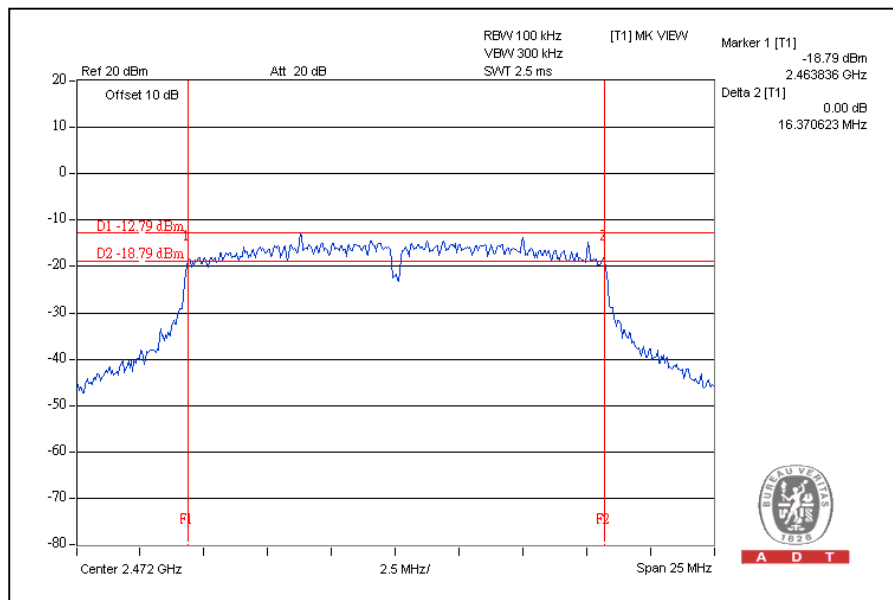



A D T

802.11n(20MHz) OFDM MODULATION:

CHANNEL	CHANNEL FREQUENCY (MHz)	6dB BANDWIDTH (MHz)	MINIMUM LIMIT (MHz)	PASS / FAIL
1	2412	14.46	0.5	PASS
6	2437	16.35	0.5	PASS
11	2462	15.73	0.5	PASS
12	2467	15.06	0.5	PASS
13	2472	15.91	0.5	PASS

CH1





A D T

CH6

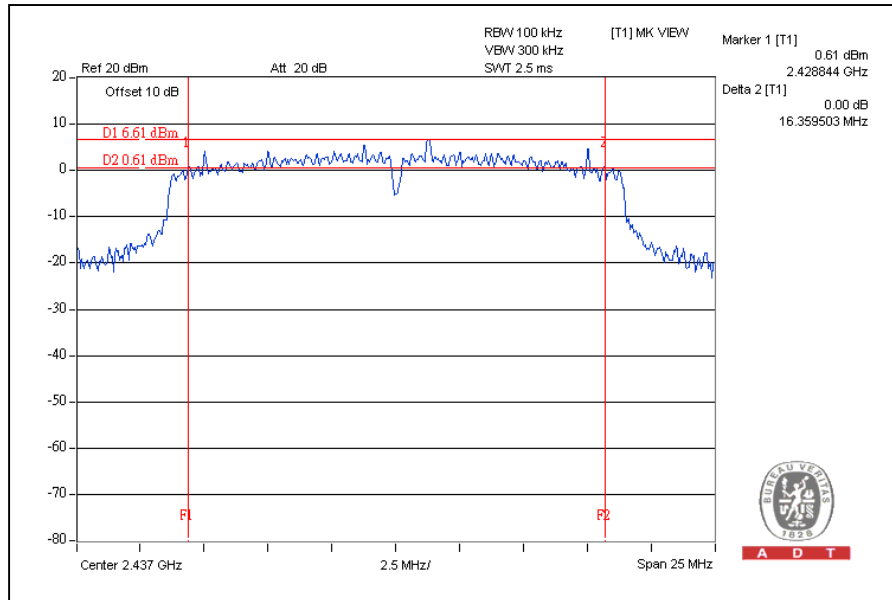

CH11

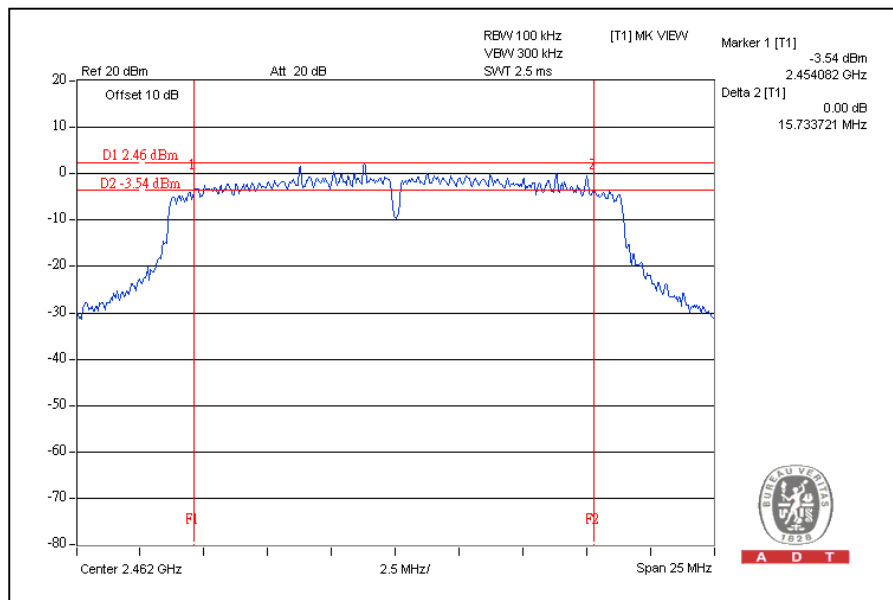



A D T

CH12

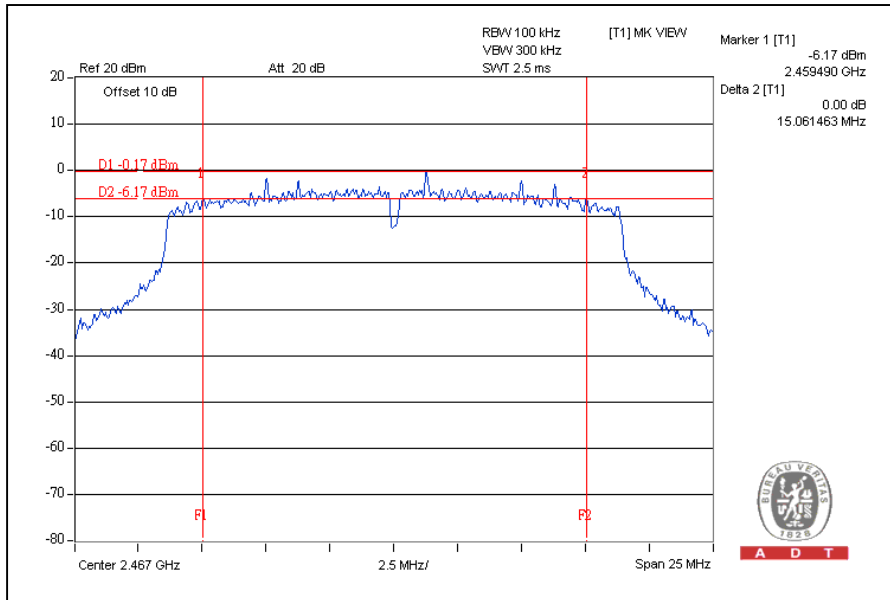

CH13

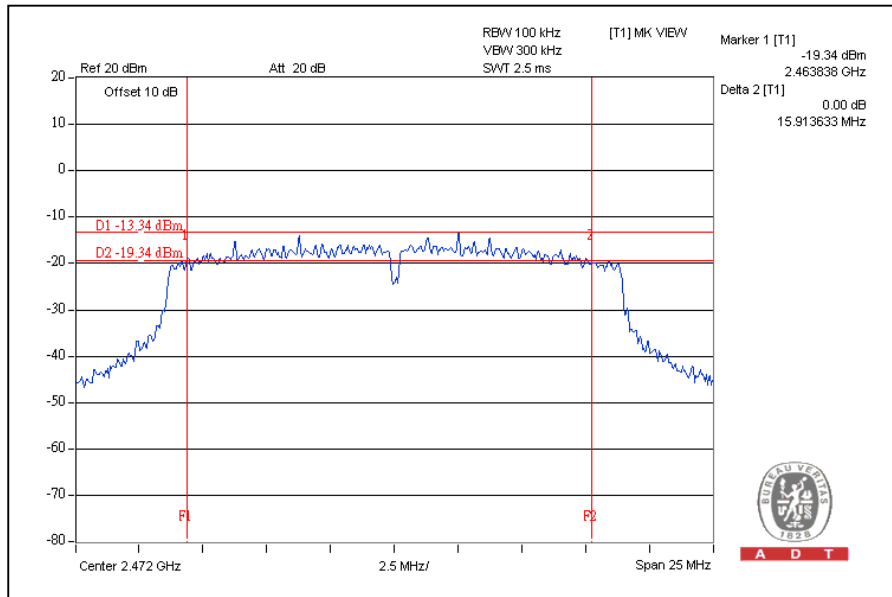

4.4 MAXIMUM PEAK OUTPUT POWER

4.4.1 LIMITS OF MAXIMUM PEAK OUTPUT POWER MEASUREMENT

The Maximum Peak Output Power Measurement is 30dBm.

4.4.2 INSTRUMENTS

Test date: May 09, 2011

DESCRIPTION & MANUFACTURER	MODEL NO.	SERIAL NO.	CALIBRATED DATE	CALIBRATED UNTIL
Anritsu Power Meter	ML2495A	0824006	May 04, 2011	May 03, 2012
Pulse Power Sensor	MA2411B	0738172	May 03, 2011	May 02, 2012

NOTE:

The calibration interval of the above test instruments is 12 months and the calibrations are traceable to NML/ROC and NIST/USA.

4.4.3 TEST PROCEDURES

1. The transmitter output was connected to the power meter through an attenuator; the bandwidth of the fundamental frequency was measured with the power meter.
2. Record the power level.

4.4.4 DEVIATION FROM TEST STANDARD

No deviation

4.4.5 TEST SETUP

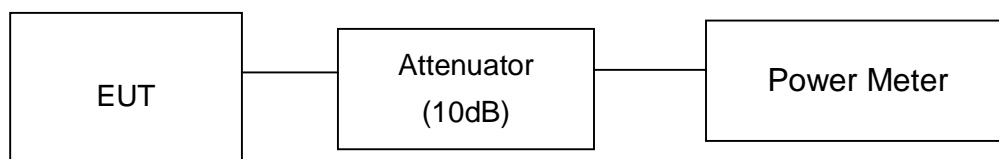

4.4.6 EUT OPERATING CONDITIONS

Same as Item 4.3.6



A D T

4.4.7 TEST RESULTS(MODE A)

802.11b DSSS MODULATION:

CHANNEL	CHANNEL FREQUENCY (MHz)	PEAK POWER (mW)	PEAK POWER (dBm)	PEAK POWER LIMIT (dBm)	PASS / FAIL
1	2412	134.9	21.3	30	PASS
6	2437	245.5	23.9	30	PASS
11	2462	151.4	21.8	30	PASS
12	2467	60.3	17.8	30	PASS
13	2472	45.7	16.6	30	PASS

802.11g OFDM MODULATION:

CHANNEL	CHANNEL FREQUENCY (MHz)	PEAK POWER (mW)	PEAK POWER (dBm)	PEAK POWER LIMIT (dBm)	PASS / FAIL
1	2412	208.9	23.2	30	PASS
6	2437	234.4	23.7	30	PASS
11	2462	169.8	22.3	30	PASS
12	2467	102.3	20.1	30	PASS
13	2472	6.6	8.2	30	PASS

Note:

1. The channels 12 and 13 have been reduced power to meet band-edge and other requirement.
2. The power was fixed by firmware and end user cannot change or increase these power level thus possibly causing EMC failures.



802.11n(20MHz) OFDM MODULATION:

CHANNEL	CHANNEL FREQUENCY (MHz)	PEAK POWER (mW)	PEAK POWER (dBm)	PEAK POWER LIMIT (dBm)	PASS / FAIL
1	2412	204.2	23.1	30	PASS
6	2437	234.4	23.7	30	PASS
11	2462	162.2	22.1	30	PASS
12	2467	85.1	19.3	30	PASS
13	2472	5.8	7.6	30	PASS

Note:

1. The channels 12 and 13 have been reduced power to meet band-edge and other requirement.
2. The power was fixed by firmware and end user cannot change or increase these power level thus possibly causing EMC failures.

4.4.8 TEST RESULTS(MODE B)

802.11b DSSS MODULATION:

CHANNEL	CHANNEL FREQUENCY (MHz)	PEAK POWER (mW)	PEAK POWER (dBm)	PEAK POWER LIMIT (dBm)	PASS / FAIL
1	2412	147.9	21.7	30	PASS
6	2437	269.2	24.3	30	PASS
11	2462	166.0	22.2	30	PASS
12	2467	66.1	18.2	30	PASS
13	2472	50.1	17.0	30	PASS

802.11g OFDM MODULATION:

CHANNEL	CHANNEL FREQUENCY (MHz)	PEAK POWER (mW)	PEAK POWER (dBm)	PEAK POWER LIMIT (dBm)	PASS / FAIL
1	2412	229.1	23.6	30	PASS
6	2437	257.0	24.1	30	PASS
11	2462	186.2	22.7	30	PASS
12	2467	112.2	20.5	30	PASS
13	2472	7.2	8.6	30	PASS

Note:

1. The channels 12 and 13 have been reduced power to meet band-edge and other requirement.
2. The power was fixed by firmware and end user cannot change or increase these power level thus possibly causing EMC failures.



A D T

802.11n(20MHz) OFDM MODULATION:

CHANNEL	CHANNEL FREQUENCY (MHz)	PEAK POWER (mW)	PEAK POWER (dBm)	PEAK POWER LIMIT (dBm)	PASS / FAIL
1	2412	223.9	23.5	30	PASS
6	2437	257.0	24.1	30	PASS
11	2462	177.8	22.5	30	PASS
12	2467	93.3	19.7	30	PASS
13	2472	6.3	8.0	30	PASS

Note:

1. The channels 12 and 13 have been reduced power to meet band-edge and other requirement.
2. The power was fixed by firmware and end user cannot change or increase these power level thus possibly causing EMC failures.

4.5 POWER SPECTRAL DENSITY MEASUREMENT

4.5.1 LIMITS OF POWER SPECTRAL DENSITY MEASUREMENT

The Maximum of Power Spectral Density Measurement is 8dBm.

4.5.2 TEST INSTRUMENTS

Test date: May 09, 2011

DESCRIPTION & MANUFACTURER	MODEL NO.	SERIAL NO.	CALIBRATED DATE	CALIBRATED UNTIL
SPECTRUM ANALYZER R&S	FSP 40	100060	May 12, 2010	May 11, 2011

NOTE:

1. The calibration interval of the above test instruments is 12 months and the calibrations are traceable to NML/ROC and NIST/USA.

4.5.3 TEST PROCEDURE

The transmitter output was connected to the spectrum analyzer through an attenuator, the bandwidth of the fundamental frequency was measured with the spectrum analyzer using 3kHz RBW and 30kHz VBW, set sweep time = span/3kHz. The power spectral density was measured and recorded.

The sweep time is allowed to be longer than span/3kHz for a full response of the mixer in the spectrum analyzer.

4.5.4 DEVIATION FROM TEST STANDARD

No deviation

4.5.5 TEST SETUP

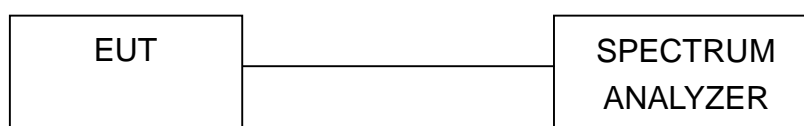



4.5.6 EUT OPERATING CONDITION

Same as Item 4.3.6



A D T

4.5.7 TEST RESULTS(MODE A)

802.11b DSSS MODULATION:

CHANNEL	CHANNEL FREQUENCY (MHz)	RF POWER LEVEL IN 3kHz BW (dBm)	MAXIMUM LIMIT (dBm)	PASS / FAIL
1	2412	-4.9	8	PASS
6	2437	-2.4	8	PASS
11	2462	-4.8	8	PASS
12	2467	-8.0	8	PASS
13	2472	-9.3	8	PASS

CH1

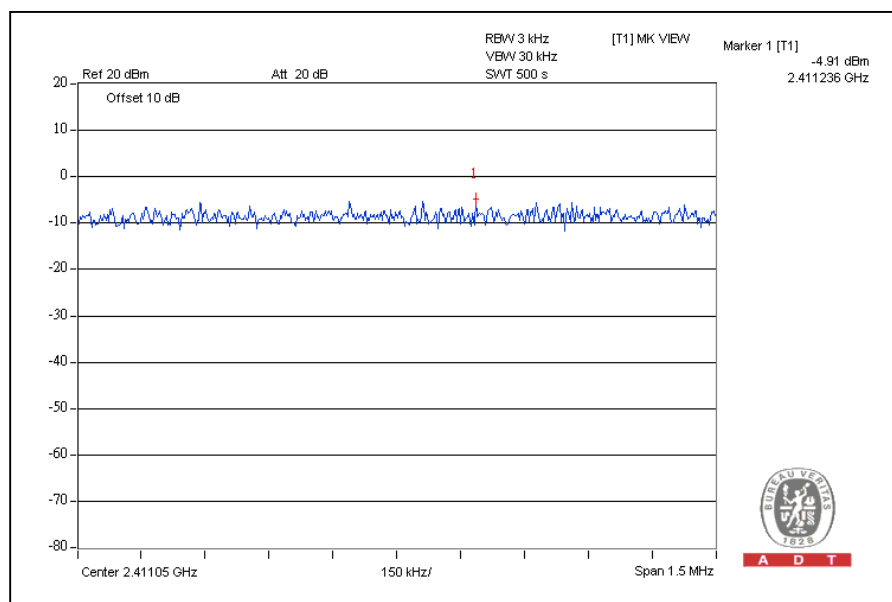



A D T

CH6

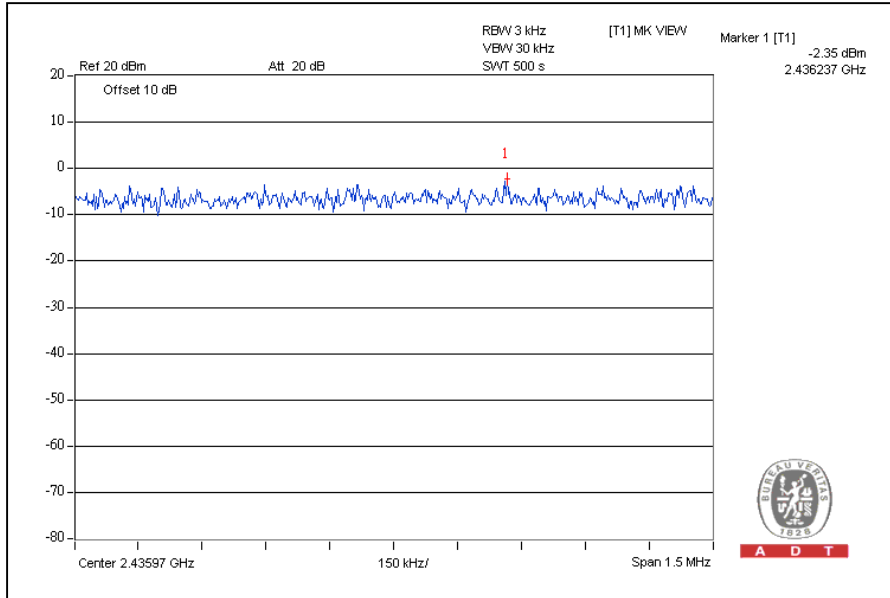

CH11

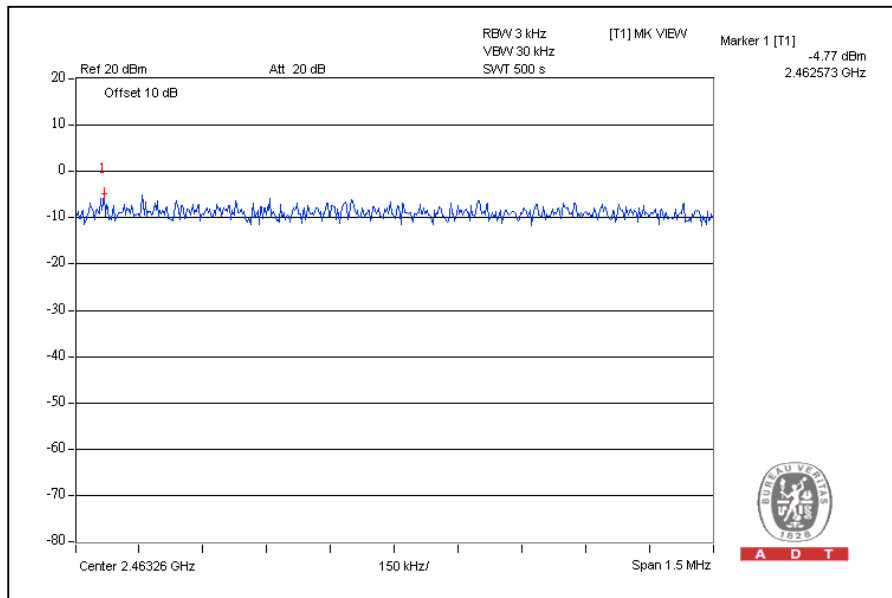



A D T

CH12

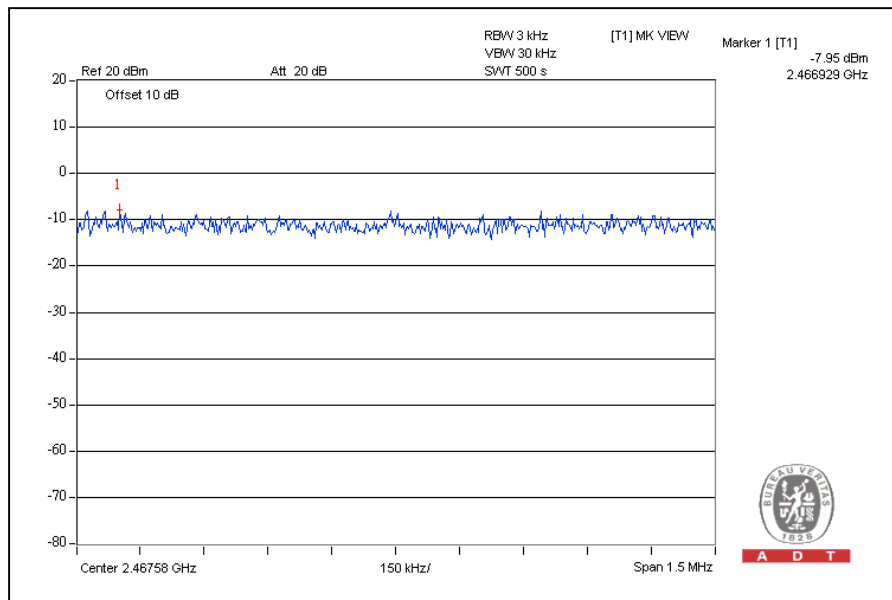

CH13

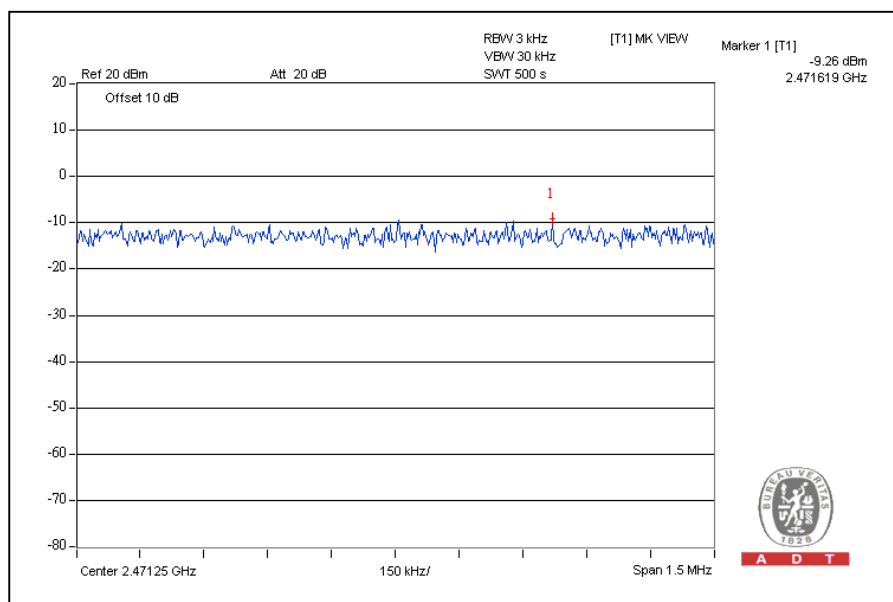



A D T

CH6

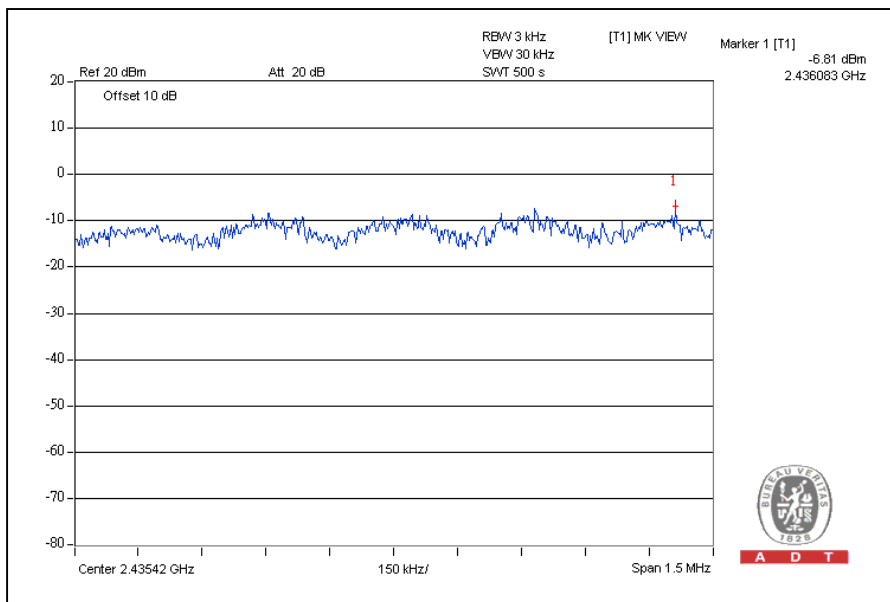

CH11

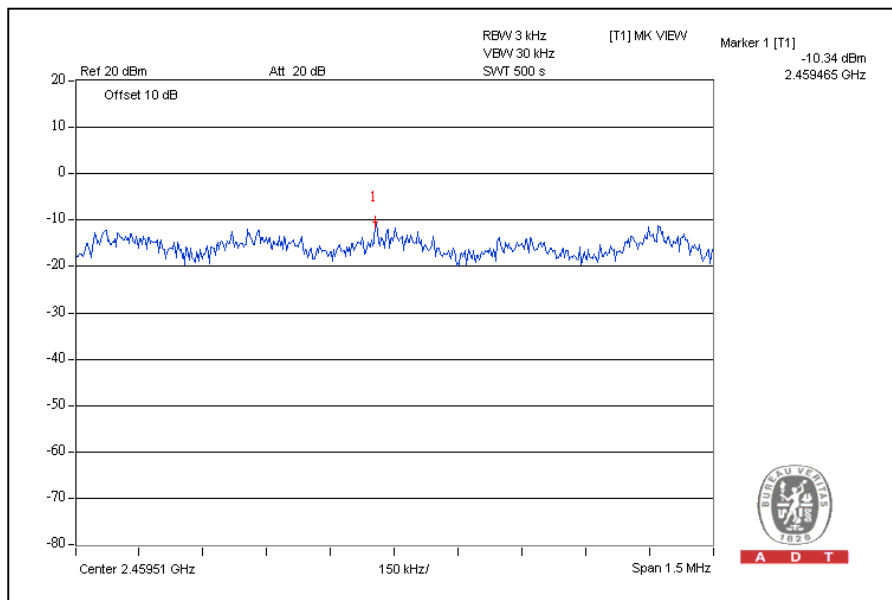



A D T

CH12

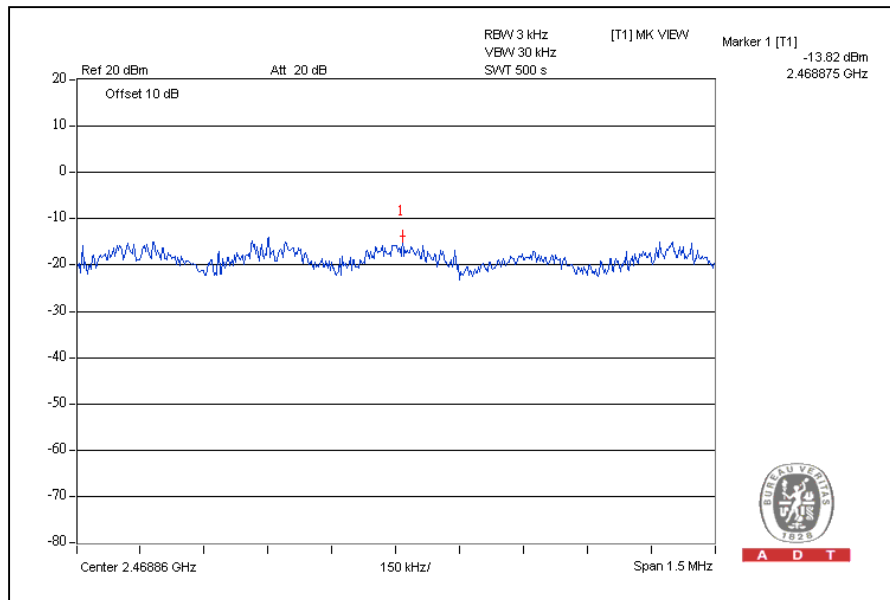

CH13

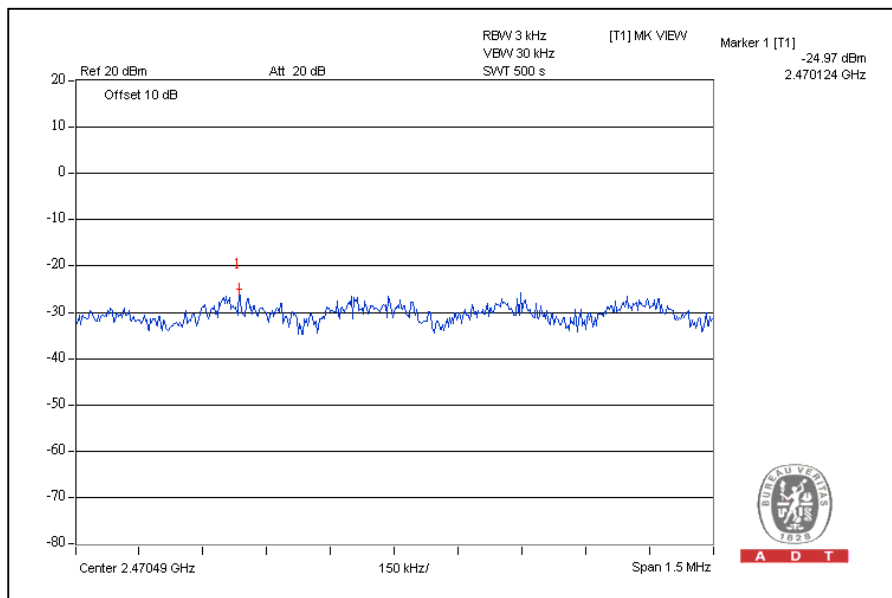



A D T

802.11n(20MHz) OFDM MODULATION:

CHANNEL	CHANNEL FREQUENCY (MHz)	RF POWER LEVEL IN 3kHz BW (dBm)	MAXIMUM LIMIT (dBm)	PASS / FAIL
1	2412	-9.9	8	PASS
6	2437	-7.7	8	PASS
11	2462	-10.7	8	PASS
12	2467	-14.6	8	PASS
13	2472	-25.8	8	PASS

CH1

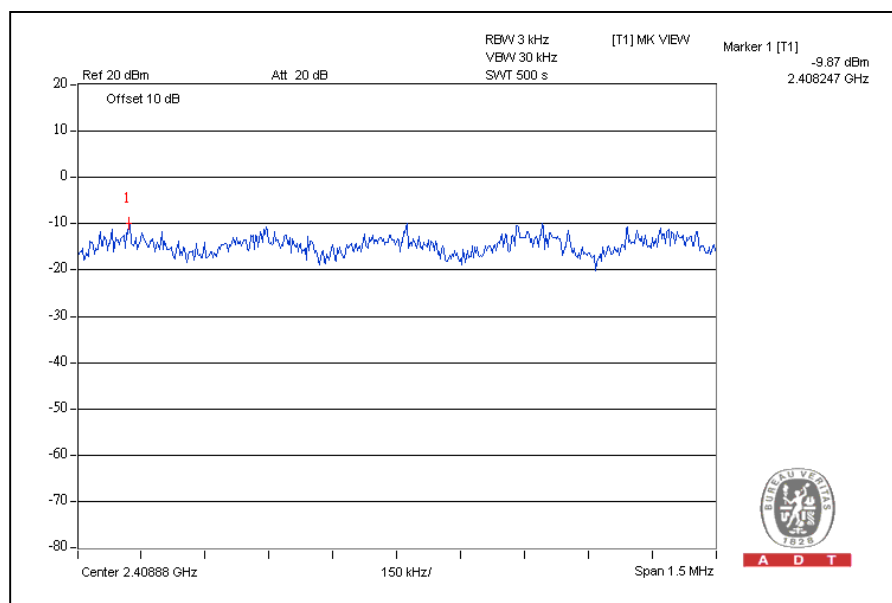



A D T

CH6

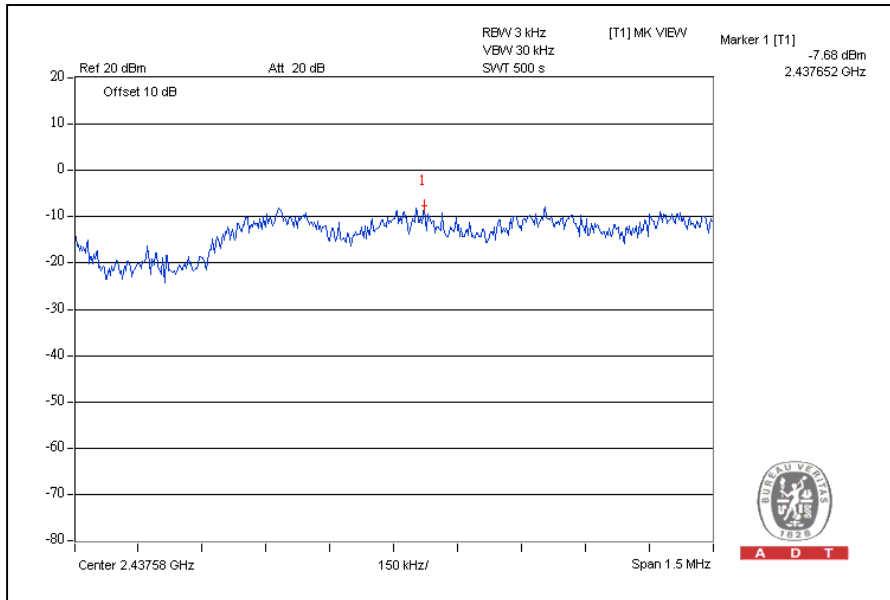

CH11

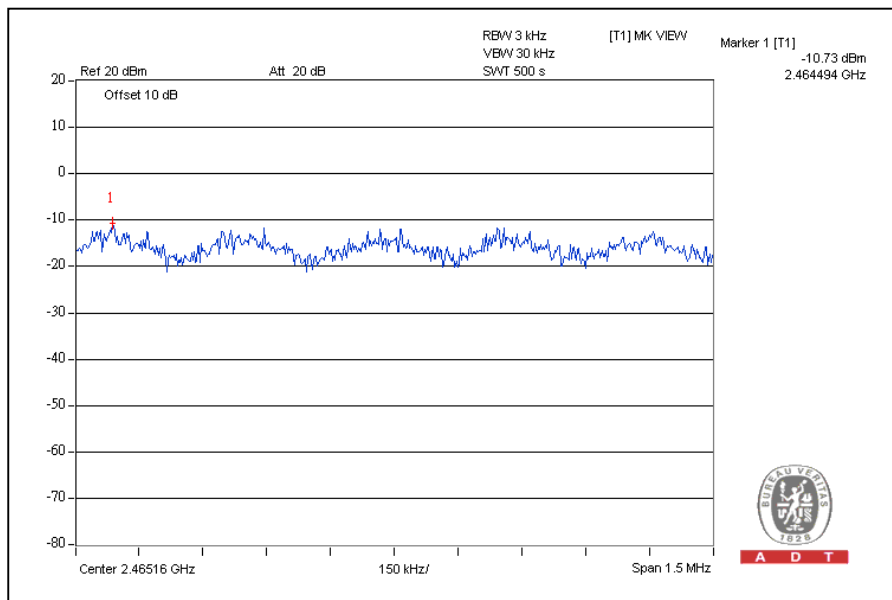



A D T

CH12

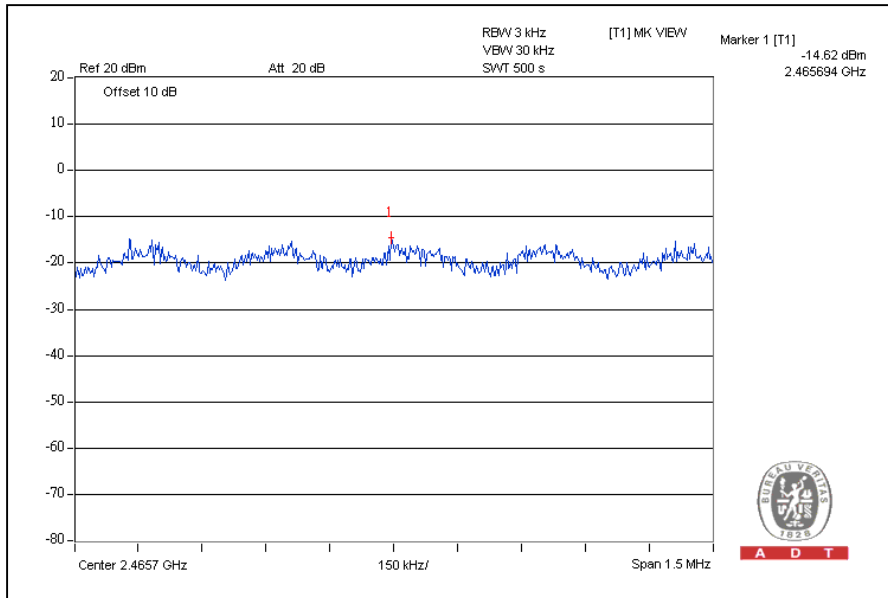

CH13

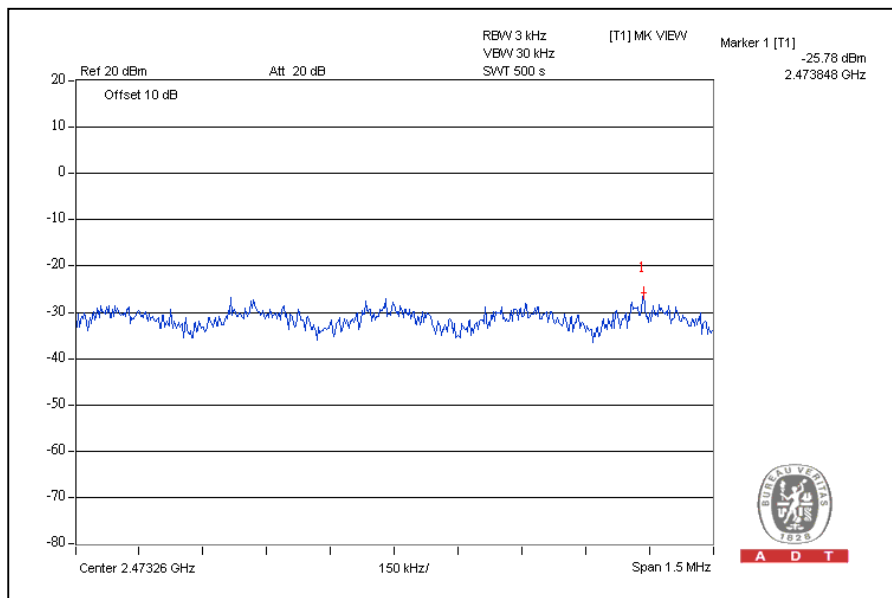



A D T

4.5.8 TEST RESULTS(MODE B)

802.11b DSSS MODULATION:

CHANNEL	CHANNEL FREQUENCY (MHz)	RF POWER LEVEL IN 3kHz BW (dBm)	MAXIMUM LIMIT (dBm)	PASS / FAIL
1	2412	-4.5	8	PASS
6	2437	-5.0	8	PASS
11	2462	-4.4	8	PASS
12	2467	-7.6	8	PASS
13	2472	-8.9	8	PASS

802.11g OFDM MODULATION:

CHANNEL	CHANNEL FREQUENCY (MHz)	RF POWER LEVEL IN 3kHz BW (dBm)	MAXIMUM LIMIT (dBm)	PASS / FAIL
1	2412	-9.8	8	PASS
6	2437	-6.4	8	PASS
11	2462	-9.9	8	PASS
12	2467	-13.4	8	PASS
13	2472	-24.6	8	PASS



A D T

802.11n(20MHz) OFDM MODULATION:

CHANNEL	CHANNEL FREQUENCY (MHz)	RF POWER LEVEL IN 3kHz BW (dBm)	MAXIMUM LIMIT (dBm)	PASS / FAIL
1	2412	-9.5	8	PASS
6	2437	-7.3	8	PASS
11	2462	-10.3	8	PASS
12	2467	-14.2	8	PASS
13	2472	-25.4	8	PASS

4.6 CONDUCTED OUT-BAND EMISSION MEASUREMENT

4.6.1 LIMITS OF CONDUCTED OUT-BAND EMISSION MEASUREMENT

Below -20dB of the highest emission level of operating band (in 100kHz Resolution Bandwidth).

4.6.2 TEST INSTRUMENTS

Test date: May 09, 2011

DESCRIPTION & MANUFACTURER	MODEL NO.	SERIAL NO.	CALIBRATED DATE	CALIBRATED UNTIL
SPECTRUM ANALYZER R&S	FSP 40	100060	May 12, 2010	May 11, 2011

NOTE:

1. The calibration interval of the above test instruments is 12 months and the calibrations are traceable to NML/ROC and NIST/USA.

4.6.3 TEST PROCEDURE

The transmitter output was connected to the spectrum analyzer via a low lose cable. Set RBW of spectrum analyzer to 100kHz and VBW of spectrum analyzer to 300kHz with suitable frequency span including 100 MHz bandwidth from band edge. The band edges was measured and recorded.

The spectrum plots (RBW = 100kHz, VBW = 300kHz) are attached on the following pages.

4.6.4 DEVIATION FROM TEST STANDARD

No deviation

4.6.5 EUT OPERATING CONDITION

Same as Item 4.3.6

4.6.6 TEST RESULTS

The spectrum plots are attached on the following images. D1 line indicates the highest level, and D2 line indicates the 20dB offset below D1. It shows compliance with the requirement in part 15.247(d).



A D T

802.11b DSSS MODULATION:

CH1

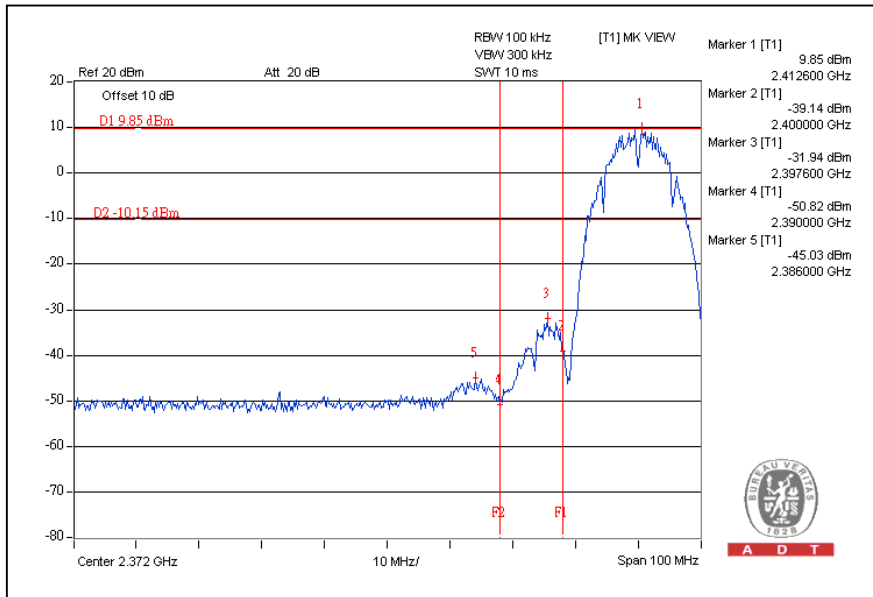

CH11

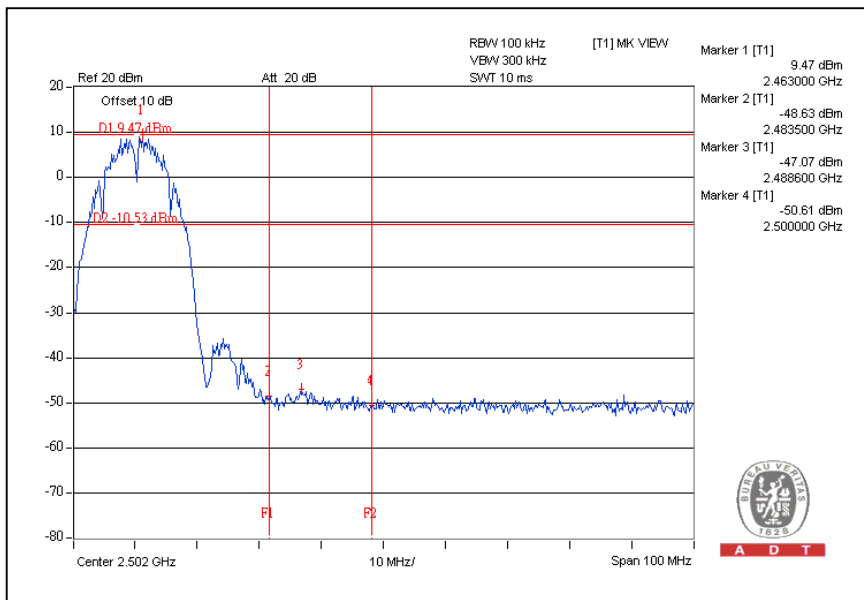



A D T

CH12

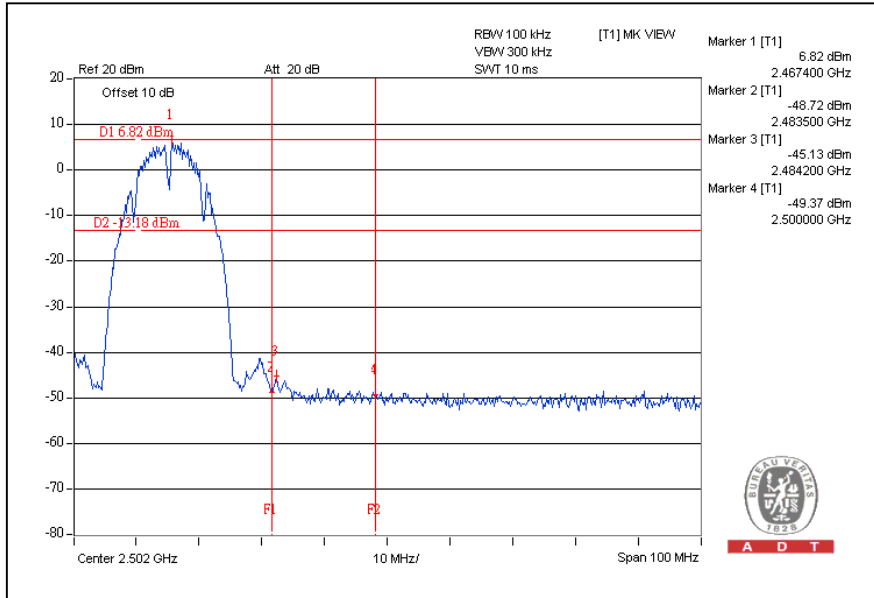

CH13

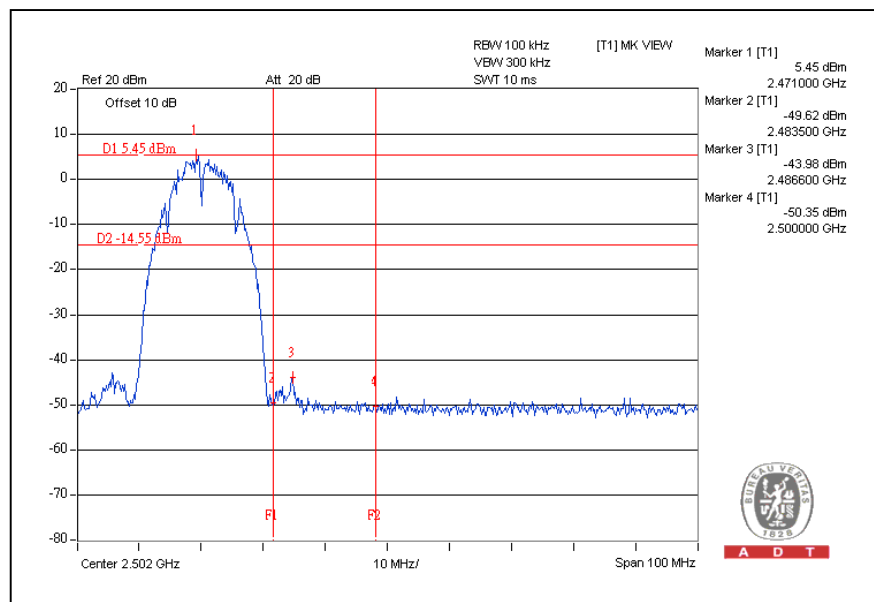



A D T

CH1

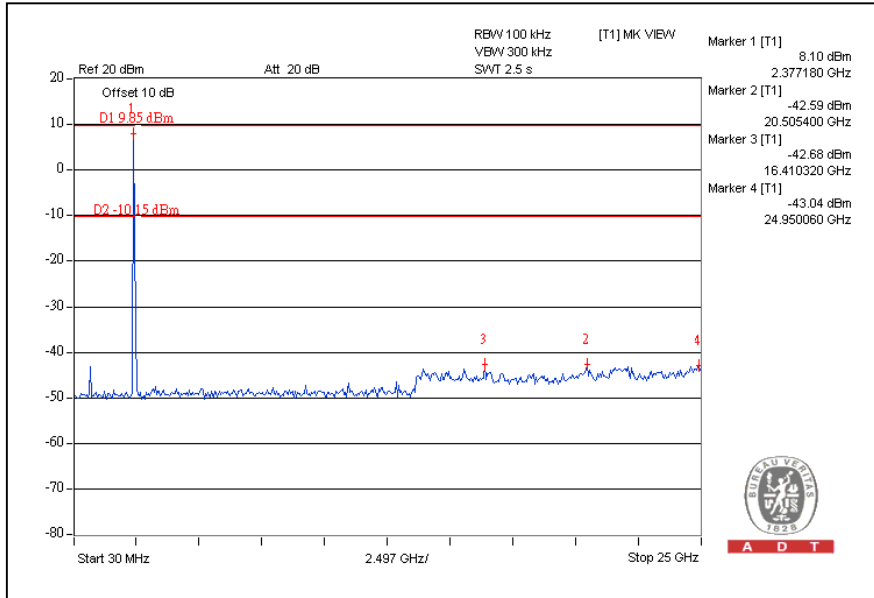

CH11

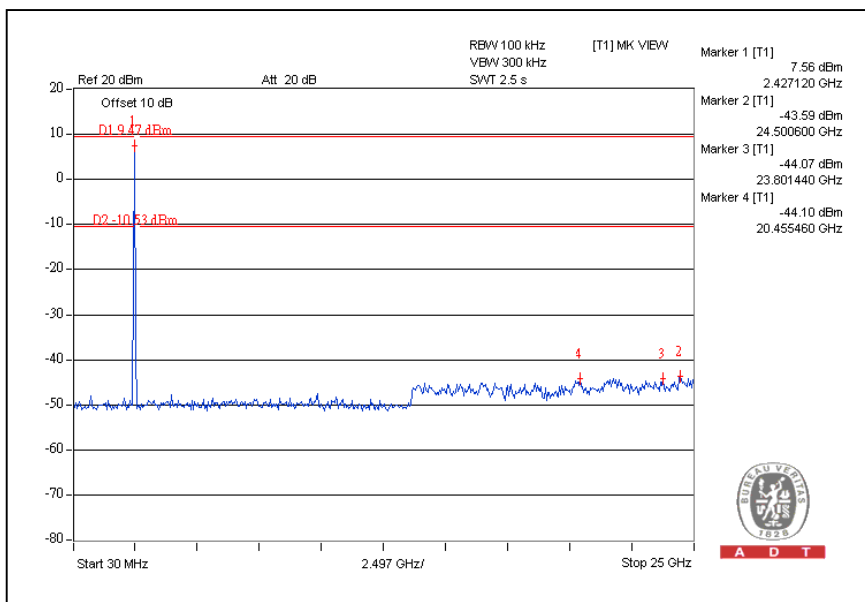



A D T

CH12

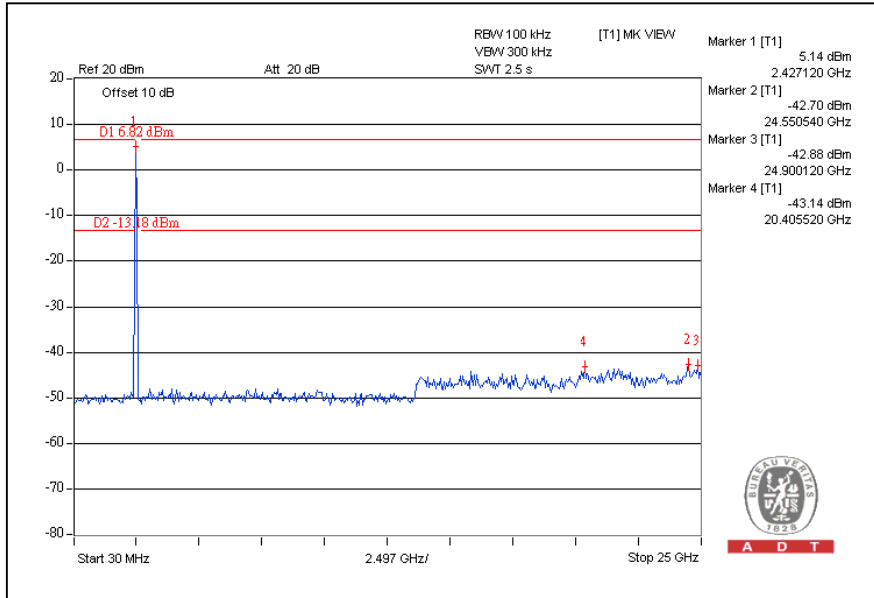

CH13

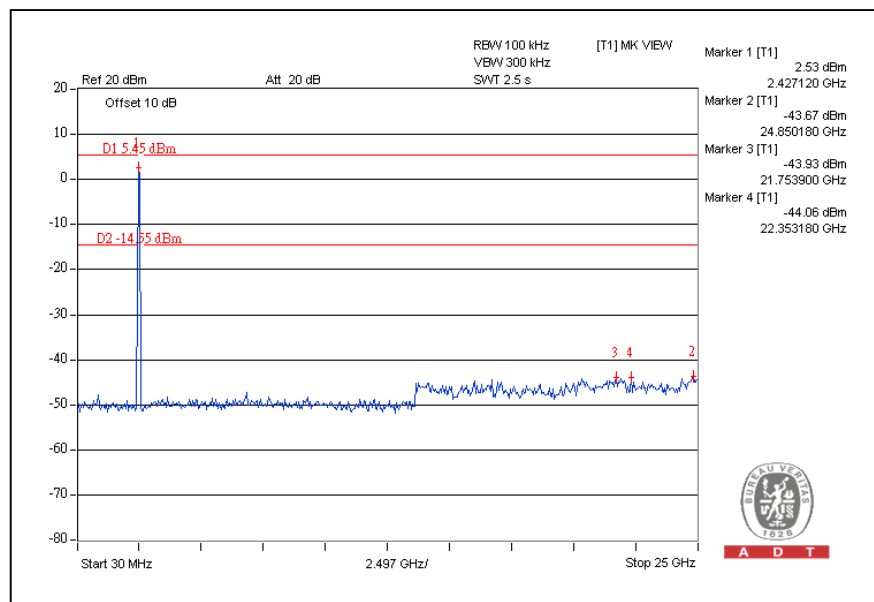



A D T

802.11g OFDM MODULATION:

CH1

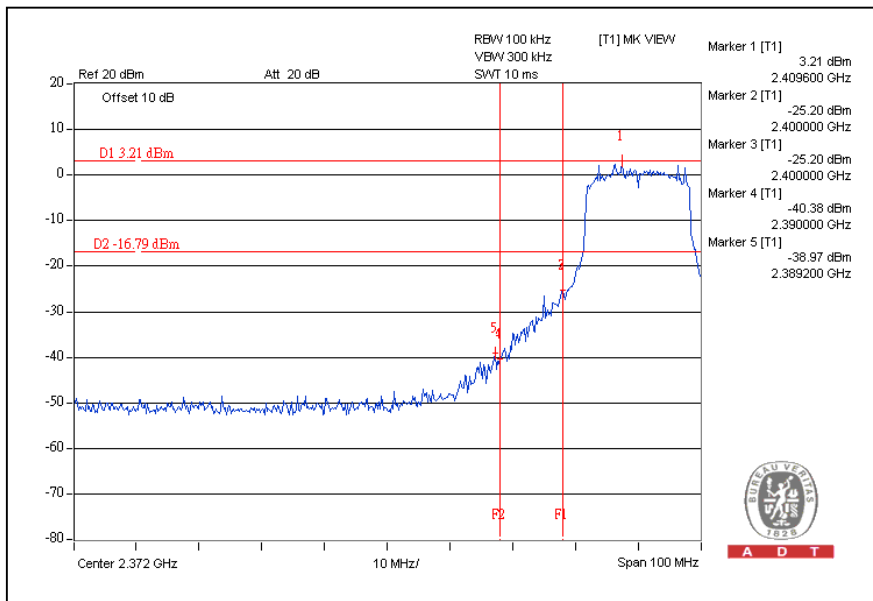

CH11

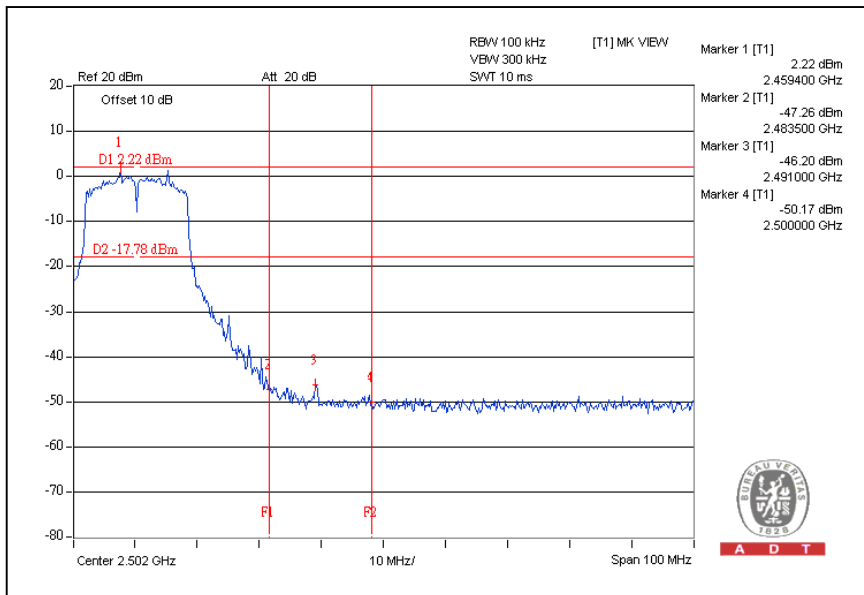

CH12

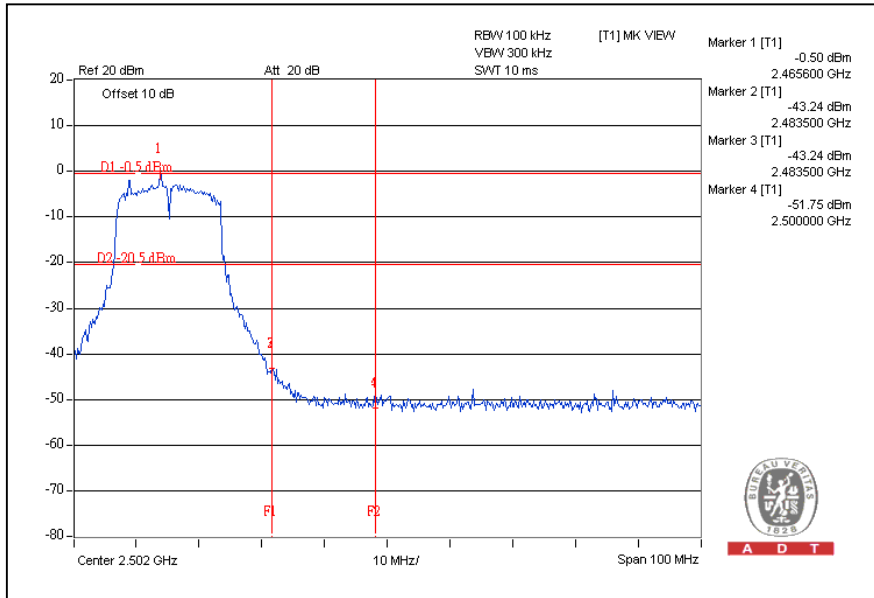

CH13

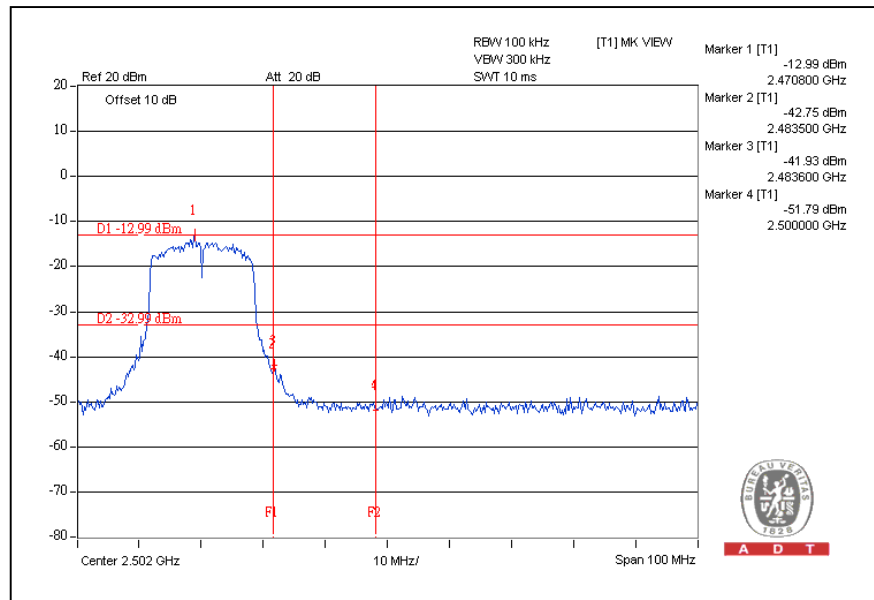



A D T

CH1

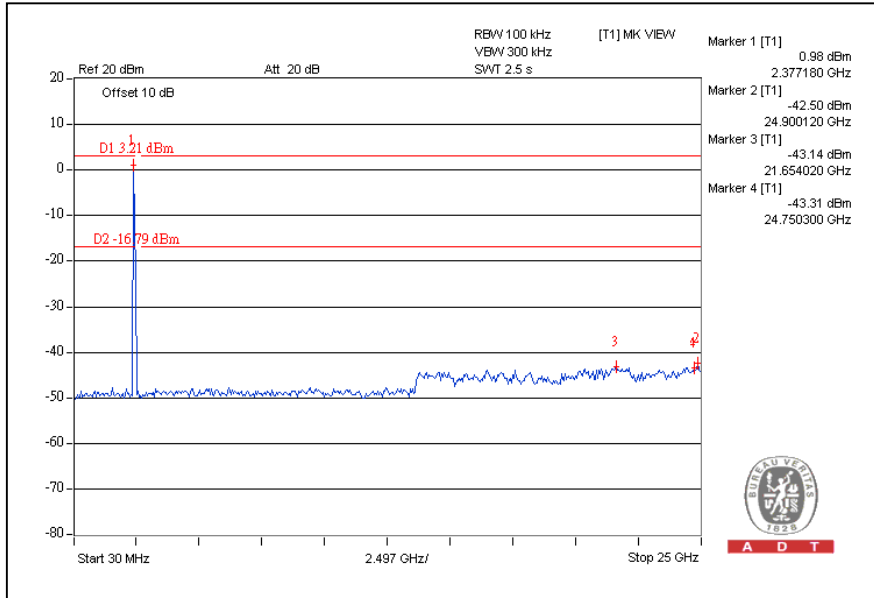

CH11

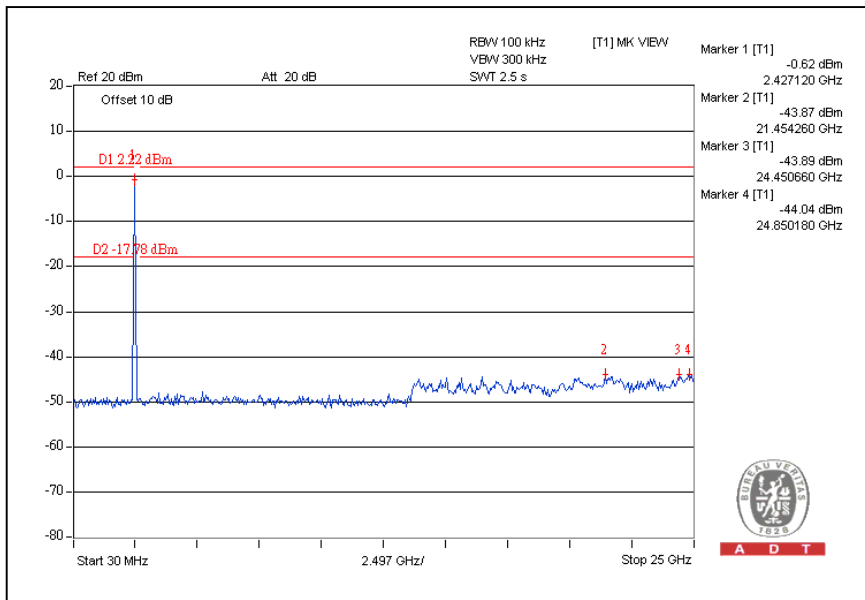

CH12

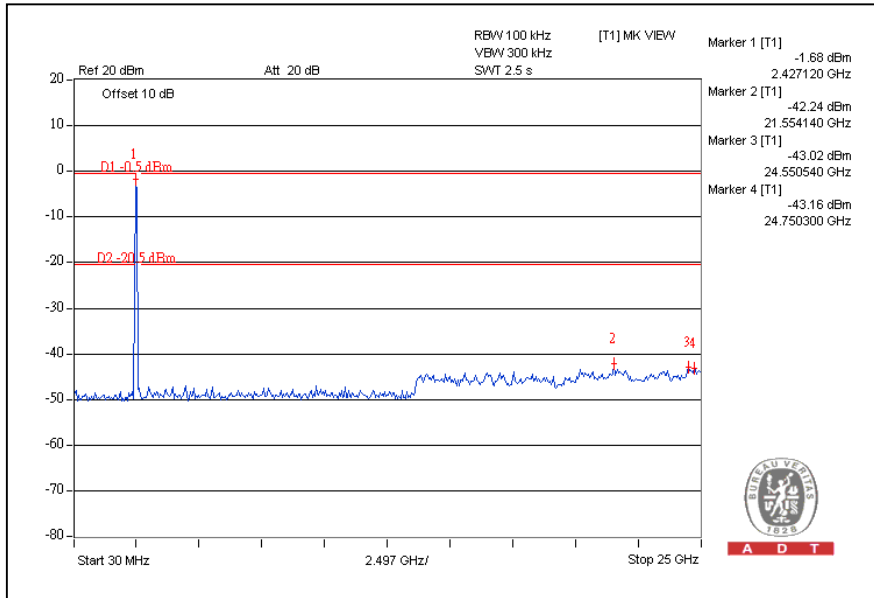

CH13

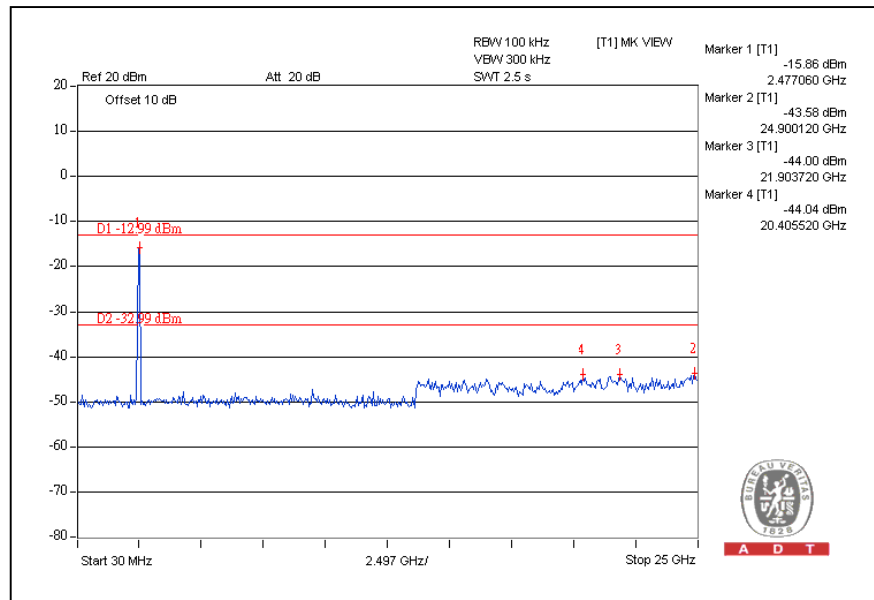



A D T

5. TEST TYPES AND RESULTS (For 5GHz, 5725~5850MHz Band)

5.1 CONDUCTED EMISSION MEASUREMENT

5.1.1 LIMITS OF CONDUCTED EMISSION MEASUREMENT

FREQUENCY OF EMISSION (MHz)	CONDUCTED LIMIT (dB μ V)	
	Quasi-peak	Average
0.15-0.5	66 to 56	56 to 46
0.5-5	56	46
5-30	60	50

- NOTE:**
1. The lower limit shall apply at the transition frequencies.
 2. The limit decreases in line with the logarithm of the frequency in the range of 0.15 to 0.50 MHz.
 3. All emanations from a class A/B digital device or system, including any network of conductors and apparatus connected thereto, shall not exceed the level of field strengths specified above.

5.1.2 TEST INSTRUMENTS

DESCRIPTION & MANUFACTURER	MODEL NO.	SERIAL NO.	CALIBRATED DATE	CALIBRATED UNTIL
ROHDE & SCHWARZ Test Receiver	ESCS 30	100287	Mar. 02, 2011	Mar. 01, 2012
Line-Impedance Stabilization Network (for EUT)	NSLK 8127	8127-523	Sep. 17, 2010	Sep. 16, 2011
Line-Impedance Stabilization Network (for Peripheral)	ENV-216	100072	June 11, 2010	June 10, 2011
RF Cable (JYEBAO)	5DFB	CONCAB-003	Aug. 06, 2010	Aug. 05, 2011
50 ohms Terminator	50	3	Nov. 03, 2010	Nov. 02, 2011
Software	BV ADT_Cond_V7.3.7	NA	NA	NA

Note:

1. The calibration interval of the above test instruments is 12 months and the calibrations are traceable to NML/ROC and NIST/USA.
2. The test was performed in Shielded Room No. A.
3. The VCCI Con A Registration No. is C-817.

5.1.3 TEST PROCEDURES

- a. The EUT was placed 0.4 meters from the conducting wall of the shielded room with EUT being connected to the power mains through a line impedance stabilization network (LISN). Other support units were connected to the power mains through another LISN. The two LISNs provide 50 ohm/ 50uH of coupling impedance for the measuring instrument.
- b. Both lines of the power mains connected to the EUT were checked for maximum conducted interference.
- c. The frequency range from 150kHz to 30MHz was searched. Emission levels under (Limit – 20dB) were not recorded.

5.1.4 DEVIATION FROM TEST STANDARD

No deviation

5.1.5 TEST SETUP

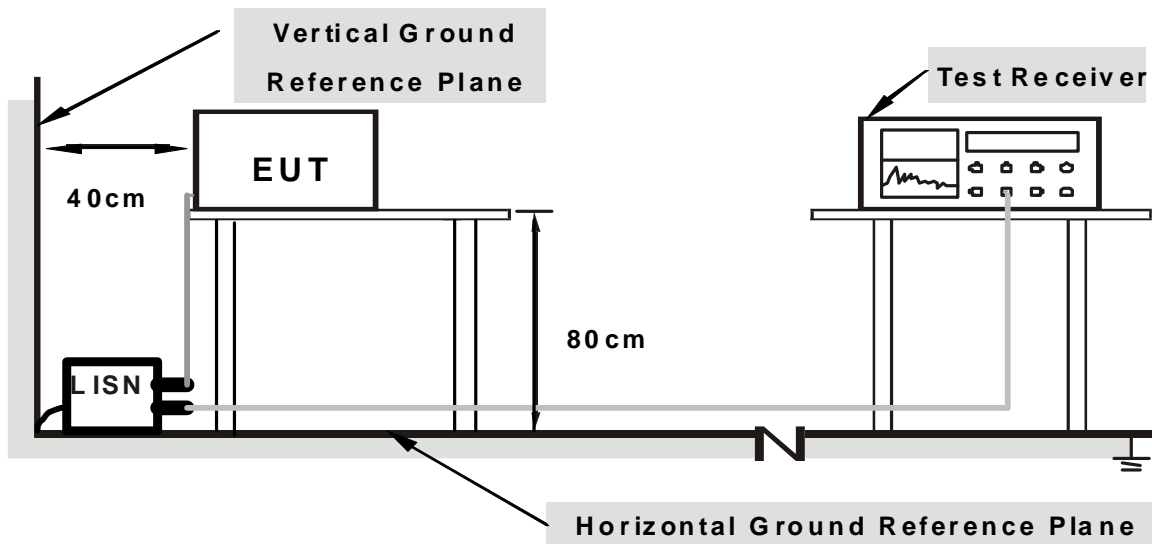

Note: 1. Support units were connected to second LISN.

2. Both of LISNs (AMN) are 80 cm from EUT and at least 80 cm from other units and other metal planes

For the actual test configuration, please refer to the related item – Photographs of the Test Configuration.

5.1.6 EUT OPERATING CONDITIONS

Same as the 4.1.6

5.1.7 TEST RESULTS

PHASE	Line (L)	6dB BANDWIDTH	9 kHz
--------------	----------	----------------------	-------

No	Freq. [MHz]	Corr. Factor (dB)	Reading Value [dB (uV)]		Emission Level [dB (uV)]		Limit [dB (uV)]		Margin (dB)	
			Q.P.	AV.	Q.P.	AV.	Q.P.	AV.	Q.P.	AV.
			1	0.205	0.36	47.90	-	48.26	-	63.42
2	0.275	0.36	40.75	-	41.11	-	60.97	50.97	-19.86	-
3	0.341	0.36	38.93	-	39.29	-	59.17	49.17	-19.88	-
4	0.482	0.37	34.20	-	34.57	-	56.30	46.30	-21.74	-
5	2.398	0.47	30.52	-	30.99	-	56.00	46.00	-25.01	-
6	5.402	0.55	29.22	-	29.77	-	60.00	50.00	-30.23	-

- REMARKS:**
1. Q.P. and AV. are abbreviations of quasi-peak and average individually.
 2. "-": The Quasi-peak reading value also meets average limit and measurement with the average detector is unnecessary.
 3. The emission levels of other frequencies were very low against the limit.
 4. Margin value = Emission level - Limit value
 5. Correction factor = Insertion loss + Cable loss
 6. Emission Level = Correction Factor + Reading Value.

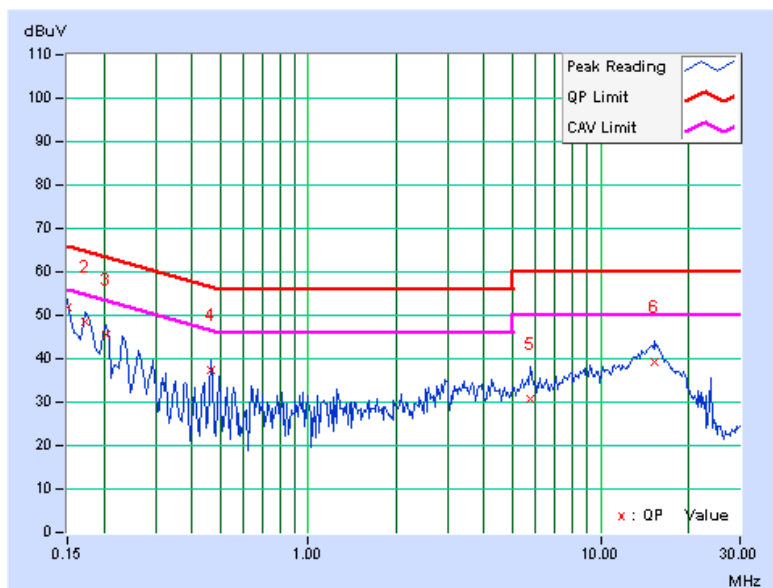

PHASE	Neutral (N)	6dB BANDWIDTH	9 kHz
-------	-------------	---------------	-------

No	Freq. [MHz]	Corr. Factor (dB)	Reading Value		Emission Level		Limit		Margin	
			[dB (uV)]		[dB (uV)]		[dB (uV)]		(dB)	
			Q.P.	AV.	Q.P.	AV.	Q.P.	AV.	Q.P.	AV.
1	0.205	0.10	45.39	-	45.49	-	63.42	53.42	-17.93	-
2	0.275	0.10	38.60	-	38.70	-	60.97	50.97	-22.26	-
3	0.341	0.11	37.19	-	37.30	-	59.17	49.17	-21.87	-
4	0.478	0.12	34.30	-	34.42	-	56.37	46.37	-21.95	-
5	2.531	0.21	33.31	-	33.52	-	56.00	46.00	-22.48	-
6	5.402	0.30	28.52	-	28.82	-	60.00	50.00	-31.18	-

- REMARKS:**
1. Q.P. and AV. are abbreviations of quasi-peak and average individually.
 2. "-": The Quasi-peak reading value also meets average limit and measurement with the average detector is unnecessary.
 3. The emission levels of other frequencies were very low against the limit.
 4. Margin value = Emission level - Limit value
 5. Correction factor = Insertion loss + Cable loss
 6. Emission Level = Correction Factor + Reading Value.

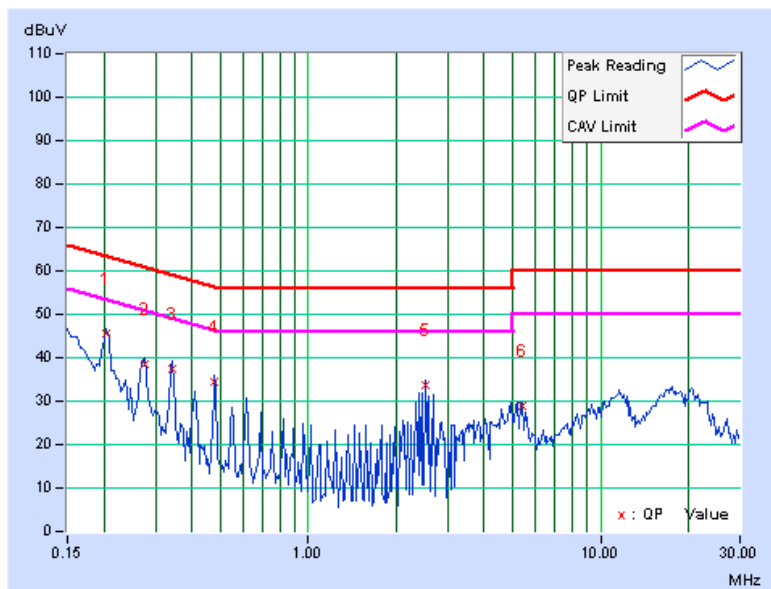

5.2 RADIATED EMISSION MEASUREMENT

5.2.1 LIMITS OF RADIATED EMISSION MEASUREMENT

Emissions radiated outside of the specified bands, shall be according to the general radiated limits in 15.209 as following:

Frequencies (MHz)	Field strength (microvolts/meter)	Measurement distance (meters)
0.009-0.490	2400/F(kHz)	300
0.490-1.705	24000/F(kHz)	30
1.705-30.0	30	30
30-88	100	3
88-216	150	3
216-960	200	3
Above 960	500	3

NOTE:

1. The lower limit shall apply at the transition frequencies.
2. Emission level (dBuV/m) = 20 log Emission level (uV/m).
3. As shown in 15.35(b), for frequencies above 1000MHz, the field strength limits are based on average detector, however, the peak field strength of any emission shall not exceed the maximum permitted average limits, specified above by more than 20dB under any condition of modulation.
4. Section 15.205 restricted bands of operation shall compliance with the limits in Section 15.209.



A D T

5.2.2 TEST INSTRUMENTS

DESCRIPTION & MANUFACTURER	MODEL NO.	SERIAL NO.	CALIBRATED DATE	CALIBRATED UNTIL
Agilent Spectrum Analyzer	E4446A	MY48250254	July 14, 2010	July 13, 2011
Agilent Pre-Selector	N9039A	MY46520311	July 14, 2010	July 13, 2011
Agilent Signal Generator	N5181A	MY49060517	July 14, 2010	July 13, 2011
Mini-Circuits Pre-Amplifier	ZFL-1000VH2B	AMP-ZFL-03	Nov. 16, 2010	Nov. 15, 2011
Agilent Pre-Amplifier	8449B	3008A02578	July 05, 2010	July 04, 2011
Miteq Pre-Amplifier	AFS33-1800265 0-30-8P-44	881786	NA	NA
SCHWARZBECK Trilog Broadband Antenna	VULB 9168	9168-360	Apr. 14, 2011	Apr. 13, 2012
AISI Horn_Antenna	AIH.8018	0000320091110	Nov. 12, 2010	Nov. 11, 2011
SCHWARZBECK Horn_Antenna	BBHA 9170	9170-424	Oct. 08, 2010	Oct. 07, 2011
RF CABLE	NA	RF104-201 RF104-203 RF104-204	Dec. 27, 2010	Dec. 26, 2011
RF Cable	NA	CHGCAB_001	NA	NA
Software	ADT_Radiated_ V8.7.05	NA	NA	NA
CT Antenna Tower & Turn Table	NA	NA	NA	NA

- Note: 1. The calibration interval of the above test instruments is 12 months and the calibrations are traceable to NML/ROC and NIST/USA.
2. The horn antenna, preamplifier (model: 8449B) are used only for the measurement of emission frequency above 1GHz if tested.
3. The test was performed in 966 Chamber No. G.
4. The FCC Site Registration No. is 966073.
5. The VCCI Site Registration No. is G-137.
6. The CANADA Site Registration No. is IC 7450H-2.

5.2.3 TEST PROCEDURES

- a. The EUT was placed on the top of a rotating table 0.8 meters above the ground at a 3 meter chamber room. The table was rotated 360 degrees to determine the position of the highest radiation.
- b. The EUT was set 3 meters away from the interference-receiving antenna, which was mounted on the top of a variable-height antenna tower.
- c. The height of antenna is varied from one meter to four meters above the ground to determine the maximum value of the field strength. Both horizontal and vertical polarizations of the antenna are set to make the measurement.
- d. For each suspected emission, the EUT was arranged to its worst case and then the antenna was tuned to heights from 1 meter to 4 meters and the rotatable table was turned from 0 degrees to 360 degrees to find the maximum reading.
- e. The test-receiver system was set to quasi-peak detect function and specified bandwidth with maximum hold mode when the test frequency is below 1 GHz.
- f. The test-receiver system was set to peak and average detect function and specified bandwidth with maximum hold mode when the test frequency is above 1 GHz. If the peak reading value also meets average limit, measurement with the average detector is unnecessary.

NOTE:

1. The resolution bandwidth and video bandwidth of test receiver/spectrum analyzer is 120kHz for Quasi-peak detection (QP) at frequency below 1GHz.
2. The resolution bandwidth of test receiver/spectrum analyzer is 1 MHz and the video bandwidth is 3 MHz for Peak detection (PK) at frequency above 1GHz.
3. The resolution bandwidth of test receiver/spectrum analyzer is 1 MHz and the video bandwidth is 10 Hz for Average detection (AV) at frequency above 1GHz.

5.2.4 DEVIATION FROM TEST STANDARD

No deviation

5.2.5 TEST SETUP

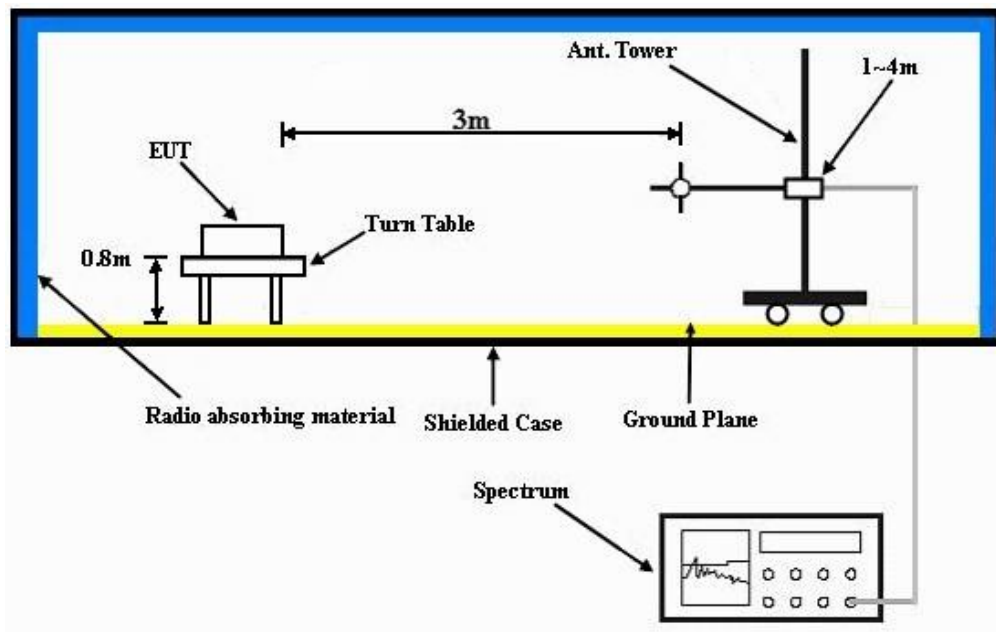

For the actual test configuration, please refer to the related item – Photographs of the Test Configuration.

5.2.6 EUT OPERATING CONDITIONS

Same as the 4.1.6



A D T

5.2.7 TEST RESULTS

BELOW 1GHz WORST-CASE DATA : 802.11a OFDM MODULATION

EUT TEST CONDITION		MEASUREMENT DETAIL	
CHANNEL	Channel 157	FREQUENCY RANGE	Below 1000MHz
INPUT POWER (SYSTEM)	120Vac, 60 Hz	DETECTOR FUNCTION	Quasi-Peak
ENVIRONMENTAL CONDITIONS	23deg. C, 68%RH 1002 hPa	TESTED BY	Wen Yu

ANTENNA POLARITY & TEST DISTANCE: HORIZONTAL AT 3 M								
NO.	FREQ. (MHz)	EMISSION LEVEL (dBuV/m)	LIMIT (dBuV/m)	MARGIN (dB)	ANTENNA HEIGHT (m)	TABLE ANGLE (Degree)	RAW VALUE (dBuV)	CORRECTION FACTOR (dB/m)
1	93.60	33.5 QP	43.5	-10.1	2.00 H	323	24.47	8.98
2	131.96	37.2 QP	43.5	-6.3	1.95 H	66	23.75	13.47
3	167.36	37.4 QP	43.5	-6.2	1.59 H	277	23.62	13.73
4	180.00	37.3 QP	43.5	-6.2	1.24 H	23	25.33	11.95
5	192.00	36.1 QP	43.5	-7.4	1.50 H	335	24.80	11.27
6	301.10	39.9 QP	46.0	-6.1	1.20 H	360	24.38	15.48
7	313.50	37.6 QP	46.0	-8.4	1.20 H	333	21.85	15.76
8	903.30	40.0 QP	46.0	-6.0	1.20 H	224	13.16	26.83
ANTENNA POLARITY & TEST DISTANCE: VERTICAL AT 3 M								
NO.	FREQ. (MHz)	EMISSION LEVEL (dBuV/m)	LIMIT (dBuV/m)	MARGIN (dB)	ANTENNA HEIGHT (m)	TABLE ANGLE (Degree)	RAW VALUE (dBuV)	CORRECTION FACTOR (dB/m)
1	43.90	33.6 QP	40.0	-6.5	1.25 V	228	19.24	14.31
2	56.00	34.0 QP	40.0	-6.1	1.25 V	225	20.21	13.74
3	167.00	37.1 QP	43.5	-6.5	1.25 V	208	23.27	13.78
4	180.00	37.4 QP	43.5	-6.1	1.22 V	115	25.46	11.95
5	301.00	33.7 QP	46.0	-12.3	1.50 V	165	18.20	15.48
6	561.00	32.4 QP	46.0	-13.6	1.25 V	112	10.91	21.49
7	904.00	39.2 QP	46.0	-6.8	1.21 V	331	12.38	26.83

- REMARKS:**
1. Emission level (dBuV/m) = Raw Value (dBuV) + Correction Factor (dB/m).
 2. Correction Factor (dB/m) = Antenna Factor (dB/m) + Cable Factor (dB).
 3. The other emission levels were very low against the limit.
 4. Margin value = Emission level – Limit value.



A D T

ABOVE 1GHz WORST-CASE DATA

802.11a OFDM MODULATION

EUT TEST CONDITION		MEASUREMENT DETAIL	
CHANNEL	Channel 149	FREQUENCY RANGE	1 ~ 40GHz
INPUT POWER (SYSTEM)	120Vac, 60 Hz	DETECTOR FUNCTION	Peak (PK) Average (AV)
ENVIRONMENTAL CONDITIONS	22deg. C, 64%RH 1002 hPa	TESTED BY	Frank Liu

ANTENNA POLARITY & TEST DISTANCE: HORIZONTAL AT 3 M								
NO.	FREQ. (MHz)	EMISSION LEVEL (dBuV/m)	LIMIT (dBuV/m)	MARGIN (dB)	ANTENNA HEIGHT (m)	TABLE ANGLE (Degree)	RAW VALUE (dBuV)	CORRECTION FACTOR (dB/m)
1	*5745.00	101.0 PK			1.33 H	294	59.45	41.55
2	*5745.00	90.5 AV			1.33 H	294	48.95	41.55
3	11490.00	55.4 PK	74.0	-18.6	1.02 H	151	7.69	47.71
4	11490.00	44.6 AV	54.0	-9.4	1.02 H	151	-3.11	47.71
ANTENNA POLARITY & TEST DISTANCE: VERTICAL AT 3 M								
NO.	FREQ. (MHz)	EMISSION LEVEL (dBuV/m)	LIMIT (dBuV/m)	MARGIN (dB)	ANTENNA HEIGHT (m)	TABLE ANGLE (Degree)	RAW VALUE (dBuV)	CORRECTION FACTOR (dB/m)
1	*5745.00	111.8 PK			1.00 V	245	70.25	41.55
2	*5745.00	101.6 AV			1.00 V	245	60.05	41.55
3	11490.00	55.1 PK	74.0	-18.9	1.00 V	211	7.39	47.71
4	11490.00	44.3 AV	54.0	-9.7	1.00 V	211	-3.41	47.71

- REMARKS:**
1. Emission level (dBuV/m) = Raw Value (dBuV) + Correction Factor (dB/m).
 2. Correction Factor (dB/m) = Antenna Factor (dB/m) + Cable Factor (dB).
 3. The other emission levels were very low against the limit.
 4. Margin value = Emission level – Limit value.
 5. “ * “: Fundamental frequency.
 6. The limit value is defined as per 15.247.



A D T

EUT TEST CONDITION		MEASUREMENT DETAIL	
CHANNEL	Channel 157	FREQUENCY RANGE	1 ~ 40GHz
INPUT POWER (SYSTEM)	120Vac, 60 Hz	DETECTOR FUNCTION	Peak (PK) Average (AV)
ENVIRONMENTAL CONDITIONS	22deg. C, 64%RH 1002 hPa	TESTED BY	Frank Liu

ANTENNA POLARITY & TEST DISTANCE: HORIZONTAL AT 3 M								
NO.	FREQ. (MHz)	EMISSION LEVEL (dBuV/m)	LIMIT (dBuV/m)	MARGIN (dB)	ANTENNA HEIGHT (m)	TABLE ANGLE (Degree)	RAW VALUE (dBuV)	CORRECTION FACTOR (dB/m)
1	*5785.00	101.1 PK			1.39 H	291	59.42	41.68
2	*5785.00	90.5 AV			1.39 H	291	48.82	41.68
3	11570.00	55.3 PK	74.0	-18.7	1.06 H	151	7.55	47.75
4	11570.00	44.5 AV	54.0	-9.5	1.06 H	151	-3.25	47.75
ANTENNA POLARITY & TEST DISTANCE: VERTICAL AT 3 M								
NO.	FREQ. (MHz)	EMISSION LEVEL (dBuV/m)	LIMIT (dBuV/m)	MARGIN (dB)	ANTENNA HEIGHT (m)	TABLE ANGLE (Degree)	RAW VALUE (dBuV)	CORRECTION FACTOR (dB/m)
1	*5785.00	112.4 PK			1.02 V	258	70.72	41.68
2	*5785.00	102.2 AV			1.02 V	258	60.52	41.68
3	11570.00	55.7 PK	74.0	-18.3	1.00 V	219	7.95	47.75
4	11570.00	45.3 AV	54.0	-8.7	1.00 V	219	-2.45	47.75

- REMARKS:**
1. Emission level (dBuV/m) = Raw Value (dBuV) + Correction Factor (dB/m).
 2. Correction Factor (dB/m) = Antenna Factor (dB/m) + Cable Factor (dB).
 3. The other emission levels were very low against the limit.
 4. Margin value = Emission level – Limit value.
 5. “ * “: Fundamental frequency.
 6. The limit value is defined as per 15.247.



A D T

EUT TEST CONDITION		MEASUREMENT DETAIL	
CHANNEL	Channel 165	FREQUENCY RANGE	1 ~ 40GHz
INPUT POWER (SYSTEM)	120Vac, 60 Hz	DETECTOR FUNCTION	Peak (PK) Average (AV)
ENVIRONMENTAL CONDITIONS	22deg. C, 64%RH 1002 hPa	TESTED BY	Frank Liu

ANTENNA POLARITY & TEST DISTANCE: HORIZONTAL AT 3 M								
NO.	FREQ. (MHz)	EMISSION LEVEL (dBuV/m)	LIMIT (dBuV/m)	MARGIN (dB)	ANTENNA HEIGHT (m)	TABLE ANGLE (Degree)	RAW VALUE (dBuV)	CORRECTION FACTOR (dB/m)
1	*5825.00	101.3 PK			1.35 H	306	59.52	41.78
2	*5825.00	90.9 AV			1.35 H	306	49.12	41.78
3	11650.00	55.2 PK	74.0	-18.8	1.06 H	149	7.37	47.83
4	11650.00	44.3 AV	54.0	-9.7	1.06 H	149	-3.53	47.83
ANTENNA POLARITY & TEST DISTANCE: VERTICAL AT 3 M								
NO.	FREQ. (MHz)	EMISSION LEVEL (dBuV/m)	LIMIT (dBuV/m)	MARGIN (dB)	ANTENNA HEIGHT (m)	TABLE ANGLE (Degree)	RAW VALUE (dBuV)	CORRECTION FACTOR (dB/m)
1	*5825.00	112.4 PK			1.05 V	252	70.62	41.78
2	*5825.00	102.1 AV			1.05 V	252	60.32	41.78
3	11650.00	55.4 PK	74.0	-18.6	1.00 V	216	7.57	47.83
4	11650.00	45.2 AV	54.0	-8.8	1.00 V	216	-2.63	47.83

- REMARKS:**
1. Emission level (dBuV/m) = Raw Value (dBuV) + Correction Factor (dB/m).
 2. Correction Factor (dB/m) = Antenna Factor (dB/m) + Cable Factor (dB).
 3. The other emission levels were very low against the limit.
 4. Margin value = Emission level – Limit value.
 5. “ * “: Fundamental frequency.
 6. The limit value is defined as per 15.247.



A D T

802.11n (20MHz) OFDM MODULATION

EUT TEST CONDITION		MEASUREMENT DETAIL	
CHANNEL	Channel 149	FREQUENCY RANGE	1 ~ 40GHz
INPUT POWER (SYSTEM)	120Vac, 60 Hz	DETECTOR FUNCTION	Peak (PK) Average (AV)
ENVIRONMENTAL CONDITIONS	22deg. C, 64%RH 1002 hPa	TESTED BY	Frank Liu

ANTENNA POLARITY & TEST DISTANCE: HORIZONTAL AT 3 M								
NO.	FREQ. (MHz)	EMISSION LEVEL (dBuV/m)	LIMIT (dBuV/m)	MARGIN (dB)	ANTENNA HEIGHT (m)	TABLE ANGLE (Degree)	RAW VALUE (dBuV)	CORRECTION FACTOR (dB/m)
1	*5745.00	100.0 PK			1.29 H	308	58.45	41.55
2	*5745.00	89.7 AV			1.29 H	308	48.15	41.55
3	11490.00	55.9 PK	74.0	-18.1	1.05 H	163	8.19	47.71
4	11490.00	45.2 AV	54.0	-8.8	1.05 H	163	-2.51	47.71
ANTENNA POLARITY & TEST DISTANCE: VERTICAL AT 3 M								
NO.	FREQ. (MHz)	EMISSION LEVEL (dBuV/m)	LIMIT (dBuV/m)	MARGIN (dB)	ANTENNA HEIGHT (m)	TABLE ANGLE (Degree)	RAW VALUE (dBuV)	CORRECTION FACTOR (dB/m)
1	*5745.00	110.5 PK			1.00 V	257	68.95	41.55
2	*5745.00	100.4 AV			1.00 V	257	58.85	41.55
3	11490.00	55.6 PK	74.0	-18.4	1.00 V	219	7.89	47.71
4	11490.00	45.7 AV	54.0	-8.3	1.00 V	219	-2.01	47.71

- REMARKS:**
1. Emission level (dBuV/m) = Raw Value (dBuV) + Correction Factor (dB/m).
 2. Correction Factor (dB/m) = Antenna Factor (dB/m) + Cable Factor (dB).
 3. The other emission levels were very low against the limit.
 4. Margin value = Emission level – Limit value.
 5. “ * “: Fundamental frequency.
 6. The limit value is defined as per 15.247.



A D T

EUT TEST CONDITION		MEASUREMENT DETAIL	
CHANNEL	Channel 157	FREQUENCY RANGE	1 ~ 40GHz
INPUT POWER (SYSTEM)	120Vac, 60 Hz	DETECTOR FUNCTION	Peak (PK) Average (AV)
ENVIRONMENTAL CONDITIONS	22deg. C, 64%RH 1002 hPa	TESTED BY	Frank Liu

ANTENNA POLARITY & TEST DISTANCE: HORIZONTAL AT 3 M								
NO.	FREQ. (MHz)	EMISSION LEVEL (dBuV/m)	LIMIT (dBuV/m)	MARGIN (dB)	ANTENNA HEIGHT (m)	TABLE ANGLE (Degree)	RAW VALUE (dBuV)	CORRECTION FACTOR (dB/m)
1	*5785.00	100.3 PK			1.33 H	280	58.62	41.68
2	*5785.00	89.6 AV			1.33 H	280	47.92	41.68
3	11570.00	56.2 PK	74.0	-17.8	1.00 H	145	8.45	47.75
4	11570.00	45.3 AV	54.0	-8.7	1.00 H	145	-2.45	47.75
ANTENNA POLARITY & TEST DISTANCE: VERTICAL AT 3 M								
NO.	FREQ. (MHz)	EMISSION LEVEL (dBuV/m)	LIMIT (dBuV/m)	MARGIN (dB)	ANTENNA HEIGHT (m)	TABLE ANGLE (Degree)	RAW VALUE (dBuV)	CORRECTION FACTOR (dB/m)
1	*5785.00	111.3 PK			1.00 V	233	69.62	41.68
2	*5785.00	101.0 AV			1.00 V	233	59.32	41.68
3	11570.00	55.8 PK	74.0	-18.2	1.00 V	230	8.05	47.75
4	11570.00	45.9 AV	54.0	-8.1	1.00 V	230	-1.85	47.75

- REMARKS:**
1. Emission level (dBuV/m) = Raw Value (dBuV) + Correction Factor (dB/m).
 2. Correction Factor (dB/m) = Antenna Factor (dB/m) + Cable Factor (dB).
 3. The other emission levels were very low against the limit.
 4. Margin value = Emission level – Limit value.
 5. “ * ”: Fundamental frequency.
 6. The limit value is defined as per 15.247.



A D T

EUT TEST CONDITION		MEASUREMENT DETAIL	
CHANNEL	Channel 165	FREQUENCY RANGE	1 ~ 40GHz
INPUT POWER (SYSTEM)	120Vac, 60 Hz	DETECTOR FUNCTION	Peak (PK) Average (AV)
ENVIRONMENTAL CONDITIONS	22deg. C, 64%RH 1002 hPa	TESTED BY	Frank Liu

ANTENNA POLARITY & TEST DISTANCE: HORIZONTAL AT 3 M								
NO.	FREQ. (MHz)	EMISSION LEVEL (dBuV/m)	LIMIT (dBuV/m)	MARGIN (dB)	ANTENNA HEIGHT (m)	TABLE ANGLE (Degree)	RAW VALUE (dBuV)	CORRECTION FACTOR (dB/m)
1	*5825.00	100.4 PK			1.30 H	287	58.62	41.78
2	*5825.00	89.8 AV			1.30 H	287	48.02	41.78
3	11650.00	55.9 PK	74.0	-18.1	1.01 H	158	8.07	47.83
4	11650.00	44.9 AV	54.0	-9.1	1.01 H	158	-2.93	47.83

ANTENNA POLARITY & TEST DISTANCE: VERTICAL AT 3 M								
NO.	FREQ. (MHz)	EMISSION LEVEL (dBuV/m)	LIMIT (dBuV/m)	MARGIN (dB)	ANTENNA HEIGHT (m)	TABLE ANGLE (Degree)	RAW VALUE (dBuV)	CORRECTION FACTOR (dB/m)
1	*5825.00	110.7 PK			1.04 V	244	68.92	41.78
2	*5825.00	100.5 AV			1.04 V	244	58.72	41.78
3	11650.00	55.9 PK	74.0	-18.1	1.00 V	231	8.07	47.83
4	11650.00	45.7 AV	54.0	-8.3	1.00 V	231	-2.13	47.83

- REMARKS:**
1. Emission level (dBuV/m) = Raw Value (dBuV) + Correction Factor (dB/m).
 2. Correction Factor (dB/m) = Antenna Factor (dB/m) + Cable Factor (dB).
 3. The other emission levels were very low against the limit.
 4. Margin value = Emission level – Limit value.
 5. “ * ”: Fundamental frequency.
 6. The limit value is defined as per 15.247.

5.3 6dB BANDWIDTH MEASUREMENT

5.3.1 LIMITS OF 6dB BANDWIDTH MEASUREMENT

The minimum of 6dB Bandwidth Measurement is 0.5 MHz.

5.3.2 TEST INSTRUMENTS

Test date: May 16, 2011

DESCRIPTION & MANUFACTURER	MODEL NO.	SERIAL NO.	CALIBRATED DATE	CALIBRATED UNTIL
SPECTRUM ANALYZER R&S	FSP 40	100060	May 11, 2011	May 10, 2012

NOTE: 1. The calibration interval of the above test instruments is 12 months and the calibrations are traceable to NML/ROC and NIST/USA.

5.3.3 TEST PROCEDURE

The transmitter output was connected to the spectrum analyzer through an attenuator. The bandwidth of the fundamental frequency was measured by spectrum analyzer with 100kHz RBW and 300kHz VBW. The 6dB bandwidth is defined as the total spectrum the power of which is higher than peak power minus 6dB.

5.3.4 DEVIATION FROM TEST STANDARD

No deviation

5.3.5 TEST SETUP

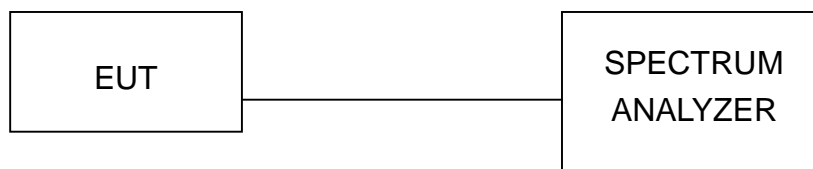

5.3.6 EUT OPERATING CONDITIONS

The software provided by client to enable the EUT under transmission condition continuously at lowest, middle and highest channel frequencies individually.



A D T

5.3.7 TEST RESULTS

802.11a OFDM MODULATION:

CHANNEL	CHANNEL FREQUENCY (MHz)	6dB BANDWIDTH (MHz)	MINIMUM LIMIT (MHz)	PASS / FAIL
149	5745	15.67	0.5	PASS
157	5785	15.12	0.5	PASS
165	5825	15.16	0.5	PASS

CH149

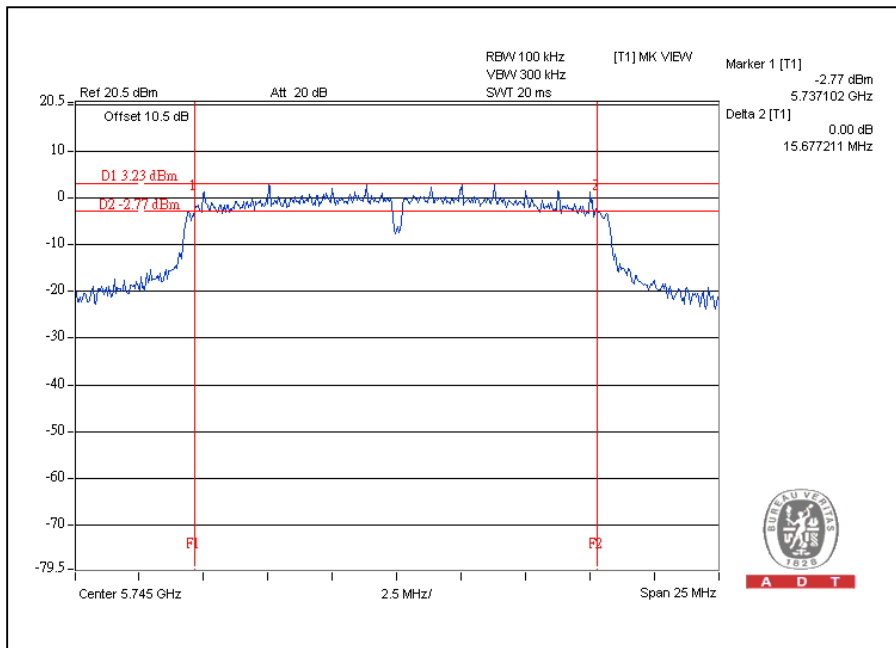



A D T

CH157

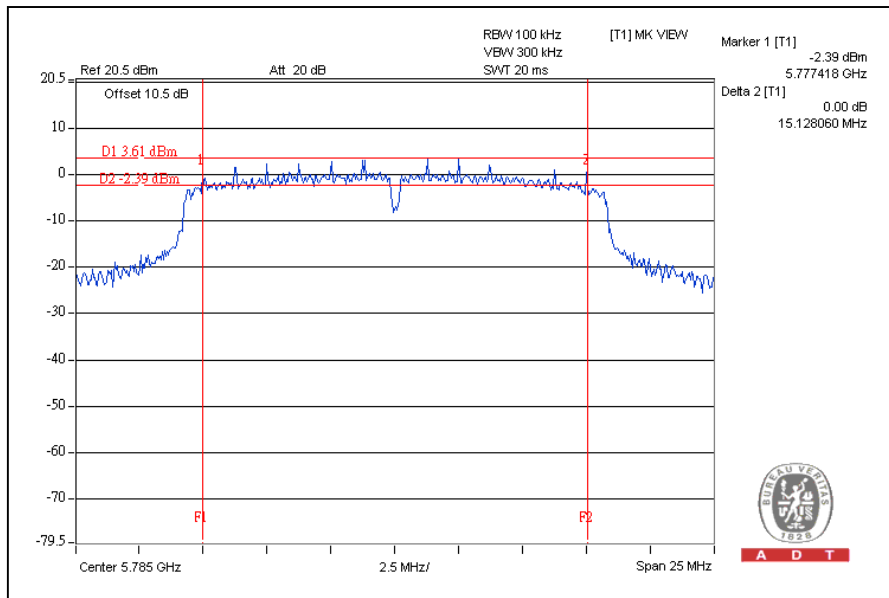

CH165

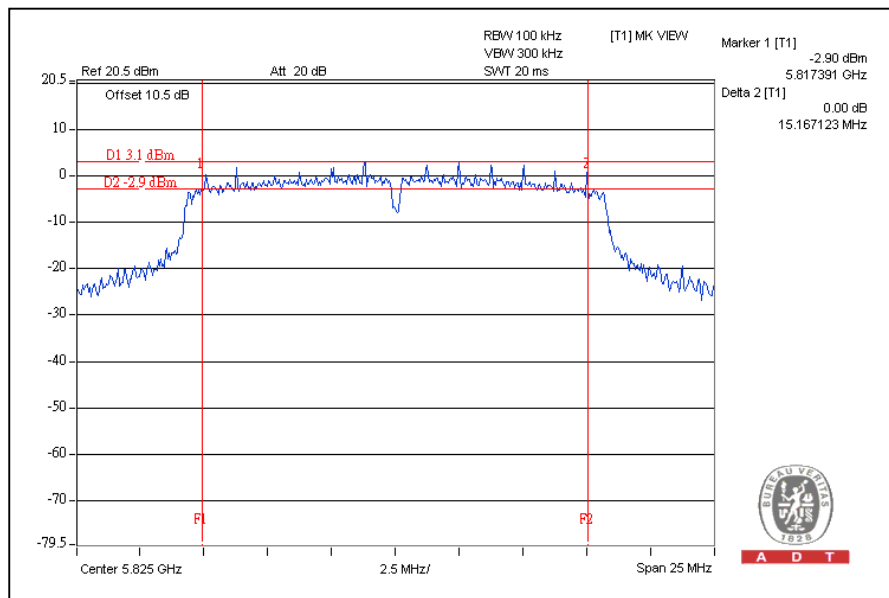



A D T

802.11n(20MHz) OFDM MODULATION:

CHANNEL	CHANNEL FREQUENCY (MHz)	6dB BANDWIDTH (MHz)	MINIMUM LIMIT (MHz)	PASS / FAIL
149	5745	15.72	0.5	PASS
157	5785	15.57	0.5	PASS
165	5825	16.08	0.5	PASS

CH149

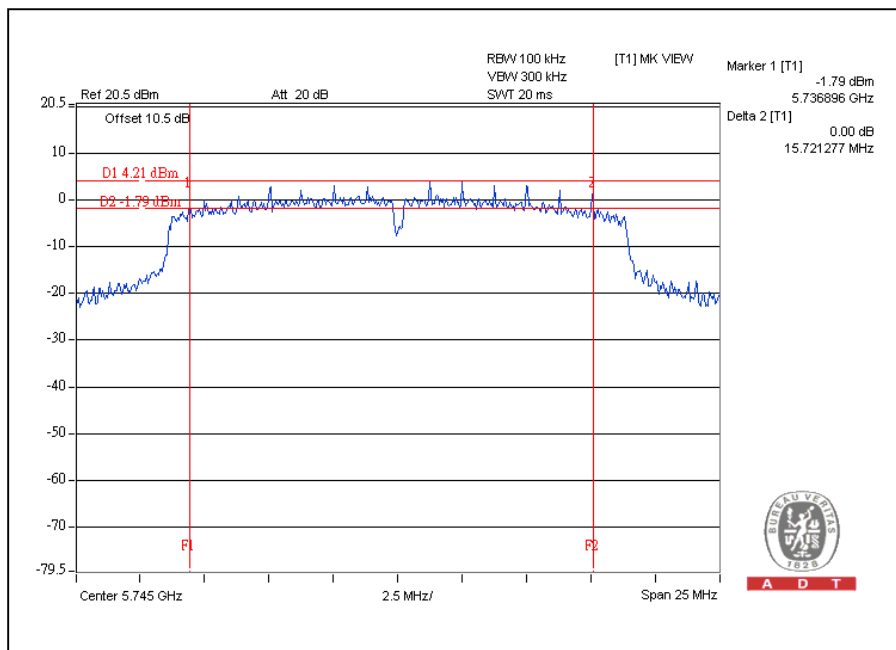



A D T

CH157

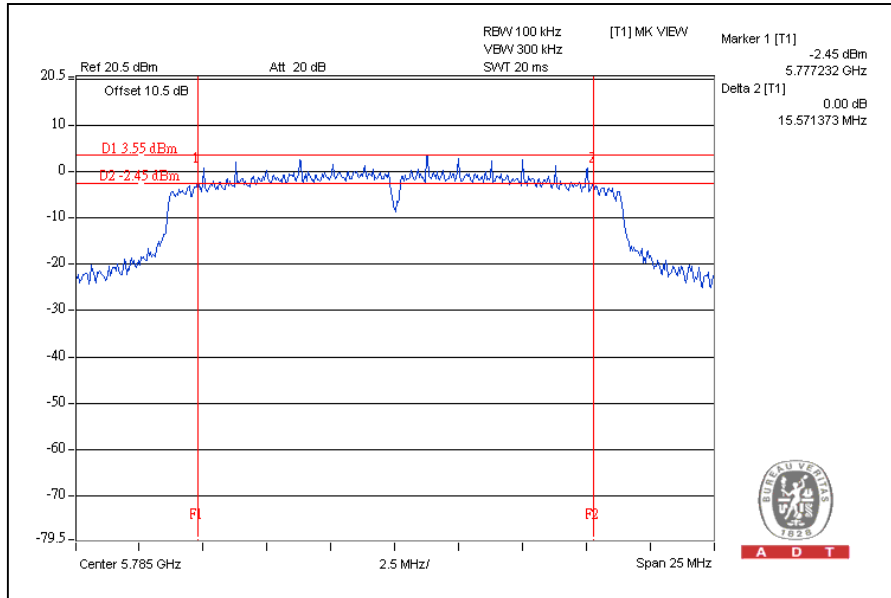

A D T

CH165

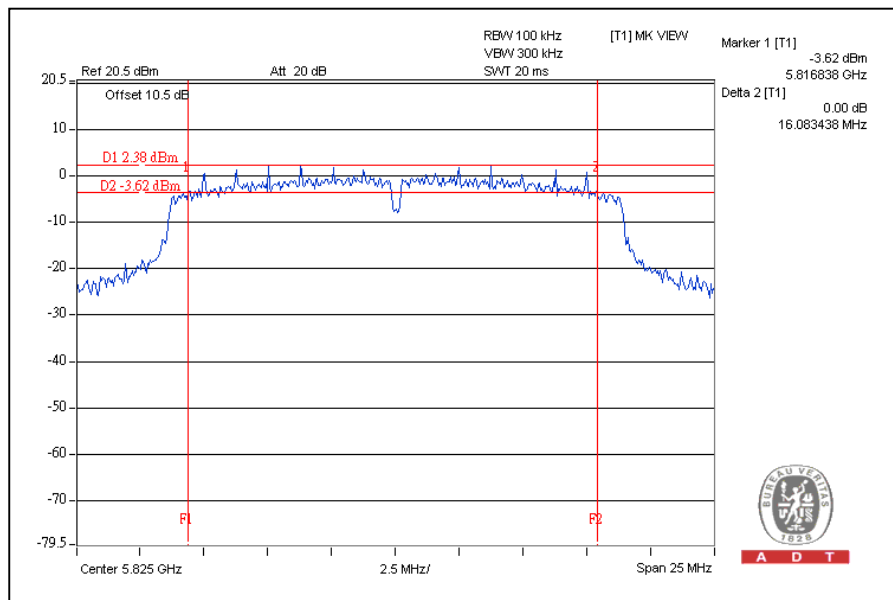

A D T

5.4 MAXIMUM PEAK OUTPUT POWER

5.4.1 LIMITS OF MAXIMUM PEAK OUTPUT POWER MEASUREMENT

The Maximum Peak Output Power Measurement is 30dBm.

5.4.2 INSTRUMENTS

Test date: May 16, 2011

DESCRIPTION & MANUFACTURER	MODEL NO.	SERIAL NO.	CALIBRATED DATE	CALIBRATED UNTIL
Anritsu Power Meter	ML2495A	0824006	May 04, 2011	May 03, 2012
Pulse Power Sensor	MA2411B	0738172	May 03, 2011	May 02, 2012

NOTE:

The calibration interval of the above test instruments is 12 months and the calibrations are traceable to NML/ROC and NIST/USA.

5.4.3 TEST PROCEDURES

1. The transmitter output was connected to the power meter through an attenuator; the bandwidth of the fundamental frequency was measured with the power meter.
2. Record the power level.

5.4.4 DEVIATION FROM TEST STANDARD

No deviation

5.4.5 TEST SETUP

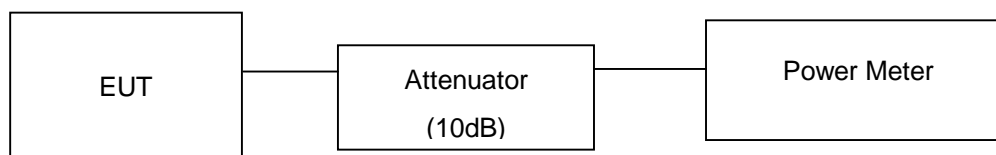

5.4.6 EUT OPERATING CONDITIONS

Same as Item 4.3.6



A D T

5.4.7 TEST RESULTS(MODE A)

802.11a OFDM modulation:

CHANNEL	CHANNEL FREQUENCY (MHz)	PEAK POWER (mW)	PEAK POWER (dBm)	PEAK POWER LIMIT (dBm)	PASS / FAIL
149	5745	134.9	21.3	30	PASS
157	5785	138.0	21.4	30	PASS
165	5825	138.0	21.4	30	PASS

802.11n(20MHz) OFDM modulation:

CHANNEL	CHANNEL FREQUENCY (MHz)	PEAK POWER (mW)	PEAK POWER (dBm)	PEAK POWER LIMIT (dBm)	PASS / FAIL
149	5745	131.8	21.2	30	PASS
157	5785	128.8	21.1	30	PASS
165	5825	131.8	21.2	30	PASS



A D T

5.4.8 TEST RESULTS(MODE B)

802.11a OFDM modulation:

CHANNEL	CHANNEL FREQUENCY (MHz)	PEAK POWER (mW)	PEAK POWER (dBm)	PEAK POWER LIMIT (dBm)	PASS / FAIL
149	5745	162.2	22.1	30	PASS
157	5785	166.0	22.2	30	PASS
165	5825	166.0	22.2	30	PASS

802.11n(20MHz) OFDM modulation:

CHANNEL	CHANNEL FREQUENCY (MHz)	PEAK POWER (mW)	PEAK POWER (dBm)	PEAK POWER LIMIT (dBm)	PASS / FAIL
149	5745	158.5	22.0	30	PASS
157	5785	154.9	21.9	30	PASS
165	5825	158.5	22.0	30	PASS



5.5 POWER SPECTRAL DENSITY MEASUREMENT

5.5.1 LIMITS OF POWER SPECTRAL DENSITY MEASUREMENT

The Maximum of Power Spectral Density Measurement is 8dBm.

5.5.2 TEST INSTRUMENTS

Test date: May 16, 2011

DESCRIPTION & MANUFACTURER	MODEL NO.	SERIAL NO.	CALIBRATED DATE	CALIBRATED UNTIL
SPECTRUM ANALYZER R&S	FSP 40	100060	May 11, 2011	May 10, 2012

NOTE: 1. The calibration interval of the above test instruments is 12 months and the calibrations are traceable to NML/ROC and NIST/USA.

5.5.3 TEST PROCEDURE

The transmitter output was connected to the spectrum analyzer through an attenuator, the bandwidth of the fundamental frequency was measured with the spectrum analyzer using 3 kHz RBW and 30 kHz VBW, set sweep time = span/3 kHz. The power spectral density was measured and recorded. The sweep time is allowed to be longer than span/3 kHz for a full response of the mixer in the spectrum analyzer.

5.5.4 DEVIATION FROM TEST STANDARD

No deviation

5.5.5 TEST SETUP



5.5.6 EUT OPERATING CONDITION

Same as Item 4.3.6



A D T

CH157

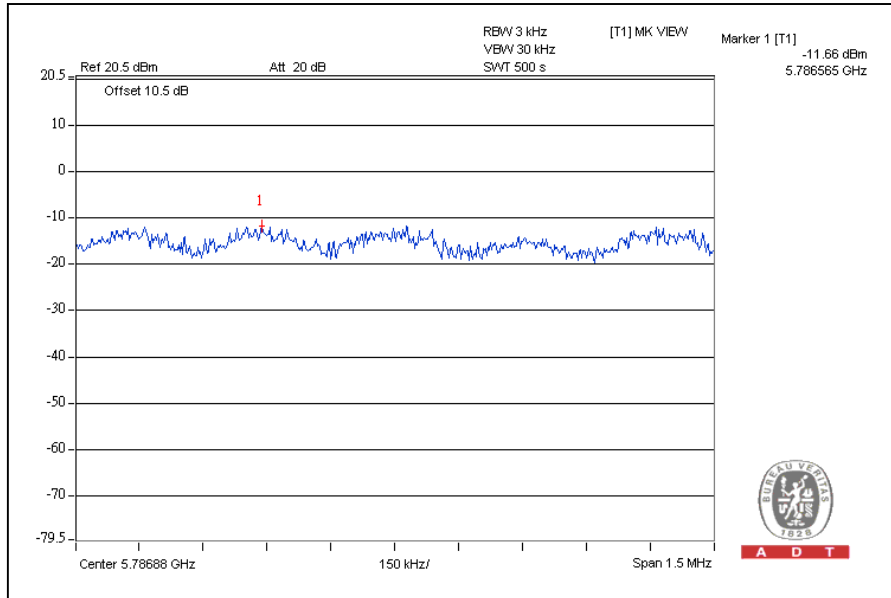

CH165

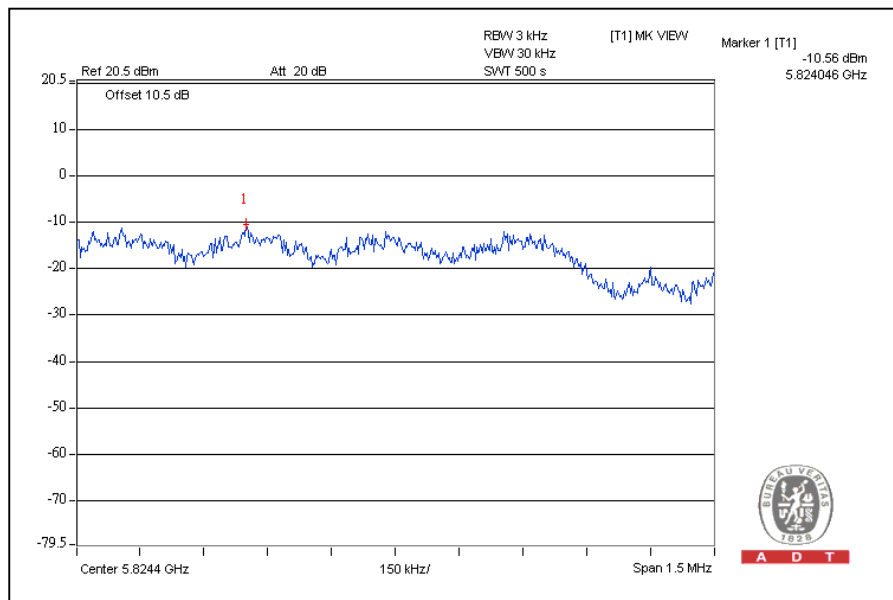



A D T

802.11n(20MHz) OFDM modulation

CHANNEL	CHANNEL FREQUENCY (MHz)	RF POWER LEVEL IN 3kHz BW (dBm)	MAXIMUM LIMIT (dBm)	PASS / FAIL
149	5745	-10.8	8	PASS
157	5785	-10.8	8	PASS
165	5825	-12.2	8	PASS

CH149

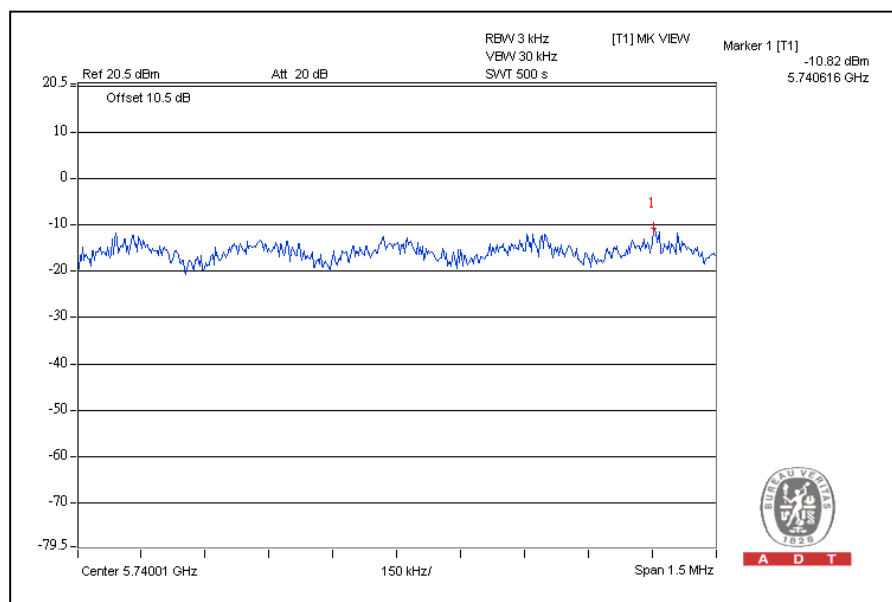



A D T

CH157

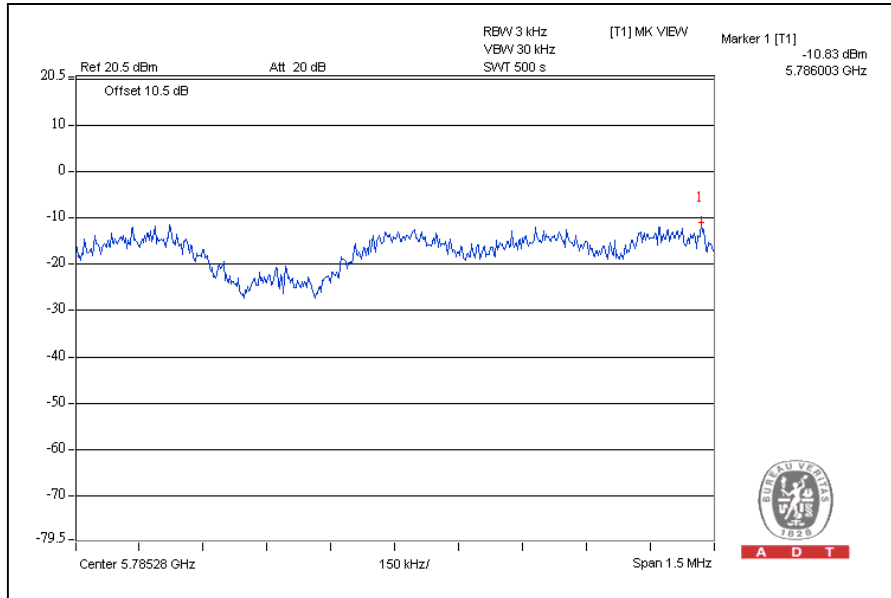

A D T

CH165

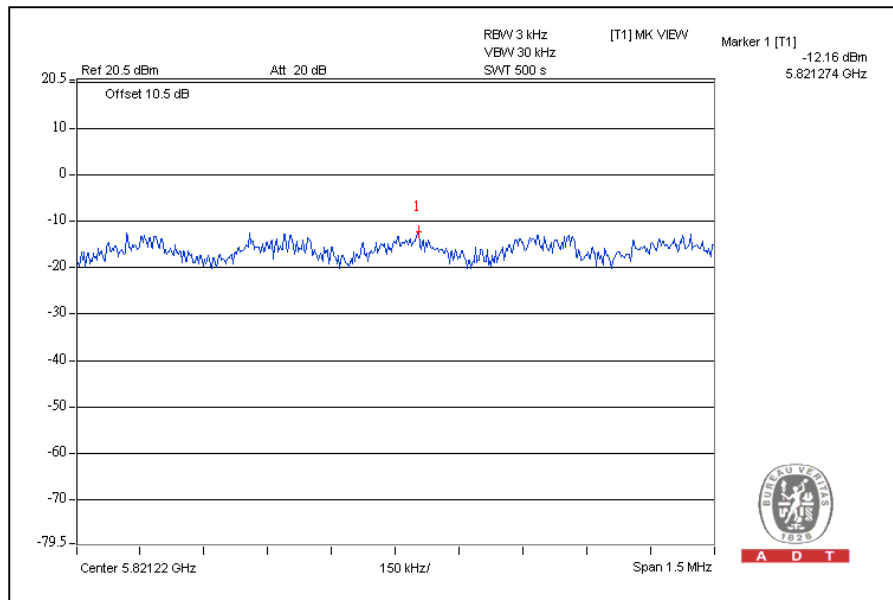

A D T

5.5.8 TEST RESULTS(MODE B)

802.11a OFDM modulation

CHANNEL	CHANNEL FREQUENCY (MHz)	RF POWER LEVEL IN 3kHz BW (dBm)	MAXIMUM LIMIT (dBm)	PASS / FAIL
149	5745	-9.7	8	PASS
157	5785	-10.9	8	PASS
165	5825	-9.8	8	PASS

802.11n(20MHz) OFDM modulation

CHANNEL	CHANNEL FREQUENCY (MHz)	RF POWER LEVEL IN 3kHz BW (dBm)	MAXIMUM LIMIT (dBm)	PASS / FAIL
149	5745	-10.0	8	PASS
157	5785	-10.0	8	PASS
165	5825	-11.8	8	PASS



5.6 CONDUCTED OUT-BAND EMISSION MEASUREMENT

5.6.1 LIMITS OF CONDUCTED OUT-BAND EMISSION MEASUREMENT

Below -20dB of the highest emission level of operating band (in 100kHz Resolution Bandwidth).

5.6.2 TEST INSTRUMENTS

Test date: May 16, 2011

DESCRIPTION & MANUFACTURER	MODEL NO.	SERIAL NO.	CALIBRATED DATE	CALIBRATED UNTIL
SPECTRUM ANALYZER R&S	FSP 40	100060	May 11, 2011	May 10, 2012

NOTE:

1. The calibration interval of the above test instruments is 12 months and the calibrations are traceable to NML/ROC and NIST/USA.

5.6.3 TEST PROCEDURE

The transmitter output was connected to the spectrum analyzer via a low lose cable. Set RBW of spectrum analyzer to 100kHz and VBW of spectrum analyzer to 300kHz with suitable frequency span including 100 MHz bandwidth from band edge. The band edges was measured and recorded.

The spectrum plots (RBW = 100kHz, VBW = 300kHz) are attached on the following pages.

5.6.4 DEVIATION FROM TEST STANDARD

No deviation

5.6.5 EUT OPERATING CONDITION

Same as Item 4.3.6

5.6.6 TEST RESULTS

The spectrum plots are attached on the following pages. D2 line indicates the highest level, D1 line indicates the 20dB offset below D2. It shows compliance with the requirement in part 15.247(d).



A D T

802.11a OFDM modulation

CH149

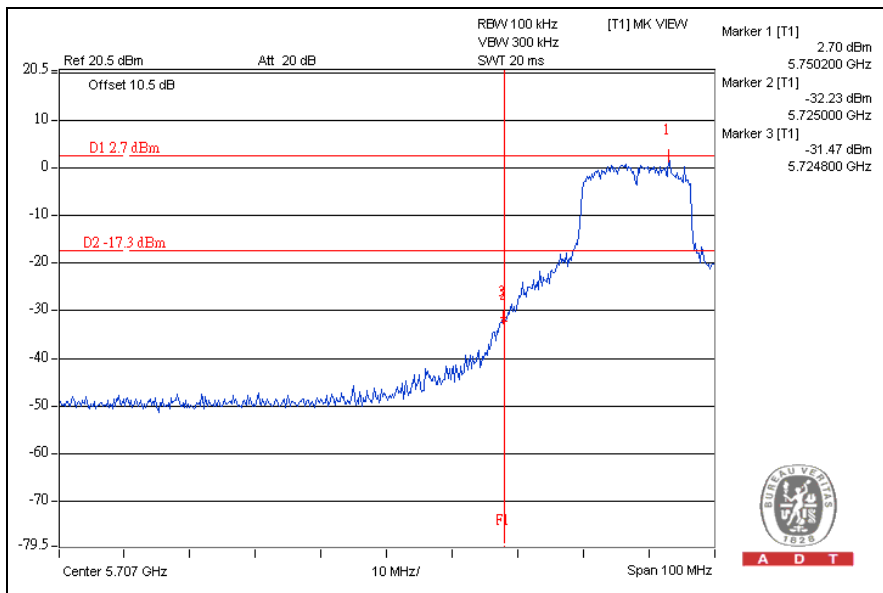

CH165

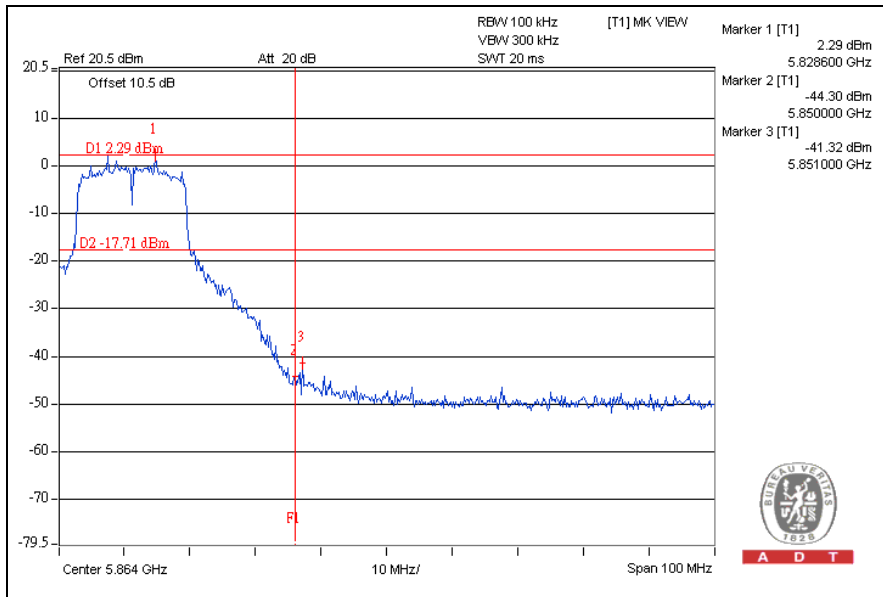



A D T

CH149

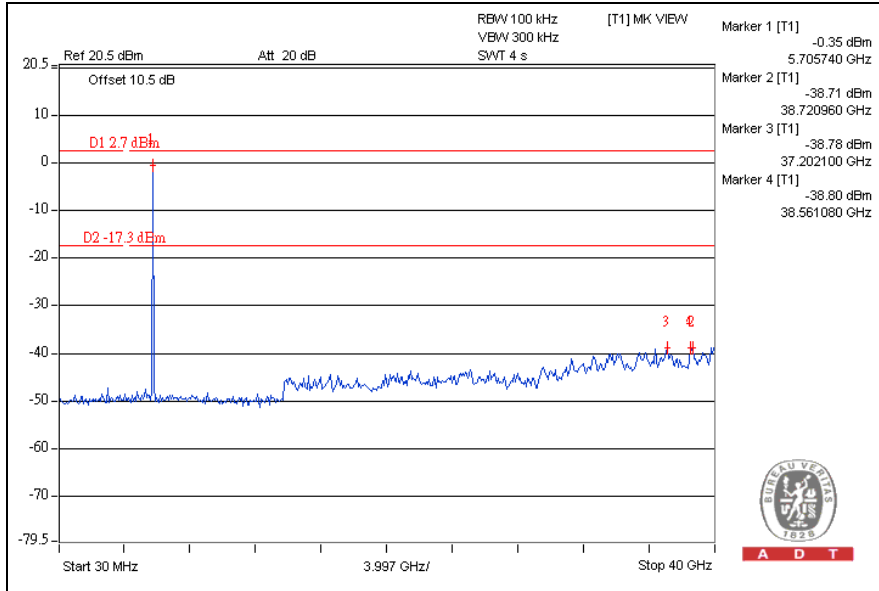

CH165

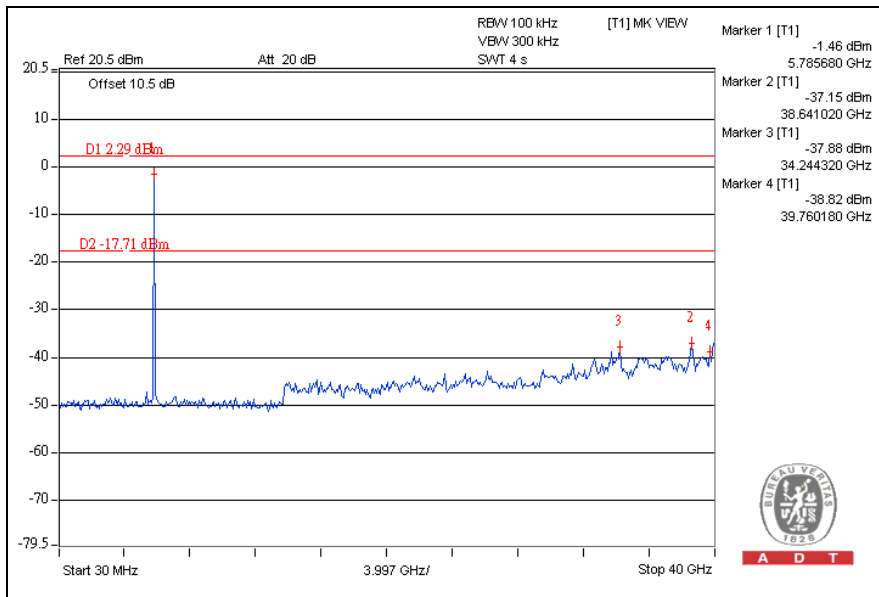



A D T

802.11n(20MHz) OFDM modulation

CH149

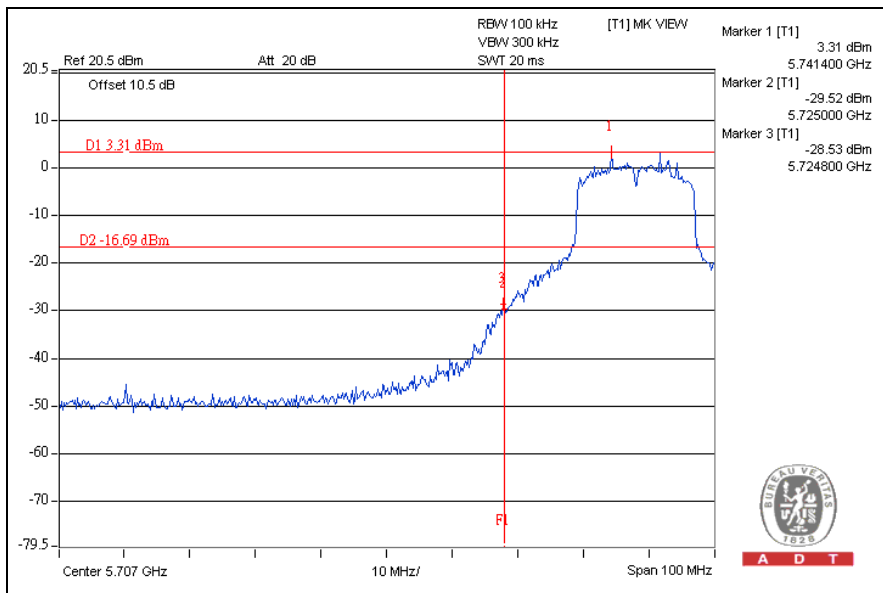

CH165

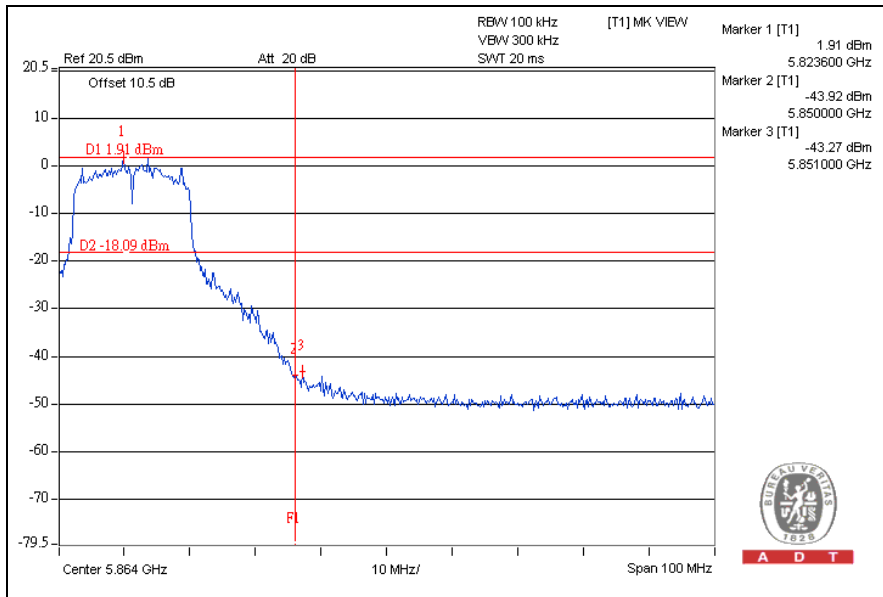



A D T

CH149

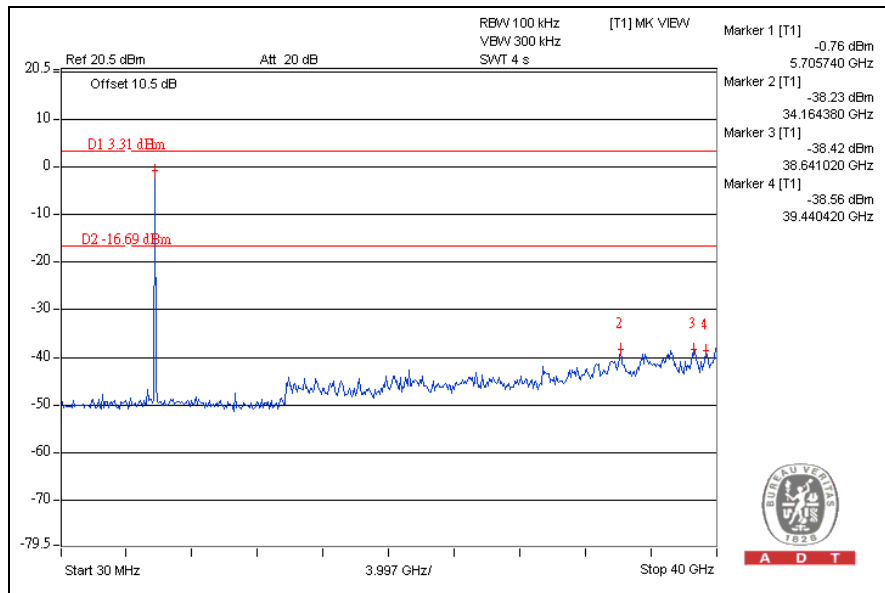

CH165

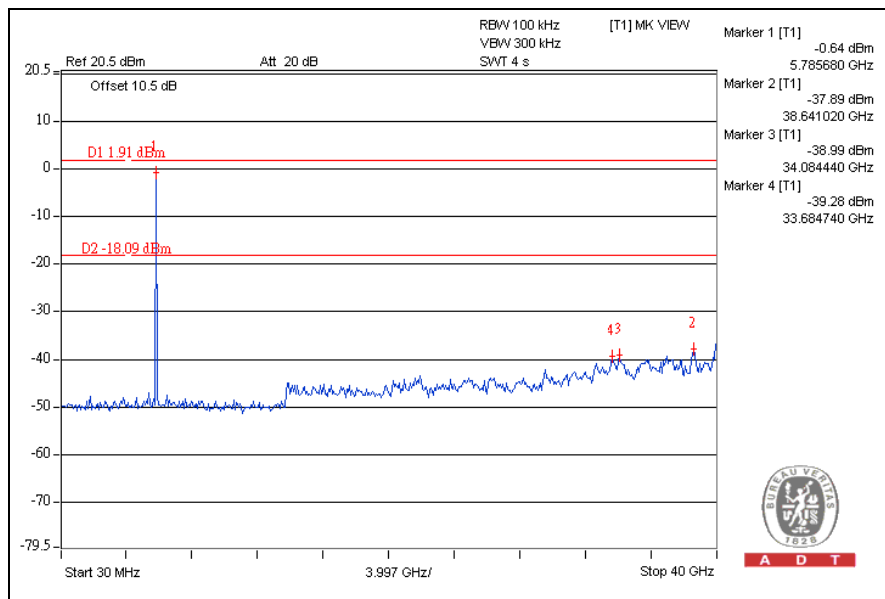



6. INFORMATION ON THE TESTING LABORATORIES

We, Bureau Veritas Consumer Products Services (H.K.) Ltd., Taoyuan Branch, were founded in 1988 to provide our best service in EMC, Radio, Telecom and Safety consultation. Our laboratories are accredited and approved according to ISO/IEC 17025:

Copies of accreditation certificates of our laboratories obtained from approval agencies can be downloaded from our web site: www.adt.com.tw/index.5.phtml.
If you have any comments, please feel free to contact us at the following:

Linko EMC/RF Lab:

Tel: 886-2-26052180

Fax: 886-2-26052943

Hsin Chu EMC/RF Lab:

Tel: 886-3-5935343

Fax: 886-3-5935342

Hwa Ya EMC/RF/Safety/Telecom Lab:

Tel: 886-3-3183232

Fax: 886-3-3185050

Email: service.adt@tw.bureauveritas.com

Web Site: www.adt.com.tw

The address and road map of all our labs can be found in our web site also.



A D T

7.APPENDIX A - MODIFICATIONS RECORDERS FOR ENGINEERING CHANGES TO THE EUT BY THE LAB

No any modifications are made to the EUT by the lab during the test.

--- END ---