

FCC Test Report

Report No.: RF160128E09-3

FCC ID: UZ7WT6000

Test Model: WT6000

Received Date: Jan. 28, 2016

Test Date: Mar. 02 to Apr. 19, 2016

Issued Date: Apr. 26, 2016

Applicant: Zebra Technologies Corporation

Address: 1 Zebra Plaza, Holtsville, NY 11742

Manufacturer: Zebra Technologies Corporation

Address: 1 Zebra Plaza, Holtsville, NY 11742

Issued By: Bureau Veritas Consumer Products Services (H.K.) Ltd., Taoyuan Branch
Hsin Chu Laboratory

Lab Address: E-2, No.1, Li Hsin 1st Road, Hsinchu Science Park, Hsinchu City 300,
Taiwan R.O.C.

Test Location (1): E-2, No.1, Li Hsin 1st Road, Hsinchu Science Park, Hsinchu City 300,
Taiwan R.O.C.

Test Location (2): No. 49, Ln. 206, Wende Rd., Shangshan Tsuen, Chiung Lin Hsiang, Hsin
Chu Hsien 307, Taiwan R.O.C.



This report is for your exclusive use. Any copying or replication of this report to or for any other person or entity, or use of our name or trademark, is permitted only with our prior written permission. This report sets forth our findings solely with respect to the test samples identified herein. The results set forth in this report are not indicative or representative of the quality or characteristics of the lot from which a test sample was taken or any similar or identical product unless specifically and expressly noted. Our report includes all of the tests requested by you and the results thereof based upon the information that you provided to us. You have 60 days from date of issuance of this report to notify us of any material error or omission caused by our negligence, provided, however, that such notice shall be in writing and shall specifically address the issue you wish to raise. A failure to raise such issue within the prescribed time shall constitute your unqualified acceptance of the completeness of this report, the tests conducted and the correctness of the report contents. Unless specific mention, the uncertainty of measurement has been explicitly taken into account to declare the compliance or non-compliance to the specification. The report must not be used by the client to claim product certification, approval, or endorsement by TAF or any government agencies.



Table of Contents

| | |
|---|-----------|
| Release Control Record | 4 |
| 1 Certificate of Conformity | 5 |
| 2 Summary of Test Results | 6 |
| 2.1 Measurement Uncertainty..... | 7 |
| 2.2 Modification Record..... | 7 |
| 3 General Information | 8 |
| 3.1 General Description of EUT..... | 8 |
| 3.2 Description of Test Modes..... | 11 |
| 3.2.1 Test Mode Applicability and Tested Channel Detail..... | 12 |
| 3.3 Description of Support Units..... | 14 |
| 3.3.1 Configuration of System under Test..... | 15 |
| 3.4 General Description of Applied Standards..... | 16 |
| 4 Test Types and Results | 17 |
| 4.1 Radiated Emission and Bandedge Measurement..... | 17 |
| 4.1.1 Limits of Radiated Emission and Bandedge Measurement..... | 17 |
| 4.1.2 Test Instruments..... | 18 |
| 4.1.3 Test Procedures..... | 20 |
| 4.1.4 Deviation from Test Standard..... | 20 |
| 4.1.5 Test Setup..... | 21 |
| 4.1.6 EUT Operating Conditions..... | 21 |
| 4.1.7 Test Results..... | 22 |
| 4.2 Conducted Emission Measurement..... | 34 |
| 4.2.1 Limits of Conducted Emission Measurement..... | 34 |
| 4.2.2 Test Instruments..... | 34 |
| 4.2.3 Test Procedures..... | 35 |
| 4.2.4 Deviation From Test Standard..... | 35 |
| 4.2.5 Test Setup..... | 35 |
| 4.2.6 EUT Operating Condition..... | 35 |
| 4.2.7 Test Results (Mode 1)..... | 36 |
| 4.2.8 Test Results (Mode 2)..... | 38 |
| 4.3 Number of Hopping Frequency Used..... | 40 |
| 4.3.1 Limits of Hopping Frequency Used Measurement..... | 40 |
| 4.3.2 Test Setup..... | 40 |
| 4.3.3 Test Instruments..... | 40 |
| 4.3.4 Test Procedure..... | 40 |
| 4.3.5 Deviation from Test Standard..... | 40 |
| 4.3.6 Test Results..... | 41 |
| 4.4 Dwell Time on Each Channel..... | 42 |
| 4.4.1 Limits of Dwell Time on Each Channel Measurement..... | 42 |
| 4.4.2 Test Setup..... | 42 |
| 4.4.3 Test Instruments..... | 42 |
| 4.4.4 Test Procedures..... | 42 |
| 4.4.5 Deviation from Test Standard..... | 42 |
| 4.4.6 Test Results..... | 43 |
| 4.5 Channel Bandwidth..... | 47 |
| 4.5.1 Limits of Channel Bandwidth Measurement..... | 47 |
| 4.5.2 Test Setup..... | 47 |
| 4.5.3 Test Instruments..... | 47 |
| 4.5.4 Test Procedure..... | 47 |
| 4.5.5 Deviation from Test Standard..... | 47 |
| 4.5.6 EUT Operating Condition..... | 47 |
| 4.5.7 Test Results..... | 48 |
| 4.6 Hopping Channel Separation..... | 49 |

| | | |
|----------|---|-----------|
| 4.6.1 | Limits of Hopping Channel Separation Measurement..... | 49 |
| 4.6.2 | Test Setup..... | 49 |
| 4.6.3 | Test Instruments | 49 |
| 4.6.4 | Test Procedure | 49 |
| 4.6.5 | Deviation from Test Standard | 49 |
| 4.6.6 | Test Results | 50 |
| 4.7 | Maximum Output Power..... | 51 |
| 4.7.1 | Limits of Maximum Output Power Measurement | 51 |
| 4.7.2 | Test Setup..... | 51 |
| 4.7.3 | Test Instruments | 51 |
| 4.7.4 | Test Procedure | 51 |
| 4.7.5 | Deviation from Test Standard | 51 |
| 4.7.6 | EUT Operating Condition | 51 |
| 4.7.7 | Test Results | 52 |
| 4.8 | Conducted Out of Band Emission Measurement..... | 53 |
| 4.8.1 | Limits of Conducted Out of Band Emission Measurement | 53 |
| 4.8.2 | Test Instruments | 53 |
| 4.8.3 | Test Procedure | 53 |
| 4.8.4 | Deviation from Test Standard | 53 |
| 4.8.5 | Eut Operating Condition | 53 |
| 4.8.6 | Test Results | 53 |
| 5 | Pictures of Test Arrangements..... | 56 |
| | Appendix – Information on the Testing Laboratories | 57 |



A D T

Release Control Record

| Issue No. | Description | Date Issued |
|---------------|-------------------|---------------|
| RF160128E09-3 | Original release. | Apr. 26, 2016 |



A D T

1 Certificate of Conformity

Product: Wearable Terminal

Brand: Zebra

Test Model: WT6000

Sample Status: ENGINEERING SAMPLE

Applicant: Zebra Technologies Corporation

Test Date: Mar. 02 to Apr. 19, 2016

Standards: 47 CFR FCC Part 15, Subpart C (Section 15.247)
ANSI C63.10: 2013

The above equipment has been tested by **Bureau Veritas Consumer Products Services (H.K.) Ltd., Taoyuan Branch**, and found compliance with the requirement of the above standards. The test record, data evaluation & Equipment Under Test (EUT) configurations represented herein are true and accurate accounts of the measurements of the sample's EMC characteristics under the conditions specified in this report.

Prepared by : _____

Wendy Wu
Wendy Wu / Specialist

Date: _____

Apr. 26, 2016

Approved by : _____

May Chen
May Chen / Manager

Date: _____

Apr. 26, 2016



2 Summary of Test Results

| 47 CFR FCC Part 15, Subpart C (SECTION 15.247) | | | |
|--|---|--------|--|
| FCC Clause | Test Item | Result | Remarks |
| 15.207 | AC Power Conducted Emission | PASS | Meet the requirement of limit. Minimum passing margin is -11.87dB at 0.41953MHz. |
| 15.247(a)(1)(iii) | Number of Hopping Frequency Used | PASS | Meet the requirement of limit. |
| 15.247(a)(1)(iii) | Dwell Time on Each Channel | PASS | Meet the requirement of limit. |
| 15.247(a)(1) | 1. Hopping Channel Separation 2. Spectrum Bandwidth of a Frequency Hopping Sequence Spread Spectrum System | PASS | Meet the requirement of limit. |
| 15.247(b) | Maximum Peak Output Power | PASS | Meet the requirement of limit. |
| 15.205 & 209 & 15.247(d) | Radiated Emissions & Band Edge Measurement | PASS | Meet the requirement of limit. Minimum passing margin is -3.5dB at 323.65MHz. |
| 15.247(d) | Antenna Port Emission | PASS | Meet the requirement of limit. |
| 15.203 | Antenna Requirement | PASS | Antenna connector is i-pex (MHF) not a standard connector. |

NOTE: If The Frequency Hopping System operating in 2400-2483.5MHz band and the output power less than 125mW. The hopping channel carrier frequencies separated by a minimum of 25kHz or two-thirds of the 20dB bandwidth of hopping channel whichever is greater.

2.1 Measurement Uncertainty

Where relevant, the following measurement uncertainty levels have been estimated for tests performed on the EUT as specified in CISPR 16-4-2:

| Measurement | Frequency | Expanded Uncertainty (k=2) (\pm) |
|------------------------------------|----------------|--------------------------------------|
| Conducted Emissions at mains ports | 150kHz ~ 30MHz | 2.86 dB |
| Radiated Emissions up to 1 GHz | 30MHz ~ 1GHz | 5.31 dB |
| Radiated Emissions above 1 GHz | 1GHz ~ 6GHz | 3.43 dB |
| | 6GHz ~ 18GHz | 3.49 dB |
| | 18GHz ~ 40GHz | 4.11 dB |

2.2 Modification Record

There were no modifications required for compliance.

3 General Information

3.1 General Description of EUT (BT-EDR)

| | |
|-----------------------|---|
| Product | Wearable Terminal |
| Brand | Zebra |
| Test Model | WT6000 |
| Status of EUT | ENGINEERING SAMPLE |
| SW Version | 3.14.52 |
| Power Supply Rating | DC 3.6V from Battery or DC 5.4V from Cradle or DC 5.4V from Adapter |
| Modulation Type | GFSK, $\pi/4$ -DQPSK, 8DPSK |
| Modulation Technology | FHSS |
| Transfer Rate | Up to 3Mbps |
| Operating Frequency | 2402MHz ~ 2480MHz |
| Number of Channel | 79 |
| Output Power | 4.178mW |
| Antenna Type | Refer to Note |
| Antenna Connector | Refer to Note |
| Accessory Device | Battery x1 |
| Data Cable Supplied | NA |

Note:

1. There are WLAN, BT, NFC technology used for the EUT.
2. For WLAN: 2.4GHz and 5GHz technology cannot transmit at same time.
3. WLAN <2.4GHz (1x2) or 5GHz (1x2)> + BT + NFC technology can transmit at same time.
4. The EUT could be supplied with a cradle, adapter or battery as below table:

| | |
|--|---|
| Battery | |
| Brand: | ZEBRA TECHNOLOGIES CORPORATION |
| Part No.: | BT000262A01 |
| Rating: | TYP: 3350mAh, 12.06WH Min: 3200mAh, 11.52WH Rechargeable, normal voltage: 3.6V, limit 4.2V |
| Cradles- 1slot (not for sale together) | |
| Brand: | Zebra |
| Model No.: | SHARECRADLE-01 |
| Part No.: | SAC-TC8X-4SCHG-01 |
| Input Power | +12V ----- 4.16A |
| Output Power: | DC 5.4V(for EUT used) DC 4.2V(for Battery used) |
| I/O Port | DC Port x 1 USB Port x 2 |
| Associated Devices: | Adapter x 1 (Adapter: Part No.: PWRS-14000-148R) |
| Cradle adapter (for Cradle- 1slot used, not for sale together) | |
| Brand: | HIPRO |
| Model No.: | HP-A0502R3D |
| Part No.: | PWRS-14000-148R |
| Input power : | 100-240Vac, 2.4A, 50-60Hz |
| Output power : | +12Vdc ----- 4.16A DC output cable (unshielded, 1.8m with one core) |
| Adapter (not for sale together) | |
| Brand: | Zebra |
| Model No.: | PWRS-14000-249R |
| Input Power | 100-240Vac, 50-60Hz, 0.6A |
| Output Power: | +5.4Vdc ----- 3A 1. DC output cable (unshielded, 1.8m) 2. USB charging cable (Brand: SINBON, Model: A9304774-005, shielded, 0.95m with one core) |

5. The EUT antennas information:

| WLAN / BT antenna | | | | |
|---------------------|---|-----------------|----------------|----------------|
| Transmitter Circuit | Antenna Gain(dBi) <Including cable loss> | Frequency range | Antenna Type | Connector Type |
| Chain (0) | 3.37 | 2.4~2.4835GHz | Patch | i-pex(MHF) |
| | 3.3 | 5.15~5.25GHz | Patch | i-pex(MHF) |
| | 3.3 | 5.25~5.35GHz | Patch | i-pex(MHF) |
| | 3.2 | 5.47~5.725GHz | Patch | i-pex(MHF) |
| | 0.61 | 5.725~5.85GHz | Patch | i-pex(MHF) |
| Chain (1) | 3.86 | 2.4~2.4835GHz | Patch | i-pex(MHF) |
| | 3.66 | 5.15~5.25GHz | Patch | i-pex(MHF) |
| | 3.66 | 5.25~5.35GHz | Patch | i-pex(MHF) |
| | 3.99 | 5.47~5.725GHz | Patch | i-pex(MHF) |
| | 3.99 | 5.725~5.85GHz | Patch | i-pex(MHF) |
| NFC antenna | | | | |
| Frequency range | Antenna Type | | Connector Type | |
| 13.56MHz | Loop | | NA | |

Note: In this report, it will fix transmission on Chain (0).

6. The EUT was pre-tested under following test modes:

| Mode | Terminal | Cradle | I/O (left) | I/O (right) | Polarity |
|--------|----------|--------|------------------|------------------|----------|
| Mode A | WT6000 | ----- | USB charge cable | wired RS419 coil | X-Y |
| Mode B | WT6000 | ----- | USB charge cable | wired RS419 coil | X-Z |
| Mode C | WT6000 | ----- | USB charge cable | wired RS419 coil | Y-Z |
| Mode D | WT6000 | 1-slot | 1-slot cradle | wired RS419 coil | NA |

From the above modes, the spurious emission below 1GHz worst case was found in **Mode D** and the spurious emission above 1GHz worst case was found in **Mode B** .Therefore only the test data of the modes were recorded in this report individually.

7. The above EUT information is declared by manufacturer and for more detailed features description, please refer to the manufacturer's specifications or user's manual.

3.2 Description of Test Modes

79 channels are provided for BT-EDR mode:

| Channel | Freq. (MHz) | Channel | Freq. (MHz) | Channel | Freq. (MHz) | Channel | Freq. (MHz) |
|---------|-------------|---------|-------------|---------|-------------|---------|-------------|
| 0 | 2402 | 20 | 2422 | 40 | 2442 | 60 | 2462 |
| 1 | 2403 | 21 | 2423 | 41 | 2443 | 61 | 2463 |
| 2 | 2404 | 22 | 2424 | 42 | 2444 | 62 | 2464 |
| 3 | 2405 | 23 | 2425 | 43 | 2445 | 63 | 2465 |
| 4 | 2406 | 24 | 2426 | 44 | 2446 | 64 | 2466 |
| 5 | 2407 | 25 | 2427 | 45 | 2447 | 65 | 2467 |
| 6 | 2408 | 26 | 2428 | 46 | 2448 | 66 | 2468 |
| 7 | 2409 | 27 | 2429 | 47 | 2449 | 67 | 2469 |
| 8 | 2410 | 28 | 2430 | 48 | 2450 | 68 | 2470 |
| 9 | 2411 | 29 | 2431 | 49 | 2451 | 69 | 2471 |
| 10 | 2412 | 30 | 2432 | 50 | 2452 | 70 | 2472 |
| 11 | 2413 | 31 | 2433 | 51 | 2453 | 71 | 2473 |
| 12 | 2414 | 32 | 2434 | 52 | 2454 | 72 | 2474 |
| 13 | 2415 | 33 | 2435 | 53 | 2455 | 73 | 2475 |
| 14 | 2416 | 34 | 2436 | 54 | 2456 | 74 | 2476 |
| 15 | 2417 | 35 | 2437 | 55 | 2457 | 75 | 2477 |
| 16 | 2418 | 36 | 2438 | 56 | 2458 | 76 | 2478 |
| 17 | 2419 | 37 | 2439 | 57 | 2459 | 77 | 2479 |
| 18 | 2420 | 38 | 2440 | 58 | 2460 | 78 | 2480 |
| 19 | 2421 | 39 | 2441 | 59 | 2461 | | |

3.2.1 Test Mode Applicability and Tested Channel Detail

| EUT CONFIGURE MODE | APPLICABLE TO | | | | DESCRIPTION |
|--------------------|---------------|-------|-----|------|--------------|
| | RE \geq 1G | RE<1G | PLC | APCM | |
| 1 | √ | √ | √ | √ | With Adapter |
| 2 | - | - | √ | - | With Cradles |

Where **RE \geq 1G**: Radiated Emission above 1GHz **RE<1G**: Radiated Emission below 1GHz
PLC: Power Line Conducted Emission **APCM**: Antenna Port Conducted Measurement

NOTE:

1. The EUT had been pre-tested on the positioned of each 3 axis. The worst case was found when positioned on **Z-plane**.
2. "-" means no effect.

Radiated Emission Test (Above 1GHz):

- Pre-Scan has been conducted to determine the worst-case mode from all possible combinations between available modulations, data rates and antenna ports (if EUT with antenna diversity architecture).
- Following channel(s) was (were) selected for the final test as listed below.

| AVAILABLE CHANNEL | TESTED CHANNEL | MODULATION TECHNOLOGY | MODULATION TYPE | PACKET TYPE |
|-------------------|----------------|-----------------------|-----------------|-------------|
| 0 to 78 | 0, 39, 78 | FHSS | GFSK | DH5 |
| 0 to 78 | 0, 39, 78 | FHSS | 8DPSK | 3DH5 |

Radiated Emission Test (Below 1GHz):

- Pre-Scan has been conducted to determine the worst-case mode from all possible combinations between available modulations, data rates and antenna ports (if EUT with antenna diversity architecture).
- Following channel(s) was (were) selected for the final test as listed below.

| AVAILABLE CHANNEL | TESTED CHANNEL | MODULATION TECHNOLOGY | MODULATION TYPE | PACKET TYPE |
|-------------------|----------------|-----------------------|-----------------|-------------|
| 0 to 78 | 0, 39, 78 | FHSS | GFSK | DH5 |
| 0 to 78 | 0, 39, 78 | FHSS | 8DPSK | 3DH5 |

Power Line Conducted Emission Test:

- Pre-Scan has been conducted to determine the worst-case mode from all possible combinations between available modulations, data rates and antenna ports (if EUT with antenna diversity architecture).
- Following channel(s) was (were) selected for the final test as listed below.

| AVAILABLE CHANNEL | TESTED CHANNEL | MODULATION TECHNOLOGY | MODULATION TYPE | PACKET TYPE |
|-------------------|----------------|-----------------------|-----------------|-------------|
| 0 to 78 | 78 | FHSS | 8DPSK | 3DH5 |

Antenna Port Conducted Measurement:

- This item includes all test value of each mode, but only includes spectrum plot of worst value of each mode.
- Pre-Scan has been conducted to determine the worst-case mode from all possible combinations between available modulations, data rates and antenna ports (if EUT with antenna diversity architecture).
- Following channel(s) was (were) selected for the final test as listed below.

| AVAILABLE CHANNEL | TESTED CHANNEL | MODULATION TECHNOLOGY | MODULATION TYPE | PACKET TYPE |
|-------------------|----------------|-----------------------|-----------------|-------------|
| 0 to 78 | 0, 39, 78 | FHSS | GFSK | DH5 |
| 0 to 78 | 0, 39, 78 | FHSS | 8DPSK | 3DH5 |

Test Condition:

| APPLICABLE TO | ENVIRONMENTAL CONDITIONS | INPUT POWER | TESTED BY | TEST LOCATION |
|------------------------------|--------------------------|--------------|---------------|---------------|
| RE\geq1G | 25deg. C, 65%RH | 120Vac, 60Hz | Tim Ho | 1 |
| RE$<$1G | 25deg. C, 69%RH | 120Vac, 60Hz | Tim Ho | 1 |
| PLC | 24deg. C, 82%RH | 120Vac, 60Hz | Wythe Lin | 2 |
| APCM | 21deg. C, 60%RH | 120Vac, 60Hz | Anderson Chen | 1 |

3.3 Description of Support Units

The EUT has been tested as an independent unit together with other necessary accessories or support units. The following support units or accessories were used to form a representative test configuration during the tests.

| ID | Product | Brand | Model No. | Serial No. | FCC ID | Remarks |
|----|-------------------|----------|---------------------|--------------|--------|--------------------|
| A. | Cradle Adapter | HIPRO | HP-A0502R3D | NA | NA | Supplied by client |
| B. | Cradles-1slot | ZEBRA | SHARECRADLE-01 | NA | NA | Supplied by client |
| C. | Notebook Computer | HP | Pavilion 14-ab023TU | 5CD5340WXZ | NA | Provided by Lab |
| D. | iPod shuffle | Apple | MC749TA/A | CC4DMFJUDFDM | NA | Provided by Lab |
| E. | Wired Scanner | ZEBRA | RS419 | NA | NA | Supplied by client |
| F. | Adapter | Motorola | PWRS-14000-249R | NA | NA | Supplied by client |

Note:

1. All power cords of the above support units are non-shielded (1.8m).

| ID | Descriptions | Qty. | Length (m) | Shielding (Yes/No) | Cores (Qty.) | Remarks |
|----|---------------------|------|------------|--------------------|--------------|--------------------|
| 1. | AC cable | 1 | 1.8 | No | 0 | Supplied by client |
| 2. | DC cable | 1 | 1.8 | No | 1 | Supplied by client |
| 3. | USB cable | 1 | 1.4 | No | 0 | Supplied by client |
| 4. | Wired Scanner cable | 1 | 0.5 | No | 0 | Supplied by client |
| 5. | USB cable | 1 | 0.1 | Yes | 0 | Provided by Lab |
| 6. | USB cable | 1 | 0.95 | No | 1 | Supplied by client |
| 7. | DC cable | 1 | 1.8 | No | 0 | Supplied by client |

Note: The core(s) is(are) originally attached to the cable(s).

3.3.1 Configuration of System under Test

For Radiated Emissions (below 1GHz) & Cradel mode test:

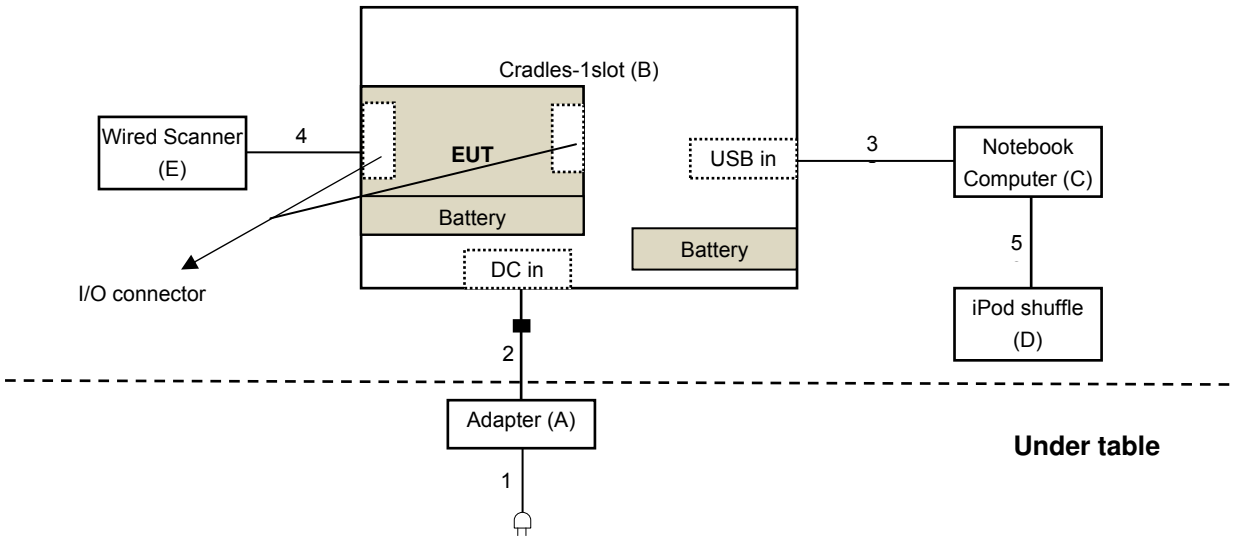

For Radiated Emissions (Above 1GHz) & Adapter mode test:

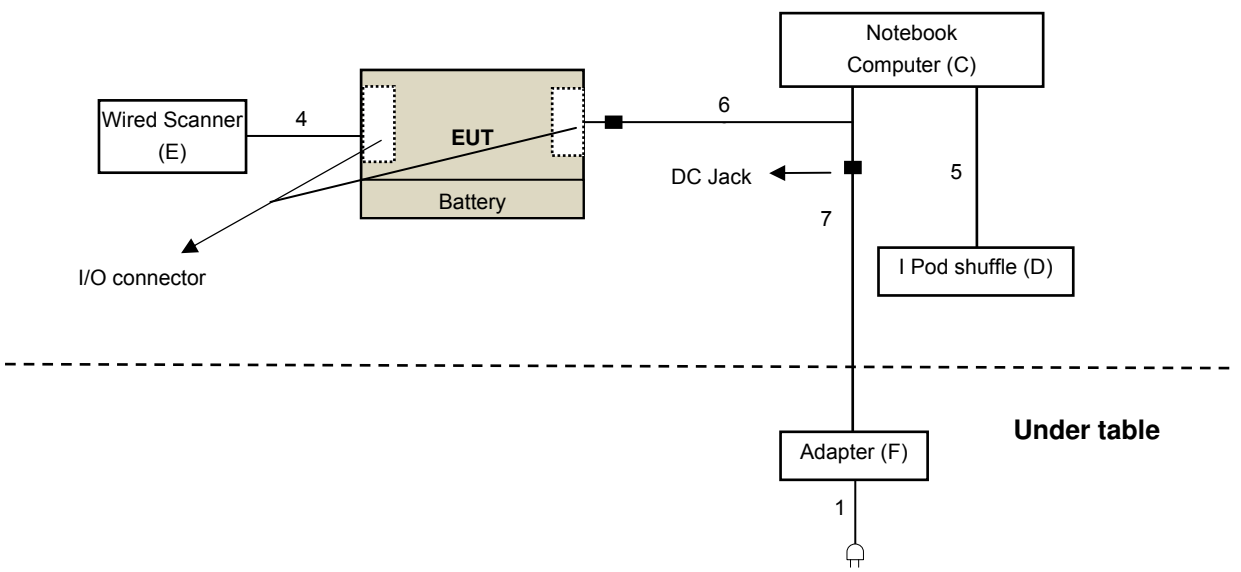



3.4 General Description of Applied Standards

The EUT is a RF Product. According to the specifications of the manufacturer, it must comply with the requirements of the following standards:

FCC Part 15, Subpart C (15.247)

ANSI C63.10-2013

All test items have been performed and recorded as per the above standards.

NOTE: The EUT has been verified to comply with the requirements of FCC Part 15, Subpart B, Class B (DoC). The test report has been issued separately.

4 Test Types and Results

4.1 Radiated Emission and Bandedge Measurement

4.1.1 Limits of Radiated Emission and Bandedge Measurement

Radiated emissions which fall in the restricted bands must comply with the radiated emission limits specified as below table. Other emissions shall be at least 20dB below the highest level of the desired power:

| Frequencies (MHz) | Field Strength (microvolts/meter) | Measurement Distance (meters) |
|-------------------|-----------------------------------|-------------------------------|
| 0.009 ~ 0.490 | 2400/F(kHz) | 300 |
| 0.490 ~ 1.705 | 24000/F(kHz) | 30 |
| 1.705 ~ 30.0 | 30 | 30 |
| 30 ~ 88 | 100 | 3 |
| 88 ~ 216 | 150 | 3 |
| 216 ~ 960 | 200 | 3 |
| Above 960 | 500 | 3 |

NOTE:

1. The lower limit shall apply at the transition frequencies.
2. Emission level (dBuV/m) = 20 log Emission level (uV/m).
3. For frequencies above 1000MHz, the field strength limits are based on average detector, however, the peak field strength of any emission shall not exceed the maximum permitted average limits, specified above by more than 20dB under any condition of modulation.



4.1.2 Test Instruments

For Radiated Emissions (below 1GHz) test:

| DESCRIPTION & MANUFACTURER | MODEL NO. | SERIAL NO. | CALIBRATED DATE | CALIBRATED UNTIL |
|--|--------------------------|-------------------------------|-----------------|------------------|
| Test Receiver Agilent | N9038A | MY50010156 | Aug. 12, 2015 | Aug. 11, 2016 |
| Pre-Amplifier ^(*) EMCI | EMC001340 | 980142 | Jan. 20, 2016 | Jan. 19, 2018 |
| Loop Antenna ^(*) Electro-Metrics | EM-6879 | 264 | Dec. 16, 2014 | Dec. 15, 2016 |
| RF Cable | NA | LOOPCAB-001 LOOPCAB-002 | Jan. 18, 2016 | Jan. 17, 2017 |
| Pre-Amplifier Mini-Circuits | ZFL-1000VH2 B | AMP-ZFL-07 | May 08, 2015 | May 07, 2016 |
| Trilog Broadband Antenna SCHWARZBECK | VULB 9168 | 9168-156 | Jan. 04, 2016 | Jan. 03, 2017 |
| RF Cable | 8D | 966-3-1 966-3-2 966-3-3 | Apr. 02, 2016 | Apr. 01, 2017 |
| Software | ADT_Radiated _V8.7.07 | NA | NA | NA |
| Antenna Tower & Turn Table CT | NA | NA | NA | NA |

Note:

1. The calibration interval of the above test instruments is 12 months and the calibrations are traceable to NML/ROC and NIST/USA.
2. *The calibration interval of the above test instruments is 24 months and the calibrations are traceable to NML/ROC and NIST/USA.
3. The test was performed in 966 Chamber No. 3.
4. The FCC Site Registration No. is 147459
6. The CANADA Site Registration No. is 20331-1
7. Loop antenna was used for all emissions below 30 MHz.
8. Tested Date: Apr. 19, 2016

For Radiated Emissions (Above 1GHz) test:

| DESCRIPTION & MANUFACTURER | MODEL NO. | SERIAL NO. | CALIBRATED DATE | CALIBRATED UNTIL |
|----------------------------------|---|----------------------------|-----------------|------------------|
| Test Receiver Agilent | N9038A | MY54450088 | July 24, 2015 | July 23, 2016 |
| Horn_Antenna SCHWARZBECK | BBHA 9120D | 9120D-783 | Jan. 19, 2016 | Jan. 18, 2017 |
| Pre-Amplifier Agilent | 8449B | 3008A01922 | Sep. 19, 2015 | Sep. 18, 2016 |
| RF Cable | EMC104-SM-S M-2000 EMC104-SM-S M-5000 EMC104-SM-S M-5000 | 150318 150323 150324 | Mar. 30, 2016 | Mar. 29, 2017 |
| Boresight Antenna Fixture | NA | NA | NA | NA |
| Pre-Amplifier EMCI | EMC184045 | 980143 | Jan. 15, 2016 | Jan. 14, 2017 |
| Horn_Antenna SCHWARZBECK | BBHA 9170 | BBHA9170608 | Jan. 08, 2016 | Jan. 07, 2017 |
| RF Cable | SUCOFLEX 102 | 36432/2 36441/2 | Jan. 16, 2016 | Jan. 15, 2017 |
| Software | ADT_Radiated _V8.7.07 | NA | NA | NA |
| Antenna Tower & Turn Table CT | NA | NA | NA | NA |
| Spectrum Analyzer R&S | FSP 40 | 100060 | May 08, 2015 | May 07, 2016 |
| Power meter Anritsu | ML2495A | 1014008 | Apr. 28, 2015 | Apr. 27, 2016 |
| Power sensor Anritsu | MA2411B | 0917122 | Apr. 28, 2015 | Apr. 27, 2016 |

Note:

1. The calibration interval of the above test instruments is 12 months and the calibrations are traceable to NML/ROC and NIST/USA.
2. The horn antenna, preamplifier (model: 8449B) are used only for the measurement of emission frequency above 1GHz if tested.
3. The test was performed in 966 Chamber No. 4.
4. The FCC Site Registration No. is 292998
5. The CANADA Site Registration No. is 20331-2
6. Tested Date: Apr. 14, 2016

4.1.3 Test Procedures

- a. The EUT was placed on the top of a rotating table 0.8 meters (for below 1GHz) / 1.5 meters (for above 1GHz) above the ground at 3 meter chamber room for test. The table was rotated 360 degrees to determine the position of the highest radiation.
- b. The EUT was set 3 meters away from the interference-receiving antenna, which was mounted on the top of a variable-height antenna tower.
- c. The height of antenna is varied from one meter to four meters above the ground to determine the maximum value of the field strength. Both horizontal and vertical polarizations of the antenna are set to make the measurement.
- d. For each suspected emission, the EUT was arranged to its worst case and then the antenna was tuned to heights from 1 meter to 4 meters and the rotatable table was turned from 0 degrees to 360 degrees to find the maximum reading.
- e. The test-receiver system was set to quasi-peak detect function and specified bandwidth with maximum hold mode when the test frequency is below 1 GHz.
- f. The test-receiver system was set to peak detect function and specified bandwidth with maximum hold mode when the test frequency is above 1 GHz.

Note:

1. The resolution bandwidth and video bandwidth of test receiver/spectrum analyzer is 120kHz for Quasi-peak detection (QP) at frequency below 1GHz.
2. The resolution bandwidth of test receiver/spectrum analyzer is 1 MHz and the video bandwidth is 3 MHz for Peak detection (PK) at frequency above 1GHz.
3. For Average measurement, due to the DH5 packet was the worse case duty cycle for a transmit dwell time on a channel, based upon bluetooth theory the transmitter is on $0.625 * 5$ per 296.25 ms per channel. Therefore, the duty cycle correlation factor be equal to: $20\log(3.125 / 100) = -30.1$ dB, therefore Average value = peak reading + $20\log(\text{duty cycle})$.
4. All modes of operation were investigated and the worst-case emissions are reported.

4.1.4 Deviation from Test Standard

No deviation.

4.1.5 Test Setup

<Frequency Range below 1GHz>

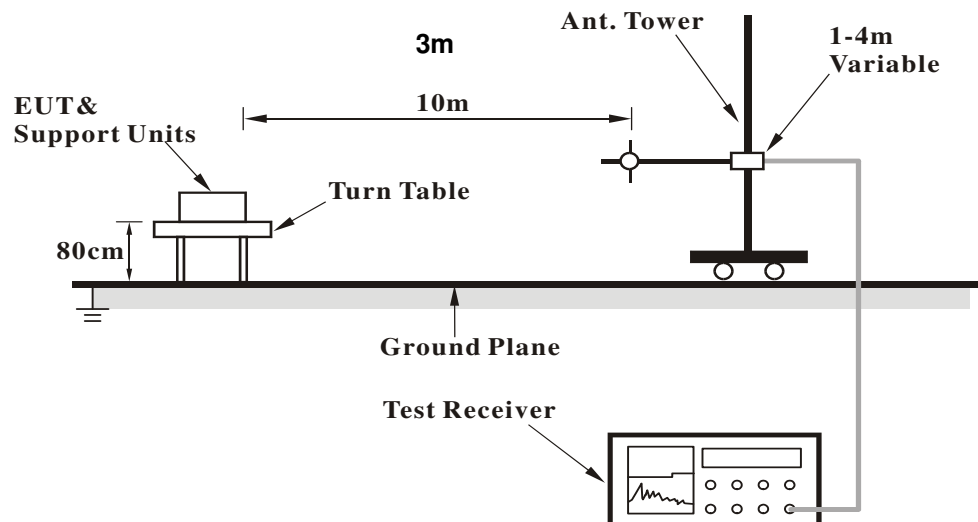

<Frequency Range above 1GHz>

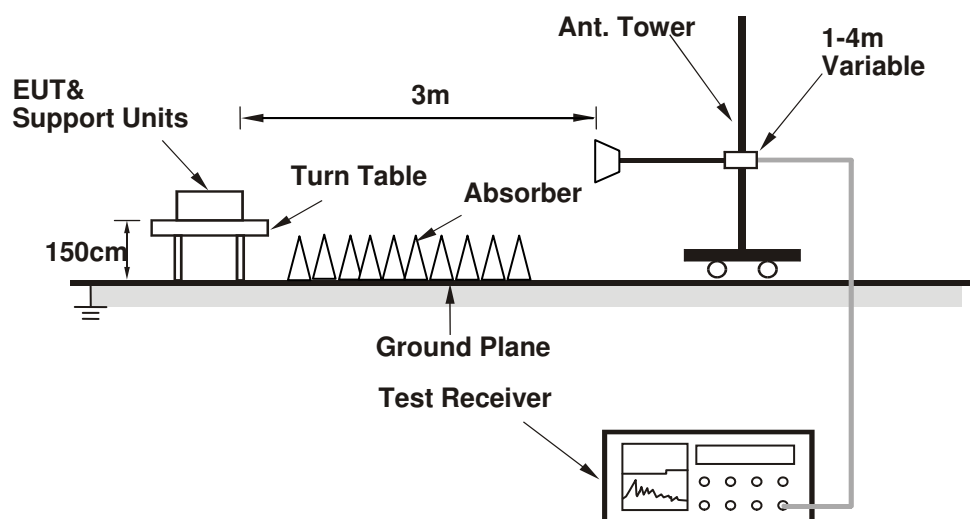

For the actual test configuration, please refer to the attached file (Test Setup Photo).

4.1.6 EUT Operating Conditions

Set the EUT under transmission condition continuously at specific channel frequency.

4.1.7 Test Results
Above 1GHz Data:
BT_GFSK

| | | | |
|------------------------|--------------|------------------------------|--------------|
| CHANNEL | TX Channel 0 | DETECTOR FUNCTION | Peak (PK) |
| FREQUENCY RANGE | 1GHz ~ 25GHz | | Average (AV) |

| ANTENNA POLARITY & TEST DISTANCE: HORIZONTAL AT 3 M | | | | | | | | |
|--|----------------|-------------------------------|-------------------|----------------|--------------------------|----------------------------|------------------------|--------------------------------|
| NO. | FREQ. (MHz) | EMISSION LEVEL (dBuV/m) | LIMIT (dBuV/m) | MARGIN (dB) | ANTENNA HEIGHT (m) | TABLE ANGLE (Degree) | RAW VALUE (dBuV) | CORRECTION FACTOR (dB/m) |
| 1 | 2390.00 | 45.4 PK | 74.0 | -28.6 | 1.14 H | 17 | 51.01 | -5.61 |
| 2 | 2390.00 | 15.3 AV | 54.0 | -38.7 | 1.14 H | 17 | 20.91 | -5.61 |
| 3 | *2402.00 | 85.7 PK | | | 1.14 H | 17 | 91.22 | -5.57 |
| 4 | *2402.00 | 55.6 AV | | | 1.14 H | 17 | 61.12 | -5.57 |
| 5 | 4804.00 | 41.8 PK | 74.0 | -32.2 | 1.28 H | 344 | 40.95 | 0.85 |
| 6 | 4804.00 | 11.7 AV | 54.0 | -42.3 | 1.28 H | 344 | 10.85 | 0.85 |
| ANTENNA POLARITY & TEST DISTANCE: VERTICAL AT 3 M | | | | | | | | |
| NO. | FREQ. (MHz) | EMISSION LEVEL (dBuV/m) | LIMIT (dBuV/m) | MARGIN (dB) | ANTENNA HEIGHT (m) | TABLE ANGLE (Degree) | RAW VALUE (dBuV) | CORRECTION FACTOR (dB/m) |
| 1 | 2390.00 | 47.1 PK | 74.0 | -26.9 | 2.06 V | 144 | 52.71 | -5.61 |
| 2 | 2390.00 | 17.0 AV | 54.0 | -37.0 | 2.06 V | 144 | 22.61 | -5.61 |
| 3 | *2402.00 | 101.0 PK | | | 2.06 V | 144 | 106.57 | -5.57 |
| 4 | *2402.00 | 70.9 AV | | | 2.06 V | 144 | 76.47 | -5.57 |
| 5 | 4804.00 | 42.5 PK | 74.0 | -31.5 | 1.32 V | 102 | 41.65 | 0.85 |
| 6 | 4804.00 | 12.4 AV | 54.0 | -41.6 | 1.32 V | 102 | 11.55 | 0.85 |

REMARKS:

1. Emission Level(dBuV/m) = Raw Value(dBuV) + Correction Factor(dB/m)
2. Correction Factor(dB/m) = Antenna Factor(dB/m) + Cable Factor(dB) – Pre-Amplifier Factor(dB)
3. The other emission levels were very low against the limit.
4. Margin value = Emission Level – Limit value
5. " * ": Fundamental frequency.



| | | | |
|------------------------|---------------|------------------------------|--------------|
| CHANNEL | TX Channel 39 | DETECTOR FUNCTION | Peak (PK) |
| FREQUENCY RANGE | 1GHz ~ 25GHz | | Average (AV) |

ANTENNA POLARITY & TEST DISTANCE: HORIZONTAL AT 3 M

| NO. | FREQ. (MHz) | EMISSION LEVEL (dBuV/m) | LIMIT (dBuV/m) | MARGIN (dB) | ANTENNA HEIGHT (m) | TABLE ANGLE (Degree) | RAW VALUE (dBuV) | CORRECTION FACTOR (dB/m) |
|-----|----------------|-------------------------------|-------------------|----------------|--------------------------|----------------------------|------------------------|--------------------------------|
| 1 | *2441.00 | 86.3 PK | | | 1.12 H | 10 | 91.72 | -5.42 |
| 2 | *2441.00 | 56.2 AV | | | 1.12 H | 10 | 61.62 | -5.42 |
| 3 | 4882.00 | 41.5 PK | 74.0 | -32.5 | 1.22 H | 322 | 40.41 | 1.09 |
| 4 | 4882.00 | 11.4 AV | 54.0 | -42.6 | 1.22 H | 322 | 10.31 | 1.09 |
| 5 | 7323.00 | 46.9 PK | 74.0 | -27.1 | 1.42 H | 220 | 39.24 | 7.66 |
| 6 | 7323.00 | 16.8 AV | 54.0 | -37.2 | 1.42 H | 220 | 9.14 | 7.66 |

ANTENNA POLARITY & TEST DISTANCE: VERTICAL AT 3 M

| NO. | FREQ. (MHz) | EMISSION LEVEL (dBuV/m) | LIMIT (dBuV/m) | MARGIN (dB) | ANTENNA HEIGHT (m) | TABLE ANGLE (Degree) | RAW VALUE (dBuV) | CORRECTION FACTOR (dB/m) |
|-----|----------------|-------------------------------|-------------------|----------------|--------------------------|----------------------------|------------------------|--------------------------------|
| 1 | *2441.00 | 102.7 PK | | | 2.10 V | 134 | 108.12 | -5.42 |
| 2 | *2441.00 | 72.6 AV | | | 2.10 V | 134 | 78.02 | -5.42 |
| 3 | 4882.00 | 43.1 PK | 74.0 | -30.9 | 1.31 V | 103 | 42.01 | 1.09 |
| 4 | 4882.00 | 13.0 AV | 54.0 | -41.0 | 1.31 V | 103 | 11.91 | 1.09 |
| 5 | 7323.00 | 47.5 PK | 74.0 | -26.5 | 1.27 V | 85 | 39.84 | 7.66 |
| 6 | 7323.00 | 17.4 AV | 54.0 | -36.6 | 1.27 V | 85 | 9.74 | 7.66 |

REMARKS:

1. Emission Level(dBuV/m) = Raw Value(dBuV) + Correction Factor(dB/m)
2. Correction Factor(dB/m) = Antenna Factor(dB/m) + Cable Factor(dB) – Pre-Amplifier Factor(dB)
3. The other emission levels were very low against the limit.
4. Margin value = Emission Level – Limit value
5. " * ": Fundamental frequency.



| | | | |
|------------------------|---------------|------------------------------|--------------|
| CHANNEL | TX Channel 78 | DETECTOR FUNCTION | Peak (PK) |
| FREQUENCY RANGE | 1GHz ~ 25GHz | | Average (AV) |

ANTENNA POLARITY & TEST DISTANCE: HORIZONTAL AT 3 M

| NO. | FREQ. (MHz) | EMISSION LEVEL (dBuV/m) | LIMIT (dBuV/m) | MARGIN (dB) | ANTENNA HEIGHT (m) | TABLE ANGLE (Degree) | RAW VALUE (dBuV) | CORRECTION FACTOR (dB/m) |
|-----|----------------|-------------------------------|-------------------|----------------|--------------------------|----------------------------|------------------------|--------------------------------|
| 1 | *2480.00 | 88.4 PK | | | 1.00 H | 39 | 93.68 | -5.28 |
| 2 | *2480.00 | 58.3 AV | | | 1.00 H | 39 | 63.58 | -5.28 |
| 3 | 2483.50 | 46.3 PK | 74.0 | -27.7 | 1.00 H | 39 | 51.57 | -5.27 |
| 4 | 2483.50 | 16.2 AV | 54.0 | -37.8 | 1.00 H | 39 | 21.47 | -5.27 |
| 5 | 4960.00 | 41.5 PK | 74.0 | -32.5 | 1.27 H | 329 | 40.18 | 1.32 |
| 6 | 4960.00 | 11.4 AV | 54.0 | -42.6 | 1.27 H | 329 | 10.08 | 1.32 |
| 7 | 7440.00 | 46.5 PK | 74.0 | -27.5 | 1.48 H | 221 | 38.60 | 7.90 |
| 8 | 7440.00 | 16.4 AV | 54.0 | -37.6 | 1.48 H | 221 | 8.50 | 7.90 |

ANTENNA POLARITY & TEST DISTANCE: VERTICAL AT 3 M

| NO. | FREQ. (MHz) | EMISSION LEVEL (dBuV/m) | LIMIT (dBuV/m) | MARGIN (dB) | ANTENNA HEIGHT (m) | TABLE ANGLE (Degree) | RAW VALUE (dBuV) | CORRECTION FACTOR (dB/m) |
|-----|----------------|-------------------------------|-------------------|----------------|--------------------------|----------------------------|------------------------|--------------------------------|
| 1 | *2480.00 | 103.4 PK | | | 1.07 V | 111 | 108.68 | -5.28 |
| 2 | *2480.00 | 73.3 AV | | | 1.07 V | 111 | 78.58 | -5.28 |
| 3 | 2483.50 | 48.4 PK | 74.0 | -25.6 | 1.07 V | 111 | 53.67 | -5.27 |
| 4 | 2483.50 | 18.3 AV | 54.0 | -35.7 | 1.07 V | 111 | 23.57 | -5.27 |
| 5 | 4960.00 | 42.7 PK | 74.0 | -31.3 | 1.29 V | 110 | 41.38 | 1.32 |
| 6 | 4960.00 | 12.6 AV | 54.0 | -41.4 | 1.29 V | 110 | 11.28 | 1.32 |
| 7 | 7440.00 | 47.3 PK | 74.0 | -26.7 | 1.29 V | 78 | 39.40 | 7.90 |
| 8 | 7440.00 | 17.2 AV | 54.0 | -36.8 | 1.29 V | 78 | 9.30 | 7.90 |

REMARKS:

1. Emission Level(dBuV/m) = Raw Value(dBuV) + Correction Factor(dB/m)
2. Correction Factor(dB/m) = Antenna Factor(dB/m) + Cable Factor(dB) – Pre-Amplifier Factor(dB)
3. The other emission levels were very low against the limit.
4. Margin value = Emission Level – Limit value
5. " * " : Fundamental frequency.



A D T

BT_8DPSK

| | | | |
|------------------------|--------------|------------------------------|--------------|
| CHANNEL | TX Channel 0 | DETECTOR FUNCTION | Peak (PK) |
| FREQUENCY RANGE | 1GHz ~ 25GHz | | Average (AV) |

| ANTENNA POLARITY & TEST DISTANCE: HORIZONTAL AT 3 M | | | | | | | | |
|---|----------------|-------------------------------|-------------------|----------------|--------------------------|----------------------------|------------------------|--------------------------------|
| NO. | FREQ. (MHz) | EMISSION LEVEL (dBuV/m) | LIMIT (dBuV/m) | MARGIN (dB) | ANTENNA HEIGHT (m) | TABLE ANGLE (Degree) | RAW VALUE (dBuV) | CORRECTION FACTOR (dB/m) |
| 1 | 2390.00 | 47.6 PK | 74.0 | -26.4 | 1.25 H | 240 | 53.21 | -5.61 |
| 2 | 2390.00 | 17.5 AV | 54.0 | -36.5 | 1.25 H | 240 | 23.11 | -5.61 |
| 3 | *2402.00 | 82.2 PK | | | 1.25 H | 240 | 87.77 | -5.57 |
| 4 | *2402.00 | 52.1 AV | | | 1.25 H | 240 | 57.67 | -5.57 |
| 5 | 4804.00 | 41.4 PK | 74.0 | -32.6 | 1.22 H | 323 | 40.55 | 0.85 |
| 6 | 4804.00 | 11.3 AV | 54.0 | -42.7 | 1.22 H | 323 | 10.45 | 0.85 |
| ANTENNA POLARITY & TEST DISTANCE: VERTICAL AT 3 M | | | | | | | | |
| NO. | FREQ. (MHz) | EMISSION LEVEL (dBuV/m) | LIMIT (dBuV/m) | MARGIN (dB) | ANTENNA HEIGHT (m) | TABLE ANGLE (Degree) | RAW VALUE (dBuV) | CORRECTION FACTOR (dB/m) |
| 1 | 2390.00 | 48.4 PK | 74.0 | -25.6 | 1.27 V | 126 | 54.01 | -5.61 |
| 2 | 2390.00 | 18.3 AV | 54.0 | -35.7 | 1.27 V | 126 | 23.91 | -5.61 |
| 3 | *2402.00 | 99.4 PK | | | 1.27 V | 126 | 104.97 | -5.57 |
| 4 | *2402.00 | 69.3 AV | | | 1.27 V | 126 | 74.87 | -5.57 |
| 5 | 4804.00 | 42.4 PK | 74.0 | -31.6 | 1.35 V | 125 | 41.55 | 0.85 |
| 6 | 4804.00 | 12.3 AV | 54.0 | -41.7 | 1.35 V | 125 | 11.45 | 0.85 |

REMARKS:

1. Emission Level(dBuV/m) = Raw Value(dBuV) + Correction Factor(dB/m)
2. Correction Factor(dB/m) = Antenna Factor(dB/m) + Cable Factor(dB) – Pre-Amplifier Factor(dB)
3. The other emission levels were very low against the limit.
4. Margin value = Emission Level – Limit value
5. " * " : Fundamental frequency.



A D T

| | | | |
|------------------------|---------------|------------------------------|--------------|
| CHANNEL | TX Channel 39 | DETECTOR FUNCTION | Peak (PK) |
| FREQUENCY RANGE | 1GHz ~ 25GHz | | Average (AV) |

| ANTENNA POLARITY & TEST DISTANCE: HORIZONTAL AT 3 M | | | | | | | | |
|--|----------------|-------------------------------|-------------------|----------------|--------------------------|----------------------------|------------------------|--------------------------------|
| NO. | FREQ. (MHz) | EMISSION LEVEL (dBuV/m) | LIMIT (dBuV/m) | MARGIN (dB) | ANTENNA HEIGHT (m) | TABLE ANGLE (Degree) | RAW VALUE (dBuV) | CORRECTION FACTOR (dB/m) |
| 1 | *2441.00 | 83.8 PK | | | 1.24 H | 237 | 89.22 | -5.42 |
| 2 | *2441.00 | 53.7 AV | | | 1.24 H | 237 | 59.12 | -5.42 |
| 3 | 4882.00 | 41.5 PK | 74.0 | -32.5 | 1.28 H | 329 | 40.41 | 1.09 |
| 4 | 4882.00 | 11.4 AV | 54.0 | -42.6 | 1.28 H | 329 | 10.31 | 1.09 |
| 5 | 7323.00 | 46.4 PK | 74.0 | -27.6 | 1.41 H | 214 | 38.74 | 7.66 |
| 6 | 7323.00 | 16.3 AV | 54.0 | -37.7 | 1.41 H | 214 | 8.64 | 7.66 |

| ANTENNA POLARITY & TEST DISTANCE: VERTICAL AT 3 M | | | | | | | | |
|--|----------------|-------------------------------|-------------------|----------------|--------------------------|----------------------------|------------------------|--------------------------------|
| NO. | FREQ. (MHz) | EMISSION LEVEL (dBuV/m) | LIMIT (dBuV/m) | MARGIN (dB) | ANTENNA HEIGHT (m) | TABLE ANGLE (Degree) | RAW VALUE (dBuV) | CORRECTION FACTOR (dB/m) |
| 1 | *2441.00 | 100.6 PK | | | 1.28 V | 116 | 106.02 | -5.42 |
| 2 | *2441.00 | 70.5 AV | | | 1.28 V | 116 | 75.92 | -5.42 |
| 3 | 4882.00 | 42.9 PK | 74.0 | -31.1 | 1.23 V | 97 | 41.81 | 1.09 |
| 4 | 4882.00 | 12.8 AV | 54.0 | -41.2 | 1.23 V | 97 | 11.71 | 1.09 |
| 5 | 7323.00 | 47.6 PK | 74.0 | -26.4 | 1.33 V | 68 | 39.94 | 7.66 |
| 6 | 7323.00 | 17.5 AV | 54.0 | -36.5 | 1.33 V | 68 | 9.84 | 7.66 |

REMARKS:

1. Emission Level(dBuV/m) = Raw Value(dBuV) + Correction Factor(dB/m)
2. Correction Factor(dB/m) = Antenna Factor(dB/m) + Cable Factor(dB) – Pre-Amplifier Factor(dB)
3. The other emission levels were very low against the limit.
4. Margin value = Emission Level – Limit value
5. " * ": Fundamental frequency.



A D T

| | | | |
|------------------------|---------------|------------------------------|--------------|
| CHANNEL | TX Channel 78 | DETECTOR FUNCTION | Peak (PK) |
| FREQUENCY RANGE | 1GHz ~ 25GHz | | Average (AV) |

| ANTENNA POLARITY & TEST DISTANCE: HORIZONTAL AT 3 M | | | | | | | | |
|---|----------------|-------------------------------|-------------------|----------------|--------------------------|----------------------------|------------------------|--------------------------------|
| NO. | FREQ. (MHz) | EMISSION LEVEL (dBuV/m) | LIMIT (dBuV/m) | MARGIN (dB) | ANTENNA HEIGHT (m) | TABLE ANGLE (Degree) | RAW VALUE (dBuV) | CORRECTION FACTOR (dB/m) |
| 1 | *2480.00 | 83.6 PK | | | 1.20 H | 226 | 88.88 | -5.28 |
| 2 | *2480.00 | 53.5 AV | | | 1.20 H | 226 | 58.78 | -5.28 |
| 3 | 2483.50 | 46.9 PK | 74.0 | -27.1 | 1.20 H | 226 | 52.17 | -5.27 |
| 4 | 2483.50 | 16.8 AV | 54.0 | -37.2 | 1.20 H | 226 | 22.07 | -5.27 |
| 5 | 4960.00 | 41.7 PK | 74.0 | -32.3 | 1.24 H | 334 | 40.38 | 1.32 |
| 6 | 4960.00 | 11.6 AV | 54.0 | -42.4 | 1.24 H | 334 | 10.28 | 1.32 |
| 7 | 7440.00 | 46.4 PK | 74.0 | -27.6 | 1.39 H | 228 | 38.50 | 7.90 |
| 8 | 7440.00 | 16.3 AV | 54.0 | -37.7 | 1.39 H | 228 | 8.40 | 7.90 |

| ANTENNA POLARITY & TEST DISTANCE: VERTICAL AT 3 M | | | | | | | | |
|---|----------------|-------------------------------|-------------------|----------------|--------------------------|----------------------------|------------------------|--------------------------------|
| NO. | FREQ. (MHz) | EMISSION LEVEL (dBuV/m) | LIMIT (dBuV/m) | MARGIN (dB) | ANTENNA HEIGHT (m) | TABLE ANGLE (Degree) | RAW VALUE (dBuV) | CORRECTION FACTOR (dB/m) |
| 1 | *2480.00 | 101.1 PK | | | 1.00 V | 112 | 106.38 | -5.28 |
| 2 | *2480.00 | 71.0 AV | | | 1.00 V | 112 | 76.28 | -5.28 |
| 3 | 2483.50 | 48.9 PK | 74.0 | -25.1 | 1.00 V | 112 | 54.17 | -5.27 |
| 4 | 2483.50 | 18.8 AV | 54.0 | -35.2 | 1.00 V | 112 | 24.07 | -5.27 |
| 5 | 4960.00 | 42.7 PK | 74.0 | -31.3 | 1.25 V | 112 | 41.38 | 1.32 |
| 6 | 4960.00 | 12.6 AV | 54.0 | -41.4 | 1.25 V | 112 | 11.28 | 1.32 |
| 7 | 7440.00 | 46.9 PK | 74.0 | -27.1 | 1.34 V | 85 | 39.00 | 7.90 |
| 8 | 7440.00 | 16.8 AV | 54.0 | -37.2 | 1.34 V | 85 | 8.90 | 7.90 |

REMARKS:

1. Emission Level(dBuV/m) = Raw Value(dBuV) + Correction Factor(dB/m)
2. Correction Factor(dB/m) = Antenna Factor(dB/m) + Cable Factor(dB) – Pre-Amplifier Factor(dB)
3. The other emission levels were very low against the limit.
4. Margin value = Emission Level – Limit value
5. " * ": Fundamental frequency.

Below 1GHz Data:

BT_GFSK

| | | | |
|------------------------|--------------|--------------------------|-----------------|
| CHANNEL | TX Channel 0 | DETECTOR FUNCTION | Quasi-Peak (QP) |
| FREQUENCY RANGE | 30MHz ~ 1GHz | | |

ANTENNA POLARITY & TEST DISTANCE: HORIZONTAL AT 3 M

| NO. | FREQ. (MHz) | EMISSION LEVEL (dBuV/m) | LIMIT (dBuV/m) | MARGIN (dB) | ANTENNA HEIGHT (m) | TABLE ANGLE (Degree) | RAW VALUE (dBuV) | CORRECTION FACTOR (dB/m) |
|-----|---------------|-------------------------|----------------|-------------|--------------------|----------------------|------------------|--------------------------|
| 1 | 42.33 | 31.4 QP | 40.0 | -8.6 | 1.57 H | 269 | 35.77 | -4.37 |
| 2 | 201.25 | 33.1 QP | 43.5 | -10.4 | 1.00 H | 48 | 40.19 | -7.09 |
| 3 | 315.09 | 41.6 QP | 46.0 | -4.4 | 1.00 H | 295 | 44.47 | -2.87 |
| 4 | 323.65 | 42.5 QP | 46.0 | -3.5 | 1.05 H | 45 | 45.12 | -2.62 |
| 5 | 497.90 | 36.1 QP | 46.0 | -9.9 | 1.52 H | 159 | 34.74 | 1.36 |
| 6 | 931.01 | 38.7 QP | 46.0 | -7.3 | 1.46 H | 54 | 29.93 | 8.77 |

ANTENNA POLARITY & TEST DISTANCE: VERTICAL AT 3 M

| NO. | FREQ. (MHz) | EMISSION LEVEL (dBuV/m) | LIMIT (dBuV/m) | MARGIN (dB) | ANTENNA HEIGHT (m) | TABLE ANGLE (Degree) | RAW VALUE (dBuV) | CORRECTION FACTOR (dB/m) |
|-----|-------------|-------------------------|----------------|-------------|--------------------|----------------------|------------------|--------------------------|
| 1 | 37.10 | 35.0 QP | 40.0 | -5.0 | 1.00 V | 128 | 40.04 | -5.04 |
| 2 | 58.59 | 29.6 QP | 40.0 | -10.4 | 1.56 V | 38 | 33.87 | -4.27 |
| 3 | 218.61 | 32.4 QP | 46.0 | -13.6 | 2.00 V | 171 | 39.28 | -6.88 |
| 4 | 267.77 | 32.4 QP | 46.0 | -13.6 | 2.01 V | 303 | 36.77 | -4.37 |
| 5 | 320.29 | 38.3 QP | 46.0 | -7.7 | 1.00 V | 141 | 41.05 | -2.75 |
| 6 | 797.49 | 37.7 QP | 46.0 | -8.3 | 1.53 V | 124 | 31.05 | 6.65 |

REMARKS:

1. Emission Level(dBuV/m) = Raw Value(dBuV) + Correction Factor(dB/m)
2. Correction Factor(dB/m) = Antenna Factor(dB/m) + Cable Factor(dB) – Pre-Amplifier Factor(dB)
3. The other emission levels were very low against the limit.
4. Margin value = Emission Level – Limit value

| | | | |
|------------------------|---------------|--------------------------|-----------------|
| CHANNEL | TX Channel 39 | DETECTOR FUNCTION | Quasi-Peak (QP) |
| FREQUENCY RANGE | 30MHz ~ 1GHz | | |

ANTENNA POLARITY & TEST DISTANCE: HORIZONTAL AT 3 M

| NO. | FREQ. (MHz) | EMISSION LEVEL (dBuV/m) | LIMIT (dBuV/m) | MARGIN (dB) | ANTENNA HEIGHT (m) | TABLE ANGLE (Degree) | RAW VALUE (dBuV) | CORRECTION FACTOR (dB/m) |
|-----|-------------|-------------------------|----------------|-------------|--------------------|----------------------|------------------|--------------------------|
| 1 | 42.33 | 31.7 QP | 40.0 | -8.3 | 1.52 H | 259 | 36.07 | -4.37 |
| 2 | 201.41 | 33.3 QP | 43.5 | -10.2 | 1.04 H | 63 | 40.40 | -7.10 |
| 3 | 315.11 | 41.5 QP | 46.0 | -4.5 | 1.00 H | 275 | 44.37 | -2.87 |
| 4 | 323.51 | 42.0 QP | 46.0 | -4.0 | 1.01 H | 59 | 44.63 | -2.63 |
| 5 | 498.04 | 36.2 QP | 46.0 | -9.8 | 1.49 H | 148 | 34.84 | 1.36 |
| 6 | 931.01 | 38.7 QP | 46.0 | -7.3 | 1.48 H | 68 | 29.93 | 8.77 |

ANTENNA POLARITY & TEST DISTANCE: VERTICAL AT 3 M

| NO. | FREQ. (MHz) | EMISSION LEVEL (dBuV/m) | LIMIT (dBuV/m) | MARGIN (dB) | ANTENNA HEIGHT (m) | TABLE ANGLE (Degree) | RAW VALUE (dBuV) | CORRECTION FACTOR (dB/m) |
|-----|-------------|-------------------------|----------------|-------------|--------------------|----------------------|------------------|--------------------------|
| 1 | 37.53 | 35.3 QP | 40.0 | -4.7 | 1.06 V | 114 | 40.24 | -4.94 |
| 2 | 58.67 | 29.7 QP | 40.0 | -10.3 | 1.60 V | 45 | 33.97 | -4.27 |
| 3 | 219.02 | 32.2 QP | 46.0 | -13.8 | 2.00 V | 202 | 39.08 | -6.88 |
| 4 | 267.66 | 32.2 QP | 46.0 | -13.8 | 1.95 V | 282 | 36.58 | -4.38 |
| 5 | 320.26 | 38.9 QP | 46.0 | -7.1 | 1.00 V | 141 | 41.65 | -2.75 |
| 6 | 797.49 | 37.7 QP | 46.0 | -8.3 | 1.63 V | 106 | 31.05 | 6.65 |

REMARKS:

1. Emission Level(dBuV/m) = Raw Value(dBuV) + Correction Factor(dB/m)
2. Correction Factor(dB/m) = Antenna Factor(dB/m) + Cable Factor(dB) – Pre-Amplifier Factor(dB)
3. The other emission levels were very low against the limit.
4. Margin value = Emission Level – Limit value



| | | | |
|------------------------|---------------|------------------------------|-----------------|
| CHANNEL | TX Channel 78 | DETECTOR FUNCTION | Quasi-Peak (QP) |
| FREQUENCY RANGE | 30MHz ~ 1GHz | | |

| ANTENNA POLARITY & TEST DISTANCE: HORIZONTAL AT 3 M | | | | | | | | |
|--|----------------|-------------------------------|-------------------|----------------|--------------------------|----------------------------|------------------------|--------------------------------|
| NO. | FREQ. (MHz) | EMISSION LEVEL (dBuV/m) | LIMIT (dBuV/m) | MARGIN (dB) | ANTENNA HEIGHT (m) | TABLE ANGLE (Degree) | RAW VALUE (dBuV) | CORRECTION FACTOR (dB/m) |
| 1 | 42.51 | 31.6 QP | 40.0 | -8.4 | 1.63 H | 260 | 35.94 | -4.34 |
| 2 | 201.00 | 33.6 QP | 43.5 | -9.9 | 1.00 H | 35 | 40.68 | -7.08 |
| 3 | 315.13 | 41.8 QP | 46.0 | -4.2 | 1.00 H | 273 | 44.67 | -2.87 |
| 4 | 323.59 | 42.0 QP | 46.0 | -4.0 | 1.05 H | 47 | 44.63 | -2.63 |
| 5 | 497.72 | 35.9 QP | 46.0 | -10.1 | 1.47 H | 160 | 34.55 | 1.35 |
| 6 | 931.01 | 38.5 QP | 46.0 | -7.5 | 1.46 H | 71 | 29.73 | 8.77 |

| ANTENNA POLARITY & TEST DISTANCE: VERTICAL AT 3 M | | | | | | | | |
|--|----------------|-------------------------------|-------------------|----------------|--------------------------|----------------------------|------------------------|--------------------------------|
| NO. | FREQ. (MHz) | EMISSION LEVEL (dBuV/m) | LIMIT (dBuV/m) | MARGIN (dB) | ANTENNA HEIGHT (m) | TABLE ANGLE (Degree) | RAW VALUE (dBuV) | CORRECTION FACTOR (dB/m) |
| 1 | 37.01 | 35.1 QP | 40.0 | -4.9 | 1.06 V | 128 | 40.16 | -5.06 |
| 2 | 58.54 | 29.5 QP | 40.0 | -10.5 | 1.62 V | 56 | 33.77 | -4.27 |
| 3 | 218.74 | 32.5 QP | 46.0 | -13.5 | 1.94 V | 191 | 39.38 | -6.88 |
| 4 | 267.54 | 31.9 QP | 46.0 | -14.1 | 2.04 V | 279 | 36.28 | -4.38 |
| 5 | 319.78 | 38.9 QP | 46.0 | -7.1 | 1.00 V | 115 | 41.66 | -2.76 |
| 6 | 797.49 | 38.1 QP | 46.0 | -7.9 | 1.56 V | 116 | 31.45 | 6.65 |

REMARKS:

1. Emission Level(dBuV/m) = Raw Value(dBuV) + Correction Factor(dB/m)
2. Correction Factor(dB/m) = Antenna Factor(dB/m) + Cable Factor(dB) – Pre-Amplifier Factor(dB)
3. The other emission levels were very low against the limit.
4. Margin value = Emission Level – Limit value

BT_8DPSK

| | | | |
|------------------------|--------------|--------------------------|-----------------|
| CHANNEL | TX Channel 0 | DETECTOR FUNCTION | Quasi-Peak (QP) |
| FREQUENCY RANGE | 30MHz ~ 1GHz | | |

ANTENNA POLARITY & TEST DISTANCE: HORIZONTAL AT 3 M

| NO. | FREQ. (MHz) | EMISSION LEVEL (dBuV/m) | LIMIT (dBuV/m) | MARGIN (dB) | ANTENNA HEIGHT (m) | TABLE ANGLE (Degree) | RAW VALUE (dBuV) | CORRECTION FACTOR (dB/m) |
|-----|-------------|-------------------------|----------------|-------------|--------------------|----------------------|------------------|--------------------------|
| 1 | 42.38 | 31.4 QP | 40.0 | -8.6 | 1.52 H | 257 | 35.76 | -4.36 |
| 2 | 201.02 | 33.1 QP | 43.5 | -10.4 | 1.00 H | 55 | 40.18 | -7.08 |
| 3 | 315.34 | 41.9 QP | 46.0 | -4.1 | 1.00 H | 278 | 44.76 | -2.86 |
| 4 | 323.63 | 42.3 QP | 46.0 | -3.7 | 1.00 H | 29 | 44.92 | -2.62 |
| 5 | 497.82 | 36.2 QP | 46.0 | -9.8 | 1.47 H | 160 | 34.84 | 1.36 |
| 6 | 931.01 | 38.8 QP | 46.0 | -7.2 | 1.48 H | 78 | 30.03 | 8.77 |

ANTENNA POLARITY & TEST DISTANCE: VERTICAL AT 3 M

| NO. | FREQ. (MHz) | EMISSION LEVEL (dBuV/m) | LIMIT (dBuV/m) | MARGIN (dB) | ANTENNA HEIGHT (m) | TABLE ANGLE (Degree) | RAW VALUE (dBuV) | CORRECTION FACTOR (dB/m) |
|-----|-------------|-------------------------|----------------|-------------|--------------------|----------------------|------------------|--------------------------|
| 1 | 37.23 | 35.2 QP | 40.0 | -4.8 | 1.07 V | 129 | 40.21 | -5.01 |
| 2 | 58.64 | 29.4 QP | 40.0 | -10.6 | 1.62 V | 30 | 33.67 | -4.27 |
| 3 | 219.07 | 32.3 QP | 46.0 | -13.7 | 2.04 V | 173 | 39.18 | -6.88 |
| 4 | 267.71 | 31.9 QP | 46.0 | -14.1 | 1.99 V | 281 | 36.27 | -4.37 |
| 5 | 320.04 | 38.6 QP | 46.0 | -7.4 | 1.00 V | 138 | 41.36 | -2.76 |
| 6 | 797.49 | 37.7 QP | 46.0 | -8.3 | 1.61 V | 125 | 31.05 | 6.65 |

REMARKS:

1. Emission Level(dBuV/m) = Raw Value(dBuV) + Correction Factor(dB/m)
2. Correction Factor(dB/m) = Antenna Factor(dB/m) + Cable Factor(dB) – Pre-Amplifier Factor(dB)
3. The other emission levels were very low against the limit.
4. Margin value = Emission Level – Limit value



A D T

| | | | |
|------------------------|---------------|------------------------------|-----------------|
| CHANNEL | TX Channel 39 | DETECTOR FUNCTION | Quasi-Peak (QP) |
| FREQUENCY RANGE | 30MHz ~ 1GHz | | |

| ANTENNA POLARITY & TEST DISTANCE: HORIZONTAL AT 3 M | | | | | | | | |
|--|----------------|-------------------------------|-------------------|----------------|--------------------------|----------------------------|------------------------|--------------------------------|
| NO. | FREQ. (MHz) | EMISSION LEVEL (dBuV/m) | LIMIT (dBuV/m) | MARGIN (dB) | ANTENNA HEIGHT (m) | TABLE ANGLE (Degree) | RAW VALUE (dBuV) | CORRECTION FACTOR (dB/m) |
| 1 | 42.32 | 31.5 QP | 40.0 | -8.5 | 1.60 H | 274 | 35.87 | -4.37 |
| 2 | 200.93 | 33.1 QP | 43.5 | -10.4 | 1.04 H | 36 | 40.18 | -7.08 |
| 3 | 315.05 | 41.7 QP | 46.0 | -4.3 | 1.03 H | 284 | 44.57 | -2.87 |
| 4 | 323.67 | 42.1 QP | 46.0 | -3.9 | 1.01 H | 37 | 44.72 | -2.62 |
| 5 | 498.16 | 36.0 QP | 46.0 | -10.0 | 1.54 H | 146 | 34.63 | 1.37 |
| 6 | 931.01 | 38.4 QP | 46.0 | -7.6 | 1.50 H | 67 | 29.63 | 8.77 |

| ANTENNA POLARITY & TEST DISTANCE: VERTICAL AT 3 M | | | | | | | | |
|--|----------------|-------------------------------|-------------------|----------------|--------------------------|----------------------------|------------------------|--------------------------------|
| NO. | FREQ. (MHz) | EMISSION LEVEL (dBuV/m) | LIMIT (dBuV/m) | MARGIN (dB) | ANTENNA HEIGHT (m) | TABLE ANGLE (Degree) | RAW VALUE (dBuV) | CORRECTION FACTOR (dB/m) |
| 1 | 37.08 | 35.0 QP | 40.0 | -5.0 | 1.01 V | 121 | 40.05 | -5.05 |
| 2 | 58.74 | 29.7 QP | 40.0 | -10.3 | 1.55 V | 56 | 33.97 | -4.27 |
| 3 | 219.05 | 32.7 QP | 46.0 | -13.3 | 2.00 V | 201 | 39.58 | -6.88 |
| 4 | 267.92 | 32.0 QP | 46.0 | -14.0 | 2.02 V | 281 | 36.36 | -4.36 |
| 5 | 320.06 | 38.6 QP | 46.0 | -7.4 | 1.03 V | 126 | 41.36 | -2.76 |
| 6 | 797.49 | 37.7 QP | 46.0 | -8.3 | 1.56 V | 118 | 31.05 | 6.65 |

REMARKS:

1. Emission Level(dBuV/m) = Raw Value(dBuV) + Correction Factor(dB/m)
2. Correction Factor(dB/m) = Antenna Factor(dB/m) + Cable Factor(dB) – Pre-Amplifier Factor(dB)
3. The other emission levels were very low against the limit.
4. Margin value = Emission Level – Limit value



| | | | |
|------------------------|---------------|------------------------------|-----------------|
| CHANNEL | TX Channel 78 | DETECTOR FUNCTION | Quasi-Peak (QP) |
| FREQUENCY RANGE | 30MHz ~ 1GHz | | |

| ANTENNA POLARITY & TEST DISTANCE: HORIZONTAL AT 3 M | | | | | | | | |
|--|----------------|-------------------------------|-------------------|----------------|--------------------------|----------------------------|------------------------|--------------------------------|
| NO. | FREQ. (MHz) | EMISSION LEVEL (dBuV/m) | LIMIT (dBuV/m) | MARGIN (dB) | ANTENNA HEIGHT (m) | TABLE ANGLE (Degree) | RAW VALUE (dBuV) | CORRECTION FACTOR (dB/m) |
| 1 | 42.16 | 31.8 QP | 40.0 | -8.2 | 1.62 H | 256 | 36.20 | -4.40 |
| 2 | 201.09 | 33.3 QP | 43.5 | -10.2 | 1.00 H | 50 | 40.38 | -7.08 |
| 3 | 315.32 | 41.9 QP | 46.0 | -4.1 | 1.00 H | 284 | 44.76 | -2.86 |
| 4 | 323.72 | 42.0 QP | 46.0 | -4.0 | 1.00 H | 38 | 44.62 | -2.62 |
| 5 | 497.69 | 36.2 QP | 46.0 | -9.8 | 1.50 H | 149 | 34.85 | 1.35 |
| 6 | 931.01 | 38.9 QP | 46.0 | -7.1 | 1.49 H | 60 | 30.13 | 8.77 |

| ANTENNA POLARITY & TEST DISTANCE: VERTICAL AT 3 M | | | | | | | | |
|--|----------------|-------------------------------|-------------------|----------------|--------------------------|----------------------------|------------------------|--------------------------------|
| NO. | FREQ. (MHz) | EMISSION LEVEL (dBuV/m) | LIMIT (dBuV/m) | MARGIN (dB) | ANTENNA HEIGHT (m) | TABLE ANGLE (Degree) | RAW VALUE (dBuV) | CORRECTION FACTOR (dB/m) |
| 1 | 37.56 | 35.1 QP | 40.0 | -4.9 | 1.05 V | 141 | 40.03 | -4.93 |
| 2 | 58.59 | 29.8 QP | 40.0 | -10.2 | 1.55 V | 48 | 34.07 | -4.27 |
| 3 | 219.11 | 32.3 QP | 46.0 | -13.7 | 2.02 V | 194 | 39.18 | -6.88 |
| 4 | 267.83 | 32.0 QP | 46.0 | -14.0 | 1.97 V | 284 | 36.37 | -4.37 |
| 5 | 319.80 | 38.4 QP | 46.0 | -7.6 | 1.03 V | 135 | 41.16 | -2.76 |
| 6 | 797.49 | 37.6 QP | 46.0 | -8.4 | 1.55 V | 129 | 30.95 | 6.65 |

REMARKS:

1. Emission Level(dBuV/m) = Raw Value(dBuV) + Correction Factor(dB/m)
2. Correction Factor(dB/m) = Antenna Factor(dB/m) + Cable Factor(dB) – Pre-Amplifier Factor(dB)
3. The other emission levels were very low against the limit.
4. Margin value = Emission Level – Limit value

4.2 Conducted Emission Measurement

4.2.1 Limits of Conducted Emission Measurement

| Frequency (MHz) | Conducted Limit (dBuV) | |
|-----------------|------------------------|---------|
| | Quasi-peak | Average |
| 0.15 - 0.5 | 66 - 56 | 56 - 46 |
| 0.50 - 5.0 | 56 | 46 |
| 5.0 - 30.0 | 60 | 50 |

Note: 1. The lower limit shall apply at the transition frequencies.

2. The limit decreases in line with the logarithm of the frequency in the range of 0.15 to 0.50MHz.

4.2.2 Test Instruments

| DESCRIPTION & MANUFACTURER | MODEL NO. | SERIAL NO. | CALIBRATED DATE | CALIBRATED UNTIL |
|---|-------------------------|------------|-----------------|------------------|
| Test Receiver R&S | ESCS 30 | 100375 | May 06, 2015 | May 05, 2016 |
| Line-Impedance Stabilization Network (for EUT) SCHWARZBECK | NSLK-8127 | 8127-522 | Sep. 01, 2015 | Aug. 31, 2016 |
| Line-Impedance Stabilization Network (for Peripheral) R&S | ENV216 | 100072 | June 11, 2015 | June 10, 2016 |
| RF Cable | 5D-FB | COCCAB-001 | Mar. 08, 2016 | Mar. 07, 2017 |
| 50 ohms Terminator | N/A | EMC-03 | Sep. 23, 2015 | Sep. 22, 2016 |
| 50 ohms Terminator | N/A | EMC-02 | Oct. 01, 2015 | Sep. 30, 2016 |
| 50 ohms Terminator | E1-011315 | 13 | Dec. 11 2015 | Dec. 10 2016 |
| Software BVADT | BVADT_Cond_ V7.3.7.3 | NA | NA | NA |

Note:

1. The calibration interval of the above test instruments are 12 months and the calibrations are traceable to NML/ROC and NIST/USA.
2. The test was performed in Shielded Room No. C.
3. The VCCI Con C Registration No. is C-3611.
4. Tested Date: Apr. 11, 2016

4.2.3 Test Procedures

- The EUT was placed 0.4 meters from the conducting wall of the shielded room with EUT being connected to the power mains through a line impedance stabilization network (LISN). Other support units were connected to the power mains through another LISN. The two LISNs provide 50 ohm/ 50uH of coupling impedance for the measuring instrument.
- Both lines of the power mains connected to the EUT were checked for maximum conducted interference.
- The frequency range from 150kHz to 30MHz was searched. Emission levels under (Limit - 20dB) was not recorded.

NOTE: The resolution bandwidth and video bandwidth of test receiver is 9kHz for quasi-peak detection (QP) and average detection (AV) at frequency 0.15MHz-30MHz.

4.2.4 Deviation From Test Standard

No deviation.

4.2.5 Test Setup

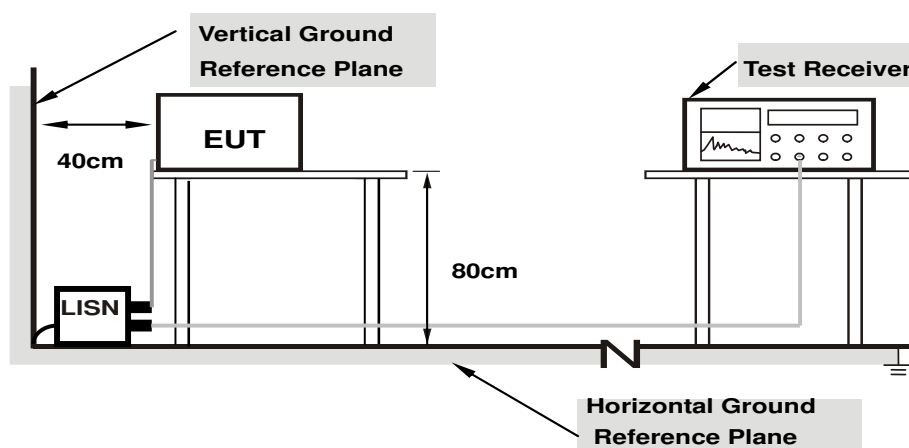

Note: 1.Support units were connected to second LISN.

For the actual test configuration, please refer to the attached file (Test Setup Photo).

4.2.6 EUT Operating Condition

Same as 4.1.6.

4.2.7 Test Results (Mode 1)

| Phase | Line (L) | Detector Function | Quasi-Peak (QP) / Average (AV) |
|-------|----------|-------------------|--------------------------------|
|-------|----------|-------------------|--------------------------------|

| No | Freq. [MHz] | Corr. | Reading Value | | Emission Level | | Limit | | Margin | |
|----|----------------|----------------|---------------|-------|----------------|-------|-----------|-------|--------|--------|
| | | Factor (dB) | [dB (uV)] | | [dB (uV)] | | [dB (uV)] | | (dB) | |
| | | | Q.P. | AV. | Q.P. | AV. | Q.P. | AV. | Q.P. | AV. |
| 1 | 0.15000 | 10.32 | 41.78 | 22.61 | 52.10 | 32.93 | 66.00 | 56.00 | -13.90 | -23.07 |
| 2 | 0.16953 | 10.31 | 37.33 | 22.19 | 47.64 | 32.50 | 64.98 | 54.98 | -17.35 | -22.49 |
| 3 | 0.20078 | 10.28 | 33.62 | 18.91 | 43.90 | 29.19 | 63.58 | 53.58 | -19.68 | -24.39 |
| 4 | 0.21250 | 10.28 | 31.94 | 17.06 | 42.22 | 27.34 | 63.11 | 53.11 | -20.89 | -25.77 |
| 5 | 0.53641 | 10.28 | 24.10 | 20.40 | 34.38 | 30.68 | 56.00 | 46.00 | -21.62 | -15.32 |
| 6 | 19.69141 | 10.94 | 17.75 | 11.87 | 28.69 | 22.81 | 60.00 | 50.00 | -31.31 | -27.19 |

REMARKS:

1. Q.P. and AV. are abbreviations of quasi-peak and average individually.
2. The emission levels of other frequencies were very low against the limit.
3. Margin value = Emission level - Limit value
4. Correction factor = Insertion loss + Cable loss
5. Emission Level = Correction Factor + Reading Value

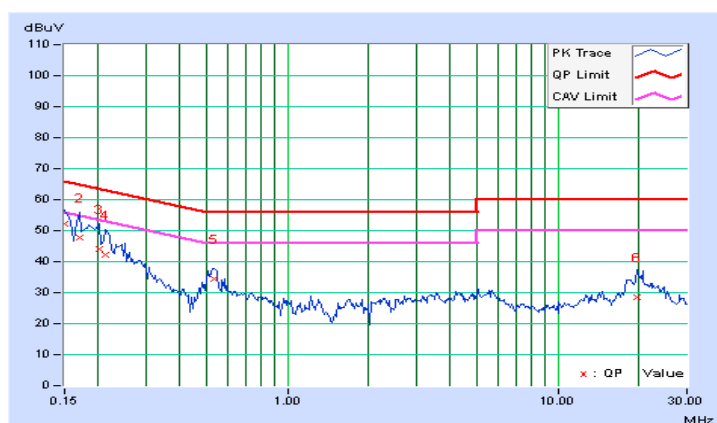

| | | | |
|-------|-------------|-------------------|--------------------------------|
| Phase | Neutral (N) | Detector Function | Quasi-Peak (QP) / Average (AV) |
|-------|-------------|-------------------|--------------------------------|

| No | Freq. [MHz] | Corr. Factor (dB) | Reading Value | | Emission Level | | Limit | | Margin | |
|----|----------------|-------------------------|---------------|-------|----------------|-------|-----------|-------|--------|--------|
| | | | [dB (uV)] | | [dB (uV)] | | [dB (uV)] | | (dB) | |
| | | | Q.P. | AV. | Q.P. | AV. | Q.P. | AV. | Q.P. | AV. |
| 1 | 0.16172 | 10.29 | 38.78 | 22.69 | 49.07 | 32.98 | 65.38 | 55.38 | -16.30 | -22.39 |
| 2 | 0.19297 | 10.27 | 35.74 | 21.12 | 46.01 | 31.39 | 63.91 | 53.91 | -17.90 | -22.52 |
| 3 | 0.22812 | 10.26 | 30.26 | 16.96 | 40.52 | 27.22 | 62.52 | 52.52 | -22.00 | -25.30 |
| 4 | 0.27891 | 10.27 | 25.58 | 14.72 | 35.85 | 24.99 | 60.85 | 50.85 | -25.00 | -25.86 |
| 5 | 0.52891 | 10.27 | 23.64 | 19.63 | 33.91 | 29.90 | 56.00 | 46.00 | -22.09 | -16.10 |
| 6 | 20.32031 | 10.98 | 22.76 | 18.14 | 33.74 | 29.12 | 60.00 | 50.00 | -26.26 | -20.88 |

REMARKS:

1. Q.P. and AV. are abbreviations of quasi-peak and average individually.
2. The emission levels of other frequencies were very low against the limit.
3. Margin value = Emission level - Limit value
4. Correction factor = Insertion loss + Cable loss
5. Emission Level = Correction Factor + Reading Value

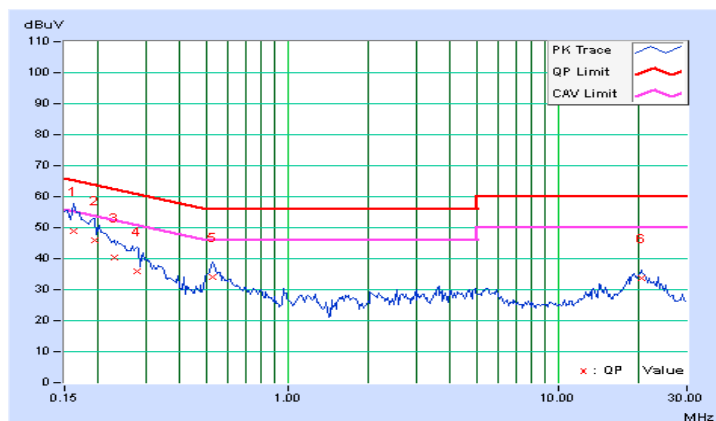

4.2.8 Test Results (Mode 2)

| Phase | Line (L) | Detector Function | Quasi-Peak (QP) / Average (AV) |
|-------|----------|-------------------|--------------------------------|
|-------|----------|-------------------|--------------------------------|

| No | Freq. [MHz] | Corr. | Reading Value | | Emission Level | | Limit | | Margin | |
|----|----------------|--------|---------------|-------|----------------|-------|-----------|-------|--------|--------|
| | | Factor | [dB (uV)] | | [dB (uV)] | | [dB (uV)] | | (dB) | |
| | (dB) | Q.P. | AV. | Q.P. | AV. | Q.P. | AV. | Q.P. | AV. | |
| 1 | 0.15391 | 10.32 | 30.82 | 19.69 | 41.14 | 30.01 | 65.79 | 55.79 | -24.64 | -25.77 |
| 2 | 0.17734 | 10.30 | 26.66 | 14.94 | 36.96 | 25.24 | 64.61 | 54.61 | -27.65 | -29.37 |
| 3 | 0.20469 | 10.28 | 24.87 | 11.20 | 35.15 | 21.48 | 63.42 | 53.42 | -28.27 | -31.94 |
| 4 | 0.24375 | 10.28 | 20.02 | 9.48 | 30.30 | 19.76 | 61.97 | 51.97 | -31.66 | -32.20 |
| 5 | 0.41953 | 10.30 | 29.97 | 24.72 | 40.27 | 35.02 | 57.46 | 47.46 | -17.19 | -12.44 |
| 6 | 0.54844 | 10.28 | 16.34 | 8.27 | 26.62 | 18.55 | 56.00 | 46.00 | -29.38 | -27.45 |

REMARKS:

1. Q.P. and AV. are abbreviations of quasi-peak and average individually.
2. The emission levels of other frequencies were very low against the limit.
3. Margin value = Emission level - Limit value
4. Correction factor = Insertion loss + Cable loss
5. Emission Level = Correction Factor + Reading Value

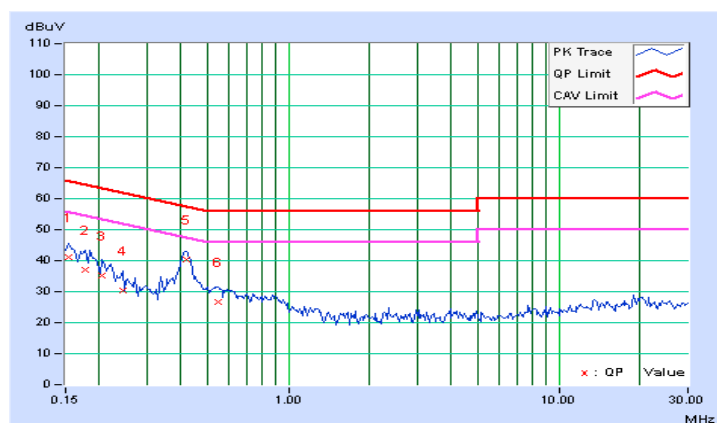

| | | | |
|-------|-------------|-------------------|--------------------------------|
| Phase | Neutral (N) | Detector Function | Quasi-Peak (QP) / Average (AV) |
|-------|-------------|-------------------|--------------------------------|

| No | Freq. [MHz] | Corr. Factor (dB) | Reading Value | | Emission Level | | Limit | | Margin | |
|----------|----------------|-------------------------|---------------|--------------|----------------|--------------|--------------|--------------|---------------|---------------|
| | | | [dB (uV)] | | [dB (uV)] | | [dB (uV)] | | (dB) | |
| | | | Q.P. | AV. | Q.P. | AV. | Q.P. | AV. | Q.P. | AV. |
| 1 | 0.15000 | 10.30 | 33.15 | 21.91 | 43.45 | 32.21 | 66.00 | 56.00 | -22.55 | -23.79 |
| 2 | 0.16172 | 10.29 | 30.35 | 18.17 | 40.64 | 28.46 | 65.38 | 55.38 | -24.73 | -26.91 |
| 3 | 0.19297 | 10.27 | 27.16 | 12.57 | 37.43 | 22.84 | 63.91 | 53.91 | -26.48 | -31.07 |
| 4 | 0.22031 | 10.26 | 23.68 | 12.79 | 33.94 | 23.05 | 62.81 | 52.81 | -28.87 | -29.76 |
| 5 | 0.41953 | 10.28 | 30.72 | 25.31 | 41.00 | 35.59 | 57.46 | 47.46 | -16.46 | -11.87 |
| 6 | 0.57969 | 10.26 | 17.49 | 11.02 | 27.75 | 21.28 | 56.00 | 46.00 | -28.25 | -24.72 |

REMARKS:

1. Q.P. and AV. are abbreviations of quasi-peak and average individually.
2. The emission levels of other frequencies were very low against the limit.
3. Margin value = Emission level - Limit value
4. Correction factor = Insertion loss + Cable loss
5. Emission Level = Correction Factor + Reading Value

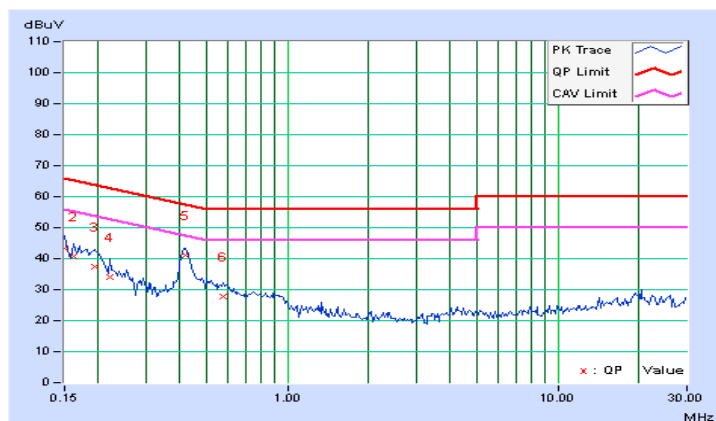

4.3 Number of Hopping Frequency Used

4.3.1 Limits of Hopping Frequency Used Measurement

At least 15 channels frequencies, and should be equally spaced.

4.3.2 Test Setup

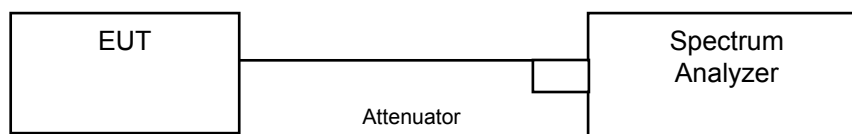

4.3.3 Test Instruments

Refer to section 4.1.2 to get information of above instrument.

4.3.4 Test Procedure

- a. Check the calibration of the measuring instrument (SA) using either an internal calibrator or a known signal from an external generator.
- b. Turn on the EUT and connect its antenna terminal to measurement via a low loss cable. Then set it to any one measured frequency within its operating range and make sure the instrument is operated in its linear range.
- c. Set the SA on MaxHold Mode, and then keep the EUT in hopping mode. Record all the signals from each channel until each one has been recorded.
- d. Set the SA on View mode and then plot the result on SA screen.
- e. Repeat above procedures until all frequencies measured were complete.

4.3.5 Deviation from Test Standard

No deviation.

4.3.6 Test Results

There are 79 hopping frequencies in the hopping mode. Please refer to next page for the test result. On the plots, it shows that the hopping frequencies are equally spaced.

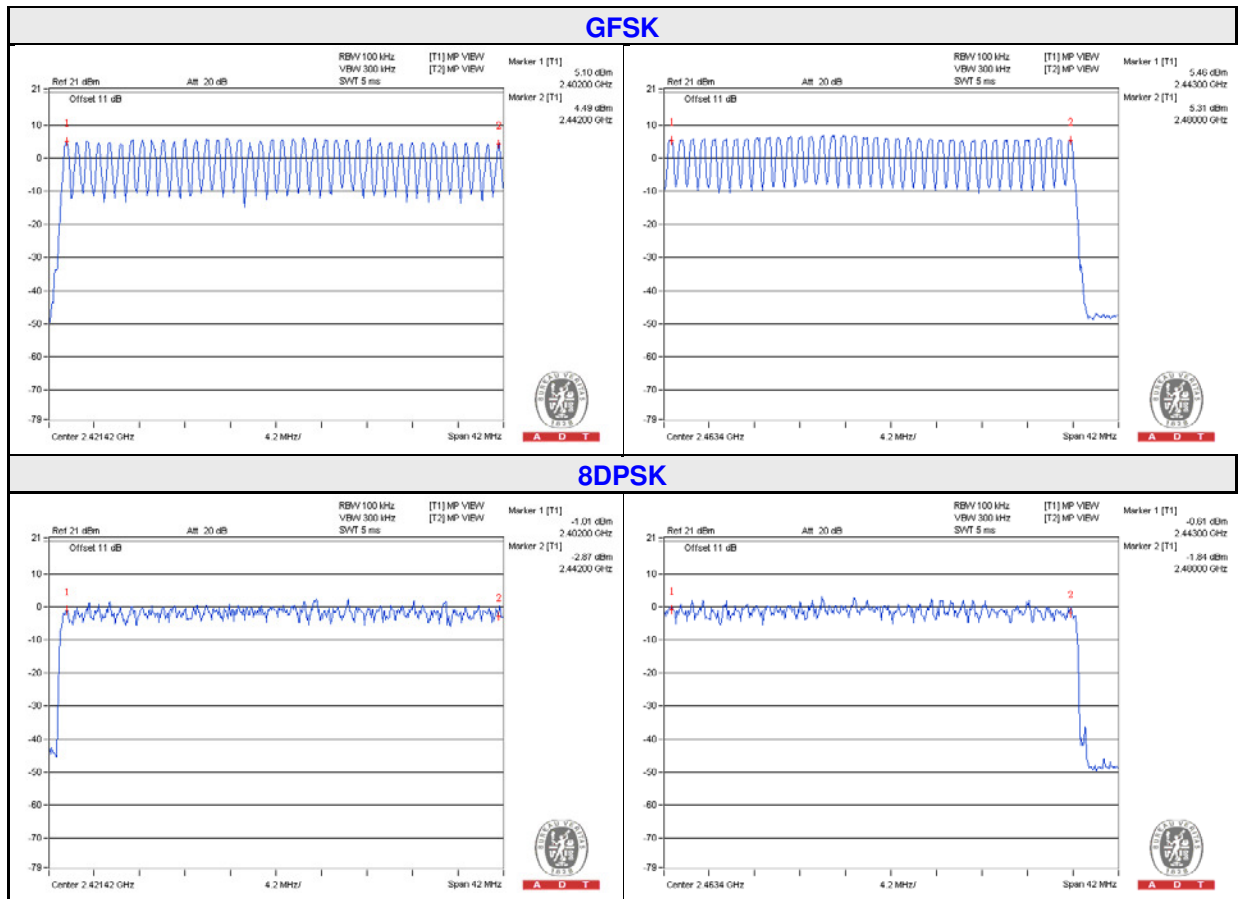

4.4 Dwell Time on Each Channel

4.4.1 Limits of Dwell Time on Each Channel Measurement

The average time of occupancy on any channel shall not be greater than 0.4 seconds within a period of 0.4 seconds multiplied by the number of hopping channels employed.

4.4.2 Test Setup

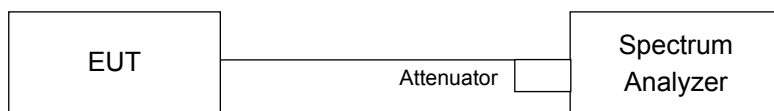

4.4.3 Test Instruments

Refer to section 4.1.2 to get information of above instrument.

4.4.4 Test Procedures

- a. Check the calibration of the measuring instrument (SA) using either an internal calibrator or a known signal from an external generator.
- b. Turn on the EUT and connect its antenna terminal to measurement via a low loss cable. Then set it to any one measured frequency within its operating range and make sure the instrument is operated in its linear range.
- c. Adjust the center frequency of SA on any frequency be measured and set SA to zero span mode. And then, set RBW and VBW of spectrum analyzer to proper value.
- d. Measure the time duration of one transmission on the measured frequency. And then plot the result with time difference of this time duration.
- e. Repeat above procedures until all different time-slot modes have been completed.

4.4.5 Deviation from Test Standard

No deviation.

4.4.6 Test Results

GFSK

| Mode | Number of transmission in a 31.6 (79Hopping*0.4) | Length of transmission time (msec) | Result (msec) | Limit (msec) |
|------|--|------------------------------------|---------------|--------------|
| DH1 | 50 (times / 5 sec) * 6.32 = 316 times | 0.48 | 151.68 | 400 |
| DH3 | 25 (times / 5 sec) * 6.32 = 158 times | 1.75 | 276.5 | 400 |
| DH5 | 17 (times / 5 sec) * 6.32 = 107.44 times | 3.04 | 326.62 | 400 |

NOTE: Test plots of the transmitting time slot are shown on next page.

DH1

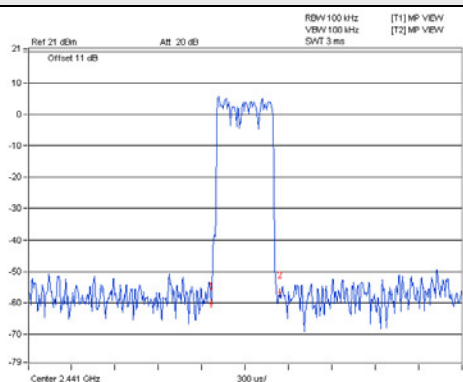
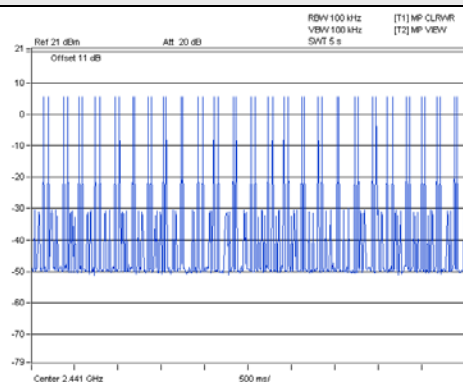

Marker 1 [T1] -50.25 dBm
1.260000 ms
Delta 2 [T1] 3.51 dB
400.000000 us

DH3

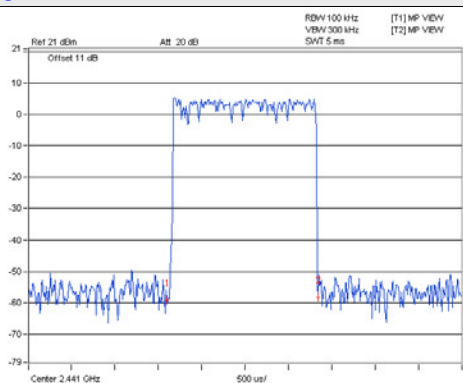
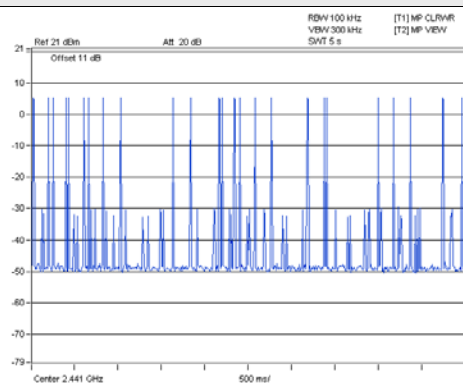

Marker 1 [T1] -59.26 dBm
1.580000 ms
Delta 2 [T1] 0.97 dB
1.750000 ms

DH5

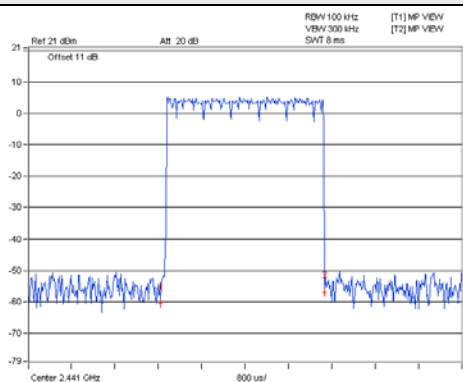
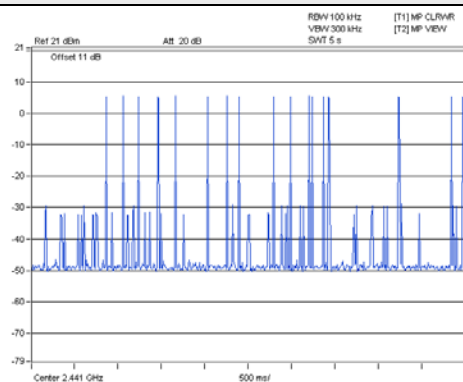

Marker 1 [T1] -60.69 dBm
2.432000 ms
Delta 2 [T1] 3.78 dB
3.040000 ms

8DPSK

| Mode | Number of transmission in a 31.6 (79Hopping*0.4) | Length of transmission time (msec) | Result (msec) | Limit (msec) |
|------|--|------------------------------------|---------------|--------------|
| 3DH1 | 50 (times / 5 sec) * 6.32 = 316 times | 0.474 | 149.78 | 400 |
| 3DH3 | 25 (times / 5 sec) * 6.32 = 158 times | 1.76 | 278.08 | 400 |
| 3DH5 | 17 (times / 5 sec) * 6.32 = 107.44 times | 2.976 | 319.74 | 400 |

NOTE: Test plots of the transmitting time slot are shown on next page.

3DH1

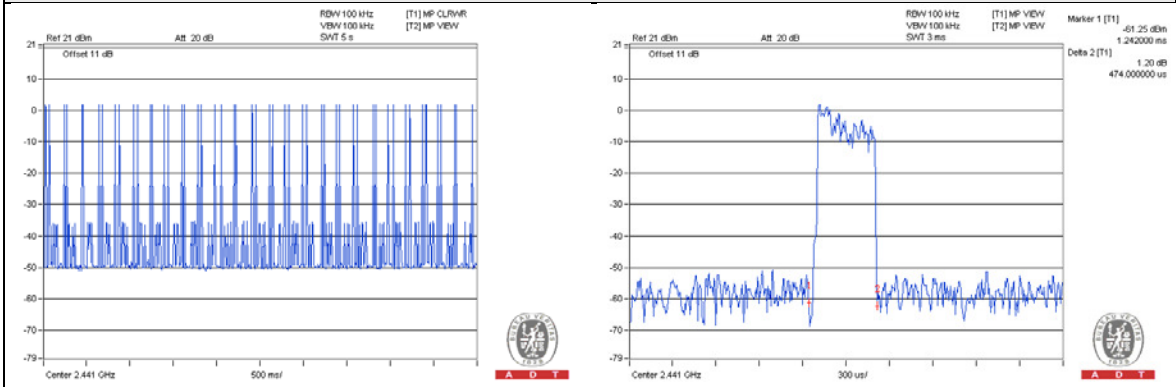

3DH3

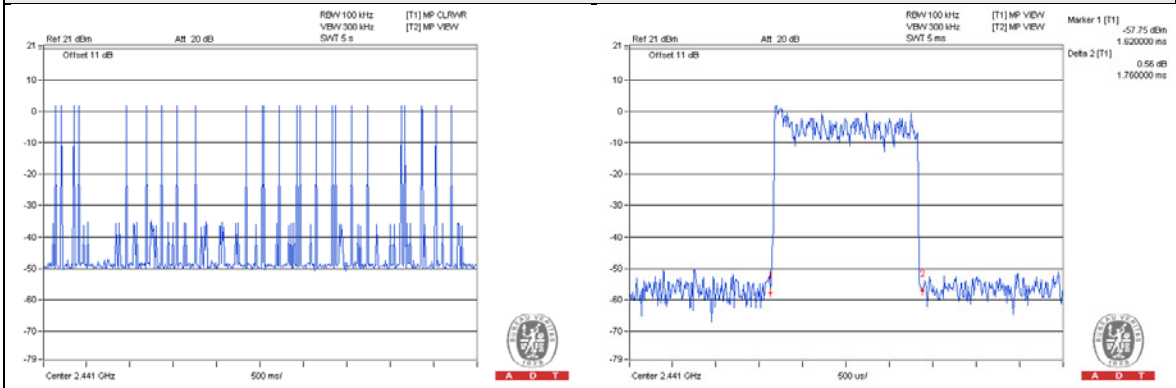

3DH5

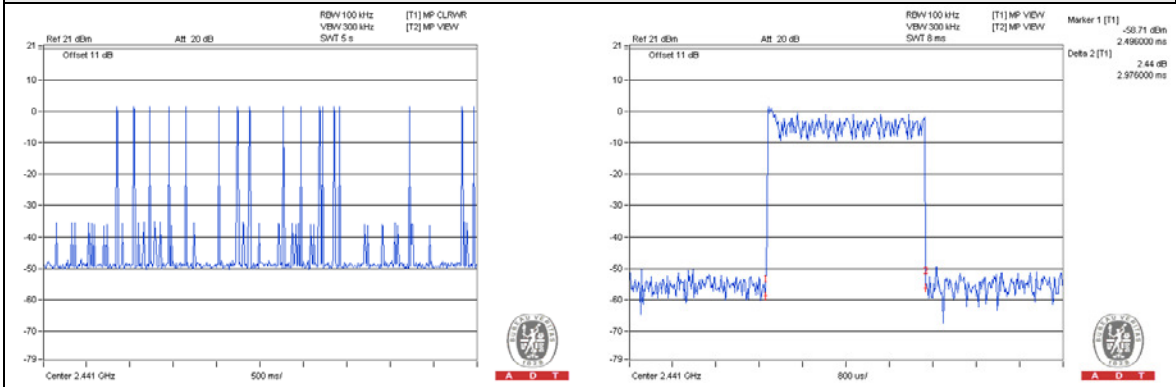

4.5 Channel Bandwidth

4.5.1 Limits of Channel Bandwidth Measurement

For frequency hopping system operating in the 2400-2483.5MHz, If the 20dB bandwidth of hopping channel is greater than 25kHz, two-thirds 20dB bandwidth of hopping channel shall be a minimum limit for the hopping channel separation.

4.5.2 Test Setup

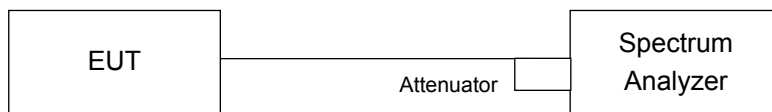

4.5.3 Test Instruments

Refer to section 4.1.2 to get information of above instrument.

4.5.4 Test Procedure

- Check the calibration of the measuring instrument using either an internal calibrator or a known signal from an external generator.
- Turn on the EUT and connect it to measurement instrument. Then set it to any one convenient frequency within its operating range. Set a reference level on the measuring instrument equal to the highest peak value.
- Measure the frequency difference of two frequencies that were attenuated 20dB from the reference level. Record the frequency difference as the emission bandwidth.
- Repeat above procedures until all frequencies measured were complete.

4.5.5 Deviation from Test Standard

No deviation.

4.5.6 EUT Operating Condition

The software provided by client enabled the EUT to transmit and receive data at lowest, middle and highest channel frequencies individually.

4.5.7 Test Results

| Channel | Frequency (MHz) | 20dB Bandwidth (MHz) | |
|---------|-----------------|----------------------|-------|
| | | GFSK | 8DPSK |
| 0 | 2402 | 0.96 | 1.38 |
| 39 | 2441 | 0.96 | 1.38 |
| 78 | 2480 | 0.96 | 1.38 |

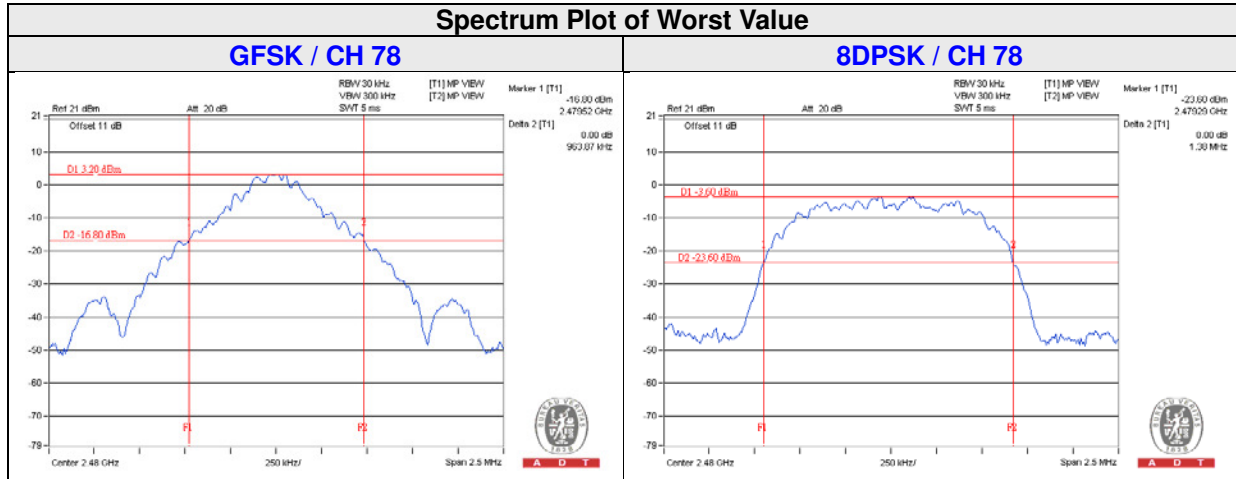

4.6 Hopping Channel Separation

4.6.1 Limits of Hopping Channel Separation Measurement

At least 25kHz or two-third of 20dB hopping channel bandwidth (whichever is greater).

4.6.2 Test Setup

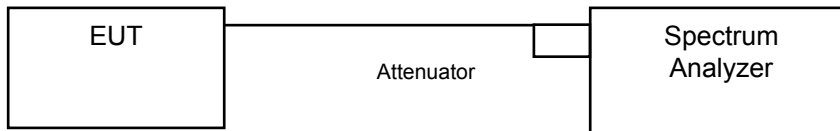

4.6.3 Test Instruments

Refer to section 4.1.2 to get information of above instrument.

4.6.4 Test Procedure

Measurement Procedure REF

- a. Check the calibration of the measuring instrument using either an internal calibrator or a known signal from an external generator.
- b. Turn on the EUT and connect it to measurement instrument. Then set it to any one convenient frequency within its operating range.
- c. By using the MaxHold function record the separation of two adjacent channels.
- d. Measure the frequency difference of these two adjacent channels by SA MARK function. And then plot the result on SA screen.
- e. Repeat above procedures until all frequencies measured were complete.

4.6.5 Deviation from Test Standard

No deviation.

4.6.6 Test Results

| Channel | Frequency (MHz) | Adjacent Channel Separation (MHz) | | 20dB Bandwidth (MHz) | | Minimum Limit (MHz) | | Pass / Fail |
|---------|-----------------|-----------------------------------|-------|----------------------|-------|---------------------|-------|-------------|
| | | GFSK | 8DPSK | GFSK | 8DPSK | GFSK | 8DPSK | |
| 0 | 2402 | 1.00 | 1.01 | 0.96 | 1.38 | 0.64 | 0.92 | Pass |
| 39 | 2441 | 1.00 | 1.00 | 0.96 | 1.38 | 0.64 | 0.92 | Pass |
| 78 | 2480 | 1.00 | 1.00 | 0.96 | 1.38 | 0.64 | 0.92 | Pass |

NOTE: The minimum limit is two-third 20dB bandwidth.

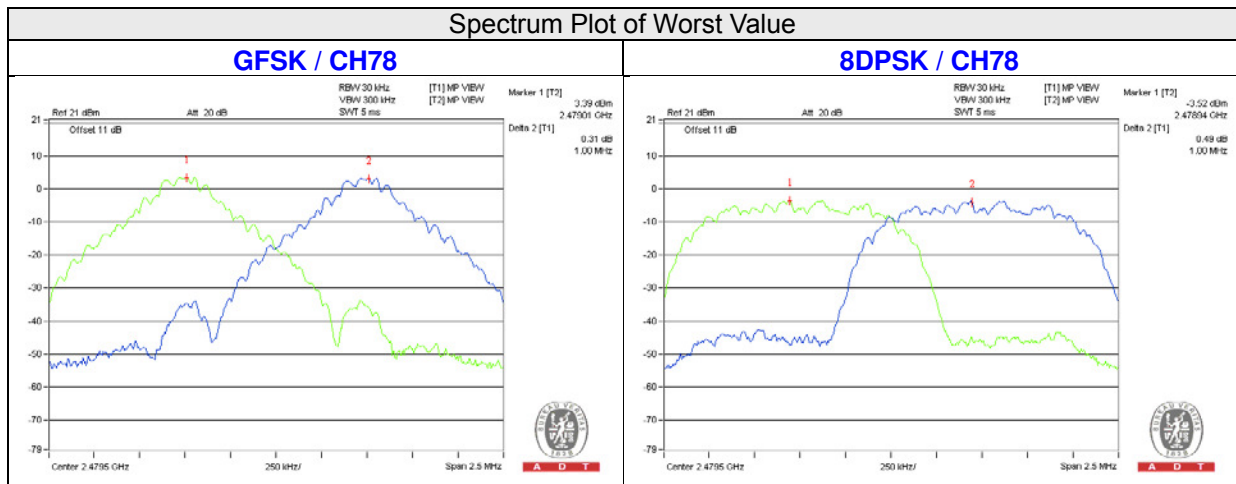

4.7 Maximum Output Power

4.7.1 Limits of Maximum Output Power Measurement

The Maximum Output Power Measurement is 125mW.

4.7.2 Test Setup

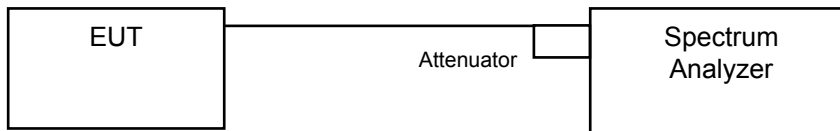

4.7.3 Test Instruments

Refer to section 4.1.2 to get information of above instrument.

4.7.4 Test Procedure

- a. Check the calibration of the measuring instrument using either an internal calibrator or a known signal from an external generator.
- b. Turn on the EUT and connect it to measurement instrument. Then set it to any one convenient frequency within its operating range. Set a reference level on the measuring instrument equal to the highest peak value.
- c. The center frequency of the spectrum analyzer is set to the fundamental frequency and using 3MHz RBW and 10 MHz VBW.
- d. Measure the captured power within the band and recording the plot.
- e. Repeat above procedures until all frequencies required were complete.

4.7.5 Deviation from Test Standard

No deviation.

4.7.6 EUT Operating Condition

The software provided by client enabled the EUT to transmit and receive data at lowest, middle and highest channel frequencies individually.

4.7.7 Test Results

| Channel | Frequency (MHZ) | Output Power (mW) | | Output Power (dBm) | | Power Limit (mW) | Pass / Fail |
|---------|-----------------|-------------------|-------|--------------------|-------|------------------|-------------|
| | | GFSK | 8DPSK | GFSK | 8DPSK | | |
| 0 | 2402 | 3.524 | 2.793 | 5.47 | 4.46 | 21.00 | Pass |
| 39 | 2441 | 3.656 | 2.951 | 5.63 | 4.70 | 21.00 | Pass |
| 78 | 2480 | 4.178 | 3.236 | 6.21 | 5.10 | 21.00 | Pass |

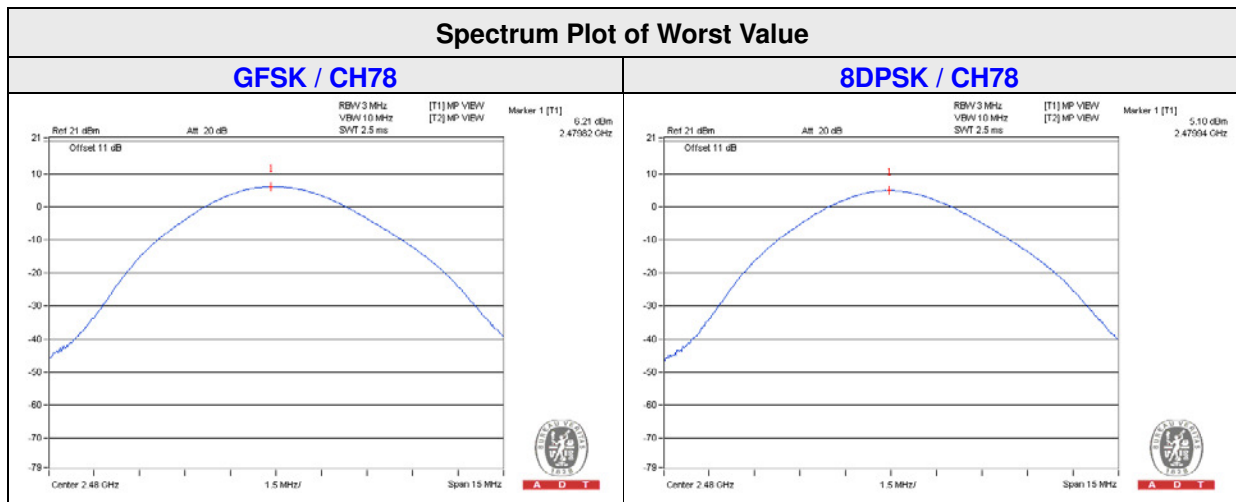

4.8 Conducted Out of Band Emission Measurement

4.8.1 Limits of Conducted Out of Band Emission Measurement

Below -20dB of the highest emission level of operating band (in 100kHz RBW).

4.8.2 Test Instruments

Refer to section 4.1.2 to get information of above instrument.

4.8.3 Test Procedure

The transmitter output was connected to the spectrum analyzer via a low lose cable. Set both RBW and VBW of spectrum analyzer to 100 kHz and 300 kHz with suitable frequency span including 100 MHz bandwidth from band edge. The band edges was measured and recorded.

4.8.4 Deviation from Test Standard

No deviation.

4.8.5 Eut Operating Condition

The software provided by client enabled the EUT to transmit and receive data at lowest, middle and highest channel frequencies individually.

4.8.6 Test Results

The spectrum plots are attached on the following images. D1 line indicates the highest level, D2 line indicates the 20dB offset below D1. It shows compliance with the requirement.

GFSK

Hopping disabled Low Channel

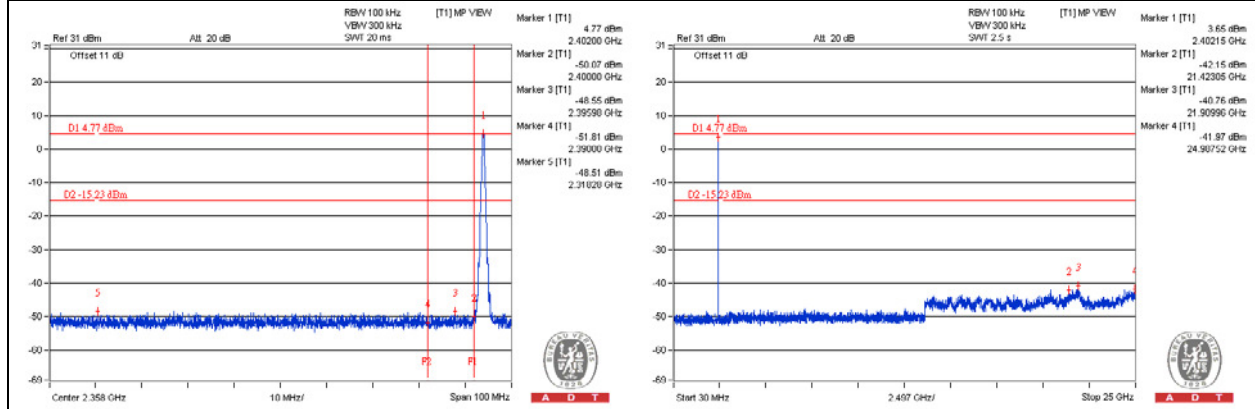

Hopping disabled High Channel

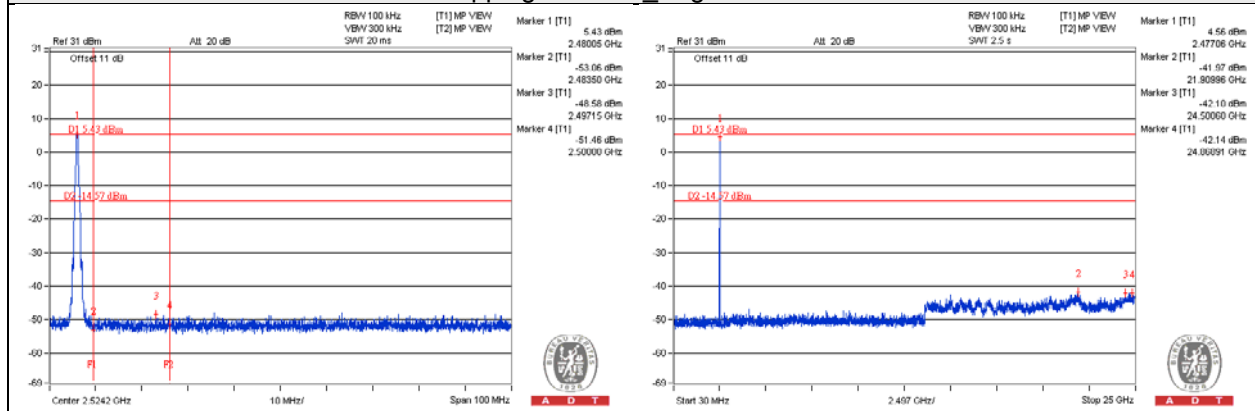

Hopping enabled Low Channel

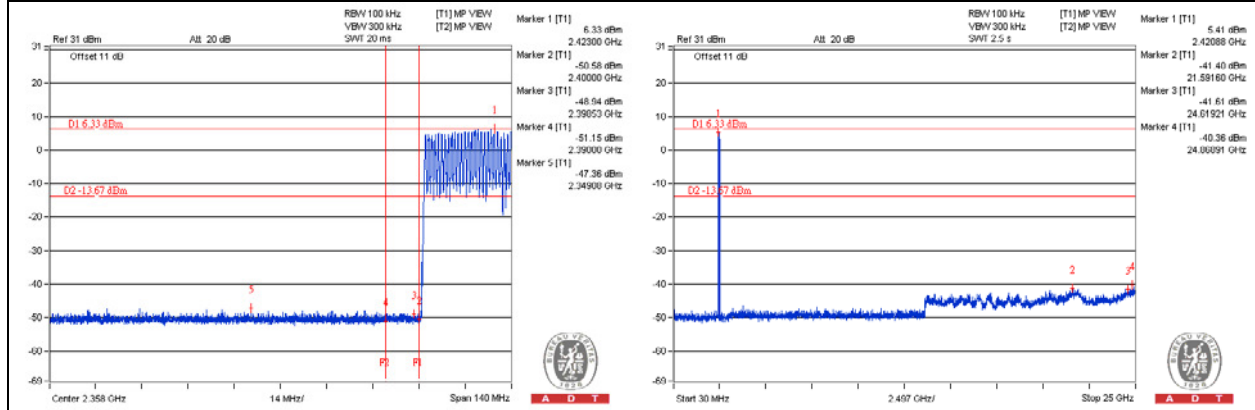

Hopping enabled High Channel

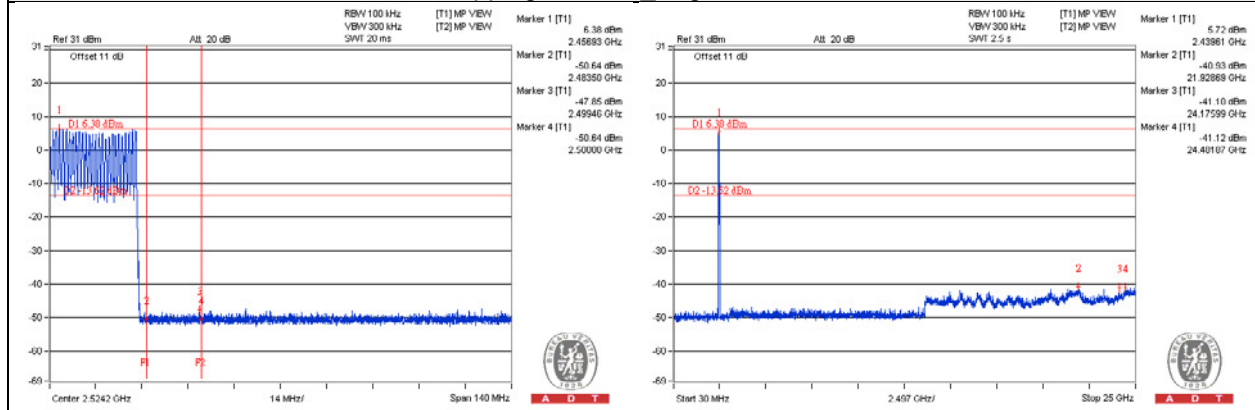

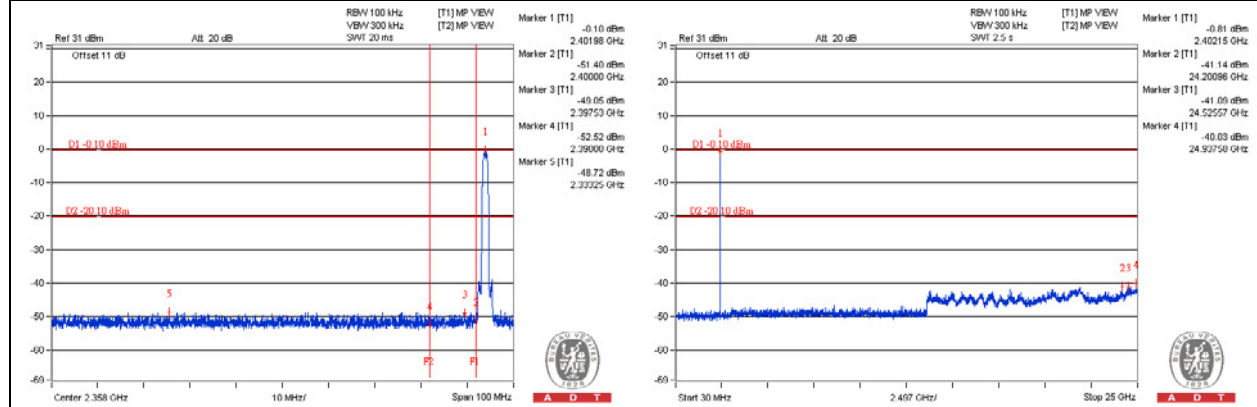
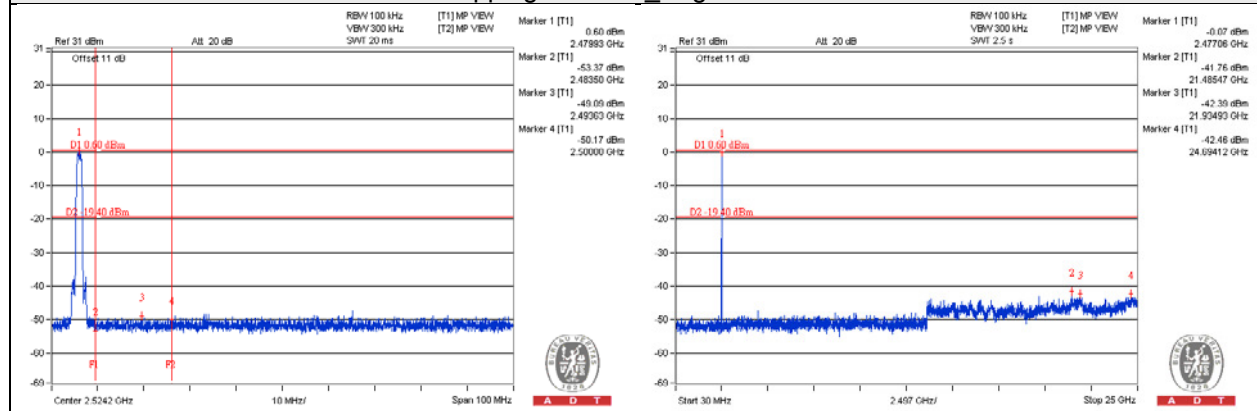
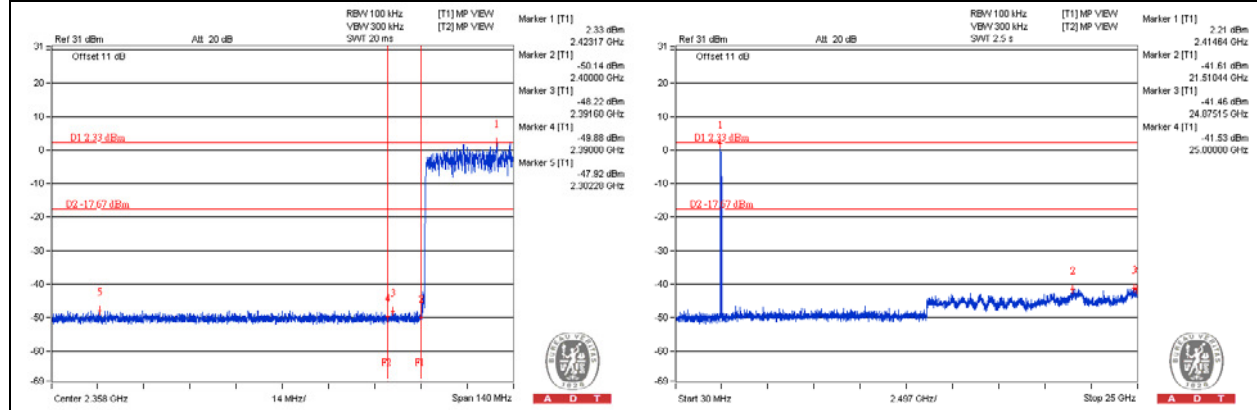
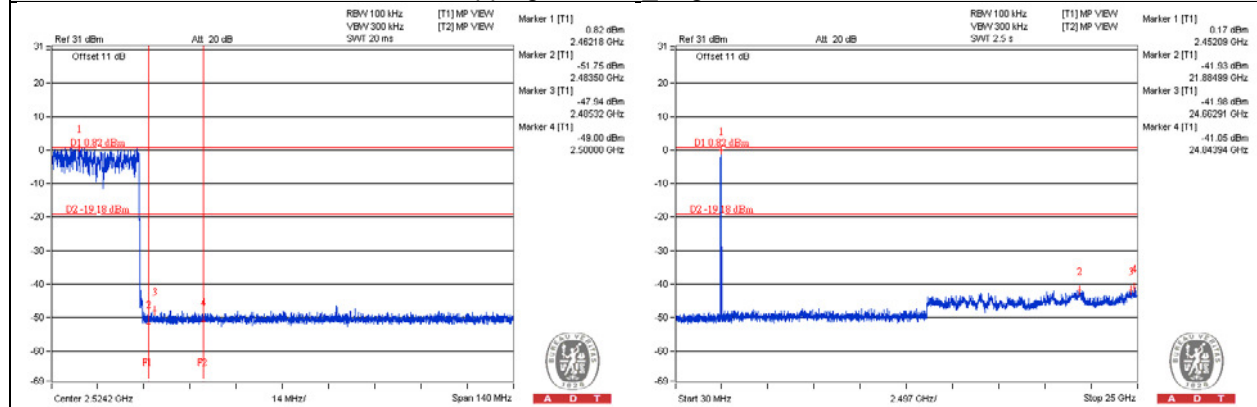
8DPSK**Hopping disabled Low Channel****Hopping disabled High Channel****Hopping enabled Low Channel****Hopping enabled High Channel**



5 Pictures of Test Arrangements

Please refer to the attached file (Test Setup Photo).

Appendix – Information on the Testing Laboratories

We, Bureau Veritas Consumer Products Services (H.K.) Ltd., Taoyuan Branch, were founded in 1988 to provide our best service in EMC, Radio, Telecom and Safety consultation. Our laboratories are accredited and approved according to ISO/IEC 17025.

If you have any comments, please feel free to contact us at the following:

Linko EMC/RF Lab

Tel: 886-2-26052180

Fax: 886-2-26051924

Hsin Chu EMC/RF/Telecom Lab

Tel: 886-3-6668565

Fax: 886-3-6668323

Hwa Ya EMC/RF/Safety Lab

Tel: 886-3-3183232

Fax: 886-3-3270892

Email: service.adt@tw.bureauveritas.com

Web Site: www.bureauveritas-adt.com

The address and road map of all our labs can be found in our web site also.

--- END ---