

FCC Test Report

Report No.: RF160128E09

FCC ID: UZ7WT6000

Test Model: WT6000

Received Date: Jan. 28, 2016

Test Date: Mar. 02 to Apr. 18, 2016

Issued Date: Apr. 26, 2016

Applicant: Zebra Technologies Corporation

Address: 1 Zebra Plaza, Holtsville, NY 11742

Manufacturer: Zebra Technologies Corporation

Address: 1 Zebra Plaza, Holtsville, NY 11742

Issued By: Bureau Veritas Consumer Products Services (H.K.) Ltd., Taoyuan Branch
Hsin Chu Laboratory

Lab Address: E-2, No.1, Li Hsin 1st Road, Hsinchu Science Park, Hsinchu City 300,
Taiwan R.O.C.

Test Location (1): E-2, No.1, Li Hsin 1st Road, Hsinchu Science Park, Hsinchu City 300,
Taiwan R.O.C.

Test Location (2): No. 49, Ln. 206, Wende Rd., Shangshan Tsuen, Chiung Lin Hsiang, Hsin
Chu Hsien 307, Taiwan R.O.C.



This report is for your exclusive use. Any copying or replication of this report to or for any other person or entity, or use of our name or trademark, is permitted only with our prior written permission. This report sets forth our findings solely with respect to the test samples identified herein. The results set forth in this report are not indicative or representative of the quality or characteristics of the lot from which a test sample was taken or any similar or identical product unless specifically and expressly noted. Our report includes all of the tests requested by you and the results thereof based upon the information that you provided to us. You have 60 days from date of issuance of this report to notify us of any material error or omission caused by our negligence, provided, however, that such notice shall be in writing and shall specifically address the issue you wish to raise. A failure to raise such issue within the prescribed time shall constitute your unqualified acceptance of the completeness of this report, the tests conducted and the correctness of the report contents. Unless specific mention, the uncertainty of measurement has been explicitly taken into account to declare the compliance or non-compliance to the specification. The report must not be used by the client to claim product certification, approval, or endorsement by TAF or any government agencies.

Table of Contents

Release Control Record	4
1 Certificate of Conformity	5
2 Summary of Test Results	6
2.1 Measurement Uncertainty.....	6
2.2 Modification Record.....	6
3 General Information	7
3.1 General Description of EUT (WLAN).....	7
3.2 Description of Test Modes.....	11
3.2.1 Test Mode Applicability and Tested Channel Detail.....	12
3.3 Duty Cycle of Test Signal.....	15
3.4 Description of Support Units.....	16
3.4.1 Configuration of System under Test.....	17
3.5 General Description of Applied Standards.....	18
4 Test Types and Results	19
4.1 Radiated Emission and Bandedge Measurement.....	19
4.1.1 Limits of Radiated Emission and Bandedge Measurement.....	19
4.1.2 Test Instruments.....	20
4.1.3 Test Procedures.....	22
4.1.4 Deviation from Test Standard.....	22
4.1.5 Test Setup.....	23
4.1.6 EUT Operating Conditions.....	23
4.1.7 Test Results.....	24
4.2 Conducted Emission Measurement.....	80
4.2.1 Limits of Conducted Emission Measurement.....	80
4.2.2 Test Instruments.....	80
4.2.3 Test Procedures.....	81
4.2.4 Deviation from Test Standard.....	81
4.2.5 Test Setup.....	81
4.2.6 EUT Operating Conditions.....	81
4.2.7 Test Results (Mode 1).....	82
4.2.8 Test Results (Mode 2).....	84
4.3 6dB Bandwidth Measurement.....	86
4.3.1 Limits of 6dB Bandwidth Measurement.....	86
4.3.2 Test Setup.....	86
4.3.3 Test Instruments.....	86
4.3.4 Test Procedure.....	86
4.3.5 Deviation from Test Standard.....	86
4.3.6 EUT Operating Conditions.....	86
4.3.7 Test Result.....	87
4.4 Conducted Output Power Measurement.....	90
4.4.1 Limits of Conducted Output Power Measurement.....	90
4.4.2 Test Setup.....	90
4.4.3 Test Instruments.....	90
4.4.4 Test Procedures.....	90
4.4.5 Deviation from Test Standard.....	90
4.4.6 EUT Operating Conditions.....	90
4.4.7 Test Results.....	91
4.5 Power Spectral Density Measurement.....	98
4.5.1 Limits of Power Spectral Density Measurement.....	98
4.5.2 Test Setup.....	98
4.5.3 Test Instruments.....	98
4.5.4 Test Procedure.....	98
4.5.5 Deviation from Test Standard.....	98



4.5.6 EUT Operating Condition	98
4.5.7 Test Results	99
4.6 Conducted Out of Band Emission Measurement.....	102
4.6.1 Limits of Conducted Out of Band Emission Measurement	102
4.6.2 Test Setup.....	102
4.6.3 Test Instruments	102
4.6.4 Test Procedure	102
4.6.5 Deviation from Test Standard	102
4.6.6 EUT Operating Condition	102
4.6.7 Test Results	103
5 Pictures of Test Arrangements.....	124
Appendix – Information on the Testing Laboratories	125



Release Control Record

Issue No.	Description	Date Issued
RF160128E09	Original release.	Apr. 26, 2016



1 Certificate of Conformity

Product: Wearable Terminal
Brand: Zebra
Test Model: WT6000
Sample Status: ENGINEERING SAMPLE
Applicant: Zebra Technologies Corporation
Test Date: Mar. 02 to Apr. 18, 2016
Standards: 47 CFR FCC Part 15, Subpart C (Section 15.247)
ANSI C63.10: 2013

The above equipment has been tested by **Bureau Veritas Consumer Products Services (H.K.) Ltd., Taoyuan Branch**, and found compliance with the requirement of the above standards. The test record, data evaluation & Equipment Under Test (EUT) configurations represented herein are true and accurate accounts of the measurements of the sample's EMC characteristics under the conditions specified in this report.

Prepared by : Wendy Wu , **Date:** Apr. 26, 2016
Wendy Wu / Specialist

Approved by : May Chen , **Date:** Apr. 26, 2016
May Chen / Manager

2 Summary of Test Results

47 CFR FCC Part 15, Subpart C (SECTION 15.247)			
FCC Clause	Test Item	Result	Remarks
15.207	AC Power Conducted Emission	PASS	Meet the requirement of limit. Minimum passing margin is -12.14dB at 0.41953MHz.
15.205 / 15.209 / 15.247(d)	Radiated Emissions and Band Edge Measurement	PASS	Meet the requirement of limit. Minimum passing margin is -1.1dB at 2483.50MHz.
15.247(d)	Antenna Port Emission	PASS	Meet the requirement of limit.
15.247(a)(2)	6dB bandwidth	PASS	Meet the requirement of limit.
15.247(b)	Conducted power	PASS	Meet the requirement of limit.
15.247(e)	Power Spectral Density	PASS	Meet the requirement of limit.
15.203	Antenna Requirement	PASS	Antenna connector is i-pex (MHF) not a standard connector.

NOTE: 1. For WLAN: The EUT was operating in 2.412 ~ 2.472GHz, 5.18~5.24 GHz, 5.26~5.32 GHz, 5.50~5.72GHz and 5.745~5.825GHz frequencies band. This report was recorded the RF parameters including 2.412 ~ 2.472GHz. For the 5.18~5.24 GHz, 5.26~5.32 GHz, 5.50~5.72GHz and 5.745~5.825GHz RF parameters was recorded in another test report.

2.1 Measurement Uncertainty

Where relevant, the following measurement uncertainty levels have been estimated for tests performed on the EUT as specified in CISPR 16-4-2:

Measurement	Frequency	Expanded Uncertainty (k=2) (\pm)
Conducted Emissions at mains ports	150kHz ~ 30MHz	2.86 dB
Radiated Emissions up to 1 GHz	30MHz ~ 1GHz	5.31 dB
Radiated Emissions above 1 GHz	1GHz ~ 6GHz	3.43 dB
	6GHz ~ 18GHz	3.49 dB
	18GHz ~ 40GHz	4.11 dB

2.2 Modification Record

There were no modifications required for compliance.

3 General Information

3.1 General Description of EUT (WLAN 2.4GHz)

Product	Wearable Terminal
Brand	Zebra
Test Model	WT6000
Status of EUT	ENGINEERING SAMPLE
SW Version	3.14.52
Power Supply Rating	DC 3.6V from Battery or DC 5.4V from Cradle or DC 5.4V from Adapter
Modulation Type	CCK, DQPSK, DBPSK for DSSS 64QAM, 16QAM, QPSK, BPSK for OFDM 256QAM for OFDM in 11ac mode
Modulation Technology	DSSS, OFDM
Transfer Rate	802.11b: up to 11Mbps 802.11a/g: up to 54Mbps 802.11n: up to 300Mbps 802.11ac: up to 866.7Mbps
Operating Frequency	For 15.407: 5.18GHz ~ 5.24GHz, 5.26GHz ~ 5.32GHz, 5.50GHz ~ 5.70GHz, 5.745GHz ~ 5.825GHz
	For 15.247: 2.412 ~ 2.472GHz
Number of Channel	For 15.407: 802.11a, 802.11n (HT20), 802.11ac (VHT20): 22 802.11n (HT40), 802.11ac (VHT40): 10 802.11ac (VHT80): 6
	For 15.247: 802.11b, 802.11g, 802.11n (HT20): 13

Output Power	<p>For 15.407: 5.18GHz ~ 5.24GHz 1TX 77.446mW 2TX CDD Mode 136.602mW Beamforming Mode 138.179mW SDM Mode 136.962mW 5.26GHz ~ 5.32GHz 1TX 77.983mW 2TX CDD Mode 140.356mW Beamforming Mode 153.864mW SDM Mode 142.056mW 5.50GHz ~ 5.70GHz 1TX 58.749mW 2TX CDD Mode 137.273mW Beamforming Mode 156.203mW SDM Mode 148.91mW 5.745GHz ~ 5.825GHz 1TX 56.754mW 2TX CDD Mode 114.166mW Beamforming Mode 102.756mW SDM Mode 101.187mW</p> <p>For 15.247: 1TX 245.471mW 2TX CDD Mode 461.663mW Beamforming Mode 492.679mW SDM Mode 481.452mW</p>
Antenna Type	Refer to Note
Antenna Connector	Refer to Note
Accessory Device	Battery x1
Data Cable Supplied	NA

Note:

1. There are WLAN, BT, NFC technology used for the EUT.
2. For WLAN: 2.4GHz and 5GHz technology cannot transmit at same time.
3. WLAN <2.4GHz (1x2) or 5GHz (1x2)> + BT + NFC technology can transmit at same time.
4. The EUT could be supplied with a cradle, adapter or battery as below table:

Battery	
Brand:	ZEBRA TECHNOLOGIES CORPORATION
Part No.:	BT000262A01
Rating:	TYP: 3350mAh, 12.06WH Min: 3200mAh, 11.52WH Rechargeable, normal voltage: 3.6V, limit 4.2V
Cradles- 1slot (not for sale together)	
Brand:	Zebra
Model No.:	SHARECRADLE-01
Part No.:	SAC-TC8X-4SCHG-01
Input Power	+12V ----- 4.16A
Output Power:	DC 5.4V(for EUT used) DC 4.2V(for Battery used)
I/O Port	DC Port x 1 USB Port x 2
Associated Devices:	Adapter x 1 (Adapter: Part No.: PWRS-14000-148R)
Cradle adapter (for Cradle- 1slot used, not for sale together)	
Brand:	HIPRO
Model No.:	HP-A0502R3D
Part No.:	PWRS-14000-148R
Input power :	100-240Vac, 2.4A, 50-60Hz
Output power :	+12Vdc ----- 4.16A DC output cable (unshielded, 1.8m with one core)
Adapter (not for sale together)	
Brand:	Zebra
Model No.:	PWRS-14000-249R
Input Power	100-240Vac, 50-60Hz, 0.6A
Output Power:	+5.4Vdc ----- 3A 1. DC output cable (unshielded, 1.8m) 2. USB charging cable (Brand: SINBON, Model: A9304774-005, shielded, 0.95m with one core)

5. The EUT antennas information:

WLAN / BT antenna				
Transmitter Circuit	Antenna Gain(dBi) <Including cable loss>	Frequency range	Antenna Type	Connector Type
Chain (0)	3.37	2.4~2.4835GHz	Patch	i-pex(MHF)
	3.3	5.15~5.25GHz	Patch	i-pex(MHF)
	3.3	5.25~5.35GHz	Patch	i-pex(MHF)
	3.2	5.47~5.725GHz	Patch	i-pex(MHF)
	0.61	5.725~5.85GHz	Patch	i-pex(MHF)
Chain (1)	3.86	2.4~2.4835GHz	Patch	i-pex(MHF)
	3.66	5.15~5.25GHz	Patch	i-pex(MHF)
	3.66	5.25~5.35GHz	Patch	i-pex(MHF)
	3.99	5.47~5.725GHz	Patch	i-pex(MHF)
	3.99	5.725~5.85GHz	Patch	i-pex(MHF)
NFC antenna				
Frequency range	Antenna Type		Connector Type	
13.56MHz	Loop		NA	

Note: From the above antennas, Chain (1) was selected as representative antenna for 1TX configuration and its data was recorded in this report.

6. The EUT incorporates a MIMO function.

2.4GHz Band			
MODULATION MODE	DATA RATE (MCS)	TX & RX CONFIGURATION	
802.11b	1 ~ 11Mbps	2TX / 1TX (diversity)	2RX
802.11g	6 ~ 54Mbps	2TX / 1TX (diversity)	2RX
802.11n (HT20)	MCS 0~7	2TX / 1TX (diversity)	2RX
	MCS 8~15	2TX	2RX
5GHz Band			
MODULATION MODE	DATA RATE (MCS)	TX & RX CONFIGURATION	
802.11a	6 ~ 54Mbps	2TX / 1TX (diversity)	2RX
802.11n (HT20)	MCS 0~7	2TX / 1TX (diversity)	2RX
	MCS 8~15	2TX	2RX
802.11n (HT40)	MCS 0~7	2TX / 1TX (diversity)	2RX
	MCS 8~15	2TX	2RX
802.11ac (VHT20)	MCS 0~8, NSS=1	2TX / 1TX (diversity)	2RX
	MCS 0~8, NSS=2	2TX	2RX
802.11ac (VHT40)	MCS 0~9, NSS=1	2TX / 1TX (diversity)	2RX
	MCS 0~9, NSS=2	2TX	2RX
802.11ac (VHT80)	MCS 0~9, NSS=1	2TX / 1TX (diversity)	2RX
	MCS 0~9, NSS=2	2TX	2RX

7. The EUT was pre-tested under following test modes:

Mode	Terminal	Cradle	I/O (left)	I/O (right)	Polarity
Mode A	WT6000	-----	USB charge cable	wired RS419 coil	X-Y
Mode B	WT6000	-----	USB charge cable	wired RS419 coil	X-Z
Mode C	WT6000	-----	USB charge cable	wired RS419 coil	Y-Z
Mode D	WT6000	1-slot	1-slot cradle	wired RS419 coil	NA

From the above modes, the spurious emission below 1GHz worst case was found in **Mode D** and the spurious emission above 1GHz worst case was found in **Mode B**. Therefore only the test data of the modes were recorded in this report individually.

8. The above EUT information is declared by manufacturer and for more detailed features description, please refer to the manufacturer's specifications or user's manual.

3.2 Description of Test Modes

13 channels are provided for 802.11b, 802.11g and 802.11n (HT20):

Channel	Frequency	Channel	Frequency
1	2412MHz	8	2447MHz
2	2417MHz	9	2452MHz
3	2422MHz	10	2457MHz
4	2427MHz	11	2462MHz
5	2432MHz	12	2467MHz
6	2437MHz	13	2472MHz
7	2442MHz		

3.2.1 Test Mode Applicability and Tested Channel Detail

EUT CONFIGURE MODE	APPLICABLE TO				DESCRIPTION
	RE \geq 1G	RE $<$ 1G	PLC	APCM	
1	√	√	√	√	With Adapter
2			√		With Cradles

Where **RE \geq 1G**: Radiated Emission above 1GHz & Bandedge Measurement
RE $<$ 1G: Radiated Emission below 1GHz
PLC: Power Line Conducted Emission
APCM: Antenna Port Conducted Measurement

NOTE: The EUT had been pre-tested on the positioned of each 3 axis. The worst case was found when positioned on **Z-plane**.

NOTE: "-" means no effect.

Radiated Emission Test (Above 1GHz):

- Pre-Scan has been conducted to determine the worst-case mode from all possible combinations between available modulations, data rates and antenna ports (if EUT with antenna diversity architecture).
- Following channel(s) was (were) selected for the final test as listed below.

1TX Configuration					
MODE	AVAILABLE CHANNEL	TESTED CHANNEL	MODULATION TECHNOLOGY	MODULATION TYPE	DATA RATE (Mbps)
802.11b	1 to 13	1,2, 6, 10, 11, 12, 13	DSSS	DBPSK	1
2TX Configuration					
CDD Mode					
MODE	AVAILABLE CHANNEL	TESTED CHANNEL	MODULATION TECHNOLOGY	MODULATION TYPE	DATA RATE (Mbps)
802.11b	1 to 13	1,2, 6, 10, 11, 12, 13	DSSS	DBPSK	1
802.11g	1 to 13	1,2, 6, 10, 11, 12, 13	OFDM	BPSK	6
Beamforming Mode					
802.11n (HT20)	1 to 13	1,2, 6, 10, 11, 12, 13	OFDM	BPSK	6.5

Radiated Emission Test (Below 1GHz):

- Pre-Scan has been conducted to determine the worst-case mode from all possible combinations between available modulations, data rates and antenna ports (if EUT with antenna diversity architecture).
- Following channel(s) was (were) selected for the final test as listed below.

1TX Configuration					
MODE	AVAILABLE CHANNEL	TESTED CHANNEL	MODULATION TECHNOLOGY	MODULATION TYPE	DATA RATE (Mbps)
802.11b	1 to 13	1,2, 6, 10, 11, 12, 13	DSSS	DBPSK	1
2TX Configuration					
CDD Mode					
MODE	AVAILABLE CHANNEL	TESTED CHANNEL	MODULATION TECHNOLOGY	MODULATION TYPE	DATA RATE (Mbps)
802.11b	1 to 13	1,2, 6, 10, 11, 12, 13	DSSS	DBPSK	1
802.11g	1 to 13	1,2, 6, 10, 11, 12, 13	OFDM	BPSK	6
Beamforming Mode					
802.11n (HT20)	1 to 13	1,2, 6, 10, 11, 12, 13	OFDM	BPSK	6.5

Power Line Conducted Emission Test:

- Pre-Scan has been conducted to determine the worst-case mode from all possible combinations between available modulations, data rates and antenna ports (if EUT with antenna diversity architecture).
- Following channel(s) was (were) selected for the final test as listed below.

2TX Configuration					
MODE	AVAILABLE CHANNEL	TESTED CHANNEL	MODULATION TECHNOLOGY	MODULATION TYPE	DATA RATE (Mbps)
802.11n (HT20)	1 to 13	10	OFDM	BPSK	6.5

Antenna Port Conducted Measurement:

- This item includes all test value of each mode, but only includes spectrum plot of worst value of each mode.
- Pre-Scan has been conducted to determine the worst-case mode from all possible combinations between available modulations, data rates and antenna ports (if EUT with antenna diversity architecture).
- Following channel(s) was (were) selected for the final test as listed below.

1TX Configuration					
MODE	AVAILABLE CHANNEL	TESTED CHANNEL	MODULATION TECHNOLOGY	MODULATION TYPE	DATA RATE (Mbps)
802.11b	1 to 13	1,2, 6, 10, 11, 12, 13	DSSS	DBPSK	1
2TX Configuration					
CDD Mode					
MODE	AVAILABLE CHANNEL	TESTED CHANNEL	MODULATION TECHNOLOGY	MODULATION TYPE	DATA RATE (Mbps)
802.11b	1 to 13	1,2, 6, 10, 11, 12, 13	DSSS	DBPSK	1
802.11g	1 to 13	1,2, 6, 10, 11, 12, 13	OFDM	BPSK	6
Beamforming Mode					
802.11n (HT20)	1 to 13	1,2, 6, 10, 11, 12, 13	OFDM	BPSK	6.5
SDM Mode (Output power only)					
802.11n (HT20)	1 to 13	1,2, 6, 10, 11, 12, 13	OFDM	BPSK	13

Test Condition:

APPLICABLE TO	ENVIRONMENTAL CONDITIONS	INPUT POWER	TESTED BY	TEST LOCATION
RE\geq1G	25deg. C, 68%RH	120Vac, 60Hz	Gary Cheng	1
RE$<$1G	25deg. C, 69%RH	120Vac, 60Hz	Tim Ho	1
PLC	24deg. C, 82%RH	120Vac, 60Hz	Wythe Lin	2
APCM	19deg. C, 64%RH	120Vac, 60Hz	Anderson Chen	1

3.3 Duty Cycle of Test Signal

Duty cycle of test signal is $\geq 98\%$, duty factor is not required.

802.11b: Duty cycle = $12.438/12.482 = 0.996$

802.11g: Duty cycle = $1.428/1.445 = 0.988$

802.11n (HT20): Duty cycle = $0.685/0.696 = 0.984$

802.11b

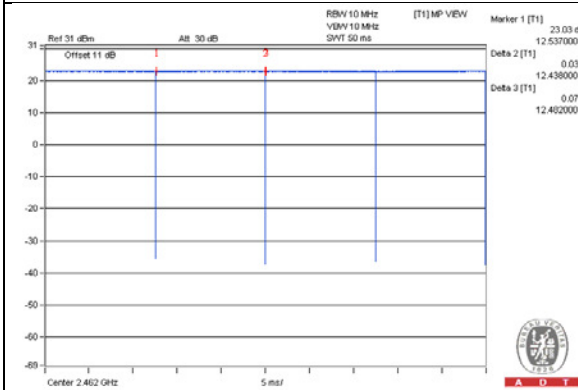

802.11g

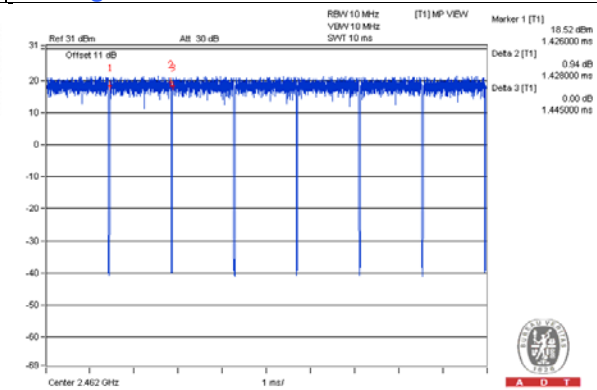

802.11n (HT20)

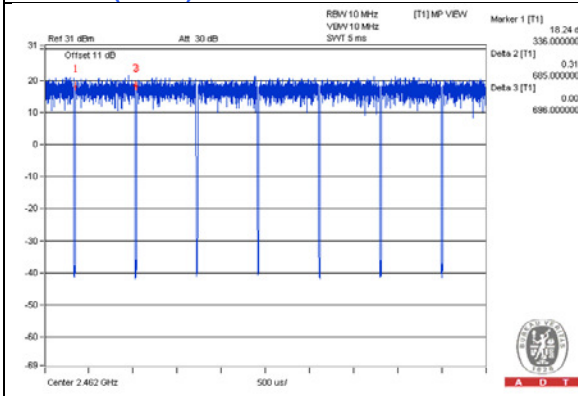

3.4 Description of Support Units

The EUT has been tested as an independent unit together with other necessary accessories or support units. The following support units or accessories were used to form a representative test configuration during the tests.

ID	Product	Brand	Model No.	Serial No.	FCC ID	Remarks
A.	Cradle Adapter	HIPRO	HP-A0502R3D	NA	NA	Supplied by client
B.	Cradles-1slot	ZEBRA	SHARECRADLE-01	NA	NA	Supplied by client
C.	Notebook Computer	HP	Pavilion 14-ab023TU	5CD5340WXZ	NA	Provided by Lab
D.	iPod shuffle	Apple	MC749TA/A	CC4DMFJUDFDM	NA	Provided by Lab
E.	Wired Scanner	ZEBRA	RS419	NA	NA	Supplied by client
F.	Adapter	Motorola	PWRS-14000-249R	NA	NA	Supplied by client

Note:

1. All power cords of the above support units are non-shielded (1.8m).

ID	Descriptions	Qty.	Length (m)	Shielding (Yes/No)	Cores (Qty.)	Remarks
1.	AC cable	1	1.8	No	0	Supplied by client
2.	DC cable	1	1.8	No	1	Supplied by client
3.	USB cable	1	1.4	Yes	0	Supplied by client
4.	Wired Scanner cable	1	0.5	No	0	Supplied by client
5.	USB cable	1	0.1	Yes	0	Provided by Lab
6.	USB cable	1	0.95	Yes	1	Supplied by client
7.	DC cable	1	1.8	No	0	Supplied by client

Note: The core(s) is(are) originally attached to the cable(s).

3.4.1 Configuration of System under Test

For Radiated Emissions (below 1GHz) & Cradle mode test:

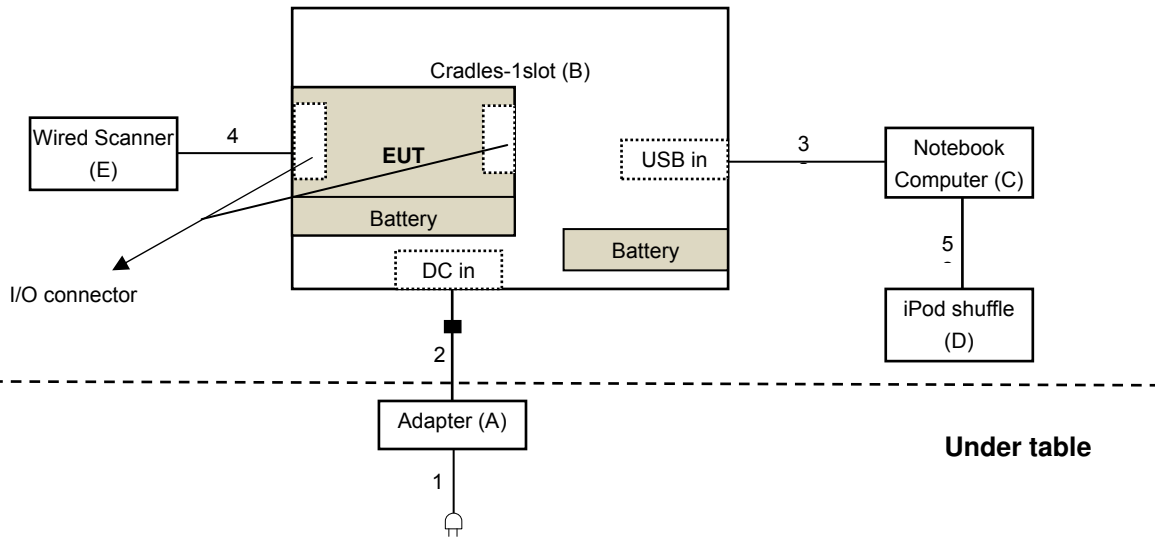

For Radiated Emissions (Above 1GHz) & Adapter mode test:

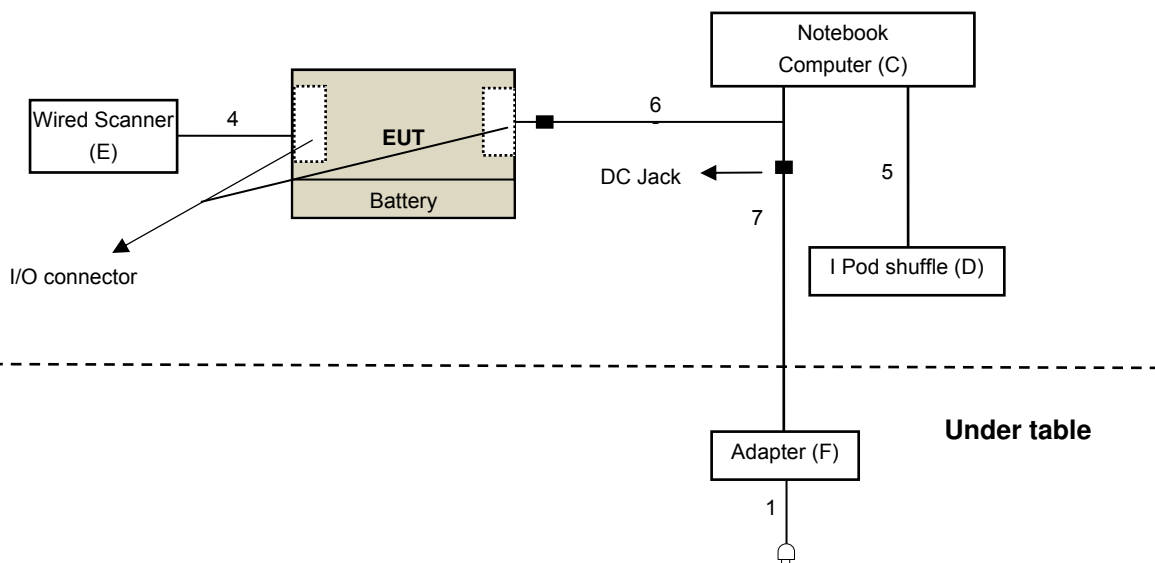

3.5 General Description of Applied Standards

The EUT is a RF Product. According to the specifications of the manufacturer, it must comply with the requirements of the following standards:

FCC Part 15, Subpart C (15.247)
KDB 558074 D01 DTS Meas Guidance v03r05
KDB 662911 D01 Multiple Transmitter Output v02r01
ANSI C63.10-2013

All test items have been performed and recorded as per the above standards.

NOTE: The EUT has been verified to comply with the requirements of FCC Part 15, Subpart B, Class B (DoC). The test report has been issued separately.

4 Test Types and Results

4.1 Radiated Emission and Bandedge Measurement

4.1.1 Limits of Radiated Emission and Bandedge Measurement

Radiated emissions which fall in the restricted bands must comply with the radiated emission limits specified as below table. Other emissions shall be at least 20dB below the highest level of the desired power:

Frequencies (MHz)	Field Strength (microvolts/meter)	Measurement Distance (meters)
0.009 ~ 0.490	2400/F(kHz)	300
0.490 ~ 1.705	24000/F(kHz)	30
1.705 ~ 30.0	30	30
30 ~ 88	100	3
88 ~ 216	150	3
216 ~ 960	200	3
Above 960	500	3

NOTE:

1. The lower limit shall apply at the transition frequencies.
2. Emission level (dBuV/m) = 20 log Emission level (uV/m).
3. For frequencies above 1000MHz, the field strength limits are based on average detector, however, the peak field strength of any emission shall not exceed the maximum permitted average limits, specified above by more than 20dB under any condition of modulation.

4.1.2 Test Instruments

For Radiated Emissions (below 1GHz) test:

DESCRIPTION & MANUFACTURER	MODEL NO.	SERIAL NO.	CALIBRATED DATE	CALIBRATED UNTIL
Test Receiver Agilent	N9038A	MY50010156	Aug. 12, 2015	Aug. 11, 2016
Pre-Amplifier ^(*) EMCI	EMC001340	980142	Jan. 20, 2016	Jan. 19, 2018
Loop Antenna ^(*) Electro-Metrics	EM-6879	264	Dec. 16, 2014	Dec. 15, 2016
RF Cable	NA	LOOPCAB-001 LOOPCAB-002	Jan. 18, 2016	Jan. 17, 2017
Pre-Amplifier Mini-Circuits	ZFL-1000VH2 B	AMP-ZFL-07	May 08, 2015	May 07, 2016
Trilog Broadband Antenna SCHWARZBECK	VULB 9168	9168-156	Jan. 04, 2016	Jan. 03, 2017
RF Cable	8D	966-3-1 966-3-2 966-3-3	Apr. 02, 2016	Apr. 01, 2017
Software	ADT_Radiated _V8.7.07	NA	NA	NA
Antenna Tower & Turn Table CT	NA	NA	NA	NA

Note:

1. The calibration interval of the above test instruments is 12 months and the calibrations are traceable to NML/ROC and NIST/USA.
2. *The calibration interval of the above test instruments is 24 months and the calibrations are traceable to NML/ROC and NIST/USA.
3. The test was performed in 966 Chamber No. 3.
4. The FCC Site Registration No. is 147459
6. The CANADA Site Registration No. is 20331-1
7. Loop antenna was used for all emissions below 30 MHz.
8. Tested Date: Apr. 07 to 18, 2016

For Radiated Emissions (Above 1GHz) test:

DESCRIPTION & MANUFACTURER	MODEL NO.	SERIAL NO.	CALIBRATED DATE	CALIBRATED UNTIL
Test Receiver Agilent	N9038A	MY54450088	July 24, 2015	July 23, 2016
Horn_Antenna SCHWARZBECK	BBHA 9120D	9120D-783	Jan. 19, 2016	Jan. 18, 2017
Pre-Amplifier Agilent	8449B	3008A01922	Sep. 19, 2015	Sep. 18, 2016
RF Cable	EMC104-SM-S M-2000 EMC104-SM-S M-5000 EMC104-SM-S M-5000	150318 150323 150324	Mar. 30, 2016	Mar. 29, 2017
Boresight Antenna Fixture	NA	NA	NA	NA
Pre-Amplifier EMCI	EMC184045	980143	Jan. 15, 2016	Jan. 14, 2017
Horn_Antenna SCHWARZBECK	BBHA 9170	BBHA9170608	Jan. 08, 2016	Jan. 07, 2017
RF Cable	SUCOFLEX 102	36432/2 36441/2	Jan. 16, 2016	Jan. 15, 2017
Software	ADT_Radiated _V8.7.07	NA	NA	NA
Antenna Tower & Turn Table CT	NA	NA	NA	NA
Spectrum Analyzer R&S	FSP 40	100060	May 08, 2015	May 07, 2016
Power meter Anritsu	ML2495A	1014008	Apr. 28, 2015	Apr. 27, 2016
Power sensor Anritsu	MA2411B	0917122	Apr. 28, 2015	Apr. 27, 2016

Note:

1. The calibration interval of the above test instruments is 12 months and the calibrations are traceable to NML/ROC and NIST/USA.
2. The horn antenna, preamplifier (model: 8449B) are used only for the measurement of emission frequency above 1GHz if tested.
3. The test was performed in 966 Chamber No. 4.
4. The FCC Site Registration No. is 292998
5. The CANADA Site Registration No. is 20331-2
6. Tested Date: Apr. 14, 2016

4.1.3 Test Procedures

- a. The EUT was placed on the top of a rotating table 0.8 meters (for below 1GHz) / 1.5 meters (for above 1GHz) above the ground at 3 meter chamber room for test. The table was rotated 360 degrees to determine the position of the highest radiation.
- b. The EUT was set 3 meters away from the interference-receiving antenna, which was mounted on the top of a variable-height antenna tower.
- c. The height of antenna is varied from one meter to four meters above the ground to determine the maximum value of the field strength. Both horizontal and vertical polarizations of the antenna are set to make the measurement.
- d. For each suspected emission, the EUT was arranged to its worst case and then the antenna was tuned to heights from 1 meter to 4 meters and the rotatable table was turned from 0 degrees to 360 degrees to find the maximum reading.
- e. The test-receiver system was set to quasi-peak detect function and specified bandwidth with maximum hold mode when the test frequency is below 1 GHz.
- f. The test-receiver system was set to peak and average detect function and specified bandwidth with maximum hold mode when the test frequency is above 1 GHz. If the peak reading value also meets average limit, measurement with the average detector is unnecessary.

Note:

1. The resolution bandwidth and video bandwidth of test receiver/spectrum analyzer is 120kHz for Quasi-peak detection (QP) at frequency below 1GHz.
2. The resolution bandwidth of test receiver/spectrum analyzer is 1 MHz and the video bandwidth is 3 MHz for Peak detection (PK) at frequency above 1GHz.
3. The resolution bandwidth of test receiver/spectrum analyzer is 1MHz and the video bandwidth is 3MHz for RMS Average (Duty cycle < 98%) for Average detection (AV) at frequency above 1GHz, then the measurement results was added to a correction factor ($10 \log(1/\text{duty cycle})$).
4. The resolution bandwidth of test receiver/spectrum analyzer is 1MHz and the video bandwidth is 10Hz (Duty cycle $\geq 98\%$) for Average detection (AV) at frequency above 1GHz.
5. All modes of operation were investigated and the worst-case emissions are reported.

4.1.4 Deviation from Test Standard

No deviation.

4.1.5 Test Setup

<Frequency Range below 1GHz>

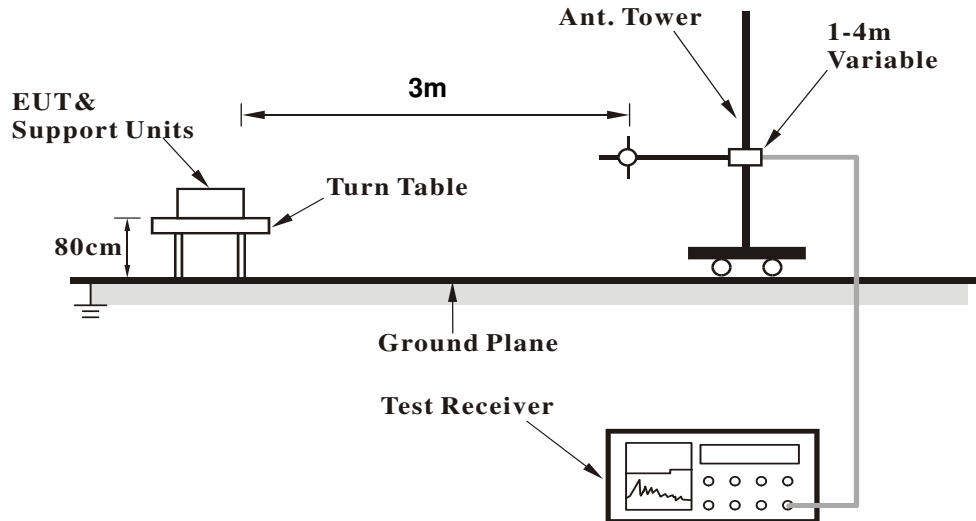

<Frequency Range above 1GHz>

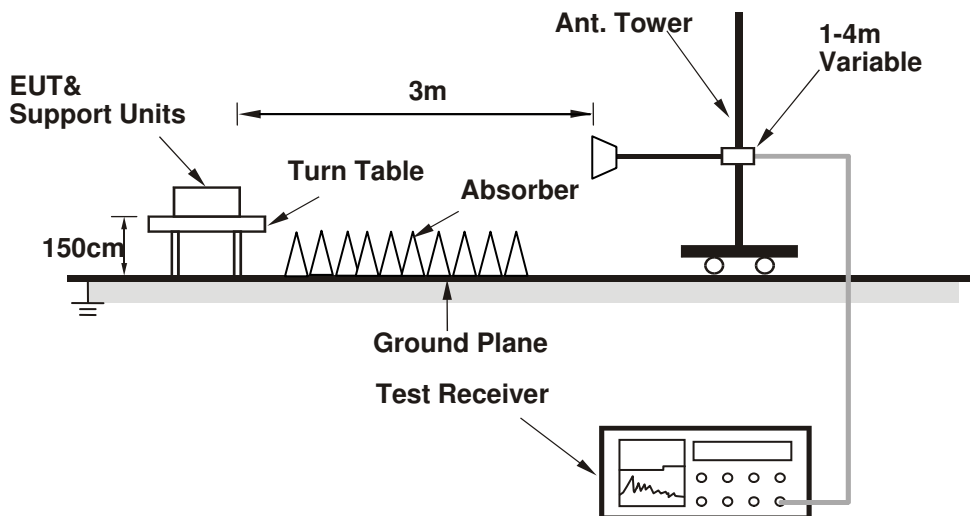

For the actual test configuration, please refer to the attached file (Test Setup Photo).

4.1.6 EUT Operating Conditions

1. Connect the EUT with the support unit C (Notebook Computer) which is placed on remote site.
2. The communication partner run test program "adb wl command" to enable EUT under transmission/receiving condition continuously at specific channel frequency.

4.1.7 Test Results

Above 1GHz Data:

1TX

802.11b

CHANNEL	TX Channel 1	DETECTOR FUNCTION	Peak (PK)
FREQUENCY RANGE	1GHz ~ 25GHz		Average (AV)

ANTENNA POLARITY & TEST DISTANCE: HORIZONTAL AT 3 M

NO.	FREQ. (MHz)	EMISSION LEVEL (dBuV/m)	LIMIT (dBuV/m)	MARGIN (dB)	ANTENNA HEIGHT (m)	TABLE ANGLE (Degree)	RAW VALUE (dBuV)	CORRECTION FACTOR (dB/m)
1	2390.00	57.3 PK	74.0	-16.7	3.80 H	139	62.91	-5.61
2	2390.00	49.1 AV	54.0	-4.9	3.80 H	139	54.71	-5.61
3	*2412.00	109.2 PK			3.80 H	139	114.73	-5.53
4	*2412.00	106.7 AV			3.80 H	139	112.23	-5.53
5	4824.00	48.9 PK	74.0	-25.1	1.02 H	223	47.99	0.91
6	4824.00	46.4 AV	54.0	-7.6	1.02 H	223	45.49	0.91

ANTENNA POLARITY & TEST DISTANCE: VERTICAL AT 3 M

NO.	FREQ. (MHz)	EMISSION LEVEL (dBuV/m)	LIMIT (dBuV/m)	MARGIN (dB)	ANTENNA HEIGHT (m)	TABLE ANGLE (Degree)	RAW VALUE (dBuV)	CORRECTION FACTOR (dB/m)
1	2390.00	56.3 PK	74.0	-17.7	1.51 V	96	61.91	-5.61
2	2390.00	48.4 AV	54.0	-5.6	1.51 V	96	54.01	-5.61
3	*2412.00	107.2 PK			1.51 V	96	112.73	-5.53
4	*2412.00	104.6 AV			1.51 V	96	110.13	-5.53
5	4824.00	47.2 PK	74.0	-26.8	1.01 V	260	46.29	0.91
6	4824.00	43.3 AV	54.0	-10.7	1.01 V	260	42.39	0.91

REMARKS:

1. Emission Level(dBuV/m) = Raw Value(dBuV) + Correction Factor(dB/m)
2. Correction Factor(dB/m) = Antenna Factor(dB/m) + Cable Factor(dB) – Pre-Amplifier Factor(dB)
3. The other emission levels were very low against the limit.
4. Margin value = Emission Level – Limit value
5. " * ": Fundamental frequency.

CHANNEL	TX Channel 2	DETECTOR FUNCTION	Peak (PK)
FREQUENCY RANGE	1GHz ~ 25GHz		Average (AV)

ANTENNA POLARITY & TEST DISTANCE: HORIZONTAL AT 3 M

NO.	FREQ. (MHz)	EMISSION LEVEL (dBuV/m)	LIMIT (dBuV/m)	MARGIN (dB)	ANTENNA HEIGHT (m)	TABLE ANGLE (Degree)	RAW VALUE (dBuV)	CORRECTION FACTOR (dB/m)
1	*2417.00	108.1 PK			3.85 H	146	113.61	-5.51
2	*2417.00	106.1 AV			3.85 H	146	111.61	-5.51
3	4834.00	49.2 PK	74.0	-24.8	1.02 H	222	48.25	0.95
4	4834.00	46.4 AV	54.0	-7.6	1.02 H	222	45.45	0.95
5	7251.00	48.4 PK	74.0	-25.6	1.72 H	242	40.77	7.63
6	7251.00	39.8 AV	54.0	-14.2	1.72 H	242	32.17	7.63

ANTENNA POLARITY & TEST DISTANCE: VERTICAL AT 3 M

NO.	FREQ. (MHz)	EMISSION LEVEL (dBuV/m)	LIMIT (dBuV/m)	MARGIN (dB)	ANTENNA HEIGHT (m)	TABLE ANGLE (Degree)	RAW VALUE (dBuV)	CORRECTION FACTOR (dB/m)
1	*2417.00	107.0 PK			1.50 V	102	112.51	-5.51
2	*2417.00	104.5 AV			1.50 V	102	110.01	-5.51
3	4834.00	47.2 PK	74.0	-26.8	1.00 V	249	46.25	0.95
4	4834.00	43.3 AV	54.0	-10.7	1.00 V	249	42.35	0.95
5	7251.00	57.4 PK	74.0	-16.6	1.60 V	167	49.77	7.63
6	7251.00	45.6 AV	54.0	-8.4	1.60 V	167	37.97	7.63

REMARKS:

1. Emission Level(dBuV/m) = Raw Value(dBuV) + Correction Factor(dB/m)
2. Correction Factor(dB/m) = Antenna Factor(dB/m) + Cable Factor(dB) – Pre-Amplifier Factor(dB)
3. The other emission levels were very low against the limit.
4. Margin value = Emission Level – Limit value
5. " * ": Fundamental frequency.

CHANNEL	TX Channel 6	DETECTOR FUNCTION	Peak (PK)
FREQUENCY RANGE	1GHz ~ 25GHz		Average (AV)

ANTENNA POLARITY & TEST DISTANCE: HORIZONTAL AT 3 M

NO.	FREQ. (MHz)	EMISSION LEVEL (dBuV/m)	LIMIT (dBuV/m)	MARGIN (dB)	ANTENNA HEIGHT (m)	TABLE ANGLE (Degree)	RAW VALUE (dBuV)	CORRECTION FACTOR (dB/m)
1	*2437.00	108.0 PK			3.86 H	155	113.43	-5.43
2	*2437.00	105.3 AV			3.86 H	155	110.73	-5.43
3	4874.00	49.1 PK	74.0	-24.9	1.00 H	227	48.03	1.07
4	4874.00	46.4 AV	54.0	-7.6	1.00 H	227	45.33	1.07
5	7311.00	48.4 PK	74.0	-25.6	1.83 H	226	40.73	7.67
6	7311.00	40.0 AV	54.0	-14.0	1.83 H	226	32.33	7.67

ANTENNA POLARITY & TEST DISTANCE: VERTICAL AT 3 M

NO.	FREQ. (MHz)	EMISSION LEVEL (dBuV/m)	LIMIT (dBuV/m)	MARGIN (dB)	ANTENNA HEIGHT (m)	TABLE ANGLE (Degree)	RAW VALUE (dBuV)	CORRECTION FACTOR (dB/m)
1	*2437.00	106.9 PK			1.46 V	106	112.33	-5.43
2	*2437.00	104.1 AV			1.46 V	106	109.53	-5.43
3	4874.00	46.9 PK	74.0	-27.1	1.03 V	252	45.83	1.07
4	4874.00	42.9 AV	54.0	-11.1	1.03 V	252	41.83	1.07
5	7311.00	57.0 PK	74.0	-17.0	1.60 V	170	49.33	7.67
6	7311.00	45.2 AV	54.0	-8.8	1.60 V	170	37.53	7.67

REMARKS:

1. Emission Level(dBuV/m) = Raw Value(dBuV) + Correction Factor(dB/m)
2. Correction Factor(dB/m) = Antenna Factor(dB/m) + Cable Factor(dB) – Pre-Amplifier Factor(dB)
3. The other emission levels were very low against the limit.
4. Margin value = Emission Level – Limit value
5. " * ": Fundamental frequency.

CHANNEL	TX Channel 10	DETECTOR FUNCTION	Peak (PK)
FREQUENCY RANGE	1GHz ~ 25GHz		Average (AV)

ANTENNA POLARITY & TEST DISTANCE: HORIZONTAL AT 3 M

NO.	FREQ. (MHz)	EMISSION LEVEL (dBuV/m)	LIMIT (dBuV/m)	MARGIN (dB)	ANTENNA HEIGHT (m)	TABLE ANGLE (Degree)	RAW VALUE (dBuV)	CORRECTION FACTOR (dB/m)
1	*2457.00	108.2 PK			3.85 H	127	113.57	-5.37
2	*2457.00	105.5 AV			3.85 H	127	110.87	-5.37
3	2483.50	57.1 PK	74.0	-16.9	3.85 H	127	62.37	-5.27
4	2483.50	46.1 AV	54.0	-7.9	3.85 H	127	51.37	-5.27
5	4914.00	48.2 PK	74.0	-25.8	1.08 H	235	47.01	1.19
6	4914.00	46.0 AV	54.0	-8.0	1.08 H	235	44.81	1.19
7	7371.00	48.1 PK	74.0	-25.9	1.80 H	222	40.44	7.66
8	7371.00	39.7 AV	54.0	-14.3	1.80 H	222	32.04	7.66

ANTENNA POLARITY & TEST DISTANCE: VERTICAL AT 3 M

NO.	FREQ. (MHz)	EMISSION LEVEL (dBuV/m)	LIMIT (dBuV/m)	MARGIN (dB)	ANTENNA HEIGHT (m)	TABLE ANGLE (Degree)	RAW VALUE (dBuV)	CORRECTION FACTOR (dB/m)
1	*2457.00	107.1 PK			1.44 V	109	112.47	-5.37
2	*2457.00	104.3 AV			1.44 V	109	109.67	-5.37
3	2483.50	55.6 PK	74.0	-18.4	1.44 V	109	60.87	-5.27
4	2483.50	44.3 AV	54.0	-9.7	1.44 V	109	49.57	-5.27
5	4914.00	47.0 PK	74.0	-27.0	1.04 V	248	45.81	1.19
6	4914.00	42.9 AV	54.0	-11.1	1.04 V	248	41.71	1.19
7	7371.00	57.3 PK	74.0	-16.7	1.62 V	181	49.64	7.66
8	7371.00	45.7 AV	54.0	-8.3	1.62 V	181	38.04	7.66

REMARKS:

1. Emission Level(dBuV/m) = Raw Value(dBuV) + Correction Factor(dB/m)
2. Correction Factor(dB/m) = Antenna Factor(dB/m) + Cable Factor(dB) – Pre-Amplifier Factor(dB)
3. The other emission levels were very low against the limit.
4. Margin value = Emission Level – Limit value
5. " * ": Fundamental frequency.

CHANNEL	TX Channel 11	DETECTOR FUNCTION	Peak (PK)
FREQUENCY RANGE	1GHz ~ 25GHz		Average (AV)

ANTENNA POLARITY & TEST DISTANCE: HORIZONTAL AT 3 M

NO.	FREQ. (MHz)	EMISSION LEVEL (dBuV/m)	LIMIT (dBuV/m)	MARGIN (dB)	ANTENNA HEIGHT (m)	TABLE ANGLE (Degree)	RAW VALUE (dBuV)	CORRECTION FACTOR (dB/m)
1	*2462.00	109.8 PK			2.32 H	174	115.14	-5.34
2	*2462.00	107.1 AV			2.32 H	174	112.44	-5.34
3	2483.50	59.2 PK	74.0	-14.8	2.32 H	174	64.47	-5.27
4	2483.50	52.6 AV	54.0	-1.4	2.32 H	174	57.87	-5.27
5	4924.00	59.1 PK	74.0	-14.9	2.35 H	92	57.89	1.21
6	4924.00	40.8 AV	54.0	-13.2	2.35 H	92	39.59	1.21
7	7386.00	58.7 PK	74.0	-15.3	1.58 H	201	51.04	7.66
8	7386.00	46.4 AV	54.0	-7.6	1.58 H	201	38.74	7.66

ANTENNA POLARITY & TEST DISTANCE: VERTICAL AT 3 M

NO.	FREQ. (MHz)	EMISSION LEVEL (dBuV/m)	LIMIT (dBuV/m)	MARGIN (dB)	ANTENNA HEIGHT (m)	TABLE ANGLE (Degree)	RAW VALUE (dBuV)	CORRECTION FACTOR (dB/m)
1	*2462.00	104.5 PK			3.66 V	90	109.84	-5.34
2	*2462.00	101.2 AV			3.66 V	90	106.54	-5.34
3	2483.50	53.0 PK	74.0	-21.0	3.66 V	90	58.27	-5.27
4	2483.50	43.3 AV	54.0	-10.7	3.66 V	90	48.57	-5.27
5	4924.00	49.2 PK	74.0	-24.8	1.62 V	180	47.99	1.21
6	4924.00	38.3 AV	54.0	-15.7	1.62 V	180	37.09	1.21
7	7386.00	57.2 PK	74.0	-16.8	1.62 V	182	49.54	7.66
8	7386.00	44.8 AV	54.0	-9.2	1.62 V	182	37.14	7.66

REMARKS:

1. Emission Level(dBuV/m) = Raw Value(dBuV) + Correction Factor(dB/m)
2. Correction Factor(dB/m) = Antenna Factor(dB/m) + Cable Factor(dB) – Pre-Amplifier Factor(dB)
3. The other emission levels were very low against the limit.
4. Margin value = Emission Level – Limit value
5. " * ": Fundamental frequency.

CHANNEL	TX Channel 12	DETECTOR FUNCTION	Peak (PK)
FREQUENCY RANGE	1GHz ~ 25GHz		Average (AV)

ANTENNA POLARITY & TEST DISTANCE: HORIZONTAL AT 3 M

NO.	FREQ. (MHz)	EMISSION LEVEL (dBuV/m)	LIMIT (dBuV/m)	MARGIN (dB)	ANTENNA HEIGHT (m)	TABLE ANGLE (Degree)	RAW VALUE (dBuV)	CORRECTION FACTOR (dB/m)
1	*2467.00	110.1 PK			1.07 H	179	115.44	-5.34
2	*2467.00	107.8 AV			1.07 H	179	113.14	-5.34
3	2483.50	60.0 PK	74.0	-14.0	1.07 H	179	65.27	-5.27
4	2483.50	52.9 AV	54.0	-1.1	1.07 H	179	58.17	-5.27
5	4934.00	52.3 PK	74.0	-21.7	2.12 H	133	51.06	1.24
6	4934.00	50.6 AV	54.0	-3.4	2.12 H	133	49.36	1.24
7	7401.00	48.0 PK	74.0	-26.0	1.82 H	222	40.34	7.66
8	7401.00	39.9 AV	54.0	-14.1	1.82 H	222	32.24	7.66

ANTENNA POLARITY & TEST DISTANCE: VERTICAL AT 3 M

NO.	FREQ. (MHz)	EMISSION LEVEL (dBuV/m)	LIMIT (dBuV/m)	MARGIN (dB)	ANTENNA HEIGHT (m)	TABLE ANGLE (Degree)	RAW VALUE (dBuV)	CORRECTION FACTOR (dB/m)
1	*2467.00	104.5 PK			3.64 V	93	109.84	-5.34
2	*2467.00	101.5 AV			3.64 V	93	106.84	-5.34
3	2483.50	58.4 PK	74.0	-15.6	3.64 V	93	63.67	-5.27
4	2483.50	50.4 AV	54.0	-3.6	3.64 V	93	55.67	-5.27
5	4934.00	49.3 PK	74.0	-24.7	1.64 V	187	48.06	1.24
6	4934.00	38.4 AV	54.0	-15.6	1.64 V	187	37.16	1.24
7	7401.00	57.3 PK	74.0	-16.7	1.61 V	195	49.64	7.66
8	7401.00	44.7 AV	54.0	-9.3	1.61 V	195	37.04	7.66

REMARKS:

1. Emission Level(dBuV/m) = Raw Value(dBuV) + Correction Factor(dB/m)
2. Correction Factor(dB/m) = Antenna Factor(dB/m) + Cable Factor(dB) – Pre-Amplifier Factor(dB)
3. The other emission levels were very low against the limit.
4. Margin value = Emission Level – Limit value
5. " * ": Fundamental frequency.

CHANNEL	TX Channel 13	DETECTOR FUNCTION	Peak (PK)
FREQUENCY RANGE	1GHz ~ 25GHz		Average (AV)

ANTENNA POLARITY & TEST DISTANCE: HORIZONTAL AT 3 M

NO.	FREQ. (MHz)	EMISSION LEVEL (dBuV/m)	LIMIT (dBuV/m)	MARGIN (dB)	ANTENNA HEIGHT (m)	TABLE ANGLE (Degree)	RAW VALUE (dBuV)	CORRECTION FACTOR (dB/m)
1	*2472.00	103.9 PK			1.08 H	168	109.21	-5.31
2	*2472.00	101.6 AV			1.08 H	168	106.91	-5.31
3	2483.50	58.6 PK	74.0	-15.4	1.08 H	168	63.87	-5.27
4	2483.50	52.5 AV	54.0	-1.5	1.08 H	168	57.77	-5.27
5	4944.00	51.9 PK	74.0	-22.1	2.11 H	131	50.63	1.27
6	4944.00	49.9 AV	54.0	-4.1	2.11 H	131	48.63	1.27
7	7416.00	47.9 PK	74.0	-26.1	1.79 H	220	40.14	7.76
8	7416.00	39.6 AV	54.0	-14.4	1.79 H	220	31.84	7.76

ANTENNA POLARITY & TEST DISTANCE: VERTICAL AT 3 M

NO.	FREQ. (MHz)	EMISSION LEVEL (dBuV/m)	LIMIT (dBuV/m)	MARGIN (dB)	ANTENNA HEIGHT (m)	TABLE ANGLE (Degree)	RAW VALUE (dBuV)	CORRECTION FACTOR (dB/m)
1	*2472.00	101.4 PK			3.60 V	102	106.71	-5.31
2	*2472.00	99.3 AV			3.60 V	102	104.61	-5.31
3	2483.50	56.2 PK	74.0	-17.8	3.60 V	102	61.47	-5.27
4	2483.50	50.4 AV	54.0	-3.6	3.60 V	102	55.67	-5.27
5	4944.00	48.3 PK	74.0	-25.7	1.59 V	183	47.03	1.27
6	4944.00	37.2 AV	54.0	-16.8	1.59 V	183	35.93	1.27
7	7416.00	56.4 PK	74.0	-17.6	1.61 V	203	48.64	7.76
8	7416.00	43.1 AV	54.0	-10.9	1.61 V	203	35.34	7.76

REMARKS:

1. Emission Level(dBuV/m) = Raw Value(dBuV) + Correction Factor(dB/m)
2. Correction Factor(dB/m) = Antenna Factor(dB/m) + Cable Factor(dB) – Pre-Amplifier Factor(dB)
3. The other emission levels were very low against the limit.
4. Margin value = Emission Level – Limit value
5. " * ": Fundamental frequency.

2TX

CDD Mode

802.11b

CHANNEL	TX Channel 1	DETECTOR FUNCTION	Peak (PK)
FREQUENCY RANGE	1GHz ~ 25GHz		Average (AV)

ANTENNA POLARITY & TEST DISTANCE: HORIZONTAL AT 3 M

NO.	FREQ. (MHz)	EMISSION LEVEL (dBuV/m)	LIMIT (dBuV/m)	MARGIN (dB)	ANTENNA HEIGHT (m)	TABLE ANGLE (Degree)	RAW VALUE (dBuV)	CORRECTION FACTOR (dB/m)
1	2390.00	56.8 PK	74.0	-17.2	1.17 H	148	62.41	-5.61
2	2390.00	51.2 AV	54.0	-2.8	1.17 H	148	56.81	-5.61
3	*2412.00	109.6 PK			1.17 H	148	115.13	-5.53
4	*2412.00	106.9 AV			1.17 H	148	112.43	-5.53
5	4824.00	51.6 PK	74.0	-22.4	4.00 H	40	50.69	0.91
6	4824.00	49.6 AV	54.0	-4.4	4.00 H	40	48.69	0.91

ANTENNA POLARITY & TEST DISTANCE: VERTICAL AT 3 M

NO.	FREQ. (MHz)	EMISSION LEVEL (dBuV/m)	LIMIT (dBuV/m)	MARGIN (dB)	ANTENNA HEIGHT (m)	TABLE ANGLE (Degree)	RAW VALUE (dBuV)	CORRECTION FACTOR (dB/m)
1	2390.00	56.2 PK	74.0	-17.8	1.03 V	101	61.81	-5.61
2	2390.00	50.7 AV	54.0	-3.3	1.03 V	101	56.31	-5.61
3	*2412.00	107.8 PK			1.03 V	101	113.33	-5.53
4	*2412.00	105.2 AV			1.03 V	101	110.73	-5.53
5	4824.00	50.1 PK	74.0	-23.9	1.00 V	243	49.19	0.91
6	4824.00	47.6 AV	54.0	-6.4	1.00 V	243	46.69	0.91

REMARKS:

1. Emission Level(dBuV/m) = Raw Value(dBuV) + Correction Factor(dB/m)
2. Correction Factor(dB/m) = Antenna Factor(dB/m) + Cable Factor(dB) – Pre-Amplifier Factor(dB)
3. The other emission levels were very low against the limit.
4. Margin value = Emission Level – Limit value
5. " * ": Fundamental frequency.

CHANNEL	TX Channel 2	DETECTOR FUNCTION	Peak (PK)
FREQUENCY RANGE	1GHz ~ 25GHz		Average (AV)

ANTENNA POLARITY & TEST DISTANCE: HORIZONTAL AT 3 M

NO.	FREQ. (MHz)	EMISSION LEVEL (dBuV/m)	LIMIT (dBuV/m)	MARGIN (dB)	ANTENNA HEIGHT (m)	TABLE ANGLE (Degree)	RAW VALUE (dBuV)	CORRECTION FACTOR (dB/m)
1	2390.00	56.3 PK	74.0	-17.7	1.17 H	131	61.91	-5.61
2	2390.00	48.4 AV	54.0	-5.6	1.17 H	131	54.01	-5.61
3	*2417.00	109.4 PK			1.17 H	131	114.91	-5.51
4	*2417.00	106.5 AV			1.17 H	131	112.01	-5.51
5	4834.00	51.3 PK	74.0	-22.7	3.36 H	45	50.35	0.95
6	4834.00	49.3 AV	54.0	-4.7	3.36 H	45	48.35	0.95
7	7251.00	50.7 PK	74.0	-23.3	3.27 H	360	43.07	7.63
8	7251.00	44.1 AV	54.0	-9.9	3.27 H	360	36.47	7.63

ANTENNA POLARITY & TEST DISTANCE: VERTICAL AT 3 M

NO.	FREQ. (MHz)	EMISSION LEVEL (dBuV/m)	LIMIT (dBuV/m)	MARGIN (dB)	ANTENNA HEIGHT (m)	TABLE ANGLE (Degree)	RAW VALUE (dBuV)	CORRECTION FACTOR (dB/m)
1	2390.00	55.9 PK	74.0	-18.1	1.08 V	108	61.51	-5.61
2	2390.00	50.5 AV	54.0	-3.5	1.08 V	108	56.11	-5.61
3	*2417.00	108.1 PK			1.06 V	91	113.61	-5.51
4	*2417.00	105.5 AV			1.06 V	91	111.01	-5.51
5	4834.00	50.4 PK	74.0	-23.6	1.04 V	255	49.45	0.95
6	4834.00	48.0 AV	54.0	-6.0	1.04 V	255	47.05	0.95
7	7251.00	58.4 PK	74.0	-15.6	1.57 V	166	50.77	7.63
8	7251.00	46.6 AV	54.0	-7.4	1.57 V	166	38.97	7.63

REMARKS:

1. Emission Level(dBuV/m) = Raw Value(dBuV) + Correction Factor(dB/m)
2. Correction Factor(dB/m) = Antenna Factor(dB/m) + Cable Factor(dB) – Pre-Amplifier Factor(dB)
3. The other emission levels were very low against the limit.
4. Margin value = Emission Level – Limit value
5. " * ": Fundamental frequency.

CHANNEL	TX Channel 6	DETECTOR FUNCTION	Peak (PK)
FREQUENCY RANGE	1GHz ~ 25GHz		Average (AV)

ANTENNA POLARITY & TEST DISTANCE: HORIZONTAL AT 3 M

NO.	FREQ. (MHz)	EMISSION LEVEL (dBuV/m)	LIMIT (dBuV/m)	MARGIN (dB)	ANTENNA HEIGHT (m)	TABLE ANGLE (Degree)	RAW VALUE (dBuV)	CORRECTION FACTOR (dB/m)
1	*2437.00	109.6 PK			1.15 H	145	115.03	-5.43
2	*2437.00	106.8 AV			1.15 H	145	112.23	-5.43
3	4874.00	51.3 PK	74.0	-22.7	3.38 H	34	50.23	1.07
4	4874.00	49.4 AV	54.0	-4.6	3.38 H	34	48.33	1.07
5	7311.00	50.6 PK	74.0	-23.4	3.30 H	360	42.93	7.67
6	7311.00	43.7 AV	54.0	-10.3	3.30 H	360	36.03	7.67

ANTENNA POLARITY & TEST DISTANCE: VERTICAL AT 3 M

NO.	FREQ. (MHz)	EMISSION LEVEL (dBuV/m)	LIMIT (dBuV/m)	MARGIN (dB)	ANTENNA HEIGHT (m)	TABLE ANGLE (Degree)	RAW VALUE (dBuV)	CORRECTION FACTOR (dB/m)
1	*2437.00	108.4 PK			1.12 V	80	113.83	-5.43
2	*2437.00	105.7 AV			1.12 V	80	111.13	-5.43
3	4874.00	50.9 PK	74.0	-23.1	1.01 V	262	49.83	1.07
4	4874.00	48.3 AV	54.0	-5.7	1.01 V	262	47.23	1.07
5	7311.00	58.5 PK	74.0	-15.5	1.57 V	160	50.83	7.67
6	7311.00	47.0 AV	54.0	-7.0	1.57 V	160	39.33	7.67

REMARKS:

1. Emission Level(dBuV/m) = Raw Value(dBuV) + Correction Factor(dB/m)
2. Correction Factor(dB/m) = Antenna Factor(dB/m) + Cable Factor(dB) – Pre-Amplifier Factor(dB)
3. The other emission levels were very low against the limit.
4. Margin value = Emission Level – Limit value
5. " * ": Fundamental frequency.

CHANNEL	TX Channel 10	DETECTOR FUNCTION	Peak (PK)
FREQUENCY RANGE	1GHz ~ 25GHz		Average (AV)

ANTENNA POLARITY & TEST DISTANCE: HORIZONTAL AT 3 M

NO.	FREQ. (MHz)	EMISSION LEVEL (dBuV/m)	LIMIT (dBuV/m)	MARGIN (dB)	ANTENNA HEIGHT (m)	TABLE ANGLE (Degree)	RAW VALUE (dBuV)	CORRECTION FACTOR (dB/m)
1	*2457.00	110.0 PK			1.17 H	119	115.37	-5.37
2	*2457.00	107.0 AV			1.17 H	119	112.37	-5.37
3	4914.00	50.8 PK	74.0	-23.2	3.41 H	21	49.61	1.19
4	4914.00	49.1 AV	54.0	-4.9	3.41 H	21	47.91	1.19
5	7371.00	50.9 PK	74.0	-23.1	3.32 H	360	43.24	7.66
6	7371.00	44.0 AV	54.0	-10.0	3.32 H	360	36.34	7.66

ANTENNA POLARITY & TEST DISTANCE: VERTICAL AT 3 M

NO.	FREQ. (MHz)	EMISSION LEVEL (dBuV/m)	LIMIT (dBuV/m)	MARGIN (dB)	ANTENNA HEIGHT (m)	TABLE ANGLE (Degree)	RAW VALUE (dBuV)	CORRECTION FACTOR (dB/m)
1	*2457.00	107.8 PK			1.18 V	85	113.17	-5.37
2	*2457.00	105.4 AV			1.18 V	85	110.77	-5.37
3	4914.00	51.2 PK	74.0	-22.8	1.00 V	254	50.01	1.19
4	4914.00	48.7 AV	54.0	-5.3	1.00 V	254	47.51	1.19
5	7371.00	58.5 PK	74.0	-15.5	1.54 V	158	50.84	7.66
6	7371.00	46.8 AV	54.0	-7.2	1.54 V	158	39.14	7.66

REMARKS:

1. Emission Level(dBuV/m) = Raw Value(dBuV) + Correction Factor(dB/m)
2. Correction Factor(dB/m) = Antenna Factor(dB/m) + Cable Factor(dB) – Pre-Amplifier Factor(dB)
3. The other emission levels were very low against the limit.
4. Margin value = Emission Level – Limit value
5. " * ": Fundamental frequency.

CHANNEL	TX Channel 11	DETECTOR FUNCTION	Peak (PK)
FREQUENCY RANGE	1GHz ~ 25GHz		Average (AV)

ANTENNA POLARITY & TEST DISTANCE: HORIZONTAL AT 3 M

NO.	FREQ. (MHz)	EMISSION LEVEL (dBuV/m)	LIMIT (dBuV/m)	MARGIN (dB)	ANTENNA HEIGHT (m)	TABLE ANGLE (Degree)	RAW VALUE (dBuV)	CORRECTION FACTOR (dB/m)
1	*2462.00	110.7 PK			1.60 H	348	116.04	-5.34
2	*2462.00	108.1 AV			1.60 H	348	113.44	-5.34
3	2483.50	61.9 PK	74.0	-12.1	1.60 H	348	67.17	-5.27
4	2483.50	52.6 AV	54.0	-1.4	1.60 H	348	57.87	-5.27
5	4924.00	50.0 PK	74.0	-24.0	2.33 H	104	48.79	1.21
6	4924.00	48.2 AV	54.0	-5.8	2.33 H	104	46.99	1.21
7	7386.00	58.9 PK	74.0	-15.1	1.52 H	209	51.24	7.66
8	7386.00	46.7 AV	54.0	-7.3	1.52 H	209	39.04	7.66

ANTENNA POLARITY & TEST DISTANCE: VERTICAL AT 3 M

NO.	FREQ. (MHz)	EMISSION LEVEL (dBuV/m)	LIMIT (dBuV/m)	MARGIN (dB)	ANTENNA HEIGHT (m)	TABLE ANGLE (Degree)	RAW VALUE (dBuV)	CORRECTION FACTOR (dB/m)
1	*2462.00	106.8 PK			1.03 V	252	112.14	-5.34
2	*2462.00	104.2 AV			1.03 V	252	109.54	-5.34
3	2483.50	60.9 PK	74.0	-13.1	1.03 V	252	66.17	-5.27
4	2483.50	50.3 AV	54.0	-3.7	1.03 V	252	55.57	-5.27
5	4924.00	50.3 PK	74.0	-23.7	1.63 V	180	49.09	1.21
6	4924.00	46.2 AV	54.0	-7.8	1.63 V	180	44.99	1.21
7	7386.00	57.4 PK	74.0	-16.6	1.61 V	171	49.74	7.66
8	7386.00	45.2 AV	54.0	-8.8	1.61 V	171	37.54	7.66

REMARKS:

1. Emission Level(dBuV/m) = Raw Value(dBuV) + Correction Factor(dB/m)
2. Correction Factor(dB/m) = Antenna Factor(dB/m) + Cable Factor(dB) – Pre-Amplifier Factor(dB)
3. The other emission levels were very low against the limit.
4. Margin value = Emission Level – Limit value
5. " * ": Fundamental frequency.

CHANNEL	TX Channel 12	DETECTOR FUNCTION	Peak (PK)
FREQUENCY RANGE	1GHz ~ 25GHz		Average (AV)

ANTENNA POLARITY & TEST DISTANCE: HORIZONTAL AT 3 M

NO.	FREQ. (MHz)	EMISSION LEVEL (dBuV/m)	LIMIT (dBuV/m)	MARGIN (dB)	ANTENNA HEIGHT (m)	TABLE ANGLE (Degree)	RAW VALUE (dBuV)	CORRECTION FACTOR (dB/m)
1	*2467.00	110.4 PK			1.50 H	185	115.74	-5.34
2	*2467.00	108.0 AV			1.50 H	185	113.34	-5.34
3	2483.50	61.5 PK	74.0	-12.5	1.50 H	185	66.77	-5.27
4	2483.50	52.8 AV	54.0	-1.2	1.50 H	185	58.07	-5.27
5	4934.00	52.0 PK	74.0	-22.0	2.01 H	133	50.76	1.24
6	4934.00	49.9 AV	54.0	-4.1	2.01 H	133	48.66	1.24
7	7401.00	48.8 PK	74.0	-25.2	1.99 H	55	41.14	7.66
8	7401.00	40.9 AV	54.0	-13.1	1.99 H	55	33.24	7.66

ANTENNA POLARITY & TEST DISTANCE: VERTICAL AT 3 M

NO.	FREQ. (MHz)	EMISSION LEVEL (dBuV/m)	LIMIT (dBuV/m)	MARGIN (dB)	ANTENNA HEIGHT (m)	TABLE ANGLE (Degree)	RAW VALUE (dBuV)	CORRECTION FACTOR (dB/m)
1	*2467.00	106.6 PK			1.05 V	255	111.94	-5.34
2	*2467.00	103.8 AV			1.05 V	255	109.14	-5.34
3	2483.50	60.2 PK	74.0	-13.8	1.05 V	255	65.47	-5.27
4	2483.50	50.0 AV	54.0	-4.0	1.05 V	255	55.27	-5.27
5	4934.00	49.5 PK	74.0	-24.5	1.64 V	169	48.26	1.24
6	4934.00	38.9 AV	54.0	-15.1	1.64 V	169	37.66	1.24
7	7401.00	57.6 PK	74.0	-16.4	1.56 V	157	49.94	7.66
8	7401.00	45.7 AV	54.0	-8.3	1.56 V	157	38.04	7.66

REMARKS:

1. Emission Level(dBuV/m) = Raw Value(dBuV) + Correction Factor(dB/m)
2. Correction Factor(dB/m) = Antenna Factor(dB/m) + Cable Factor(dB) – Pre-Amplifier Factor(dB)
3. The other emission levels were very low against the limit.
4. Margin value = Emission Level – Limit value
5. " * ": Fundamental frequency.

CHANNEL	TX Channel 13	DETECTOR FUNCTION	Peak (PK)
FREQUENCY RANGE	1GHz ~ 25GHz		Average (AV)

ANTENNA POLARITY & TEST DISTANCE: HORIZONTAL AT 3 M

NO.	FREQ. (MHz)	EMISSION LEVEL (dBuV/m)	LIMIT (dBuV/m)	MARGIN (dB)	ANTENNA HEIGHT (m)	TABLE ANGLE (Degree)	RAW VALUE (dBuV)	CORRECTION FACTOR (dB/m)
1	*2472.00	105.1 PK			1.49 H	188	110.41	-5.31
2	*2472.00	102.7 AV			1.49 H	188	108.01	-5.31
3	2483.50	58.2 PK	74.0	-15.8	1.49 H	188	63.47	-5.27
4	2483.50	52.5 AV	54.0	-1.5	1.49 H	188	57.77	-5.27
5	4944.00	50.4 PK	74.0	-23.6	1.95 H	149	49.13	1.27
6	4944.00	47.6 AV	54.0	-6.4	1.95 H	149	46.33	1.27
7	7416.00	45.4 PK	74.0	-28.6	1.98 H	59	37.64	7.76
8	7416.00	38.4 AV	54.0	-15.6	1.98 H	59	30.64	7.76

ANTENNA POLARITY & TEST DISTANCE: VERTICAL AT 3 M

NO.	FREQ. (MHz)	EMISSION LEVEL (dBuV/m)	LIMIT (dBuV/m)	MARGIN (dB)	ANTENNA HEIGHT (m)	TABLE ANGLE (Degree)	RAW VALUE (dBuV)	CORRECTION FACTOR (dB/m)
1	*2472.00	101.4 PK			1.06 V	250	106.71	-5.31
2	*2472.00	98.2 AV			1.06 V	250	103.51	-5.31
3	2483.50	56.4 PK	74.0	-17.6	1.06 V	250	61.67	-5.27
4	2483.50	50.3 AV	54.0	-3.7	1.06 V	250	55.57	-5.27
5	4944.00	47.4 PK	74.0	-26.6	1.60 V	177	46.13	1.27
6	4944.00	36.5 AV	54.0	-17.5	1.60 V	177	35.23	1.27
7	7416.00	55.4 PK	74.0	-18.6	1.58 V	142	47.64	7.76
8	7416.00	44.3 AV	54.0	-9.7	1.58 V	142	36.54	7.76

REMARKS:

1. Emission Level(dBuV/m) = Raw Value(dBuV) + Correction Factor(dB/m)
2. Correction Factor(dB/m) = Antenna Factor(dB/m) + Cable Factor(dB) – Pre-Amplifier Factor(dB)
3. The other emission levels were very low against the limit.
4. Margin value = Emission Level – Limit value
5. " * ": Fundamental frequency.

2TX

CDD Mode

802.11g

CHANNEL	TX Channel 1	DETECTOR FUNCTION	Peak (PK)
FREQUENCY RANGE	1GHz ~ 25GHz		Average (AV)

ANTENNA POLARITY & TEST DISTANCE: HORIZONTAL AT 3 M

NO.	FREQ. (MHz)	EMISSION LEVEL (dBuV/m)	LIMIT (dBuV/m)	MARGIN (dB)	ANTENNA HEIGHT (m)	TABLE ANGLE (Degree)	RAW VALUE (dBuV)	CORRECTION FACTOR (dB/m)
1	2390.00	67.0 PK	74.0	-7.0	1.17 H	152	72.61	-5.61
2	2390.00	52.3 AV	54.0	-1.7	1.17 H	152	57.91	-5.61
3	*2412.00	111.1 PK			1.17 H	152	116.63	-5.53
4	*2412.00	99.1 AV			1.17 H	152	104.63	-5.53
5	4824.00	50.3 PK	74.0	-23.7	1.89 H	141	49.39	0.91
6	4824.00	47.6 AV	54.0	-6.4	1.89 H	141	46.69	0.91

ANTENNA POLARITY & TEST DISTANCE: VERTICAL AT 3 M

NO.	FREQ. (MHz)	EMISSION LEVEL (dBuV/m)	LIMIT (dBuV/m)	MARGIN (dB)	ANTENNA HEIGHT (m)	TABLE ANGLE (Degree)	RAW VALUE (dBuV)	CORRECTION FACTOR (dB/m)
1	2390.00	65.4 PK	74.0	-8.6	1.10 V	254	71.01	-5.61
2	2390.00	50.3 AV	54.0	-3.7	1.10 V	254	55.91	-5.61
3	*2412.00	109.6 PK			1.10 V	254	115.13	-5.53
4	*2412.00	96.5 AV			1.10 V	254	102.03	-5.53
5	4824.00	47.6 PK	74.0	-26.4	1.64 V	162	46.69	0.91
6	4824.00	36.8 AV	54.0	-17.2	1.64 V	162	35.89	0.91

REMARKS:

1. Emission Level(dBuV/m) = Raw Value(dBuV) + Correction Factor(dB/m)
2. Correction Factor(dB/m) = Antenna Factor(dB/m) + Cable Factor(dB) – Pre-Amplifier Factor(dB)
3. The other emission levels were very low against the limit.
4. Margin value = Emission Level – Limit value
5. " * ": Fundamental frequency.

CHANNEL	TX Channel 2	DETECTOR FUNCTION	Peak (PK)
FREQUENCY RANGE	1GHz ~ 25GHz		Average (AV)

ANTENNA POLARITY & TEST DISTANCE: HORIZONTAL AT 3 M

NO.	FREQ. (MHz)	EMISSION LEVEL (dBuV/m)	LIMIT (dBuV/m)	MARGIN (dB)	ANTENNA HEIGHT (m)	TABLE ANGLE (Degree)	RAW VALUE (dBuV)	CORRECTION FACTOR (dB/m)
1	2390.00	65.3 PK	74.0	-8.7	1.16 H	151	70.91	-5.61
2	2390.00	52.4 AV	54.0	-1.6	1.16 H	151	58.01	-5.61
3	*2417.00	112.0 PK			1.16 H	151	117.51	-5.51
4	*2417.00	100.0 AV			1.16 H	151	105.51	-5.51
5	4834.00	51.0 PK	74.0	-23.0	1.98 H	156	50.05	0.95
6	4834.00	48.0 AV	54.0	-6.0	1.98 H	156	47.05	0.95
7	7251.00	45.3 PK	74.0	-28.7	2.00 H	68	37.67	7.63
8	7251.00	38.5 AV	54.0	-15.5	2.00 H	68	30.87	7.63

ANTENNA POLARITY & TEST DISTANCE: VERTICAL AT 3 M

NO.	FREQ. (MHz)	EMISSION LEVEL (dBuV/m)	LIMIT (dBuV/m)	MARGIN (dB)	ANTENNA HEIGHT (m)	TABLE ANGLE (Degree)	RAW VALUE (dBuV)	CORRECTION FACTOR (dB/m)
1	2390.00	64.2 PK	74.0	-9.8	1.12 V	250	69.81	-5.61
2	2390.00	51.4 AV	54.0	-2.6	1.12 V	250	57.01	-5.61
3	*2417.00	110.3 PK			1.12 V	250	115.81	-5.51
4	*2417.00	98.2 AV			1.12 V	250	103.71	-5.51
5	4834.00	47.8 PK	74.0	-26.2	1.60 V	173	46.85	0.95
6	4834.00	36.6 AV	54.0	-17.4	1.60 V	173	35.65	0.95
7	7251.00	55.4 PK	74.0	-18.6	1.56 V	141	47.77	7.63
8	7251.00	44.2 AV	54.0	-9.8	1.56 V	141	36.57	7.63

REMARKS:

1. Emission Level(dBuV/m) = Raw Value(dBuV) + Correction Factor(dB/m)
2. Correction Factor(dB/m) = Antenna Factor(dB/m) + Cable Factor(dB) – Pre-Amplifier Factor(dB)
3. The other emission levels were very low against the limit.
4. Margin value = Emission Level – Limit value
5. " * ": Fundamental frequency.

CHANNEL	TX Channel 6	DETECTOR FUNCTION	Peak (PK)
FREQUENCY RANGE	1GHz ~ 25GHz		Average (AV)

ANTENNA POLARITY & TEST DISTANCE: HORIZONTAL AT 3 M

NO.	FREQ. (MHz)	EMISSION LEVEL (dBuV/m)	LIMIT (dBuV/m)	MARGIN (dB)	ANTENNA HEIGHT (m)	TABLE ANGLE (Degree)	RAW VALUE (dBuV)	CORRECTION FACTOR (dB/m)
1	2390.00	57.9 PK	74.0	-16.1	1.17 H	156	63.51	-5.61
2	2390.00	44.0 AV	54.0	-10.0	1.17 H	156	49.61	-5.61
3	*2437.00	112.5 PK			1.17 H	156	117.93	-5.43
4	*2437.00	101.1 AV			1.17 H	156	106.53	-5.43
5	2483.50	58.5 PK	74.0	-15.5	1.17 H	156	63.77	-5.27
6	2483.50	43.7 AV	54.0	-10.3	1.17 H	156	48.97	-5.27
7	4874.00	50.5 PK	74.0	-23.5	1.99 H	164	49.43	1.07
8	4874.00	47.7 AV	54.0	-6.3	1.99 H	164	46.63	1.07
9	7311.00	45.0 PK	74.0	-29.0	1.98 H	56	37.33	7.67
10	7311.00	38.0 AV	54.0	-16.0	1.98 H	56	30.33	7.67

ANTENNA POLARITY & TEST DISTANCE: VERTICAL AT 3 M

NO.	FREQ. (MHz)	EMISSION LEVEL (dBuV/m)	LIMIT (dBuV/m)	MARGIN (dB)	ANTENNA HEIGHT (m)	TABLE ANGLE (Degree)	RAW VALUE (dBuV)	CORRECTION FACTOR (dB/m)
1	2390.00	55.6 PK	74.0	-18.4	1.14 V	260	61.21	-5.61
2	2390.00	43.2 AV	54.0	-10.8	1.14 V	260	48.81	-5.61
3	*2437.00	111.0 PK			1.14 V	260	116.43	-5.43
4	*2437.00	96.0 AV			1.14 V	260	101.43	-5.43
5	2483.50	56.4 PK	74.0	-17.6	1.14 V	260	61.67	-5.27
6	2483.50	41.4 AV	54.0	-12.6	1.14 V	260	46.67	-5.27
7	4874.00	46.7 PK	74.0	-27.3	1.65 V	169	45.63	1.07
8	4874.00	36.0 AV	54.0	-18.0	1.65 V	169	34.93	1.07
9	7311.00	55.0 PK	74.0	-19.0	1.60 V	127	47.33	7.67
10	7311.00	44.0 AV	54.0	-10.0	1.60 V	127	36.33	7.67

REMARKS:

1. Emission Level(dBuV/m) = Raw Value(dBuV) + Correction Factor(dB/m)
2. Correction Factor(dB/m) = Antenna Factor(dB/m) + Cable Factor(dB) – Pre-Amplifier Factor(dB)
3. The other emission levels were very low against the limit.
4. Margin value = Emission Level – Limit value
5. " * ": Fundamental frequency.

CHANNEL	TX Channel 10	DETECTOR FUNCTION	Peak (PK)
FREQUENCY RANGE	1GHz ~ 25GHz		Average (AV)

ANTENNA POLARITY & TEST DISTANCE: HORIZONTAL AT 3 M

NO.	FREQ. (MHz)	EMISSION LEVEL (dBuV/m)	LIMIT (dBuV/m)	MARGIN (dB)	ANTENNA HEIGHT (m)	TABLE ANGLE (Degree)	RAW VALUE (dBuV)	CORRECTION FACTOR (dB/m)
1	*2457.00	112.4 PK			1.07 H	156	117.77	-5.37
2	*2457.00	101.2 AV			1.07 H	156	106.57	-5.37
3	2483.50	67.2 PK	74.0	-6.8	1.07 H	156	72.47	-5.27
4	2483.50	52.4 AV	54.0	-1.6	1.07 H	156	57.67	-5.27
5	4914.00	50.3 PK	74.0	-23.7	1.93 H	142	49.11	1.19
6	4914.00	47.3 AV	54.0	-6.7	1.93 H	142	46.11	1.19
7	7371.00	45.5 PK	74.0	-28.5	2.01 H	66	37.84	7.66
8	7371.00	38.7 AV	54.0	-15.3	2.01 H	66	31.04	7.66

ANTENNA POLARITY & TEST DISTANCE: VERTICAL AT 3 M

NO.	FREQ. (MHz)	EMISSION LEVEL (dBuV/m)	LIMIT (dBuV/m)	MARGIN (dB)	ANTENNA HEIGHT (m)	TABLE ANGLE (Degree)	RAW VALUE (dBuV)	CORRECTION FACTOR (dB/m)
1	*2457.00	112.4 PK			1.11 V	275	117.77	-5.37
2	*2457.00	97.5 AV			1.11 V	275	102.87	-5.37
3	2483.50	65.6 PK	74.0	-8.4	1.11 V	275	70.87	-5.27
4	2483.50	50.4 AV	54.0	-3.6	1.11 V	275	55.67	-5.27
5	4914.00	48.1 PK	74.0	-25.9	1.64 V	166	46.91	1.19
6	4914.00	36.9 AV	54.0	-17.1	1.64 V	166	35.71	1.19
7	7371.00	55.6 PK	74.0	-18.4	1.61 V	127	47.94	7.66
8	7371.00	44.2 AV	54.0	-9.8	1.61 V	127	36.54	7.66

REMARKS:

1. Emission Level(dBuV/m) = Raw Value(dBuV) + Correction Factor(dB/m)
2. Correction Factor(dB/m) = Antenna Factor(dB/m) + Cable Factor(dB) – Pre-Amplifier Factor(dB)
3. The other emission levels were very low against the limit.
4. Margin value = Emission Level – Limit value
5. " * ": Fundamental frequency.

CHANNEL	TX Channel 11	DETECTOR FUNCTION	Peak (PK)
FREQUENCY RANGE	1GHz ~ 25GHz		Average (AV)

ANTENNA POLARITY & TEST DISTANCE: HORIZONTAL AT 3 M

NO.	FREQ. (MHz)	EMISSION LEVEL (dBuV/m)	LIMIT (dBuV/m)	MARGIN (dB)	ANTENNA HEIGHT (m)	TABLE ANGLE (Degree)	RAW VALUE (dBuV)	CORRECTION FACTOR (dB/m)
1	*2462.00	110.1 PK			1.08 H	157	115.44	-5.34
2	*2462.00	99.4 AV			1.08 H	157	104.74	-5.34
3	2483.50	67.9 PK	74.0	-6.1	1.08 H	157	73.17	-5.27
4	2483.50	52.4 AV	54.0	-1.6	1.08 H	157	57.67	-5.27
5	4924.00	50.7 PK	74.0	-23.3	1.92 H	141	49.49	1.21
6	4924.00	47.9 AV	54.0	-6.1	1.92 H	141	46.69	1.21
7	7386.00	45.9 PK	74.0	-28.1	2.00 H	55	38.24	7.66
8	7386.00	38.7 AV	54.0	-15.3	2.00 H	55	31.04	7.66

ANTENNA POLARITY & TEST DISTANCE: VERTICAL AT 3 M

NO.	FREQ. (MHz)	EMISSION LEVEL (dBuV/m)	LIMIT (dBuV/m)	MARGIN (dB)	ANTENNA HEIGHT (m)	TABLE ANGLE (Degree)	RAW VALUE (dBuV)	CORRECTION FACTOR (dB/m)
1	*2462.00	107.5 PK			1.10 V	277	112.84	-5.34
2	*2462.00	96.5 AV			1.10 V	277	101.84	-5.34
3	2483.50	65.5 PK	74.0	-8.5	1.10 V	277	70.77	-5.27
4	2483.50	50.1 AV	54.0	-3.9	1.10 V	277	55.37	-5.27
5	4924.00	47.1 PK	74.0	-26.9	1.55 V	172	45.89	1.21
6	4924.00	36.3 AV	54.0	-17.7	1.55 V	172	35.09	1.21
7	7386.00	56.0 PK	74.0	-18.0	1.60 V	137	48.34	7.66
8	7386.00	44.7 AV	54.0	-9.3	1.60 V	137	37.04	7.66

REMARKS:

1. Emission Level(dBuV/m) = Raw Value(dBuV) + Correction Factor(dB/m)
2. Correction Factor(dB/m) = Antenna Factor(dB/m) + Cable Factor(dB) – Pre-Amplifier Factor(dB)
3. The other emission levels were very low against the limit.
4. Margin value = Emission Level – Limit value
5. " * ": Fundamental frequency.

CHANNEL	TX Channel 12	DETECTOR FUNCTION	Peak (PK)
FREQUENCY RANGE	1GHz ~ 25GHz		Average (AV)

ANTENNA POLARITY & TEST DISTANCE: HORIZONTAL AT 3 M

NO.	FREQ. (MHz)	EMISSION LEVEL (dBuV/m)	LIMIT (dBuV/m)	MARGIN (dB)	ANTENNA HEIGHT (m)	TABLE ANGLE (Degree)	RAW VALUE (dBuV)	CORRECTION FACTOR (dB/m)
1	*2467.00	108.3 PK			1.12 H	164	113.64	-5.34
2	*2467.00	97.1 AV			1.12 H	164	102.44	-5.34
3	2483.50	67.5 PK	74.0	-6.5	1.12 H	164	72.77	-5.27
4	2483.50	52.2 AV	54.0	-1.8	1.12 H	164	57.47	-5.27
5	4934.00	48.4 PK	74.0	-25.6	1.98 H	163	47.16	1.24
6	4934.00	45.4 AV	54.0	-8.6	1.98 H	163	44.16	1.24
7	7401.00	42.2 PK	74.0	-31.8	1.96 H	61	34.54	7.66
8	7401.00	35.4 AV	54.0	-18.6	1.96 H	61	27.74	7.66

ANTENNA POLARITY & TEST DISTANCE: VERTICAL AT 3 M

NO.	FREQ. (MHz)	EMISSION LEVEL (dBuV/m)	LIMIT (dBuV/m)	MARGIN (dB)	ANTENNA HEIGHT (m)	TABLE ANGLE (Degree)	RAW VALUE (dBuV)	CORRECTION FACTOR (dB/m)
1	*2467.00	105.5 PK			1.11 V	276	110.84	-5.34
2	*2467.00	94.4 AV			1.11 V	276	99.74	-5.34
3	2483.50	65.5 PK	74.0	-8.5	1.11 V	276	70.77	-5.27
4	2483.50	49.9 AV	54.0	-4.1	1.11 V	276	55.17	-5.27
5	4934.00	46.4 PK	74.0	-27.6	1.59 V	173	45.16	1.24
6	4934.00	35.4 AV	54.0	-18.6	1.59 V	173	34.16	1.24
7	7401.00	52.4 PK	74.0	-21.6	1.56 V	154	44.74	7.66
8	7401.00	41.5 AV	54.0	-12.5	1.56 V	154	33.84	7.66

REMARKS:

1. Emission Level(dBuV/m) = Raw Value(dBuV) + Correction Factor(dB/m)
2. Correction Factor(dB/m) = Antenna Factor(dB/m) + Cable Factor(dB) – Pre-Amplifier Factor(dB)
3. The other emission levels were very low against the limit.
4. Margin value = Emission Level – Limit value
5. " * ": Fundamental frequency.

CHANNEL	TX Channel 13	DETECTOR FUNCTION	Peak (PK)
FREQUENCY RANGE	1GHz ~ 25GHz		Average (AV)

ANTENNA POLARITY & TEST DISTANCE: HORIZONTAL AT 3 M

NO.	FREQ. (MHz)	EMISSION LEVEL (dBuV/m)	LIMIT (dBuV/m)	MARGIN (dB)	ANTENNA HEIGHT (m)	TABLE ANGLE (Degree)	RAW VALUE (dBuV)	CORRECTION FACTOR (dB/m)
1	*2472.00	103.8 PK			1.11 H	159	109.11	-5.31
2	*2472.00	92.2 AV			1.11 H	159	97.51	-5.31
3	2483.50	71.0 PK	74.0	-3.0	1.11 H	159	76.27	-5.27
4	2483.50	52.6 AV	54.0	-1.4	1.11 H	159	57.87	-5.27
5	4944.00	44.3 PK	74.0	-29.7	1.97 H	144	43.03	1.27
6	4944.00	41.3 AV	54.0	-12.7	1.97 H	144	40.03	1.27
7	7416.00	42.6 PK	74.0	-31.4	2.00 H	60	34.84	7.76
8	7416.00	35.5 AV	54.0	-18.5	2.00 H	60	27.74	7.76

ANTENNA POLARITY & TEST DISTANCE: VERTICAL AT 3 M

NO.	FREQ. (MHz)	EMISSION LEVEL (dBuV/m)	LIMIT (dBuV/m)	MARGIN (dB)	ANTENNA HEIGHT (m)	TABLE ANGLE (Degree)	RAW VALUE (dBuV)	CORRECTION FACTOR (dB/m)
1	*2472.00	100.5 PK			1.20 V	277	105.81	-5.31
2	*2472.00	89.6 AV			1.20 V	277	94.91	-5.31
3	2483.50	69.5 PK	74.0	-4.5	1.20 V	277	74.77	-5.27
4	2483.50	50.4 AV	54.0	-3.6	1.20 V	277	55.67	-5.27
5	4944.00	43.3 PK	74.0	-30.7	1.62 V	173	42.03	1.27
6	4944.00	32.4 AV	54.0	-21.6	1.62 V	173	31.13	1.27
7	7416.00	50.4 PK	74.0	-23.6	1.53 V	151	42.64	7.76
8	7416.00	40.4 AV	54.0	-13.6	1.53 V	151	32.64	7.76

REMARKS:

1. Emission Level(dBuV/m) = Raw Value(dBuV) + Correction Factor(dB/m)
2. Correction Factor(dB/m) = Antenna Factor(dB/m) + Cable Factor(dB) – Pre-Amplifier Factor(dB)
3. The other emission levels were very low against the limit.
4. Margin value = Emission Level – Limit value
5. " * ": Fundamental frequency.

2TX
Beamforming Mode
802.11n (HT20)

CHANNEL	TX Channel 1	DETECTOR FUNCTION	Peak (PK)
FREQUENCY RANGE	1GHz ~ 25GHz		Average (AV)

ANTENNA POLARITY & TEST DISTANCE: HORIZONTAL AT 3 M

NO.	FREQ. (MHz)	EMISSION LEVEL (dBuV/m)	LIMIT (dBuV/m)	MARGIN (dB)	ANTENNA HEIGHT (m)	TABLE ANGLE (Degree)	RAW VALUE (dBuV)	CORRECTION FACTOR (dB/m)
1	2390.00	68.4 PK	74.0	-5.6	1.41 H	167	74.01	-5.61
2	2390.00	52.8 AV	54.0	-1.2	1.41 H	167	58.41	-5.61
3	*2412.00	112.6 PK			1.41 H	167	118.13	-5.53
4	*2412.00	98.4 AV			1.41 H	167	103.93	-5.53
5	4824.00	50.2 PK	74.0	-23.8	1.86 H	152	49.29	0.91
6	4824.00	47.4 AV	54.0	-6.6	1.86 H	152	46.49	0.91

ANTENNA POLARITY & TEST DISTANCE: VERTICAL AT 3 M

NO.	FREQ. (MHz)	EMISSION LEVEL (dBuV/m)	LIMIT (dBuV/m)	MARGIN (dB)	ANTENNA HEIGHT (m)	TABLE ANGLE (Degree)	RAW VALUE (dBuV)	CORRECTION FACTOR (dB/m)
1	2390.00	65.8 PK	74.0	-8.2	1.10 V	252	71.41	-5.61
2	2390.00	50.8 AV	54.0	-3.2	1.10 V	252	56.41	-5.61
3	*2412.00	110.1 PK			1.10 V	252	115.63	-5.53
4	*2412.00	96.9 AV			1.10 V	252	102.43	-5.53
5	4824.00	47.6 PK	74.0	-26.4	1.59 V	153	46.69	0.91
6	4824.00	37.0 AV	54.0	-17.0	1.59 V	153	36.09	0.91

REMARKS:

1. Emission Level(dBuV/m) = Raw Value(dBuV) + Correction Factor(dB/m)
2. Correction Factor(dB/m) = Antenna Factor(dB/m) + Cable Factor(dB) – Pre-Amplifier Factor(dB)
3. The other emission levels were very low against the limit.
4. Margin value = Emission Level – Limit value
5. " * ": Fundamental frequency.

CHANNEL	TX Channel 2	DETECTOR FUNCTION	Peak (PK)
FREQUENCY RANGE	1GHz ~ 25GHz		Average (AV)

ANTENNA POLARITY & TEST DISTANCE: HORIZONTAL AT 3 M

NO.	FREQ. (MHz)	EMISSION LEVEL (dBuV/m)	LIMIT (dBuV/m)	MARGIN (dB)	ANTENNA HEIGHT (m)	TABLE ANGLE (Degree)	RAW VALUE (dBuV)	CORRECTION FACTOR (dB/m)
1	2390.00	66.8 PK	74.0	-7.2	1.39 H	170	72.41	-5.61
2	2390.00	52.7 AV	54.0	-1.3	1.39 H	170	58.31	-5.61
3	*2417.00	114.1 PK			1.39 H	170	119.61	-5.51
4	*2417.00	100.2 AV			1.39 H	170	105.71	-5.51
5	4834.00	51.5 PK	74.0	-22.5	2.00 H	151	50.55	0.95
6	4834.00	48.3 AV	54.0	-5.7	2.00 H	151	47.35	0.95
7	7251.00	45.4 PK	74.0	-28.6	1.96 H	75	37.77	7.63
8	7251.00	38.6 AV	54.0	-15.4	1.96 H	75	30.97	7.63

ANTENNA POLARITY & TEST DISTANCE: VERTICAL AT 3 M

NO.	FREQ. (MHz)	EMISSION LEVEL (dBuV/m)	LIMIT (dBuV/m)	MARGIN (dB)	ANTENNA HEIGHT (m)	TABLE ANGLE (Degree)	RAW VALUE (dBuV)	CORRECTION FACTOR (dB/m)
1	2390.00	64.2 PK	74.0	-9.8	1.10 V	261	69.81	-5.61
2	2390.00	51.6 AV	54.0	-2.4	1.10 V	261	57.21	-5.61
3	*2417.00	109.7 PK			1.10 V	261	115.21	-5.51
4	*2417.00	97.9 AV			1.10 V	261	103.41	-5.51
5	4834.00	47.8 PK	74.0	-26.2	1.59 V	158	46.85	0.95
6	4834.00	36.4 AV	54.0	-17.6	1.59 V	158	35.45	0.95
7	7251.00	55.7 PK	74.0	-18.3	1.59 V	129	48.07	7.63
8	7251.00	44.5 AV	54.0	-9.5	1.59 V	129	36.87	7.63

REMARKS:

1. Emission Level(dBuV/m) = Raw Value(dBuV) + Correction Factor(dB/m)
2. Correction Factor(dB/m) = Antenna Factor(dB/m) + Cable Factor(dB) – Pre-Amplifier Factor(dB)
3. The other emission levels were very low against the limit.
4. Margin value = Emission Level – Limit value
5. " * ": Fundamental frequency.

CHANNEL	TX Channel 6	DETECTOR FUNCTION	Peak (PK)
FREQUENCY RANGE	1GHz ~ 25GHz		Average (AV)

ANTENNA POLARITY & TEST DISTANCE: HORIZONTAL AT 3 M

NO.	FREQ. (MHz)	EMISSION LEVEL (dBuV/m)	LIMIT (dBuV/m)	MARGIN (dB)	ANTENNA HEIGHT (m)	TABLE ANGLE (Degree)	RAW VALUE (dBuV)	CORRECTION FACTOR (dB/m)
1	2390.00	58.8 PK	74.0	-15.2	1.58 H	334	64.41	-5.61
2	2390.00	44.1 AV	54.0	-9.9	1.58 H	334	49.71	-5.61
3	*2437.00	112.5 PK			1.58 H	334	117.93	-5.43
4	*2437.00	101.0 AV			1.58 H	334	106.43	-5.43
5	2483.50	62.2 PK	74.0	-11.8	1.58 H	334	67.47	-5.27
6	2483.50	44.3 AV	54.0	-9.7	1.58 H	334	49.57	-5.27
7	4874.00	50.6 PK	74.0	-23.4	2.05 H	162	49.53	1.07
8	4874.00	47.8 AV	54.0	-6.2	2.05 H	162	46.73	1.07
9	7311.00	44.7 PK	74.0	-29.3	1.97 H	43	37.03	7.67
10	7311.00	37.8 AV	54.0	-16.2	1.97 H	43	30.13	7.67

ANTENNA POLARITY & TEST DISTANCE: VERTICAL AT 3 M

NO.	FREQ. (MHz)	EMISSION LEVEL (dBuV/m)	LIMIT (dBuV/m)	MARGIN (dB)	ANTENNA HEIGHT (m)	TABLE ANGLE (Degree)	RAW VALUE (dBuV)	CORRECTION FACTOR (dB/m)
1	2390.00	55.3 PK	74.0	-18.7	1.18 V	254	60.91	-5.61
2	2390.00	42.8 AV	54.0	-11.2	1.18 V	254	48.41	-5.61
3	*2437.00	110.9 PK			1.18 V	254	116.33	-5.43
4	*2437.00	96.1 AV			1.18 V	254	101.53	-5.43
5	2483.50	56.1 PK	74.0	-17.9	1.18 V	254	61.37	-5.27
6	2483.50	41.4 AV	54.0	-12.6	1.18 V	254	46.67	-5.27
7	4874.00	46.1 PK	74.0	-27.9	1.69 V	154	45.03	1.07
8	4874.00	35.5 AV	54.0	-18.5	1.69 V	154	34.43	1.07
9	7311.00	55.5 PK	74.0	-18.5	1.55 V	115	47.83	7.67
10	7311.00	44.5 AV	54.0	-9.5	1.55 V	115	36.83	7.67

REMARKS:

1. Emission Level(dBuV/m) = Raw Value(dBuV) + Correction Factor(dB/m)
2. Correction Factor(dB/m) = Antenna Factor(dB/m) + Cable Factor(dB) – Pre-Amplifier Factor(dB)
3. The other emission levels were very low against the limit.
4. Margin value = Emission Level – Limit value
5. " * ": Fundamental frequency.



CHANNEL	TX Channel 10	DETECTOR FUNCTION	Peak (PK)
FREQUENCY RANGE	1GHz ~ 25GHz		Average (AV)

ANTENNA POLARITY & TEST DISTANCE: HORIZONTAL AT 3 M

NO.	FREQ. (MHz)	EMISSION LEVEL (dBuV/m)	LIMIT (dBuV/m)	MARGIN (dB)	ANTENNA HEIGHT (m)	TABLE ANGLE (Degree)	RAW VALUE (dBuV)	CORRECTION FACTOR (dB/m)
1	*2457.00	114.9 PK			1.19 H	165	120.27	-5.37
2	*2457.00	101.2 AV			1.19 H	165	106.57	-5.37
3	2483.50	66.7 PK	74.0	-7.3	1.19 H	165	71.97	-5.27
4	2483.50	52.6 AV	54.0	-1.4	1.19 H	165	57.87	-5.27
5	4914.00	50.4 PK	74.0	-23.6	1.97 H	138	49.21	1.19
6	4914.00	47.5 AV	54.0	-6.5	1.97 H	138	46.31	1.19
7	7371.00	45.8 PK	74.0	-28.2	1.98 H	73	38.14	7.66
8	7371.00	39.0 AV	54.0	-15.0	1.98 H	73	31.34	7.66

ANTENNA POLARITY & TEST DISTANCE: VERTICAL AT 3 M

NO.	FREQ. (MHz)	EMISSION LEVEL (dBuV/m)	LIMIT (dBuV/m)	MARGIN (dB)	ANTENNA HEIGHT (m)	TABLE ANGLE (Degree)	RAW VALUE (dBuV)	CORRECTION FACTOR (dB/m)
1	*2457.00	112.3 PK			1.10 V	261	117.67	-5.37
2	*2457.00	97.4 AV			1.10 V	261	102.77	-5.37
3	2483.50	66.1 PK	74.0	-7.9	1.10 V	261	71.37	-5.27
4	2483.50	50.9 AV	54.0	-3.1	1.10 V	261	56.17	-5.27
5	4914.00	48.4 PK	74.0	-25.6	1.63 V	182	47.21	1.19
6	4914.00	37.0 AV	54.0	-17.0	1.63 V	182	35.81	1.19
7	7371.00	55.9 PK	74.0	-18.1	1.66 V	137	48.24	7.66
8	7371.00	44.2 AV	54.0	-9.8	1.66 V	137	36.54	7.66

REMARKS:

1. Emission Level(dBuV/m) = Raw Value(dBuV) + Correction Factor(dB/m)
2. Correction Factor(dB/m) = Antenna Factor(dB/m) + Cable Factor(dB) – Pre-Amplifier Factor(dB)
3. The other emission levels were very low against the limit.
4. Margin value = Emission Level – Limit value
5. " * ": Fundamental frequency.

CHANNEL	TX Channel 11	DETECTOR FUNCTION	Peak (PK)
FREQUENCY RANGE	1GHz ~ 25GHz		Average (AV)

ANTENNA POLARITY & TEST DISTANCE: HORIZONTAL AT 3 M

NO.	FREQ. (MHz)	EMISSION LEVEL (dBuV/m)	LIMIT (dBuV/m)	MARGIN (dB)	ANTENNA HEIGHT (m)	TABLE ANGLE (Degree)	RAW VALUE (dBuV)	CORRECTION FACTOR (dB/m)
1	*2462.00	113.3 PK			1.40 H	163	118.64	-5.34
2	*2462.00	100.3 AV			1.40 H	163	105.64	-5.34
3	2483.50	69.8 PK	74.0	-4.2	1.40 H	163	75.07	-5.27
4	2483.50	52.8 AV	54.0	-1.2	1.40 H	163	58.07	-5.27
5	4924.00	50.8 PK	74.0	-23.2	1.87 H	140	49.59	1.21
6	4924.00	48.3 AV	54.0	-5.7	1.87 H	140	47.09	1.21
7	7386.00	46.4 PK	74.0	-27.6	1.98 H	65	38.74	7.66
8	7386.00	39.0 AV	54.0	-15.0	1.98 H	65	31.34	7.66

ANTENNA POLARITY & TEST DISTANCE: VERTICAL AT 3 M

NO.	FREQ. (MHz)	EMISSION LEVEL (dBuV/m)	LIMIT (dBuV/m)	MARGIN (dB)	ANTENNA HEIGHT (m)	TABLE ANGLE (Degree)	RAW VALUE (dBuV)	CORRECTION FACTOR (dB/m)
1	*2462.00	107.6 PK			1.08 V	281	112.94	-5.34
2	*2462.00	96.5 AV			1.08 V	281	101.84	-5.34
3	2483.50	65.0 PK	74.0	-9.0	1.08 V	281	70.27	-5.27
4	2483.50	49.8 AV	54.0	-4.2	1.08 V	281	55.07	-5.27
5	4924.00	46.5 PK	74.0	-27.5	1.58 V	181	45.29	1.21
6	4924.00	35.9 AV	54.0	-18.1	1.58 V	181	34.69	1.21
7	7386.00	56.0 PK	74.0	-18.0	1.60 V	145	48.34	7.66
8	7386.00	44.4 AV	54.0	-9.6	1.60 V	145	36.74	7.66

REMARKS:

1. Emission Level(dBuV/m) = Raw Value(dBuV) + Correction Factor(dB/m)
2. Correction Factor(dB/m) = Antenna Factor(dB/m) + Cable Factor(dB) – Pre-Amplifier Factor(dB)
3. The other emission levels were very low against the limit.
4. Margin value = Emission Level – Limit value
5. " * ": Fundamental frequency.

CHANNEL	TX Channel 12	DETECTOR FUNCTION	Peak (PK)
FREQUENCY RANGE	1GHz ~ 25GHz		Average (AV)

ANTENNA POLARITY & TEST DISTANCE: HORIZONTAL AT 3 M

NO.	FREQ. (MHz)	EMISSION LEVEL (dBuV/m)	LIMIT (dBuV/m)	MARGIN (dB)	ANTENNA HEIGHT (m)	TABLE ANGLE (Degree)	RAW VALUE (dBuV)	CORRECTION FACTOR (dB/m)
1	*2467.00	109.6 PK			1.15 H	161	114.94	-5.34
2	*2467.00	96.6 AV			1.15 H	161	101.94	-5.34
3	2483.50	68.5 PK	74.0	-5.5	1.15 H	161	73.77	-5.27
4	2483.50	52.5 AV	54.0	-1.5	1.15 H	161	57.77	-5.27
5	4934.00	49.1 PK	74.0	-24.9	1.94 H	174	47.86	1.24
6	4934.00	45.9 AV	54.0	-8.1	1.94 H	174	44.66	1.24
7	7401.00	41.4 PK	74.0	-32.6	1.96 H	62	33.74	7.66
8	7401.00	34.9 AV	54.0	-19.1	1.96 H	62	27.24	7.66

ANTENNA POLARITY & TEST DISTANCE: VERTICAL AT 3 M

NO.	FREQ. (MHz)	EMISSION LEVEL (dBuV/m)	LIMIT (dBuV/m)	MARGIN (dB)	ANTENNA HEIGHT (m)	TABLE ANGLE (Degree)	RAW VALUE (dBuV)	CORRECTION FACTOR (dB/m)
1	*2467.00	106.1 PK			1.11 V	270	111.44	-5.34
2	*2467.00	94.9 AV			1.11 V	270	100.24	-5.34
3	2483.50	65.5 PK	74.0	-8.5	1.11 V	270	70.77	-5.27
4	2483.50	49.9 AV	54.0	-4.1	1.11 V	270	55.17	-5.27
5	4934.00	46.7 PK	74.0	-27.3	1.54 V	178	45.46	1.24
6	4934.00	35.8 AV	54.0	-18.2	1.54 V	178	34.56	1.24
7	7401.00	52.5 PK	74.0	-21.5	1.51 V	159	44.84	7.66
8	7401.00	41.7 AV	54.0	-12.3	1.51 V	159	34.04	7.66

REMARKS:

1. Emission Level(dBuV/m) = Raw Value(dBuV) + Correction Factor(dB/m)
2. Correction Factor(dB/m) = Antenna Factor(dB/m) + Cable Factor(dB) – Pre-Amplifier Factor(dB)
3. The other emission levels were very low against the limit.
4. Margin value = Emission Level – Limit value
5. " * ": Fundamental frequency.

CHANNEL	TX Channel 13	DETECTOR FUNCTION	Peak (PK)
FREQUENCY RANGE	1GHz ~ 25GHz		Average (AV)

ANTENNA POLARITY & TEST DISTANCE: HORIZONTAL AT 3 M

NO.	FREQ. (MHz)	EMISSION LEVEL (dBuV/m)	LIMIT (dBuV/m)	MARGIN (dB)	ANTENNA HEIGHT (m)	TABLE ANGLE (Degree)	RAW VALUE (dBuV)	CORRECTION FACTOR (dB/m)
1	*2472.00	104.4 PK			1.15 H	161	109.71	-5.31
2	*2472.00	90.6 AV			1.15 H	161	95.91	-5.31
3	2483.50	71.0 PK	74.0	-3.0	1.15 H	161	76.27	-5.27
4	2483.50	52.8 AV	54.0	-1.2	1.15 H	161	58.07	-5.27
5	4944.00	44.1 PK	74.0	-29.9	1.96 H	132	42.83	1.27
6	4944.00	41.3 AV	54.0	-12.7	1.96 H	132	40.03	1.27
7	7416.00	43.0 PK	74.0	-31.0	1.98 H	50	35.24	7.76
8	7416.00	35.9 AV	54.0	-18.1	1.98 H	50	28.14	7.76

ANTENNA POLARITY & TEST DISTANCE: VERTICAL AT 3 M

NO.	FREQ. (MHz)	EMISSION LEVEL (dBuV/m)	LIMIT (dBuV/m)	MARGIN (dB)	ANTENNA HEIGHT (m)	TABLE ANGLE (Degree)	RAW VALUE (dBuV)	CORRECTION FACTOR (dB/m)
1	*2472.00	98.7 PK			1.03 V	93	104.01	-5.31
2	*2472.00	85.1 AV			1.03 V	93	90.41	-5.31
3	2483.50	65.6 PK	74.0	-8.4	1.03 V	93	70.87	-5.27
4	2483.50	47.7 AV	54.0	-6.3	1.03 V	93	52.97	-5.27
5	4944.00	43.6 PK	74.0	-30.4	1.65 V	174	42.33	1.27
6	4944.00	32.5 AV	54.0	-21.5	1.65 V	174	31.23	1.27
7	7416.00	50.7 PK	74.0	-23.3	1.51 V	167	42.94	7.76
8	7416.00	40.5 AV	54.0	-13.5	1.51 V	167	32.74	7.76

REMARKS:

1. Emission Level(dBuV/m) = Raw Value(dBuV) + Correction Factor(dB/m)
2. Correction Factor(dB/m) = Antenna Factor(dB/m) + Cable Factor(dB) – Pre-Amplifier Factor(dB)
3. The other emission levels were very low against the limit.
4. Margin value = Emission Level – Limit value
5. " * ": Fundamental frequency.

Below 1GHz Data:
1TX
802.11b

CHANNEL	TX Channel 1	DETECTOR FUNCTION	Quasi-Peak (QP)
FREQUENCY RANGE	30MHz ~ 1GHz		

ANTENNA POLARITY & TEST DISTANCE: HORIZONTAL AT 3 M

NO.	FREQ. (MHz)	EMISSION LEVEL (dBuV/m)	LIMIT (dBuV/m)	MARGIN (dB)	ANTENNA HEIGHT (m)	TABLE ANGLE (Degree)	RAW VALUE (dBuV)	CORRECTION FACTOR (dB/m)
1	42.51	32.1 QP	40.0	-7.9	1.55 H	278	36.44	-4.34
2	201.43	33.7 QP	43.5	-9.8	1.04 H	64	40.80	-7.10
3	314.54	41.7 QP	46.0	-4.3	1.00 H	286	44.59	-2.89
4	323.32	41.7 QP	46.0	-4.3	1.00 H	43	44.34	-2.64
5	497.74	36.2 QP	46.0	-9.8	1.52 H	149	34.85	1.35
6	931.01	38.8 QP	46.0	-7.2	1.49 H	97	30.03	8.77

ANTENNA POLARITY & TEST DISTANCE: VERTICAL AT 3 M

NO.	FREQ. (MHz)	EMISSION LEVEL (dBuV/m)	LIMIT (dBuV/m)	MARGIN (dB)	ANTENNA HEIGHT (m)	TABLE ANGLE (Degree)	RAW VALUE (dBuV)	CORRECTION FACTOR (dB/m)
1	37.23	34.8 QP	40.0	-5.2	1.05 V	105	39.81	-5.01
2	58.44	29.7 QP	40.0	-10.3	1.54 V	46	33.97	-4.27
3	218.86	32.1 QP	46.0	-13.9	2.05 V	180	38.97	-6.87
4	267.97	32.0 QP	46.0	-14.0	2.03 V	313	36.36	-4.36
5	319.92	39.0 QP	46.0	-7.0	1.04 V	144	41.76	-2.76
6	797.49	37.7 QP	46.0	-8.3	1.48 V	110	31.05	6.65

REMARKS:

1. Emission Level(dBuV/m) = Raw Value(dBuV) + Correction Factor(dB/m)
2. Correction Factor(dB/m) = Antenna Factor(dB/m) + Cable Factor(dB) – Pre-Amplifier Factor(dB)
3. The other emission levels were very low against the limit.
4. Margin value = Emission Level – Limit value

CHANNEL	TX Channel 2	DETECTOR FUNCTION	Quasi-Peak (QP)
FREQUENCY RANGE	30MHz ~ 1GHz		

ANTENNA POLARITY & TEST DISTANCE: HORIZONTAL AT 3 M

NO.	FREQ. (MHz)	EMISSION LEVEL (dBuV/m)	LIMIT (dBuV/m)	MARGIN (dB)	ANTENNA HEIGHT (m)	TABLE ANGLE (Degree)	RAW VALUE (dBuV)	CORRECTION FACTOR (dB/m)
1	42.78	31.9 QP	40.0	-8.1	1.53 H	274	36.19	-4.29
2	201.14	33.8 QP	43.5	-9.7	1.06 H	62	40.89	-7.09
3	314.76	41.7 QP	46.0	-4.3	1.03 H	284	44.58	-2.88
4	323.68	41.6 QP	46.0	-4.4	1.00 H	25	44.22	-2.62
5	497.93	36.2 QP	46.0	-9.8	1.45 H	152	34.84	1.36
6	931.01	38.9 QP	46.0	-7.1	1.52 H	83	30.13	8.77

ANTENNA POLARITY & TEST DISTANCE: VERTICAL AT 3 M

NO.	FREQ. (MHz)	EMISSION LEVEL (dBuV/m)	LIMIT (dBuV/m)	MARGIN (dB)	ANTENNA HEIGHT (m)	TABLE ANGLE (Degree)	RAW VALUE (dBuV)	CORRECTION FACTOR (dB/m)
1	36.80	35.0 QP	40.0	-5.0	1.00 V	126	40.12	-5.12
2	58.18	29.7 QP	40.0	-10.3	1.58 V	49	33.96	-4.26
3	219.27	32.3 QP	46.0	-13.7	2.00 V	194	39.18	-6.88
4	267.67	31.8 QP	46.0	-14.2	2.11 V	287	36.17	-4.37
5	320.25	38.6 QP	46.0	-7.4	1.00 V	159	41.35	-2.75
6	797.49	37.3 QP	46.0	-8.7	1.44 V	104	30.65	6.65

REMARKS:

1. Emission Level(dBuV/m) = Raw Value(dBuV) + Correction Factor(dB/m)
2. Correction Factor(dB/m) = Antenna Factor(dB/m) + Cable Factor(dB) – Pre-Amplifier Factor(dB)
3. The other emission levels were very low against the limit.
4. Margin value = Emission Level – Limit value

CHANNEL	TX Channel 6	DETECTOR FUNCTION	Quasi-Peak (QP)
FREQUENCY RANGE	30MHz ~ 1GHz		

ANTENNA POLARITY & TEST DISTANCE: HORIZONTAL AT 3 M

NO.	FREQ. (MHz)	EMISSION LEVEL (dBuV/m)	LIMIT (dBuV/m)	MARGIN (dB)	ANTENNA HEIGHT (m)	TABLE ANGLE (Degree)	RAW VALUE (dBuV)	CORRECTION FACTOR (dB/m)
1	42.83	32.0 QP	40.0	-8.0	1.48 H	296	36.28	-4.28
2	201.41	33.8 QP	43.5	-9.7	1.09 H	48	40.90	-7.10
3	314.67	41.5 QP	46.0	-4.5	1.04 H	287	44.39	-2.89
4	323.41	41.9 QP	46.0	-4.1	1.00 H	42	44.53	-2.63
5	497.59	36.4 QP	46.0	-9.6	1.44 H	136	35.05	1.35
6	931.01	39.0 QP	46.0	-7.0	1.54 H	69	30.23	8.77

ANTENNA POLARITY & TEST DISTANCE: VERTICAL AT 3 M

NO.	FREQ. (MHz)	EMISSION LEVEL (dBuV/m)	LIMIT (dBuV/m)	MARGIN (dB)	ANTENNA HEIGHT (m)	TABLE ANGLE (Degree)	RAW VALUE (dBuV)	CORRECTION FACTOR (dB/m)
1	37.10	35.0 QP	40.0	-5.0	1.03 V	116	40.04	-5.04
2	58.48	29.6 QP	40.0	-10.4	1.60 V	36	33.87	-4.27
3	219.01	32.1 QP	46.0	-13.9	2.04 V	173	38.98	-6.88
4	267.59	31.7 QP	46.0	-14.3	2.05 V	292	36.08	-4.38
5	320.05	38.6 QP	46.0	-7.4	1.00 V	149	41.36	-2.76
6	797.49	37.3 QP	46.0	-8.7	1.51 V	97	30.65	6.65

REMARKS:

1. Emission Level(dBuV/m) = Raw Value(dBuV) + Correction Factor(dB/m)
2. Correction Factor(dB/m) = Antenna Factor(dB/m) + Cable Factor(dB) – Pre-Amplifier Factor(dB)
3. The other emission levels were very low against the limit.
4. Margin value = Emission Level – Limit value

CHANNEL	TX Channel 10	DETECTOR FUNCTION	Quasi-Peak (QP)
FREQUENCY RANGE	30MHz ~ 1GHz		

ANTENNA POLARITY & TEST DISTANCE: HORIZONTAL AT 3 M

NO.	FREQ. (MHz)	EMISSION LEVEL (dBuV/m)	LIMIT (dBuV/m)	MARGIN (dB)	ANTENNA HEIGHT (m)	TABLE ANGLE (Degree)	RAW VALUE (dBuV)	CORRECTION FACTOR (dB/m)
1	42.59	32.0 QP	40.0	-8.0	1.56 H	295	36.32	-4.32
2	201.23	33.7 QP	43.5	-9.8	1.01 H	40	40.79	-7.09
3	314.81	41.5 QP	46.0	-4.5	1.08 H	261	44.38	-2.88
4	323.57	41.5 QP	46.0	-4.5	1.00 H	29	44.13	-2.63
5	498.08	36.2 QP	46.0	-9.8	1.43 H	132	34.84	1.36
6	931.01	39.0 QP	46.0	-7.0	1.51 H	77	30.23	8.77

ANTENNA POLARITY & TEST DISTANCE: VERTICAL AT 3 M

NO.	FREQ. (MHz)	EMISSION LEVEL (dBuV/m)	LIMIT (dBuV/m)	MARGIN (dB)	ANTENNA HEIGHT (m)	TABLE ANGLE (Degree)	RAW VALUE (dBuV)	CORRECTION FACTOR (dB/m)
1	37.27	34.8 QP	40.0	-5.2	1.00 V	125	39.80	-5.00
2	58.37	29.8 QP	40.0	-10.2	1.52 V	34	34.07	-4.27
3	218.73	32.6 QP	46.0	-13.4	2.02 V	175	39.48	-6.88
4	267.80	32.2 QP	46.0	-13.8	2.07 V	313	36.57	-4.37
5	319.93	38.6 QP	46.0	-7.4	1.05 V	155	41.36	-2.76
6	797.49	37.5 QP	46.0	-8.5	1.51 V	106	30.85	6.65

REMARKS:

1. Emission Level(dBuV/m) = Raw Value(dBuV) + Correction Factor(dB/m)
2. Correction Factor(dB/m) = Antenna Factor(dB/m) + Cable Factor(dB) – Pre-Amplifier Factor(dB)
3. The other emission levels were very low against the limit.
4. Margin value = Emission Level – Limit value

CHANNEL	TX Channel 11	DETECTOR FUNCTION	Quasi-Peak (QP)
FREQUENCY RANGE	30MHz ~ 1GHz		

ANTENNA POLARITY & TEST DISTANCE: HORIZONTAL AT 3 M

NO.	FREQ. (MHz)	EMISSION LEVEL (dBuV/m)	LIMIT (dBuV/m)	MARGIN (dB)	ANTENNA HEIGHT (m)	TABLE ANGLE (Degree)	RAW VALUE (dBuV)	CORRECTION FACTOR (dB/m)
1	42.44	31.8 QP	40.0	-8.2	1.49 H	292	36.15	-4.35
2	201.06	33.6 QP	43.5	-9.9	1.05 H	55	40.68	-7.08
3	314.47	41.6 QP	46.0	-4.4	1.00 H	265	44.49	-2.89
4	323.48	41.7 QP	46.0	-4.3	1.00 H	49	44.33	-2.63
5	497.58	36.1 QP	46.0	-9.9	1.54 H	125	34.75	1.35
6	931.01	39.1 QP	46.0	-6.9	1.56 H	70	30.33	8.77

ANTENNA POLARITY & TEST DISTANCE: VERTICAL AT 3 M

NO.	FREQ. (MHz)	EMISSION LEVEL (dBuV/m)	LIMIT (dBuV/m)	MARGIN (dB)	ANTENNA HEIGHT (m)	TABLE ANGLE (Degree)	RAW VALUE (dBuV)	CORRECTION FACTOR (dB/m)
1	37.19	34.8 QP	40.0	-5.2	1.03 V	126	39.82	-5.02
2	58.41	29.6 QP	40.0	-10.4	1.58 V	40	33.87	-4.27
3	218.81	32.6 QP	46.0	-13.4	2.03 V	185	39.47	-6.87
4	267.86	31.8 QP	46.0	-14.2	2.00 V	287	36.17	-4.37
5	319.94	38.6 QP	46.0	-7.4	1.00 V	158	41.36	-2.76
6	797.49	37.7 QP	46.0	-8.3	1.49 V	110	31.05	6.65

REMARKS:

1. Emission Level(dBuV/m) = Raw Value(dBuV) + Correction Factor(dB/m)
2. Correction Factor(dB/m) = Antenna Factor(dB/m) + Cable Factor(dB) – Pre-Amplifier Factor(dB)
3. The other emission levels were very low against the limit.
4. Margin value = Emission Level – Limit value

CHANNEL	TX Channel 12	DETECTOR FUNCTION	Quasi-Peak (QP)
FREQUENCY RANGE	30MHz ~ 1GHz		

ANTENNA POLARITY & TEST DISTANCE: HORIZONTAL AT 3 M

NO.	FREQ. (MHz)	EMISSION LEVEL (dBuV/m)	LIMIT (dBuV/m)	MARGIN (dB)	ANTENNA HEIGHT (m)	TABLE ANGLE (Degree)	RAW VALUE (dBuV)	CORRECTION FACTOR (dB/m)
1	42.67	31.8 QP	40.0	-8.2	1.60 H	302	36.11	-4.31
2	201.02	33.6 QP	43.5	-9.9	1.00 H	44	40.68	-7.08
3	314.60	41.6 QP	46.0	-4.4	1.05 H	274	44.49	-2.89
4	323.66	41.4 QP	46.0	-4.6	1.01 H	32	44.02	-2.62
5	497.53	36.1 QP	46.0	-9.9	1.51 H	150	34.75	1.35
6	931.01	38.7 QP	46.0	-7.3	1.59 H	82	29.93	8.77

ANTENNA POLARITY & TEST DISTANCE: VERTICAL AT 3 M

NO.	FREQ. (MHz)	EMISSION LEVEL (dBuV/m)	LIMIT (dBuV/m)	MARGIN (dB)	ANTENNA HEIGHT (m)	TABLE ANGLE (Degree)	RAW VALUE (dBuV)	CORRECTION FACTOR (dB/m)
1	37.16	34.8 QP	40.0	-5.2	1.00 V	108	39.83	-5.03
2	58.17	29.8 QP	40.0	-10.2	1.59 V	35	34.06	-4.26
3	219.05	32.4 QP	46.0	-13.6	1.98 V	196	39.28	-6.88
4	267.81	31.9 QP	46.0	-14.1	2.09 V	306	36.27	-4.37
5	320.18	38.9 QP	46.0	-7.1	1.02 V	163	41.65	-2.75
6	797.49	37.7 QP	46.0	-8.3	1.50 V	96	31.05	6.65

REMARKS:

1. Emission Level(dBuV/m) = Raw Value(dBuV) + Correction Factor(dB/m)
2. Correction Factor(dB/m) = Antenna Factor(dB/m) + Cable Factor(dB) – Pre-Amplifier Factor(dB)
3. The other emission levels were very low against the limit.
4. Margin value = Emission Level – Limit value

CHANNEL	TX Channel 13	DETECTOR FUNCTION	Quasi-Peak (QP)
FREQUENCY RANGE	30MHz ~ 1GHz		

ANTENNA POLARITY & TEST DISTANCE: HORIZONTAL AT 3 M

NO.	FREQ. (MHz)	EMISSION LEVEL (dBuV/m)	LIMIT (dBuV/m)	MARGIN (dB)	ANTENNA HEIGHT (m)	TABLE ANGLE (Degree)	RAW VALUE (dBuV)	CORRECTION FACTOR (dB/m)
1	42.63	31.7 QP	40.0	-8.3	1.49 H	291	36.02	-4.32
2	201.40	33.4 QP	43.5	-10.1	1.09 H	55	40.50	-7.10
3	314.34	41.4 QP	46.0	-4.6	1.01 H	268	44.29	-2.89
4	323.52	41.5 QP	46.0	-4.5	1.00 H	51	44.13	-2.63
5	497.65	35.8 QP	46.0	-10.2	1.50 H	138	34.45	1.35
6	931.01	38.7 QP	46.0	-7.3	1.48 H	96	29.93	8.77

ANTENNA POLARITY & TEST DISTANCE: VERTICAL AT 3 M

NO.	FREQ. (MHz)	EMISSION LEVEL (dBuV/m)	LIMIT (dBuV/m)	MARGIN (dB)	ANTENNA HEIGHT (m)	TABLE ANGLE (Degree)	RAW VALUE (dBuV)	CORRECTION FACTOR (dB/m)
1	37.15	34.9 QP	40.0	-5.1	1.00 V	104	39.93	-5.03
2	58.51	29.6 QP	40.0	-10.4	1.58 V	50	33.87	-4.27
3	219.10	32.7 QP	46.0	-13.3	1.99 V	191	39.58	-6.88
4	267.58	32.2 QP	46.0	-13.8	2.07 V	293	36.58	-4.38
5	320.23	38.6 QP	46.0	-7.4	1.00 V	135	41.35	-2.75
6	797.49	37.5 QP	46.0	-8.5	1.51 V	117	30.85	6.65

REMARKS:

1. Emission Level(dBuV/m) = Raw Value(dBuV) + Correction Factor(dB/m)
2. Correction Factor(dB/m) = Antenna Factor(dB/m) + Cable Factor(dB) – Pre-Amplifier Factor(dB)
3. The other emission levels were very low against the limit.
4. Margin value = Emission Level – Limit value

2TX

CDD Mode

802.11b

CHANNEL	TX Channel 1	DETECTOR FUNCTION	Quasi-Peak (QP)
FREQUENCY RANGE	30MHz ~ 1GHz		

ANTENNA POLARITY & TEST DISTANCE: HORIZONTAL AT 3 M

NO.	FREQ. (MHz)	EMISSION LEVEL (dBuV/m)	LIMIT (dBuV/m)	MARGIN (dB)	ANTENNA HEIGHT (m)	TABLE ANGLE (Degree)	RAW VALUE (dBuV)	CORRECTION FACTOR (dB/m)
1	43.15	31.7 QP	40.0	-8.3	1.52 H	302	35.92	-4.22
2	201.22	33.6 QP	43.5	-9.9	1.00 H	47	40.69	-7.09
3	314.88	41.6 QP	46.0	-4.4	1.03 H	280	44.48	-2.88
4	323.18	41.3 QP	46.0	-4.7	1.00 H	67	43.94	-2.64
5	497.91	35.7 QP	46.0	-10.3	1.47 H	117	34.34	1.36
6	931.01	38.8 QP	46.0	-7.2	1.49 H	75	30.03	8.77

ANTENNA POLARITY & TEST DISTANCE: VERTICAL AT 3 M

NO.	FREQ. (MHz)	EMISSION LEVEL (dBuV/m)	LIMIT (dBuV/m)	MARGIN (dB)	ANTENNA HEIGHT (m)	TABLE ANGLE (Degree)	RAW VALUE (dBuV)	CORRECTION FACTOR (dB/m)
1	37.12	35.0 QP	40.0	-5.0	1.00 V	100	40.04	-5.04
2	58.32	29.8 QP	40.0	-10.2	1.44 V	28	34.07	-4.27
3	219.05	32.7 QP	46.0	-13.3	2.05 V	158	39.58	-6.88
4	267.72	31.8 QP	46.0	-14.2	2.05 V	327	36.17	-4.37
5	319.76	39.2 QP	46.0	-6.8	1.00 V	156	41.96	-2.76
6	797.49	37.7 QP	46.0	-8.3	1.48 V	108	31.05	6.65

REMARKS:

1. Emission Level(dBuV/m) = Raw Value(dBuV) + Correction Factor(dB/m)
2. Correction Factor(dB/m) = Antenna Factor(dB/m) + Cable Factor(dB) – Pre-Amplifier Factor(dB)
3. The other emission levels were very low against the limit.
4. Margin value = Emission Level – Limit value

CHANNEL	TX Channel 2	DETECTOR FUNCTION	Quasi-Peak (QP)
FREQUENCY RANGE	30MHz ~ 1GHz		

ANTENNA POLARITY & TEST DISTANCE: HORIZONTAL AT 3 M

NO.	FREQ. (MHz)	EMISSION LEVEL (dBuV/m)	LIMIT (dBuV/m)	MARGIN (dB)	ANTENNA HEIGHT (m)	TABLE ANGLE (Degree)	RAW VALUE (dBuV)	CORRECTION FACTOR (dB/m)
1	42.72	31.8 QP	40.0	-8.2	1.53 H	295	36.10	-4.30
2	201.43	33.7 QP	43.5	-9.8	1.03 H	28	40.80	-7.10
3	314.33	41.2 QP	46.0	-4.8	1.01 H	286	44.09	-2.89
4	323.55	41.4 QP	46.0	-4.6	1.04 H	42	44.03	-2.63
5	497.67	35.6 QP	46.0	-10.4	1.44 H	115	34.25	1.35
6	931.01	39.0 QP	46.0	-7.0	1.50 H	82	30.23	8.77

ANTENNA POLARITY & TEST DISTANCE: VERTICAL AT 3 M

NO.	FREQ. (MHz)	EMISSION LEVEL (dBuV/m)	LIMIT (dBuV/m)	MARGIN (dB)	ANTENNA HEIGHT (m)	TABLE ANGLE (Degree)	RAW VALUE (dBuV)	CORRECTION FACTOR (dB/m)
1	36.88	34.6 QP	40.0	-5.4	1.00 V	95	39.69	-5.09
2	58.41	29.6 QP	40.0	-10.4	1.51 V	22	33.87	-4.27
3	219.17	32.8 QP	46.0	-13.2	2.04 V	172	39.68	-6.88
4	267.57	31.6 QP	46.0	-14.4	1.98 V	306	35.98	-4.38
5	320.06	38.9 QP	46.0	-7.1	1.02 V	135	41.66	-2.76
6	797.49	37.7 QP	46.0	-8.3	1.53 V	95	31.05	6.65

REMARKS:

1. Emission Level(dBuV/m) = Raw Value(dBuV) + Correction Factor(dB/m)
2. Correction Factor(dB/m) = Antenna Factor(dB/m) + Cable Factor(dB) – Pre-Amplifier Factor(dB)
3. The other emission levels were very low against the limit.
4. Margin value = Emission Level – Limit value

CHANNEL	TX Channel 6	DETECTOR FUNCTION	Quasi-Peak (QP)
FREQUENCY RANGE	30MHz ~ 1GHz		

ANTENNA POLARITY & TEST DISTANCE: HORIZONTAL AT 3 M

NO.	FREQ. (MHz)	EMISSION LEVEL (dBuV/m)	LIMIT (dBuV/m)	MARGIN (dB)	ANTENNA HEIGHT (m)	TABLE ANGLE (Degree)	RAW VALUE (dBuV)	CORRECTION FACTOR (dB/m)
1	43.27	31.7 QP	40.0	-8.3	1.45 H	292	35.90	-4.20
2	201.46	33.6 QP	43.5	-9.9	1.05 H	35	40.70	-7.10
3	314.64	41.6 QP	46.0	-4.4	1.00 H	268	44.49	-2.89
4	323.35	41.6 QP	46.0	-4.4	1.00 H	56	44.24	-2.64
5	497.78	35.8 QP	46.0	-10.2	1.53 H	137	34.45	1.35
6	931.01	38.6 QP	46.0	-7.4	1.52 H	79	29.83	8.77

ANTENNA POLARITY & TEST DISTANCE: VERTICAL AT 3 M

NO.	FREQ. (MHz)	EMISSION LEVEL (dBuV/m)	LIMIT (dBuV/m)	MARGIN (dB)	ANTENNA HEIGHT (m)	TABLE ANGLE (Degree)	RAW VALUE (dBuV)	CORRECTION FACTOR (dB/m)
1	37.10	35.1 QP	40.0	-4.9	1.05 V	105	40.14	-5.04
2	57.99	29.7 QP	40.0	-10.3	1.45 V	39	33.96	-4.26
3	219.20	32.4 QP	46.0	-13.6	1.97 V	171	39.28	-6.88
4	267.90	32.0 QP	46.0	-14.0	1.95 V	308	36.36	-4.36
5	319.89	39.2 QP	46.0	-6.8	1.00 V	153	41.96	-2.76
6	797.49	37.5 QP	46.0	-8.5	1.47 V	112	30.85	6.65

REMARKS:

1. Emission Level(dBuV/m) = Raw Value(dBuV) + Correction Factor(dB/m)
2. Correction Factor(dB/m) = Antenna Factor(dB/m) + Cable Factor(dB) – Pre-Amplifier Factor(dB)
3. The other emission levels were very low against the limit.
4. Margin value = Emission Level – Limit value

CHANNEL	TX Channel 10	DETECTOR FUNCTION	Quasi-Peak (QP)
FREQUENCY RANGE	30MHz ~ 1GHz		

ANTENNA POLARITY & TEST DISTANCE: HORIZONTAL AT 3 M

NO.	FREQ. (MHz)	EMISSION LEVEL (dBuV/m)	LIMIT (dBuV/m)	MARGIN (dB)	ANTENNA HEIGHT (m)	TABLE ANGLE (Degree)	RAW VALUE (dBuV)	CORRECTION FACTOR (dB/m)
1	43.07	32.0 QP	40.0	-8.0	1.52 H	294	36.24	-4.24
2	201.31	33.9 QP	43.5	-9.6	1.00 H	40	40.99	-7.09
3	314.66	41.4 QP	46.0	-4.6	1.06 H	258	44.29	-2.89
4	323.30	41.4 QP	46.0	-4.6	1.04 H	40	44.04	-2.64
5	498.03	35.7 QP	46.0	-10.3	1.48 H	114	34.34	1.36
6	931.01	38.9 QP	46.0	-7.1	1.50 H	72	30.13	8.77

ANTENNA POLARITY & TEST DISTANCE: VERTICAL AT 3 M

NO.	FREQ. (MHz)	EMISSION LEVEL (dBuV/m)	LIMIT (dBuV/m)	MARGIN (dB)	ANTENNA HEIGHT (m)	TABLE ANGLE (Degree)	RAW VALUE (dBuV)	CORRECTION FACTOR (dB/m)
1	36.57	35.0 QP	40.0	-5.0	1.00 V	105	40.18	-5.18
2	58.01	30.1 QP	40.0	-9.9	1.51 V	24	34.36	-4.26
3	219.39	32.3 QP	46.0	-13.7	1.99 V	186	39.18	-6.88
4	268.10	31.7 QP	46.0	-14.3	2.03 V	317	36.05	-4.35
5	319.85	39.0 QP	46.0	-7.0	1.02 V	154	41.76	-2.76
6	797.49	37.5 QP	46.0	-8.5	1.47 V	96	30.85	6.65

REMARKS:

1. Emission Level(dBuV/m) = Raw Value(dBuV) + Correction Factor(dB/m)
2. Correction Factor(dB/m) = Antenna Factor(dB/m) + Cable Factor(dB) – Pre-Amplifier Factor(dB)
3. The other emission levels were very low against the limit.
4. Margin value = Emission Level – Limit value

CHANNEL	TX Channel 11	DETECTOR FUNCTION	Quasi-Peak (QP)
FREQUENCY RANGE	30MHz ~ 1GHz		

ANTENNA POLARITY & TEST DISTANCE: HORIZONTAL AT 3 M

NO.	FREQ. (MHz)	EMISSION LEVEL (dBuV/m)	LIMIT (dBuV/m)	MARGIN (dB)	ANTENNA HEIGHT (m)	TABLE ANGLE (Degree)	RAW VALUE (dBuV)	CORRECTION FACTOR (dB/m)
1	43.26	31.8 QP	40.0	-8.2	1.51 H	293	36.00	-4.20
2	201.48	33.8 QP	43.5	-9.7	1.04 H	34	40.90	-7.10
3	314.82	41.7 QP	46.0	-4.3	1.00 H	275	44.58	-2.88
4	323.37	41.8 QP	46.0	-4.2	1.00 H	46	44.44	-2.64
5	497.57	35.8 QP	46.0	-10.2	1.51 H	144	34.45	1.35
6	931.01	38.5 QP	46.0	-7.5	1.54 H	77	29.73	8.77

ANTENNA POLARITY & TEST DISTANCE: VERTICAL AT 3 M

NO.	FREQ. (MHz)	EMISSION LEVEL (dBuV/m)	LIMIT (dBuV/m)	MARGIN (dB)	ANTENNA HEIGHT (m)	TABLE ANGLE (Degree)	RAW VALUE (dBuV)	CORRECTION FACTOR (dB/m)
1	37.13	35.0 QP	40.0	-5.0	1.04 V	121	40.03	-5.03
2	58.05	30.1 QP	40.0	-9.9	1.48 V	32	34.36	-4.26
3	219.29	32.6 QP	46.0	-13.4	1.98 V	182	39.48	-6.88
4	267.58	31.9 QP	46.0	-14.1	1.97 V	321	36.28	-4.38
5	320.09	39.3 QP	46.0	-6.7	1.01 V	138	42.06	-2.76
6	797.49	37.7 QP	46.0	-8.3	1.50 V	111	31.05	6.65

REMARKS:

1. Emission Level(dBuV/m) = Raw Value(dBuV) + Correction Factor(dB/m)
2. Correction Factor(dB/m) = Antenna Factor(dB/m) + Cable Factor(dB) – Pre-Amplifier Factor(dB)
3. The other emission levels were very low against the limit.
4. Margin value = Emission Level – Limit value

CHANNEL	TX Channel 12	DETECTOR FUNCTION	Quasi-Peak (QP)
FREQUENCY RANGE	30MHz ~ 1GHz		

ANTENNA POLARITY & TEST DISTANCE: HORIZONTAL AT 3 M

NO.	FREQ. (MHz)	EMISSION LEVEL (dBuV/m)	LIMIT (dBuV/m)	MARGIN (dB)	ANTENNA HEIGHT (m)	TABLE ANGLE (Degree)	RAW VALUE (dBuV)	CORRECTION FACTOR (dB/m)
1	43.18	31.6 QP	40.0	-8.4	1.46 H	288	35.82	-4.22
2	201.51	33.8 QP	43.5	-9.7	1.00 H	47	40.90	-7.10
3	314.72	41.4 QP	46.0	-4.6	1.00 H	259	44.29	-2.89
4	323.65	41.4 QP	46.0	-4.6	1.02 H	66	44.02	-2.62
5	498.03	35.6 QP	46.0	-10.4	1.46 H	130	34.24	1.36
6	931.01	38.4 QP	46.0	-7.6	1.45 H	64	29.63	8.77

ANTENNA POLARITY & TEST DISTANCE: VERTICAL AT 3 M

NO.	FREQ. (MHz)	EMISSION LEVEL (dBuV/m)	LIMIT (dBuV/m)	MARGIN (dB)	ANTENNA HEIGHT (m)	TABLE ANGLE (Degree)	RAW VALUE (dBuV)	CORRECTION FACTOR (dB/m)
1	36.67	34.9 QP	40.0	-5.1	1.04 V	102	40.06	-5.16
2	58.25	30.0 QP	40.0	-10.0	1.55 V	42	34.27	-4.27
3	219.13	32.4 QP	46.0	-13.6	2.02 V	161	39.28	-6.88
4	268.11	31.6 QP	46.0	-14.4	1.99 V	328	35.95	-4.35
5	319.55	38.8 QP	46.0	-7.2	1.01 V	134	41.57	-2.77
6	797.49	37.4 QP	46.0	-8.6	1.44 V	99	30.75	6.65

REMARKS:

1. Emission Level(dBuV/m) = Raw Value(dBuV) + Correction Factor(dB/m)
2. Correction Factor(dB/m) = Antenna Factor(dB/m) + Cable Factor(dB) – Pre-Amplifier Factor(dB)
3. The other emission levels were very low against the limit.
4. Margin value = Emission Level – Limit value

CHANNEL	TX Channel 13	DETECTOR FUNCTION	Quasi-Peak (QP)
FREQUENCY RANGE	30MHz ~ 1GHz		

ANTENNA POLARITY & TEST DISTANCE: HORIZONTAL AT 3 M

NO.	FREQ. (MHz)	EMISSION LEVEL (dBuV/m)	LIMIT (dBuV/m)	MARGIN (dB)	ANTENNA HEIGHT (m)	TABLE ANGLE (Degree)	RAW VALUE (dBuV)	CORRECTION FACTOR (dB/m)
1	43.13	31.7 QP	40.0	-8.3	1.51 H	303	35.93	-4.23
2	201.20	33.8 QP	43.5	-9.7	1.04 H	51	40.89	-7.09
3	314.33	41.2 QP	46.0	-4.8	1.00 H	281	44.09	-2.89
4	323.17	41.5 QP	46.0	-4.5	1.04 H	41	44.14	-2.64
5	497.98	35.6 QP	46.0	-10.4	1.52 H	115	34.24	1.36
6	931.01	38.7 QP	46.0	-7.3	1.55 H	83	29.93	8.77

ANTENNA POLARITY & TEST DISTANCE: VERTICAL AT 3 M

NO.	FREQ. (MHz)	EMISSION LEVEL (dBuV/m)	LIMIT (dBuV/m)	MARGIN (dB)	ANTENNA HEIGHT (m)	TABLE ANGLE (Degree)	RAW VALUE (dBuV)	CORRECTION FACTOR (dB/m)
1	36.55	34.7 QP	40.0	-5.3	1.01 V	127	39.89	-5.19
2	58.05	29.6 QP	40.0	-10.4	1.54 V	24	33.86	-4.26
3	219.44	32.9 QP	46.0	-13.1	1.98 V	162	39.78	-6.88
4	267.74	31.6 QP	46.0	-14.4	2.00 V	315	35.97	-4.37
5	319.93	39.1 QP	46.0	-6.9	1.01 V	152	41.86	-2.76
6	797.49	37.7 QP	46.0	-8.3	1.50 V	112	31.05	6.65

REMARKS:

1. Emission Level(dBuV/m) = Raw Value(dBuV) + Correction Factor(dB/m)
2. Correction Factor(dB/m) = Antenna Factor(dB/m) + Cable Factor(dB) – Pre-Amplifier Factor(dB)
3. The other emission levels were very low against the limit.
4. Margin value = Emission Level – Limit value

802.11g

CHANNEL	TX Channel 1	DETECTOR FUNCTION	Quasi-Peak (QP)
FREQUENCY RANGE	30MHz ~ 1GHz		

ANTENNA POLARITY & TEST DISTANCE: HORIZONTAL AT 3 M

NO.	FREQ. (MHz)	EMISSION LEVEL (dBuV/m)	LIMIT (dBuV/m)	MARGIN (dB)	ANTENNA HEIGHT (m)	TABLE ANGLE (Degree)	RAW VALUE (dBuV)	CORRECTION FACTOR (dB/m)
1	42.78	31.9 QP	40.0	-8.1	1.45 H	296	36.19	-4.29
2	201.57	33.7 QP	43.5	-9.8	1.00 H	30	40.80	-7.10
3	314.55	41.7 QP	46.0	-4.3	1.03 H	278	44.59	-2.89
4	323.66	41.2 QP	46.0	-4.8	1.02 H	40	43.82	-2.62
5	497.96	35.8 QP	46.0	-10.2	1.46 H	143	34.44	1.36
6	931.01	38.9 QP	46.0	-7.1	1.54 H	61	30.13	8.77

ANTENNA POLARITY & TEST DISTANCE: VERTICAL AT 3 M

NO.	FREQ. (MHz)	EMISSION LEVEL (dBuV/m)	LIMIT (dBuV/m)	MARGIN (dB)	ANTENNA HEIGHT (m)	TABLE ANGLE (Degree)	RAW VALUE (dBuV)	CORRECTION FACTOR (dB/m)
1	36.67	34.9 QP	40.0	-5.1	1.05 V	123	40.06	-5.16
2	58.40	29.6 QP	40.0	-10.4	1.52 V	17	33.87	-4.27
3	219.15	32.7 QP	46.0	-13.3	2.01 V	172	39.58	-6.88
4	268.10	31.9 QP	46.0	-14.1	1.97 V	330	36.25	-4.35
5	319.83	39.0 QP	46.0	-7.0	1.05 V	137	41.76	-2.76
6	797.49	38.0 QP	46.0	-8.0	1.56 V	94	31.35	6.65

REMARKS:

1. Emission Level(dBuV/m) = Raw Value(dBuV) + Correction Factor(dB/m)
2. Correction Factor(dB/m) = Antenna Factor(dB/m) + Cable Factor(dB) – Pre-Amplifier Factor(dB)
3. The other emission levels were very low against the limit.
4. Margin value = Emission Level – Limit value

CHANNEL	TX Channel 2	DETECTOR FUNCTION	Quasi-Peak (QP)
FREQUENCY RANGE	30MHz ~ 1GHz		

ANTENNA POLARITY & TEST DISTANCE: HORIZONTAL AT 3 M

NO.	FREQ. (MHz)	EMISSION LEVEL (dBUV/m)	LIMIT (dBUV/m)	MARGIN (dB)	ANTENNA HEIGHT (m)	TABLE ANGLE (Degree)	RAW VALUE (dBUV)	CORRECTION FACTOR (dB/m)
1	42.92	31.6 QP	40.0	-8.4	1.45 H	297	35.86	-4.26
2	201.30	33.8 QP	43.5	-9.7	1.01 H	41	40.89	-7.09
3	314.86	41.6 QP	46.0	-4.4	1.06 H	265	44.48	-2.88
4	323.29	41.2 QP	46.0	-4.8	1.00 H	53	43.84	-2.64
5	497.88	36.1 QP	46.0	-9.9	1.56 H	137	34.74	1.36
6	931.01	38.4 QP	46.0	-7.6	1.53 H	80	29.63	8.77

ANTENNA POLARITY & TEST DISTANCE: VERTICAL AT 3 M

NO.	FREQ. (MHz)	EMISSION LEVEL (dBUV/m)	LIMIT (dBUV/m)	MARGIN (dB)	ANTENNA HEIGHT (m)	TABLE ANGLE (Degree)	RAW VALUE (dBUV)	CORRECTION FACTOR (dB/m)
1	36.54	34.7 QP	40.0	-5.3	1.04 V	126	39.89	-5.19
2	58.38	29.7 QP	40.0	-10.3	1.48 V	46	33.97	-4.27
3	219.14	32.4 QP	46.0	-13.6	1.98 V	169	39.28	-6.88
4	267.91	31.9 QP	46.0	-14.1	2.03 V	325	36.26	-4.36
5	319.68	39.3 QP	46.0	-6.7	1.00 V	160	42.07	-2.77
6	797.49	37.7 QP	46.0	-8.3	1.52 V	95	31.05	6.65

REMARKS:

1. Emission Level(dBUV/m) = Raw Value(dBUV) + Correction Factor(dB/m)
2. Correction Factor(dB/m) = Antenna Factor(dB/m) + Cable Factor(dB) – Pre-Amplifier Factor(dB)
3. The other emission levels were very low against the limit.
4. Margin value = Emission Level – Limit value

CHANNEL	TX Channel 6	DETECTOR FUNCTION	Quasi-Peak (QP)
FREQUENCY RANGE	30MHz ~ 1GHz		

ANTENNA POLARITY & TEST DISTANCE: HORIZONTAL AT 3 M

NO.	FREQ. (MHz)	EMISSION LEVEL (dBuV/m)	LIMIT (dBuV/m)	MARGIN (dB)	ANTENNA HEIGHT (m)	TABLE ANGLE (Degree)	RAW VALUE (dBuV)	CORRECTION FACTOR (dB/m)
1	43.00	31.6 QP	40.0	-8.4	1.45 H	296	35.85	-4.25
2	201.19	33.4 QP	43.5	-10.1	1.02 H	28	40.49	-7.09
3	314.42	41.3 QP	46.0	-4.7	1.01 H	277	44.19	-2.89
4	323.31	41.5 QP	46.0	-4.5	1.00 H	41	44.14	-2.64
5	497.77	35.6 QP	46.0	-10.4	1.45 H	119	34.25	1.35
6	931.01	38.9 QP	46.0	-7.1	1.46 H	71	30.13	8.77

ANTENNA POLARITY & TEST DISTANCE: VERTICAL AT 3 M

NO.	FREQ. (MHz)	EMISSION LEVEL (dBuV/m)	LIMIT (dBuV/m)	MARGIN (dB)	ANTENNA HEIGHT (m)	TABLE ANGLE (Degree)	RAW VALUE (dBuV)	CORRECTION FACTOR (dB/m)
1	37.07	34.9 QP	40.0	-5.1	1.00 V	100	39.95	-5.05
2	58.41	29.7 QP	40.0	-10.3	1.52 V	36	33.97	-4.27
3	219.19	32.4 QP	46.0	-13.6	2.01 V	178	39.28	-6.88
4	267.84	32.0 QP	46.0	-14.0	1.94 V	312	36.37	-4.37
5	319.58	38.9 QP	46.0	-7.1	1.00 V	164	41.67	-2.77
6	797.49	37.6 QP	46.0	-8.4	1.51 V	110	30.95	6.65

REMARKS:

1. Emission Level(dBuV/m) = Raw Value(dBuV) + Correction Factor(dB/m)
2. Correction Factor(dB/m) = Antenna Factor(dB/m) + Cable Factor(dB) – Pre-Amplifier Factor(dB)
3. The other emission levels were very low against the limit.
4. Margin value = Emission Level – Limit value

CHANNEL	TX Channel 10	DETECTOR FUNCTION	Quasi-Peak (QP)
FREQUENCY RANGE	30MHz ~ 1GHz		

ANTENNA POLARITY & TEST DISTANCE: HORIZONTAL AT 3 M

NO.	FREQ. (MHz)	EMISSION LEVEL (dBuV/m)	LIMIT (dBuV/m)	MARGIN (dB)	ANTENNA HEIGHT (m)	TABLE ANGLE (Degree)	RAW VALUE (dBuV)	CORRECTION FACTOR (dB/m)
1	42.85	31.6 QP	40.0	-8.4	1.54 H	295	35.88	-4.28
2	201.45	33.7 QP	43.5	-9.8	1.05 H	38	40.80	-7.10
3	314.42	41.3 QP	46.0	-4.7	1.03 H	274	44.19	-2.89
4	323.65	41.2 QP	46.0	-4.8	1.02 H	40	43.82	-2.62
5	497.94	35.7 QP	46.0	-10.3	1.49 H	141	34.34	1.36
6	931.01	38.5 QP	46.0	-7.5	1.50 H	90	29.73	8.77

ANTENNA POLARITY & TEST DISTANCE: VERTICAL AT 3 M

NO.	FREQ. (MHz)	EMISSION LEVEL (dBuV/m)	LIMIT (dBuV/m)	MARGIN (dB)	ANTENNA HEIGHT (m)	TABLE ANGLE (Degree)	RAW VALUE (dBuV)	CORRECTION FACTOR (dB/m)
1	36.84	34.9 QP	40.0	-5.1	1.00 V	98	40.01	-5.11
2	58.23	29.9 QP	40.0	-10.1	1.50 V	21	34.16	-4.26
3	219.31	32.8 QP	46.0	-13.2	2.03 V	157	39.68	-6.88
4	268.00	31.6 QP	46.0	-14.4	2.00 V	308	35.96	-4.36
5	319.87	38.8 QP	46.0	-7.2	1.01 V	142	41.56	-2.76
6	797.49	38.0 QP	46.0	-8.0	1.56 V	97	31.35	6.65

REMARKS:

1. Emission Level(dBuV/m) = Raw Value(dBuV) + Correction Factor(dB/m)
2. Correction Factor(dB/m) = Antenna Factor(dB/m) + Cable Factor(dB) – Pre-Amplifier Factor(dB)
3. The other emission levels were very low against the limit.
4. Margin value = Emission Level – Limit value

CHANNEL	TX Channel 11	DETECTOR FUNCTION	Quasi-Peak (QP)
FREQUENCY RANGE	30MHz ~ 1GHz		

ANTENNA POLARITY & TEST DISTANCE: HORIZONTAL AT 3 M

NO.	FREQ. (MHz)	EMISSION LEVEL (dBuV/m)	LIMIT (dBuV/m)	MARGIN (dB)	ANTENNA HEIGHT (m)	TABLE ANGLE (Degree)	RAW VALUE (dBuV)	CORRECTION FACTOR (dB/m)
1	43.20	31.7 QP	40.0	-8.3	1.52 H	299	35.91	-4.21
2	201.38	34.0 QP	43.5	-9.5	1.00 H	27	41.10	-7.10
3	314.73	41.3 QP	46.0	-4.7	1.01 H	260	44.19	-2.89
4	323.56	41.3 QP	46.0	-4.7	1.01 H	56	43.93	-2.63
5	497.81	36.0 QP	46.0	-10.0	1.45 H	131	34.64	1.36
6	931.01	39.0 QP	46.0	-7.0	1.44 H	91	30.23	8.77

ANTENNA POLARITY & TEST DISTANCE: VERTICAL AT 3 M

NO.	FREQ. (MHz)	EMISSION LEVEL (dBuV/m)	LIMIT (dBuV/m)	MARGIN (dB)	ANTENNA HEIGHT (m)	TABLE ANGLE (Degree)	RAW VALUE (dBuV)	CORRECTION FACTOR (dB/m)
1	36.58	35.0 QP	40.0	-5.0	1.00 V	125	40.18	-5.18
2	57.92	29.7 QP	40.0	-10.3	1.46 V	43	33.96	-4.26
3	219.53	32.6 QP	46.0	-13.4	2.03 V	165	39.48	-6.88
4	267.97	32.0 QP	46.0	-14.0	2.01 V	312	36.36	-4.36
5	319.57	38.8 QP	46.0	-7.2	1.05 V	156	41.57	-2.77
6	797.49	37.9 QP	46.0	-8.1	1.49 V	88	31.25	6.65

REMARKS:

1. Emission Level(dBuV/m) = Raw Value(dBuV) + Correction Factor(dB/m)
2. Correction Factor(dB/m) = Antenna Factor(dB/m) + Cable Factor(dB) – Pre-Amplifier Factor(dB)
3. The other emission levels were very low against the limit.
4. Margin value = Emission Level – Limit value

CHANNEL	TX Channel 12	DETECTOR FUNCTION	Quasi-Peak (QP)
FREQUENCY RANGE	30MHz ~ 1GHz		

ANTENNA POLARITY & TEST DISTANCE: HORIZONTAL AT 3 M

NO.	FREQ. (MHz)	EMISSION LEVEL (dBuV/m)	LIMIT (dBuV/m)	MARGIN (dB)	ANTENNA HEIGHT (m)	TABLE ANGLE (Degree)	RAW VALUE (dBuV)	CORRECTION FACTOR (dB/m)
1	43.12	31.9 QP	40.0	-8.1	1.49 H	304	36.13	-4.23
2	201.62	33.7 QP	43.5	-9.8	1.05 H	27	40.80	-7.10
3	314.35	41.4 QP	46.0	-4.6	1.00 H	275	44.29	-2.89
4	323.21	41.5 QP	46.0	-4.5	1.06 H	56	44.14	-2.64
5	497.76	35.7 QP	46.0	-10.3	1.52 H	133	34.35	1.35
6	931.01	38.7 QP	46.0	-7.3	1.45 H	82	29.93	8.77

ANTENNA POLARITY & TEST DISTANCE: VERTICAL AT 3 M

NO.	FREQ. (MHz)	EMISSION LEVEL (dBuV/m)	LIMIT (dBuV/m)	MARGIN (dB)	ANTENNA HEIGHT (m)	TABLE ANGLE (Degree)	RAW VALUE (dBuV)	CORRECTION FACTOR (dB/m)
1	37.11	34.6 QP	40.0	-5.4	1.03 V	106	39.64	-5.04
2	58.46	29.8 QP	40.0	-10.2	1.47 V	29	34.07	-4.27
3	219.17	32.9 QP	46.0	-13.1	2.02 V	170	39.78	-6.88
4	267.87	31.9 QP	46.0	-14.1	1.99 V	326	36.27	-4.37
5	319.92	39.1 QP	46.0	-6.9	1.00 V	147	41.86	-2.76
6	797.49	37.7 QP	46.0	-8.3	1.48 V	118	31.05	6.65

REMARKS:

1. Emission Level(dBuV/m) = Raw Value(dBuV) + Correction Factor(dB/m)
2. Correction Factor(dB/m) = Antenna Factor(dB/m) + Cable Factor(dB) – Pre-Amplifier Factor(dB)
3. The other emission levels were very low against the limit.
4. Margin value = Emission Level – Limit value

CHANNEL	TX Channel 13	DETECTOR FUNCTION	Quasi-Peak (QP)
FREQUENCY RANGE	30MHz ~ 1GHz		

ANTENNA POLARITY & TEST DISTANCE: HORIZONTAL AT 3 M

NO.	FREQ. (MHz)	EMISSION LEVEL (dBuV/m)	LIMIT (dBuV/m)	MARGIN (dB)	ANTENNA HEIGHT (m)	TABLE ANGLE (Degree)	RAW VALUE (dBuV)	CORRECTION FACTOR (dB/m)
1	42.93	31.7 QP	40.0	-8.3	1.47 H	295	35.96	-4.26
2	201.35	34.0 QP	43.5	-9.5	1.00 H	54	41.09	-7.09
3	314.38	41.7 QP	46.0	-4.3	1.00 H	273	44.59	-2.89
4	323.41	41.4 QP	46.0	-4.6	1.00 H	47	44.03	-2.63
5	497.54	35.7 QP	46.0	-10.3	1.52 H	130	34.35	1.35
6	931.01	38.7 QP	46.0	-7.3	1.47 H	82	29.93	8.77

ANTENNA POLARITY & TEST DISTANCE: VERTICAL AT 3 M

NO.	FREQ. (MHz)	EMISSION LEVEL (dBuV/m)	LIMIT (dBuV/m)	MARGIN (dB)	ANTENNA HEIGHT (m)	TABLE ANGLE (Degree)	RAW VALUE (dBuV)	CORRECTION FACTOR (dB/m)
1	37.00	34.8 QP	40.0	-5.2	1.03 V	121	39.86	-5.06
2	58.44	29.9 QP	40.0	-10.1	1.45 V	16	34.17	-4.27
3	219.13	32.6 QP	46.0	-13.4	1.95 V	179	39.48	-6.88
4	268.12	32.0 QP	46.0	-14.0	1.99 V	302	36.35	-4.35
5	319.70	39.1 QP	46.0	-6.9	1.00 V	155	41.87	-2.77
6	797.49	37.6 QP	46.0	-8.4	1.54 V	104	30.95	6.65

REMARKS:

1. Emission Level(dBuV/m) = Raw Value(dBuV) + Correction Factor(dB/m)
2. Correction Factor(dB/m) = Antenna Factor(dB/m) + Cable Factor(dB) – Pre-Amplifier Factor(dB)
3. The other emission levels were very low against the limit.
4. Margin value = Emission Level – Limit value

Beamforming Mode

802.11n (HT20)

CHANNEL	TX Channel 1	DETECTOR FUNCTION	Quasi-Peak (QP)
FREQUENCY RANGE	30MHz ~ 1GHz		

ANTENNA POLARITY & TEST DISTANCE: HORIZONTAL AT 3 M

NO.	FREQ. (MHz)	EMISSION LEVEL (dBuV/m)	LIMIT (dBuV/m)	MARGIN (dB)	ANTENNA HEIGHT (m)	TABLE ANGLE (Degree)	RAW VALUE (dBuV)	CORRECTION FACTOR (dB/m)
1	42.92	31.9 QP	40.0	-8.1	1.48 H	305	36.16	-4.26
2	201.37	33.5 QP	43.5	-10.0	1.00 H	35	40.59	-7.09
3	314.75	41.4 QP	46.0	-4.6	1.00 H	264	44.28	-2.88
4	323.68	41.6 QP	46.0	-4.4	1.00 H	61	44.22	-2.62
5	497.68	36.0 QP	46.0	-10.0	1.51 H	134	34.65	1.35
6	931.01	38.8 QP	46.0	-7.2	1.55 H	67	30.03	8.77

ANTENNA POLARITY & TEST DISTANCE: VERTICAL AT 3 M

NO.	FREQ. (MHz)	EMISSION LEVEL (dBuV/m)	LIMIT (dBuV/m)	MARGIN (dB)	ANTENNA HEIGHT (m)	TABLE ANGLE (Degree)	RAW VALUE (dBuV)	CORRECTION FACTOR (dB/m)
1	36.77	34.5 QP	40.0	-5.5	1.00 V	122	39.63	-5.13
2	58.49	30.1 QP	40.0	-9.9	1.46 V	29	34.37	-4.27
3	219.21	32.8 QP	46.0	-13.2	2.02 V	183	39.68	-6.88
4	267.86	31.9 QP	46.0	-14.1	1.98 V	318	36.27	-4.37
5	319.53	39.3 QP	46.0	-6.7	1.02 V	154	42.07	-2.77
6	797.49	37.5 QP	46.0	-8.5	1.54 V	87	30.85	6.65

REMARKS:

1. Emission Level(dBuV/m) = Raw Value(dBuV) + Correction Factor(dB/m)
2. Correction Factor(dB/m) = Antenna Factor(dB/m) + Cable Factor(dB) – Pre-Amplifier Factor(dB)
3. The other emission levels were very low against the limit.
4. Margin value = Emission Level – Limit value

CHANNEL	TX Channel 2	DETECTOR FUNCTION	Quasi-Peak (QP)
FREQUENCY RANGE	30MHz ~ 1GHz		

ANTENNA POLARITY & TEST DISTANCE: HORIZONTAL AT 3 M

NO.	FREQ. (MHz)	EMISSION LEVEL (dBuV/m)	LIMIT (dBuV/m)	MARGIN (dB)	ANTENNA HEIGHT (m)	TABLE ANGLE (Degree)	RAW VALUE (dBuV)	CORRECTION FACTOR (dB/m)
1	43.17	31.9 QP	40.0	-8.1	1.52 H	317	36.12	-4.22
2	201.50	33.6 QP	43.5	-9.9	1.06 H	30	40.70	-7.10
3	314.74	41.7 QP	46.0	-4.3	1.00 H	257	44.59	-2.89
4	323.47	41.5 QP	46.0	-4.5	1.00 H	41	44.13	-2.63
5	497.59	35.7 QP	46.0	-10.3	1.46 H	130	34.35	1.35
6	931.01	38.6 QP	46.0	-7.4	1.45 H	88	29.83	8.77

ANTENNA POLARITY & TEST DISTANCE: VERTICAL AT 3 M

NO.	FREQ. (MHz)	EMISSION LEVEL (dBuV/m)	LIMIT (dBuV/m)	MARGIN (dB)	ANTENNA HEIGHT (m)	TABLE ANGLE (Degree)	RAW VALUE (dBuV)	CORRECTION FACTOR (dB/m)
1	36.90	35.1 QP	40.0	-4.9	1.03 V	123	40.19	-5.09
2	58.18	29.6 QP	40.0	-10.4	1.49 V	47	33.86	-4.26
3	219.24	32.5 QP	46.0	-13.5	1.98 V	158	39.38	-6.88
4	268.09	31.9 QP	46.0	-14.1	2.00 V	303	36.25	-4.35
5	319.69	39.0 QP	46.0	-7.0	1.00 V	149	41.77	-2.77
6	797.49	37.5 QP	46.0	-8.5	1.56 V	88	30.85	6.65

REMARKS:

1. Emission Level(dBuV/m) = Raw Value(dBuV) + Correction Factor(dB/m)
2. Correction Factor(dB/m) = Antenna Factor(dB/m) + Cable Factor(dB) – Pre-Amplifier Factor(dB)
3. The other emission levels were very low against the limit.
4. Margin value = Emission Level – Limit value

CHANNEL	TX Channel 6	DETECTOR FUNCTION	Quasi-Peak (QP)
FREQUENCY RANGE	30MHz ~ 1GHz		

ANTENNA POLARITY & TEST DISTANCE: HORIZONTAL AT 3 M

NO.	FREQ. (MHz)	EMISSION LEVEL (dBuV/m)	LIMIT (dBuV/m)	MARGIN (dB)	ANTENNA HEIGHT (m)	TABLE ANGLE (Degree)	RAW VALUE (dBuV)	CORRECTION FACTOR (dB/m)
1	42.88	32.1 QP	40.0	-7.9	1.51 H	286	36.37	-4.27
2	201.40	33.6 QP	43.5	-9.9	1.00 H	41	40.70	-7.10
3	314.54	41.7 QP	46.0	-4.3	1.05 H	273	44.59	-2.89
4	323.64	41.3 QP	46.0	-4.7	1.06 H	64	43.92	-2.62
5	497.58	36.0 QP	46.0	-10.0	1.50 H	133	34.65	1.35
6	931.01	38.4 QP	46.0	-7.6	1.45 H	59	29.63	8.77

ANTENNA POLARITY & TEST DISTANCE: VERTICAL AT 3 M

NO.	FREQ. (MHz)	EMISSION LEVEL (dBuV/m)	LIMIT (dBuV/m)	MARGIN (dB)	ANTENNA HEIGHT (m)	TABLE ANGLE (Degree)	RAW VALUE (dBuV)	CORRECTION FACTOR (dB/m)
1	36.60	34.7 QP	40.0	-5.3	1.01 V	114	39.87	-5.17
2	58.33	29.8 QP	40.0	-10.2	1.55 V	45	34.07	-4.27
3	219.09	32.6 QP	46.0	-13.4	1.97 V	166	39.48	-6.88
4	267.91	31.6 QP	46.0	-14.4	1.99 V	304	35.96	-4.36
5	320.08	39.2 QP	46.0	-6.8	1.04 V	136	41.96	-2.76
6	797.49	37.9 QP	46.0	-8.1	1.52 V	116	31.25	6.65

REMARKS:

1. Emission Level(dBuV/m) = Raw Value(dBuV) + Correction Factor(dB/m)
2. Correction Factor(dB/m) = Antenna Factor(dB/m) + Cable Factor(dB) – Pre-Amplifier Factor(dB)
3. The other emission levels were very low against the limit.
4. Margin value = Emission Level – Limit value

CHANNEL	TX Channel 10	DETECTOR FUNCTION	Quasi-Peak (QP)
FREQUENCY RANGE	30MHz ~ 1GHz		

ANTENNA POLARITY & TEST DISTANCE: HORIZONTAL AT 3 M

NO.	FREQ. (MHz)	EMISSION LEVEL (dBUV/m)	LIMIT (dBUV/m)	MARGIN (dB)	ANTENNA HEIGHT (m)	TABLE ANGLE (Degree)	RAW VALUE (dBUV)	CORRECTION FACTOR (dB/m)
1	43.08	31.9 QP	40.0	-8.1	1.45 H	302	36.14	-4.24
2	201.10	33.9 QP	43.5	-9.6	1.05 H	39	40.98	-7.08
3	314.60	41.3 QP	46.0	-4.7	1.04 H	271	44.19	-2.89
4	323.21	41.6 QP	46.0	-4.4	1.00 H	59	44.24	-2.64
5	497.49	35.6 QP	46.0	-10.4	1.54 H	118	34.25	1.35
6	931.01	38.8 QP	46.0	-7.2	1.50 H	64	30.03	8.77

ANTENNA POLARITY & TEST DISTANCE: VERTICAL AT 3 M

NO.	FREQ. (MHz)	EMISSION LEVEL (dBUV/m)	LIMIT (dBUV/m)	MARGIN (dB)	ANTENNA HEIGHT (m)	TABLE ANGLE (Degree)	RAW VALUE (dBUV)	CORRECTION FACTOR (dB/m)
1	36.94	34.6 QP	40.0	-5.4	1.03 V	113	39.68	-5.08
2	57.98	29.6 QP	40.0	-10.4	1.53 V	39	33.86	-4.26
3	219.34	32.7 QP	46.0	-13.3	2.04 V	165	39.58	-6.88
4	268.11	32.0 QP	46.0	-14.0	1.94 V	313	36.35	-4.35
5	319.63	38.8 QP	46.0	-7.2	1.00 V	141	41.57	-2.77
6	797.49	37.8 QP	46.0	-8.2	1.51 V	96	31.15	6.65

REMARKS:

1. Emission Level(dBUV/m) = Raw Value(dBUV) + Correction Factor(dB/m)
2. Correction Factor(dB/m) = Antenna Factor(dB/m) + Cable Factor(dB) – Pre-Amplifier Factor(dB)
3. The other emission levels were very low against the limit.
4. Margin value = Emission Level – Limit value

CHANNEL	TX Channel 11	DETECTOR FUNCTION	Quasi-Peak (QP)
FREQUENCY RANGE	30MHz ~ 1GHz		

ANTENNA POLARITY & TEST DISTANCE: HORIZONTAL AT 3 M

NO.	FREQ. (MHz)	EMISSION LEVEL (dBuV/m)	LIMIT (dBuV/m)	MARGIN (dB)	ANTENNA HEIGHT (m)	TABLE ANGLE (Degree)	RAW VALUE (dBuV)	CORRECTION FACTOR (dB/m)
1	43.24	31.9 QP	40.0	-8.1	1.54 H	298	36.11	-4.21
2	201.52	34.0 QP	43.5	-9.5	1.05 H	53	41.10	-7.10
3	314.89	41.3 QP	46.0	-4.7	1.00 H	270	44.18	-2.88
4	323.57	41.8 QP	46.0	-4.2	1.00 H	50	44.43	-2.63
5	497.50	36.1 QP	46.0	-9.9	1.49 H	124	34.75	1.35
6	931.01	39.0 QP	46.0	-7.0	1.53 H	78	30.23	8.77

ANTENNA POLARITY & TEST DISTANCE: VERTICAL AT 3 M

NO.	FREQ. (MHz)	EMISSION LEVEL (dBuV/m)	LIMIT (dBuV/m)	MARGIN (dB)	ANTENNA HEIGHT (m)	TABLE ANGLE (Degree)	RAW VALUE (dBuV)	CORRECTION FACTOR (dB/m)
1	36.55	34.5 QP	40.0	-5.5	1.00 V	117	39.69	-5.19
2	58.26	29.6 QP	40.0	-10.4	1.48 V	22	33.87	-4.27
3	219.36	32.6 QP	46.0	-13.4	2.06 V	178	39.48	-6.88
4	267.65	31.8 QP	46.0	-14.2	1.94 V	314	36.18	-4.38
5	319.72	39.0 QP	46.0	-7.0	1.01 V	159	41.77	-2.77
6	797.49	37.9 QP	46.0	-8.1	1.47 V	109	31.25	6.65

REMARKS:

1. Emission Level(dBuV/m) = Raw Value(dBuV) + Correction Factor(dB/m)
2. Correction Factor(dB/m) = Antenna Factor(dB/m) + Cable Factor(dB) – Pre-Amplifier Factor(dB)
3. The other emission levels were very low against the limit.
4. Margin value = Emission Level – Limit value

CHANNEL	TX Channel 12	DETECTOR FUNCTION	Quasi-Peak (QP)
FREQUENCY RANGE	30MHz ~ 1GHz		

ANTENNA POLARITY & TEST DISTANCE: HORIZONTAL AT 3 M

NO.	FREQ. (MHz)	EMISSION LEVEL (dBuV/m)	LIMIT (dBuV/m)	MARGIN (dB)	ANTENNA HEIGHT (m)	TABLE ANGLE (Degree)	RAW VALUE (dBuV)	CORRECTION FACTOR (dB/m)
1	43.27	31.7 QP	40.0	-8.3	1.48 H	298	35.90	-4.20
2	201.36	33.6 QP	43.5	-9.9	1.00 H	31	40.69	-7.09
3	314.66	41.7 QP	46.0	-4.3	1.00 H	283	44.59	-2.89
4	323.39	41.3 QP	46.0	-4.7	1.00 H	49	43.93	-2.63
5	497.69	35.7 QP	46.0	-10.3	1.49 H	121	34.35	1.35
6	931.01	38.8 QP	46.0	-7.2	1.50 H	64	30.03	8.77

ANTENNA POLARITY & TEST DISTANCE: VERTICAL AT 3 M

NO.	FREQ. (MHz)	EMISSION LEVEL (dBuV/m)	LIMIT (dBuV/m)	MARGIN (dB)	ANTENNA HEIGHT (m)	TABLE ANGLE (Degree)	RAW VALUE (dBuV)	CORRECTION FACTOR (dB/m)
1	36.90	34.9 QP	40.0	-5.1	1.02 V	122	39.99	-5.09
2	57.99	30.1 QP	40.0	-9.9	1.51 V	42	34.36	-4.26
3	219.15	32.6 QP	46.0	-13.4	1.97 V	159	39.48	-6.88
4	267.79	31.9 QP	46.0	-14.1	2.03 V	300	36.27	-4.37
5	319.51	39.4 QP	46.0	-6.6	1.00 V	134	42.17	-2.77
6	797.49	37.9 QP	46.0	-8.1	1.50 V	114	31.25	6.65

REMARKS:

1. Emission Level(dBuV/m) = Raw Value(dBuV) + Correction Factor(dB/m)
2. Correction Factor(dB/m) = Antenna Factor(dB/m) + Cable Factor(dB) – Pre-Amplifier Factor(dB)
3. The other emission levels were very low against the limit.
4. Margin value = Emission Level – Limit value

CHANNEL	TX Channel 13	DETECTOR FUNCTION	Quasi-Peak (QP)
FREQUENCY RANGE	30MHz ~ 1GHz		

ANTENNA POLARITY & TEST DISTANCE: HORIZONTAL AT 3 M

NO.	FREQ. (MHz)	EMISSION LEVEL (dBuV/m)	LIMIT (dBuV/m)	MARGIN (dB)	ANTENNA HEIGHT (m)	TABLE ANGLE (Degree)	RAW VALUE (dBuV)	CORRECTION FACTOR (dB/m)
1	43.23	31.8 QP	40.0	-8.2	1.48 H	302	36.01	-4.21
2	201.41	33.4 QP	43.5	-10.1	1.01 H	31	40.50	-7.10
3	314.33	41.8 QP	46.0	-4.2	1.04 H	282	44.69	-2.89
4	323.15	41.3 QP	46.0	-4.7	1.00 H	41	43.94	-2.64
5	498.02	35.7 QP	46.0	-10.3	1.53 H	134	34.34	1.36
6	931.01	38.6 QP	46.0	-7.4	1.44 H	69	29.83	8.77

ANTENNA POLARITY & TEST DISTANCE: VERTICAL AT 3 M

NO.	FREQ. (MHz)	EMISSION LEVEL (dBuV/m)	LIMIT (dBuV/m)	MARGIN (dB)	ANTENNA HEIGHT (m)	TABLE ANGLE (Degree)	RAW VALUE (dBuV)	CORRECTION FACTOR (dB/m)
1	36.96	34.7 QP	40.0	-5.3	1.00 V	127	39.77	-5.07
2	58.49	29.8 QP	40.0	-10.2	1.50 V	39	34.07	-4.27
3	219.45	32.3 QP	46.0	-13.7	1.97 V	159	39.18	-6.88
4	267.59	32.1 QP	46.0	-13.9	2.00 V	306	36.48	-4.38
5	319.69	39.1 QP	46.0	-6.9	1.03 V	153	41.87	-2.77
6	797.49	37.8 QP	46.0	-8.2	1.47 V	102	31.15	6.65

REMARKS:

1. Emission Level(dBuV/m) = Raw Value(dBuV) + Correction Factor(dB/m)
2. Correction Factor(dB/m) = Antenna Factor(dB/m) + Cable Factor(dB) – Pre-Amplifier Factor(dB)
3. The other emission levels were very low against the limit.
4. Margin value = Emission Level – Limit value

4.2 Conducted Emission Measurement

4.2.1 Limits of Conducted Emission Measurement

Frequency (MHz)	Conducted Limit (dBuV)	
	Quasi-peak	Average
0.15 - 0.5	66 - 56	56 - 46
0.50 - 5.0	56	46
5.0 - 30.0	60	50

Note: 1. The lower limit shall apply at the transition frequencies.

2. The limit decreases in line with the logarithm of the frequency in the range of 0.15 to 0.50MHz.

4.2.2 Test Instruments

DESCRIPTION & MANUFACTURER	MODEL NO.	SERIAL NO.	CALIBRATED DATE	CALIBRATED UNTIL
Test Receiver R&S	ESCS 30	100375	May 06, 2015	May 05, 2016
Line-Impedance Stabilization Network (for EUT) SCHWARZBECK	NSLK-8127	8127-522	Sep. 01, 2015	Aug. 31, 2016
Line-Impedance Stabilization Network (for Peripheral) R&S	ENV216	100072	June 11, 2015	June 10, 2016
RF Cable	5D-FB	COCCAB-001	Mar. 08, 2016	Mar. 07, 2017
50 ohms Terminator	N/A	EMC-03	Sep. 23, 2015	Sep. 22, 2016
50 ohms Terminator	N/A	EMC-02	Oct. 01, 2015	Sep. 30, 2016
50 ohms Terminator	E1-011315	13	Dec. 11 2015	Dec. 10 2016
Software BVADT	BVADT_Cond_ V7.3.7.3	NA	NA	NA

Note:

1. The calibration interval of the above test instruments are 12 months and the calibrations are traceable to NML/ROC and NIST/USA.
2. The test was performed in Shielded Room No. C.
3. The VCCI Con C Registration No. is C-3611.
4. Tested Date: Apr. 11, 2016

4.2.3 Test Procedures

- The EUT was placed 0.4 meters from the conducting wall of the shielded room with EUT being connected to the power mains through a line impedance stabilization network (LISN). Other support units were connected to the power mains through another LISN. The two LISNs provide 50 ohm/ 50uH of coupling impedance for the measuring instrument.
- Both lines of the power mains connected to the EUT were checked for maximum conducted interference.
- The frequency range from 150kHz to 30MHz was searched. Emission levels under (Limit - 20dB) was not recorded.

NOTE: The resolution bandwidth and video bandwidth of test receiver is 9kHz for quasi-peak detection (QP) and average detection (AV) at frequency 0.15MHz-30MHz.

4.2.4 Deviation from Test Standard

No deviation.

4.2.5 Test Setup

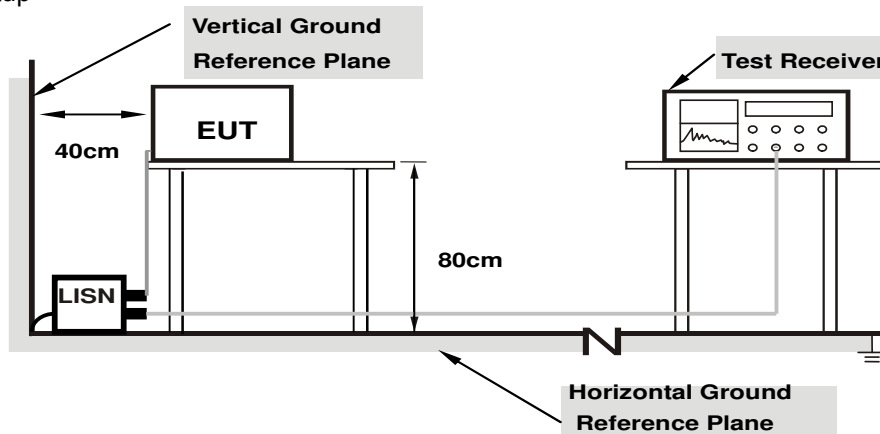

Note: 1.Support units were connected to second LISN.

For the actual test configuration, please refer to the attached file (Test Setup Photo).

4.2.6 EUT Operating Conditions

Same as 4.1.6.

4.2.7 Test Results (Mode 1)

Phase	Line (L)	Detector Function	Quasi-Peak (QP) / Average (AV)
-------	----------	-------------------	--------------------------------

Phase Of Power : Line (L)										
No	Frequency (MHz)	Correction Factor (dB)	Reading Value (dBuV)		Emission Level (dBuV)		Limit (dBuV)		Margin (dB)	
			Q.P.	AV.	Q.P.	AV.	Q.P.	AV.	Q.P.	AV.
1	0.15391	10.32	38.80	22.27	49.12	32.59	65.79	55.79	-16.66	-23.19
2	0.16953	10.31	39.81	20.56	50.12	30.87	64.98	54.98	-14.87	-24.12
3	0.20078	10.28	33.40	16.98	43.68	27.26	63.58	53.58	-19.90	-26.32
4	0.25156	10.29	27.82	15.44	38.11	25.73	61.71	51.71	-23.60	-25.98
5	0.53566	10.28	24.14	20.36	34.42	30.64	56.00	46.00	-21.58	-15.36
6	19.41797	10.93	17.71	12.15	28.64	23.08	60.00	50.00	-31.36	-26.92

Remarks:

1. Q.P. and AV. are abbreviations of quasi-peak and average individually.
2. The emission levels of other frequencies were very low against the limit.
3. Margin value = Emission level – Limit value
4. Correction factor = Insertion loss + Cable loss
5. Emission Level = Correction Factor + Reading Value

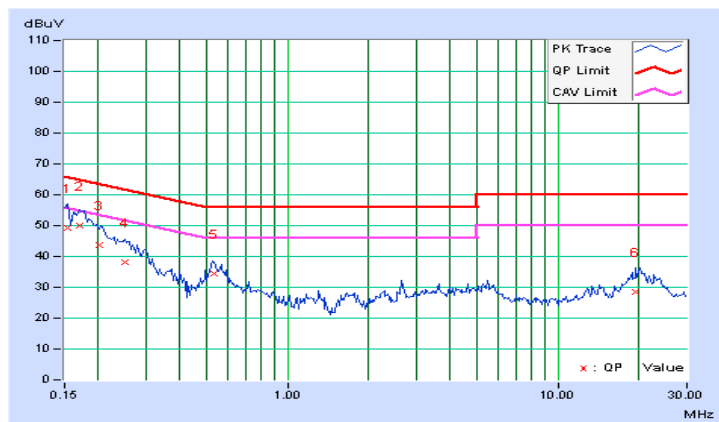

Phase	Neutral (N)	Detector Function	Quasi-Peak (QP) / Average (AV)
-------	-------------	-------------------	--------------------------------

Phase Of Power : Neutral (N)										
No	Frequency (MHz)	Correction Factor (dB)	Reading Value (dBuV)		Emission Level (dBuV)		Limit (dBuV)		Margin (dB)	
			Q.P.	AV.	Q.P.	AV.	Q.P.	AV.	Q.P.	AV.
1	0.15000	10.30	40.89	22.77	51.19	33.07	66.00	56.00	-14.81	-22.93
2	0.18516	10.27	35.62	19.23	45.89	29.50	64.25	54.25	-18.36	-24.75
3	0.24375	10.26	28.75	16.65	39.01	26.91	61.97	51.97	-22.95	-25.05
4	0.28281	10.27	25.50	14.80	35.77	25.07	60.73	50.73	-24.96	-25.66
5	0.53875	10.27	24.14	20.40	34.41	30.67	56.00	46.00	-21.59	-15.33
6	20.57031	10.98	19.04	13.23	30.02	24.21	60.00	50.00	-29.98	-25.79

Remarks:

1. Q.P. and AV. are abbreviations of quasi-peak and average individually.
2. The emission levels of other frequencies were very low against the limit.
3. Margin value = Emission level – Limit value
4. Correction factor = Insertion loss + Cable loss
5. Emission Level = Correction Factor + Reading Value

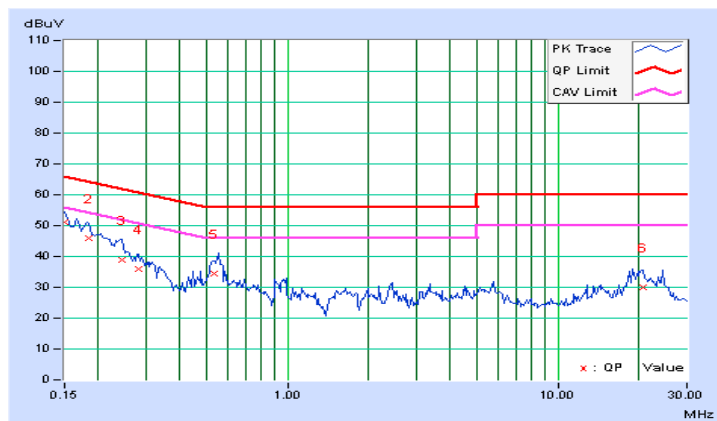

4.2.8 Test Results (Mode 2)

Phase	Line (L)	Detector Function	Quasi-Peak (QP) / Average (AV)
-------	----------	-------------------	--------------------------------

Phase Of Power : Line (L)										
No	Frequency (MHz)	Correction Factor (dB)	Reading Value (dBuV)		Emission Level (dBuV)		Limit (dBuV)		Margin (dB)	
			Q.P.	AV.	Q.P.	AV.	Q.P.	AV.	Q.P.	AV.
1	0.15000	10.32	33.01	21.30	43.33	31.62	66.00	56.00	-22.67	-24.38
2	0.17344	10.30	29.17	15.59	39.47	25.89	64.79	54.79	-25.32	-28.90
3	0.18906	10.29	26.94	12.63	37.23	22.92	64.08	54.08	-26.85	-31.16
4	0.21250	10.28	22.54	9.87	32.82	20.15	63.11	53.11	-30.29	-32.96
5	0.41563	10.30	30.12	23.49	40.42	33.79	57.54	47.54	-17.12	-13.75
6	0.48203	10.29	18.71	11.52	29.00	21.81	56.30	46.30	-27.30	-24.49

Remarks:

1. Q.P. and AV. are abbreviations of quasi-peak and average individually.
2. The emission levels of other frequencies were very low against the limit.
3. Margin value = Emission level – Limit value
4. Correction factor = Insertion loss + Cable loss
5. Emission Level = Correction Factor + Reading Value

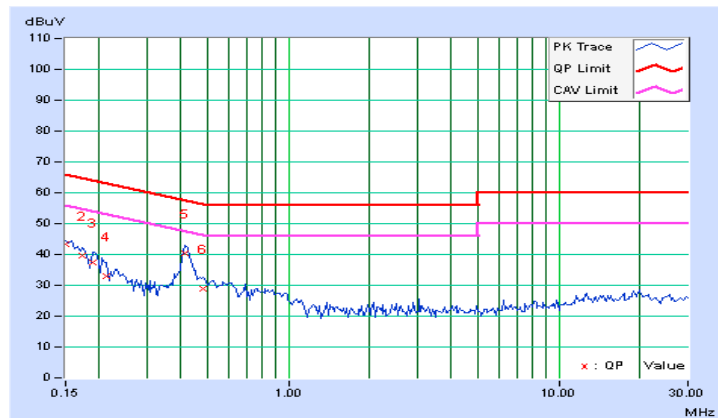

Phase	Neutral (N)	Detector Function	Quasi-Peak (QP) / Average (AV)
-------	-------------	-------------------	--------------------------------

Phase Of Power : Neutral (N)										
No	Frequency (MHz)	Correction Factor (dB)	Reading Value (dBuV)		Emission Level (dBuV)		Limit (dBuV)		Margin (dB)	
			Q.P.	AV.	Q.P.	AV.	Q.P.	AV.	Q.P.	AV.
1	0.15000	10.30	33.05	21.73	43.35	32.03	66.00	56.00	-22.65	-23.97
2	0.18906	10.27	28.21	13.68	38.48	23.95	64.08	54.08	-25.60	-30.13
3	0.22812	10.26	23.01	10.19	33.27	20.45	62.52	52.52	-29.25	-32.07
4	0.41953	10.28	30.40	25.04	40.68	35.32	57.46	47.46	-16.78	-12.14
5	0.59531	10.26	16.89	10.18	27.15	20.44	56.00	46.00	-28.85	-25.56
6	20.36719	10.98	12.63	5.10	23.61	16.08	60.00	50.00	-36.39	-33.92

Remarks:

1. Q.P. and AV. are abbreviations of quasi-peak and average individually.
2. The emission levels of other frequencies were very low against the limit.
3. Margin value = Emission level – Limit value
4. Correction factor = Insertion loss + Cable loss
5. Emission Level = Correction Factor + Reading Value

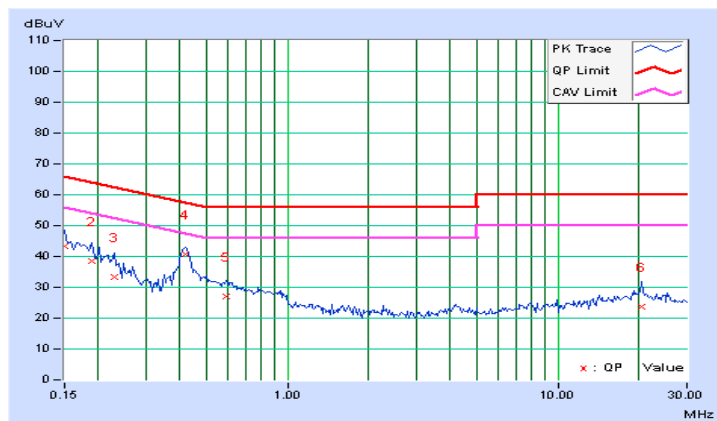

4.3 6dB Bandwidth Measurement

4.3.1 Limits of 6dB Bandwidth Measurement

The minimum of 6dB Bandwidth Measurement is 0.5 MHz.

4.3.2 Test Setup

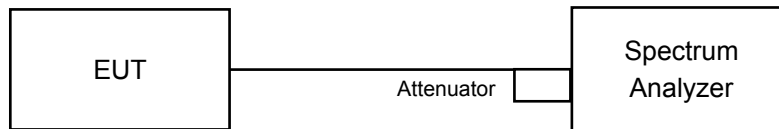

4.3.3 Test Instruments

Refer to section 4.1.2 to get information of above instrument.

4.3.4 Test Procedure

- a. Set resolution bandwidth (RBW) = 100kHz
- b. Set the video bandwidth (VBW) $\geq 3 \times$ RBW, Detector = Peak.
- c. Trace mode = max hold.
- d. Sweep = auto couple.
- e. Measure the maximum width of the emission that is constrained by the frequencies associated with the two amplitude points (upper and lower) that are attenuated by 6 dB relative to the maximum level measured in the fundamental emission

4.3.5 Deviation from Test Standard

No deviation.

4.3.6 EUT Operating Conditions

The software provided by client to enable the EUT under transmission condition continuously at lowest, middle and highest channel frequencies individually.

4.3.7 Test Result

1TX

802.11b

Channel	Frequency (MHz)	6dB Bandwidth (MHz)	Minimum Limit (MHz)	Pass / Fail
1	2412	9.06	0.5	Pass
2	2417	9.10	0.5	Pass
6	2437	9.56	0.5	Pass
10	2457	8.61	0.5	Pass
11	2462	8.63	0.5	Pass
12	2467	9.11	0.5	Pass
13	2472	9.11	0.5	Pass

2TX

CDD Mode

802.11b

Channel	Frequency (MHz)	6dB Bandwidth (MHz)		Minimum Limit (MHz)	Pass / Fail
		Chain 0	Chain 1		
1	2412	9.08	9.09	0.5	Pass
2	2417	9.08	9.08	0.5	Pass
6	2437	8.62	9.11	0.5	Pass
10	2457	8.58	8.59	0.5	Pass
11	2462	8.61	9.08	0.5	Pass
12	2467	9.07	9.11	0.5	Pass
13	2472	9.09	9.11	0.5	Pass

802.11g

Channel	Frequency (MHz)	6dB Bandwidth (MHz)		Minimum Limit (MHz)	Pass / Fail
		Chain 0	Chain 1		
1	2412	16.40	16.39	0.5	Pass
2	2417	16.39	16.42	0.5	Pass
6	2437	16.42	16.40	0.5	Pass
10	2457	16.12	15.82	0.5	Pass
11	2462	16.14	16.41	0.5	Pass
12	2467	16.39	16.47	0.5	Pass
13	2472	16.39	16.37	0.5	Pass

Beamforming Mode**802.11n (HT20)**

Channel	Frequency (MHz)	6dB Bandwidth (MHz)		Minimum Limit (MHz)	Pass / Fail
		Chain 0	Chain 1		
1	2412	17.62	17.65	0.5	Pass
2	2417	17.63	17.66	0.5	Pass
6	2437	17.65	17.66	0.5	Pass
10	2457	17.22	17.04	0.5	Pass
11	2462	17.22	17.65	0.5	Pass
12	2467	17.64	17.72	0.5	Pass
13	2472	17.63	17.62	0.5	Pass



A D T

Spectrum Plot of Worst Value

802.11b / Chain 1 : CH10 (1TX)

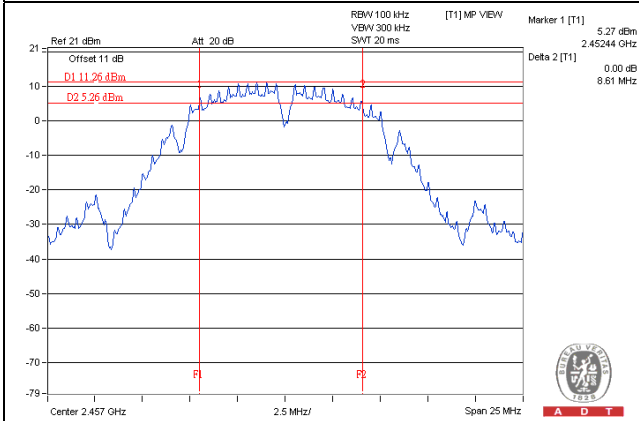

802.11b / Chain 0 : CH10 (2TX)

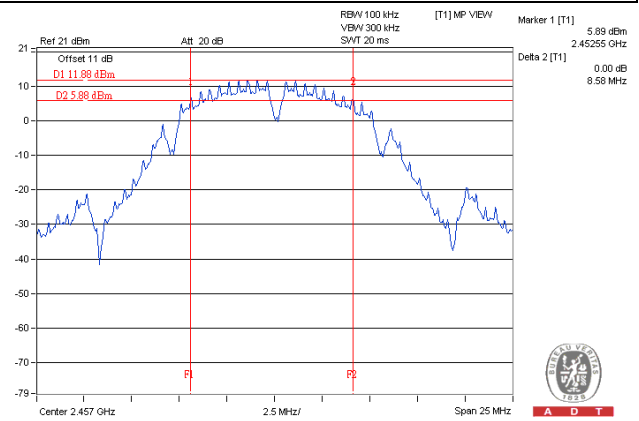

802.11g / Chain 1 : CH10

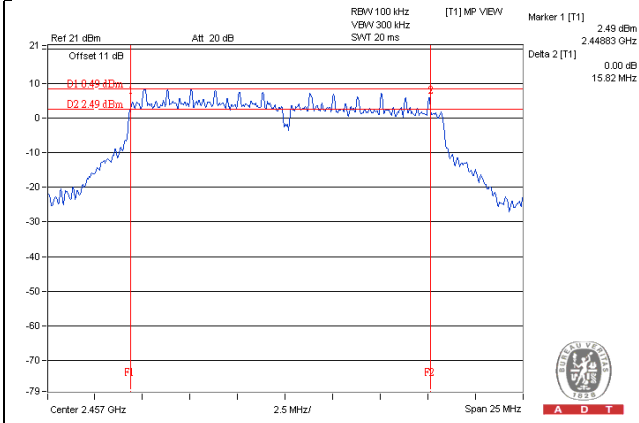

802.11n (HT20) / Chain 1 : CH10

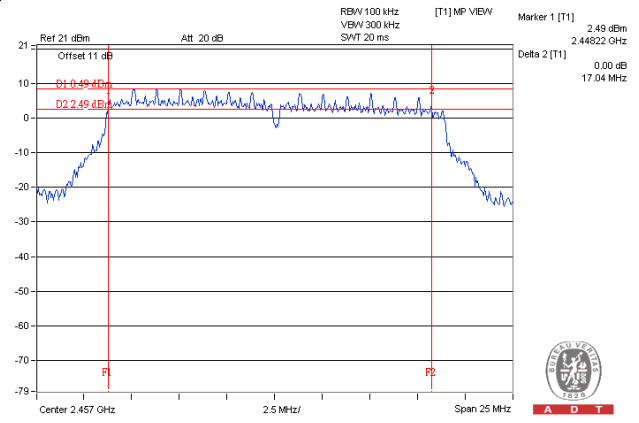

4.4 Conducted Output Power Measurement

4.4.1 Limits of Conducted Output Power Measurement

For systems using digital modulation in the 2400–2483.5 MHz bands: 1 Watt (30dBm)

Per KDB 662911 D01 Multiple Transmitter Output Method of conducted output power measurement on IEEE 802.11 devices,

Array Gain = 0 dB (i.e., no array gain) for $NANT \leq 4$;

Array Gain = 0 dB (i.e., no array gain) for channel widths ≥ 40 MHz for any NANT;

Array Gain = $5 \log(NANT/NSS)$ dB or 3 dB, whichever is less for 20-MHz channel widths with $NANT \geq 5$.

For power measurements on all other devices: Array Gain = $10 \log(NANT/NSS)$ dB.

4.4.2 Test Setup

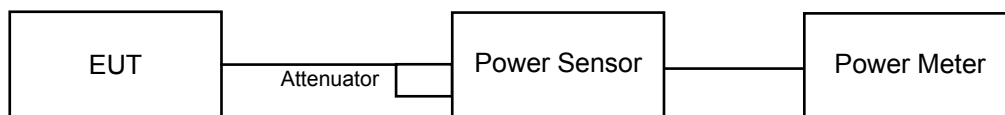

4.4.3 Test Instruments

Refer to section 4.1.2 to get information of above instrument.

4.4.4 Test Procedures

A peak / average power sensor was used on the output port of the EUT. A power meter was used to read the response of the peak / average power sensor. Record the power level.

4.4.5 Deviation from Test Standard

No deviation.

4.4.6 EUT Operating Conditions

Same as Item 4.3.6.

4.4.7 Test Results

FOR PEAK POWER

1TX Mode

802.11b

Channel	Frequency (MHz)	Peak Power (mW)	Peak Power (dBm)	Limit (dBm)	Pass/Fail
1	2412	211.836	23.26	30	Pass
2	2417	209.411	23.21	30	Pass
6	2437	204.644	23.11	30	Pass
10	2457	207.97	23.18	30	Pass
11	2462	245.471	23.90	30	Pass
12	2467	169.434	22.29	30	Pass
13	2472	46.989	16.72	30	Pass

2TX Mode

CDD Mode

802.11b

Channel	Frequency (MHz)	Peak Power (dBm)		Total Power (mW)	Total Power (dBm)	Limit (dBm)	Pass / Fail
		Chain 0	Chain 1				
1	2412	23.02	22.98	399.056	26.01	30	Pass
2	2417	23.32	22.98	413.392	26.16	30	Pass
6	2437	23.14	22.66	390.565	25.92	30	Pass
10	2457	22.97	22.69	383.933	25.84	30	Pass
11	2462	21.64	21.04	272.938	24.36	30	Pass
12	2467	20.47	20.49	223.373	23.49	30	Pass
13	2472	15.26	15.04	65.489	18.16	30	Pass

802.11g

Channel	Frequency (MHz)	Peak Power (dBm)		Total Power (mW)	Total Power (dBm)	Limit (dBm)	Pass / Fail
		Chain 0	Chain 1				
1	2412	22.90	23.02	395.431	25.97	30	Pass
2	2417	23.48	23.54	448.788	26.52	30	Pass
6	2437	23.79	23.47	461.663	26.64	30	Pass
10	2457	23.64	23.56	458.192	26.61	30	Pass
11	2462	22.70	22.13	349.514	25.43	30	Pass
12	2467	19.72	20.71	211.517	23.25	30	Pass
13	2472	15.52	15.48	70.963	18.51	30	Pass

Beamforming Mode
802.11n (HT20)

Channel	Frequency (MHz)	Peak Power (dBm)		Total Power (mW)	Total Power (dBm)	Limit (dBm)	Pass / Fail
		Chain 0	Chain 1				
1	2412	22.69	22.61	368.17	25.66	29.37	Pass
2	2417	23.89	23.68	478.252	26.80	29.37	Pass
6	2437	23.81	23.79	479.768	26.81	29.37	Pass
10	2457	23.86	23.97	492.679	26.93	29.37	Pass
11	2462	22.83	22.33	362.869	25.60	29.37	Pass
12	2467	19.62	20.02	192.084	22.83	29.37	Pass
13	2472	15.76	15.82	75.864	18.80	29.37	Pass

Directional gain = $10 \log[(10^{G1/20} + 10^{G2/20})^2 / 2] = 6.63\text{dBi} > 6\text{dBi}$, so the power limit shall be reduced to $30 - (6.63 - 6) = 29.37\text{dBm}$.

SDM Mode**802.11n (HT20)**

Channel	Frequency (MHz)	Peak Power (dBm)		Total Power (mW)	Total Power (dBm)	Limit (dBm)	Pass / Fail
		Chain 0	Chain 1				
1	2412	22.64	22.54	363.127	25.60	30	Pass
2	2417	23.77	23.62	468.376	26.71	30	Pass
6	2437	23.80	23.65	471.622	26.74	30	Pass
10	2457	23.77	23.86	481.452	26.83	30	Pass
11	2462	22.81	22.25	358.865	25.55	30	Pass
12	2467	19.58	20.00	190.782	22.81	30	Pass
13	2472	15.80	15.69	75.087	18.76	30	Pass

FOR AVERAGE POWER
1TX Mode
802.11b

Channel	Frequency (MHz)	Average Power (mW)	Average Power (dBm)
1	2412	90.365	19.56
2	2417	89.95	19.54
6	2437	88.308	19.46
10	2457	83.56	19.22
11	2462	96.605	19.85
12	2467	93.756	19.72
13	2472	22.699	13.56

2TX
CDD Mode
802.11b

Chan.	Frequency (MHz)	Avg. Power (dBm)		Total Power (mW)	Total Power (dBm)
		Chain 0	Chain 1		
1	2412	19.57	19.42	178.071	22.51
2	2417	19.68	19.47	181.409	22.59
6	2437	19.59	19.13	172.837	22.38
10	2457	19.66	19.48	181.186	22.58
11	2462	18.32	18.11	132.634	21.23
12	2467	17.36	17.31	108.277	20.35
13	2472	11.73	11.59	29.315	14.67

802.11g

Chan.	Frequency (MHz)	Avg. Power (dBm)		Total Power (mW)	Total Power (dBm)
		Chain 0	Chain 1		
1	2412	17.08	17.20	103.531	20.15
2	2417	18.01	18.23	129.768	21.13
6	2437	19.92	19.60	189.376	22.77
10	2457	18.89	18.69	151.407	21.80
11	2462	16.48	16.15	85.673	19.33
12	2467	13.88	14.34	51.598	17.13
13	2472	9.25	9.02	16.394	12.15

Beamforming Mode
802.11n (HT20)

Chan.	Frequency (MHz)	Avg. Power (dBm)		Total Power (mW)	Total Power (dBm)
		Chain 0	Chain 1		
1	2412	17.00	17.13	101.761	20.08
2	2417	17.95	18.08	126.642	21.03
6	2437	19.66	19.24	176.416	22.47
10	2457	18.43	18.12	134.526	21.29
11	2462	16.02	15.91	78.988	18.98
12	2467	13.95	13.89	49.322	16.93
13	2472	9.80	9.70	18.883	12.76

SDM Mode
802.11n (HT20)

Chan.	Frequency (MHz)	Avg. Power (dBm)		Total Power (mW)	Total Power (dBm)
		Chain 0	Chain 1		
1	2412	16.98	16.88	98.641	19.94
2	2417	17.90	17.94	123.89	20.93
6	2437	19.61	19.17	174.015	22.41
10	2457	18.40	18.07	133.304	21.25
11	2462	15.98	15.87	78.265	18.94
12	2467	13.71	13.82	47.595	16.78
13	2472	8.92	8.88	15.525	11.91

※Add test for each data rate output power (require by manufacturer):

1TX Mode

802.11b

Chan.	Chan. Freq. (MHz)	Peak Power (dBm)			
		Data rate			
		1Mbps	2Mbps	5.5Mbps	11Mbps
1	2412	23.26	23.10	23.24	23.22
2	2417	23.21	23.08	23.17	23.02
6	2437	23.11	23.10	22.99	23.04
10	2457	23.18	23.16	22.94	22.99
11	2462	23.90	23.77	23.85	23.68
12	2467	22.29	22.12	22.09	22.26
13	2472	16.72	16.53	16.33	16.48

2TX Mode

CDD Mode

802.11b

Chan.	Chan. Freq. (MHz)	Peak Power (dBm)			
		Data rate			
		1Mbps	2Mbps	5.5Mbps	11Mbps
1	2412	26.01	25.90	25.76	25.59
2	2417	26.16	25.95	25.95	25.92
6	2437	25.92	25.85	25.86	25.82
10	2457	25.84	25.69	25.81	25.65
11	2462	24.36	24.35	24.34	24.33
12	2467	23.49	23.38	23.38	23.21
13	2472	18.16	17.97	18.13	17.93

802.11g

Chan.	Chan. Freq. (MHz)	Peak Power (dBm)							
		Data rate							
		6Mbps	9Mbps	12Mbps	18Mbps	24Mbps	36Mbps	48Mbps	54Mbps
1	2412	25.97	25.79	25.79	25.86	25.76	25.59	25.62	25.84
2	2417	26.52	26.44	26.26	26.24	26.08	26.27	26.23	26.08
6	2437	26.64	26.56	26.47	26.51	26.37	26.28	26.50	26.55
10	2457	26.61	26.53	26.40	26.48	26.44	26.43	26.41	26.26
11	2462	25.43	25.29	25.35	25.40	25.39	25.31	25.18	25.23
12	2467	23.25	23.07	23.18	22.96	22.86	22.73	22.71	22.50
13	2472	18.51	18.30	18.49	18.43	18.21	18.03	18.24	18.17

Beamforming Mode

802.11n (HT20)

Chan.	Chan. Freq. (MHz)	Peak Power (dBm)							
		Data rate							
		MCS0	MCS1	MCS2	MCS3	MCS4	MCS5	MCS6	MCS7
1	2412	25.66	25.64	25.44	25.64	25.55	25.50	25.44	25.53
2	2417	26.80	26.63	26.78	26.78	26.66	26.49	26.42	26.39
6	2437	26.81	26.67	26.73	26.66	26.73	26.67	26.67	26.80
10	2457	26.93	26.87	26.70	26.71	26.89	26.90	26.68	26.65
11	2462	25.60	25.38	25.58	25.38	25.24	25.08	25.00	24.86
12	2467	22.83	22.63	22.79	22.76	22.64	22.54	22.69	22.61
13	2472	18.80	18.73	18.70	18.58	18.63	18.68	18.77	18.60

SDM Mode

802.11n (HT20)

Chan.	Chan. Freq. (MHz)	Peak Power (dBm)							
		Data rate							
		MCS0	MCS1	MCS2	MCS3	MCS4	MCS5	MCS6	MCS7
1	2412	25.60	25.45	25.31	25.52	25.45	25.36	25.45	25.48
2	2417	26.71	26.58	26.36	26.51	26.62	26.56	26.41	26.48
6	2437	26.74	26.65	26.58	26.66	26.50	26.55	26.39	26.28
10	2457	26.83	26.80	26.68	26.70	26.79	26.72	26.73	26.81
11	2462	25.55	25.43	25.39	25.20	25.27	25.33	25.23	25.27
12	2467	22.81	22.67	22.54	22.46	22.42	22.23	22.27	22.13
13	2472	18.76	18.69	18.73	18.55	18.71	18.66	18.75	18.60

4.5 Power Spectral Density Measurement

4.5.1 Limits of Power Spectral Density Measurement

The Maximum of Power Spectral Density Measurement is 8dBm.

4.5.2 Test Setup

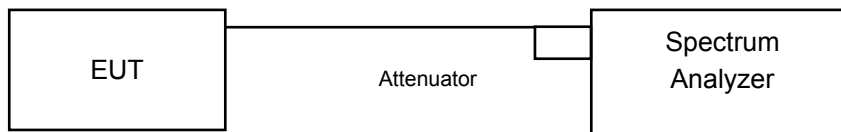

4.5.3 Test Instruments

Refer to section 4.1.2 to get information of above instrument.

4.5.4 Test Procedure

- Set analyzer center frequency to DTS channel center frequency.
- Set the span to 1.5 times the DTS bandwidth.
- Set the RBW to: $3 \text{ kHz} \leq \text{RBW} \leq 100 \text{ kHz}$.
- Set the VBW $\geq 3 \times \text{RBW}$.
- Detector = peak.
- Sweep time = auto couple.
- Trace mode = max hold.
- Allow trace to fully stabilize.
- Use the peak marker function to determine the maximum amplitude level within the RBW.

4.5.5 Deviation from Test Standard

No deviation.

4.5.6 EUT Operating Condition

Same as Item 4.3.6

4.5.7 Test Results

1TX

802.11b

Channel	Freq. (MHz)	PSD (dBm/3kHz)	Limit (dBm/3kHz)	Pass /Fail
1	2412	-4.51	8.00	Pass
2	2417	-3.61	8.00	Pass
6	2437	-2.08	8.00	Pass
10	2457	-3.60	8.00	Pass
11	2462	-2.74	8.00	Pass
12	2467	-3.42	8.00	Pass
13	2472	-9.55	8.00	Pass

2TX

CDD Mode

802.11b

TX chain	Channel	Freq. (MHz)	PSD (dBm/3kHz)	10 log (N=2) dB	Total PSD (dBm/3kHz)	Limit (dBm/3kHz)	Pass /Fail
0	1	2412	-2.94	3.01	0.07	7.37	Pass
	2	2417	-2.96	3.01	0.05	7.37	Pass
	6	2437	-4.73	3.01	-1.72	7.37	Pass
	10	2457	-2.48	3.01	0.53	7.37	Pass
	11	2462	-3.89	3.01	-0.88	7.37	Pass
	12	2467	-5.42	3.01	-2.41	7.37	Pass
	13	2472	-10.64	3.01	-7.63	7.37	Pass
1	1	2412	-4.11	3.01	-1.10	7.37	Pass
	2	2417	-3.75	3.01	-0.74	7.37	Pass
	6	2437	-4.40	3.01	-1.39	7.37	Pass
	10	2457	-3.62	3.01	-0.61	7.37	Pass
	11	2462	-5.39	3.01	-2.38	7.37	Pass
	12	2467	-5.74	3.01	-2.73	7.37	Pass
	13	2472	-11.22	3.01	-8.21	7.37	Pass

Directional gain = $10 \log[(10^{G1/20} + 10^{G2/20})^2 / 2] = 6.63\text{dBi} > 6\text{dBi}$, so the power limit shall be reduced to $8-(6.63-6) = 7.37\text{dBm}$.

802.11g

TX chain	Channel	Freq. (MHz)	PSD (dBm/3kHz)	10 log (N=2) dB	Total PSD (dBm/3kHz)	Limit (dBm/3kHz)	Pass /Fail
0	1	2412	-8.57	3.01	-5.56	7.37	Pass
	2	2417	-6.96	3.01	-3.95	7.37	Pass
	6	2437	-6.54	3.01	-3.53	7.37	Pass
	10	2457	-6.81	3.01	-3.80	7.37	Pass
	11	2462	-8.72	3.01	-5.71	7.37	Pass
	12	2467	-11.20	3.01	-8.19	7.37	Pass
	13	2472	-16.19	3.01	-13.18	7.37	Pass
1	1	2412	-8.56	3.01	-5.55	7.37	Pass
	2	2417	-7.49	3.01	-4.48	7.37	Pass
	6	2437	-5.52	3.01	-2.51	7.37	Pass
	10	2457	-6.51	3.01	-3.50	7.37	Pass
	11	2462	-7.61	3.01	-4.60	7.37	Pass
	12	2467	-11.83	3.01	-8.82	7.37	Pass
	13	2472	-15.60	3.01	-12.59	7.37	Pass

Directional gain = $10 \log[(10^{G1/20} + 10^{G2/20})^2 / 2]$ = 6.63dBi > 6dBi , so the power limit shall be reduced to 8-(6.63-6) = 7.37dBm.

Beamforming Mode
802.11n (HT20)

TX chain	Channel	Freq. (MHz)	PSD (dBm/3kHz)	10 log (N=2) dB	Total PSD (dBm/3kHz)	Limit (dBm/3kHz)	Pass /Fail
0	1	2412	-8.28	3.01	-5.27	7.37	Pass
	2	2417	-6.97	3.01	-3.96	7.37	Pass
	6	2437	-6.09	3.01	-3.08	7.37	Pass
	10	2457	-7.40	3.01	-4.39	7.37	Pass
	11	2462	-8.72	3.01	-5.71	7.37	Pass
	12	2467	-12.53	3.01	-9.52	7.37	Pass
	13	2472	-17.19	3.01	-14.18	7.37	Pass
1	1	2412	-8.17	3.01	-5.16	7.37	Pass
	2	2417	-7.84	3.01	-4.83	7.37	Pass
	6	2437	-6.23	3.01	-3.22	7.37	Pass
	10	2457	-6.74	3.01	-3.73	7.37	Pass
	11	2462	-8.65	3.01	-5.64	7.37	Pass
	12	2467	-12.57	3.01	-9.56	7.37	Pass
	13	2472	-16.65	3.01	-13.64	7.37	Pass

Directional gain = $10 \log[(10^{G1/20} + 10^{G2/20})^2 / 2]$ = 6.63dBi > 6dBi , so the power limit shall be reduced to 8-(6.63-6) = 7.37dBm.

Spectrum Plot of Worst Value

802.11b / Chain 1 : CH6 (1TX)

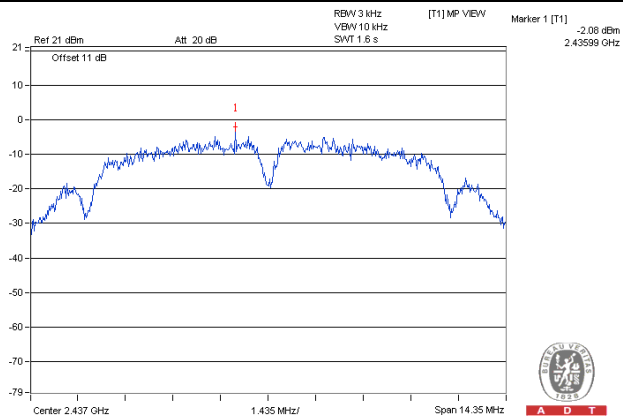

802.11b / Chain 0 : CH10 (2TX)

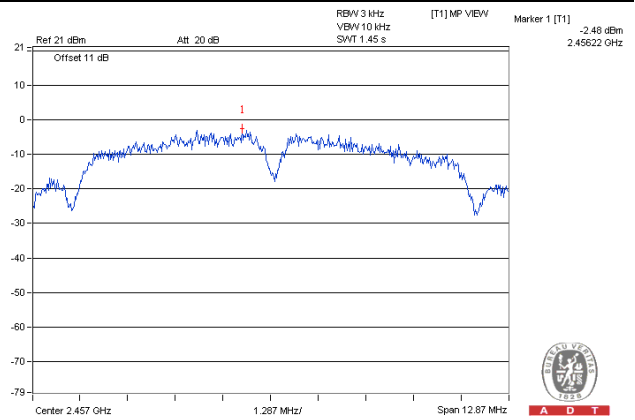

802.11g / Chain 1 : CH6

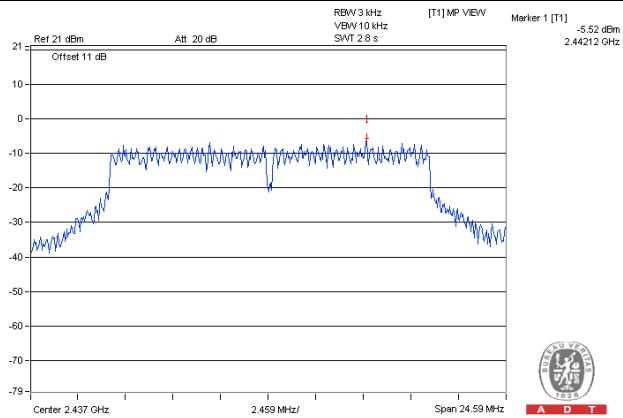

802.11n (HT20) / Chain 0 : CH6

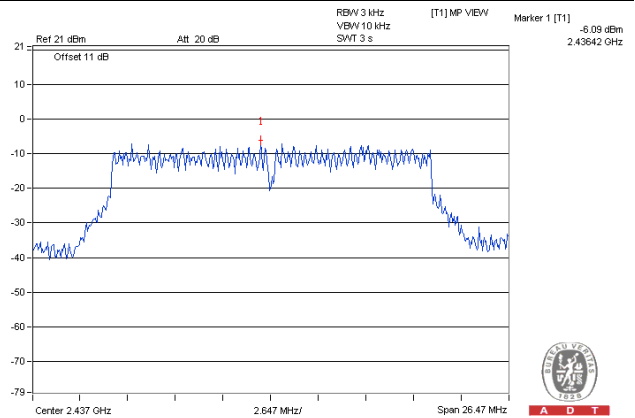

4.6 Conducted Out of Band Emission Measurement

4.6.1 Limits of Conducted Out of Band Emission Measurement

Below 20dBof the highest emission level of operating band (in 100kHz Resolution Bandwidth).

4.6.2 Test Setup

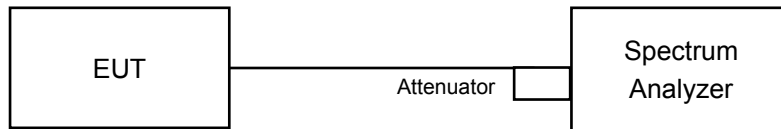

4.6.3 Test Instruments

Refer to section 4.1.2 to get information of above instrument.

4.6.4 Test Procedure

MEASUREMENT PROCEDURE REF

1. Set the RBW = 100 kHz.
2. Set the VBW \geq 300 kHz.
3. Detector = peak.
4. Sweep time = auto couple.
5. Trace mode = max hold.
6. Allow trace to fully stabilize.
7. Use the peak marker function to determine the maximum power level in any 100 kHz band segment within the fundamental EBW.

MEASUREMENT PROCEDURE OOB

1. Set RBW = 100 kHz.
2. Set VBW \geq 300 kHz.
3. Detector = peak.
4. Sweep = auto couple.
5. Trace Mode = max hold.
6. Allow trace to fully stabilize.
7. Use the peak marker function to determine the maximum amplitude level.

4.6.5 Deviation from Test Standard

No deviation.

4.6.6 EUT Operating Condition

Same as Item 4.3.6

4.6.7 Test Results

The spectrum plots are attached on the following pages. D1 line indicates the highest level, and D2 line indicates the 20dB offset below D1. It shows compliance with the requirement.

1TX 802.11b

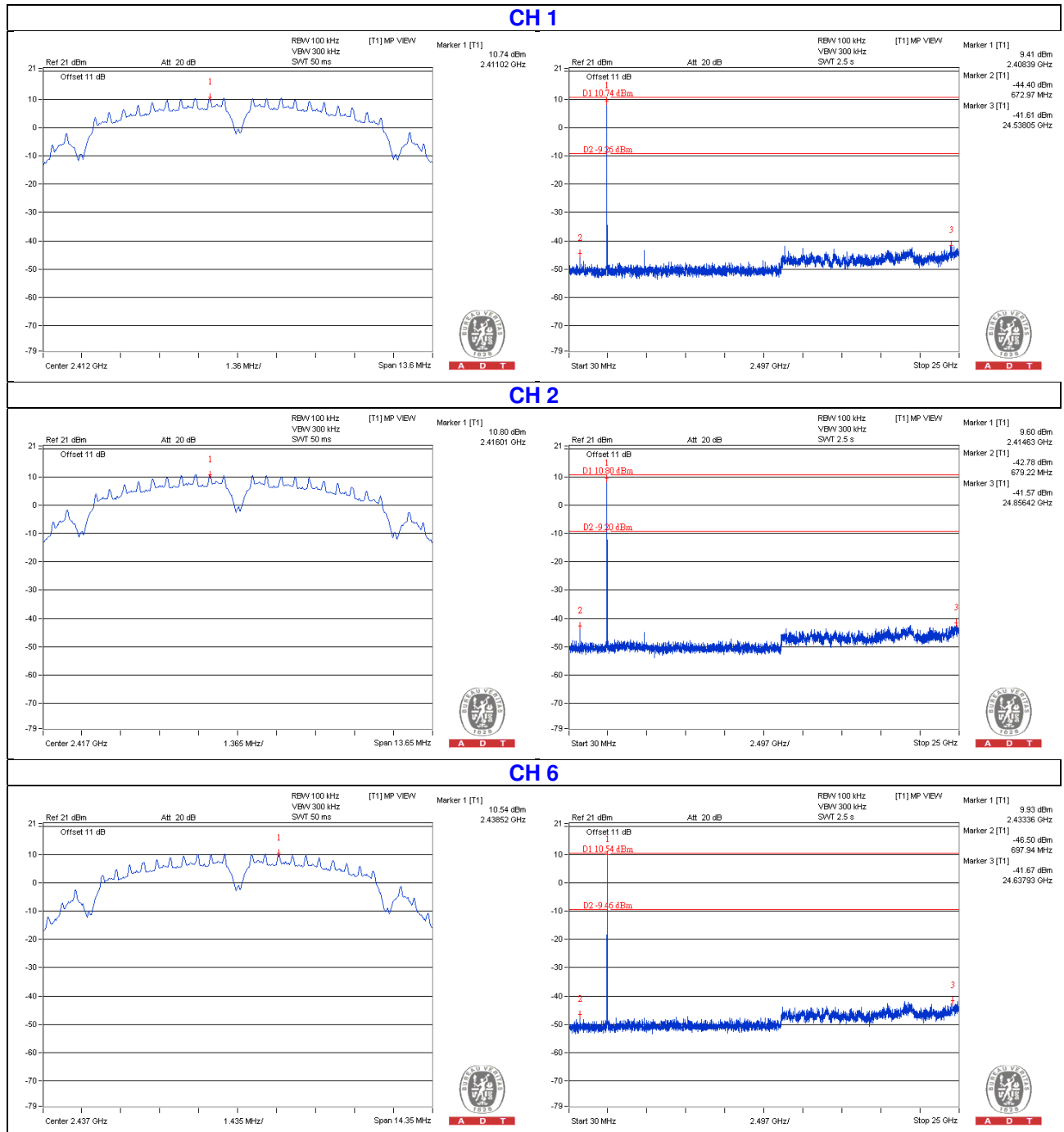

CH 10

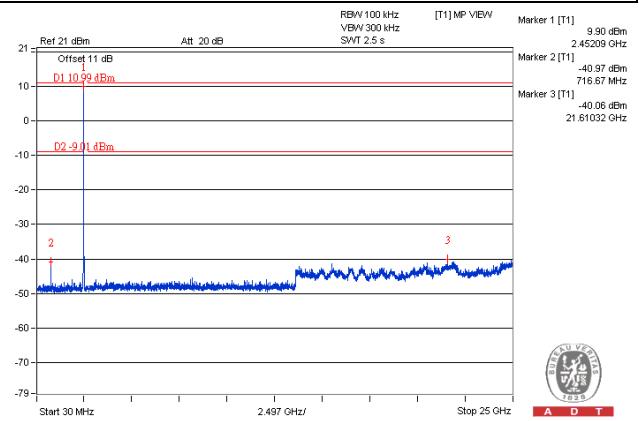
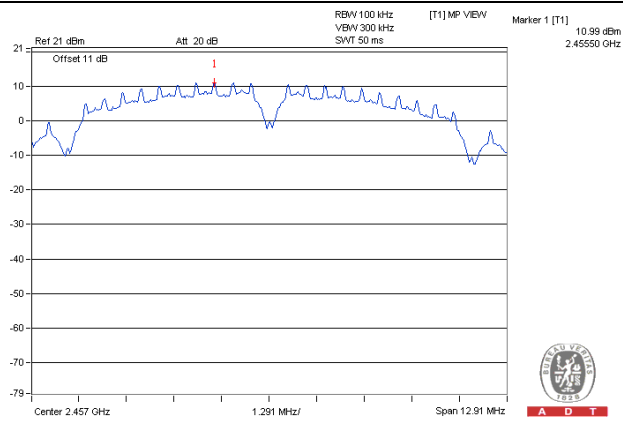

CH 11

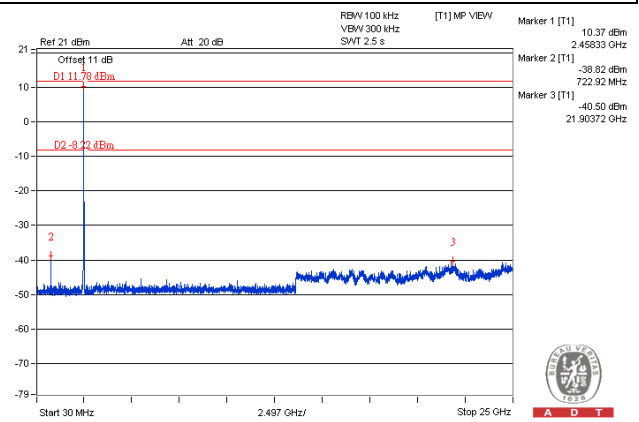
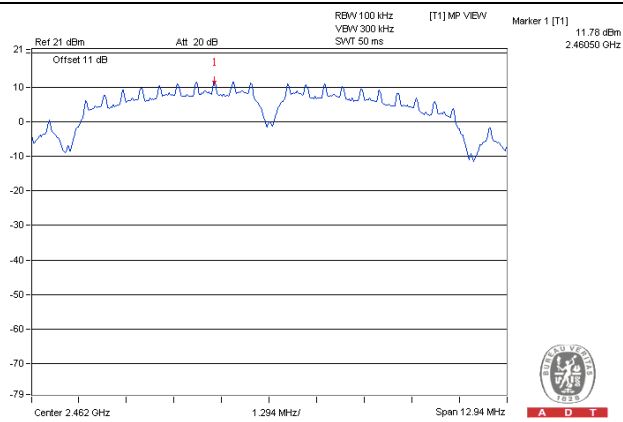

CH 12

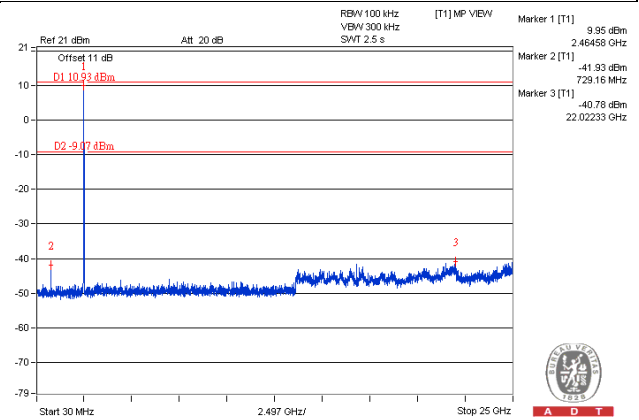
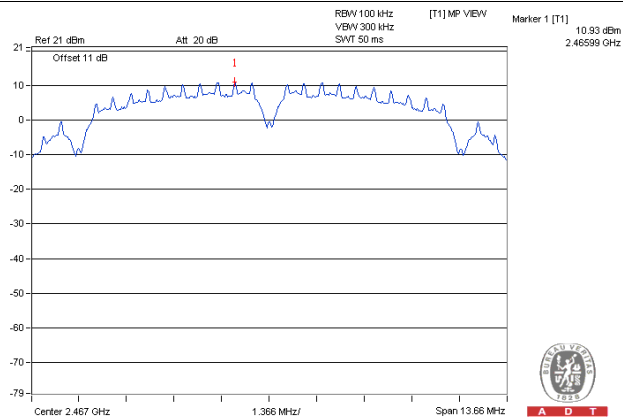

CH 13

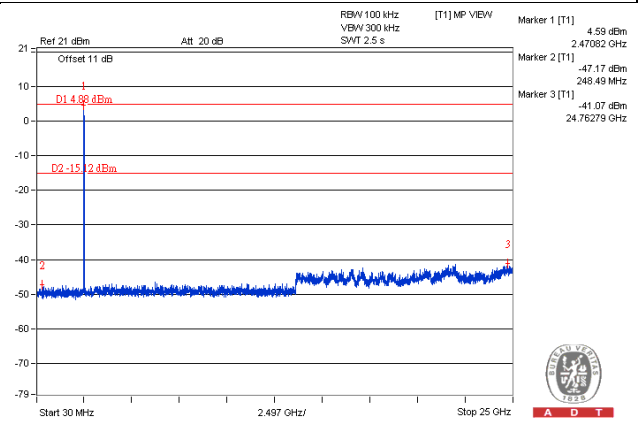
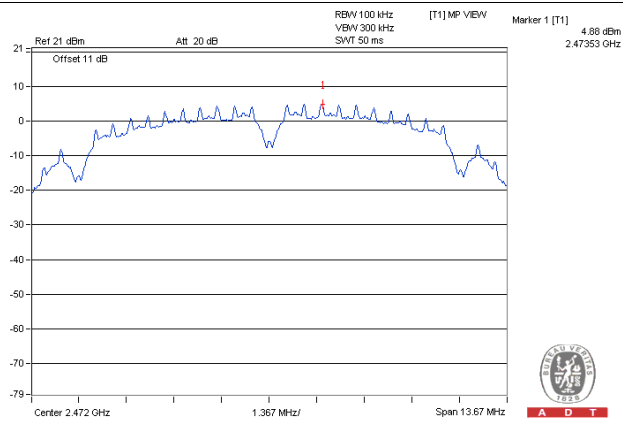

CH 1 Band edge

CH 13 Band edge

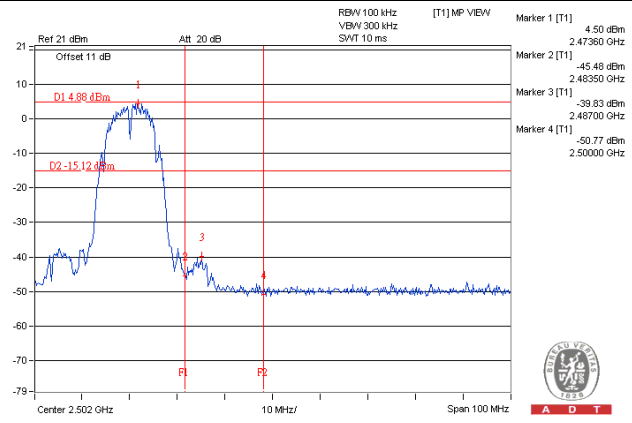
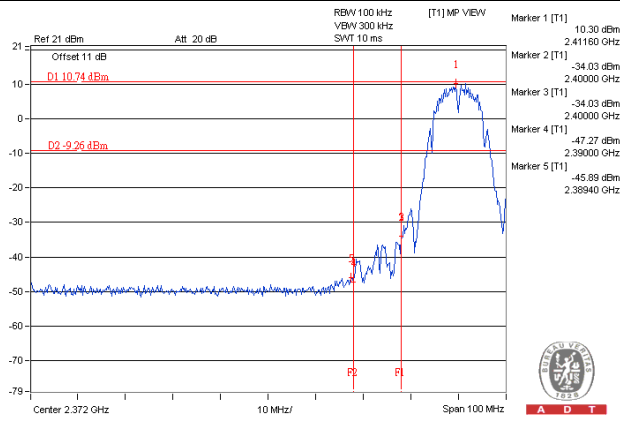

2TX
802.11b
Chain 0

CH 1

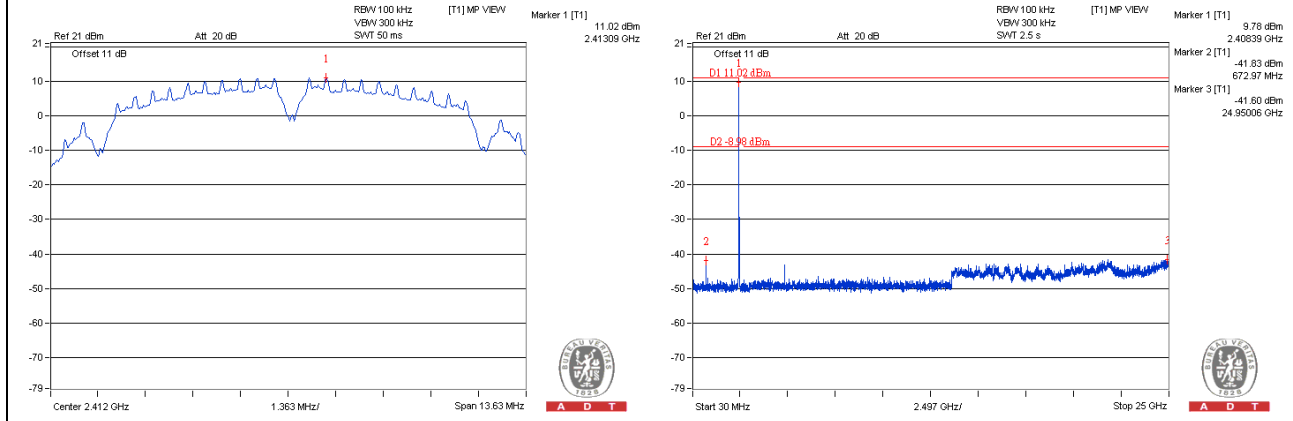

CH 2

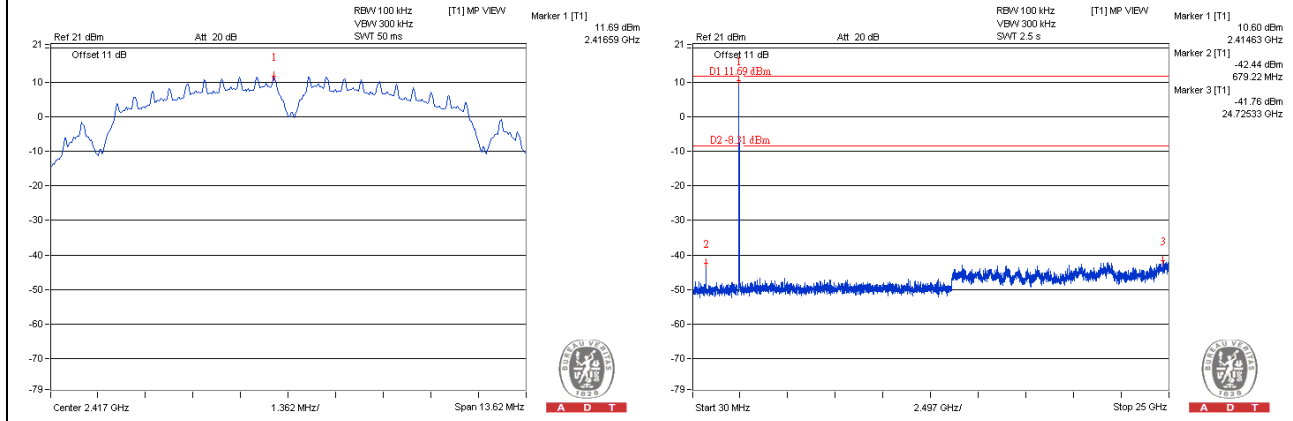

CH 6

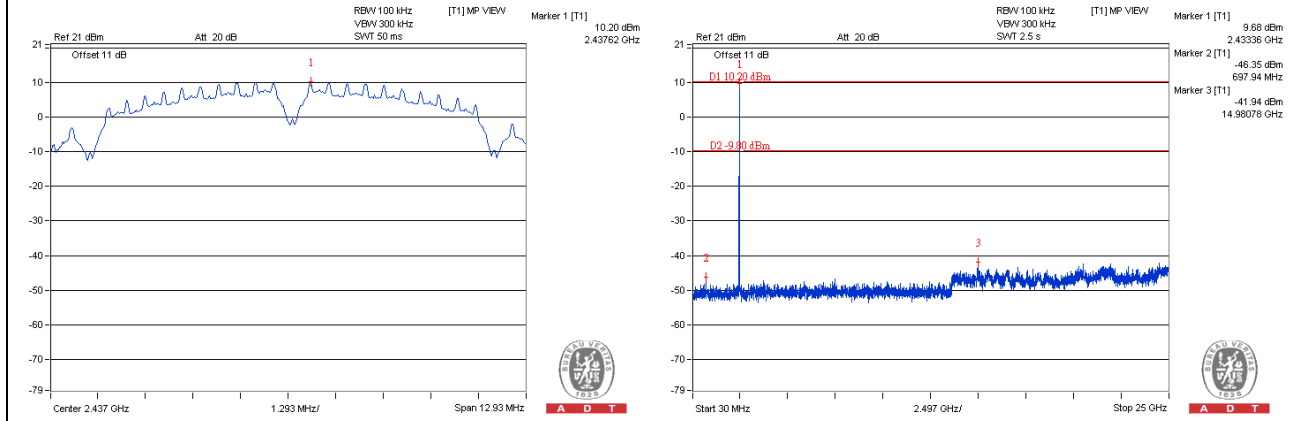

CH 10

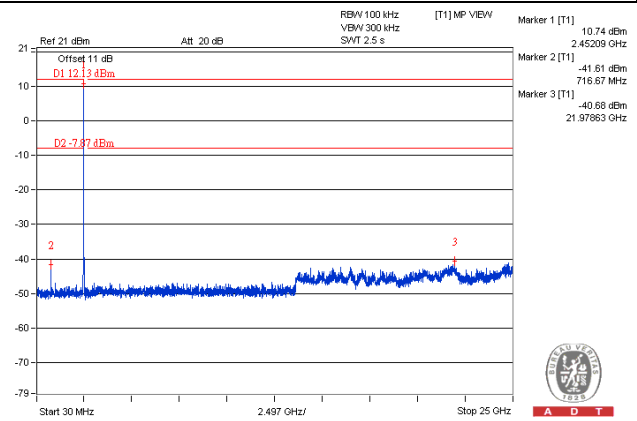
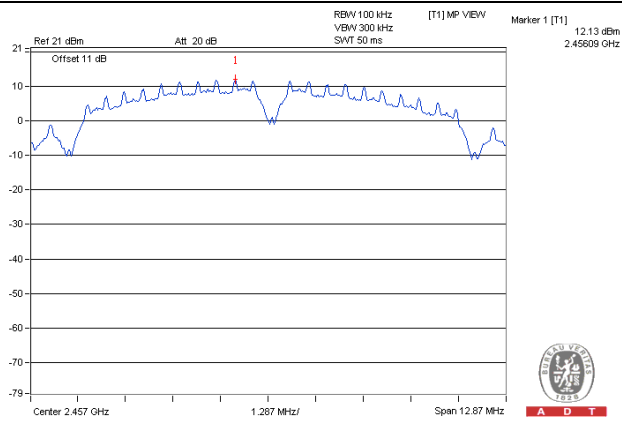

CH 11

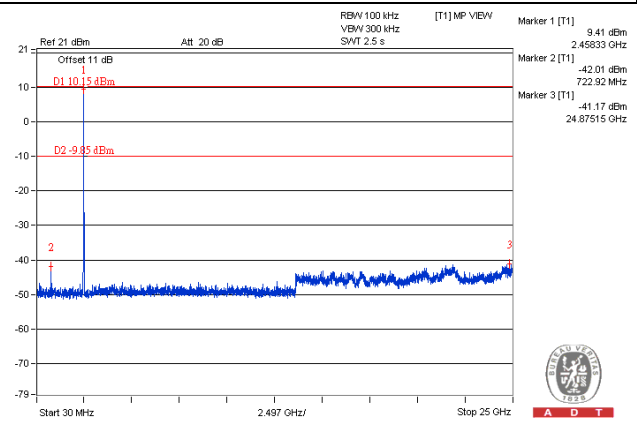
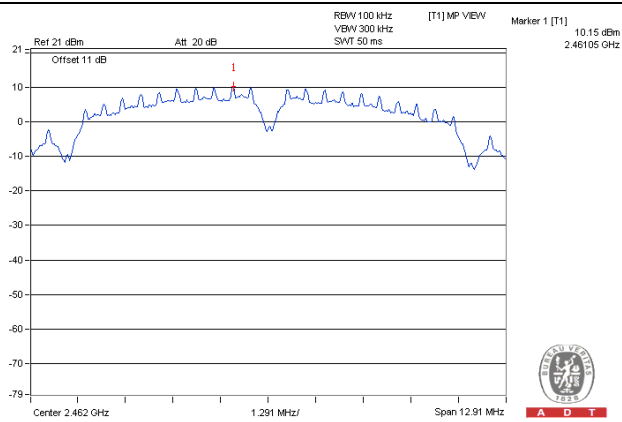

CH 12

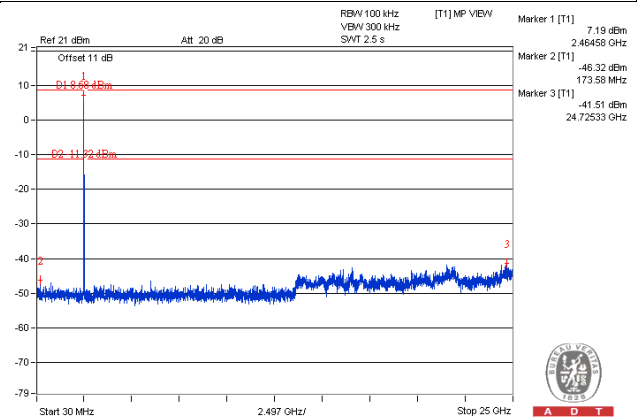
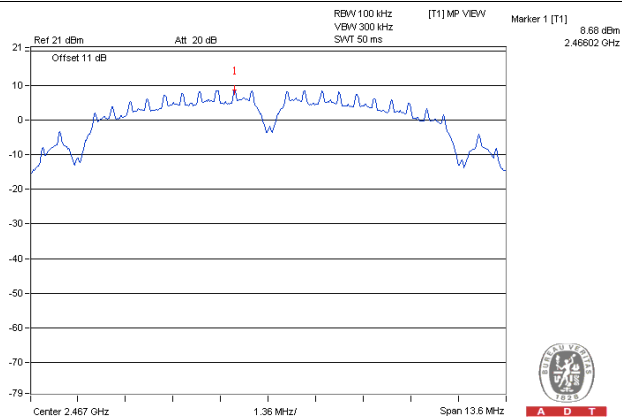

CH 13

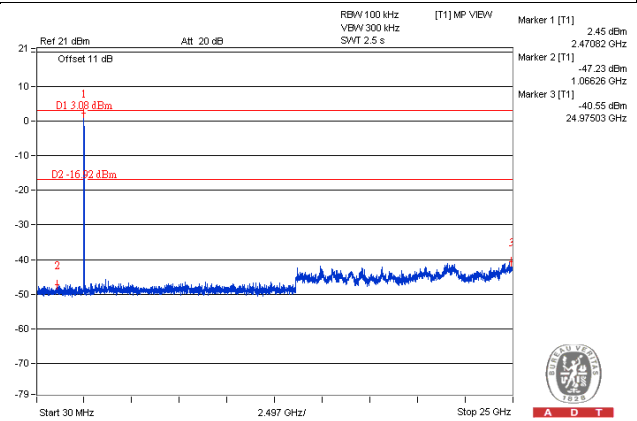
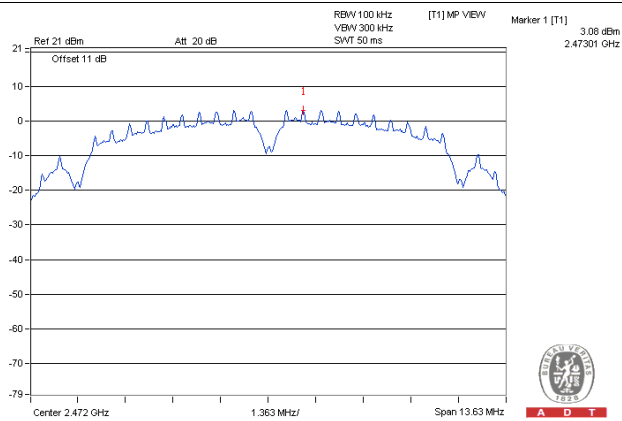

CH 1 Band edge

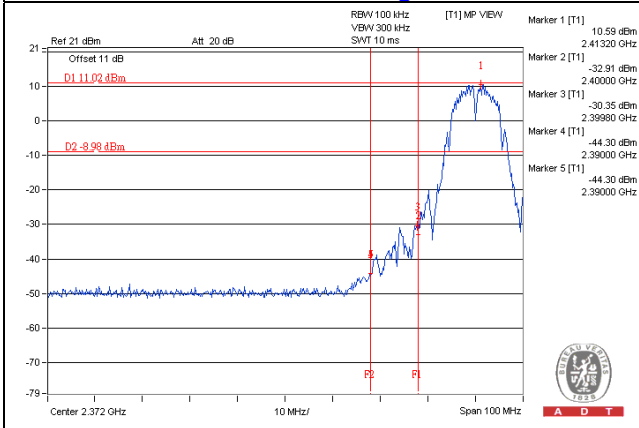

CH 13 Band edge

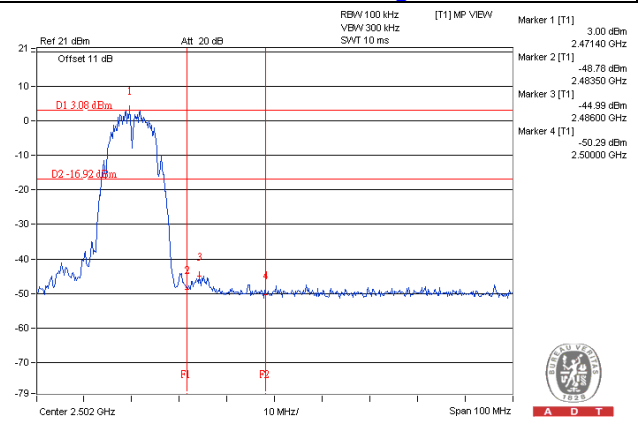

Chain 1

CH 1

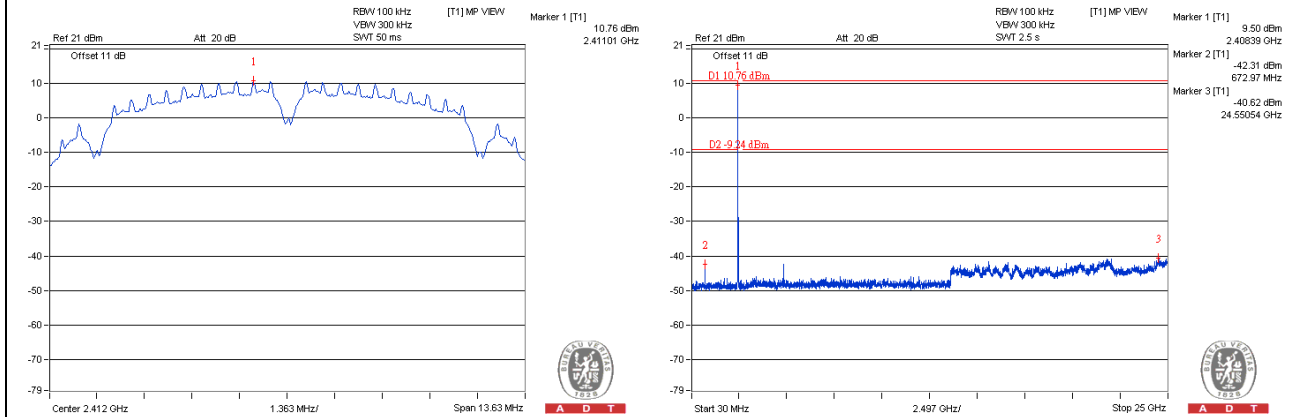

CH 2

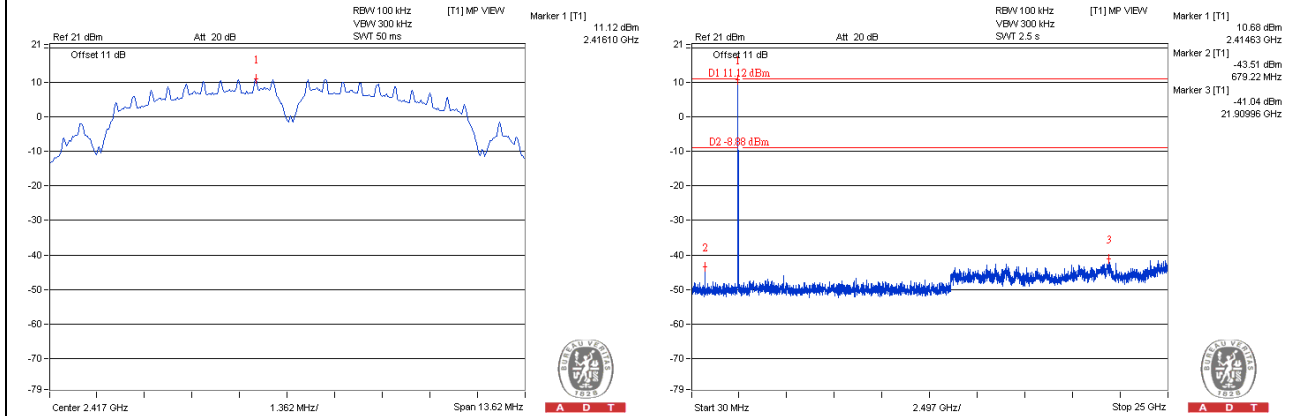

CH 6

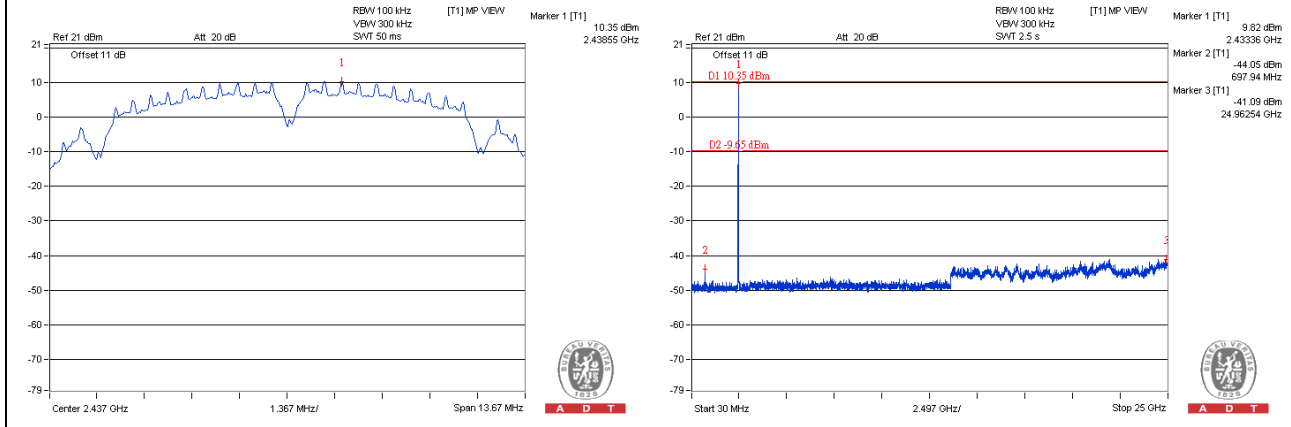

CH 10

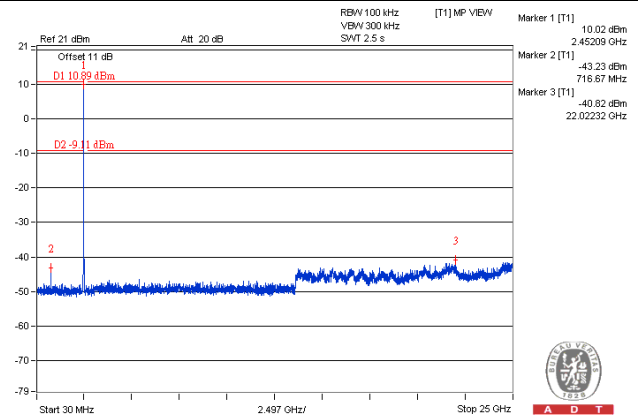
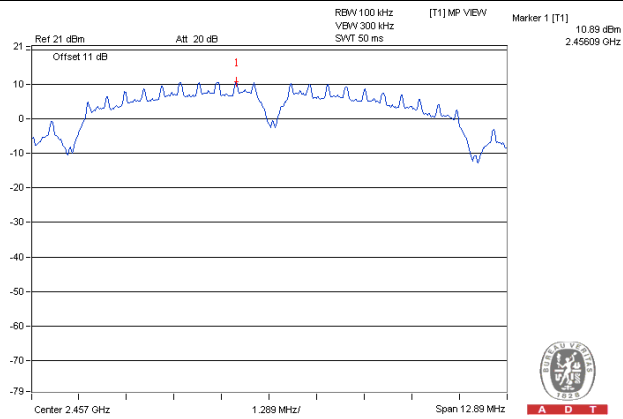

CH 11

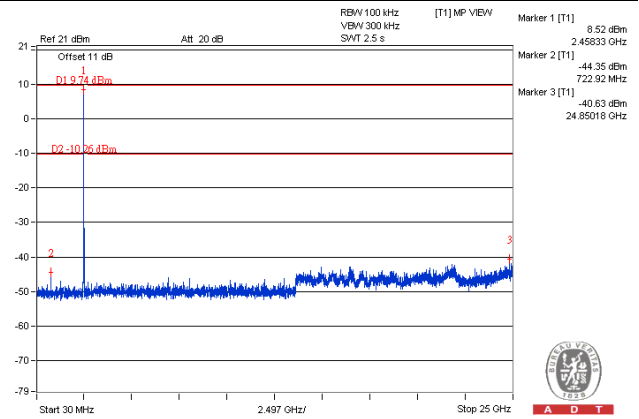
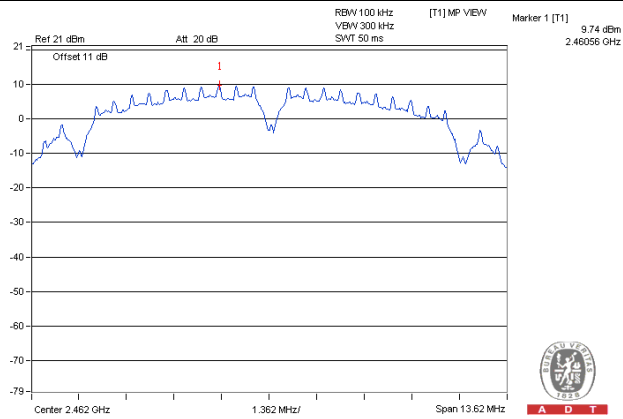

CH 12

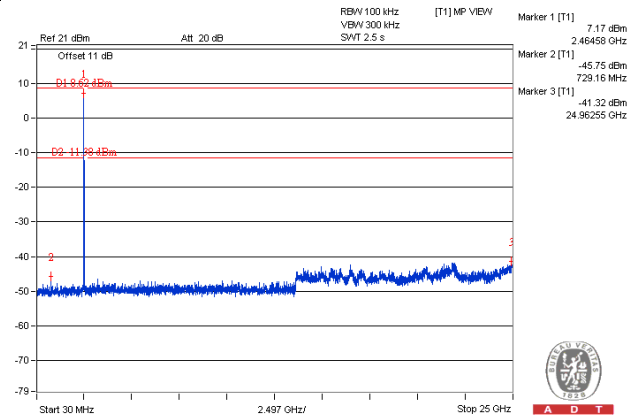
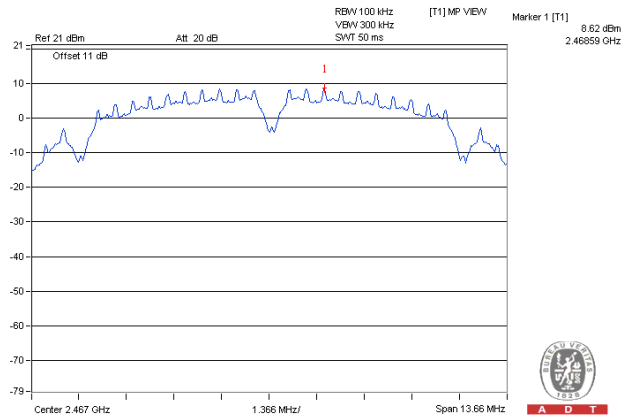

CH 13

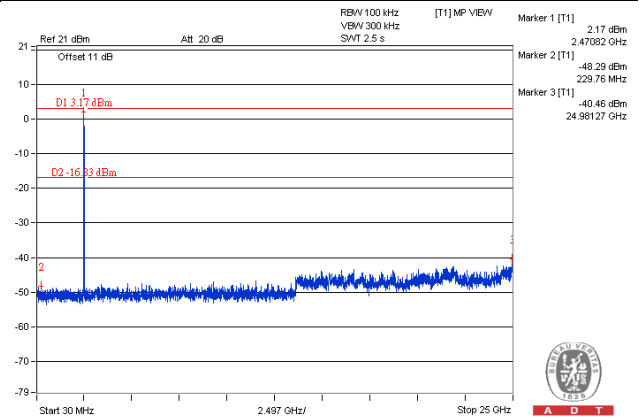
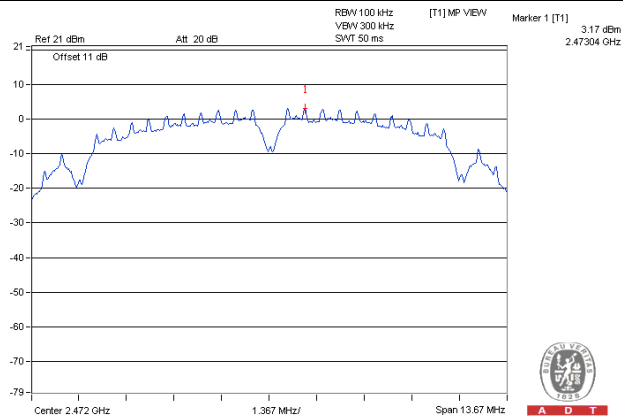

CH 1 Band edge

CH 13 Band edge

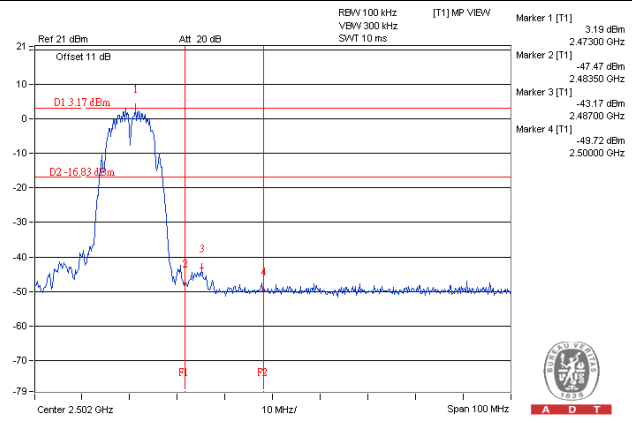
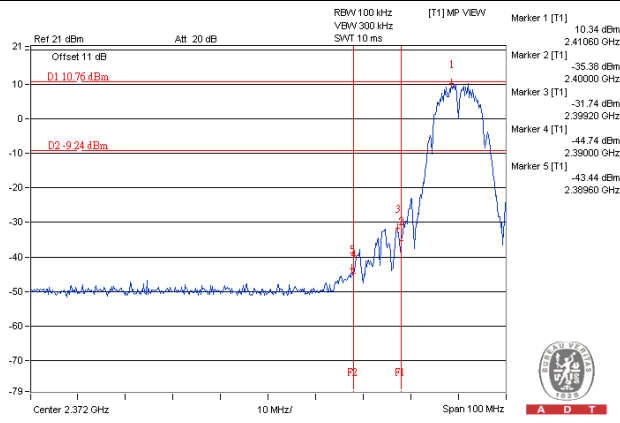

802.11g

Chain 0

CH 1

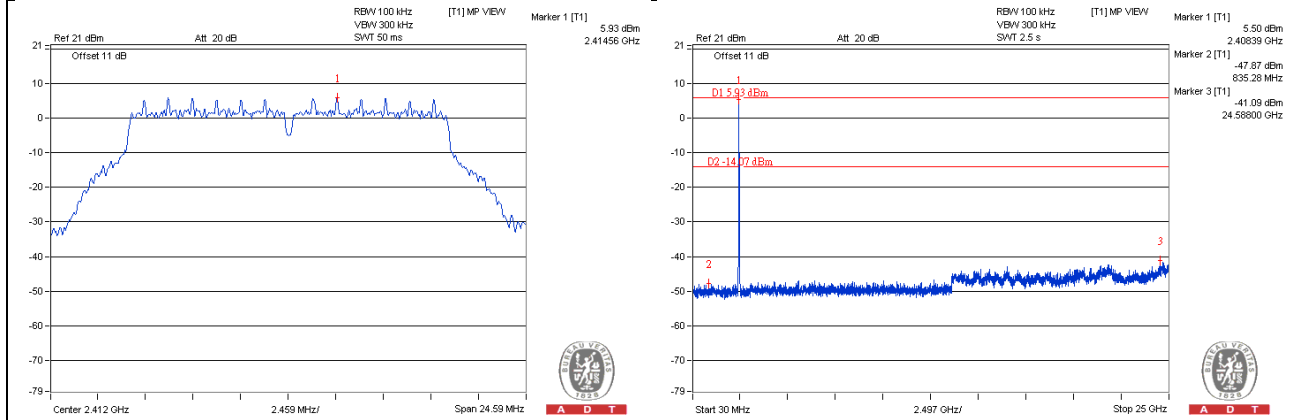

CH 2

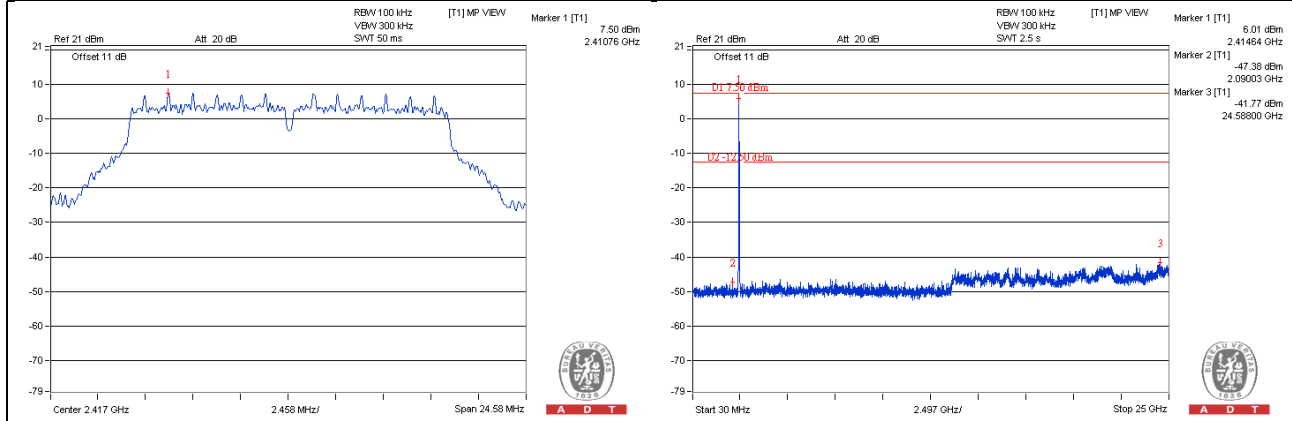

CH 6

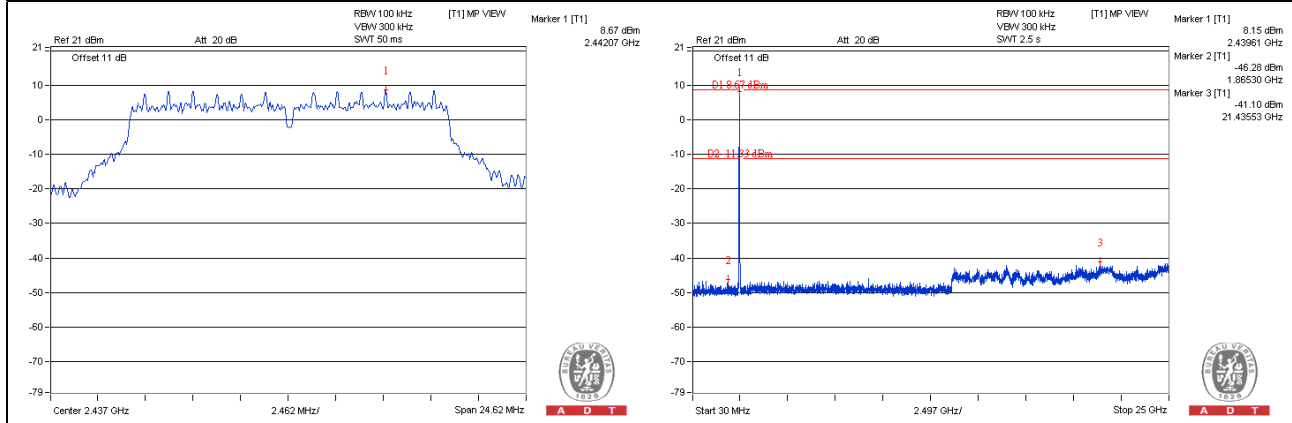

CH 10

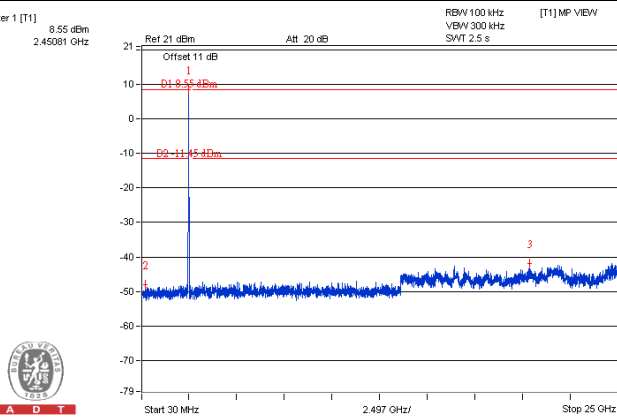
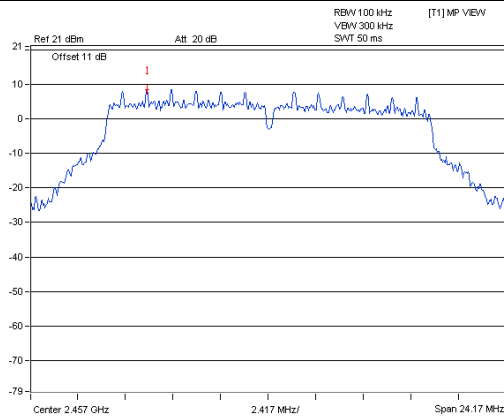

CH 11

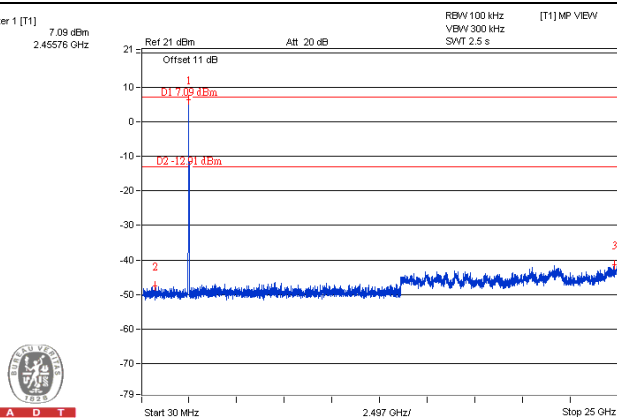
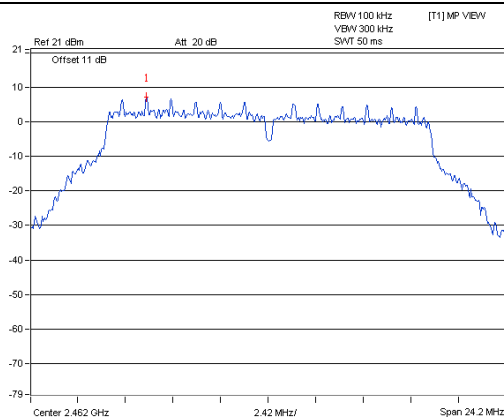

CH 12

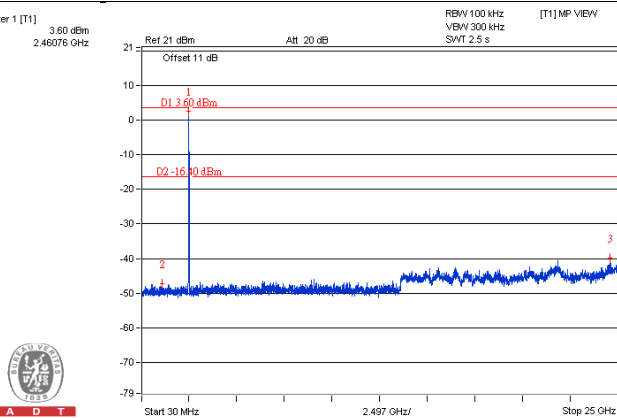
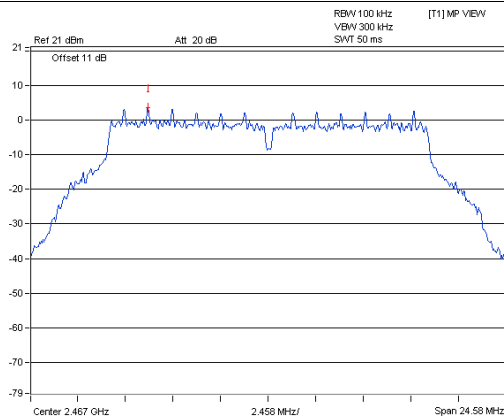

CH 13

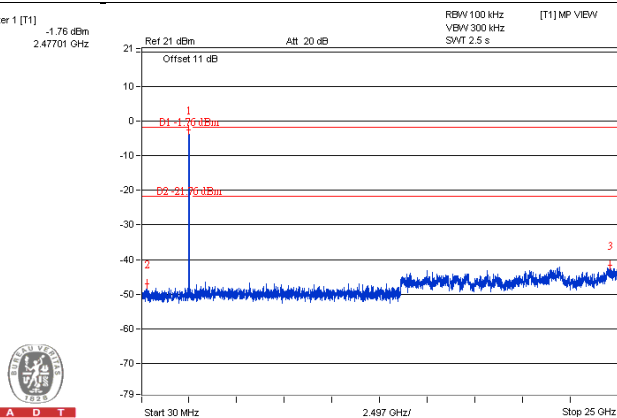
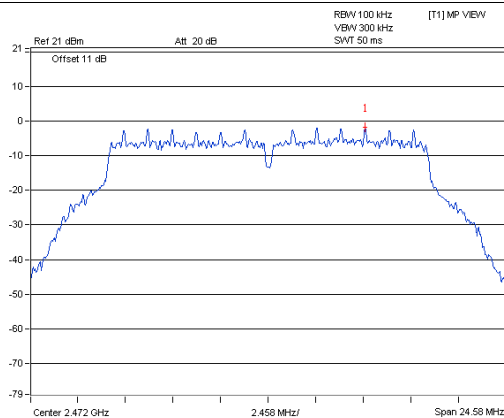

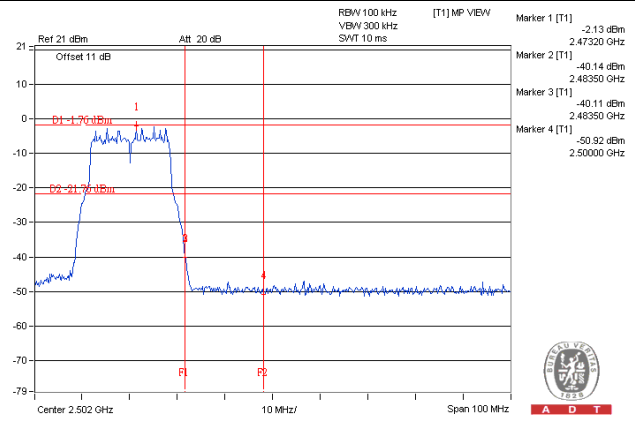
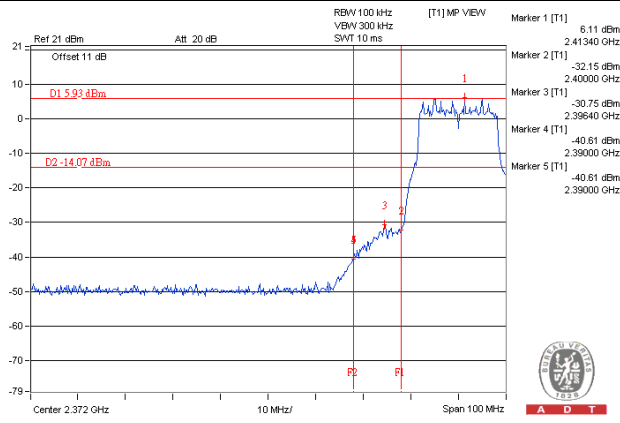
CH 1 Band edge**CH 13 Band edge**

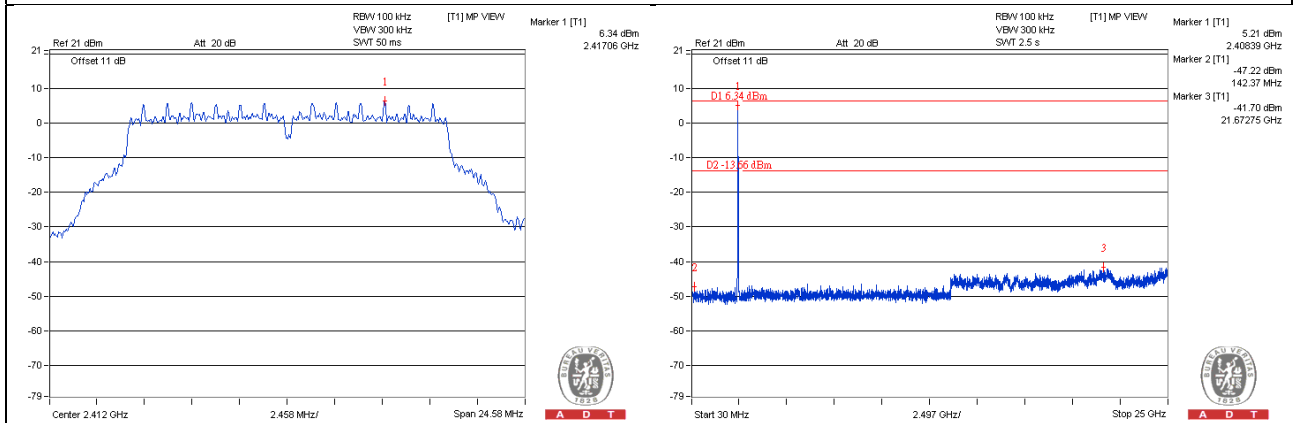
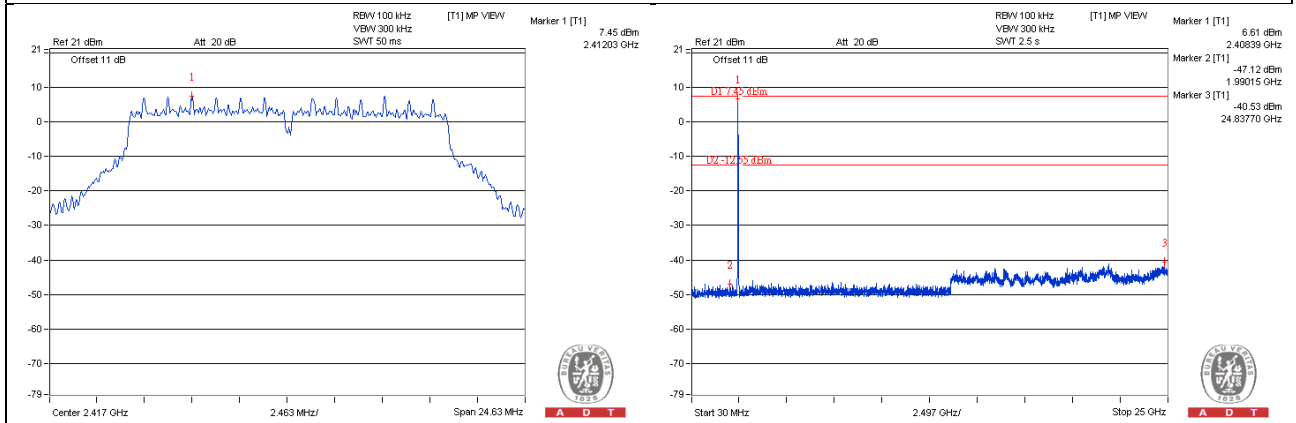
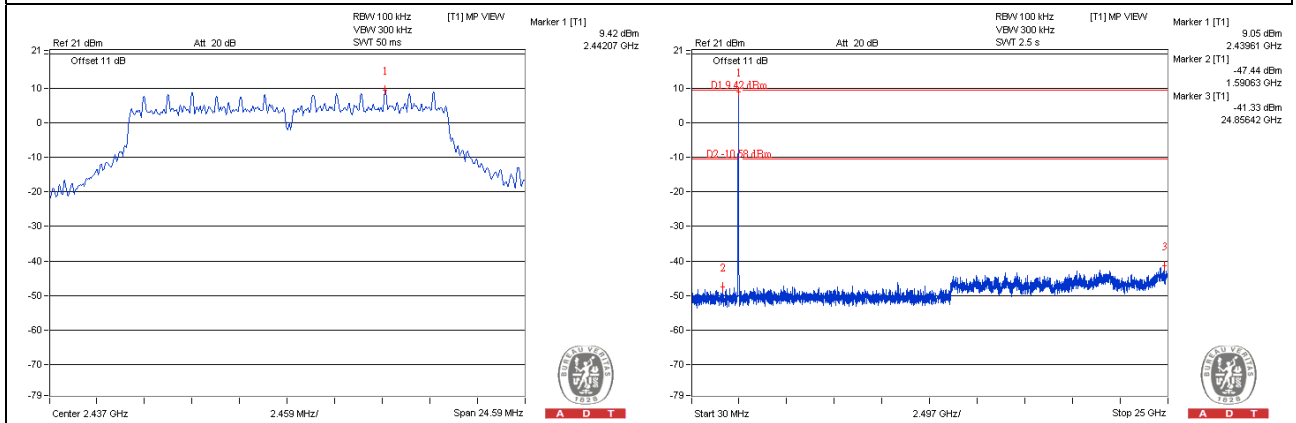
Chain 1**CH 1****CH 2****CH 6**

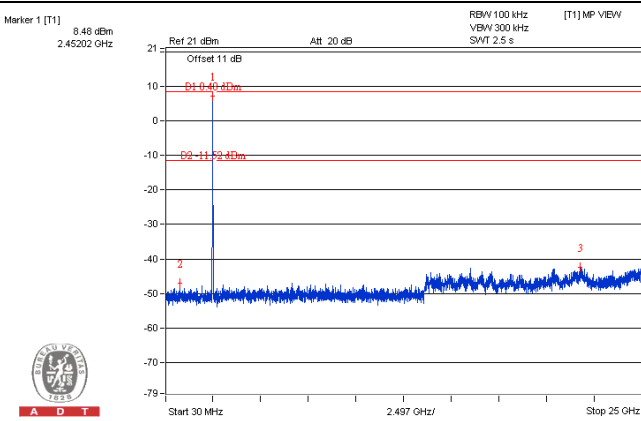
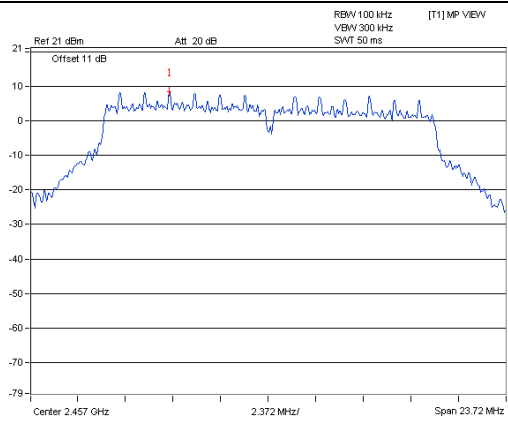
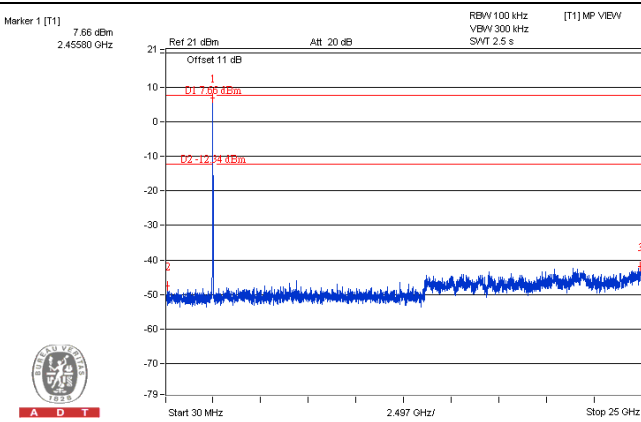
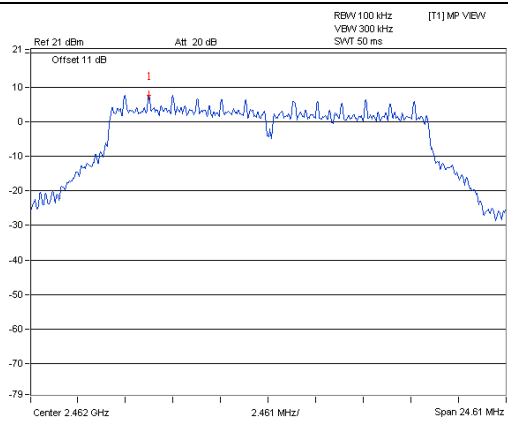
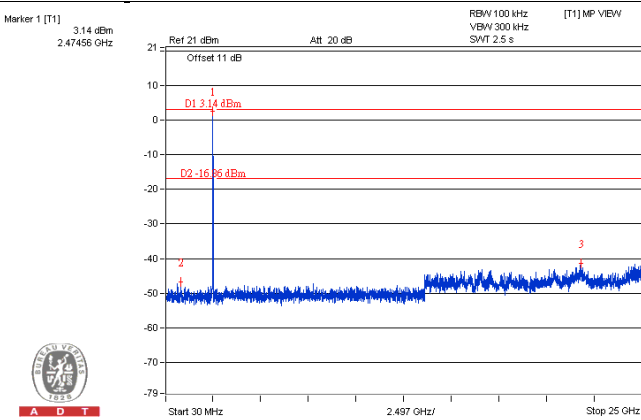
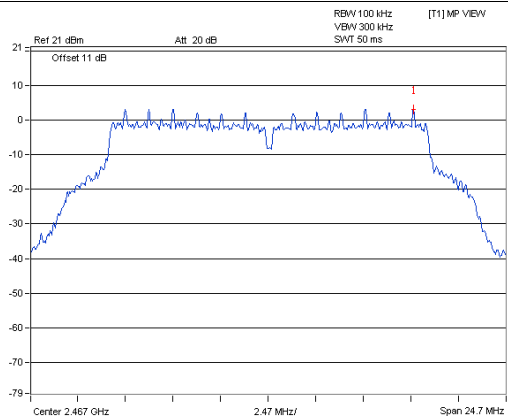
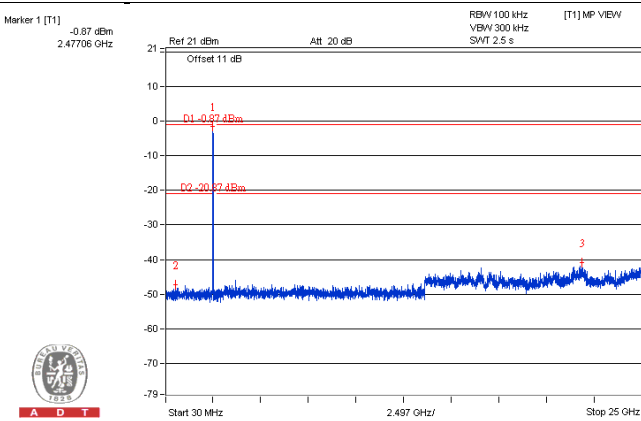
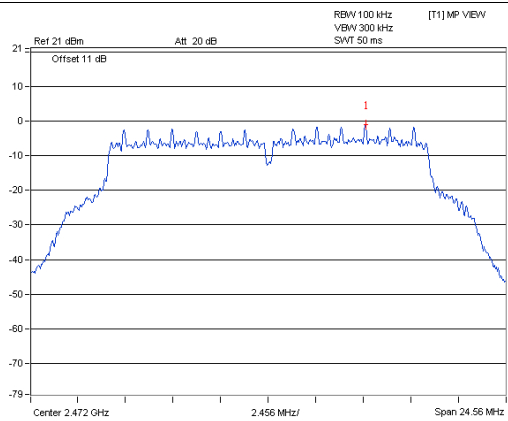
CH 10**CH 11****CH 12****CH 13**

CH 1 Band edge

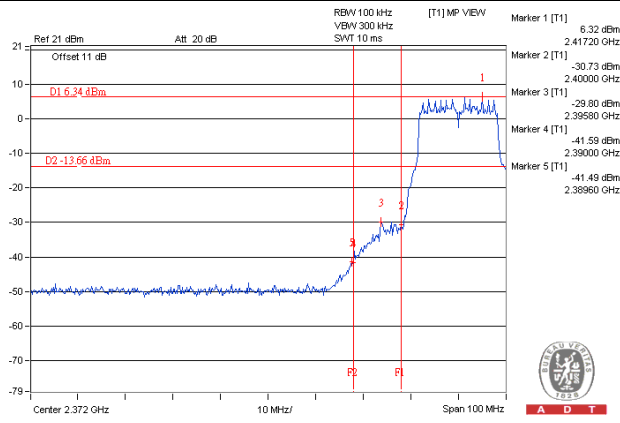

CH 13 Band edge

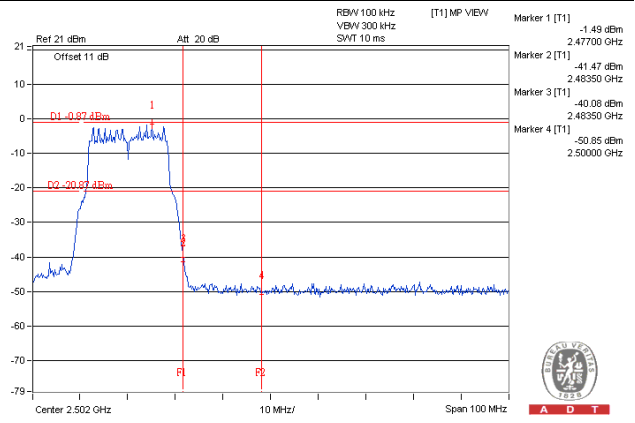

802.11n (HT20)
Chain 0

CH 1

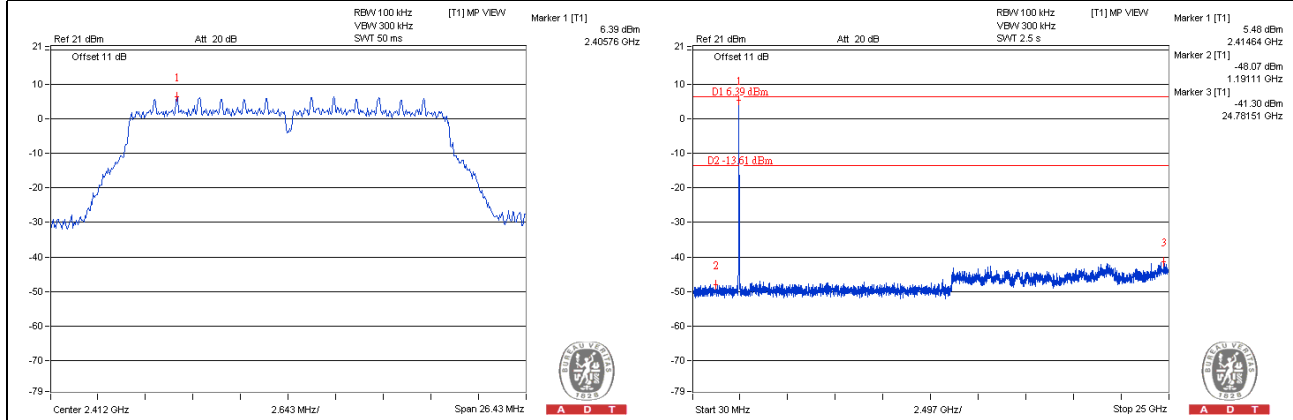

CH 2

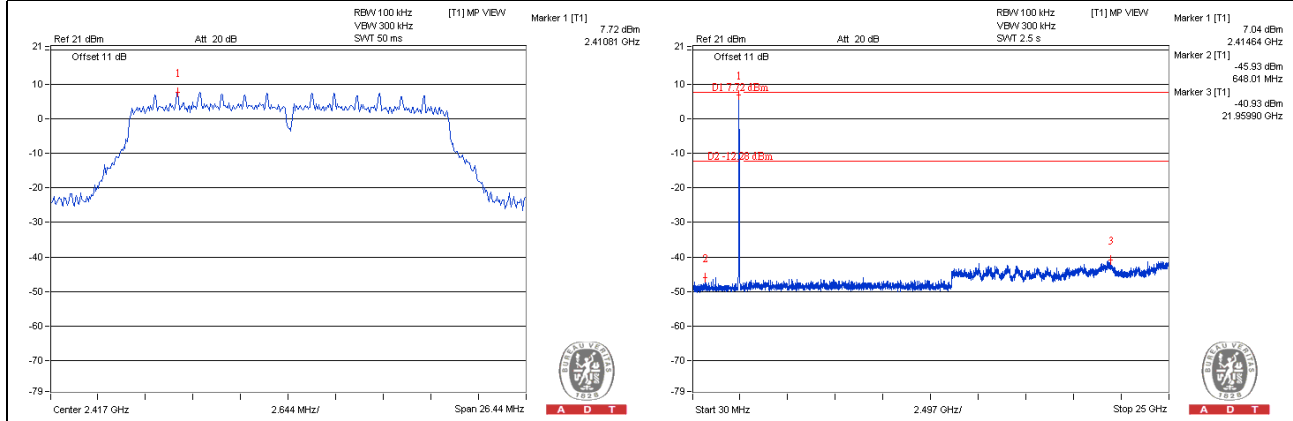

CH 6

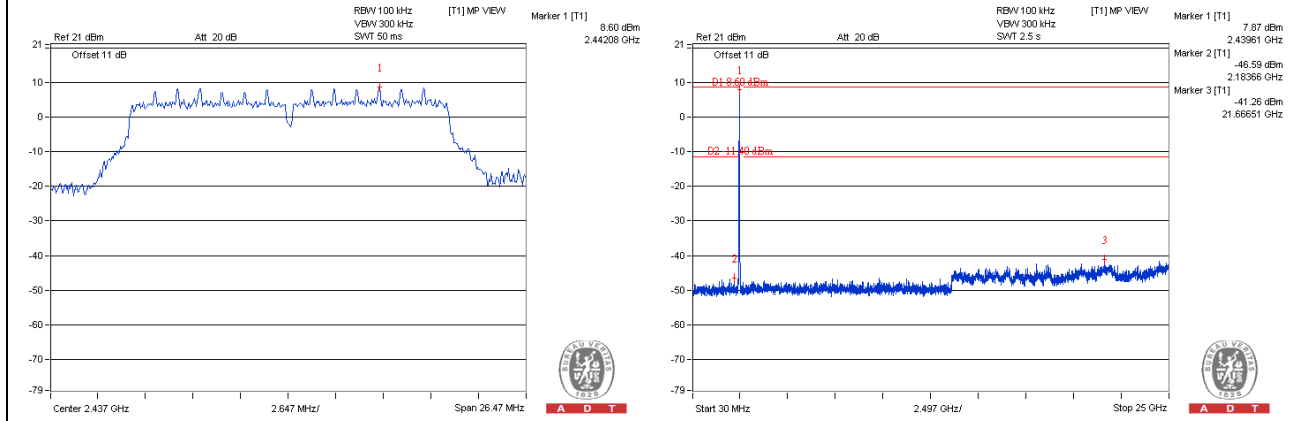

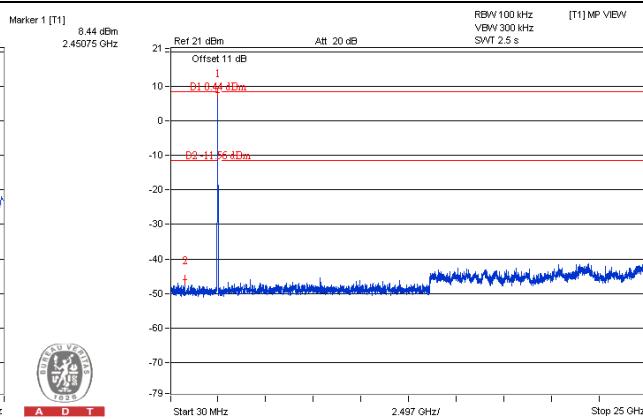
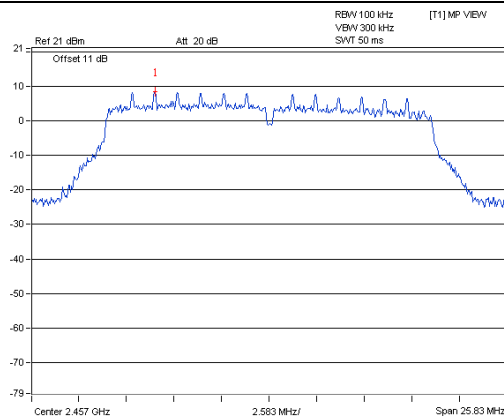
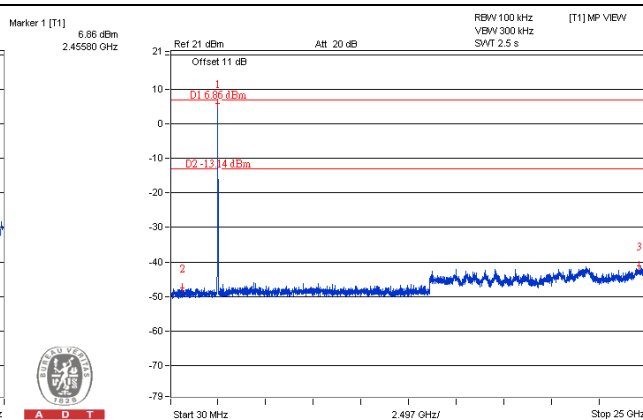
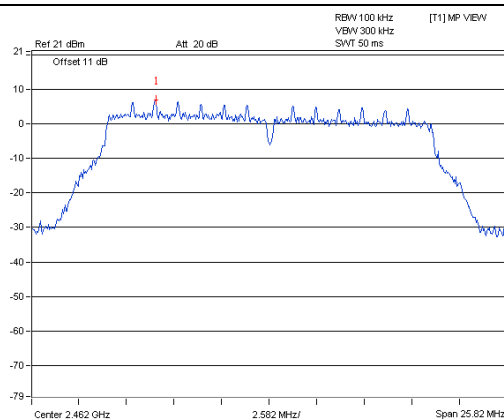
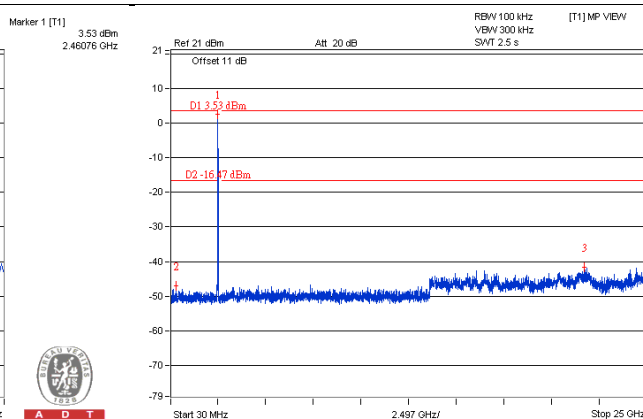
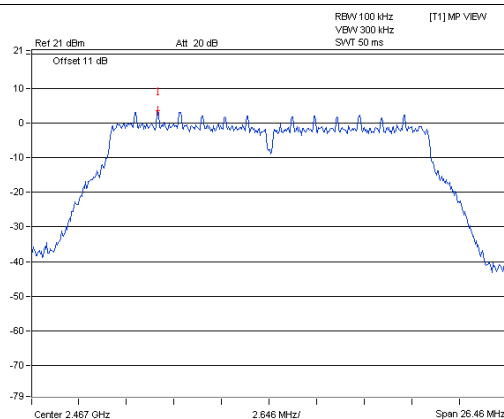
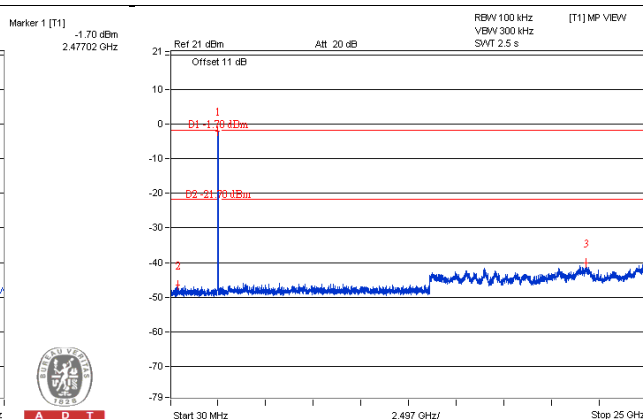
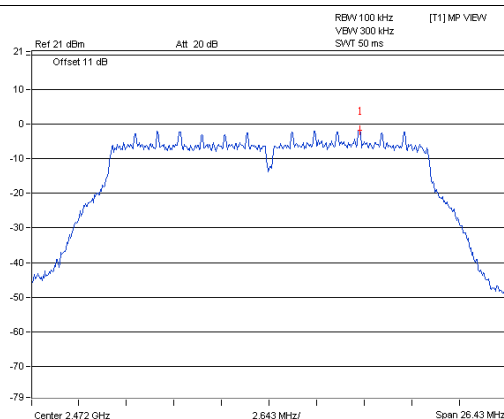
CH 10**CH 11****CH 12****CH 13**



A D T

CH 1 Band edge

CH 13 Band edge

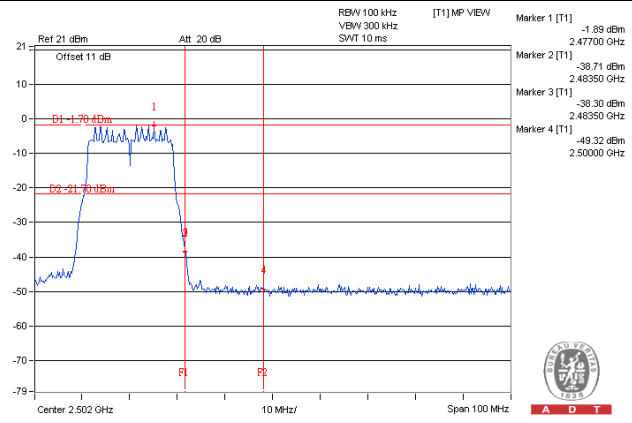
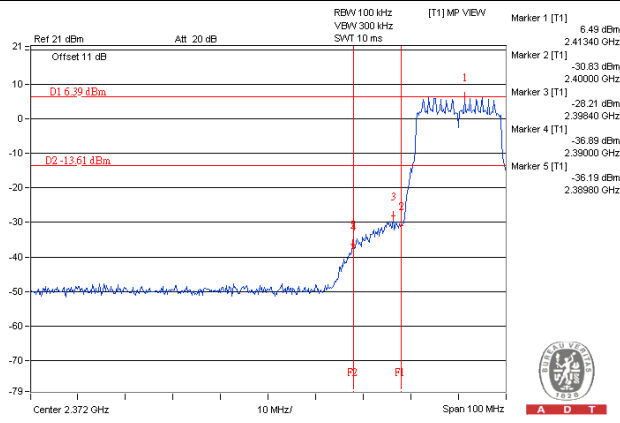

A D T



A D T

Chain 1

CH 1

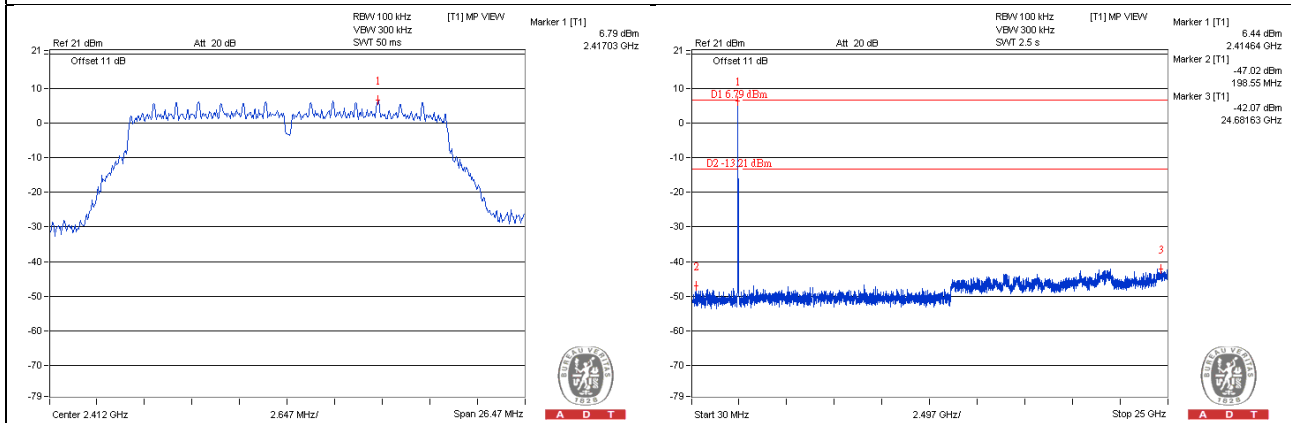

CH 2

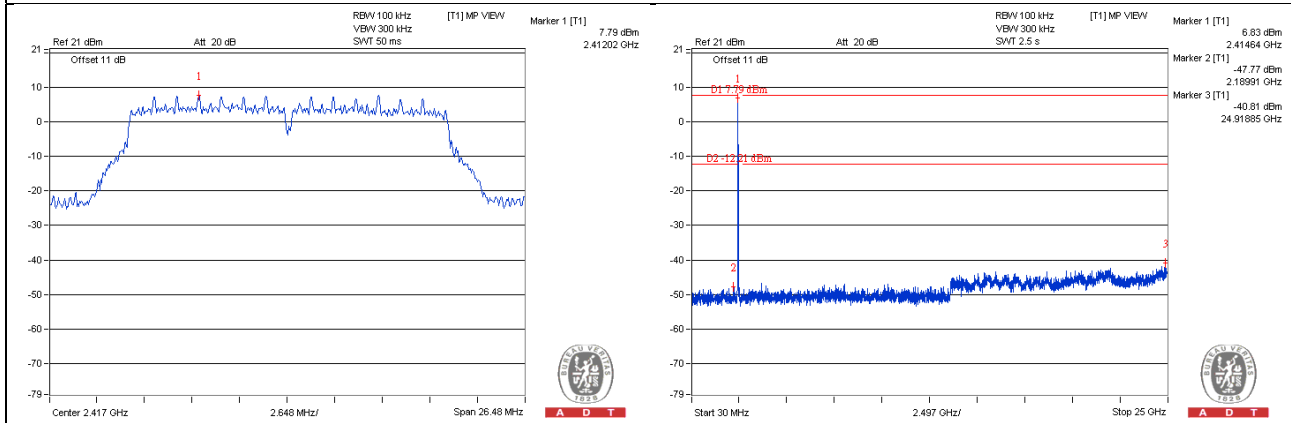

CH 6

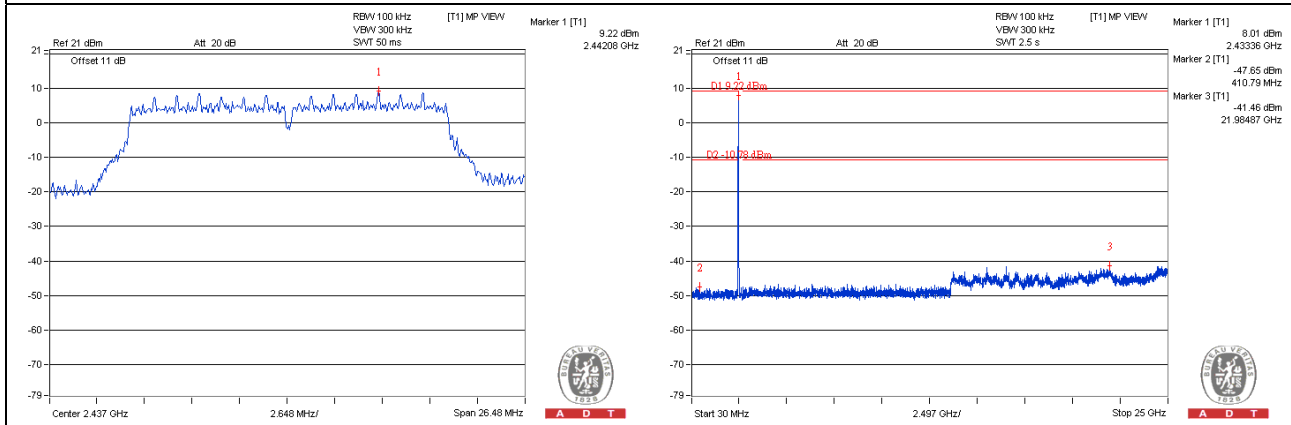

CH 10

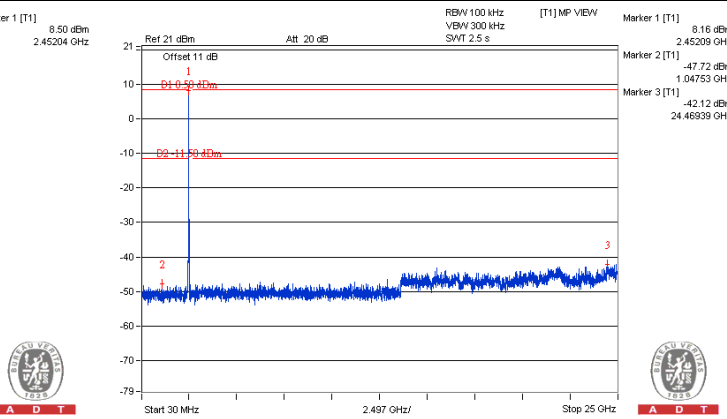
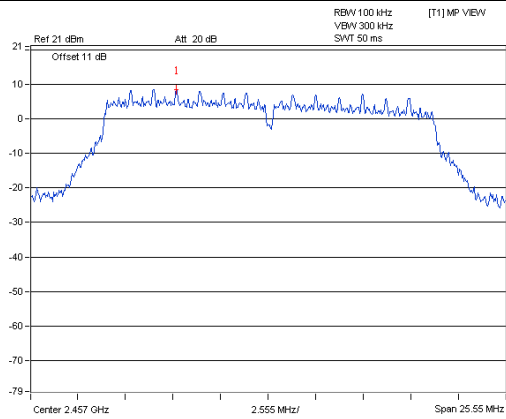

CH 11

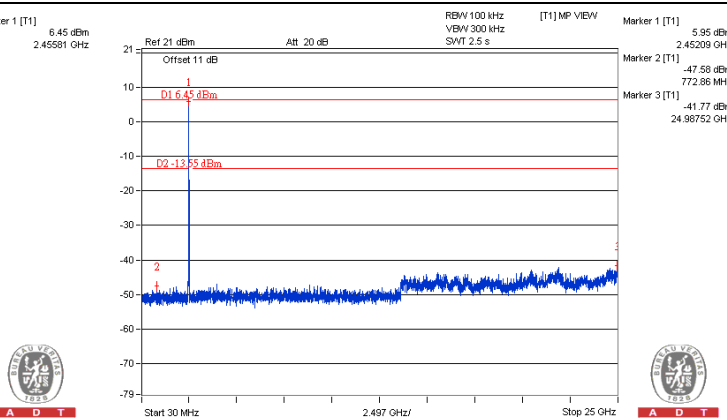
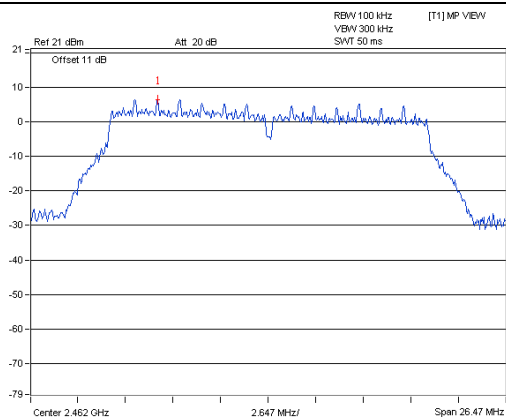

CH 12

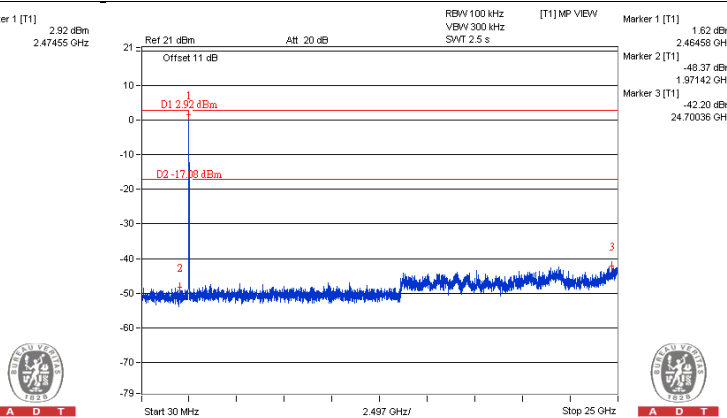
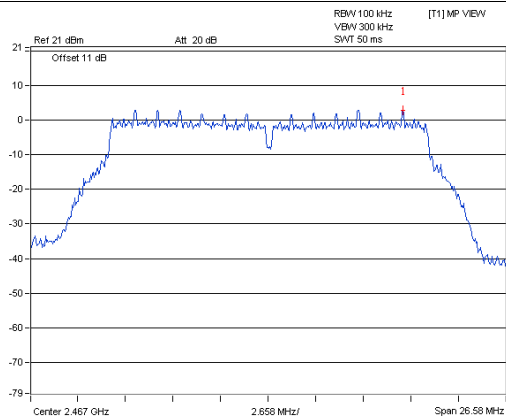

CH 13

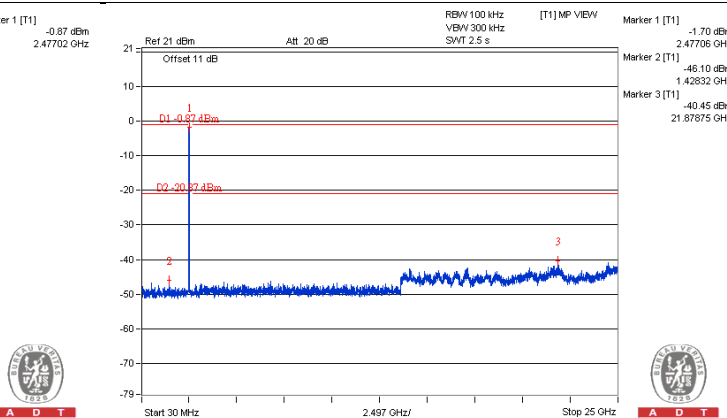
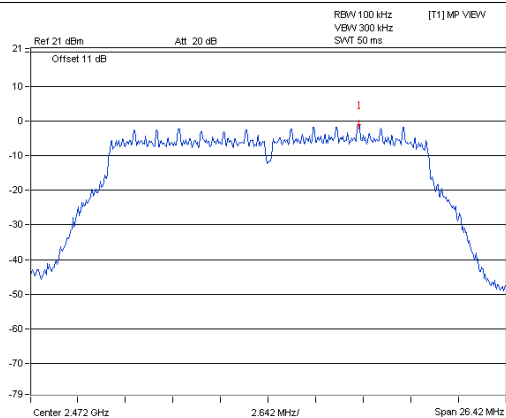

CH 1 Band edge

CH 13 Band edge

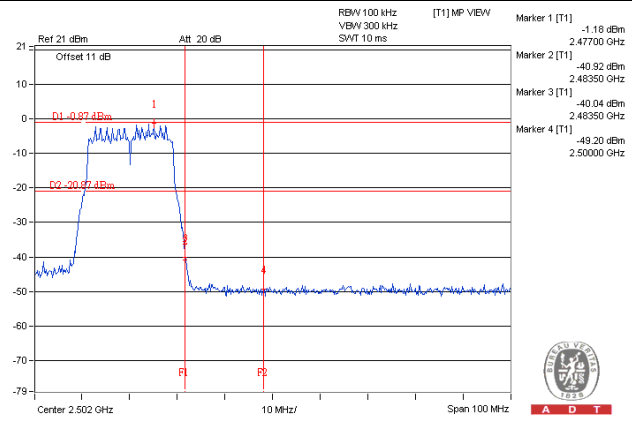
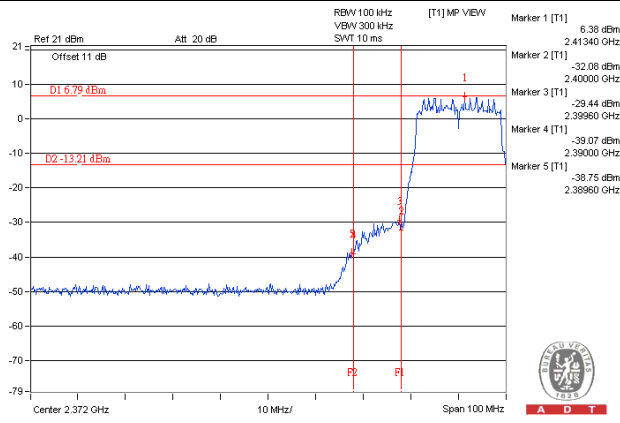

5 Pictures of Test Arrangements

Please refer to the attached file (Test Setup Photo).

Appendix – Information on the Testing Laboratories

We, Bureau Veritas Consumer Products Services (H.K.) Ltd., Taoyuan Branch, were founded in 1988 to provide our best service in EMC, Radio, Telecom and Safety consultation. Our laboratories are accredited and approved according to ISO/IEC 17025.

If you have any comments, please feel free to contact us at the following:

Linko EMC/RF Lab

Tel: 886-2-26052180

Fax: 886-2-26051924

Hsin Chu EMC/RF/Telecom Lab

Tel: 886-3-6668565

Fax: 886-3-6668323

Hwa Ya EMC/RF/Safety Lab

Tel: 886-3-3183232

Fax: 886-3-3270892

Email: service.adt@tw.bureauveritas.com

Web Site: www.bureauveritas-adt.com

The address and road map of all our labs can be found in our web site also.

--- END ---