



FCC RADIO TEST REPORT

FCC ID : UZ7WS5001
Equipment : WS50 Wearable Computer
Brand Name : Zebra
Model Name : WS5001
Applicant : Zebra Technologies Corporation
1 Zebra Plaza, Holtsville, NY 11742
Manufacturer : Zebra Technologies Corporation
1 Zebra Plaza, Holtsville, NY 11742
Standard : FCC Part 15 Subpart C §15.247

The product was received on Dec. 20, 2021 and testing was performed from Jan. 03, 2022 to Mar. 08, 2022. We, Sporton International Inc. Wensan Laboratory, would like to declare that the tested sample has been evaluated in accordance with the test procedures and has been in compliance with the applicable technical standards.

The test results in this report apply exclusively to the tested model / sample. Without written approval from Sporton International Inc. Wensan Laboratory, the test report shall not be reproduced except in full.

Approved by: Louis Wu

Sporton International Inc. Wensan Laboratory

No.58, Aly. 75, Ln. 564, Wenhua 3rd, Rd., Guishan Dist., Taoyuan City 333010, Taiwan (R.O.C.)



Table of Contents

History of this test report.....	3
Summary of Test Result.....	4
1 General Description.....	5
1.1 Product Feature of Equipment Under Test.....	5
1.2 Product Specification of Equipment Under Test.....	6
1.3 Modification of EUT	6
1.4 Testing Location	7
1.5 Applicable Standards.....	7
2 Test Configuration of Equipment Under Test.....	8
2.1 Carrier Frequency Channel	8
2.2 Test Mode.....	9
2.3 Connection Diagram of Test System.....	12
2.4 Support Unit used in test configuration and system	13
2.5 EUT Operation Test Setup	13
2.6 Measurement Results Explanation Example.....	13
3 Test Result.....	14
3.1 Number of Channel Measurement	14
3.2 Hopping Channel Separation Measurement	16
3.3 Dwell Time Measurement.....	21
3.4 20dB and 99% Bandwidth Measurement	23
3.5 Output Power Measurement.....	32
3.6 Conducted Band Edges Measurement.....	34
3.7 Conducted Spurious Emission Measurement	39
3.8 Radiated Band Edges and Spurious Emission Measurement	46
3.9 AC Conducted Emission Measurement.....	50
3.10 Antenna Requirements.....	52
4 List of Measuring Equipment	53
5 Uncertainty of Evaluation.....	55
Appendix A. AC Conducted Emission Test Result	
Appendix B. Radiated Spurious Emission	
Appendix C. Radiated Spurious Emission Plots	
Appendix D. Duty Cycle Plots	
Appendix E. Setup Photographs	



Summary of Test Result

Report Clause	Ref Std. Clause	Test Items	Result (PASS/FAIL)	Remark
3.1	15.247(a)(1)	Number of Channels	Pass	-
3.2	15.247(a)(1)	Hopping Channel Separation	Pass	-
3.3	15.247(a)(1)	Dwell Time of Each Channel	Pass	-
3.4	15.247(a)(1)	20dB Bandwidth	Pass	-
3.4	2.1049	99% Occupied Bandwidth	Reporting only	-
3.5	15.247(b)(1)	Peak Output Power	Pass	-
3.6	15.247(d)	Conducted Band Edges	Pass	-
3.7	15.247(d)	Conducted Spurious Emission	Pass	-
3.8	15.247(d)	Radiated Band Edges and Radiated Spurious Emission	Pass	8.77 dB under the limit at 63.950 MHz
3.9	15.207	AC Conducted Emission	Pass	4.95 dB under the limit at 13.560 MHz
3.10	15.203 & 15.247(b)	Antenna Requirement	Pass	-

Declaration of Conformity:

1. The test results (PASS/FAIL) with all measurement uncertainty excluded are presented in accordance with the regulation limits or requirements declared by manufacturers. It's means measurement values may risk exceeding the limit of regulation standards, if measurement uncertainty is include in test results.
2. The measurement uncertainty please refer to this report "Uncertainty of Evaluation".

Comments and Explanations:

The product specifications of the EUT presented in the report are declared by the manufacturer who shall take full responsibility for the authenticity.

Reviewed by: Wei Chen**Report Producer: Amy Chen**



1 General Description

1.1 Product Feature of Equipment Under Test

Product Feature	
Equipment	WS50 Wearable Computer
Brand Name	Zebra
Model Name	WS5001
FCC ID	UZ7WS5001
EUT supports Radios application	NFC WLAN 11a/b/g/n HT20/HT40 WLAN 11ac VHT20/VHT40/VHT80 Bluetooth BR/EDR/LE
HW Version	EV2.2
SW Version	11-12-01.00-RN-U00-PRD-WTX-04
FW Version	FUSION_QA_3_1.0.0.007_R
MFD	SKU 1: 23NOV21 SKU 3-1: 14DEC21 SKU 3-2: 15DEC21 SKU 5: 23NOV21
EUT Stage	Identical Prototype

Remark: The above EUT's information was declared by manufacturer.

SKU List				
Helix SKU	Scanner	Battery	Camera	Mounting
SKU 1	SE4770	1.6x Battery	N/A	Finger Trigger
SKU 3-1	N/A	1x Battery	Yes	Wrist Strap
SKU 3-2	N/A	1x Battery	N/A	Wrist Strap
SKU 5	SE4770	1.6x Battery	N/A	BOH

Specification of Accessories				
Adaptor	Brand Name	Zebra	Part Number	PWR-WUA5V12W0US
Battery 1x	Brand Name	Zebra	Model Name	BT-000446
Battery 1.6x	Brand Name	Zebra	Model Name	BT-000446B
USB charging cable with cup	Brand Name	Zebra	Model Name	CBL-WS5X-USB1-01
USB C CABLE	Brand Name	Zebra	Part Number	CBL-TC2X-USBC-01

Supported Unit used in test configuration and system				
Converged Scanner Shell	Brand Name	Zebra	Part Number	SG-WS5X-SHLCS-01
Replacement Finger Trigger for Converged	Brand Name	Zebra	Part Number	SG-WS5X-TRGA-01
Wrist Shell	Brand Name	Zebra	Part Number	SG-WS5X-SHLWR-01
Wrist Strap	Brand Name	Zebra	Part Number	SG-WS5X-WSTRP-01
Wrist Mount (without strap)	Brand Name	Zebra	Part Number	SG-WS5X-WSTMT-01
Wrist Mount with strap	Brand Name	Zebra	Part Number	SG-WS5X-WPLTS-01
Back of Hand Mount for Converged	Brand Name	Zebra	Part Number	SG-WS5X-BHMT-01



1.2 Product Specification of Equipment Under Test

Product Specification is subject to this standard	
Tx/Rx Frequency Range	2402 MHz ~ 2480 MHz
Number of Channels	79
Carrier Frequency of Each Channel	2402+n*1 MHz; n=0~78
Maximum Output Power to Antenna	Bluetooth BR(1Mbps) : 7.04 dBm (0.0051 W) Bluetooth EDR (2Mbps) : 6.40 dBm (0.0044 W) Bluetooth EDR (3Mbps) : 6.69 dBm (0.0047 W)
99% Occupied Bandwidth	Bluetooth BR(1Mbps) : 0.863 MHz Bluetooth EDR (2Mbps) : 1.169 MHz Bluetooth EDR (3Mbps) : 1.149 MHz
Antenna Type / Gain	PIFA Antenna with gain 2.50 dBi
Type of Modulation	Bluetooth BR (1Mbps) : GFSK Bluetooth EDR (2Mbps) : $\pi/4$ -DQPSK Bluetooth EDR (3Mbps) : 8-DPSK

Remark: The above EUT's information was declared by manufacturer. Please refer to Comments and Explanations in report summary.

1.3 Modification of EUT

No modifications made to the EUT during the testing.



1.4 Testing Location

Test Site	Sporton International Inc. EMC & Wireless Communications Laboratory
Test Site Location	No.52, Huaya 1st Rd., Guishan Dist., Taoyuan City 333, Taiwan (R.O.C.) TEL: +886-3-327-3456 FAX: +886-3-328-4978
Test Site No.	Sporton Site No. CO05-HY (TAF Code: 1190)
Remark	The AC Conducted Emission test item subcontracted to Sporton International Inc. EMC & Wireless Communications Laboratory.

Note: The test site complies with ANSI C63.4 2014 requirement.

Test Site	Sporton International Inc. Wensan Laboratory
Test Site Location	No.58, Aly. 75, Ln. 564, Wenhua 3rd, Rd., Guishan Dist., Taoyuan City 333010, Taiwan (R.O.C.) TEL: +886-3-327-0868 FAX: +886-3-327-0855
Test Site No.	Sporton Site No. TH05-HY, 03CH11-HY

Note: The test site complies with ANSI C63.4 2014 requirement.

FCC designation No.: TW1190 and TW3786

1.5 Applicable Standards

According to the specifications declared by the manufacturer, the EUT must comply with the requirements of the following standards:

- ♦ FCC Part 15 Subpart C §15.247
- ♦ FCC KDB Publication No. 558074 D01 DTS Meas. Guidance v05r02
- ♦ FCC KDB 414788 D01 Radiated Test Site v01r01
- ♦ ANSI C63.10-2013

Remark:

1. All the test items were validated and recorded in accordance with the standards without any modification during the testing.
2. The TAF code is not including all the FCC KDB listed without accreditation.
3. This EUT has also been tested and complied with the requirements of FCC Part 15, Subpart B, recorded in a separate test report.



2 Test Configuration of Equipment Under Test

2.1 Carrier Frequency Channel

Frequency Band	Channel	Freq. (MHz)	Channel	Freq. (MHz)	Channel	Freq. (MHz)
2400-2483.5 MHz	0	2402	27	2429	54	2456
	1	2403	28	2430	55	2457
	2	2404	29	2431	56	2458
	3	2405	30	2432	57	2459
	4	2406	31	2433	58	2460
	5	2407	32	2434	59	2461
	6	2408	33	2435	60	2462
	7	2409	34	2436	61	2463
	8	2410	35	2437	62	2464
	9	2411	36	2438	63	2465
	10	2412	37	2439	64	2466
	11	2413	38	2440	65	2467
	12	2414	39	2441	66	2468
	13	2415	40	2442	67	2469
	14	2416	41	2443	68	2470
	15	2417	42	2444	69	2471
	16	2418	43	2445	70	2472
	17	2419	44	2446	71	2473
	18	2420	45	2447	72	2474
	19	2421	46	2448	73	2475
	20	2422	47	2449	74	2476
	21	2423	48	2450	75	2477
	22	2424	49	2451	76	2478
	23	2425	50	2452	77	2479
	24	2426	51	2453	78	2480
	25	2427	52	2454	-	-
	26	2428	53	2455	-	-



2.2 Test Mode

Channel	Frequency	Bluetooth Average Output Power		
		GFSK / 1Mbps		
		DH1	DH3	DH5
Ch00	2402MHz	5.38 dBm	5.06 dBm	4.69 dBm
Ch39	2441MHz	6.01 dBm	5.24 dBm	5.15 dBm
Ch78	2480MHz	4.38 dBm	4.02 dBm	3.86 dBm

Channel	Frequency	Bluetooth Average Output Power		
		$\pi/4$ -DQPSK / 2Mbps		
		2DH1	2DH3	2DH5
Ch00	2402MHz	3.13 dBm	2.60 dBm	2.39 dBm
Ch39	2441MHz	3.57 dBm	3.07 dBm	2.90 dBm
Ch78	2480MHz	2.81 dBm	2.40 dBm	2.04 dBm

Channel	Frequency	Bluetooth Average Output Power		
		8-DPSK / 3Mbps		
		3DH1	3DH3	3DH5
Ch00	2402MHz	3.36 dBm	2.62 dBm	2.41 dBm
Ch39	2441MHz	3.65 dBm	3.16 dBm	3.12 dBm
Ch78	2480MHz	2.98 dBm	2.52 dBm	2.12 dBm



Channel	Frequency	Bluetooth Peak Output Power		
		GFSK / 1Mbps		
		DH1	DH3	DH5
Ch00	2402MHz	6.53 dBm	6.44 dBm	6.33 dBm
Ch39	2441MHz	7.04 dBm	6.91 dBm	6.82 dBm
Ch78	2480MHz	5.90 dBm	5.86 dBm	5.80 dBm

Channel	Frequency	Bluetooth Peak Output Power		
		$\pi/4$ -DQPSK / 2Mbps		
		2DH1	2DH3	2DH5
Ch00	2402MHz	6.06 dBm	5.96 dBm	5.80 dBm
Ch39	2441MHz	6.40 dBm	6.38 dBm	6.33 dBm
Ch78	2480MHz	5.51 dBm	5.45 dBm	5.38 dBm

Channel	Frequency	Bluetooth Peak Output Power		
		8-DPSK / 3Mbps		
		3DH1	3DH3	3DH5
Ch00	2402MHz	6.11 dBm	6.05 dBm	6.01 dBm
Ch39	2441MHz	6.69 dBm	6.65 dBm	6.58 dBm
Ch78	2480MHz	5.71 dBm	5.66 dBm	5.61 dBm

Remark: The data rate was set in 1Mbps for all the test items due to the highest RF output power.



- a. The EUT has been associated with peripherals and configuration operated in a manner tended to maximize its emission characteristics in a typical application. Frequency range investigated: conduction emission (150 kHz to 30 MHz), radiation emission (9 kHz to the 10th harmonic of the highest fundamental frequency or to 40 GHz, whichever is lower). For radiated measurement, the measured emission level of the EUT was maximized by rotating the EUT on a turntable, adjusting the orientation of the EUT and EUT antenna in three orthogonal axis (X: flat, Y: portrait, Z: landscape), and adjusting the measurement antenna orientation, following C63.10 exploratory test procedures and find X plane as worst plane, and the worst mode of radiated spurious emissions is Bluetooth 1Mbps mode, and recorded in this report.
- b. AC power line Conducted Emission was tested under maximum output power.

The following summary table is showing all test modes to demonstrate in compliance with the standard.

Summary table of Test Cases			
Test Item	Data Rate / Modulation		
Conducted Test Cases	Bluetooth BR 1Mbps GFSK	Bluetooth EDR 2Mbps $\pi/4$-DQPSK	Bluetooth EDR 3Mbps 8-DPSK
	Mode 1: CH00_2402 MHz	Mode 4: CH00_2402 MHz	Mode 7: CH00_2402 MHz
	Mode 2: CH39_2441 MHz	Mode 5: CH39_2441 MHz	Mode 8: CH39_2441 MHz
	Mode 3: CH78_2480 MHz	Mode 6: CH78_2480 MHz	Mode 9: CH78_2480 MHz
Radiated Test Cases	Bluetooth BR 1Mbps GFSK		
	Mode 1: CH00_2402 MHz		
	Mode 2: CH39_2441 MHz		
	Mode 3: CH78_2480 MHz		
AC Conducted Emission	Mode 1 : Bluetooth Link + WLAN (2.4GHz) Link + NFC Link + Camera + Battery 1x (BT-000446) + USB Data Link with Notebook + Wrist Strap (SG-WS5X-WSTRP-01) for SKU 3-1:		
Remark:			
1. For Radiated Test Cases, the worst mode data rate 1Mbps was reported only since the highest RF output power in the preliminary tests. The conducted spurious emissions and conducted band edge measurement for other data rates were not worse than 1Mbps, and no other significantly frequencies found in conducted spurious emission.			
2. Data Link with USB HD means data application transferred mode between EUT and USB HD.			
3. For Radiated Test Cases, the tests were performed with Battery 1.6x and SKU 1.			

2.3 Connection Diagram of Test System

<AC Conducted Emission Mode>

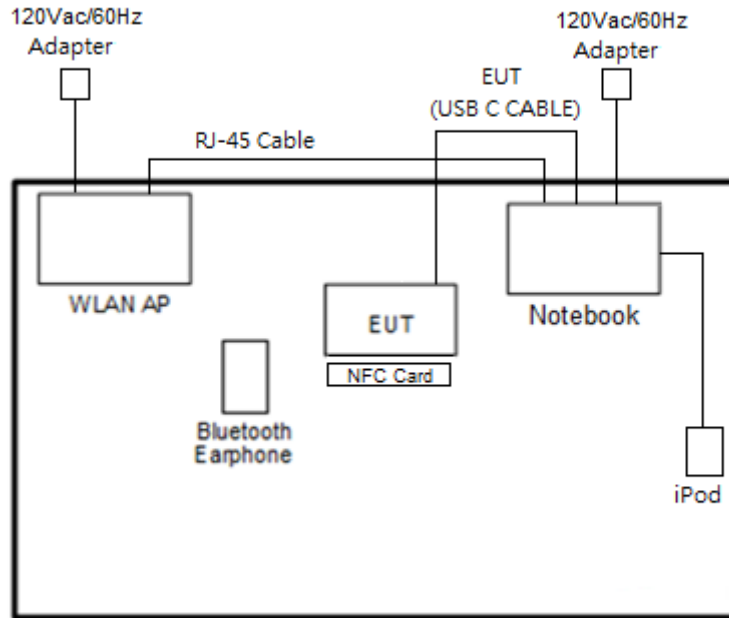

<Bluetooth Tx Mode>

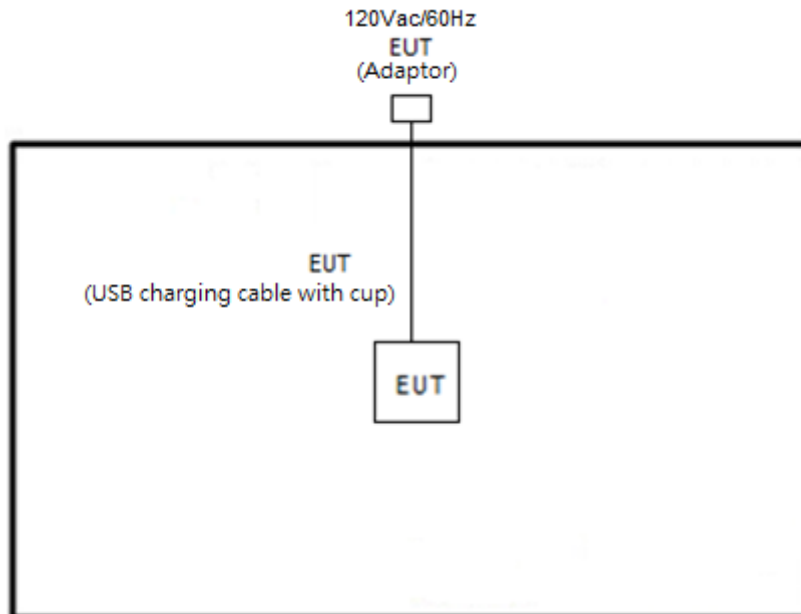

2.4 Support Unit used in test configuration and system

Item	Equipment	Brand Name	Model Name	FCC ID	Data Cable	Power Cord
1.	Bluetooth Earphone	Sony Ericsson	MW600	PY7DDA-2029	N/A	N/A
2.	WLAN AP	ASUS	RT-AC66U	MSQ-RTAC66U	N/A	Unshielded, 1.8 m
3.	iPod	Apple	A1285	FCC DoC	Shielded, 1.0 m	N/A
4.	Notebook	Dell	Latitude 3400	FCC DoC	N/A	AC I/P: Unshielded, 1.2m DC O/P: Shielded, 1.8m
5.	NFC Card	N/A	N/A	N/A	N/A	N/A

2.5 EUT Operation Test Setup

The RF test items, utility "QRCT4.0.00158.0" was installed in Notebook which was programmed in order to make the EUT get into the engineering modes to provide channel selection, power level, data rate and the application type and for continuous transmitting signals.

2.6 Measurement Results Explanation Example

For all conducted test items:

The offset level is set in the spectrum analyzer to compensate the RF cable loss and attenuator factor between EUT conducted output port and spectrum analyzer. With the offset compensation, the spectrum analyzer reading level is exactly the EUT RF output level.

Example:

The spectrum analyzer offset is derived from RF cable loss and attenuator factor.

Offset = RF cable loss + attenuator factor.

Following shows an offset computation example with cable loss 4.2 dB and 10 dB attenuator.

$$\begin{aligned}
 \text{Offset(dB)} &= \text{RF cable loss(dB)} + \text{attenuator factor(dB)}. \\
 &= 4.2 + 10 = 14.2 \text{ (dB)}
 \end{aligned}$$

3 Test Result

3.1 Number of Channel Measurement

3.1.1 Limits of Number of Hopping Frequency

Frequency hopping systems in the 2400-2483.5 MHz band shall use at least 15 channels.

3.1.2 Measuring Instruments

Please refer to the measuring equipment list in this test report.

3.1.3 Test Procedure

1. The testing follows ANSI C63.10-2013 clause 7.8.3.
2. The RF output of EUT is connected to the spectrum analyzer by RF cable and attenuator. The path loss is compensated to the results for each measurement.
3. Set the maximum power setting and enable the EUT to transmit continuously.
4. Enable the EUT hopping function.
5. Use the following spectrum analyzer settings: Span = the frequency band of operation; RBW = 300 kHz; VBW \geq RBW; Sweep = auto; Detector function = peak; Trace = max hold.
6. The number of hopping frequency used is defined as the number of total channel.
7. Record the measurement data derived from spectrum analyzer.

3.1.4 Test Setup

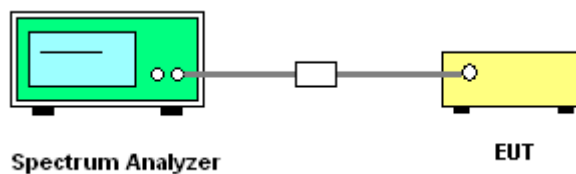



3.1.5 Test Result of Number of Hopping Frequency

Test Engineer :	Mina Liu	Temperature :	21~25°C
		Relative Humidity :	51~54%

Number of Hopping (Channel)	Adaptive Frequency Hopping (Channel)	Limits (Channel)	Pass/Fail
79	20	> 15	Pass

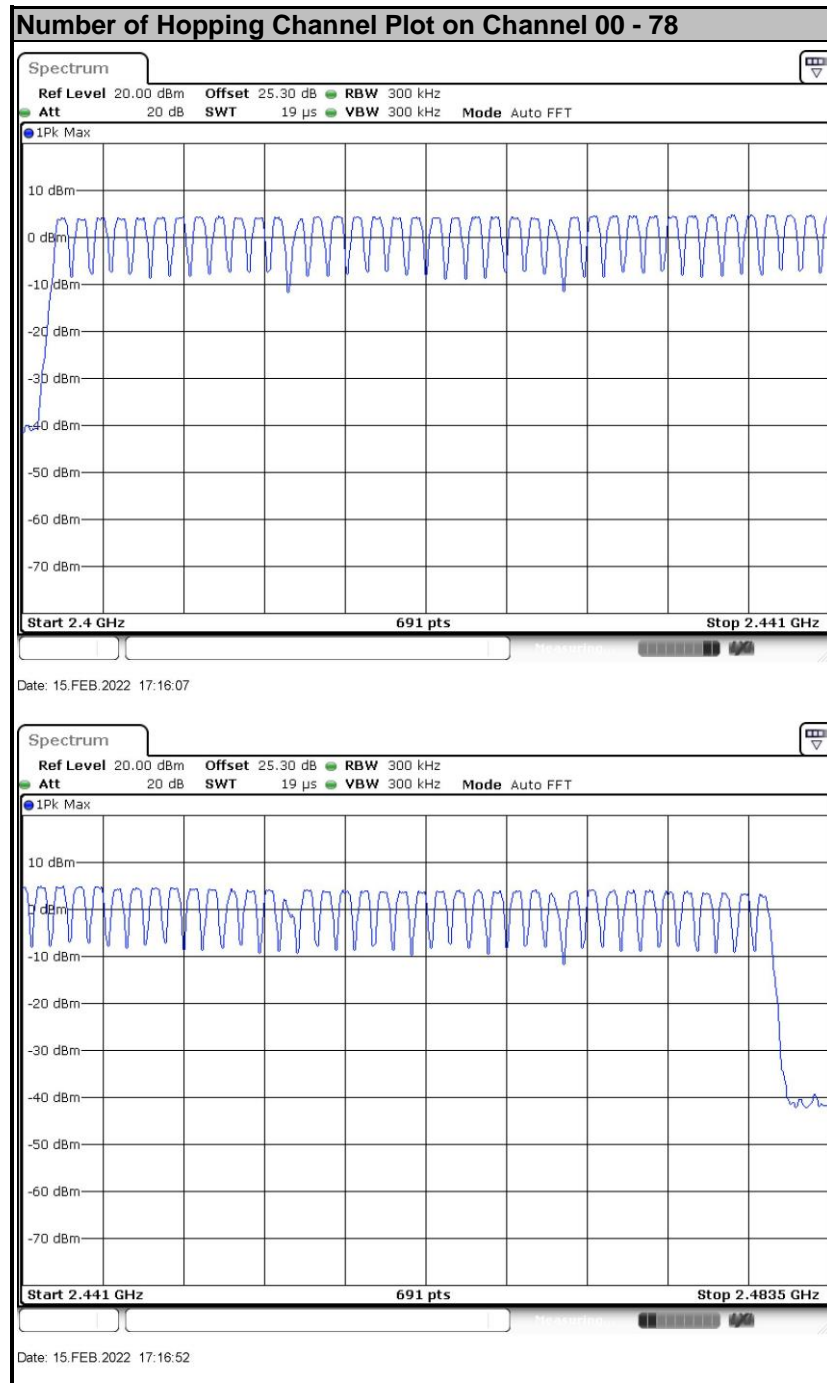

3.2 Hopping Channel Separation Measurement

3.2.1 Limit of Hopping Channel Separation

Frequency hopping systems operating in the 2400-2483.5 MHz band may have hopping channel carrier frequencies that are separated by 25 kHz or two-thirds of the 20 dB bandwidth of the hopping channel, whichever is greater.

3.2.2 Measuring Instruments

Please refer to the measuring equipment list in this test report.

3.2.3 Test Procedures

1. The testing follows ANSI C63.10-2013 clause 7.8.2.
2. The RF output of EUT is connected to the spectrum analyzer by RF cable and attenuator. The path loss is compensated to the results for each measurement.
3. Set the maximum power setting and enable the EUT to transmit continuously.
4. Enable the EUT hopping function.
5. Use the following spectrum analyzer settings:
Span = wide enough to capture the peaks of two adjacent channels;
RBW = 300 kHz; VBW \geq RBW; Sweep = auto; Detector function = peak; Trace = max hold.
6. Measure and record the results in the test report.

3.2.4 Test Setup

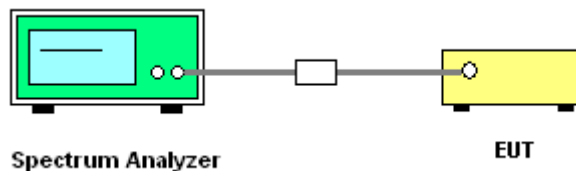



3.2.5 Test Result of Hopping Channel Separation

Test Engineer :	Mina Liu	Temperature :	21~25°C
		Relative Humidity :	51~54%

Mod.	Data Rate	NTX	CH.	Freq. (MHz)	Hopping Channel Separation Measurement (MHz)	Hopping Channel Separation Limit (MHz)	Pass/Fail
DH	1Mbps	1	0	2402	1.003	0.6039	Pass
DH	1Mbps	1	39	2441	1.003	0.6271	Pass
DH	1Mbps	1	78	2480	0.999	0.6059	Pass
2DH	2Mbps	1	0	2402	0.999	0.8365	Pass
2DH	2Mbps	1	39	2441	0.999	0.8393	Pass
2DH	2Mbps	1	78	2480	0.999	0.8393	Pass
3DH	3Mbps	1	0	2402	0.999	0.8162	Pass
3DH	3Mbps	1	39	2441	0.999	0.8307	Pass
3DH	3Mbps	1	78	2480	0.999	0.8162	Pass



<1Mbps>

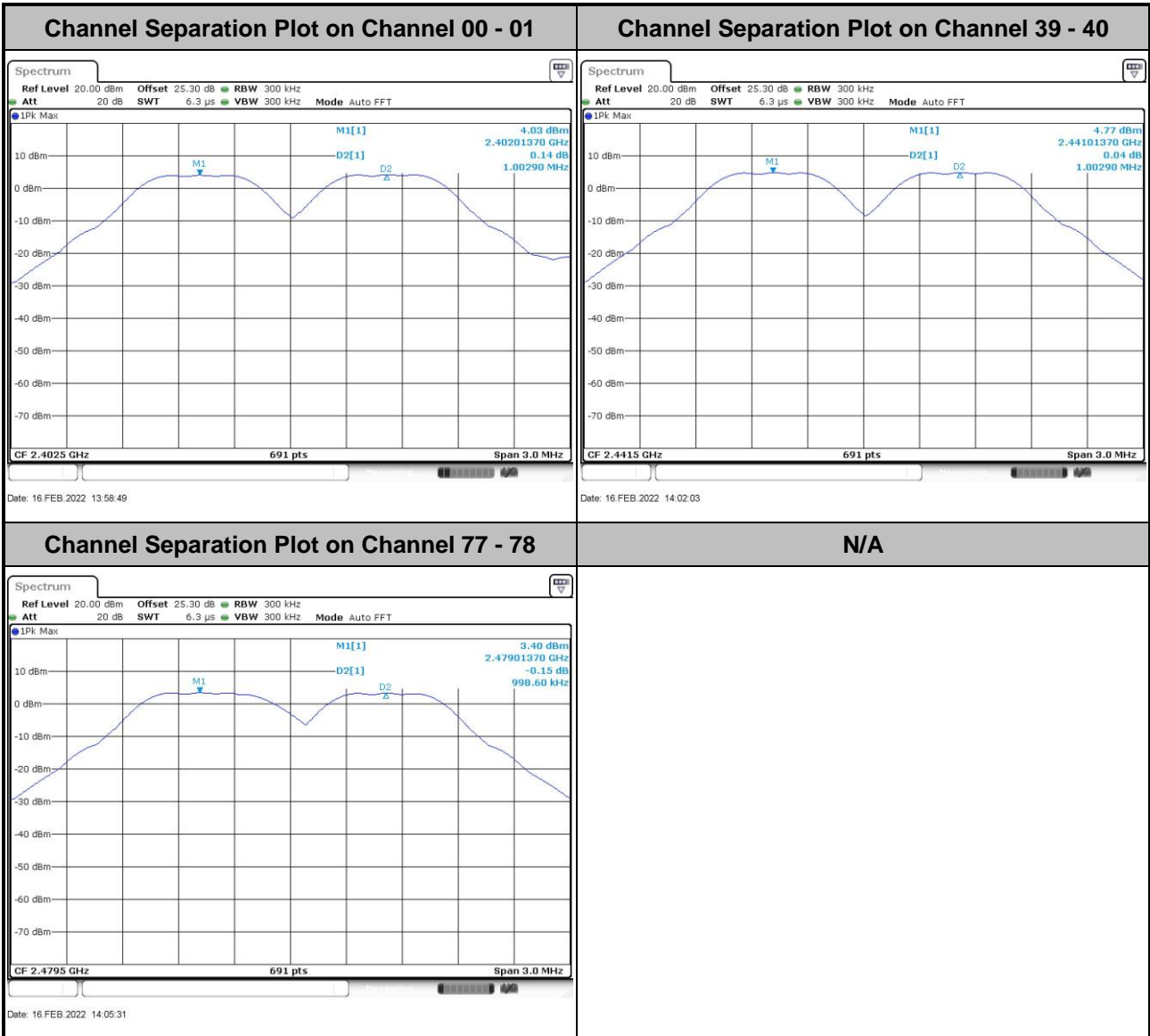



<2Mbps>

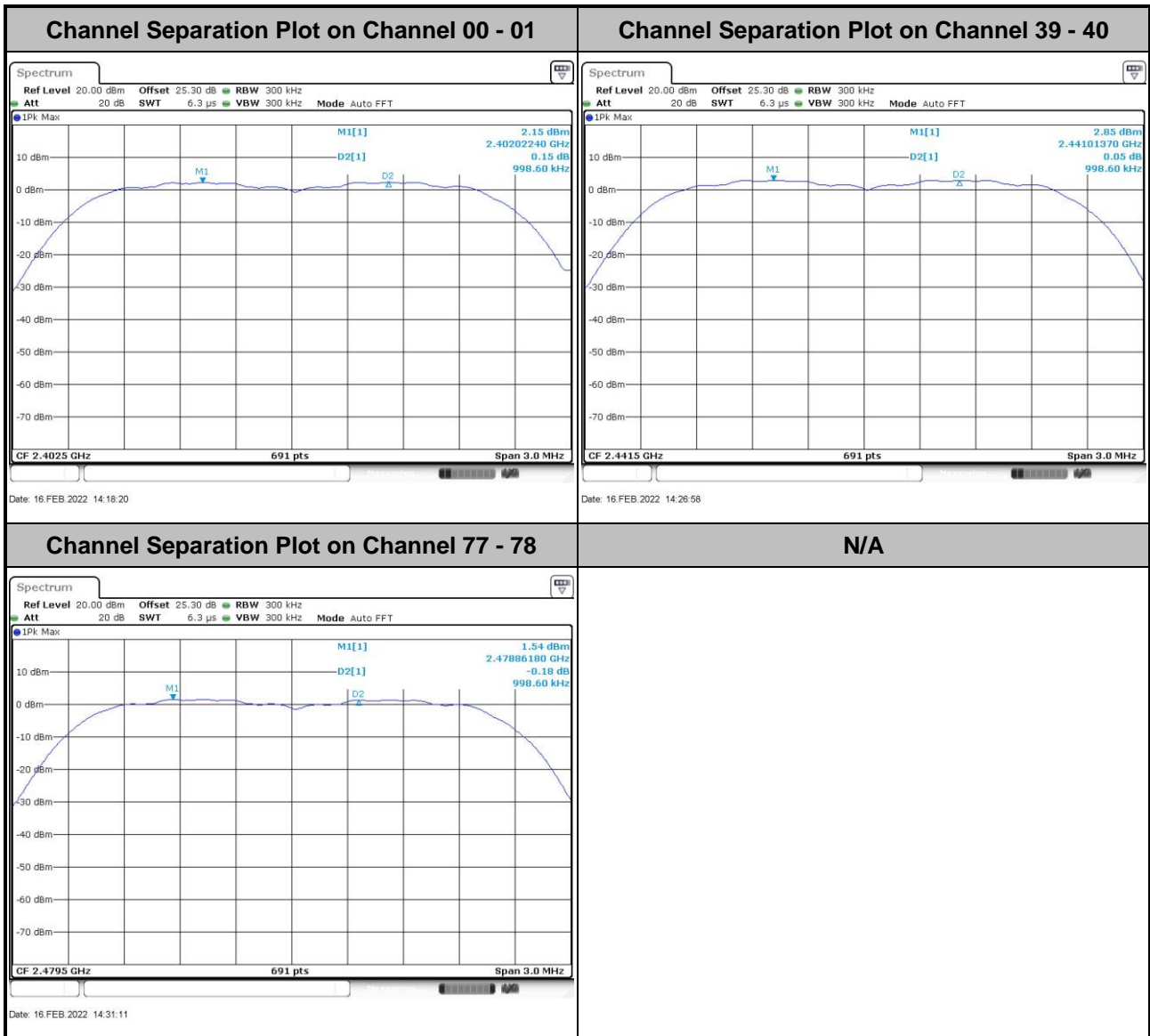



<3Mbps>

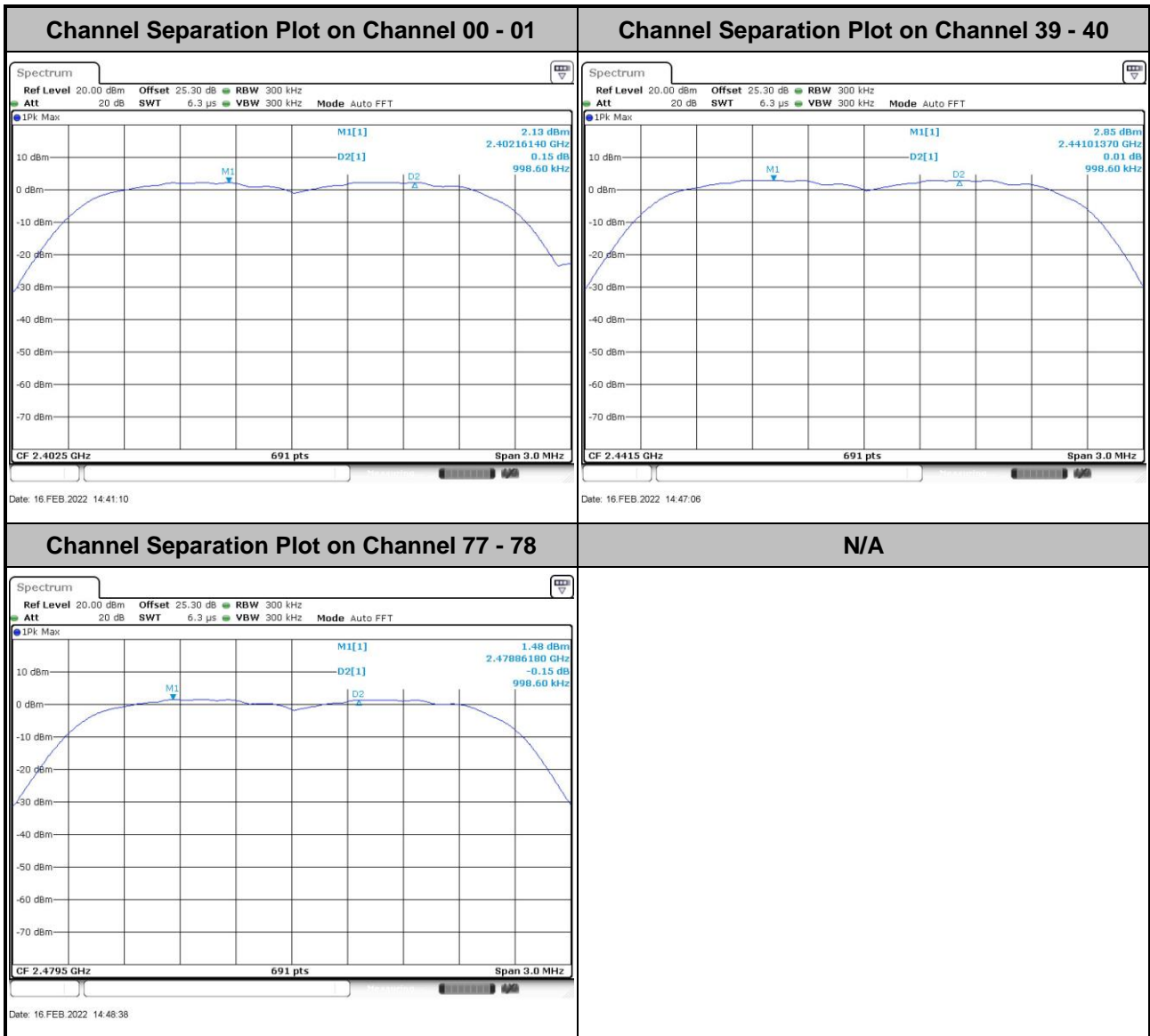

3.3 Dwell Time Measurement

3.3.1 Limit of Dwell Time

The average time of occupancy on any channel shall not be greater than 0.4 seconds within a period of 0.4 seconds multiplied by the number of hopping channels employed.

3.3.2 Measuring Instruments

Please refer to the measuring equipment list in this test report.

3.3.3 Test Procedures

1. The testing follows ANSI C63.10-2013 clause 7.8.4.
2. The RF output of EUT is connected to the spectrum analyzer by RF cable and attenuator. The path loss is compensated to the results for each measurement.
3. Set the maximum power setting and enable the EUT to transmit continuously.
4. Enable the EUT hopping function.
5. Use the following spectrum analyzer settings: Span = zero span, centered on a hopping channel; RBW = 1 MHz; VBW \geq RBW; Sweep = as necessary to capture the entire dwell time per hopping channel; Detector function = peak; Trace = max hold.
6. Measure and record the results in the test report.

3.3.4 Test Setup

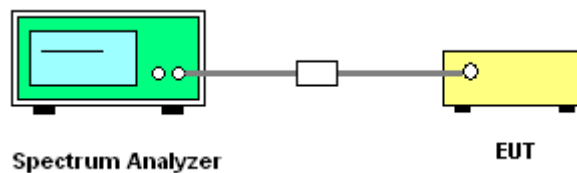



3.3.5 Test Result of Dwell Time

Test Engineer :	Mina Liu	Temperature :	21~25°C
		Relative Humidity :	51~54%

Mod.	Hopping Channel Number Rate	Hops Over Occupancy Time(hops)	Package Transfer Time (msec)	Dwell Time (sec)	Limits (sec)	Pass/Fail
Nomal	79	106.67	2.90	0.31	0.4	Pass
AFH	20	53.33	2.90	0.15	0.4	Pass

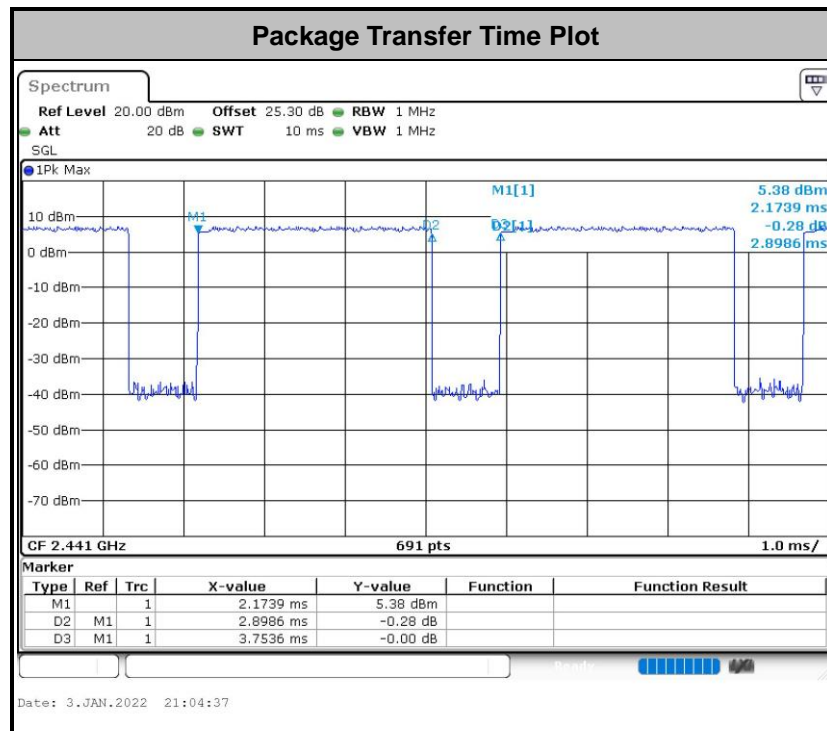

Remark:

- In normal mode, hopping rate is 1600 hops/s with 6 slots in 79 hopping channels. With channel hopping rate (1600 / 6 / 79) in Occupancy Time Limit (0.4 x 79) (s), Hops Over Occupancy Time comes to (1600 / 6 / 79) x (0.4 x 79) = 106.67 hops.
- In AFH mode, hopping rate is 800 hops/s with 6 slots in 20 hopping channels. With channel hopping rate (800 / 6 / 20) in Occupancy Time Limit (0.4 x 20) (s), Hops Over Occupancy Time comes to (800 / 6 / 20) x (0.4 x 20) = 53.33 hops.
- Dwell Time(s) = Hops Over Occupancy Time (hops) x Package Transfer Time

3.4 20dB and 99% Bandwidth Measurement

3.4.1 Limit of 20dB and 99% Bandwidth

Reporting only

3.4.2 Measuring Instruments

Please refer to the measuring equipment list in this test report.

3.4.3 Test Procedures

1. The testing follows ANSI C63.10-2013 clause 6.9.2 and 6.9.3.
2. The RF output of EUT is connected to the spectrum analyzer by RF cable and attenuator. The path loss is compensated to the results for each measurement.
3. Set the maximum power setting and enable the EUT to transmit continuously.
4. Use the following spectrum analyzer settings for 20 dB Bandwidth measurement.
Span = approximately 2 to 5 times the 20 dB bandwidth, centered on a hopping channel;
RBW \geq 1% of the 20 dB bandwidth; VBW \geq RBW; Sweep = auto; Detector function = peak;
Trace = max hold.
5. Use the following spectrum analyzer settings for 99 % Bandwidth measurement.
Span = approximately 1.5 to 5 times the 99% bandwidth, centered on a hopping channel;
RBW \geq 1-5% of the 99% bandwidth; VBW \geq 3 * RBW; Sweep = auto; Detector function = peak;
Trace = max hold.
6. Measure and record the results in the test report.

3.4.4 Test Setup





3.4.5 Test Result of 20dB Bandwidth

Test Engineer :	Mina Liu	Temperature :	21~25°C
		Relative Humidity :	51~54%

Mod.	Data Rate	NTX	CH.	Freq. (MHz)	20db BW (MHz)	Pass/Fail
DH	1Mbps	1	0	2402	0.906	Pass
DH	1Mbps	1	39	2441	0.941	Pass
DH	1Mbps	1	78	2480	0.909	Pass
2DH	2Mbps	1	0	2402	1.255	Pass
2DH	2Mbps	1	39	2441	1.259	Pass
2DH	2Mbps	1	78	2480	1.259	Pass
3DH	3Mbps	1	0	2402	1.224	Pass
3DH	3Mbps	1	39	2441	1.246	Pass
3DH	3Mbps	1	78	2480	1.224	Pass



<1Mbps>

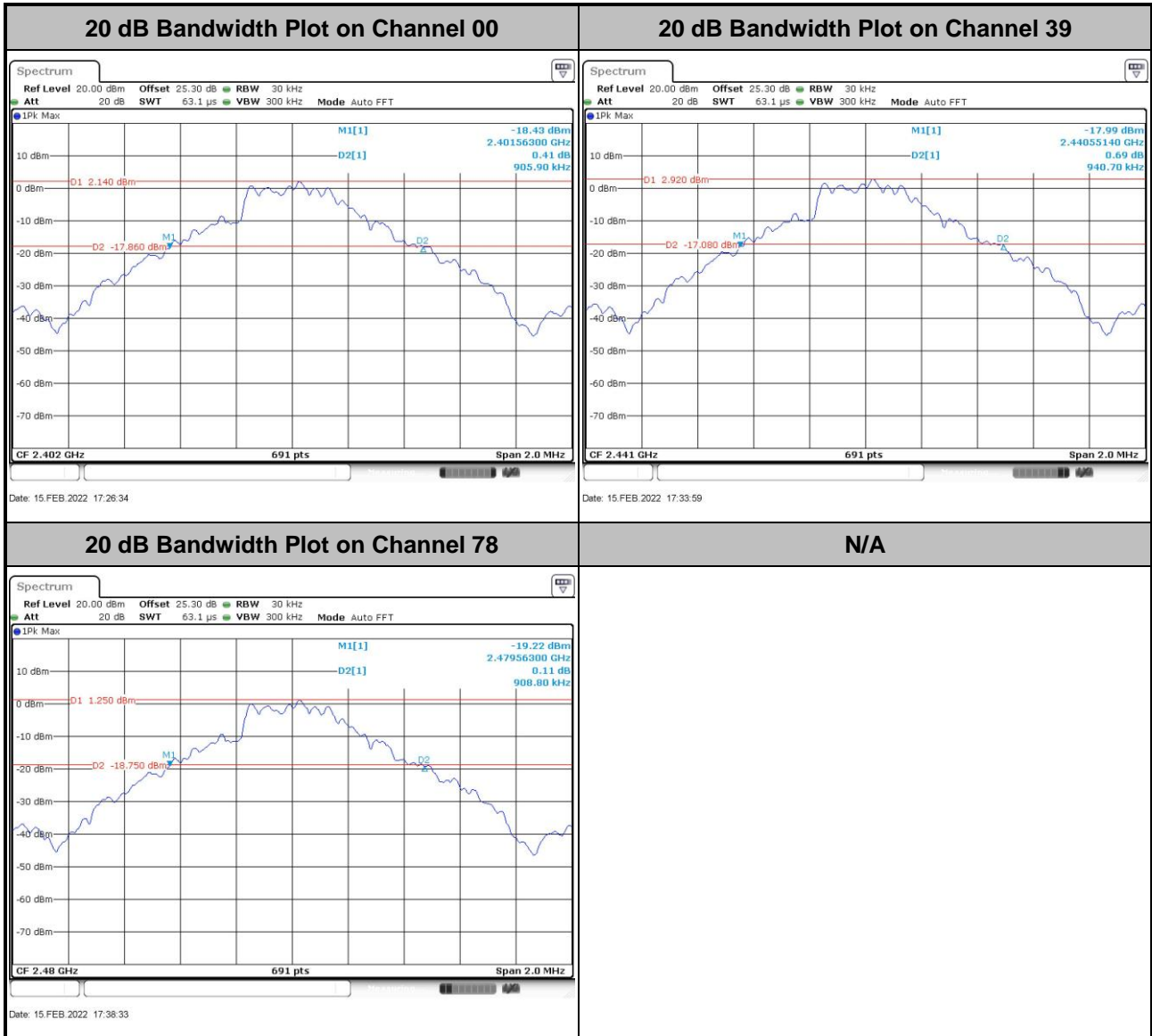



<2Mbps>

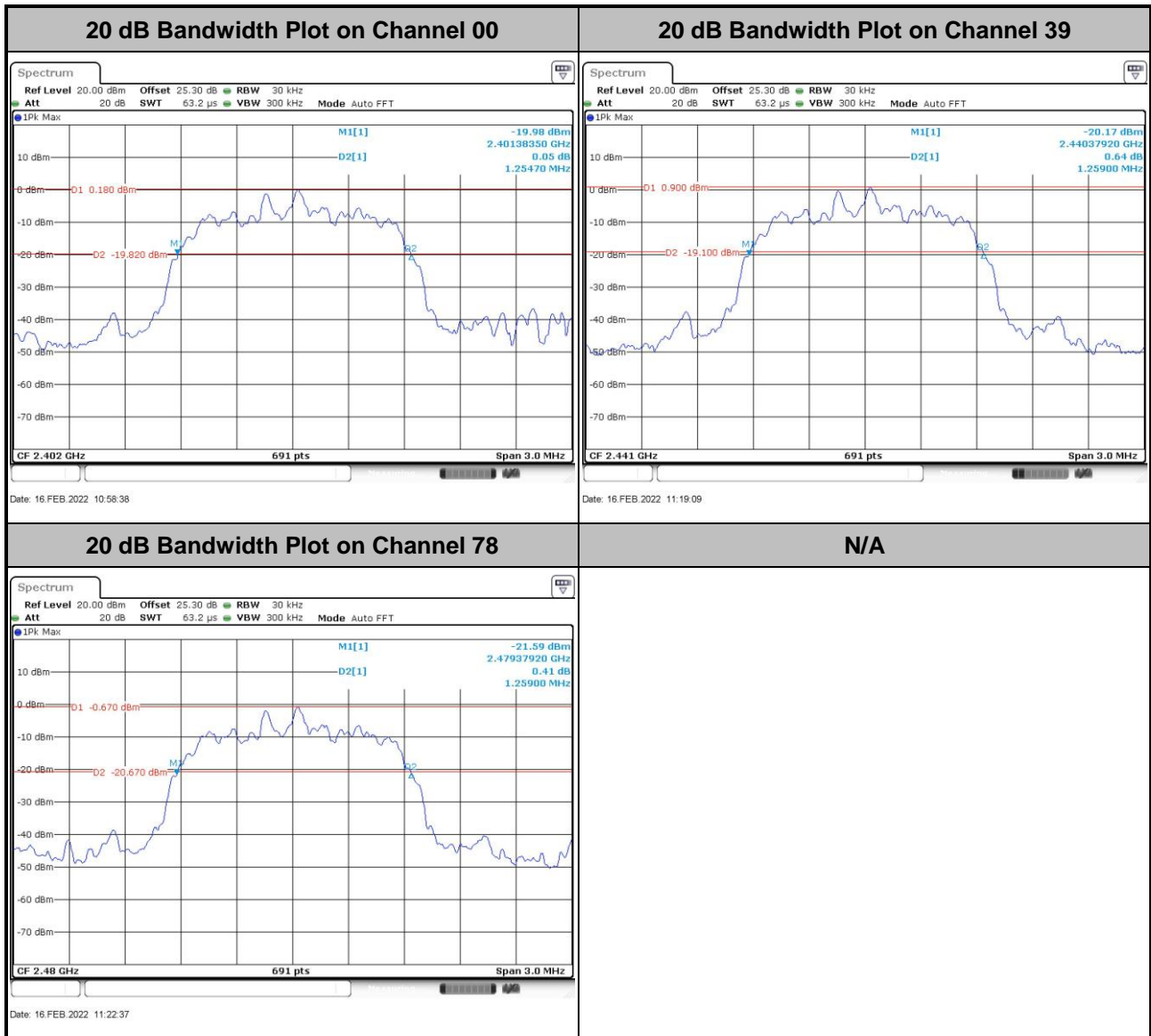



<3Mbps>

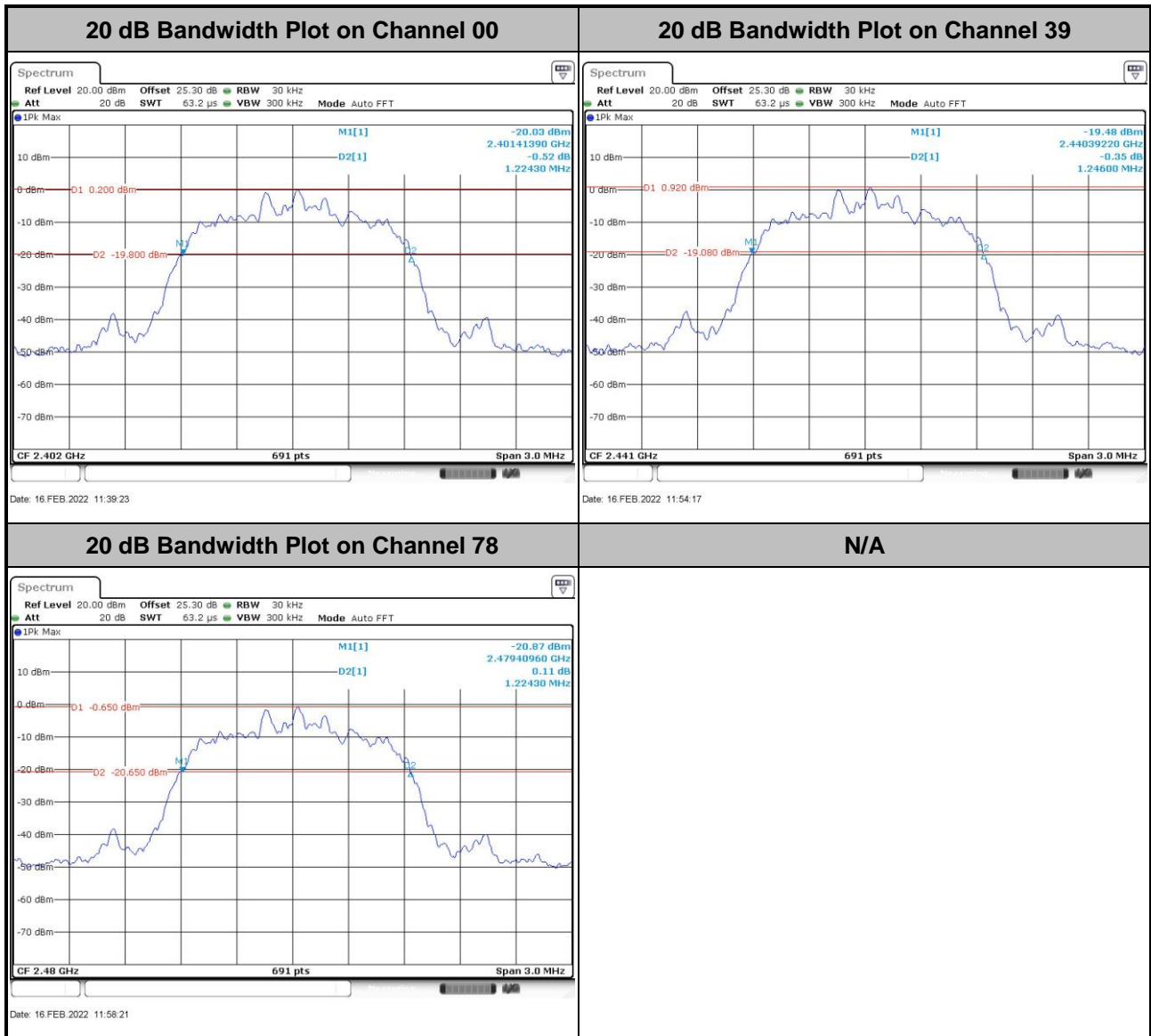



3.4.6 Test Result of 99% Occupied Bandwidth

Test Engineer :	Mina Liu	Temperature :	21~25°C
		Relative Humidity :	51~54%

Mod.	Data Rate	NTX	CH.	Freq. (MHz)	99% Bandwidth (MHz)	Pass/Fail
DH	1Mbps	1	0	2402	0.863	Pass
DH	1Mbps	1	39	2441	0.863	Pass
DH	1Mbps	1	78	2480	0.863	Pass
2DH	2Mbps	1	0	2402	1.169	Pass
2DH	2Mbps	1	39	2441	1.164	Pass
2DH	2Mbps	1	78	2480	1.164	Pass
3DH	3Mbps	1	0	2402	1.149	Pass
3DH	3Mbps	1	39	2441	1.146	Pass
3DH	3Mbps	1	78	2480	1.146	Pass



<1Mbps>

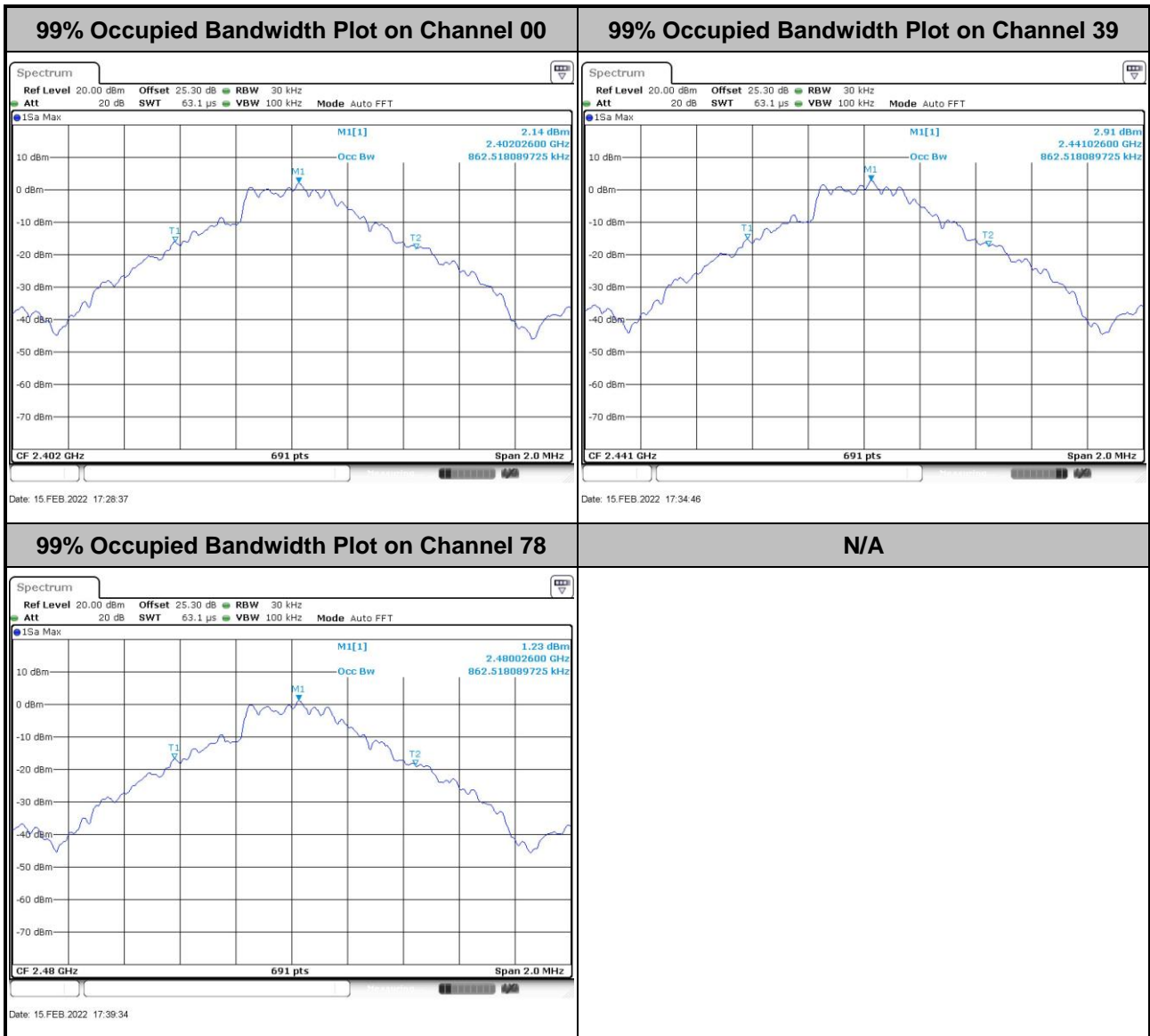

Note: The occupied channel bandwidth is maintained within the band of operation for all of the modulations.



<2Mbps>

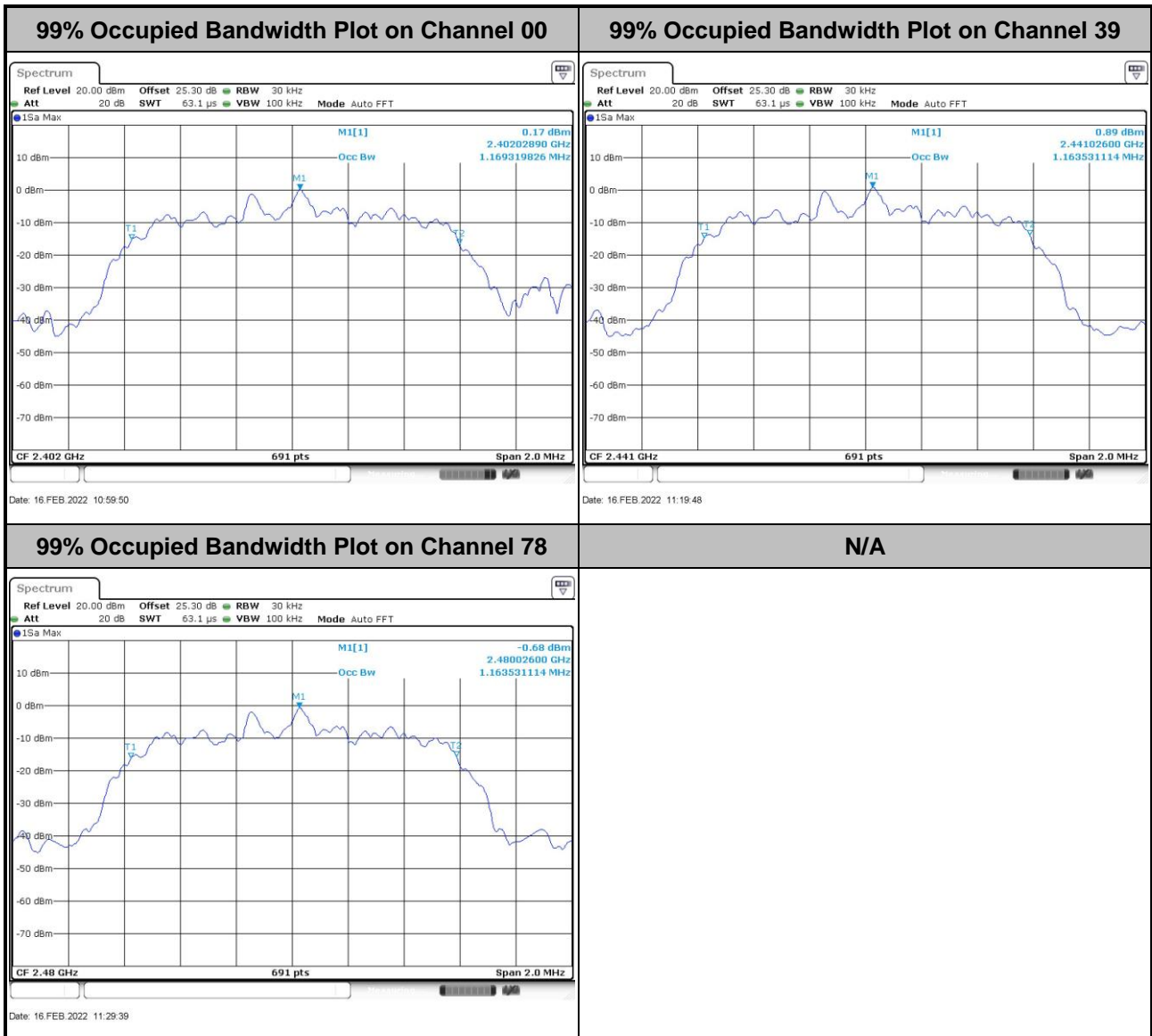

Note: The occupied channel bandwidth is maintained within the band of operation for all of the modulations.



<3Mbps>

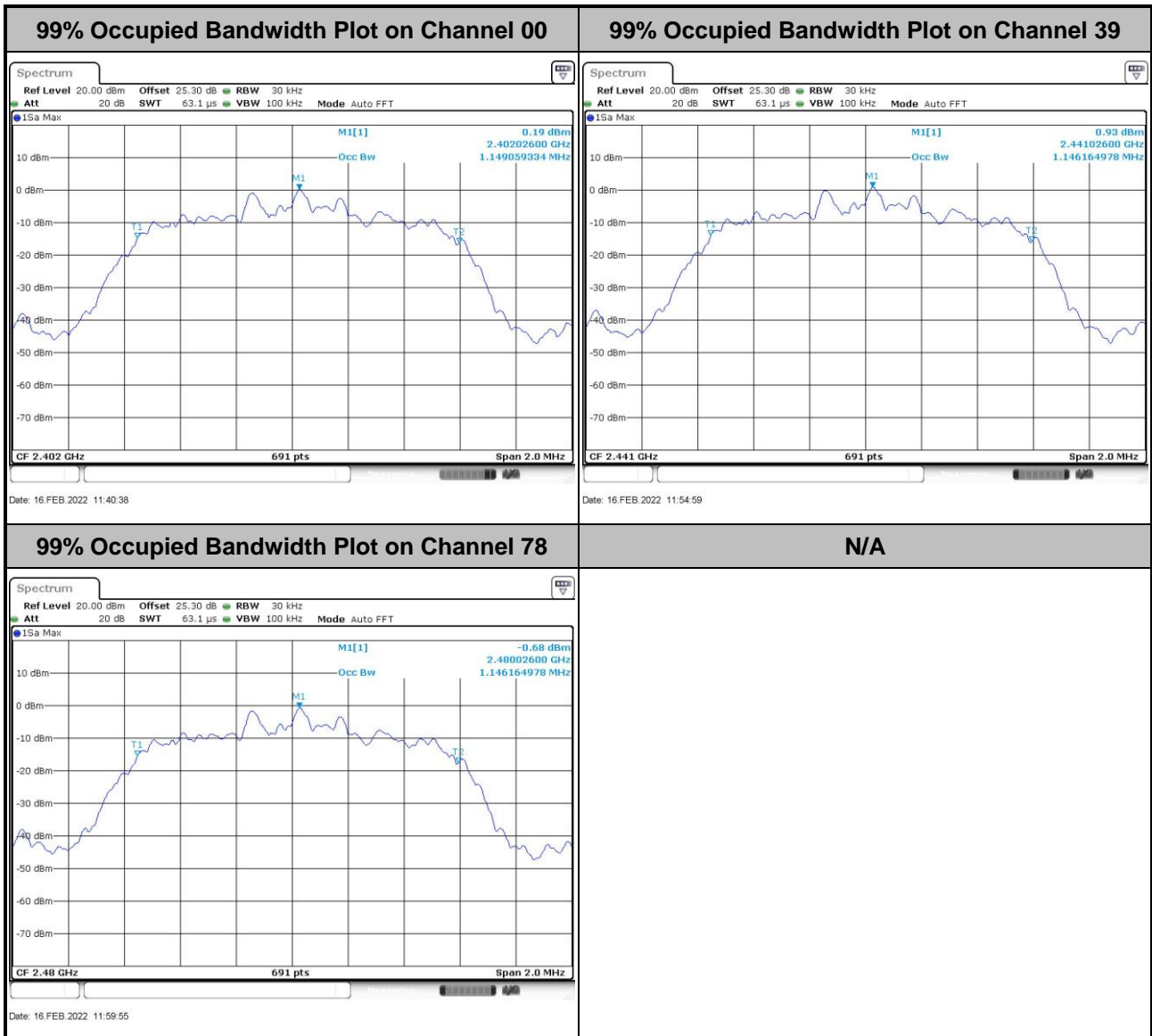

Note: The occupied channel bandwidth is maintained within the band of operation for all of the modulations.

3.5 Output Power Measurement

3.5.1 Limit of Output Power

The maximum peak conducted output power of the intentional radiator shall not exceed the following:
For frequency hopping systems operating in the 2400-2483.5 MHz band employing at least 75 non-overlapping hopping channels, and all frequency hopping systems in the 5725-5850 MHz band: 1 watt. For all other frequency hopping systems in the 2400-2483.5 MHz band 0.125 watts.

3.5.2 Measuring Instruments

Please refer to the measuring equipment list in this test report.

3.5.3 Test Procedures

1. The testing follows ANSI C63.10-2013 clause 7.8.5.
2. The RF output of EUT is connected to the power meter by RF cable and attenuator. The path loss is compensated to the results for each measurement.
3. Set the maximum power setting and enable the EUT to transmit continuously.
4. Measure the conducted output power with cable loss and record the results in the test report.
5. Measure and record the results in the test report.

3.5.4 Test Setup

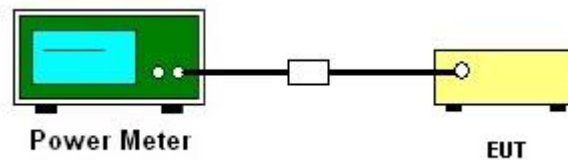



3.5.5 Test Result of Peak Output Power

Test Engineer :	Mina Liu	Temperature :	21~25°C
		Relative Humidity :	51~54%

DH	CH.	NTX	Peak Power (dBm)	Power Limit (dBm)	Test Result
DH1	0	1	6.53	20.97	Pass
	39	1	7.04	20.97	Pass
	78	1	5.90	20.97	Pass
2DH1	0	1	6.06	20.97	Pass
	39	1	6.40	20.97	Pass
	78	1	5.51	20.97	Pass
3DH1	0	1	6.11	20.97	Pass
	39	1	6.69	20.97	Pass
	78	1	5.71	20.97	Pass

3.5.6 Test Result of Average Output Power (Reporting Only)

Test Engineer :	Mina Liu	Temperature :	21~25°C
		Relative Humidity :	51~54%

DH	CH.	NTX	Average Power (dBm)	Duty Factor (dB)
DH1	0	1	5.38	5.18
	39	1	6.01	5.18
	78	1	4.38	5.18
2DH1	0	1	3.13	5.12
	39	1	3.57	5.12
	78	1	2.81	5.12
3DH1	0	1	3.36	5.08
	39	1	3.65	5.08
	78	1	2.98	5.08

3.6 Conducted Band Edges Measurement

3.6.1 Limit of Band Edges

In any 100 kHz bandwidth outside the intentional radiation frequency band, the radio frequency power shall be at least 20 dB below the highest level of the radiated power. In addition, radiated emissions which fall in the restricted bands must also comply with the radiated emission limits.

3.6.2 Measuring Instruments

Please refer to the measuring equipment list in this test report.

3.6.3 Test Procedures

1. The testing follows ANSI C63.10-2013 clause 7.8.6.
2. Set the maximum power setting and enable the EUT to transmit continuously.
3. Set RBW = 100 kHz, VBW = 300 kHz. Band edge emissions must be at least 20 dB down from the highest emission level within the authorized band as measured with a 100 kHz RBW. The attenuation shall be 30 dB instead of 20 dB when RMS conducted output power procedure is used.
4. Enable hopping function of the EUT and then repeat step 2 and 3.
5. Measure and record the results in the test report.

3.6.4 Test Setup

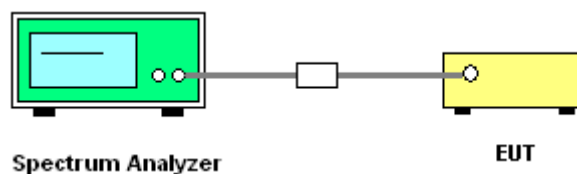



3.6.5 Test Result of Conducted Band Edges

<1Mbps>

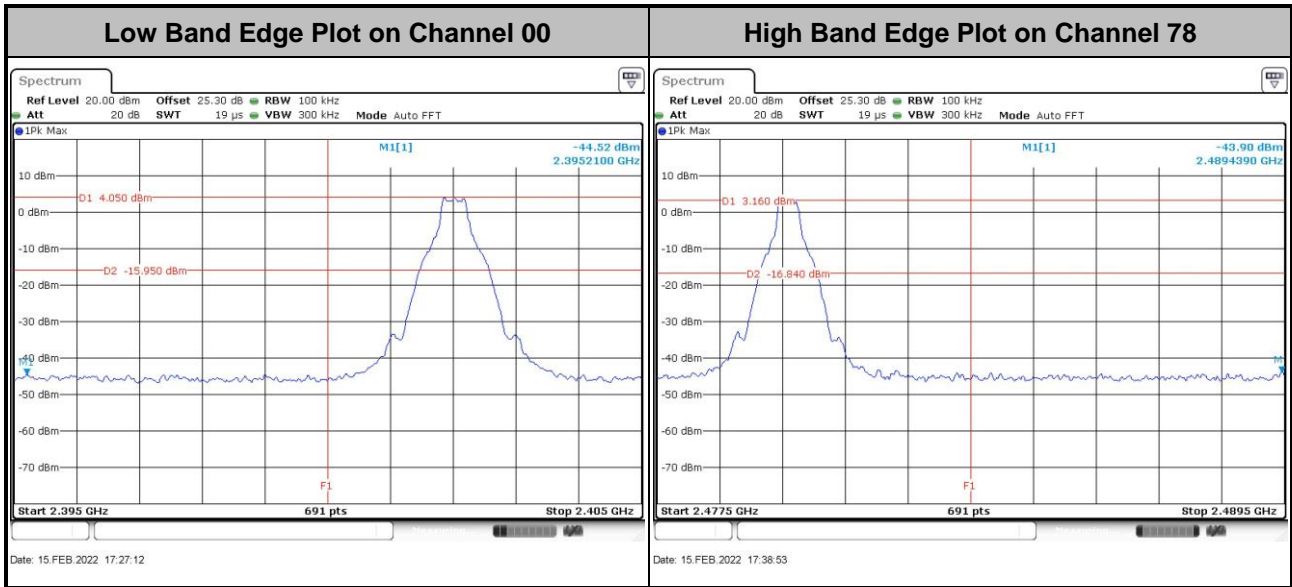

<2Mbps>

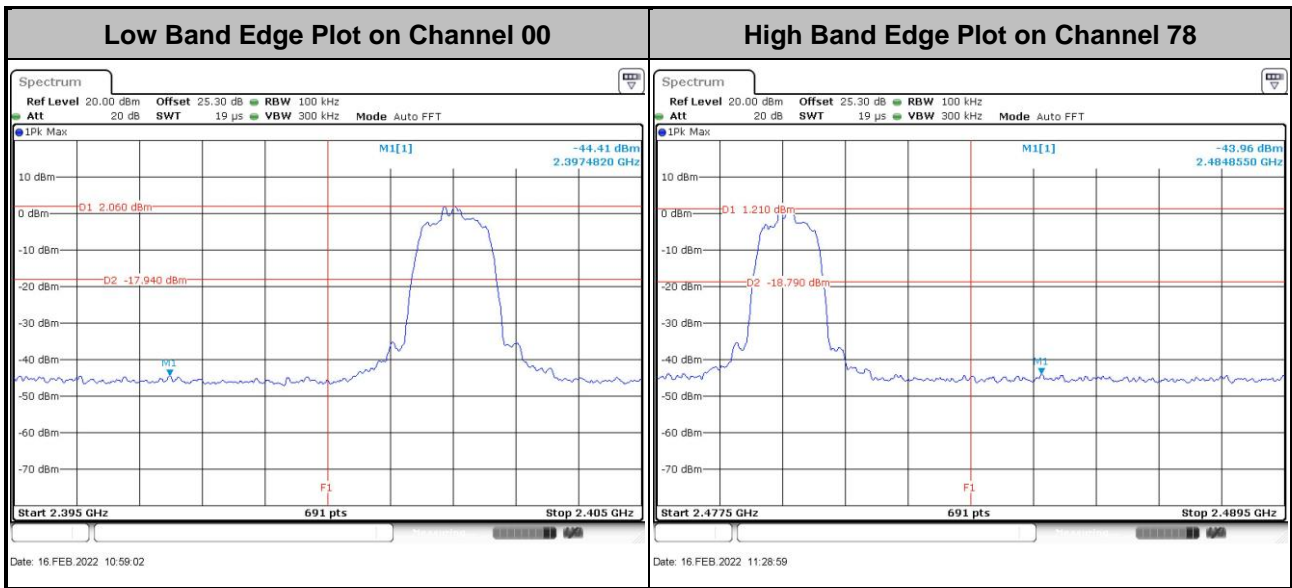



<3Mbps>

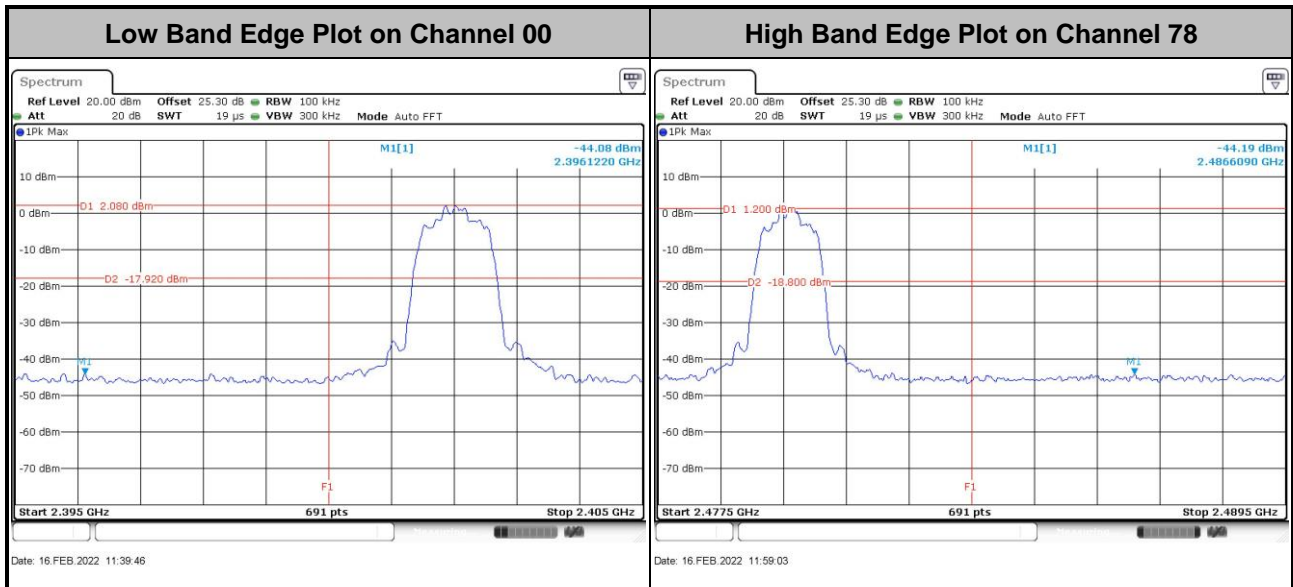



3.6.6 Test Result of Conducted Hopping Mode Band Edges

<1Mbps>

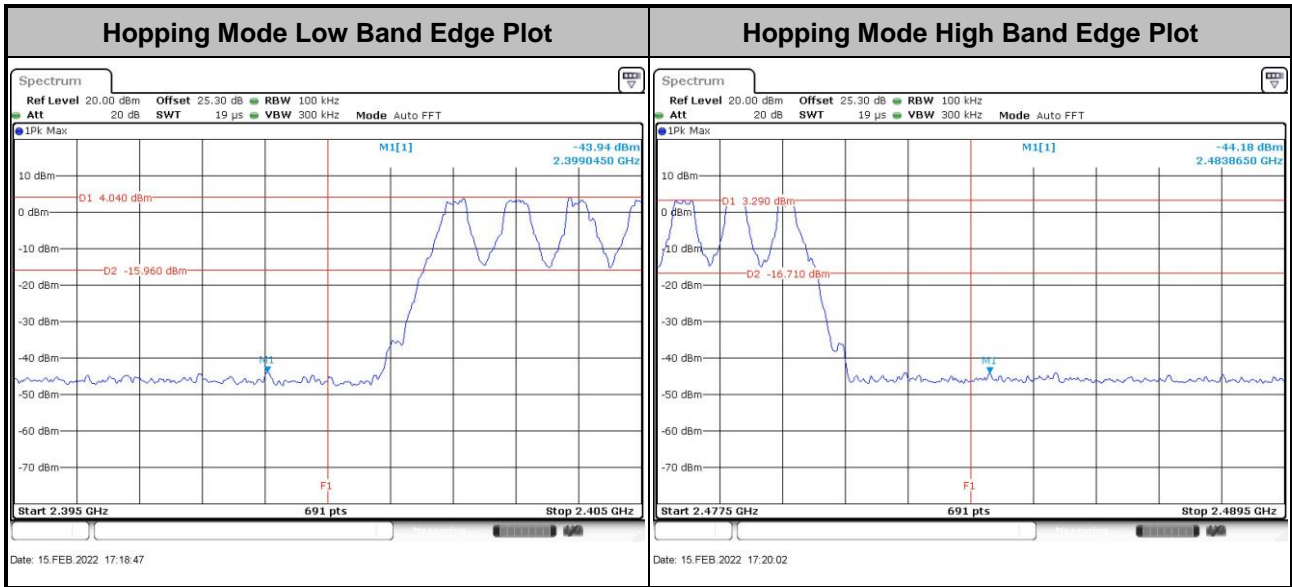

<2Mbps>

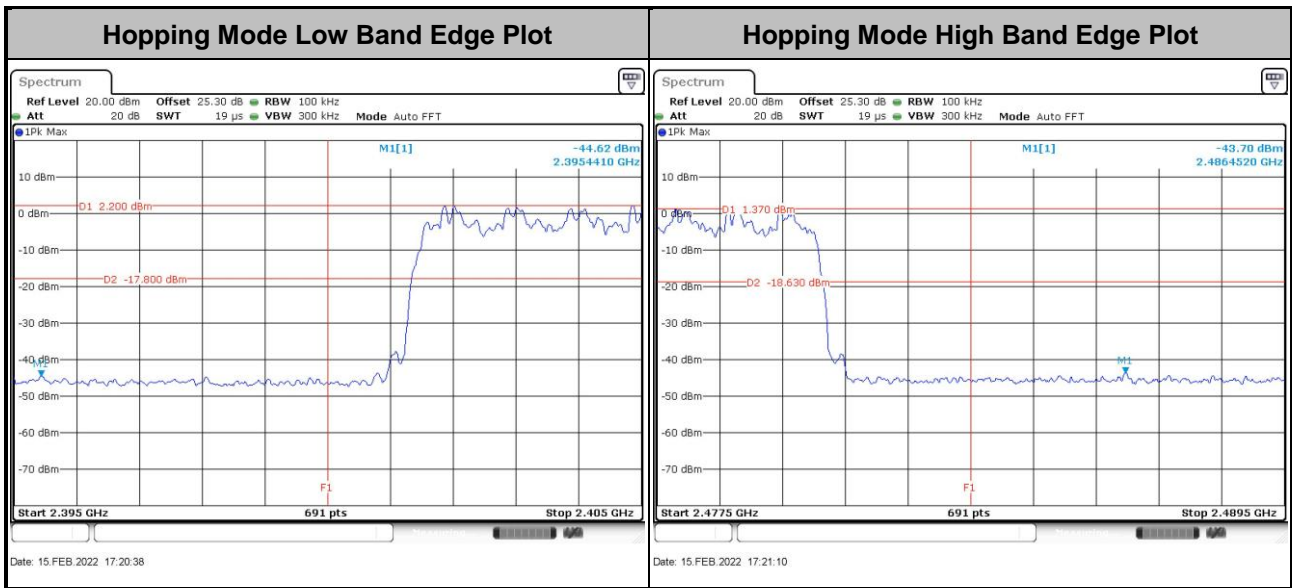



<3Mbps>

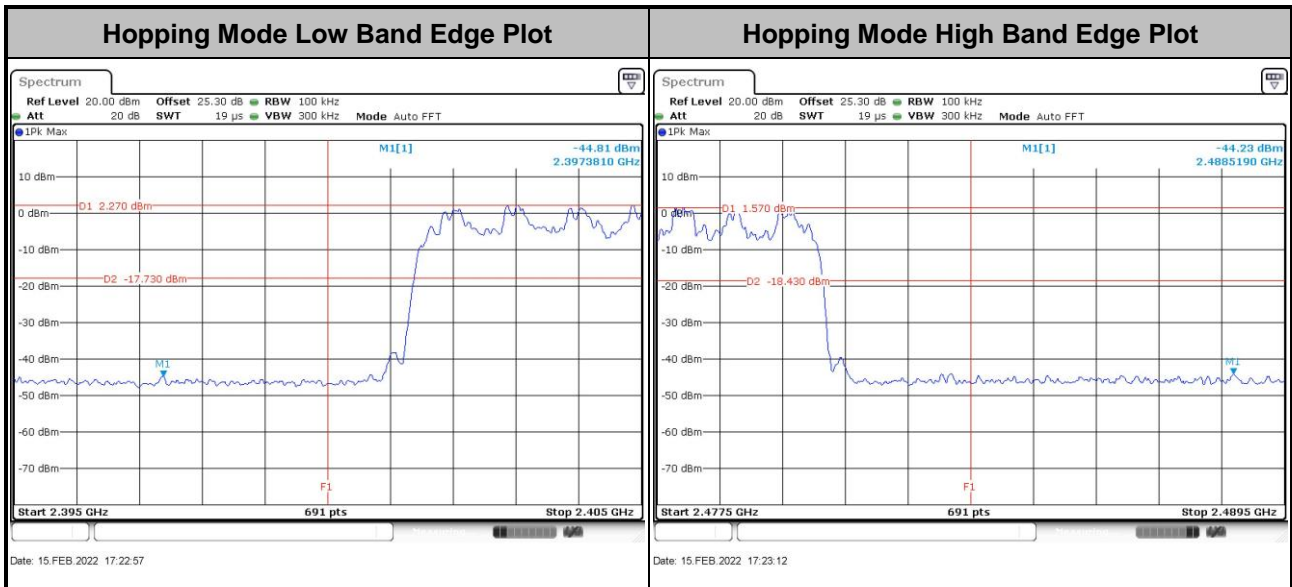

3.7 Conducted Spurious Emission Measurement

3.7.1 Limit of Spurious Emission Measurement

In any 100 kHz bandwidth outside the intentional radiation frequency band, the radio frequency power shall be at least 20 dB below the highest level of the radiated power. In addition, radiated emissions which fall in the restricted bands must also comply with the radiated emission limits.

3.7.2 Measuring Instruments

Please refer to the measuring equipment list in this test report.

3.7.3 Test Procedure

1. The testing follows ANSI C63.10-2013 clause 7.8.8.
2. The RF output of EUT is connected to the spectrum analyzer by RF cable and attenuator. The path loss is compensated to the results for each measurement.
3. Set the maximum power setting and enable the EUT to transmit continuously.
4. Set RBW = 100 kHz, VBW = 300 kHz, scan up through 10th harmonic. All harmonics / spurious must be at least 20 dB down from the highest emission level within the authorized band as measured with a 100 kHz RBW.
5. Measure and record the results in the test report.
6. The RF fundamental frequency should be excluded against the limit line in the operating frequency band.

3.7.4 Test Setup

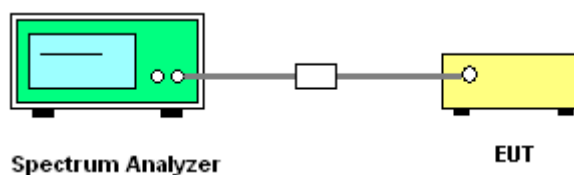



3.7.5 Test Result of Conducted Spurious Emission

<1Mbps>

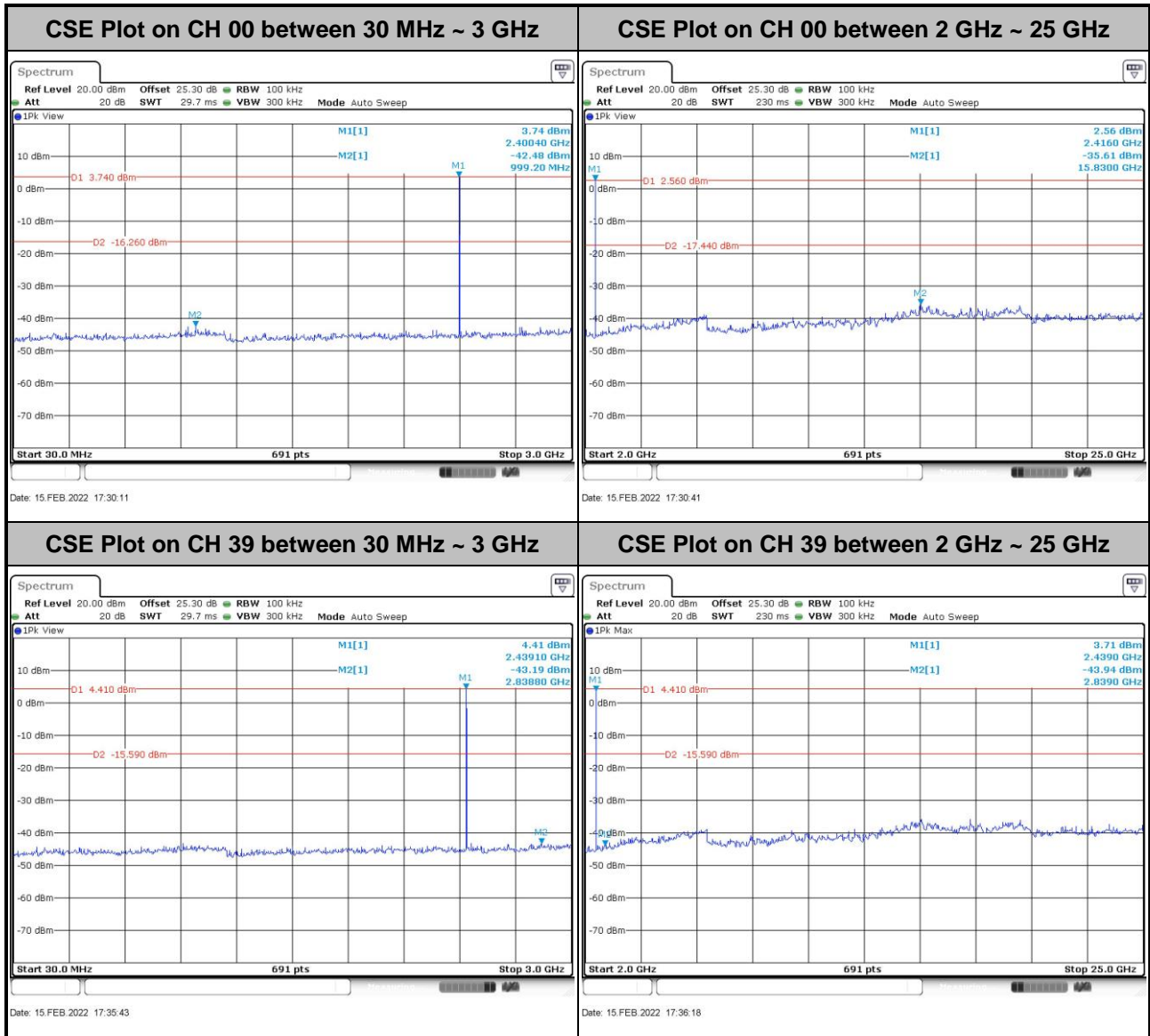

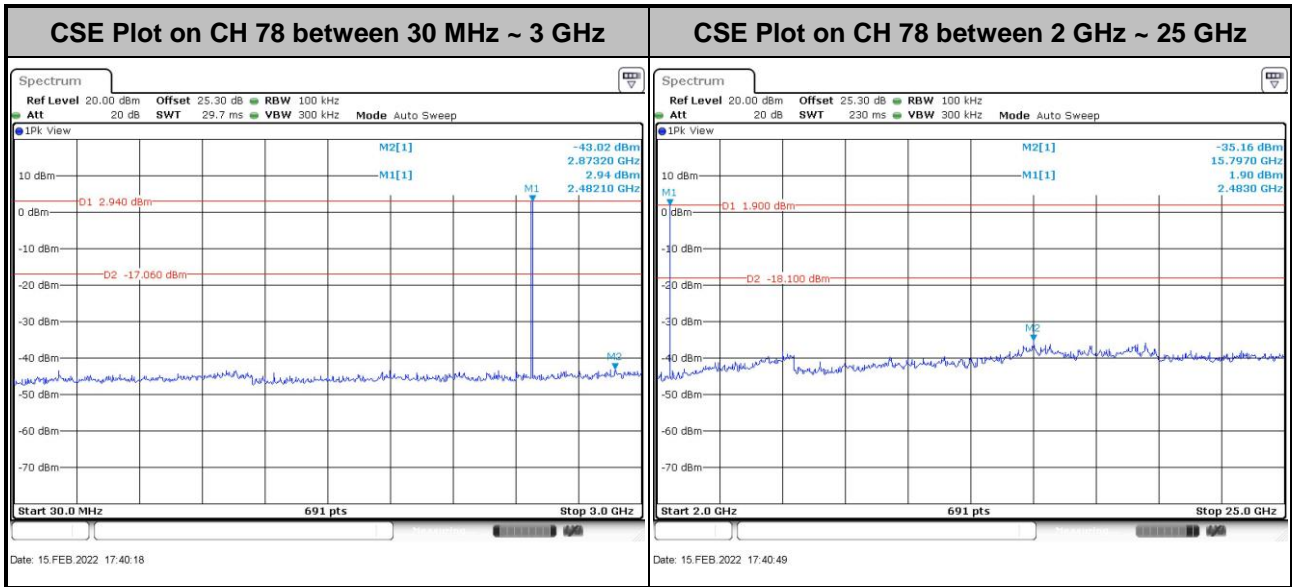



<2Mbps>

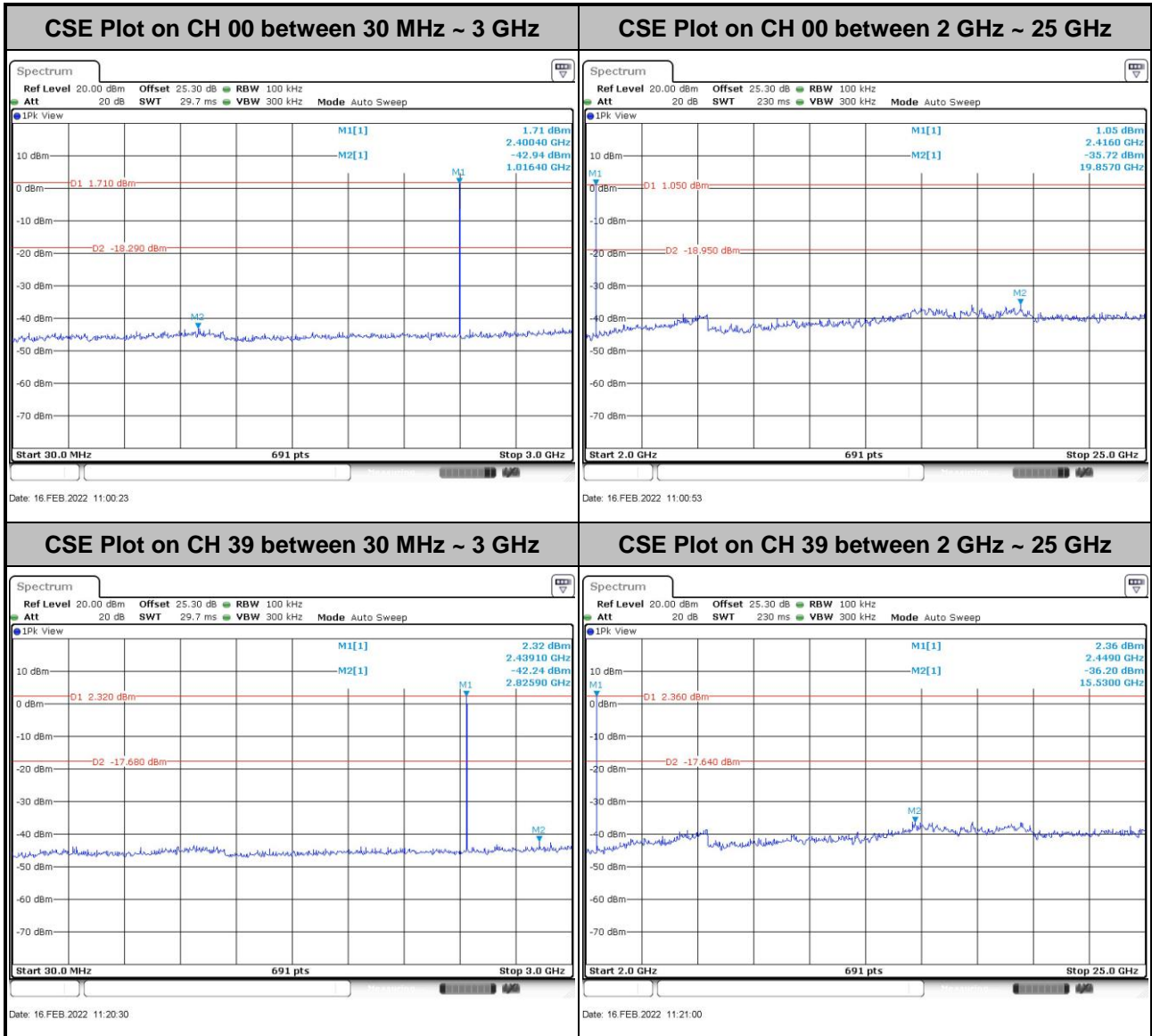

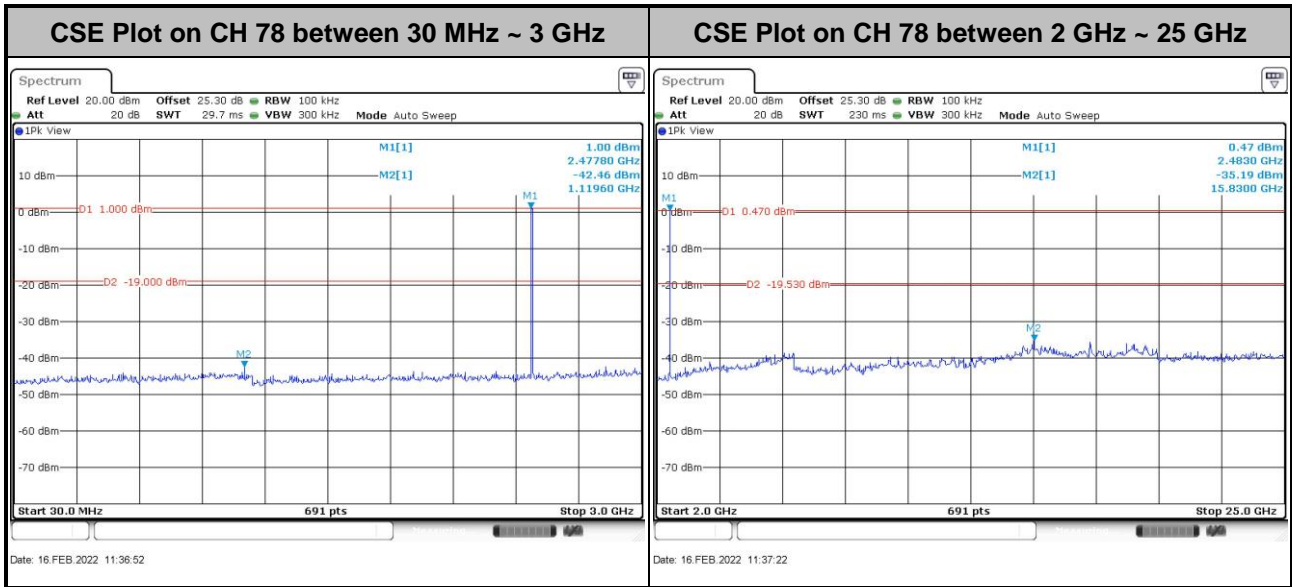



<3Mbps>

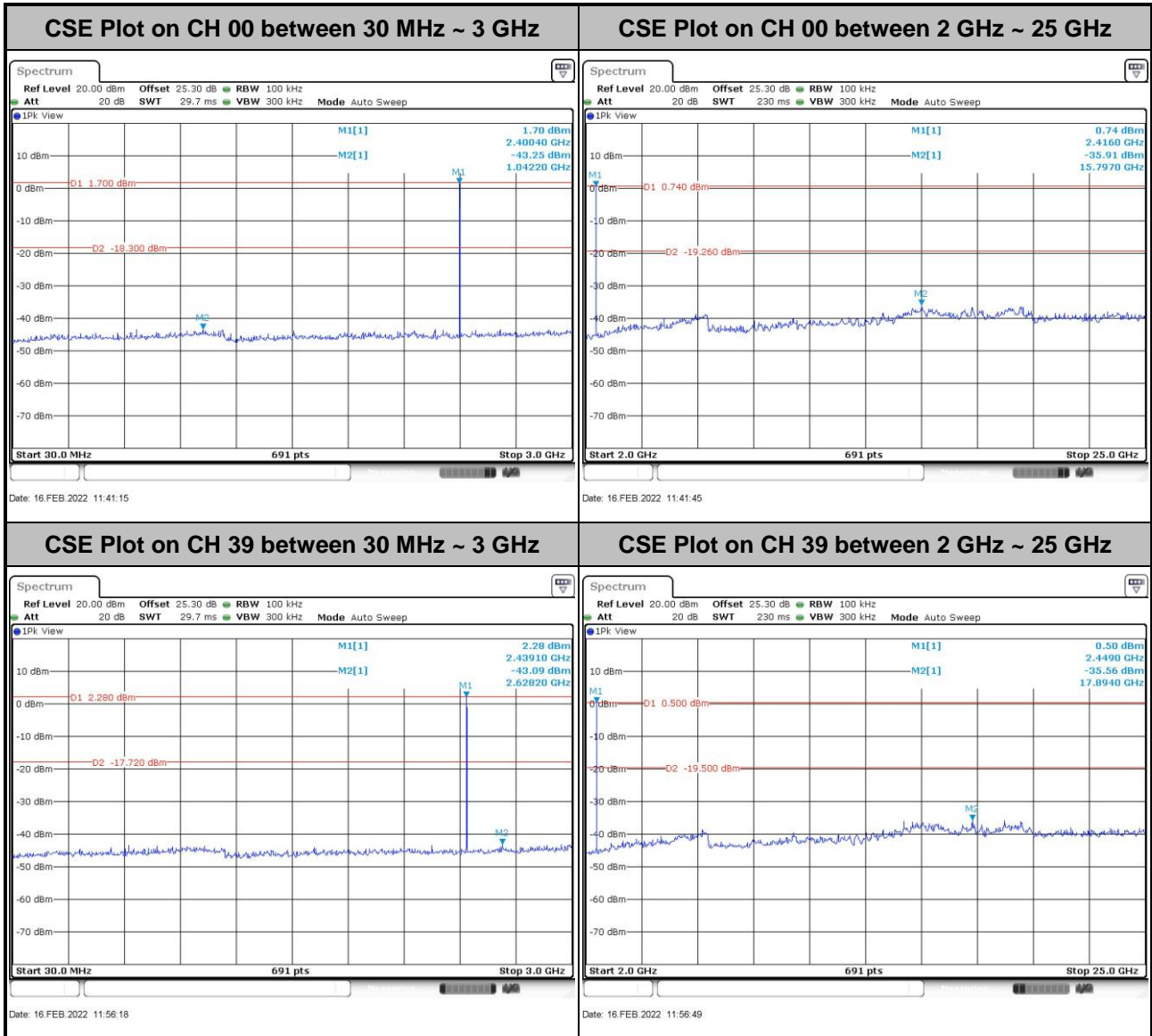

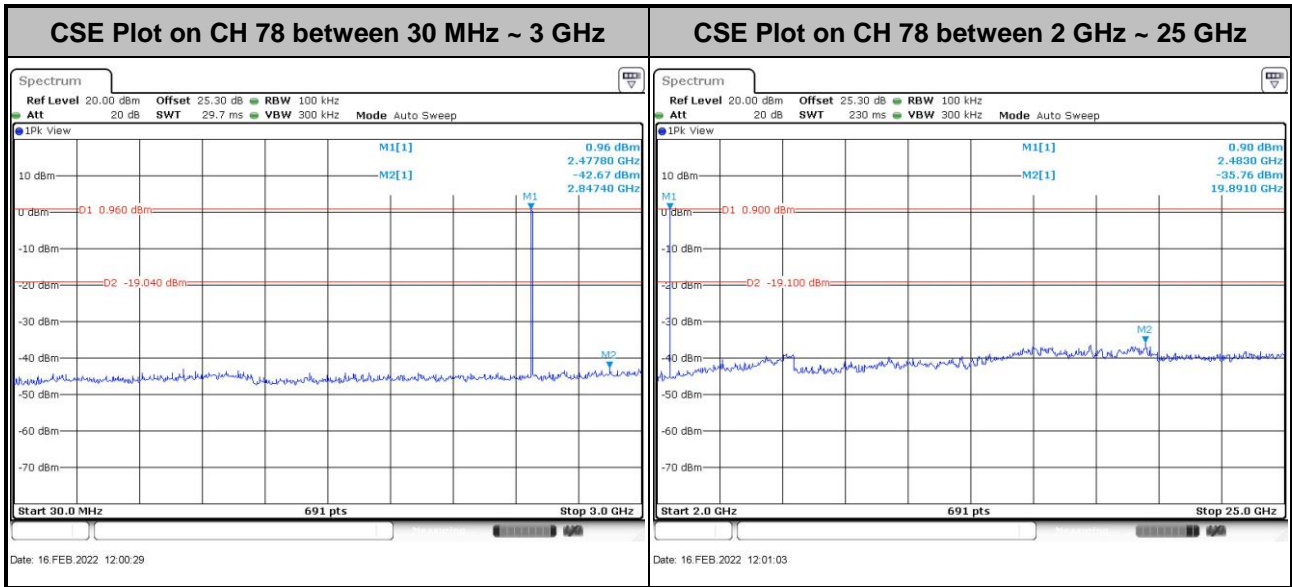



3.8 Radiated Band Edges and Spurious Emission Measurement

3.8.1 Limit of Radiated Band Edges and Spurious Emission

In any 100 kHz bandwidth outside the intentional radiator frequency band, all harmonics / spurious must be at least 20 dB below the highest emission level within the authorized band. In addition, radiated emissions which fall in the restricted bands must also comply with the limits as below.

Frequency (MHz)	Field Strength (microvolts/meter)	Measurement Distance (meters)
0.009 – 0.490	2400/F(kHz)	300
0.490 – 1.705	24000/F(kHz)	30
1.705 – 30.0	30	30
30 – 88	100	3
88 – 216	150	3
216 - 960	200	3
Above 960	500	3

3.8.2 Measuring Instruments

Please refer to the measuring equipment list in this test report.



3.8.3 Test Procedures

1. The EUT is placed on a turntable with 0.8 meter for frequency below 1 GHz and 1.5 meter for frequency above 1 GHz respectively above ground.
2. The EUT is set 3 meters away from the receiving antenna, which is mounted on the top of a variable height antenna tower.
3. For each suspected emission, the EUT is arranged to its worst case and then tune the Antenna tower (from 1 m to 4 m) and turntable (from 0 degree to 360 degrees) to find the maximum reading. A pre-amp and a high pass filter are used for the test in order to get better signal level to comply with the guidelines.
4. Set the maximum power setting and enable the EUT to transmit continuously.
5. Use the following spectrum analyzer settings:
 - (1) Span shall wide enough to fully capture the emission being measured;
 - (2) Set RBW = 100 kHz for $f < 1$ GHz, RBW = 1 MHz for $f > 1$ GHz ; VBW \geq RBW; Sweep = auto; Detector function = peak; Trace = max hold for peak
 - (3) For average measurement: use duty cycle correction factor method per 15.35(c).
Duty cycle = On time/100 milliseconds
On time = $N_1 * L_1 + N_2 * L_2 + \dots + N_{n-1} * L_{n-1} + N_n * L_n$
Where N_1 is number of type 1 pulses, L_1 is length of type 1 pulses, etc.
Average Emission Level = Peak Emission Level + $20 * \log$ (Duty cycle)
6. Corrected Reading: Antenna Factor + Cable Loss + Read Level - Preamp Factor = Level
7. Radiated testing below 1 GHz is performed by adjusting the antenna tower from 1 m to 4 m and by rotating the turn table from 0 degree to 360 degrees to find the peak maximum hold reading. When there is no suspected emission found and the emission level is with at least 6 dB margin against QP limit line, the position is marked as “-“.
8. Radiated testing above 1 GHz is performed by adjusting the antenna tower from 1 m to 4 m and by rotating the turn table from 0 degree to 360 degrees to find the peak maximum hold reading for scanning all frequencies. When there is no suspected emission found and the harmonic emission level is with at least 6 dB margin against average limit line, the position is marked as “-“.

Note: The average levels are calculated from the peak level corrected with duty cycle correction factor (-24.79dB) derived from $20 \log$ (dwell time/100ms). This correction is only for signals that hop with the fundamental signal, such as band-edge and harmonic. Other spurious signals that are independent of the hopping signal would not use this correction.

3.8.4 Test Setup

For radiated test below 30MHz

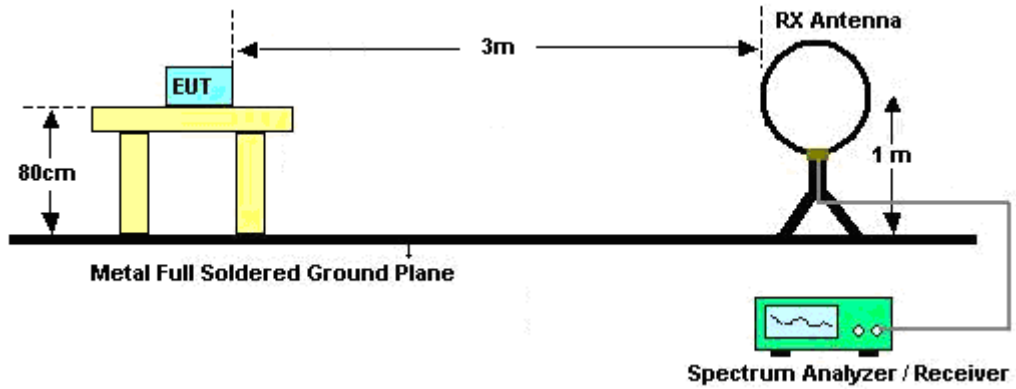

For radiated test from 30MHz to 1GHz

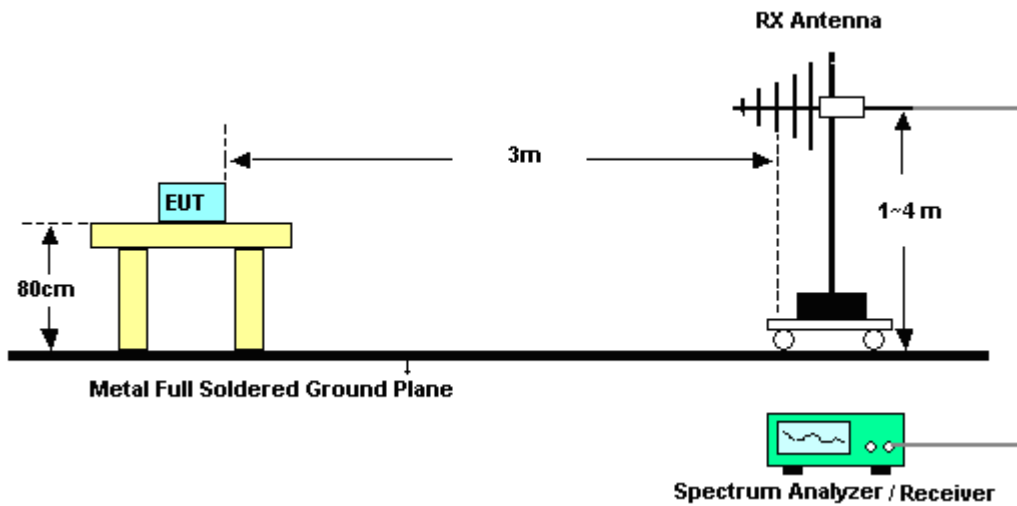

For radiated test from 1GHz to 18GHz

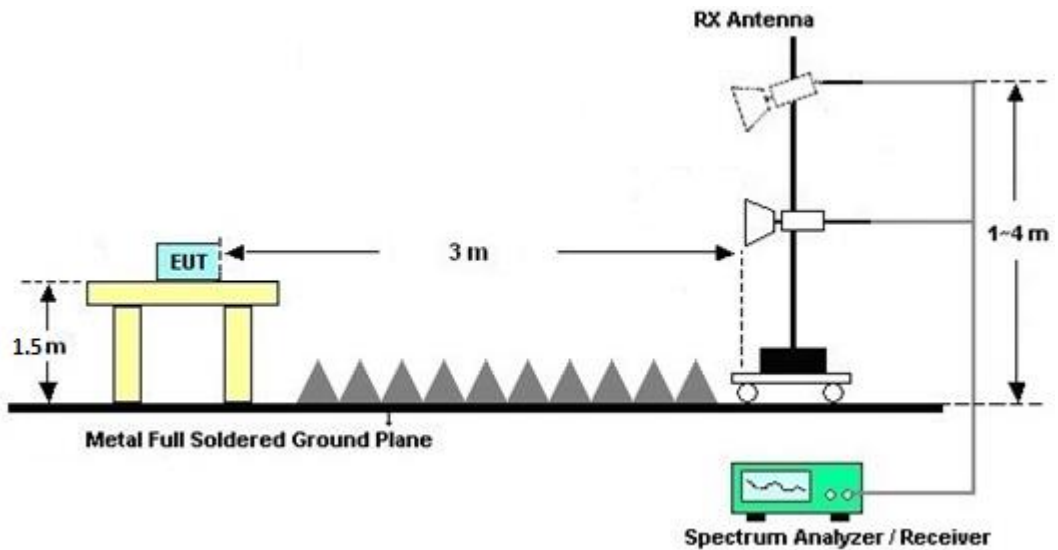

For radiated test above 18GHz

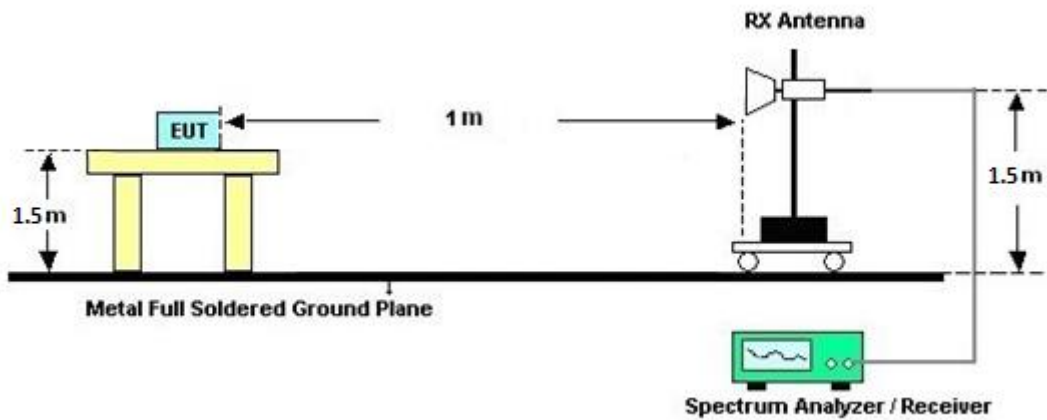

3.8.5 Test Results of Radiated Spurious Emissions (9 kHz ~ 30 MHz)

The low frequency, which starts from 9 kHz to 30 MHz, is pre-scanned and the result which is 20 dB lower than the limit line is not reported.

There is adequate comparison measurement of both open-field test site and alternative test site - semi-Anechoic chamber according to 414788 D01 Radiated Test Site v01r01, and the result comes out very similar.

3.8.6 Test Result of Radiated Spurious at Band Edges

Please refer to Appendix B and C.

3.8.7 Duty Cycle

Please refer to Appendix D.

3.8.8 Test Result of Radiated Spurious Emission (30MHz ~ 10th Harmonic)

Please refer to Appendix B and C.



3.9 AC Conducted Emission Measurement

3.9.1 Limit of AC Conducted Emission

For equipment that is designed to be connected to the public utility (AC) power line, the radio frequency voltage that is conducted back onto the AC power line on any frequency or frequencies within the band 150 kHz to 30 MHz shall not exceed the limits in the following table.

Frequency of emission (MHz)	Conducted limit (dBµV)	
	Quasi-peak	Average
0.15-0.5	66 to 56*	56 to 46*
0.5-5	56	46
5-30	60	50

*Decreases with the logarithm of the frequency.

3.9.2 Measuring Instruments

Please refer to the measuring equipment list in this test report.

3.9.3 Test Procedures

1. The EUT is placed 0.4 meter away from the conducting wall of the shielding room, and is kept at least 80 centimeters from any other grounded conducting surface.
2. Connect EUT to the power mains through a line impedance stabilization network (LISN).
3. All the support units are connecting to the other LISN.
4. The LISN provides 50 ohm coupling impedance for the measuring instrument.
5. The FCC states that a 50 ohm, 50 microhenry LISN shall be used.
6. Both Line and Neutral shall be tested in order to find out the maximum conducted emission.
7. The frequency range from 150 kHz to 30 MHz is scanned.
8. Set the test-receiver system to Peak Detect Function and specified bandwidth (IF Bandwidth = 9 kHz) with Maximum Hold Mode. Then measurement is also conducted by Average Detector and Quasi-Peak Detector Function respectively.

3.9.4 Test Setup

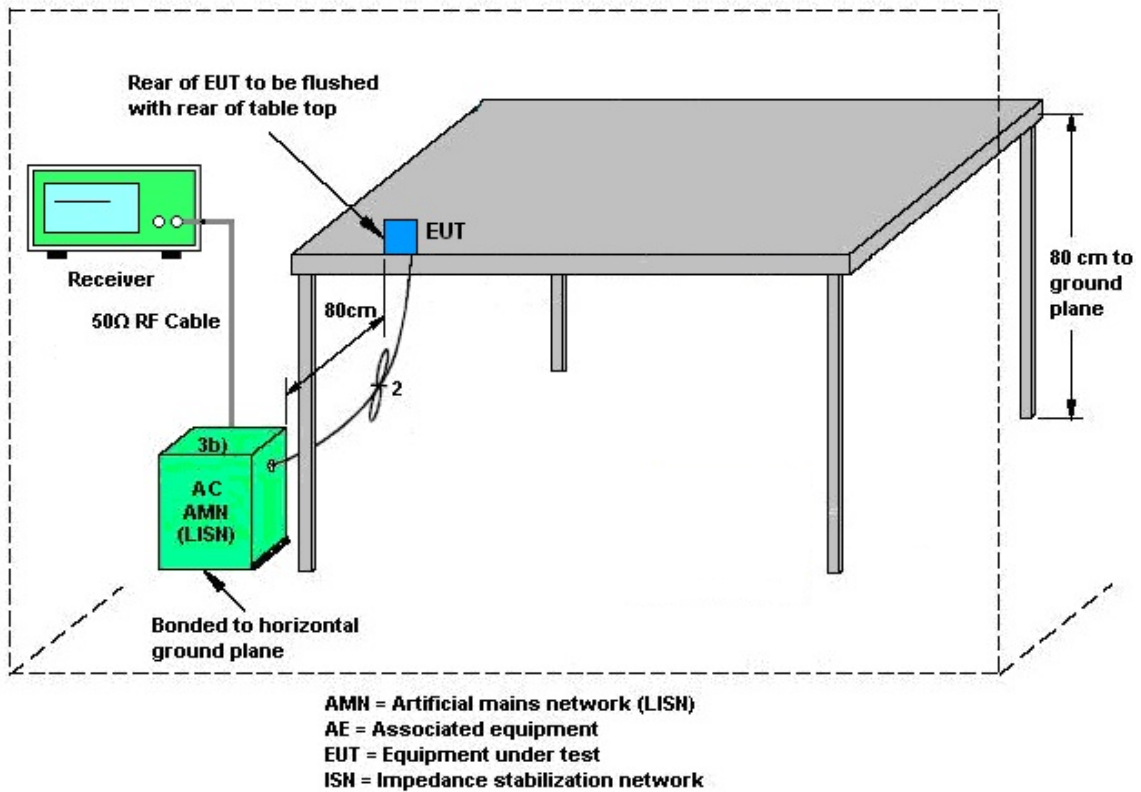

3.9.5 Test Result of AC Conducted Emission

Please refer to Appendix A.



3.10 Antenna Requirements

3.10.1 Standard Applicable

If directional gain of transmitting antennas is greater than 6 dBi, the power shall be reduced by the same level in dB comparing to gain minus 6 dBi. The use of a permanently attached antenna or of an antenna that uses a unique coupling to the intentional radiator shall be considered sufficient to comply with the rule.

3.10.2 Antenna Anti-Replacement Construction

An embedded-in antenna design is used.

3.10.3 Antenna Gain

The antenna peak gain of EUT is less than 6 dBi. Therefore, it is not necessary to reduce maximum peak output power limit.



4 List of Measuring Equipment

Instrument	Brand Name	Model No.	Serial No.	Characteristics	Calibration Date	Test Date	Due Date	Remark
Loop Antenna	Rohde & Schwarz	HFH2-Z2	100315	9 kHz~50 MHz	Jan. 07, 2022	Jan. 09, 2022~ Mar. 08, 2022	Jan. 06, 2023	Radiation (03CH11-HY)
Bilog Antenna	TESEQ	CBL 6111D & N-6-06	35414 & AT-N0602	30MHz~1GHz	Oct. 09, 2021	Jan. 09, 2022~ Mar. 08, 2022	Oct. 08, 2022	Radiation (03CH11-HY)
Horn Antenna	SCHWARZBE CK	BBHA 9120 D	9120D-1326	1GHz ~ 18GHz	Oct. 25, 2021	Jan. 09, 2022~ Mar. 08, 2022	Oct. 24, 2022	Radiation (03CH11-HY)
SHF-EHF Horn Antenna	SCHWARZBE CK	BBHA9170	00993	18GHz~40GHz	Nov. 30, 2021	Jan. 09, 2022~ Mar. 08, 2022	Nov. 29, 2022	Radiation (03CH11-HY)
Amplifier	SONOMA	310N	187312	9kHz~1GHz	Dec. 10, 2021	Jan. 09, 2022~ Mar. 08, 2022	Dec. 09, 2022	Radiation (03CH11-HY)
Preamplifier	Keysight	83017A	MY53270080	1GHz~26.5GHz	Nov. 10, 2021	Jan. 09, 2022~ Mar. 08, 2022	Nov. 09, 2022	Radiation (03CH11-HY)
Preamplifier	Jet-Power	JPA0118-55-303	17100018000 55007	1GHz~18GHz	Jun. 16, 2021	Jan. 09, 2022~ Mar. 08, 2022	Jun. 15, 2022	Radiation (03CH11-HY)
Preamplifier	EMEC	EM18G40G	060801	18GHz~40GHz	Jun. 22, 2021	Jan. 09, 2022~ Mar. 08, 2022	Jun. 21, 2022	Radiation (03CH11-HY)
Spectrum Analyzer	Keysight	N9010A	MY54200486	10Hz~44GHz	Oct. 15, 2021	Jan. 09, 2022~ Mar. 08, 2022	Oct. 14, 2022	Radiation (03CH11-HY)
EMI Test Receiver	Keysight	N9038A(MXE)	MY55420170	20MHz~8.4GHz	Jul. 15, 2021	Jan. 09, 2022~ Mar. 08, 2022	Jul. 14, 2022	Radiation (03CH11-HY)
Controller	EMEC	EM 1000	N/A	Control Turn table & Ant Mast	N/A	Jan. 09, 2022~ Mar. 08, 2022	N/A	Radiation (03CH11-HY)
Antenna Mast	EMEC	AM-BS-4500-B	N/A	1~4m	N/A	Jan. 09, 2022~ Mar. 08, 2022	N/A	Radiation (03CH11-HY)
Turn Table	EMEC	TT 2000	N/A	0~360 Degree	N/A	Jan. 09, 2022~ Mar. 08, 2022	N/A	Radiation (03CH11-HY)
Software	Audix	E3 6.2009-8-24	RK-001053	N/A	N/A	Jan. 09, 2022~ Mar. 08, 2022	N/A	Radiation (03CH11-HY)
RF Cable	HUBER + SUHNER	SUCOFLEX 102	MY2859/2	30MHz-40GHz	Mar. 11, 2021	Jan. 09, 2022~ Mar. 08, 2022	Mar. 10, 2022	Radiation (03CH11-HY)
RF Cable	HUBER + SUHNER	SUCOFLEX 104	MY9837/4PE	9kHz-30MHz	Mar. 11, 2021	Jan. 09, 2022~ Mar. 08, 2022	Mar. 10, 2022	Radiation (03CH11-HY)
RF Cable	HUBER + SUHNER	SUCOFLEX 104	MY9837/4PE	30M-18G	Mar. 11, 2021	Jan. 09, 2022~ Mar. 08, 2022	Mar. 10, 2022	Radiation (03CH11-HY)
RF Cable	HUBER + SUHNER	SUCOFLEX 102·SUCOFLEX 104	811852/4,MY 2859/2,MY98 37/4PE	30MHz-18GHz	Nov. 15, 2021	Jan. 09, 2022~ Mar. 08, 2022	Nov. 14, 2022	Radiation (03CH11-HY)
Filter	Wainwright	WLK4-1000-153 0-8000-40SS	SN11	1.53G Low Pass	Sep. 13, 2021	Jan. 09, 2022~ Mar. 08, 2022	Sep. 12, 2022	Radiation (03CH11-HY)
Filter	Wainwright	WHKX12-2700-3 000-18000-60SS	SN3	3GHz High Pass Filter	Sep. 13, 2021	Jan. 09, 2022~ Mar. 08, 2022	Sep. 12, 2022	Radiation (03CH11-HY)
Hygrometer	TECPEL	DTM-303B	TP140325	N/A	Nov. 26, 2021	Jan. 09, 2022~ Mar. 08, 2022	Nov. 25, 2022	Radiation (03CH11-HY)
Hygrometer	TECPEL	DTM-303B	TP200880	N/A	Sep. 30, 2021	Jan. 09, 2022~ Mar. 08, 2022	Sep. 29, 2022	Radiation (03CH11-HY)



Instrument	Brand Name	Model No.	Serial No.	Characteristics	Calibration Date	Test Date	Due Date	Remark
AC Power Source	ChainTek	APC-1000W	N/A	N/A	N/A	Feb. 17, 2022	N/A	Conduction (CO05-HY)
EMI Test Receiver	Rohde & Schwarz	ESR3	102388	9kHz~3.6GHz	Dec. 01, 2021	Feb. 17, 2022	Nov. 30, 2022	Conduction (CO05-HY)
Hygrometer	Testo	608-H1	34913912	N/A	Nov. 17, 2021	Feb. 17, 2022	Nov. 16, 2022	Conduction (CO05-HY)
LISN	Rohde & Schwarz	ENV216	100080	9kHz~30MHz	Dec. 03, 2021	Feb. 17, 2022	Dec. 02, 2022	Conduction (CO05-HY)
LISN	Rohde & Schwarz	ENV216	100081	9kHz~30MHz	Nov. 16, 2021	Feb. 17, 2022	Nov. 15, 2022	Conduction (CO05-HY)
Software	Rohde & Schwarz	EMC32	N/A	N/A	N/A	Feb. 17, 2022	N/A	Conduction (CO05-HY)
Pulse Limiter	SCHWARZBECK	VTSD 9561-F N	00691	N/A	Jul. 28, 2021	Feb. 17, 2022	Jul. 27, 2022	Conduction (CO05-HY)
LISN Cable	MVE	RG-400	260260	N/A	Dec. 30, 2021	Feb. 17, 2022	Dec. 29, 2022	Conduction (CO05-HY)
Hygrometer	TECPEL	DTM-303A	TP201996	N/A	Nov. 16, 2021	Jan. 03, 2022~ Feb. 16, 2022	Nov. 15, 2022	Conducted (TH05-HY)
Power Meter	Anritsu	ML2495A	1036004	N/A	Aug. 01, 2021	Jan. 03, 2022~ Feb. 16, 2022	Jul. 31, 2022	Conducted (TH05-HY)
Signal Analyzer	Rohde & Schwarz	FSV40	101566	10Hz~40GHz	Aug. 30, 2021	Jan. 03, 2022~ Feb. 16, 2022	Aug. 29, 2022	Conducted (TH05-HY)
Switch Control Manframe	E-IUSTRUMENT	ETF-1405-0	EC1900067 (BOX7)	N/A	Aug. 12, 2021	Jan. 03, 2022~ Feb. 16, 2022	Aug. 11, 2022	Conducted (TH05-HY)



5 Uncertainty of Evaluation

Uncertainty of Conducted Emission Measurement (150 kHz ~ 30 MHz)

Measuring Uncertainty for a Level of Confidence of 95% ($U = 2Uc(y)$)	3.1 dB
---	--------

Uncertainty of Radiated Emission Measurement (30 MHz ~ 1000 MHz)

Measuring Uncertainty for a Level of Confidence of 95% ($U = 2Uc(y)$)	3.7 dB
---	--------

Uncertainty of Radiated Emission Measurement (1000 MHz ~ 18000 MHz)

Measuring Uncertainty for a Level of Confidence of 95% ($U = 2Uc(y)$)	5.8 dB
---	--------

Uncertainty of Radiated Emission Measurement (18000 MHz ~ 40000 MHz)

Measuring Uncertainty for a Level of Confidence of 95% ($U = 2Uc(y)$)	5.4 dB
---	--------



Appendix A. AC Conducted Emission Test Results

Test Engineer :	Calvin Wang	Temperature :	23~26°C
		Relative Humidity :	45~55%

EUT Information

Report NO : 100707-02
 Test Mode : Mode 1
 Test Voltage : Power From System
 Phase : Line

Full Spectrum

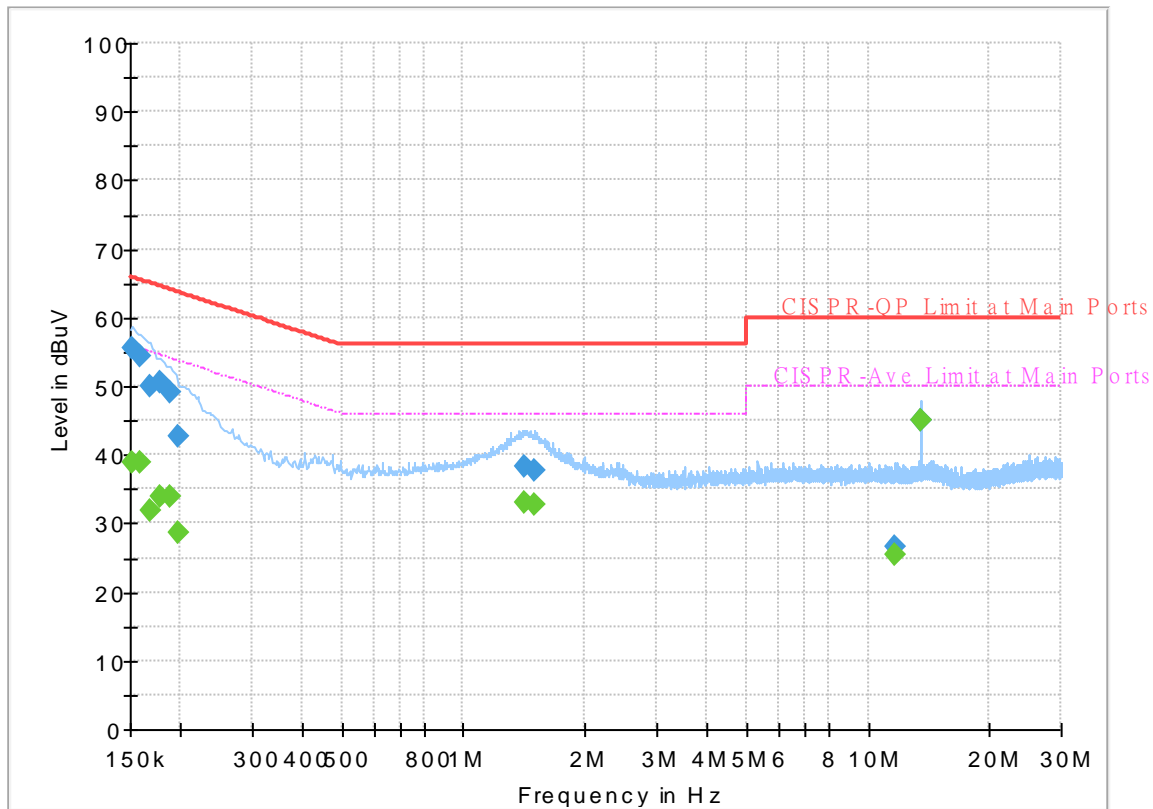

Final Result

Frequency (MHz)	QuasiPeak (dBuV)	CAverage (dBuV)	Limit (dBuV)	Margin (dB)	Line	Filter	Corr. (dB)
0.152250	---	38.77	55.88	17.11	L1	OFF	19.6
0.152250	55.62	---	65.88	10.26	L1	OFF	19.6
0.159000	---	38.97	55.52	16.55	L1	OFF	19.6
0.159000	54.34	---	65.52	11.18	L1	OFF	19.6
0.168000	---	31.76	55.06	23.30	L1	OFF	19.6
0.168000	50.02	---	65.06	15.04	L1	OFF	19.6
0.177000	---	33.81	54.63	20.82	L1	OFF	19.6
0.177000	50.66	---	64.63	13.97	L1	OFF	19.6
0.188250	---	33.98	54.11	20.13	L1	OFF	19.6
0.188250	49.17	---	64.11	14.94	L1	OFF	19.6
0.197250	---	28.55	53.73	25.18	L1	OFF	19.6
0.197250	42.73	---	63.73	21.00	L1	OFF	19.6
1.419000	---	33.02	46.00	12.98	L1	OFF	19.6
1.419000	38.31	---	56.00	17.69	L1	OFF	19.6
1.495500	---	32.77	46.00	13.23	L1	OFF	19.6
1.495500	37.81	---	56.00	18.19	L1	OFF	19.6
11.697000	---	25.37	50.00	24.63	L1	OFF	20.1
11.697000	26.71	---	60.00	33.29	L1	OFF	20.1
13.560000	---	45.05	50.00	4.95	L1	OFF	20.1
13.560000	45.10	---	60.00	14.90	L1	OFF	20.1

EUT Information

Report NO : 1O0707-02
 Test Mode : Mode 1
 Test Voltage : Power From System
 Phase : Neutral

Full Spectrum

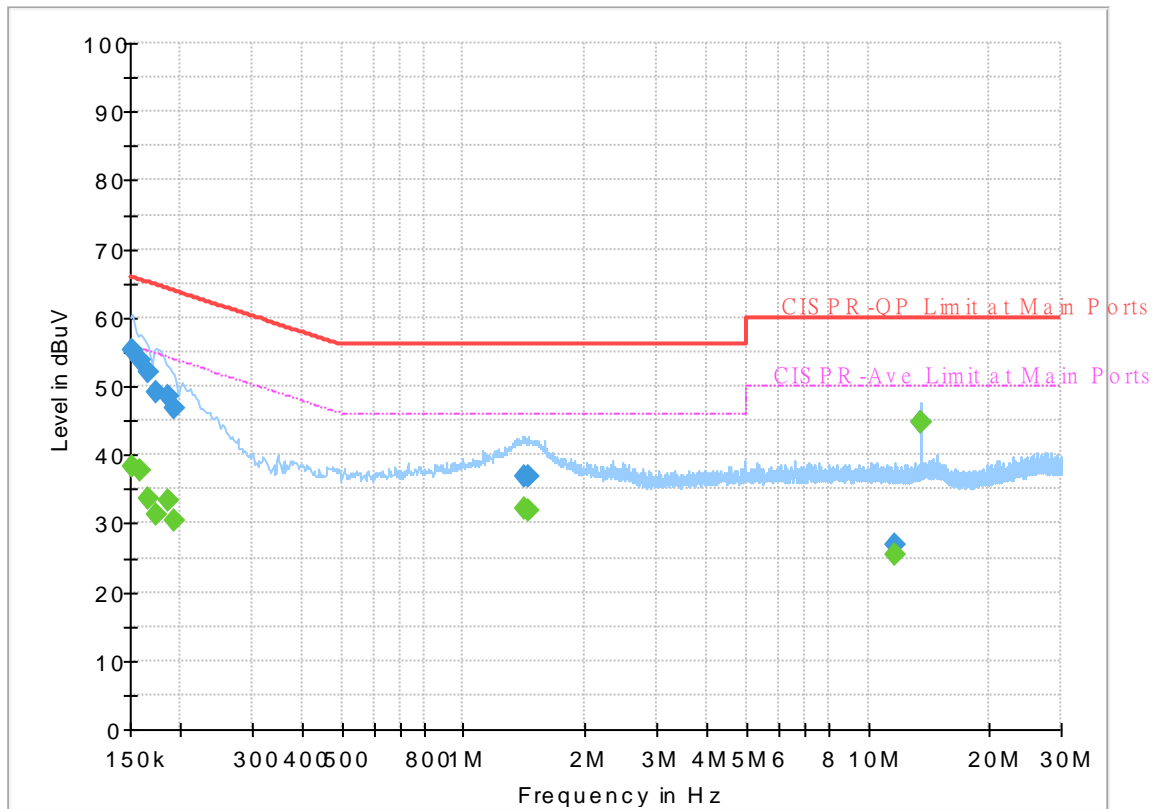

Final_Result

Frequency (MHz)	QuasiPeak (dBuV)	CAverage (dBuV)	Limit (dBuV)	Margin (dB)	Line	Filter	Corr. (dB)
0.152250	---	38.24	55.88	17.64	N	OFF	19.6
0.152250	55.38	---	65.88	10.50	N	OFF	19.6
0.159000	---	37.78	55.52	17.74	N	OFF	19.6
0.159000	53.68	---	65.52	11.84	N	OFF	19.6
0.165750	---	33.60	55.17	21.57	N	OFF	19.6
0.165750	52.10	---	65.17	13.07	N	OFF	19.6
0.174750	---	31.39	54.73	23.34	N	OFF	19.6
0.174750	49.11	---	64.73	15.62	N	OFF	19.6
0.186000	---	33.36	54.21	20.85	N	OFF	19.6
0.186000	48.54	---	64.21	15.67	N	OFF	19.6
0.192750	---	30.33	53.92	23.59	N	OFF	19.6
0.192750	46.83	---	63.92	17.09	N	OFF	19.6
1.410000	---	32.20	46.00	13.80	N	OFF	19.6
1.410000	36.96	---	56.00	19.04	N	OFF	19.6
1.446000	---	31.89	46.00	14.11	N	OFF	19.6
1.446000	36.87	---	56.00	19.13	N	OFF	19.6
11.604750	---	25.46	50.00	24.54	N	OFF	20.1
11.604750	26.76	---	60.00	33.24	N	OFF	20.1
13.560000	---	44.60	50.00	5.40	N	OFF	20.2
13.560000	44.67	---	60.00	15.33	N	OFF	20.2



Appendix B. Radiated Spurious Emission

Test Engineer :	Daniel Lee, Hayden Wu, James Chiu, and Fu Chen	Temperature :	19.5~22.5°C
		Relative Humidity :	54.6~68.3%

2.4GHz 2400~2483.5MHz

BT (Band Edge @ 3m)

BT	Note	Frequency (MHz)	Level (dBμV/m)	Over Limit (dB)	Limit Line (dBμV/m)	Read Level (dBμV)	Antenna Factor (dB/m)	Path Loss (dB)	Preamp Factor (dB)	Ant Pos (cm)	Table Pos (deg)	Peak Avg. (P/A)	Pol. (H/V)	
BT CH00 2402MHz		2385.6	42.31	-31.69	74	41.5	27.63	7.13	33.95	323	360	P	H	
		2385.6	17.55	-36.45	54	-	-	-	-	-	-	A	H	
	*	2402	98.33	-	-	97.54	27.6	7.14	33.95	323	360	P	H	
		2402	73.57	-	-	-	-	-	-	-	-	A	H	
													H	
														H
			2326.59	42.32	-31.68	74	41.43	27.79	7.07	33.97	400	309	P	V
			2326.59	17.56	-36.44	54	-	-	-	-	-	-	A	V
	*		2402	95.05	-	-	94.26	27.6	7.14	33.95	400	309	P	V
			2402	70.29	-	-	-	-	-	-	-	-	A	V
														V
														V
BT CH 39 2441MHz		2316.58	43.27	-30.73	74	42.35	27.83	7.06	33.97	275	0	P	H	
		2316.58	18.51	-35.49	54	-	-	-	-	-	-	A	H	
	*	2441	100.05	-	-	99.27	27.52	7.2	33.94	275	0	P	H	
		2441	75.29	-	-	-	-	-	-	-	-	A	H	
		2491.81	41.96	-32.04	74	41.18	27.42	7.28	33.92	275	0	P	H	
		2491.81	17.2	-36.8	54	-	-	-	-	-	-	A	H	
		2379.16	42.21	-31.79	74	41.4	27.64	7.12	33.95	400	275	P	V	
		2379.16	17.45	-36.55	54	-	-	-	-	-	-	A	V	
	*		2441	94.89	-	-	94.11	27.52	7.2	33.94	400	275	P	V
			2441	70.13	-	-	-	-	-	-	-	A	V	
			2490.27	42.41	-31.59	74	41.63	27.42	7.28	33.92	400	275	P	V
			2490.27	17.65	-36.35	54	-	-	-	-	-	A	V	



BT CH 78 2480MHz	*	2480	99.43	-	-	98.66	27.44	7.26	33.93	300	15	P	H
		2480	74.67	-	-	-	-	-	-	-	-	A	H
		2483.68	45.61	-28.39	74	44.83	27.43	7.27	33.92	300	15	P	H
		2483.68	20.85	-33.15	54	-	-	-	-	-	-	A	H
													H
													H
	*	2480	94.46	-	-	93.69	27.44	7.26	33.93	300	301	P	V
		2480	69.7	-	-	-	-	-	-	-	-	A	V
		2492.28	42.4	-31.6	74	41.62	27.42	7.28	33.92	300	301	P	V
		2492.28	17.64	-36.36	54	-	-	-	-	-	-	A	V
													V
													V
Remark	1. No other spurious found. 2. All results are PASS against Peak and Average limit line.												



BT	Note	Frequency (MHz)	Level (dBµV/m)	Over Limit (dB)	Limit Line (dBµV/m)	Read Level (dBµV)	Antenna Factor (dB/m)	Path Loss (dB)	Preamp Factor (dB)	Ant Pos (cm)	Table Pos (deg)	Peak Avg. (P/A)	Pol. (H/V)	
BT CH 39 2441MHz		4882	38.36	-35.64	74	53.46	31.26	12.12	58.48	-	-	P	H	
		4882	13.6	-40.4	54	-	-	-	-	-	-	A	H	
		7323	42.3	-31.7	74	50.31	36.6	14.56	59.17	-	-	P	H	
		7323	17.54	-36.46	54	-	-	-	-	-	-	A	H	
		10800	47.54	-26.46	74	51.37	40.2	17.23	61.26	-	-	P	H	
		14475	47.77	-26.23	74	49.44	41.3	20.06	63.03	-	-	P	H	
		17970	53.25	-20.75	74	40.53	46.32	23.07	56.67	-	-	P	H	
		17970	43.17	-10.83	54	-	-	-	-	-	-	A	H	
														H
														H
														H
														H
			4882	37.32	-36.68	74	52.42	31.26	12.12	58.48	-	-	P	V
			4882	12.56	-41.44	54	-	-	-	-	-	-	A	V
			7323	42.18	-31.82	74	50.19	36.6	14.56	59.17	-	-	P	V
			7323	17.42	-36.58	54	-	-	-	-	-	-	A	V
			10965	47.56	-26.44	74	51.4	40.26	17.36	61.46	-	-	P	V
			14475	47.86	-26.14	74	49.53	41.3	20.06	63.03	-	-	P	V
			18000	53.52	-20.48	74	40.22	46.8	23.1	56.6	-	-	P	V
			18000	43.49	-10.51	54	-	-	-	-	-	-	A	V
													V	
													V	
													V	
													V	



BT	Note	Frequency (MHz)	Level (dBμV/m)	Over Limit (dB)	Limit Line (dBμV/m)	Read Level (dBμV)	Antenna Factor (dB/m)	Path Loss (dB)	Preamp Factor (dB)	Ant Pos (cm)	Table Pos (deg)	Peak Avg. (P/A)	Pol. (H/V)	
BT CH 78 2480MHz		4960	38.65	-35.35	74	53.47	31.5	12.17	58.49	-	-	P	H	
		4960	13.89	-40.11	54	-	-	-	-	-	-	A	H	
		7440	41.16	-32.84	74	49.05	36.68	14.55	59.12	-	-	P	H	
		7440	16.4	-37.6	54	-	-	-	-	-	-	A	H	
		11055	47.49	-26.51	74	51.55	40.08	17.43	61.57	-	-	P	H	
		14490	47.88	-26.12	74	49.51	41.3	20.08	63.01	-	-	P	H	
		17985	53.13	-20.87	74	40.13	46.56	23.08	56.64	-	-	P	H	
		17985	43.18	-10.82	54	-	-	-	-	-	-	A	H	
														H
														H
														H
														H
			4960	37.69	-36.31	74	52.51	31.5	12.17	58.49	-	-	P	V
			4960	12.93	-41.07	54	-	-	-	-	-	-	A	V
			7440	41.97	-32.03	74	49.86	36.68	14.55	59.12	-	-	P	V
			7440	17.21	-36.79	54	-	-	-	-	-	-	A	V
			11415	47.49	-26.51	74	51.82	39.9	17.77	62	-	-	P	V
			14490	47.94	-26.06	74	49.57	41.3	20.08	63.01	-	-	P	V
			17985	53.31	-20.69	74	40.31	46.56	23.08	56.64	-	-	P	V
			17985	43.3	-10.7	54	-	-	-	-	-	-	A	V
													V	
													V	
													V	
													V	
Remark	<ol style="list-style-type: none"> No other spurious found. All results are PASS against Peak and Average limit line. The emission position marked as "-" means no suspected emission found with sufficient margin against limit line or noise floor only. The emission level close to 18GHz is checked that the average emission level is noise floor only. 													



Emission above 18GHz
2.4GHz BT (SHF)

BT	Note	Frequency (MHz)	Level (dBμV/m)	Over Limit (dB)	Limit Line (dBμV/m)	Read Level (dBμV)	Antenna Factor (dB/m)	Path Loss (dB)	Preamp Factor (dB)	Ant Pos (cm)	Table Pos (deg)	Peak Avg. (P/A)	Pol. (H/V)
2.4GHz BT SHF		23796	39.22	-34.78	74	56.47	38.8	-2.23	53.82	-	-	P	H
													H
													H
													H
													H
													H
													H
													H
													H
													H
													H
													H
													H
													H
													H
													H
													H
													H
													H
			23740	39.3	-34.7	74	56.61	38.8	-2.25	53.86	-	-	P
													V
													V
													V
													V
													V
													V
													V
													V
													V
													V
													V
													V
													V
Remark	1. No other spurious found. 2. All results are PASS against limit line. 3. The emission position marked as "-" means no suspected emission found with sufficient margin against limit line or noise floor only.												



Emission below 1GHz

2.4GHz BT (LF)

BT	Note	Frequency	Level	Over	Limit	Read	Antenna	Path	Preamp	Ant	Table	Peak	Pol.	
		(MHz)	(dBμV/m)	(dB)	(dBμV/m)	(dBμV)	(dB/m)	(dB)	(dB)	(cm)	(deg)	(P/A)	(H/V)	
2.4GHz BT LF		63.95	21.47	-18.53	40	40.91	11.81	1.21	32.46	-	-	P	H	
		138.64	22.67	-20.83	43.5	36.09	17.24	1.78	32.44	-	-	P	H	
		181.32	22.27	-21.23	43.5	38.05	14.68	2.04	32.5	-	-	P	H	
		767.2	27.83	-18.17	46	27.65	27.98	4.15	31.95	-	-	P	H	
		865.17	29.64	-16.36	46	27.45	29.15	4.45	31.41	-	-	P	H	
		953.44	29.4	-16.6	46	25.02	30.57	4.68	30.87	-	-	P	H	
														H
														H
														H
														H
														H
														H
			41.64	30.16	-9.84	40	43.24	18.37	0.99	32.44	100	343	Q	V
			63.95	31.23	-8.77	40	50.67	11.81	1.21	32.46	-	-	P	V
			170.65	26.49	-17.01	43.5	41.65	15.36	1.97	32.49	-	-	P	V
			859.35	28.94	-17.06	46	26.8	29.15	4.43	31.44	-	-	P	V
			917.55	29.29	-16.71	46	26.82	28.99	4.59	31.11	-	-	P	V
			957.32	29.63	-16.37	46	25.01	30.77	4.7	30.85	-	-	P	V
														V
														V
													V	
													V	
													V	
													V	

Remark

- No other spurious found.
- All results are PASS against limit line.
- The emission position marked as "-" means no suspected emission found and emission level has at least 6dB margin against limit or emission is noise floor only.



Note symbol

*	Fundamental Frequency which can be ignored. However, the level of any unwanted emissions shall not exceed the level of the fundamental frequency.
!	Test result is over limit line.
P/A	Peak or Average
H/V	Horizontal or Vertical



A calculation example for radiated spurious emission is shown as below:

BT	Note	Frequency	Level	Over	Limit	Read	Antenna	Path	Preamp	Ant	Table	Peak	Pol.
		(MHz)	(dBμV/m)	(dB)	(dBμV/m)	(dBμV)	(dB/m)	(dB)	(dB)	(cm)	(deg)	(P/A)	(H/V)
BT CH 00 2402MHz		2390	55.45	-18.55	74	54.51	32.22	4.58	35.86	103	308	P	H
		2390	43.54	-10.46	54	42.6	32.22	4.58	35.86	103	308	A	H

1. Path Loss(dB) = Cable loss(dB) + Filter loss(dB) + Attenuator loss(dB)
2. Level(dBμV/m) =
Antenna Factor(dB/m) + Path Loss(dB) + Read Level(dBμV) - Preamp Factor(dB)
3. Over Limit(dB) = Level(dBμV/m) – Limit Line(dBμV/m)

For Peak Limit @ 2390MHz:

1. Level(dBμV/m)
= Antenna Factor(dB/m) + Path Loss(dB) + Read Level(dBμV) - Preamp Factor(dB)
= 32.22(dB/m) + 4.58(dB) + 54.51(dBμV) – 35.86 (dB)
= 55.45 (dBμV/m)
2. Over Limit(dB)
= Level(dBμV/m) – Limit Line(dBμV/m)
= 55.45(dBμV/m) – 74(dBμV/m)
= -18.55(dB)

Both peak and average measured complies with the limit line, so test result is “PASS”.



Appendix C. Radiated Spurious Emission Plots

Test Engineer :	Daniel Lee, Hayden Wu, James Chiu, and Fu Chen	Temperature :	19.5~22.5°C
		Relative Humidity :	54.6~68.3%

2.4GHz 2400~2483.5MHz

BT (Band Edge @ 3m)

BT	2.4GHz 2400~2483.5MHz Band Edge @ 3m	
	BT CH00 2402MHz	
	Horizontal	Fundamental
Peak	<p>Site : 03CH11-HY Condition : PEAK_BE_74 3m 91200_1326_20211025 HORIZONTAL : RBW:1000.000KHz VBW:3000.000KHz SWT:Auto</p>	<p>Site : 03CH11-HY Condition : PEAK_74 3m 91200_1326_20211025 HORIZONTAL : RBW:1000.000KHz VBW:3000.000KHz SWT:Auto</p>

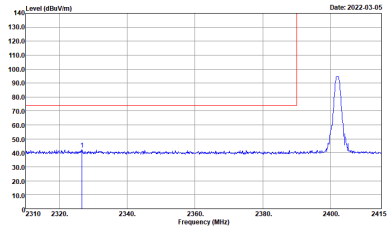
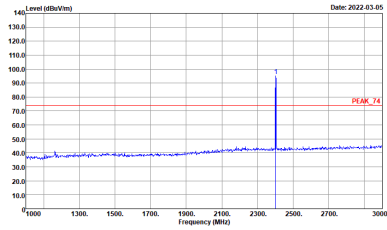

BT	2.4GHz 2400~2483.5MHz Band Edge @ 3m	
	BT CH00 2402MHz	
	Vertical	Fundamental
Peak	 <p>Site : 03CH11-1F Condition : PEAK_BE_74 3m 91200_1326_20211025 VERTICAL : RBW:1000.000kHz VBW:3000.000kHz SWT:Auto</p>	 <p>Site : 03CH11-1F Condition : PEAK_F4 3m 91200_1326_20211025 VERTICAL : RBW:1000.000kHz VBW:3000.000kHz SWT:Auto</p>



BT	2.4GHz 2400~2483.5MHz Band Edge @ 3m	
BT CH39 2441MHz		
Horizontal		Fundamental
Peak	<p>Site : 03CH11-FY Condition : PEAK_BE_74 3m 91200_1326_20211025 HORIZONTAL : RBW:1000.000kHz VBW:3000.000kHz SWT:Auto</p>	<p>Site : 03CH11-FY Condition : PEAK_74 3m 91200_1326_20211025 HORIZONTAL : RBW:1000.000kHz VBW:3000.000kHz SWT:Auto</p>
Peak	<p>Site : 03CH11-FY Condition : PEAK_BE_74 3m 91200_1326_20211025 HORIZONTAL : RBW:1000.000kHz VBW:3000.000kHz SWT:Auto</p>	Left blank



BT	2.4GHz 2400~2483.5MHz Band Edge @ 3m	
BT CH39 2441MHz		
Vertical		Fundamental
Peak	<p>Site : 03CH11-FY Condition : PEAK_BE_74 3m 91200_1326_20211025 VERTICAL : RBW:1000.000kHz VBW:3000.000kHz SWT:Auto</p>	<p>Site : 03CH11-FY Condition : PEAK_74 3m 91200_1326_20211025 VERTICAL : RBW:1000.000kHz VBW:3000.000kHz SWT:Auto</p>
Peak	<p>Site : 03CH11-FY Condition : PEAK_BE_74 3m 91200_1326_20211025 VERTICAL : RBW:1000.000kHz VBW:3000.000kHz SWT:Auto</p>	Left blank

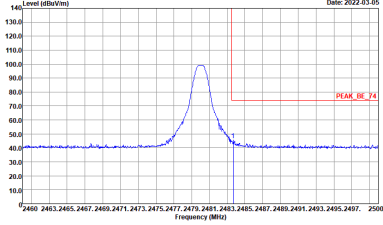
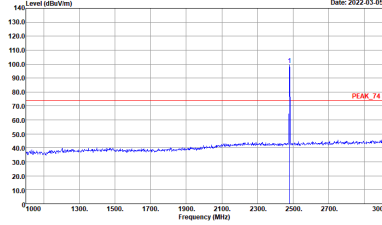

BT	2.4GHz 2400~2483.5MHz Band Edge @ 3m	
	BT CH78 2480MHz	
	Horizontal	Fundamental
Peak	 <p>Site : 03CH11-1F Condition : PEAK_BE_74 3m 91200_1326_20211025 HORIZONTAL : RBW:1000.000kHz VBW:3000.000kHz SWT:Auto</p>	 <p>Site : 03CH11-1F Condition : PEAK_74 3m 91200_1326_20211025 HORIZONTAL : RBW:1000.000kHz VBW:3000.000kHz SWT:Auto</p>



BT	2.4GHz 2400~2483.5MHz Band Edge @ 3m	
BT CH78 2480MHz		
	Vertical	Fundamental
Peak	<p>Vertical spectrum plot showing a peak at 2480 MHz. The y-axis is Level (dBm/100Hz) from 10.0 to 140.0. The x-axis is Frequency (MHz) from 2450 to 2500. A red line indicates the peak level at approximately 100 dBm/100Hz. Metadata: Date: 2022-03-05, Site: 03CH11-1F, Condition: PEAK_BE_74 3m 91200_1326_20211025 VERTICAL, RBW:1000.000kHz VBW:3000.000kHz SWT:Auto.</p>	<p>Fundamental spectrum plot showing a peak at 2480 MHz. The y-axis is Level (dBm/100Hz) from 10.0 to 140.0. The x-axis is Frequency (MHz) from 1000 to 3000. A red line indicates the peak level at approximately 100 dBm/100Hz. Metadata: Date: 2022-03-05, Site: 03CH11-1F, Condition: PEAK_74 3m 91200_1326_20211025 VERTICAL, RBW:1000.000kHz VBW:3000.000kHz SWT:Auto.</p>



2.4GHz 2400~2483.5MHz

BT (Harmonic @ 3m)

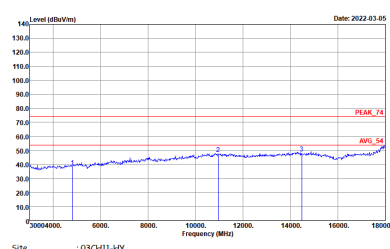
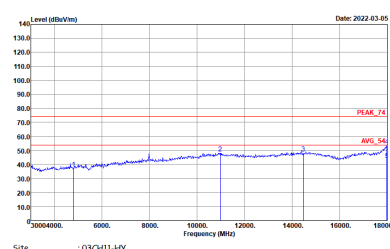
BT	2.4GHz 2400~2483.5MHz Harmonic @ 3m	
	BT CH00 2402MHz	
	Horizontal	Vertical
Peak Avg.	 <p data-bbox="422 840 702 862">Site : 03CH11-HY Condition : PEAK_74 3m 91200_1326_20211025 HORIZONTAL</p>	 <p data-bbox="896 840 1176 862">Site : 03CH11-HY Condition : PEAK_74 3m 91200_1326_20211025 VERTICAL</p>

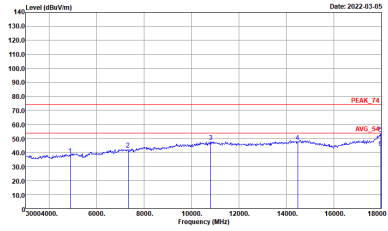
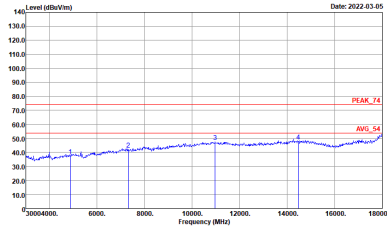

BT	2.4GHz 2400~2483.5MHz Harmonic @ 3m	
	BT CH39 2441MHz	
	Horizontal	Vertical
Peak Avg.	 <p>Site : 03CH11-HY Condition : PEAK_74 3m 91200_1326_20211025 HORIZONTAL</p>	 <p>Site : 03CH11-HY Condition : PEAK_74 3m 91200_1326_20211025 VERTICAL</p>

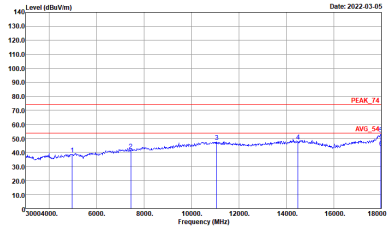
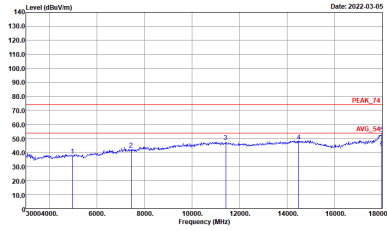

BT	2.4GHz 2400~2483.5MHz Harmonic @ 3m	
	BT CH78 2480MHz	
	Horizontal	Vertical
Peak Avg.	 <p>Site : 03CH11-HY Condition : PEAK_74 3m 91200_1326_20211025 HORIZONTAL</p>	 <p>Site : 03CH11-HY Condition : PEAK_74 3m 91200_1326_20211025 VERTICAL</p>



Emission above 18GHz

2.4GHz BT (SHF @ 1m)

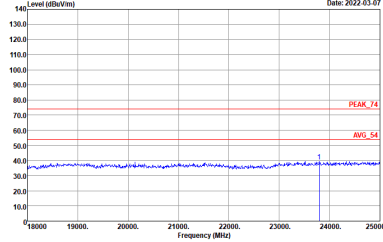
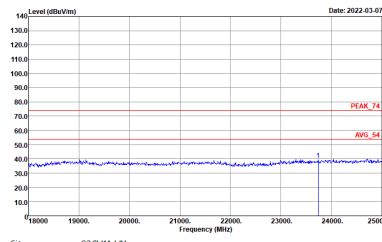
BT	2.4GHz 2400~2483.5MHz	
	BT SHF	
	Horizontal	Vertical
Peak Avg.	 <p>Site : 03CH11-HY Condition : PEAK_74 1m SHF ANT_9170_00993 HORIZONTAL</p>	 <p>Site : 03CH11-HY Condition : PEAK_74 1m SHF ANT_9170_00993 VERTICAL</p>



Emission below 1GHz

2.4GHz BT (LF)

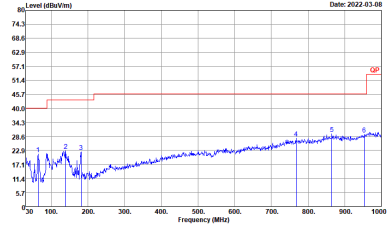
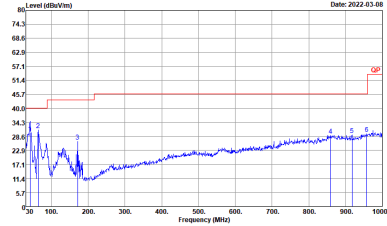
BT	2.4GHz 2400~2483.5MHz	
	BT LF	
	Horizontal	Vertical
QP / Peak	 <p>Site : 03CH11-HY Condition : QP 3m BE-LOG 35414-211009 HORIZONTAL</p>	 <p>Site : 03CH11-HY Condition : QP 3m BE-LOG 35414-211009 VERTICAL</p>



Appendix D. Duty Cycle Plots

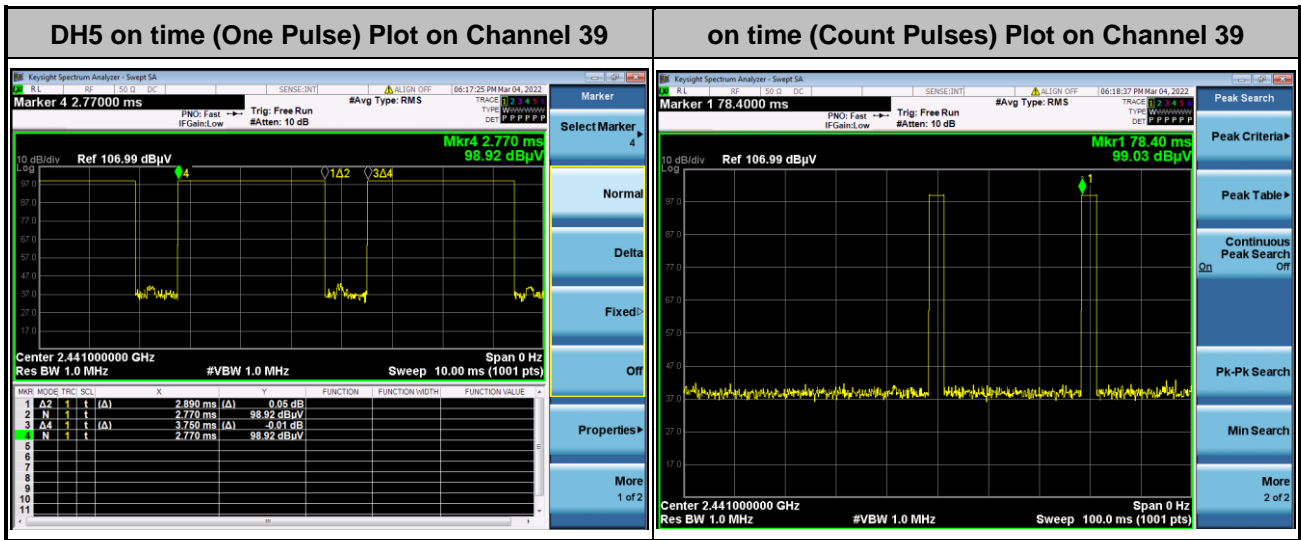

Note:

1. Worst case Duty cycle = on time/100 milliseconds = 2 * 2.89 / 100 = 5.78 %
2. Worst case Duty cycle correction factor = 20*log(Duty cycle) = -24.76 dB
3. DH5 has the highest duty cycle worst case and is reported.

Duty Cycle Correction Factor Consideration for AFH mode:

Bluetooth normal hopping rate is 1600Hz and reduced to 800Hz in AFH mode; due to the reduced number of hopping frequencies, with the same packet configuration the dwell time in each channel frequency within 100msec period is longer in AFH mode than normal mode.

In AFH mode, the minimum hopping frequencies are 20, to get the longest dwell time DH5 packet is observed; the on time period to have DH5 packet completing one hopping sequence is

$$2.89 \text{ ms} \times 20 \text{ channels} = 57.8 \text{ ms}$$

There cannot be 2 complete hopping sequences within 100ms period, considering the random hopping behavior, maximum 2 hops can be possibly observed within the period. [100 ms / 57.8 ms] = 2 hops

Thus, the maximum possible ON time:

$$2.89 \text{ ms} \times 2 = 5.78 \text{ ms}$$

Worst case Duty Cycle Correction factor, which is derived from the maximum possible ON time,

$$20 \times \log(5.78 \text{ ms}/100 \text{ ms}) = -24.76 \text{ dB}$$