



FCC RF Test Report

FCC ID : UZ7WCMTA
EQUIPMENT : Touch Computer
BRAND NAME : Zebra
MODEL NAME : WCMTA
APPLICANT : Zebra Technologies Corporation
1 Zebra Plaza, Holtsville, NY 11742
MANUFACTURER : Zebra Technologies Corporation
1 Zebra Plaza, Holtsville, NY 11742
STANDARD : 47 CFR Part 2, 27 Subpart O (3700-3980MHz)
CLASSIFICATION : PCS Licensed Transmitter Held to Ear (PCE)
TEST DATE(S) : Feb. 20, 2023 ~ Mar. 30, 2023

We, Sporton International Inc. (KunShan), would like to declare that the tested sample has been evaluated in accordance with the procedures given in ANSI C63.26-2015 and shown compliance with the applicable technical standards.

The test results in this report apply exclusively to the tested model / sample. Without written approval of Sporton International Inc. (KunShan), the test report shall not be reproduced except in full.

Jason Jia

Approved by: Jason Jia



Sporton International Inc. (Kunshan)

**No. 1098, Pengxi North Road, Kunshan Economic Development Zone Jiangsu Province 215300
People's Republic of China**



TABLE OF CONTENTS

REVISION HISTORY...3
SUMMARY OF TEST RESULT...4
1 GENERAL DESCRIPTION...5
1.1 Product Feature of Equipment Under Test...5
1.2 Product Specification of Equipment Under Test...6
1.3 Modification of EUT...6
1.4 Maximum EIRP and Emission Designator...7
1.5 Testing Location...8
1.6 Test Software...8
1.7 Applicable Standards...8
2 TEST CONFIGURATION OF EQUIPMENT UNDER TEST...9
2.1 Test Mode...9
2.2 Connection Diagram of Test System...10
2.3 Support Unit used in test configuration and system...10
2.4 Measurement Results Explanation Example...10
2.5 Frequency List of Low/Middle/High Channels...11
3 CONDUCTED TEST ITEMS...12
3.1 Measuring Instruments...12
3.2 Test Setup...12
3.3 Test Result of Conducted Test...12
3.4 Conducted Output Power and EIRP...13
3.5 Peak-to-Average Ratio...14
3.6 Occupied Bandwidth...15
3.7 Conducted Band Edge...16
3.8 Conducted Spurious Emission...17
3.9 Frequency Stability...18
4 RADIATED TEST ITEMS...19
4.1 Measuring Instruments...19
4.2 Test Setup...19
4.3 Test Result of Radiated Test...20
4.4 Radiated Spurious Emission...21
5 LIST OF MEASURING EQUIPMENT...22
6 UNCERTAINTY OF EVALUATION...23
APPENDIX A. TEST RESULTS OF CONDUCTED TEST
APPENDIX B. TEST RESULTS OF RADIATED TEST
APPENDIX C. TEST SETUP PHOTOGRAPHS



REVISION HISTORY

REPORT NO.	VERSION	DESCRIPTION	ISSUED DATE
FG311602N	Rev. 01	Initial issue of report	Apr. 27, 2023



SUMMARY OF TEST RESULT

Report Section	FCC Rule	Description	Limit	Result	Remark
3.4	§2.1046	Conducted Output Power	Reporting Only	PASS	-
	§27.50(j)(3)	Equivalent Isotropic Radiated Power	EIRP < 1Watt		
3.5	§27.50(j)(4)	Peak-to-Average Ratio	<13 dB	PASS	-
3.6	§2.1049	Occupied Bandwidth	Reporting Only	PASS	-
3.7	§2.1051	Conducted Band Edge Measurement	< 43+10log10(P[Watts])	PASS	-
	§27.53(l)(2)				
3.8	§2.1051	Conducted Spurious Emission	< 43+10log10(P[Watts])	PASS	-
	§27.53(l)(2)				
3.9	§27.54	Frequency Stability Temperature & Voltage	Within Authorized Band	PASS	-
4.4	§2.1053 §27.53(l)(2)	Radiated Spurious Emission	< 43+10log ₁₀ (P[Watts])	PASS	Under limit 44.50 dB at 15180.000 MHz

Declaration of Conformity:
The test results with all measurement uncertainty excluded are presented in accordance with the regulation limits or requirements declared by manufacturers.
Comments and Explanations:
The declared of product specification for EUT presented in the report are provided by the manufacturer, and the manufacturer takes all the responsibilities for the accuracy of product specification.



1 General Description

1.1 Product Feature of Equipment Under Test

Product Feature	
Equipment	Touch Computer
Brand Name	Zebra
Model Name	WCMTA
FCC ID	UZ7WCMTA
Sample 1	Scanner(SE4710)
Sample 2	Scanner(SE5500)
HW Version	DV
SW Version	13-09-09.00-TG-U00-PRD-ATH-04
MFD	09MAR23
EUT Stage	Identical Prototype

Remark:

1. The above EUT's information was declared by manufacturer. Please refer to the specifications or user's manual for more detailed description.
2. There are two types of EUT: the main differences between them are the scanner and memory. According to the difference, we choose the Sample 1 to perform full test, and verify the worst RSE mode for Sample 2.

Specification of Accessory				
Battery 1	Brand Name	Zebra	Model Number	BT-000473

Supported Unit used in test configuration and system				
Battery 2	Brand Name	Zebra	Model Number	BT-000473B
Battery 3	Brand Name	Zebra	Model Number	BT-000473E
AC Adapter	Brand Name	Zebra	Part Number	PWR-WUA5V12W0US
Earphone 1	Brand Name	Zebra	Part Number	HDST-35MM-PTT1-01
Earphone 2	Brand Name	Zebra	Part Number	HDST-USBC-PTT1-01
USB Cable (Type C to Type A)	Brand Name	Zebra	Part Number	CBL-TC5X-USBC2A-01
Type C-Audio Cable (Type C to 3.5mm)	Brand Name	Zebra	Part Number	ADP-USBC-35MM1-01
Trigger Handle	Brand Name	Zebra	Part Number	TRG-TC2L-SNP1-01
Hand Strap	Brand Name	Zebra	Part Number	SG-TC2L-HSTRP1-01
Soft Holster	Brand Name	Zebra	Part Number	SG-TC2L-HLSTR1-01



1.2 Product Specification of Equipment Under Test

Standards-related Product Specification	
Tx/Rx Frequency	5G NR n77: 3700 MHz ~ 3980 MHz
SCS	30kHz
Bandwidth	20 / 30 / 40 / 50 / 60 / 70 / 80 / 90 / 100MHz
Antenna Gain	<p><Ant. 0> 5G NR n77: 0.10 dBi</p> <p><Ant. 1> 5G NR n77: -1.30 dBi</p> <p><Ant. 5> 5G NR n77: 0.15 dBi</p> <p><Ant. 6> 5G NR n77: 0.40 dBi</p>
Type of Modulation	CP-OFDM: QPSK / 16QAM / 64QAM / 256QAM DFT-s-OFDM: PI/2 BPSK / QPSK / 16QAM / 64QAM / 256QAM

Remark:

1. The maximum EIRP is calculated from max output power and max antenna gain, only the maximum EIRP is shown in the report, 5G NR n77 for Antenna 5.
2. The device supports n77(1T4R) SRS resources on Antenna 0/1/5/6, only the test data of worst Antenna 5 is showed in the report according to the maximum power.
3. 5G NR n77 support UL MIMO mode for Antenna 5+1.
4. 5G NR n77 UL_MIMO mode only supports CP-OFDM Modulation, the MIMO mode is completely uncorrelated, so the directional gain is selected the maximum gain among all antennas.
5. For UL MIMO mode, the conducted test data is the final combined data according to KDB 662911 D01.
6. 5G NR n77 support SA and NSA mode. According to the maximum power between SA and NSA mode, SA covers NSA mode.
7. The device supports HPUE mode for 5G NR n77.
8. For NSA mode of RSE testing, we only choose the combination of the maximum power among all NSA combinations to test.
9. The EN-DC mode combination could be referred to the product spec.

1.3 Modification of EUT

No modifications are made to the EUT during all test items.



1.4 Maximum EIRP and Emission Designator

5G NR n77 SA		PI/2 BPSK / QPSK		16QAM / 64QAM / 256QAM	
BW (MHz)	Frequency Range (MHz)	Maximum EIRP(W)	Emission Designator (99%OBW)	Maximum EIRP(W)	Emission Designator (99%OBW)
20	3710.01 ~ 3969.99	0.4550	18M2G7D	0.3597	18M2W7D
30	3715.02 ~ 3964.98	0.4529	27M6G7D	0.3516	27M9W7D
40	3720.00 ~ 3960.00	0.4467	37M8G7D	0.3381	38M0W7D
50	3725.01 ~ 3954.99	0.4457	47M4G7D	0.3404	47M5W7D
60	3730.02 ~ 3949.98	0.4416	57M9G7D	0.3443	58M0W7D
70	3735.00 ~ 3945.00	0.4395	67M5G7D	0.3443	67M5W7D
80	3740.01 ~ 3939.99	0.4325	77M6G7D	0.3334	77M6W7D
90	3745.02 ~ 3934.98	0.4395	87M5G7D	0.3404	87M6W7D
100	3750.00 ~ 3930.00	0.4645	97M4G7D	0.3581	97M5W7D

5G NR n77 UL MIMO		QPSK		16QAM / 64QAM / 256QAM	
BW (MHz)	Frequency Range (MHz)	Maximum EIRP(W)	Emission Designator (99%OBW)	Maximum EIRP(W)	Emission Designator (99%OBW)
20	3710.01 ~ 3969.99	0.3327	18M2G7D	0.3027	18M2W7D
30	3715.02 ~ 3964.98	0.3373	27M8G7D	0.3020	27M9W7D
40	3720.00 ~ 3960.00	0.3342	37M9G7D	0.3097	38M0W7D
50	3725.01 ~ 3954.99	0.3266	47M5G7D	0.2904	47M6W7D
60	3730.02 ~ 3949.98	0.3221	57M9G7D	0.2864	58M0W7D
70	3735.00 ~ 3945.00	0.3119	67M6G7D	0.2805	67M6W7D
80	3740.01 ~ 3939.99	0.3069	77M6G7D	0.2799	77M5W7D
90	3745.02 ~ 3934.98	0.3055	87M3G7D	0.2818	87M6W7D
100	3750.00 ~ 3930.00	0.3451	97M4G7D	0.2780	97M9W7D

Note: All modulations have been tested, and only the worst test results of PSK & QAM are shown in the report.



1.5 Testing Location

Sporton International Inc. (Kunshan) is accredited to ISO/IEC 17025:2017 by American Association for Laboratory Accreditation with Certificate Number 5145.02.

Test Firm	Sporton International Inc. (Kunshan)		
Test Site Location	No. 1098, Pengxi North Road, Kunshan Economic Development Zone Jiangsu Province 215300 People's Republic of China TEL : +86-512-57900158		
Test Site No.	Sporton Site No.	FCC Designation No.	FCC Test Firm Registration No.
	03CH04-KS TH01-KS	CN1257	314309

1.6 Test Software

Item	Site	Manufacturer	Name	Version
1.	03CH04-KS	AUDIX	E3	6.2009-8-24al

1.7 Applicable Standards

According to the specifications of the manufacturer, the EUT must comply with the requirements of the following standards:

- ♦ 47 CFR Part 2, 27
- ♦ ANSI C63.26-2015
- ♦ FCC KDB 971168 D01 Power Meas License Digital Systems v03r01
- ♦ FCC KDB 412172 D01 Determining ERP and EIRP v01r01

Remark: All test items were verified and recorded according to the standards and without any deviation during the test.



2 Test Configuration of Equipment Under Test

2.1 Test Mode

Antenna port conducted and radiated test items are performed according to KDB 971168 D01 Power Meas License Digital Systems v03r01 with maximum output power.

For radiated measurement, pre-scanned in three orthogonal panels, X, Y, Z. The worst cases (X plane) were recorded in this report.

The device is investigated from 30MHz to 10 times of fundamental signal for radiated spurious emission test under different RB size/offset and modulations in exploratory test. Subsequently, only the worst case emissions are reported.

Orthogonal Planes of EUT	X Plane	Y Plane	Z Plane
			

Test Items	5G NR	Bandwidth (MHz)									Modulation					RB #			Test Channel		
		20	30	40	50	60	70	80	90	100	PI/2 BPSK	QPSK	16QAM	64QAM	256 QAM	1	Half	Full	L	M	H
Max. Output Power	n77	v	v	v	v	v	v	v	v	v	v	v	v	v	v	v		v	v	v	v
Peak-to-Average Ratio	n77				-		-		-	v	v					v		v		v	
26dB and 99% Bandwidth	n77	v	v	v	v	v	v	v	v	v		v	v	v	v			v		v	
Conducted Band Edge	n77	v			-	v	-		-	v	v					v		v	v		v
Conducted Spurious Emission	n77	v			-	v	-		-	v	v					v			v	v	v
Frequency Stability	n77	v			-		-		-			v						v		v	
E.R.P / E.I.R.P	n77	v	v	v	v	v	v	v	v	v	v	v	v	v	v	v		v	v	v	v
Radiated Spurious Emission	n77	Worst Case																	v	v	v
Note	<ol style="list-style-type: none"> The mark "v" means that this configuration is chosen for testing The mark "-" means that this bandwidth is not supported. The device is investigated from 30MHz to 10 times of fundamental signal for radiated spurious emission test under different RB size/offset and modulations in exploratory test. Subsequently, only the worst case emissions are reported. Normal Voltage: 3.85Vdc, Extreme Voltage: 3.45Vdc ~4.41Vdc 																				

2.2 Connection Diagram of Test System

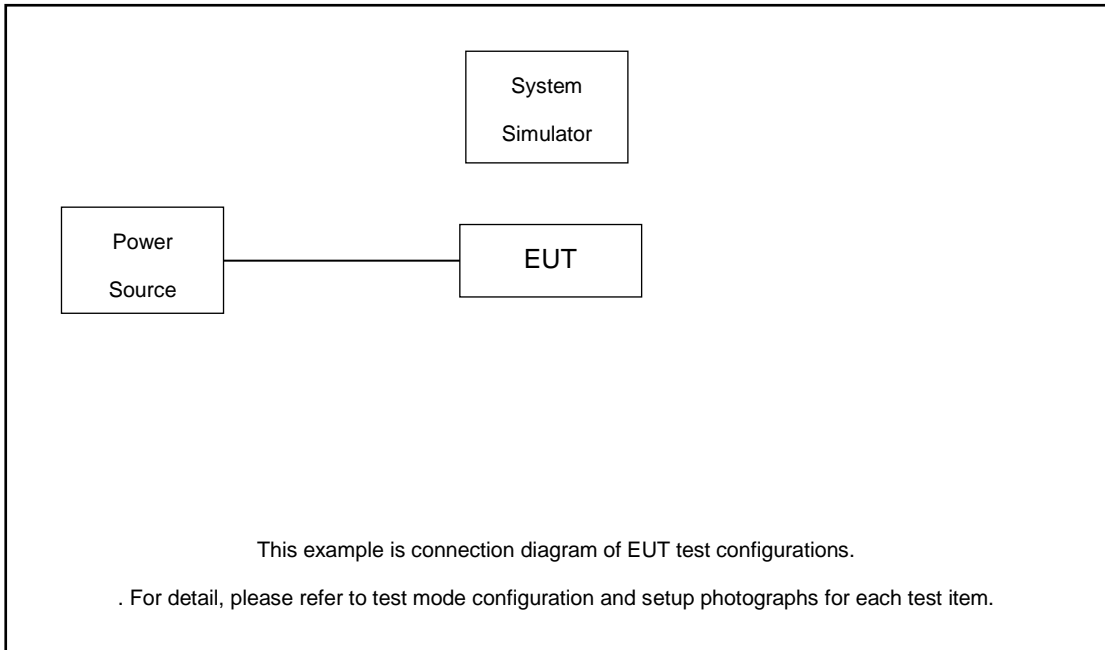

2.3 Support Unit used in test configuration and system

Item	Equipment	Trade Name	Model No.	FCC ID	Data Cable	Power Cord
1.	DC Power Supply	GW	GPS-3030D	N/A	N/A	Unshielded, 1.8 m
2.	LTE Base Station	Anritsu	MT8821C	N/A	N/A	Unshielded, 1.8 m
3.	NR Base Station	Anritsu	MT8000A	N/A	N/A	Unshielded, 1.8 m

2.4 Measurement Results Explanation Example

For all conducted test items:

The offset level is set in the spectrum analyzer to compensate the RF cable loss and attenuator factor between EUT conducted output port and spectrum analyzer. With the offset compensation, the spectrum analyzer reading level is exactly the EUT RF output level.

The spectrum analyzer offset is derived from RF cable loss and attenuator factor.

$$\text{Offset} = \text{RF cable loss} + \text{attenuator factor}.$$

Following shows an offset computation example with cable loss 3.48 dB and 30dB attenuator.

Example :

$$\begin{aligned} \text{Offset(dB)} &= \text{RF cable loss(dB)} + \text{attenuator factor(dB)}. \\ &= 3.47 + 30 = 33.47 \text{ (dB)} \end{aligned}$$



2.5 Frequency List of Low/Middle/High Channels

5G n77 (30kHz) Channel and Frequency List				
BW [MHz]	Channel/Frequency(MHz)	Lowest	Middle	Highest
100	Channel	650000	656000	662000
	Frequency	3750	3840	3930
90	Channel	649668	656000	662332
	Frequency	3745.02	3840	3934.98
80	Channel	649334	656000	662666
	Frequency	3740.01	3840	3939.99
70	Channel	649000	656000	663000
	Frequency	3735	3840	3945
60	Channel	648668	656000	663332
	Frequency	3730.02	3840	3949.98
50	Channel	648334	656000	663666
	Frequency	3725.01	3840	3954.99
40	Channel	648000	656000	664000
	Frequency	3720	3840	3960
30	Channel	647668	656000	664332
	Frequency	3715.02	3840	3964.98
20	Channel	647334	656000	664666
	Frequency	3710.01	3840	3969.99

3 Conducted Test Items

3.1 Measuring Instruments

See list of measuring instruments of this test report.

3.2 Test Setup

3.2.1 Conducted Output Power



3.2.2 Peak-to-Average Ratio, Occupied Bandwidth, Conducted Band-Edge and Conducted Spurious Emission

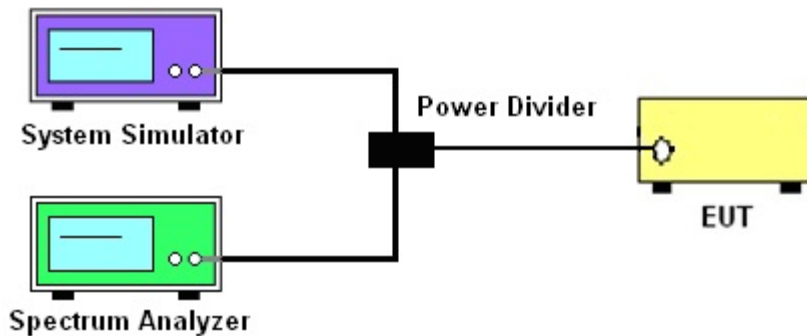

3.2.3 Frequency Stability

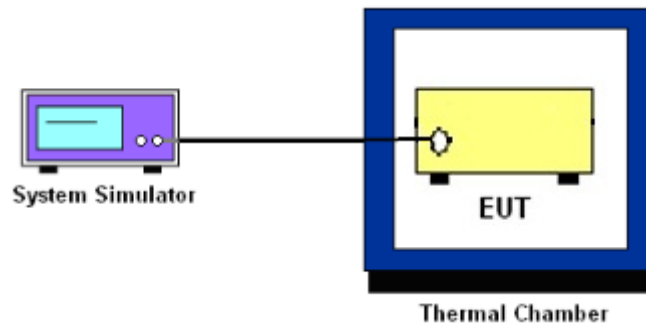

3.3 Test Result of Conducted Test

Please refer to Appendix A.



3.4 Conducted Output Power and EIRP

3.4.1 Description of the Conducted Output Power Measurement and EIRP Measurement

A system simulator was used to establish communication with the EUT. Its parameters were set to force the EUT transmitting at maximum output power. The measured power in the radio frequency on the transmitter output terminals shall be reported.

The EIRP of mobile transmitters must not exceed 1 Watts for 5G NR n77.

According to KDB 412172 D01 Power Approach,

$EIRP = P_T + G_T - L_C$, $ERP = EIRP - 2.15$, where

P_T = transmitter output power in dBm

G_T = gain of the transmitting antenna in dBi

L_C = signal attenuation in the connecting cable between the transmitter and antenna in dB

3.4.2 Test Procedures

1. The testing follows ANSI C63.26 Section 5.2
2. The transmitter output port was connected to the system simulator.
3. Set EUT at maximum power through the system simulator.
4. Select lowest, middle, and highest channels for each band and different modulation.
5. Measure and record the power level from the system simulator.



3.5 Peak-to-Average Ratio

3.5.1 Description of the PAR Measurement

Power Complementary Cumulative Distribution Function (CCDF) curves provide a means for characterizing the power peaks of a digitally modulated signal on a statistical basis. A CCDF curve depicts the probability of the peak signal amplitude exceeding the average power level. Most contemporary measurement instrumentation include the capability to produce CCDF curves for an input signal provided that the instrument's resolution bandwidth can be set wide enough to accommodate the entire input signal bandwidth. In measuring transmissions in this band using an average power technique, the peak-to-average ratio (PAR) of the transmission may not exceed 13 dB.

3.5.2 Test Procedures

1. The testing follows ANSI C63.26 Section 5.2.3.4 (CCDF).
2. The EUT was connected to spectrum and system simulator via a power divider.
3. Set the CCDF (Complementary Cumulative Distribution Function) option in spectrum analyzer.
4. The highest RF powers were measured and recorded the maximum PAPR level associated with a probability of 0.1 %.
5. Record the deviation as Peak to Average Ratio.



3.6 Occupied Bandwidth

3.6.1 Description of Occupied Bandwidth Measurement

The occupied bandwidth is the width of a frequency band such that, below the lower and above the upper frequency limits, the mean powers emitted are each equal to a specified percentage 0.5% of the total mean transmitted power.

The 26 dB emission bandwidth is defined as the frequency range between two points, one above and one below the carrier frequency, at which the spectral density of the emission is attenuated 26 dB below the maximum in-band spectral density of the modulated signal. Spectral density (power per unit bandwidth) is to be measured with a detector of resolution bandwidth equal to approximately 1.0% of the emission bandwidth.

3.6.2 Test Procedures

1. The testing follows ANSI C63.26 Section 5.4
2. The EUT was connected to spectrum analyzer and system simulator via a power divider.
3. The spectrum analyzer center frequency is set to the nominal EUT channel center frequency. The span range for the spectrum analyzer shall be between two and five times the anticipated OBW.
4. The nominal resolution bandwidth (RBW) shall be in the range of 1 to 5 % of the anticipated OBW, and the VBW shall be at least 3 times the RBW.
5. Set the detection mode to peak, and the trace mode to max hold.
6. Determine the reference value: Set the EUT to transmit a modulated signal. Allow the trace to stabilize. Set the spectrum analyzer marker to the highest level of the displayed trace.
(this is the reference value)
7. Determine the “-26 dB down amplitude” as equal to (Reference Value – X).
8. Place two markers, one at the lowest and the other at the highest frequency of the envelope of the spectral display such that each marker is at or slightly below the “-X dB down amplitude” determined in step 6. If a marker is below this “-X dB down amplitude” value it shall be placed as close as possible to this value. The OBW is the positive frequency difference between the two markers.
9. Use the 99 % power bandwidth function of the spectrum analyzer and report the measured bandwidth.



3.7 Conducted Band Edge

3.7.1 Description of Conducted Band Edge Measurement

27.53(l)(2)

For mobile operations in the 3700-3980 MHz band, the conducted power of any emission outside the licensee's authorized bandwidth shall not exceed -13 dBm/MHz. Compliance with this paragraph is based on the use of measurement instrumentation employing a resolution bandwidth of 1 megahertz or greater. However, in the 1 megahertz bands immediately outside and adjacent to the licensee's frequency block, the minimum resolution bandwidth for the measurement shall be either one percent of the emission bandwidth of the fundamental emission of the transmitter or 350 kHz. In the bands between 1 and 5 MHz removed from the licensee's frequency block, the minimum resolution bandwidth for the measurement shall be 500 kHz.

3.7.2 Test Procedures

1. The testing follows ANSI C63.26 section 5.7
2. The EUT was connected to spectrum analyzer and system simulator via a power divider.
3. The band edges of low and high channels for the highest RF powers were measured.
4. Set RBW \geq 1% EBW in the 1MHz band immediately outside and adjacent to the band edge.
5. Beyond the 1 MHz band from the band edge, RBW=1MHz was used or a narrower RBW was used (generally limited to no less than 1% of the OBW) and the measured power was integrated over the full required measurement bandwidth.
6. Set spectrum analyzer with RMS detector.
7. The RF fundamental frequency should be excluded against the limit line in the operating frequency band.
8. Checked that all the results comply with the emission limit line.

Example:

$$\begin{aligned} & \text{The limit line is derived from } 43 + 10\log(P)\text{dB below the transmitter power } P(\text{Watts}) \\ & = P(\text{W}) - [43 + 10\log(P)] \text{ (dB)} \\ & = [30 + 10\log(P)] \text{ (dBm)} - [43 + 10\log(P)] \text{ (dB)} = -13\text{dBm}. \end{aligned}$$

9. When using the integration method, the starting frequency of the integration shall be centered at one-half of the RBW away from the band edge.



3.8 Conducted Spurious Emission

3.8.1 Description of Conducted Spurious Emission Measurement

The power of any emission outside of the authorized operating frequency ranges must be lower than the transmitter power (P) by a factor of at least $43 + 10 \log (P)$ dB.

It is measured by means of a calibrated spectrum analyzer and scanned from 30 MHz up to a frequency including its 10th harmonic.

3.8.2 Test Procedures

1. The testing follows ANSI C63.26 section 5.7
2. The EUT was connected to spectrum analyzer and system simulator via a power divider.
3. The RF output of EUT was connected to the spectrum analyzer by RF cable and attenuator. The path loss was compensated to the results for each measurement.
4. The middle channel for the highest RF power within the transmitting frequency was measured.
5. The conducted spurious emission for the whole frequency range was taken.
6. Make the measurement with the spectrum analyzer's RBW = 1MHz, VBW = 3MHz.
7. Set spectrum analyzer with RMS detector.
8. Taking the record of maximum spurious emission.
9. The RF fundamental frequency should be excluded against the limit line in the operating frequency band.
10. The limit line is derived from $43 + 10\log(P)$ dB below the transmitter power P(Watts)
= P(W)- [43 + 10log(P)] (dB)
= [30 + 10log(P)] (dBm) - [43 + 10log(P)] (dB)
= -13dBm.



3.9 Frequency Stability

3.9.1 Description of Frequency Stability Measurement

The frequency stability shall be measured by variation of ambient temperature and variation of primary supply voltage to ensure that the fundamental emission stays within the authorized frequency block. The frequency stability of the transmitter shall be maintained within $\pm 0.00025\%$ ($\pm 2.5\text{ppm}$) of the center frequency.

3.9.2 Test Procedures for Temperature Variation

1. The testing follows ANSI C63.26 section 5.6.4
2. The EUT was set up in the thermal chamber and connected with the system simulator.
3. With power OFF, the temperature was decreased to -30°C and the EUT was stabilized before testing. Power was applied and the maximum change in frequency was recorded within one minute.
4. With power OFF, the temperature was raised in 10°C step up to 50°C . The EUT was stabilized at each step for at least half an hour. Power was applied and the maximum frequency change was recorded within one minute.

3.9.3 Test Procedures for Voltage Variation

1. The testing follows ANSI C63.26 section 5.6.5
2. The EUT was placed in a temperature chamber at $20\pm 5^{\circ}\text{C}$ and connected with the system simulator.
3. The power supply voltage to the EUT was varied from 85% to 115% of the nominal value for other than hand carried battery equipment.
4. For hand carried, battery powered equipment, reduce the primary ac or dc supply voltage to the battery operating end point, which shall be specified by the manufacturer.
5. The variation in frequency was measured for the worst case.

4 Radiated Test Items

4.1 Measuring Instruments

See list of measuring instruments of this test report.

4.2 Test Setup

4.2.1 For radiated test below 30MHz

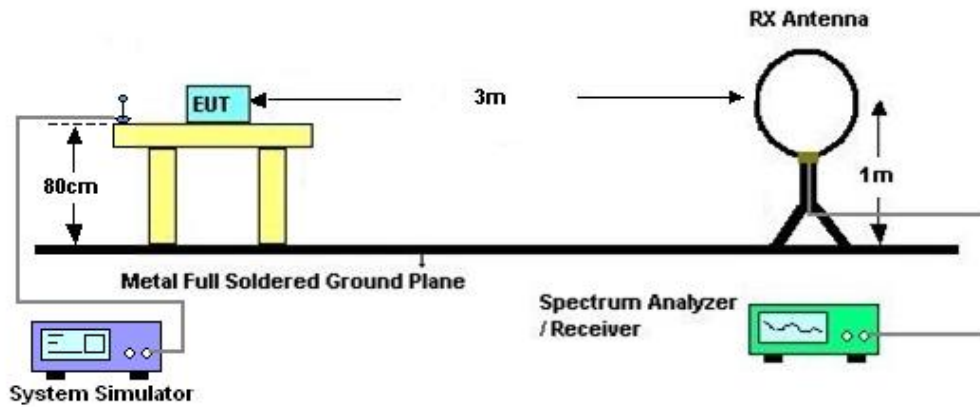

4.2.2 For radiated test from 30MHz to 1GHz

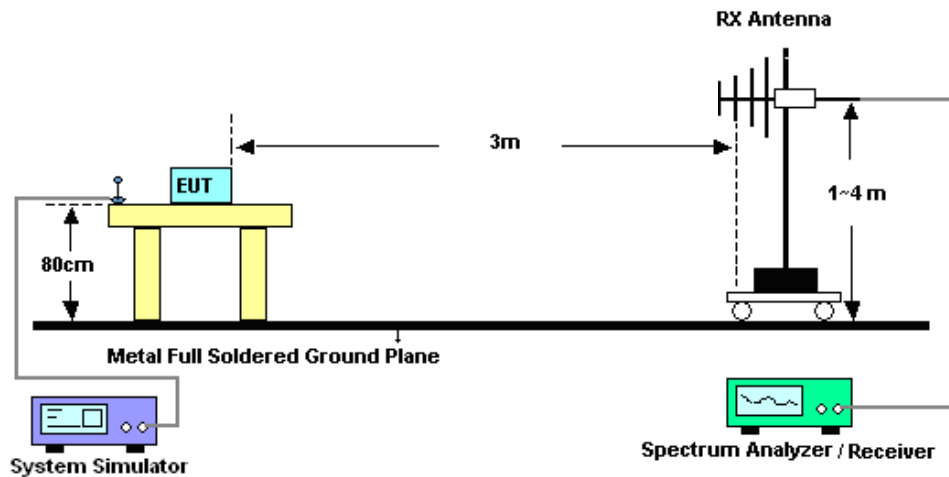

4.2.3 For radiated test above 1GHz

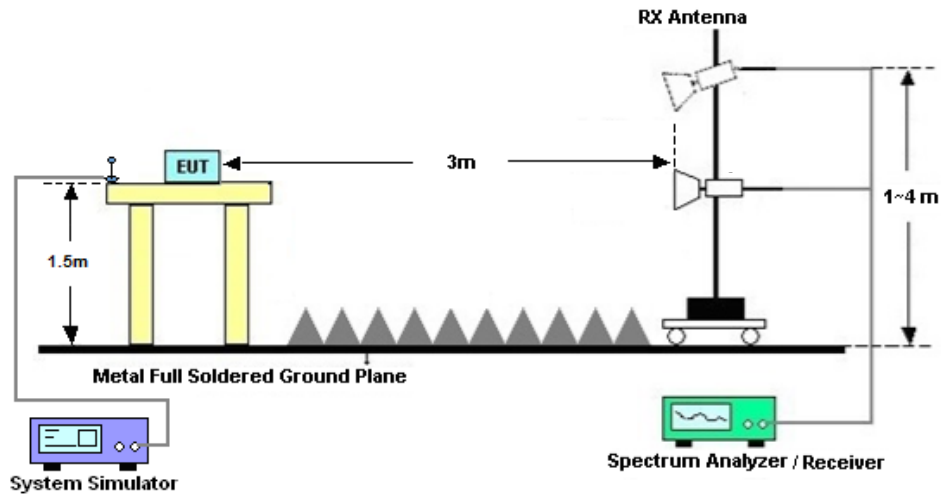

4.3 Test Result of Radiated Test

The low frequency, which started from 9 kHz to 30MHz, was pre-scanned and the result which was 20dB lower than the limit line was not reported.

Please refer to Appendix B.



4.4 Radiated Spurious Emission

4.4.1 Description of Radiated Spurious Emission

The radiated spurious emission was measured by substitution method according to ANSI C63.26. The power of any emission outside of the authorized operating frequency ranges must be attenuated below the transmitter power (P) by a factor of at least $43 + 10 \log (P)$ dB. The spectrum is scanned from 30 MHz up to a frequency including its 10th harmonic.

4.4.2 Test Procedures

1. The testing follows ANSI C63.26 Section 5.5
2. The EUT was placed on a turntable with 0.8 meter height for frequency below 1GHz and 1.5 meter height for frequency above 1GHz respectively above ground.
3. The EUT was set 3 meters from the receiving antenna mounted on the antenna tower.
4. The table was rotated 360 degrees to determine the position of the highest spurious emission.
5. The height of the receiving antenna is varied between 1m to 4m to search the maximum spurious emission for both horizontal and vertical polarizations.
6. During the measurement, the system simulator parameters were set to force the EUT transmitting at maximum output power.
7. Make the measurement with the spectrum analyzer's RBW = 1MHz, VBW = 3MHz, taking the record of maximum spurious emission.
8. A horn antenna was substituted in place of the EUT and was driven by a signal generator.
9. Tune the output power of signal generator to the same emission level with EUT maximum spurious emission.
10. $EIRP (dBm) = S.G. Power - Tx Cable Loss + Tx Antenna Gain$
11. $ERP (dBm) = EIRP - 2.15$
12. The RF fundamental frequency should be excluded against the limit line in the operating frequency band.

The limit line is derived from $43 + 10\log(P)$ dB below the transmitter power P(Watts)
= $P(W) - [43 + 10\log(P)] (dB)$
= $[30 + 10\log(P)] (dBm) - [43 + 10\log(P)] (dB)$
= -13dBm.



5 List of Measuring Equipment

Instrument	Manufacturer	Model No.	Serial No.	Characteristics	Calibration Date	Test Date	Due Date	Remark
Spectrum Analyzer	R&S	FSV40	101040	10Hz~40GHz	Oct. 12, 2022	Feb. 20, 2023~ Mar. 15, 2023	Oct. 11, 2023	Conducted (TH01-KS)
Power divider	STI	STI08-0055	-	0.5~40GHz	NCR	Feb. 20, 2023~ Mar. 15, 2023	NCR	Conducted (TH01-KS)
Temperature & humidity chamber	Hongzhan	LP-150U	H2014011440	-40~+150°C 20%~95%RH	Jul. 15, 2022	Feb. 20, 2023~ Mar. 15, 2023	Jul. 14, 2023	Conducted (TH01-KS)
EXA Spectrum Analyzer	Keysight	N9010B	MY57471079	10Hz~44G,MAX 30dB	Oct. 12, 2022	Mar. 01, 2023~ Mar. 30, 2023	Oct. 11, 2023	Radiation (03CH04-KS)
Loop Antenna	R&S	HFH2-Z2	100321	9kHz~30MHz	Oct. 16, 2022	Mar. 01, 2023~ Mar. 30, 2023	Oct. 15, 2023	Radiation (03CH04-KS)
Bilog Antenna	TeseQ	CBL6111D	49922	30MHz~1GHz	May 24, 2022	Mar. 01, 2023~ Mar. 30, 2023	May 23, 2023	Radiation (03CH04-KS)
Horn Antenna	Schwarzbeck	BBHA9120D	1284	1GHz~18GHz	Oct. 16, 2022	Mar. 01, 2023~ Mar. 30, 2023	Oct. 15, 2023	Radiation (03CH04-KS)
SHF-EHF Horn	Com-power	AH-840	101070	18GHz~40GHz	Jan. 08, 2023	Mar. 01, 2023~ Mar. 30, 2023	Jan. 07, 2024	Radiation (03CH04-KS)
Amplifier	SONOMA	310N	187289	9KHz~1GHz	May 24, 2022	Mar. 01, 2023~ Mar. 30, 2023	May 23, 2023	Radiation (03CH04-KS)
Amplifier	MITEQ	EM18G40G GA	060728	18~40GHz	Jan. 05, 2023	Mar. 01, 2023~ Mar. 30, 2023	Jan. 04, 2024	Radiation (03CH04-KS)
high gain Amplifier	EM	EM01G18G A	060839	1Ghz~18Ghz	Oct. 12, 2022	Mar. 01, 2023~ Mar. 30, 2023	Oct. 11, 2023	Radiation (03CH04-KS)
Amplifier	Keysight	83017A	MY57280106	500MHz~26.5GHz	Oct. 12, 2022	Mar. 01, 2023~ Mar. 30, 2023	Oct. 11, 2023	Radiation (03CH04-KS)
AC Power Source	Chroma	61601	F104090004	N/A	NCR	Mar. 01, 2023~ Mar. 30, 2023	NCR	Radiation (03CH04-KS)
Turn Table	ChamPro	EM 1000-T	060762-T	0~360 degree	NCR	Mar. 01, 2023~ Mar. 30, 2023	NCR	Radiation (03CH04-KS)
Antenna Mast	ChamPro	EM 1000-A	060762-A	1 m~4 m	NCR	Mar. 01, 2023~ Mar. 30, 2023	NCR	Radiation (03CH04-KS)

NCR: No Calibration Required



6 Uncertainty of Evaluation

The measurement uncertainties shown below were calculated in accordance with the requirements of ANSI 63.26-2015. All the measurement uncertainty value were shown with a coverage K=2 to indicate 95% level of confidence. The measurement data show herein meets or exceeds the CISPR measurement uncertainty values specified in CISPR 16-4-2 and can be compared directly to specified limit to determine compliance.

Uncertainty of Conducted Measurement

Test Item	Uncertainty
Conducted Power	±0.46 dB
Conducted Emissions	±0.48 dB
Occupied Channel Bandwidth	±0.1 %

Uncertainty of Radiated Emission Measurement (30 MHz ~ 1000 MHz)

Measuring Uncertainty for a Level of Confidence of 95% (U = 2Uc(y))	3.3dB
---------------------------------------------------------------------	-------

Uncertainty of Radiated Emission Measurement (1 GHz ~ 18 GHz)

Measuring Uncertainty for a Level of Confidence of 95% (U = 2Uc(y))	2.8dB
---------------------------------------------------------------------	-------

Uncertainty of Radiated Emission Measurement (18 GHz ~ 40 GHz)

Measuring Uncertainty for a Level of Confidence of 95% (U = 2Uc(y))	2.8dB
---------------------------------------------------------------------	-------

----- THE END -----



Appendix A. Test Results of Conducted Test

Test Engineer :	Smile Wang	Temperature :	22~23°C
		Relative Humidity :	40~42%

FR1 N77 (ANT5)

Transmitter Conducted Output Power and EIRP, ($G_T - L_C$)=0.15dB

NR Band	SCS (kHz)	Bandwidth (MHz)	Arfcn	Freq (MHz)	Modulation	RB	Conducted Power(dBm)	EIRP (dBm)	EIRP (W)
77	30	20	647334	3710	DFT-s-OFDM PI/2 BPSK	1@1	26.41	26.56	0.4529
77	30	20	647334	3710	DFT-s-OFDM QPSK	1@1	26.28	26.43	0.4395
77	30	20	647334	3710	DFT-s-OFDM 16 QAM	1@1	25.41	25.56	0.3597
77	30	20	656000	3840	DFT-s-OFDM PI/2 BPSK	1@1	26.43	26.58	0.4550
77	30	20	656000	3840	DFT-s-OFDM QPSK	1@1	26.38	26.53	0.4498
77	30	20	656000	3840	DFT-s-OFDM 16 QAM	1@1	25.33	25.48	0.3532
77	30	20	664666	3969.99	DFT-s-OFDM PI/2 BPSK	1@1	26.39	26.54	0.4508
77	30	20	664666	3969.99	DFT-s-OFDM QPSK	1@1	26.42	26.57	0.4539
77	30	20	664666	3969.99	DFT-s-OFDM 16 QAM	1@1	25.22	25.37	0.3443
77	30	30	647668	3715.02	DFT-s-OFDM PI/2 BPSK	1@1	26.11	26.26	0.4227
77	30	30	647668	3715.02	DFT-s-OFDM QPSK	1@1	26.24	26.39	0.4355
77	30	30	647668	3715.02	DFT-s-OFDM 16 QAM	1@1	25.14	25.29	0.3381
77	30	30	656000	3840	DFT-s-OFDM PI/2 BPSK	1@1	26.39	26.54	0.4508
77	30	30	656000	3840	DFT-s-OFDM QPSK	1@1	26.41	26.56	0.4529
77	30	30	656000	3840	DFT-s-OFDM 16 QAM	1@1	25.28	25.43	0.3491
77	30	30	664332	3964.98	DFT-s-OFDM PI/2 BPSK	1@1	26.31	26.46	0.4426
77	30	30	664332	3964.98	DFT-s-OFDM QPSK	1@1	26.25	26.4	0.4365
77	30	30	664332	3964.98	DFT-s-OFDM 16 QAM	1@1	25.31	25.46	0.3516
77	30	40	648000	3720	DFT-s-OFDM PI/2 BPSK	1@1	26.2	26.35	0.4315
77	30	40	648000	3720	DFT-s-OFDM QPSK	1@1	26.28	26.43	0.4395
77	30	40	648000	3720	DFT-s-OFDM 16 QAM	1@1	25.14	25.29	0.3381
77	30	40	656000	3840	DFT-s-OFDM PI/2 BPSK	1@1	26.23	26.38	0.4345
77	30	40	656000	3840	DFT-s-OFDM QPSK	1@1	26.14	26.29	0.4256
77	30	40	656000	3840	DFT-s-OFDM 16 QAM	1@1	25.08	25.23	0.3334
77	30	40	664000	3960	DFT-s-OFDM PI/2 BPSK	1@1	26.35	26.5	0.4467
77	30	40	664000	3960	DFT-s-OFDM QPSK	1@1	26.22	26.37	0.4335
77	30	40	664000	3960	DFT-s-OFDM 16 QAM	1@1	25.11	25.26	0.3357
77	30	50	648334	3725.01	DFT-s-OFDM PI/2 BPSK	1@1	25.93	26.08	0.4055

77	30	50	648334	3725.01	DFT-s-OFDM QPSK	1@1	25.85	26	0.3981
77	30	50	648334	3725.01	DFT-s-OFDM 16 QAM	1@1	24.89	25.04	0.3192
77	30	50	656000	3840	DFT-s-OFDM PI/2 BPSK	1@1	26.34	26.49	0.4457
77	30	50	656000	3840	DFT-s-OFDM QPSK	1@1	26.11	26.26	0.4227
77	30	50	656000	3840	DFT-s-OFDM 16 QAM	1@1	25.11	25.26	0.3357
77	30	50	663666	3954.99	DFT-s-OFDM PI/2 BPSK	1@1	26.13	26.28	0.4246
77	30	50	663666	3954.99	DFT-s-OFDM QPSK	1@1	26.05	26.2	0.4169
77	30	50	663666	3954.99	DFT-s-OFDM 16 QAM	1@1	25.17	25.32	0.3404
77	30	60	648668	3730.02	DFT-s-OFDM PI/2 BPSK	1@1	25.88	26.03	0.4009
77	30	60	648668	3730.02	DFT-s-OFDM QPSK	1@1	26.01	26.16	0.4130
77	30	60	648668	3730.02	DFT-s-OFDM 16 QAM	1@1	25.11	25.26	0.3357
77	30	60	656000	3840	DFT-s-OFDM PI/2 BPSK	1@1	26.3	26.45	0.4416
77	30	60	656000	3840	DFT-s-OFDM QPSK	1@1	26.18	26.33	0.4295
77	30	60	656000	3840	DFT-s-OFDM 16 QAM	1@1	25.22	25.37	0.3443
77	30	60	663332	3949.98	DFT-s-OFDM PI/2 BPSK	1@1	26.18	26.33	0.4295
77	30	60	663332	3949.98	DFT-s-OFDM QPSK	1@1	26.15	26.3	0.4266
77	30	60	663332	3949.98	DFT-s-OFDM 16 QAM	1@1	25.11	25.26	0.3357
77	30	70	649000	3735	DFT-s-OFDM PI/2 BPSK	1@1	25.76	25.91	0.3899
77	30	70	649000	3735	DFT-s-OFDM QPSK	1@1	25.74	25.89	0.3882
77	30	70	649000	3735	DFT-s-OFDM 16 QAM	1@1	24.78	24.93	0.3112
77	30	70	656000	3840	DFT-s-OFDM PI/2 BPSK	1@1	26.24	26.39	0.4355
77	30	70	656000	3840	DFT-s-OFDM QPSK	1@1	26.28	26.43	0.4395
77	30	70	656000	3840	DFT-s-OFDM 16 QAM	1@1	25.22	25.37	0.3443
77	30	70	663000	3945	DFT-s-OFDM PI/2 BPSK	1@1	26.03	26.18	0.4150
77	30	70	663000	3945	DFT-s-OFDM QPSK	1@1	26.19	26.34	0.4305
77	30	70	663000	3945	DFT-s-OFDM 16 QAM	1@1	25.01	25.16	0.3281
77	30	80	649334	3740.01	DFT-s-OFDM PI/2 BPSK	1@1	25.74	25.89	0.3882
77	30	80	649334	3740.01	DFT-s-OFDM QPSK	1@1	25.65	25.8	0.3802
77	30	80	649334	3740.01	DFT-s-OFDM 16 QAM	1@1	24.78	24.93	0.3112
77	30	80	656000	3840	DFT-s-OFDM PI/2 BPSK	1@1	26.21	26.36	0.4325
77	30	80	656000	3840	DFT-s-OFDM QPSK	1@1	26.19	26.34	0.4305
77	30	80	656000	3840	DFT-s-OFDM 16 QAM	1@1	25.08	25.23	0.3334
77	30	80	662666	3939.99	DFT-s-OFDM PI/2 BPSK	1@1	25.9	26.05	0.4027
77	30	80	662666	3939.99	DFT-s-OFDM QPSK	1@1	25.78	25.93	0.3917

77	30	80	662666	3939.99	DFT-s-OFDM 16 QAM	1@1	24.89	25.04	0.3192
77	30	90	649668	3745.02	DFT-s-OFDM PI/2 BPSK	1@1	25.79	25.94	0.3926
77	30	90	649668	3745.02	DFT-s-OFDM QPSK	1@1	25.85	26	0.3981
77	30	90	649668	3745.02	DFT-s-OFDM 16 QAM	1@1	24.77	24.92	0.3105
77	30	90	656000	3840	DFT-s-OFDM PI/2 BPSK	1@1	26.14	26.29	0.4256
77	30	90	656000	3840	DFT-s-OFDM QPSK	1@1	26.28	26.43	0.4395
77	30	90	656000	3840	DFT-s-OFDM 16 QAM	1@1	25.17	25.32	0.3404
77	30	90	662332	3934.98	DFT-s-OFDM PI/2 BPSK	1@1	25.95	26.1	0.4074
77	30	90	662332	3934.98	DFT-s-OFDM QPSK	1@1	25.98	26.13	0.4102
77	30	90	662332	3934.98	DFT-s-OFDM 16 QAM	1@1	24.85	25	0.3162
77	30	100	650000	3750	DFT-s-OFDM PI/2 BPSK	135@67	25.99	26.14	0.4111
77	30	100	650000	3750	DFT-s-OFDM PI/2 BPSK	1@1	25.87	26.02	0.3999
77	30	100	650000	3750	DFT-s-OFDM PI/2 BPSK	1@271	26.1	26.25	0.4217
77	30	100	650000	3750	DFT-s-OFDM QPSK	135@67	25.94	26.09	0.4064
77	30	100	650000	3750	DFT-s-OFDM QPSK	1@1	25.91	26.06	0.4036
77	30	100	650000	3750	DFT-s-OFDM QPSK	1@271	26.14	26.29	0.4256
77	30	100	650000	3750	DFT-s-OFDM 16 QAM	135@67	24.95	25.1	0.3236
77	30	100	650000	3750	DFT-s-OFDM 16 QAM	1@1	24.94	25.09	0.3228
77	30	100	650000	3750	DFT-s-OFDM 16 QAM	1@271	25.26	25.41	0.3475
77	30	100	650000	3750	DFT-s-OFDM 64 QAM	135@67	23.46	23.61	0.2296
77	30	100	650000	3750	DFT-s-OFDM 64 QAM	1@1	23.21	23.36	0.2168
77	30	100	650000	3750	DFT-s-OFDM 64 QAM	1@271	23.58	23.73	0.2360
77	30	100	650000	3750	DFT-s-OFDM 256 QAM	135@67	21.47	21.62	0.1452
77	30	100	650000	3750	DFT-s-OFDM 256 QAM	1@1	21.19	21.34	0.1361
77	30	100	650000	3750	DFT-s-OFDM 256 QAM	1@271	21.54	21.69	0.1476
77	30	100	650000	3750	CP-OFDM QPSK	1@1	24.35	24.5	0.2818
77	30	100	656000	3840	DFT-s-OFDM PI/2 BPSK	135@67	26.28	26.43	0.4395
77	30	100	656000	3840	DFT-s-OFDM PI/2 BPSK	1@1	26.22	26.37	0.4335
77	30	100	656000	3840	DFT-s-OFDM PI/2 BPSK	1@271	26.21	26.36	0.4325
77	30	100	656000	3840	DFT-s-OFDM QPSK	135@67	26.28	26.43	0.4395
77	30	100	656000	3840	DFT-s-OFDM QPSK	1@1	26.52	26.67	0.4645
77	30	100	656000	3840	DFT-s-OFDM QPSK	1@271	26.26	26.41	0.4375
77	30	100	656000	3840	DFT-s-OFDM 16 QAM	135@67	25.16	25.31	0.3396
77	30	100	656000	3840	DFT-s-OFDM 16 QAM	1@1	25.39	25.54	0.3581

77	30	100	656000	3840	DFT-s-OFDM 16 QAM	1@271	25.36	25.51	0.3556
77	30	100	656000	3840	DFT-s-OFDM 64 QAM	135@67	23.68	23.83	0.2415
77	30	100	656000	3840	DFT-s-OFDM 64 QAM	1@1	23.57	23.72	0.2355
77	30	100	656000	3840	DFT-s-OFDM 64 QAM	1@271	23.71	23.86	0.2432
77	30	100	656000	3840	DFT-s-OFDM 256 QAM	135@67	21.69	21.84	0.1528
77	30	100	656000	3840	DFT-s-OFDM 256 QAM	1@1	21.56	21.71	0.1483
77	30	100	656000	3840	DFT-s-OFDM 256 QAM	1@271	21.51	21.66	0.1466
77	30	100	656000	3840	CP-OFDM QPSK	1@1	24.85	25	0.3162
77	30	100	662000	3930	DFT-s-OFDM PI/2 BPSK	135@67	26.22	26.37	0.4335
77	30	100	662000	3930	DFT-s-OFDM PI/2 BPSK	1@1	26.03	26.18	0.4150
77	30	100	662000	3930	DFT-s-OFDM PI/2 BPSK	1@271	26.09	26.24	0.4207
77	30	100	662000	3930	DFT-s-OFDM QPSK	135@67	26.21	26.36	0.4325
77	30	100	662000	3930	DFT-s-OFDM QPSK	1@1	26.08	26.23	0.4198
77	30	100	662000	3930	DFT-s-OFDM QPSK	1@271	26.13	26.28	0.4246
77	30	100	662000	3930	DFT-s-OFDM 16 QAM	135@67	25.19	25.34	0.3420
77	30	100	662000	3930	DFT-s-OFDM 16 QAM	1@1	25.22	25.37	0.3443
77	30	100	662000	3930	DFT-s-OFDM 16 QAM	1@271	25.16	25.31	0.3396
77	30	100	662000	3930	DFT-s-OFDM 64 QAM	135@67	23.69	23.84	0.2421
77	30	100	662000	3930	DFT-s-OFDM 64 QAM	1@1	23.42	23.57	0.2275
77	30	100	662000	3930	DFT-s-OFDM 64 QAM	1@271	23.53	23.68	0.2333
77	30	100	662000	3930	DFT-s-OFDM 256 QAM	135@67	21.7	21.85	0.1531
77	30	100	662000	3930	DFT-s-OFDM 256 QAM	1@1	21.48	21.63	0.1455
77	30	100	662000	3930	DFT-s-OFDM 256 QAM	1@271	21.46	21.61	0.1449
77	30	100	662000	3930	CP-OFDM QPSK	1@1	24.54	24.69	0.2944

Frequency Stability

NR Band	SCS (kHz)	Bandwidth (MHz)	Arfcn	Freq (MHz)	Modulation	RB	Deviation (ppm)	Verdict	Environment
77	30	20	656000	3840.0	DFT-s-OFDM QPSK	50@0	0.0016	PASS	NV
77	30	20	656000	3840.0	DFT-s-OFDM QPSK	50@0	0.0021	PASS	LV
77	30	20	656000	3840.0	DFT-s-OFDM QPSK	50@0	0.0019	PASS	HV
77	30	20	656000	3840.0	DFT-s-OFDM QPSK	50@0	0.0035	PASS	-30°C
77	30	20	656000	3840.0	DFT-s-OFDM QPSK	50@0	0.0014	PASS	-20°C
77	30	20	656000	3840.0	DFT-s-OFDM QPSK	50@0	0.0012	PASS	-10°C
77	30	20	656000	3840.0	DFT-s-OFDM QPSK	50@0	0.0029	PASS	0°C
77	30	20	656000	3840.0	DFT-s-OFDM QPSK	50@0	0.0027	PASS	10°C
77	30	20	656000	3840.0	DFT-s-OFDM QPSK	50@0	0.0023	PASS	20°C
77	30	20	656000	3840.0	DFT-s-OFDM QPSK	50@0	0.0029	PASS	30°C
77	30	20	656000	3840.0	DFT-s-OFDM QPSK	50@0	0.0039	PASS	40°C
77	30	20	656000	3840.0	DFT-s-OFDM QPSK	50@0	0.0024	PASS	50°C

Peak to Average Ratio

NR Band	SCS (kHz)	Bandwidth (MHz)	Arfcn	Freq (MHz)	Modulation	RB	Result (dB)	Limit (dB)	Verdict
77	30	100	656000	3840.0	DFT-s-OFDM PI/2 BPSK	270@0	10.09	13	PASS
77	30	100	656000	3840.0	DFT-s-OFDM PI/2 BPSK	1@0	7.11	13	PASS
77	30	100	656000	3840.0	DFT-s-OFDM QPSK	270@0	10.4	13	PASS
77	30	100	656000	3840.0	DFT-s-OFDM QPSK	1@0	8.6	13	PASS

N77(100M)_DFT-s-OFDM_PI_2-BPSK_Outer_Full_Mid_CH



N77(100M)_DFT-s-OFDM_PI_2-BPSK_Edge_1RB_Left_Mid_CH

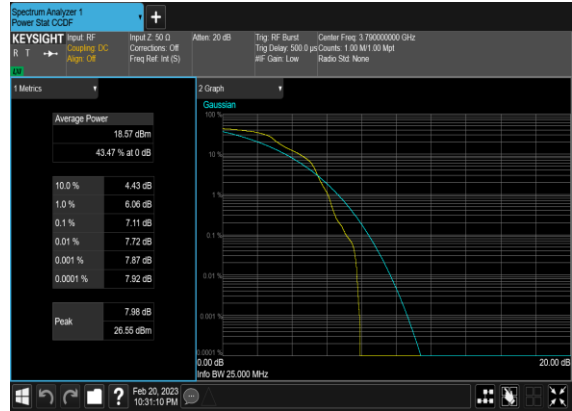

N77(100M)_DFT-s-OFDM_QPSK_Outer_Full_Mid_CH



N77(100M)_DFT-s-OFDM_QPSK_Edge_1RB_Left_Mid_CH



Occupied Bandwidth

NR Band	SCS (kHz)	Bandwidth (MHz)	Arfcn	Freq (MHz)	Modulation	RB	OBW (MHz)	26dB BW (MHz)
77	30	20	656000	3840.0	CP-OFDM QPSK	51@0	18.224	19.57
77	30	20	656000	3840.0	CP-OFDM 16 QAM	51@0	18.231	19.05
77	30	20	656000	3840.0	CP-OFDM 64 QAM	51@0	18.209	19.25
77	30	20	656000	3840.0	CP-OFDM 256 QAM	51@0	18.202	19.11
77	30	30	656000	3840.0	CP-OFDM QPSK	78@0	27.854	29.02
77	30	30	656000	3840.0	CP-OFDM 16 QAM	78@0	27.773	28.84
77	30	30	656000	3840.0	CP-OFDM 64 QAM	78@0	27.88	28.89
77	30	30	656000	3840.0	CP-OFDM 256 QAM	78@0	27.811	29.17
77	30	40	656000	3840.0	CP-OFDM QPSK	106@0	37.763	39.18
77	30	40	656000	3840.0	CP-OFDM 16 QAM	106@0	37.753	39.31
77	30	40	656000	3840.0	CP-OFDM 64 QAM	106@0	37.838	39.39
77	30	40	656000	3840.0	CP-OFDM 256 QAM	106@0	37.946	39.23
77	30	50	656000	3840.0	CP-OFDM QPSK	133@0	47.397	49.22
77	30	50	656000	3840.0	CP-OFDM 16 QAM	133@0	47.42	49.02
77	30	50	656000	3840.0	CP-OFDM 64 QAM	133@0	47.522	48.96
77	30	50	656000	3840.0	CP-OFDM 256 QAM	133@0	47.301	49.03
77	30	60	656000	3840.0	CP-OFDM QPSK	162@0	57.853	59.7
77	30	60	656000	3840.0	CP-OFDM 16 QAM	162@0	57.92	59.7
77	30	60	656000	3840.0	CP-OFDM 64 QAM	162@0	57.967	59.7
77	30	60	656000	3840.0	CP-OFDM 256 QAM	162@0	57.672	59.63
77	30	70	656000	3840.0	CP-OFDM QPSK	189@0	67.448	69.56
77	30	70	656000	3840.0	CP-OFDM 16 QAM	189@0	67.444	69.55
77	30	70	656000	3840.0	CP-OFDM 64 QAM	189@0	67.516	69.6
77	30	70	656000	3840.0	CP-OFDM 256 QAM	189@0	67.539	69.54
77	30	80	656000	3840.0	CP-OFDM QPSK	217@0	77.619	79.92
77	30	80	656000	3840.0	CP-OFDM 16 QAM	217@0	77.578	79.9

77	30	80	656000	3840.0	CP-OFDM 64 QAM	217@0	77.492	79.91
77	30	80	656000	3840.0	CP-OFDM 256 QAM	217@0	77.568	79.9
77	30	90	656000	3840.0	CP-OFDM QPSK	245@0	87.485	90.21
77	30	90	656000	3840.0	CP-OFDM 16 QAM	245@0	87.357	90.27
77	30	90	656000	3840.0	CP-OFDM 64 QAM	245@0	87.325	90.17
77	30	90	656000	3840.0	CP-OFDM 256 QAM	245@0	87.586	90.33
77	30	100	656000	3840.0	CP-OFDM QPSK	273@0	97.443	100.6
77	30	100	656000	3840.0	CP-OFDM 16 QAM	273@0	97.486	100.5
77	30	100	656000	3840.0	CP-OFDM 64 QAM	273@0	97.28	100.5
77	30	100	656000	3840.0	CP-OFDM 256 QAM	273@0	97.462	100.5

N77(20M)_CP-OFDM_QPSK_Outer_Full_Mid_CH

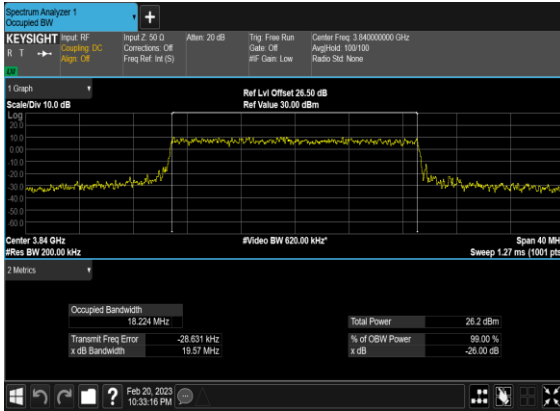

N77(20M)_CP-OFDM_16QAM_Outer_Full_Mid_CH

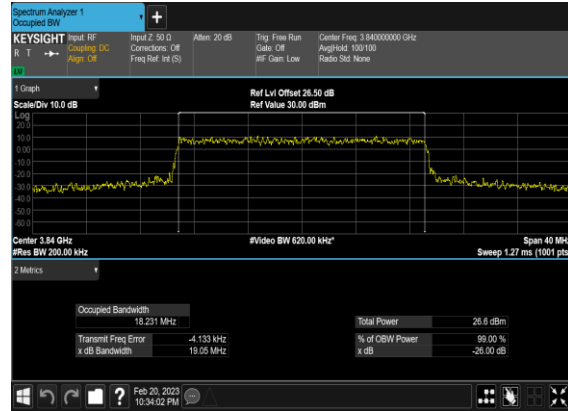

N77(20M)_CP-OFDM_64QAM_Outer_Full_Mid_CH

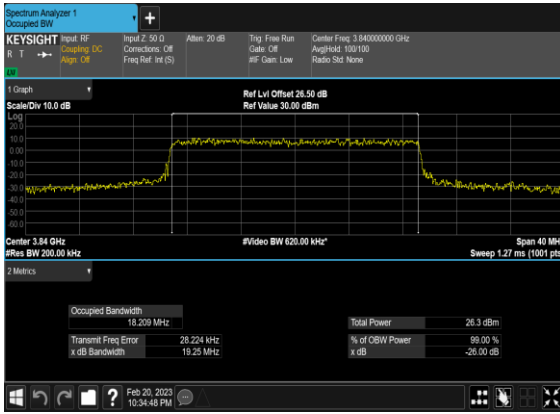

N77(20M)_CP-OFDM_256QAM_Outer_Full_Mid_CH

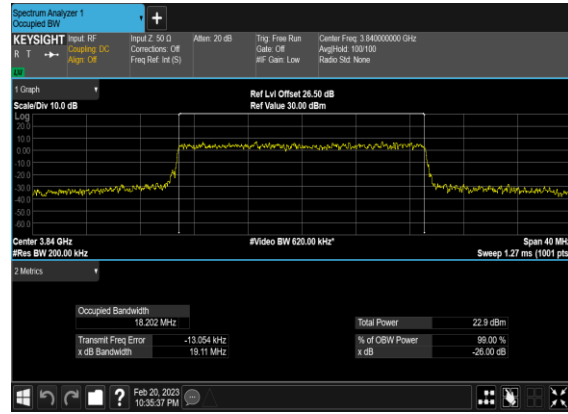

N77(30M)_CP-OFDM_QPSK_Outer_Full_Mid_CH

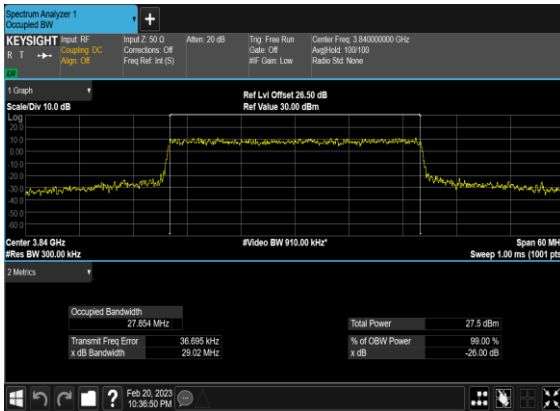

N77(30M)_CP-OFDM_16QAM_Outer_Full_Mid_CH

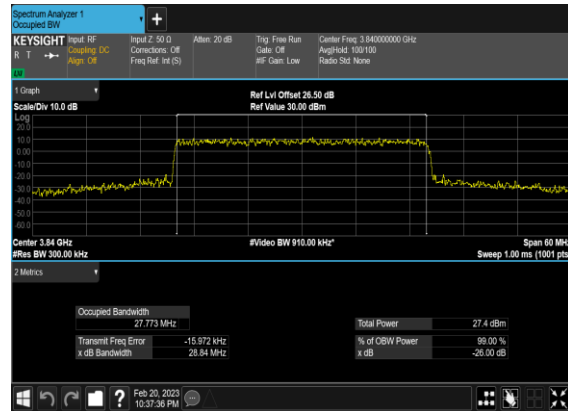

N77(30M)_CP-OFDM_64 QAM_Outer_Full_Mid_CH

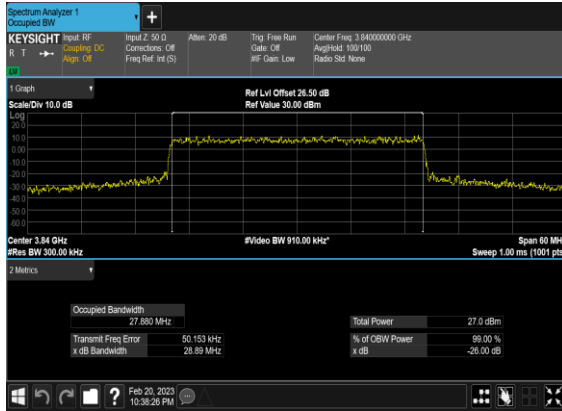

N77(30M)_CP-OFDM_256 QAM_Outer_Full_Mid_CH

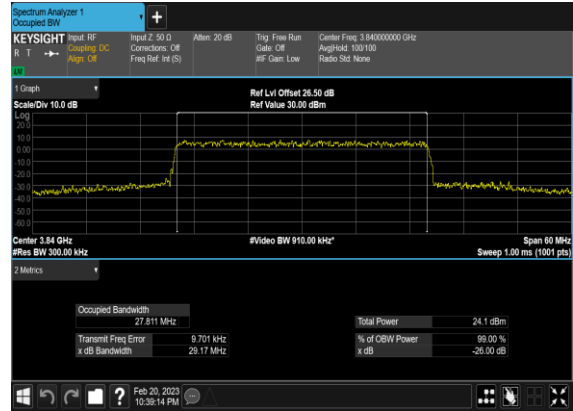

N77(40M)_CP- OFDM_QPSK_Outer_Full_Mid_CH

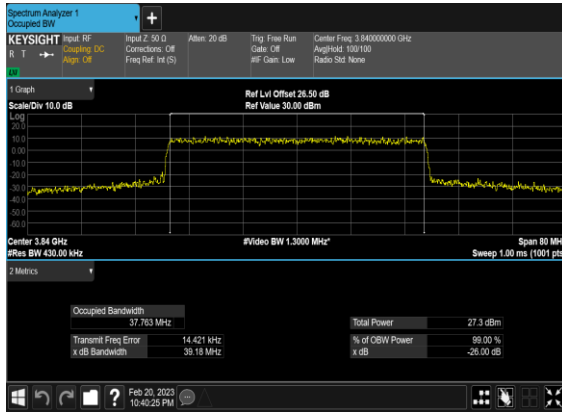

N77(40M)_CP-OFDM_16 QAM_Outer_Full_Mid_CH

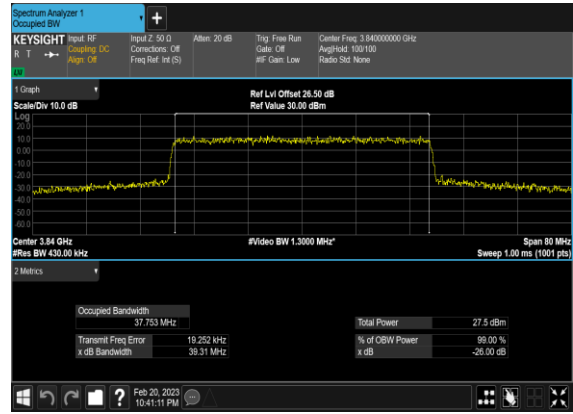

N77(40M)_CP-OFDM_64 QAM_Outer_Full_Mid_CH

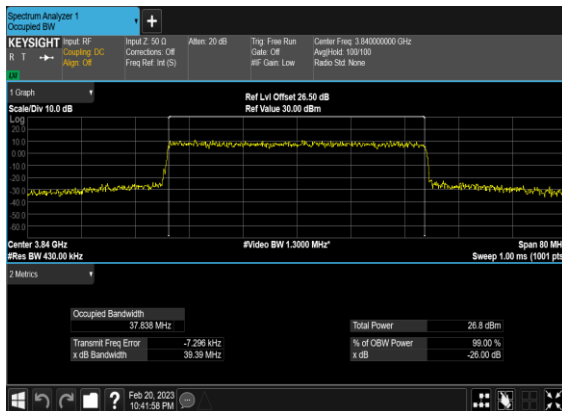

N77(40M)_CP-OFDM_256 QAM_Outer_Full_Mid_CH

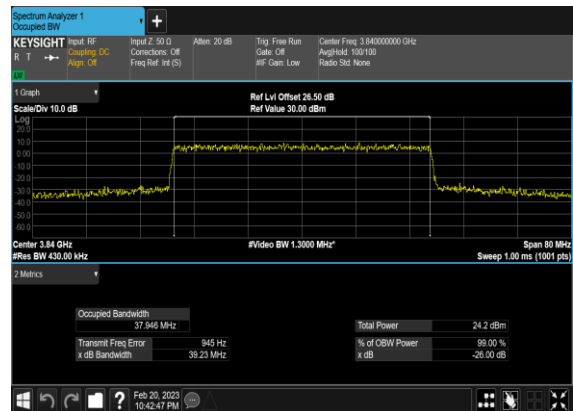

N77(50M)_CP-OFDM_QPSK_Outer_Full_Mid_CH

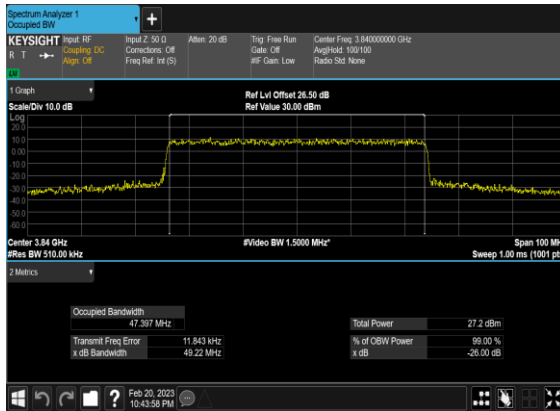

N77(50M)_CP-OFDM_16 QAM_Outer_Full_Mid_CH

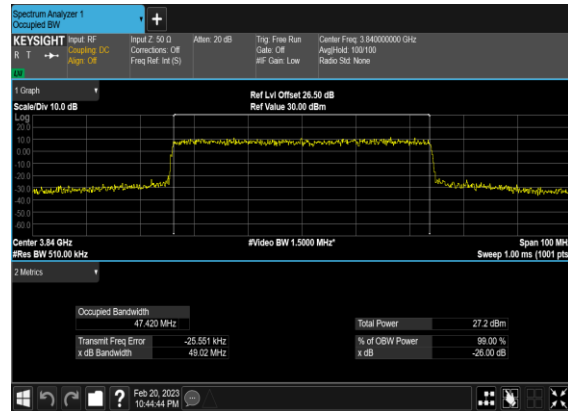

N77(50M)_CP-OFDM_64 QAM_Outer_Full_Mid_CH

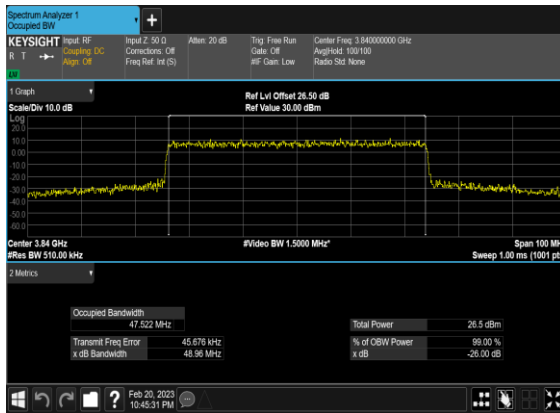

N77(50M)_CP-OFDM_256 QAM_Outer_Full_Mid_CH

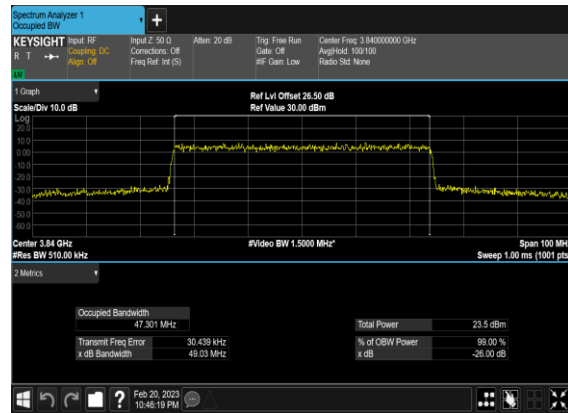

N77(60M)_CP-OFDM_QPSK_Outer_Full_Mid_CH

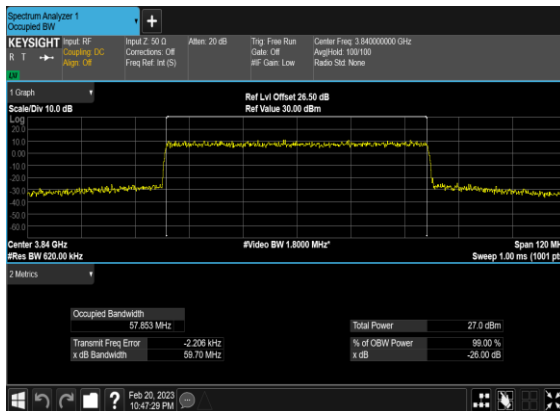

N77(60M)_CP-OFDM_16 QAM_Outer_Full_Mid_CH

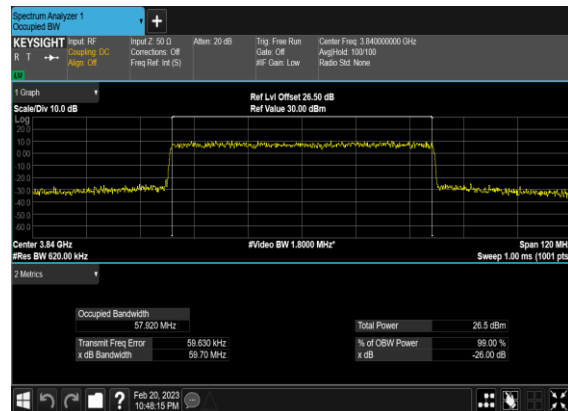

N77(60M)_CP-OFDM_64 QAM_Outer_Full_Mid_CH

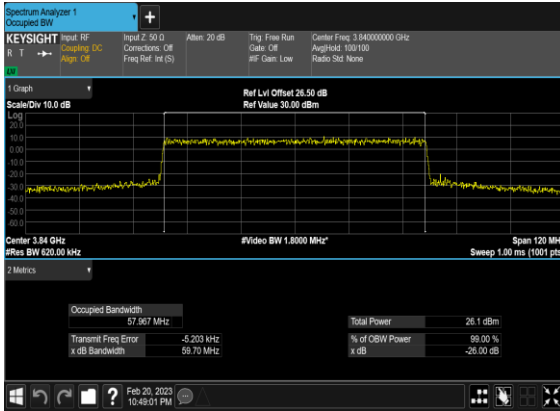

N77(60M)_CP-OFDM_256 QAM_Outer_Full_Mid_CH

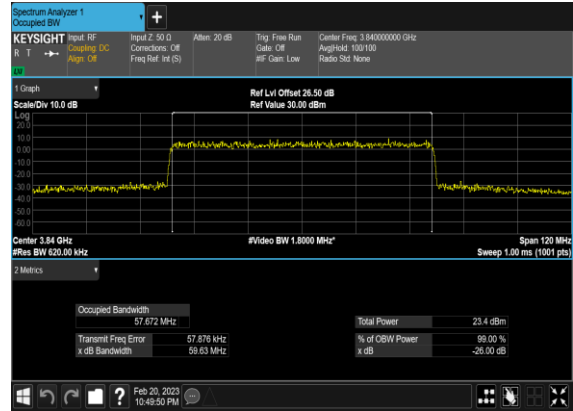

N77(70M)_CP- OFDM_QPSK_Outer_Full_Mid_CH

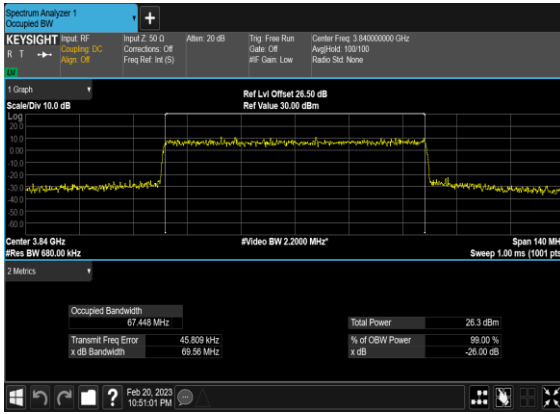

N77(70M)_CP-OFDM_16 QAM_Outer_Full_Mid_CH

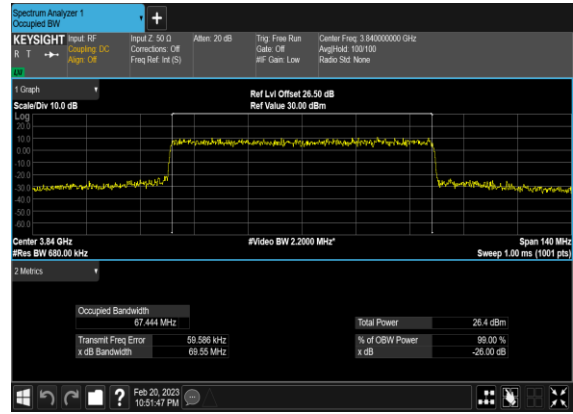

N77(70M)_CP-OFDM_64 QAM_Outer_Full_Mid_CH

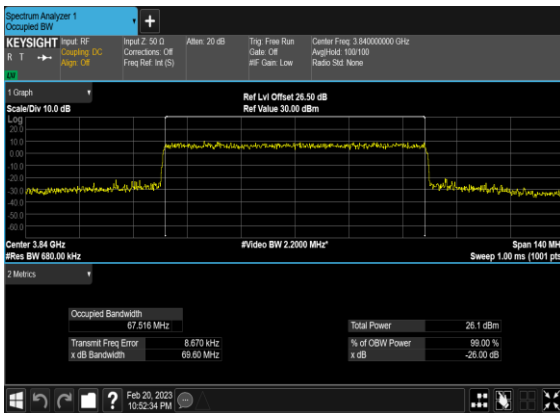

N77(70M)_CP-OFDM_256 QAM_Outer_Full_Mid_CH

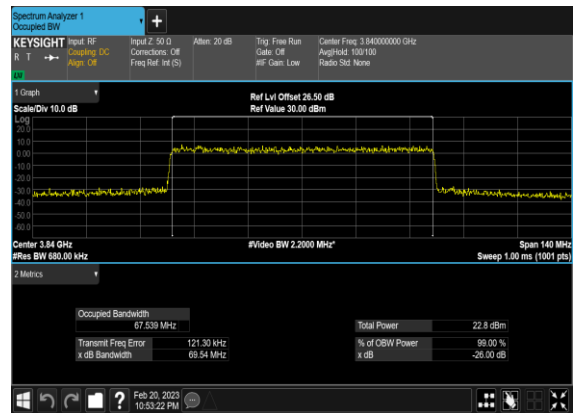

N77(80M)_CP-OFDM_QPSK_Outer_Full_Mid_CH

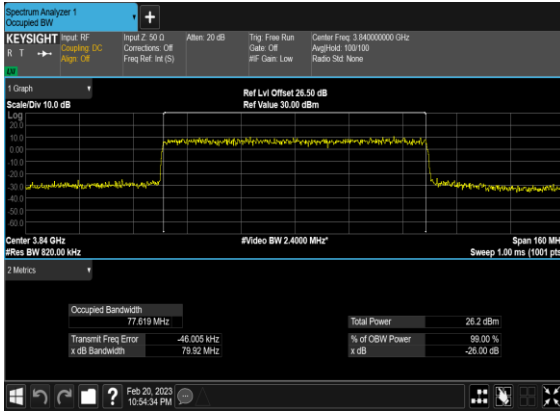

N77(80M)_CP-OFDM_16 QAM_Outer_Full_Mid_CH

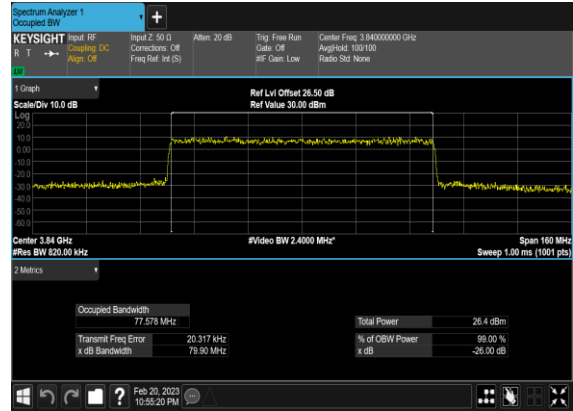

N77(80M)_CP-OFDM_64 QAM_Outer_Full_Mid_CH

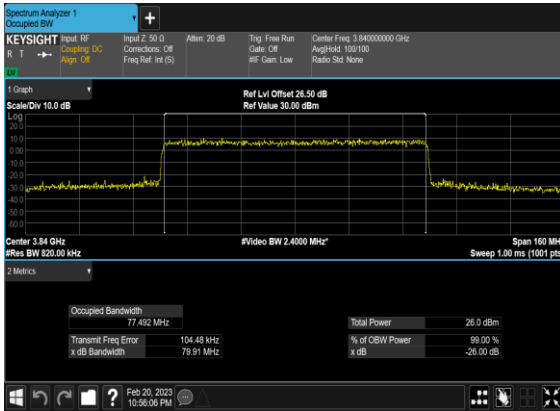

N77(80M)_CP-OFDM_256 QAM_Outer_Full_Mid_CH

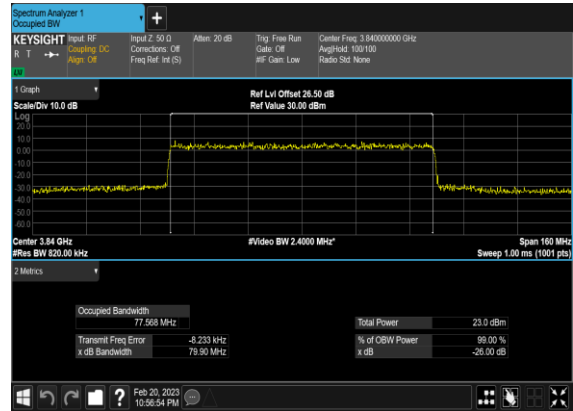

N77(90M)_CP-OFDM_QPSK_Outer_Full_Mid_CH

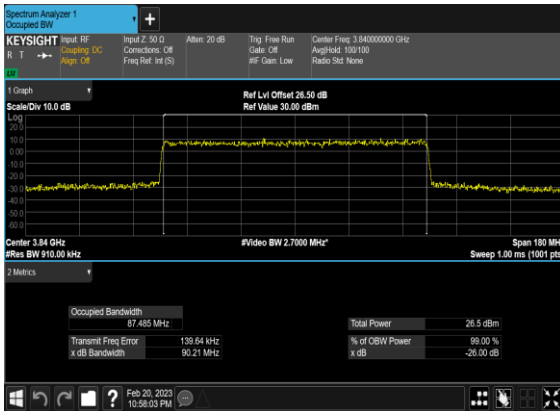

N77(90M)_CP-OFDM_16 QAM_Outer_Full_Mid_CH

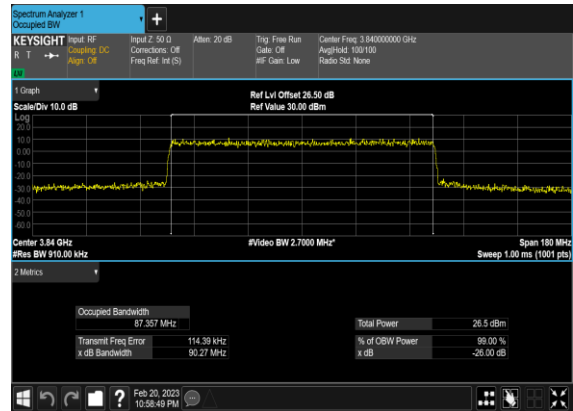

N77(90M)_CP-OFDM_64 QAM_Outer_Full_Mid_CH

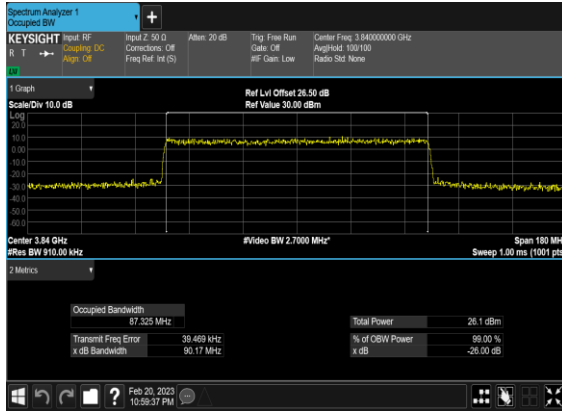

N77(90M)_CP-OFDM_256 QAM_Outer_Full_Mid_CH

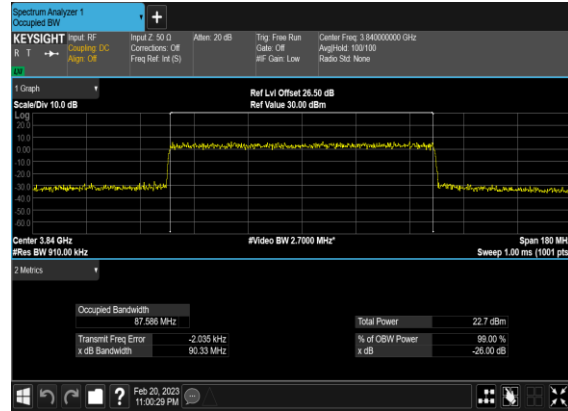

N77(100M)_CP- OFDM_QPSK_Outer_Full_Mid_CH

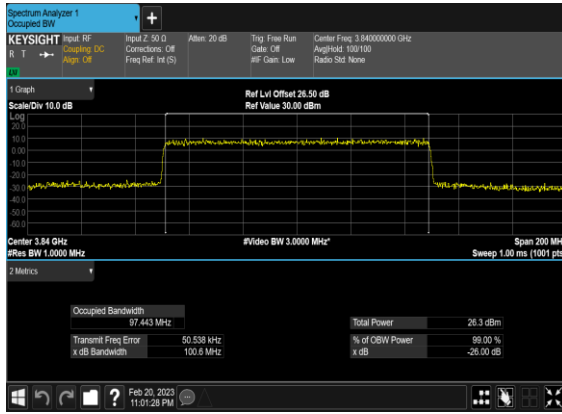

N77(100M)_CP-OFDM_16 QAM_Outer_Full_Mid_CH

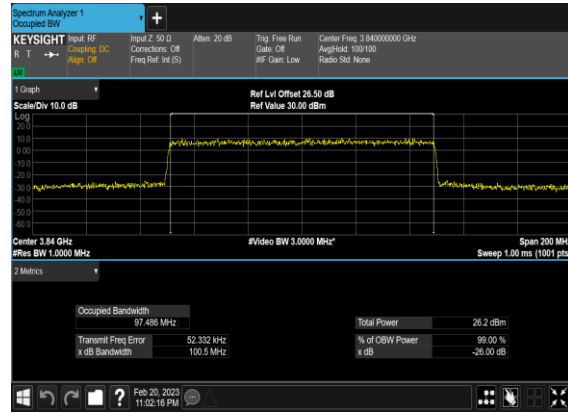

N77(100M)_CP-OFDM_64 QAM_Outer_Full_Mid_CH

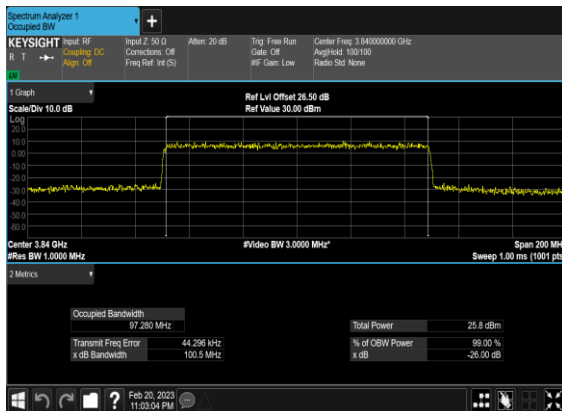

N77(100M)_CP-OFDM_256 QAM_Outer_Full_Mid_CH

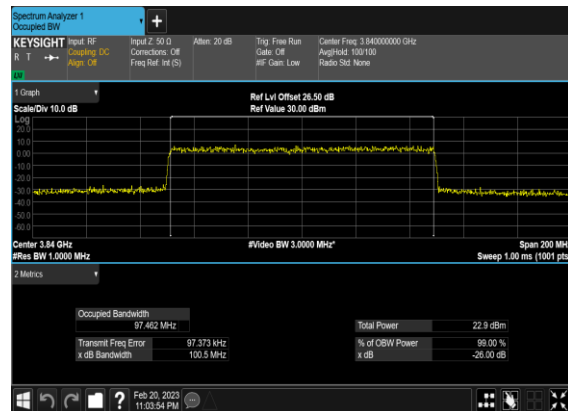

Conducted Spurious Emissions

NR Band	SCS (kHz)	Bandwidth (MHz)	Arfcn	Freq (MHz)	Modulation	RB	Result	Verdict
77	30	20	647334	3710.01	DFT-s-OFDM BPSK	1@0	see graph	---
77	30	20	647334	3710.01	DFT-s-OFDM BPSK	1@0	see graph	PASS
77	30	20	647334	3710.01	DFT-s-OFDM BPSK	1@0	see graph	PASS
77	30	20	647334	3710.01	DFT-s-OFDM QPSK	1@0	see graph	---
77	30	20	647334	3710.01	DFT-s-OFDM QPSK	1@0	see graph	PASS
77	30	20	647334	3710.01	DFT-s-OFDM QPSK	1@0	see graph	PASS
77	30	20	656000	3840.0	DFT-s-OFDM BPSK	1@0	see graph	---
77	30	20	656000	3840.0	DFT-s-OFDM BPSK	1@0	see graph	PASS
77	30	20	656000	3840.0	DFT-s-OFDM BPSK	1@0	see graph	PASS
77	30	20	656000	3840.0	DFT-s-OFDM QPSK	1@0	see graph	---
77	30	20	656000	3840.0	DFT-s-OFDM QPSK	1@0	see graph	PASS
77	30	20	656000	3840.0	DFT-s-OFDM QPSK	1@0	see graph	PASS
77	30	20	664666	3969.99	DFT-s-OFDM BPSK	1@0	see graph	---
77	30	20	664666	3969.99	DFT-s-OFDM BPSK	1@0	see graph	PASS
77	30	20	664666	3969.99	DFT-s-OFDM BPSK	1@0	see graph	PASS
77	30	20	664666	3969.99	DFT-s-OFDM QPSK	1@0	see graph	---
77	30	20	664666	3969.99	DFT-s-OFDM QPSK	1@0	see graph	PASS
77	30	20	664666	3969.99	DFT-s-OFDM QPSK	1@0	see graph	PASS
77	30	60	648668	3730.02	DFT-s-OFDM BPSK	1@0	see graph	---
77	30	60	648668	3730.02	DFT-s-OFDM BPSK	1@0	see graph	PASS
77	30	60	648668	3730.02	DFT-s-OFDM BPSK	1@0	see graph	PASS
77	30	60	648668	3730.02	DFT-s-OFDM QPSK	1@0	see graph	---
77	30	60	648668	3730.02	DFT-s-OFDM QPSK	1@0	see graph	PASS

77	30	60	648668	3730.02	DFT-s-OFDM QPSK	1@0	see graph	PASS
77	30	60	656000	3840.0	DFT-s-OFDM BPSK	1@0	see graph	---
77	30	60	656000	3840.0	DFT-s-OFDM BPSK	1@0	see graph	PASS
77	30	60	656000	3840.0	DFT-s-OFDM BPSK	1@0	see graph	PASS
77	30	60	656000	3840.0	DFT-s-OFDM QPSK	1@0	see graph	---
77	30	60	656000	3840.0	DFT-s-OFDM QPSK	1@0	see graph	PASS
77	30	60	656000	3840.0	DFT-s-OFDM QPSK	1@0	see graph	PASS
77	30	60	663332	3949.98	DFT-s-OFDM BPSK	1@0	see graph	---
77	30	60	663332	3949.98	DFT-s-OFDM BPSK	1@0	see graph	PASS
77	30	60	663332	3949.98	DFT-s-OFDM BPSK	1@0	see graph	PASS
77	30	60	663332	3949.98	DFT-s-OFDM QPSK	1@0	see graph	---
77	30	60	663332	3949.98	DFT-s-OFDM QPSK	1@0	see graph	PASS
77	30	60	663332	3949.98	DFT-s-OFDM QPSK	1@0	see graph	PASS
77	30	100	650000	3750.0	DFT-s-OFDM BPSK	1@0	see graph	---
77	30	100	650000	3750.0	DFT-s-OFDM BPSK	1@0	see graph	PASS
77	30	100	650000	3750.0	DFT-s-OFDM BPSK	1@0	see graph	PASS
77	30	100	650000	3750.0	DFT-s-OFDM QPSK	1@0	see graph	---
77	30	100	650000	3750.0	DFT-s-OFDM QPSK	1@0	see graph	PASS
77	30	100	650000	3750.0	DFT-s-OFDM QPSK	1@0	see graph	PASS
77	30	100	656000	3840.0	DFT-s-OFDM BPSK	1@0	see graph	---
77	30	100	656000	3840.0	DFT-s-OFDM BPSK	1@0	see graph	PASS
77	30	100	656000	3840.0	DFT-s-OFDM BPSK	1@0	see graph	PASS
77	30	100	656000	3840.0	DFT-s-OFDM QPSK	1@0	see graph	---
77	30	100	656000	3840.0	DFT-s-OFDM QPSK	1@0	see graph	PASS

77	30	100	656000	3840.0	DFT-s-OFDM QPSK	1@0	see graph	PASS
77	30	100	662000	3930.0	DFT-s-OFDM BPSK	1@0	see graph	---
77	30	100	662000	3930.0	DFT-s-OFDM BPSK	1@0	see graph	PASS
77	30	100	662000	3930.0	DFT-s-OFDM BPSK	1@0	see graph	PASS
77	30	100	662000	3930.0	DFT-s-OFDM QPSK	1@0	see graph	---
77	30	100	662000	3930.0	DFT-s-OFDM QPSK	1@0	see graph	PASS
77	30	100	662000	3930.0	DFT-s-OFDM QPSK	1@0	see graph	PASS

N77(20M)_DFT-s-OFDM_BPSK_Edge_1RB_Left_Low_CH

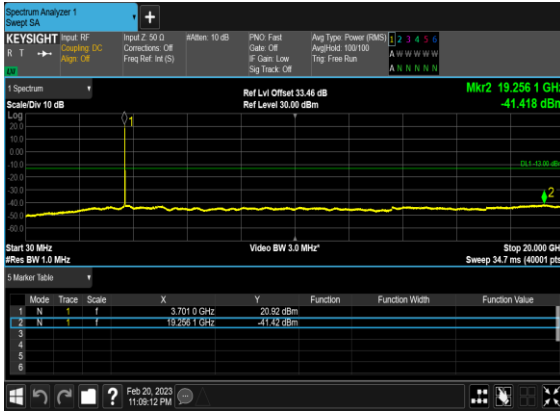

N77(20M)_DFT-s-OFDM_BPSK_Edge_1RB_Left_Low_CH

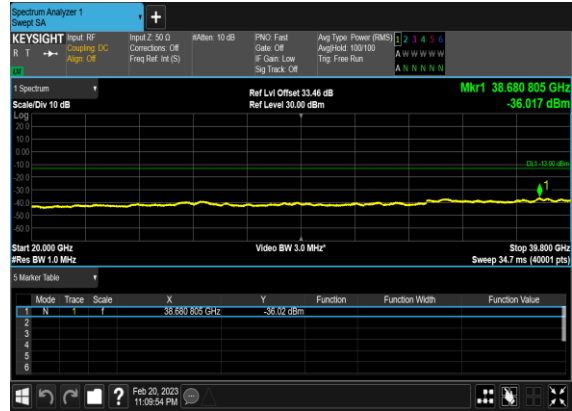

N77(20M)_DFT-s-OFDM_QPSK_Edge_1RB_Left_Low_CH

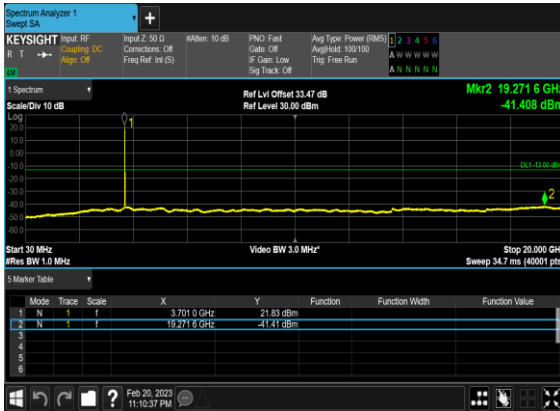

N77(20M)_DFT-s-OFDM_QPSK_Edge_1RB_Left_Low_CH

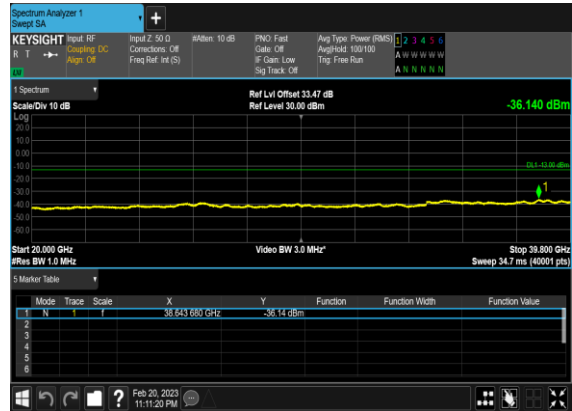

N77(20M)_DFT-s-OFDM_BPSK_Edge_1RB_Left_Mid_CH

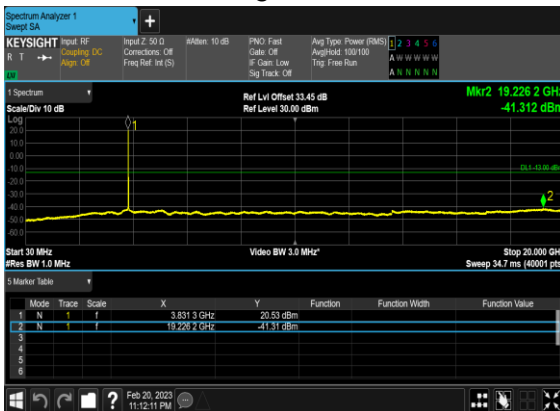

N77(20M)_DFT-s-OFDM_BPSK_Edge_1RB_Left_Mid_CH

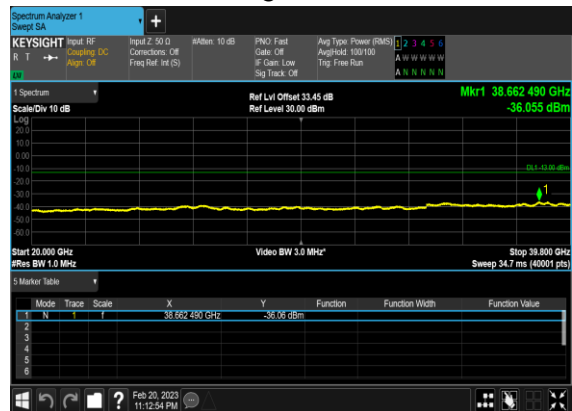

N77(20M)_DFT-s-OFDM_QPSK_Edge_1RB_Left_Mid_CH

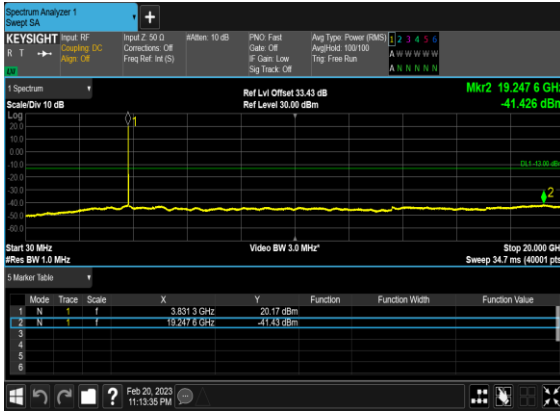

N77(20M)_DFT-s-OFDM_QPSK_Edge_1RB_Left_Mid_CH

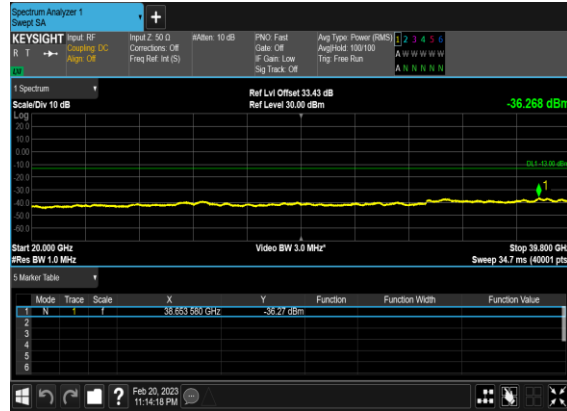

N77(20M)_DFT-s-OFDM_BPSK_Edge_1RB_Left_High_CH

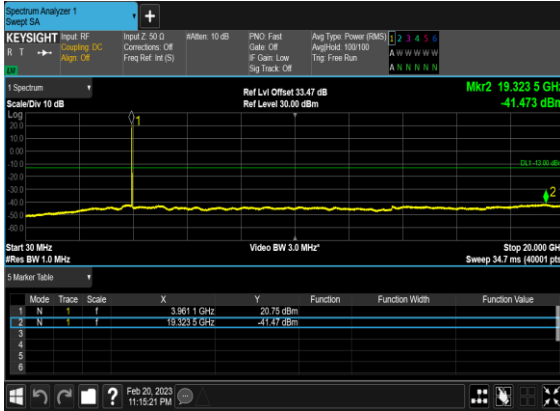

N77(20M)_DFT-s-OFDM_BPSK_Edge_1RB_Left_High_CH

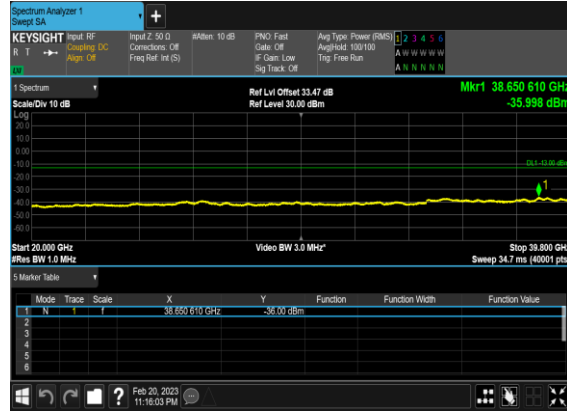

N77(20M)_DFT-s-OFDM_QPSK_Edge_1RB_Left_High_CH

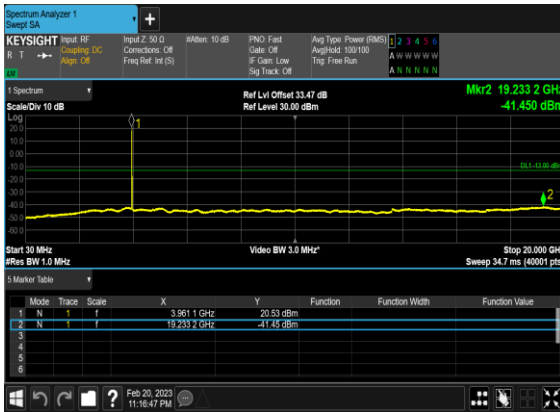

N77(20M)_DFT-s-OFDM_QPSK_Edge_1RB_Left_High_CH

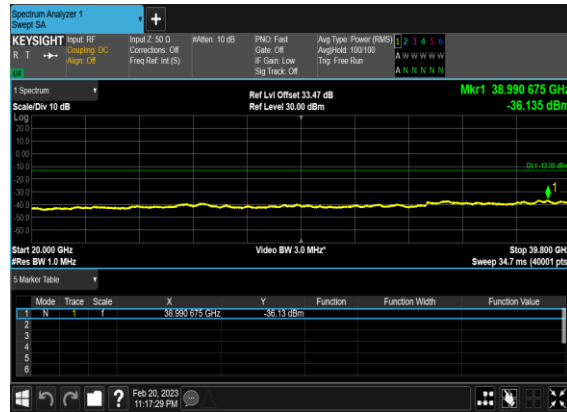

N77(60M)_DFT-s-OFDM_BPSK_Edge_1RB_Left_Low_CH

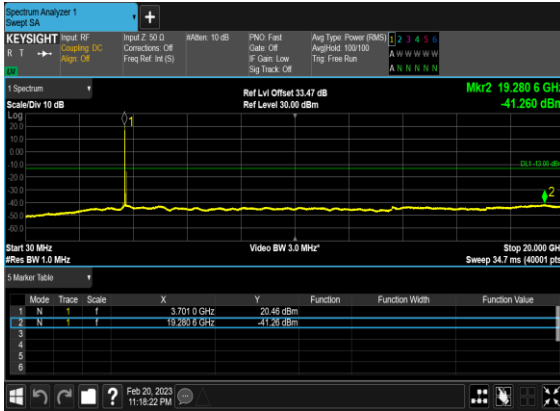

N77(60M)_DFT-s-OFDM_BPSK_Edge_1RB_Left_Low_CH

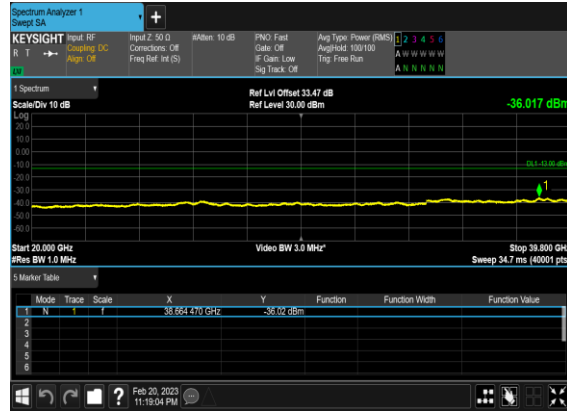

N77(60M)_DFT-s-OFDM_QPSK_Edge_1RB_Left_Low_CH

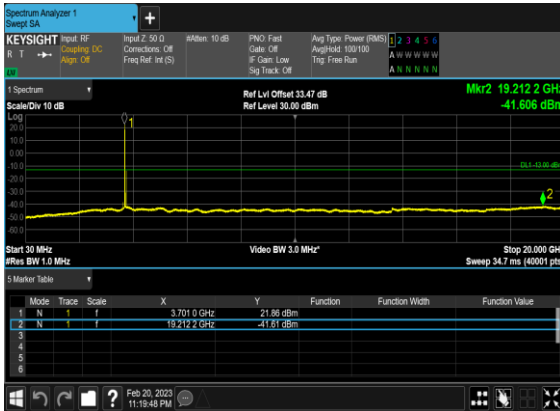

N77(60M)_DFT-s-OFDM_QPSK_Edge_1RB_Left_Low_CH

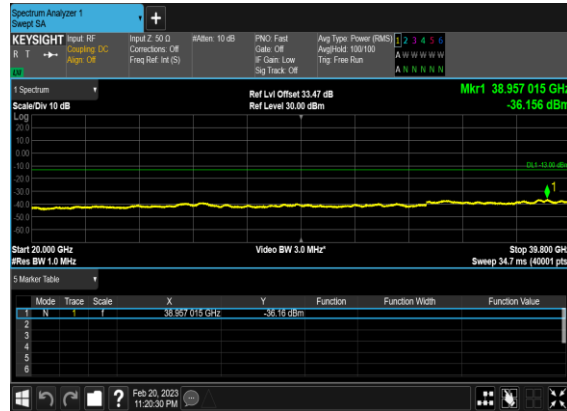

N77(60M)_DFT-s-OFDM_BPSK_Edge_1RB_Left_Mid_CH

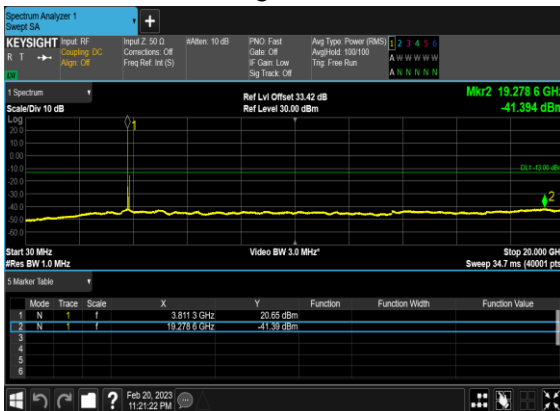

N77(60M)_DFT-s-OFDM_BPSK_Edge_1RB_Left_Mid_CH

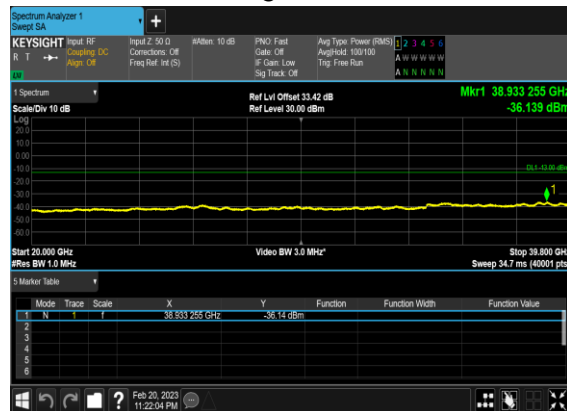

N77(60M)_DFT-s-OFDM_QPSK_Edge_1RB_Left_Mid_CH

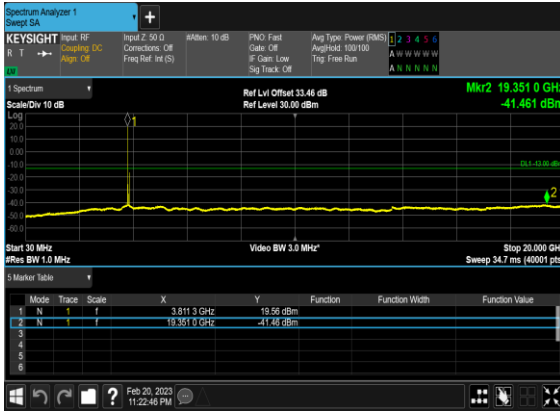

N77(60M)_DFT-s-OFDM_QPSK_Edge_1RB_Left_Mid_CH

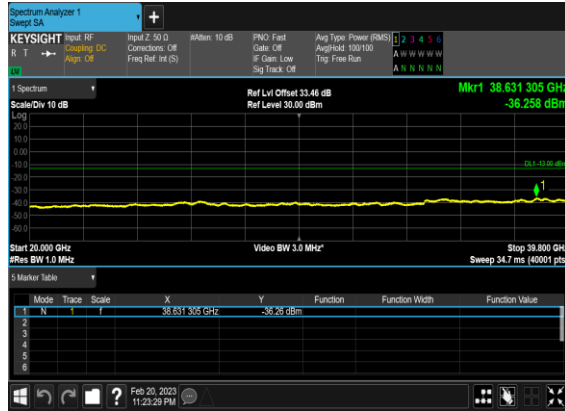

N77(60M)_DFT-s-OFDM_BPSK_Edge_1RB_Left_High_CH

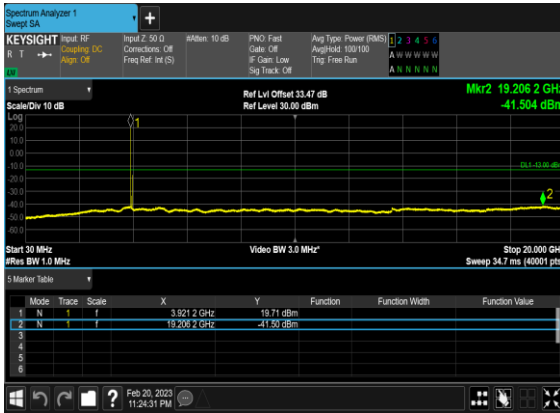

N77(60M)_DFT-s-OFDM_BPSK_Edge_1RB_Left_High_CH

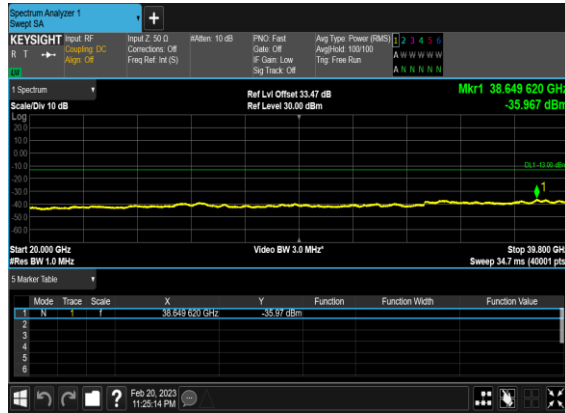

N77(60M)_DFT-s-OFDM_QPSK_Edge_1RB_Left_High_CH

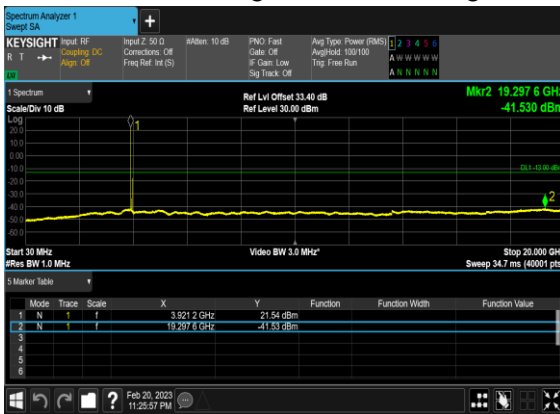

N77(60M)_DFT-s-OFDM_QPSK_Edge_1RB_Left_High_CH

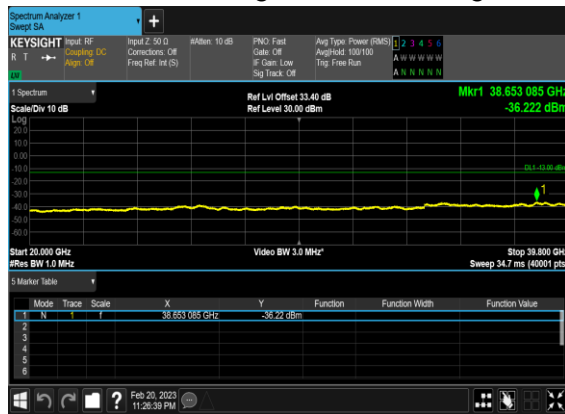

N77(100M)_DFT-s-OFDM_BPSK_Edge_1RB_Left_Low_CH



N77(100M)_DFT-s-OFDM_BPSK_Edge_1RB_Left_Low_CH

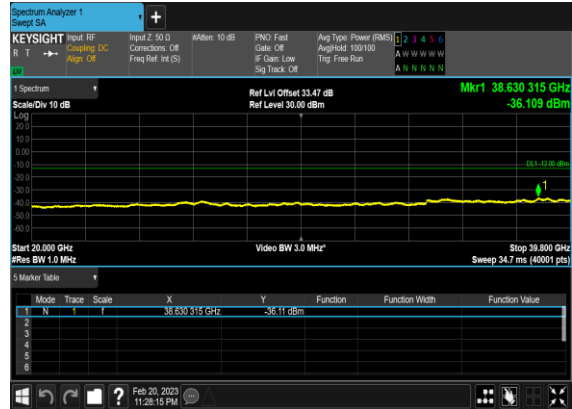

N77(100M)_DFT-s-OFDM_QPSK_Edge_1RB_Left_Low_CH

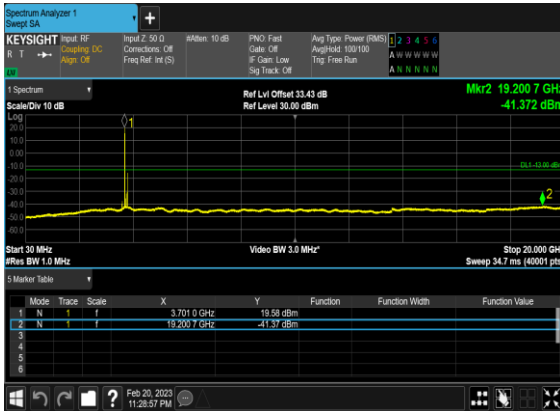

N77(100M)_DFT-s-OFDM_QPSK_Edge_1RB_Left_Low_CH

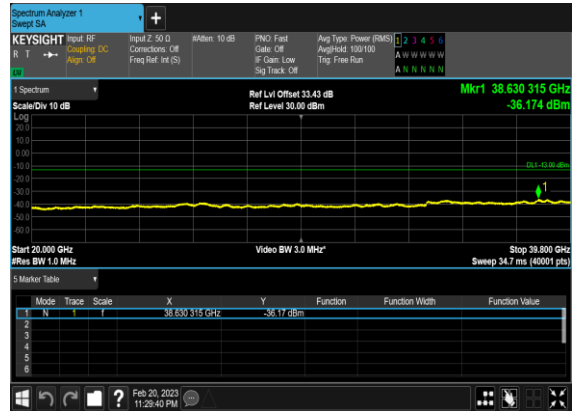

N77(100M)_DFT-s-OFDM_BPSK_Edge_1RB_Left_Mid_CH

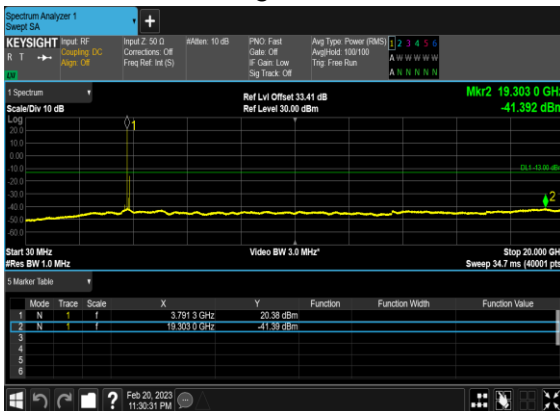

N77(100M)_DFT-s-OFDM_BPSK_Edge_1RB_Left_Mid_CH

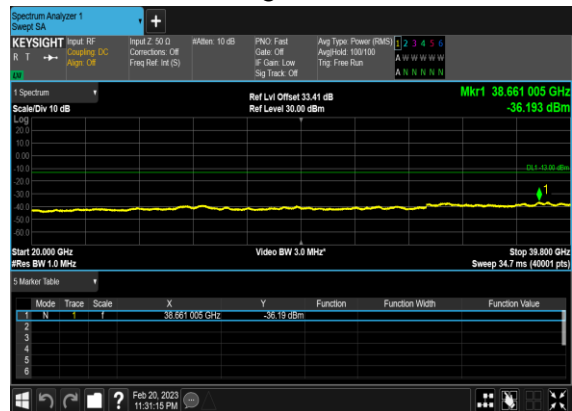

N77(100M)_DFT-s-OFDM_QPSK_Edge_1RB_Left_Mid_CH

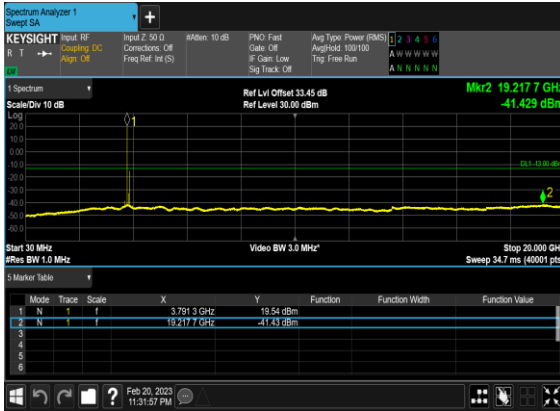

N77(100M)_DFT-s-OFDM_QPSK_Edge_1RB_Left_Mid_CH

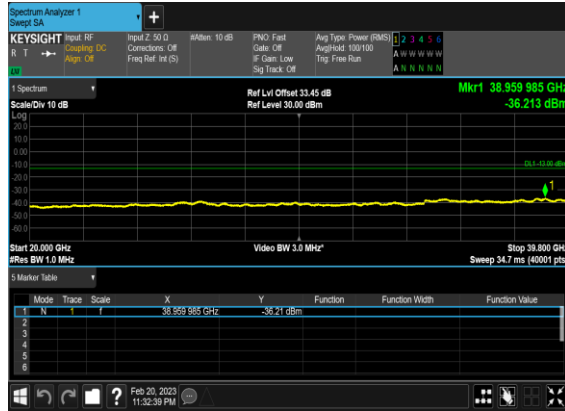

N77(100M)_DFT-s-OFDM_BPSK_Edge_1RB_Left_High_CH

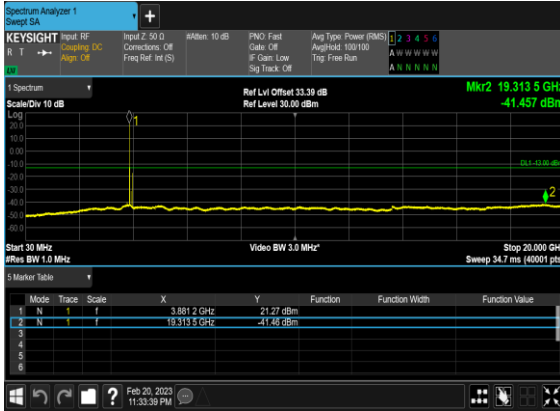

N77(100M)_DFT-s-OFDM_BPSK_Edge_1RB_Left_High_CH

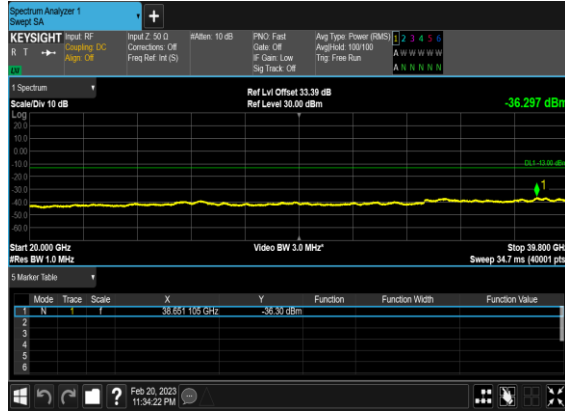

N77(100M)_DFT-s-OFDM_QPSK_Edge_1RB_Left_High_CH

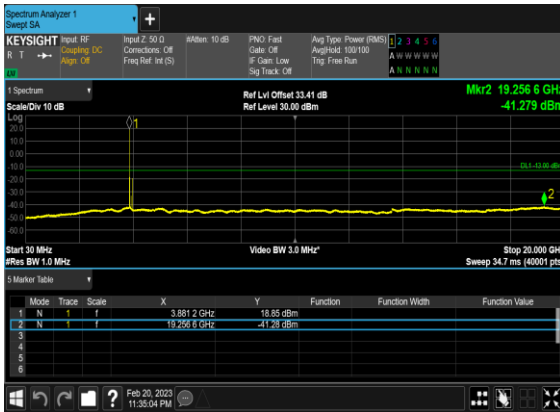

N77(100M)_DFT-s-OFDM_QPSK_Edge_1RB_Left_High_CH

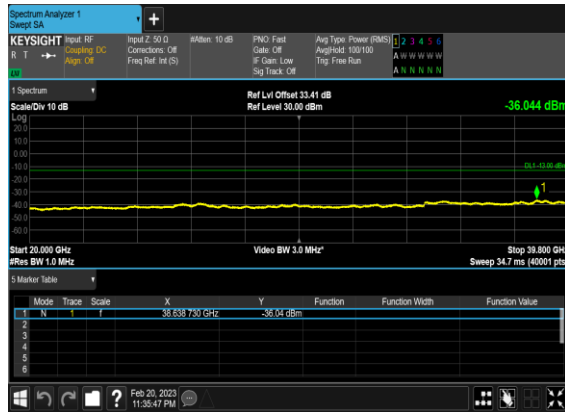

Conducted Band Edge

NR Band	SCS (kHz)	Bandwidth (MHz)	Arfcn	Freq (MHz)	Modulation	RB	Result	Verdict
77	30	20	647334	3710.01	DFT-s-OFDM BPSK	1@0	see graph	PASS
77	30	20	647334	3710.01	DFT-s-OFDM QPSK	1@0	see graph	PASS
77	30	20	647334	3710.01	DFT-s-OFDM BPSK	50@0	see graph	PASS
77	30	20	647334	3710.01	DFT-s-OFDM QPSK	50@0	see graph	PASS
77	30	20	664666	3969.99	DFT-s-OFDM BPSK	1@50	see graph	PASS
77	30	20	664666	3969.99	DFT-s-OFDM QPSK	1@50	see graph	PASS
77	30	20	664666	3969.99	DFT-s-OFDM BPSK	50@0	see graph	PASS
77	30	20	664666	3969.99	DFT-s-OFDM QPSK	50@0	see graph	PASS
77	30	60	648668	3730.02	DFT-s-OFDM BPSK	1@0	see graph	PASS
77	30	60	648668	3730.02	DFT-s-OFDM QPSK	1@0	see graph	PASS
77	30	60	648668	3730.02	DFT-s-OFDM BPSK	162@0	see graph	PASS
77	30	60	648668	3730.02	DFT-s-OFDM QPSK	162@0	see graph	PASS
77	30	60	663332	3949.98	DFT-s-OFDM BPSK	1@161	see graph	PASS
77	30	60	663332	3949.98	DFT-s-OFDM QPSK	1@161	see graph	PASS
77	30	60	663332	3949.98	DFT-s-OFDM BPSK	162@0	see graph	PASS
77	30	60	663332	3949.98	DFT-s-OFDM QPSK	162@0	see graph	PASS
77	30	100	650000	3750.0	DFT-s-OFDM BPSK	1@0	see graph	PASS
77	30	100	650000	3750.0	DFT-s-OFDM QPSK	1@0	see graph	PASS
77	30	100	650000	3750.0	DFT-s-OFDM BPSK	270@0	see graph	PASS
77	30	100	650000	3750.0	DFT-s-OFDM QPSK	270@0	see graph	PASS
77	30	100	662000	3930.0	DFT-s-OFDM BPSK	1@272	see graph	PASS
77	30	100	662000	3930.0	DFT-s-OFDM QPSK	1@272	see graph	PASS
77	30	100	662000	3930.0	DFT-s-OFDM BPSK	270@0	see graph	PASS
77	30	100	662000	3930.0	DFT-s-OFDM QPSK	270@0	see graph	PASS

N77(20M)_DFT-s- OFDM_BPSK_Edge_1RB_Left_Low_CH

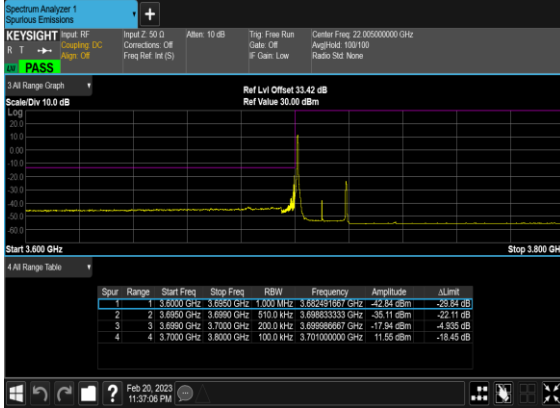

N77(20M)_DFT-s- OFDM_QPSK_Edge_1RB_Left_Low_CH

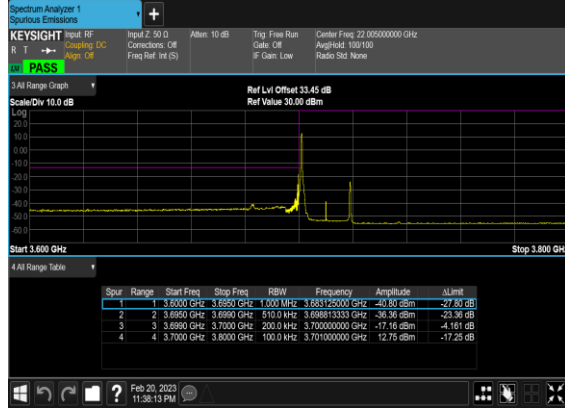

N77(20M)_DFT-s- OFDM_BPSK_Outer_Full_Low_CH

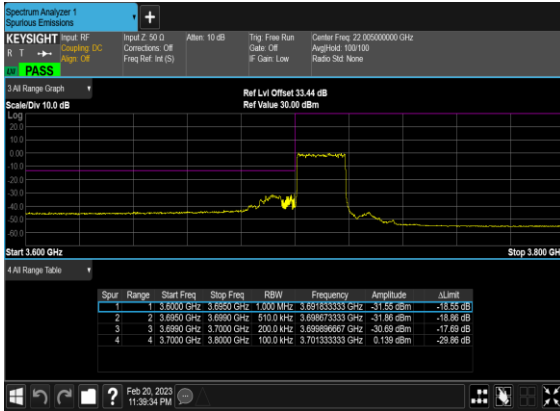

N77(20M)_DFT-s- OFDM_QPSK_Outer_Full_Low_CH

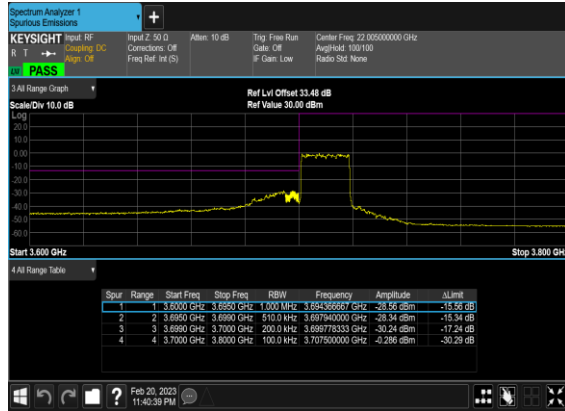

N77(20M)_DFT-s- OFDM_BPSK_Edge_1RB_Right_High_CH

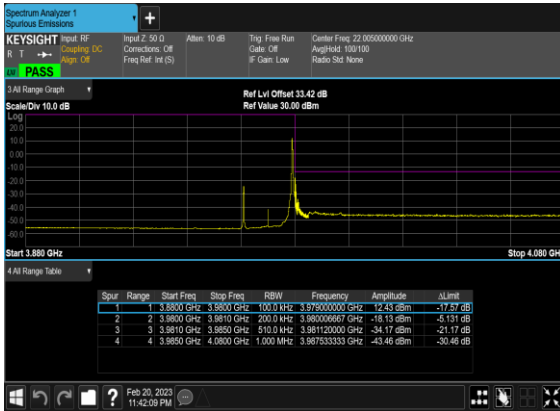

N77(20M)_DFT-s- OFDM_QPSK_Edge_1RB_Right_High_CH

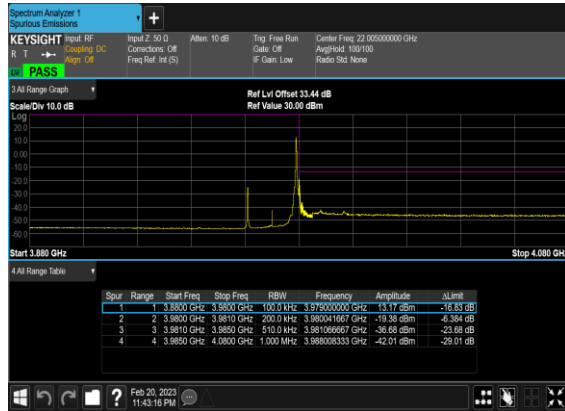

N77(20M)_DFT-s-OFDM_BPSK_Outer_Full_High_CH

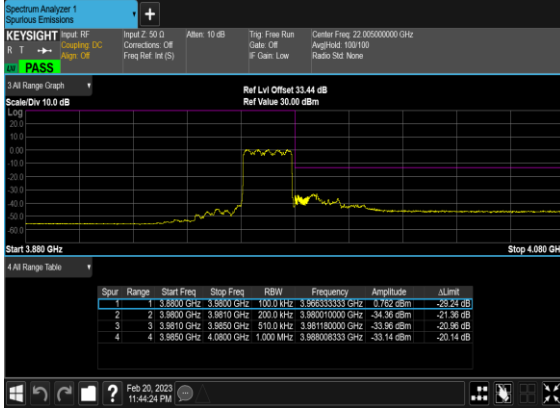

N77(20M)_DFT-s-OFDM_QPSK_Outer_Full_High_CH

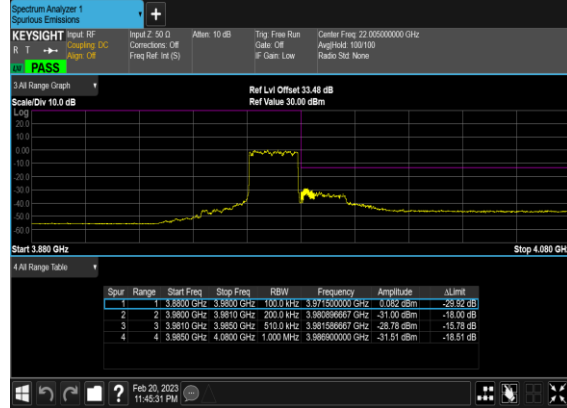

N77(60M)_DFT-s-OFDM_BPSK_Edge_1RB_Left_Low_CH

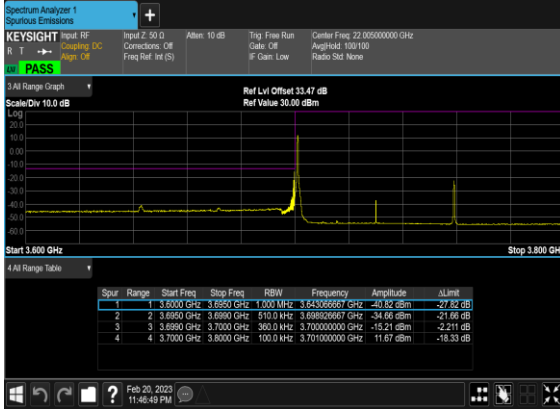

N77(60M)_DFT-s-OFDM_QPSK_Edge_1RB_Left_Low_CH

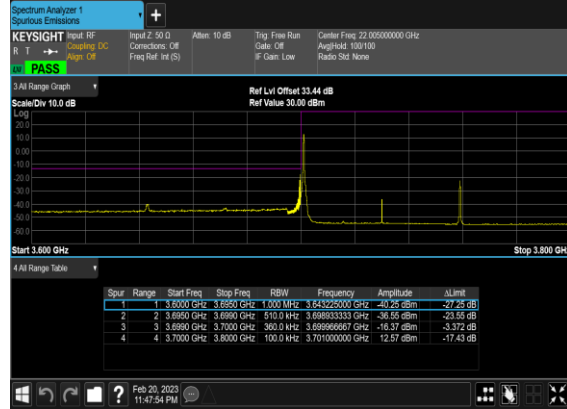

N77(60M)_DFT-s-OFDM_BPSK_Outer_Full_Low_CH

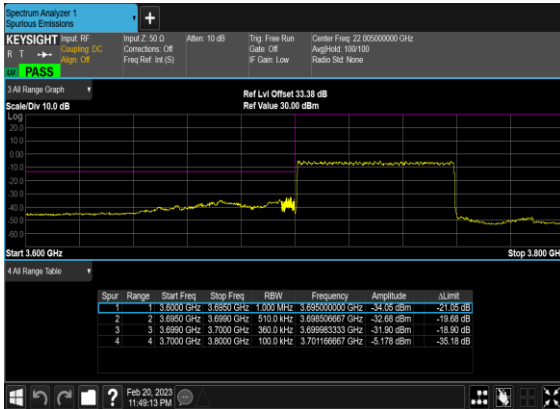

N77(60M)_DFT-s-OFDM_QPSK_Outer_Full_Low_CH

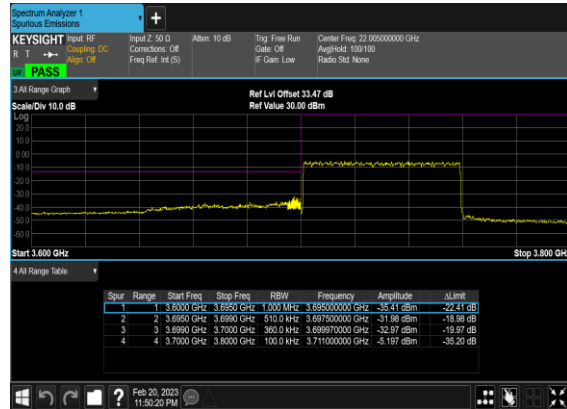

N77(60M)_DFT-s-OFDM_BPSK_Edge_1RB_Right_High_CH

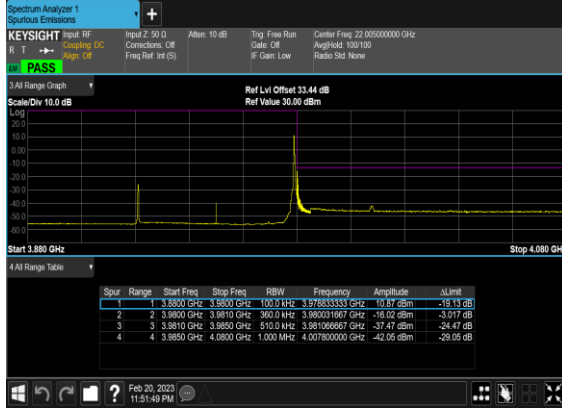

N77(60M)_DFT-s-OFDM_QPSK_Edge_1RB_Right_High_CH

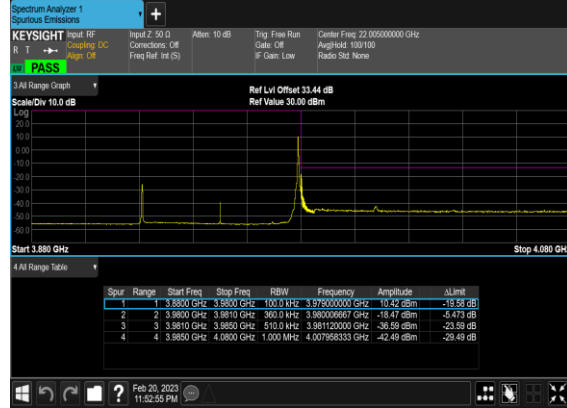

N77(60M)_DFT-s-OFDM_BPSK_Outer_Full_High_CH

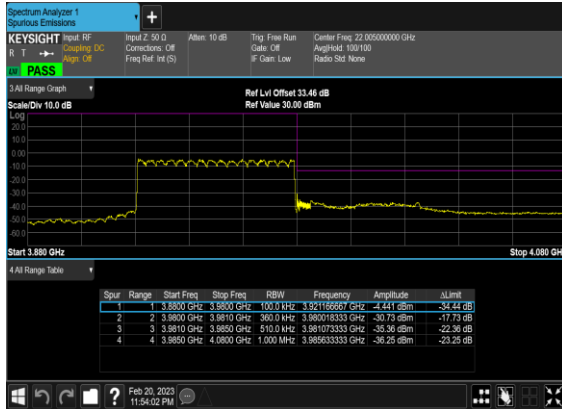

N77(60M)_DFT-s-OFDM_QPSK_Outer_Full_High_CH

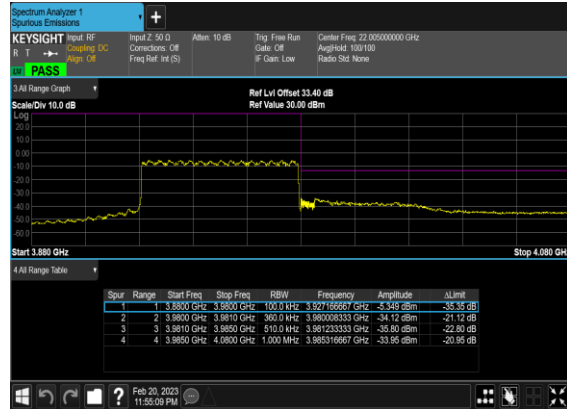

N77(100M)_DFT-s-OFDM_BPSK_Edge_1RB_Left_Low_CH

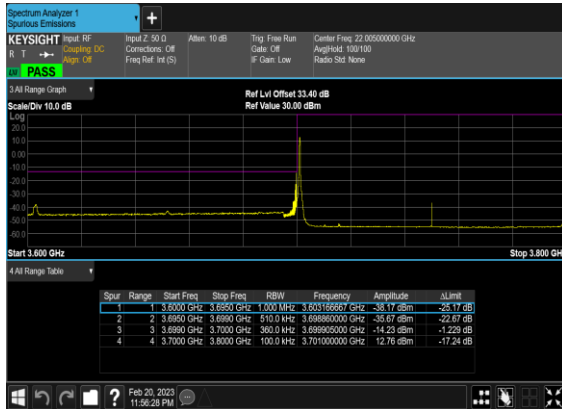

N77(100M)_DFT-s-OFDM_QPSK_Edge_1RB_Left_Low_CH

