



# FCC RF Test Report

**APPLICANT** : Zebra Technologies Corporation  
**EQUIPMENT** : Vehicle Computer  
**BRAND NAME** : Zebra  
**MODEL NAME** : VC80x  
**FCC ID** : UZ7VC80X  
**STANDARD** : FCC Part 15 Subpart C §15.247  
**CLASSIFICATION** : (DSS) Spread Spectrum Transmitter

The product was received on May 24, 2017 and testing was completed on Aug. 24, 2017. We, SPORTON INTERNATIONAL INC., would like to declare that the tested sample has been evaluated in accordance with the test procedures and has been in compliance with the applicable technical standards.

The test results in this report apply exclusively to the tested model / sample. Without written approval of SPORTON INTERNATIONAL INC., the test report shall not be reproduced except in full.

Reviewed by: Joseph Lin / Supervisor

Approved by: Jones Tsai / Manager



## SPORTON INTERNATIONAL INC.

No. 52, Hwa Ya 1<sup>st</sup> Rd., Hwa Ya Technology Park, Kwei-Shan District, Tao Yuan City, Taiwan, R.O.C.

SPORTON INTERNATIONAL INC.

TEL : 886-3-327-3456

FAX : 886-3-328-4978

FCC ID : UZ7VC80X

Page Number : 1 of 64

Report Issued Date : Oct. 11, 2017

Report Version : Rev. 01

Report Template No.: BU5-FR15CBT Version 2.0



# TABLE OF CONTENTS

**REVISION HISTORY..... 3**

**SUMMARY OF TEST RESULT ..... 4**

**1 GENERAL DESCRIPTION..... 5**

    1.1 Applicant ..... 5

    1.2 Manufacturer ..... 5

    1.3 Product Feature of Equipment Under Test..... 5

    1.4 Product Specification of Equipment Under Test..... 7

    1.5 Modification of EUT ..... 7

    1.6 Testing Location ..... 8

    1.7 Applicable Standards ..... 8

**2 TEST CONFIGURATION OF EQUIPMENT UNDER TEST..... 9**

    2.1 Carrier Frequency Channel ..... 9

    2.2 Test Mode ..... 10

    2.3 Connection Diagram of Test System ..... 13

    2.4 Support Unit used in test configuration and system ..... 14

    2.5 EUT Operation Test Setup ..... 14

    2.6 Measurement Results Explanation Example ..... 14

**3 TEST RESULT ..... 15**

    3.1 Number of Channel Measurement ..... 15

    3.2 Hopping Channel Separation Measurement ..... 17

    3.3 Dwell Time Measurement ..... 23

    3.4 20dB and 99% Bandwidth Measurement ..... 25

    3.5 Peak Output Power Measurement ..... 36

    3.6 Conducted Band Edges Measurement..... 38

    3.7 Conducted Spurious Emission Measurement ..... 45

    3.8 Radiated Band Edges and Spurious Emission Measurement ..... 55

    3.9 AC Conducted Emission Measurement..... 60

    3.10 Antenna Requirements ..... 62

**4 LIST OF MEASURING EQUIPMENT ..... 63**

**5 UNCERTAINTY OF EVALUATION..... 64**

**APPENDIX A. AC CONDUCTED EMISSION TEST RESULT**

**APPENDIX B. RADIATED SPURIOUS EMISSION**

**APPENDIX C. RADIATED SPURIOUS EMISSION PLOTS**

**APPENDIX D. DUTY CYCLE PLOTS**

**APPENDIX E. SETUP PHOTOGRAPHS**





### SUMMARY OF TEST RESULT

Report Section	FCC Rule	Description	Limit	Result	Remark
3.1	15.247(a)(1)	Number of Channels	≥ 15Chs	Pass	-
3.2	15.247(a)(1)	Hopping Channel Separation	≥ 2/3 of 20dB BW	Pass	-
3.3	15.247(a)(1)	Dwell Time of Each Channel	≤ 0.4sec in 31.6sec period	Pass	-
3.4	15.247(a)(1)	20dB Bandwidth	NA	Pass	-
3.4	-	99% Bandwidth	-	Pass	-
3.5	15.247(b)(1)	Peak Output Power	≤ 125 mW	Pass	-
3.6	15.247(d)	Conducted Band Edges	≤ 20dBc	Pass	-
3.7	15.247(d)	Conducted Spurious Emission	≤ 20dBc	Pass	-
3.8	15.247(d)	Radiated Band Edges and Radiated Spurious Emission	15.209(a) & 15.247(d)	Pass	Under limit 3.51 dB at 31.080 MHz
3.9	15.207	AC Conducted Emission	15.207(a)	Pass	Under limit 14.60 dB at 0.150 MHz
3.10	15.203 & 15.247(b)	Antenna Requirement	N/A	Pass	-



# 1 General Description

## 1.1 Applicant

**Zebra Technologies Corporation**  
1 Zebra Plaza, Holtsville, NY 11742-1300, USA

## 1.2 Manufacturer

**Zebra Technologies Corporation**  
1 Zebra Plaza, Holtsville, NY 11742-1300, USA

## 1.3 Product Feature of Equipment Under Test

Product Feature	
Equipment	Vehicle Computer
Brand Name	Zebra
Model Name	VC80x
FCC ID	UZ7VC80X
Sample 1	Standard SKU
Sample 2	Outdoor SKU
Sample 3	Freezer SKU
EUT supports Radios application	WLAN 11a/b/g/n HT20/HT40 WLAN 11ac VHT20/VHT40/VHT80 Bluetooth BR/EDR/LE
HW Version	EV
SW Version	91-15-01.7-MN-00
FW Version	FUSION_BA_2_00.0.0.033_M
MFD	25May17
EUT Stage	Identical Prototype

**Remark:** The above EUT's information was declared by manufacturer. Please refer to the specifications or user's manual for more detailed description.



Accessories Information				
AC Adapter	Brand Name	Zebra	Model Name	FSP150
Car Charger	Brand Name	Zebra	Model Name	CA1210
RJ50/USB cable	Brand Name	Zebra	Model Name	CBA-U01-S07ZAP
Scanner	Brand Name	Zebra	Model Name	DS3508
Scanner	Brand Name	Zebra	Model Name	LS3408
Audio Speaker	Brand Name	Zebra	Model Name	M1000
Ferrite Core	Brand Name	Zebra	Model Name	M1000
Keyboard (ikey)	Brand Name	Zebra	Model Name	iKey
Keyboard (remote keyboard)	Brand Name	Zebra	Model Name	KYBD-QW-VC
External Antenna (Monopole)	Brand Name	Zebra	Model Name	AN2010
External Antenna (Monopole)	Brand Name	Zebra	Model Name	AN2020
External Antenna (Dipole)	Brand Name	Zebra	Model Name	AN2030



### 1.4 Product Specification of Equipment Under Test

Standards-related Product Specification	
Tx/Rx Frequency Range	2402 MHz ~ 2480 MHz
Number of Channels	79
Carrier Frequency of Each Channel	2402+n*1 MHz; n=0~78
Maximum Output Power to Antenna	Bluetooth BR(1Mbps) : 3.63 dBm (0.0023 W) Bluetooth EDR (2Mbps) : 3.59 dBm (0.0023 W) Bluetooth EDR (3Mbps) : 3.72 dBm (0.0024 W)
99% Occupied Bandwidth	Bluetooth BR(1Mbps) : 0.884MHz Bluetooth EDR (2Mbps) : 1.208MHz Bluetooth EDR (3Mbps) : 1.184MHz
Type of Modulation	Bluetooth BR (1Mbps) : GFSK Bluetooth EDR (2Mbps) : $\pi/4$ -DQPSK Bluetooth EDR (3Mbps) : 8-DPSK

Antenna No.	Chain No.	Model	Antenna Type	Antenna Gain (dBi) Exclude Cable loss	Internal Cable loss (dB)	External Cable loss (dB)	Antenna Gain (dBi) Include Cable loss	Frequency (GHz)
1	Int. Chain 0	AN000097A01	Patch	3.96	N/A	N/A	3.96	2.4~2.4835
				5	N/A	N/A	5	5.15~5.85
	Int. Chain 1			3.69	N/A	N/A	3.69	2.4~2.4835
				5	N/A	N/A	5	5.15~5.85
2	Ext. Chain 0	AN2010	Monopole	2	0.6	1.8	-0.4	2.4~2.4835
				2	0.9	2.6	-1.5	5.15~5.85
	Ext. Chain 1			2	0.6	1.8	-0.4	2.4~2.4835
				2	0.9	2.6	-1.5	5.15~5.85
3	Ext. Chain 0	AN2020	Monopole	5	0.6	1.8	2.6	2.4~2.4835
	Ext. Chain 1			5	0.6	1.8	2.6	2.4~2.4835
4	Ext. Chain 0	AN2030	Dipole	2	0.6	N/A	1.4	2.4~2.4835
				3.7	0.9	N/A	2.8	5.15~5.85
	Ext. Chain 1			2	0.6	N/A	1.4	2.4~2.4835
				3.7	0.9	N/A	2.8	5.15~5.85

### 1.5 Modification of EUT

No modifications are made to the EUT during all test items.



### 1.6 Testing Location

Sporton Lab is accredited to ISO 17025 by Taiwan Accreditation Foundation (TAF code : 1190) and the FCC designation No. TW1190 under the FCC 2.948(e) by Mutual Recognition Agreement (MRA) in FCC Test.

<b>Test Site</b>	SPORTON INTERNATIONAL INC.		
<b>Test Site Location</b>	No. 52, Hwa Ya 1 <sup>st</sup> Rd., Hwa Ya Technology Park, Kwei-Shan District, Tao Yuan City, Taiwan, R.O.C. TEL: +886-3-327-3456 FAX: +886-3-328-4978		
<b>Test Site No.</b>	<b>Sporton Site No.</b>		
	TH05-HY	CO05-HY	03CH07-HY

**Note:** The test site complies with ANSI C63.4 2014 requirement.

### 1.7 Applicable Standards

According to the specifications of the manufacturer, the EUT must comply with the requirements of the following standards:

- ♦ FCC Part 15 Subpart C §15.247
- ♦ ANSI C63.10-2013

**Remark:**

1. All test items were verified and recorded according to the standards and without any deviation during the test.
2. This EUT has also been tested and complied with the requirements of FCC Part 15, Subpart B, recorded in a separate test report.





## 2 Test Configuration of Equipment Under Test

### 2.1 Carrier Frequency Channel

Frequency Band	Channel	Freq. (MHz)	Channel	Freq. (MHz)	Channel	Freq. (MHz)
2400-2483.5 MHz	0	2402	27	2429	54	2456
	1	2403	28	2430	55	2457
	2	2404	29	2431	56	2458
	3	2405	30	2432	57	2459
	4	2406	31	2433	58	2460
	5	2407	32	2434	59	2461
	6	2408	33	2435	60	2462
	7	2409	34	2436	61	2463
	8	2410	35	2437	62	2464
	9	2411	36	2438	63	2465
	10	2412	37	2439	64	2466
	11	2413	38	2440	65	2467
	12	2414	39	2441	66	2468
	13	2415	40	2442	67	2469
	14	2416	41	2443	68	2470
	15	2417	42	2444	69	2471
	16	2418	43	2445	70	2472
	17	2419	44	2446	71	2473
	18	2420	45	2447	72	2474
	19	2421	46	2448	73	2475
	20	2422	47	2449	74	2476
	21	2423	48	2450	75	2477
	22	2424	49	2451	76	2478
	23	2425	50	2452	77	2479
	24	2426	51	2453	78	2480
	25	2427	52	2454	-	-
	26	2428	53	2455	-	-



## 2.2 Test Mode

Channel	Frequency	Bluetooth Average Output Power		
		GFSK / 1Mbps		
		DH1	DH3	DH5
Ch00	2402MHz	2.15 dBm	2.07 dBm	2.05 dBm
Ch39	2441MHz	2.38 dBm	2.37 dBm	2.35 dBm
Ch78	2480MHz	2.97 dBm	2.84 dBm	2.80 dBm

Channel	Frequency	Bluetooth Average Output Power		
		$\pi/4$ -DQPSK / 2Mbps		
		2DH1	2DH3	2DH5
Ch00	2402MHz	-1.08 dBm	-1.11 dBm	-1.11 dBm
Ch39	2441MHz	0.44 dBm	0.38 dBm	0.35 dBm
Ch78	2480MHz	0.62 dBm	0.61 dBm	0.57 dBm

Channel	Frequency	Bluetooth Average Output Power		
		8-DPSK / 3Mbps		
		3DH1	3DH3	3DH5
Ch00	2402MHz	-1.07 dBm	-1.11 dBm	-1.12 dBm
Ch39	2441MHz	0.44 dBm	0.35 dBm	0.37 dBm
Ch78	2480MHz	0.63 dBm	0.62 dBm	0.58 dBm



Channel	Frequency	Bluetooth Peak Output Power		
		GFSK / 1Mbps		
		DH1	DH3	DH5
Ch00	2402MHz	3.05 dBm	3.00 dBm	2.99 dBm
Ch39	2441MHz	3.36 dBm	3.30 dBm	3.25 dBm
Ch78	2480MHz	3.63 dBm	3.58 dBm	3.58 dBm

Channel	Frequency	Bluetooth Peak Output Power		
		π/4-DQPSK / 2Mbps		
		2DH1	2DH3	2DH5
Ch00	2402MHz	2.18 dBm	2.15 dBm	2.13 dBm
Ch39	2441MHz	3.49 dBm	3.45 dBm	3.45 dBm
Ch78	2480MHz	3.59 dBm	3.45 dBm	3.45 dBm

Channel	Frequency	Bluetooth Peak Output Power		
		8-DPSK / 3Mbps		
		3DH1	3DH3	3DH5
Ch00	2402MHz	2.39 dBm	2.36 dBm	2.37 dBm
Ch39	2441MHz	3.68 dBm	3.66 dBm	3.65 dBm
Ch78	2480MHz	3.72 dBm	3.70 dBm	3.70 dBm

Remark: The data rate was set in 3Mbps for all the test items due to the highest RF output power.

The EUT has been associated with peripherals and configuration operated in a manner tended to maximize its emission characteristics in a typical application. Frequency range investigated: conduction emission (150 kHz to 30 MHz), radiation emission (9 kHz to the 10th harmonic of the highest fundamental frequency or to 40 GHz, whichever is lower). For radiated measurement, pre-scanned in three orthogonal panels, X, Y, Z. The worst cases (X plane for Antenna No. 1 and Antenna No. 4; Y plane for Antenna No. 3) were recorded in this report, and the worst mode of radiated spurious emissions is Bluetooth 3Mbps mode, and recorded in this report.

- a. AC power line Conducted Emission was tested under maximum output power.



The following summary table is showing all test modes to demonstrate in compliance with the standard.

Summary table of Test Cases			
Test Item	Data Rate / Modulation		
	Bluetooth BR 1Mbps GFSK	Bluetooth EDR 2Mbps $\pi/4$ -DQPSK	Bluetooth EDR 3Mbps 8-DPSK
<b>Conducted Test Cases</b>	Mode 1: CH00_2402 MHz Mode 2: CH39_2441 MHz Mode 3: CH78_2480 MHz	Mode 4: CH00_2402 MHz Mode 5: CH39_2441 MHz Mode 6: CH78_2480 MHz	Mode 7: CH00_2402 MHz Mode 8: CH39_2441 MHz Mode 9: CH78_2480 MHz
<b>Radiated Test Cases</b>	<b>Bluetooth EDR 3Mbps 8-DPSK</b>		
	Mode 1: CH00_2402 MHz Mode 2: CH39_2441 MHz Mode 3: CH78_2480 MHz		
<b>AC Conducted Emission</b>	Mode 1 :WLAN (2.4GHz) Link + Bluetooth Link + Audio Speaker (M1000) + Keyboard (ikey) + Scanner (DS3508) + RS-232 (cable load)* 2 + Ext. Antenna AN2020 + AC/DC Adapter + MPEG4 for Sample 1		
<b>Remark:</b> For radiated test cases, the worst mode data rate 3Mbps was reported only, because this data rate has the highest RF output power at preliminary tests, and the conducted spurious emissions and conducted band edge measurement for each data rate are no worse than 3Mbps, and no other significantly frequencies found in conducted spurious emission.			

## 2.3 Connection Diagram of Test System

<EUT + Internal Antenna with Accessory Mode>

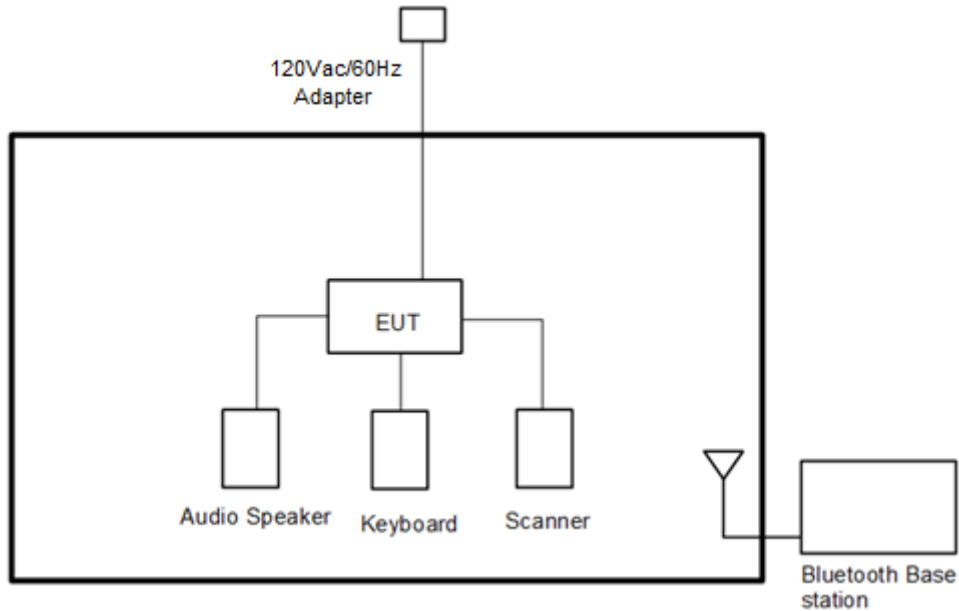

<EUT + External Antenna with Accessory Mode>

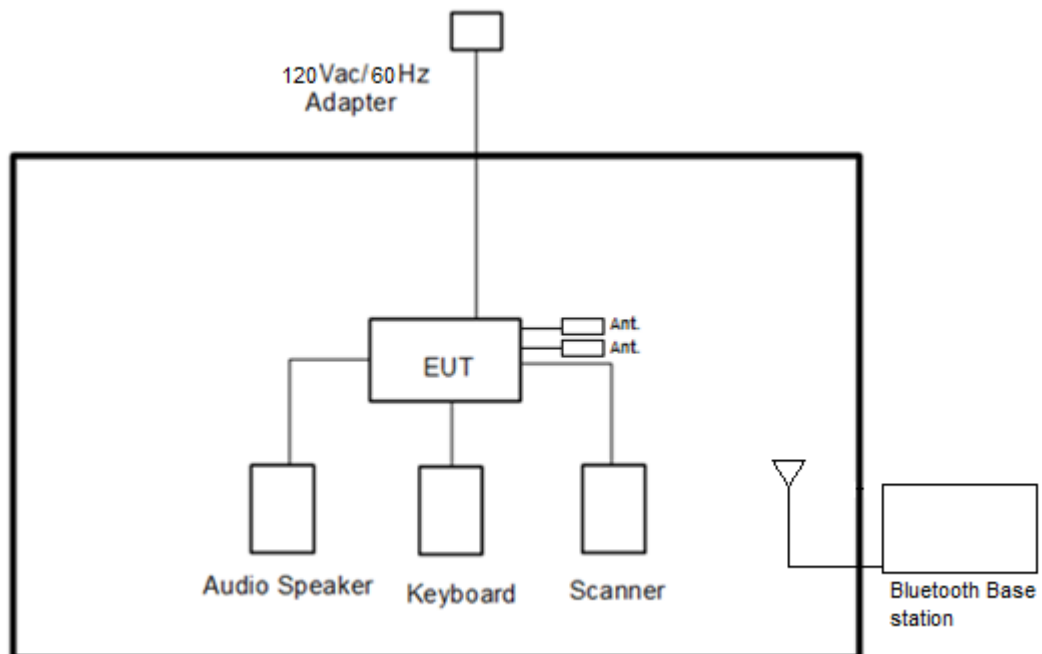

## 2.4 Support Unit used in test configuration and system

Item	Equipment	Trade Name	Model Name	FCC ID	Data Cable	Power Cord
1.	Bluetooth Earphone	Sony Ericsson	MW600	PY7DDA-2029	N/A	N/A
2.	WLAN AP	ASUS	RT-AC66U	MSQ-RTAC66U	N/A	Unshielded, 1.8m
3.	Notebook	DELL	Latitude E6320	FCC DoC/ Contains FCC ID: QDS-BRCM1054	N/A	AC I/P: Unshielded, 1.2 m DC O/P: Shielded, 1.8 m
4.	Notebook	Lenovo	M490S	N/A	N/A	AC I/P: Unshielded, 1.2 m DC O/P: Shielded, 1.8 m
5.	Bluetooth Base Station	R&S	CBT32	N/A	N/A	Unshielded, 1.8 m

## 2.5 EUT Operation Test Setup

For Bluetooth function, the RF utility, “command” was installed in notebook which was programmed in order to make the EUT get into the engineering modes to contact with Bluetooth base station for continuous transmitting and receiving signals.

## 2.6 Measurement Results Explanation Example

For all conducted test items:

The offset level is set in the spectrum analyzer to compensate the RF cable loss and attenuator factor between EUT conducted output port and spectrum analyzer. With the offset compensation, the spectrum analyzer reading level is exactly the EUT RF output level.

Example:

The spectrum analyzer offset is derived from RF cable loss and attenuator factor.

*Offset = RF cable loss + attenuator factor.*

Following shows an offset computation example with cable loss 4.2 dB and 10dB attenuator.

$$\begin{aligned}
 \text{Offset(dB)} &= \text{RF cable loss(dB)} + \text{attenuator factor(dB)} \\
 &= 4.2 + 10 = 14.2 \text{ (dB)}
 \end{aligned}$$

### 3 Test Result

#### 3.1 Number of Channel Measurement

##### 3.1.1 Limits of Number of Hopping Frequency

Frequency hopping systems in the 2400-2483.5 MHz band shall use at least 15 channels.

##### 3.1.2 Measuring Instruments

The measuring equipment is listed in the section 4 of this test report.

##### 3.1.3 Test Procedure

1. The testing follows ANSI C63.10-2013 clause 7.8.3.
2. The RF output of EUT was connected to the spectrum analyzer by RF cable and attenuator. The path loss was compensated to the results for each measurement.
3. Set to the maximum power setting and enable the EUT transmit continuously.
4. Enable the EUT hopping function.
5. Use the following spectrum analyzer settings: Span = the frequency band of operation; RBW = 300kHz; VBW  $\geq$  RBW; Sweep = auto; Detector function = peak; Trace = max hold.
6. The number of hopping frequency used is defined as the number of total channel.
7. Record the measurement data derived from spectrum analyzer.

##### 3.1.4 Test Setup

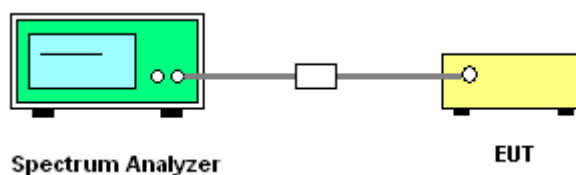



### 3.1.5 Test Result of Number of Hopping Frequency

Number of Hopping (Channel)	Adaptive Frequency Hopping (Channel)	Limits (Channel)	Pass/Fail
79	20	> 15	Pass

Number of Hopping Channel Plot on Channel 00 - 78

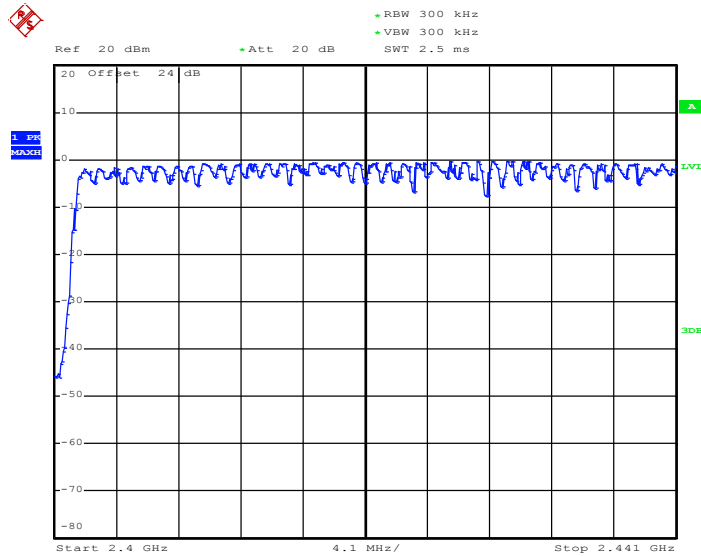

Date: 4.JUL.2017 23:11:25

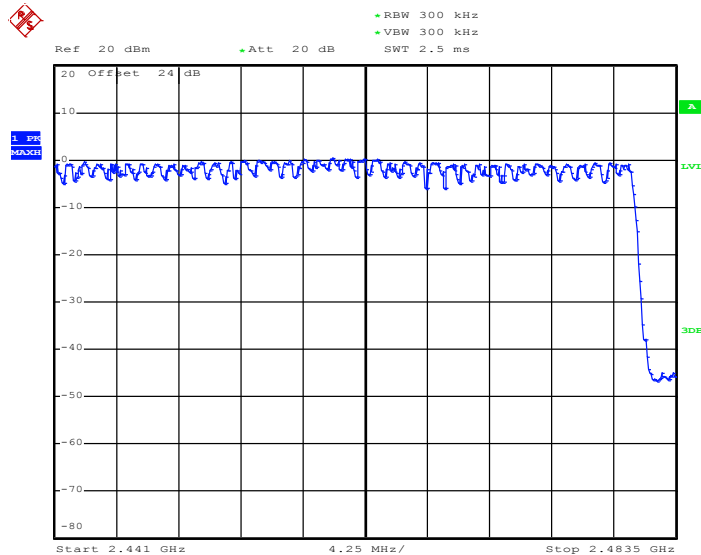

Date: 4.JUL.2017 23:11:56



## 3.2 Hopping Channel Separation Measurement

### 3.2.1 Limit of Hopping Channel Separation

Frequency hopping systems operating in the 2400-2483.5 MHz band may have hopping channel carrier frequencies that are separated by 25 kHz or two-thirds of the 20 dB bandwidth of the hopping channel, whichever is greater.

### 3.2.2 Measuring Instruments

The measuring equipment is listed in the section 4 of this test report.

### 3.2.3 Test Procedures

1. The testing follows ANSI C63.10-2013 clause 7.8.2.
2. The RF output of EUT was connected to the spectrum analyzer by RF cable and attenuator. The path loss was compensated to the results for each measurement.
3. Set to the maximum power setting and enable the EUT transmit continuously.
4. Enable the EUT hopping function.
5. Use the following spectrum analyzer settings:  
Span = wide enough to capture the peaks of two adjacent channels;  
RBW = 300kHz; VBW  $\geq$  RBW; Sweep = auto; Detector function = peak; Trace = max hold.
6. Measure and record the results in the test report.

### 3.2.4 Test Setup

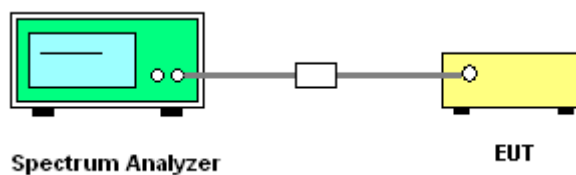



### 3.2.5 Test Result of Hopping Channel Separation

Mod.	Data Rate	NTX	CH.	Freq. (MHz)	Hopping Channel Separation Measurement (MHz)	Hopping Channel Separation Measurement Limit (MHz)	Pass/Fail
DH	1Mbps	1	0	2402	1.002	0.6400	Pass
DH	1Mbps	1	39	2441	1.008	0.6640	Pass
DH	1Mbps	1	78	2480	1.002	0.6560	Pass
2DH	2Mbps	1	0	2402	1.008	0.9000	Pass
2DH	2Mbps	1	39	2441	1.008	0.8960	Pass
2DH	2Mbps	1	78	2480	1.008	0.9000	Pass
3DH	3Mbps	1	0	2402	1.008	0.8640	Pass
3DH	3Mbps	1	39	2441	1.002	0.8720	Pass
3DH	3Mbps	1	78	2480	1.008	0.8720	Pass

<1Mbps>

Channel Separation Plot on Channel 00 - 01

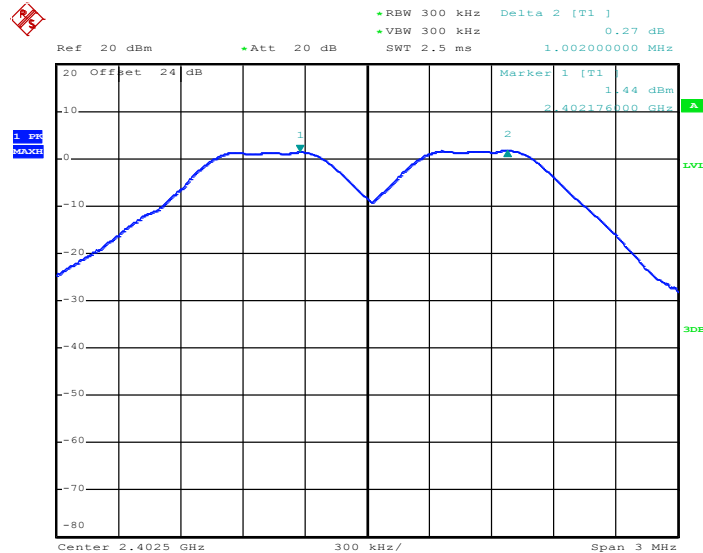

Date: 4.JUL.2017 23:26:43



### Channel Separation Plot on Channel 39 - 40

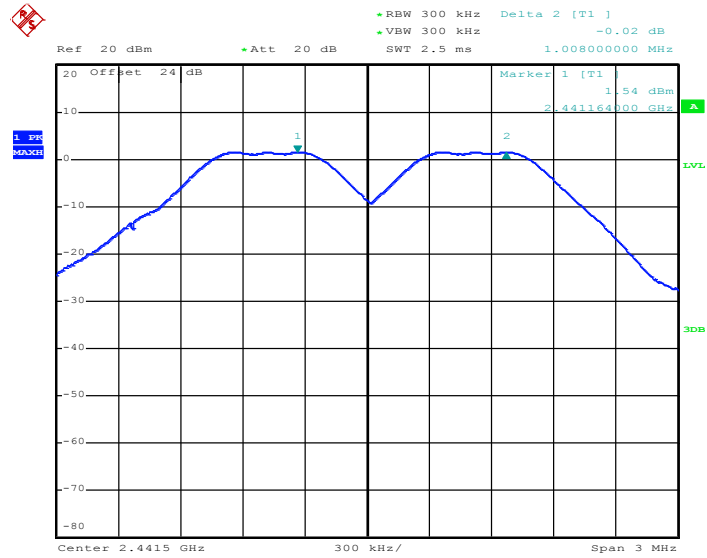

Date: 4.JUL.2017 23:32:44

### Channel Separation Plot on Channel 77 - 78

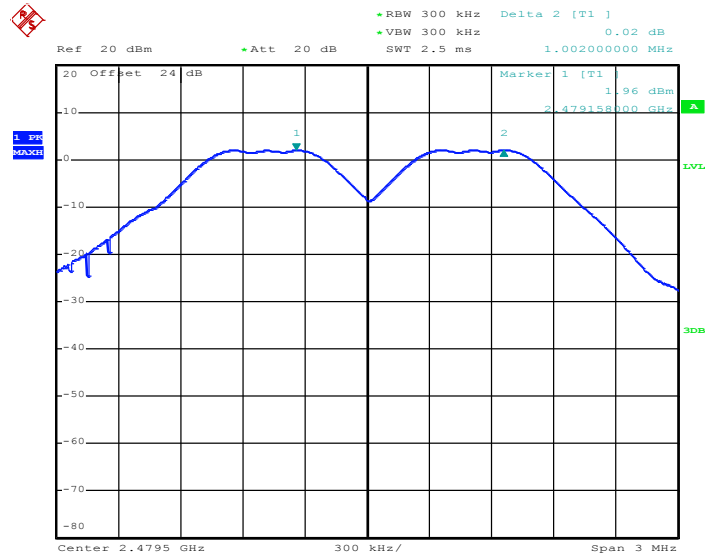

Date: 4.JUL.2017 23:39:37





Channel Separation Plot on Channel 77 - 78

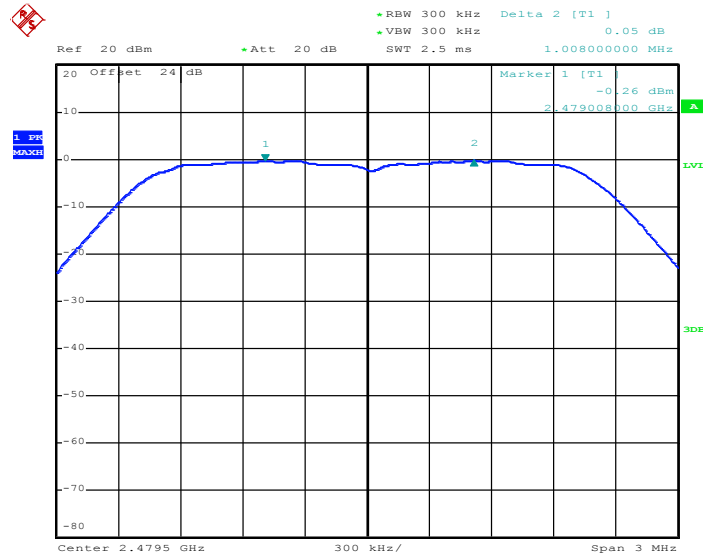

Date: 5.JUL.2017 00:09:05

<3Mbps>

Channel Separation Plot on Channel 00 - 01

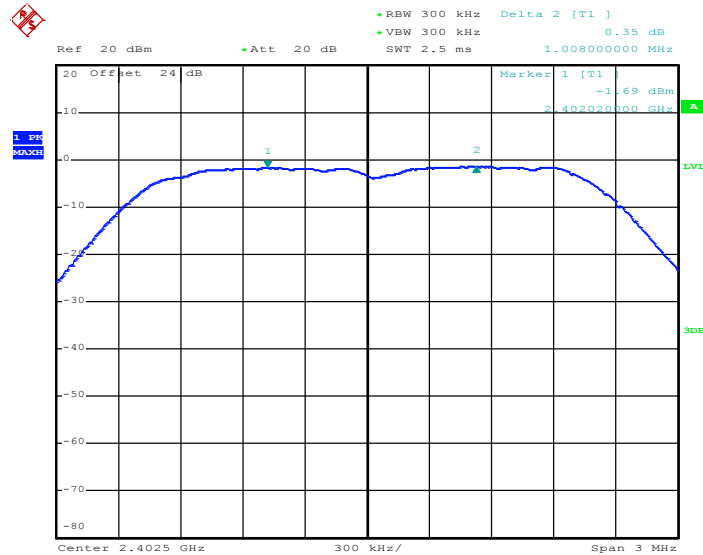

Date: 5.JUL.2017 00:20:18



### Channel Separation Plot on Channel 39 - 40

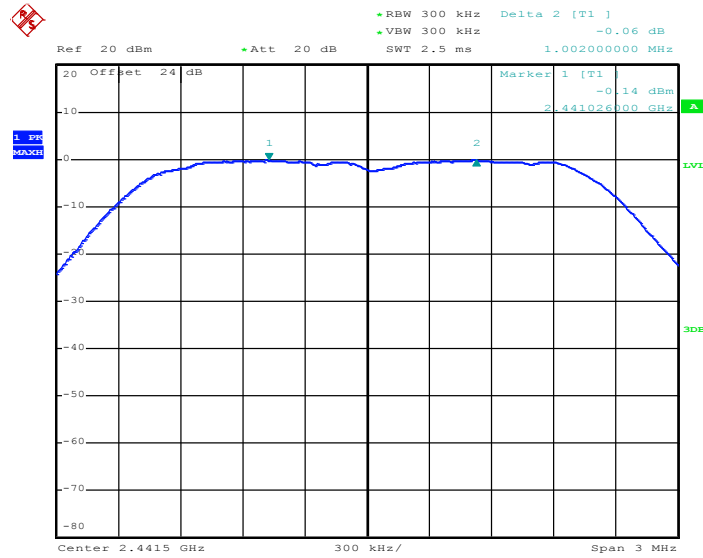

Date: 5.JUL.2017 00:24:46

### Channel Separation Plot on Channel 77 - 78

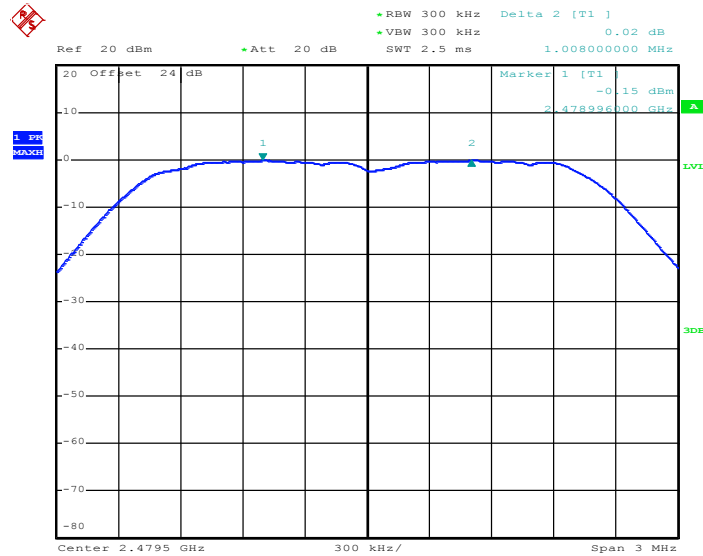

Date: 5.JUL.2017 00:35:19

### 3.3 Dwell Time Measurement

#### 3.3.1 Limit of Dwell Time

The average time of occupancy on any channel shall not be greater than 0.4 seconds within a period of 0.4 seconds multiplied by the number of hopping channels employed.

#### 3.3.2 Measuring Instruments

The measuring equipment is listed in the section 4 of this test report.

#### 3.3.3 Test Procedures

1. The testing follows ANSI C63.10-2013 clause 7.8.4.
2. The RF output of EUT was connected to the spectrum analyzer by RF cable and attenuator. The path loss was compensated to the results for each measurement.
3. Set to the maximum power setting and enable the EUT transmit continuously.
4. Enable the EUT hopping function.
5. Use the following spectrum analyzer settings: Span = zero span, centered on a hopping channel; RBW = 1 MHz; VBW  $\geq$  RBW; Sweep = as necessary to capture the entire dwell time per hopping channel; Detector function = peak; Trace = max hold.
6. Measure and record the results in the test report.

#### 3.3.4 Test Setup

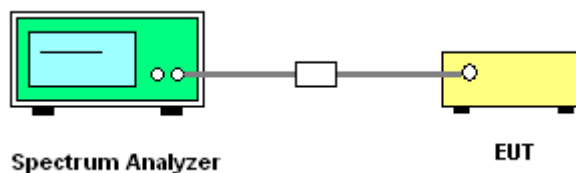



3.3.5 Test Result of Dwell Time

Mod.	Hopping Channel Number Rate	Hops Over Occupancy Time(hops)	Package Transfer Time (msec) (MHz)	Dwell Time (sec)	Limits (sec)	Pass/Fail
Nomal	79	106.67	2.89	0.31	0.4	Pass
AFH	20	53.33	2.89	0.15	0.4	Pass

Package Transfer Time Plot

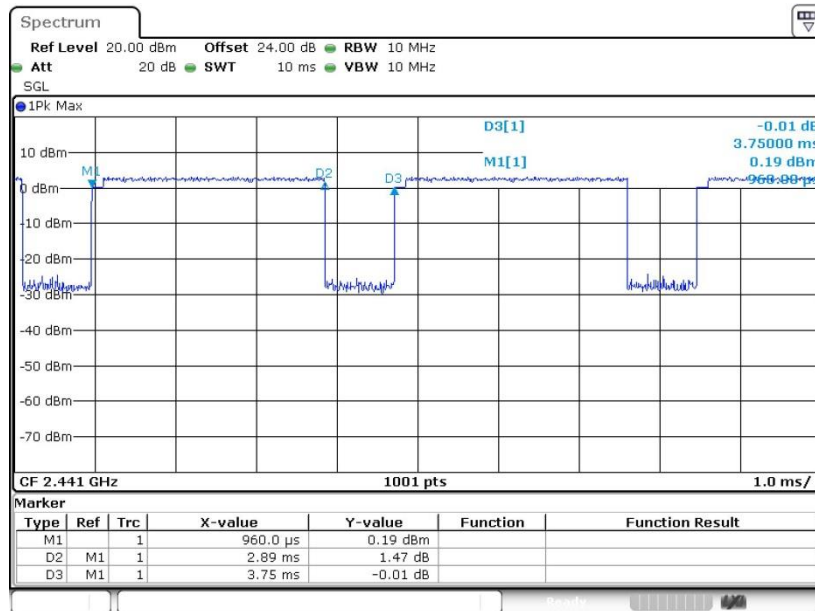

Date: 27.JUN.2017 18:43:36

Remark:

- In normal mode, hopping rate is 1600 hops/s with 6 slots in 79 hopping channels. With channel hopping rate  $(1600 / 6 / 79)$  in Occupancy Time Limit  $(0.4 \times 79)$  (s), Hops Over Occupancy Time comes to  $(1600 / 6 / 79) \times (0.4 \times 79) = 106.67$  hops.
- In AFH mode, hopping rate is 800 hops/s with 6 slots in 20 hopping channels. With channel hopping rate  $(800 / 6 / 20)$  in Occupancy Time Limit  $(0.4 \times 20)$  (s), Hops Over Occupancy Time comes to  $(800 / 6 / 20) \times (0.4 \times 20) = 53.33$  hops.
- Dwell Time(s) = Hops Over Occupancy Time (hops) x Package Transfer Time



### 3.4 20dB and 99% Bandwidth Measurement

#### 3.4.1 Limit of 20dB and 99% Bandwidth

Reporting only

#### 3.4.2 Measuring Instruments

The measuring equipment is listed in the section 4 of this test report.

#### 3.4.3 Test Procedures

1. The testing follows ANSI C63.10-2013 clause 6.9.2 and 6.9.3.
2. The RF output of EUT was connected to the spectrum analyzer by RF cable and attenuator. The path loss was compensated to the results for each measurement.
3. Set to the maximum power setting and enable the EUT transmit continuously.
4. Use the following spectrum analyzer settings for 20dB Bandwidth measurement.  
Span = approximately 2 to 5 times the 20 dB bandwidth, centered on a hopping channel;  
RBW  $\geq$  1% of the 20 dB bandwidth; VBW  $\geq$  RBW; Sweep = auto; Detector function = peak;  
Trace = max hold.
5. Use the following spectrum analyzer settings for 99 % Bandwidth measurement.  
Span = approximately 1.5 to 5 times the 99% bandwidth, centered on a hopping channel;  
RBW  $\geq$  1% of the 99% bandwidth; VBW  $\geq$  RBW; Sweep = auto; Detector function = peak;  
Trace = max hold.
6. Measure and record the results in the test report.

#### 3.4.4 Test Setup

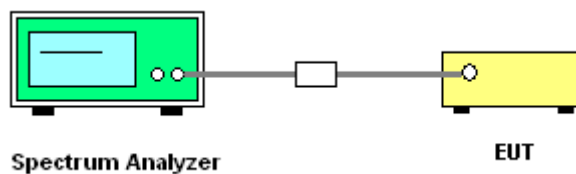



3.4.5 Test Result of 20dB Bandwidth

Mod.	Data Rate	Nrx	CH.	Freq. (MHz)	20db BW (MHz)	Pass/Fail
DH	1Mbps	1	0	2402	0.960	Pass
DH	1Mbps	1	39	2441	0.996	Pass
DH	1Mbps	1	78	2480	0.984	Pass
2DH	2Mbps	1	0	2402	1.350	Pass
2DH	2Mbps	1	39	2441	1.344	Pass
2DH	2Mbps	1	78	2480	1.350	Pass
3DH	3Mbps	1	0	2402	1.296	Pass
3DH	3Mbps	1	39	2441	1.308	Pass
3DH	3Mbps	1	78	2480	1.308	Pass

<1Mbps>

20 dB Bandwidth Plot on Channel 00

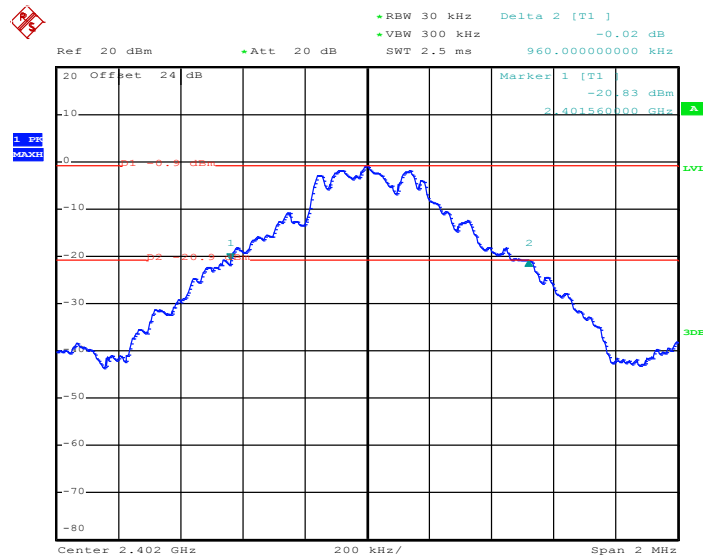

Date: 4.JUL.2017 23:22:01



### 20 dB Bandwidth Plot on Channel 39

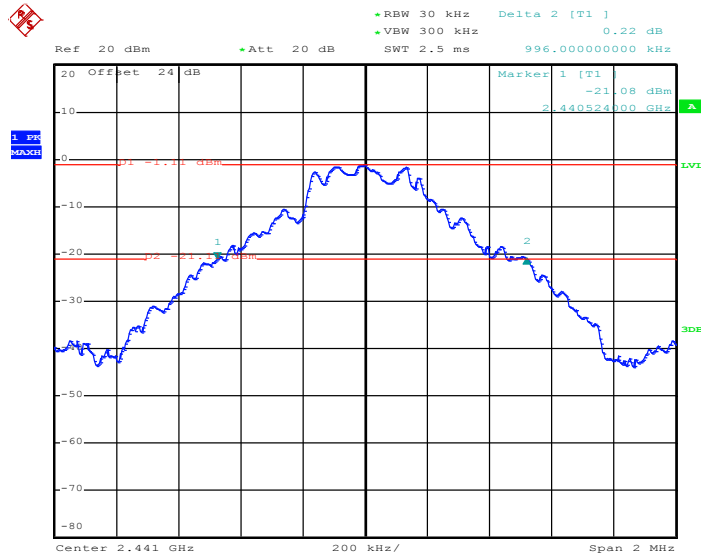

Date: 4.JUL.2017 23:28:47

### 20 dB Bandwidth Plot on Channel 78

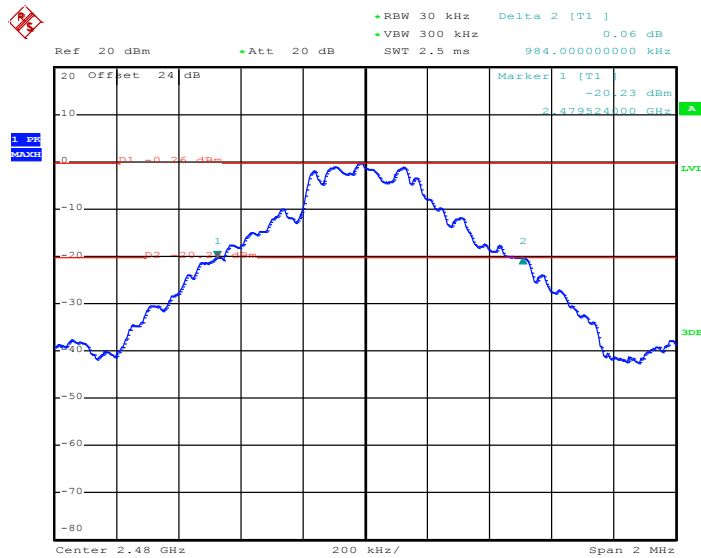

Date: 4.JUL.2017 23:33:54



<2Mbps>

20 dB Bandwidth Plot on Channel 00

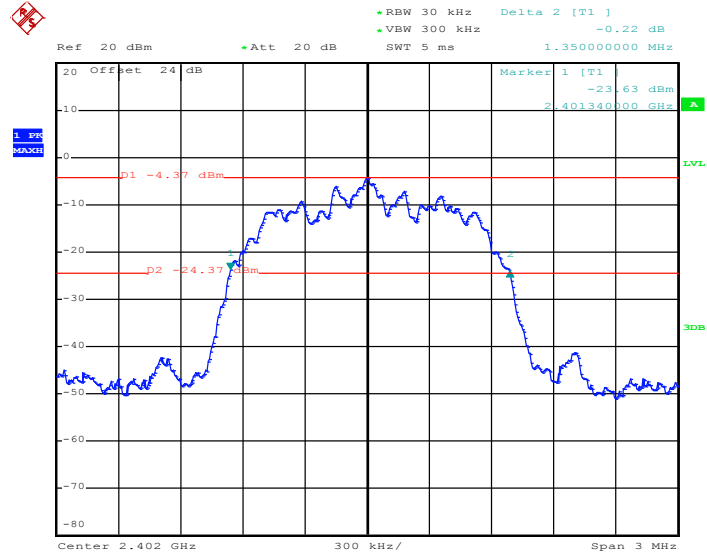

Date: 4.JUL.2017 23:43:20

20 dB Bandwidth Plot on Channel 39

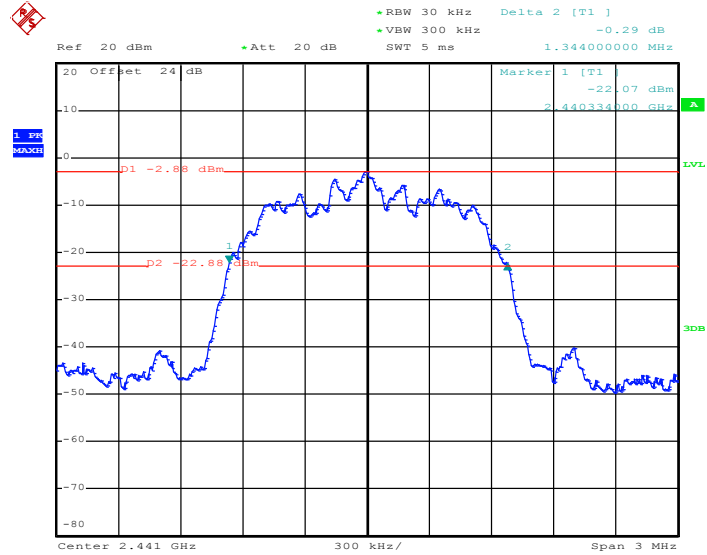

Date: 4.JUL.2017 23:52:40



### 20 dB Bandwidth Plot on Channel 78

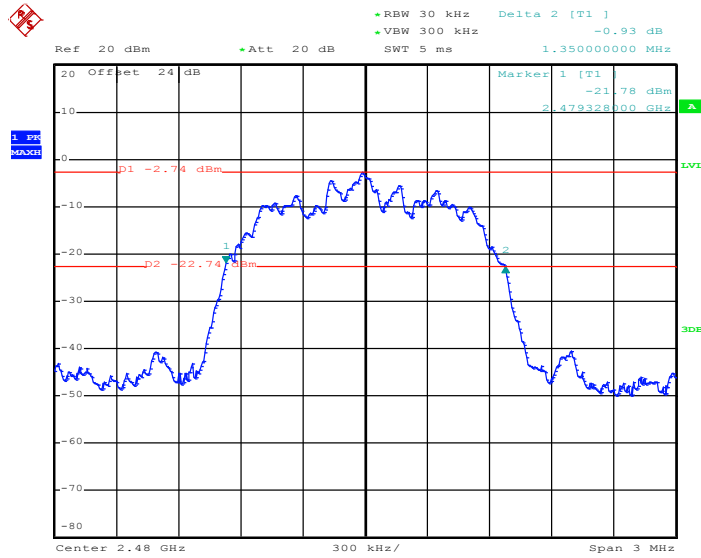

Date: 5.JUL.2017 00:43:46

### <3Mbps>

### 20 dB Bandwidth Plot on Channel 00

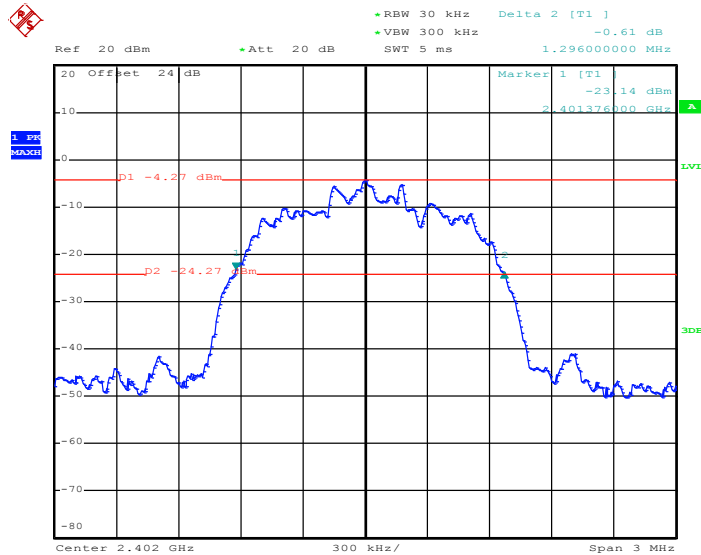

Date: 5.JUL.2017 00:11:36



### 20 dB Bandwidth Plot on Channel 39

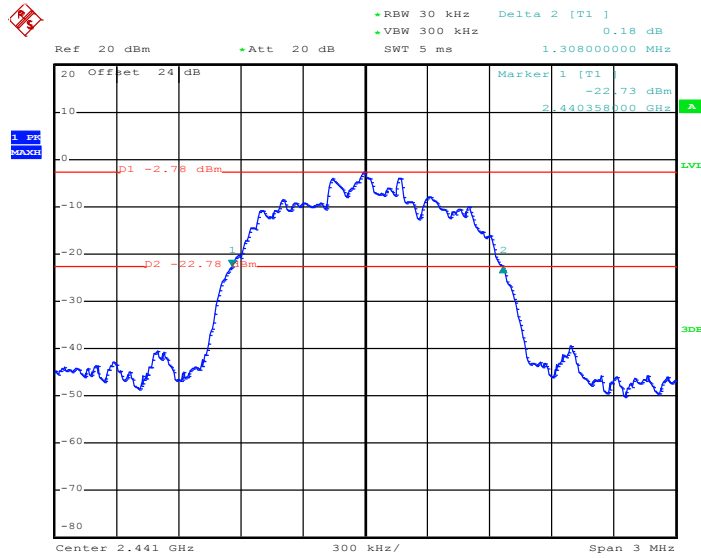

Date: 5.JUL.2017 00:21:35

### 20 dB Bandwidth Plot on Channel 78

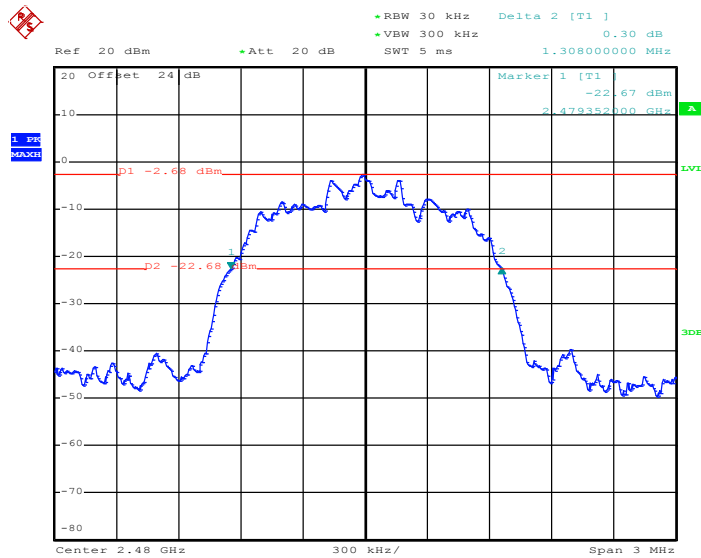

Date: 5.JUL.2017 00:27:05



3.4.6 Test Result of 99% Occupied Bandwidth

Mod.	Data Rate	Nrx	CH.	Freq. (MHz)	99% Bandwidth (MHz)	Pass/Fail
DH	1Mbps	1	0	2402	0.884	Pass
DH	1Mbps	1	39	2441	0.884	Pass
DH	1Mbps	1	78	2480	0.884	Pass
2DH	2Mbps	1	0	2402	1.208	Pass
2DH	2Mbps	1	39	2441	1.208	Pass
2DH	2Mbps	1	78	2480	1.208	Pass
3DH	3Mbps	1	0	2402	1.180	Pass
3DH	3Mbps	1	39	2441	1.180	Pass
3DH	3Mbps	1	78	2480	1.184	Pass

<1Mbps>

99% Occupied Bandwidth Plot on Channel 00

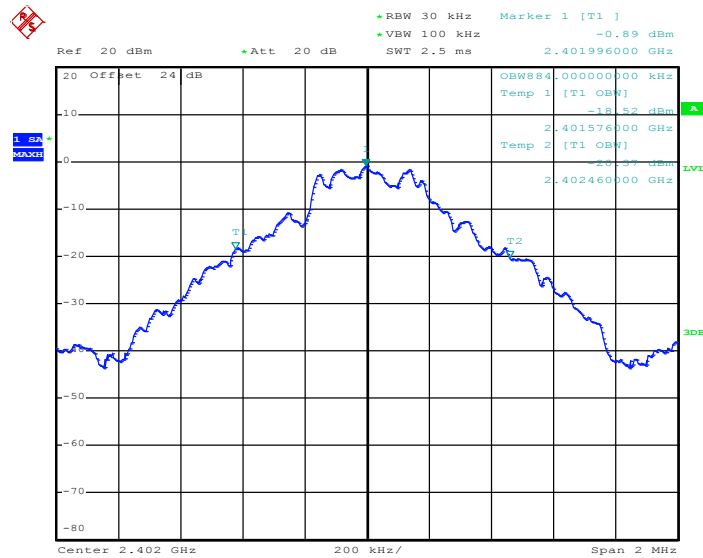

Date: 4.JUL.2017 23:24:06



99% Occupied Bandwidth Plot on Channel 39

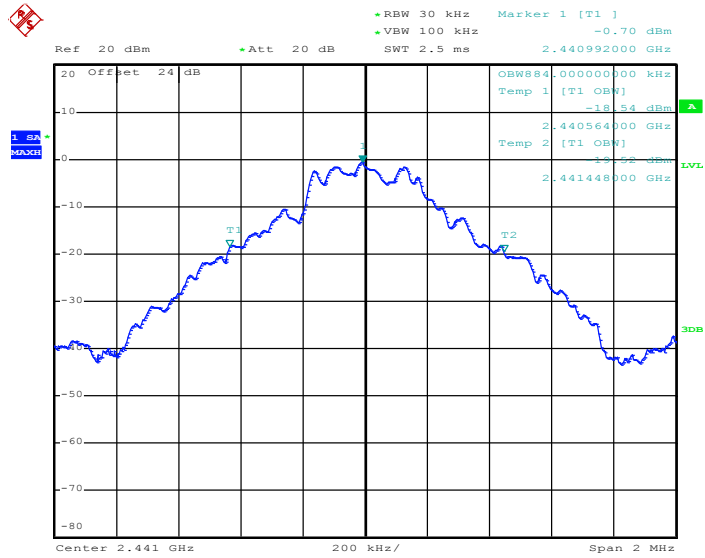

Date: 4.JUL.2017 23:30:41

99% Occupied Bandwidth Plot on Channel 78

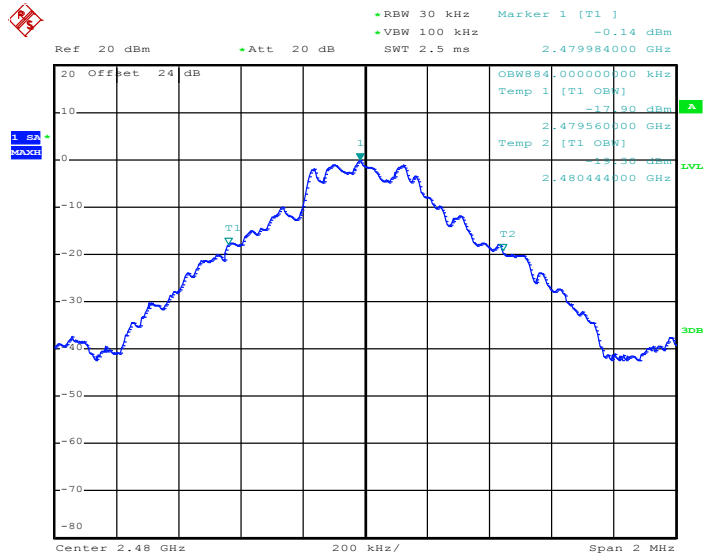

Date: 4.JUL.2017 23:35:22





<2Mbps>

99% Occupied Bandwidth Plot on Channel 00

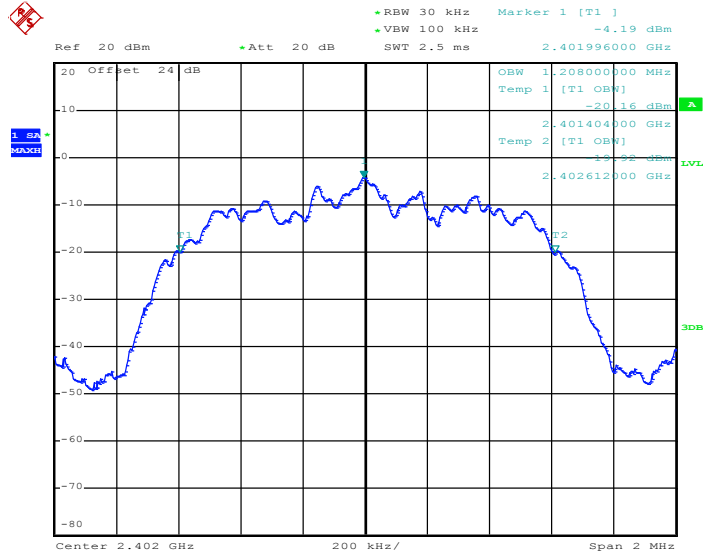

Date: 4.JUL.2017 23:45:06

99% Occupied Bandwidth Plot on Channel 39

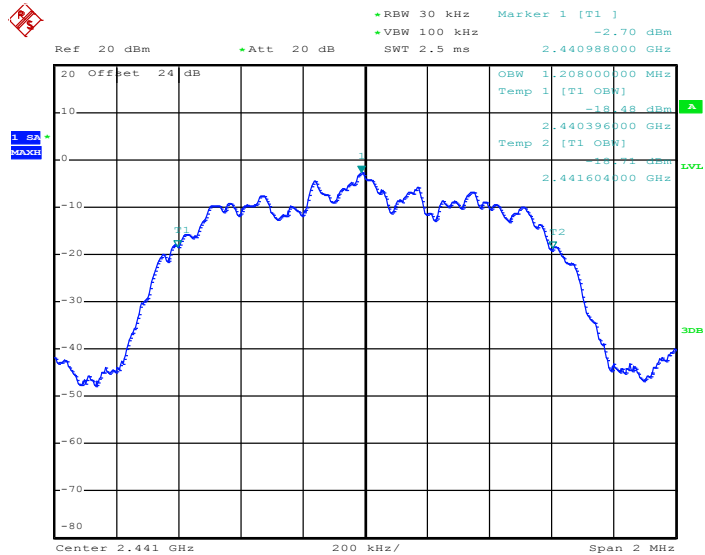

Date: 4.JUL.2017 23:53:47



99% Occupied Bandwidth Plot on Channel 78

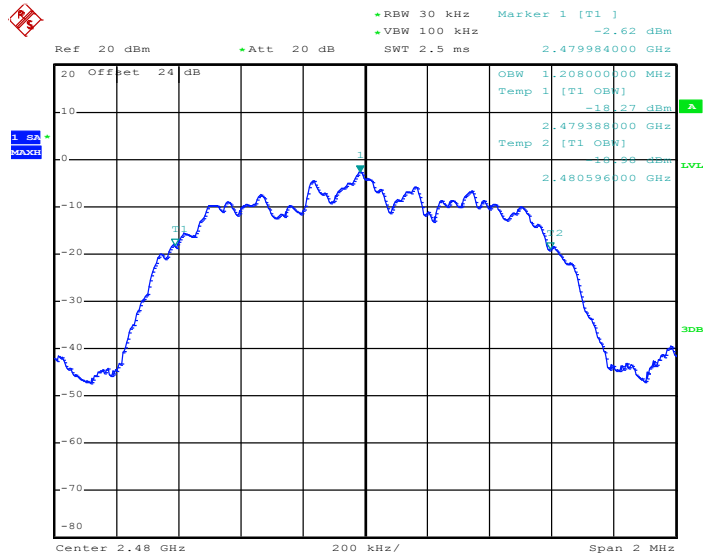

Date: 5.JUL.2017 00:01:58

<3Mbps>

99% Occupied Bandwidth Plot on Channel 00

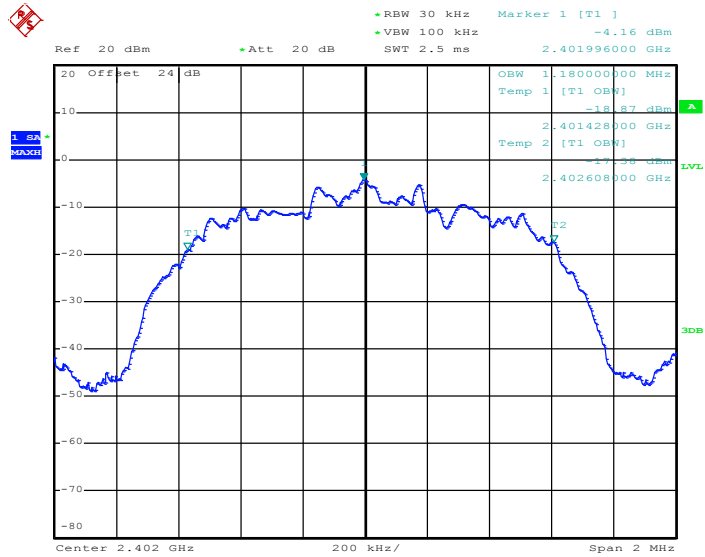

Date: 5.JUL.2017 00:14:14



99% Occupied Bandwidth Plot on Channel 39

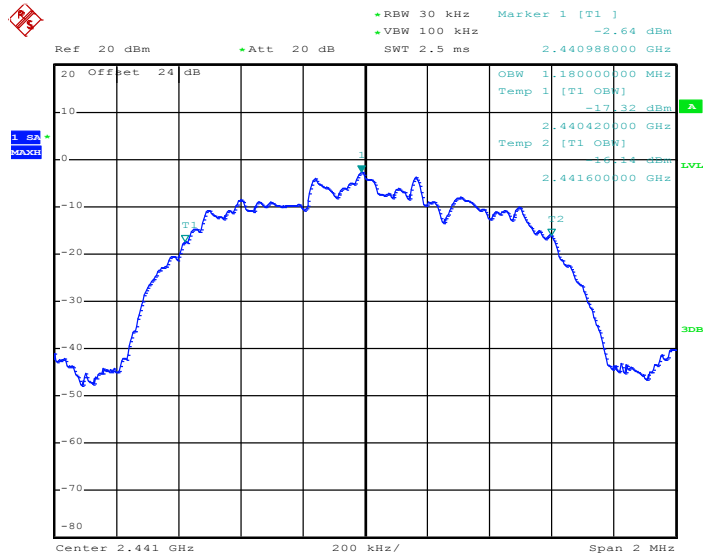

Date: 5.JUL.2017 00:22:44

99% Occupied Bandwidth Plot on Channel 78

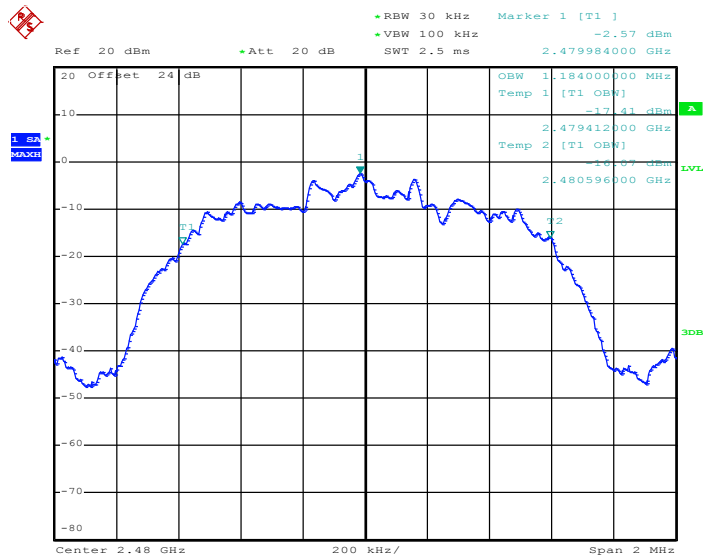

Date: 5.JUL.2017 00:28:48

**Note:** The occupied channel bandwidth is maintained within the band of operation for all of the modulations.

### 3.5 Peak Output Power Measurement

#### 3.5.1 Limit of Peak Output Power

Section 15.247 (b) The maximum peak conducted output power of the intentional radiator shall not exceed the following: (1) For frequency hopping systems operating in the 2400-2483.5 MHz band employing at least 75 non-overlapping hopping channels, and all frequency hopping systems in the 5725-5850 MHz band: 1 watt. For all other frequency hopping systems in the 2400-2483.5 MHz band 0.125 watts. The power limit for 1Mbps, 2Mbps, 3Mbps and AFH modes are 0.125 watts.

#### 3.5.2 Measuring Instruments

The measuring equipment is listed in the section 4 of this test report.

#### 3.5.3 Test Procedures

1. The testing follows ANSI C63.10-2013 clause 7.8.5.
2. The RF output of EUT was connected to the power meter by RF cable and attenuator. The path loss was compensated to the results for each measurement.
3. Set to the maximum power setting and enable the EUT transmit continuously.
4. Measure the conducted output power with cable loss and record the results in the test report.
5. Measure and record the results in the test report.

#### 3.5.4 Test Setup

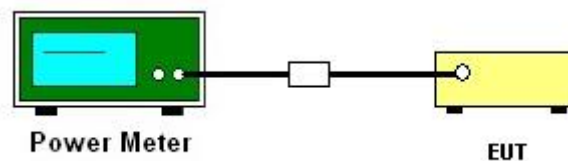



3.5.5 Test Result of Peak Output Power

DH	CH.	N <sub>TX</sub>	Peak Power (dBm)	Power Limit (dBm)	Test Result
DH1	0	1	3.05	20.97	Pass
	39	1	3.36	20.97	Pass
	78	1	<b>3.63</b>	20.97	Pass

2DH	CH.	N <sub>TX</sub>	Peak Power (dBm)	Power Limit (dBm)	Test Result
2DH1	0	1	2.18	20.97	Pass
	39	1	3.49	20.97	Pass
	78	1	<b>3.59</b>	20.97	Pass

3DH	CH.	N <sub>TX</sub>	Peak Power (dBm)	Power Limit (dBm)	Test Result
3DH1	0	1	2.39	20.97	Pass
	39	1	3.68	20.97	Pass
	78	1	<b>3.72</b>	20.97	Pass

## 3.6 Conducted Band Edges Measurement

### 3.6.1 Limit of Band Edges

In any 100 kHz bandwidth outside the intentional radiation frequency band, the radio frequency power shall be at least 20 dB below the highest level of the radiated power. In addition, radiated emissions which fall in the restricted bands must also comply with the radiated emission limits.

### 3.6.2 Measuring Instruments

The measuring equipment is listed in the section 4 of this test report.

### 3.6.3 Test Procedures

1. The testing follows ANSI C63.10-2013 clause 7.8.6.
2. Set to the maximum power setting and enable the EUT transmit continuously.
3. Set RBW = 100kHz, VBW = 300kHz. Band edge emissions must be at least 20 dB down from the highest emission level within the authorized band as measured with a 100kHz RBW. The attenuation shall be 30 dB instead of 20 dB when RMS conducted output power procedure is used.
4. Enable hopping function of the EUT and then repeat step 2. and 3.
5. Measure and record the results in the test report.

### 3.6.4 Test Setup

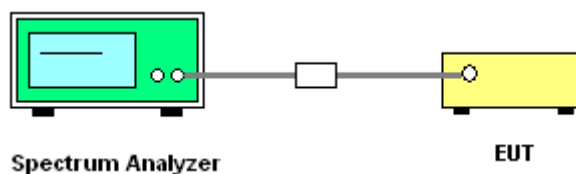



### 3.6.5 Test Result of Conducted Band Edges

<1Mbps>

#### Low Band Edge Plot on Channel 00

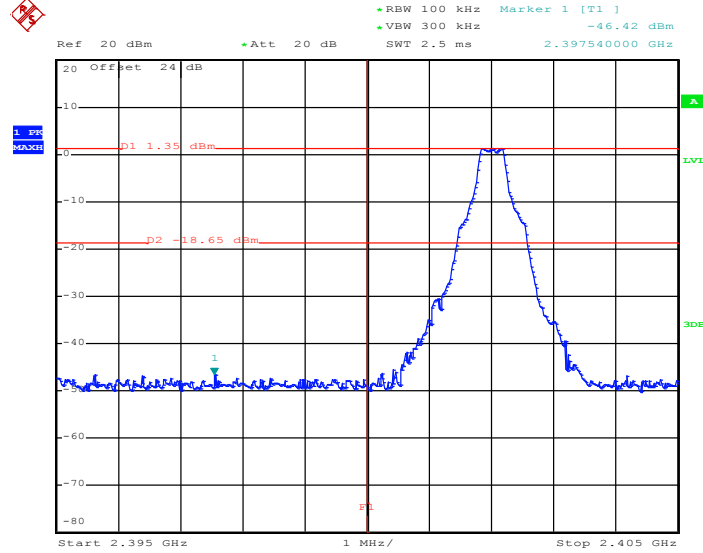

Date: 4.JUL.2017 23:23:33

#### High Band Edge Plot on Channel 78

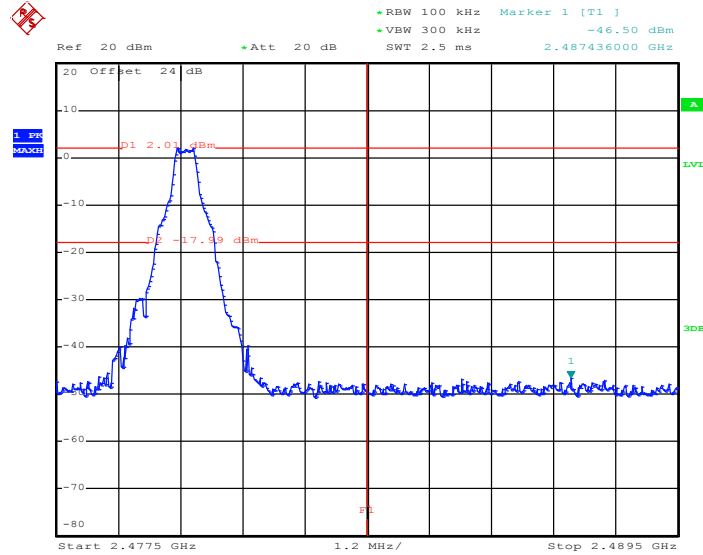

Date: 4.JUL.2017 23:34:44



<2Mbps>

Low Band Edge Plot on Channel 00

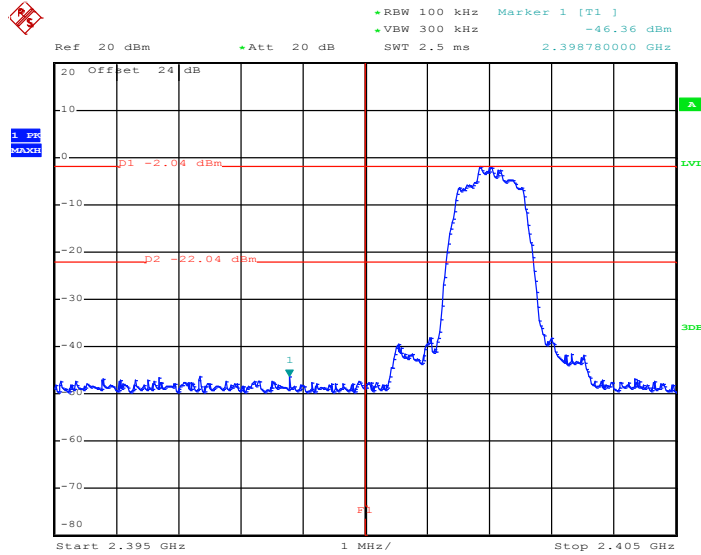

Date: 4.JUL.2017 23:44:11

High Band Edge Plot on Channel 78

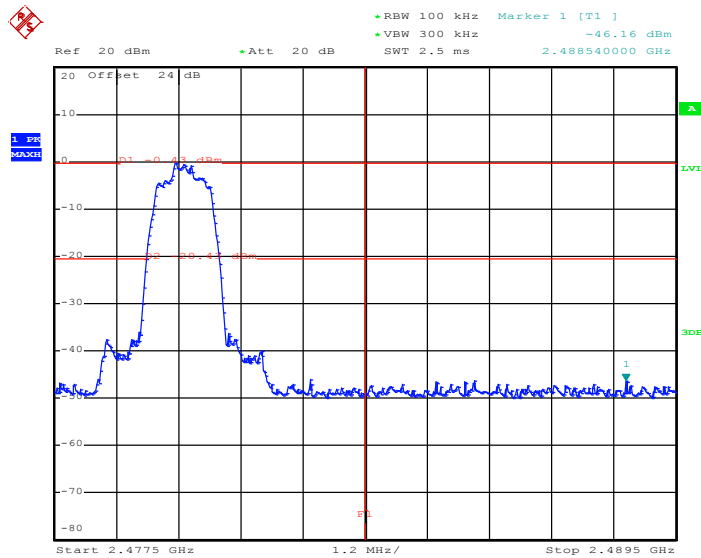

Date: 5.JUL.2017 00:00:56





<3Mbps>

Low Band Edge Plot on Channel 00

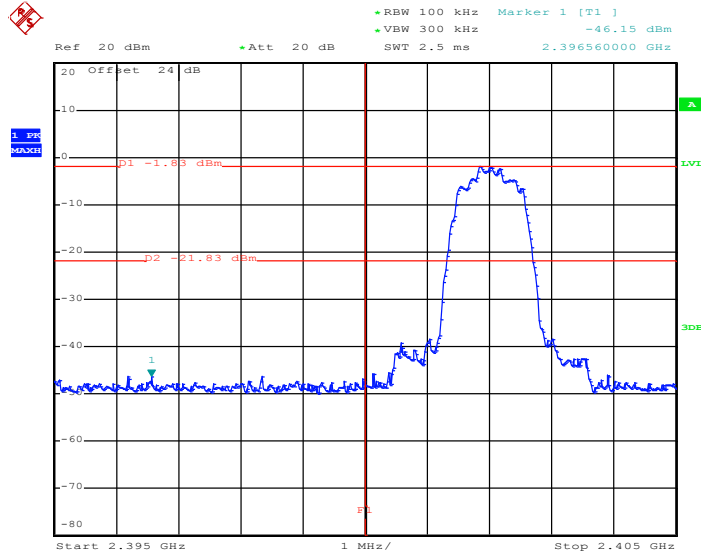

Date: 5.JUL.2017 00:13:12

High Band Edge Plot on Channel 78

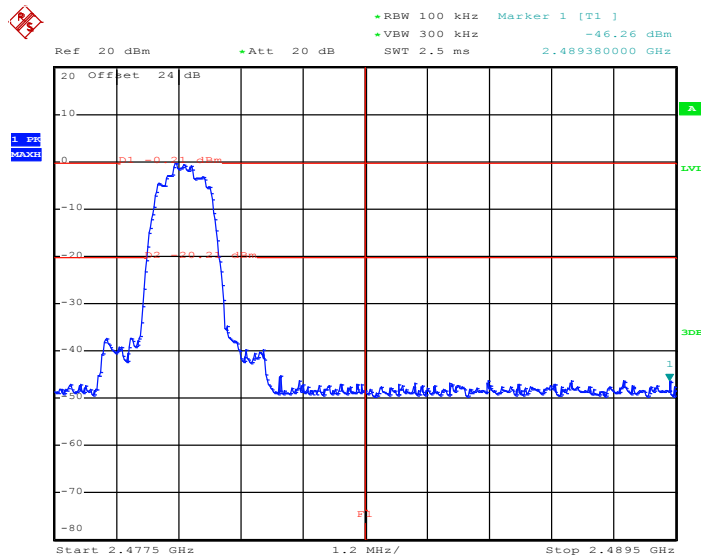

Date: 5.JUL.2017 00:28:12



### 3.6.6 Test Result of Conducted Hopping Mode Band Edges

<1Mbps>

#### Hopping Mode Low Band Edge Plot

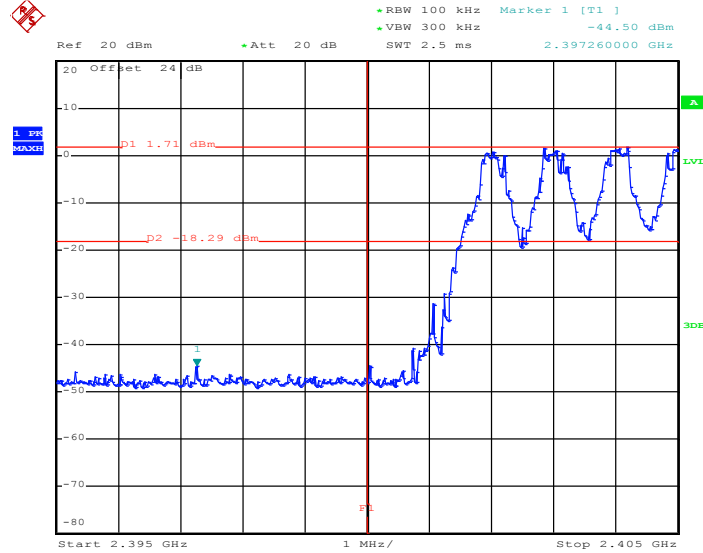

Date: 4.JUL.2017 23:17:33

#### Hopping Mode High Band Edge Plot

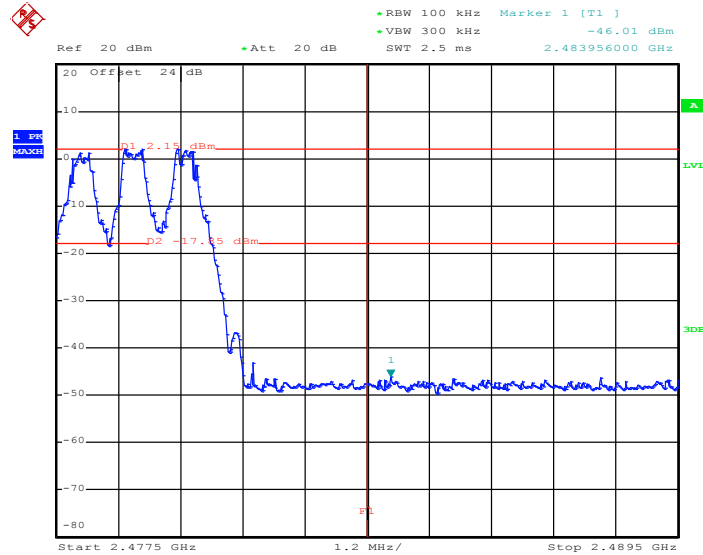

Date: 4.JUL.2017 23:18:09



<2Mbps>

Hopping Mode Low Band Edge Plot

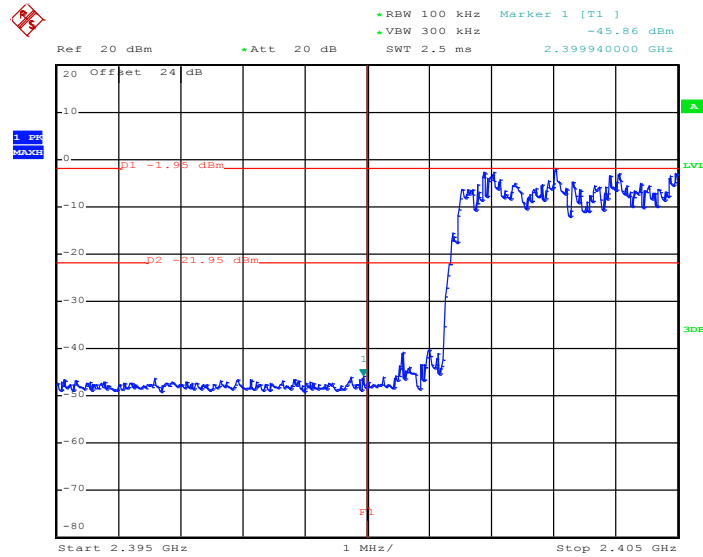

Date: 4.JUL.2017 23:15:09

Hopping Mode High Band Edge Plot

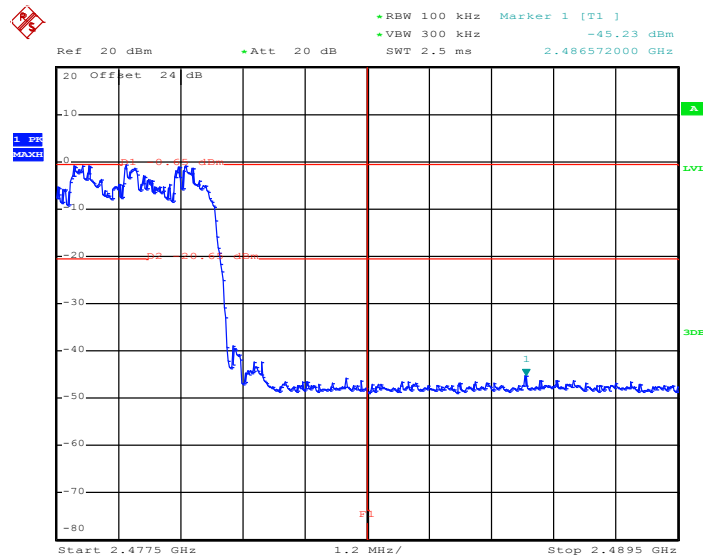

Date: 4.JUL.2017 23:16:11



<3Mbps>

Hopping Mode Low Band Edge Plot

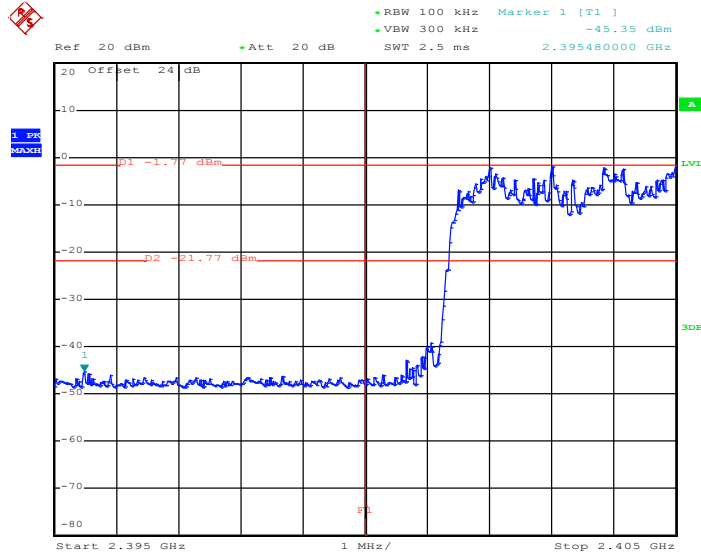

Date: 4.JUL.2017 23:13:17

Hopping Mode High Band Edge Plot

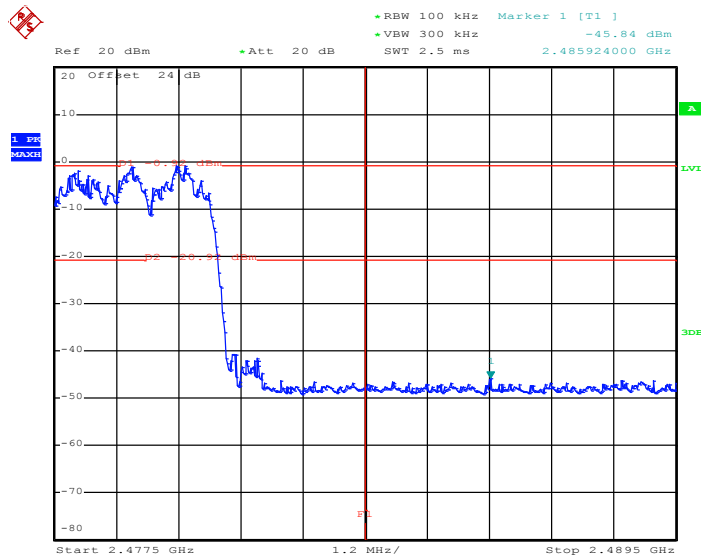

Date: 4.JUL.2017 23:13:59

## 3.7 Conducted Spurious Emission Measurement

### 3.7.1 Limit of Spurious Emission Measurement

In any 100 kHz bandwidth outside the intentional radiation frequency band, the radio frequency power shall be at least 20 dB below the highest level of the radiated power. In addition, radiated emissions which fall in the restricted bands must also comply with the radiated emission limits.

### 3.7.2 Measuring Instruments

The measuring equipment is listed in the section 4 of this test report.

### 3.7.3 Test Procedure

1. The testing follows ANSI C63.10-2013 clause 7.8.8.
2. The RF output of EUT was connected to the spectrum analyzer by RF cable and attenuator. The path loss was compensated to the results for each measurement.
3. Set to the maximum power setting and enable the EUT transmit continuously.
4. Set RBW = 100 kHz, VBW = 300kHz, scan up through 10th harmonic. All harmonics / spurs must be at least 20 dB down from the highest emission level within the authorized band as measured with a 100 kHz RBW.
5. Measure and record the results in the test report.
6. The RF fundamental frequency should be excluded against the limit line in the operating frequency band.

### 3.7.4 Test Setup

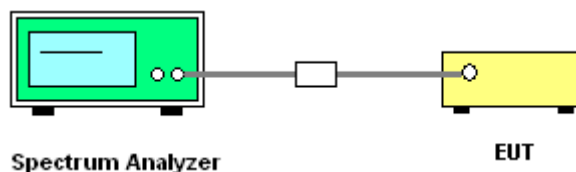



### 3.7.5 Test Result of Conducted Spurious Emission

<1Mbps>

CSE Plot on Ch 00 between 30MHz ~ 3 GHz

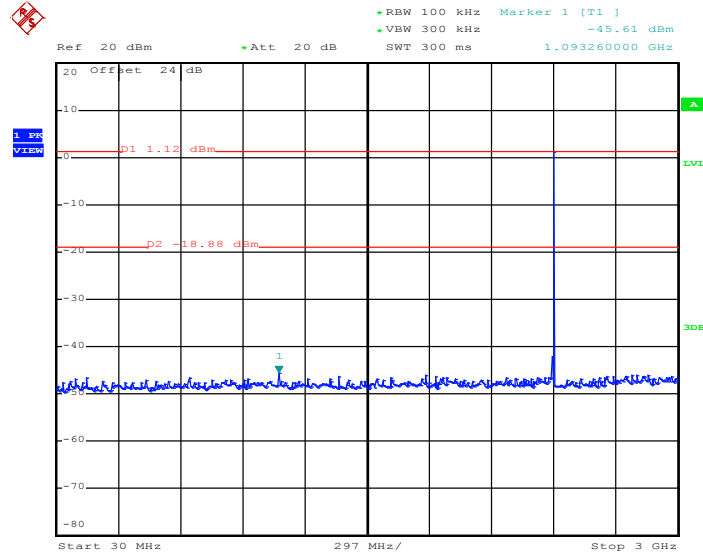

Date: 4.JUL.2017 23:25:26

1Mbps CSE Plot on Ch 00 between 2 GHz ~ 25 GHz

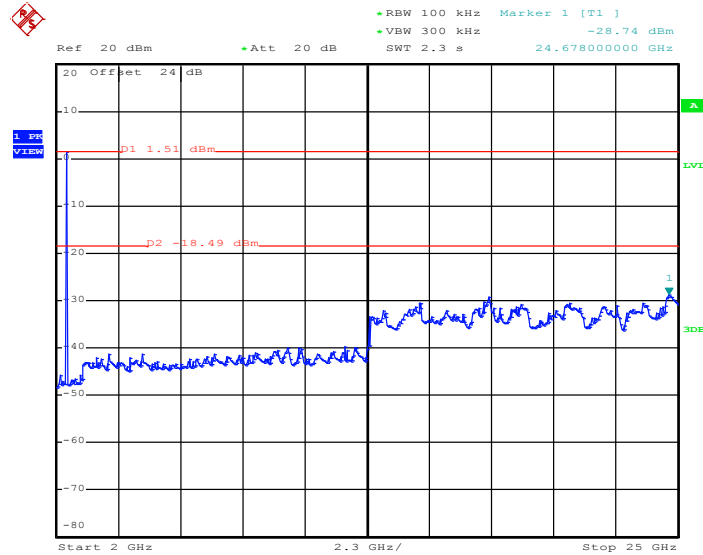

Date: 4.JUL.2017 23:25:48



CSE Plot on Ch 39 between 30MHz ~ 3 GHz

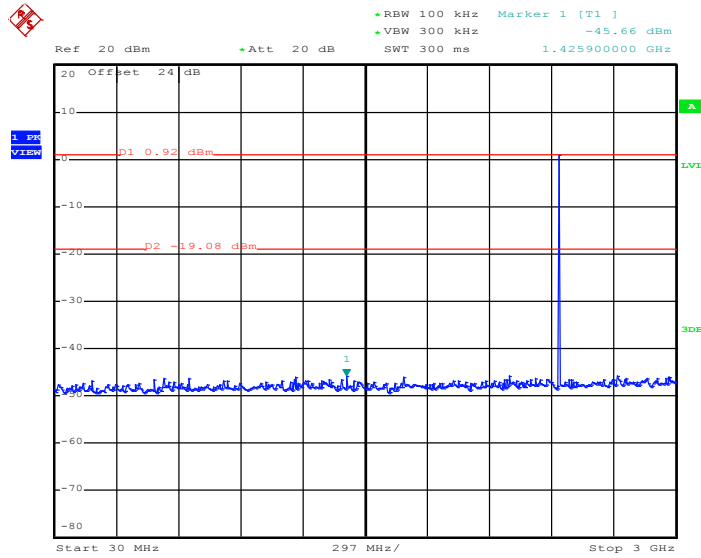

Date: 4.JUL.2017 23:31:04

CSE Plot on Ch 39 between 2 GHz ~ 25 GHz

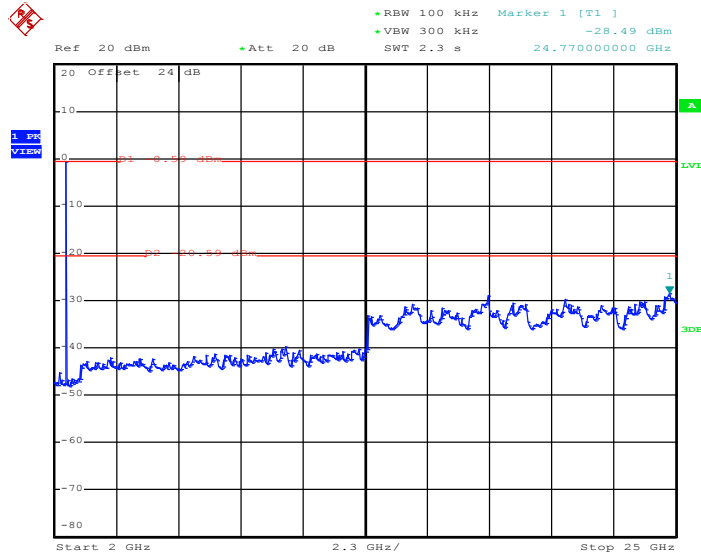

Date: 4.JUL.2017 23:31:26



CSE Plot on Ch 78 between 30MHz ~ 3 GHz

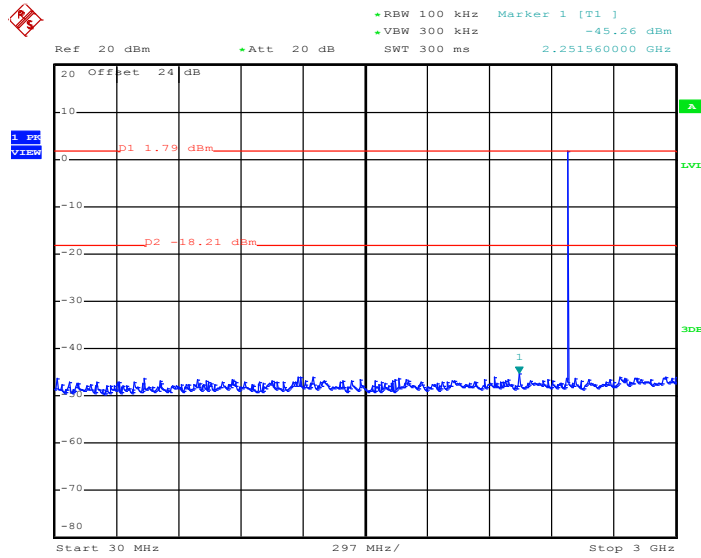

Date: 4.JUL.2017 23:35:49

CSE Plot on Ch 78 between 2 GHz ~ 25 GHz

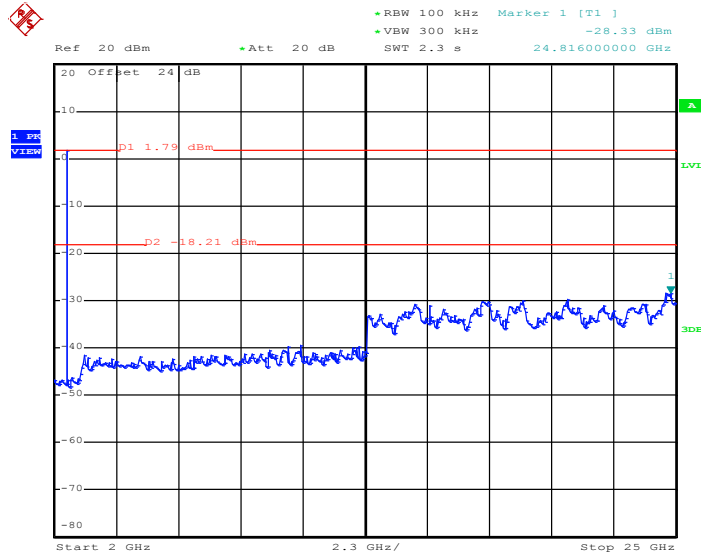

Date: 4.JUL.2017 23:36:10





<2Mbps>

CSE Plot on Ch 00 between 30MHz ~ 3 GHz

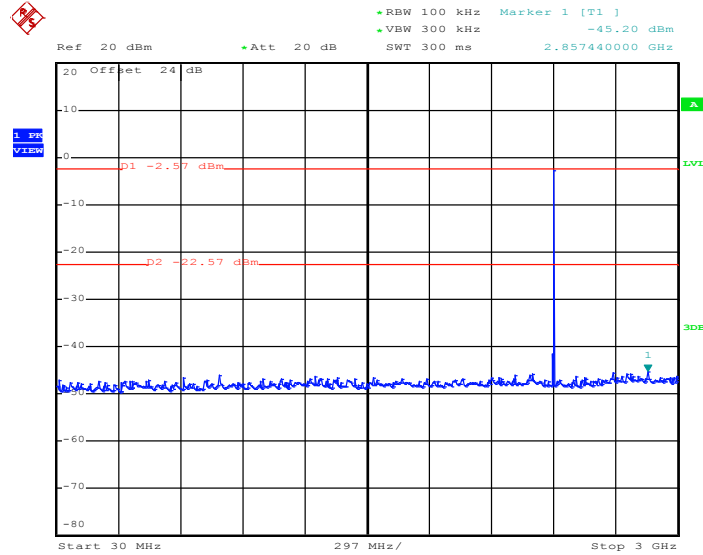

Date: 4.JUL.2017 23:48:42

CSE Plot on Ch 00 between 2 GHz ~ 25 GHz

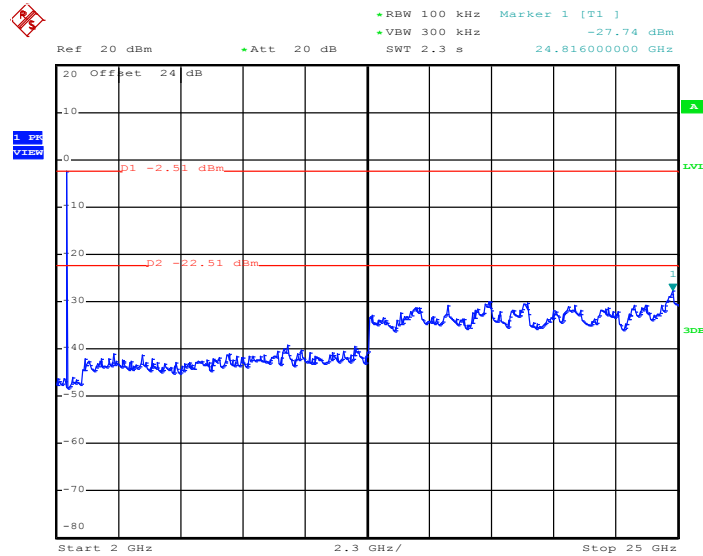

Date: 4.JUL.2017 23:49:03



CSE Plot on Ch 39 between 30MHz ~ 3 GHz

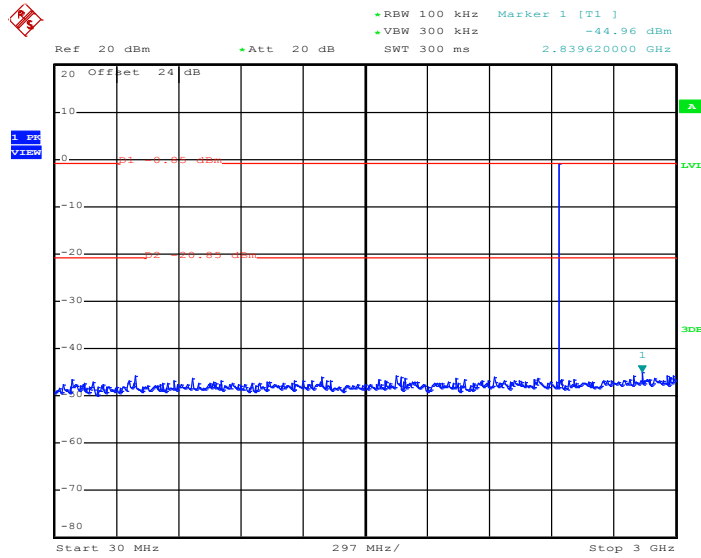

Date: 4.JUL.2017 23:54:58

CSE Plot on Ch 39 between 2 GHz ~ 25 GHz

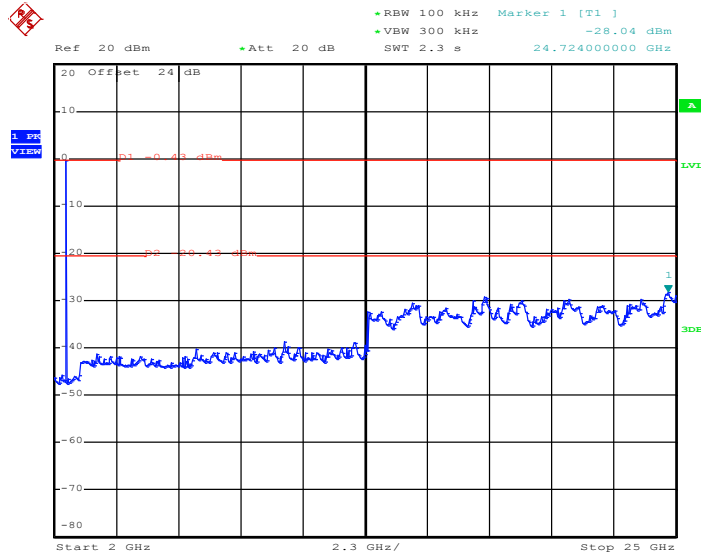

Date: 4.JUL.2017 23:57:07



CSE Plot on Ch 78 between 30MHz ~ 3 GHz

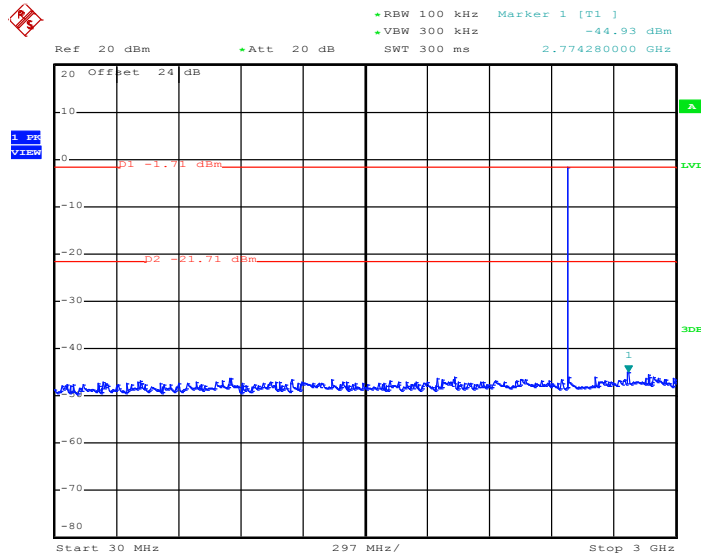

Date: 5.JUL.2017 00:03:19

CSE Plot on Ch 78 between 2 GHz ~ 25 GHz

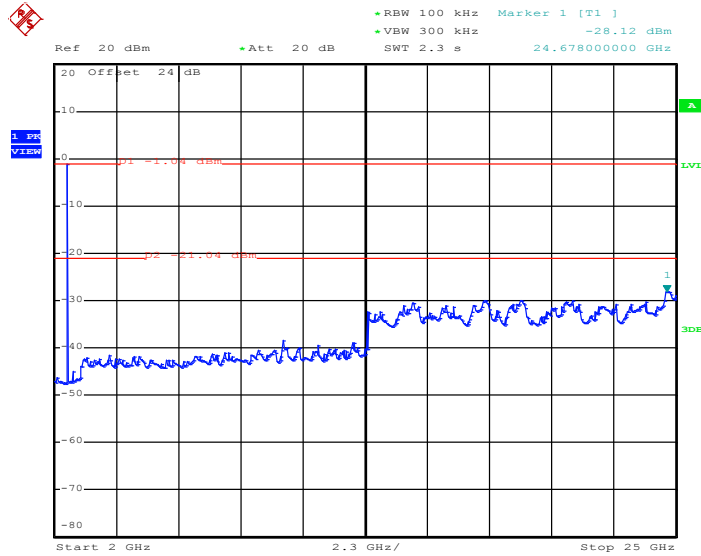

Date: 5.JUL.2017 00:07:58



<3Mbps>

CSE Plot on Ch 00 between 30MHz ~ 3 GHz

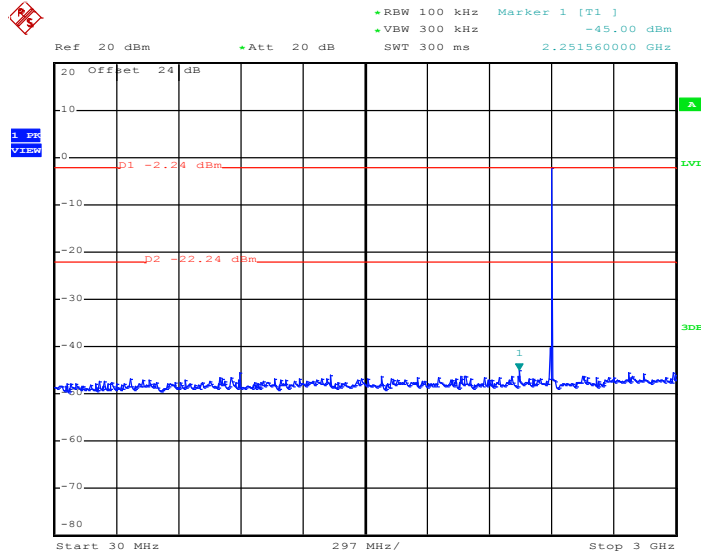

Date: 5.JUL.2017 00:15:26

CSE Plot on Ch 00 between 2 GHz ~ 25 GHz

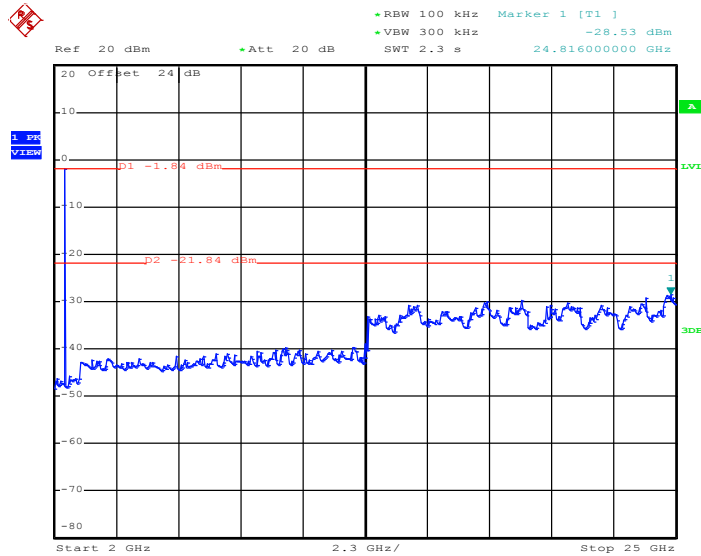

Date: 5.JUL.2017 00:19:09



CSE Plot on Ch 39 between 30MHz ~ 3 GHz

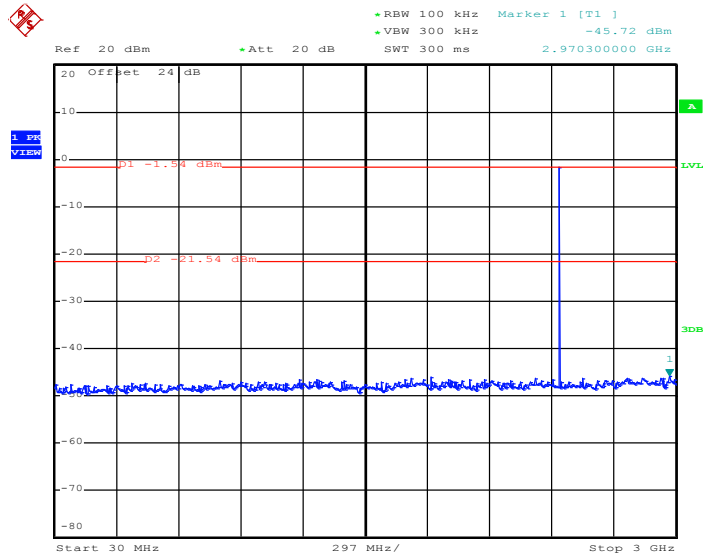

Date: 5.JUL.2017 00:23:13

CSE Plot on Ch 39 between 2 GHz ~ 25 GHz

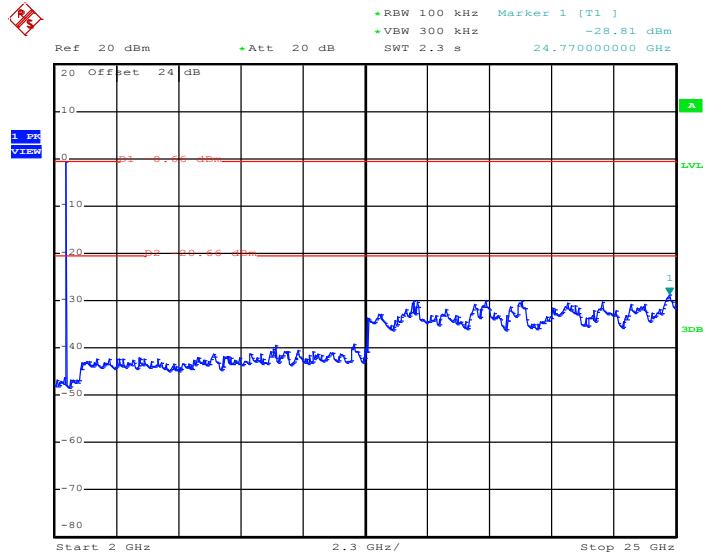

Date: 5.JUL.2017 00:23:35



CSE Plot on Ch 78 between 30MHz ~ 3 GHz

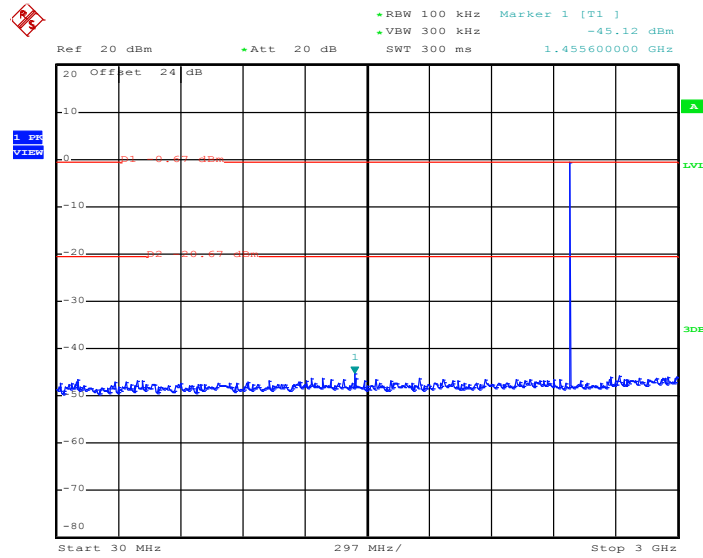

Date: 5.JUL.2017 00:29:56

CSE Plot on Ch 78 between 2 GHz ~ 25 GHz

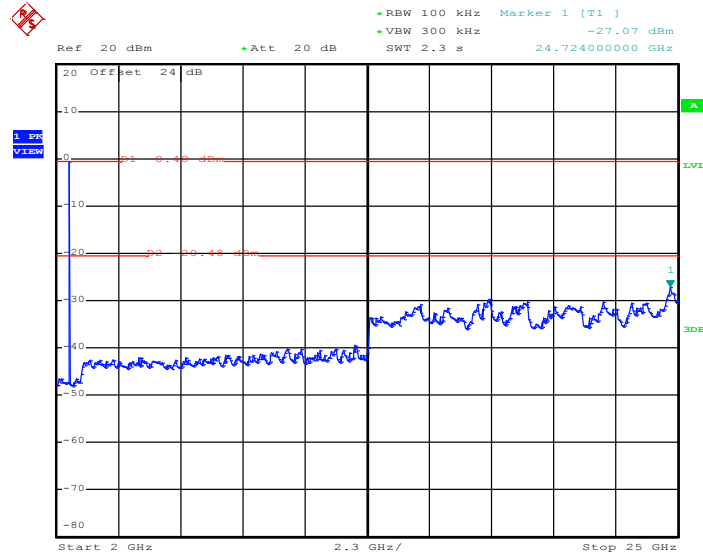

Date: 5.JUL.2017 00:32:40



### 3.8 Radiated Band Edges and Spurious Emission Measurement

#### 3.8.1 Limit of Radiated Band Edges and Spurious Emission

In any 100 kHz bandwidth outside the intentional radiator frequency band, all harmonics/spurious must be at least 20 dB below the highest emission level within the authorized band. In addition, radiated emissions which fall in the restricted bands must also comply with the limits as below.

Frequency (MHz)	Field Strength (microvolts/meter)	Measurement Distance (meters)
0.009 – 0.490	2400/F(kHz)	300
0.490 – 1.705	24000/F(kHz)	30
1.705 – 30.0	30	30
30 – 88	100	3
88 – 216	150	3
216 - 960	200	3
Above 960	500	3

#### 3.8.2 Measuring Instruments

The measuring equipment is listed in the section 4 of this test report.



### 3.8.3 Test Procedures

1. The EUT was placed on a turntable with 0.8 meter for frequency below 1GHz and 1.5 meter for frequency above 1GHz respectively above ground.
2. The EUT was set 3 meters from the interference receiving antenna, which was mounted on the top of a variable height antenna tower.
3. For each suspected emission, the EUT was arranged to its worst case and then tune the Antenna tower (from 1 m to 4 m) and turntable (from 0 degree to 360 degrees) to find the maximum reading. A pre-amp and a high pass filter are used for the test in order to get better signal level to comply with the guidelines.
4. Set to the maximum power setting and enable the EUT transmit continuously.
5. Use the following spectrum analyzer settings:
  - (1) Span shall wide enough to fully capture the emission being measured;
  - (2) Set RBW=100 kHz for  $f < 1 \text{ GHz}$ , RBW=1MHz for  $f > 1\text{GHz}$  ; VBW  $\geq$  RBW; Sweep = auto; Detector function = peak; Trace = max hold for peak
  - (3) For average measurement: use duty cycle correction factor method per 15.35(c).  
Duty cycle = On time/100 milliseconds  
On time =  $N_1 * L_1 + N_2 * L_2 + \dots + N_{n-1} * L_{n-1} + N_n * L_n$   
Where  $N_1$  is number of type 1 pulses,  $L_1$  is length of type 1 pulses, etc.  
Average Emission Level = Peak Emission Level +  $20 * \log(\text{Duty cycle})$
6. Corrected Reading: Antenna Factor + Cable Loss + Read Level - Preamp Factor = Level





**<For Sample 1>**

**<Ant. No. 1>**

Note: The average levels were calculated from the peak level corrected with duty cycle correction factor (-24.73dB) derived from  $20\log(\text{dwell time}/100\text{ms})$ . This correction is only for signals that hop with the fundamental signal, such as band-edge and harmonic. Other spurious signals that are independent of the hopping signal would not use this correction.

**<Ant No. 3>**

Note: The average levels were calculated from the peak level corrected with duty cycle correction factor (-24.76dB) derived from  $20\log(\text{dwell time}/100\text{ms})$ . This correction is only for signals that hop with the fundamental signal, such as band-edge and harmonic. Other spurious signals that are independent of the hopping signal would not use this correction.

**<Ant No. 4>**

Note: The average levels were calculated from the peak level corrected with duty cycle correction factor (-24.76dB) derived from  $20\log(\text{dwell time}/100\text{ms})$ . This correction is only for signals that hop with the fundamental signal, such as band-edge and harmonic. Other spurious signals that are independent of the hopping signal would not use this correction.

**<For Sample 2>**

**<Ant. No. 4>**

Note: The average levels were calculated from the peak level corrected with duty cycle correction factor (-24.76dB) derived from  $20\log(\text{dwell time}/100\text{ms})$ . This correction is only for signals that hop with the fundamental signal, such as band-edge and harmonic. Other spurious signals that are independent of the hopping signal would not use this correction.

**<For Sample 3>**

**<Ant. No. 4>**

Note: The average levels were calculated from the peak level corrected with duty cycle correction factor (-24.76dB) derived from  $20\log(\text{dwell time}/100\text{ms})$ . This correction is only for signals that hop with the fundamental signal, such as band-edge and harmonic. Other spurious signals that are independent of the hopping signal would not use this correction.

### 3.8.4 Test Setup

For radiated emissions below 30MHz

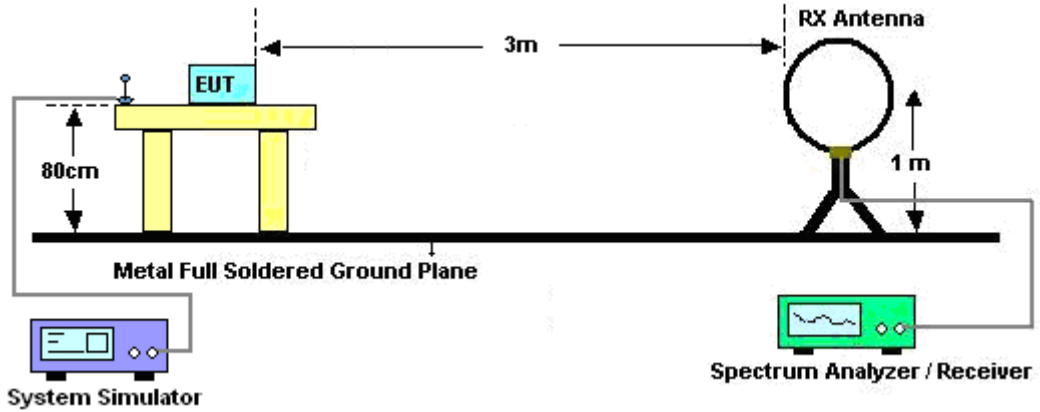

For radiated emissions from 30MHz to 1GHz

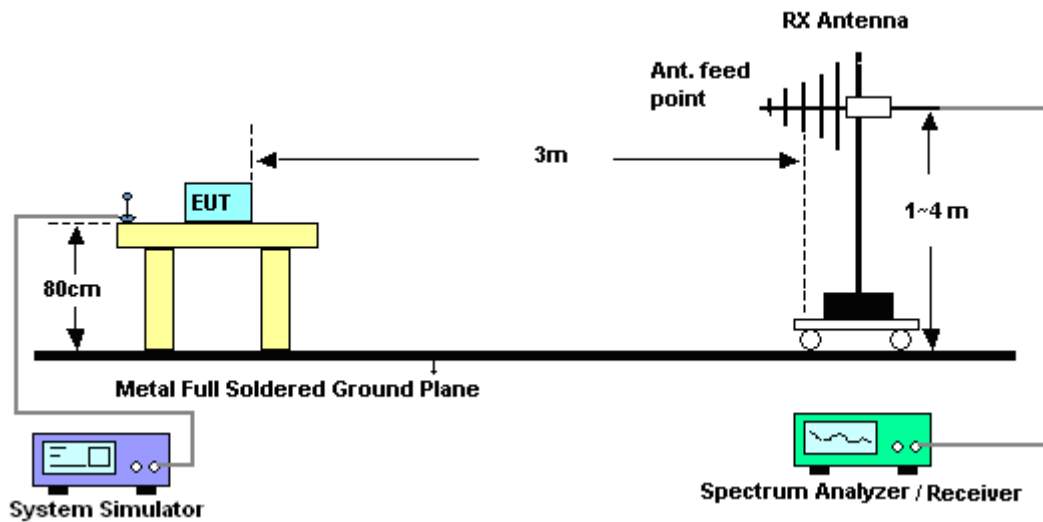

For radiated emissions above 1GHz

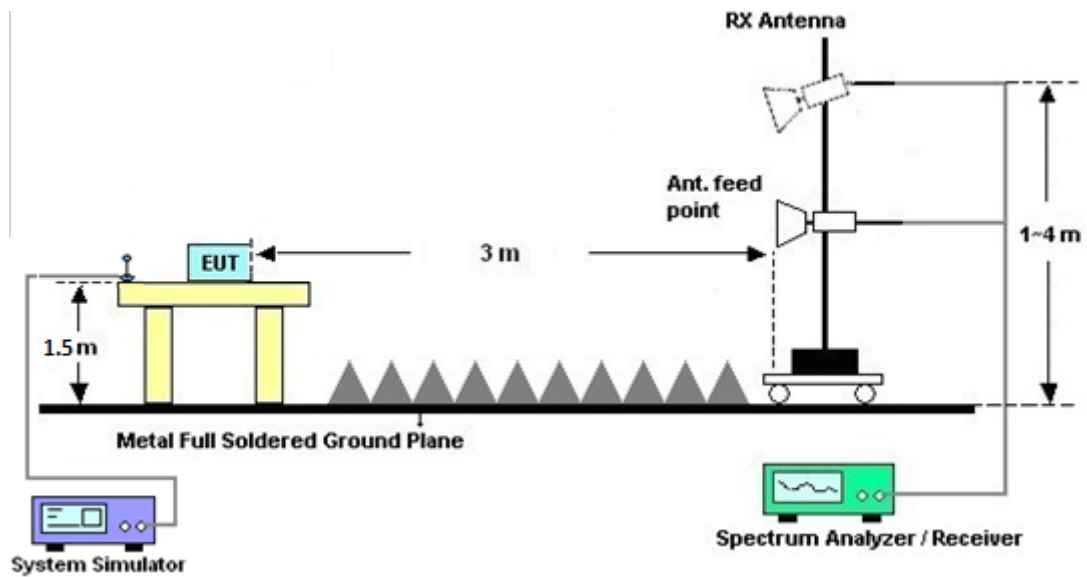

### 3.8.5 Test Results of Radiated Spurious Emissions (9 kHz ~ 30 MHz)

The low frequency, which started from 9 kHz to 30MHz, was pre-scanned and the result which was 20dB lower than the limit line per 15.31(o) was not reported.

### 3.8.6 Test Result of Radiated Spurious at Band Edges

Please refer to Appendix B and C.

### 3.8.7 Duty Cycle

Please refer to Appendix D.

### 3.8.8 Test Result of Radiated Spurious Emission (30MHz ~ 10<sup>th</sup> Harmonic)

Please refer to Appendix B and C.



### 3.9 AC Conducted Emission Measurement

#### 3.9.1 Limit of AC Conducted Emission

For equipment that is designed to be connected to the public utility (AC) power line, the radio frequency voltage that is conducted back onto the AC power line on any frequency or frequencies within the band 150 kHz to 30 MHz shall not exceed the limits in the following table.

Frequency of emission (MHz)	Conducted limit (dBµV)	
	Quasi-peak	Average
0.15-0.5	66 to 56*	56 to 46*
0.5-5	56	46
5-30	60	50

\*Decreases with the logarithm of the frequency.

#### 3.9.2 Measuring Instruments

The measuring equipment is listed in the section 4 of this test report.

#### 3.9.3 Test Procedures

1. The EUT was placed 0.4 meter from the conducting wall of the shielding room was kept at least 80 centimeters from any other grounded conducting surface.
2. Connect EUT to the power mains through a line impedance stabilization network (LISN).
3. All the support units are connecting to the other LISN.
4. The LISN provides 50 ohm coupling impedance for the measuring instrument.
5. The FCC states that a 50 ohm, 50 microhenry LISN should be used.
6. Both sides of AC line were checked for maximum conducted interference.
7. The frequency range from 150 kHz to 30 MHz was searched.
8. Set the test-receiver system to Peak Detect Function and specified bandwidth (IF Bandwidth = 9kHz) with Maximum Hold Mode. Then measurement is also conducted by Average Detector and Quasi-Peak Detector Function respectively.

### 3.9.4 Test Setup

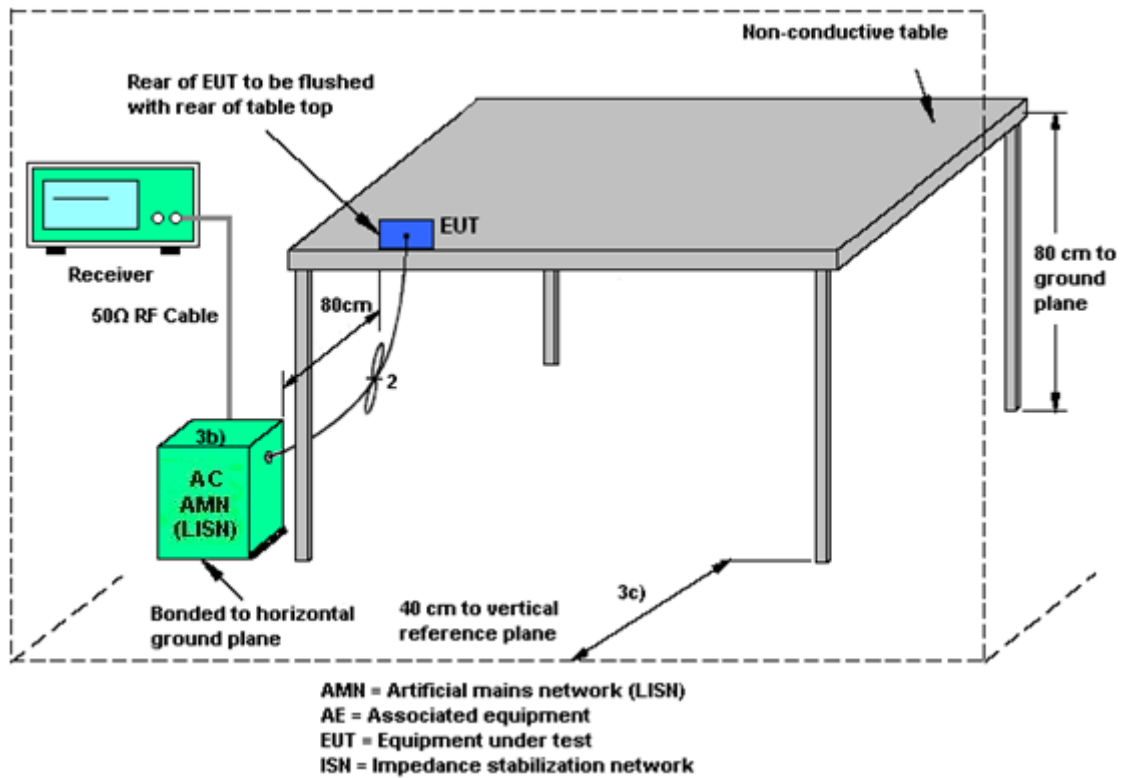

### 3.9.5 Test Result of AC Conducted Emission

Please refer to Appendix A.



## **3.10 Antenna Requirements**

### **3.10.1 Standard Applicable**

If directional gain of transmitting antennas is greater than 6dBi, the power shall be reduced by the same level in dB comparing to gain minus 6dBi. The use of a permanently attached antenna or of an antenna that uses a unique coupling to the intentional radiator shall be considered sufficient to comply with the rule.

### **3.10.2 Antenna Anti-Replacement Construction**

An embedded-in antenna design is used.

### **3.10.3 Antenna Gain**

The antenna peak gain of EUT is less than 6 dBi. Therefore, it is not necessary to reduce maximum peak output power limit.



## 4 List of Measuring Equipment

Instrument	Manufacturer	Model No.	Serial No.	Characteristics	Calibration Date	Test Date	Due Date	Remark
Power Meter	Agilent	E4416A	GB412923 44	NA	Dec. 26, 2016	Jun. 28, 2017 ~ Jul. 01, 2017	Dec. 25, 2017	Conducted (TH05-HY)
Power Sensor	Agilent	E9327A	US404415 48	50MHz~18GHz	Dec. 26, 2016	Jun. 28, 2017 ~ Jul. 01, 2017	Dec. 25, 2017	Conducted (TH05-HY)
Spectrum Analyzer	Rohde & Schwarz	FSP40	100055	9kHz-40GHz	Jul. 17, 2016	Jun. 28, 2017 ~ Jul. 01, 2017	Jul. 16, 2017	Conducted (TH05-HY)
BT Base Station (Measure)	Rohde & Schwarz	CBT	101136	BT 3.0	Sep. 21, 2016	Jun. 28, 2017 ~ Jul. 01, 2017	Sep. 20, 2017	Conducted (TH05-HY)
AC Power Source	ChainTek	APC-1000W	N/A	N/A	N/A	Jul. 02, 2017	N/A	Conduction (CO05-HY)
EMI Test Receiver	Rohde & Schwarz	ESCI 7	100724	9kHz~7GHz	Aug. 30, 2016	Jul. 02, 2017	Aug. 29, 2017	Conduction (CO05-HY)
LISN	Rohde & Schwarz	ENV216	100080	9kHz~30MHz	Nov. 29, 2016	Jul. 02, 2017	Nov. 28, 2017	Conduction (CO05-HY)
Bilog Antenna	TESEQ	CBL 6111D&00800 N1D01N-06	35419&03	30MHz to 1GHz	Jan. 07, 2017	Jun. 08, 2017 ~ Aug. 24, 2017	Jan. 06, 2018	Radiation (03CH07-HY)
Double Ridge Horn Antenna	ESCO	3117	00075962	1GHz ~ 18GHz	Aug. 19, 2016	Jun. 08, 2017 ~ Aug. 17, 2017	Aug. 18, 2017	Radiation (03CH07-HY)
Horn Antenna	ESCO	3117	00066584	1GHz ~ 18GHz	Sep. 02, 2016	Aug. 18, 2017 ~ Aug. 24, 2017	Sep. 01, 2017	Radiation (03CH07-HY)
Loop Antenna	Rohde & Schwarz	HFH2-Z2	100315	9 kHz~30 MHz	May 15, 2017	Jun. 08, 2017 ~ Aug. 24, 2017	May 14, 2019	Radiation (03CH07-HY)
Preamplifier	MITEQ	AMF-7D-0010 1800-30-10P	1590075	1GHz ~ 18GHz	Apr. 25, 2017	Jun. 08, 2017 ~ Aug. 24, 2017	Apr. 24, 2018	Radiation (03CH07-HY)
Preamplifier	COM-POWER	PA-103A	161241	10MHz-1GHz	Mar. 14, 2017	Jun. 08, 2017 ~ Aug. 24, 2017	Mar. 13, 2018	Radiation (03CH07-HY)
Preamplifier	Agilent	8449B	3008A023 62	1GHz~ 26.5GHz	Oct. 12, 2016	Jun. 08, 2017 ~ Aug. 24, 2017	Oct. 11, 2017	Radiation (03CH07-HY)
Antenna Mast	Max-Full	MFA520BS	N/A	1m~4m	N/A	Jun. 08, 2017 ~ Aug. 24, 2017	N/A	Radiation (03CH07-HY)
Turn Table	ChainTek	Chaintek 3000	N/A	0~360 Degree	N/A	Jun. 08, 2017 ~ Aug. 24, 2017	N/A	Radiation (03CH07-HY)
Amplifier	MITEQ	TTA1840-35- HG	1871923	18GHz~40GHz, VSWR : 2.5:1 max	Jun. 08, 2017	Jun. 08, 2017 ~ Aug. 24, 2017	Jun. 07, 2018	Radiation (03CH07-HY)
SHF-EHF Horn Antenna	SCHWARZBE CK	BBHA 9170	BBHA9170 584	18GHz- 40GHz	Nov. 08, 2016	Jun. 08, 2017 ~ Aug. 24, 2017	Nov. 07, 2017	Radiation (03CH07-HY)
EMI Test Receiver	Agilent	N9038A (MXE)	MY532900 53	20Hz to 26.5GHz	Jan. 12, 2017	Jun. 08, 2017 ~ Aug. 24, 2017	Jan. 11, 2018	Radiation (03CH07-HY)



## 5 Uncertainty of Evaluation

### Uncertainty of Conducted Emission Measurement (150 kHz ~ 30 MHz)

Measuring Uncertainty for a Level of Confidence of 95% ( $U = 2Uc(y)$ )	2.70
---	------

### Uncertainty of Radiated Emission Measurement (30 MHz ~ 1000 MHz)

Measuring Uncertainty for a Level of Confidence of 95% ( $U = 2Uc(y)$ )	5.70
---	------

### Uncertainty of Radiated Emission Measurement (1000 MHz ~ 18000 MHz)

Measuring Uncertainty for a Level of Confidence of 95% ( $U = 2Uc(y)$ )	5.50
---	------

### Uncertainty of Radiated Emission Measurement (18000 MHz ~ 40000 MHz)

Measuring Uncertainty for a Level of Confidence of 95% ( $U = 2Uc(y)$ )	5.20
---	------





## Appendix A. AC Conducted Emission Test Results

Test Engineer :	Arthur Hsieh	Temperature :	22~25°C
		Relative Humidity :	51~55%

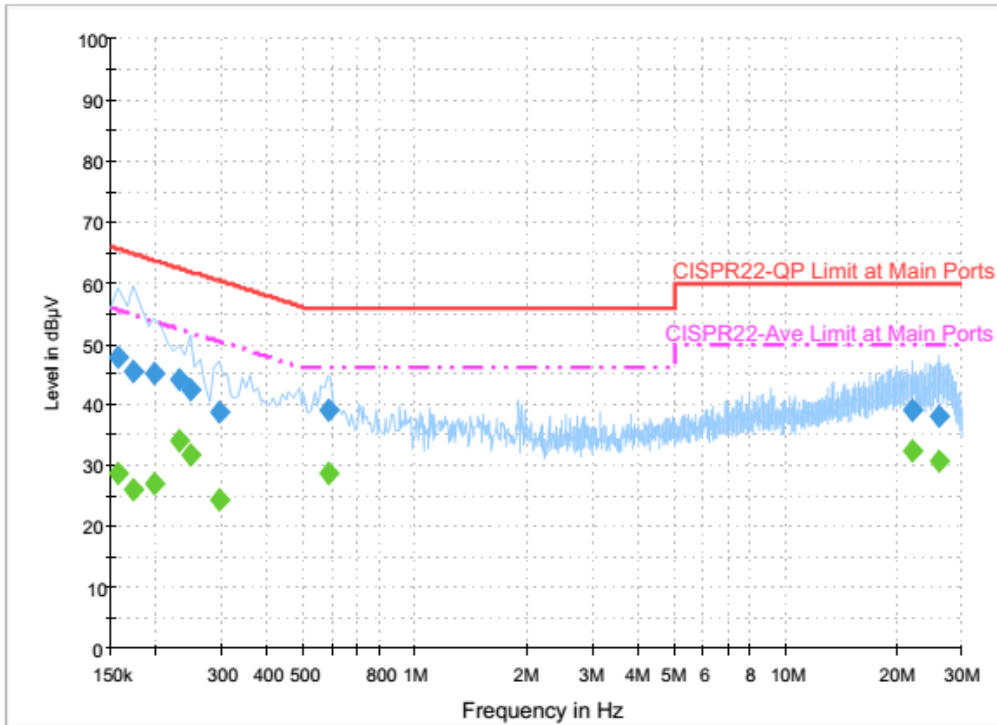

### Final Result 1

Frequency (MHz)	QuasiPeak (dBµV)	Filter	Line	Corr. (dB)	Margin (dB)	Limit (dBµV)
0.158000	47.8	Off	L1	19.5	17.8	65.6
0.174000	45.6	Off	L1	19.5	19.2	64.8
0.198000	45.2	Off	L1	19.5	18.5	63.7
0.230000	44.0	Off	L1	19.5	18.4	62.4
0.246000	42.5	Off	L1	19.5	19.4	61.9
0.294000	38.9	Off	L1	19.5	21.5	60.4
0.582000	39.0	Off	L1	19.5	17.0	56.0
21.910000	39.2	Off	L1	19.8	20.8	60.0
26.150000	38.1	Off	L1	19.8	21.9	60.0

### Final Result 2

Frequency (MHz)	Average (dBµV)	Filter	Line	Corr. (dB)	Margin (dB)	Limit (dBµV)
0.158000	28.7	Off	L1	19.5	26.9	55.6
0.174000	26.2	Off	L1	19.5	28.6	54.8
0.198000	27.0	Off	L1	19.5	26.7	53.7
0.230000	34.1	Off	L1	19.5	18.3	52.4
0.246000	31.8	Off	L1	19.5	20.1	51.9
0.294000	24.4	Off	L1	19.5	26.0	50.4
0.582000	28.9	Off	L1	19.5	17.1	46.0
21.910000	32.5	Off	L1	19.8	17.5	50.0
26.150000	30.8	Off	L1	19.8	19.2	50.0

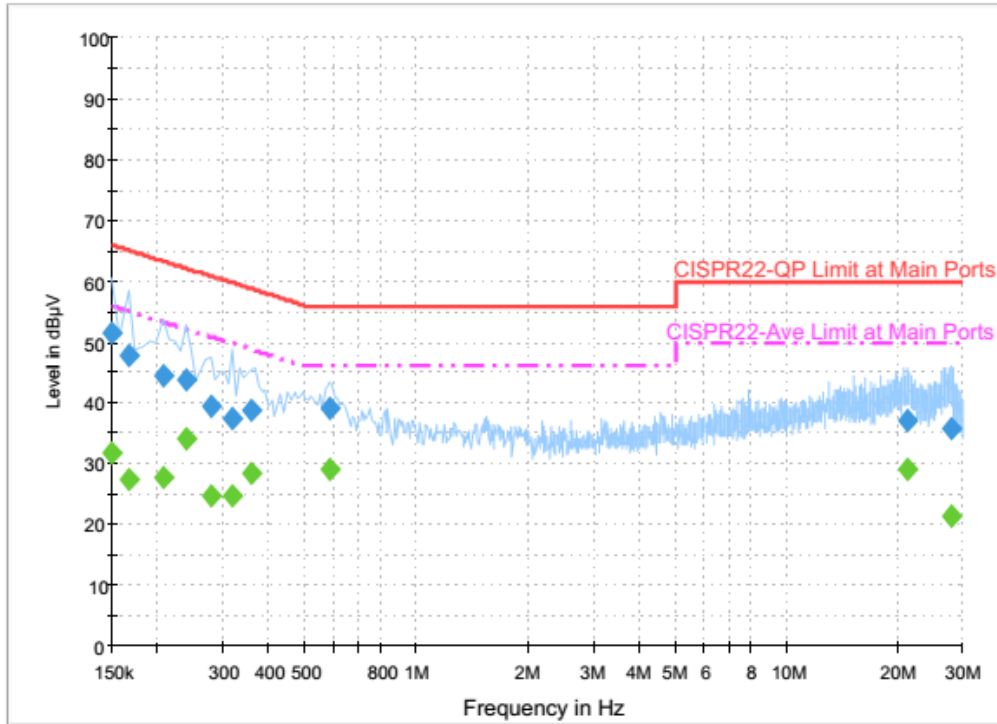

**Final Result 1**

Frequency (MHz)	QuasiPeak (dBµV)	Filter	Line	Corr. (dB)	Margin (dB)	Limit (dBµV)
0.150000	51.4	Off	N	19.5	14.6	66.0
0.166000	47.8	Off	N	19.5	17.4	65.2
0.206000	44.5	Off	N	19.5	18.9	63.4
0.238000	43.7	Off	N	19.5	18.5	62.2
0.278000	39.4	Off	N	19.5	21.5	60.9
0.318000	37.3	Off	N	19.5	22.5	59.8
0.358000	38.7	Off	N	19.5	20.1	58.8
0.582000	39.0	Off	N	19.5	17.0	56.0
21.358000	37.2	Off	N	19.9	22.8	60.0
28.054000	35.9	Off	N	20.0	24.1	60.0

**Final Result 2**

Frequency (MHz)	Average (dBµV)	Filter	Line	Corr. (dB)	Margin (dB)	Limit (dBµV)
0.150000	31.7	Off	N	19.5	24.3	56.0
0.166000	27.5	Off	N	19.5	27.7	55.2
0.206000	27.9	Off	N	19.5	25.5	53.4
0.238000	34.2	Off	N	19.5	18.0	52.2
0.278000	24.7	Off	N	19.5	26.2	50.9
0.318000	24.7	Off	N	19.5	25.1	49.8
0.358000	28.5	Off	N	19.5	20.3	48.8
0.582000	29.1	Off	N	19.5	16.9	46.0



## Appendix B. Radiated Spurious Emission

Test Engineer :	Jesse Wang, James Chiu, and Potter Liu	Temperature :	22~26°C
		Relative Humidity :	52~58%

<For Sample 1>

<Ant. No. 1>

2.4GHz 2400~2483.5MHz

BT (Band Edge @ 3m)

BT	Note	Frequency ( MHz )	Level ( dBμV/m )	Over Limit ( dB )	Limit Line ( dBμV/m )	Read Level ( dBμV )	Antenna Factor ( dB/m )	Cable Loss ( dB )	Preamp Factor ( dB )	Ant Pos ( cm )	Table Pos ( deg )	Peak Avg. ( P/A )	Pol. ( H/V )
BT CH00 2402MHz		2357.88	45.58	-28.42	74	40.2	32.09	8.26	34.97	100	193	P	H
		2357.88	20.85	-33.15	54	-	-	-	-	-	-	A	H
	*	2402	99.54	-	-	94.09	32.19	8.24	34.98	100	193	P	H
	*	2402	74.81	-	-	-	-	-	-	-	-	A	H
		2375.63	46.02	-27.98	74	40.59	32.14	8.26	34.97	200	182	P	V
		2375.63	21.29	-32.71	54	-	-	-	-	-	-	A	V
	*	2402	93.89	-	-	88.44	32.19	8.24	34.98	200	182	P	V
	*	2402	69.16	-	-	-	-	-	-	-	-	A	V
BT CH 39 2441MHz		2319.94	45.47	-28.53	74	40.17	31.98	8.28	34.96	107	192	P	H
		2319.94	20.74	-33.26	54	-	-	-	-	-	-	A	H
	*	2441	102.3	-	-	96.68	32.34	8.27	34.99	107	192	P	H
	*	2441	77.57	-	-	-	-	-	-	-	-	A	H
		2487.12	46.36	-27.64	74	40.61	32.45	8.3	35	107	192	P	H
		2487.12	21.63	-32.37	54	-	-	-	-	-	-	A	H
		2382.52	46.21	-27.79	74	40.8	32.14	8.24	34.97	200	180	P	V
		2382.52	21.48	-32.52	54	-	-	-	-	-	-	A	V
	*	2441	95.24	-	-	89.62	32.34	8.27	34.99	200	180	P	V
	*	2441	70.51	-	-	-	-	-	-	-	-	A	V
		2497.9	45.91	-28.09	74	40.12	32.5	8.3	35.01	200	180	P	V
		2497.9	21.18	-32.82	54	-	-	-	-	-	-	A	V



<b>BT CH 78 2480MHz</b>	*	2480	100.8	-	-	95.05	32.45	8.3	35	115	191	P	H
	*	2480	76.07	-	-	-	-	-	-	-	-	A	H
		2485.52	46.25	-27.75	74	40.5	32.45	8.3	35	115	191	P	H
		2485.52	21.52	-32.48	54	-	-	-	-	-	-	A	H
													H
													H
	*	2480	93.96	-	-	88.21	32.45	8.3	35	200	178	P	V
	*	2480	69.23	-	-	-	-	-	-	-	-	A	V
		2484.68	46.11	-27.89	74	40.36	32.45	8.3	35	200	178	P	V
		2484.68	21.38	-32.62	54	-	-	-	-	-	-	A	V
													V
													V
<b>Remark</b>	<ol style="list-style-type: none"> <li>1. No other spurious found.</li> <li>2. All results are PASS against Peak and Average limit line.</li> </ol>												



2.4GHz 2400~2483.5MHz

BT (Harmonic @ 3m)

BT	Note	Frequency ( MHz )	Level ( dBµV/m )	Over Limit ( dB )	Limit Line ( dBµV/m )	Read Level ( dBµV )	Antenna Factor ( dB/m )	Cable Loss ( dB )	Preamp Factor ( dB )	Ant Pos ( cm )	Table Pos ( deg )	Peak Avg. ( P/A )	Pol. ( H/V )
BT CH 00 2402MHz		4806	41.56	-32.44	74	55.32	33.68	11.96	59.4	100	0	P	H
		4806	16.83	-37.17	54	-	-	-	-	-	-	A	H
													H
													H
		4806	40.32	-33.68	74	54.08	33.68	11.96	59.4	100	0	P	V
		4806	15.59	-38.41	54	-	-	-	-	-	-	A	V
													V
													V
BT CH 39 2441MHz		4884	40.58	-33.42	74	54.43	33.54	11.9	59.29	100	0	P	H
		4884	15.85	-38.15	54	-	-	-	-	-	-	A	H
		7320	40.12	-33.88	74	48.59	34.65	14.94	58.06	100	0	P	H
		7320	15.39	-38.61	54	-	-	-	-	-	-	A	H
		4884	38.96	-35.04	74	52.81	33.54	11.9	59.29	100	0	P	V
		4884	14.23	-39.77	54	-	-	-	-	-	-	A	V
		7320	40.14	-33.86	74	48.61	34.65	14.94	58.06	100	0	P	V
		7320	15.41	-38.59	54	-	-	-	-	-	-	A	V
BT CH 78 2480MHz		4962	39.52	-34.48	74	53.47	33.37	11.84	59.16	100	0	P	H
		4962	14.79	-39.21	54	-	-	-	-	-	-	A	H
		7440	41.62	-32.38	74	50.35	34.33	15.1	58.16	100	0	P	H
		7440	16.89	-37.11	54	-	-	-	-	-	-	A	H
		4962	40.35	-33.65	74	54.3	33.37	11.84	59.16	100	0	P	V
		4962	15.62	-38.38	54	-	-	-	-	-	-	A	V
		7440	41.14	-32.86	74	49.87	34.33	15.1	58.16	100	0	P	V
		7440	16.41	-37.59	54	-	-	-	-	-	-	A	V
Remark	1. No other spurious found. 2. All results are PASS against Peak and Average limit line.												



Emission below 1GHz  
2.4GHz BT (LF)

BT	Note	Frequency ( MHz )	Level ( dBµV/m )	Over Limit ( dB )	Limit Line ( dBµV/m )	Read Level ( dBµV )	Antenna Factor ( dB/m )	Cable Loss ( dB )	Preamp Factor ( dB )	Ant Pos ( cm )	Table Pos ( deg )	Peak Avg. ( P/A )	Pol. ( H/V )	
2.4GHz BT LF		96.15	31.43	-12.07	43.5	45	15.88	2.11	31.56	-	-	P	H	
		158.25	34.26	-9.24	43.5	46	17.14	2.62	31.5	-	-	P	H	
		294.87	31.86	-14.14	46	40.14	19.75	3.28	31.31	-	-	P	H	
		519.8	40.77	-5.23	46	43.23	24.36	4.13	30.95	100	66	P	H	
		584.9	38.27	-7.73	46	39.58	25.15	4.39	30.85	-	-	P	H	
		650	39.4	-6.6	46	39.67	25.9	4.59	30.76	-	-	P	H	
													H	
													H	
													H	
													H	
													H	
													H	
													H	
			30.81	36.14	-3.86	40	40.33	25.46	1.71	31.36	100	69	P	V
			220.89	30.24	-15.76	46	42.15	16.48	3.03	31.42	-	-	P	V
			260.04	34.87	-11.13	46	42.95	20	3.28	31.36	-	-	P	V
			389.6	35.01	-10.99	46	40.18	22.16	3.82	31.15	-	-	P	V
			519.8	38.88	-7.12	46	41.34	24.36	4.13	30.95	-	-	P	V
			650	40.88	-5.12	46	41.15	25.9	4.59	30.76	-	-	P	V
													V	
												V		
												V		
												V		
												V		
												V		
Remark	1. No other spurious found. 2. All results are PASS against limit line.													



<Ant. No. 3>

2.4GHz 2400~2483.5MHz

BT (Band Edge @ 3m)

BT	Note	Frequency ( MHz )	Level ( dBμV/m )	Over Limit ( dB )	Limit Line ( dBμV/m )	Read Level ( dBμV )	Antenna Factor ( dB/m )	Cable Loss ( dB )	Preamp Factor ( dB )	Ant Pos ( cm )	Table Pos ( deg )	Peak Avg. (P/A)	Pol. (H/V)	
BT CH00 2402MHz		2316.2	45.92	-28.08	74	40.67	31.93	8.28	34.96	305	65	P	H	
		2316.2	21.16	-32.84	54	-	-	-	-	-	-	A	H	
	*	2402	92.41	-	-	86.96	32.19	8.24	34.98	305	65	P	H	
	*	2402	67.65	-	-	-	-	-	-	-	-	A	H	
													H	
														H
			2388.23	45.76	-28.24	74	40.3	32.19	8.24	34.97	100	280	P	V
			2388.23	21	-33	54	-	-	-	-	-	-	A	V
	*	2402	94.9	-	-	89.45	32.19	8.24	34.98	100	280	P	V	
	*	2402	70.14	-	-	-	-	-	-	-	-	-	A	V
														V
														V
BT CH 78 2480MHz	*	2480	94.22	-	-	88.47	32.45	8.3	35	286	65	P	H	
	*	2480	69.46	-	-	-	-	-	-	-	-	A	H	
		2496.48	46.18	-27.82	74	40.39	32.5	8.3	35.01	286	65	P	H	
		2496.48	21.42	-32.58	54	-	-	-	-	-	-	A	H	
														H
														H
	*	2480	97.02	-	-	91.27	32.45	8.3	35	128	222	P	V	
	*	2480	72.26	-	-	-	-	-	-	-	-	-	A	V
		2493.48	45.69	-28.31	74	39.9	32.5	8.3	35.01	128	222	P	V	
		2493.48	20.93	-33.07	54	-	-	-	-	-	-	A	V	
														V
														V
Remark	1. No other spurious found. 2. All results are PASS against Peak and Average limit line.													



2.4GHz 2400~2483.5MHz

BT (Harmonic @ 3m)

BT	Note	Frequency ( MHz )	Level ( dBμV/m )	Over Limit ( dB )	Limit Line ( dBμV/m )	Read Level ( dBμV )	Antenna Factor ( dB/m )	Cable Loss ( dB )	Preamp Factor ( dB )	Ant Pos ( cm )	Table Pos ( deg )	Peak Avg. ( P/A )	Pol. ( H/V )
BT CH 39 2441MHz		4882	38.64	-35.36	74	52.49	33.54	11.9	59.29	100	0	P	H
		4882	13.88	-40.12	54	-	-	-	-	-	-	A	H
		7323	41.08	-32.92	74	49.55	34.65	14.94	58.06	100	0	P	H
		7323	16.32	-37.68	54	-	-	-	-	-	-	A	H
		4882	39.81	-34.19	74	53.66	33.54	11.9	59.29	100	0	P	V
		4882	15.05	-38.95	54	-	-	-	-	-	-	A	V
		7323	39.74	-34.26	74	48.21	34.65	14.94	58.06	100	0	P	V
		7323	14.98	-39.02	54	-	-	-	-	-	-	A	V
Remark	1. No other spurious found. 2. All results are PASS against Peak and Average limit line.												





Emission below 1GHz  
2.4GHz BT (LF)

BT	Note	Frequency ( MHz )	Level ( dBμV/m )	Over Limit ( dB )	Limit Line ( dBμV/m )	Read Level ( dBμV )	Antenna Factor ( dB/m )	Cable Loss ( dB )	Preamp Factor ( dB )	Ant Pos ( cm )	Table Pos ( deg )	Peak Avg. ( P/A )	Pol. ( H/V )	
2.4GHz BT LF		30	29.16	-10.84	40	32.8	26	1.71	31.35	-	-	P	H	
		196.59	35.51	-7.99	43.5	48.39	15.85	2.72	31.45	-	-	P	H	
		273.54	36.57	-9.43	46	45.27	19.36	3.28	31.34	-	-	P	H	
		519.8	33.48	-12.52	46	35.94	24.36	4.13	30.95	-	-	P	H	
		650	39.75	-6.25	46	40.02	25.9	4.59	30.76	100	163	P	H	
		715.1	34.48	-11.52	46	33.7	26.64	4.81	30.67	-	-	P	H	
														H
														H
														H
														H
														H
														H
														H
			31.62	33.73	-6.27	40	38.48	24.92	1.71	31.38	100	247	P	V
			151.77	34.75	-8.75	43.5	46.07	17.56	2.62	31.5	-	-	P	V
			271.92	34.61	-11.39	46	43.29	19.38	3.28	31.34	-	-	P	V
			389.6	33.59	-12.41	46	38.76	22.16	3.82	31.15	-	-	P	V
			519.8	39.27	-6.73	46	41.73	24.36	4.13	30.95	-	-	P	V
			650	36.17	-9.83	46	36.44	25.9	4.59	30.76	-	-	P	V
														V
													V	
													V	
													V	
													V	
													V	
Remark	1. No other spurious found. 2. All results are PASS against limit line.													



<Ant. No. 4>

2.4GHz 2400~2483.5MHz

BT (Band Edge @ 3m)

BT	Note	Frequency ( MHz )	Level ( dBμV/m )	Over Limit ( dB )	Limit Line ( dBμV/m )	Read Level ( dBμV )	Antenna Factor ( dB/m )	Cable Loss ( dB )	Preamp Factor ( dB )	Ant Pos ( cm )	Table Pos ( deg )	Peak Avg. (P/A)	Pol. (H/V)	
BT CH00 2402MHz		2325.02	46.48	-27.52	74	41.18	31.98	8.28	34.96	251	38	P	H	
		2325.02	21.72	-32.28	54	-	-	-	-	-	-	A	H	
	*	2402	94.45	-	-	89	32.19	8.24	34.98	251	38	P	H	
	*	2402	69.69	-	-	-	-	-	-	-	-	A	H	
													H	
													H	
			2386.02	45.72	-28.28	74	40.26	32.19	8.24	34.97	342	13	P	V
			2386.02	20.96	-33.04	54	-	-	-	-	-	-	A	V
	*	2402	96.72	-	-	91.27	32.19	8.24	34.98	342	13	P	V	
	*	2402	71.96	-	-	-	-	-	-	-	-	-	A	V
													V	
													V	
BT CH 78 2480MHz	*	2480	92.42	-	-	86.67	32.45	8.3	35	378	60	P	H	
	*	2480	67.66	-	-	-	-	-	-	-	-	A	H	
		2483.64	46.48	-27.52	74	40.73	32.45	8.3	35	378	60	P	H	
		2483.64	21.72	-32.28	54	-	-	-	-	-	-	A	H	
													H	
													H	
	*	2480	99.06	-	-	93.31	32.45	8.3	35	311	0	P	V	
	*	2480	74.3	-	-	-	-	-	-	-	-	-	A	V
		2484.32	46.66	-27.34	74	40.91	32.45	8.3	35	311	0	P	V	
		2484.32	21.9	-32.1	54	-	-	-	-	-	-	A	V	
													V	
													V	
Remark	1. No other spurious found. 2. All results are PASS against Peak and Average limit line.													



2.4GHz 2400~2483.5MHz

BT (Harmonic @ 3m)

BT	Note	Frequency ( MHz )	Level ( dBμV/m )	Over Limit ( dB )	Limit Line ( dBμV/m )	Read Level ( dBμV )	Antenna Factor ( dB/m )	Cable Loss ( dB )	Preamp Factor ( dB )	Ant Pos ( cm )	Table Pos ( deg )	Peak Avg. ( P/A )	Pol. ( H/V )
BT CH 39 2441MHz		4882	38.94	-35.06	74	52.79	33.54	11.9	59.29	100	0	P	H
		4882	14.18	-39.82	54	-	-	-	-	-	-	A	H
		7323	40.6	-33.4	74	49.07	34.65	14.94	58.06	100	0	P	H
		7323	15.84	-38.16	54	-	-	-	-	-	-	A	H
		4882	39.65	-34.35	74	53.5	33.54	11.9	59.29	100	0	P	V
		4882	14.89	-39.11	54	-	-	-	-	-	-	A	V
		7323	40.88	-33.12	74	49.35	34.65	14.94	58.06	100	0	P	V
		7323	16.12	-37.88	54	-	-	-	-	-	-	A	V
Remark	1. No other spurious found. 2. All results are PASS against Peak and Average limit line.												



Emission below 1GHz

2.4GHz BT (LF)

BT	Note	Frequency ( MHz )	Level ( dBµV/m )	Over Limit ( dB )	Limit Line ( dBµV/m )	Read Level ( dBµV )	Antenna Factor ( dB/m )	Cable Loss ( dB )	Preamp Factor ( dB )	Ant Pos ( cm )	Table Pos ( deg )	Peak Avg. ( P/A )	Pol. ( H/V )	
2.4GHz BT LF		30.27	30.73	-9.27	40	34.37	26	1.71	31.35	-	-	P	H	
		95.88	30.1	-13.4	43.5	43.67	15.88	2.11	31.56	-	-	P	H	
		229.26	29.55	-16.45	46	40.81	17.12	3.03	31.41	-	-	P	H	
		519.8	38.71	-7.29	46	41.17	24.36	4.13	30.95	100	22	P	H	
		844.6	34.57	-11.43	46	31.33	28.6	5.2	30.56	-	-	P	H	
		977.6	35.22	-18.78	54	30.07	30.26	5.4	30.51	-	-	P	H	
														H
														H
														H
														H
														H
														H
														H
														H
														H
														H
														H
														H
														H
			31.08	36.49	-3.51	40	40.68	25.46	1.71	31.36	100	126	P	V
		65.1	31.9	-8.1	40	49.03	12.35	2.11	31.59	-	-	P	V	
		229.26	28.21	-17.79	46	39.47	17.12	3.03	31.41	-	-	P	V	
		389.6	35.63	-10.37	46	40.8	22.16	3.82	31.15	-	-	P	V	
		519.8	41.8	-4.2	46	44.26	24.36	4.13	30.95	-	-	P	V	
		584.9	36	-10	46	37.31	25.15	4.39	30.85	-	-	P	V	
													V	
													V	
													V	
													V	
													V	
													V	
													V	
<b>Remark</b>	1. No other spurious found. 2. All results are PASS against limit line.													



<For Sample 2>

<Ant. No. 4>

2.4GHz 2400~2483.5MHz

BT (Band Edge @ 3m)

BT	Note	Frequency ( MHz )	Level ( dBµV/m )	Over Limit ( dB )	Limit Line ( dBµV/m )	Read Level ( dBµV )	Antenna Factor ( dB/m )	Cable Loss ( dB )	Preamp Factor ( dB )	Ant Pos ( cm )	Table Pos ( deg )	Peak Avg. ( P/A )	Pol. ( H/V )	
BT CH 78 2480MHz	*	2480	92.9	-	-	87.15	32.45	8.3	35	238	76	P	H	
	*	2480	68.14	-	-	-	-	-	-	-	-	A	H	
		2489.08	46	-28	74	40.2	32.5	8.3	35	238	76	P	H	
		2489.08	21.24	-32.76	54	-	-	-	-	-	-	A	H	
													H	
														H
	*	2480	97.76	-	-	92.01	32.45	8.3	35	335	0	P	V	
	*	2480	73	-	-	-	-	-	-	-	-	-	A	V
		2493.92	46.07	-27.93	74	40.28	32.5	8.3	35.01	335	0	P	V	
		2493.92	21.31	-32.69	54	-	-	-	-	-	-	A	V	
														V
														V
Remark	1. No other spurious found. 2. All results are PASS against Peak and Average limit line.													



2.4GHz 2400~2483.5MHz

BT (Harmonic @ 3m)

BT	Note	Frequency ( MHz )	Level ( dBμV/m )	Over Limit ( dB )	Limit Line ( dBμV/m )	Read Level ( dBμV )	Antenna Factor ( dB/m )	Cable Loss ( dB )	Preamp Factor ( dB )	Ant Pos ( cm )	Table Pos ( deg )	Peak Avg. ( P/A )	Pol. ( H/V )
BT CH 78 2480MHz		4960	40.61	-33.39	74	52.46	35.47	11.84	59.16	100	0	P	H
		4960	15.85	-38.15	54	-	-	-	-	-	-	A	H
		7440	43.07	-30.93	74	48.53	37.6	15.1	58.16	100	0	P	H
		7440	18.31	-35.69	54	-	-	-	-	-	-	A	H
		4960	42.13	-31.87	74	53.98	35.47	11.84	59.16	100	0	P	V
		4960	17.37	-36.63	54	-	-	-	-	-	-	A	V
		7440	43.71	-30.29	74	49.17	37.6	15.1	58.16	100	0	P	V
		7440	18.95	-35.05	54	-	-	-	-	-	-	A	V
Remark	1. No other spurious found. 2. All results are PASS against Peak and Average limit line.												



<For Sample 3>

<Ant. No. 4>

2.4GHz 2400~2483.5MHz

BT (Band Edge @ 3m)

BT	Note	Frequency ( MHz )	Level ( dBμV/m )	Over Limit ( dB )	Limit Line ( dBμV/m )	Read Level ( dBμV )	Antenna Factor ( dB/m )	Cable Loss ( dB )	Preamp Factor ( dB )	Ant Pos ( cm )	Table Pos ( deg )	Peak Avg. ( P/A )	Pol. ( H/V )	
BT CH 78 2480MHz	*	2480	95.19	-	-	89.44	32.45	8.3	35	280	41	P	H	
	*	2480	70.43	-	-	-	-	-	-	-	-	A	H	
		2485.08	45.99	-28.01	74	40.24	32.45	8.3	35	280	41	P	H	
		2485.08	21.23	-32.77	54	-	-	-	-	-	-	A	H	
													H	
														H
	*	2480	98.15	-	-	92.4	32.45	8.3	35	145	212	P	V	
	*	2480	73.39	-	-	-	-	-	-	-	-	-	A	V
		2490.92	45.9	-28.1	74	40.1	32.5	8.3	35	145	212	P	V	
		2490.92	21.14	-32.86	54	-	-	-	-	-	-	A	V	
														V
														V
Remark	1. No other spurious found. 2. All results are PASS against Peak and Average limit line.													



2.4GHz 2400~2483.5MHz

BT (Harmonic @ 3m)

BT	Note	Frequency ( MHz )	Level ( dBμV/m )	Over Limit ( dB )	Limit Line ( dBμV/m )	Read Level ( dBμV )	Antenna Factor ( dB/m )	Cable Loss ( dB )	Preamp Factor ( dB )	Ant Pos ( cm )	Table Pos ( deg )	Peak Avg. (P/A)	Pol. (H/V)
BT CH 78 2480MHz		4960	41.44	-32.56	74	53.29	35.47	11.84	59.16	100	0	P	H
		4960	16.68	-37.32	54	-	-	-	-	-	-	A	H
		7440	43.77	-30.23	74	49.23	37.6	15.1	58.16	100	0	P	H
		7440	19.01	-34.99	54	-	-	-	-	-	-	A	H
		4960	41.61	-32.39	74	53.46	35.47	11.84	59.16	100	0	P	V
		4960	16.85	-37.15	54	-	-	-	-	-	-	A	V
		7440	43.89	-30.11	74	49.35	37.6	15.1	58.16	100	0	P	V
		7440	19.13	-34.87	54	-	-	-	-	-	-	A	V
Remark	1. No other spurious found. 2. All results are PASS against Peak and Average limit line.												





**Note symbol**

*	<b>Fundamental Frequency</b> which can be ignored. However, the level of any unwanted emissions shall not exceed the level of the fundamental frequency.
!	Test result is <b>over limit</b> line.
P/A	<b>Peak</b> or <b>Average</b>
H/V	<b>Horizontal</b> or <b>Vertical</b>



A calculation example for radiated spurious emission is shown as below:

WIFI	Note	Frequency	Level	Over	Limit	Read	Antenna	Cable	Preamp	Ant	Table	Peak	Pol.
Ant.				Limit	Line	Level	Factor	Loss	Factor	Pos	Pos	Avg.	
1+2		( MHz )	( dBμV/m )	( dB )	( dBμV/m )	( dBμV )	( dB/m )	( dB )	( dB )	( cm )	( deg )	( P/A )	( H/V )
802.11b		2390	55.45	-18.55	74	54.51	32.22	4.58	35.86	103	308	P	H
CH 01													
2412MHz		2390	43.54	-10.46	54	42.6	32.22	4.58	35.86	103	308	A	H

- Level(dBμV/m) =  
Antenna Factor(dB/m) + Cable Loss(dB) + Read Level(dBμV) - Preamp Factor(dB)
- Over Limit(dB) = Level(dBμV/m) – Limit Line(dBμV/m)

**For Peak Limit @ 2390MHz:**

- Level(dBμV/m)  
= Antenna Factor(dB/m) + Cable Loss(dB) + Read Level(dBμV) - Preamp Factor(dB)  
= 32.22(dB/m) + 4.58(dB) + 54.51(dBμV) – 35.86 (dB)  
= 55.45 (dBμV/m)
- Over Limit(dB)  
= Level(dBμV/m) – Limit Line(dBμV/m)  
= 55.45(dBμV/m) – 74(dBμV/m)  
= -18.55(dB)

**For Average Limit @ 2390MHz:**

- Level(dBμV/m)  
= Antenna Factor(dB/m) + Cable Loss(dB) + Read Level(dBμV) - Preamp Factor(dB)  
= 32.22(dB/m) + 4.58(dB) + 42.6(dBμV) – 35.86 (dB)  
= 43.54 (dBμV/m)
- Over Limit(dB)  
= Level(dBμV/m) – Limit Line(dBμV/m)  
= 43.54(dBμV/m) – 54(dBμV/m)  
= -10.46(dB)

Both peak and average measured complies with the limit line, so test result is “PASS”.



## Appendix C. Radiated Spurious Emission Plots

Test Engineer :	Jesse Wang, James Chiu, and Potter Liu	Temperature :	22~26°C
		Relative Humidity :	52~58%

<For Sample 1>

<Ant. No. 1>

### 2.4GHz 2400~2483.5MHz

#### BT (Band Edge @ 3m)

BT	2.4GHz 2400~2483.5MHz Band Edge @ 3m	
	BT CH00 2402MHz	
	Horizontal	Fundamental
Peak	<p>Site : 03CH074HY            Condition : PEAK, 3m, 3m HF-ANT, 130829 HORIZONTAL            ResBW: 1000.000kHz, VBW: 3000.000kHz, SWT: Auto            Detector : Peak            Project : 752421            Mode : 1</p>	<p>Site : 03CH074HY            Condition : PEAK, 3m, 3m HF-ANT, 130829 HORIZONTAL            ResBW: 1000.000kHz, VBW: 3000.000kHz, SWT: Auto            Detector : Peak            Project : 752421            Mode : 1</p>

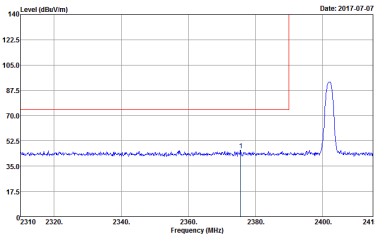
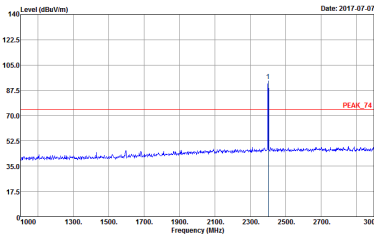

BT	2.4GHz 2400~2483.5MHz Band Edge @ 3m	
BT CH00 2402MHz		
	Vertical	Fundamental
Peak	 <p data-bbox="438 694 662 750">Site : 03CH0744Y Condition : PEAK_BE_74 3m HF-ANT_130829 VERTICAL Sweep : 1000.000kHz VBW:3000.000kHz SWT:Auto Detector : Peak Project : 752421 Mode : 1</p>	 <p data-bbox="912 694 1136 750">Site : 03CH0744Y Condition : PEAK_74 3m HF-ANT_130829 VERTICAL Sweep : 1000.000kHz VBW:3000.000kHz SWT:Auto Detector : Peak Project : 752421 Mode : 1</p>



BT	2.4GHz 2400~2483.5MHz Band Edge @ 3m	
BT CH39 2441MHz		
Horizontal		Fundamental
Peak	<p>Date: 2017-07-07</p> <p>Site : 03CH074HY            Condition : PEAK_BE_74 3m HF-ANT_130829 HORIZONTAL            : RBW:1000.000kHz VBW:3000.000kHz SWT:Auto            Detector : Peak            Project : 752421            Mode : 2</p>	<p>Date: 2017-07-07</p> <p>Site : 03CH074HY            Condition : PEAK_74 3m HF-ANT_130829 HORIZONTAL            : RBW:1000.000kHz VBW:3000.000kHz SWT:Auto            Detector : Peak            Project : 752421            Mode : 2</p>
Peak	<p>Date: 2017-07-07</p> <p>Site : 03CH074HY            Condition : PEAK_BE_74 3m HF-ANT_130829 HORIZONTAL            : RBW:1000.000kHz VBW:3000.000kHz SWT:Auto            Detector : Peak            Project : 752421            Mode : 2</p>	Left blank



BT	2.4GHz 2400~2483.5MHz Band Edge @ 3m	
BT CH39 2441MHz		
	Vertical	Fundamental
Peak	<p>Date: 2017-07-07</p> <p>Site : 03CH074HY            Condition : PEAK_BE_74 3m HF-ANT_130829 VERTICAL            : RBW:1000.000kHz VBW:3000.000kHz SWT:Auto            Detector : Peak            Project : 752421            Mode : 2</p>	<p>Date: 2017-07-07</p> <p>Site : 03CH074HY            Condition : PEAK_74 3m HF-ANT_130829 VERTICAL            : RBW:1000.000kHz VBW:3000.000kHz SWT:Auto            Detector : Peak            Project : 752421            Mode : 2</p>
Peak	<p>Date: 2017-07-07</p> <p>Site : 03CH074HY            Condition : PEAK_BE_74 3m HF-ANT_130829 VERTICAL            : RBW:1000.000kHz VBW:3000.000kHz SWT:Auto            Detector : Peak            Project : 752421            Mode : 2</p>	Left blank



BT	2.4GHz 2400~2483.5MHz Band Edge @ 3m	
BT CH78 2480MHz		
Horizontal		Fundamental
Peak	<p>Date: 2017-07-07</p> <p>Site : 03CH07-HY            Condition : PEAK_BE_74 3m HF-ANT_130829 HORIZONTAL            RBW: 1000.000kHz VBW: 3000.000kHz SWT: Auto            Detector : Peak            Project : 752421            Mode : 3</p>	<p>Date: 2017-07-07</p> <p>Site : 03CH07-HY            Condition : PEAK_74 3m HF-ANT_130829 HORIZONTAL            RBW: 1000.000kHz VBW: 3000.000kHz SWT: Auto            Detector : Peak            Project : 752421            Mode : 3</p>



BT	2.4GHz 2400~2483.5MHz Band Edge @ 3m	
BT CH78 2480MHz		
Vertical		Fundamental
Peak	<p>Date: 2017-07-07</p> <p>Site : 03CH07-4Y            Condition : PEAK_BE_74 3m HF-ANT_130829 VERTICAL            : RBW:1000.000kHz VBW:3000.000kHz SWT:Auto            Detector : Peak            Project : 752421            Mode : 3</p>	<p>Date: 2017-07-07</p> <p>Site : 03CH07-4Y            Condition : PEAK_74 3m HF-ANT_130829 VERTICAL            : RBW:1000.000kHz VBW:3000.000kHz SWT:Auto            Detector : Peak            Project : 752421            Mode : 3</p>





2.4GHz 2400~2483.5MHz

BT (Harmonic @ 3m)

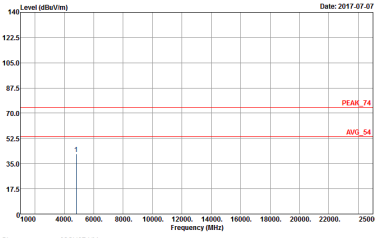
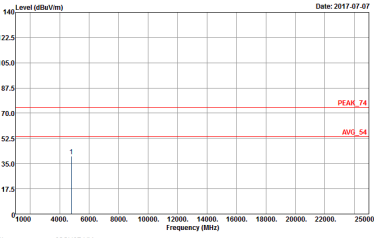
BT	2.4GHz 2400~2483.5MHz Harmonic @ 3m	
	BT CH00 2402MHz	
	Horizontal	Vertical
Peak Avg.	 <p>Site : 03CH074HY Condition : PEAK_74.3m SHF-EHF_131029 HORIZONTAL Detector : Peak Project : 752421 Mode : 1</p>	 <p>Site : 03CH074HY Condition : PEAK_74.3m SHF-EHF_131029 VERTICAL Detector : Peak Project : 752421 Mode : 1</p>



BT	2.4GHz 2400~2483.5MHz Harmonic @ 3m	
BT CH39 2441MHz		
	Horizontal	Vertical
<b>Peak</b> <b>Avg.</b>	<p>Horizontal Spectrum Plot (Date: 2017-07-07)</p> <p>Y-axis: Level (dBuV/m) (0 to 140) X-axis: Frequency (MHz) (0 to 25000)</p> <p>Peaks labeled: 1, 2</p> <p>Reference lines: PEAK_74, AVG_54</p> <p>Metadata: Site : 03CH39-01 Condition : PEAK_74 3m SHF-EHF_131029 HORIZONTAL Detector : Peak Project : FR2421 Mode : 2</p>	<p>Vertical Spectrum Plot (Date: 2017-07-07)</p> <p>Y-axis: Level (dBuV/m) (0 to 140) X-axis: Frequency (MHz) (0 to 25000)</p> <p>Peaks labeled: 1, 2</p> <p>Reference lines: PEAK_74, AVG_54</p> <p>Metadata: Site : 03CH39-01 Condition : PEAK_74 3m SHF-EHF_131029 VERTICAL Detector : Peak Project : FR2421 Mode : 2</p>



BT	2.4GHz 2400~2483.5MHz Harmonic @ 3m	
BT CH78 2480MHz		
Horizontal		Vertical
<p>Peak Avg.</p>	<p>Site : 03CH78Y1 Condition : PEAK_74 3m SHF-EHF_131029 HORIZONTAL Detector : Peak Project : 752421 Mode : 3</p>	<p>Site : 03CH78Y1 Condition : PEAK_74 3m SHF-EHF_131029 VERTICAL Detector : Peak Project : 752421 Mode : 3</p>



Emission below 1GHz

2.4GHz BT (LF)

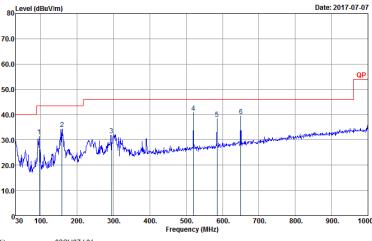
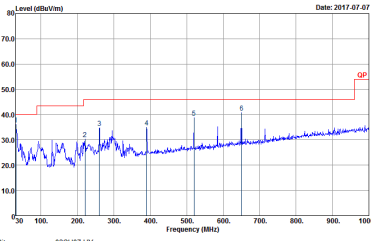
BT	2.4GHz 2400~2483.5MHz	
BT LF		
	Horizontal	Vertical
QP / Peak	 <p data-bbox="435 813 624 864">Site : 03CH074HY Condition : QP 3m LF ANT-35419(E) HORIZONTAL Detector : Peak Project : 752421 Mode : 4</p>	 <p data-bbox="909 813 1098 864">Site : 03CH074HY Condition : QP 3m LF ANT-35419(E) VERTICAL Detector : Peak Project : 752421 Mode : 4</p>



<Ant. No. 3>

2.4GHz 2400~2483.5MHz  
BT (Band Edge @ 3m)

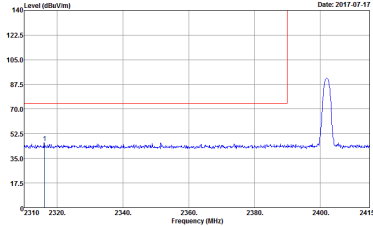
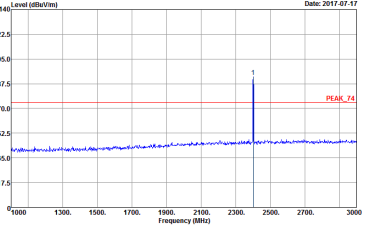
BT	2.4GHz 2400~2483.5MHz Band Edge @ 3m	
BT CH00 2402MHz		
	Horizontal	Fundamental
Peak	 <p>Date: 2017-07-17</p> <p>Site : 03CH07-HY Condition : PEAK_BE_74 3m HF-ANT_130829 HORIZONTAL Detector : RESV:5000:5000Hz-VISV:3000:0000Hz-SWFT:Auto Peak : Peak Project : T52421 Mode : 67</p>	 <p>Date: 2017-07-17</p> <p>Site : 03CH07-HY Condition : PEAK_74 3m HF-ANT_130829 HORIZONTAL Detector : RESV:5000:5000Hz-VISV:3000:0000Hz-SWFT:Auto Peak : Peak Project : T52421 Mode : 67</p>

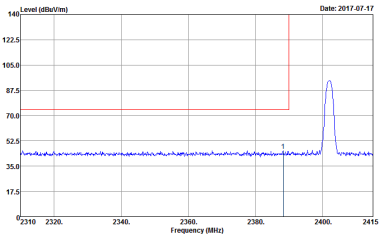
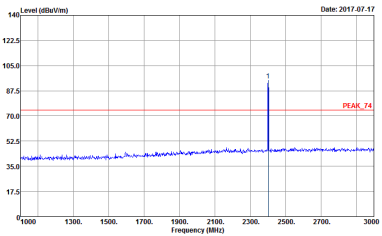

BT	2.4GHz 2400~2483.5MHz Band Edge @ 3m	
BT CH00 2402MHz		
	Vertical	Fundamental
Peak	 <p>Date: 2017-07-17</p> <p>Site : 03CH0744Y Condition : PEAK_BE_74 3m HF-ANT 130829 VERTICAL Sweep : 1000.000kHz VBW 3000.000kHz SVWT-Auto Detector : Peak Project : FS2421 Mode : 67</p>	 <p>Date: 2017-07-17</p> <p>Site : 03CH0744Y Condition : PEAK_74 3m HF-ANT 130829 VERTICAL Sweep : 1000.000kHz VBW 3000.000kHz SVWT-Auto Detector : Peak Project : FS2421 Mode : 67</p>



BT	2.4GHz 2400~2483.5MHz Band Edge @ 3m	
BT CH78 2480MHz		
Horizontal		Fundamental
Peak	<p>Date: 2017-07-17</p> <p>Site : 03CH07-HY            Condition : PEAK_BE_74 3m HF-ANT_130829 HORIZONTAL            : RBW:1000.000kHz VBW:3000.000kHz SWT:Auto            Detector : Peak            Project : FR2421            Mode : 69</p>	<p>Date: 2017-07-17</p> <p>Site : 03CH07-HY            Condition : PEAK_74 3m HF-ANT_130829 HORIZONTAL            : RBW:1000.000kHz VBW:3000.000kHz SWT:Auto            Detector : Peak            Project : FR2421            Mode : 69</p>

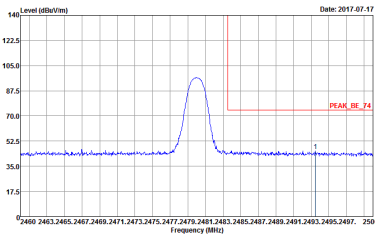
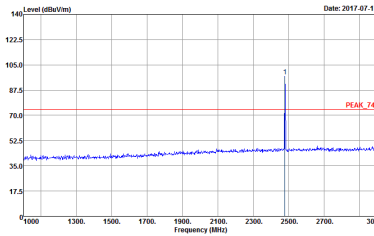

BT	2.4GHz 2400~2483.5MHz Band Edge @ 3m	
BT CH78 2480MHz		
	Vertical	Fundamental
Peak	 <p>Date: 2017-07-17</p> <p>Site : 03CH07-HY            Condition : PEAK_BE_74 3m HF-AUT 130829 VERTICAL            : RBW:1000.000kHz VBW:3000.000kHz SVWT:Auto            Detector : Peak            Project : 752421            Mode : 69</p>	 <p>Date: 2017-07-17</p> <p>Site : 03CH07-HY            Condition : PEAK_74 3m HF-AUT 130829 VERTICAL            : RBW:1000.000kHz VBW:3000.000kHz SVWT:Auto            Detector : Peak            Project : 752421            Mode : 69</p>



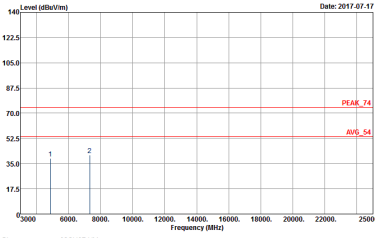
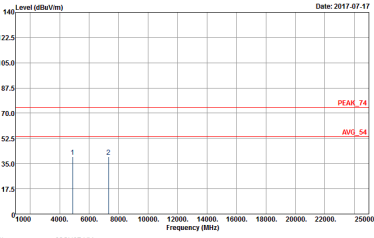

2.4GHz 2400~2483.5MHz  
BT (Harmonic @ 3m)

BT	2.4GHz 2400~2483.5MHz Harmonic @ 3m	
	BT CH39 2441MHz	
	Horizontal	Vertical
<p><b>Peak</b> <b>Avg.</b></p>	 <p>Site : 03CH074HY Condition : PEAK_74.3m SHF-EHF_131029 HORIZONTAL Detector : Peak Project : 752421 Mode : 68</p>	 <p>Site : 03CH074HY Condition : PEAK_74.3m SHF-EHF_131029 VERTICAL Detector : Peak Project : 752421 Mode : 68</p>



Emission below 1GHz

2.4GHz BT (LF)

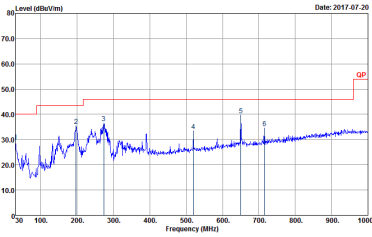
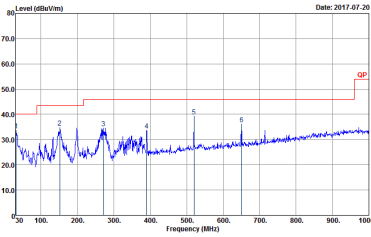
BT	2.4GHz 2400~2483.5MHz	
BT LF		
Horizontal		Vertical
QP / Peak	 <p data-bbox="435 813 823 864">Site : 03CH0741Y Condition : QP 3m LF-ANT-35419(6) HORIZONTAL Detector : Peak Project : 752421 Mode : 70</p>	 <p data-bbox="909 813 1297 864">Site : 03CH0741Y Condition : QP 3m LF-ANT-35419(6) VERTICAL Detector : Peak Project : 752421 Mode : 70</p>



<Ant. No. 4>

2.4GHz 2400~2483.5MHz  
BT (Band Edge @ 3m)

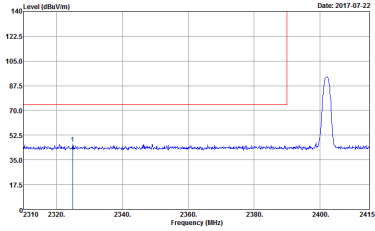
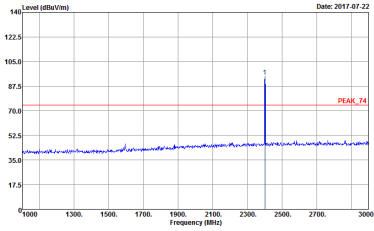
BT	2.4GHz 2400~2483.5MHz Band Edge @ 3m	
	BT CH00 2402MHz	
	Horizontal	Fundamental
Peak	 <p>Date: 2017.07.22</p> <p>Site : 03CH07-HY Condition : PEAK_BE_74 3m HF-ANT_130829 HORIZONTAL Detector : PEW:1000:0000Hz:VIEW:3000:0000Hz:SWT:Auto Peak : Peak Project : 752421 Mode : 109</p>	 <p>Date: 2017.07.22</p> <p>Site : 03CH07-HY Condition : PEAK_74 3m HF-ANT_130829 HORIZONTAL Detector : PEW:1000:0000Hz:VIEW:3000:0000Hz:SWT:Auto Peak : Peak Project : 752421 Mode : 109</p>

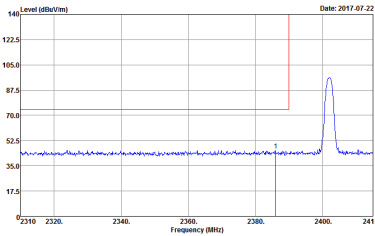
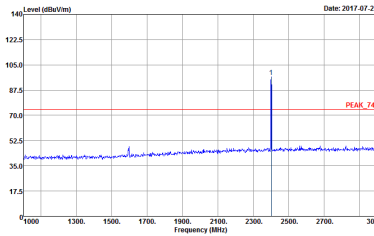

BT	2.4GHz 2400~2483.5MHz Band Edge @ 3m	
BT CH00 2402MHz		
	Vertical	Fundamental
Peak	 <p data-bbox="438 694 662 750">Site : 03CH07-HY Condition : PEAK_BE_74 3m HF-Ant 130820 VERTICAL Sbw: 1000.000kHz VBW: 3000.000kHz SVWT: Auto Detector : Peak Project : 752421 Mode : 109</p>	 <p data-bbox="909 694 1133 750">Site : 03CH07-HY Condition : PEAK_74 3m HF-Ant 130820 VERTICAL Sbw: 1000.000kHz VBW: 3000.000kHz SVWT: Auto Detector : Peak Project : 752421 Mode : 109</p>



BT	2.4GHz 2400~2483.5MHz Band Edge @ 3m	
BT CH78 2480MHz		
Horizontal		Fundamental
Peak	<p>Date: 2017-07-22</p> <p>Site : 03CH07-HY            Condition : PEAK_BE_74 3m HF-ANT 130829 HORIZONTAL            : RBW:1000.000kHz VBW:3000.000kHz SVWT:Auto            Detector : Peak            Project : 752421            Mode : 111</p>	<p>Date: 2017-07-22</p> <p>Site : 03CH07-HY            Condition : PEAK_74 3m HF-ANT 130829 HORIZONTAL            : RBW:1000.000kHz VBW:3000.000kHz SVWT:Auto            Detector : Peak            Project : 752421            Mode : 111</p>



BT	2.4GHz 2400~2483.5MHz Band Edge @ 3m	
BT CH78 2480MHz		
Vertical		Fundamental
Peak	<p>Date: 2017-07-22</p> <p>Site : 03CH07-HY            Condition : PEAK_BE_74 3m HF-Ant 130820 VERTICAL            : RBW:1000.000kHz VBW:3000.000kHz SVWT:Auto            Detector : Peak            Project : 752421            Mode : 111</p>	<p>Date: 2017-07-22</p> <p>Site : 03CH07-HY            Condition : PEAK_74 3m HF-Ant 130820 VERTICAL            : RBW:1000.000kHz VBW:3000.000kHz SVWT:Auto            Detector : Peak            Project : 752421            Mode : 111</p>



2.4GHz 2400~2483.5MHz

BT (Harmonic @ 3m)

BT	2.4GHz 2400~2483.5MHz Harmonic @ 3m	
BT CH39 2441MHz		
Horizontal		Vertical
<p>Peak Avg.</p>	<p>Site : 03CH074Y Condition : PEAK_74.3m SHF-EHF_131029 HORIZONTAL Detector : Peak Project : 752421 Mode : 110</p>	<p>Site : 03CH074Y Condition : PEAK_74.3m SHF-EHF_131029 VERTICAL Detector : Peak Project : 752421 Mode : 110</p>



Emission below 1GHz

2.4GHz BT (LF)

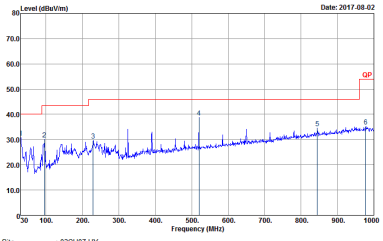
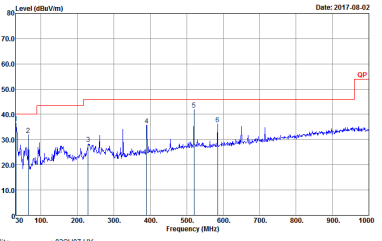
<b>BT</b>	<b>2.4GHz 2400~2483.5MHz</b>	
	<b>BT LF</b>	
	<b>Horizontal</b>	<b>Vertical</b>
<b>QP / Peak</b>	 <p>Site : 03CH0741Y  Condition : QP 3m LF-ANT-35419(6) HORIZONTAL  Detector : Peak  Project : 752421  Mode : 112</p>	 <p>Site : 03CH0741Y  Condition : QP 3m LF-ANT-35419(6) VERTICAL  Detector : Peak  Project : 752421  Mode : 112</p>





<For Sample 2>

<Ant. No. 4>

2.4GHz 2400~2483.5MHz

BT (Band Edge @ 3m)

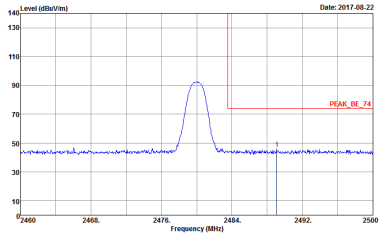
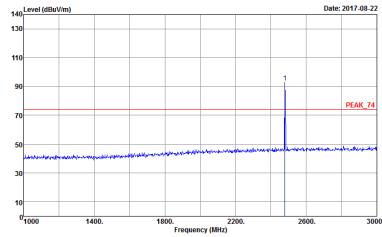
BT	2.4GHz 2400~2483.5MHz Band Edge @ 3m	
BT CH78 2480MHz		
Horizontal		Fundamental
Peak	 <p>Date: 2017-08-22</p> <p>Site : 03CH07-HY            Condition : PEAK_BE_74 3m HF-ANT_130829 HORIZONTAL            Detector : Peak            Project : 752421            Mode : 151</p>	 <p>Date: 2017-08-22</p> <p>Site : 03CH07-HY            Condition : PEAK_74 3m HF-ANT_130829 HORIZONTAL            Detector : Peak            Project : 752421            Mode : 151</p>

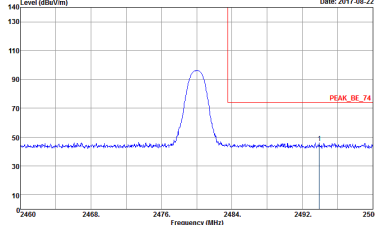
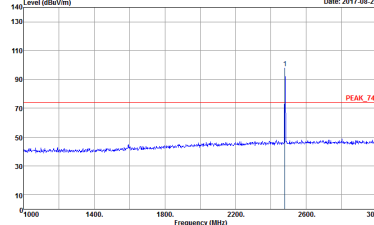

BT	2.4GHz 2400~2483.5MHz Band Edge @ 3m	
BT CH78 2480MHz		
	Vertical	Fundamental
Peak	 <p>Date: 2017-08-22</p> <p>Site : 03CH07-HY Condition : PEAK_BE_74 3m HF-ANT_130829 VERTICAL Detector : Peak Project : 752421 Mode : 151</p>	 <p>Date: 2017-08-22</p> <p>Site : 03CH07-HY Condition : PEAK_74 3m HF-ANT_130829 VERTICAL Detector : Peak Project : 752421 Mode : 151</p>



2.4GHz 2400~2483.5MHz

BT (Harmonic @ 3m)

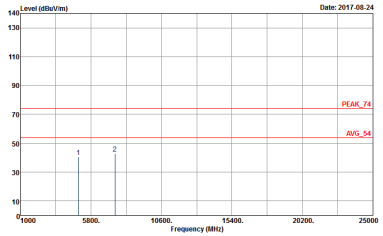
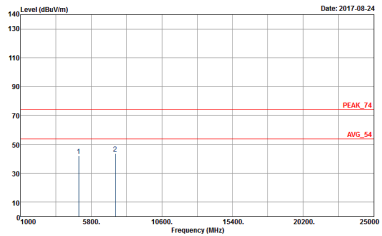
BT	2.4GHz 2400~2483.5MHz Harmonic @ 3m	
BT CH78 2480MHz		
Horizontal		Vertical
<p><b>Peak</b></p> <p><b>Avg.</b></p>	 <p>Site : 03CH07-HY            Condition : PEAK_74 3m SHF-EHF_131029 HORIZONTAL            Detector : Peak            Project : 752421            Mode : 151</p>	 <p>Site : 03CH07-HY            Condition : PEAK_74 3m SHF-EHF_131029 VERTICAL            Detector : Peak            Project : 752421            Mode : 151</p>



<For Sample 3>

<Ant. No. 4>

2.4GHz 2400~2483.5MHz

BT (Band Edge @ 3m)

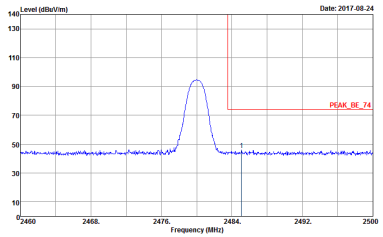
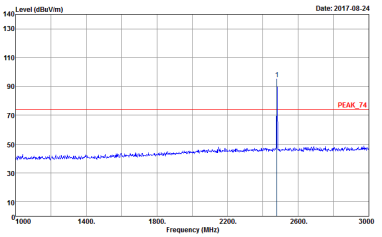
BT	2.4GHz 2400~2483.5MHz Band Edge @ 3m	
BT CH78 2480MHz		
Horizontal		Fundamental
Peak	 <p>Date: 2017-08-24</p> <p>Site : 03CH07-HY            Condition : PEAK_BE_74 3m HF-ANT_130829 HORIZONTAL            RBW:1000.000KHz VBW:3000.000KHz SWT:Auto            Detector : Peak            Project : 752421            Mode : 154</p>	 <p>Date: 2017-08-24</p> <p>Site : 03CH07-HY            Condition : PEAK_74 3m HF-ANT_130829 HORIZONTAL            RBW:1000.000KHz VBW:3000.000KHz SWT:Auto            Detector : Peak            Project : 752421            Mode : 154</p>

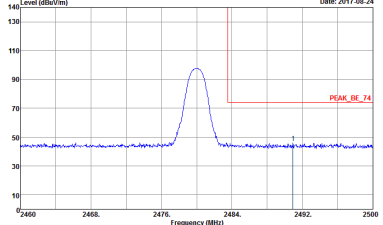
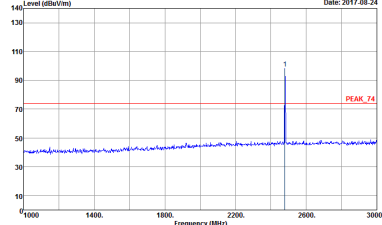

BT	2.4GHz 2400~2483.5MHz Band Edge @ 3m	
BT CH78 2480MHz		
	Vertical	Fundamental
Peak	 <p>Date: 2017-08-24</p> <p>Site : 03CH07-HY Condition : PEAK_BE_74 3m HF-ANT_130829 VERTICAL Detector : Peak Project : 752421 Mode : 154</p>	 <p>Date: 2017-08-24</p> <p>Site : 03CH07-HY Condition : PEAK_74 3m HF-ANT_130829 VERTICAL Detector : Peak Project : 752421 Mode : 154</p>



2.4GHz 2400~2483.5MHz

BT (Harmonic @ 3m)

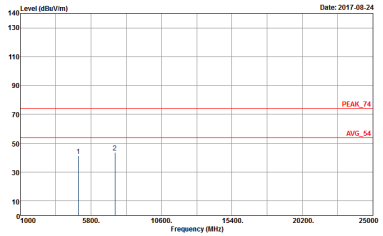
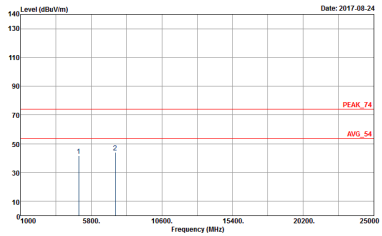
BT	2.4GHz 2400~2483.5MHz Harmonic @ 3m	
	BT CH78 2480MHz	
	Horizontal	Vertical
<p><b>Peak</b></p> <p><b>Avg.</b></p>	 <p>Site : 03CH07-4Y            Condition : PEAK_74 3m SHF-EHF_131029 HORIZONTAL            Detector : Peak            Project : 752421            Mode : 154</p>	 <p>Site : 03CH07-4Y            Condition : PEAK_74 3m SHF-EHF_131029 VERTICAL            Detector : Peak            Project : 752421            Mode : 154</p>

## Appendix D. Duty Cycle Plots

For Sample 1 Ant. No. 1

3DH5 on time (One Pulse) Plot on Channel 39

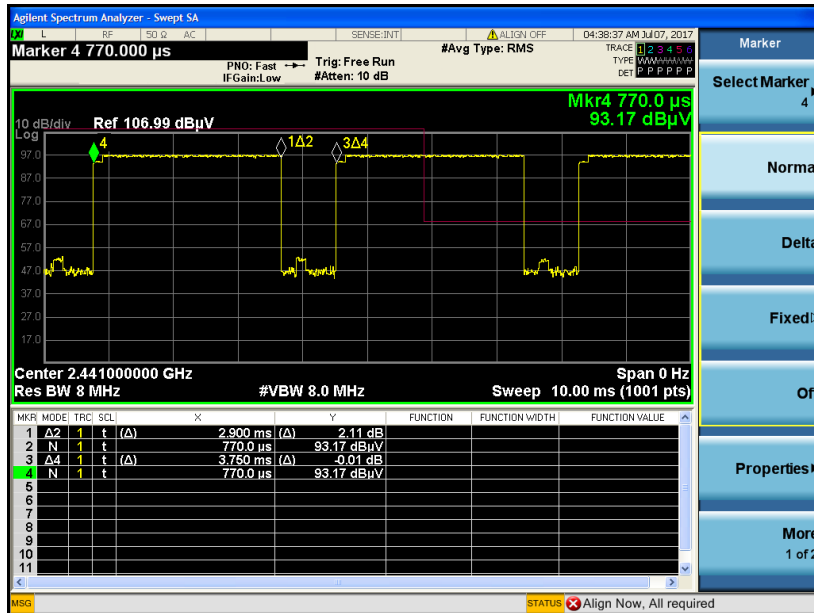

on time (Count Pulses) Plot on Channel 39

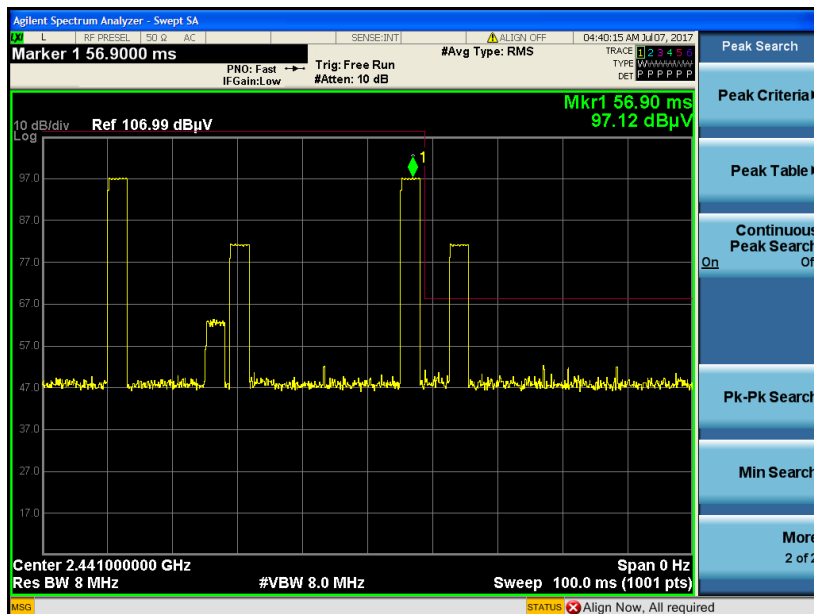

**Note:**

1. Worst case Duty cycle = on time/100 milliseconds =  $2 * 2.90 / 100 = 5.8 \%$
2. Worst case Duty cycle correction factor =  $20 * \log(\text{Duty cycle}) = -24.73 \text{ dB}$
3. 3DH5 has the highest duty cycle worst case and is reported.



**Duty Cycle Correction Factor Consideration for AFH mode:**

Bluetooth normal hopping rate is 1600Hz and reduced to 800Hz in AFH mode; due to the reduced number of hopping frequencies, with the same packet configuration the dwell time in each channel frequency within 100msec period is longer in AFH mode than normal mode.

In AFH mode, the minimum hopping frequencies are 20, to get the longest dwell time DH5 packet is observed; the period to have DH5 packet completing one hopping sequence is

$$2.90 \text{ ms} \times 20 \text{ channels} = 58 \text{ ms}$$

There cannot be 2 complete hopping sequences within 100ms period, considering the random hopping behavior, maximum 2 hops can be possibly observed within the period.  $[100\text{ms} / 57.6\text{ms}] = 2$  hops

Thus, the maximum possible ON time:

$$2.90 \text{ ms} \times 2 = 5.8 \text{ ms}$$

Worst case Duty Cycle Correction factor, which is derived from the maximum possible ON time,

$$20 \times \log(5.8 \text{ ms}/100\text{ms}) = -24.73 \text{ dB}$$



For Sample 1 Ant. No. 3

3DH5 on time (One Pulse) Plot on Channel 39

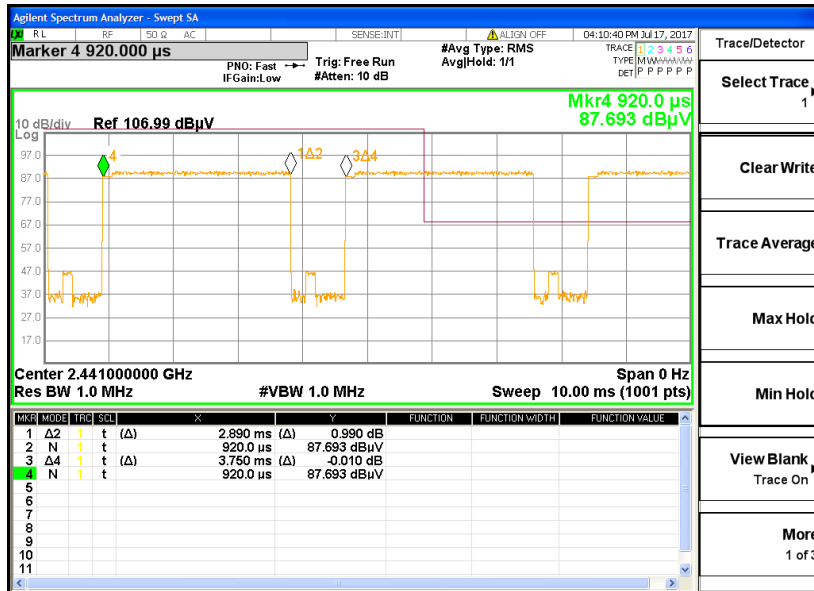

on time (Count Pulses) Plot on Channel 39

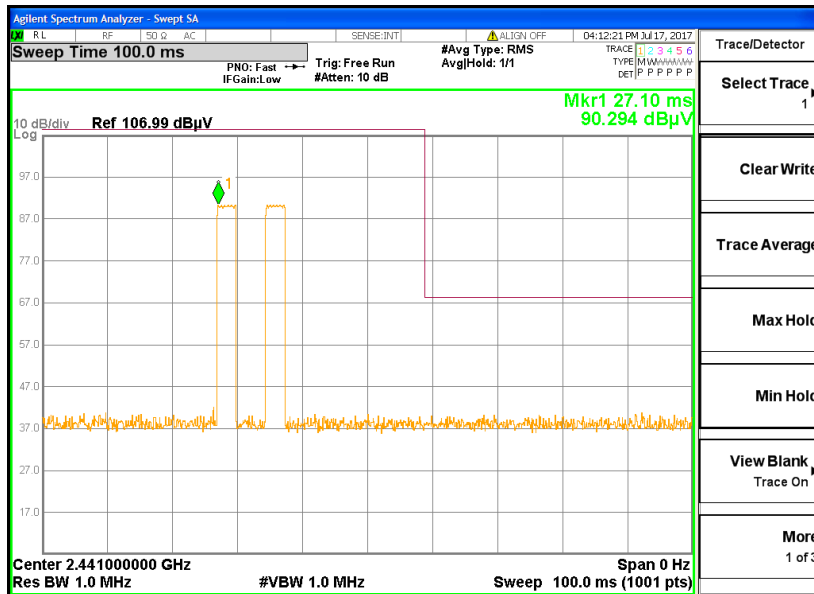

Note:

1. Worst case Duty cycle = on time/100 milliseconds =  $2 * 2.89 / 100 = 5.78\%$
2. Worst case Duty cycle correction factor =  $20 * \log(\text{Duty cycle}) = -24.76 \text{ dB}$
3. 3DH5 has the highest duty cycle worst case and is reported.

For Sample 1 Ant. No. 4

3DH5 on time (One Pulse) Plot on Channel 39

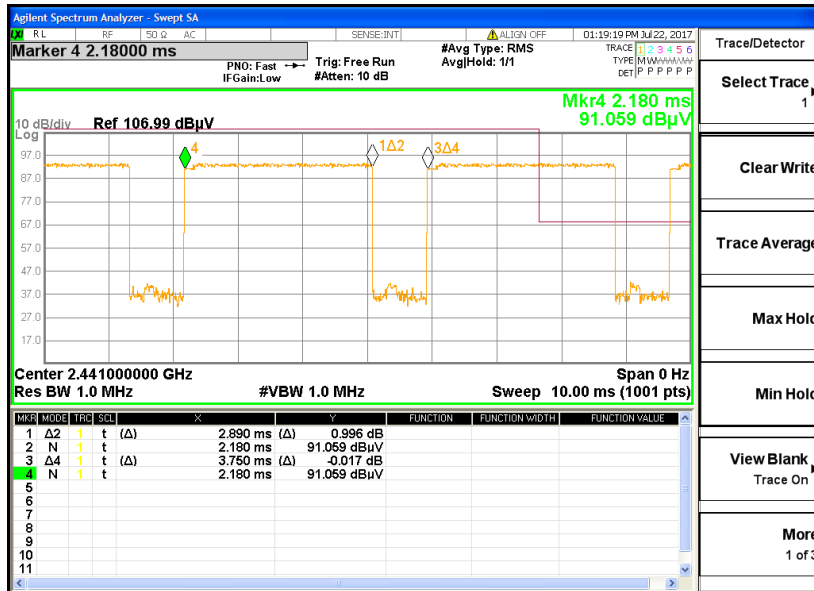

on time (Count Pulses) Plot on Channel 39

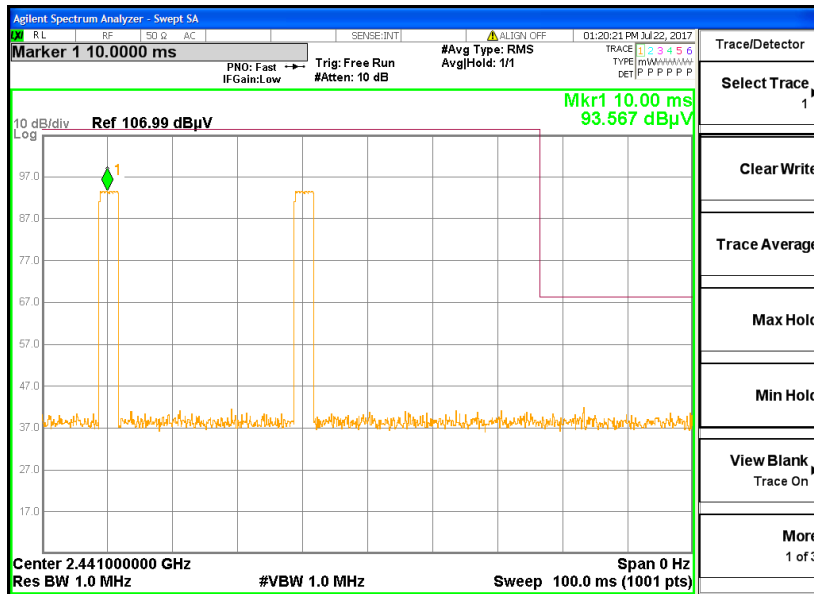

Note:

1. Worst case Duty cycle = on time/100 milliseconds =  $2 * 2.89 / 100 = 5.78\%$
2. Worst case Duty cycle correction factor =  $20 * \log(\text{Duty cycle}) = -24.76 \text{ dB}$
3. 3DH5 has the highest duty cycle worst case and is reported.

For Sample 2 Ant. No. 4

3DH5 on time (One Pulse) Plot on Channel 39

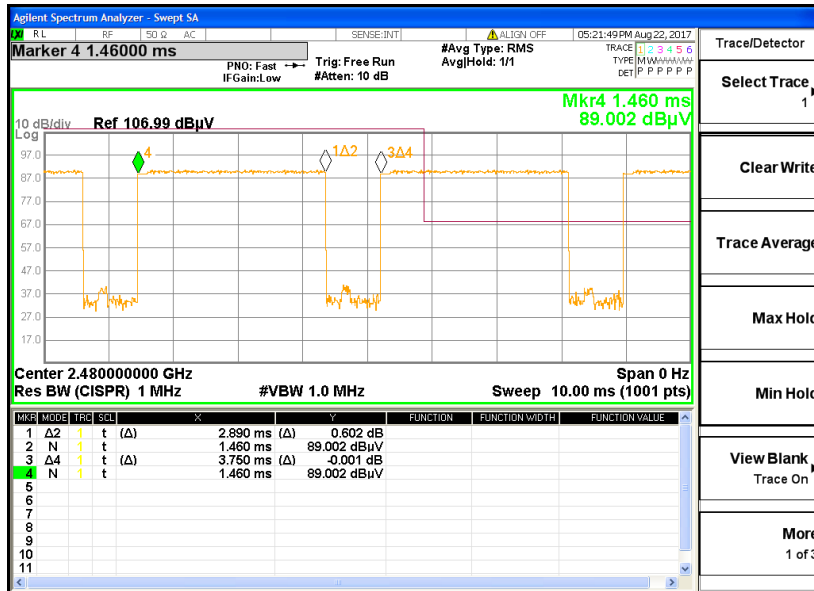

on time (Count Pulses) Plot on Channel 39

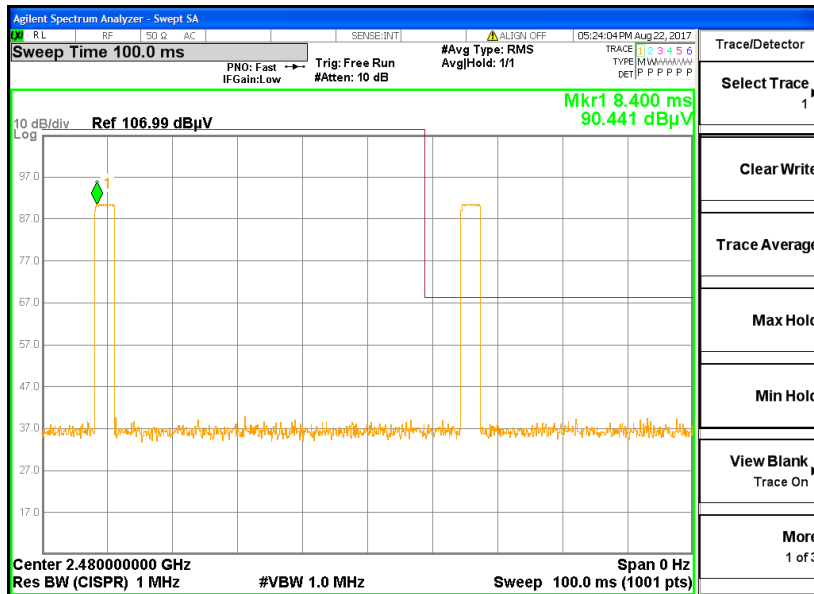

Note:

1. Worst case Duty cycle = on time/100 milliseconds =  $2 * 2.89 / 100 = 5.78\%$
2. Worst case Duty cycle correction factor =  $20 * \log(\text{Duty cycle}) = -24.76 \text{ dB}$
3. 3DH5 has the highest duty cycle worst case and is reported.



For Sample 3 Ant. No. 4

3DH5 on time (One Pulse) Plot on Channel 39

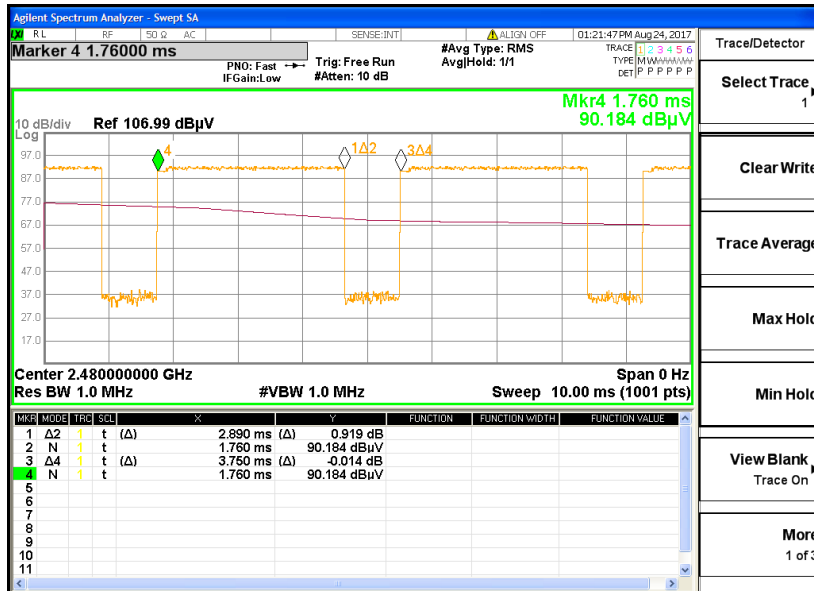

on time (Count Pulses) Plot on Channel 39

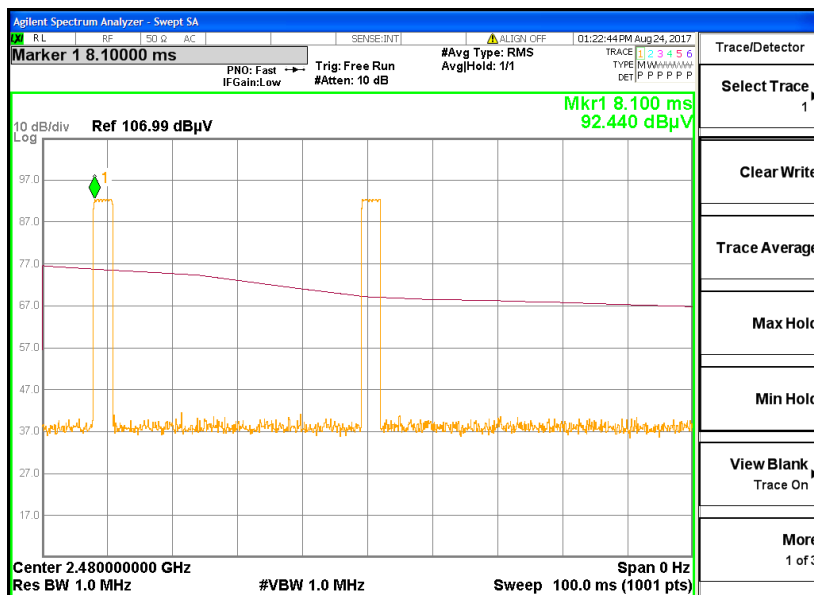

Note:

1. Worst case Duty cycle = on time/100 milliseconds =  $2 * 2.89 / 100 = 5.78\%$
2. Worst case Duty cycle correction factor =  $20 * \log(\text{Duty cycle}) = -24.76 \text{ dB}$
3. 3DH5 has the highest duty cycle worst case and is reported.