



FCC RF Test Report

APPLICANT : Zebra Technologies Corporation
EQUIPMENT : Vehicle Computer
BRAND NAME : Zebra
MODEL NAME : VC80x
FCC ID : UZ7VC80X
STANDARD : FCC Part 15 Subpart C §15.247
CLASSIFICATION : (DTS) Digital Transmission System

The product was received on May 24, 2017 and testing was completed on Aug. 24, 2017. We, SPORTON INTERNATIONAL INC., would like to declare that the tested sample has been evaluated in accordance with the test procedures and has been in compliance with the applicable technical standards.

The test results in this report apply exclusively to the tested model / sample. Without written approval of SPORTON INTERNATIONAL INC., the test report shall not be reproduced except in full.

Reviewed by: Joseph Lin / Supervisor

Approved by: Jones Tsai / Manager



SPORTON INTERNATIONAL INC.

No. 52, Hwa Ya 1st Rd., Hwa Ya Technology Park, Kwei-Shan District, Tao Yuan City, Taiwan, R.O.C.

SPORTON INTERNATIONAL INC.

TEL : 886-3-327-3456

FAX : 886-3-328-4978

FCC ID : UZ7VC80X

Page Number : 1 of 111

Report Issued Date : Oct. 11, 2017

Report Version : Rev. 01

Report Template No.: BU5-FR15CWLAC MA Version 2.0



TABLE OF CONTENTS

REVISION HISTORY..... 3

SUMMARY OF TEST RESULT 4

1 GENERAL DESCRIPTION 5

 1.1 Applicant 5

 1.2 Manufacturer 5

 1.3 Product Feature of Equipment Under Test..... 5

 1.4 Product Specification of Equipment Under Test..... 6

 1.5 Modification of EUT 8

 1.6 Testing Location 8

 1.7 Applicable Standards..... 8

2 TEST CONFIGURATION OF EQUIPMENT UNDER TEST 9

 2.1 Carrier Frequency and Channel 9

 2.2 Test Mode 10

 2.3 Connection Diagram of Test System 19

 2.4 Support Unit used in test configuration and system 21

 2.5 EUT Operation Test Setup 21

 2.6 Measurement Results Explanation Example..... 21

3 TEST RESULT 22

 3.1 6dB and 99% Bandwidth Measurement 22

 3.2 Output Power Measurement..... 26

 3.3 Power Spectral Density Measurement 37

 3.4 Conducted Band Edges and Spurious Emission Measurement 44

 3.5 Radiated Band Edges and Spurious Emission Measurement 101

 3.6 AC Conducted Emission Measurement..... 106

 3.7 Antenna Requirements 108

4 LIST OF MEASURING EQUIPMENT 110

5 UNCERTAINTY OF EVALUATION 111

APPENDIX A. AC CONDUCTED EMISSION TEST RESULT

APPENDIX B. RADIATED SPURIOUS EMISSION

APPENDIX C. RADIATED SPURIOUS EMISSION PLOTS

APPENDIX D. DUTY CYCLE PLOTS

APPENDIX E. SETUP PHOTOGRAPHS



REVISION HISTORY

REPORT NO.	VERSION	DESCRIPTION	ISSUED DATE
FR752421C	Rev. 01	Initial issue of report	Oct. 11, 2017



SUMMARY OF TEST RESULT

Report Section	FCC Rule	Description	Limit	Result	Remark
3.1	15.247(a)(2)	6dB Bandwidth	$\geq 0.5\text{MHz}$	Pass	-
3.1	-	99% Bandwidth	-	Pass	-
3.2	15.247(b)	Power Output Measurement	$\leq 30\text{dBm}$	Pass	-
3.3	15.247(e)	Power Spectral Density	$\leq 8\text{dBm}/3\text{kHz}$	Pass	-
3.4	15.247(d)	Conducted Band Edges	$\leq 20\text{dBc}$	Pass	-
		Conducted Spurious Emission		Pass	-
3.5	15.247(d)	Radiated Band Edges and Radiated Spurious Emission	15.209(a) & 15.247(d)	Pass	Under limit 1.13 dB at 2390.000 MHz
3.6	15.207	AC Conducted Emission	15.207(a)	Pass	Under limit 14.60 dB at 0.150 MHz
3.7	15.203 & 15.247(b)	Antenna Requirement	N/A	Pass	-



1 General Description

1.1 Applicant

Zebra Technologies Corporation
1 Zebra Plaza, Holtsville, NY 11742-1300, USA

1.2 Manufacturer

Zebra Technologies Corporation
1 Zebra Plaza, Holtsville, NY 11742-1300, USA

1.3 Product Feature of Equipment Under Test

Product Feature	
Equipment	Vehicle Computer
Brand Name	Zebra
Model Name	VC80x
FCC ID	UZ7VC80X
Sample 1	Standard SKU
Sample 2	Outdoor SKU
Sample 3	Freezer SKU
EUT supports Radios application	WLAN 11a/b/g/n HT20/HT40 WLAN 11ac VHT20/VHT40/VHT80 Bluetooth BR/EDR/LE
HW Version	EV
SW Version	91-15-01.7-MN-00
FW Version	FUSION_BA_2_00.0.0.033_M
MFD	25May17
EUT Stage	Identical Prototype

Remark: The above EUT's information was declared by manufacturer. Please refer to the specifications or user's manual for more detailed description.



1.4 Product Specification of Equipment Under Test

Standards-related Product Specification	
Tx/Rx Channel Frequency Range	2412 MHz ~ 2462 MHz
Maximum (Average) Output Power to antenna <CDD Mode>	<p><Chain 0> 802.11b : 20.08 dBm (0.1019 W) 802.11g : 20.25 dBm (0.1059 W) 802.11n HT20 : 18.13 dBm (0.0650 W) 802.11n HT40 : 12.71 dBm (0.0187 W) 802.11ac VHT20 : 18.08 dBm (0.0643 W) 802.11ac VHT40 : 12.75 dBm (0.0188 W)</p> <p><Chain 1> 802.11b : 21.00 dBm (0.1259 W) 802.11g : 20.65 dBm (0.1161 W) 802.11n HT20 : 17.99 dBm (0.0630 W) 802.11n HT40 : 12.69 dBm (0.0186 W) 802.11ac VHT20 : 18.08 dBm (0.0643 W) 802.11ac VHT40 : 12.81 dBm (0.0191 W)</p> <p><MIMO Chain 0 + 1> 802.11b : 21.81 dBm (0.1517 W) 802.11g : 20.91 dBm (0.1233 W) 802.11n HT20 : 21.13 dBm (0.1297 W) 802.11n HT40 : 15.79 dBm (0.0379 W) 802.11ac VHT20 : 21.15 dBm (0.1303 W) 802.11ac VHT40 : 15.82 dBm (0.0382 W)</p>
Maximum (Average) Output Power to antenna <TXBF Mode>	<p><MIMO Chain 0 + 1> 802.11n HT20 : 22.57 dBm (0.1807 W) 802.11n HT40 : 17.57 dBm (0.0571 W) 802.11ac VHT20 : 22.61 dBm (0.1824 W) 802.11ac VHT40 : 17.58 dBm (0.0573 W)</p>
99% Occupied Bandwidth <CDD Mode>	<p><Chain 0> 802.11b : 12.00MHz 802.11g : 20.40MHz</p> <p><Chain 1> 802.11b : 12.40MHz 802.11g : 21.15MHz</p> <p><MIMO Chain 0> 802.11b : 11.90MHz 802.11g : 18.80MHz 802.11ac VHT20 : 19.60MHz 802.11ac VHT40 : 36.80MHz</p> <p><MIMO Chain 1> 802.11b : 12.10MHz 802.11g : 18.95MHz 802.11ac VHT20 : 19.60MHz 802.11ac VHT40 : 36.80MHz</p>



Standards-related Product Specification														
99% Occupied Bandwidth <TXBF Mode>	<MIMO Chain 0> 802.11ac VHT20 : 19.05MHz 802.11ac VHT40 : 36.60MHz <MIMO Chain 1> 802.11ac VHT20 : 19.25MHz 802.11ac VHT40 : 36.70MHz													
Antenna Function Description	<table border="1"> <thead> <tr> <th></th> <th>Chain 0</th> <th>Ant. 1</th> </tr> </thead> <tbody> <tr> <td>802.11 b/g/n/ac</td> <td>V</td> <td>V</td> </tr> <tr> <td>802.11 b/g/n/ac MIMO</td> <td>V</td> <td>V</td> </tr> <tr> <td>802.11 n/ac TXBF</td> <td>V</td> <td>V</td> </tr> </tbody> </table>			Chain 0	Ant. 1	802.11 b/g/n/ac	V	V	802.11 b/g/n/ac MIMO	V	V	802.11 n/ac TXBF	V	V
	Chain 0	Ant. 1												
802.11 b/g/n/ac	V	V												
802.11 b/g/n/ac MIMO	V	V												
802.11 n/ac TXBF	V	V												
Type of Modulation	802.11b : DSSS (DBPSK / DQPSK / CCK) 802.11a/g/n : OFDM (BPSK / QPSK / 16QAM / 64QAM) 802.11ac : OFDM (BPSK / QPSK / 16QAM / 64QAM / 256QAM)													

Note: MIMO Ant. 1+2 is a calculated result from sum of the power MIMO Ant. 1 and MIMO Ant. 2.

Antenna No.	Chain No.	Model	Antenna Type	Antenna Gain (dBi) Exclude Cable loss	Internal Cable loss (dB)	External Cable loss (dB)	Antenna Gain (dBi) Include Cable loss	Frequency (GHz)
1	Int. Chain 0	AN000097A01	Patch	3.96	N/A	N/A	3.96	2.4~2.4835
				5	N/A	N/A	5	5.15~5.85
	Int. Chain 1			3.69	N/A	N/A	3.69	2.4~2.4835
				5	N/A	N/A	5	5.15~5.85
2	Ext. Chain 0	AN2010	Monopole	2	0.6	1.8	-0.4	2.4~2.4835
				2	0.9	2.6	-1.5	5.15~5.85
	Ext. Chain 1			2	0.6	1.8	-0.4	2.4~2.4835
				2	0.9	2.6	-1.5	5.15~5.85
3	Ext. Chain 0	AN2020	Monopole	5	0.6	1.8	2.6	2.4~2.4835
	Ext. Chain 1			5	0.6	1.8	2.6	2.4~2.4835
4	Ext. Chain 0	AN2030	Dipole	2	0.6	N/A	1.4	2.4~2.4835
				3.7	0.9	N/A	2.8	5.15~5.85
	Ext. Chain 1			2	0.6	N/A	1.4	2.4~2.4835
				3.7	0.9	N/A	2.8	5.15~5.85



1.5 Modification of EUT

No modifications are made to the EUT during all test items.

1.6 Testing Location

Sporton Lab is accredited to ISO 17025 by Taiwan Accreditation Foundation (TAF code : 1190) and the FCC designation No. TW1190 under the FCC 2.948(e) by Mutual Recognition Agreement (MRA) in FCC Test.

Test Site	SPORTON INTERNATIONAL INC.		
Test Site Location	No. 52, Hwa Ya 1 st Rd., Hwa Ya Technology Park, Kwei-Shan District, Tao Yuan City, Taiwan, R.O.C. TEL: +886-3-327-3456 FAX: +886-3-328-4978		
Test Site No.	Sporton Site No.		
	TH05-HY	CO05-HY	03CH07-HY

Note: The test site complies with ANSI C63.4 2014 requirement.

1.7 Applicable Standards

According to the specifications of the manufacturer, the EUT must comply with the requirements of the following standards:

- FCC Part 15 Subpart C §15.247
- FCC KDB Publication No. 558074 D01 DTS Meas. Guidance v04
- FCC KDB 662911 D01 Multiple Transmitter Output v02r01.
- ANSI C63.10-2013

Remark:

1. All test items were verified and recorded according to the standards and without any deviation during the test.
2. This EUT has also been tested and complied with the requirements of FCC Part 15, Subpart B, recorded in a separate test report.



2 Test Configuration of Equipment Under Test

- a. The EUT has been associated with peripherals and configuration operated in a manner tended to maximize its emission characteristics in a typical application. Frequency range investigated: conduction emission (150 kHz to 30 MHz), radiation emission (9 kHz to the 10th harmonic of the highest fundamental frequency or to 40 GHz, whichever is lower). For radiated measurement, pre-scanned in three orthogonal panels, X, Y, Z. The worst cases (X plane for Antenna No. 1 (Chain 0 / Chain 1 / Chain 0+1); X plane for Antenna No. 3 (Chain 0 / Chain 1), Y Plane for Antenna No. 3 (Chain 0+1); X plane for Antenna No. 4) were recorded in this report.

- b. AC power line Conducted Emission was tested under maximum output power.

2.1 Carrier Frequency and Channel

Frequency Band	Channel	Freq. (MHz)	Channel	Freq. (MHz)
2400-2483.5 MHz	1	2412	7	2442
	2	2417	8	2447
	3	2422	9	2452
	4	2427	10	2457
	5	2432	11	2462
	6	2437		



2.2 Test Mode

Final test mode of conducted test items and radiated spurious emissions are considering the modulation and worse data rates as below table.

Single Antenna

Modulation	Data Rate
802.11b	1 Mbps
802.11g	6 Mbps
802.11n HT20	MCS0
802.11n HT40	MCS0
802.11ac VHT20	MCS0
802.11ac VHT40	MCS0

MIMO Antenna

Modulation	Data Rate
802.11b	1 Mbps
802.11g	6 Mbps
802.11n HT20	MCS0
802.11n HT40	MCS0
802.11ac VHT20	MCS0
802.11ac VHT40	MCS0

TXBF Antenna

Modulation	Data Rate
802.11n HT20	MCS0
802.11n HT40	MCS0
802.11ac VHT20	MCS0
802.11ac VHT40	MCS0



<CDD Modes>

<Chain 0>

802.11b mode		
Power vs. Channel		
Channel	Frequency (MHz)	Data Rate (bps)
		1M
Duty Cycle (%)		98.62
CH 01	2412	18.76
CH 02	2417	18.84
CH 06	2437	20.08
CH 10	2457	19.46
CH 11	2462	19.44

802.11g mode		
Power vs. Channel		
Channel	Frequency (MHz)	Data Rate (bps)
		6M
Duty Cycle (%)		93.42
CH 01	2412	14.08
CH 02	2417	18.27
CH 06	2437	20.25
CH 10	2457	16.16
CH 11	2462	14.77

802.11n HT20 mode		
Power vs. Channel		
Channel	Frequency (MHz)	MCS Index
		MCS0
Duty Cycle (%)		91.67
CH 01	2412	11.34
CH 02	2417	14.71
CH 06	2437	18.13
CH 10	2457	15.30
CH 11	2462	12.03



802.11n HT40 mode		
Power vs. Channel		
Channel	Frequency (MHz)	MCS Index
		MCS0
Duty Cycle (%)		86.84
CH 03	2422	8.54
CH 04	2427	9.36
CH 06	2437	12.71
CH 08	2447	12.61
CH 09	2452	9.36
CH 10	2457	8.97
CH 11	2462	6.29

802.11n VHT20 mode		
Power vs. Channel		
Channel	Frequency (MHz)	MCS Index
		MCS0
Duty Cycle (%)		91.78
CH 01	2412	11.37
CH 02	2417	14.67
CH 06	2437	18.08
CH 10	2457	15.38
CH 11	2462	12.13

802.11n VHT40 mode		
Power vs. Channel		
Channel	Frequency (MHz)	MCS Index
		MCS0
Duty Cycle (%)		87.01
CH 03	2422	8.70
CH 04	2427	9.41
CH 06	2437	12.75
CH 08	2447	12.70
CH 09	2452	9.48
CH 10	2457	9.00
CH 11	2462	6.31



<Chain 1>

802.11b mode		
Power vs. Channel		
Channel	Frequency (MHz)	Data Rate (bps)
		1M
Duty Cycle (%)		98.62
CH 01	2412	15.44
CH 02	2417	19.03
CH 06	2437	20.81
CH 10	2457	21.00
CH 11	2462	16.18

802.11g mode		
Power vs. Channel		
Channel	Frequency (MHz)	Data Rate (bps)
		6M
Duty Cycle (%)		92.21
CH 01	2412	15.86
CH 02	2417	16.95
CH 06	2437	20.65
CH 10	2457	16.98
CH 11	2462	13.14

802.11n HT20 mode		
Power vs. Channel		
Channel	Frequency (MHz)	MCS Index
		MCS0
Duty Cycle (%)		93.06
CH 01	2412	11.27
CH 02	2417	14.71
CH 06	2437	17.99
CH 10	2457	15.47
CH 11	2462	12.02



802.11n HT40 mode		
Power vs. Channel		
Channel	Frequency (MHz)	MCS Index
		MCS0
Duty Cycle (%)		85.71
CH 03	2422	8.67
CH 04	2427	9.39
CH 06	2437	12.65
CH 08	2447	12.69
CH 09	2452	9.38
CH 10	2457	9.00
CH 11	2462	6.31

802.11n VHT20 mode		
Power vs. Channel		
Channel	Frequency (MHz)	MCS Index
		MCS0
Duty Cycle (%)		91.78
CH 01	2412	11.38
CH 02	2417	14.72
CH 06	2437	18.08
CH 10	2457	15.32
CH 11	2462	12.12

802.11n VHT40 mode		
Power vs. Channel		
Channel	Frequency (MHz)	MCS Index
		MCS0
Duty Cycle (%)		85.90
CH 03	2422	8.89
CH 04	2427	9.41
CH 06	2437	12.81
CH 08	2447	12.66
CH 09	2452	9.36
CH 10	2457	9.12
CH 11	2462	6.40



MIMO<Chain 0 + 1>

802.11b mode		
Power vs. Channel		
Channel	Frequency (MHz)	Data Rate (bps)
		1M
CH 01	2412	19.51
CH 02	2417	21.44
CH 06	2437	21.81
CH 10	2457	20.78
CH 11	2462	17.53

802.11g mode		
Power vs. Channel		
Channel	Frequency (MHz)	Data Rate (bps)
		6M
CH 01	2412	15.69
CH 02	2417	18.54
CH 06	2437	20.91
CH 10	2457	18.34
CH 11	2462	15.60

802.11n HT20 mode		
Power vs. Channel		
Channel	Frequency (MHz)	MCS Index
		MCS0
CH 01	2412	14.36
CH 02	2417	17.74
CH 06	2437	21.13
CH 10	2457	18.47
CH 11	2462	15.10



802.11n HT40 mode		
Power vs. Channel		
Channel	Frequency (MHz)	MCS Index
		MCS0
CH 03	2422	11.67
CH 04	2427	12.41
CH 06	2437	15.75
CH 08	2447	15.79
CH 09	2452	12.39
CH 10	2457	12.09
CH 11	2462	9.38

802.11n VHT20 mode		
Power vs. Channel		
Channel	Frequency (MHz)	MCS Index
		MCS0
CH 01	2412	14.39
CH 02	2417	17.75
CH 06	2437	21.15
CH 10	2457	18.48
CH 11	2462	15.16

802.11n VHT40 mode		
Power vs. Channel		
Channel	Frequency (MHz)	MCS Index
		MCS0
CH 03	2422	11.89
CH 04	2427	12.42
CH 06	2437	15.82
CH 08	2447	15.80
CH 09	2452	12.49
CH 10	2457	12.12
CH 11	2462	9.41



<TXBF Mode>

MIMO< Chain 0 + 1>

802.11n HT20 mode		
Power vs. Channel		
Channel	Frequency (MHz)	MCS Index
		MCS0
CH 01	2412	17.11
CH 02	2417	19.91
CH 06	2437	22.57
CH 10	2457	19.51
CH 11	2462	16.26

802.11n HT40 mode		
Power vs. Channel		
Channel	Frequency (MHz)	MCS Index
		MCS0
CH 03	2422	15.41
CH 04	2427	14.42
CH 06	2437	17.21
CH 08	2447	17.16
CH 09	2452	17.03
CH 10	2457	17.57
CH 11	2462	12.46

802.11n VHT20 mode		
Power vs. Channel		
Channel	Frequency (MHz)	MCS Index
		MCS0
CH 01	2412	17.16
CH 02	2417	19.96
CH 06	2437	22.61
CH 10	2457	19.56
CH 11	2462	16.36



802.11n VHT40 mode		
Power vs. Channel		
Channel	Frequency (MHz)	MCS Index
		MCS0
CH 03	2422	15.47
CH 04	2427	14.52
CH 06	2437	17.26
CH 08	2447	17.21
CH 09	2452	17.07
CH 10	2457	17.58
CH 11	2462	12.51

Test Cases	
AC Conducted Emission	Mode 1 :WLAN (2.4GHz) Link + Bluetooth Link + Audio Speaker (M1000) + Keyboard (ikey) + Scanner (DS3508) + RS-232 (cable load)* 2 + Ext. Antenna AN2020 + AC/DC Adapter + MPEG4 for Sample 1

2.3 Connection Diagram of Test System

<CDD Modes>

<EUT + Internal Antenna with Accessory Mode>

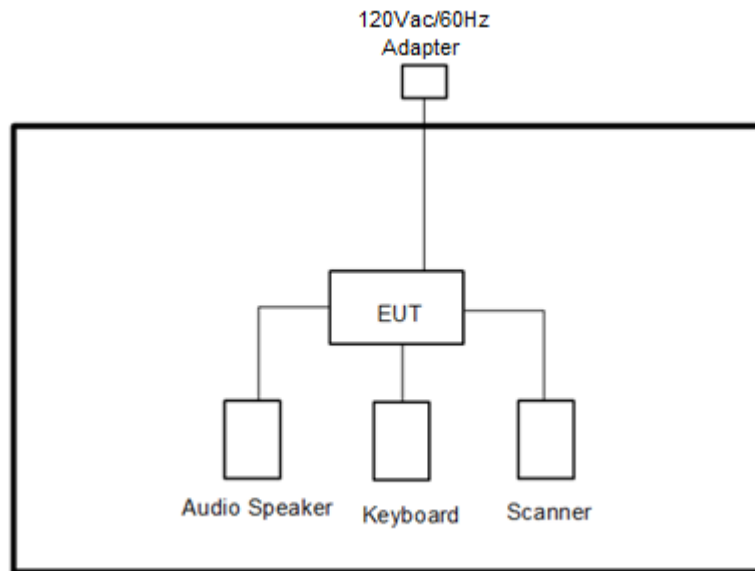

<EUT + External Antenna with Accessory Mode>

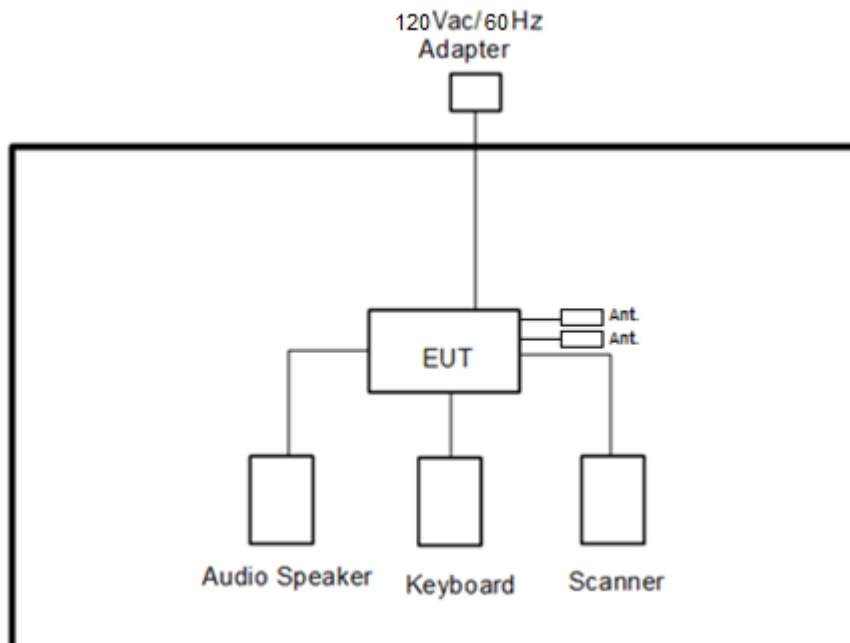

<TXBF Mode>

<EUT + Internal Antenna with Accessory Mode>

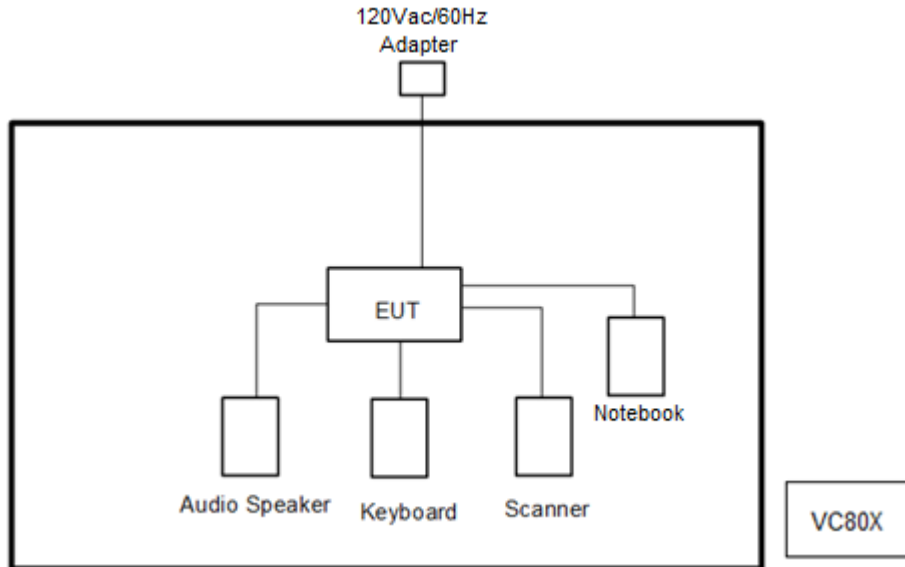

<EUT + External Antenna with Accessory Mode>

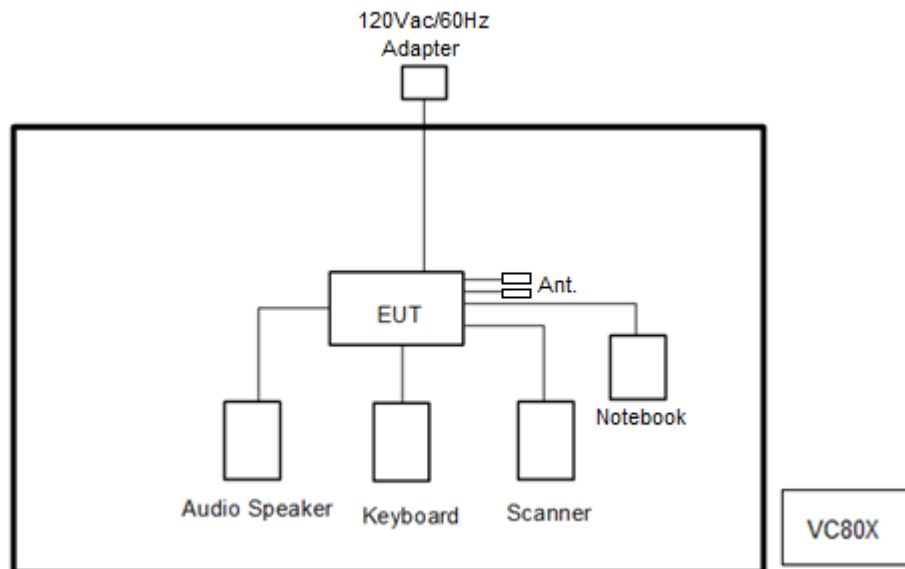



2.4 Support Unit used in test configuration and system

Item	Equipment	Trade Name	Model Name	FCC ID	Data Cable	Power Cord
1.	Bluetooth Earphone	Sony Ericsson	MW600	PY7DDA-2029	N/A	N/A
2.	WLAN AP	ASUS	RT-AC66U	MSQ-RTAC66U	N/A	Unshielded, 1.8m
3.	Notebook	DELL	Latitude E6320	FCC DoC/ Contains FCC ID: QDS-BRCM1054	N/A	AC I/P: Unshielded, 1.2 m DC O/P: Shielded, 1.8 m
4.	Notebook	Lenovo	M490S	N/A	N/A	AC I/P: Unshielded, 1.2 m DC O/P: Shielded, 1.8 m

2.5 EUT Operation Test Setup

The RF test items, programmed RF utility, "command" installed in the notebook make the EUT provide functions like channel selection and power level for continuous transmitting and receiving signals.

For WLAN MIMO TXBF modes, the EUT was tested under normal operation and link to another device with power, modulation modes and data rates controlled by engineer mode command lines. The CMD software tool was used to make EUT continuous transmitting signals.

2.6 Measurement Results Explanation Example

For all conducted test items:

The offset level is set in the spectrum analyzer to compensate the RF cable loss and attenuator factor between EUT conducted output port and spectrum analyzer. With the offset compensation, the spectrum analyzer reading level is exactly the EUT RF output level.

Example:

The spectrum analyzer offset is derived from RF cable loss and attenuator factor.

$$\text{Offset} = \text{RF cable loss} + \text{attenuator factor}.$$

Following shows an offset computation example with cable loss 4.2 dB and 10dB attenuator.

$$\begin{aligned} \text{Offset(dB)} &= \text{RF cable loss(dB)} + \text{attenuator factor(dB)}. \\ &= 4.2 + 10 = 14.2 \text{ (dB)} \end{aligned}$$

3 Test Result

3.1 6dB and 99% Bandwidth Measurement

3.1.1 Limit of 6dB and 99% Bandwidth

The minimum 6 dB bandwidth shall be at least 500 kHz.

3.1.2 Measuring Instruments

The measuring equipment is listed in the section 4 of this test report.

3.1.3 Test Procedures

1. The testing follows FCC KDB Publication No. 558074 DTS D01 Meas. Guidance v04.
2. The RF output of EUT was connected to the spectrum analyzer by RF cable and attenuator. The path loss was compensated to the results for each measurement.
3. Set to the maximum power setting and enable the EUT transmit continuously.
4. Make the measurement with the spectrum analyzer's resolution bandwidth (RBW) = 100 kHz. Set the Video bandwidth (VBW) = 300 kHz. In order to make an accurate measurement. The 6 dB bandwidth must be greater than 500 kHz.
5. For 99% Bandwidth Measurement, the spectrum analyzer's resolution bandwidth (RBW) = 1MHz and set the Video bandwidth (VBW) = 3MHz.
6. Measure and record the results in the test report.

3.1.4 Test Setup

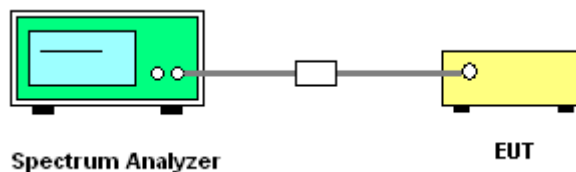



3.1.5 Test Result of 6dB and 99% Occupied Bandwidth

<CDD Mode>

2.4GHz Band										
Mod.	Data Rate	NTX	CH.	Freq. (MHz)	99% Occupied BW (MHz)		6dB BW (MHz)		6dB BW Limit (MHz)	Pass/Fail
					Ant 1	Ant 2	Ant 1	Ant 2		
11b	1Mbps	1	1	2412	11.90	11.85	8.56	9.02	0.50	Pass
11b	1Mbps	1	6	2437	12.00	12.40	9.02	9.00	0.50	Pass
11b	1Mbps	1	11	2462	11.90	11.90	8.56	8.58	0.50	Pass
11g	6Mbps	1	1	2412	18.25	18.25	16.32	16.28	0.50	Pass
11g	6Mbps	1	6	2437	20.40	21.15	16.32	16.32	0.50	Pass
11g	6Mbps	1	11	2462	18.15	18.20	15.70	16.08	0.50	Pass
11b	1Mbps	2	1	2412	11.85	11.95	9.00	9.02	0.50	Pass
11b	1Mbps	2	6	2437	11.90	12.10	8.98	9.02	0.50	Pass
11b	1Mbps	2	11	2462	11.70	11.85	8.02	8.50	0.50	Pass
11g	6Mbps	2	1	2412	18.25	18.25	16.32	16.32	0.50	Pass
11g	6Mbps	2	6	2437	18.80	18.95	16.28	16.32	0.50	Pass
11g	6Mbps	2	11	2462	18.25	18.10	16.04	15.68	0.50	Pass
VHT20	MCS0	2	1	2412	19.05	18.85	17.52	17.58	0.50	Pass
VHT20	MCS0	2	6	2437	19.60	19.60	17.52	17.48	0.50	Pass
VHT20	MCS0	2	11	2462	18.90	18.90	17.16	17.52	0.50	Pass
VHT40	MCS0	2	3	2422	36.80	36.80	36.28	36.28	0.50	Pass
VHT40	MCS0	2	6	2437	36.80	36.80	36.28	36.32	0.50	Pass
VHT40	MCS0	2	9	2452	36.40	36.60	35.08	35.68	0.50	Pass
VHT40	MCS0	2	10	2457	36.50	36.60	35.40	36.08	0.50	Pass
VHT40	MCS0	2	11	2462	36.50	36.60	35.40	35.64	0.50	Pass

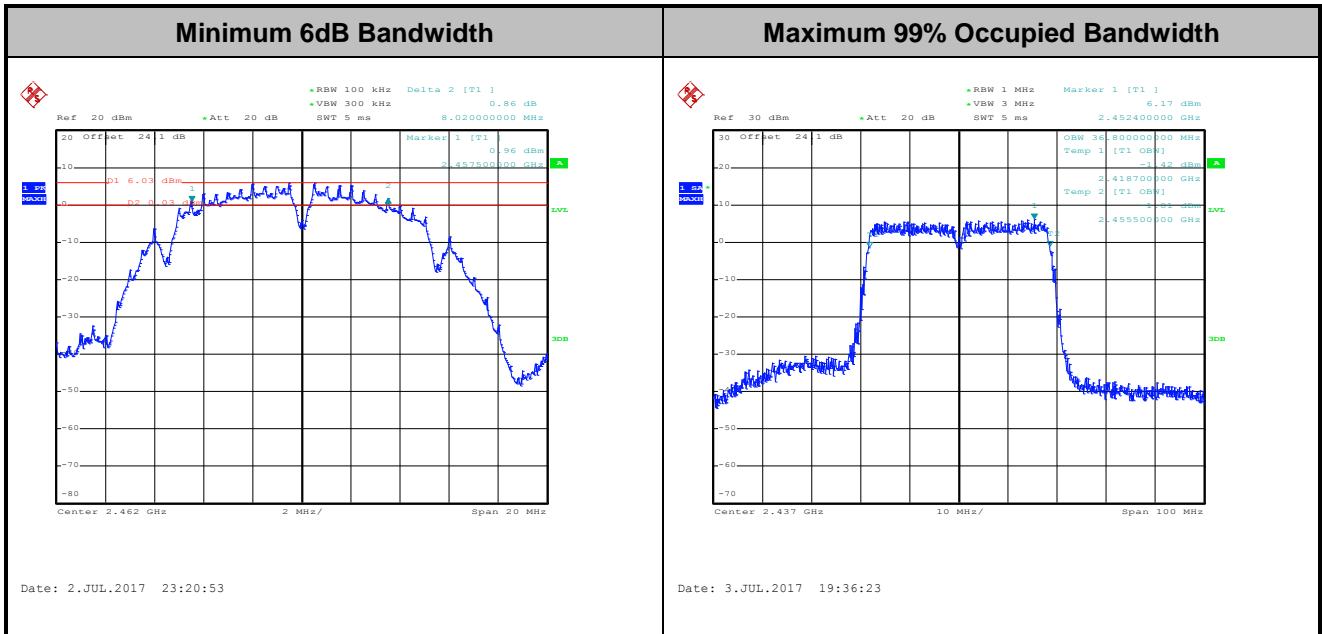

Note : The occupied channel bandwidth is maintained within the band of operation for all of the modulations.



<TXBF Mode>

2.4GHz Band										
Mod.	Data Rate	NTX	CH.	Freq. (MHz)	99% Occupied BW (MHz)		6dB BW (MHz)		6dB BW Limit (MHz)	Pass/Fail
					Ant 1	Ant 2	Ant 1	Ant 2		
VHT20	MCS0	2	1	2412	18.45	18.55	17.56	17.56	0.50	Pass
VHT20	MCS0	2	6	2437	19.05	19.25	17.54	17.58	0.50	Pass
VHT20	MCS0	2	11	2462	18.85	18.95	17.62	17.56	0.50	Pass
VHT40	MCS0	2	3	2422	36.50	36.70	35.04	35.04	0.50	Pass
VHT40	MCS0	2	6	2437	36.60	36.60	32.56	32.48	0.50	Pass
VHT40	MCS0	2	9	2452	36.30	36.20	32.56	30.08	0.50	Pass
VHT40	MCS0	2	10	2457	36.30	36.40	32.52	35.04	0.50	Pass
VHT40	MCS0	2	11	2462	36.20	36.50	34.96	28.76	0.50	Pass

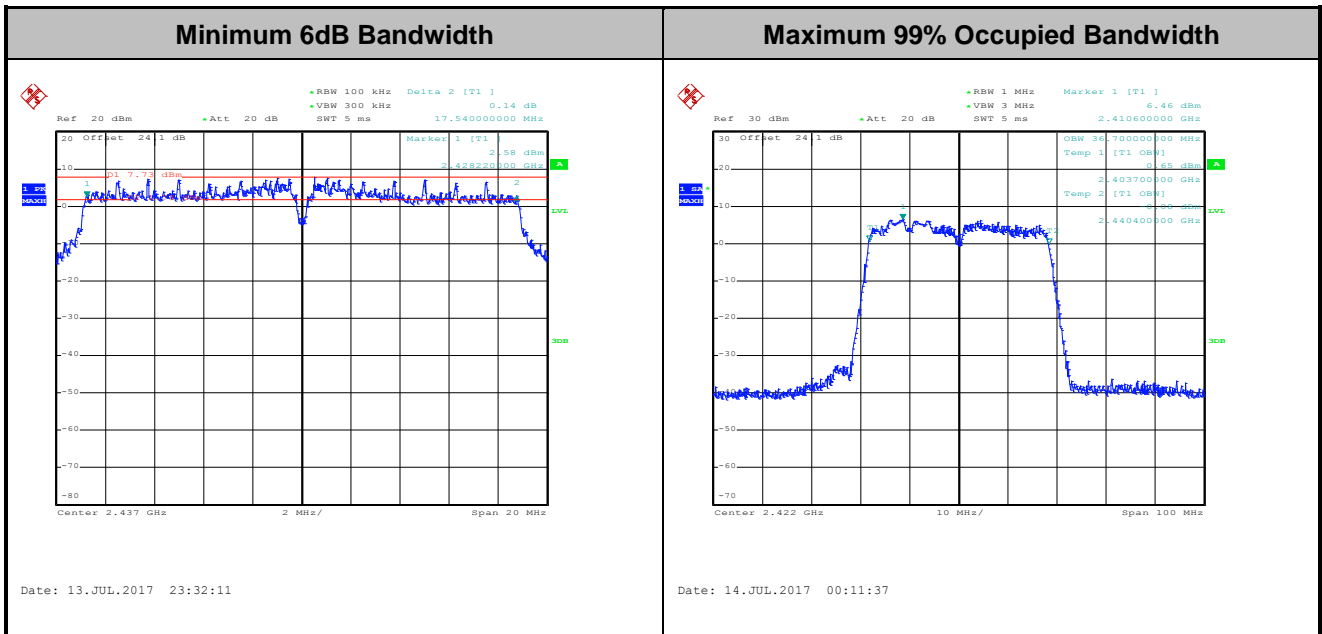

Note : The occupied channel bandwidth is maintained within the band of operation for all of the modulations.



3.2 Output Power Measurement

3.2.1 Limit of Output Power

For systems using digital modulation in the 2400-2483.5MHz, the limit for output power is 30dBm. If transmitting antenna with directional gain greater than 6dBi is used, the output power from the intentional radiator shall be reduced below the above stated value by the amount in dB that the directional gain of the antenna exceeds 6 dBi. In case of point-to-point operation, the limit has to be reduced by 1dB for every 3dB that the directional gain of the antenna exceeds 6dBi.

3.2.2 Measuring Instruments

The measuring equipment is listed in the section 4 of this test report.

3.2.3 Test Procedures

CDD Modes

1. The testing follows the Measurement Procedure of FCC KDB No. 558074 DTS D01 Meas. Guidance v04 section 9.2.3.1 Method AVGPM.
2. The RF output of EUT was connected to the power meter by RF cable and attenuator. The path loss was compensated to the results for each measurement.
3. Set to the maximum power setting and enable the EUT transmit continuously.
4. Measure the conducted output power and record the results in the test report.
5. For MIMO mode, calculation method follows FCC KDB 662911 D01 Multiple Transmitter Output v02r01.

TXBF Modes

1. The testing follows the Measurement Procedure of FCC KDB No. 558074 DTS D01 Meas. Guidance v04 section 9.2.3.2 Method AVGPM-G.
2. The RF output of EUT was connected to the power meter by RF cable and attenuator. The path loss was compensated to the results for each measurement.
3. Set to the maximum power setting and enable the EUT transmit continuously.
4. Measure the conducted output power and record the results in the test report.
5. For MIMO mode, calculation method follows FCC KDB 662911 D01 Multiple Transmitter Output v02r01.

3.2.4 Test Setup

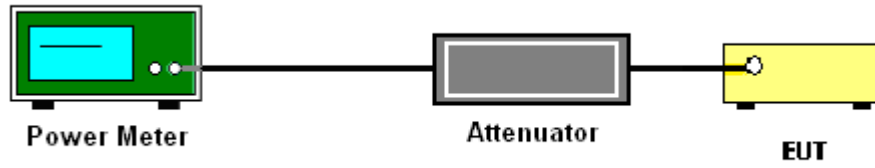



3.2.5 Test Result of Peak Output Power (Reporting Only)

<CDD Modes>

2.4GHz Band											
Mod.	Data Rate	NTX	CH.	Freq. (MHz)	Peak Conducted Power (dBm)			DG (dBi)		EIRP Power (dBm)	
					Ant 1	Ant 2	SUM	Ant 1	Ant 2	Ant 1	Ant 2
11b	1Mbps	1	1	2412	21.82	18.88		3.96	3.69	25.78	22.57
11b	1Mbps	1	2	2417	22.10	22.10		3.96	3.69	26.06	25.79
11b	1Mbps	1	6	2437	22.90	23.24		3.96	3.69	26.86	26.93
11b	1Mbps	1	10	2457	22.64	23.37		3.96	3.69	26.60	27.06
11b	1Mbps	1	11	2462	22.62	19.49		3.96	3.69	26.58	23.18
11g	6Mbps	1	1	2412	20.85	21.95		3.96	3.69	24.81	25.64
11g	6Mbps	1	2	2417	23.55	22.87		3.96	3.69	27.51	26.56
11g	6Mbps	1	6	2437	23.90	23.98		3.96	3.69	27.86	27.67
11g	6Mbps	1	10	2457	22.47	22.83		3.96	3.69	26.43	26.52
11g	6Mbps	1	11	2462	21.26	19.84		3.96	3.69	25.22	23.53
HT20	MCS0	1	1	2412	18.54	18.46		3.96	3.69	22.50	22.15
HT20	MCS0	1	2	2417	21.72	21.24		3.96	3.69	25.68	24.93
HT20	MCS0	1	6	2437	23.30	23.37		3.96	3.69	27.26	27.06
HT20	MCS0	1	10	2457	21.94	22.20		3.96	3.69	25.90	25.89
HT20	MCS0	1	11	2462	19.30	19.41		3.96	3.69	23.26	23.10
HT40	MCS0	1	3	2422	15.36	15.42		3.96	3.69	19.32	19.11
HT40	MCS0	1	4	2427	16.91	16.91		3.96	3.69	20.87	20.60
HT40	MCS0	1	6	2437	20.05	20.16		3.96	3.69	24.01	23.85
HT40	MCS0	1	8	2447	20.04	20.10		3.96	3.69	24.00	23.79
HT40	MCS0	1	9	2452	16.27	16.74		3.96	3.69	20.23	20.43
HT40	MCS0	1	10	2457	16.09	15.92		3.96	3.69	20.05	19.61
HT40	MCS0	1	11	2462	13.13	13.60		3.96	3.69	17.09	17.29
VHT20	MCS0	1	1	2412	18.60	18.64		3.96	3.69	22.56	22.33
VHT20	MCS0	1	2	2417	21.50	21.56		3.96	3.69	25.46	25.25
VHT20	MCS0	1	6	2437	23.30	23.37		3.96	3.69	27.26	27.06
VHT20	MCS0	1	10	2457	21.93	22.05		3.96	3.69	25.89	25.74



Mod.	Data Rate	NTX	CH.	Freq. (MHz)	Peak Conducted Power (dBm)			DG (dBi)		EIRP Power (dBm)	
					Ant 1	Ant 2	SUM	Ant 1	Ant 2	Ant 1	Ant 2
VHT20	MCS0	1	11	2462	19.44	19.51		3.96	3.69	23.40	23.20
VHT40	MCS0	1	3	2422	15.72	15.68		3.96	3.69	19.68	19.37
VHT40	MCS0	1	4	2427	17.11	16.40		3.96	3.69	21.07	20.09
VHT40	MCS0	1	6	2437	20.36	20.37		3.96	3.69	24.32	24.06
VHT40	MCS0	1	8	2447	20.47	20.35		3.96	3.69	24.43	24.04
VHT40	MCS0	1	9	2452	17.32	16.38		3.96	3.69	21.28	20.07
VHT40	MCS0	1	10	2457	16.10	16.62		3.96	3.69	20.06	20.31
VHT40	MCS0	1	11	2462	13.30	13.51		3.96	3.69	17.26	17.20



Mod.	Data Rate	NTX	CH.	Freq. (MHz)	Peak Conducted Power (dBm)			DG (dBi)		EIRP Power (dBm)	
					Ant 1	Ant 2	SUM	Ant 1	Ant 2	Ant 1	Ant 2
11b	1Mbps	2	1	2412	19.51	20.06	22.80	3.96		26.76	
11b	1Mbps	2	2	2417	21.45	21.74	24.61	3.96		28.57	
11b	1Mbps	2	6	2437	21.53	22.20	24.89	3.96		28.85	
11b	1Mbps	2	10	2457	20.90	21.11	24.02	3.96		27.98	
11b	1Mbps	2	11	2462	17.65	18.04	20.86	3.96		24.82	
11g	6Mbps	2	1	2412	19.30	19.84	22.59	3.96		26.55	
11g	6Mbps	2	2	2417	21.82	22.13	24.99	3.96		28.95	
11g	6Mbps	2	6	2437	23.00	23.11	26.07	3.96		30.03	
11g	6Mbps	2	10	2457	21.68	21.72	24.71	3.96		28.67	
11g	6Mbps	2	11	2462	19.25	19.38	22.33	3.96		26.29	
HT20	MCS0	2	1	2412	19.20	18.59	21.92	3.96		25.88	
HT20	MCS0	2	2	2417	21.21	21.51	24.37	3.96		28.33	
HT20	MCS0	2	6	2437	23.11	23.20	26.17	3.96		30.13	
HT20	MCS0	2	10	2457	22.16	22.48	25.33	3.96		29.29	
HT20	MCS0	2	11	2462	19.27	19.40	22.35	3.96		26.31	
HT40	MCS0	2	3	2422	15.55	15.51	18.54	3.96		22.50	
HT40	MCS0	2	4	2427	16.30	16.11	19.22	3.96		23.18	
HT40	MCS0	2	6	2437	19.48	20.41	22.98	3.96		26.94	
HT40	MCS0	2	8	2447	19.84	20.28	23.08	3.96		27.04	
HT40	MCS0	2	9	2452	16.21	16.21	19.22	3.96		23.18	
HT40	MCS0	2	10	2457	16.15	16.04	19.11	3.96		23.07	
HT40	MCS0	2	11	2462	13.20	13.46	16.34	3.96		20.30	



Mod.	Data Rate	NTX	CH.	Freq. (MHz)	Peak Conducted Power (dBm)			DG (dBi)		EIRP Power (dBm)	
					Ant 1	Ant 2	SUM	Ant 1	Ant 2	Ant 1	Ant 2
VHT20	MCS0	2	1	2412	18.62	18.77	21.71	3.96		25.67	
VHT20	MCS0	2	2	2417	21.24	21.45	24.36	3.96		28.32	
VHT20	MCS0	2	6	2437	23.07	23.27	26.18	3.96		30.14	
VHT20	MCS0	2	10	2457	22.02	22.05	25.05	3.96		29.01	
VHT20	MCS0	2	11	2462	19.16	19.30	22.24	3.96		26.20	
VHT40	MCS0	2	3	2422	16.02	15.81	18.93	3.96		22.89	
VHT40	MCS0	2	4	2427	16.43	16.37	19.41	3.96		23.37	
VHT40	MCS0	2	6	2437	20.06	20.36	23.22	3.96		27.18	
VHT40	MCS0	2	8	2447	20.23	20.47	23.36	3.96		27.32	
VHT40	MCS0	2	9	2452	16.57	17.20	19.91	3.96		23.87	
VHT40	MCS0	2	10	2457	16.47	15.94	19.22	3.96		23.18	
VHT40	MCS0	2	11	2462	13.34	13.31	16.34	3.96		20.30	



3.2.6 Test Result of Average output Power

<CDD Mode>

2.4GHz Band																		
Mod.	Data Rate	NTX	CH.	Freq. (MHz)	Duty Factor (dB)		Average Conducted Power (dBm)			Conducted Power Limit (dBm)		DG (dBi)		EIRP Power (dBm)		EIRP Power Limit (dBm)		Pass /Fail
					Ant 1	Ant 2	Ant 1	Ant 2	SUM	Ant 1	Ant 2	Ant 1	Ant 2	Ant 1	Ant 2	Ant 1	Ant 2	
11b	1Mbps	1	1	2412	0.06	0.06	18.76	15.44		30.00	30.00	3.96	3.69	22.72	19.13	36.00	36.00	Pass
11b	1Mbps	1	2	2417	0.06	0.06	18.84	19.03		30.00	30.00	3.96	3.69	22.80	22.72	36.00	36.00	Pass
11b	1Mbps	1	6	2437	0.06	0.06	20.08	20.81		30.00	30.00	3.96	3.69	24.04	24.50	36.00	36.00	Pass
11b	1Mbps	1	10	2457	0.06	0.06	19.46	21.00		30.00	30.00	3.96	3.69	23.42	24.69	36.00	36.00	Pass
11b	1Mbps	1	11	2462	0.06	0.06	19.44	16.18		30.00	30.00	3.96	3.69	23.40	19.87	36.00	36.00	Pass
11g	6Mbps	1	1	2412	0.30	0.35	14.08	15.86		30.00	30.00	3.96	3.69	18.04	19.55	36.00	36.00	Pass
11g	6Mbps	1	2	2417	0.30	0.35	18.27	16.95		30.00	30.00	3.96	3.69	22.23	20.64	36.00	36.00	Pass
11g	6Mbps	1	6	2437	0.30	0.35	20.25	20.65		30.00	30.00	3.96	3.69	24.21	24.34	36.00	36.00	Pass
11g	6Mbps	1	10	2457	0.30	0.35	16.16	16.98		30.00	30.00	3.96	3.69	20.12	20.67	36.00	36.00	Pass
11g	6Mbps	1	11	2462	0.30	0.35	14.77	13.14		30.00	30.00	3.96	3.69	18.73	16.83	36.00	36.00	Pass
HT20	MCS0	1	1	2412	0.38	0.31	11.34	11.27		30.00	30.00	3.96	3.69	15.30	14.96	36.00	36.00	Pass
HT20	MCS0	1	2	2417	0.38	0.31	14.71	14.71		30.00	30.00	3.96	3.69	18.67	18.40	36.00	36.00	Pass
HT20	MCS0	1	6	2437	0.38	0.31	18.13	17.99		30.00	30.00	3.96	3.69	22.09	21.68	36.00	36.00	Pass
HT20	MCS0	1	10	2457	0.38	0.31	15.30	15.47		30.00	30.00	3.96	3.69	19.26	19.16	36.00	36.00	Pass
HT20	MCS0	1	11	2462	0.38	0.31	12.03	12.02		30.00	30.00	3.96	3.69	15.99	15.71	36.00	36.00	Pass
HT40	MCS0	1	3	2422	0.61	0.67	8.54	8.67		30.00	30.00	3.96	3.69	12.50	12.36	36.00	36.00	Pass
HT40	MCS0	1	4	2427	0.61	0.67	9.36	9.39		30.00	30.00	3.96	3.69	13.32	13.08	36.00	36.00	Pass
HT40	MCS0	1	6	2437	0.61	0.67	12.71	12.65		30.00	30.00	3.96	3.69	16.67	16.34	36.00	36.00	Pass
HT40	MCS0	1	8	2442	0.61	0.67	12.61	12.69		30.00	30.00	3.96	3.69	16.57	16.38	36.00	36.00	Pass
HT40	MCS0	1	9	2452	0.61	0.67	9.36	9.38		30.00	30.00	3.96	3.69	13.32	13.07	36.00	36.00	Pass
HT40	MCS0	1	10	2457	0.61	0.67	8.97	9.00		30.00	30.00	3.96	3.69	12.93	12.69	36.00	36.00	Pass
HT40	MCS0	1	11	2462	0.61	0.67	6.29	6.31		30.00	30.00	3.96	3.69	10.25	10.00	36.00	36.00	Pass



2.4GHz Band																		
Mod.	Data Rate	NTX	CH.	Freq. (MHz)	Duty Factor (dB)		Average Conducted Power (dBm)			Conducted Power Limit (dBm)		DG (dBi)		EIRP Power (dBm)		EIRP Power Limit (dBm)		Pass /Fail
					Ant 1	Ant 2	Ant 1	Ant 2	SUM	Ant 1	Ant 2	Ant 1	Ant 2	Ant 1	Ant 2	Ant 1	Ant 2	
VHT20	MCS0	1	1	2412	0.37	0.37	11.37	11.38		30.00	30.00	3.96	3.69	15.33	15.07	36.00	36.00	Pass
VHT20	MCS0	1	2	2417	0.37	0.37	14.67	14.72		30.00	30.00	3.96	3.69	18.63	18.41	36.00	36.00	Pass
VHT20	MCS0	1	6	2437	0.37	0.37	18.08	18.08		30.00	30.00	3.96	3.69	22.04	21.77	36.00	36.00	Pass
VHT20	MCS0	1	10	2457	0.37	0.37	15.38	15.32		30.00	30.00	3.96	3.69	19.34	19.01	36.00	36.00	Pass
VHT20	MCS0	1	11	2462	0.37	0.37	12.13	12.12		30.00	30.00	3.96	3.69	16.09	15.81	36.00	36.00	Pass
VHT40	MCS0	1	3	2422	0.60	0.66	8.70	8.89		30.00	30.00	3.96	3.69	12.66	12.58	36.00	36.00	Pass
VHT40	MCS0	1	4	2427	0.60	0.66	9.41	9.41		30.00	30.00	3.96	3.69	13.37	13.10	36.00	36.00	Pass
VHT40	MCS0	1	6	2437	0.60	0.66	12.75	12.81		30.00	30.00	3.96	3.69	16.71	16.50	36.00	36.00	Pass
VHT40	MCS0	1	8	2442	0.60	0.66	12.70	12.66		30.00	30.00	3.96	3.69	16.66	16.35	36.00	36.00	Pass
VHT40	MCS0	1	9	2452	0.60	0.66	9.48	9.36		30.00	30.00	3.96	3.69	13.44	13.05	36.00	36.00	Pass
VHT40	MCS0	1	10	2457	0.60	0.66	9.00	9.12		30.00	30.00	3.96	3.69	12.96	12.81	36.00	36.00	Pass
VHT40	MCS0	1	11	2462	0.60	0.66	6.31	6.40		30.00	30.00	3.96	3.69	10.27	10.09	36.00	36.00	Pass



2.4GHz Band																		
Mod.	Data Rate	NTX	CH.	Freq. (MHz)	Duty Factor (dB)		Average Conducted Power (dBm)			Conducted Power Limit (dBm)		DG (dBi)		EIRP Power (dBm)		EIRP Power Limit (dBm)		Pass /Fail
					Ant 1	Ant 2	Ant 1	Ant 2	SUM	Ant 1	Ant 2	Ant 1	Ant 2	Ant 1	Ant 2	Ant 1	Ant 2	
11b	1Mbps	2	1	2412	0.06	0.06	16.25	16.74	19.51	30.00	3.96	23.47	36.00	Pass				
11b	1Mbps	2	2	2417	0.06	0.06	18.28	18.57	21.44	30.00	3.96	25.40	36.00	Pass				
11b	1Mbps	2	6	2437	0.06	0.06	18.36	19.19	21.81	30.00	3.96	25.77	36.00	Pass				
11b	1Mbps	2	10	2457	0.06	0.06	17.65	17.89	20.78	30.00	3.96	24.74	36.00	Pass				
11b	1Mbps	2	11	2462	0.06	0.06	14.43	14.61	17.53	30.00	3.96	21.49	36.00	Pass				
11g	6Mbps	2	1	2412	0.35	0.35	12.46	12.88	15.69	30.00	3.96	19.65	36.00	Pass				
11g	6Mbps	2	2	2417	0.35	0.35	15.35	15.70	18.54	30.00	3.96	22.50	36.00	Pass				
11g	6Mbps	2	6	2437	0.35	0.35	17.68	18.10	20.91	30.00	3.96	24.87	36.00	Pass				
11g	6Mbps	2	10	2457	0.35	0.35	15.40	15.25	18.34	30.00	3.96	22.30	36.00	Pass				
11g	6Mbps	2	11	2462	0.35	0.35	12.55	12.63	15.60	30.00	3.96	19.56	36.00	Pass				
HT20	MCS0	2	1	2412	0.38	0.38	11.38	11.33	14.36	30.00	3.96	18.32	36.00	Pass				
HT20	MCS0	2	2	2417	0.38	0.38	14.48	14.97	17.74	30.00	3.96	21.70	36.00	Pass				
HT20	MCS0	2	6	2437	0.38	0.38	17.88	18.35	21.13	30.00	3.96	25.09	36.00	Pass				
HT20	MCS0	2	10	2457	0.38	0.38	15.28	15.63	18.47	30.00	3.96	22.43	36.00	Pass				
HT20	MCS0	2	11	2462	0.38	0.38	11.99	12.20	15.10	30.00	3.96	19.06	36.00	Pass				
HT40	MCS0	2	3	2422	0.67	0.60	8.78	8.53	11.67	30.00	3.96	15.63	36.00	Pass				
HT40	MCS0	2	4	2427	0.67	0.60	9.52	9.27	12.41	30.00	3.96	16.37	36.00	Pass				
HT40	MCS0	2	6	2437	0.67	0.60	12.52	12.95	15.75	30.00	3.96	19.71	36.00	Pass				
HT40	MCS0	2	8	2442	0.67	0.60	12.59	12.95	15.79	30.00	3.96	19.75	36.00	Pass				
HT40	MCS0	2	9	2452	0.67	0.60	9.41	9.35	12.39	30.00	3.96	16.35	36.00	Pass				
HT40	MCS0	2	10	2457	0.67	0.60	9.07	9.08	12.09	30.00	3.96	16.05	36.00	Pass				
HT40	MCS0	2	11	2462	0.67	0.60	6.38	6.35	9.38	30.00	3.96	13.34	36.00	Pass				



2.4GHz Band																		
Mod.	Data Rate	NTX	CH.	Freq. (MHz)	Duty Factor (dB)		Average Conducted Power (dBm)			Conducted Power Limit (dBm)		DG (dBi)		EIRP Power (dBm)		EIRP Power Limit (dBm)		Pass /Fail
					Ant 1	Ant 2	Ant 1	Ant 2	SUM	Ant 1	Ant 2	Ant 1	Ant 2	Ant 1	Ant 2	Ant 1	Ant 2	
VHT20	MCS0	2	1	2412	0.37	0.37	11.24	11.51	14.39	30.00	3.96	18.35	36.00	Pass				
VHT20	MCS0	2	2	2417	0.37	0.37	14.62	14.86	17.75	30.00	3.96	21.71	36.00	Pass				
VHT20	MCS0	2	6	2437	0.37	0.37	17.87	18.38	21.15	30.00	3.96	25.11	36.00	Pass				
VHT20	MCS0	2	10	2457	0.37	0.37	15.37	15.57	18.48	30.00	3.96	22.44	36.00	Pass				
VHT20	MCS0	2	11	2462	0.37	0.37	12.07	12.23	15.16	30.00	3.96	19.12	36.00	Pass				
VHT40	MCS0	2	3	2422	0.60	0.60	8.88	8.88	11.89	30.00	3.96	15.85	36.00	Pass				
VHT40	MCS0	2	4	2427	0.60	0.60	9.51	9.30	12.42	30.00	3.96	16.38	36.00	Pass				
VHT40	MCS0	2	6	2437	0.60	0.60	12.62	12.99	15.82	30.00	3.96	19.78	36.00	Pass				
VHT40	MCS0	2	8	2442	0.60	0.60	12.72	12.85	15.80	30.00	3.96	19.76	36.00	Pass				
VHT40	MCS0	2	9	2452	0.60	0.60	9.55	9.39	12.49	30.00	3.96	16.45	36.00	Pass				
VHT40	MCS0	2	10	2457	0.60	0.60	9.30	8.90	12.12	30.00	3.96	16.08	36.00	Pass				
VHT40	MCS0	2	11	2462	0.60	0.60	6.40	6.40	9.41	30.00	3.96	13.37	36.00	Pass				



<TXBF Mode>

2.4GHz Band																
Mod.	Data Rate	NTX	CH.	Freq. (MHz)	Average Conducted Power (dBm)			Conducted Power Limit (dBm)		DG (dBi)		EIRP Power (dBm)		EIRP Power Limit (dBm)		Pass /Fail
					Ant 1	Ant 2	SUM	Ant 1	Ant 2	Ant 1	Ant 2	Ant 1	Ant 2	Ant 1	Ant 2	
HT20	MCS0	2	1	2412	14.00	14.20	17.11	29.16	29.16	6.84	6.84	23.95	23.95	36.00	36.00	Pass
HT20	MCS0	2	2	2417	16.70	17.10	19.91	29.16	29.16	6.84	6.84	26.75	26.75	36.00	36.00	Pass
HT20	MCS0	2	6	2437	19.30	19.80	22.57	29.16	29.16	6.84	6.84	29.40	29.40	36.00	36.00	Pass
HT20	MCS0	2	10	2457	16.40	16.60	19.51	29.16	29.16	6.84	6.84	26.35	26.35	36.00	36.00	Pass
HT20	MCS0	2	11	2462	13.20	13.30	16.26	29.16	29.16	6.84	6.84	23.10	23.10	36.00	36.00	Pass
HT40	MCS0	2	3	2422	12.20	12.60	15.41	29.16	29.16	6.84	6.84	22.25	22.25	36.00	36.00	Pass
HT40	MCS0	2	4	2427	11.10	11.70	14.42	29.16	29.16	6.84	6.84	21.26	21.26	36.00	36.00	Pass
HT40	MCS0	2	6	2437	14.00	14.40	17.21	29.16	29.16	6.84	6.84	24.05	24.05	36.00	36.00	Pass
HT40	MCS0	2	8	2442	14.00	14.30	17.16	29.16	29.16	6.84	6.84	24.00	24.00	36.00	36.00	Pass
HT40	MCS0	2	9	2452	13.60	14.40	17.03	29.16	29.16	6.84	6.84	23.87	23.87	36.00	36.00	Pass
HT40	MCS0	2	10	2457	14.20	14.90	17.57	29.16	29.16	6.84	6.84	24.41	24.41	36.00	36.00	Pass
HT40	MCS0	2	11	2462	9.30	9.60	12.46	29.16	29.16	6.84	6.84	19.30	19.30	36.00	36.00	Pass
VHT20	MCS0	2	1	2412	14.00	14.30	17.16	29.16	29.16	6.84	6.84	24.00	24.00	36.00	36.00	Pass
VHT20	MCS0	2	2	2417	16.80	17.10	19.96	29.16	29.16	6.84	6.84	26.80	26.80	36.00	36.00	Pass
VHT20	MCS0	2	6	2437	19.40	19.80	22.61	29.16	29.16	6.84	6.84	29.45	29.45	36.00	36.00	Pass
VHT20	MCS0	2	10	2457	16.40	16.70	19.56	29.16	29.16	6.84	6.84	26.40	26.40	36.00	36.00	Pass
VHT20	MCS0	2	11	2462	13.30	13.40	16.36	29.16	29.16	6.84	6.84	23.20	23.20	36.00	36.00	Pass
VHT40	MCS0	2	3	2422	12.20	12.70	15.47	29.16	29.16	6.84	6.84	22.30	22.30	36.00	36.00	Pass
VHT40	MCS0	2	4	2427	11.20	11.80	14.52	29.16	29.16	6.84	6.84	21.36	21.36	36.00	36.00	Pass
VHT40	MCS0	2	6	2437	14.10	14.40	17.26	29.16	29.16	6.84	6.84	24.10	24.10	36.00	36.00	Pass
VHT40	MCS0	2	8	2442	14.00	14.40	17.21	29.16	29.16	6.84	6.84	24.05	24.05	36.00	36.00	Pass
VHT40	MCS0	2	9	2452	13.70	14.40	17.07	29.16	29.16	6.84	6.84	23.91	23.91	36.00	36.00	Pass
VHT40	MCS0	2	10	2457	14.10	15.00	17.58	29.16	29.16	6.84	6.84	24.42	24.42	36.00	36.00	Pass
VHT40	MCS0	2	11	2462	9.40	9.60	12.51	29.16	29.16	6.84	6.84	19.35	19.35	36.00	36.00	Pass



3.3 Power Spectral Density Measurement

3.3.1 Limit of Power Spectral Density

The peak power spectral density shall not be greater than 8dBm in any 3kHz band at any time interval of continuous transmission.

3.3.2 Measuring Instruments

The measuring equipment is listed in the section 4 of this test report.



3.3.3 Test Procedures

CDD Modes

Method AVGPSD-2

1. The testing follows Measurement Procedure 10.2 Method PKPSD of FCC KDB Publication No. 558074 D01 DTS Meas. Guidance v04
2. The RF output of EUT was connected to the spectrum analyzer by RF cable and attenuator. The path loss was compensated to the results for each measurement.
3. Set to the maximum power setting and enable the EUT transmit continuously.
4. Make the measurement with the spectrum analyzer's resolution bandwidth (RBW) = 10 kHz. Video bandwidth VBW = 30 kHz In order to make an accurate measurement, set the span to 1.5 times DTS Channel Bandwidth. (6dB BW)
5. Number of points in sweep ≥ 2 Span / RBW. (This ensures that bin-to-bin spacing is \leq RBW/2, so that narrowband signals are not lost between frequency bins).
6. Detector = RMS, Sweep time = auto couple.
7. Trace average at least 100 traces in power averaging mode.
8. Add $10 \log(1/x)$, where x is the duty cycle, to the measured power in order to compute the average power during the actual transmission times. For example, add $10 \log(1/0.25) = 6$ dB if the duty cycle is 25 percent.
9. Measure and record the results in the test report. For MIMO mode, calculation method follows FCC KDB 662911 D01 Multiple Transmitter Output v02r01.
Method (c): Measure and add $10 \log(N_{ANT})$ dB.

With this technique, spectrum measurements are performed at each output of the device, but rather than summing the spectra or the spectral peaks across the outputs, the quantity $10 \log(N_{ANT})$ dB is added to each spectrum value before comparing to the emission limit. The addition of $10 \log(N_{ANT})$ dB serves to apportion the emission limit among the N_{ANT} outputs so that each output is permitted to contribute no more than $1/N_{ANT}^{\text{th}}$ of the PSD limit .

TXBF Modes**Method AVGPSD-3**

1. The testing follows Measurement Procedure 10.7 Method AVGPSD-3 of FCC KDB Publication No. 558074 D01 DTS Meas. Guidance v04.
2. The RF output of EUT was connected to the spectrum analyzer by RF cable and attenuator. The path loss was compensated to the results for each measurement.
3. Set to the maximum power setting and enable the EUT transmit continuously.
4. Make the measurement with the spectrum analyzer's resolution bandwidth (RBW) = 10 kHz. Video bandwidth VBW = 30 kHz In order to make an accurate measurement, set the span to 1.5 times DTS Channel Bandwidth. (6dB BW).
5. Number of points in sweep ≥ 2 Span / RBW. (This ensures that bin-to-bin spacing is \leq RBW/2, so that narrowband signals are not lost between frequency bins).
6. Detector = RMS, Sweep time = auto couple.
7. Trace mode = max hold.
8. Allow max hold to run for at least 60 seconds, or longer as needed to allow the trace to stabilize.
9. Measure and record the results in the test report. For MIMO mode, calculation method follows FCC KDB 662911 D01 Multiple Transmitter Output v02r01.

Method (c): Measure and add $10 \log(N_{\text{ANT}})$ dB.

With this technique, spectrum measurements are performed at each output of the device, but rather than summing the spectra or the spectral peaks across the outputs, the quantity $10 \log(N_{\text{ANT}})$ dB is added to each spectrum value before comparing to the emission limit. The addition of $10 \log(N_{\text{ANT}})$ dB serves to apportion the emission limit among the N_{ANT} outputs so that each output is permitted to contribute no more than $1/N_{\text{ANT}}^{\text{th}}$ of the PSD limit .

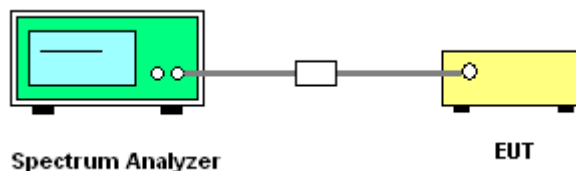
3.3.4 Test Setup



3.3.5 Test Result of Power Spectral Density

<CDD Mode>

2.4GHz Band												
Mod.	Data Rate	NTX	CH.	Freq. (MHz)	Average PSD (dBm/3kHz)			DG (dBi)		Average PSD Limit (dBm/3kHz)		Pass/Fail
					Ant 1	Ant 2	Worse + 3.01	Ant 1	Ant 2	Ant 1	Ant 2	
11b	1Mbps	1	1	2412	-6.91	-11.47	-	3.96	3.69	8.00	8.00	Pass
11b	1Mbps	1	6	2437	-6.35	-5.81		3.96	3.69	8.00	8.00	Pass
11b	1Mbps	1	11	2462	-6.07	-9.83		3.96	3.69	8.00	8.00	Pass
11g	6Mbps	1	1	2412	-12.80	-10.71		3.96	3.69	8.00	8.00	Pass
11g	6Mbps	1	6	2437	-6.30	-6.16		3.96	3.69	8.00	8.00	Pass
11g	6Mbps	1	11	2462	-11.67	-13.42		3.96	3.69	8.00	8.00	Pass
11b	1Mbps	2	1	2412	-9.32	-9.07	-6.06	6.84		7.16		Pass
11b	1Mbps	2	6	2437	-7.80	-7.23	-4.22	6.84		7.16		Pass
11b	1Mbps	2	11	2462	-11.61	-11.74	-8.60	6.84		7.16		Pass
11g	6Mbps	2	1	2412	-14.64	-14.79	-11.63	6.84		7.16		Pass
11g	6Mbps	2	6	2437	-9.59	-9.10	-6.09	6.84		7.16		Pass
11g	6Mbps	2	11	2462	-13.81	-14.12	-10.80	6.84		7.16		Pass
VHT20	MCS0	2	1	2412	-17.57	-16.35	-13.34	6.84		7.16		Pass
VHT20	MCS0	2	6	2437	-10.42	-9.86	-6.85	6.84		7.16		Pass
VHT20	MCS0	2	11	2462	-16.18	-14.99	-11.98	6.84		7.16		Pass
VHT40	MCS0	2	3	2422	-22.63	-22.17	-19.16	6.84		7.16		Pass
VHT40	MCS0	2	6	2437	-18.16	-17.78	-14.77	6.84		7.16		Pass
VHT40	MCS0	2	9	2452	-21.26	-21.29	-18.25	6.84		7.16		Pass
VHT40	MCS0	2	10	2457	-20.89	-20.79	-17.78	6.84		7.16		Pass
VHT40	MCS0	2	11	2462	-24.44	-24.31	-21.30	6.84		7.16		Pass



Worst Case Power Density (dBm/3kHz) for MIMO Ant. 1

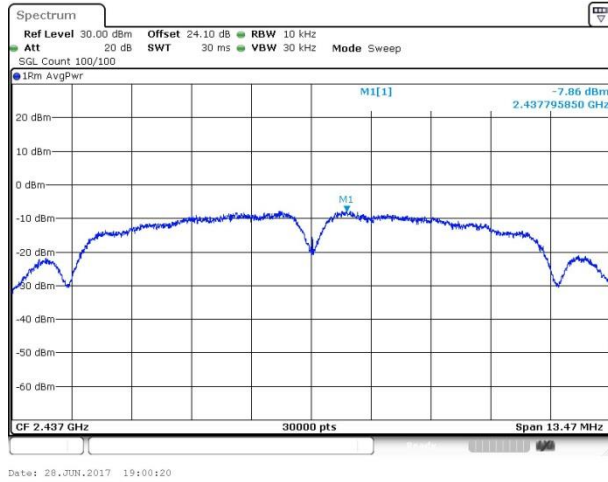

Worst Case Power Density (dBm/3kHz) for MIMO Ant. 2

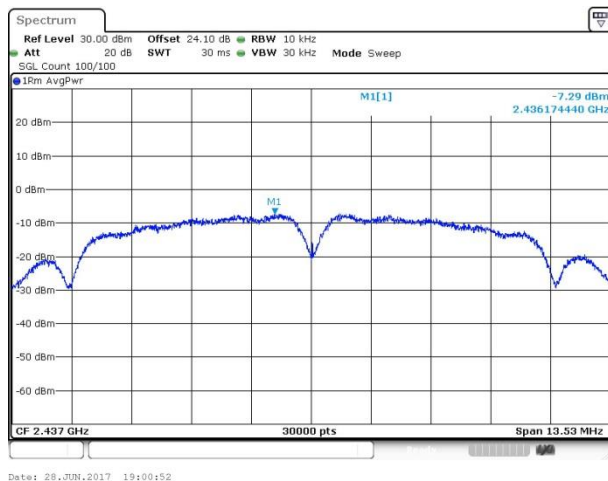

Note: Average Power Density (dB) = Measured value+ Duty Factor



<TXBF Mode>

2.4GHz Band												
Mod.	Data Rate	NTX	CH.	Freq. (MHz)	Average PSD (dBm/3kHz)			DG (dBi)		Average PSD Limit (dBm/3kHz)		Pass/Fail
					Ant 1	Ant 2	Worse + 3.01	Ant 1	Ant 2	Ant 1	Ant 2	
VHT20	MCS0	2	1	2412	-8.52	-7.57	-4.56	6.84		7.16		Pass
VHT20	MCS0	2	6	2437	-2.60	-1.59	1.42	6.84		7.16		Pass
VHT20	MCS0	2	11	2462	-8.42	-7.96	-4.95	6.84		7.16		Pass
VHT40	MCS0	2	3	2422	-9.34	-8.88	-5.87	6.84		7.16		Pass
VHT40	MCS0	2	6	2437	-7.65	-7.55	-4.54	6.84		7.16		Pass
VHT40	MCS0	2	9	2452	-5.64	-7.40	-2.63	6.84		7.16		Pass
VHT40	MCS0	2	10	2457	-7.89	-7.24	-4.23	6.84		7.16		Pass
VHT40	MCS0	2	11	2462	-11.00	-12.58	-7.99	6.84		7.16		Pass



Worst Case Power Density (dBm/3kHz) for MIMO Ant. 1

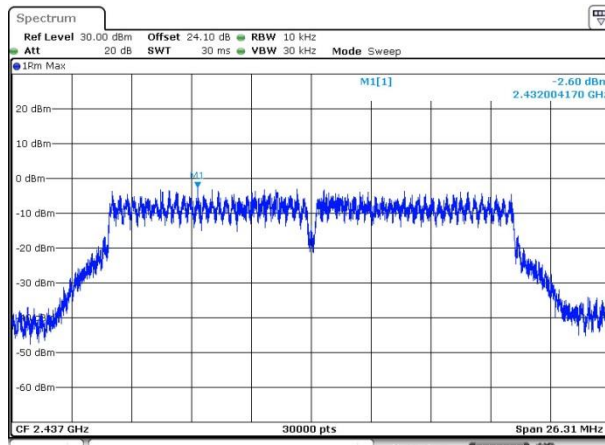

Date: 13.JUL.2017 19:16:22

Worst Case Power Density (dBm/3kHz) for MIMO Ant. 2

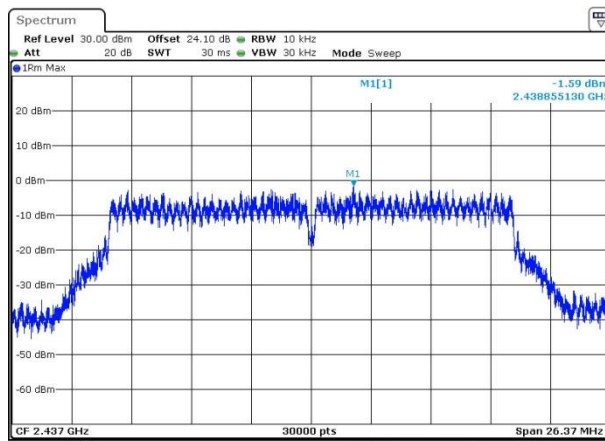

Date: 13.JUL.2017 19:16:55

Note: Average Power Density (dB) = Measured value+ Duty Factor

3.4 Conducted Band Edges and Spurious Emission Measurement

3.4.1 Limit of Conducted Band Edges and Spurious Emission Measurement

In any 100 kHz bandwidth outside of the authorized frequency band, the emissions which fall in the non-restricted bands shall be attenuated at least 20 dB / 30dB relative to the maximum PSD level in 100 kHz by RF conducted measurement and radiated emissions which fall in the restricted bands, as defined in Section 15.205(a), must also comply with the radiated emission limits specified in Section 15.209(a).

3.4.2 Measuring Instruments

The measuring equipment is listed in the section 4 of this test report.

3.4.3 Test Procedures

1. The testing follows FCC KDB Publication No. 558074 D01 DTS Meas. Guidance v04.
2. The RF output of EUT was connected to the spectrum analyzer by RF cable and attenuator. The path loss was compensated to the results for each measurement.
3. Set to the maximum power setting and enable the EUT transmit continuously.
4. Set RBW = 100 kHz, VBW=300 kHz, Peak Detector. Unwanted Emissions measured in any 100 kHz bandwidth outside of the authorized frequency band shall be attenuated by at least 20 dB relative to the maximum in-band peak PSD level in 100 kHz when maximum peak conducted output power procedure is used. If the transmitter complies with the conducted power limits based on the use of RMS averaging over a time interval, the attenuation required under this paragraph shall be 30 dB instead of 20 dB per 15.247(d).
5. Measure and record the results in the test report.
6. The RF fundamental frequency should be excluded against the limit line in the operating frequency band.

3.4.4 Test Setup

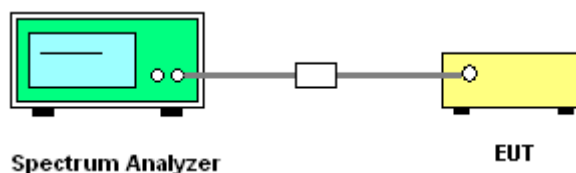



3.4.5 Test Result of Conducted Band Edges and Spurious Emission

<CDD Mode>

Number of TX = 1, Ant. 1 (Measured)

Number of TX	1	Ant. :	1
Test Mode :	802.11b	Temperature :	21~25°C
Test Band :	2.4GHz Low	Relative Humidity :	51~54%
Test Channel :	01	Test Engineer :	Derek Hsu

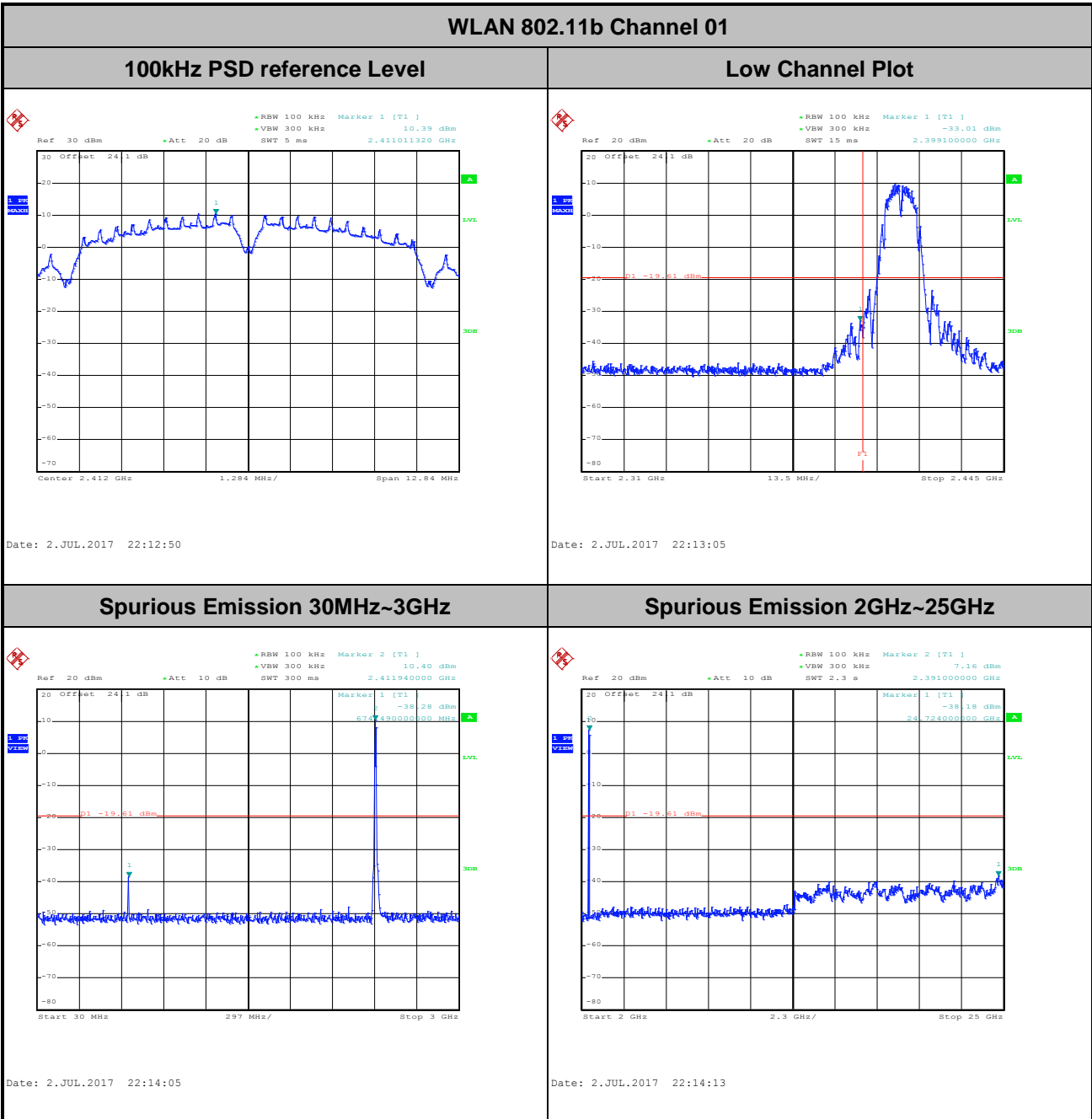



Number of TX :	1	Ant. :	1
Test Mode :	802.11b	Temperature :	21~25°C
Test Band :	2.4GHz Mid	Relative Humidity :	51~54%
Test Channel :	06	Test Engineer :	Derek Hsu

WLAN 802.11b Channel 06

100kHz PSD reference Level

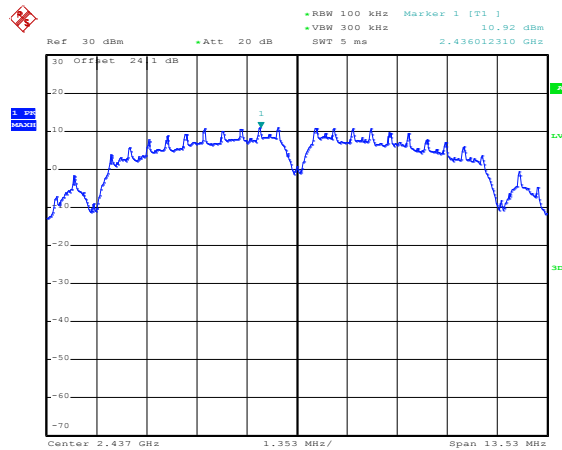

Date: 2.JUL.2017 22:24:08

Spurious Emission 30MHz~3GHz

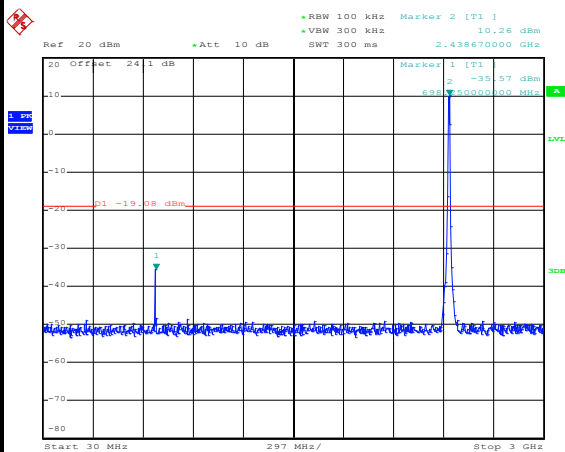

Date: 2.JUL.2017 22:24:26

Spurious Emission 2GHz~25GHz

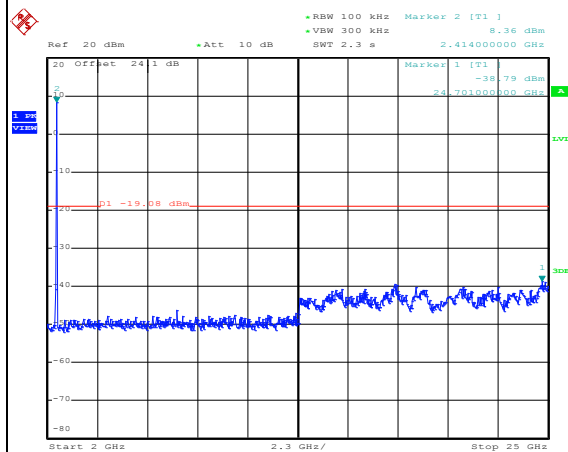

Date: 2.JUL.2017 22:24:34



Number of TX :	1	Ant. :	1
Test Mode :	802.11b	Temperature :	21~25°C
Test Band :	2.4GHz High	Relative Humidity :	51~54%
Test Channel :	11	Test Engineer :	Derek Hsu

WLAN 802.11b Channel 11

100kHz PSD reference Level

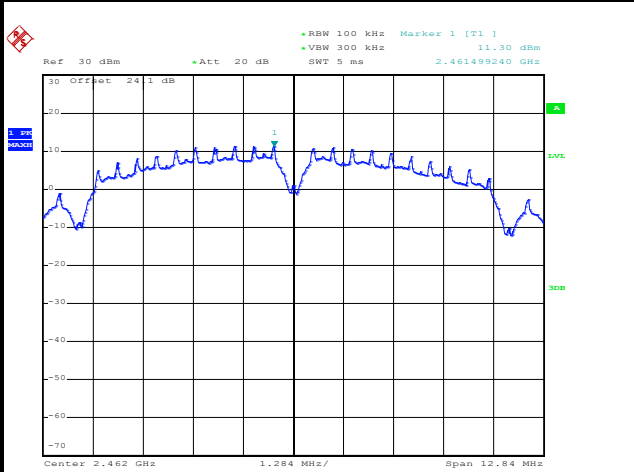

Date: 2.JUL.2017 22:28:30

High Channel Plot

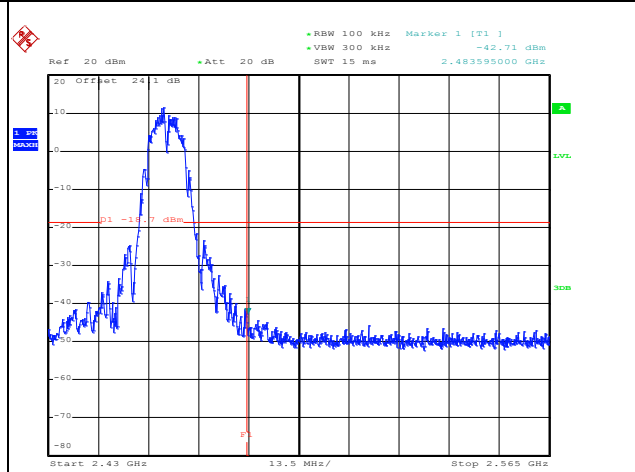

Date: 2.JUL.2017 22:29:09

Spurious Emission 30MHz~3GHz

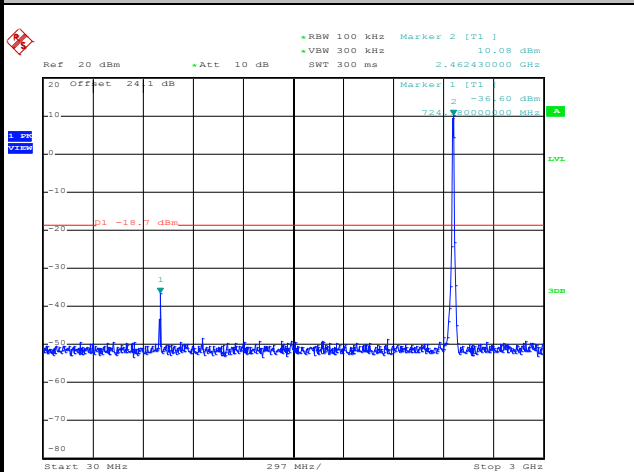

Date: 2.JUL.2017 22:29:20

Spurious Emission 2GHz~25GHz

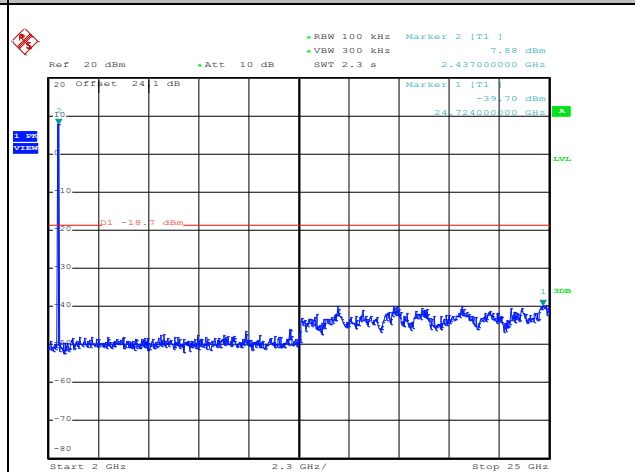

Date: 2.JUL.2017 22:29:29



Number of TX :	1	Ant. :	1
Test Mode :	802.11g	Temperature :	21~25°C
Test Band :	2.4GHz Low	Relative Humidity :	51~54%
Test Channel :	01	Test Engineer :	Derek Hsu

WLAN 802.11g Channel 01

100kHz PSD reference Level

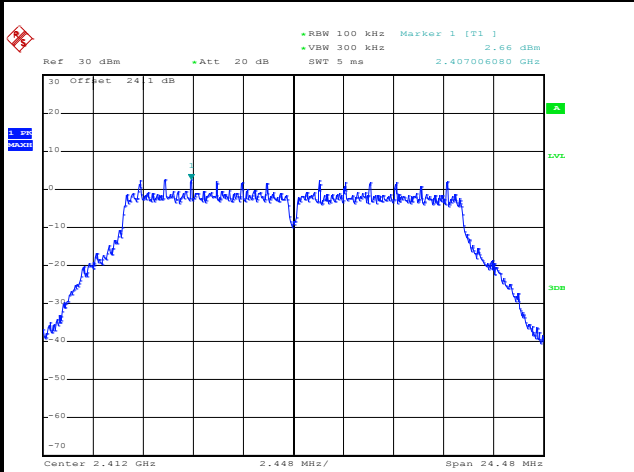

Date: 2.JUL.2017 23:29:34

Low Channel Plot

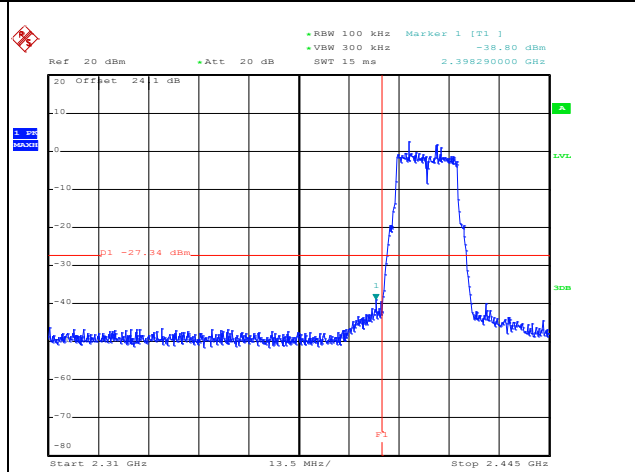

Date: 2.JUL.2017 23:30:04

Spurious Emission 30MHz~3GHz

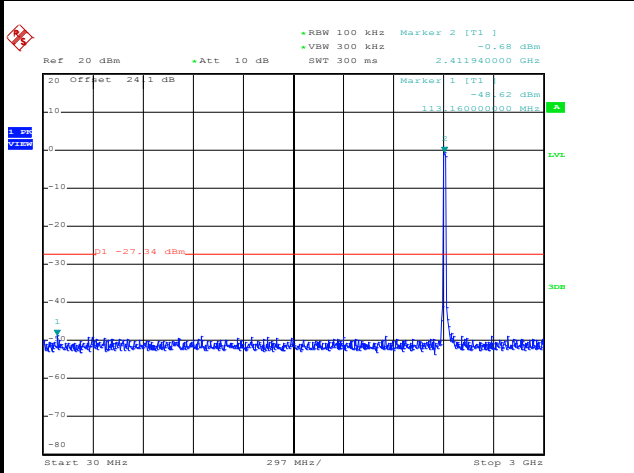

Date: 2.JUL.2017 23:30:17

Spurious Emission 2GHz~25GHz

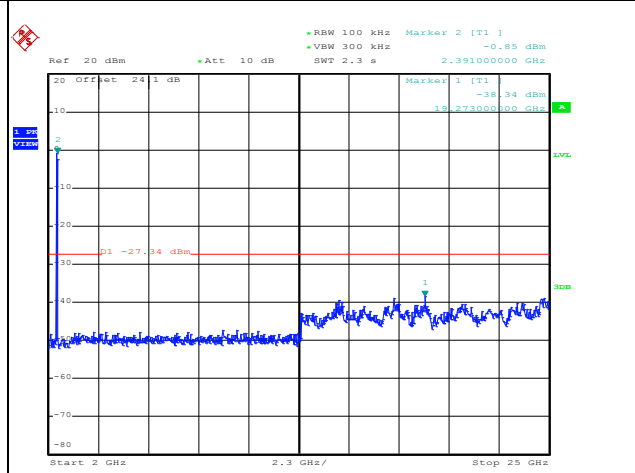

Date: 2.JUL.2017 23:30:25



Number of TX :	1	Ant. :	1
Test Mode :	802.11g	Temperature :	21~25°C
Test Band :	2.4GHz Mid	Relative Humidity :	51~54%
Test Channel :	06	Test Engineer :	Derek Hsu

WLAN 802.11g Channel 06

100kHz PSD reference Level

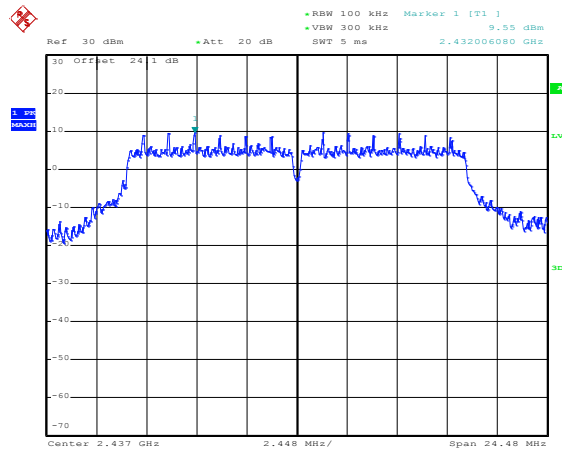

Date: 2.JUL.2017 23:32:32

Spurious Emission 30MHz~3GHz

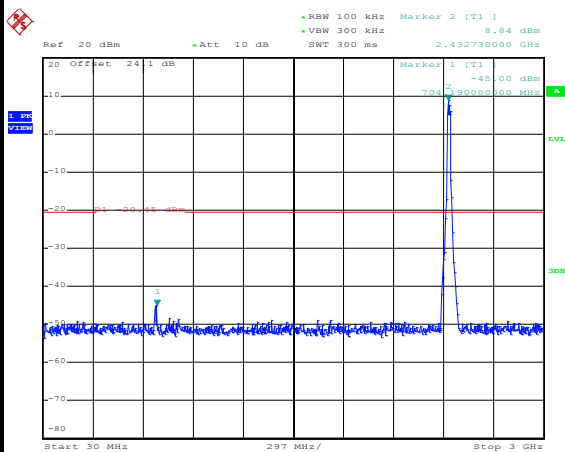

Date: 2.JUL.2017 23:32:47

Spurious Emission 2GHz~25GHz

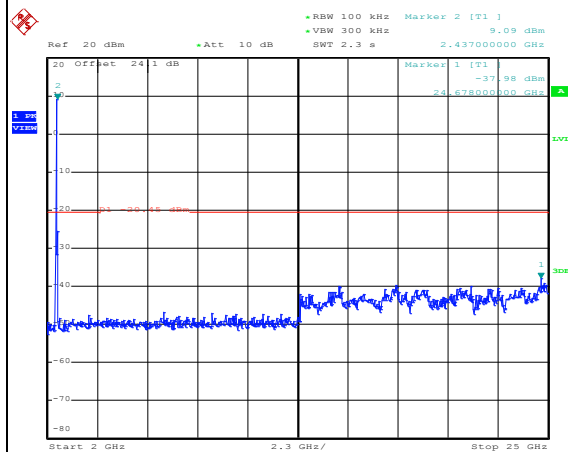

Date: 2.JUL.2017 23:32:55



Number of TX :	1	Ant. :	1
Test Mode :	802.11g	Temperature :	21~25°C
Test Band :	2.4GHz High	Relative Humidity :	51~54%
Test Channel :	11	Test Engineer :	Derek Hsu

WLAN 802.11g Channel 11

100kHz PSD reference Level

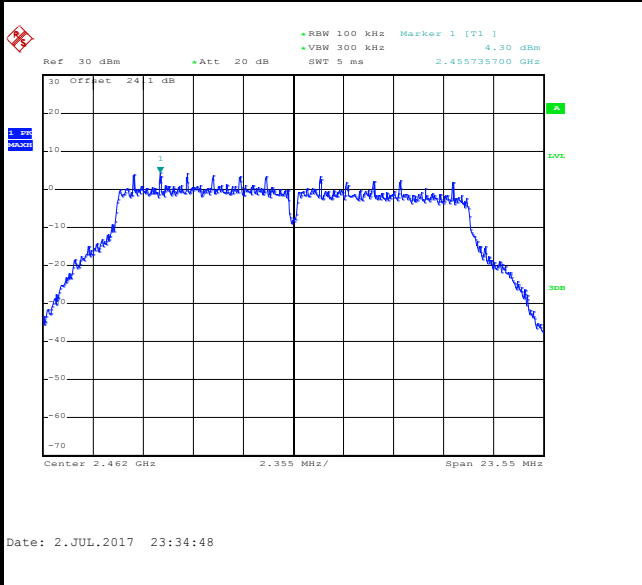

High Channel Plot

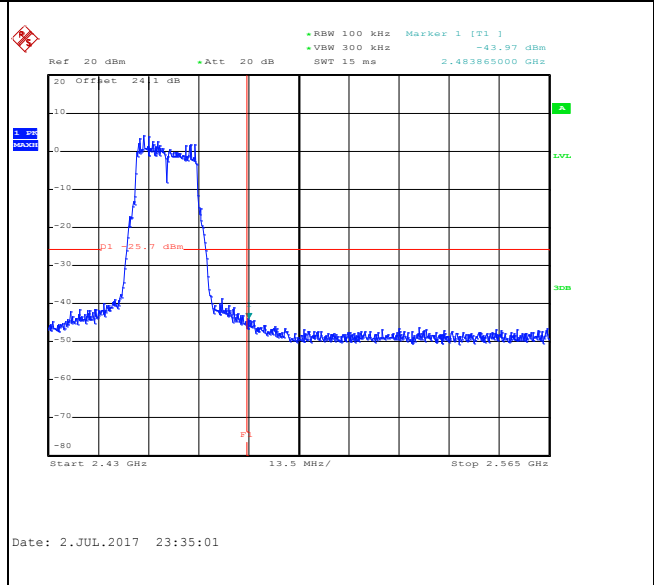

Spurious Emission 30MHz~3GHz

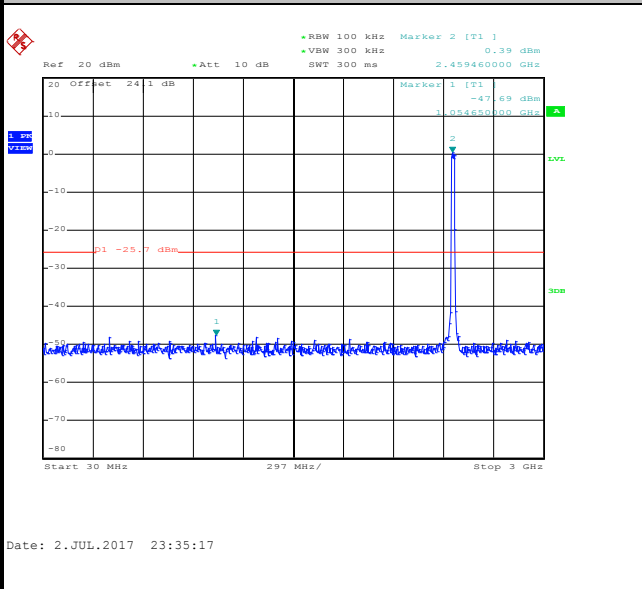

Spurious Emission 2GHz~25GHz

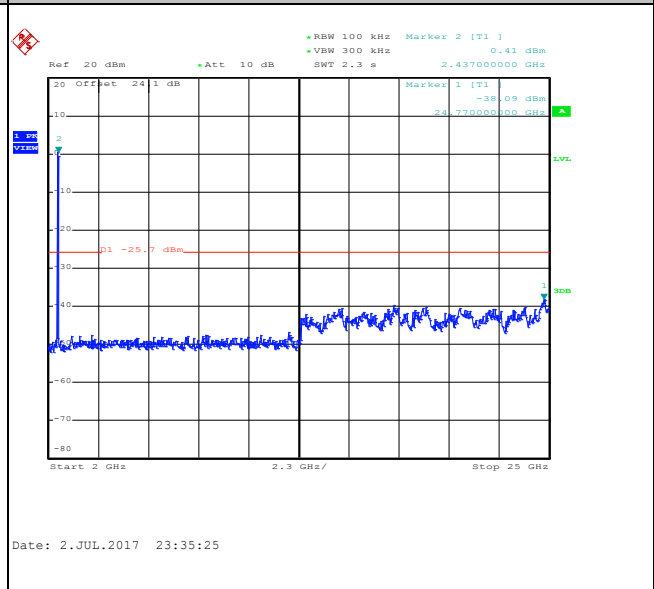



Number of TX = 1, Ant. 2 (Measured)

Number of TX	1	Ant. :	2
Test Mode :	802.11b	Temperature :	21~25°C
Test Band :	2.4GHz Low	Relative Humidity :	51~54%
Test Channel :	01	Test Engineer :	Derek Hsu

WLAN 802.11b Channel 01

100kHz PSD reference Level

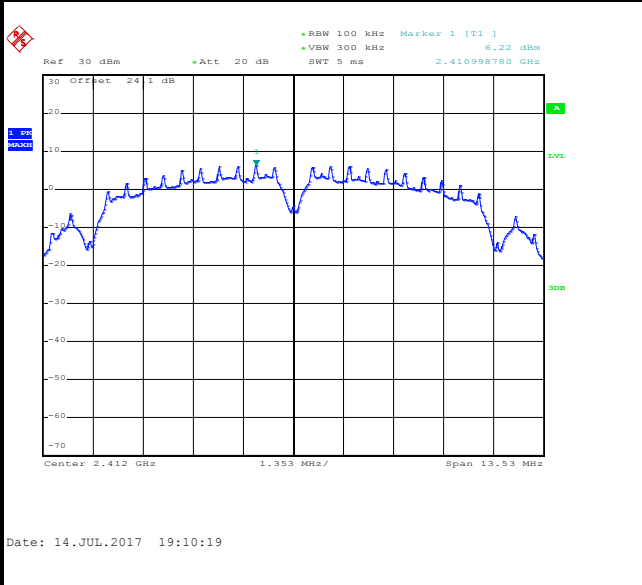

Low Channel Plot

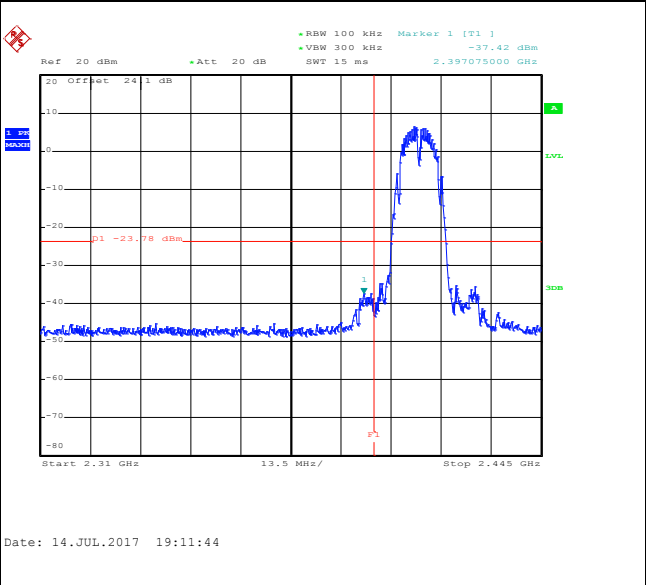

Spurious Emission 30MHz~3GHz

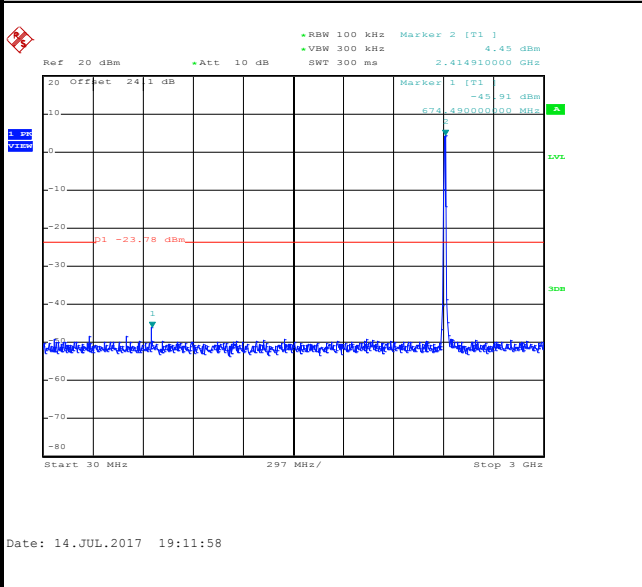

Spurious Emission 2GHz~25GHz

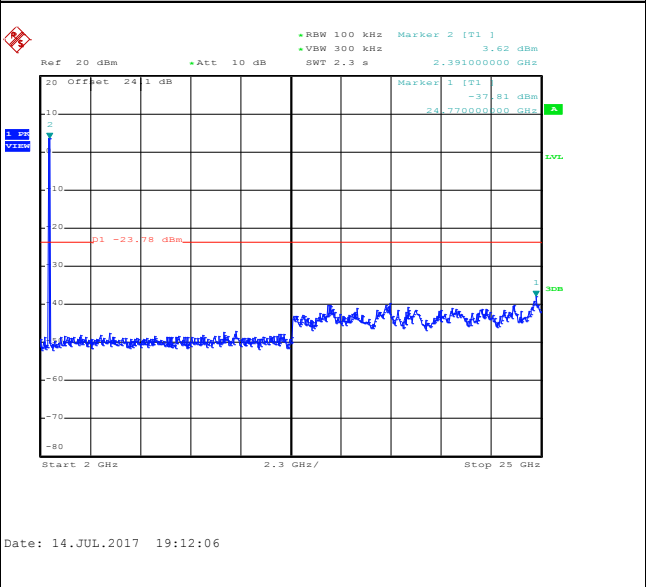



Number of TX :	1	Ant. :	2
Test Mode :	802.11b	Temperature :	21~25°C
Test Band :	2.4GHz Mid	Relative Humidity :	51~54%
Test Channel :	06	Test Engineer :	Derek Hsu

WLAN 802.11b Channel 06

100kHz PSD reference Level

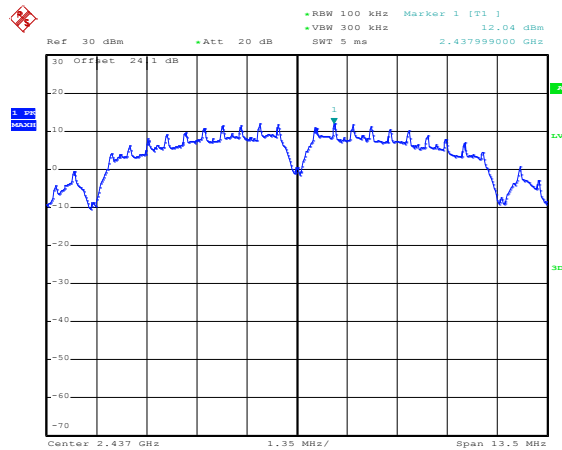

Date: 2.JUL.2017 22:59:30

Spurious Emission 30MHz~3GHz

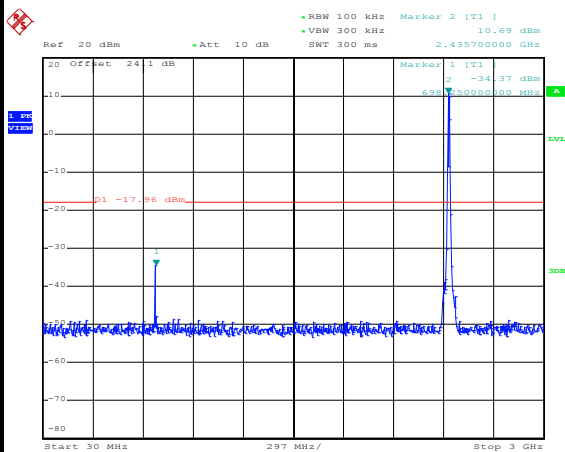

Date: 2.JUL.2017 22:59:58

Spurious Emission 2GHz~25GHz

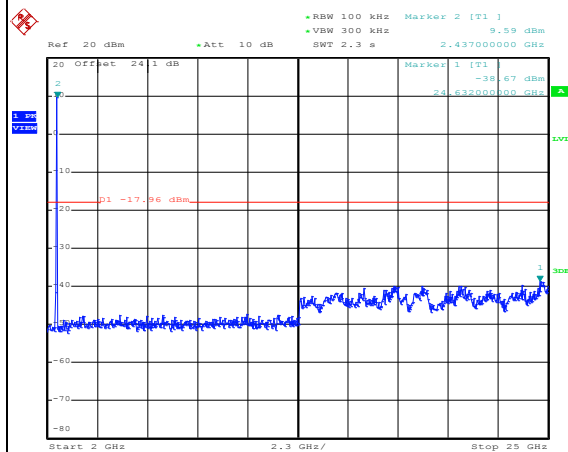

Date: 2.JUL.2017 23:00:07



Number of TX :	1	Ant. :	2
Test Mode :	802.11b	Temperature :	21~25°C
Test Band :	2.4GHz High	Relative Humidity :	51~54%
Test Channel :	11	Test Engineer :	Derek Hsu

WLAN 802.11b Channel 11

100kHz PSD reference Level

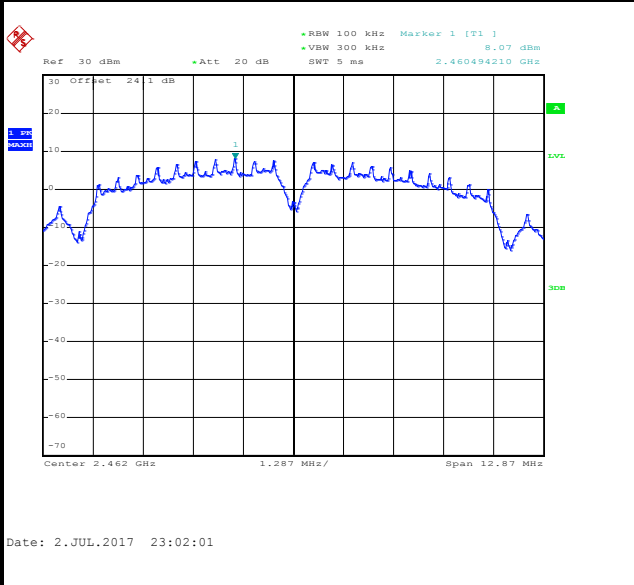

High Channel Plot

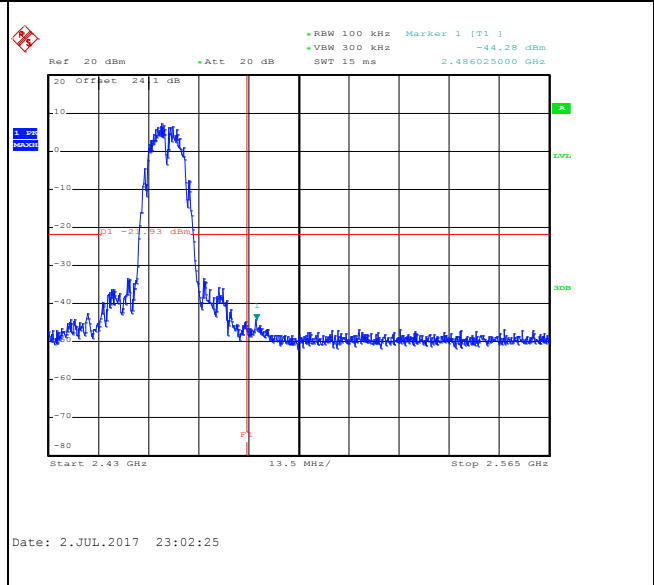

Spurious Emission 30MHz~3GHz

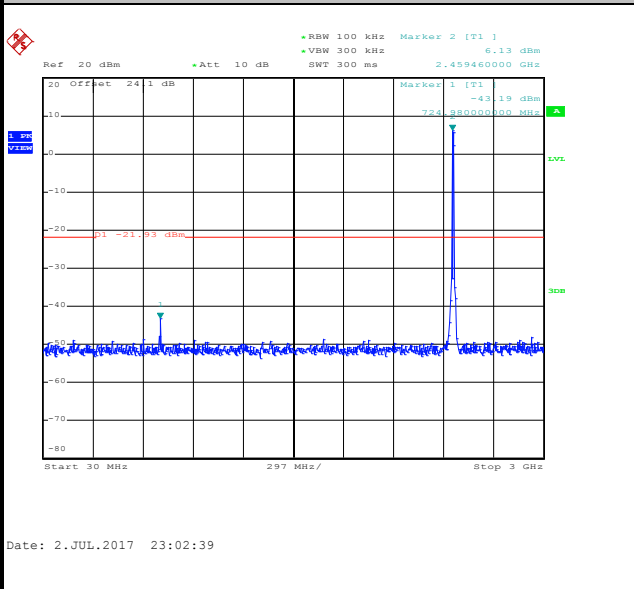

Spurious Emission 2GHz~25GHz

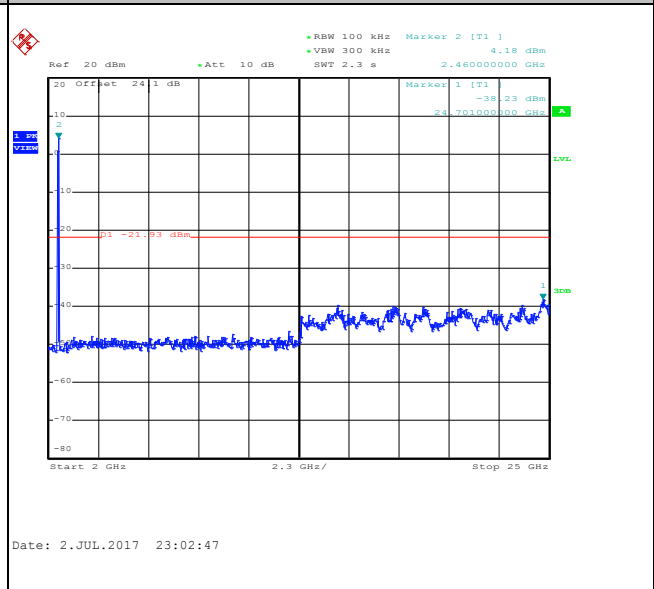



Number of TX :	1	Ant. :	2
Test Mode :	802.11g	Temperature :	21~25°C
Test Band :	2.4GHz Low	Relative Humidity :	51~54%
Test Channel :	01	Test Engineer :	Derek Hsu

WLAN 802.11g Channel 01

100kHz PSD reference Level

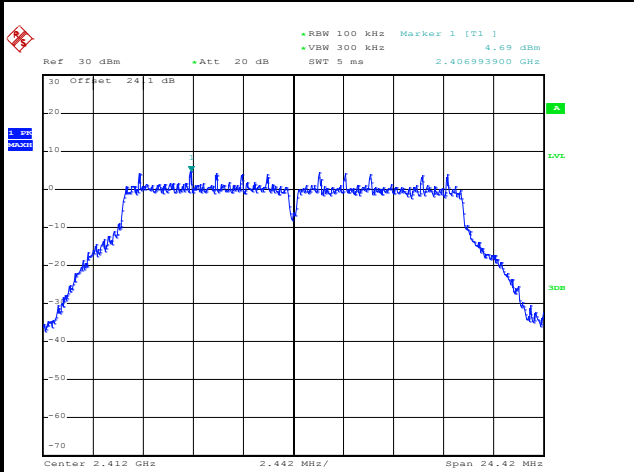

Date: 2.JUL.2017 23:39:55

Low Channel Plot

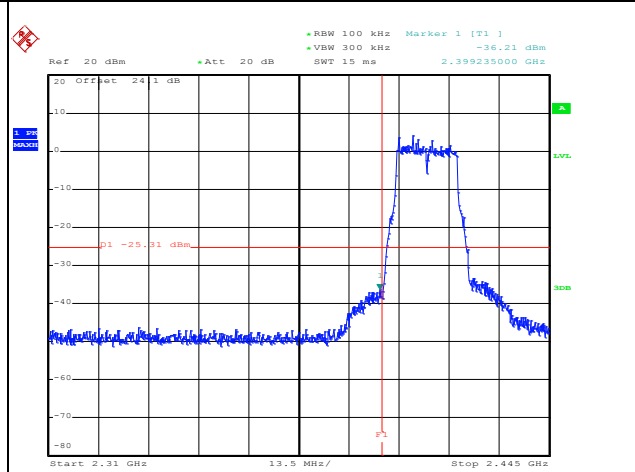

Date: 2.JUL.2017 23:40:19

Spurious Emission 30MHz~3GHz

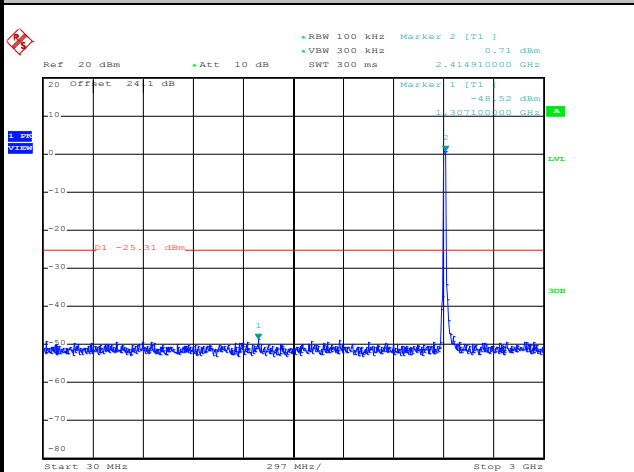

Date: 2.JUL.2017 23:40:32

Spurious Emission 2GHz~25GHz

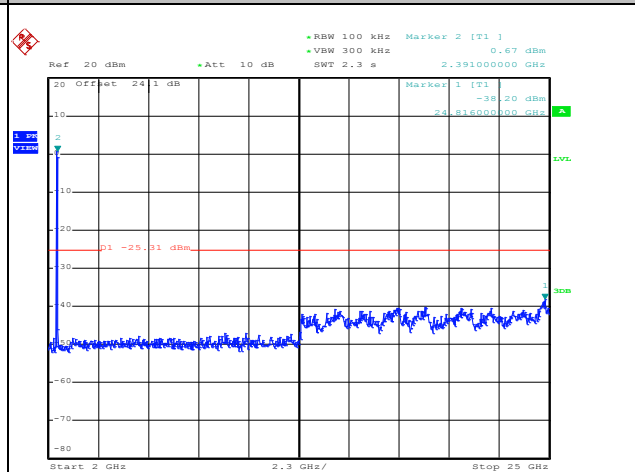

Date: 2.JUL.2017 23:40:40



Number of TX :	1	Ant. :	2
Test Mode :	802.11g	Temperature :	21~25°C
Test Band :	2.4GHz Mid	Relative Humidity :	51~54%
Test Channel :	06	Test Engineer :	Derek Hsu

WLAN 802.11g Channel 06

100kHz PSD reference Level

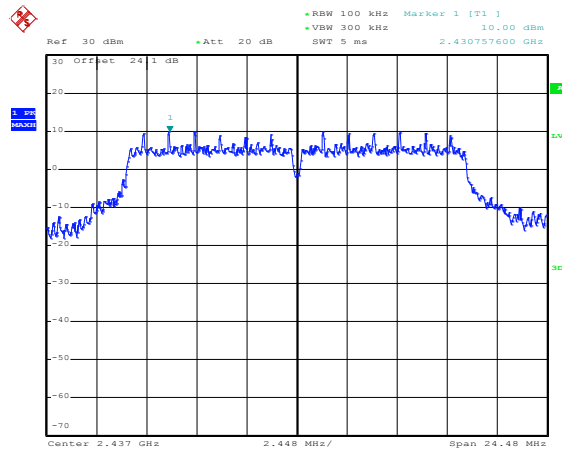

Date: 2.JUL.2017 23:41:55

Spurious Emission 30MHz~3GHz

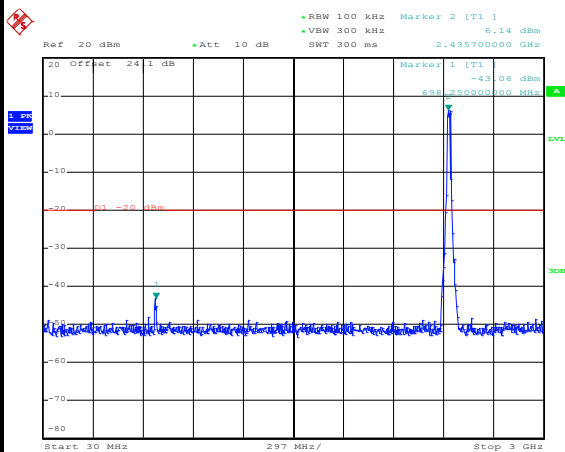

Date: 2.JUL.2017 23:42:06

Spurious Emission 2GHz~25GHz

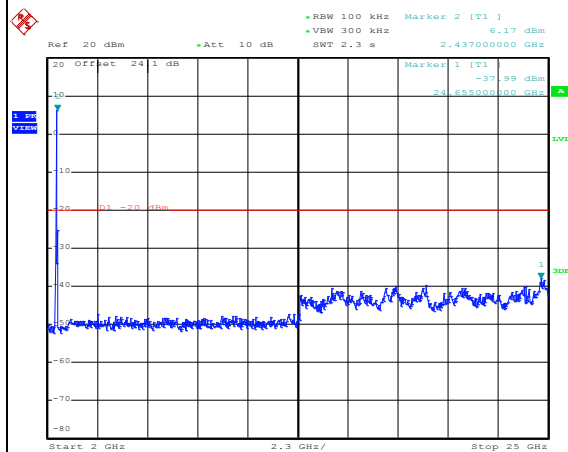

Date: 2.JUL.2017 23:42:14



Number of TX :	1	Ant. :	2
Test Mode :	802.11g	Temperature :	21~25°C
Test Band :	2.4GHz High	Relative Humidity :	51~54%
Test Channel :	11	Test Engineer :	Derek Hsu

WLAN 802.11g Channel 11

100kHz PSD reference Level

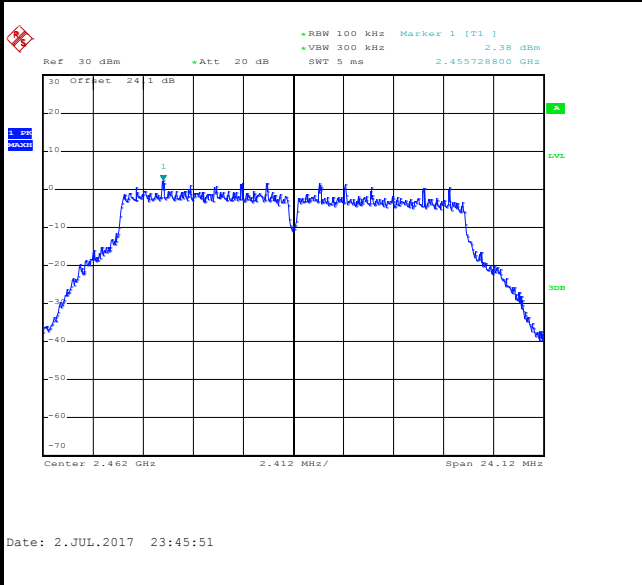

High Channel Plot

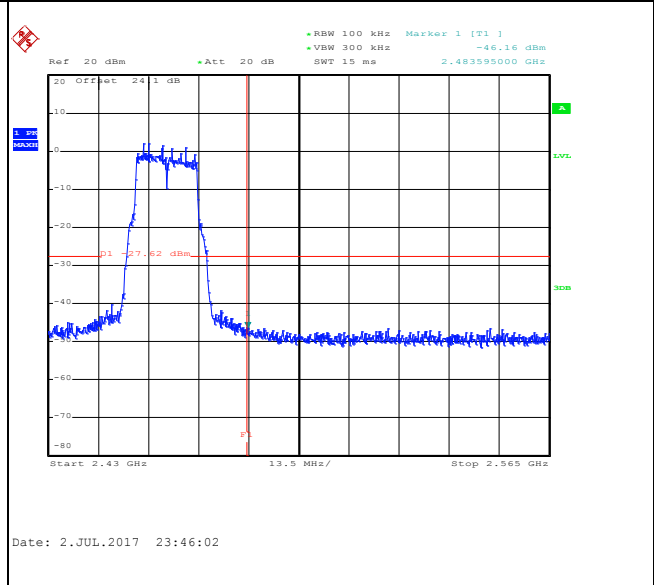

Spurious Emission 30MHz~3GHz

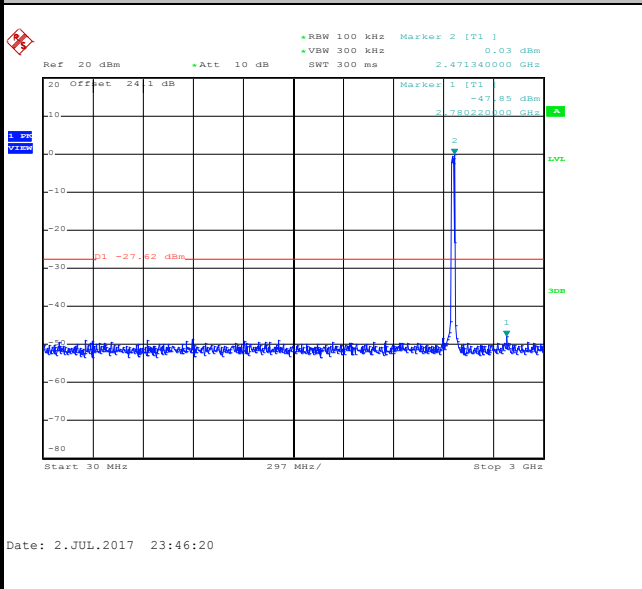

Spurious Emission 2GHz~25GHz

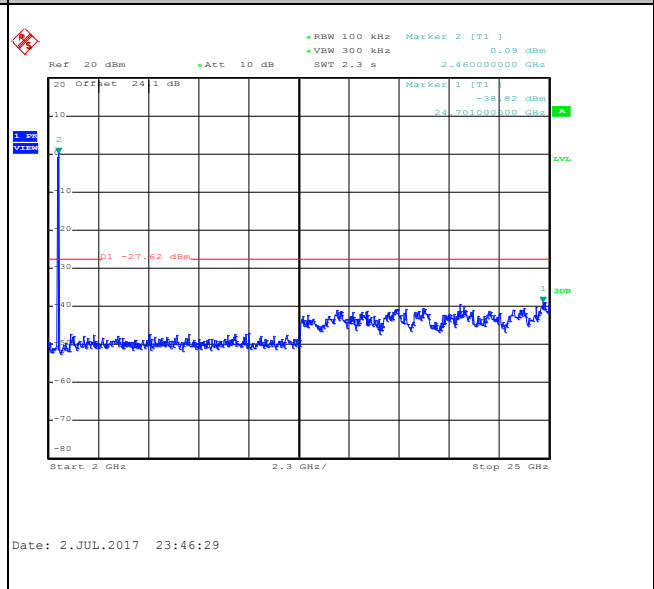



Number of TX = 2, Ant. 1 (Measured)

Number of TX	2	Ant. :	1
Test Mode :	802.11b	Temperature :	21~25°C
Test Band :	2.4GHz Low	Relative Humidity :	51~54%
Test Channel :	01	Test Engineer :	Derek Hsu

WLAN 802.11b Channel 01

100kHz PSD reference Level

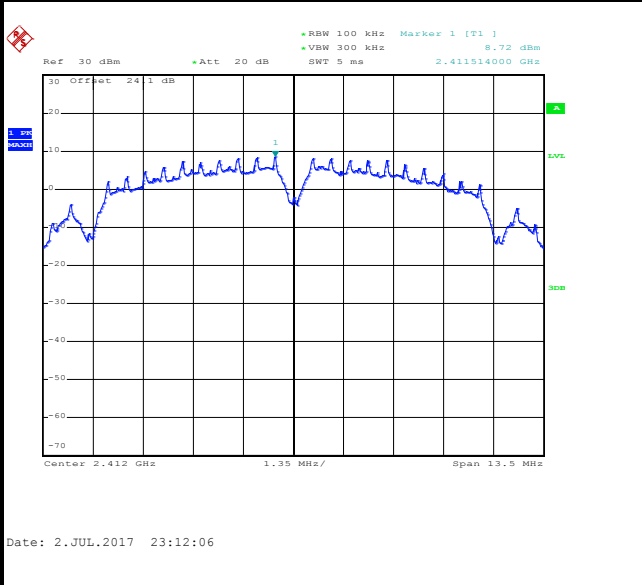

Low Channel Plot

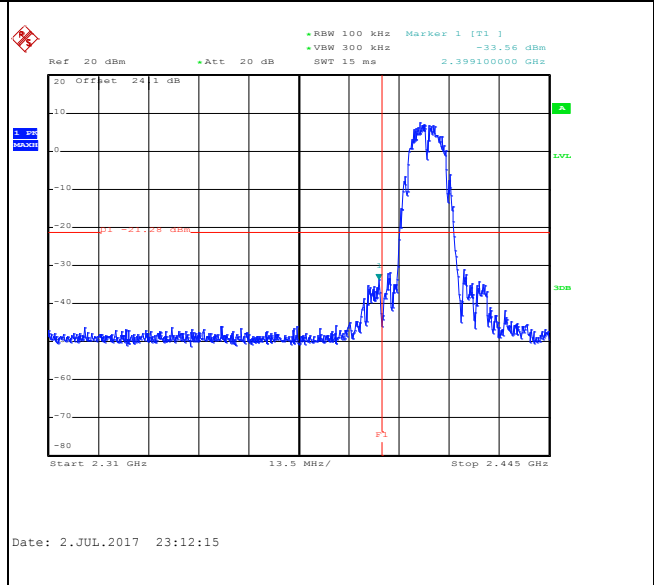

Spurious Emission 30MHz~3GHz

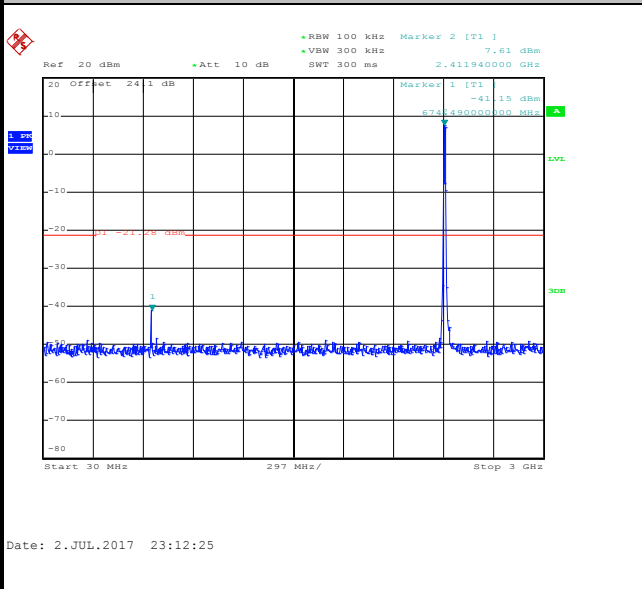

Spurious Emission 2GHz~25GHz

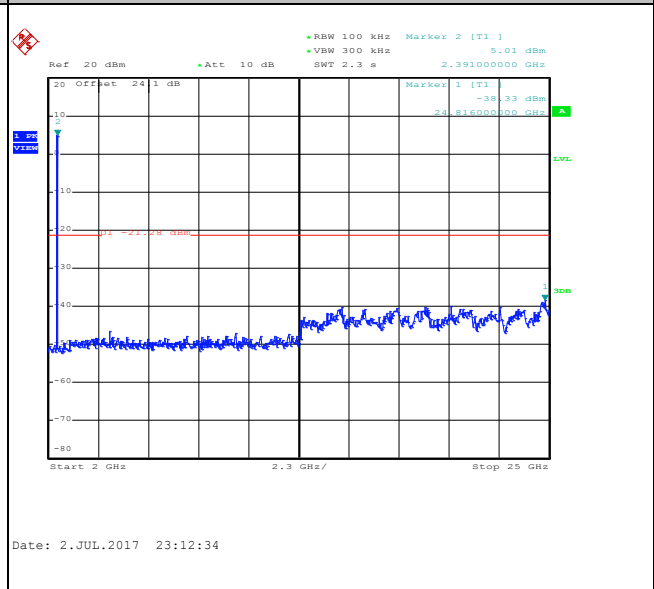



Number of TX :	2	Ant. :	1
Test Mode :	802.11b	Temperature :	21~25°C
Test Band :	2.4GHz Mid	Relative Humidity :	51~54%
Test Channel :	06	Test Engineer :	Derek Hsu

WLAN 802.11b Channel 06

100kHz PSD reference Level

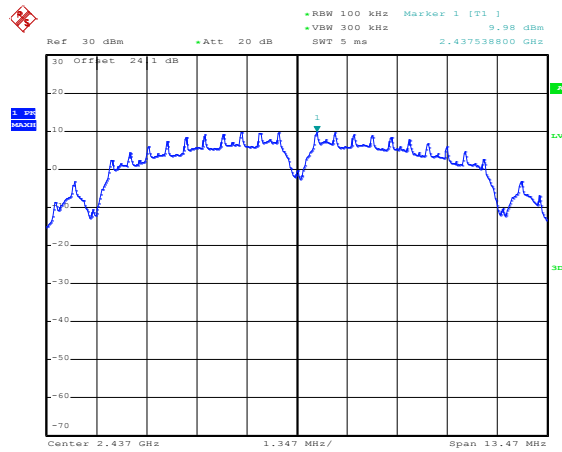

Date: 2.JUL.2017 23:17:04

Spurious Emission 30MHz~3GHz

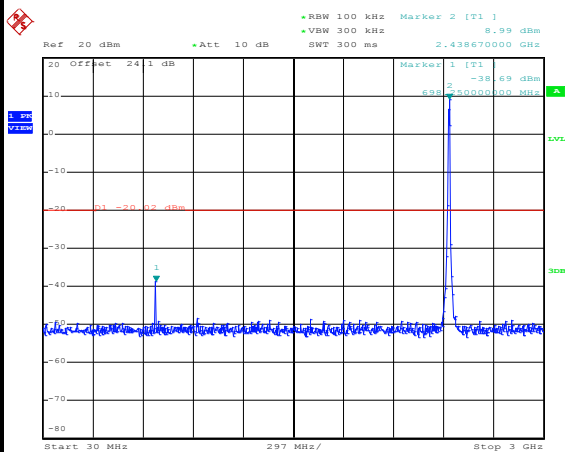

Date: 2.JUL.2017 23:17:20

Spurious Emission 2GHz~25GHz

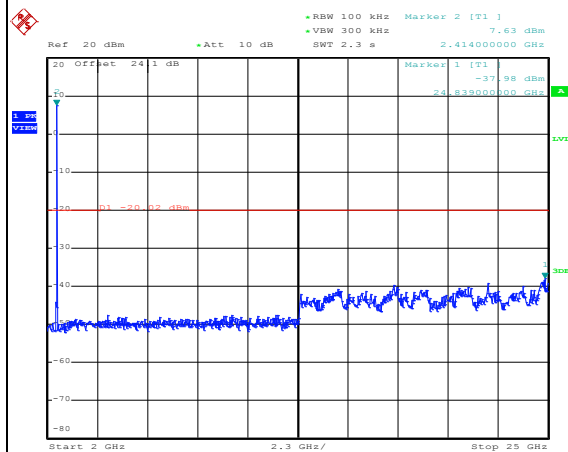

Date: 2.JUL.2017 23:17:29



Number of TX :	2	Ant. :	1
Test Mode :	802.11b	Temperature :	21~25°C
Test Band :	2.4GHz High	Relative Humidity :	51~54%
Test Channel :	11	Test Engineer :	Derek Hsu

WLAN 802.11b Channel 11

100kHz PSD reference Level

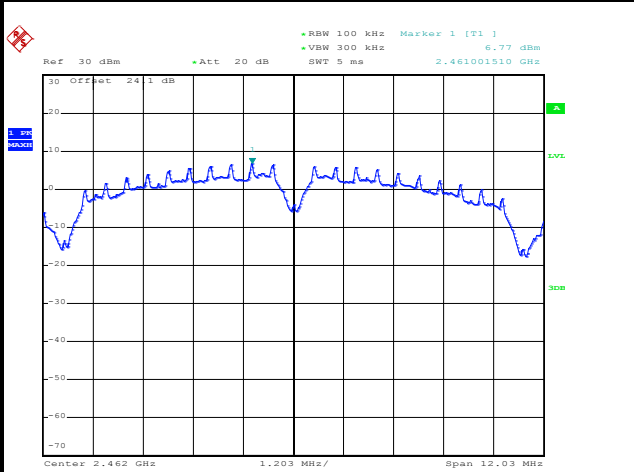

Date: 2.JUL.2017 23:21:45

High Channel Plot

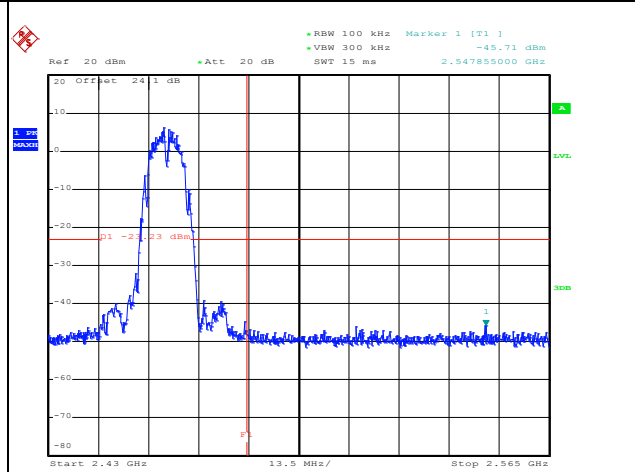

Date: 2.JUL.2017 23:21:54

Spurious Emission 30MHz~3GHz

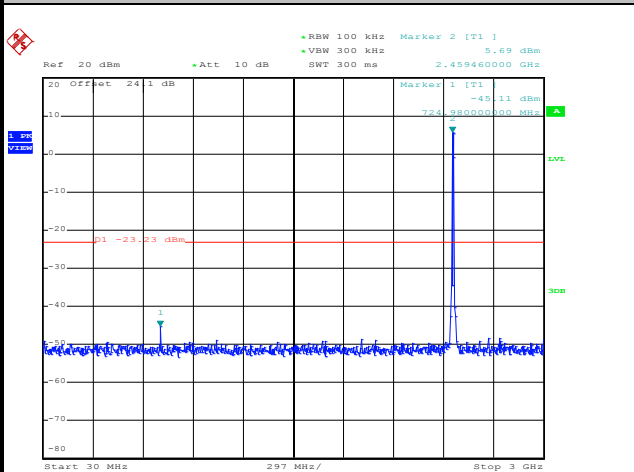

Date: 2.JUL.2017 23:22:08

Spurious Emission 2GHz~25GHz

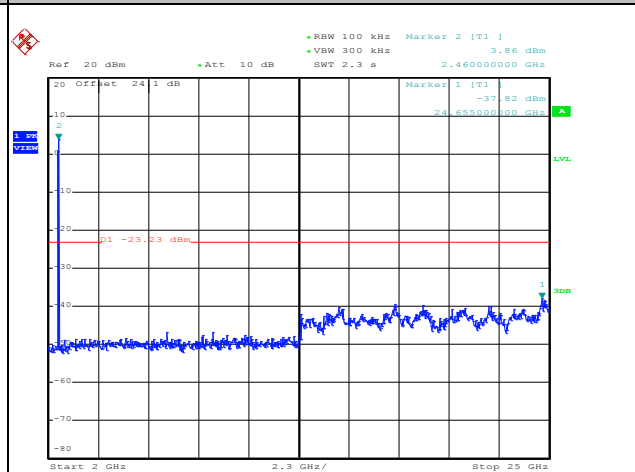

Date: 2.JUL.2017 23:22:16



Number of TX :	2	Ant. :	1
Test Mode :	802.11g	Temperature :	21~25°C
Test Band :	2.4GHz Low	Relative Humidity :	51~54%
Test Channel :	01	Test Engineer :	Derek Hsu

WLAN 802.11g Channel 01

100kHz PSD reference Level

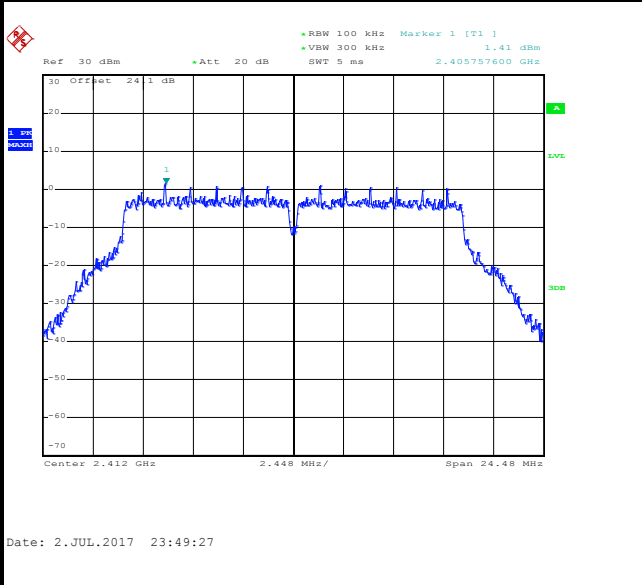

Low Channel Plot

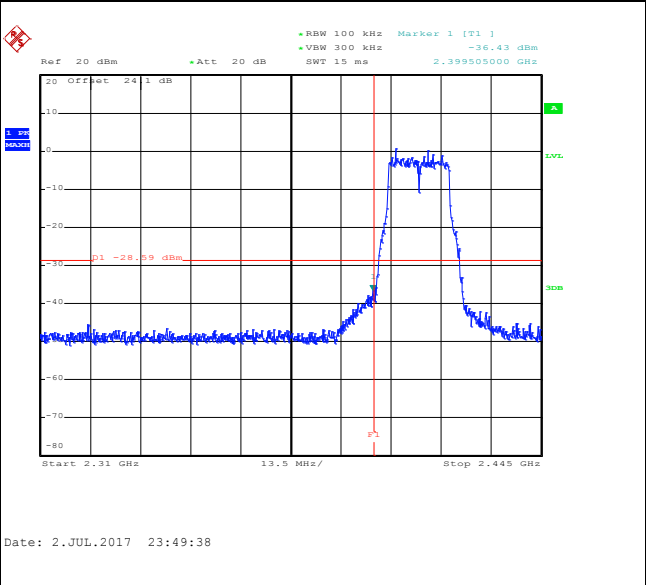

Spurious Emission 30MHz~3GHz

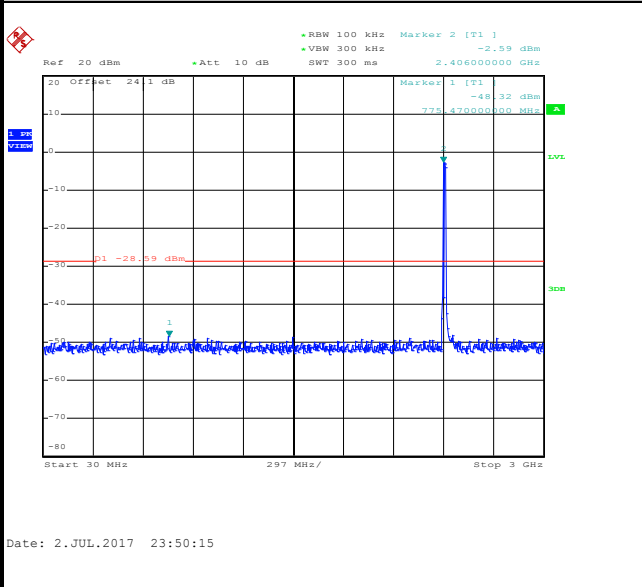

Spurious Emission 2GHz~25GHz

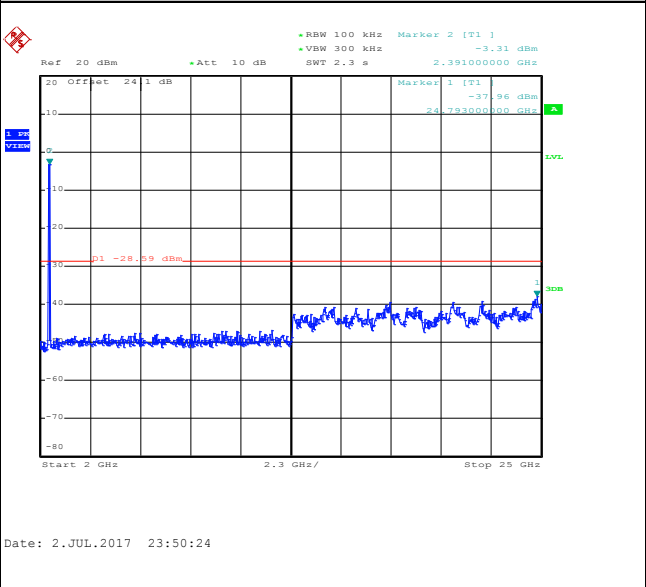



Number of TX :	2	Ant. :	1
Test Mode :	802.11g	Temperature :	21~25°C
Test Band :	2.4GHz Mid	Relative Humidity :	51~54%
Test Channel :	06	Test Engineer :	Derek Hsu

WLAN 802.11g Channel 06

100kHz PSD reference Level

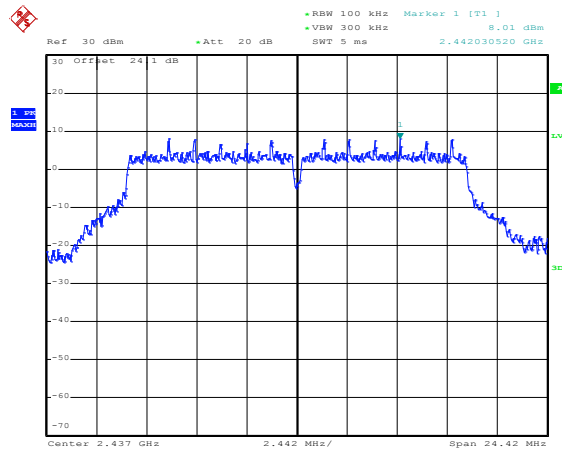

Date: 2.JUL.2017 23:54:16

Spurious Emission 30MHz~3GHz

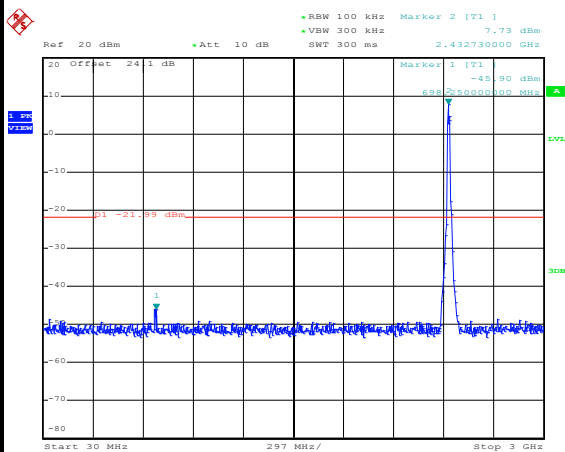

Date: 2.JUL.2017 23:54:28

Spurious Emission 2GHz~25GHz

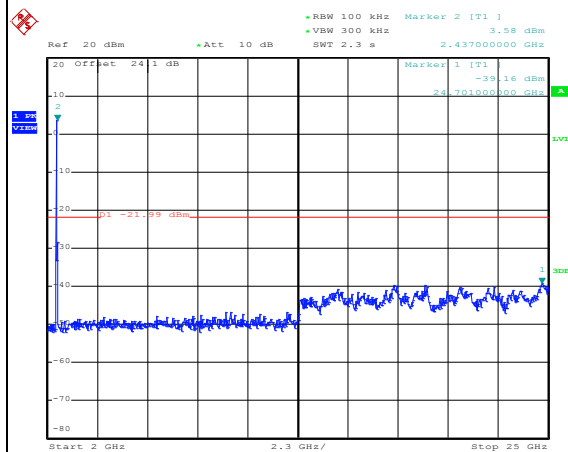

Date: 2.JUL.2017 23:54:36



Number of TX :	2	Ant. :	1
Test Mode :	802.11g	Temperature :	21~25°C
Test Band :	2.4GHz High	Relative Humidity :	51~54%
Test Channel :	11	Test Engineer :	Derek Hsu

WLAN 802.11g Channel 11

100kHz PSD reference Level

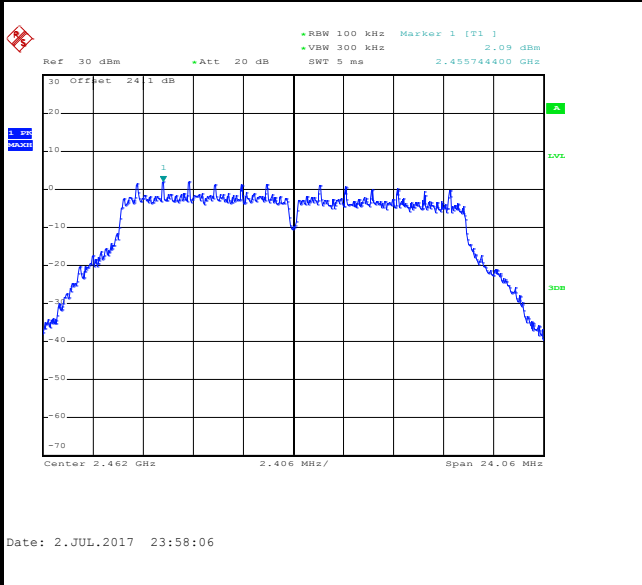

High Channel Plot

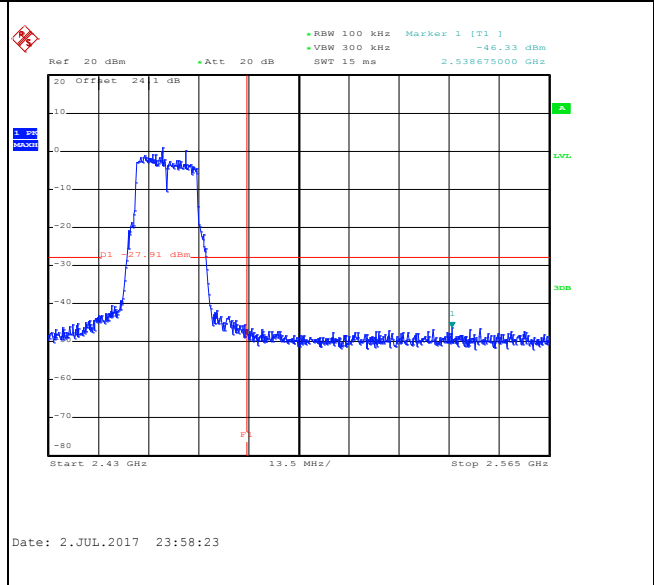

Spurious Emission 30MHz~3GHz

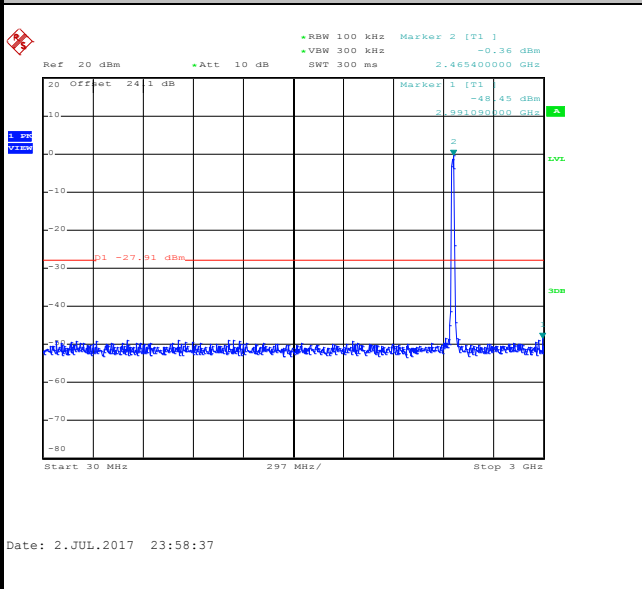

Spurious Emission 2GHz~25GHz

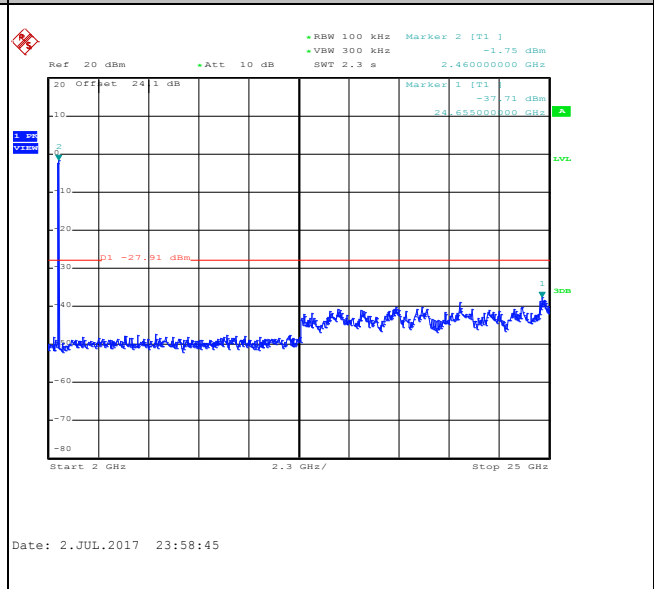



Number of TX :	2	Ant. :	1
Test Mode :	802.11ac VHT20	Temperature :	21~25°C
Test Band :	2.4GHz Low	Relative Humidity :	51~54%
Test Channel :	01	Test Engineer :	Derek Hsu

WLAN 802.11ac VHT20 Channel 01

100kHz PSD reference Level

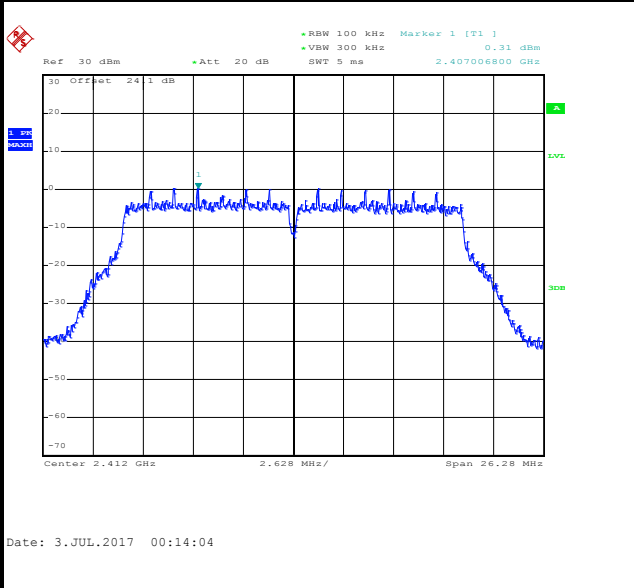

Low Channel Plot

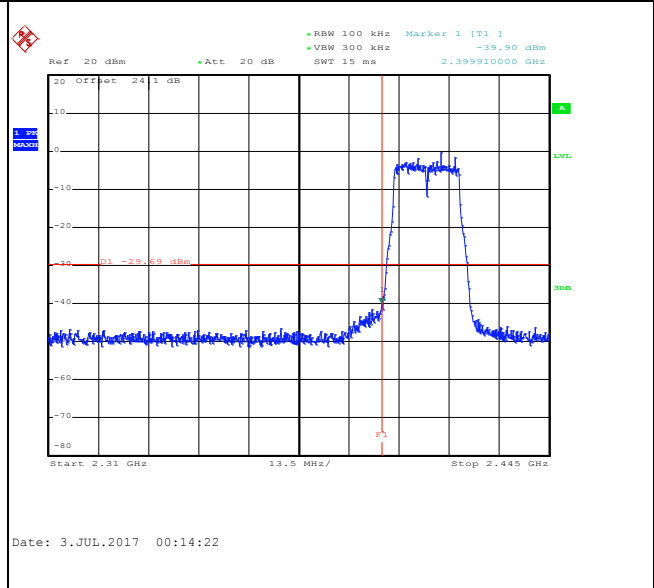

Spurious Emission 30MHz~3GHz

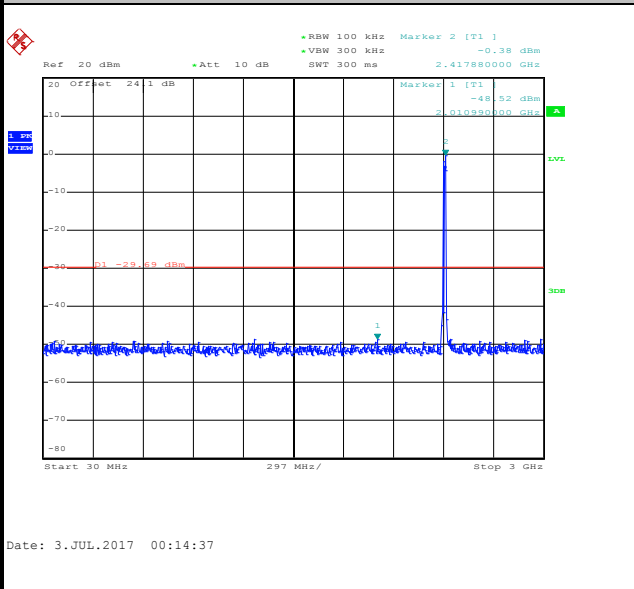

Spurious Emission 2GHz~25GHz

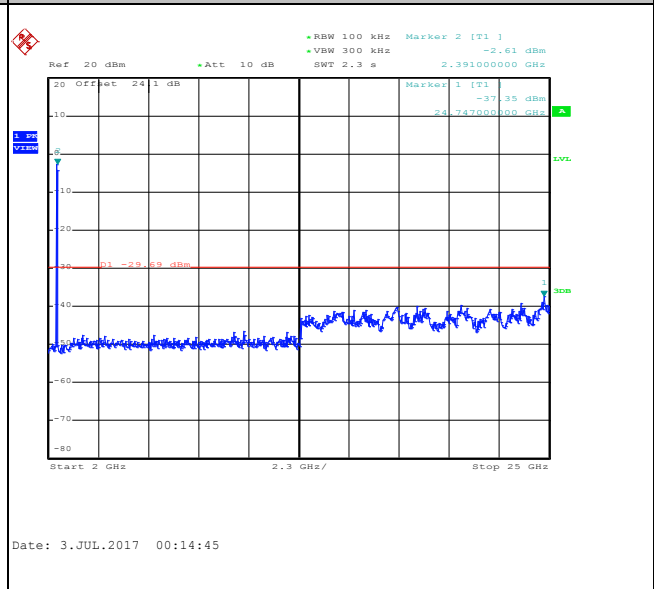



Number of TX :	2	Ant. :	1
Test Mode :	802.11ac VHT20	Temperature :	21~25°C
Test Band :	2.4GHz Mid	Relative Humidity :	51~54%
Test Channel :	06	Test Engineer :	Derek Hsu

WLAN 802.11ac VHT20 Channel 06

100kHz PSD reference Level

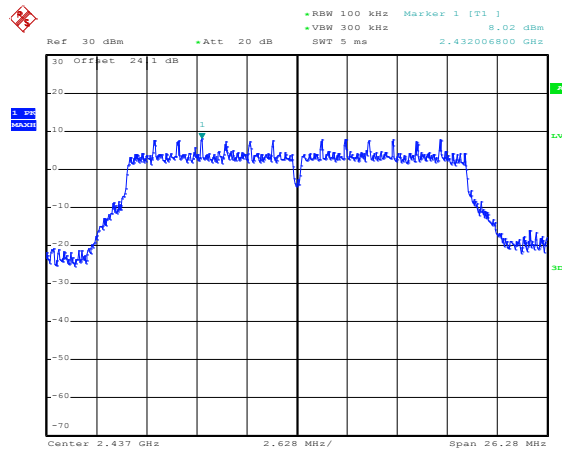

Date: 3.JUL.2017 00:19:15

Spurious Emission 30MHz~3GHz

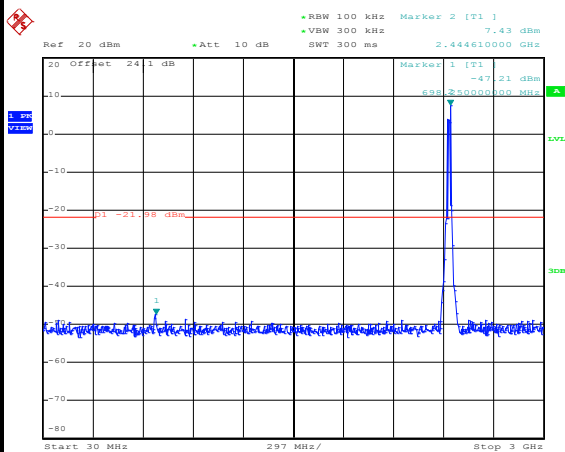

Date: 3.JUL.2017 00:19:27

Spurious Emission 2GHz~25GHz

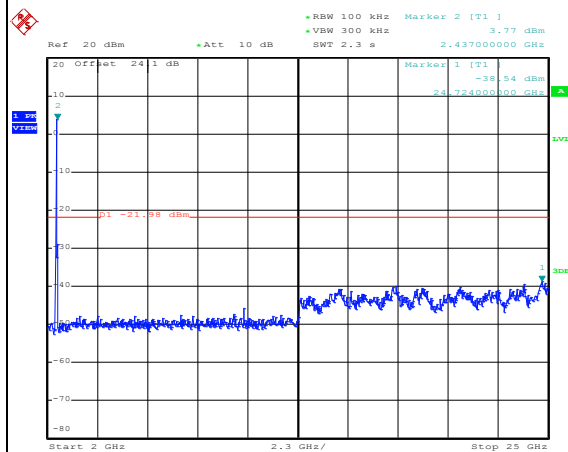

Date: 3.JUL.2017 00:19:35



Number of TX :	2	Ant. :	1
Test Mode :	802.11ac VHT20	Temperature :	21~25°C
Test Band :	2.4GHz High	Relative Humidity :	51~54%
Test Channel :	11	Test Engineer :	Derek Hsu

WLAN 802.11ac VHT20 Channel 11

100kHz PSD reference Level

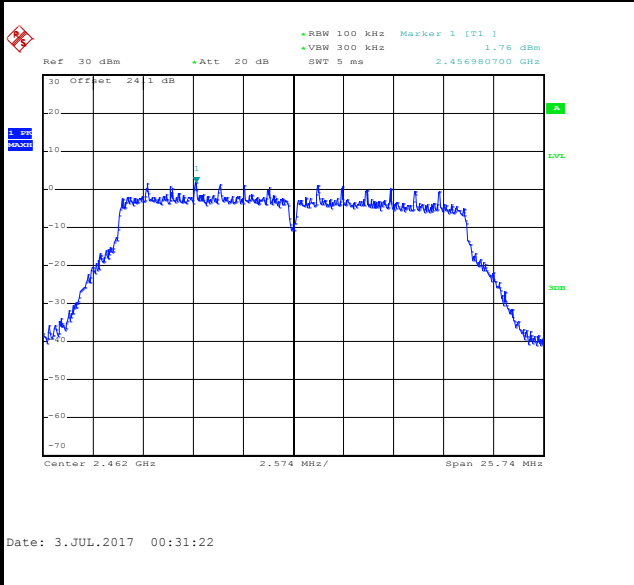

High Channel Plot

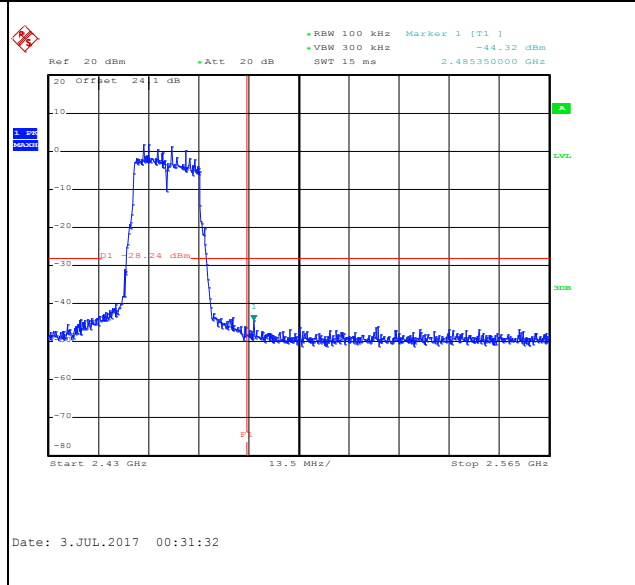

Spurious Emission 30MHz~3GHz

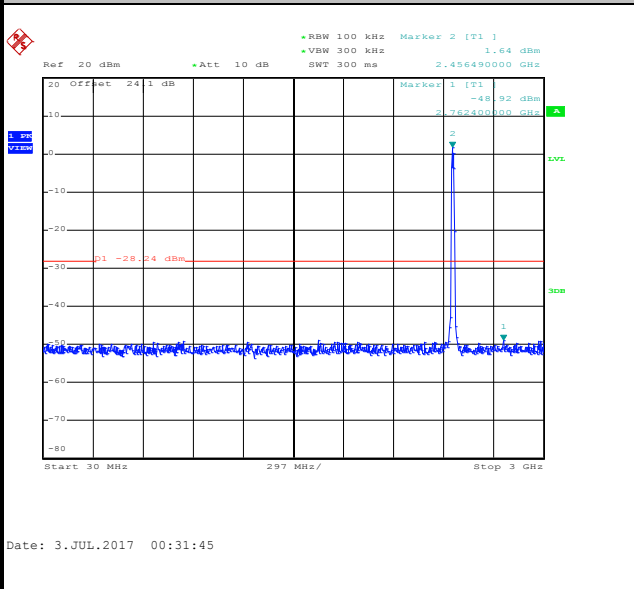

Spurious Emission 2GHz~25GHz

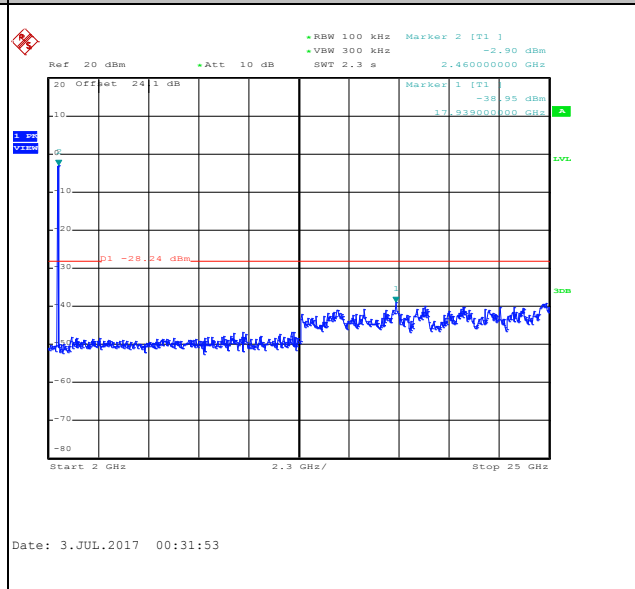



Number of TX :	2	Ant. :	1
Test Mode :	802.11ac VHT40	Temperature :	21~25°C
Test Band :	2.4GHz Low	Relative Humidity :	51~54%
Test Channel :	03	Test Engineer :	Derek Hsu

WLAN 802.11ac VHT40 Channel 03

100kHz PSD reference Level

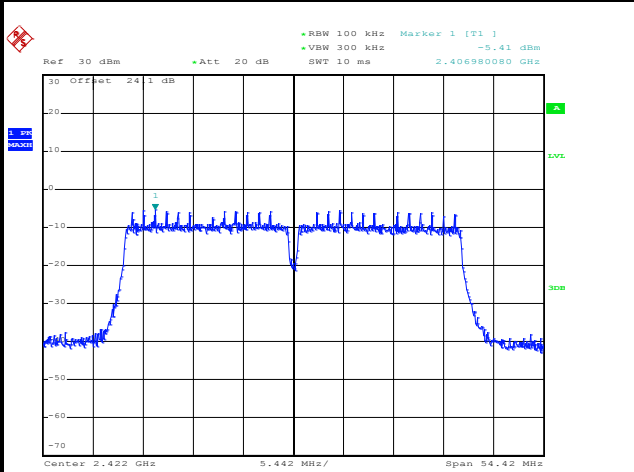

Date: 3.JUL.2017 19:14:08

Low Channel Plot

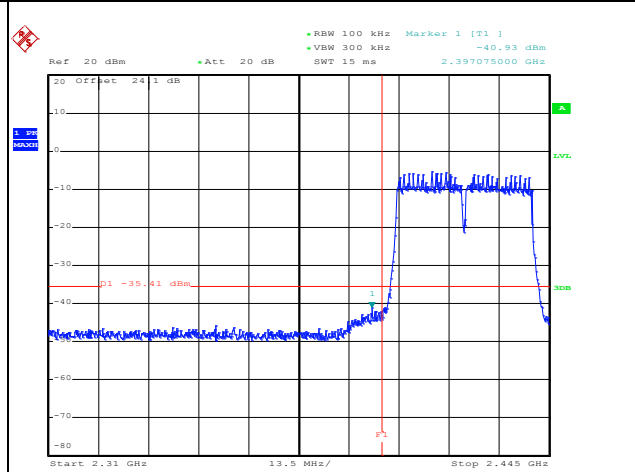

Date: 3.JUL.2017 19:14:29

Spurious Emission 30MHz~3GHz

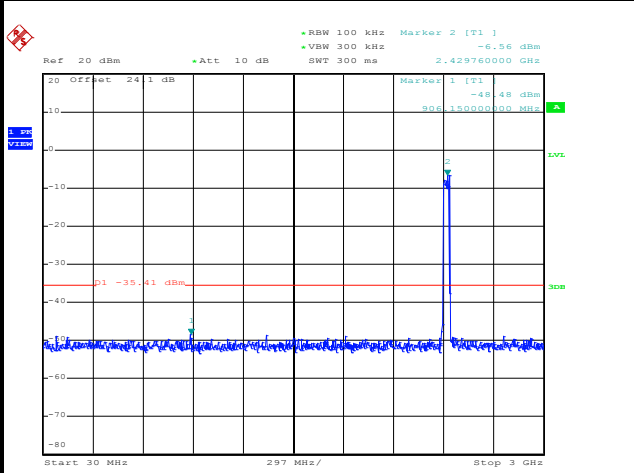

Date: 3.JUL.2017 20:02:12

Spurious Emission 2GHz~25GHz

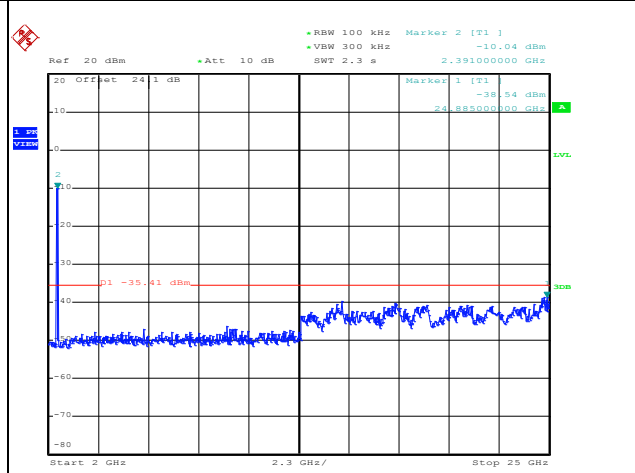

Date: 3.JUL.2017 20:02:29



Number of TX :	2	Ant. :	1
Test Mode :	802.11ac VHT40	Temperature :	21~25°C
Test Band :	2.4GHz Mid	Relative Humidity :	51~54%
Test Channel :	06	Test Engineer :	Derek Hsu

WLAN 802.11ac VHT40 Channel 06

100kHz PSD reference Level

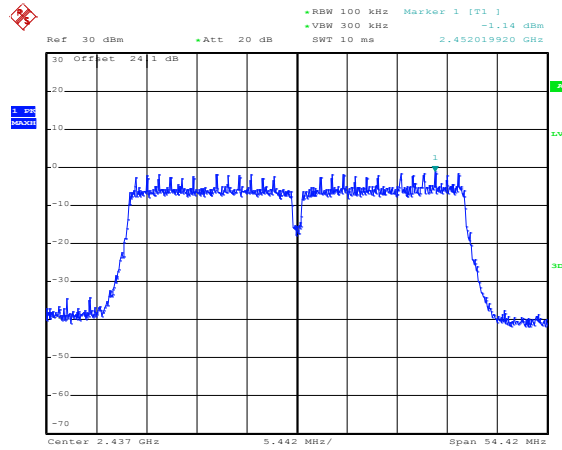

Date: 3.JUL.2017 19:33:46

Spurious Emission 30MHz~3GHz

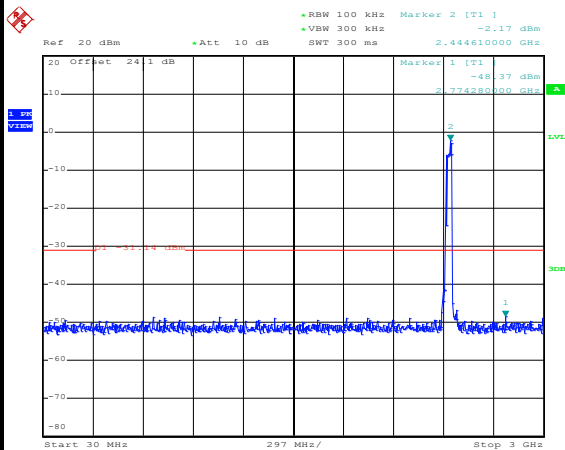

Date: 3.JUL.2017 19:41:01

Spurious Emission 2GHz~25GHz

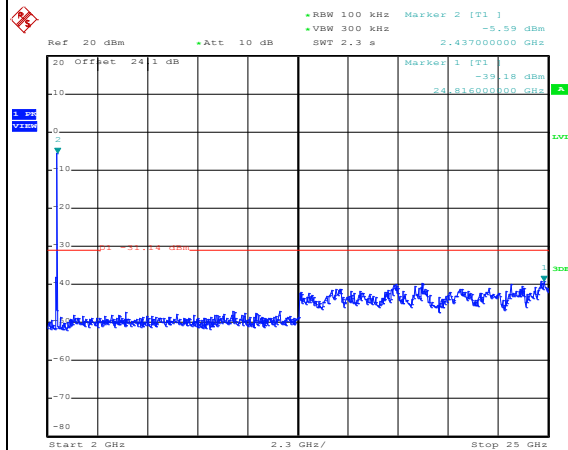

Date: 3.JUL.2017 19:41:09



Number of TX :	2	Ant. :	1
Test Mode :	802.11ac VHT40	Temperature :	21~25°C
Test Band :	2.4GHz High	Relative Humidity :	51~54%
Test Channel :	09	Test Engineer :	Derek Hsu

WLAN 802.11ac VHT40 Channel 09

100kHz PSD reference Level

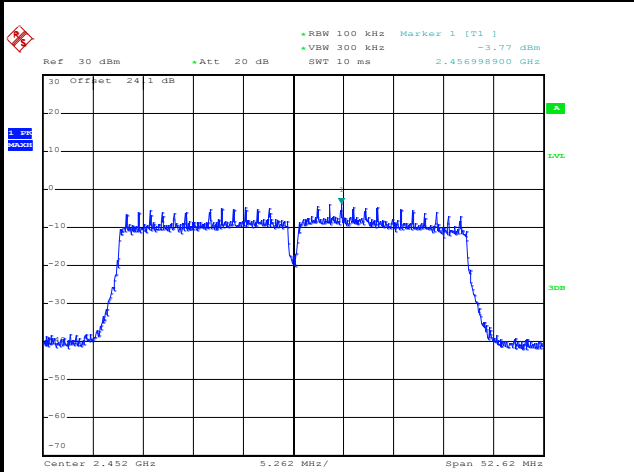

Date: 3.JUL.2017 19:55:32

High Channel Plot

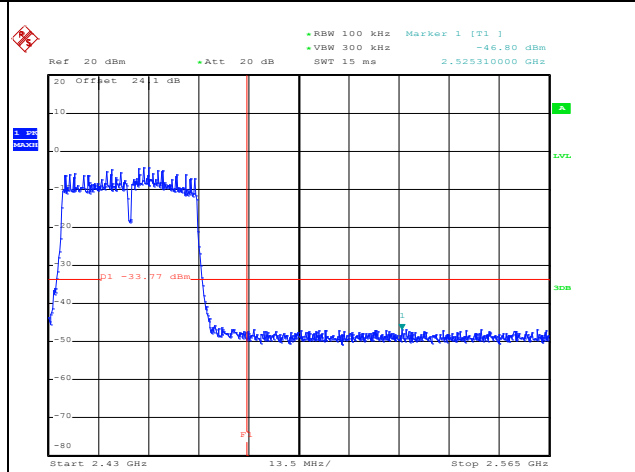

Date: 3.JUL.2017 19:55:48

Spurious Emission 30MHz~3GHz

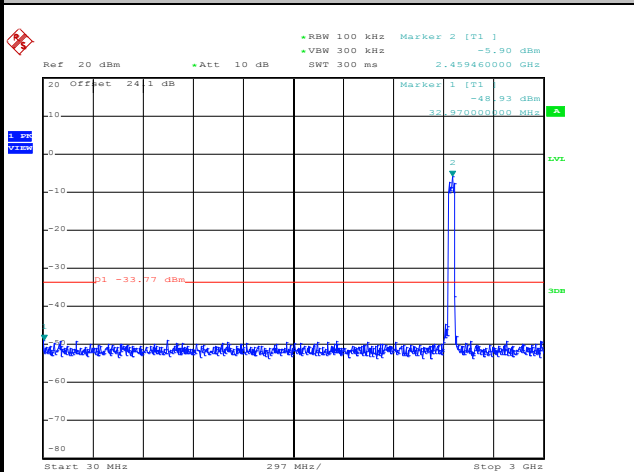

Date: 3.JUL.2017 19:56:37

Spurious Emission 2GHz~25GHz

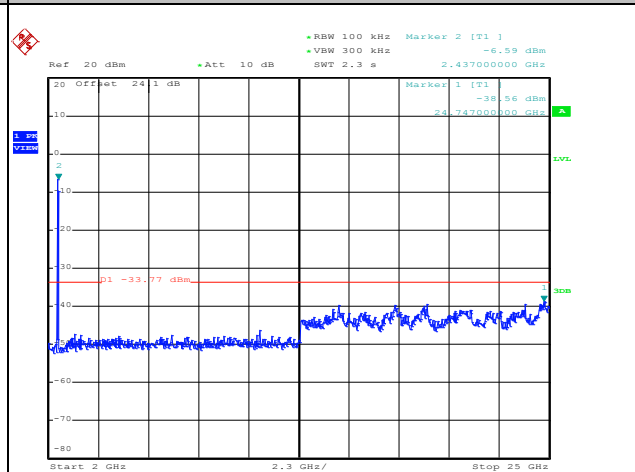

Date: 3.JUL.2017 19:56:10



Number of TX :	2	Ant. :	1
Test Mode :	802.11ac VHT40	Temperature :	21~25°C
Test Band :	2.4GHz High	Relative Humidity :	51~54%
Test Channel :	10	Test Engineer :	Derek Hsu

WLAN 802.11ac VHT40 Channel 10

100kHz PSD reference Level

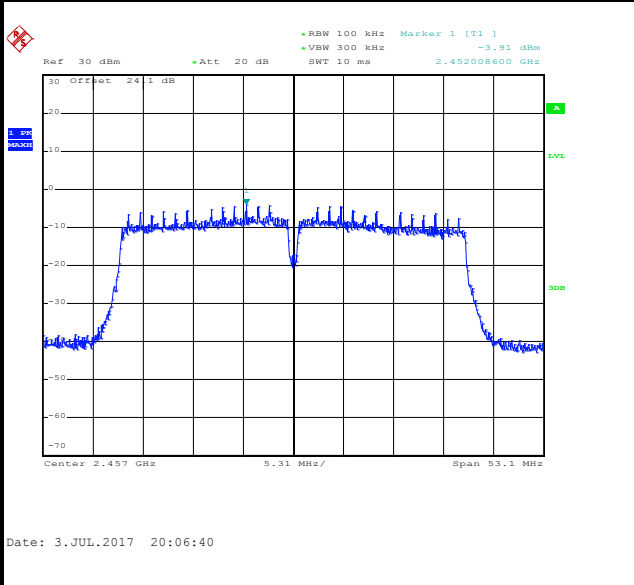

High Channel Plot

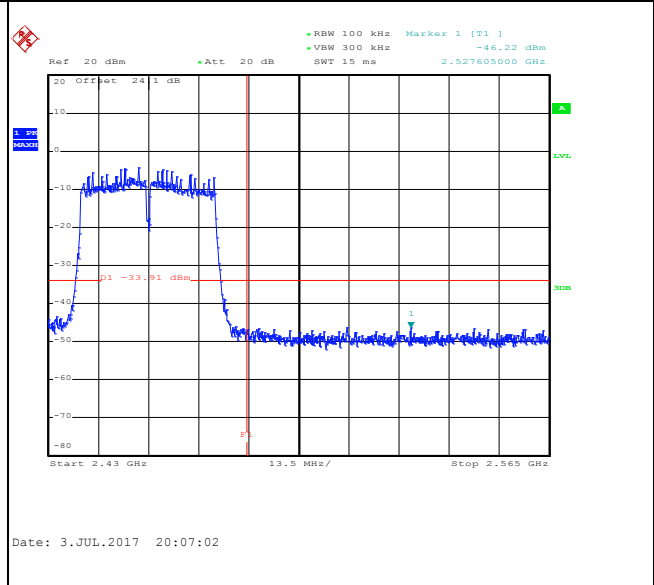

Spurious Emission 30MHz~3GHz

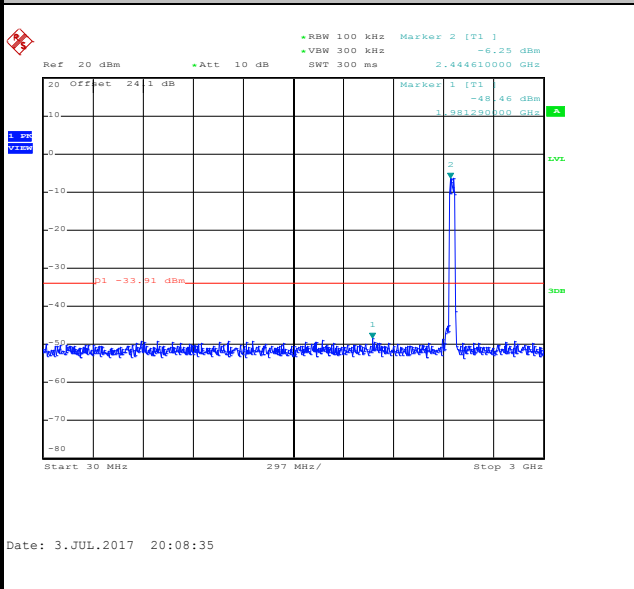

Spurious Emission 2GHz~25GHz

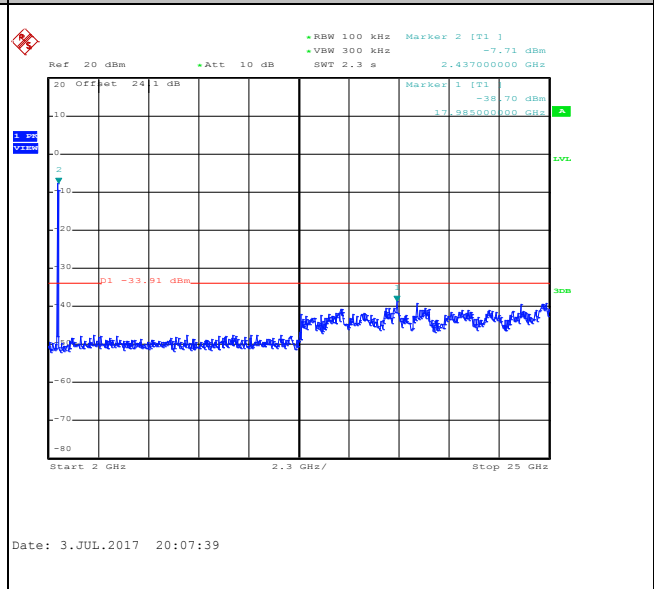



Number of TX :	2	Ant. :	1
Test Mode :	802.11ac VHT40	Temperature :	21~25°C
Test Band :	2.4GHz High	Relative Humidity :	51~54%
Test Channel :	11	Test Engineer :	Derek Hsu

WLAN 802.11ac VHT40 Channel 11

100kHz PSD reference Level

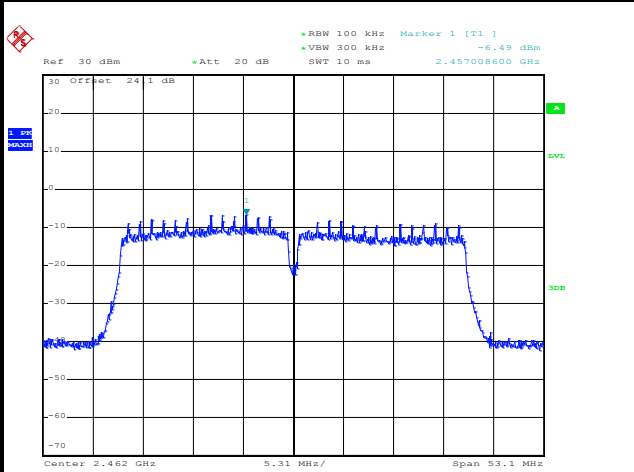

Date: 3.JUL.2017 20:14:52

High Channel Plot

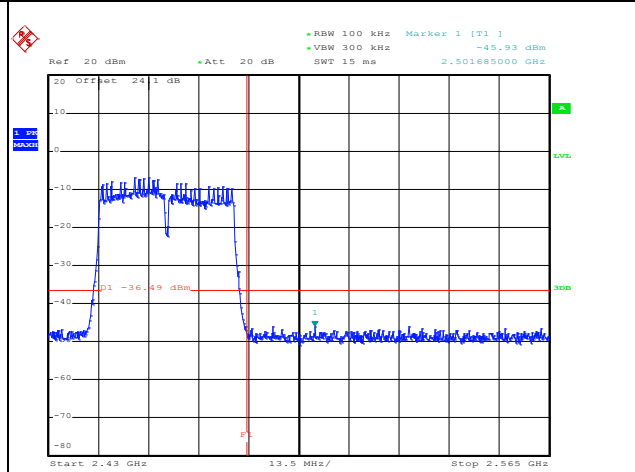

Date: 3.JUL.2017 20:15:04

Spurious Emission 30MHz~3GHz

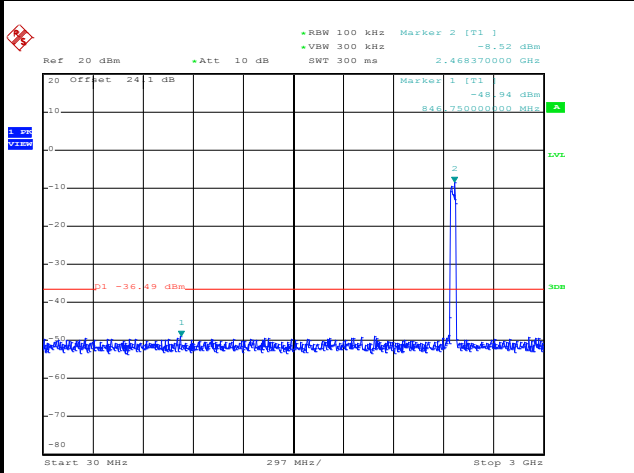

Date: 3.JUL.2017 20:16:13

Spurious Emission 2GHz~25GHz

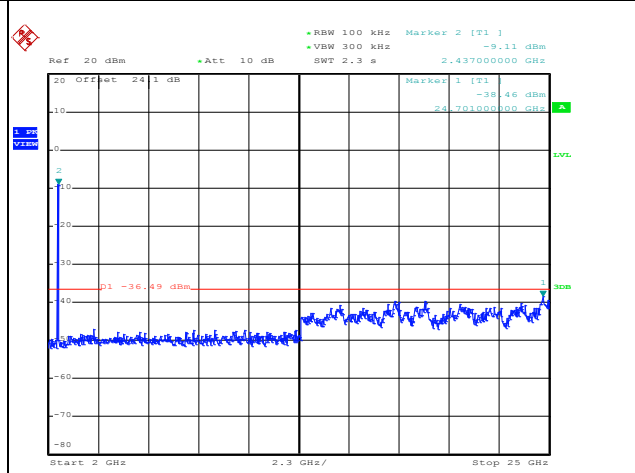

Date: 3.JUL.2017 20:15:27



Number of TX = 2, Ant. 2 (Measured)

Number of TX :	2	Ant. :	2
Test Mode :	802.11b	Temperature :	21~25°C
Test Band :	2.4GHz Low	Relative Humidity :	51~54%
Test Channel :	01	Test Engineer :	Derek Hsu

WLAN 802.11b Channel 01

100kHz PSD reference Level

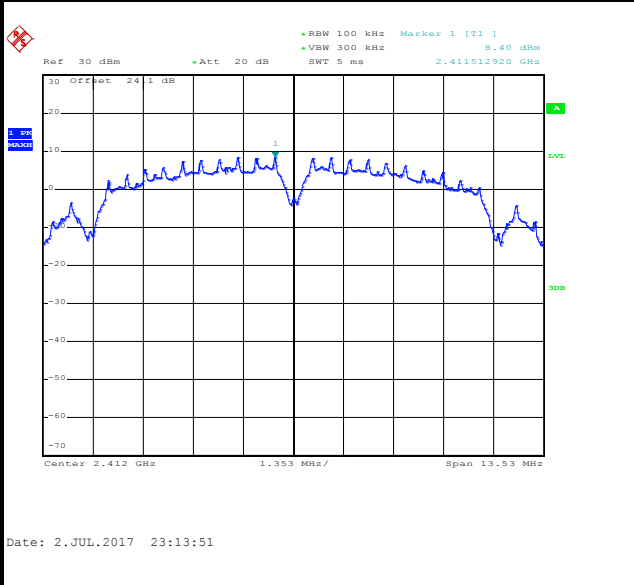

Low Channel Plot

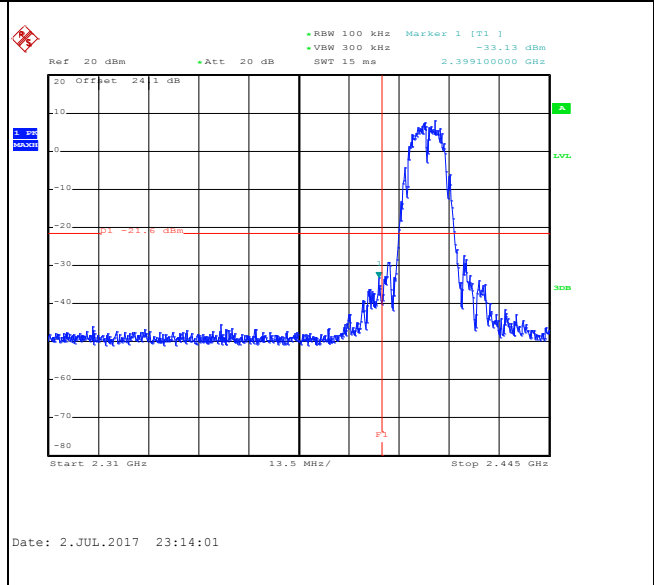

Spurious Emission 30MHz~3GHz

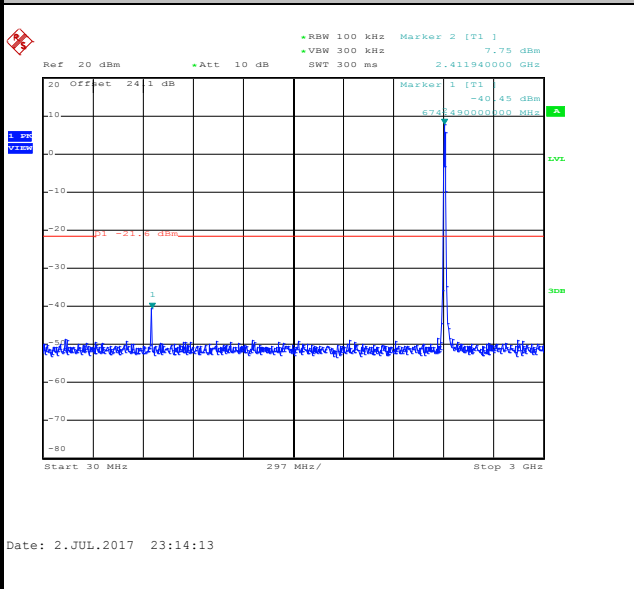

Spurious Emission 2GHz~25GHz

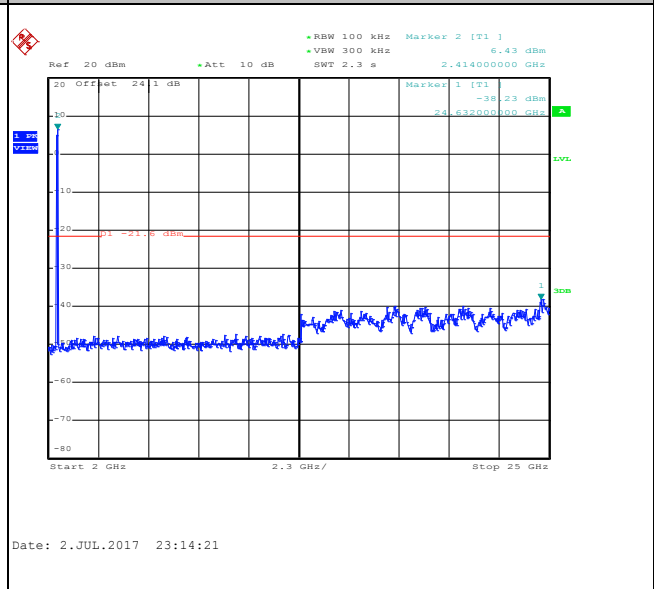



Number of TX :	2	Ant. :	2
Test Mode :	802.11b	Temperature :	21~25°C
Test Band :	2.4GHz Mid	Relative Humidity :	51~54%
Test Channel :	06	Test Engineer :	Derek Hsu

WLAN 802.11b Channel 06

100kHz PSD reference Level

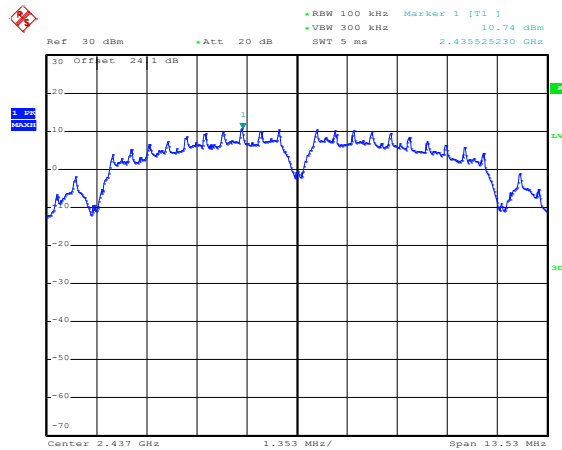

Date: 2.JUL.2017 23:18:39

Spurious Emission 30MHz~3GHz

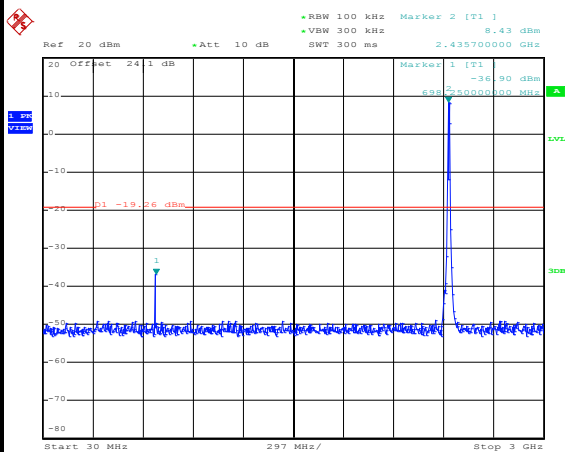

Date: 2.JUL.2017 23:18:53

Spurious Emission 2GHz~25GHz

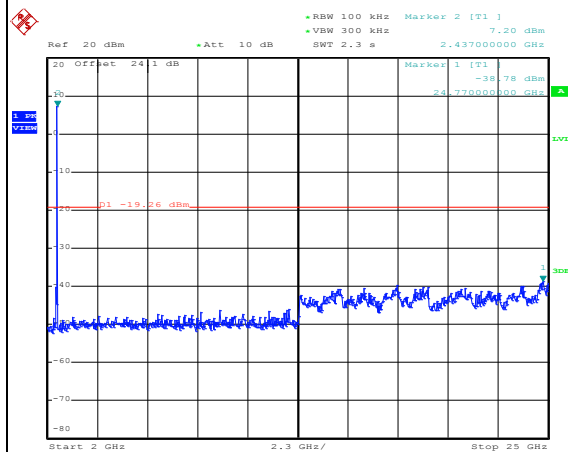

Date: 2.JUL.2017 23:19:01



Number of TX :	2	Ant. :	2
Test Mode :	802.11b	Temperature :	21~25°C
Test Band :	2.4GHz High	Relative Humidity :	51~54%
Test Channel :	11	Test Engineer :	Derek Hsu

WLAN 802.11b Channel 11

100kHz PSD reference Level

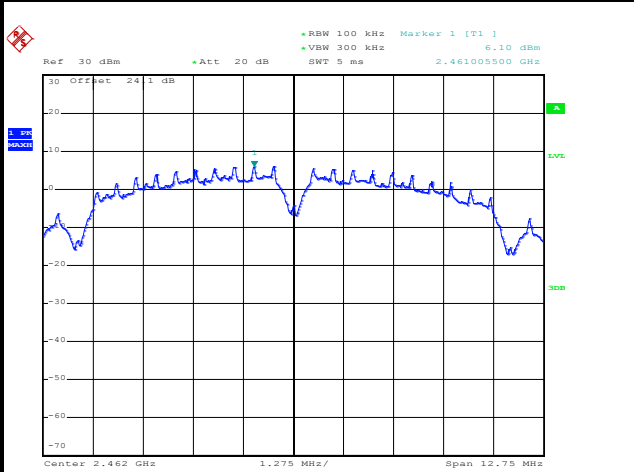

Date: 2.JUL.2017 23:23:29

High Channel Plot

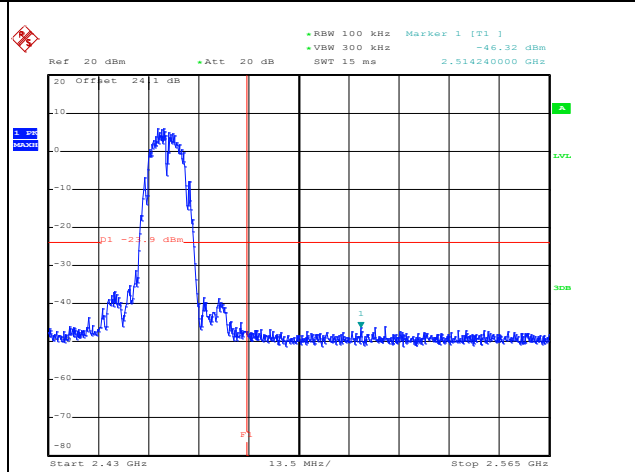

Date: 2.JUL.2017 23:23:49

Spurious Emission 30MHz~3GHz

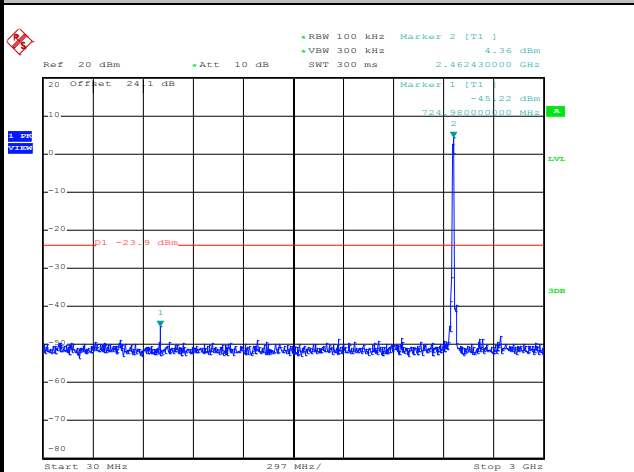

Date: 2.JUL.2017 23:24:03

Spurious Emission 2GHz~25GHz

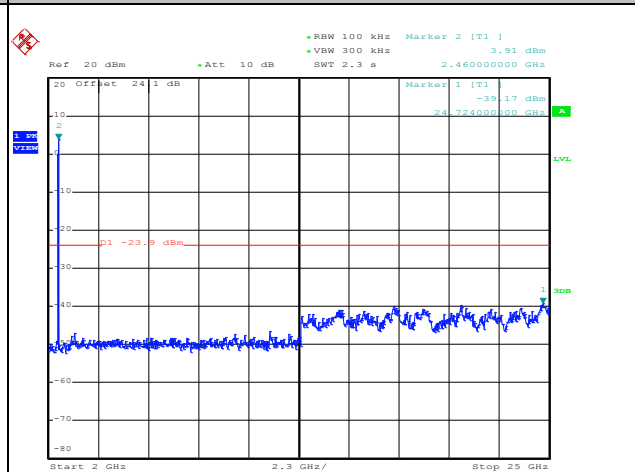

Date: 2.JUL.2017 23:24:11



Number of TX :	2	Ant. :	2
Test Mode :	802.11g	Temperature :	21~25°C
Test Band :	2.4GHz Low	Relative Humidity :	51~54%
Test Channel :	01	Test Engineer :	Derek Hsu

WLAN 802.11g Channel 01

100kHz PSD reference Level

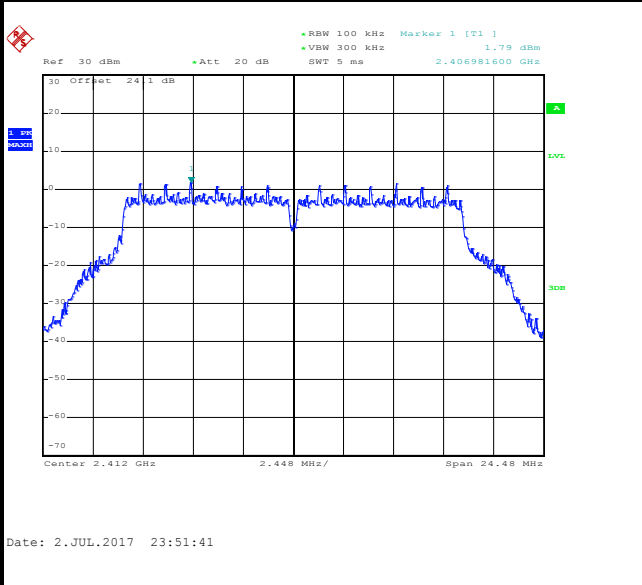

Low Channel Plot

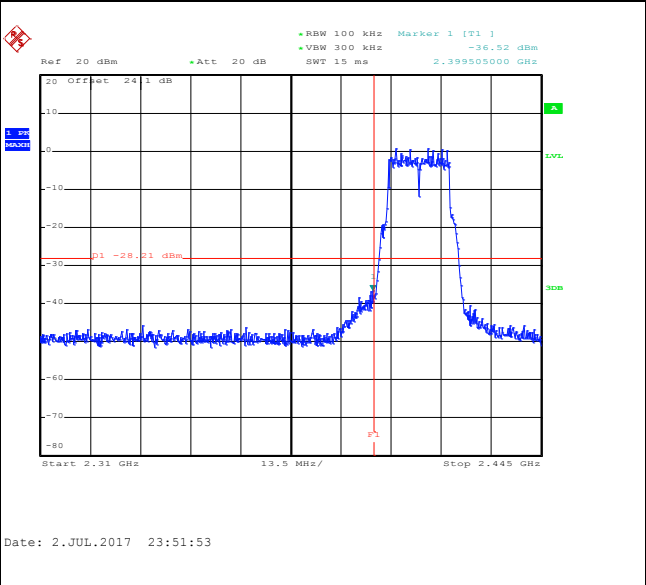

Spurious Emission 30MHz~3GHz

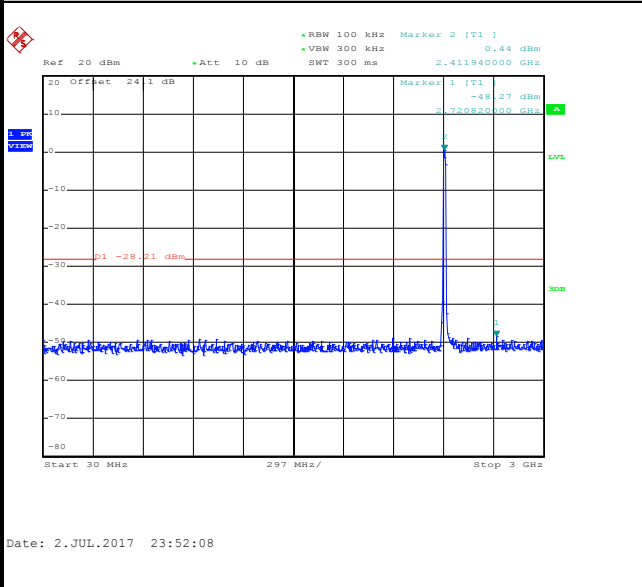

Spurious Emission 2GHz~25GHz

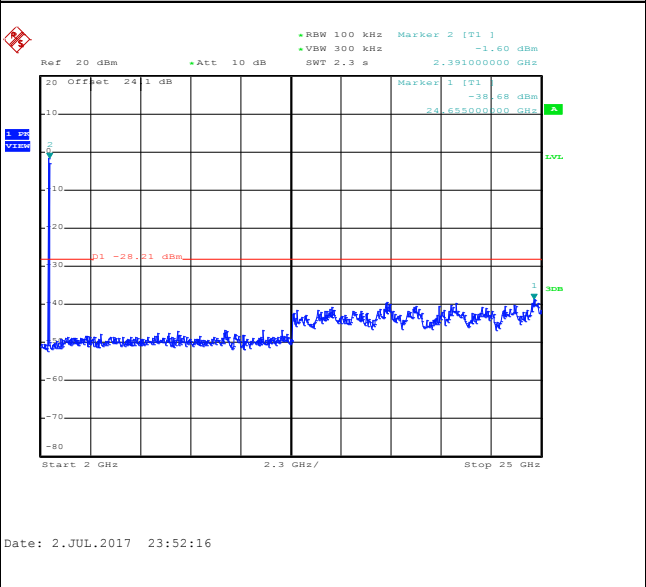



Number of TX :	2	Ant. :	2
Test Mode :	802.11g	Temperature :	21~25°C
Test Band :	2.4GHz Mid	Relative Humidity :	51~54%
Test Channel :	06	Test Engineer :	Derek Hsu

WLAN 802.11g Channel 06

100kHz PSD reference Level

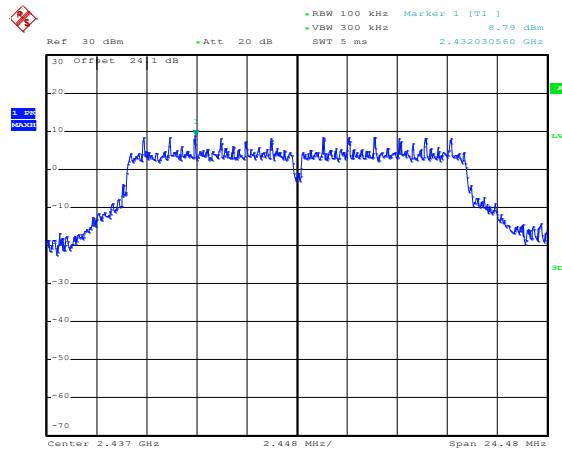

Date: 2.JUL.2017 23:55:35

Spurious Emission 30MHz~3GHz

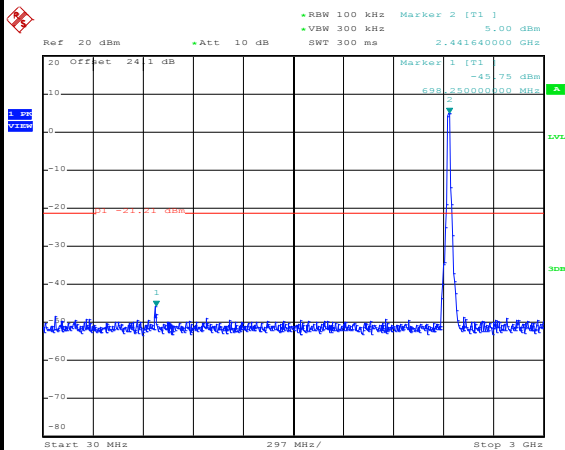

Date: 2.JUL.2017 23:55:47

Spurious Emission 2GHz~25GHz

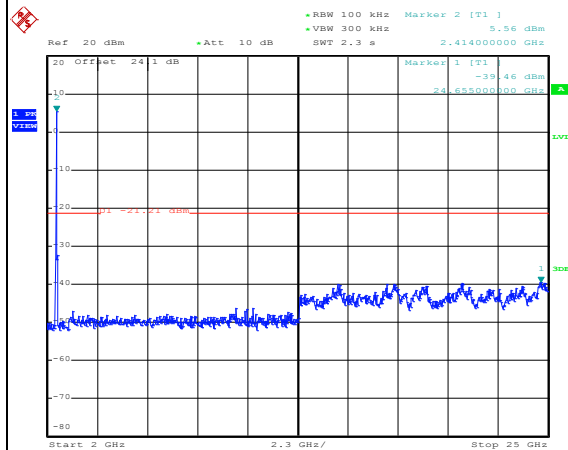

Date: 2.JUL.2017 23:55:56



Number of TX :	2	Ant. :	2
Test Mode :	802.11g	Temperature :	21~25°C
Test Band :	2.4GHz High	Relative Humidity :	51~54%
Test Channel :	11	Test Engineer :	Derek Hsu

WLAN 802.11g Channel 11

100kHz PSD reference Level

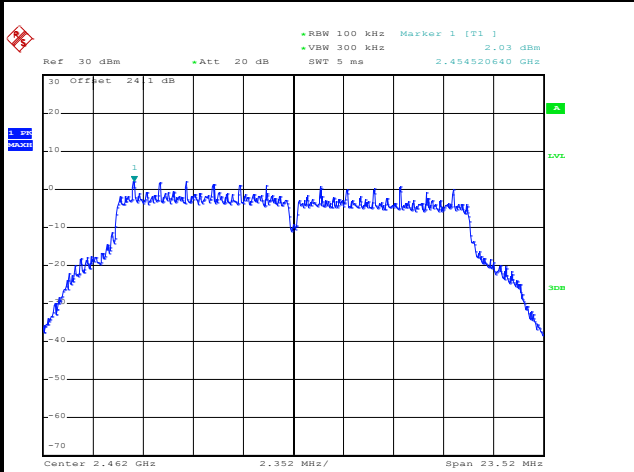

Date: 3.JUL.2017 00:01:01

High Channel Plot

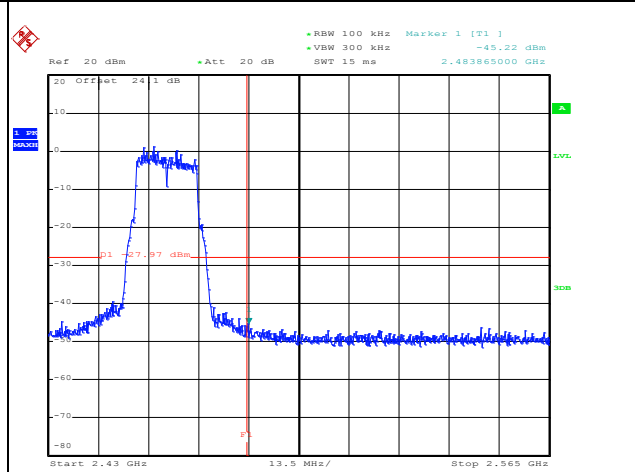

Date: 3.JUL.2017 00:01:12

Spurious Emission 30MHz~3GHz

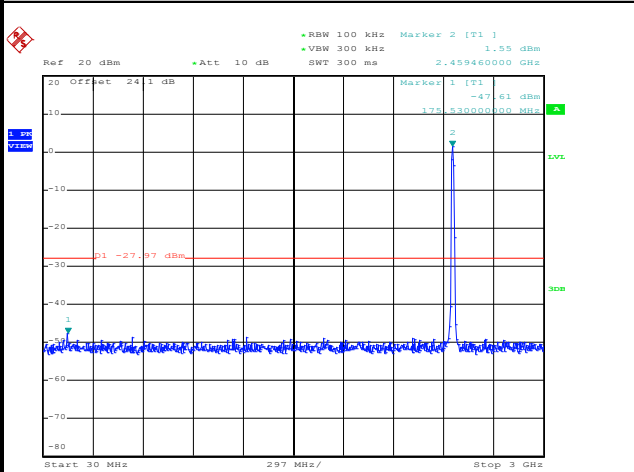

Date: 3.JUL.2017 00:01:45

Spurious Emission 2GHz~25GHz

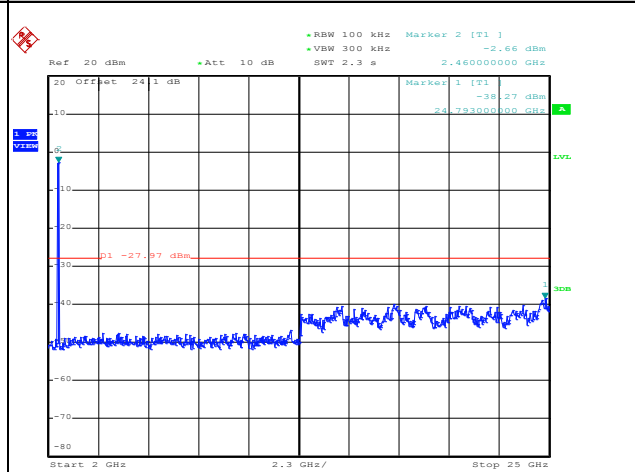

Date: 3.JUL.2017 00:01:53



Number of TX :	2	Ant. :	2
Test Mode :	802.11ac VHT20	Temperature :	21~25°C
Test Band :	2.4GHz Low	Relative Humidity :	51~54%
Test Channel :	01	Test Engineer :	Derek Hsu

WLAN 802.11ac VHT20 Channel 01

100kHz PSD reference Level

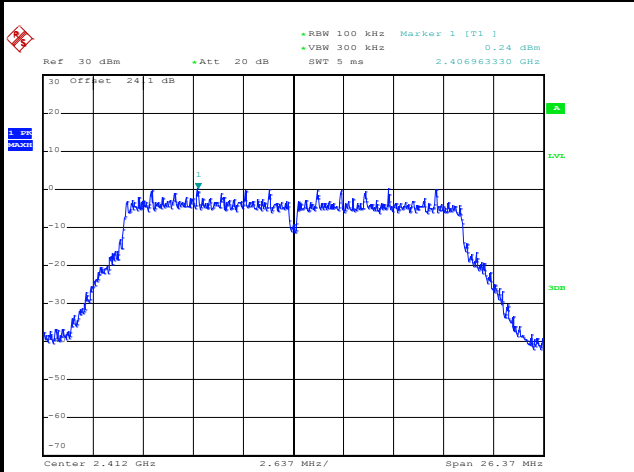

Date: 3.JUL.2017 00:15:51

Low Channel Plot

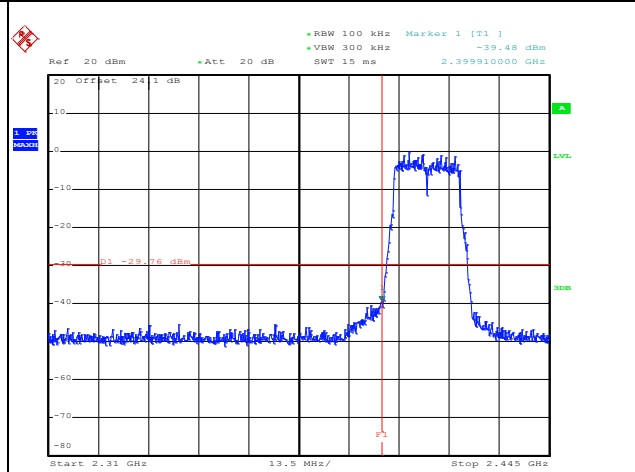

Date: 3.JUL.2017 00:15:59

Spurious Emission 30MHz~3GHz

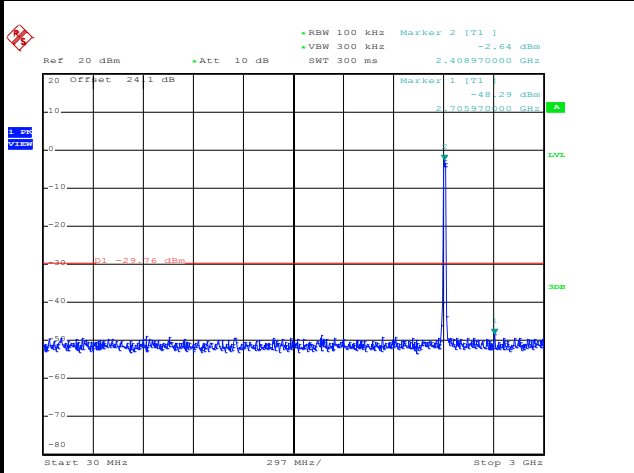

Date: 3.JUL.2017 00:16:33

Spurious Emission 2GHz~25GHz

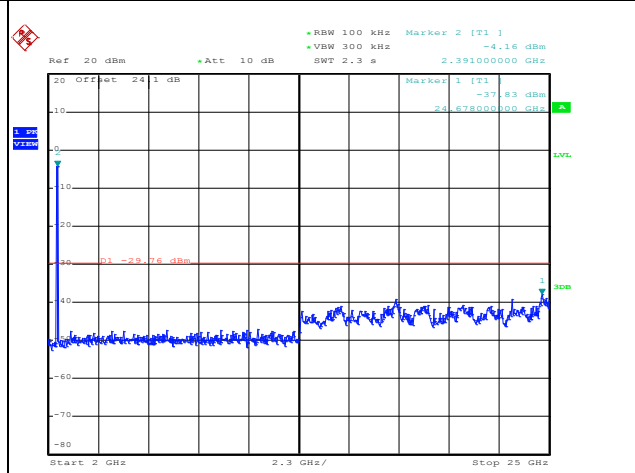

Date: 3.JUL.2017 00:16:41



Number of TX :	2	Ant. :	2
Test Mode :	802.11ac VHT20	Temperature :	21~25°C
Test Band :	2.4GHz Mid	Relative Humidity :	51~54%
Test Channel :	06	Test Engineer :	Derek Hsu

WLAN 802.11ac VHT20 Channel 06

100kHz PSD reference Level

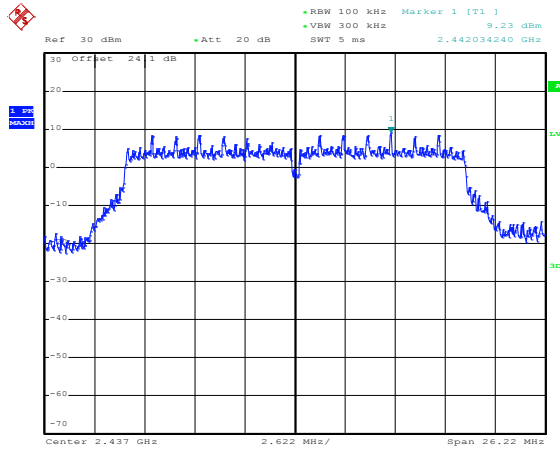

Date: 3.JUL.2017 00:20:41

Spurious Emission 30MHz~3GHz

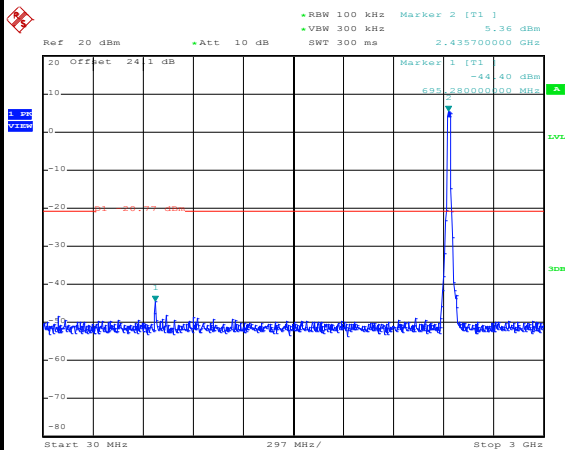

Date: 3.JUL.2017 00:20:52

Spurious Emission 2GHz~25GHz

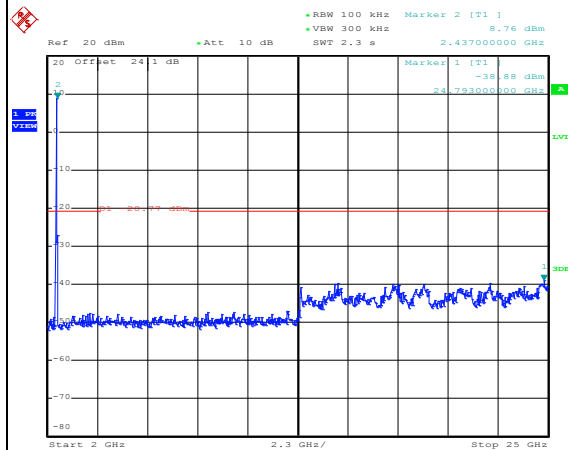

Date: 3.JUL.2017 00:21:00



Number of TX :	2	Ant. :	2
Test Mode :	802.11ac VHT20	Temperature :	21~25°C
Test Band :	2.4GHz High	Relative Humidity :	51~54%
Test Channel :	11	Test Engineer :	Derek Hsu

WLAN 802.11ac VHT20 Channel 11

100kHz PSD reference Level

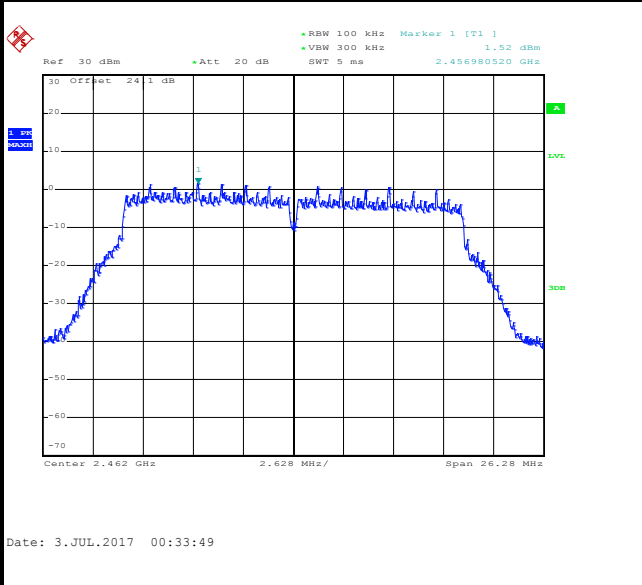

High Channel Plot

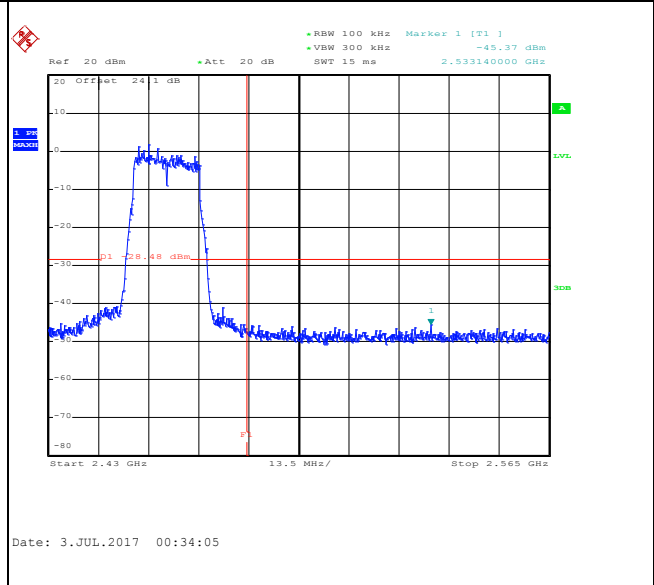

Spurious Emission 30MHz~3GHz

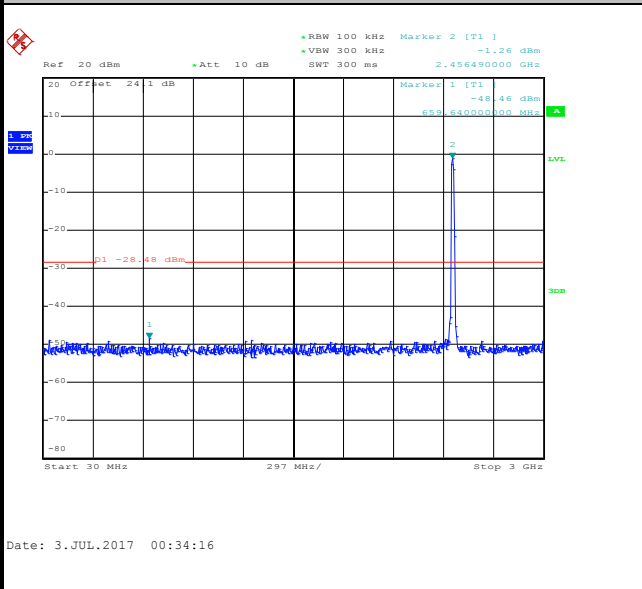

Spurious Emission 2GHz~25GHz

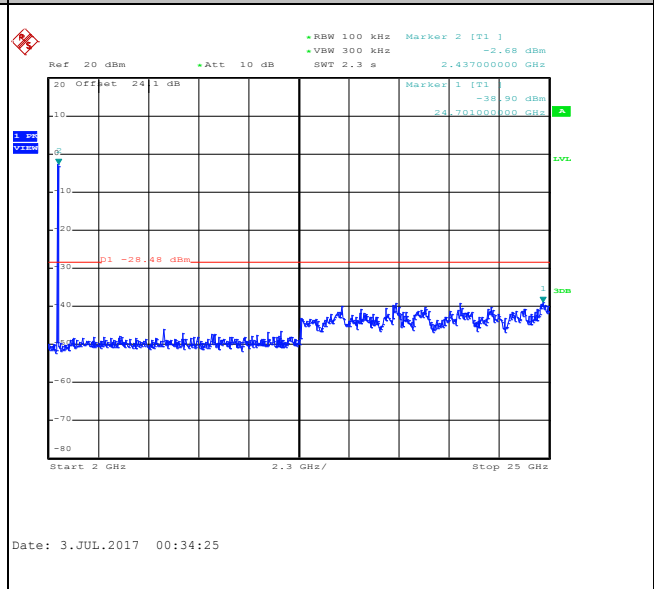



Number of TX :	2	Ant. :	2
Test Mode :	802.11ac VHT40	Temperature :	21~25°C
Test Band :	2.4GHz Low	Relative Humidity :	51~54%
Test Channel :	03	Test Engineer :	Derek Hsu

WLAN 802.11ac VHT40 Channel 03

100kHz PSD reference Level

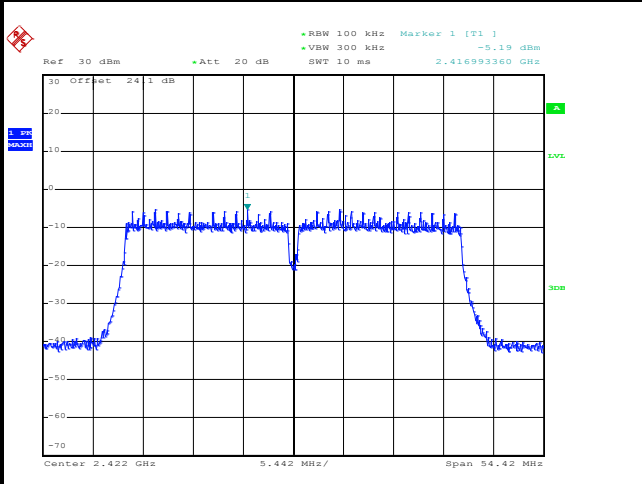

Date: 3.JUL.2017 20:26:59

Low Channel Plot

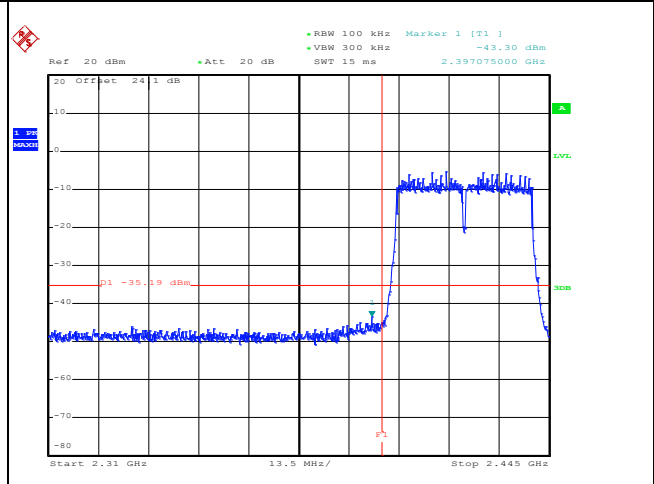

Date: 3.JUL.2017 20:27:12

Spurious Emission 30MHz~3GHz

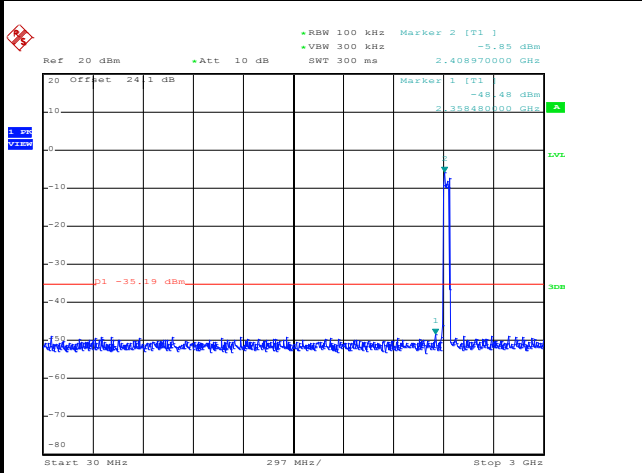

Date: 3.JUL.2017 20:27:28

Spurious Emission 2GHz~25GHz

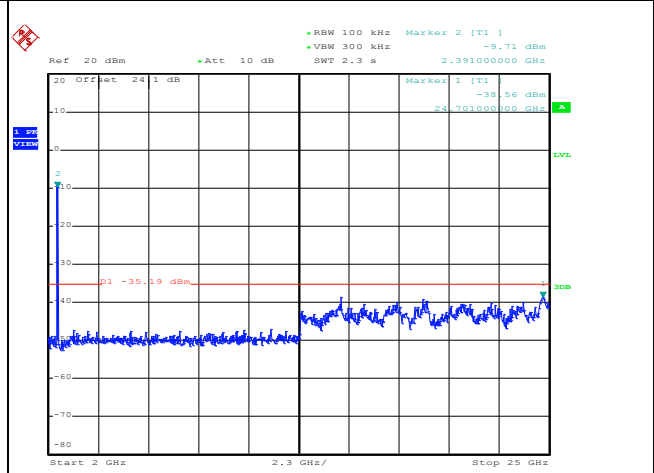

Date: 3.JUL.2017 20:27:36



Number of TX :	2	Ant. :	2
Test Mode :	802.11ac VHT40	Temperature :	21~25°C
Test Band :	2.4GHz Mid	Relative Humidity :	51~54%
Test Channel :	06	Test Engineer :	Derek Hsu

WLAN 802.11ac VHT40 Channel 06

100kHz PSD reference Level

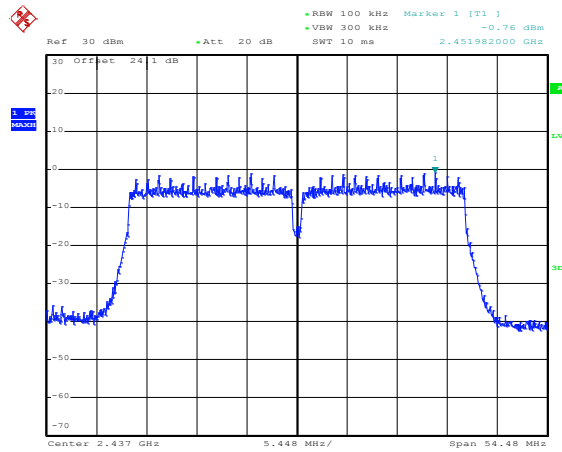

Date: 3.JUL.2017 19:38:03

Spurious Emission 30MHz~3GHz

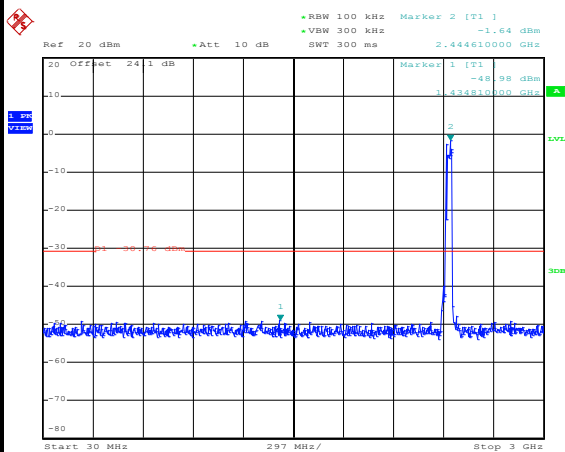

Date: 3.JUL.2017 19:39:51

Spurious Emission 2GHz~25GHz

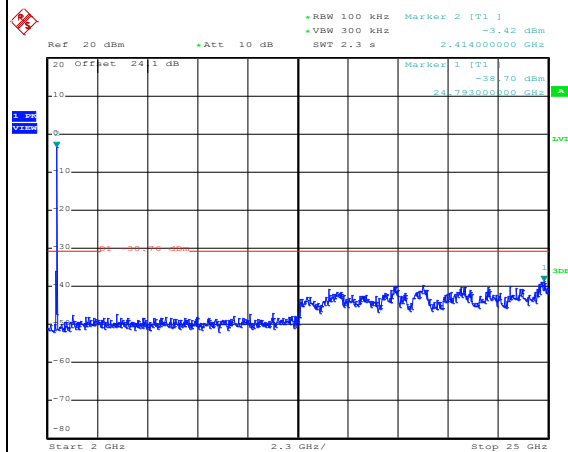

Date: 3.JUL.2017 19:38:26



Number of TX :	2	Ant. :	2
Test Mode :	802.11ac VHT40	Temperature :	21~25°C
Test Band :	2.4GHz High	Relative Humidity :	51~54%
Test Channel :	09	Test Engineer :	Derek Hsu

WLAN 802.11ac VHT40 Channel 09

100kHz PSD reference Level

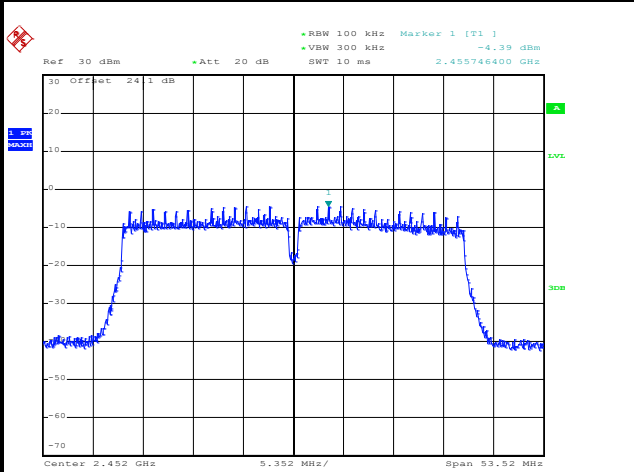

Date: 3.JUL.2017 19:58:03

High Channel Plot

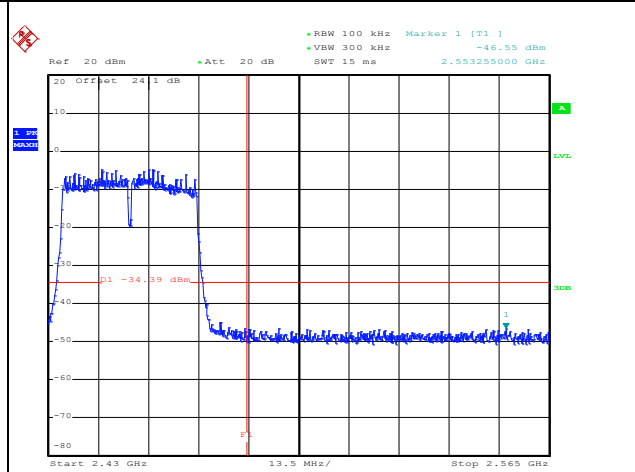

Date: 3.JUL.2017 19:58:16

Spurious Emission 30MHz~3GHz

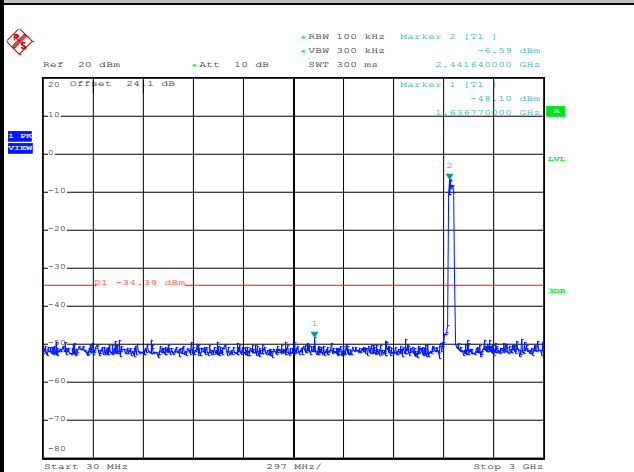

Date: 3.JUL.2017 20:00:24

Spurious Emission 2GHz~25GHz

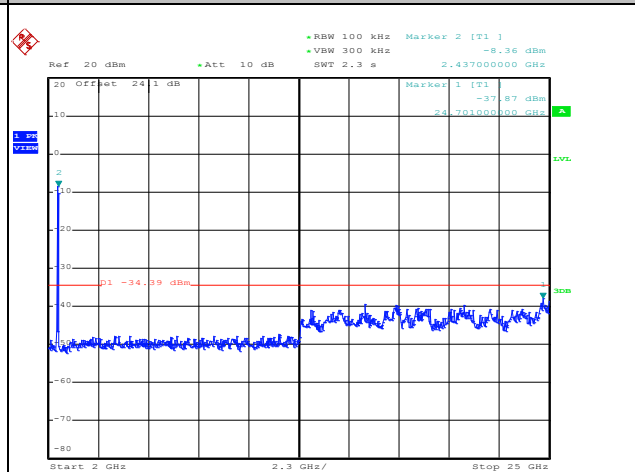

Date: 3.JUL.2017 19:58:36



Number of TX :	2	Ant. :	2
Test Mode :	802.11ac VHT40	Temperature :	21~25°C
Test Band :	2.4GHz High	Relative Humidity :	51~54%
Test Channel :	10	Test Engineer :	Derek Hsu

WLAN 802.11ac VHT40 Channel 10

100kHz PSD reference Level

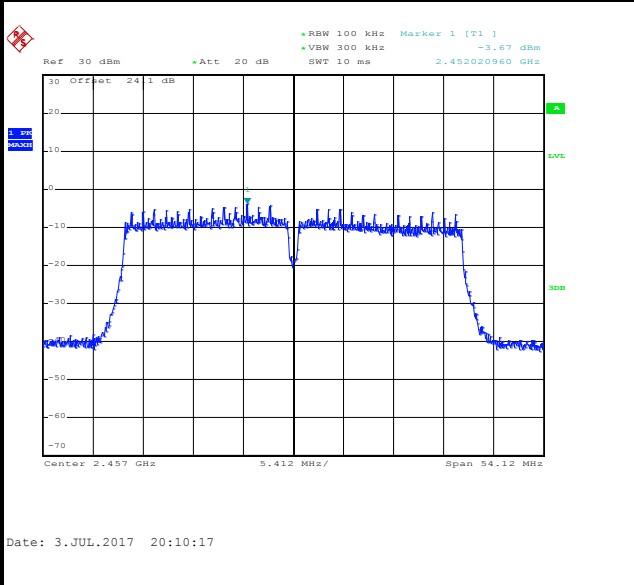

High Channel Plot

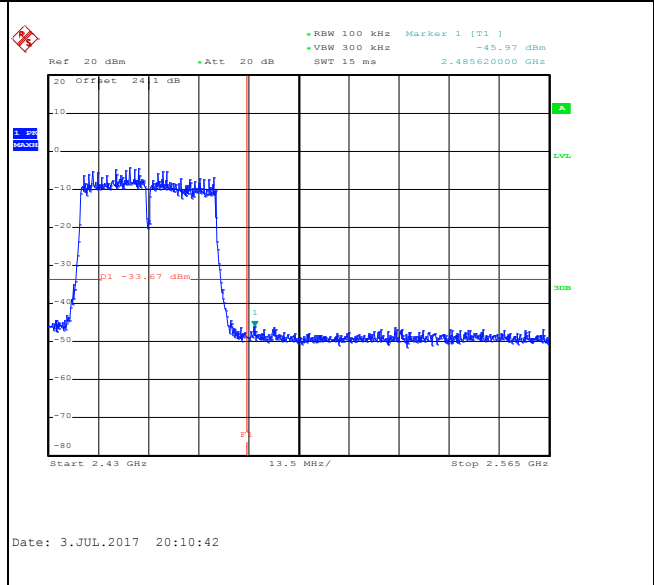

Spurious Emission 30MHz~3GHz

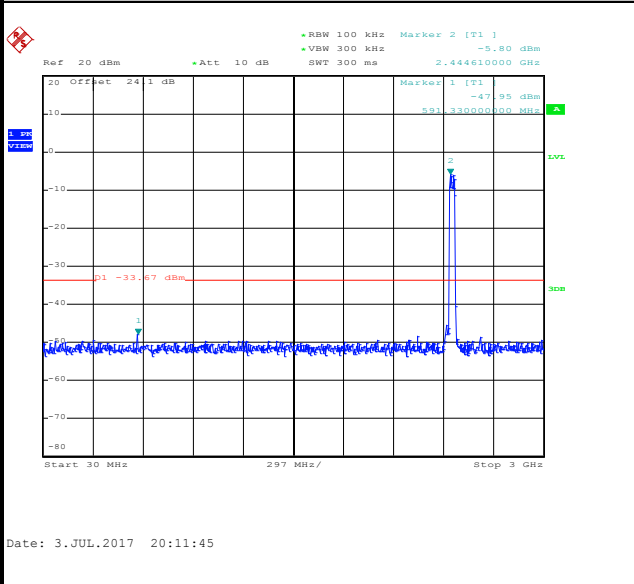

Spurious Emission 2GHz~25GHz

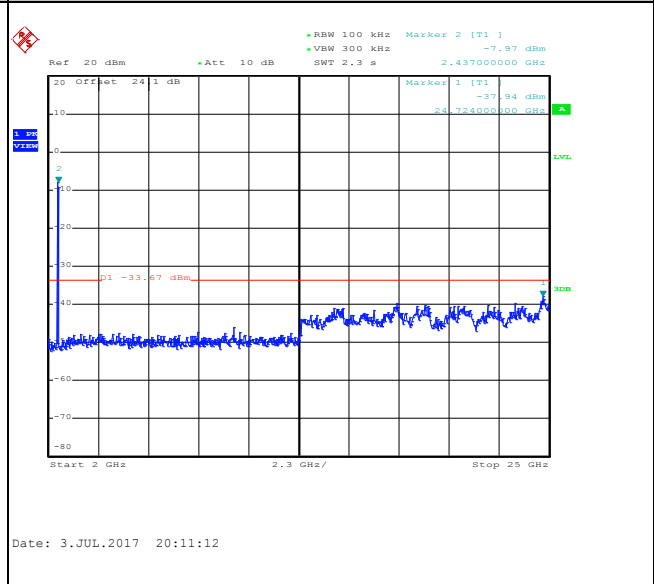



Number of TX :	2	Ant. :	2
Test Mode :	802.11ac VHT40	Temperature :	21~25°C
Test Band :	2.4GHz High	Relative Humidity :	51~54%
Test Channel :	11	Test Engineer :	Derek Hsu

WLAN 802.11ac VHT40 Channel 11

100kHz PSD reference Level

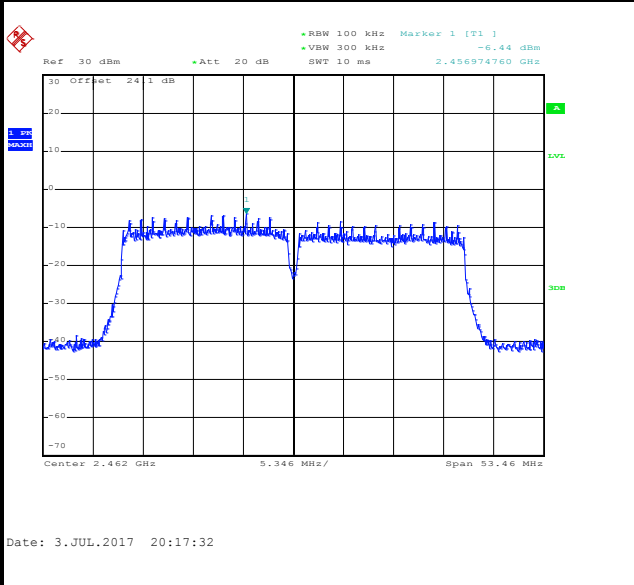

High Channel Plot

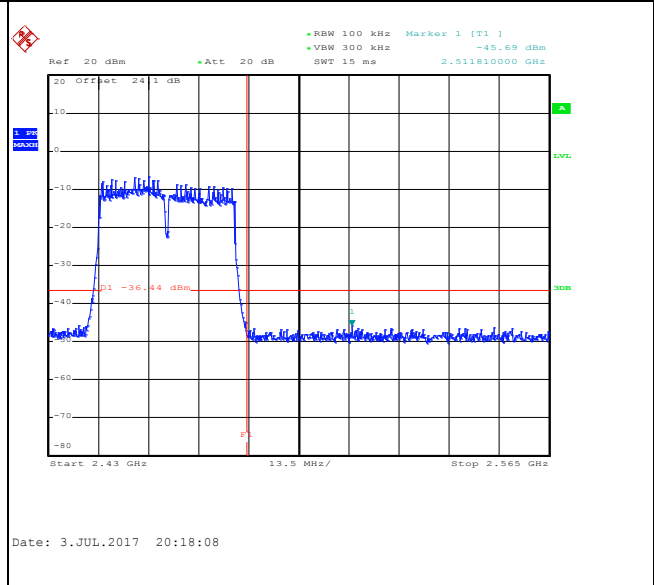

Spurious Emission 30MHz~3GHz

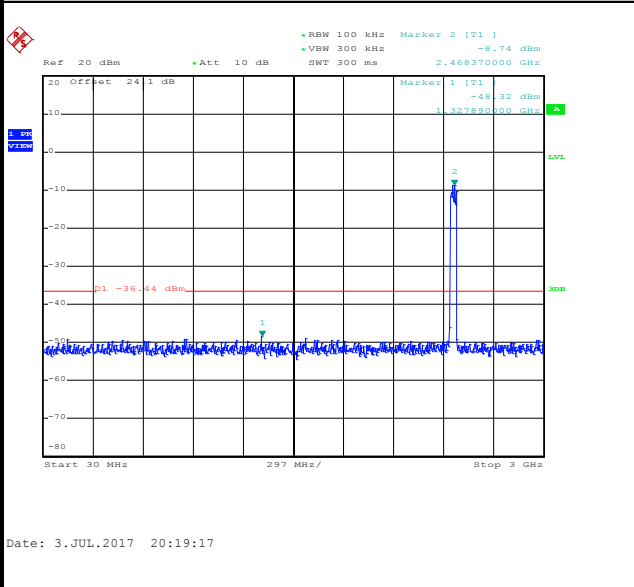

Spurious Emission 2GHz~25GHz

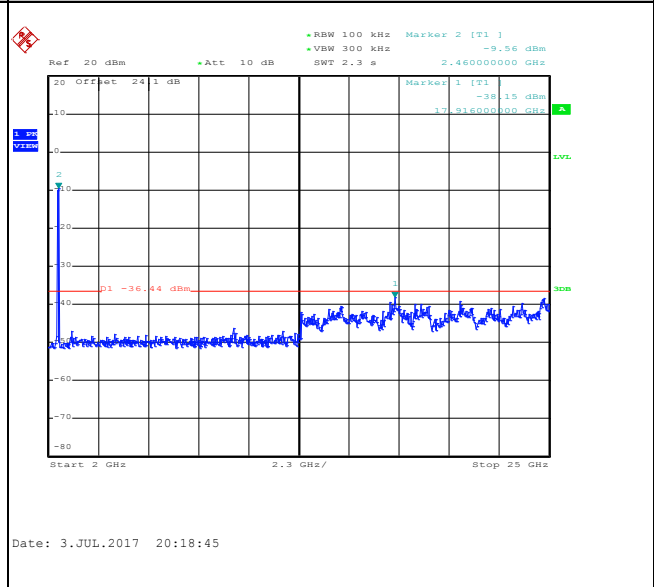



<TXBF Mode>

Number of TX = 2, Ant. 1 (Measured)

Number of TX :	2	Ant. :	1
Test Mode :	802.11ac VHT20	Temperature :	21~25°C
Test Band :	2.4GHz Low	Relative Humidity :	51~54%
Test Channel :	01	Test Engineer :	Derek Hsu

WLAN 802.11ac VHT20 Channel 01

100kHz PSD reference Level

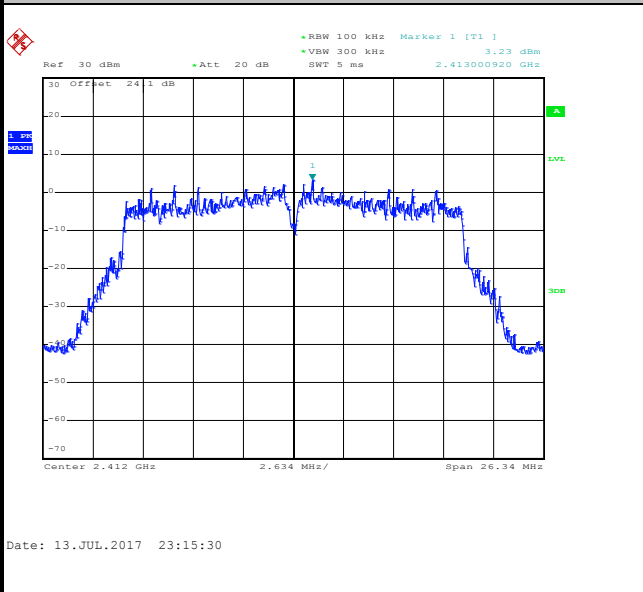

Low Channel Plot

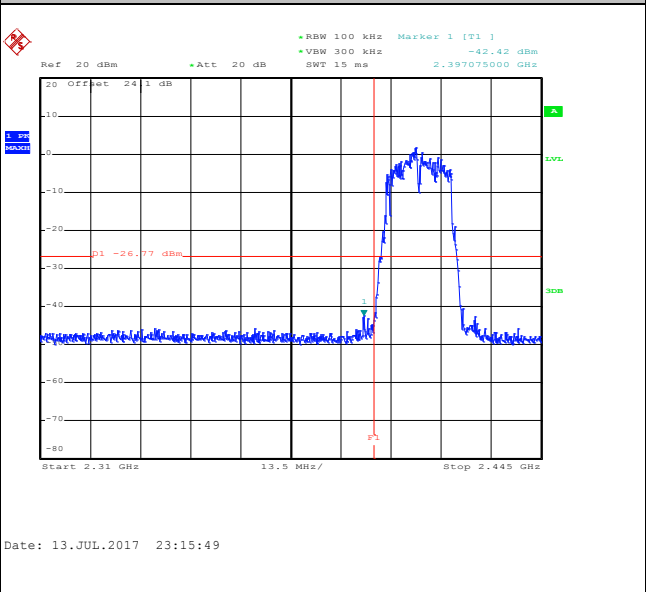

Spurious Emission 30MHz~3GHz

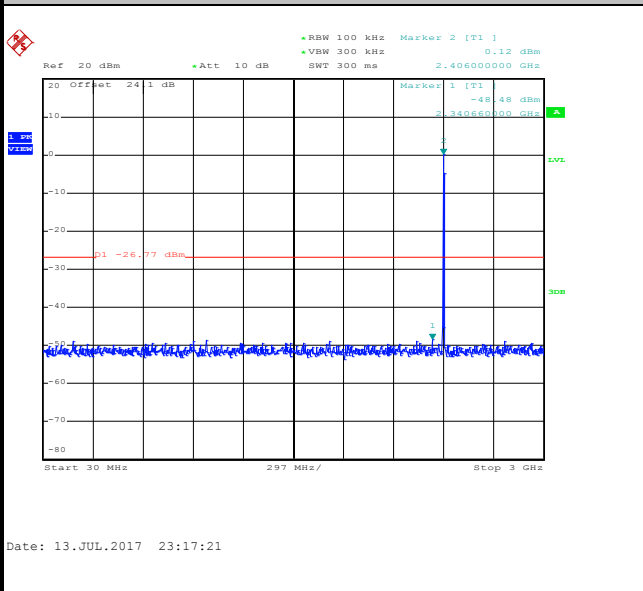

Spurious Emission 2GHz~25GHz

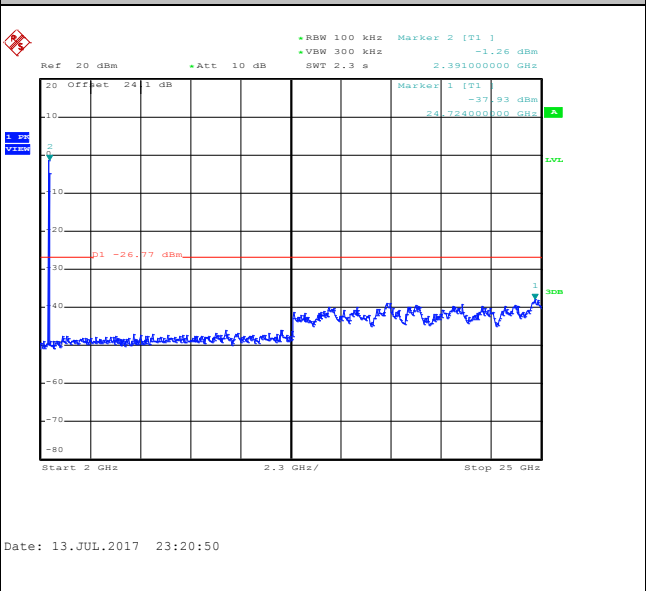



Number of TX :	2	Ant. :	1
Test Mode :	802.11ac VHT20	Temperature :	21~25°C
Test Band :	2.4GHz Mid	Relative Humidity :	51~54%
Test Channel :	06	Test Engineer :	Derek Hsu

WLAN 802.11ac VHT20 Channel 06

100kHz PSD reference Level

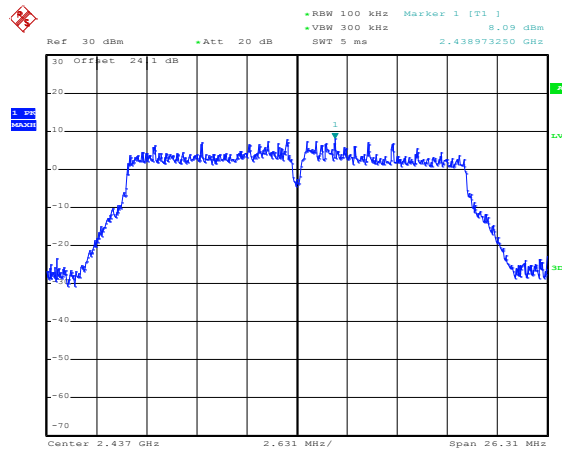

Date: 13.JUL.2017 23:32:37

Spurious Emission 30MHz~3GHz

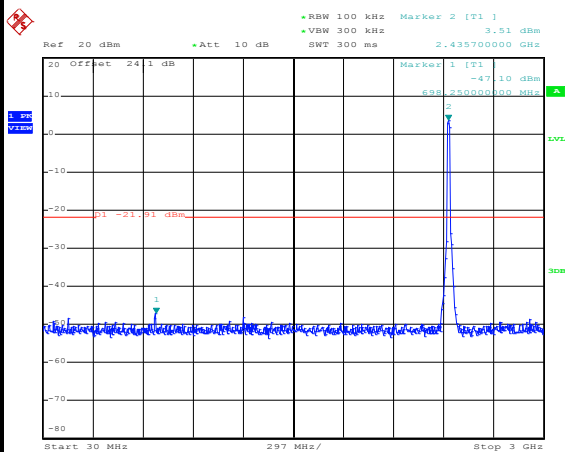

Date: 13.JUL.2017 23:32:55

Spurious Emission 2GHz~25GHz

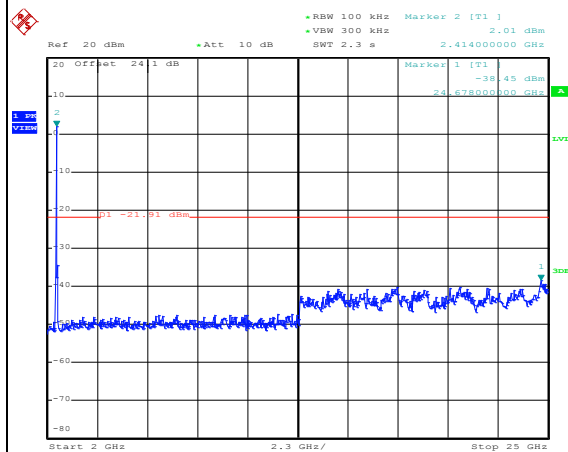

Date: 13.JUL.2017 23:33:03



Number of TX :	2	Ant. :	1
Test Mode :	802.11ac VHT20	Temperature :	21~25°C
Test Band :	2.4GHz High	Relative Humidity :	51~54%
Test Channel :	11	Test Engineer :	Derek Hsu

WLAN 802.11ac VHT20 Channel 11

100kHz PSD reference Level

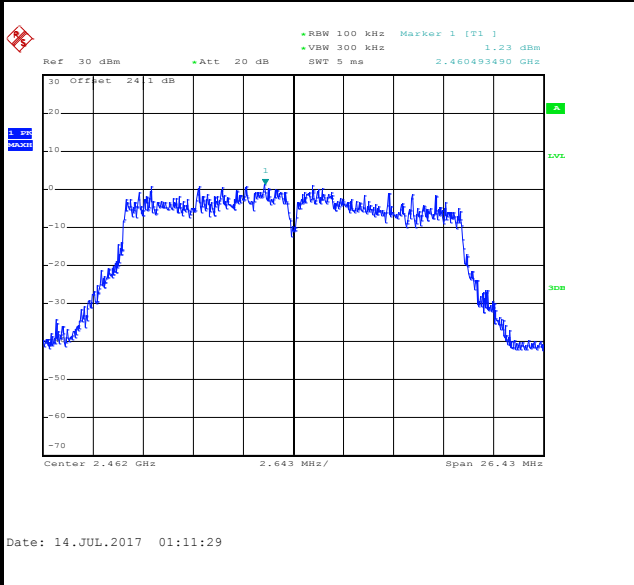

High Channel Plot

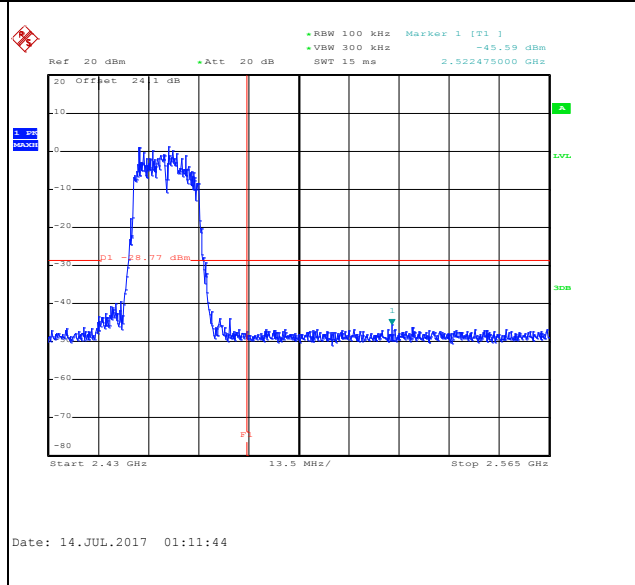

Spurious Emission 30MHz~3GHz

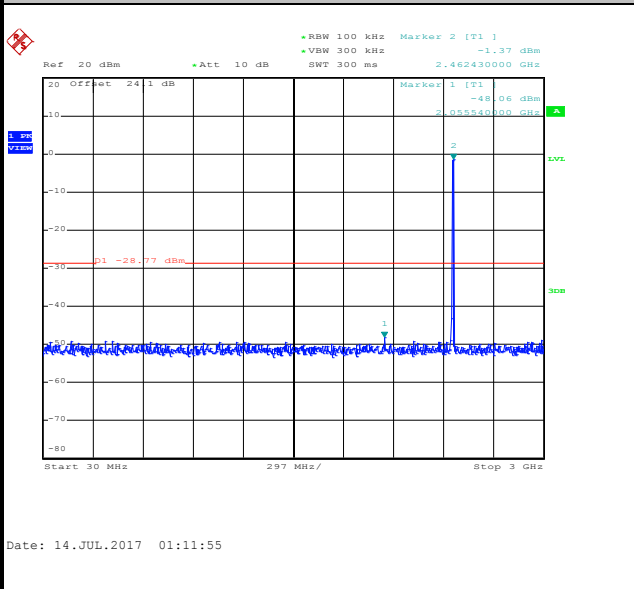

Spurious Emission 2GHz~25GHz

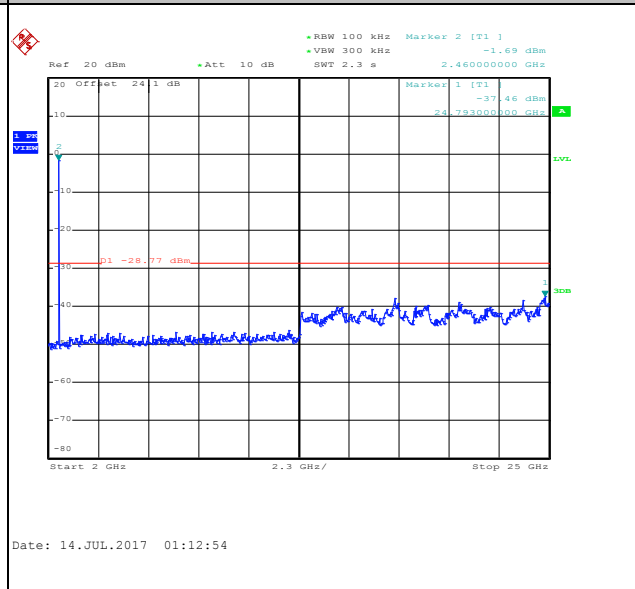



Number of TX :	2	Ant. :	1
Test Mode :	802.11ac VHT40	Temperature :	21~25°C
Test Band :	2.4GHz Low	Relative Humidity :	51~54%
Test Channel :	03	Test Engineer :	Derek Hsu

WLAN 802.11ac VHT40 Channel 03

100kHz PSD reference Level

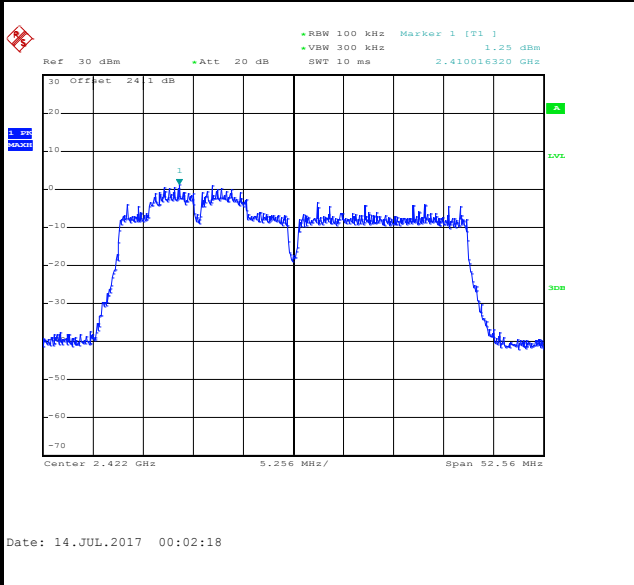

Low Channel Plot

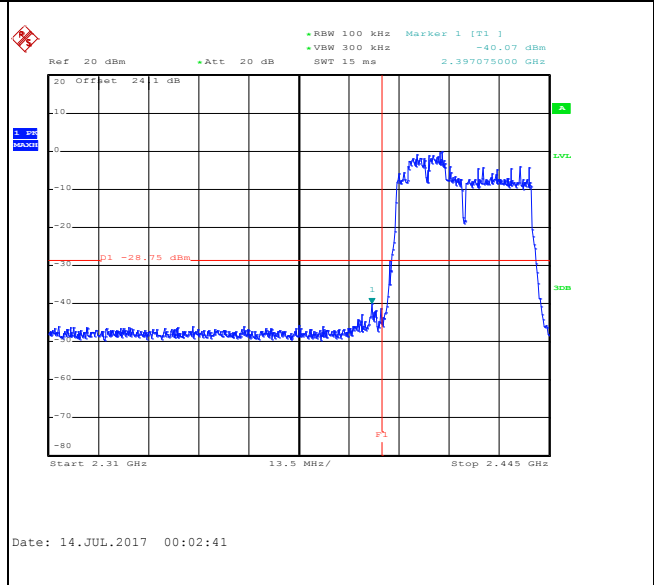

Spurious Emission 30MHz~3GHz

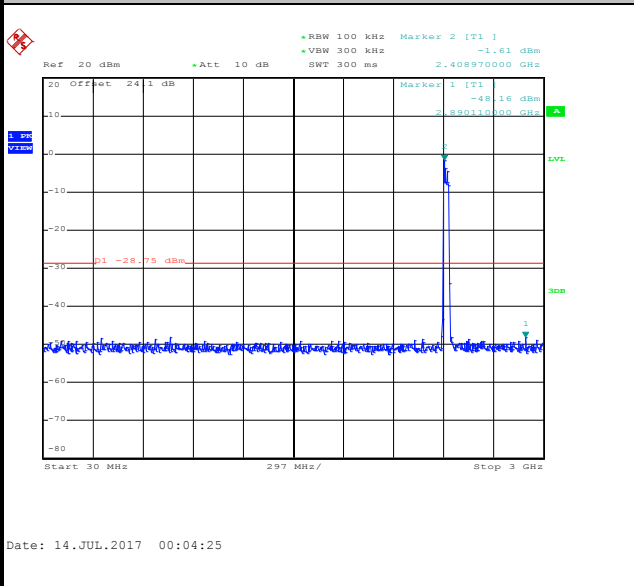

Spurious Emission 2GHz~25GHz

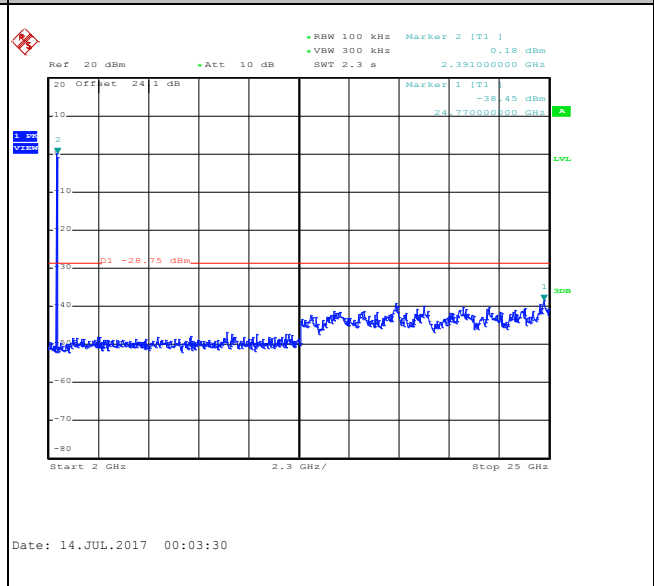



Number of TX :	2	Ant. :	1
Test Mode :	802.11ac VHT40	Temperature :	21~25°C
Test Band :	2.4GHz Mid	Relative Humidity :	51~54%
Test Channel :	06	Test Engineer :	Derek Hsu

WLAN 802.11ac VHT40 Channel 06

100kHz PSD reference Level

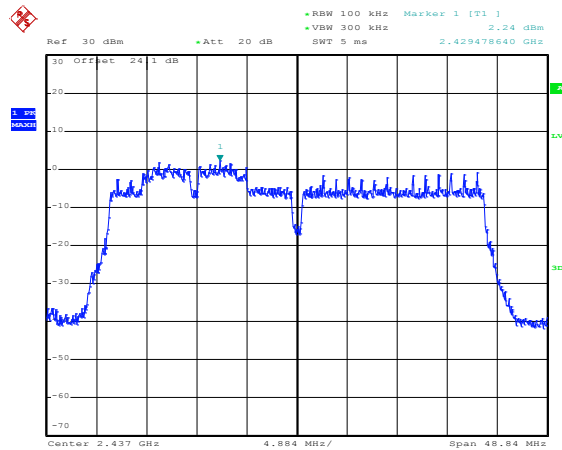

Date: 14.JUL.2017 00:16:04

Spurious Emission 30MHz~3GHz

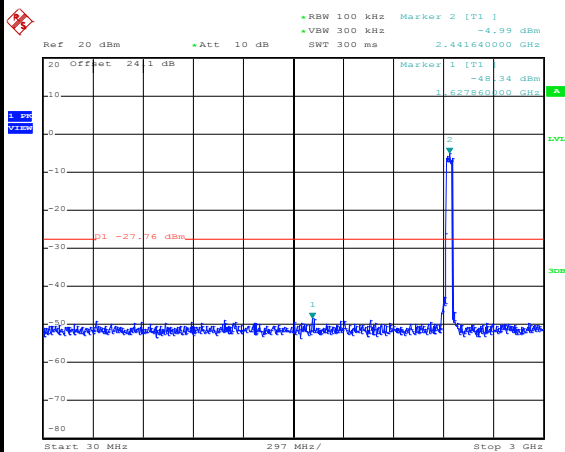

Date: 14.JUL.2017 00:16:15

Spurious Emission 2GHz~25GHz

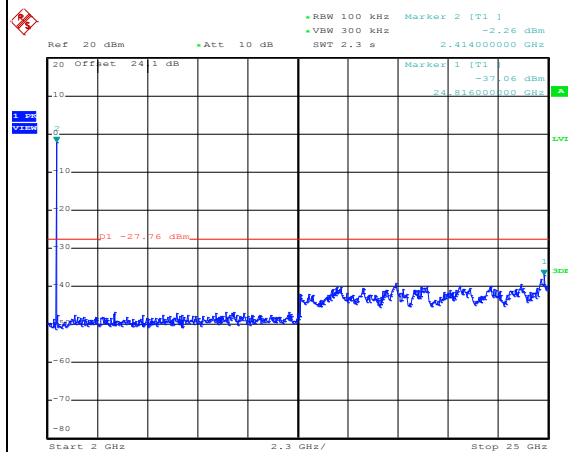

Date: 14.JUL.2017 00:18:04



Number of TX :	2	Ant. :	1
Test Mode :	802.11ac VHT40	Temperature :	21~25°C
Test Band :	2.4GHz High	Relative Humidity :	51~54%
Test Channel :	09	Test Engineer :	Derek Hsu

WLAN 802.11ac VHT40 Channel 09

100kHz PSD reference Level

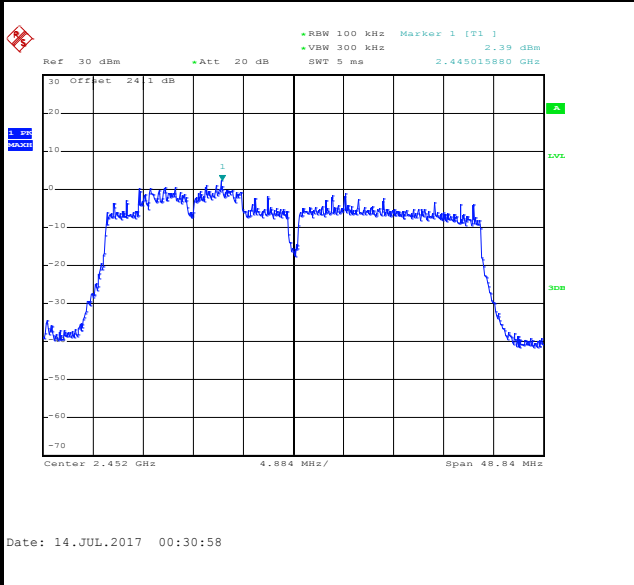

High Channel Plot

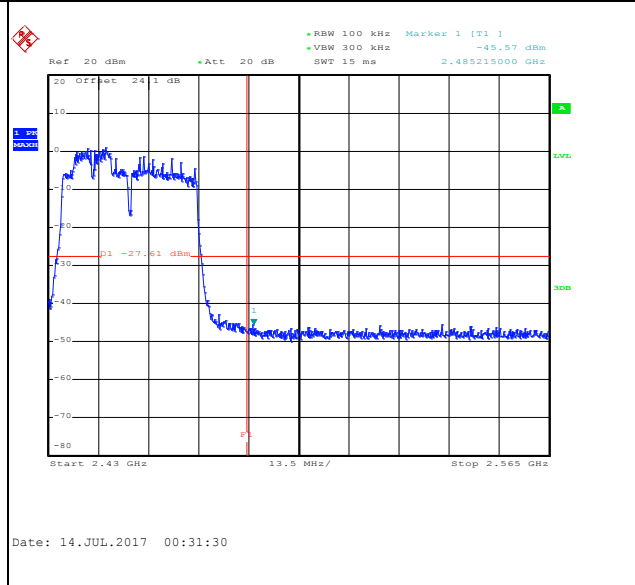

Spurious Emission 30MHz~3GHz

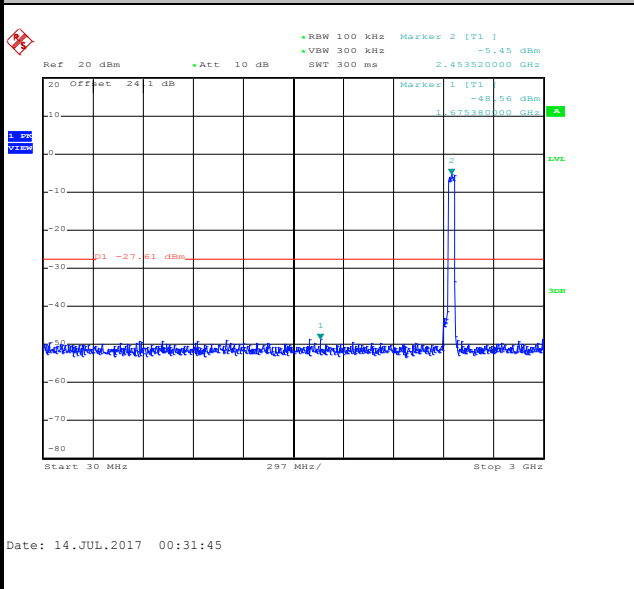

Spurious Emission 2GHz~25GHz

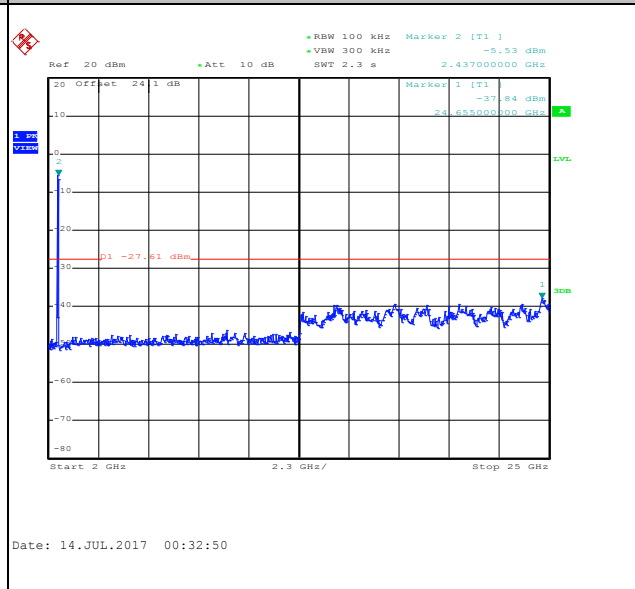



Number of TX :	2	Ant. :	1
Test Mode :	802.11ac VHT40	Temperature :	21~25°C
Test Band :	2.4GHz High	Relative Humidity :	51~54%
Test Channel :	10	Test Engineer :	Derek Hsu

WLAN 802.11ac VHT40 Channel 10

100kHz PSD reference Level

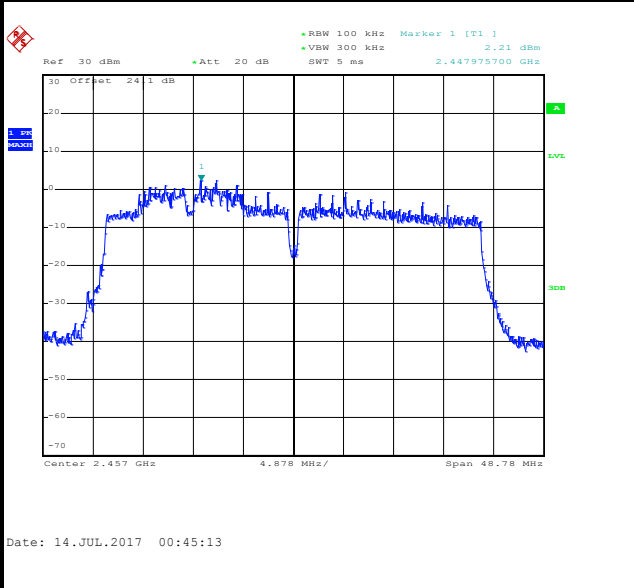

High Channel Plot

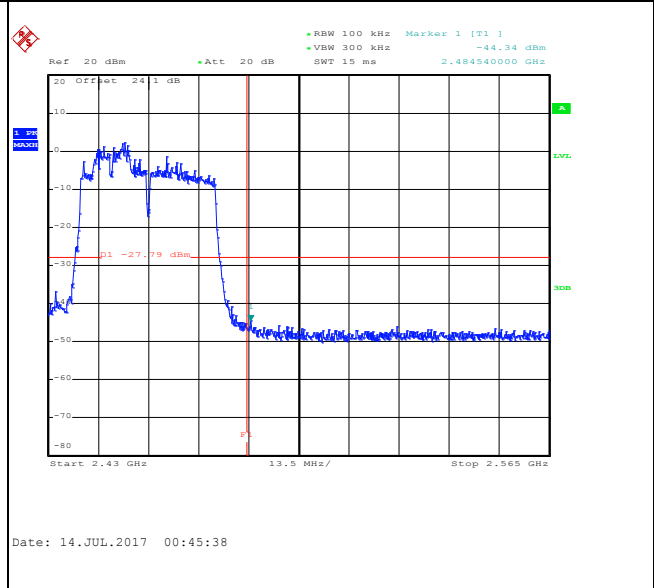

Spurious Emission 30MHz~3GHz

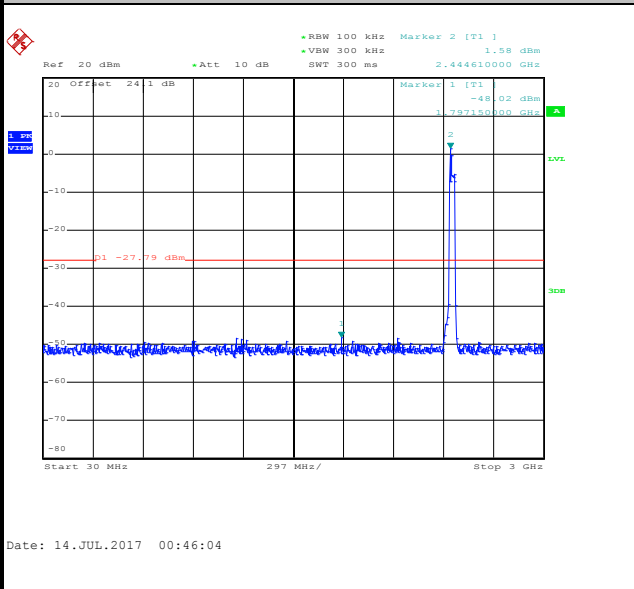

Spurious Emission 2GHz~25GHz

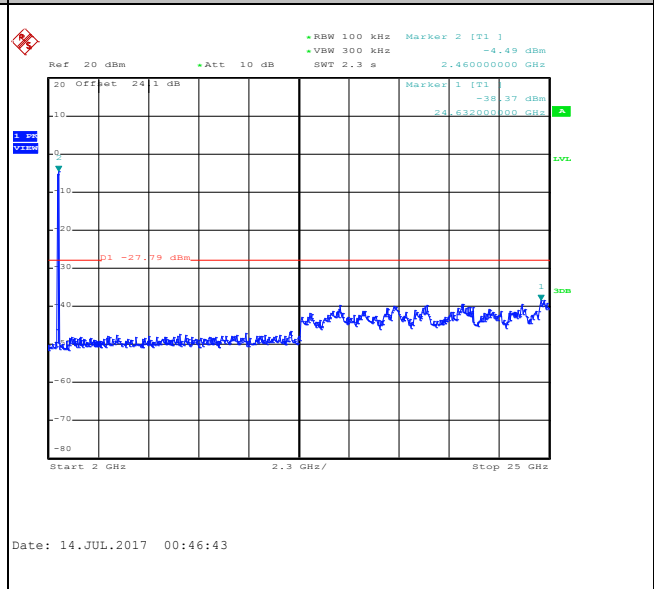



Number of TX :	2	Ant. :	1
Test Mode :	802.11ac VHT40	Temperature :	21~25°C
Test Band :	2.4GHz High	Relative Humidity :	51~54%
Test Channel :	11	Test Engineer :	Derek Hsu

WLAN 802.11ac VHT40 Channel 11

100kHz PSD reference Level

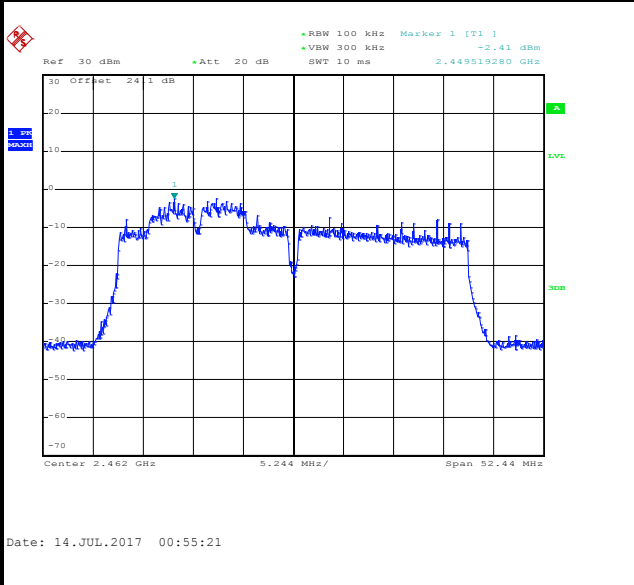

High Channel Plot

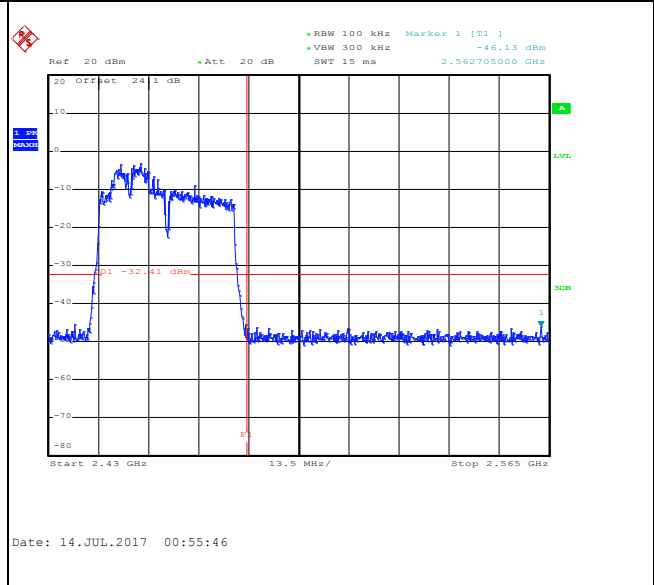

Spurious Emission 30MHz~3GHz

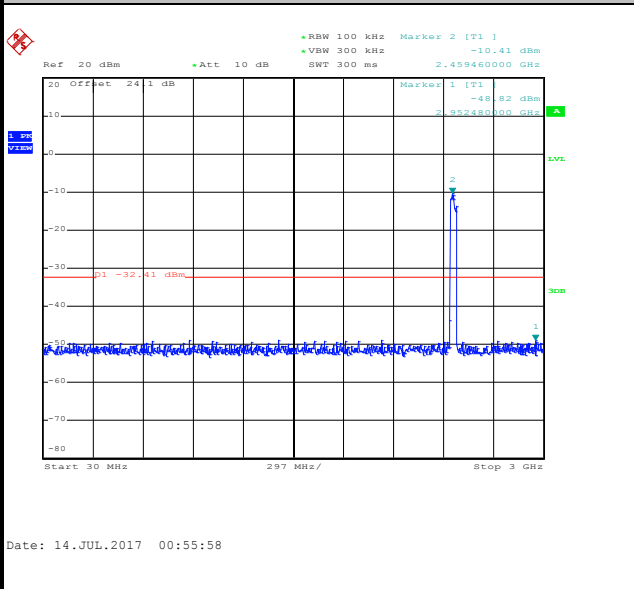

Spurious Emission 2GHz~25GHz

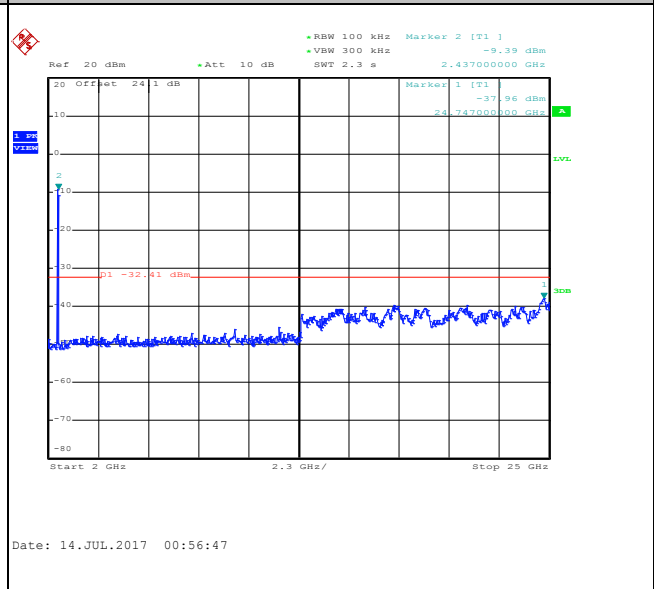



Number of TX = 2, Ant. 2 (Measured)

Number of TX :	2	Ant. :	2
Test Mode :	802.11ac VHT20	Temperature :	21~25°C
Test Band :	2.4GHz Low	Relative Humidity :	51~54%
Test Channel :	01	Test Engineer :	Derek Hsu

WLAN 802.11ac VHT20 Channel 01

100kHz PSD reference Level

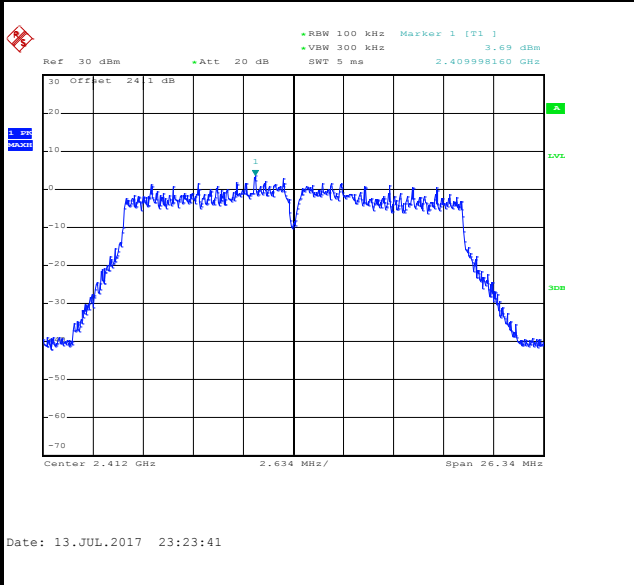

Low Channel Plot

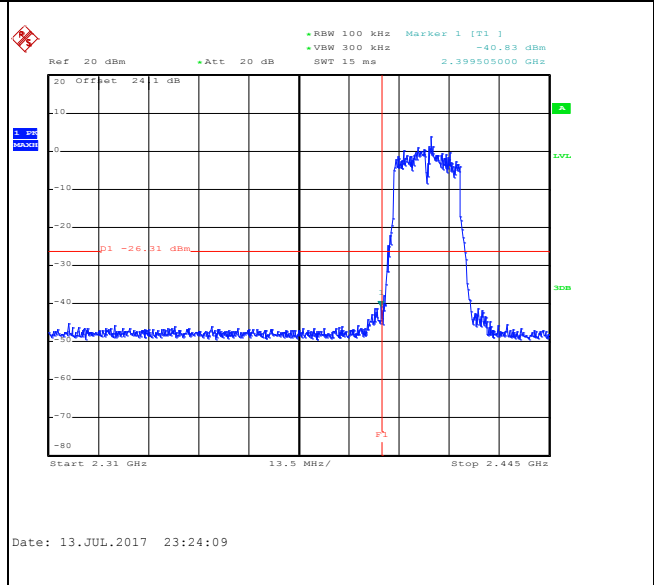

Spurious Emission 30MHz~3GHz



Spurious Emission 2GHz~25GHz

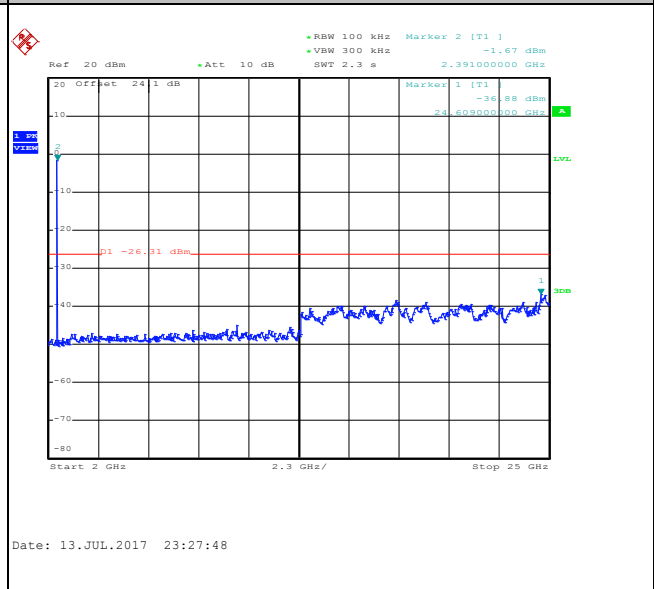



Number of TX :	2	Ant. :	2
Test Mode :	802.11ac VHT20	Temperature :	21~25°C
Test Band :	2.4GHz Mid	Relative Humidity :	51~54%
Test Channel :	06	Test Engineer :	Derek Hsu

WLAN 802.11ac VHT20 Channel 06

100kHz PSD reference Level

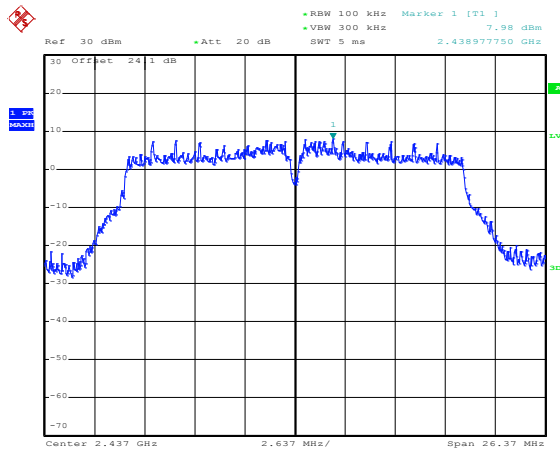

Date: 13.JUL.2017 23:34:35

Spurious Emission 30MHz~3GHz

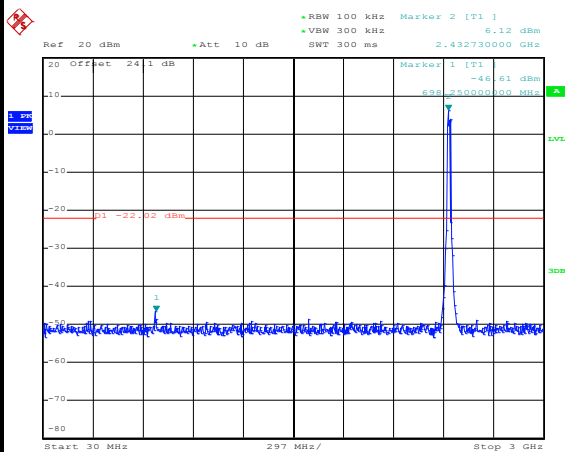

Date: 13.JUL.2017 23:34:46

Spurious Emission 2GHz~25GHz

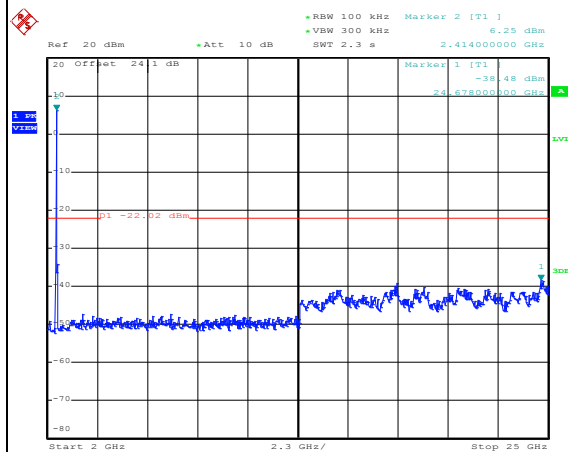

Date: 13.JUL.2017 23:34:55



Number of TX :	2	Ant. :	2
Test Mode :	802.11ac VHT20	Temperature :	21~25°C
Test Band :	2.4GHz High	Relative Humidity :	51~54%
Test Channel :	11	Test Engineer :	Derek Hsu

WLAN 802.11ac VHT20 Channel 11

100kHz PSD reference Level

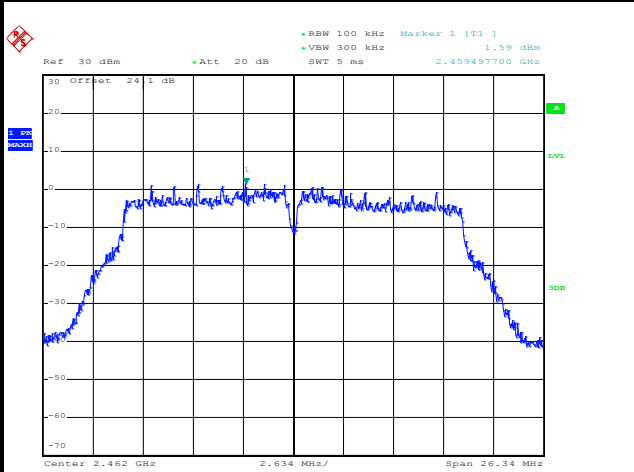

Date: 13.JUL.2017 23:45:13

High Channel Plot

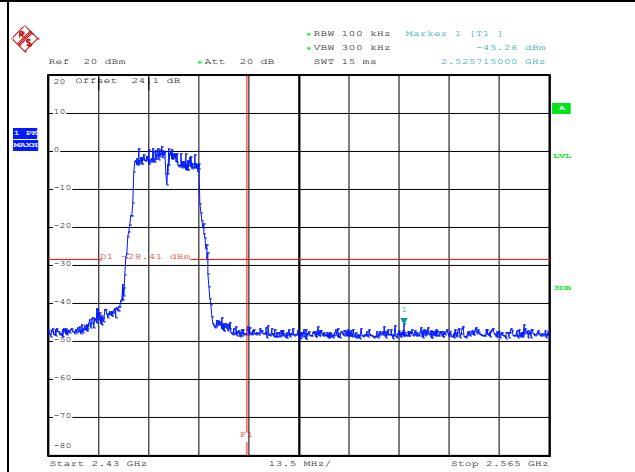

Date: 13.JUL.2017 23:45:57

Spurious Emission 30MHz~3GHz

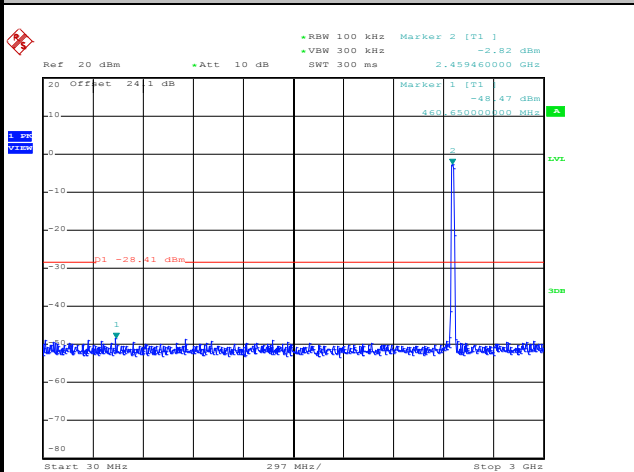

Date: 13.JUL.2017 23:46:49

Spurious Emission 2GHz~25GHz

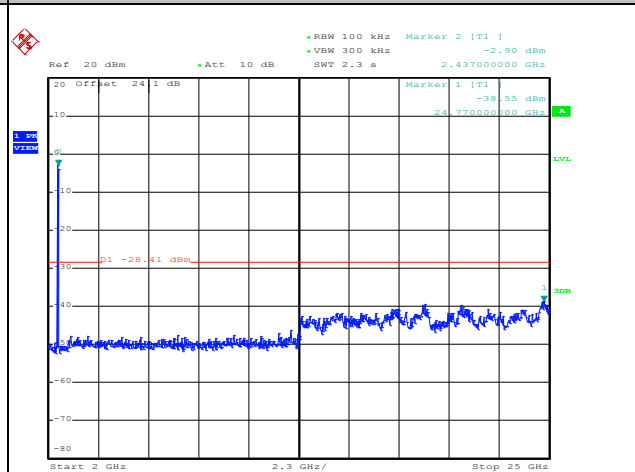

Date: 13.JUL.2017 23:46:57



Number of TX :	2	Ant. :	2
Test Mode :	802.11ac VHT40	Temperature :	21~25°C
Test Band :	2.4GHz Low	Relative Humidity :	51~54%
Test Channel :	03	Test Engineer :	Derek Hsu

WLAN 802.11ac VHT40 Channel 03

100kHz PSD reference Level

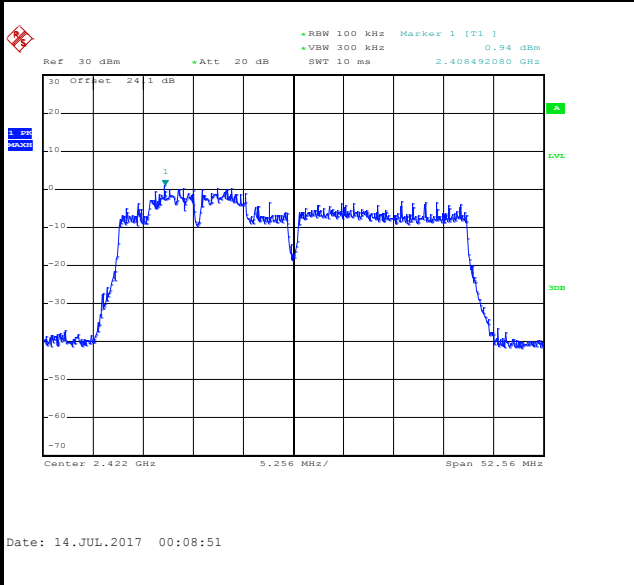

Low Channel Plot

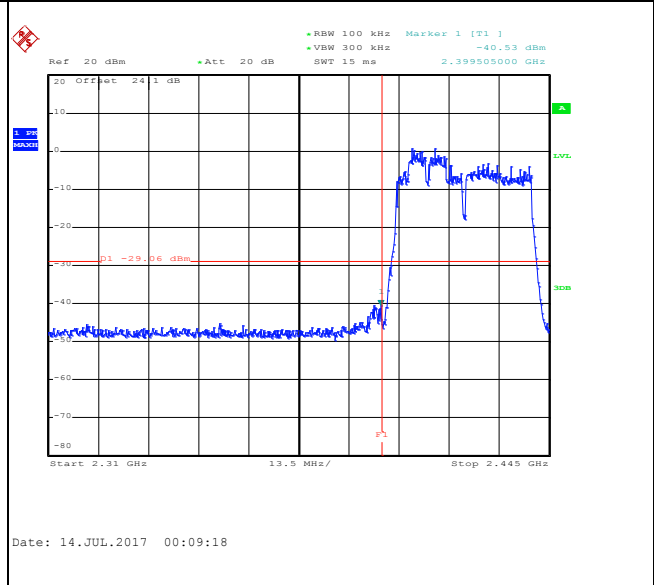

Spurious Emission 30MHz~3GHz

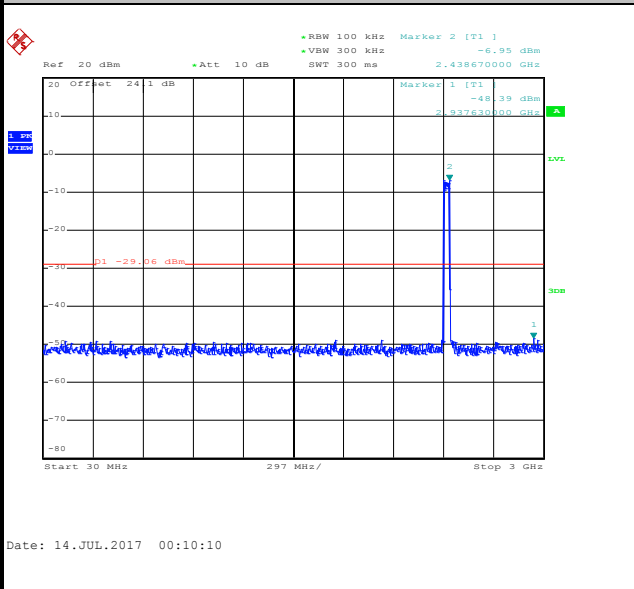

Spurious Emission 2GHz~25GHz

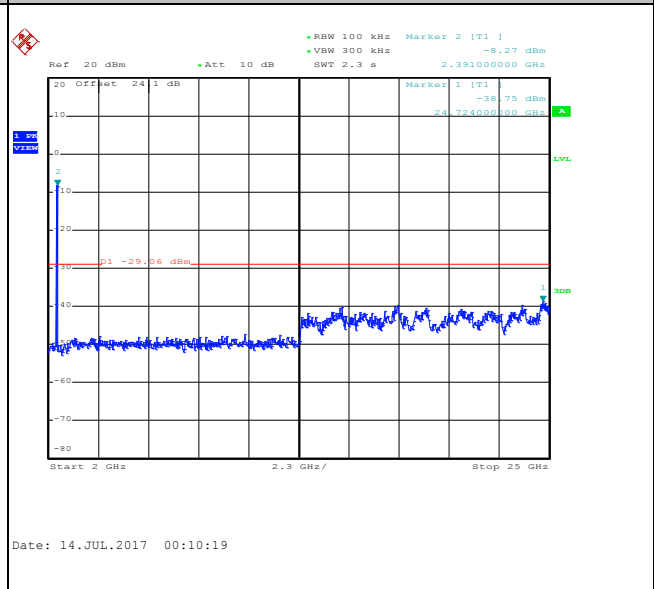



Number of TX :	2	Ant. :	2
Test Mode :	802.11ac VHT40	Temperature :	21~25°C
Test Band :	2.4GHz Mid	Relative Humidity :	51~54%
Test Channel :	06	Test Engineer :	Derek Hsu

WLAN 802.11ac VHT40 Channel 06

100kHz PSD reference Level

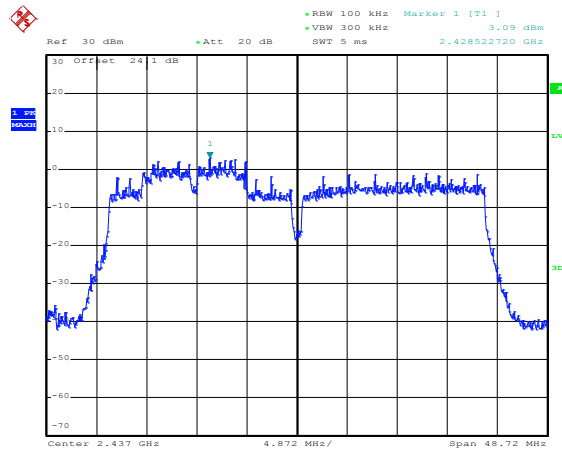

Date: 14.JUL.2017 00:21:20

Spurious Emission 30MHz~3GHz

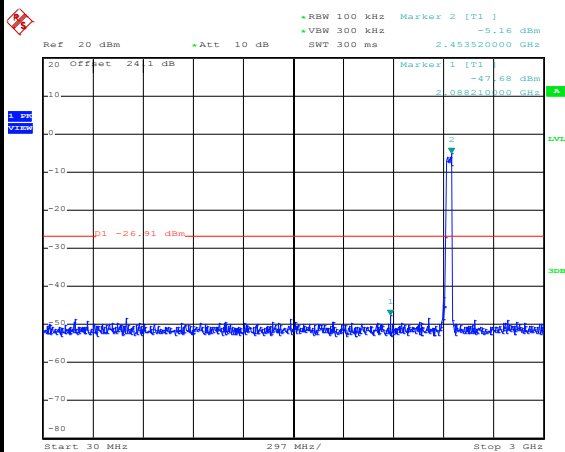

Date: 14.JUL.2017 00:21:31

Spurious Emission 2GHz~25GHz

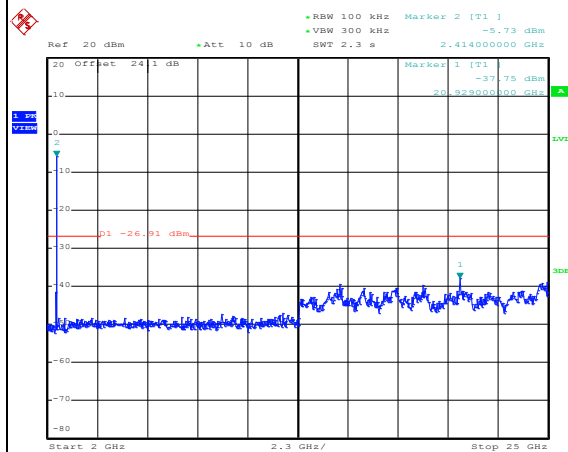

Date: 14.JUL.2017 00:21:40



Number of TX :	2	Ant. :	2
Test Mode :	802.11ac VHT40	Temperature :	21~25°C
Test Band :	2.4GHz High	Relative Humidity :	51~54%
Test Channel :	09	Test Engineer :	Derek Hsu

WLAN 802.11ac VHT40 Channel 09

100kHz PSD reference Level

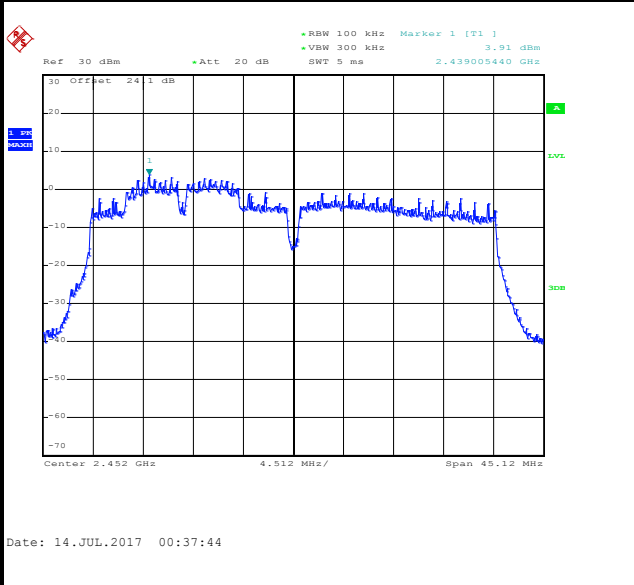

High Channel Plot

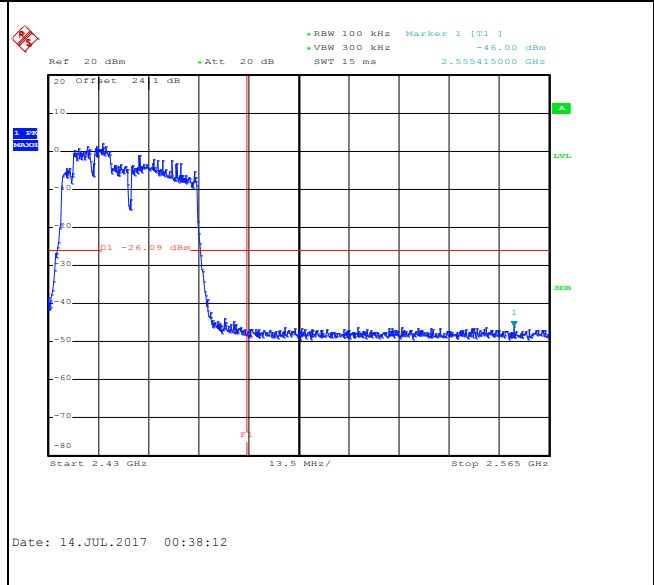

Spurious Emission 30MHz~3GHz

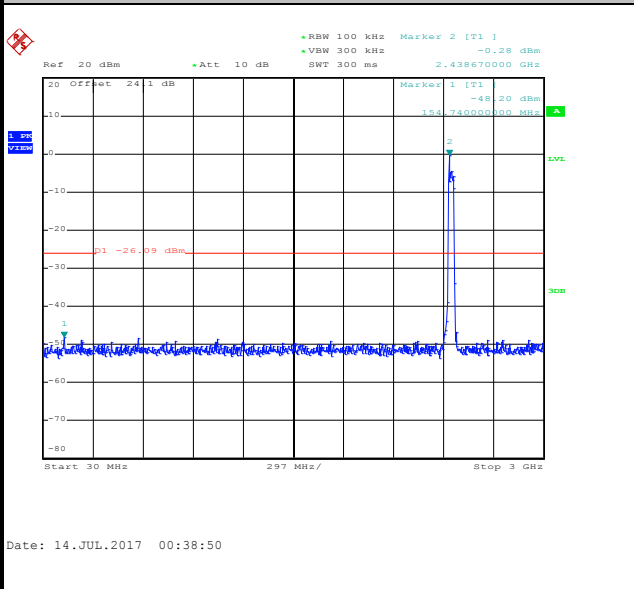

Spurious Emission 2GHz~25GHz

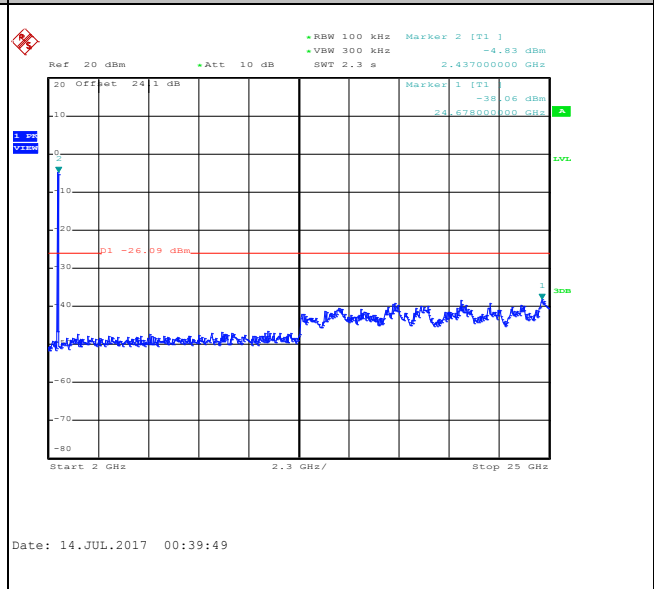



Number of TX :	2	Ant. :	2
Test Mode :	802.11ac VHT40	Temperature :	21~25°C
Test Band :	2.4GHz High	Relative Humidity :	51~54%
Test Channel :	10	Test Engineer :	Derek Hsu

WLAN 802.11ac VHT40 Channel 10

100kHz PSD reference Level

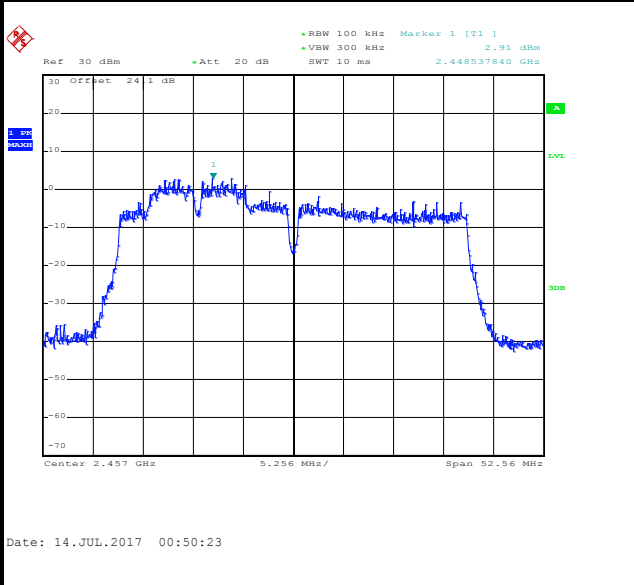

High Channel Plot

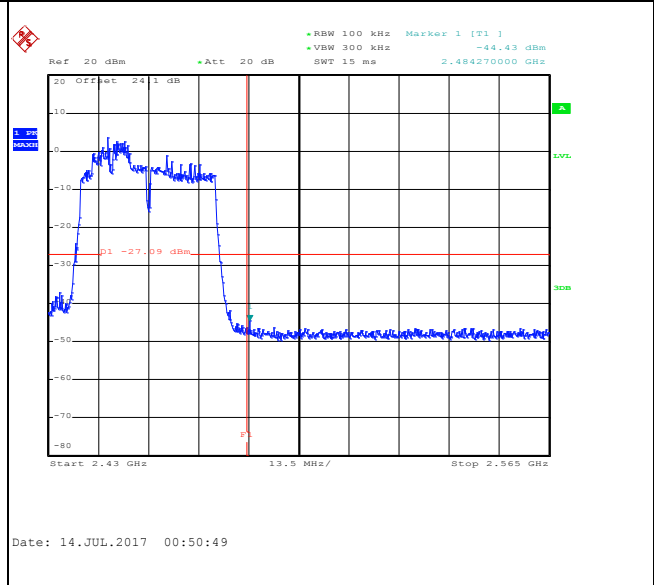

Spurious Emission 30MHz~3GHz

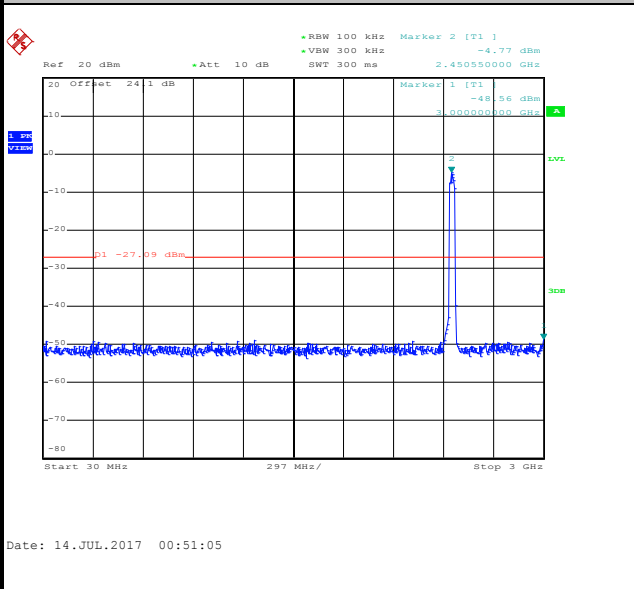

Spurious Emission 2GHz~25GHz

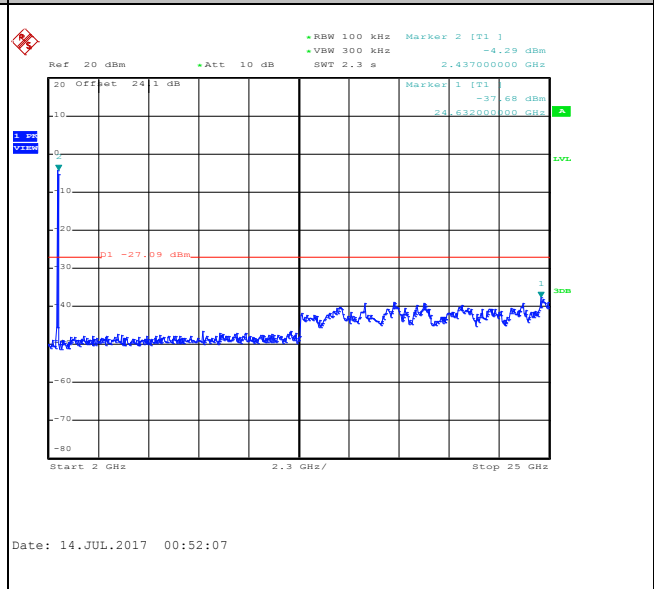



Number of TX :	2	Ant. :	2
Test Mode :	802.11ac VHT40	Temperature :	21~25°C
Test Band :	2.4GHz High	Relative Humidity :	51~54%
Test Channel :	11	Test Engineer :	Derek Hsu

WLAN 802.11ac VHT40 Channel 11

100kHz PSD reference Level

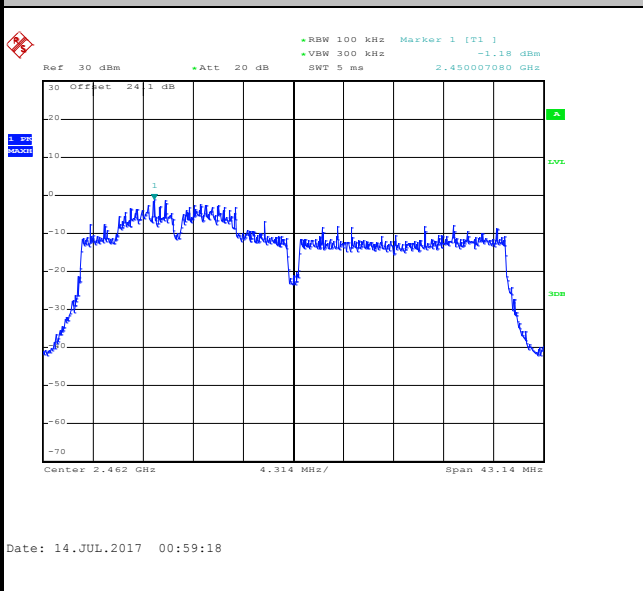

High Channel Plot

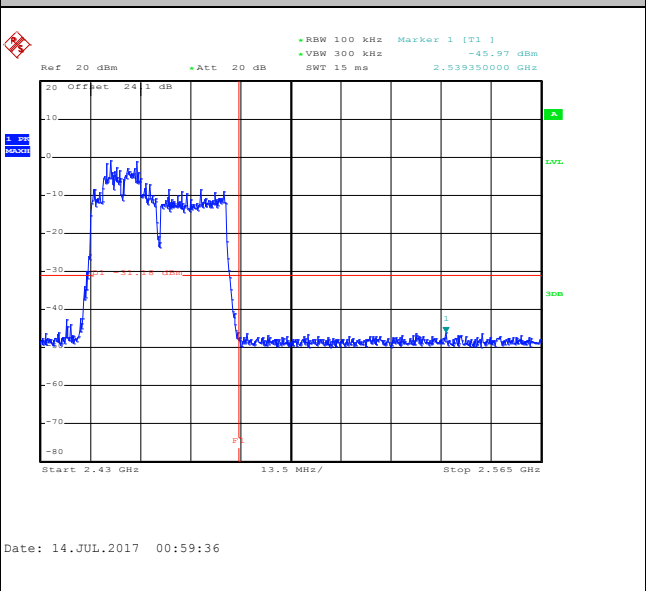

Spurious Emission 30MHz~3GHz

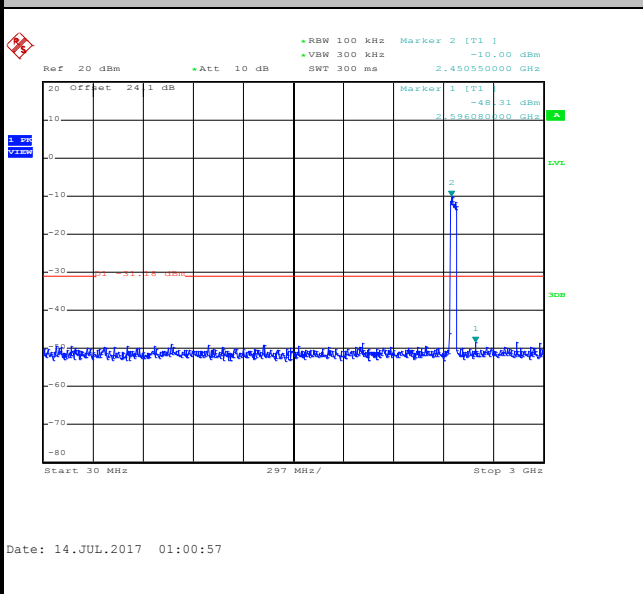

Spurious Emission 2GHz~25GHz

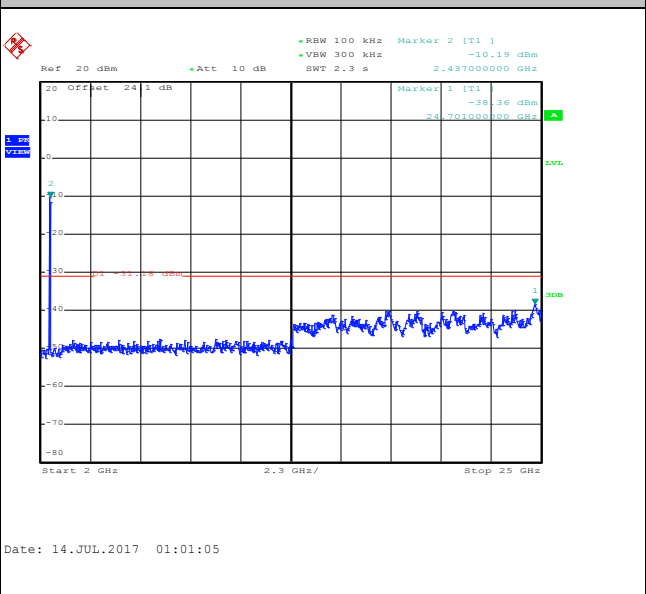



3.5 Radiated Band Edges and Spurious Emission Measurement

3.5.1 Limit of Radiated band edge and Spurious Emission Measurement

In any 100 kHz bandwidth outside the intentional radiator frequency band, all harmonics/spurious must be at least 20 dB below the highest emission level within the authorized band. If the output power of this device was measured by spectrum analyzer, the attenuation under this paragraph shall be 30 dB instead of 20 dB. In addition, radiated emissions which fall in the restricted bands must also comply with the limits as below.

Frequency (MHz)	Field Strength (microvolts/meter)	Measurement Distance (meters)
0.009 – 0.490	2400/F(kHz)	300
0.490 – 1.705	24000/F(kHz)	30
1.705 – 30.0	30	30
30 – 88	100	3
88 – 216	150	3
216 - 960	200	3
Above 960	500	3

3.5.2 Measuring Instruments

The measuring equipment is listed in the section 4 of this test report.



3.5.3 Test Procedures

1. The testing follows FCC KDB Publication No. 558074 D01 DTS Meas. Guidance v04.
2. The EUT was arranged to its worst case and then tune the antenna tower (from 1 m to 4 m) and turntable (from 0 degree to 360 degrees) to find the maximum reading. A pre-amp and a high pass filter are used for the test in order to get better signal level.
3. The EUT was placed on a turntable with 0.8 meter for frequency below 1GHz and 1.5 meter for frequency above 1GHz respectively above ground.
4. The EUT was set 3 meters from the interference receiving antenna, which was mounted on the top of a variable height antenna tower.
5. Corrected Reading: Antenna Factor + Cable Loss + Read Level - Preamp Factor = Level
6. For measurement below 1GHz, If the emission level of the EUT measured by the peak detector is 3 dB lower than the applicable limit, the peak emission level will be reported. Otherwise, the emission measurement will be repeated using the quasi-peak detector and reported.
7. Use the following spectrum analyzer settings:
 - (1) Span shall wide enough to fully capture the emission being measured;
 - (2) Set RBW=100 kHz for $f < 1$ GHz; VBW \geq RBW; Sweep = auto; Detector function = peak; Trace = max hold;
 - (3) Set RBW = 1 MHz, VBW= 3MHz for $f \geq 1$ GHz for peak measurement.
For average measurement:
 - VBW = 10 Hz, when duty cycle is no less than 98 percent.
 - VBW $\geq 1/T$, when duty cycle is less than 98 percent where T is the minimum transmission duration over which the transmitter is on and is transmitting at its maximum power control level for the tested mode of operation.

3.5.4 Test Setup

For radiated emissions below 30MHz

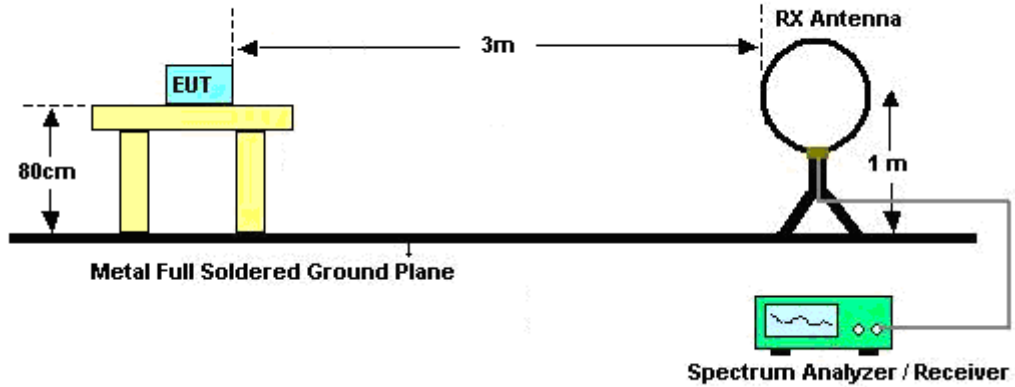

For radiated emissions from 30MHz to 1GHz

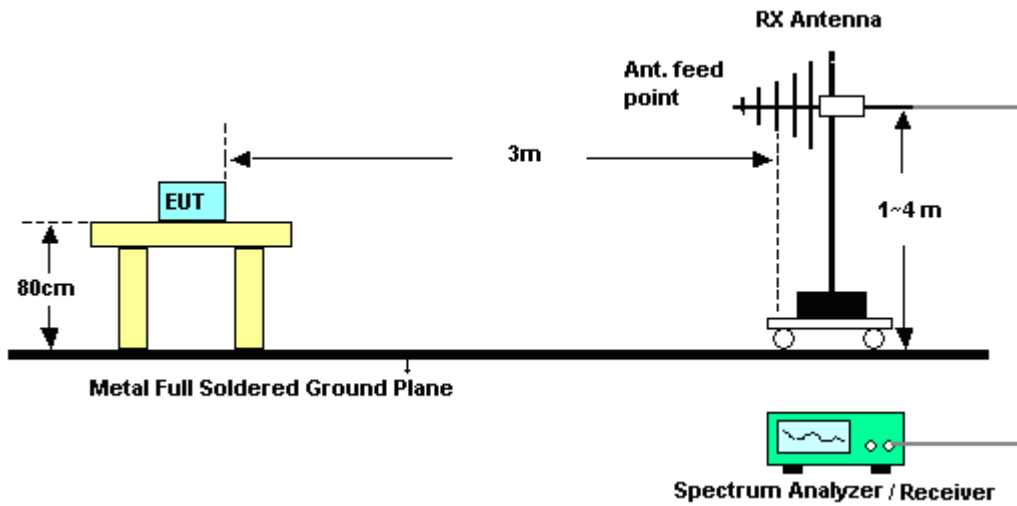

For radiated emissions above 1GHz

<CDD Modes>

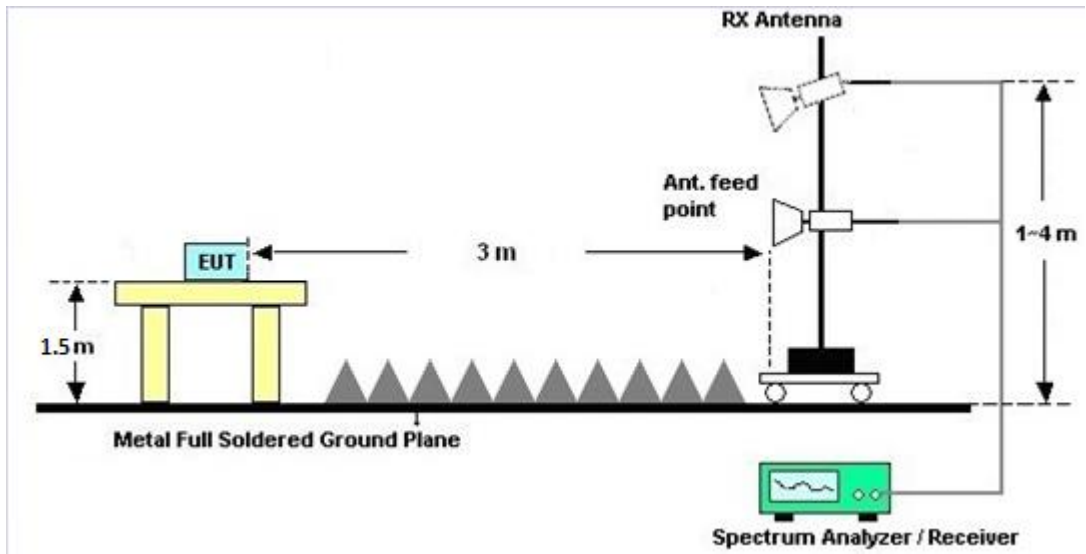

<TXBF Modes>

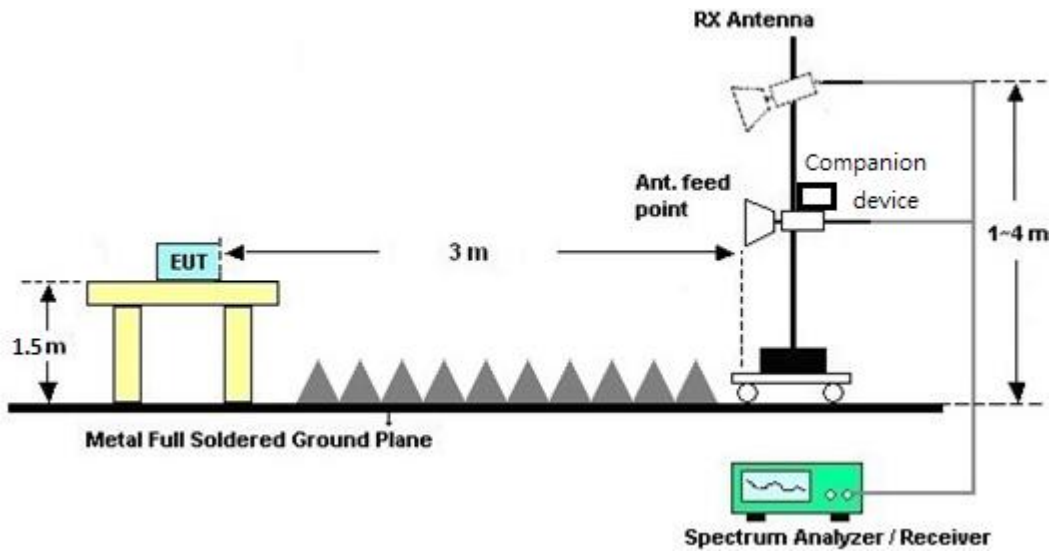



3.5.5 Test Results of Radiated Spurious Emissions (9kHz ~ 30MHz)

The low frequency, which started from 9 kHz to 30MHz, was pre-scanned and the result which was 20dB lower than the limit line was not reported.

3.5.6 Test Result of Radiated Spurious at Band Edges

Please refer to Appendix B and C.

3.5.7 Duty Cycle

Please refer to Appendix D.

3.5.8 Test Result of Radiated Spurious Emission (30MHz ~ 10th Harmonic)

Please refer to Appendix B and C.



3.6 AC Conducted Emission Measurement

3.6.1 Limit of AC Conducted Emission

For equipment that is designed to be connected to the public utility (AC) power line, the radio frequency voltage that is conducted back onto the AC power line on any frequency or frequencies within the band 150 kHz to 30 MHz shall not exceed the limits in the following table.

Frequency of Emission (MHz)	Conducted Limit (dBµV)	
	Quasi-Peak	Average
0.15-0.5	66 to 56*	56 to 46*
0.5-5	56	46
5-30	60	50

*Decreases with the logarithm of the frequency.

3.6.2 Measuring Instruments

The measuring equipment is listed in the section 4 of this test report.

3.6.3 Test Procedures

1. The EUT was placed 0.4 meter from the conducting wall of the shielding room, and it was kept at least 80 centimeters from any other grounded conducting surface.
2. Connect EUT to the power mains through a line impedance stabilization network (LISN).
3. All the support units are connecting to the other LISN.
4. The LISN provides 50 ohm coupling impedance for the measuring instrument.
5. The FCC states that a 50 ohm, 50 microhenry LISN should be used.
6. Both sides of AC line were checked for maximum conducted interference.
7. The frequency range from 150 kHz to 30 MHz was searched.
8. Set the test-receiver system to Peak Detect Function and specified bandwidth (IF bandwidth = 9kHz) with Maximum Hold Mode.

3.6.4 Test Setup

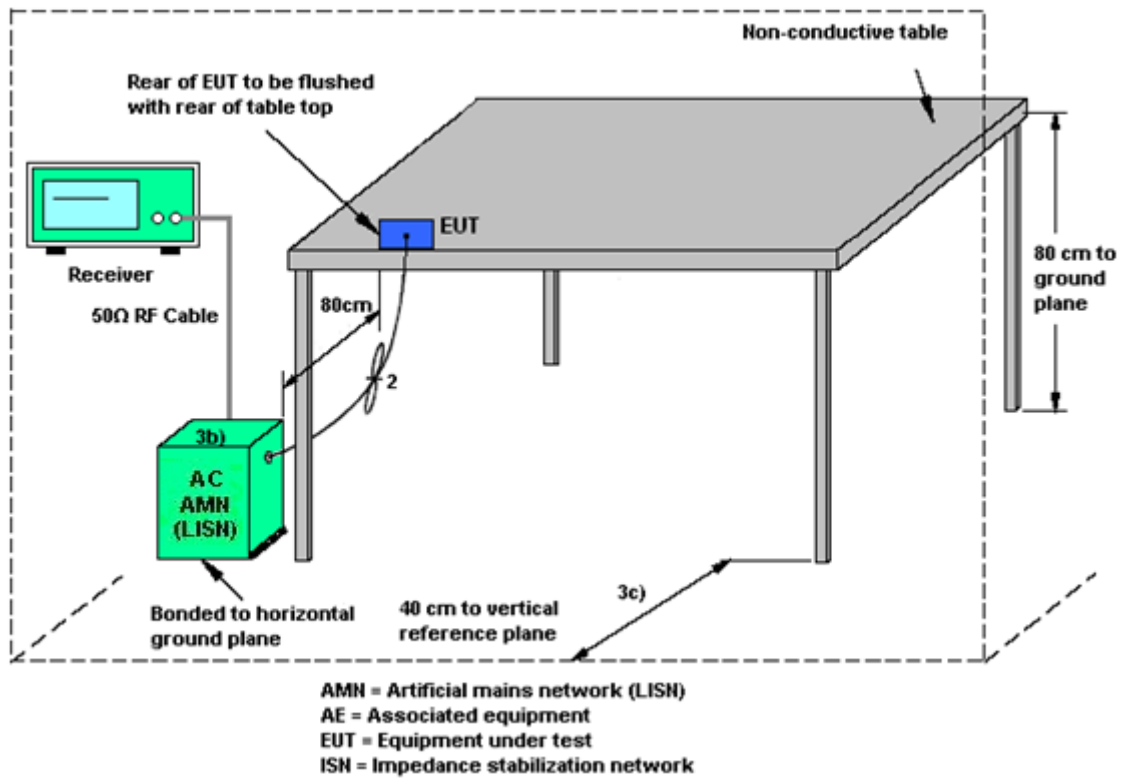

3.6.5 Test Result of AC Conducted Emission

Please refer to Appendix A.



3.7 Antenna Requirements

3.7.1 Standard Applicable

If directional gain of transmitting Antennas is greater than 6dBi, the power shall be reduced by the same level in dB comparing to gain minus 6dBi. The use of a permanently attached Antenna or of an Antenna that uses a unique coupling to the intentional radiator shall be considered sufficient to comply with the rule.

3.7.2 Antenna Anti-Replacement Construction

An embedded-in antenna design is used.

3.7.3 Antenna Gain

CDD modes

FCC KDB 662911 D01 Multiple Transmitter Output v02r01

For CDD transmissions, directional gain is calculated as

Directional gain = $G_{ANT} + \text{Array Gain}$, where Array Gain is as follows.

For power spectral density (PSD) measurements on all devices,

Array Gain = $10 \log(N_{ANT}/N_{SS}=1)$ dB.

For power measurements on IEEE 802.11 devices,

Array Gain = 0 dB (i.e., no array gain) for $N_{ANT} \leq 4$.

Directional gain may be calculated by using the formulas applicable to equal gain antennas with G_{ANT} set equal to the gain of the antenna having the highest gain;

The EUT supports CDD mode.

For power, the directional gain G_{ANT} is set equal to the antenna having the highest gain, i.e., F)2)f)i).

For PSD, the directional gain calculation is following F)2)f)ii) of KDB 662911 D01 v02r01.

The power and PSD limit should be modified if the directional gain of EUT is over 6 dBi,

The directional gain "DG" is calculated as following table.

			DG for Power (dBi)	DG for PSD (dBi)	Power Limit Reduction (dB)	PSD Limit Reduction (dB)
	Chain 1 (dBi)	Chain 2 (dBi)				
2.4 GHz	3.96	3.69	3.96	6.84	0.00	0.84

$Power\ Limit\ Reduction = DG(Power) - 6dBi, (min = 0)$

$PSD\ Limit\ Reduction = DG(PSD) - 6dBi, (min = 0)$

TXBF modes

FCC KDB 662911 D01 Multiple Transmitter Output v02r01

For CDD transmissions, directional gain is calculated as

$$DirectionalGain = 10 \cdot \log \left[\frac{\sum_{j=1}^{N_{SS}} \left\{ \sum_{k=1}^{N_{ANT}} g_{j,k} \right\}^2}{N_{ANT}} \right]$$

where

Each antenna is driven by no more than one spatial stream;

N_{SS} = the number of independent spatial streams of data;

N_{ANT} = the total number of antennas

$g_{j,k} = 10^{G_k / 20}$ if the k th antenna is being fed by spatial stream j , or zero if it is not;
 G_k is the gain in dBi of the k th antenna.

The EUT supports beamforming for 802.11ac modes.

The directional gain calculation is following F)2)e)ii) of KDB 662911 D01 v02r01.

The power and PSD limit should be modified if the directional gain of EUT is over 6 dBi,

The directional gain “DG” is calculated as following table.

			DG	DG	Power	PSD
			for	for	Limit	Limit
	Ant. 1	Ant. 2	Power	PSD	Reduction	Reduction
	(dBi)	(dBi)	(dBi)	(dBi)	(dB)	(dB)
2.4 GHz	3.96	3.69	6.84	6.84	0.84	0.84

$Power\ Limit\ Reduction = DG(Power) - 6dBi, (min = 0)$

$PSD\ Limit\ Reduction = DG(PSD) - 6dBi, (min = 0)$



4 List of Measuring Equipment

Instrument	Manufacturer	Model No.	Serial No.	Characteristics	Calibration Date	Test Date	Due Date	Remark
Power Meter	Anritsu	ML2495A	0932001	N/A	Sep. 29, 2016	Jun. 01, 2017 ~ Aug. 14, 2017	Sep. 28, 2017	Conducted (TH05-HY)
Power Sensor	DARE	RadiPower	15I00041S NO09	10MHz-6GHz	May. 03, 2017	Jul. 13, 2017 ~ Jul. 14, 2017	May. 02, 2018	Conducted (TH05-HY)
Power Sensor	Anritsu	MA2411B	0846202	300MHz-40GHz	Sep. 29, 2016	Jun. 01, 2017 ~ Aug. 14, 2017	Sep. 28, 2017	Conducted (TH05-HY)
Spectrum Analyzer	Rohde & Schwarz	FSP40	100057	9kHz-40GHz	Nov. 25, 2016	Jun. 01, 2017 ~ Aug. 14, 2017	Nov. 24, 2017	Conducted (TH05-HY)
Signal Analyzer	Rohde & Schwarz	FSV40	101397	10Hz-40GHz	Nov. 04, 2016	Jun. 01, 2017 ~ Aug. 14, 2017	Nov. 03, 2017	Conducted (TH05-HY)
AC Power Source	ChainTek	APC-1000W	N/A	N/A	N/A	Jul. 02, 2017	N/A	Conduction (CO05-HY)
EMI Test Receiver	Rohde & Schwarz	ESCI 7	100724	9kHz-7GHz	Aug. 30, 2016	Jul. 02, 2017	Aug. 29, 2017	Conduction (CO05-HY)
LISN	Rohde & Schwarz	ENV216	100080	9kHz-30MHz	Nov. 29, 2016	Jul. 02, 2017	Nov. 28, 2017	Conduction (CO05-HY)
Bilog Antenna	TESEQ	CBL 6111D&00800 N1D01N-06	35419&03	30MHz to 1GHz	Jan. 07, 2017	Jun. 08, 2017 ~ Aug. 24, 2017	Jan. 06, 2018	Radiation (03CH07-HY)
Double Ridge Horn Antenna	ESCO	3117	00075962	1GHz ~ 18GHz	Aug. 19, 2016	Jun. 08, 2017 ~ Aug. 17, 2017	Aug. 18, 2017	Radiation (03CH07-HY)
Horn Antenna	ESCO	3117	00066584	1GHz ~ 18GHz	Sep. 02, 2016	Aug. 18, 2017 ~ Aug. 24, 2017	Sep. 01, 2017	Radiation (03CH07-HY)
Loop Antenna	Rohde & Schwarz	HFH2-Z2	100315	9 kHz-30 MHz	May 15, 2017	Jun. 08, 2017 ~ Aug. 24, 2017	May 14, 2019	Radiation (03CH07-HY)
Preamplifier	MITEQ	AMF-7D-0010 1800-30-10P	1590075	1GHz ~ 18GHz	Apr. 25, 2017	Jun. 08, 2017 ~ Aug. 24, 2017	Apr. 24, 2018	Radiation (03CH07-HY)
Preamplifier	COM-POWER	PA-103A	161241	10MHz-1GHz	Mar. 14, 2017	Jun. 08, 2017 ~ Aug. 24, 2017	Mar. 13, 2018	Radiation (03CH07-HY)
Preamplifier	Agilent	8449B	3008A023 62	1GHz~ 26.5GHz	Oct. 12, 2016	Jun. 08, 2017 ~ Aug. 24, 2017	Oct. 11, 2017	Radiation (03CH07-HY)
Antenna Mast	Max-Full	MFA520BS	N/A	1m~4m	N/A	Jun. 08, 2017 ~ Aug. 24, 2017	N/A	Radiation (03CH07-HY)
Turn Table	ChainTek	Chaintek 3000	N/A	0~360 Degree	N/A	Jun. 08, 2017 ~ Aug. 24, 2017	N/A	Radiation (03CH07-HY)
Amplifier	MITEQ	TTA1840-35-HG	1871923	18GHz-40GHz, VSWR : 2.5:1 max	Jun. 08, 2017	Jun. 08, 2017 ~ Aug. 24, 2017	Jun. 07, 2018	Radiation (03CH07-HY)
SHF-EHF Horn Antenna	SCHWARZBECK	BBHA 9170	BBHA9170 584	18GHz- 40GHz	Nov. 08, 2016	Jun. 08, 2017 ~ Aug. 24, 2017	Nov. 07, 2017	Radiation (03CH07-HY)
EMI Test Receiver	Agilent	N9038A (MXE)	MY532900 53	20Hz to 26.5GHz	Jan. 12, 2017	Jun. 08, 2017 ~ Aug. 24, 2017	Jan. 11, 2018	Radiation (03CH07-HY)



5 Uncertainty of Evaluation

Uncertainty of Conducted Emission Measurement (150kHz ~ 30MHz)

Measuring Uncertainty for a Level of Confidence of 95% ($U = 2Uc(y)$)	2.70
---	------

Uncertainty of Radiated Emission Measurement (30 MHz ~ 1000 MHz)

Measuring Uncertainty for a Level of Confidence of 95% ($U = 2Uc(y)$)	5.70
---	------

Uncertainty of Radiated Emission Measurement (1000 MHz ~ 18000 MHz)

Measuring Uncertainty for a Level of Confidence of 95% ($U = 2Uc(y)$)	5.50
---	------

Uncertainty of Radiated Emission Measurement (18000 MHz ~ 40000 MHz)

Measuring Uncertainty for a Level of Confidence of 95% ($U = 2Uc(y)$)	5.20
---	------



Appendix A. AC Conducted Emission Test Results

Test Engineer :	Arthur Hsieh	Temperature :	22~25°C
		Relative Humidity :	51~55%

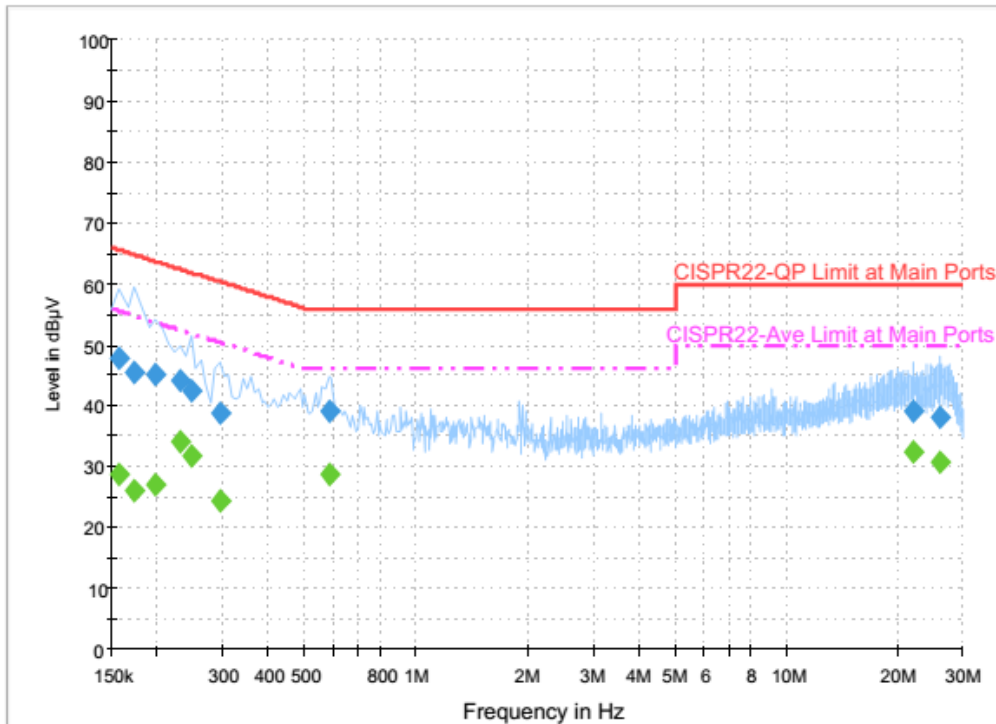

Final Result 1

Frequency (MHz)	QuasiPeak (dBµV)	Filter	Line	Corr. (dB)	Margin (dB)	Limit (dBµV)
0.158000	47.8	Off	L1	19.5	17.8	65.6
0.174000	45.6	Off	L1	19.5	19.2	64.8
0.198000	45.2	Off	L1	19.5	18.5	63.7
0.230000	44.0	Off	L1	19.5	18.4	62.4
0.246000	42.5	Off	L1	19.5	19.4	61.9
0.294000	38.9	Off	L1	19.5	21.5	60.4
0.582000	39.0	Off	L1	19.5	17.0	56.0
21.910000	39.2	Off	L1	19.8	20.8	60.0
26.150000	38.1	Off	L1	19.8	21.9	60.0

Final Result 2

Frequency (MHz)	Average (dBµV)	Filter	Line	Corr. (dB)	Margin (dB)	Limit (dBµV)
0.158000	28.7	Off	L1	19.5	26.9	55.6
0.174000	26.2	Off	L1	19.5	28.6	54.8
0.198000	27.0	Off	L1	19.5	26.7	53.7
0.230000	34.1	Off	L1	19.5	18.3	52.4
0.246000	31.8	Off	L1	19.5	20.1	51.9
0.294000	24.4	Off	L1	19.5	26.0	50.4
0.582000	28.9	Off	L1	19.5	17.1	46.0
21.910000	32.5	Off	L1	19.8	17.5	50.0
26.150000	30.8	Off	L1	19.8	19.2	50.0

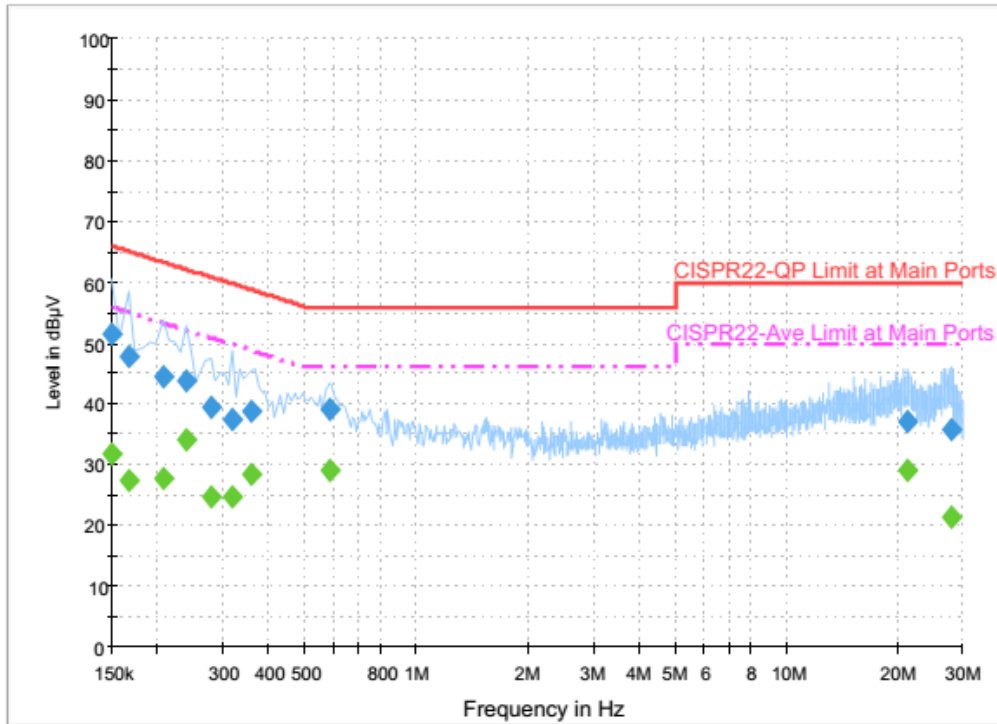

Final Result 1

Frequency (MHz)	QuasiPeak (dBµV)	Filter	Line	Corr. (dB)	Margin (dB)	Limit (dBµV)
0.150000	51.4	Off	N	19.5	14.6	66.0
0.166000	47.8	Off	N	19.5	17.4	65.2
0.206000	44.5	Off	N	19.5	18.9	63.4
0.238000	43.7	Off	N	19.5	18.5	62.2
0.278000	39.4	Off	N	19.5	21.5	60.9
0.318000	37.3	Off	N	19.5	22.5	59.8
0.358000	38.7	Off	N	19.5	20.1	58.8
0.582000	39.0	Off	N	19.5	17.0	56.0
21.358000	37.2	Off	N	19.9	22.8	60.0
28.054000	35.9	Off	N	20.0	24.1	60.0

Final Result 2

Frequency (MHz)	Average (dBµV)	Filter	Line	Corr. (dB)	Margin (dB)	Limit (dBµV)
0.150000	31.7	Off	N	19.5	24.3	56.0
0.166000	27.5	Off	N	19.5	27.7	55.2
0.206000	27.9	Off	N	19.5	25.5	53.4
0.238000	34.2	Off	N	19.5	18.0	52.2
0.278000	24.7	Off	N	19.5	26.2	50.9
0.318000	24.7	Off	N	19.5	25.1	49.8
0.358000	28.5	Off	N	19.5	20.3	48.8
0.582000	29.1	Off	N	19.5	16.9	46.0



Appendix B. Radiated Spurious Emission

Test Engineer :	Jesse Wang, James Chiu, and Potter Liu	Temperature :	22~26°C
		Relative Humidity :	52~58%

<For Sample 1>

<CDD Mode>

<Ant. No. 1 Chain 0>

2.4GHz 2400~2483.5MHz

WIFI 802.11b (Band Edge @ 3m)

WIFI	Note	Frequency (MHz)	Level (dBμV/m)	Over Limit (dB)	Limit Line (dBμV/m)	Read Level (dBμV)	Antenna Factor (dB/m)	Cable Loss (dB)	Preamp Factor (dB)	Ant Pos (cm)	Table Pos (deg)	Peak Avg. (P/A)	Pol. (H/V)
802.11b CH 01 2412MHz		2389.7	57.45	-16.55	74	51.99	32.19	8.24	34.97	100	218	P	H
		2390	49.57	-4.43	54	44.12	32.19	8.24	34.98	100	218	A	H
	*	2412	111.46	-	-	105.96	32.24	8.24	34.98	100	218	P	H
	*	2412	108.44	-	-	102.94	32.24	8.24	34.98	100	218	A	H
		2377.83	55.95	-18.05	74	50.52	32.14	8.26	34.97	100	192	P	V
		2390	46.73	-7.27	54	41.28	32.19	8.24	34.98	100	192	A	V
	*	2412	106.63	-	-	101.13	32.24	8.24	34.98	100	192	P	V
	*	2412	103.6	-	-	98.1	32.24	8.24	34.98	100	192	A	V
802.11b CH 02 2417MHz		2389.66	57.05	-16.95	74	51.59	32.19	8.24	34.97	100	220	P	H
		2389.9	49.79	-4.21	54	44.34	32.19	8.24	34.98	100	220	A	H
	*	2417	109.47	-	-	103.98	32.24	8.24	34.99	100	220	P	H
	*	2417	106.48	-	-	100.99	32.24	8.24	34.99	100	220	A	H
		2316.44	56.7	-17.3	74	51.45	31.93	8.28	34.96	100	190	P	V
		2389.94	46.95	-7.05	54	41.5	32.19	8.24	34.98	100	190	A	V
	*	2417	105.69	-	-	100.2	32.24	8.24	34.99	100	190	P	V
	*	2417	102.63	-	-	97.14	32.24	8.24	34.99	100	190	A	V



WIFI	Note	Frequency (MHz)	Level (dBμV/m)	Over Limit (dB)	Limit Line (dBμV/m)	Read Level (dBμV)	Antenna Factor (dB/m)	Cable Loss (dB)	Preamp Factor (dB)	Ant Pos (cm)	Table Pos (deg)	Peak Avg. (P/A)	Pol. (H/V)
802.11b CH 06 2437MHz		2382.66	56.68	-17.32	74	51.27	32.14	8.24	34.97	100	134	P	H
		2389.94	45.64	-8.36	54	40.19	32.19	8.24	34.98	100	134	A	H
	*	2437	115.19	-	-	109.57	32.34	8.27	34.99	100	134	P	H
	*	2437	112.13	-	-	106.51	32.34	8.27	34.99	100	134	A	H
		2490.13	56.48	-17.52	74	50.68	32.5	8.3	35	100	134	P	H
		2483.83	46.54	-7.46	54	40.79	32.45	8.3	35	100	134	A	H
		2324.14	55.73	-18.27	74	50.43	31.98	8.28	34.96	146	194	P	V
		2389.94	45.42	-8.58	54	39.97	32.19	8.24	34.98	146	194	A	V
	*	2437	112.51	-	-	106.89	32.34	8.27	34.99	146	194	P	V
	*	2437	109.38	-	-	103.76	32.34	8.27	34.99	146	194	A	V
		2491.11	57.12	-16.88	74	51.32	32.5	8.3	35	146	194	P	V
		2483.97	45.94	-8.06	54	40.19	32.45	8.3	35	146	194	A	V
802.11b CH 10 2457MHz	*	2457	111.71	-	-	106.03	32.4	8.27	34.99	116	210	P	H
	*	2457	108.6	-	-	102.92	32.4	8.27	34.99	116	210	A	H
		2483.8	58.81	-15.19	74	53.06	32.45	8.3	35	116	210	P	H
		2483.68	51.31	-2.69	54	45.56	32.45	8.3	35	116	210	A	H
													H
													H
	*	2457	108.58	-	-	102.9	32.4	8.27	34.99	209	124	P	V
	*	2457	105.64	-	-	99.96	32.4	8.27	34.99	209	124	A	V
		2484.58	56.65	-17.35	74	50.9	32.45	8.3	35	209	124	P	V
		2483.62	48.38	-5.62	54	42.63	32.45	8.3	35	209	124	A	V
													V
													V



WIFI	Note	Frequency (MHz)	Level (dBμV/m)	Over Limit (dB)	Limit Line (dBμV/m)	Read Level (dBμV)	Antenna Factor (dB/m)	Cable Loss (dB)	Preamp Factor (dB)	Ant Pos (cm)	Table Pos (deg)	Peak Avg. (P/A)	Pol. (H/V)	
802.11b CH 11 2462MHz	*	2462	111.74	-	-	106.03	32.4	8.3	34.99	100	211	P	H	
	*	2462	108.54	-	-	102.83	32.4	8.3	34.99	100	211	A	H	
		2488.44	59.51	-14.49	74	53.71	32.5	8.3	35	100	211	P	H	
		2483.52	52.54	-1.46	54	46.79	32.45	8.3	35	100	211	A	H	
													H	
														H
	*	2462	105.84	-	-	100.13	32.4	8.3	34.99	122	113	P	V	
	*	2462	102.85	-	-	97.14	32.4	8.3	34.99	122	113	A	V	
		2490.2	56.46	-17.54	74	50.66	32.5	8.3	35	122	113	P	V	
		2483.52	48.58	-5.42	54	42.83	32.45	8.3	35	122	113	A	V	
														V
														V
Remark	<ol style="list-style-type: none"> No other spurious found. All results are PASS against Peak and Average limit line. 													



2.4GHz 2400~2483.5MHz
WIFI 802.11b (Harmonic @ 3m)

WIFI	Note	Frequency (MHz)	Level (dBμV/m)	Over Limit (dB)	Limit Line (dBμV/m)	Read Level (dBμV)	Antenna Factor (dB/m)	Cable Loss (dB)	Preamp Factor (dB)	Ant Pos (cm)	Table Pos (deg)	Peak Avg. (P/A)	Pol. (H/V)
802.11b CH 01 2412MHz		4824	48.01	-25.99	74	61.82	33.64	11.93	59.38	100	0	P	H
													H
													H
													H
													V
													V
													V
802.11b CH 06 2437MHz		4874	47.45	-26.55	74	61.3	33.54	11.9	59.29	100	0	P	H
		7311	49.42	-24.58	74	57.84	34.69	14.94	58.05	100	0	P	H
													H
													H
													V
													V
													V
802.11b CH 11 2462MHz		4924	41.88	-32.12	74	55.78	33.44	11.87	59.21	100	0	P	H
		7386	47.81	-26.19	74	56.38	34.47	15.08	58.12	100	0	P	H
													H
													H
													V
													V
													V
Remark	1. No other spurious found. 2. All results are PASS against Peak and Average limit line.												



**2.4GHz 2400~2483.5MHz
WIFI 802.11g (Band Edge @ 3m)**

WIFI	Note	Frequency (MHz)	Level (dBµV/m)	Over Limit (dB)	Limit Line (dBµV/m)	Read Level (dBµV)	Antenna Factor (dB/m)	Cable Loss (dB)	Preamp Factor (dB)	Ant Pos (cm)	Table Pos (deg)	Peak Avg. (P/A)	Pol. (H/V)	
802.11g CH 01 2412MHz		2389.8	62.93	-11.07	74	57.48	32.19	8.24	34.98	100	188	P	H	
		2390	52.34	-1.66	54	46.89	32.19	8.24	34.98	100	188	A	H	
	*	2412	110.81	-	-	105.31	32.24	8.24	34.98	100	188	P	H	
	*	2412	103.31	-	-	97.81	32.24	8.24	34.98	100	188	A	H	
													H	
													H	
			2389.7	56.95	-17.05	74	51.49	32.19	8.24	34.97	100	192	P	V
			2390	48.68	-5.32	54	43.23	32.19	8.24	34.98	100	192	A	V
	*		2412	105.89	-	-	100.39	32.24	8.24	34.98	100	192	P	V
	*		2412	98.19	-	-	92.69	32.24	8.24	34.98	100	192	A	V
													V	
													V	
802.11g CH 02 2417MHz		2389.94	59.17	-14.83	74	53.72	32.19	8.24	34.98	380	181	P	H	
		2389.94	49.55	-4.45	54	44.1	32.19	8.24	34.98	380	181	A	H	
	*	2417	111.68	-	-	106.19	32.24	8.24	34.99	380	181	P	H	
	*	2417	103.98	-	-	98.49	32.24	8.24	34.99	380	181	A	H	
													H	
													H	
			2389.94	56.98	-17.02	74	51.53	32.19	8.24	34.98	100	197	P	V
			2389.94	47.14	-6.86	54	41.69	32.19	8.24	34.98	100	197	A	V
	*		2417	106.45	-	-	100.96	32.24	8.24	34.99	100	197	P	V
	*		2417	98.63	-	-	93.14	32.24	8.24	34.99	100	197	A	V
													V	
													V	



WIFI	Note	Frequency (MHz)	Level (dBµV/m)	Over Limit (dB)	Limit Line (dBµV/m)	Read Level (dBµV)	Antenna Factor (dB/m)	Cable Loss (dB)	Preamp Factor (dB)	Ant Pos (cm)	Table Pos (deg)	Peak Avg. (P/A)	Pol. (H/V)
802.11g CH 06 2437MHz		2389.94	59.58	-14.42	74	54.13	32.19	8.24	34.98	100	135	P	H
		2389.94	50.77	-3.23	54	45.32	32.19	8.24	34.98	100	135	A	H
	*	2437	117.04	-	-	111.42	32.34	8.27	34.99	100	135	P	H
	*	2437	108.95	-	-	103.33	32.34	8.27	34.99	100	135	A	H
		2484.04	62.86	-11.14	74	57.11	32.45	8.3	35	100	135	P	H
		2483.62	52.49	-1.51	54	46.74	32.45	8.3	35	100	135	A	H
		2389.94	57.61	-16.39	74	52.16	32.19	8.24	34.98	200	173	P	V
		2389.94	47.86	-6.14	54	42.41	32.19	8.24	34.98	200	173	A	V
	*	2437	112.61	-	-	106.99	32.34	8.27	34.99	200	173	P	V
	*	2437	105.04	-	-	99.42	32.34	8.27	34.99	200	173	A	V
		2483.62	61.05	-12.95	74	55.3	32.45	8.3	35	200	173	P	V
		2483.55	50.88	-3.12	54	45.13	32.45	8.3	35	200	173	A	V
	802.11g CH 10 2457MHz	*	2457	112.83	-	-	107.15	32.4	8.27	34.99	365	202	P
*		2457	104.88	-	-	99.2	32.4	8.27	34.99	365	202	A	H
		2486.14	62.43	-11.57	74	56.68	32.45	8.3	35	365	202	P	H
		2483.5	52.68	-1.32	54	46.93	32.45	8.3	35	365	202	A	H
													H
													H
*		2457	106.99	-	-	101.31	32.4	8.27	34.99	161	192	P	V
*		2457	99.27	-	-	93.59	32.4	8.27	34.99	161	192	A	V
		2483.56	58.28	-15.72	74	52.53	32.45	8.3	35	161	192	P	V
		2483.56	48.46	-5.54	54	42.71	32.45	8.3	35	161	192	A	V
													V
												V	



WIFI	Note	Frequency (MHz)	Level (dBμV/m)	Over Limit (dB)	Limit Line (dBμV/m)	Read Level (dBμV)	Antenna Factor (dB/m)	Cable Loss (dB)	Preamp Factor (dB)	Ant Pos (cm)	Table Pos (deg)	Peak Avg. (P/A)	Pol. (H/V)
802.11g CH 11 2462MHz	*	2462	109.68	-	-	103.97	32.4	8.3	34.99	100	214	P	H
	*	2462	101.81	-	-	96.1	32.4	8.3	34.99	100	214	A	H
		2484.6	62.88	-11.12	74	57.13	32.45	8.3	35	100	214	P	H
		2483.56	52.5	-1.5	54	46.75	32.45	8.3	35	100	214	A	H
													H
													H
	*	2462	106.27	-	-	100.56	32.4	8.3	34.99	298	208	P	V
	*	2462	98.48	-	-	92.77	32.4	8.3	34.99	298	208	A	V
		2483.84	58.8	-15.2	74	53.05	32.45	8.3	35	298	208	P	V
		2483.56	49.38	-4.62	54	43.63	32.45	8.3	35	298	208	A	V
													V
													V
Remark	1. No other spurious found. 2. All results are PASS against Peak and Average limit line.												



**2.4GHz 2400~2483.5MHz
WIFI 802.11g (Harmonic @ 3m)**

WIFI	Note	Frequency (MHz)	Level (dBµV/m)	Over Limit (dB)	Limit Line (dBµV/m)	Read Level (dBµV)	Antenna Factor (dB/m)	Cable Loss (dB)	Preamp Factor (dB)	Ant Pos (cm)	Table Pos (deg)	Peak Avg. (P/A)	Pol. (H/V)
802.11g CH 01 2412MHz		4824	40.95	-33.05	74	54.76	33.64	11.93	59.38	100	0	P	H
													H
													H
													H
													V
													V
													V
802.11g CH 06 2437MHz		4874	44.77	-29.23	74	58.62	33.54	11.9	59.29	100	0	P	H
		7311	49.73	-24.27	74	58.15	34.69	14.94	58.05	100	0	P	H
													H
													H
													V
													V
													V
802.11g CH 11 2462MHz		4924	40.33	-33.67	74	54.23	33.44	11.87	59.21	100	0	P	H
		7386	42.49	-31.51	74	51.06	34.47	15.08	58.12	100	0	P	H
													H
													H
													V
													V
													V
Remark	1. No other spurious found. 2. All results are PASS against Peak and Average limit line.												



**Emission below 1GHz
2.4GHz WIFI 802.11g (LF)**

WIFI	Note	Frequency	Level	Over	Limit	Read	Antenna	Cable	Preamp	Ant	Table	Peak	Pol.	
		(MHz)	(dBμV/m)	(dB)	(dBμV/m)	(dBμV)	(dB/m)	(dB)	(dB)	(cm)	(deg)	(P/A)	(H/V)	
2.4GHz 802.11g LF		65.1	31.96	-8.04	40	49.09	12.35	2.11	31.59	-	-	P	H	
		157.17	34.68	-8.82	43.5	46.35	17.21	2.62	31.5	-	-	P	H	
		292.71	34.92	-11.08	46	43.22	19.73	3.28	31.31	-	-	P	H	
		390.3	33.45	-12.55	46	38.62	22.16	3.82	31.15	-	-	P	H	
		519.8	39.46	-6.54	46	41.92	24.36	4.13	30.95	100	98	P	H	
		650	33.77	-12.23	46	34.04	25.9	4.59	30.76	-	-	P	H	
														H
														H
														H
														H
														H
														H
														H
			30.81	36.48	-3.52	40	40.67	25.46	1.71	31.36	100	77	P	V
			65.1	31.13	-8.87	40	48.26	12.35	2.11	31.59	-	-	P	V
			158.79	30.42	-13.08	43.5	42.23	17.07	2.62	31.5	-	-	P	V
			325.2	35.44	-10.56	46	42.77	20.5	3.43	31.26	-	-	P	V
			519.8	38.24	-7.76	46	40.7	24.36	4.13	30.95	-	-	P	V
			650	36.48	-9.52	46	36.75	25.9	4.59	30.76	-	-	P	V
														V
													V	
													V	
													V	
													V	
													V	
Remark	1. No other spurious found. 2. All results are PASS against limit line.													



<Ant. 1 No. 1 Chain 1>

2.4GHz 2400~2483.5MHz

WIFI 802.11b (Band Edge @ 3m)

WIFI	Note	Frequency	Level	Over Limit	Limit Line	Read Level	Antenna Factor	Cable Loss	Preamp Factor	Ant Pos	Table Pos	Peak Avg.	Pol.	
		(MHz)	(dBμV/m)	(dB)	(dBμV/m)	(dBμV)	(dB/m)	(dB)	(dB)	(cm)	(deg)	(P/A)	(H/V)	
802.11b CH 01 2412MHz		2389.91	56.13	-17.87	74	50.68	32.19	8.24	34.98	100	191	P	H	
		2390	48.39	-5.61	54	42.94	32.19	8.24	34.98	100	191	A	H	
	*	2412	108.39	-	-	102.89	32.24	8.24	34.98	100	191	P	H	
	*	2412	106.21	-	-	100.71	32.24	8.24	34.98	100	191	A	H	
													H	
														H
			2348.22	55.6	-18.4	74	50.28	32.03	8.26	34.97	100	255	P	V
			2390	45.35	-8.65	54	39.9	32.19	8.24	34.98	100	255	A	V
	*		2412	100.25	-	-	94.75	32.24	8.24	34.98	100	255	P	V
	*		2412	97.79	-	-	92.29	32.24	8.24	34.98	100	255	A	V
														V
													V	
802.11b CH 02 2417MHz		2389.8	59.35	-14.65	74	53.9	32.19	8.24	34.98	100	202	P	H	
		2389.94	51.65	-2.35	54	46.2	32.19	8.24	34.98	100	202	A	H	
	*	2417	114.58	-	-	109.09	32.24	8.24	34.99	100	202	P	H	
	*	2417	111.53	-	-	106.04	32.24	8.24	34.99	100	202	A	H	
														H
														H
			2325.4	56.16	-17.84	74	50.86	31.98	8.28	34.96	100	187	P	V
			2389.94	45.68	-8.32	54	40.23	32.19	8.24	34.98	100	187	A	V
	*		2417	106.34	-	-	100.85	32.24	8.24	34.99	100	187	P	V
	*		2417	103.37	-	-	97.88	32.24	8.24	34.99	100	187	A	V
														V
													V	



WIFI	Note	Frequency (MHz)	Level (dBµV/m)	Over Limit (dB)	Limit Line (dBµV/m)	Read Level (dBµV)	Antenna Factor (dB/m)	Cable Loss (dB)	Preamp Factor (dB)	Ant Pos (cm)	Table Pos (deg)	Peak Avg. (P/A)	Pol. (H/V)
802.11b CH 06 2437MHz		2389.94	56.75	-17.25	74	51.3	32.19	8.24	34.98	100	176	P	H
		2389.94	47.58	-6.42	54	42.13	32.19	8.24	34.98	100	176	A	H
	*	2437	114.07	-	-	108.45	32.34	8.27	34.99	100	176	P	H
	*	2437	111.08	-	-	105.46	32.34	8.27	34.99	100	176	A	H
		2484.11	57.74	-16.26	74	51.99	32.45	8.3	35	100	176	P	H
		2483.9	47.15	-6.85	54	41.4	32.45	8.3	35	100	176	A	H
		2371.74	56.28	-17.72	74	50.85	32.14	8.26	34.97	300	178	P	V
		2389.94	45.45	-8.55	54	40	32.19	8.24	34.98	300	178	A	V
	*	2437	102.94	-	-	97.32	32.34	8.27	34.99	300	178	P	V
	*	2437	99.93	-	-	94.31	32.34	8.27	34.99	300	178	A	V
		2496.08	55.65	-18.35	74	49.86	32.5	8.3	35.01	300	178	P	V
		2488.8	45.59	-8.41	54	39.79	32.5	8.3	35	300	178	A	V
802.11b CH 10 2457MHz	*	2457	113.99	-	-	108.31	32.4	8.27	34.99	100	178	P	H
	*	2457	110.87	-	-	105.19	32.4	8.27	34.99	100	178	A	H
		2483.8	59.12	-14.88	74	53.37	32.45	8.3	35	100	178	P	H
		2483.5	50.35	-3.65	54	44.6	32.45	8.3	35	100	178	A	H
													H
													H
	*	2457	104.44	-	-	98.76	32.4	8.27	34.99	100	232	P	V
	*	2457	101.18	-	-	95.5	32.4	8.27	34.99	100	232	A	V
		2484.1	56.33	-17.67	74	50.58	32.45	8.3	35	100	232	P	V
		2489.38	45.58	-8.42	54	39.78	32.5	8.3	35	100	232	A	V
												V	
												V	



WIFI	Note	Frequency (MHz)	Level (dBμV/m)	Over Limit (dB)	Limit Line (dBμV/m)	Read Level (dBμV)	Antenna Factor (dB/m)	Cable Loss (dB)	Preamp Factor (dB)	Ant Pos (cm)	Table Pos (deg)	Peak Avg. (P/A)	Pol. (H/V)	
802.11b CH 11 2462MHz	*	2462	110.09	-	-	104.38	32.4	8.3	34.99	117	178	P	H	
	*	2462	106.95	-	-	101.24	32.4	8.3	34.99	117	178	A	H	
		2486.6	60.79	-13.21	74	55.04	32.45	8.3	35	117	178	P	H	
		2483.52	52.61	-1.39	54	46.86	32.45	8.3	35	117	178	A	H	
													H	
														H
	*	2462	100.55	-	-	94.84	32.4	8.3	34.99	215	166	P	V	
	*	2462	97.51	-	-	91.8	32.4	8.3	34.99	215	166	A	V	
		2485.32	55.81	-18.19	74	50.06	32.45	8.3	35	215	166	P	V	
		2483.52	45.78	-8.22	54	40.03	32.45	8.3	35	215	166	A	V	
													V	
													V	
	Remark	<ol style="list-style-type: none"> No other spurious found. All results are PASS against Peak and Average limit line. 												