



# SPORTON International Inc.

No. 52, Hwa Ya 1st Rd., Kwei-Shan Hsiang, TaoYuan Hsien, Taiwan, R.O.C.  
Ph: 886-3-327-3456 / FAX: 886-3-327-0973 / www.sporton.com.tw

## FCC RADIO TEST REPORT

Applicant's company	Motorola Solutions, Inc.
Applicant Address	One Motorola Plaza Holtsville, NY 11742 USA
FCC ID	UZ7TW5
Manufacturer's company	Wistron NeWeb Corporation
Manufacturer Address	20 Park Avenue II, Hsinchu Science Park, Hsinchu 308, Taiwan, R.O.C.

Product Name	2x2 802.11n PCIe module
Brand Name	MOTOROLA
Model No.	TW-5
Test Rule Part(s)	47 CFR FCC Part 15 Subpart E § 15.407
Test Freq. Range	5150 ~ 5250MHz
Received Date	May 02, 2013
Final Test Date	Jun. 10, 2013
Submission Type	Original Equipment
Operating Mode	Master

### Statement

**Test result included is for the IEEE 802.11n and IEEE 802.11a (5150~5250MHz) of the product.**

The test result in this report refers exclusively to the presented test model / sample.

Without written approval of SPORTON International Inc., the test report shall not be reproduced except in full.

The measurements and test results shown in this test report were made in accordance with the procedures and found in compliance with the limit given in **ANSI C63.10-2009, 47 CFR FCC Part 15 Subpart E, KDB 789033 D01 v01r03 and KDB 662911 D01 v01r02.**

The test equipment used to perform the test is calibrated and traceable to NML/ROC.



## Table of Contents

<b>1. CERTIFICATE OF COMPLIANCE .....</b>	<b>1</b>
<b>2. SUMMARY OF THE TEST RESULT .....</b>	<b>2</b>
<b>3. GENERAL INFORMATION .....</b>	<b>3</b>
3.1. Product Details.....	3
3.2. Accessories.....	4
3.3. Table for Filed Antenna.....	5
3.4. Table for Carrier Frequencies .....	6
3.5. Table for Test Modes .....	6
3.6. Table for Testing Locations.....	7
3.7. Table for Supporting Units .....	7
3.8. Table for Parameters of Test Software Setting .....	7
3.9. EUT Operation during Test .....	7
3.10. Duty Cycle.....	8
3.11. Test Configurations .....	10
<b>4. TEST RESULT .....</b>	<b>12</b>
4.1. AC Power Line Conducted Emissions Measurement.....	12
4.2. 26dB Bandwidth & 99% Occupied Bandwidth Measurement.....	16
4.3. Maximum Conducted Output Power Measurement.....	23
4.4. Power Spectral Density Measurement .....	26
4.5. Peak Excursion Measurement .....	32
4.6. Radiated Emissions Measurement .....	37
4.7. Band Edge Emissions Measurement .....	51
4.8. Frequency Stability Measurement .....	60
4.9. Antenna Requirements .....	62
<b>5. LIST OF MEASURING EQUIPMENTS .....</b>	<b>63</b>
<b>6. TEST LOCATION.....</b>	<b>65</b>
<b>7. MEASUREMENT UNCERTAINTY.....</b>	<b>66</b>
<b>APPENDIX A. TEST PHOTOS .....</b>	<b>A1 ~ A8</b>
<b>APPENDIX B. MAXIMUM PERMISSIBLE EXPOSURE .....</b>	<b>B1 ~ B3</b>



## History of This Test Report

REPORT NO.	VERSION	DESCRIPTION	ISSUED DATE
FR290357-02AB	Rev. 01	Initial issue of report	Jun. 24, 2013



## 1. CERTIFICATE OF COMPLIANCE

**Product Name** : 2x2 802.11n PCIe module  
**Brand Name** : MOTOROLA  
**Model No.** : TW-5  
**Applicant** : Motorola Solutions, Inc.  
**Test Rule Part(s)** : 47 CFR FCC Part 15 Subpart E § 15.407

Sporton International as requested by the applicant to evaluate the EMC performance of the product sample received on May 02, 2013 would like to declare that the tested sample has been evaluated and found to be in compliance with the tested rule parts. The data recorded as well as the test configuration specified is true and accurate for showing the sample's EMC nature.

A handwritten signature in blue ink that reads 'Sam Chen' is written over a horizontal line.

**Sam Chen**

**SPORTON INTERNATIONAL INC.**

## 2. SUMMARY OF THE TEST RESULT

Applied Standard: 47 CFR FCC Part 15 Subpart E				
Part	Rule Section	Description of Test	Result	Under Limit
4.1	15.207	AC Power Line Conducted Emissions	Complies	7.44 dB
4.2	15.407(a)	26dB Spectrum Bandwidth & 99% Occupied Bandwidth	Complies	-
4.3	15.407(a)	Maximum Conducted Output Power	Complies	0.21 dB
4.4	15.407(a)	Power Spectral Density	Complies	0.08 dB
4.5	15.407(a)	Peak Excursion	Complies	1.44 dB
4.6	15.407(b)	Radiated Emissions	Complies	3.07 dB
4.7	15.407(b)	Band Edge Emissions	Complies	1.16 dB
4.8	15.407(g)	Frequency Stability	Complies	-
4.9	15.203	Antenna Requirements	Complies	-

### 3. GENERAL INFORMATION

#### 3.1. Product Details

##### IEEE 802.11n

Items	Description
Product Type	WLAN (2TX, 2RX)
Radio Type	Intentional Transceiver
Power Type	From Host System
Modulation	see the below table for IEEE 802.11n
Data Modulation	OFDM (BPSK / QPSK / 16QAM / 64QAM)
Data Rate (Mbps)	see the below table for IEEE 802.11n
Frequency Range	5150 ~ 5250MHz
Channel Number	4 for 20MHz bandwidth ; 2 for 40MHz bandwidth
Channel Band Width (99%)	MCS0 (20MHz): 16.80 MHz ; MCS0 (40MHz): 37.12 MHz
Maximum Conducted Output Power	MCS0 (20MHz): 16.67 dBm ; MCS0 (40MHz): 16.79 dBm
Carrier Frequencies	Please refer to section 3.4
Antenna	Please refer to section 3.3

##### IEEE 802.11a

Items	Description
Product Type	WLAN (2TX, 2RX)
Radio Type	Intentional Transceiver
Power Type	From Host System
Modulation	OFDM for IEEE 802.11a
Data Modulation	OFDM (BPSK / QPSK / 16QAM / 64QAM)
Data Rate (Mbps)	OFDM (6/9/12/18/24/36/48/54)
Frequency Range	5150 ~ 5250MHz
Channel Number	4
Channel Band Width (99%)	17.76 MHz
Maximum Conducted Output Power	16.61 dBm
Carrier Frequencies	Please refer to section 3.4
Antenna	Please refer to section 3.3

**Antenna & Band width**

Antenna	Two (TX)	
Band width Mode	20 MHz	40 MHz
IEEE 802.11a	V	X
IEEE 802.11n	V	V

**IEEE 11n Spec.**

Protocol	Number of Transmit Chains (NTX)	Data Rate / MCS
802.11n (HT20)	2	M0-15
802.11n (HT40)	2	M0-15

Note 1: IEEE Std. 802.11n modulation consists of HT20 and HT40 (HT: High Throughput). Then EUT support HT20 and HT40.

Note 2: Modulation modes consist of below configuration:  
HT20/HT40: IEEE 802.11n

**3.2. Accessories**

N/A

### 3.3. Table for Filed Antenna

Ant.	Brand	Model Name	Antenna Type	Connector	Gain (dBi)	
					2.4G	5G
1	WNC	95EAAH15.G07	PIFA Antenna	I-PEX	-1.57	3.71
2	WNC	95EAAH15.G08	PIFA Antenna	I-PEX	-1.57	3.71

Note: The EUT has two antennas.

- (1) Chain 1 and Chain 2 can be used as transmitting/receiving antennas.  
Chain 1 and Chain 2 could transmit/receive simultaneously.

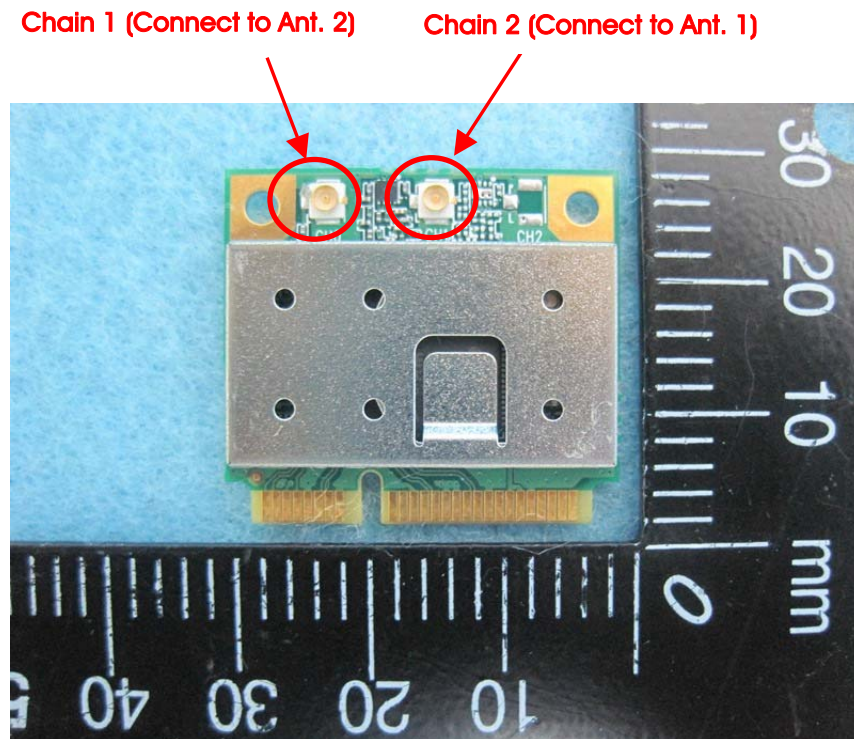



### 3.4. Table for Carrier Frequencies

The EUT has two bandwidth system.

For 20MHz bandwidth systems, use Channel 36, 40, 44, 48.

For 40MHz bandwidth systems, use Channel 38, 46.

Frequency Band	Channel No.	Frequency	Channel No.	Frequency
5150~5250 MHz Band 1	36	5180 MHz	44	5220 MHz
	38	5190 MHz	46	5230 MHz
	40	5200 MHz	48	5240 MHz

### 3.5. Table for Test Modes

Preliminary tests were performed in different data rate to find the worst radiated emission. The data rate shown in the table below is the worst-case rate with respect to the specific test item. Investigation has been done on all the possible configurations for searching the worst cases. The following table is a list of the test modes shown in this test report.

Test Items	Mode		Data Rate	Channel	Chain
AC Power Conducted Emission	CTX		-	-	-
Max. Conducted Output Power	11n 20MHz	Band 1	MCS0	36/40/48	1+2
	11n 40MHz	Band 1	MCS0	38/46	1+2
	11a	Band 1	6Mbps	36/40/48	1+2
Power Spectral Density	11n 20MHz	Band 1	MCS0	36/40/48	1+2
	11n 40MHz	Band 1	MCS0	38/46	1+2
	11a	Band 1	6Mbps	36/40/48	1+2
26dB Spectrum Bandwidth 99% Occupied Bandwidth	11n 20MHz	Band 1	MCS0	36/40/48	1+2
	11n 40MHz	Band 1	MCS0	38/46	1+2
	11a	Band 1	6Mbps	36/40/48	1+2
Measurement Peak Excursion	11n 20MHz	Band 1	MCS0	48	1+2
	11n 40MHz	Band 1	MCS0	46	1+2
	11a	Band 1	6Mbps	48	1+2
Radiated Emission Below 1GHz	CTX		-	-	-
Radiated Emission Above 1GHz	11n 20MHz	Band 1	MCS0	36/40/48	1+2
	11n 40MHz	Band 1	MCS0	38/46	1+2
	11a	Band 1	6Mbps	36/40/48	1+2
Band Edge Emission	11n 20MHz	Band 1	MCS0	36/40/48	1+2
	11n 40MHz	Band 1	MCS0	38/46	1+2
	11a	Band 1	6Mbps	36/40/48	1+2
Frequency Stability	Un-modulation		-	40	N/A

### 3.6. Table for Testing Locations

Test Site No.	Site Category	Location	FCC Reg. No.	IC File No.	VCCI Reg. No
03CH01-CB	SAC	Hsin Chu	262045	IC 4086D	-
CO01-CB	Conduction	Hsin Chu	262045	IC 4086D	-
TH01-CB	OVEN Room	Hsin Chu	-	-	-

Open Area Test Site (OATS); Semi Anechoic Chamber (SAC); Please refer section 6 for Test Site Address.

### 3.7. Table for Supporting Units

Support Unit	Brand	Model	FCC ID
Notebook	DELL	E6430	QDS-BRCM1049LE
Test Fixture	Bplus	PE3B	N/A

### 3.8. Table for Parameters of Test Software Setting

#### Power Parameters of IEEE 802.11n MCS0 20MHz

Test Software Version	ART2-GUI Version:1.5		
Frequency	5180 MHz	5200 MHz	5240 MHz
MCS0 20MHz	14	14.5	13.5

#### Power Parameters of IEEE 802.11n MCS0 40MHz

Test Software Version	ART2-GUI Version:1.5	
Frequency	5190 MHz	5230 MHz
MCS0 40MHz	11.5	14

#### Power Parameters of IEEE 802.11a

Test Software Version	ART2-GUI Version:1.5		
Frequency	5180 MHz	5200 MHz	5240 MHz
11a	14	14	13.5

### 3.9. EUT Operation during Test

The EUT was programmed to be in continuously transmitting mode.

### 3.10. Duty Cycle

#### IEEE 802.11n MCS0 20MHz

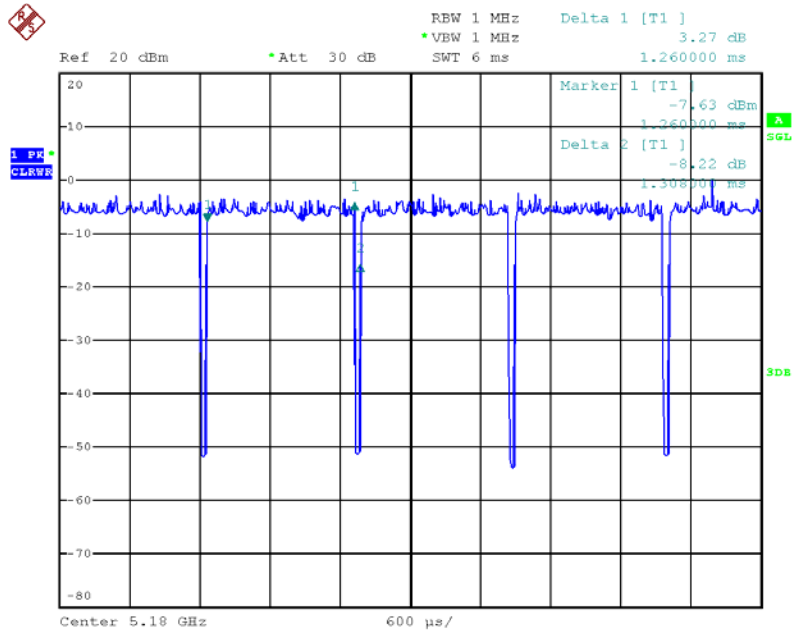

Date: 8.JUN.2013 14:25:07

#### IEEE 802.11n MCS0 40MHz

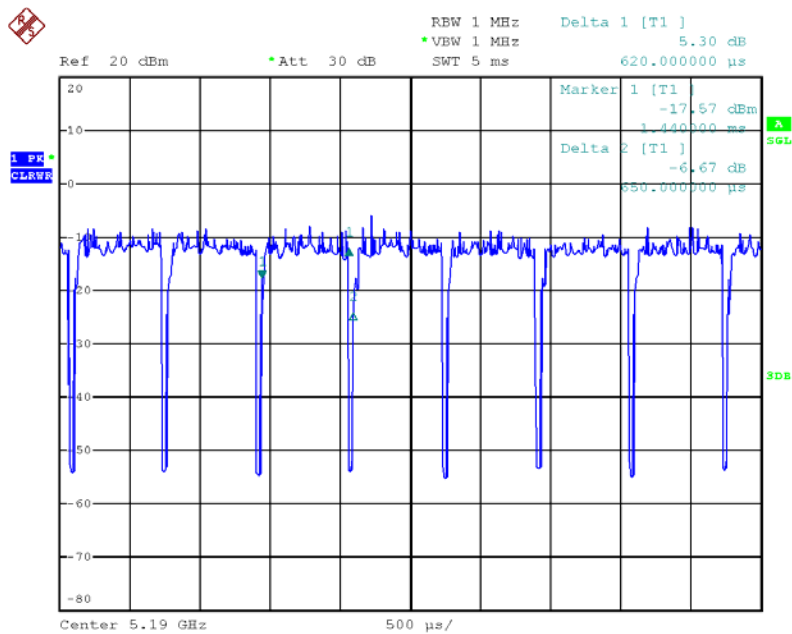

Date: 8.JUN.2013 14:26:33

IEEE 802.11a

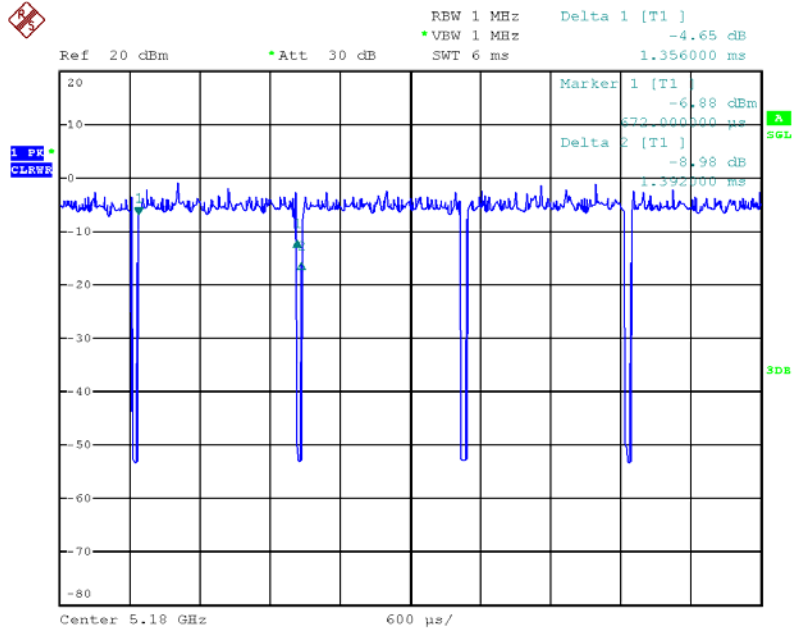

Date: 8.JUN.2013 14:23:34

### 3.11. Test Configurations

#### 3.11.1. AC Power Line Conduction Emissions Test Configuration

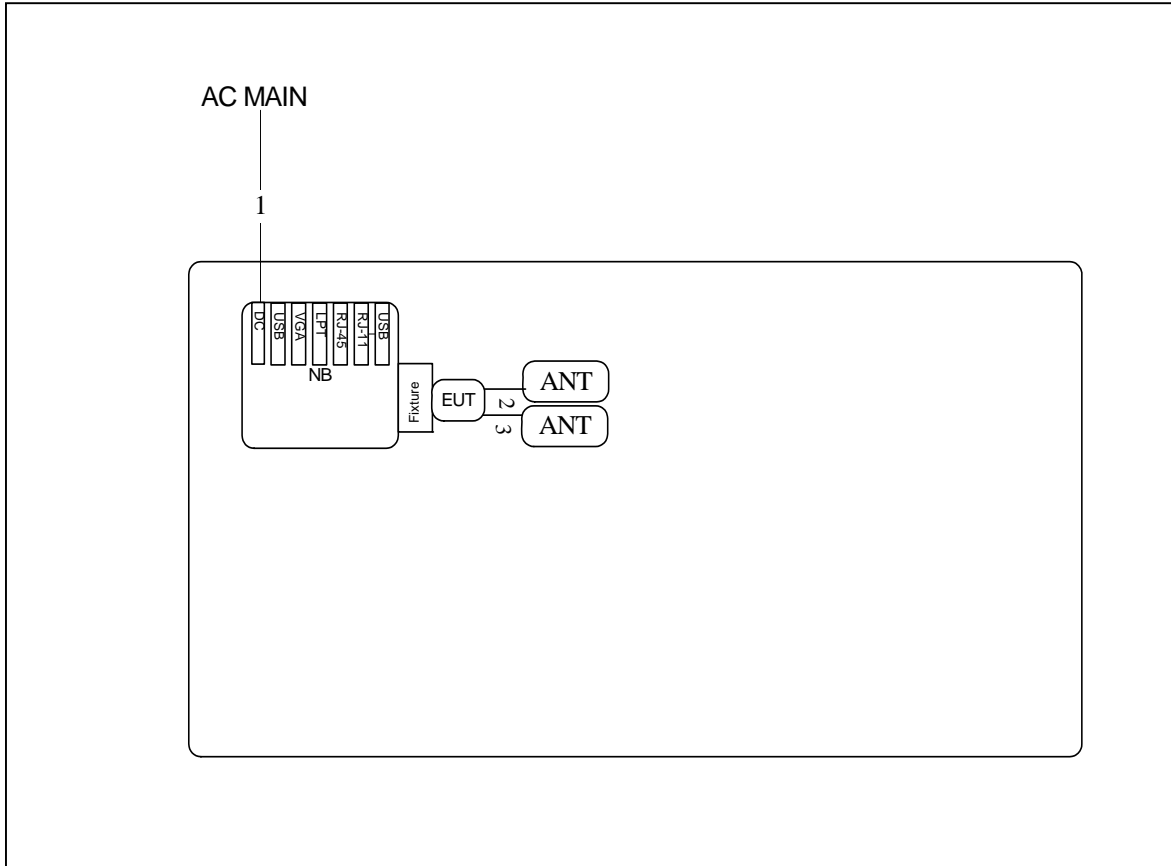

Item	Connection	Shield	Length
1	AC power cable	No	2.6m
2	Antenna cable	No	0.08m
3	Antenna cable	No	0.06m

### 3.11.2. Radiation Emissions Test Configuration

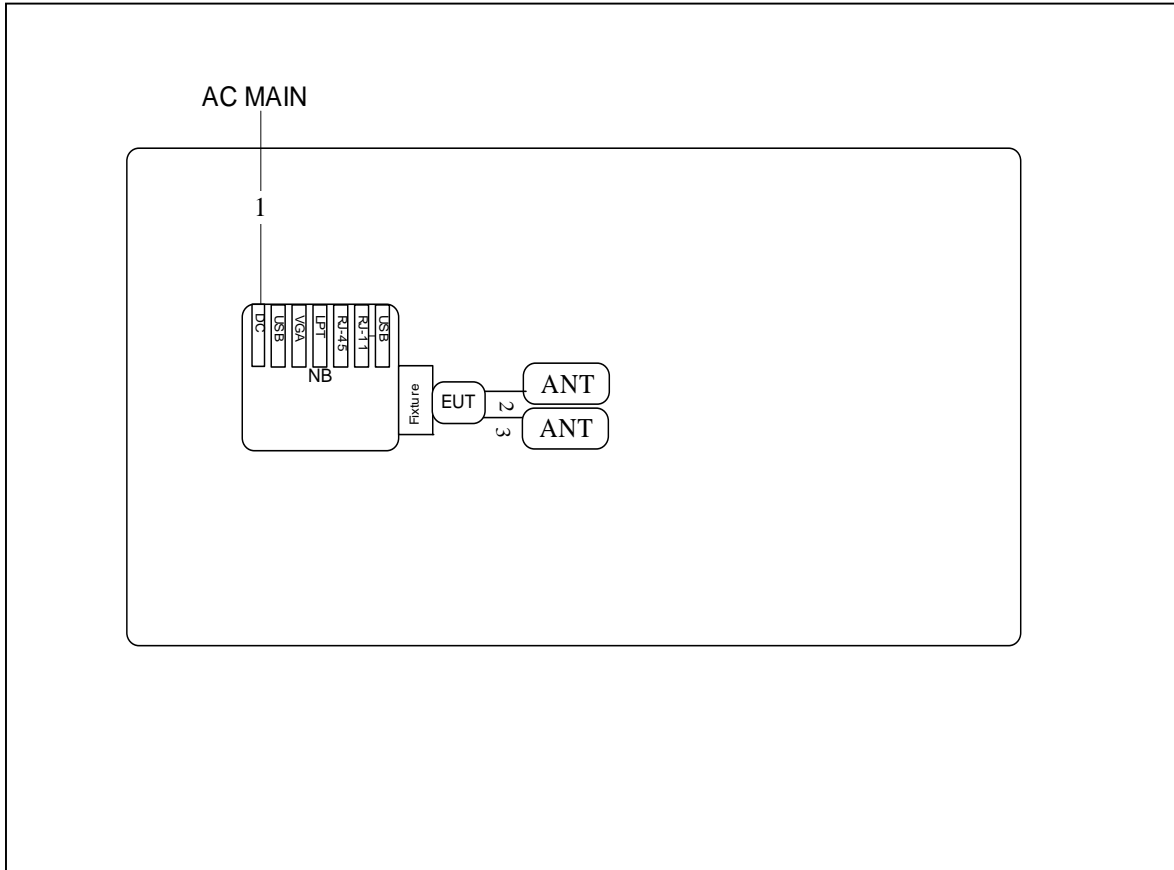

Item	Connection	Shield	Length
1	AC power cable	No	2.6m
2	Antenna cable	No	0.08m
3	Antenna cable	No	0.06m

## 4. TEST RESULT

### 4.1. AC Power Line Conducted Emissions Measurement

#### 4.1.1. Limit

For this product that is designed to connect to the AC power line, the radio frequency voltage that is conducted back onto the AC power line on any frequency or frequencies within the band 150 kHz to 30 MHz shall not exceed below limits table.

Frequency (MHz)	QP Limit (dBuV)	AV Limit (dBuV)
0.15~0.5	66~56	56~46
0.5~5	56	46
5~30	60	50

#### 4.1.2. Measuring Instruments and Setting

Please refer to section 5 of equipments list in this report. The following table is the setting of the receiver.

Receiver Parameters	Setting
Attenuation	10 dB
Start Frequency	0.15 MHz
Stop Frequency	30 MHz
IF Bandwidth	9 KHz

#### 4.1.3. Test Procedures

1. Configure the EUT according to ANSI C63.10. The EUT or host of EUT has to be placed 0.4 meter far from the conducting wall of the shielding room and at least 80 centimeters from any other grounded conducting surface.
2. Connect EUT or host of EUT to the power mains through a line impedance stabilization network (LISN).
3. All the support units are connected to the other LISNs. The LISN should provide 50uH/50ohms coupling impedance.
4. The frequency range from 150 KHz to 30 MHz was searched.
5. Set the test-receiver system to Peak Detect Function and Specified Bandwidth with Maximum Hold Mode.
6. The measurement has to be done between each power line and ground at the power terminal.

#### 4.1.4. Test Setup Layout

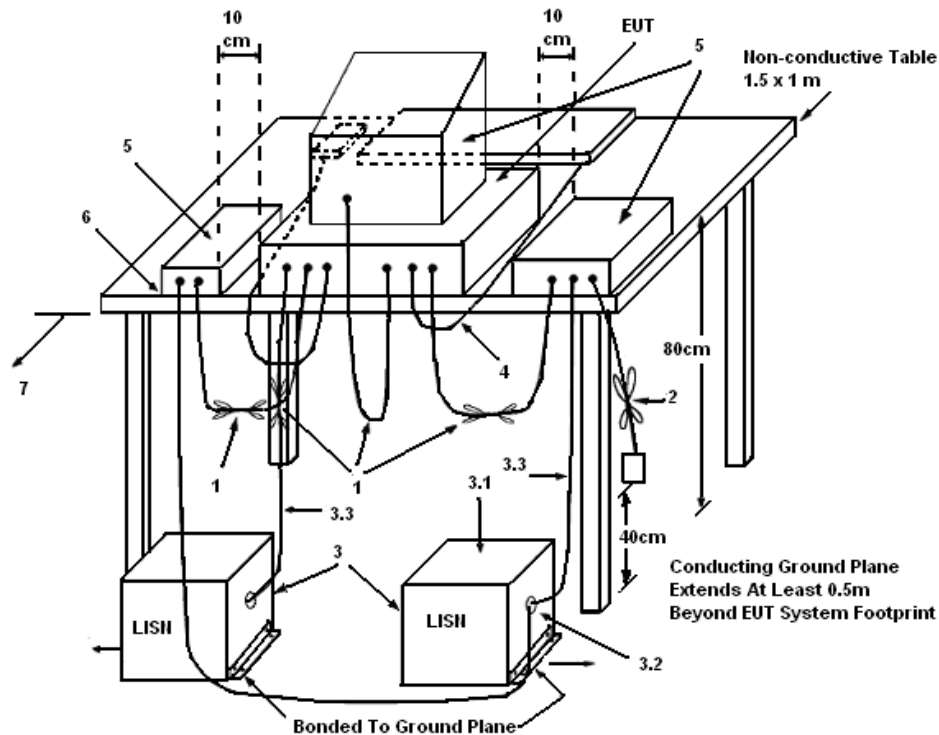

#### LEGEND:

- (1) Interconnecting cables that hang closer than 40 cm to the ground plane shall be folded back and forth in the center forming a bundle 30 to 40 cm long.
- (2) I/O cables that are not connected to a peripheral shall be bundled in the center. The end of the cable may be terminated, if required, using the correct terminating impedance. The overall length shall not exceed 1 m.
- (3) EUT connected to one LISN. Unused LISN measuring port connectors shall be terminated in 50  $\Omega$ . LISN can be placed on top of, or immediately beneath, reference ground plane.
  - (3.1) All other equipment powered from additional LISN(s).
  - (3.2) Multiple outlet strip can be used for multiple power cords of non-EUT equipment.
  - (3.3) LISN at least 80 cm from nearest part of EUT chassis.
- (4) Cables of hand-operated devices, such as keyboards, mice, etc., shall be placed as for normal use.
- (5) Non-EUT components of EUT system being tested.
- (6) Rear of EUT, including peripherals, shall all be aligned and flush with rear of tabletop.
- (7) Rear of tabletop shall be 40 cm removed from a vertical conducting plane that is bonded to the ground plane.

#### 4.1.5. Test Deviation

There is no deviation with the original standard.

#### 4.1.6. EUT Operation during Test

The EUT was placed on the test table and programmed in normal function.



## 4.1.7. Results of AC Power Line Conducted Emissions Measurement

Temperature	24°C	Humidity	48%
Test Engineer	Hank Yang	Phase	Line
Configuration	CTX		

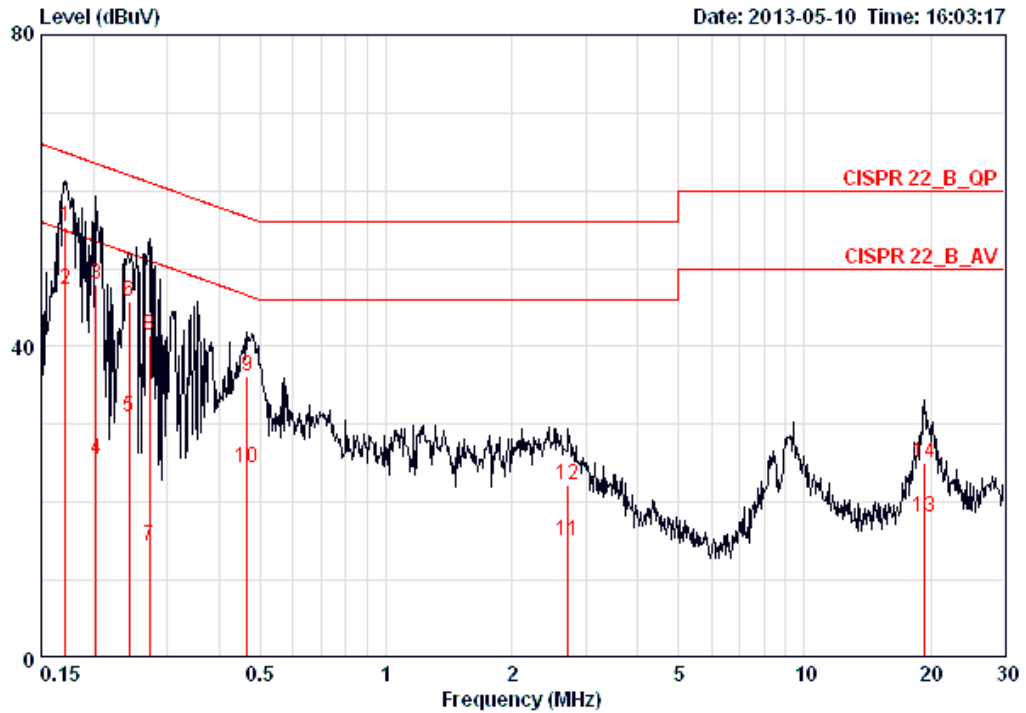

	Freq	Level	Over Limit	Limit Line	Read Level	LISN Factor	Cable Loss	Pol/Phase	Remark
	MHz	dB $\mu$ V	dB	dB $\mu$ V	dB $\mu$ V	dB	dB		
1	0.17125	55.37	-9.53	64.90	55.02	0.16	0.19	LINE	QP
2	0.17125	47.31	-7.59	54.90	46.96	0.16	0.19	LINE	AVERAGE
3	0.20289	48.06	-15.43	63.49	47.71	0.15	0.20	LINE	QP
4	0.20289	25.59	-27.90	53.49	25.24	0.15	0.20	LINE	AVERAGE
5	0.24362	30.95	-21.02	51.97	30.60	0.15	0.20	LINE	AVERAGE
6	0.24362	45.72	-16.25	61.97	45.37	0.15	0.20	LINE	QP
7	0.27152	14.32	-36.75	51.07	13.97	0.15	0.20	LINE	AVERAGE
8	0.27152	41.40	-19.67	61.07	41.05	0.15	0.20	LINE	QP
9	0.46614	36.27	-20.31	56.58	35.92	0.15	0.20	LINE	QP
10	0.46614	24.43	-22.15	46.58	24.08	0.15	0.20	LINE	AVERAGE
11	2.721	15.04	-30.96	46.00	14.59	0.20	0.25	LINE	AVERAGE
12	2.721	22.16	-33.84	56.00	21.71	0.20	0.25	LINE	QP
13	19.326	18.06	-31.94	50.00	17.09	0.47	0.50	LINE	AVERAGE
14	19.326	25.17	-34.83	60.00	24.20	0.47	0.50	LINE	QP

Temperature	24°C	Humidity	48%
Test Engineer	Hank Yang	Phase	Neutral
Configuration	CTX		

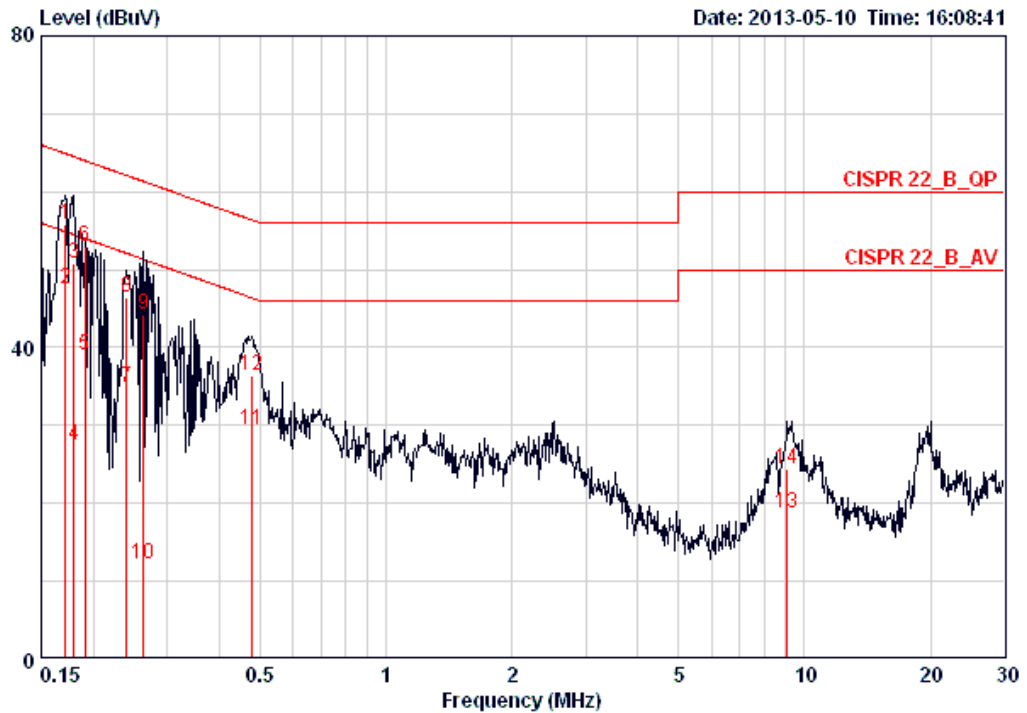

	Freq	Level	Over Limit	Limit Line	Read Level	LISN Factor	Cable Loss	Pol/Phase	Remark
	MHz	dBuV	dB	dBuV	dBuV	dB	dB		
1	0.17125	55.87	-9.03	64.90	55.60	0.08	0.19	NEUTRAL	QP
2	0.17125	47.46	-7.44	54.90	47.19	0.08	0.19	NEUTRAL	AVERAGE
3	0.17961	50.82	-13.68	64.50	50.55	0.08	0.19	NEUTRAL	QP
4	0.17961	27.52	-26.98	54.50	27.25	0.08	0.19	NEUTRAL	AVERAGE
5	0.19039	38.99	-15.03	54.02	38.71	0.08	0.20	NEUTRAL	AVERAGE
6	0.19039	52.99	-11.03	64.02	52.71	0.08	0.20	NEUTRAL	QP
7	0.24037	34.89	-17.19	52.08	34.61	0.08	0.20	NEUTRAL	AVERAGE
8	0.24037	46.47	-15.61	62.08	46.19	0.08	0.20	NEUTRAL	QP
9	0.26303	44.28	-17.06	61.34	44.00	0.08	0.20	NEUTRAL	QP
10	0.26303	12.11	-39.23	51.34	11.83	0.08	0.20	NEUTRAL	AVERAGE
11	0.47865	29.44	-16.92	46.36	29.16	0.08	0.20	NEUTRAL	AVERAGE
12	0.47865	36.51	-19.85	56.36	36.23	0.08	0.20	NEUTRAL	QP
13	9.107	18.65	-31.35	50.00	18.12	0.22	0.31	NEUTRAL	AVERAGE
14	9.107	24.49	-35.51	60.00	23.96	0.22	0.31	NEUTRAL	QP

Note:

Level = Read Level + LISN Factor + Cable Loss

## 4.2. 26dB Bandwidth & 99% Occupied Bandwidth Measurement

### 4.2.1. Limit

No restriction limits.

### 4.2.2. Measuring Instruments and Setting

Please refer to section 5 of equipments list in this report. The following table is the setting of the spectrum analyzer.

26dB Bandwidth	
Spectrum Parameters	Setting
Attenuation	Auto
Span Frequency	> 26dB Bandwidth
RBW	Approximately 1% of the emission bandwidth
VBW	VBW > RBW
Detector	Peak
Trace	Max Hold
Sweep Time	Auto
99% Occupied Bandwidth	
Spectrum Parameters	Setting
Span	1.5 times to 5.0 times the OBW
RBW	1 % to 5 % of the OBW
VBW	$\geq 3 \times \text{RBW}$
Detector	Peak
Trace	Max Hold

### 4.2.3. Test Procedures

1. The transmitter output (antenna port) was connected to the spectrum analyzer in peak hold mode.
2. Measure the maximum width of the emission that is 26 dB down from the peak of the emission. Compare this with the RBW setting of the analyzer. Readjust RBW and repeat measurement as needed until the RBW/EBW ratio is approximately 1%.

### 4.2.4. Test Setup Layout

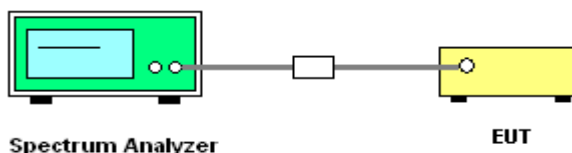

### 4.2.5. Test Deviation

There is no deviation with the original standard.

### 4.2.6. EUT Operation during Test

The EUT was programmed to be in continuously transmitting mode.

#### 4.2.7. Test Result of 26dB Bandwidth & 99% Occupied Bandwidth

Temperature	25°C	Humidity	56%
Test Engineer	Magic Lai	Configurations	IEEE 802.11n

##### Configuration IEEE 802.11n MCS0 20MHz / Chain 1 + Chain 2

Channel	Frequency	26dB Bandwidth (MHz)	99% Occupied Bandwidth (MHz)
36	5180 MHz	22.40	16.80
40	5200 MHz	22.40	16.64
48	5240 MHz	22.08	16.80

##### Configuration IEEE 802.11n MCS0 40MHz / Chain 1 + Chain 2

Channel	Frequency	26dB Bandwidth (MHz)	99% Occupied Bandwidth (MHz)
38	5190 MHz	45.76	37.12
46	5230 MHz	44.80	36.48

<b>Temperature</b>	25°C	<b>Humidity</b>	56%
<b>Test Engineer</b>	Magic Lai	<b>Configurations</b>	IEEE 802.11a

**Configuration IEEE 802.11a / Chain 1 + Chain 2**

Channel	Frequency	26dB Bandwidth (MHz)	99% Occupied Bandwidth (MHz)
36	5180 MHz	24.64	17.60
40	5200 MHz	24.00	17.76
48	5240 MHz	22.08	16.48

**26dB Bandwidth & 99% Occupied Bandwidth Plot on Configuration IEEE 802.11n MCS0 20MHz / Chain 1 + Chain 2 / 5180 MHz**

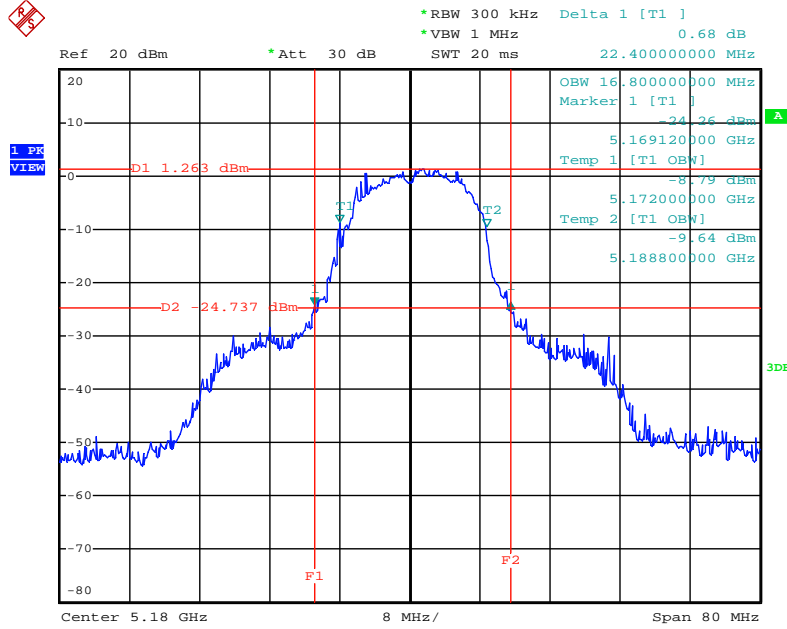

Date: 8.JUN.2013 18:26:12

**26dB Bandwidth & 99% Occupied Bandwidth Plot on Configuration IEEE 802.11n MCS0 20MHz / Chain 1 + Chain 2 / 5200 MHz**

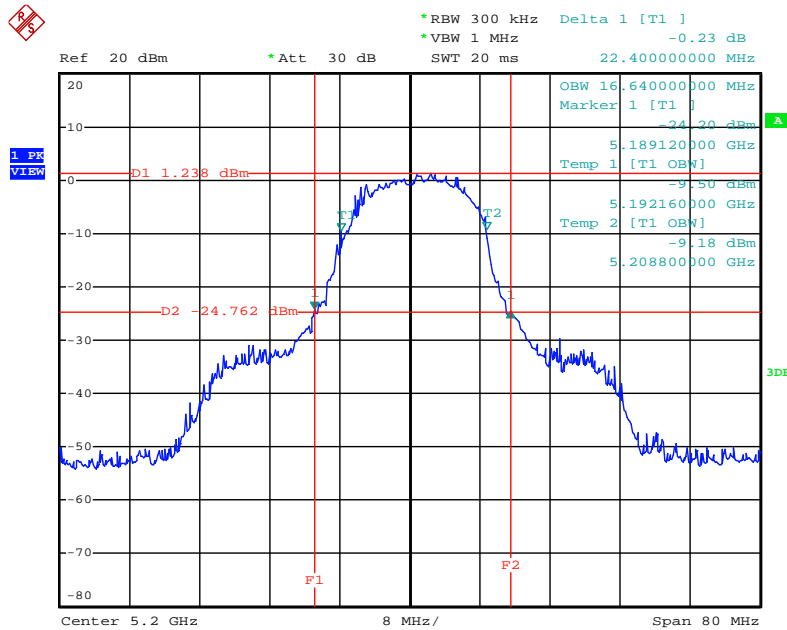

Date: 8.JUN.2013 18:27:03

**26dB Bandwidth & 99% Occupied Bandwidth Plot on Configuration IEEE 802.11n MCS0 20MHz / Chain 1 + Chain 2 / 5240 MHz**

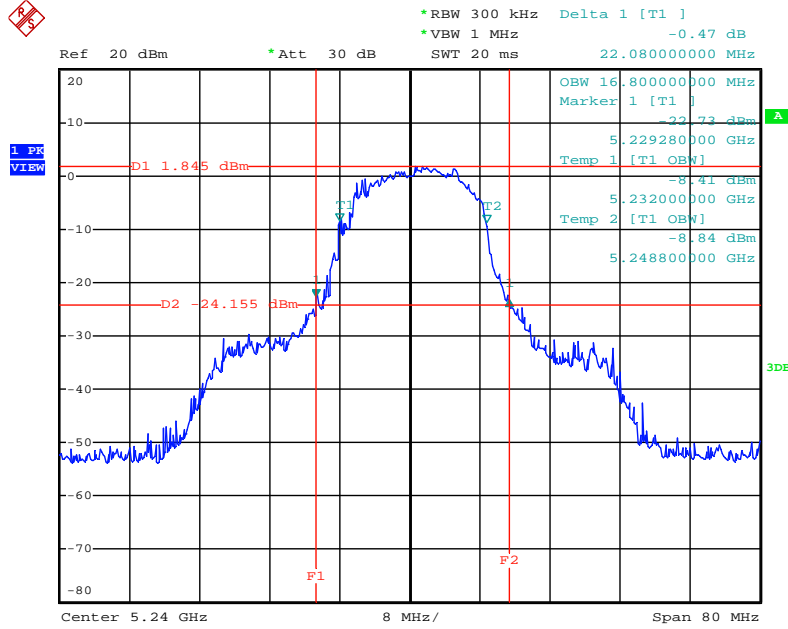

Date: 8.JUN.2013 18:27:44

**26dB Bandwidth & 99% Occupied Bandwidth Plot on Configuration IEEE 802.11n MCS0 40MHz / Chain 1 + Chain 2 / 5190 MHz**

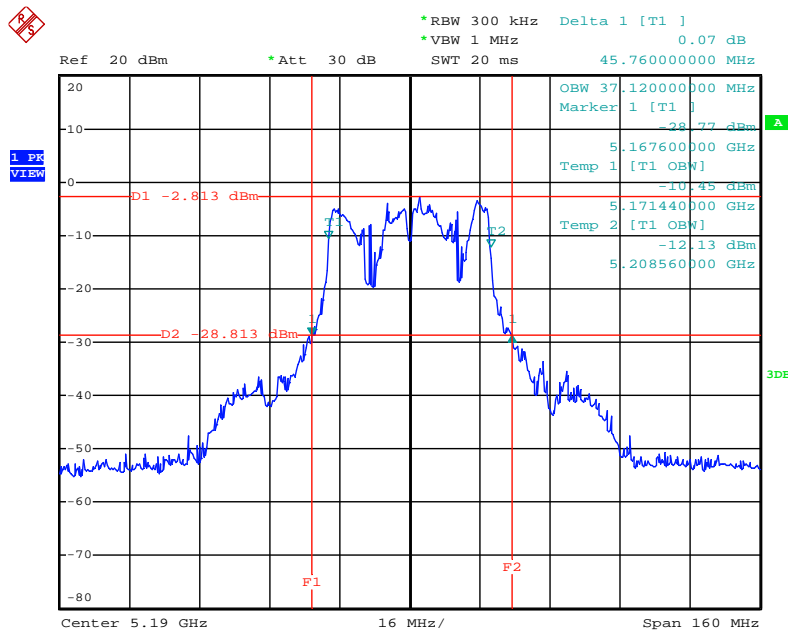

Date: 8.JUN.2013 18:40:58

**26dB Bandwidth & 99% Occupied Bandwidth Plot on Configuration IEEE 802.11n MCS0 40MHz / Chain 1 + Chain 2 / 5230 MHz**

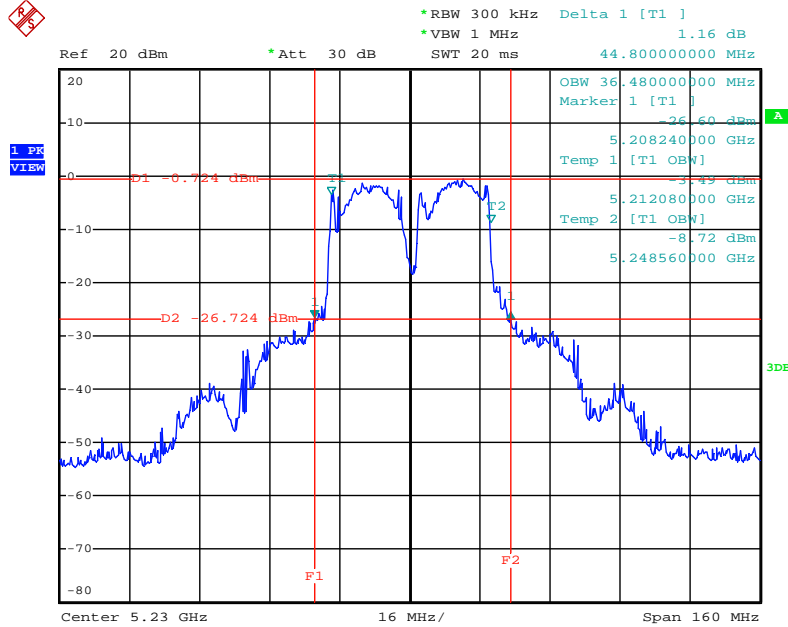

Date: 8.JUN.2013 18:41:41

**26dB Bandwidth & 99% Occupied Bandwidth Plot on Configuration IEEE 802.11a / Chain 1 + Chain 2 / 5180 MHz**

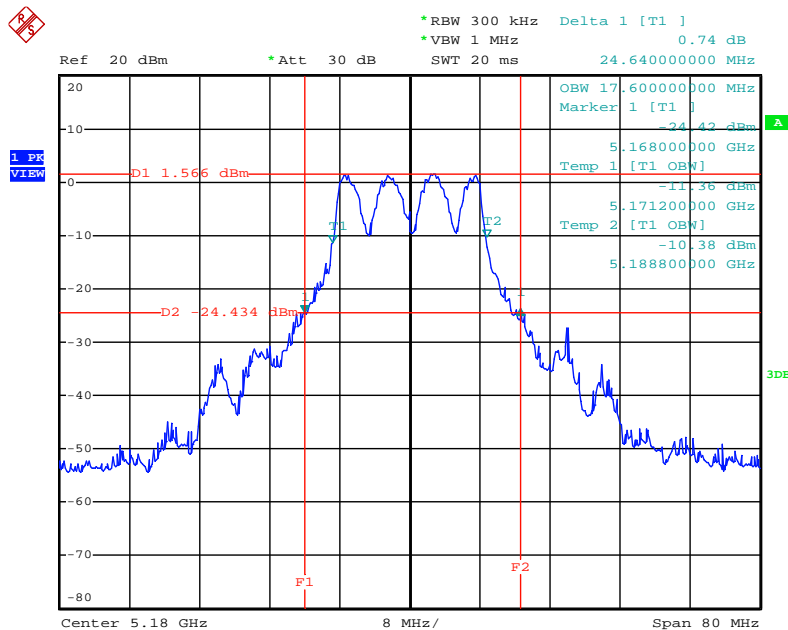

Date: 8.JUN.2013 18:23:01



**26dB Bandwidth & 99% Occupied Bandwidth Plot on Configuration IEEE 802.11a / Chain 1 + Chain 2 / 5200 MHz**

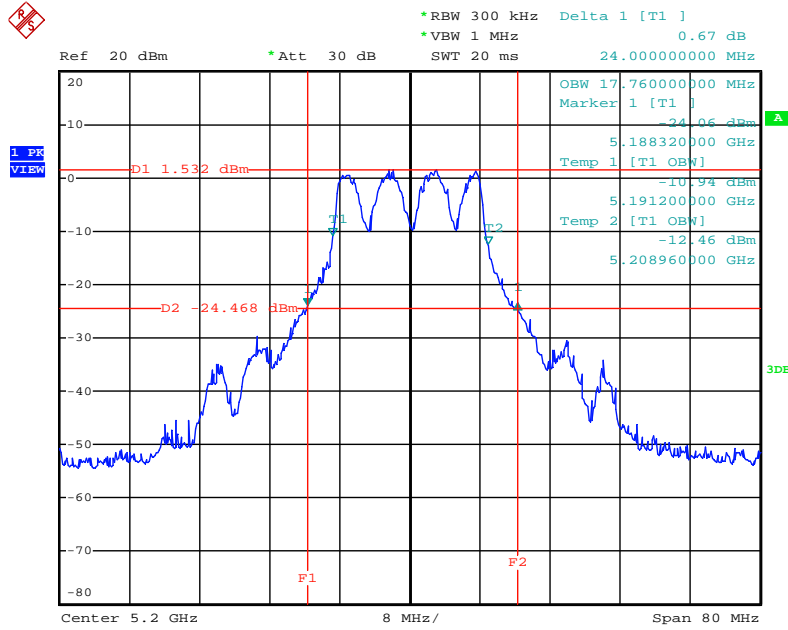

Date: 8.JUN.2013 18:24:07

**26dB Bandwidth & 99% Occupied Bandwidth Plot on Configuration IEEE 802.11a / Chain 1 + Chain 2 / 5240 MHz**

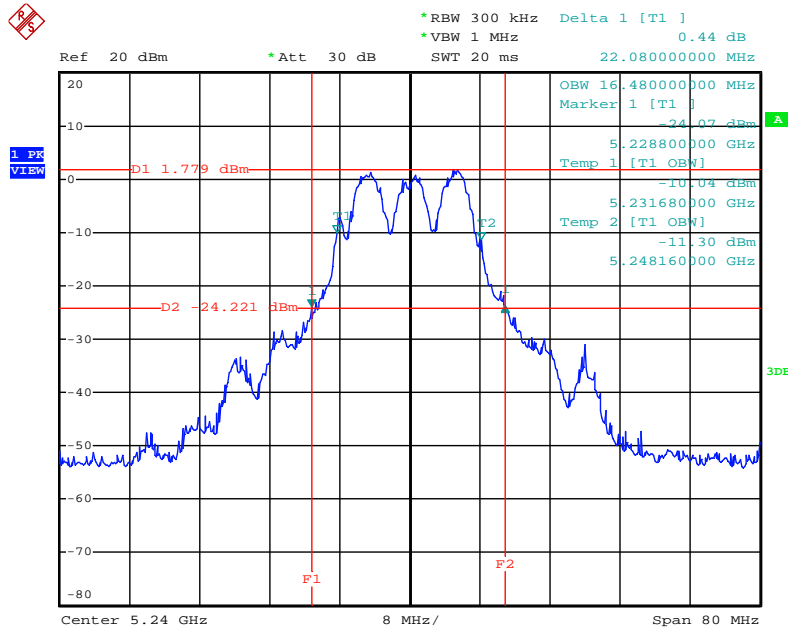

Date: 8.JUN.2013 18:24:44

### 4.3. Maximum Conducted Output Power Measurement

#### 4.3.1. Limit

For the band 5.15~5.25 GHz, the maximum conducted output power over the frequency band of operation shall not exceed the lesser of 50 mW (17dBm) or  $4 \text{ dBm} + 10\log B$ , where B is the 26 dB emissions bandwidth in MHz. If transmitting antennas of directional gain greater than 6 dBi are used, both the maximum conducted output power and the peak power spectral density shall be reduced by the amount in dB that the directional gain of the antenna exceeds 6 dBi.

#### 4.3.2. Measuring Instruments and Setting

The following table is the setting of the peak power meter.

Power Meter Parameter	Setting
Detector	AVERAGE

#### 4.3.3. Test Procedures

1. The transmitter output (antenna port) was connected to the power meter.
2. Test was performed in accordance with KDB 789033 D01 v01r03 for Compliance Testing of Unlicensed National Information Infrastructure (U-NII) Devices - Part 15, Subpart E, section (E) Maximum conducted output power =>(3) Method PM (Measurement using an RF average power meter) Multiple antenna systems was performed in accordance with KDB 662911 D01 v01r02 Emissions Testing of Transmitters with Multiple Outputs in the Same Band.
3. When measuring maximum conducted output power with multiple antenna systems, add every result of the values by mathematic formula.

#### 4.3.4. Test Setup Layout

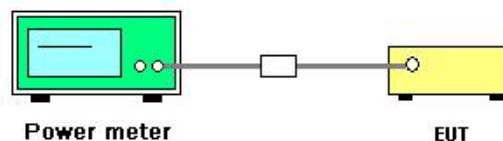

#### 4.3.5. Test Deviation

There is no deviation with the original standard.

#### 4.3.6. EUT Operation during Test

The EUT was programmed to be in continuously transmitting mode.

#### 4.3.7. Test Result of Maximum Conducted Output Power

Temperature	25°C	Humidity	56%
Test Engineer	Magic Lai	Configurations	IEEE 802.11n
Test Date	Jun. 08, 2013		

##### Configuration IEEE 802.11n MCS0 20MHz / Chain 1 + Chain 2

Channel	Frequency	Conducted Power (dBm)		Total Conducted Power (dBm)	Max. Limit (dBm)	Result
		Chain 1	Chain 2			
36	5180 MHz	13.53	13.78	16.67	17.00	Complies
40	5200 MHz	13.64	13.55	16.61	17.00	Complies
48	5240 MHz	13.56	13.27	16.43	17.00	Complies

##### Configuration IEEE 802.11n MCS0 40MHz / Chain 1 + Chain 2

Channel	Frequency	Conducted Power (dBm)		Total Conducted Power (dBm)	Max. Limit (dBm)	Result
		Chain 1	Chain 2			
38	5190 MHz	11.16	11.41	14.30	17.00	Complies
46	5230 MHz	13.91	13.64	16.79	17.00	Complies

<b>Temperature</b>	25°C	<b>Humidity</b>	56%
<b>Test Engineer</b>	Magic Lai	<b>Configurations</b>	IEEE 802.11a
<b>Test Date</b>	Jun. 08, 2013		

**Configuration IEEE 802.11a / Chain 1 + Chain 2**

Channel	Frequency	Conducted Power (dBm)		Total Conducted Power (dBm)	Max. Limit (dBm)	Result
		Chain 1	Chain 2			
36	5180 MHz	13.48	13.71	16.61	17.00	<b>Complies</b>
40	5200 MHz	13.38	13.21	16.31	17.00	<b>Complies</b>
48	5240 MHz	13.51	13.29	16.41	17.00	<b>Complies</b>

## 4.4. Power Spectral Density Measurement

### 4.4.1. Limit

The power spectral density is defined as the highest level of power in dBm per MHz generated by the transmitter within the power envelope. The following table is power spectral density limits and decrease power density limit rule refer to section 4.3.1.

Frequency Range	Power Spectral Density limit (dBm/MHz)
5.15~5.25 GHz	4

### 4.4.2. Measuring Instruments and Setting

Please refer to section 5 of equipments list in this report. The following table is the setting of the spectrum analyzer.

Spectrum Parameter	Setting
Attenuation	Auto
Span Frequency	Encompass the entire emissions bandwidth (EBW) of the signal
RBW	1000 kHz
VBW	3000 kHz
Detector	RMS
Trace	AVERAGE
Sweep Time	Auto
Trace Average	100 times

### 4.4.3. Test Procedures

1. The transmitter output (antenna port) was connected RF switch to the spectrum analyzer.
2. Test was performed in accordance with KDB 789033 D01 v01r03 for Compliance Testing of Unlicensed National Information Infrastructure (U-NII) Devices - Part 15, Subpart E, section (C) Maximum conducted output power => (d) Method SA-2 (trace averaging across on and off times of the EUT transmissions, followed by duty cycle correction).
3. Multiple antenna systems was performed in accordance KDB 662911 D01 v01r02 in-Band Power Spectral Density (PSD) Measurements (1) Measure and sum the spectra across the outputs.
4. When measuring first spectral bin of output 1 is summed with that in the first spectral bin of output 2 and that from the first spectral bin of output 3 and so on up to the Nth output to obtain the value for the first frequency bin of the summed spectrum. The summed spectrum value for each of the other frequency bins is computed in the same way.

#### 4.4.4. Test Setup Layout

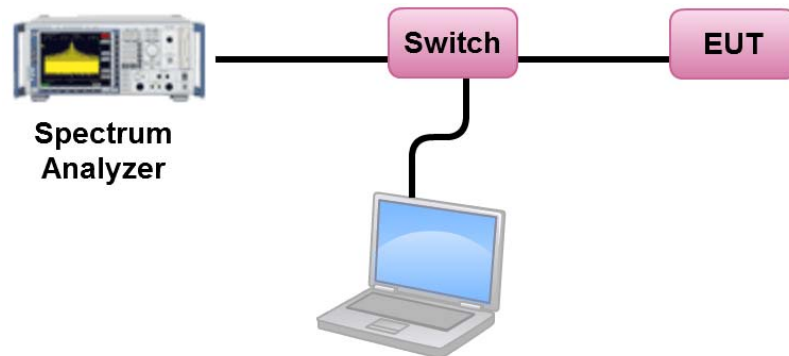

#### 4.4.5. Test Deviation

There is no deviation with the original standard.

#### 4.4.6. EUT Operation during Test

The EUT was programmed to be in continuously transmitting mode.

#### 4.4.7. Test Result of Power Spectral Density

Temperature	25°C	Humidity	56%
Test Engineer	Magic Lai	Configurations	IEEE 802.11n
Test Date	Jun. 08, 2013		

##### Configuration IEEE 802.11n MCS0 20MHz / Chain 1 & Chain 2

Channel	Frequency	Total Power Density (dBm/MHz)	Max. Limit (dBm/MHz)	Result
36	5180 MHz	3.19	3.28	Complies
40	5200 MHz	3.15	3.28	Complies
48	5240 MHz	2.85	3.28	Complies

Note:  $Directional\ gain = G_{ANT} + 10\ log(N_{ANT}/N_{SS}) = 6.72\ dBi > 6\ dBi$ , So Band1 Limit =  $4 - (6.72 - 6)$   
 $= 3.28\ dBm/MHz$

##### Configuration IEEE 802.11n MCS0 40MHz / Chain 1 & Chain 2

Channel	Frequency	Total Power Density (dBm/MHz)	Max. Limit (dBm/MHz)	Result
38	5190 MHz	-1.92	3.28	Complies
46	5230 MHz	0.81	3.28	Complies

Note:  $Directional\ gain = G_{ANT} + 10\ log(N_{ANT}/N_{SS}) = 6.72\ dBi > 6\ dBi$ , So Band1 Limit =  $4 - (6.72 - 6)$   
 $= 3.28\ dBm/MHz$

Temperature	25°C	Humidity	56%
Test Engineer	Magic Lai	Configurations	IEEE 802.11a
Test Date	Jun. 08, 2013		

**Configuration IEEE 802.11a / Chain 1 & Chain 2**

Channel	Frequency	Total Power Density (dBm/MHz)	Max. Limit (dBm/MHz)	Result
36	5180 MHz	2.95	3.28	Complies
40	5200 MHz	2.95	3.28	Complies
48	5240 MHz	3.20	3.28	Complies

Note:  $Directional\ gain = G_{ANT} + 10\ log(N_{ANT}/N_{SS}) = 6.72\ dBi > 6\ dBi$ , So Band1 Limit =  $4 - (6.72 - 6)$   
 $= 3.28\ dBm/MHz$

Note: All the test values were listed in the report.

For plots, only the channel with maximum results was shown.



**Power Density Plot on Configuration IEEE 802.11n MCS0 20MHz / Chain 1 & Chain 2 / 5180 MHz**

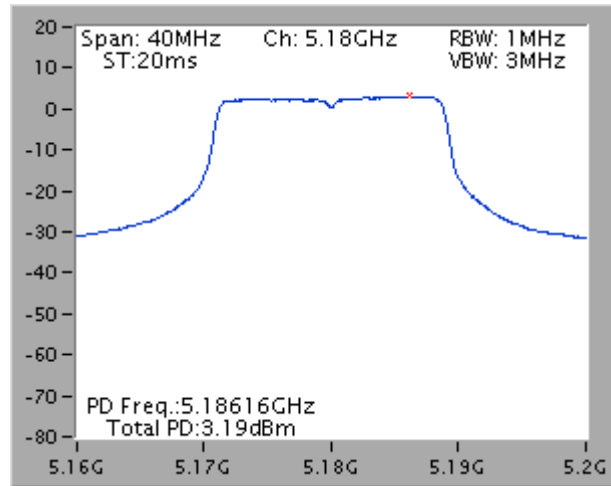

**Power Density Plot on Configuration IEEE 802.11n MCS0 40MHz / Chain 1 & Chain 2 / 5230 MHz**

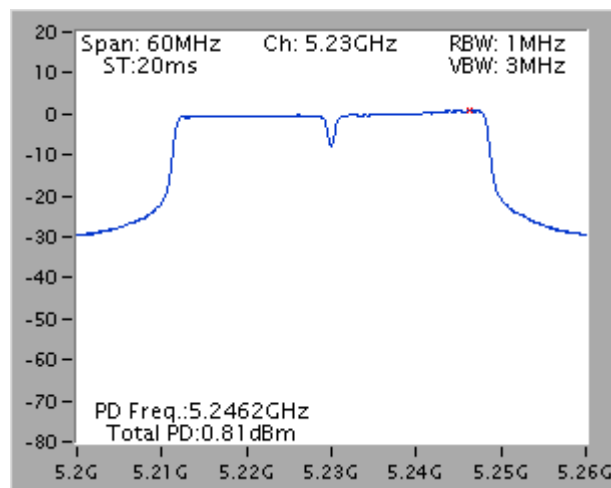

Power Density Plot on Configuration IEEE 802.11a / Chain 1 & Chain 2 / 5240 MHz

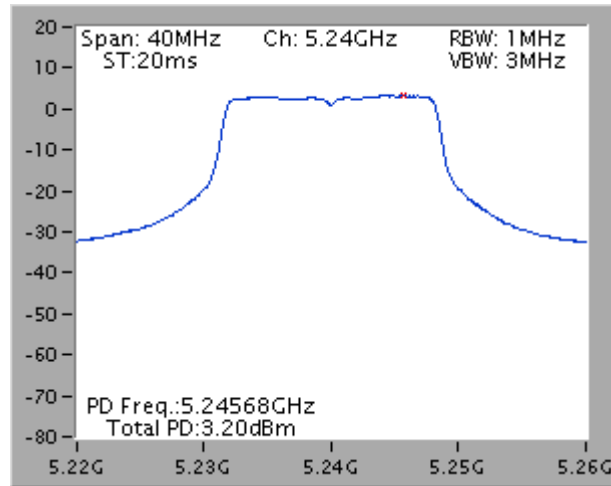

## 4.5. Peak Excursion Measurement

### 4.5.1. Limit

The ratio of the peak excursion of the modulation envelope (measured using a peak hold function) to the maximum conducted output power (measured as specified above) shall not exceed 13 dB across any 1 MHz bandwidth or the emissions bandwidth whichever is less.

### 4.5.2. Measuring Instruments and Setting

Please refer to section 5 of equipments list in this report. The following table is the setting of the spectrum analyzer.

Spectrum Parameter	Setting
Attenuation	Auto
Span Frequency	Encompass the entire emissions bandwidth (EBW) of the signal
RBW	1 MHz (Peak Trace) / 1 MHz (Average Trace)
VBW	≥ 3 MHz (Peak Trace) / ≥ 3 MHz (Average Trace)
Detector	Peak (Peak Trace) / RMS (Average Trace)
Trace	Trace: Max hold (Peak Trace) / Trace Average Sweep Count 100 (Average Trace)
Sweep Time	AUTO

### 4.5.3. Test Procedures

1. Trace A, Set RBW = 1MHz, VBW = 3MHz, Span >26dB bandwidth, Max. hold.
2. Delta Mark trace A Maximum frequency and trace B same frequency.
3. Repeat the above procedure until measurements for all frequencies were complete.
4. Testing each modulation mode on a single channel in single operating band at single output port.  
All signal types need test (DSSS, OFDM). All modulation types need test (BPSK, QPSK, 16-QAM, 64-QAM, 256-QAM). All bandwidth modes need test.

### 4.5.4. Test Setup Layout

This test setup layout is the same as that shown in section 4.4.4.

### 4.5.5. Test Deviation

There is no deviation with the original standard.

### 4.5.6. EUT Operation during Test

The EUT was programmed to be in continuously transmitting mode.

#### 4.5.7. Test Result of Peak Excursion

<b>Temperature</b>	25°C	<b>Humidity</b>	56%
<b>Test Engineer</b>	Magic Lai	<b>Configurations</b>	IEEE 802.11n

##### Configuration IEEE 802.11n MCS0 20MHz / Chain 1 + Chain 2

Modulation	Frequency	Peak Excursion (dB)	Max. Limit (dB)	Result
BSPK(MCS0)	5180MHz	9.11	13	Complies
QPSK(MCS1)	5180MHz	10.24	13	Complies
16QAM(MCS3)	5180MHz	10.30	13	Complies
64QAM(MCS5)	5180MHz	11.56	13	Complies

##### Configuration IEEE 802.11n MCS0 40MHz / Chain 1 + Chain 2

Modulation	Frequency	Peak Excursion (dB)	Max. Limit (dB)	Result
BSPK(MCS0)	5230MHz	9.87	13	Complies
QPSK(MCS1)	5230MHz	10.09	13	Complies
16QAM(MCS3)	5230MHz	10.89	13	Complies
64QAM(MCS5)	5230MHz	10.38	13	Complies

<b>Temperature</b>	25°C	<b>Humidity</b>	56%
<b>Test Engineer</b>	Magic Lai	<b>Configurations</b>	IEEE 802.11a

**Configuration IEEE 802.11a / Chain 1 + Chain 2**

<b>Modulation</b>	<b>Frequency</b>	<b>Peak Excursion (dB)</b>	<b>Max. Limit (dB)</b>	<b>Result</b>
BSPK(6Mbps)	5180MHz	10.38	13	<b>Complies</b>
QPSK(12Mbps)	5180MHz	9.63	13	<b>Complies</b>
16QAM(24Mbps)	5180MHz	10.04	13	<b>Complies</b>
64QAM(48Mbps)	5180MHz	11.30	13	<b>Complies</b>

Note: Only the channel with maximum results was listed in the report.

**Peak Excursion Plot on Configuration IEEE 802.11n MCS0 20MHz / Chain 1 + Chain 2 / 16QAM(MCS3)  
/ 5180MHz**

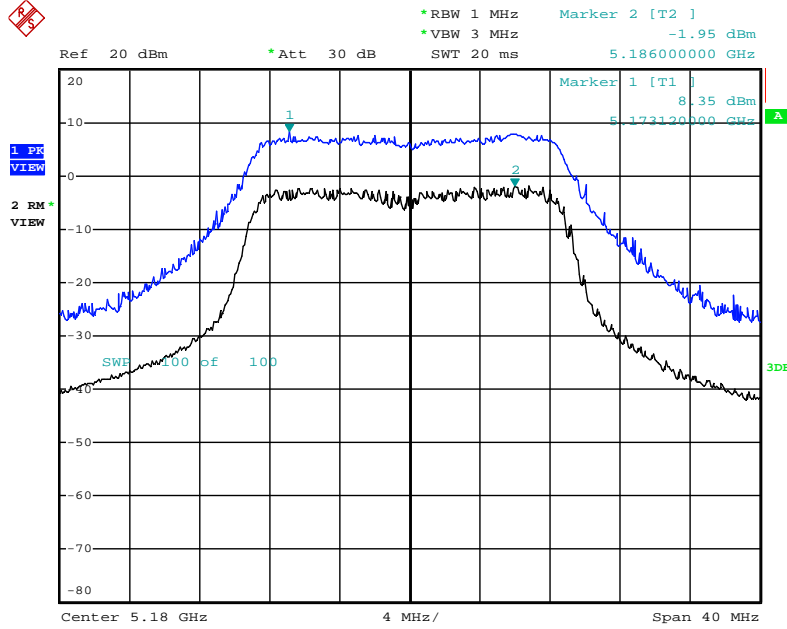

Date: 8.JUN.2013 18:58:04

**Peak Excursion Plot on Configuration IEEE 802.11n MCS0 40MHz / Chain 1 + Chain 2 / 16QAM(MCS3)  
/ 5230MHz**

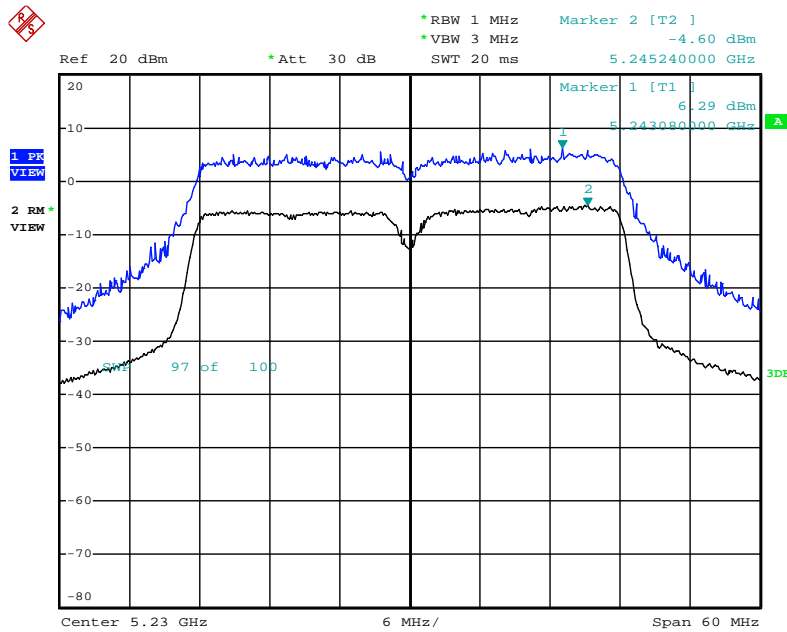

Date: 8.JUN.2013 19:01:05

Peak Excursion Plot on Configuration IEEE 802.11a / Chain 1 + Chain 2 / 64QAM(48Mbps) / 5180MHz

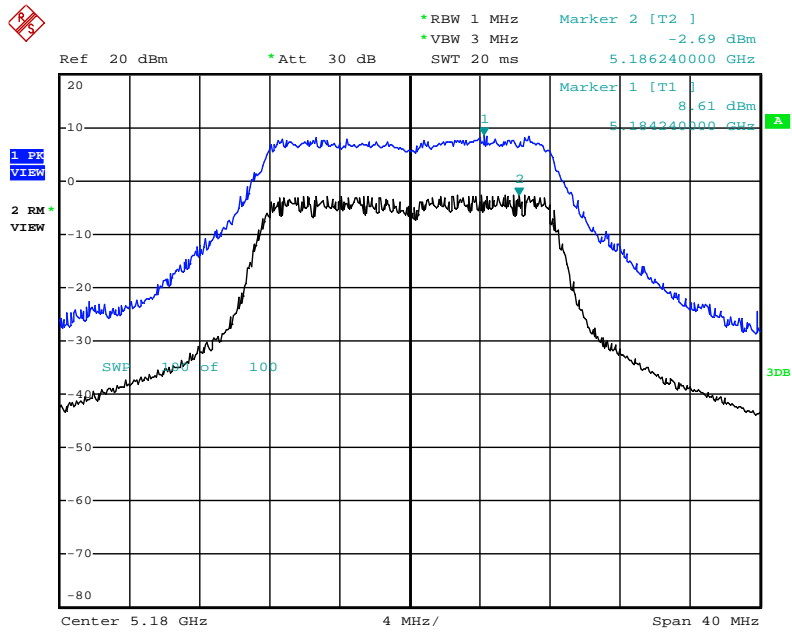

Date: 8.JUN.2013 18:56:13

## 4.6. Radiated Emissions Measurement

### 4.6.1. Limit

For transmitters operating in the 5.15-5.35 GHz band: all emissions outside of the 5.15-5.35 GHz band shall not exceed a -27dBm peak limit or average 54dBuV/m and peak 74dBuV/m limits. For transmitters operating in the In addition, In case the emission fall within the restricted band specified on 15.205(a), then the 15.209(a) limit in the table below has to be followed.

Frequencies (MHz)	Field Strength (micorvolts/meter)	Measurement Distance (meters)
0.009~0.490	2400/F(KHz)	300
0.490~1.705	24000/F(KHz)	30
1.705~30.0	30	30
30~88	100	3
88~216	150	3
216~960	200	3
Above 960	500	3

### 4.6.2. Measuring Instruments and Setting

Please refer to section 5 of equipments list in this report. The following table is the setting of spectrum analyzer and receiver.

Spectrum Parameter	Setting
Attenuation	Auto
Start Frequency	1000 MHz
Stop Frequency	40 GHz
RBW / VBW (Emission in restricted band)	1 MHz / 3MHz for Peak, 1 MHz / 10Hz for Average
RBW / VBW (Emission in non-restricted band)	1 MHz / 3MHz for peak

Receiver Parameter	Setting
Attenuation	Auto
Start ~ Stop Frequency	9kHz~150kHz / RB 200Hz for QP
Start ~ Stop Frequency	150kHz~30MHz / RB 9kHz for QP
Start ~ Stop Frequency	30MHz~1000MHz / RB 120kHz for QP



#### 4.6.3. Test Procedures

1. Configure the EUT according to ANSI C63.10. The EUT was placed on the top of the turntable 0.8 meter above ground. The phase center of the receiving antenna mounted on the top of a height-variable antenna tower was placed 3 meters far away from the turntable.
2. Power on the EUT and all the supporting units. The turntable was rotated by 360 degrees to determine the position of the highest radiation.
3. The height of the broadband receiving antenna was varied between one meter and four meters above ground to find the maximum emissions field strength of both horizontal and vertical polarization.
4. For each suspected emissions, the antenna tower was scan (from 1 M to 4 M) and then the turntable was rotated (from 0 degree to 360 degrees) to find the maximum reading.
5. Set the test-receiver system to Peak or CISPR quasi-peak Detect Function with specified bandwidth under Maximum Hold Mode.
6. For emissions above 1GHz, use 1MHz VBW and RBW for peak reading. Then 1MHz RBW and 10Hz VBW for average reading in spectrum analyzer.
7. When the radiated emissions limits are expressed in terms of the average value of the emissions, and pulsed operation is employed, the measurement field strength shall be determined by averaging over one complete pulse train, including blanking intervals, as long as the pulse train does not exceed 0.1 seconds. As an alternative (provided the transmitter operates for longer than 0.1 seconds) or in cases where the pulse train exceeds 0.1 seconds, the measured field strength shall be determined from the average absolute voltage during a 0.1 second interval during which the field strength is at its maximum value.
8. If the emissions level of the EUT in peak mode was 3 dB lower than the average limit specified, then testing will be stopped and peak values of EUT will be reported, otherwise, the emissions which do not have 3 dB margin will be repeated one by one using the quasi-peak method for below 1GHz.
9. For testing above 1GHz, the emissions level of the EUT in peak mode was lower than average limit (that means the emissions level in peak mode also complies with the limit in average mode), then testing will be stopped and peak values of EUT will be reported, otherwise, the emissions will be measured in average mode again and reported.
10. In case the emission is lower than 30MHz, loop antenna has to be used for measurement and the recorded data should be QP measured by receiver. High – Low scan is not required in this case.

#### 4.6.4. Test Setup Layout

For radiated emissions below 1GHz

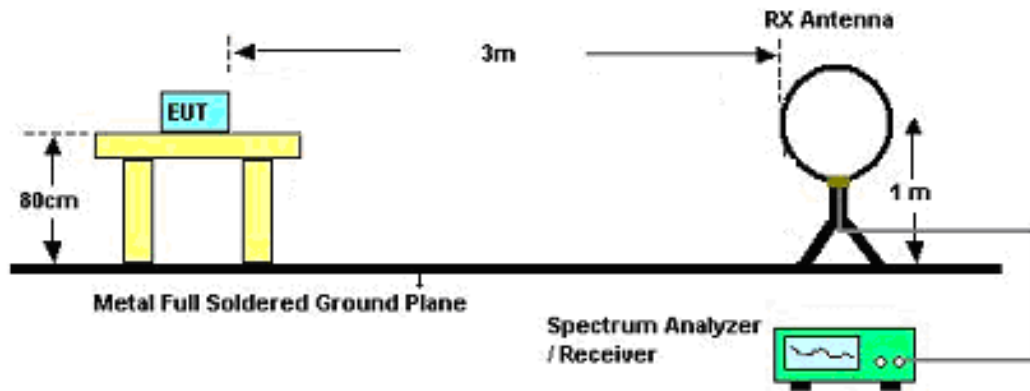

For radiated emissions above 1GHz

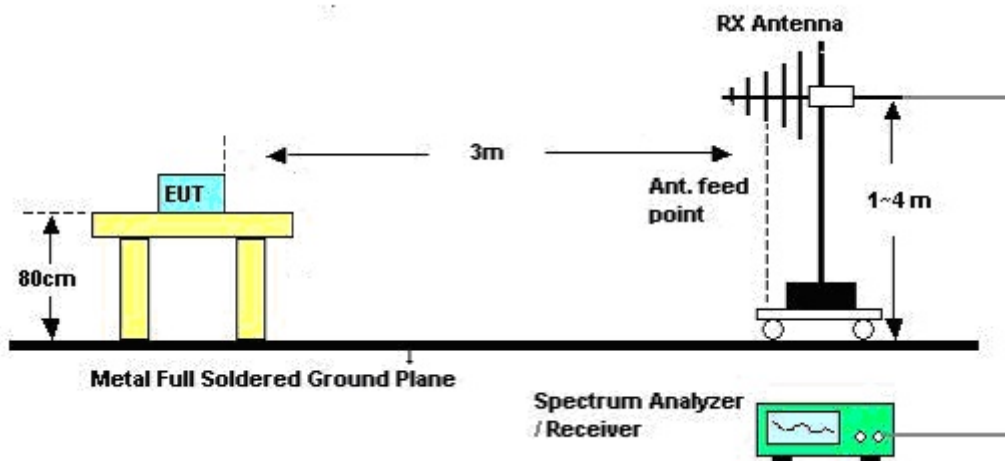

#### 4.6.5. Test Deviation

There is no deviation with the original standard.

#### 4.6.6. EUT Operation during Test

The EUT was programmed to be in continuously transmitting mode.

4.6.7. Results of Radiated Emissions (9kHz~30MHz)

Temperature	26°C	Humidity	48%
Test Engineer	Wen Chao	Configurations	CTX
Test Date	Jun. 10, 2013		

Freq. (MHz)	Level (dBuV)	Over Limit (dB)	Limit Line (dBuV)	Remark
-	-	-	-	See Note

Note:

The amplitude of spurious emissions that are attenuated by more than 20 dB below the permissible value has no need to be reported.

Distance extrapolation factor =  $40 \log(\text{specific distance} / \text{test distance})$  (dB);

Limit line = specific limits (dBuV) + distance extrapolation factor.

4.6.8. Results of Radiated Emissions (30MHz~1GHz)

Temperature	26°C	Humidity	48%
Test Engineer	Wen Chao	Configurations	CTX

Horizontal

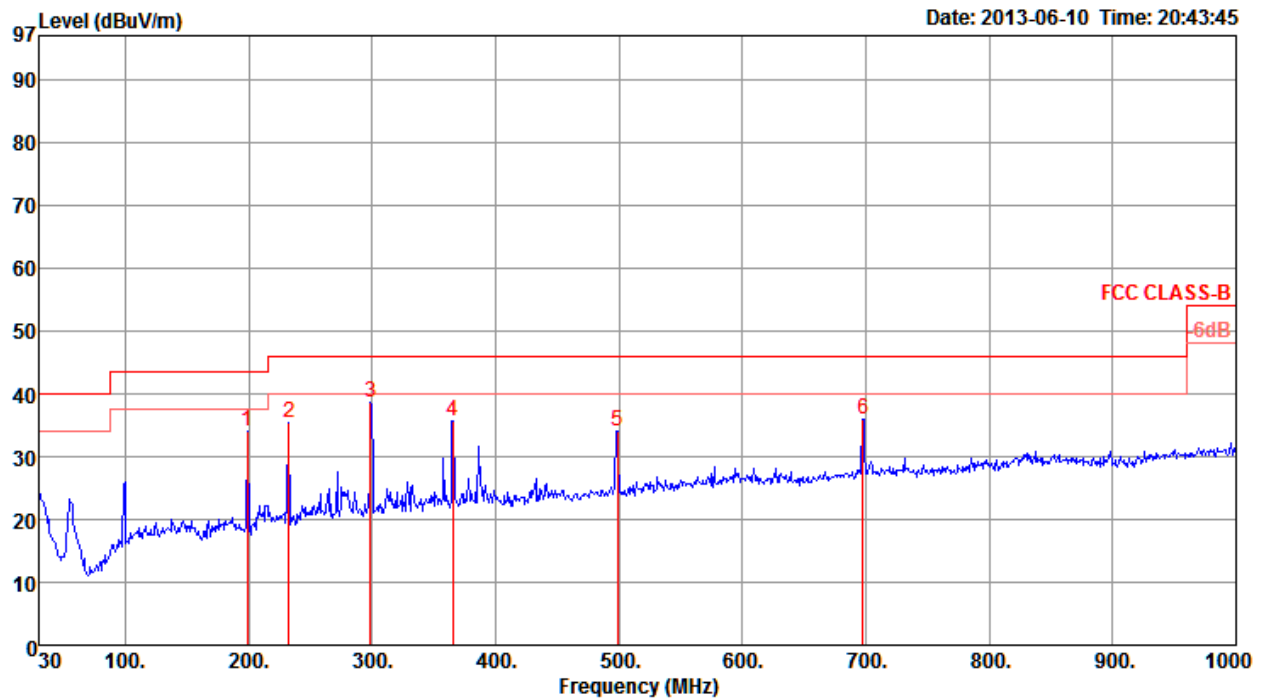

	Freq	Level	Limit	Over	Read	Cable	Preamp	Antenna	Remark	T/Pos	A/Pos	Pol/Phase
	MHz	dBuV/m	dBuV/m	dB	dBuV	dB	dB	dB/m		deg	cm	
1	198.78	34.09	43.50	-9.41	48.92	2.09	27.26	10.34	Peak	0	400	HORIZONTAL
2	232.73	35.50	46.00	-10.50	48.68	2.29	27.01	11.54	Peak	0	400	HORIZONTAL
3	298.69	38.74	46.00	-7.26	49.26	2.51	26.83	13.80	Peak	0	400	HORIZONTAL
4	365.62	35.79	46.00	-10.21	44.44	2.86	27.19	15.68	Peak	0	400	HORIZONTAL
5	498.51	34.15	46.00	-11.85	40.93	3.38	27.93	17.77	Peak	0	400	HORIZONTAL
6	697.36	35.98	46.00	-10.02	38.96	4.15	27.11	19.98	Peak	0	400	HORIZONTAL

**Vertical**

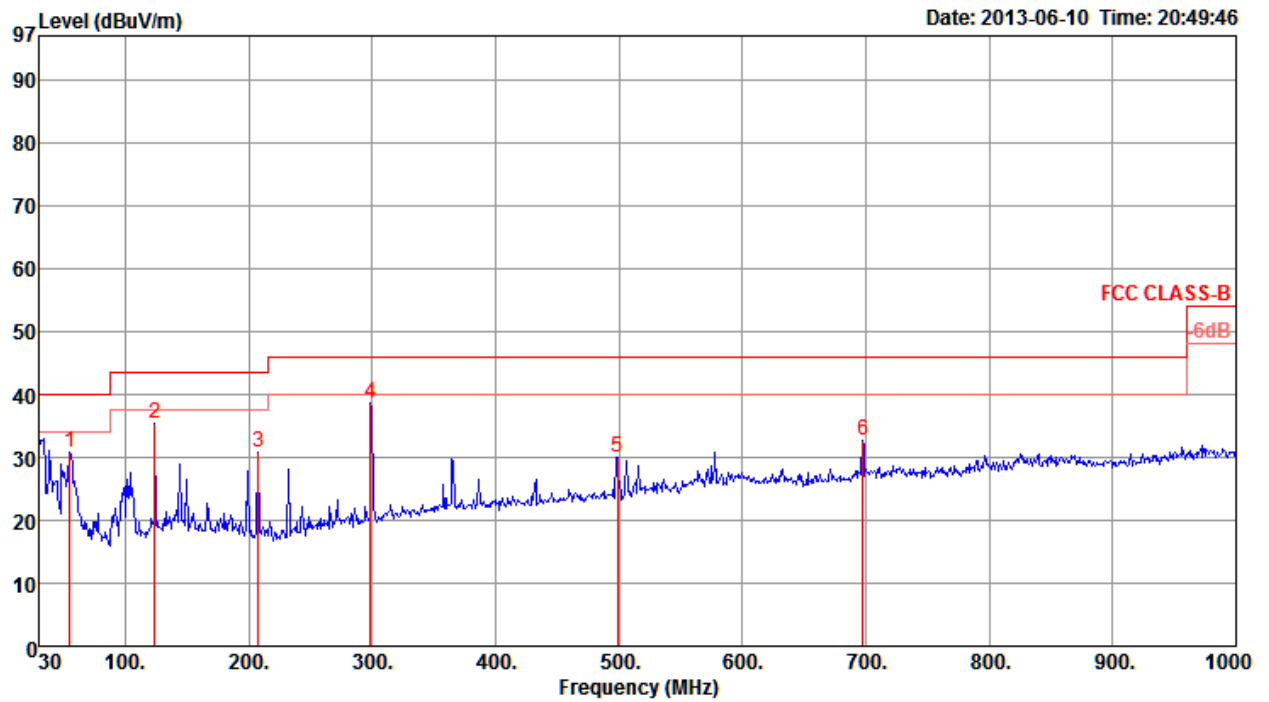

	Freq	Level	Limit	Over	Read	Cable	Preamp	Antenna	Remark	T/Pos	A/Pos	Pol/Phase
	MHz	dBuV/m	dBuV/m	dB	dBuV	dB	dB	dB/m		deg	cm	
1	55.22	30.87	40.00	-9.13	49.84	1.13	27.90	7.80	Peak	0	100	VERTICAL
2	124.09	35.29	43.50	-8.21	48.39	1.65	27.67	12.92	Peak	0	100	VERTICAL
3	207.51	30.75	43.50	-12.75	45.24	2.15	27.19	10.55	Peak	0	100	VERTICAL
4	298.69	38.51	46.00	-7.49	49.03	2.51	26.83	13.80	Peak	0	100	VERTICAL
5	498.51	30.12	46.00	-15.88	36.90	3.38	27.93	17.77	Peak	0	100	VERTICAL
6	697.36	32.64	46.00	-13.36	35.62	4.15	27.11	19.98	Peak	0	100	VERTICAL

**Note:**

The amplitude of spurious emissions that are attenuated by more than 20dB below the permissible value has no need to be reported.

Emission level (dBuV/m) = 20 log Emission level (uV/m).

Corrected Reading: Antenna Factor + Cable Loss + Read Level - Preamp Factor = Level.

#### 4.6.9. Results for Radiated Emissions (1GHz~40GHz)

<b>Temperature</b>	26°C	<b>Humidity</b>	56%
<b>Test Engineer</b>	Wen Chao	<b>Configurations</b>	IEEE 802.11n MCS0 20MHz Ch 36 / Chain 1 + Chain 2
<b>Test Date</b>	Jun. 06, 2013		

##### Horizontal

	Freq	Level	Limit	Over	Read	CableAntenna	Preamp	Remark	A/Pos	T/Pos	Pol/Phase
	MHz	dBuV/m	dBuV/m	dB	dBuV	dB	dB/m	dB	cm	deg	
1	10363.28	59.92	74.00	-14.08	46.95	8.54	39.75	35.32	Peak	140	19 HORIZONTAL
2	10364.24	45.79	54.00	-8.21	32.82	8.54	39.75	35.32	Average	140	19 HORIZONTAL
3	15538.12	56.56	74.00	-17.44	43.26	10.77	38.12	35.59	Peak	100	58 HORIZONTAL
4	15538.40	43.52	54.00	-10.48	30.22	10.77	38.12	35.59	Average	138	58 HORIZONTAL

##### Vertical

	Freq	Level	Limit	Over	Read	CableAntenna	Preamp	Remark	A/Pos	T/Pos	Pol/Phase
	MHz	dBuV/m	dBuV/m	dB	dBuV	dB	dB/m	dB	cm	deg	
1	10361.28	46.17	54.00	-7.83	33.20	8.54	39.75	35.32	Average	160	357 VERTICAL
2	10363.44	60.70	74.00	-13.30	47.73	8.54	39.75	35.32	Peak	160	357 VERTICAL
3	15537.68	43.17	54.00	-10.83	29.84	10.77	38.15	35.59	Average	100	326 VERTICAL
4	15544.00	55.99	74.00	-18.01	42.68	10.78	38.12	35.59	Peak	100	326 VERTICAL

<b>Temperature</b>	26°C	<b>Humidity</b>	56%
<b>Test Engineer</b>	Wen Chao	<b>Configurations</b>	IEEE 802.11n MCS0 20MHz Ch 40 / Chain 1 + Chain 2
<b>Test Date</b>	Jun. 06, 2013		

### Horizontal

	Freq	Level	Limit Line	Over Limit	Read Level	CableAntenna Loss	Antenna Factor	Preamp Factor	Remark	A/Pos	T/Pos	Pol/Phase
	MHz	dBuV/m	dBuV/m	dB	dBuV	dB	dB/m	dB		cm	deg	
1	10406.56	67.73	74.00	-6.27	54.65	8.55	39.81	35.28	Peak	146	347	HORIZONTAL
2	10407.36	50.55	54.00	-3.45	37.47	8.55	39.81	35.28	Average	146	347	HORIZONTAL
3	15598.08	56.24	74.00	-17.76	43.00	10.78	38.04	35.58	Peak	100	51	HORIZONTAL
4	15604.66	43.47	54.00	-10.53	30.23	10.78	38.04	35.58	Average	146	51	HORIZONTAL

### Vertical

	Freq	Level	Limit Line	Over Limit	Read Level	CableAntenna Loss	Antenna Factor	Preamp Factor	Remark	A/Pos	T/Pos	Pol/Phase
	MHz	dBuV/m	dBuV/m	dB	dBuV	dB	dB/m	dB		cm	deg	
1	10401.04	49.94	54.00	-4.06	36.86	8.55	39.81	35.28	Average	161	358	VERTICAL
2	10403.20	66.38	74.00	-7.62	53.30	8.55	39.81	35.28	Peak	161	358	VERTICAL
3	15601.76	43.46	54.00	-10.54	30.22	10.78	38.04	35.58	Average	159	333	VERTICAL
4	15614.88	55.62	74.00	-18.38	42.40	10.78	38.01	35.57	Peak	100	333	VERTICAL



<b>Temperature</b>	26°C	<b>Humidity</b>	56%
<b>Test Engineer</b>	Wen Chao	<b>Configurations</b>	IEEE 802.11n MCS0 20MHz Ch 48 / Chain 1 + Chain 2
<b>Test Date</b>	Jun. 06, 2013		

**Horizontal**

	Freq	Level	Limit Line	Over Limit	Read Level	CableAntenna Loss	Antenna Factor	Preamp Factor	Remark	A/Pos	T/Pos	Pol/Phase
	MHz	dBuV/m	dBuV/m	dB	dBuV	dB	dB/m	dB		cm	deg	
1	10483.52	68.12	74.00	-5.88	54.81	8.56	39.97	35.22	Peak	145	345	HORIZONTAL
2	10484.00	50.64	54.00	-3.36	37.33	8.56	39.97	35.22	Average	145	345	HORIZONTAL
3	15725.00	57.14	74.00	-16.86	44.06	10.79	37.85	35.56	Peak	100	33	HORIZONTAL
4	15728.48	43.91	54.00	-10.09	30.85	10.79	37.83	35.56	Average	100	33	HORIZONTAL

**Vertical**

	Freq	Level	Limit Line	Over Limit	Read Level	CableAntenna Loss	Antenna Factor	Preamp Factor	Remark	A/Pos	T/Pos	Pol/Phase
	MHz	dBuV/m	dBuV/m	dB	dBuV	dB	dB/m	dB		cm	deg	
1	10482.80	50.57	54.00	-3.43	37.26	8.56	39.97	35.22	Average	149	133	VERTICAL
2	10484.40	67.16	74.00	-6.84	53.85	8.56	39.97	35.22	Peak	149	133	VERTICAL
3	15720.96	44.42	54.00	-9.58	31.34	10.79	37.85	35.56	Average	149	343	VERTICAL
4	15725.08	56.66	74.00	-17.34	43.58	10.79	37.85	35.56	Peak	100	343	VERTICAL





<b>Temperature</b>	26°C	<b>Humidity</b>	56%
<b>Test Engineer</b>	Wen Chao	<b>Configurations</b>	IEEE 802.11n MCS0 40MHz Ch 38 / Chain 1 + Chain 2
<b>Test Date</b>	Jun. 06, 2013		

**Horizontal**

	Freq	Level	Limit	Over	Read	CableAntenna	Preamp	Remark	A/Pos	T/Pos	Pol/Phase
	MHz	dBuV/m	dBuV/m	dB	dBuV	dB	dB/m	dB	cm	deg	
1	15535.16	55.76	74.00	-18.24	42.43	10.77	38.15	35.59 Peak	100	313	HORIZONTAL
2	15540.90	42.98	54.00	-11.02	29.68	10.77	38.12	35.59 Average	100	313	HORIZONTAL

**Vertical**

	Freq	Level	Limit	Over	Read	CableAntenna	Preamp	Remark	A/Pos	T/Pos	Pol/Phase
	MHz	dBuV/m	dBuV/m	dB	dBuV	dB	dB/m	dB	cm	deg	
1	15535.28	43.13	54.00	-10.87	29.80	10.77	38.15	35.59 Average	100	66	VERTICAL
2	15540.24	56.17	74.00	-17.83	42.87	10.77	38.12	35.59 Peak	100	66	VERTICAL

<b>Temperature</b>	26°C	<b>Humidity</b>	56%
<b>Test Engineer</b>	Wen Chao	<b>Configurations</b>	IEEE 802.11n MCS0 40MHz Ch 46 / Chain 1 + Chain 2
<b>Test Date</b>	Jun. 06, 2013		

### Horizontal

	Freq	Level	Limit Line	Over Limit	Read Level	CableAntenna Loss	Antenna Factor	Preamp Factor	Remark	A/Pos	T/Pos	Pol/Phase
	MHz	dBuV/m	dBuV/m	dB	dBuV	dB	dB/m	dB		cm	deg	
1	10464.72	67.16	74.00	-6.84	53.90	8.56	39.94	35.24	Peak	149	345	HORIZONTAL
2	10466.96	50.91	54.00	-3.09	37.65	8.56	39.94	35.24	Average	149	345	HORIZONTAL
3	15692.18	56.54	74.00	-17.46	43.43	10.79	37.88	35.56	Peak	100	49	HORIZONTAL
4	15694.34	43.56	54.00	-10.44	30.45	10.79	37.88	35.56	Average	148	49	HORIZONTAL

### Vertical

	Freq	Level	Limit Line	Over Limit	Read Level	CableAntenna Loss	Antenna Factor	Preamp Factor	Remark	A/Pos	T/Pos	Pol/Phase
	MHz	dBuV/m	dBuV/m	dB	dBuV	dB	dB/m	dB		cm	deg	
1	10466.24	64.64	74.00	-9.36	51.38	8.56	39.94	35.24	Peak	149	29	VERTICAL
2	10468.64	49.83	54.00	-4.17	36.57	8.56	39.94	35.24	Average	149	29	VERTICAL
3	15687.00	43.35	54.00	-10.65	30.21	10.79	37.91	35.56	Average	147	59	VERTICAL
4	15690.22	56.50	74.00	-17.50	43.36	10.79	37.91	35.56	Peak	100	59	VERTICAL



<b>Temperature</b>	26°C	<b>Humidity</b>	56%
<b>Test Engineer</b>	Wen Chao	<b>Configurations</b>	IEEE 802.11a Ch 36 / Chain 1 + Chain 2
<b>Test Date</b>	Jun. 06, 2013		

**Horizontal**

	Freq	Level	Limit	Over	Read	CableAntenna	Preamp	Remark	A/Pos	T/Pos	Pol/Phase
	MHz	dBuV/m	dBuV/m	dB	dBuV	dB	dB/m	dB	cm	deg	
1	10361.56	62.22	74.00	-11.78	49.25	8.54	39.75	35.32	154	346	HORIZONTAL
2	10362.28	47.18	54.00	-6.82	34.21	8.54	39.75	35.32	154	346	HORIZONTAL
3	15538.32	43.39	54.00	-10.61	30.09	10.77	38.12	35.59	153	53	HORIZONTAL
4	15540.76	56.23	74.00	-17.77	42.93	10.77	38.12	35.59	100	53	HORIZONTAL

**Vertical**

	Freq	Level	Limit	Over	Read	CableAntenna	Preamp	Remark	A/Pos	T/Pos	Pol/Phase
	MHz	dBuV/m	dBuV/m	dB	dBuV	dB	dB/m	dB	cm	deg	
1	10360.48	46.15	54.00	-7.85	33.18	8.54	39.75	35.32	161	359	VERTICAL
2	10361.08	60.65	74.00	-13.35	47.68	8.54	39.75	35.32	161	359	VERTICAL
3	15537.20	43.24	54.00	-10.76	29.91	10.77	38.15	35.59	100	331	VERTICAL
4	15544.76	56.06	74.00	-17.94	42.75	10.78	38.12	35.59	100	331	VERTICAL



<b>Temperature</b>	26°C	<b>Humidity</b>	56%
<b>Test Engineer</b>	Wen Chao	<b>Configurations</b>	IEEE 802.11a Ch 40 / Chain 1 + Chain 2
<b>Test Date</b>	Jun. 06, 2013		

**Horizontal**

	Freq	Level	Limit	Over	Read	CableAntenna	Preamp	Remark	A/Pos	T/Pos	Pol/Phase
	MHz	dBuV/m	dBuV/m	dB	dBuV	dB	dB/m	dB	cm	deg	
1	10396.92	66.62	74.00	-7.38	53.56	8.55	39.81	35.30 Peak	148	350	HORIZONTAL
2	10402.16	49.91	54.00	-4.09	36.83	8.55	39.81	35.28 Average	148	350	HORIZONTAL
3	15601.56	42.74	54.00	-11.26	29.50	10.78	38.04	35.58 Average	100	55	HORIZONTAL
4	15602.44	55.21	74.00	-18.79	41.97	10.78	38.04	35.58 Peak	100	55	HORIZONTAL

**Vertical**

	Freq	Level	Limit	Over	Read	CableAntenna	Preamp	Remark	A/Pos	T/Pos	Pol/Phase
	MHz	dBuV/m	dBuV/m	dB	dBuV	dB	dB/m	dB	cm	deg	
1	10399.28	50.92	54.00	-3.08	37.84	8.55	39.81	35.28 Average	162	170	VERTICAL
2	10403.48	68.17	74.00	-5.83	55.09	8.55	39.81	35.28 Peak	162	170	VERTICAL
3	15598.48	44.24	54.00	-9.76	31.00	10.78	38.04	35.58 Average	100	338	VERTICAL
4	15598.96	56.42	74.00	-17.58	43.18	10.78	38.04	35.58 Peak	100	338	VERTICAL

<b>Temperature</b>	26°C	<b>Humidity</b>	56%
<b>Test Engineer</b>	Wen Chao	<b>Configurations</b>	IEEE 802.11a Ch 48 / Chain 1 + Chain 2
<b>Test Date</b>	Jun. 06, 2013		

### Horizontal

	Freq	Level	Limit	Over	Read	CableAntenna	Preamp	Remark	A/Pos	T/Pos	Pol/Phase	
	MHz	dBuV/m	dBuV/m	dB	dBuV	dB	dB/m	dB	cm	deg		
1	10480.80	69.72	74.00	-4.28	56.41	8.56	39.97	35.22	Peak	148	345	HORIZONTAL
2	10481.44	50.93	54.00	-3.07	37.62	8.56	39.97	35.22	Average	148	345	HORIZONTAL
3	15723.52	43.34	54.00	-10.66	30.26	10.79	37.85	35.56	Average	100	60	HORIZONTAL
4	15725.40	56.20	74.00	-17.80	43.14	10.79	37.83	35.56	Peak	100	60	HORIZONTAL

### Vertical

	Freq	Level	Limit	Over	Read	CableAntenna	Preamp	Remark	A/Pos	T/Pos	Pol/Phase	
	MHz	dBuV/m	dBuV/m	dB	dBuV	dB	dB/m	dB	cm	deg		
1	10476.70	64.57	74.00	-9.43	51.29	8.56	39.94	35.22	Peak	152	29	VERTICAL
2	10481.96	47.83	54.00	-6.17	34.52	8.56	39.97	35.22	Average	152	29	VERTICAL
3	15715.92	43.20	54.00	-10.80	30.12	10.79	37.85	35.56	Average	100	323	VERTICAL
4	15719.84	56.30	74.00	-17.70	43.22	10.79	37.85	35.56	Peak	100	323	VERTICAL

### Note:

The amplitude of spurious emissions that are attenuated by more than 20dB below the permissible value has no need to be reported.

Emission level (dBuV/m) = 20 log Emission level (uV/m).

Corrected Reading: Antenna Factor + Cable Loss + Read Level - Preamp Factor = Level.

## 4.7. Band Edge Emissions Measurement

### 4.7.1. Limit

For transmitters operating in the 5.15-5.35 GHz band: all emissions outside of the 5.15-5.35 GHz band shall not exceed a -27dBm peak limit or average 54dBuV/m and peak 74dBuV/m limits. In addition, in case the emission fall within the restricted band specified on 15.205(a), then the 15.209(a) limit in the table below has to be followed.

Frequencies (MHz)	Field Strength (microvolts/meter)	Measurement Distance (meters)
0.009~0.490	2400/F(KHz)	300
0.490~1.705	24000/F(KHz)	30
1.705~30.0	30	30
30~88	100	3
88~216	150	3
216~960	200	3
Above 960	500	3

### 4.7.2. Measuring Instruments and Setting

Please refer to section 5 of equipments list in this report. The following table is the setting of the spectrum analyzer.

Spectrum Parameter	Setting
Attenuation	Auto
Span Frequency	100 MHz
RBW / VBW (Emission in restricted band)	1 MHz / 3MHz for Peak, 1 MHz / 10Hz for Average
RBW / VBW (Emission in non-restricted band)	1 MHz / 3MHz for peak

### 4.7.3. Test Procedures

1. The test procedure is the same as section 4.6.3, only the frequency range investigated is limited to 100MHz around bandedges.
2. In case the emission is fail due to the used RB/VB is too wide, marker-delta method of FCC Public Notice DA00-705 will be followed.

### 4.7.4. Test Setup Layout

This test setup layout is the same as that shown in section 4.6.4.

### 4.7.5. Test Deviation

There is no deviation with the original standard.

### 4.7.6. EUT Operation during Test

The EUT was programmed to be in continuously transmitting mode.

#### 4.7.7. Test Result of Band Edge and Fundamental Emissions

Temperature	24.5°C	Humidity	56%
Test Engineer	Wen Chao	Configurations	IEEE 802.11n MCS0 20MHz Ch 36 / Chain 1 + Chain 2
Test Date	Jun. 06, 2013		

##### Channel 36 / Horizontal

	Freq	Level	Limit	Over	Read	CableAntenna	Preamp	Remark	A/Pos	T/Pos	Pol/Phase
	MHz	dBuV/m	dBuV/m	dB	dBuV	dB	dB/m	dB	cm	deg	
1	5149.40	72.32	74.00	-1.68	32.18	6.13	34.01	0.00 Peak	183	168	HORIZONTAL
2	5150.00	52.84	54.00	-1.16	12.70	6.13	34.01	0.00 Average	183	168	HORIZONTAL
3	5173.40	99.40			59.22	6.14	34.04	0.00 Average	183	168	HORIZONTAL
4	5173.80	111.16			70.97	6.15	34.04	0.00 Peak	183	168	HORIZONTAL

##### Channel 36 / Vertical

	Freq	Level	Limit	Over	Read	CableAntenna	Preamp	Remark	A/Pos	T/Pos	Pol/Phase
	MHz	dBuV/m	dBuV/m	dB	dBuV	dB	dB/m	dB	cm	deg	
1	5150.00	51.93	54.00	-2.07	11.79	6.13	34.01	0.00 Average	116	15	VERTICAL
2	5150.00	72.36	74.00	-1.64	32.22	6.13	34.01	0.00 Peak	116	15	VERTICAL
3	5186.00	99.52			59.29	6.15	34.08	0.00 Average	116	15	VERTICAL
4	5187.60	111.27			71.04	6.15	34.08	0.00 Peak	116	15	VERTICAL

Item 3, 4 are the fundamental frequency at 5180 MHz.

<b>Temperature</b>	24.5°C	<b>Humidity</b>	56%
<b>Test Engineer</b>	Wen Chao	<b>Configurations</b>	IEEE 802.11n MCS0 20MHz Ch 40 / Chain 1 + Chain 2
<b>Test Date</b>	Jun. 06, 2013		

**Channel 40 / Horizontal**

	Freq	Level	Limit Line	Over Limit	Read Level	CableAntenna Loss	Factor	Preamp Factor	Remark	A/Pos	T/Pos	Pol/Phase
	MHz	dBuV/m	dBuV/m	dB	dBuV	dB	dB/m	dB		cm	deg	
1	5119.60	45.18	54.00	-8.82	5.13	6.11	33.94	0.00	Average	142	170	HORIZONTAL
2	5148.00	63.79	74.00	-10.21	23.65	6.13	34.01	0.00	Peak	142	170	HORIZONTAL
3	5203.60	111.81			71.54	6.16	34.11	0.00	Peak	142	170	HORIZONTAL
4	5204.00	100.38			60.11	6.16	34.11	0.00	Average	142	170	HORIZONTAL

**Channel 40 / Vertical**

	Freq	Level	Limit Line	Over Limit	Read Level	CableAntenna Loss	Factor	Preamp Factor	Remark	A/Pos	T/Pos	Pol/Phase
	MHz	dBuV/m	dBuV/m	dB	dBuV	dB	dB/m	dB		cm	deg	
1	5119.60	46.72	54.00	-7.28	6.67	6.11	33.94	0.00	Average	130	19	VERTICAL
2	5148.00	58.16	74.00	-15.84	18.02	6.13	34.01	0.00	Peak	130	19	VERTICAL
3	5196.00	111.73			71.46	6.16	34.11	0.00	Peak	130	19	VERTICAL
4	5197.20	100.16			59.89	6.16	34.11	0.00	Average	130	19	VERTICAL

Item 3, 4 are the fundamental frequency at 5180 MHz.



<b>Temperature</b>	24.5°C	<b>Humidity</b>	56%
<b>Test Engineer</b>	Wen Chao	<b>Configurations</b>	IEEE 802.11n MCS0 20MHz Ch 48 / Chain 1 + Chain 2
<b>Test Date</b>	Jun. 06, 2013		

**Channel 48 / Horizontal**

	Freq	Level	Limit Line	Over Limit	Read Level	CableAntenna Loss	Antenna Factor	Preamp Factor	Remark	A/Pos	T/Pos	Pol/Phase
	MHz	dBuV/m	dBuV/m	dB	dBuV	dB	dB/m	dB		cm	deg	
1	5120.00	45.39	54.00	-8.61	5.34	6.11	33.94	0.00	Average	153	167	HORIZONTAL
2	5141.60	54.79	74.00	-19.21	14.68	6.13	33.98	0.00	Peak	153	167	HORIZONTAL
3	5243.60	100.80			60.42	6.20	34.18	0.00	Average	153	167	HORIZONTAL
4	5244.20	112.02			71.64	6.20	34.18	0.00	Peak	153	167	HORIZONTAL
5	5350.00	54.47	74.00	-19.53	13.79	6.26	34.42	0.00	Peak	153	167	HORIZONTAL
6	5360.20	44.81	54.00	-9.19	4.13	6.26	34.42	0.00	Average	153	167	HORIZONTAL

**Channel 48 / Vertical**

	Freq	Level	Limit Line	Over Limit	Read Level	CableAntenna Loss	Antenna Factor	Preamp Factor	Remark	A/Pos	T/Pos	Pol/Phase
	MHz	dBuV/m	dBuV/m	dB	dBuV	dB	dB/m	dB		cm	deg	
1	5119.40	47.79	54.00	-6.21	7.74	6.11	33.94	0.00	Average	116	18	VERTICAL
2	5145.80	54.74	74.00	-19.26	14.60	6.13	34.01	0.00	Peak	116	18	VERTICAL
3	5237.00	100.43			60.07	6.18	34.18	0.00	Average	116	18	VERTICAL
4	5237.60	111.94			71.58	6.18	34.18	0.00	Peak	116	18	VERTICAL
5	5354.80	55.35	74.00	-18.65	14.67	6.26	34.42	0.00	Peak	116	18	VERTICAL
6	5360.20	43.34	54.00	-10.66	2.66	6.26	34.42	0.00	Average	116	18	VERTICAL

Item 3, 4 are the fundamental frequency at 5180 MHz.

Note:

Emission level (dBuV/m) = 20 log Emission level (uV/m)

Corrected Reading: Antenna Factor + Cable Loss + Read Level - Preamp Factor = Level

<b>Temperature</b>	24.5°C	<b>Humidity</b>	56%
<b>Test Engineer</b>	Wen Chao	<b>Configurations</b>	IEEE 802.11n MCS0 40MHz Ch 38 / Chain 1 + Chain 2
<b>Test Date</b>	Jun. 06, 2013		

**Channel 38 / Horizontal**

	Freq	Level	Limit	Over	Read	CableAntenna	Preamp	Remark	A/Pos	T/Pos	Pol/Phase
	MHz	dBuV/m	dBuV/m	dB	dBuV	dB	dB/m	dB	cm	deg	
1	5148.80	68.35	74.00	-5.65	28.21	6.13	34.01	0.00 Peak	186	168	HORIZONTAL
2	5150.00	52.32	54.00	-1.68	12.18	6.13	34.01	0.00 Average	186	168	HORIZONTAL
3	5174.40	90.50			50.31	6.15	34.04	0.00 Average	186	168	HORIZONTAL
4	5205.60	103.44			63.17	6.16	34.11	0.00 Peak	186	168	HORIZONTAL

**Channel 38 / Vertical**

	Freq	Level	Limit	Over	Read	CableAntenna	Preamp	Remark	A/Pos	T/Pos	Pol/Phase
	MHz	dBuV/m	dBuV/m	dB	dBuV	dB	dB/m	dB	cm	deg	
1	5148.80	68.46	74.00	-5.54	28.32	6.13	34.01	0.00 Peak	116	16	VERTICAL
2	5150.00	50.69	54.00	-3.31	10.55	6.13	34.01	0.00 Average	116	16	VERTICAL
3	5205.20	103.16			62.89	6.16	34.11	0.00 Peak	116	16	VERTICAL
4	5206.40	90.93			50.66	6.16	34.11	0.00 Average	116	16	VERTICAL

Item 3, 4 are the fundamental frequency at 5190 MHz.

<b>Temperature</b>	24.5°C	<b>Humidity</b>	56%
<b>Test Engineer</b>	Wen Chao	<b>Configurations</b>	IEEE 802.11n MCS0 40MHz ch 46/ Chain 1 + Chain 2
<b>Test Date</b>	Jun. 06, 2013		

**Channel 46 / Horizontal**

	Freq	Level	Limit	Over	Read	CableAntenna	Preamp	Remark	A/Pos	T/Pos	Pol/Phase
	MHz	dBuV/m	dBuV/m	dB	dBuV	dB	dB/m	dB	cm	deg	
1	5150.00	47.39	54.00	-6.61	7.25	6.13	34.01	0.00 Average	155	169	HORIZONTAL
2	5150.00	66.87	74.00	-7.13	26.73	6.13	34.01	0.00 Peak	155	169	HORIZONTAL
3	5232.40	96.79			56.43	6.18	34.18	0.00 Average	155	169	HORIZONTAL
4	5245.60	110.10			69.68	6.20	34.22	0.00 Peak	155	169	HORIZONTAL
5	5351.80	58.49	74.00	-15.51	17.81	6.26	34.42	0.00 Peak	155	169	HORIZONTAL
6	5360.20	44.48	54.00	-9.52	3.80	6.26	34.42	0.00 Average	155	169	HORIZONTAL

**Channel 46 / Vertical**

	Freq	Level	Limit	Over	Read	CableAntenna	Preamp	Remark	A/Pos	T/Pos	Pol/Phase
	MHz	dBuV/m	dBuV/m	dB	dBuV	dB	dB/m	dB	cm	deg	
1	5150.00	47.79	54.00	-6.21	7.65	6.13	34.01	0.00 Average	115	17	VERTICAL
2	5150.00	63.63	74.00	-10.37	23.49	6.13	34.01	0.00 Peak	115	17	VERTICAL
3	5245.60	109.51			69.09	6.20	34.22	0.00 Peak	115	17	VERTICAL
4	5246.20	97.17			56.75	6.20	34.22	0.00 Average	115	17	VERTICAL
5	5350.00	42.92	54.00	-11.08	2.24	6.26	34.42	0.00 Average	115	17	VERTICAL
6	5350.00	53.12	74.00	-20.88	12.44	6.26	34.42	0.00 Peak	115	17	VERTICAL

Item 3, 4 are the fundamental frequency at 5230 MHz.

Note:

Emission level (dBuV/m) = 20 log Emission level (uV/m)

Corrected Reading: Antenna Factor + Cable Loss + Read Level - Preamp Factor = Level



<b>Temperature</b>	24.5°C	<b>Humidity</b>	56%
<b>Test Engineer</b>	Wen Chao	<b>Configurations</b>	IEEE 802.11a Ch 36 / Chain 1 + Chain 2
<b>Test Date</b>	Jun. 06, 2013		

**Channel 36 / Horizontal**

	Freq	Level	Limit	Over	Read	CableAntenna	Preamp	Remark	A/Pos	T/Pos	Pol/Phase
	MHz	dBuV/m	dBuV/m	dB	dBuV	dB	dB/m	dB	cm	deg	
1	5147.40	72.72	74.00	-1.28	32.58	6.13	34.01	0.00 Peak	186	166	HORIZONTAL
2	5148.80	50.68	54.00	-3.32	10.54	6.13	34.01	0.00 Average	186	166	HORIZONTAL
3	5178.40	100.44			60.21	6.15	34.08	0.00 Average	186	166	HORIZONTAL
4	5183.20	112.02			71.79	6.15	34.08	0.00 Peak	186	166	HORIZONTAL

**Channel 36 / Vertical**

	Freq	Level	Limit	Over	Read	CableAntenna	Preamp	Remark	A/Pos	T/Pos	Pol/Phase
	MHz	dBuV/m	dBuV/m	dB	dBuV	dB	dB/m	dB	cm	deg	
1	5147.60	72.61	74.00	-1.39	32.47	6.13	34.01	0.00 Peak	116	17	VERTICAL
2	5150.00	49.40	54.00	-4.60	9.26	6.13	34.01	0.00 Average	116	17	VERTICAL
3	5186.20	112.59			72.36	6.15	34.08	0.00 Peak	116	17	VERTICAL
4	5187.00	100.67			60.44	6.15	34.08	0.00 Average	116	17	VERTICAL

Item 3, 4 are the fundamental frequency at 5180 MHz.

<b>Temperature</b>	24.5°C	<b>Humidity</b>	56%
<b>Test Engineer</b>	Wen Chao	<b>Configurations</b>	IEEE 802.11a Ch 40 / Chain 1 + Chain 2
<b>Test Date</b>	Jun. 06, 2013		

### Channel 40 / Horizontal

	Freq	Level	Limit Line	Over Limit	Read Level	CableAntenna Loss Factor	Preamp Factor	Remark	A/Pos	T/Pos	Pol/Phase
	MHz	dBuV/m	dBuV/m	dB	dBuV	dB	dB/m	dB	cm	deg	
1	5119.60	45.75	54.00	-8.25	5.70	6.11	33.94	0.00 Average	171	173	HORIZONTAL
2	5148.40	57.49	74.00	-16.51	17.35	6.13	34.01	0.00 Peak	171	173	HORIZONTAL
3	5193.20	100.12			59.88	6.16	34.08	0.00 Average	171	173	HORIZONTAL
4	5193.20	111.17			70.93	6.16	34.08	0.00 Peak	171	173	HORIZONTAL

### Channel 40 / Vertical

	Freq	Level	Limit Line	Over Limit	Read Level	CableAntenna Loss Factor	Preamp Factor	Remark	A/Pos	T/Pos	Pol/Phase
	MHz	dBuV/m	dBuV/m	dB	dBuV	dB	dB/m	dB	cm	deg	
1	5120.00	46.40	54.00	-7.60	6.35	6.11	33.94	0.00 Average	115	17	VERTICAL
2	5145.60	56.73	74.00	-17.27	16.59	6.13	34.01	0.00 Peak	115	17	VERTICAL
3	5201.60	102.59			62.32	6.16	34.11	0.00 Average	115	17	VERTICAL
4	5202.80	113.76			73.49	6.16	34.11	0.00 Peak	115	17	VERTICAL

Item 3, 4 are the fundamental frequency at 5200 MHz.

<b>Temperature</b>	24.5°C	<b>Humidity</b>	56%
<b>Test Engineer</b>	Wen Chao	<b>Configurations</b>	IEEE 802.11a Ch 48 / Chain 1 + Chain 2
<b>Test Date</b>	Jun. 06, 2013		

**Channel 48 / Horizontal**

	Freq	Level	Limit Line	Over Limit	Read Level	CableAntenna Loss	Preamp Factor	Remark	A/Pos	T/Pos	Pol/Phase
	MHz	dBuV/m	dBuV/m	dB	dBuV	dB	dB/m	dB	cm	deg	
1	5119.40	45.71	54.00	-8.29	5.66	6.11	33.94	0.00 Average	152	166	HORIZONTAL
2	5124.80	54.83	74.00	-19.17	14.77	6.12	33.94	0.00 Peak	152	166	HORIZONTAL
3	5246.00	101.11			60.69	6.20	34.22	0.00 Average	152	166	HORIZONTAL
4	5246.00	112.13			71.71	6.20	34.22	0.00 Peak	152	166	HORIZONTAL
5	5359.60	55.61	74.00	-18.39	14.93	6.26	34.42	0.00 Peak	152	166	HORIZONTAL
6	5360.80	44.73	54.00	-9.27	4.04	6.27	34.42	0.00 Average	152	166	HORIZONTAL

**Channel 48 / Vertical**

	Freq	Level	Limit Line	Over Limit	Read Level	CableAntenna Loss	Preamp Factor	Remark	A/Pos	T/Pos	Pol/Phase
	MHz	dBuV/m	dBuV/m	dB	dBuV	dB	dB/m	dB	cm	deg	
1	5120.00	46.75	54.00	-7.25	6.70	6.11	33.94	0.00 Average	114	18	VERTICAL
2	5147.60	54.89	74.00	-19.11	14.75	6.13	34.01	0.00 Peak	114	18	VERTICAL
3	5244.80	101.01			60.63	6.20	34.18	0.00 Average	114	18	VERTICAL
4	5244.80	112.78			72.40	6.20	34.18	0.00 Peak	114	18	VERTICAL
5	5352.40	54.51	74.00	-19.49	13.83	6.26	34.42	0.00 Peak	114	18	VERTICAL
6	5360.20	44.26	54.00	-9.74	3.58	6.26	34.42	0.00 Average	114	18	VERTICAL

Item 3, 4 are the fundamental frequency at 5240 MHz.

Note:

Emission level (dBuV/m) = 20 log Emission level (uV/m)

Corrected Reading: Antenna Factor + Cable Loss + Read Level - Preamp Factor = Level

## 4.8. Frequency Stability Measurement

### 4.8.1. Limit

In-band emission is maintained within the band of operation under all conditions of normal operation as specified in the user's manual.

The transmitter center frequency tolerance shall be  $\pm 20$  ppm maximum for the 5 GHz band (IEEE 802.11n specification).

### 4.8.2. Measuring Instruments and Setting

Please refer to section 5 of equipments list in this report. The following table is the setting of the spectrum analyzer.

Spectrum Parameter	Setting
Attenuation	Auto
Span Frequency	Entire absence of modulation emissions bandwidth
RBW	10 kHz
VBW	10 kHz
Sweep Time	Auto

### 4.8.3. Test Procedures

1. The transmitter output (antenna port) was connected to the spectrum analyzer.
2. EUT have transmitted absence of modulation signal and fixed channelize.
3. Set the spectrum analyzer span to view the entire absence of modulation emissions bandwidth.
4. Set RBW = 10 kHz, VBW = 10 kHz with peak detector and maxhold settings.
5.  $f_c$  is declaring of channel frequency. Then the frequency error formula is  $(f_c - f)/f_c \times 10^6$  ppm and the limit is less than  $\pm 20$  ppm (IEEE 802.11n specification).
6. The test extreme voltage is to change the primary supply voltage from 85 to 115 percent of the nominal value
7. Extreme temperature rule is  $0^\circ\text{C} \sim 50^\circ\text{C}$ .

### 4.8.4. Test Setup Layout

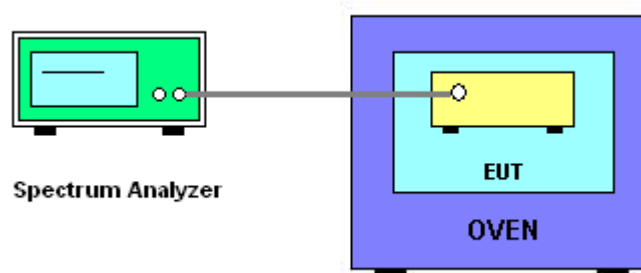

#### 4.8.5. Test Deviation

There is no deviation with the original standard.

#### 4.8.6. EUT Operation during Test

The EUT was programmed to be in continuously un-modulation transmitting mode.

#### 4.8.7. Test Result of Frequency Stability

##### Voltage vs. Frequency Stability

Voltage	Measurement Frequency (MHz)
(V)	5200
126.50	5200.0025
110.00	5200.0010
93.50	5200.0001
Max. Deviation (MHz)	0.002500
Max. Deviation (ppm)	0.48

##### Temperature vs. Frequency Stability

Temperature	Measurement Frequency (MHz)
(°C)	5200
0	5200.0045
10	5200.0045
20	5200.0050
30	5200.0099
40	5200.0140
50	5200.0210
Max. Deviation (MHz)	0.021000
Max. Deviation (ppm)	4.04



## 4.9. Antenna Requirements

### 4.9.1. Limit

Except for special regulations, the Low-power Radio-frequency Devices must not be equipped with any jacket for installing an antenna with extension cable. An intentional radiator shall be designed to ensure that no antenna other than that furnished by the responsible party shall be used with the device. The use of a permanently attached antenna or of an antenna that uses a unique coupling to the intentional radiator shall be considered sufficient to comply with the provisions of this Section. The manufacturer may design the unit so that the user can replace a broken antenna, but the use of a standard antenna jack or electrical connector is prohibited. Further, this requirement does not apply to intentional radiators that must be professionally installed.

### 4.9.2. Antenna Connector Construction

Please refer to section 3.3 in this test report; antenna connector complied with the requirements.

## 5. LIST OF MEASURING EQUIPMENTS

Instrument	Manufacturer	Model No.	Serial No.	Characteristics	Calibration Date	Remark
EMI Test Receiver	R&S	ESCS 30	100377	9kHz ~ 2.75GHz	Oct. 23, 2012	Conduction (CO01-CB)
LISN	F.C.C.	FCC-LISN-50-16-2	04083	150kHz ~ 100MHz	Nov. 26, 2012	Conduction (CO01-CB)
V- LISN	Schwarzbeck	NSLK 8127	8127-478	9kHz ~ 30MHz	Jun. 22, 2012	Conduction (CO01-CB)
Impulsbegrenzer Pulse Limiter	Rohde&Schwarz	ESH3-Z2	100430	9kHz~30MHz	Feb. 21, 2013	Conduction (CO01-CB)
COND Cable	Woken	Cable	01	0.15MHz~30MHz	Dec. 04, 2012	Conduction (CO01-CB)
Software	Audix	E3	5.410e	-	-	Conduction (CO01-CB)
BILOG ANTENNA	Schaffner	CBL6112D	22021	20MHz ~ 2GHz	Apr. 16, 2013	Radiation (03CH01-CB)
Loop Antenna	Teseq	HLA 6120	24155	9 kHz - 30 MHz	Nov. 05, 2012*	Radiation (03CH01-CB)
Horn Antenna	EMCO	3115	00075790	750MHz~18GHz	Nov. 27, 2012	Radiation (03CH01-CB)
Horn Antenna	SCHWARZBEAK	BBHA 9170	BBHA9170252	15GHz ~ 40GHz	Nov. 23, 2012	Radiation (03CH01-CB)
Pre-Amplifier	Agilent	8447D	2944A10991	0.1MHz ~ 1.3GHz	Nov. 27, 2012	Radiation (03CH01-CB)
Pre-Amplifier	Agilent	8449B	3008A02310	1GHz ~ 26.5GHz	Nov. 23, 2012	Radiation (03CH01-CB)
Pre-Amplifier	WM	TF-130N-R1	923365	26.5GHz ~ 40GHz	Jul. 31, 2012	Radiation (03CH01-CB)
Spectrum analyzer	R&S	FSP40	100056	9KHz~40GHz	Nov. 16, 2012	Radiation (03CH01-CB)
EMI Test Receiver	R&S	ESCS 30	100355	9KHz ~ 2.75GHz	Apr. 15, 2013	Radiation (03CH01-CB)
Turn Table	INN CO	CO 2000	N/A	0 ~ 360 degree	N.C.R	Radiation (03CH01-CB)
Antenna Mast	INN CO	CO2000	N/A	1 m - 4 m	N.C.R	Radiation (03CH01-CB)
RF Cable-low	Woken	Low Cable-1	N/A	30 MHz - 1 GHz	Nov. 18, 2012	Radiation (03CH01-CB)
RF Cable-high	Woken	High Cable-1	N/A	1 GHz - 26.5 GHz	Nov. 18, 2012	Radiation (03CH01-CB)
RF Cable-high	Woken	High Cable-2	N/A	1 GHz - 26.5 GHz	Nov. 18, 2012	Radiation (03CH01-CB)
RF Cable-high	Woken	High Cable-3	N/A	1 GHz - 40 GHz	Nov. 18, 2012	Radiation (03CH01-CB)
RF Cable-high	Woken	High Cable-4	N/A	1 GHz - 40 GHz	Nov. 18, 2012	Radiation (03CH01-CB)
Signal analyzer	R&S	FSV40	100979	9KHz~40GHz	Oct. 08, 2012	Conducted (TH01-CB)
Temp. and Humidity Chamber	Ten Billion	TTH-D3SP	TBN-931011	-30~100 degree	Jun. 05, 2012	Conducted (TH01-CB)
RF Power Divider	Woken	2 Way	0120A02056002D	2GHz ~ 18GHz	Nov. 18, 2012	Conducted (TH01-CB)
RF Power Divider	Woken	3 Way	MDC2366	2GHz ~ 18GHz	Nov. 18, 2012	Conducted (TH01-CB)



Instrument	Manufacturer	Model No.	Serial No.	Characteristics	Calibration Date	Remark
RF Power Divider	Woken	4 Way	0120A04056002D	2GHz ~ 18GHz	Nov. 18, 2012	Conducted (TH01-CB)
RF Cable-high	Woken	High Cable-7	-	1 GHz – 26.5 GHz	Nov. 19, 2012	Conducted (TH01-CB)
RF Cable-high	Woken	High Cable-8	-	1 GHz – 26.5 GHz	Nov. 19, 2012	Conducted (TH01-CB)
RF Cable-high	Woken	High Cable-9	-	1 GHz – 26.5 GHz	Nov. 19, 2012	Conducted (TH01-CB)
RF Cable-high	Woken	High Cable-10	-	1 GHz – 26.5 GHz	Nov. 19, 2012	Conducted (TH01-CB)
RF Cable-high	Woken	High Cable-11	-	1 GHz – 26.5 GHz	Nov. 19, 2012	Conducted (TH01-CB)
Power Sensor	Anritsu	MA2411B	0917223	300MHz~40GHz	Nov. 28, 2012	Conducted (TH01-CB)
Power Meter	Anritsu	ML2495A	1035008	300MHz~40GHz	Nov. 27, 2012	Conducted (TH01-CB)

Note: Calibration Interval of instruments listed above is one year.

\*Calibration Interval of instruments listed above is two years.

N.C.R. means Non-Calibration required.

## 6. TEST LOCATION

SHIJR	ADD : 6Fl., No. 106, Sec. 1, Shintai 5th Rd., Shijr City, Taipei, Taiwan 221, R.O.C. TEL : 886-2-2696-2468 FAX : 886-2-2696-2255
HWA YA	ADD : No. 52, Hwa Ya 1st Rd., Kwei-Shan Hsiang, Tao Yuan Hsien, Taiwan, R.O.C. TEL : 886-3-327-3456 FAX : 886-3-318-0055
LINKOU	ADD : No. 30-2, Dingfu Tsuen, Linkou Shiang, Taipei, Taiwan 244, R.O.C TEL : 886-2-2601-1640 FAX : 886-2-2601-1695
DUNGHU	ADD : No. 3, Lane 238, Kangle St., Neihu Chiu, Taipei, Taiwan 114, R.O.C. TEL : 886-2-2631-4739 FAX : 886-2-2631-9740
JUNGHE	ADD : 7Fl., No. 758, Jungjeng Rd., Junghe City, Taipei, Taiwan 235, R.O.C. TEL : 886-2-8227-2020 FAX : 886-2-8227-2626
NEIHU	ADD : 4Fl., No. 339, Hsin Hu 2 <sup>nd</sup> Rd., Taipei 114, Taiwan, R.O.C. TEL : 886-2-2794-8886 FAX : 886-2-2794-9777
JHUBEI	ADD : No.8, Lane 724, Bo-ai St., Jhubei City, HsinChu County 302, Taiwan, R.O.C. TEL : 886-3-656-9065 FAX : 886-3-656-9085

## 7. MEASUREMENT UNCERTAINTY

### Uncertainty of Conducted Emission Measurement (150kHz ~ 30MHz)

Contribution	Uncertainty of $x_i$			$u(x_i)$
	Value	Unit	Probability Distribution k	
Receiver reading	0.026	dB	normal(k=2)	0.013
Cable loss	0.002	dB	normal(k=2)	0.001
AMN/LISN specification	1.200	dB	normal(k=2)	0.600
Mismatch Receiver VSWR 1= AMN/LISN VSWR 2=	-0.080	dB	U-shaped	0.060
combined standard uncertainty $Ue(y)$	1.2			
Measuring uncertainty for a level of confidence of 95% $U=2Ue(y)$	2.4			

### Uncertainty of Conducted Emission Measurement

Contribution	Uncertainty of $x_i$			$u(x_i)$
	Value	Unit	Probability Distribution k	
Cable loss	0.038	dB	normal(k=2)	0.019
Attenuator	0.047	dB	normal(k=2)	0.024
Power Meter specification	0.300	dB	normal(k=2)	0.150
Power Sensor specification	0.300	dB	normal(k=2)	0.150
Mismatch Receiver VSWR 1= Antenna VSWR 2= Pre Amplifier VSWR 3=	-0.080	dB	U-shaped	0.060
combined standard uncertainty $Ue(y)$	0.403			
Measuring uncertainty for a level of confidence of 95% $U=2Ue(y)$	0.806			

**Uncertainty of Radiated Emission Measurement (30MHz ~ 1,000MHz)**

Contribution	Uncertainty of $x_i$			$u(x_i)$
	Value	Unit	Probability Distribution k	
Receiver reading	0.1727	dB	normal(k=1)	0.1727
Cable loss	0.1736	dB	normal(k=2)	0.0868
Antenna gain	0.1687	dB	normal(k=2)	0.0843
Site imperfection	0.4898	dB	Triangular	0.2
Pre-amplifier gain	0.3661	dB	normal(k=2)	0.183
Transmitter antenna	1.7	dB	rectangular	0.9815
Signal generator	0.5	dB	rectangular	0.2887
Mismatch	0.08	dB	u-shape	0.244
Spectrum analyzer	0.5	dB	rectangular	0.2887
combined standard uncertainty $Ue(y)$	1.1434			
Measuring uncertainty for a level of confidence of 95% $U=2Ue(y)$	2.2869			

**Uncertainty of Radiated Emission Measurement (1GHz ~ 18GHz)**

Contribution	Uncertainty of $x_i$			$u(x_i)$
	Value	Unit	Probability Distribution k	
Receiver reading	0.1908	dB	normal(k=1)	0.1908
Cable loss	0.1685	dB	normal(k=2)	0.0843
Antenna gain	0.1912	dB	normal(k=2)	0.0956
Site imperfection	1.3091	dB	Triangular	0.5344
Pre-amplifier gain	0.3043	dB	normal(k=2)	0.1521
Transmitter antenna	1.7	dB	rectangular	0.9815
Signal generator	0.5	dB	rectangular	0.2887
Mismatch	0.08	dB	u-shape	0.244
Spectrum analyzer	0.8	dB	rectangular	0.4619
combined standard uncertainty $Ue(y)$	1.2965			
Measuring uncertainty for a level of confidence of 95% $U=2Ue(y)$	2.593			

**Uncertainty of Radiated Emission Measurement (18GHz ~ 40GHz)**

Contribution	Uncertainty of $x_i$			$u(x_i)$
	Value	Unit	Probability Distribution k	
Receiver reading	0.1864	dB	normal(k=1)	0.1864
Cable loss	0.1666	dB	normal(k=2)	0.0833
Antenna gain	0.1904	dB	normal(k=2)	0.0952
Site imperfection	0.4882	dB	Triangular	0.1993
Pre-amplifier gain	0.2688	dB	normal(k=2)	0.1344
Transmitter antenna	1.7	dB	rectangular	0.9815
Signal generator	0.5	dB	rectangular	0.2887
Mismatch	0.08	dB	u-shape	0.244
Spectrum analyzer	0.8	dB	rectangular	0.4619
combined standard uncertainty $Ue(y)$	1.1874			
Measuring uncertainty for a level of confidence of 95% $U=2Ue(y)$	2.3749			