



FCC RADIO TEST REPORT

FCC ID : UZ7TC83BH
Equipment : Mobile Computer
Brand Name : ZEBRA
Model Name : TC83BH
Applicant : Zebra Technologies Corporation
1 Zebra Plaza, Holtsville, NY 11742
Manufacturer : Zebra Technologies Corporation
1 Zebra Plaza, Holtsville, NY 11742
Standard : FCC Part 15 Subpart C §15.247

The product was received on Nov. 01, 2018 and testing was started from Nov. 07, 2018 and completed on Mar. 11, 2019. We, SPORTON INTERNATIONAL INC. EMC & Wireless Communications Laboratory, would like to declare that the tested sample has been evaluated in accordance with the test procedures and has been in compliance with the applicable technical standards.

The report must not be used by the client to claim product certification, approval, or endorsement by TAF or any agency of government.

The test results in this report apply exclusively to the tested model / sample. Without written approval of SPORTON INTERNATIONAL INC. EMC & Wireless Communications Laboratory, the test report shall not be reproduced except in full.

Approved by: Jones Tsai

SPORTON INTERNATIONAL INC. EMC & Wireless Communications Laboratory

No. 52, Huaya 1st Rd., Guishan Dist., Taoyuan City, Taiwan (R.O.C.)



Table of Contents

History of this test report.....	3
Summary of Test Result.....	4
1 General Description	5
1.1 Product Feature of Equipment Under Test.....	5
1.2 Product Specification of Equipment Under Test.....	6
1.3 Modification of EUT	7
1.4 Testing Location	8
1.5 Applicable Standards.....	8
2 Test Configuration of Equipment Under Test	9
2.1 Carrier Frequency and Channel	9
2.2 Test Mode.....	10
2.3 Connection Diagram of Test System.....	18
2.4 Support Unit used in test configuration and system	19
2.5 EUT Operation Test Setup	20
2.6 Measurement Results Explanation Example.....	20
3 Test Result	21
3.1 6dB and 99% Bandwidth Measurement	21
3.2 Output Power Measurement.....	25
3.3 Power Spectral Density Measurement	32
3.4 Conducted Band Edges and Spurious Emission Measurement	38
3.5 Radiated Band Edges and Spurious Emission Measurement	99
3.6 AC Conducted Emission Measurement.....	104
3.7 Antenna Requirements.....	106
4 List of Measuring Equipment.....	108
5 Uncertainty of Evaluation	110
Appendix A. AC Conducted Emission Test Result	
Appendix B. Radiated Spurious Emission	
Appendix C. Radiated Spurious Emission Plots	
Appendix D. Duty Cycle Plots	
Appendix E. Setup Photographs	



Summary of Test Result

Report Clause	Ref Std. Clause	Test Items	Result (PASS/FAIL)	Remark
3.1	15.247(a)(2)	6dB Bandwidth	Pass	-
3.1	2.1049	99% Occupied Bandwidth	Reporting only	-
3.2	15.247(b)	Power Output Measurement	Pass	-
3.3	15.247(e)	Power Spectral Density	Pass	-
3.4	15.247(d)	Conducted Band Edges	Pass	-
		Conducted Spurious Emission	Pass	-
3.5	15.247(d)	Radiated Band Edges and Radiated Spurious Emission	Pass	Under limit 1.06 dB at 2483.520 MHz
3.6	15.207	AC Conducted Emission	Pass	Under limit 12.02 dB at 0.755 MHz
3.7	15.203 & 15.247(b)	Antenna Requirement	Pass	-

Declaration of Conformity:

The test results with all measurement uncertainty excluded are presented in accordance with the regulation limits or requirements declared by manufacturers.

Comments and Explanations:

The declared of product specification for EUT presented in the report are provided by the manufacturer, and the manufacturer takes all the responsibilities for the accuracy of product specification.

Reviewed by: Wii Chang**Report Producer: Maggie Chiang**



1 General Description

1.1 Product Feature of Equipment Under Test

Product Feature	
Equipment	Mobile Computer
Brand Name	ZEBRA
Model Name	TC83BH
FCC ID	UZ7TC83BH
Sample 1	EUT with Scanner 1 (SE4750SR)
Sample 2	EUT with Scanner 2 (SE4750MR)
Sample 3	EUT with Scanner 3 (SE4850)
EUT supports Radios application	NFC WLAN 11a/b/g/n HT20/HT40 WLAN 11ac VHT20/VHT40/VHT80 Bluetooth BR/EDR/LE
HW Version	EV
SW Version	01-12-13.00-OG-U00-PRD
FW Version	FUSION_QA_2_1.1.0.003_O
MFD	17-Oct-18
EUT Stage	Engineering Sample

Remark: The above EUT's information was declared by manufacturer.

Specification of Accessories				
Battery 1	Brand Name	Zebra	Part Number	BT-000380
Battery 2	Brand Name	Zebra	Part Number	82-176054-01
Headset 1	Brand Name	Zebra	Part Number	HDST-35MM-PTVP-01
Audio adapter cable 1	Brand Name	Zebra	Part Number	CBL-TC8X-AUDBJ-01
Headset 2	Brand Name	Zebra	Part Number	HS2100-OTH
HS2100 to Quick Disconnect Cable	Brand Name	Zebra	Part Number	CBL-HS2100-QDC1-01
Audio adapter cable 2	Brand Name	Zebra	Part Number	CBL-TC8X-AUDQD-01
Hand Strap	Brand Name	Zebra	Part Number	SG-TC8X-HDSTP-01
USB Cable	Brand Name	Zebra	Part Number	CBL-TC8X-USBCHG-01
Holster 1	Brand Name	Zebra	Part Number	SG-TC8X-QDHLST-01
Holster 2	Brand Name	Zebra	Part Number	SG-TC8X-PMHLST-01
Adapter	Brand Name	Zebra	Part Number	PWR-BUA5V16W0WW
DC Line Cord	Brand Name	Zebra	Part Number	CBL-DC-383A1-01

Remark: USB cable was modified, all test item with this modified cable.



1.2 Product Specification of Equipment Under Test

Standards-related Product Specification	
Tx/Rx Channel Frequency Range	2412 MHz ~ 2462 MHz
Maximum (Average) Output Power to antenna <CDD Mode>	<p><Ant. 1> 802.11b : 21.43 dBm (0.1390 W) 802.11g : 18.61 dBm (0.0726 W) 802.11n HT20 : 21.21 dBm (0.1321 W) 802.11n HT40 : 17.19 dBm (0.0524 W) 802.11ac VHT20 : 21.20 dBm (0.1318 W) 802.11ac VHT40 : 17.13 dBm (0.0516 W)</p> <p><Ant. 2> 802.11b : 21.38 dBm (0.1374 W) 802.11g : 18.63 dBm (0.0729 W) 802.11n HT20 : 21.48 dBm (0.1406 W) 802.11n HT40 : 18.09 dBm (0.0644 W) 802.11ac VHT20 : 21.46 dBm (0.1400 W) 802.11ac VHT40 : 18.03 dBm (0.0635 W)</p> <p><MIMO Ant. 1 + 2> 802.11b : 24.40 dBm (0.2754 W) 802.11g : 21.60 dBm (0.1445 W) 802.11n HT20 : 23.81 dBm (0.2404 W) 802.11n HT40 : 16.86 dBm (0.0485 W) 802.11ac VHT20 : 23.76 dBm (0.2377 W) 802.11ac VHT40 : 16.81 dBm (0.0480 W)</p>
Maximum (Average) Output Power to antenna <TXBF Mode>	<p><MIMO Ant. 1 + 2> 802.11ac VHT20 : 23.44 dBm(0.2208 W) 802.11ac VHT40 : 24.24 dBm(0.2655 W)</p>
99% Occupied Bandwidth <CDD Mode>	<p><Ant. 1> 802.11b : 13.90MHz 802.11g : 16.88MHz 802.11n HT20 : 18.13MHz 802.11n HT40 : 36.56MHz</p> <p><Ant. 2> 802.11b : 13.34MHz 802.11g : 16.88MHz 802.11n HT20 : 18.28MHz 802.11n HT40 : 36.66MHz</p> <p><MIMO Ant. 1> 802.11b : 14.64MHz 802.11g : 17.03MHz 802.11n HT20 : 18.18MHz 802.11n HT40 : 36.76MHz</p> <p><MIMO Ant. 2> 802.11b : 13.29MHz 802.11g : 16.83MHz 802.11n HT20 : 18.53MHz 802.11n HT40 : 37.46MHz</p>



Standards-related Product Specification			
99% Occupied Bandwidth <TXBF Mode>	<MIMO Ant. 1> 802.11n VHT20 : 17.58MHz 802.11n VHT40 : 36.66MHz		
	<MIMO Ant. 2> 802.11n VHT20 : 19.13MHz 802.11n VHT40 : 37.26MHz		
Antenna Type / Gain	<Ant. 1>Dipole Antenna with gain 2.76 dBi <Ant. 2>Dipole Antenna with gain 2.64 dBi		
Type of Modulation	802.11b : DSSS (DBPSK / DQPSK / CCK) 802.11g/n : OFDM (BPSK / QPSK / 16QAM / 64QAM) 802.11ac: OFDM (BPSK / QPSK / 16QAM / 64QAM / 256QAM)		
Antenna Function Description		Ant. 1	Ant. 2
	802.11 b/g/n/ac	V	V
	802.11 b/g/n/ac MIMO	V	V
	802.11 ac TXBF	V	V

Note: MIMO Ant. 1+2 is a calculated result from sum of the power MIMO Ant. 1 and MIMO Ant. 2.

1.3 Modification of EUT

No modifications are made to the EUT during all test items.



1.4 Testing Location

Test Site	SPORTON INTERNATIONAL INC.	
Test Site Location	No.52, Huaya 1st Rd., Guishan Dist., Taoyuan City, Taiwan (R.O.C.) TEL: +886-3-327-3456 FAX: +886-3-328-4978	
Test Site No.	Sporton Site No.	
	TH05-HY	CO05-HY

Note: The test site complies with ANSI C63.4 2014 requirement.

Test Site	SPORTON INTERNATIONAL INC.	
Test Site Location	No.58, Aly. 75, Ln. 564, Wenhua 3rd, Rd., Guishan Dist., Taoyuan City, Taiwan (R.O.C.) TEL: +886-3-327-0868 FAX: +886-3-327-0855	
Test Site No.	Sporton Site No.	
	03CH13-HY	

Note: The test site complies with ANSI C63.4 2014 requirement.

FCC Designation No. TW1190 and TW0007

1.5 Applicable Standards

According to the specifications of the manufacturer, the EUT must comply with the requirements of the following standards:

- ♦ FCC Part 15 Subpart C §15.247
- ♦ FCC KDB Publication No. 558074 D01 DTS Meas. Guidance v05r01
- ♦ FCC KDB 414788 D01 Radiated Test Site v01r01.
- ♦ FCC KDB 662911 D01 Multiple Transmitter Output v02r01.
- ♦ ANSI C63.10-2013

Remark:

1. All test items were verified and recorded according to the standards and without any deviation during the test.
2. This EUT has also been tested and complied with the requirements of FCC Part 15, Subpart B, recorded in a separate test report.



2 Test Configuration of Equipment Under Test

- a. The EUT has been associated with peripherals and configuration operated in a manner tended to maximize its emission characteristics in a typical application. Frequency range investigated: conduction emission (150 kHz to 30 MHz), radiation emission (9 kHz to the 10th harmonic of the highest fundamental frequency or to 40 GHz, whichever is lower). For radiated measurement, pre-scanned in three orthogonal panels, X, Y, Z. The worst cases (Z plane for Ant. 1 and Ant. 2, Y plane for Ant. 1+2) were recorded in this report.

- b. AC power line Conducted Emission was tested under maximum output power.

2.1 Carrier Frequency and Channel

Frequency Band	Channel	Freq. (MHz)	Channel	Freq. (MHz)
2400-2483.5 MHz	1	2412	7	2442
	2	2417	8	2447
	3	2422	9	2452
	4	2427	10	2457
	5	2432	11	2462
	6	2437		



2.2 Test Mode

Final test modes are considering the modulation and worse data rates as below table.

Single Antenna

Modulation	Data Rate
802.11b	1 Mbps
802.11g	6 Mbps
802.11n HT20	MCS0
802.11n HT40	MCS0
802.11ac VHT20 (Covered by HT20)	MCS0
802.11ac VHT40 (Covered by HT40)	MCS0

MIMO Antenna

Modulation	Data Rate
802.11b	1 Mbps
802.11g	6 Mbps
802.11n HT20	MCS0
802.11n HT40	MCS0
802.11ac VHT20 (Covered by HT20)	MCS0
802.11ac VHT40 (Covered by HT40)	MCS0

TXBF Mode

Modulation	Data Rate
802.11ac VHT20	MCS0
802.11ac VHT40	MCS0

Test Cases	
AC Conducted Emission	Mode 1: WLAN (2.4GHz) Link + Bluetooth Link + Camera + USB Cable (Data Link with Notebook) (Notebook to SD Card) + DC Line Cord + Battery 2 + AC Adapter for Sample 3
Remark: 1. Data Linking with Notebook means data application transferred mode between EUT and Notebook. 2. For Radiated Test Cases, the tests were performed with Battery 2 and Sample 3.	



<CDD Mode>

<Ant. 1>

802.11b RF Avg Output Power (dBm)						
Power vs. Channel			Power vs Data Rate			
Channel	Frequency (MHz)	Data Rate (bps)	Channel	Data Rate (bps)		
		1M		2M	5.5M	11M
Duty Cycle (%)		99.27		98.49	96.15	93.12
CH 01	2412	21.14	CH 06	21.39	21.20	21.03
CH 02	2417	20.73				
CH 03	2422	20.74				
CH 06	2437	21.43				
CH 11	2462	20.65				

802.11g RF Avg Output Power (dBm)										
Power vs. Channel			Power vs Data Rate							
Channel	Frequency (MHz)	Data Rate (bps)	Channel	Data Rate (bps)						
		6M		9Mbps	12Mbps	18Mbps	24Mbps	36Mbps	48Mbps	54Mbps
Duty Cycle (%)		95.31		93.47	92.31	88.46	86.07	77.27	75.00	74.39
CH 01	2412	18.61	CH 01	18.39	18.36	18.14	18.06	17.92	17.80	17.73
CH 02	2417	18.54								
CH 03	2422	17.31								
CH 06	2437	18.54								
CH 11	2462	17.60								

802.11n HT20 RF Avg Output Power (dBm)										
Power vs. Channel			Power vs Data Rate							
Channel	Frequency (MHz)	MCS Index	Channel	MCS Index						
		MCS 0		MCS 1	MCS 2	MCS 3	MCS 4	MCS 5	MCS 6	MCS 7
Duty Cycle (%)		95.70		92.34	87.33	85.47	76.92	75.57	73.94	72.26
CH 01	2412	18.07	CH 06	21.14	20.95	20.88	20.72	20.54	20.59	20.52
CH 06	2437	21.21								
CH 11	2462	17.04								



802.11n HT40 RF Avg Output Power (dBm)										
Power vs. Channel			Power vs Data Rate							
Channel	Frequency (MHz)	MCS Index	Channel	MCS Index						
		MCS 0		MCS 1	MCS 2	MCS 3	MCS 4	MCS 5	MCS 6	MCS 7
Duty Cycle (%)		91.63		92.34	87.33	85.47	76.92	75.57	73.94	72.26
CH 03	2422	16.28	CH 06	17.15	17.08	17.15	17.04	17.05	17.09	17.15
CH 06	2437	17.19								
CH 09	2452	12.52								

802.11ac VHT20 RF Avg Output Power (dBm)											
Power vs. Channel			Power vs Data Rate								
Channel	Frequency (MHz)	MCS Index	Channel	MCS Index							
		MCS 0		MCS 1	MCS 2	MCS 3	MCS 4	MCS 5	MCS 6	MCS 7	MCS 8
Duty Cycle (%)		95.24		90.65	88.00	85.59	80.73	76.67	74.70	73.08	69.75
CH 01	2412	17.99	CH 06	21.19	20.92	20.86	20.61	20.54	20.50	20.47	20.54
CH 06	2437	21.20									
CH 11	2462	16.99									

802.11ac VHT40 RF Avg Output Power (dBm)												
Power vs. Channel			Power vs Data Rate									
Channel	Frequency (MHz)	MCS Index	Channel	MCS Index								
		MCS 0		MCS 1	MCS 2	MCS 3	MCS 4	MCS 5	MCS 6	MCS 7	MCS 8	MCS 9
Duty Cycle (%)		91.67		85.96	78.16	73.33	70.07	64.41	62.78	61.40	57.21	55.96
CH 03	2422	16.25	CH 06	17.02	17.12	17.12	17.06	17.09	17.00	17.04	17.11	17.10
CH 06	2437	17.13										
CH 09	2452	12.48										



<Ant. 2>

802.11b RF Avg Output Power (dBm)						
Power vs. Channel			Power vs Data Rate			
Channel	Frequency (MHz)	Data Rate (bps)	Channel	Data Rate (bps)		
		1M		2M	5.5M	11M
Duty Cycle (%)		99.27		98.73	96.35	93.45
CH 01	2412	21.13	CH 06	21.31	21.22	21.04
CH 06	2437	21.38				
CH 11	2462	20.34				

802.11g RF Avg Output Power (dBm)										
Power vs. Channel			Power vs Data Rate							
Channel	Frequency (MHz)	Data Rate (bps)	Channel	Data Rate (bps)						
		6M		9Mbps	12Mbps	18Mbps	24Mbps	36Mbps	48Mbps	54Mbps
Duty Cycle (%)		95.29		94.12	92.34	89.68	85.95	76.14	76.84	73.65
CH 01	2412	16.84	CH 06	18.62	18.62	18.42	18.47	18.48	18.17	18.18
CH 06	2437	18.63								
CH 11	2462	16.73								

802.11n HT20 RF Avg Output Power (dBm)										
Power vs. Channel			Power vs Data Rate							
Channel	Frequency (MHz)	MCS Index	Channel	MCS Index						
		MCS 0		MCS 1	MCS 2	MCS 3	MCS 4	MCS 5	MCS 6	MCS 7
Duty Cycle (%)		95.45		91.87	88.51	85.47	80.46	73.63	72.62	72.26
CH 01	2412	16.70	CH 06	21.11	21.45	21.46	21.32	21.35	21.32	21.24
CH 06	2437	21.48								
CH 11	2462	16.61								



802.11n HT40 RF Avg Output Power (dBm)										
Power vs. Channel			Power vs Data Rate							
Channel	Frequency (MHz)	MCS Index	Channel	MCS Index						
		MCS 0		MCS 1	MCS 2	MCS 3	MCS 4	MCS 5	MCS 6	MCS 7
Duty Cycle (%)		91.58		85.09	80.72	73.03	69.12	64.07	61.54	60.38
CH 03	2422	18.09	CH 03							
CH 06	2437	15.13		17.95	18.00	18.06	17.92	17.93	17.96	17.89
CH 09	2452	14.98								

802.11ac VHT20 RF Avg Output Power (dBm)											
Power vs. Channel			Power vs Data Rate								
Channel	Frequency (MHz)	MCS Index	Channel	MCS Index							
		MCS 0		MCS 1	MCS 2	MCS 3	MCS 4	MCS 5	MCS 6	MCS 7	MCS 8
Duty Cycle (%)		95.48		91.08	87.92	85.71	80.73	74.19	74.25	70.81	69.75
CH 01	2412	16.66	CH 06								
CH 06	2437	21.46		21.16	21.19	21.23	20.81	21.02	20.86	20.96	20.88
CH 11	2462	16.58									

802.11ac VHT40 RF Avg Output Power (dBm)												
Power vs. Channel			Power vs Data Rate									
Channel	Frequency (MHz)	MCS Index	Channel	MCS Index								
		MCS 0		MCS 1	MCS 2	MCS 3	MCS 4	MCS 5	MCS 6	MCS 7	MCS 8	MCS 9
Duty Cycle (%)		92.16		83.76	80.19	75.43	68.57	64.14	62.50	60.83	58.00	56.02
CH 03	2422	18.03	CH 03									
CH 06	2437	15.06		17.97	17.97	18.00	18.02	18.01	17.98	17.99	17.92	17.93
CH 09	2452	14.93										



MIMO <Ant. 1+2>

802.11b RF Avg Output Power (dBm)						
Power vs. Channel			Power vs Data Rate			
Channel	Frequency (MHz)	Data Rate (bps)	Channel	Data Rate (bps)		
		1M		2M	5.5M	11M
CH 01	2412	24.40	CH 01	24.32	24.25	24.12
CH 06	2437	24.19				
CH 11	2462	22.77				

802.11g RF Avg Output Power (dBm)										
Power vs. Channel			Power vs Data Rate							
Channel	Frequency (MHz)	Data Rate (bps)	Channel	Data Rate (bps)						
		6M		9Mbps	12Mbps	18Mbps	24Mbps	36Mbps	48Mbps	54Mbps
CH 01	2412	20.26	CH 06	21.53	21.42	21.23	21.17	20.83	20.67	20.75
CH 06	2437	21.60								
CH 11	2462	19.47								

802.11n HT20 RF Avg Output Power (dBm)										
Power vs. Channel			Power vs Data Rate							
Channel	Frequency (MHz)	MCS Index	Channel	MCS Index						
		MCS0		MCS1	MCS2	MCS3	MCS4	MCS5	MCS6	MCS7
CH 01	2412	19.56	CH 06	23.63	23.68	23.73	23.49	23.26	23.24	23.37
CH 06	2437	23.81								
CH 11	2462	18.78								



802.11n HT40 RF Output Power (dBm)										
Power vs. Channel			Power vs Data Rate							
Channel	Frequency (MHz)	MCS Index	Channel	MCS Index						
		MCS0		MCS1	MCS2	MCS3	MCS4	MCS5	MCS6	MCS7
CH 03	2422	16.86	CH 03	16.73	16.70	16.84	16.76	16.72	16.77	16.72
CH 06	2437	16.79								
CH 09	2452	15.01								

802.11ac VHT20 RF Avg Output Power (dBm)											
Power vs. Channel			Power vs Data Rate								
Channel	Frequency (MHz)	MCS Index	Channel	MCS Index							
		MCS 0		MCS 1	MCS 2	MCS 3	MCS 4	MCS 5	MCS 6	MCS 7	MCS 8
CH 01	2412	19.50	CH 06	23.64	23.74	23.63	23.23	23.37	23.31	23.27	23.30
CH 06	2437	23.76									
CH 11	2462	18.77									

802.11ac VHT40 RF Avg Output Power (dBm)												
Power vs. Channel			Power vs Data Rate									
Channel	Frequency (MHz)	MCS Index	Channel	MCS Index								
		MCS 0		MCS 1	MCS 2	MCS 3	MCS 4	MCS 5	MCS 6	MCS 7	MCS 8	MCS 9
CH 03	2422	16.81	CH 03	16.79	16.80	16.80	16.79	16.74	16.74	16.76	16.71	16.73
CH 06	2437	16.69										
CH 09	2452	14.95										



<TXBF Mode>

MIMO <Ant. 1+2>

802.11ac VHT20 RF Avg Output Power (dBm)												
Power vs. Channel			Power vs Data Rate									
Channel	Frequency (MHz)	MCS Index	Channel	MCS Index								
		MCS 0		MCS 1	MCS 2	MCS 3	MCS 4	MCS 5	MCS 6	MCS 7	MCS 8	
CH 01	2412	23.44	CH 01									
CH 06	2437	23.18		22.57	22.69	22.69	23.27	23.38	23.38	23.38	23.18	
CH 11	2462	22.25										

802.11ac VHT40 RF Avg Output Power (dBm)												
Power vs. Channel			Power vs Data Rate									
Channel	Frequency (MHz)	MCS Index	Channel	MCS Index								
		MCS 0		MCS 1	MCS 2	MCS 3	MCS 4	MCS 5	MCS 6	MCS 7	MCS 8	MCS 9
CH 03	2422	19.52	CH 06									
CH 06	2437	24.24		23.93	23.48	23.54	23.73	23.67	23.63	23.53	23.13	23.17
CH 09	2452	18.31										

2.3 Connection Diagram of Test System

<WLAN Tx Mode>

<CDD Mode>

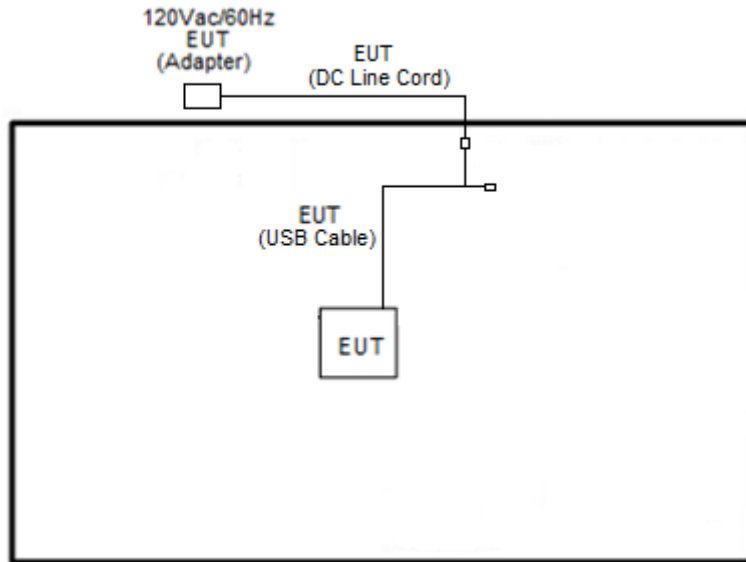

<TXBF Mode>

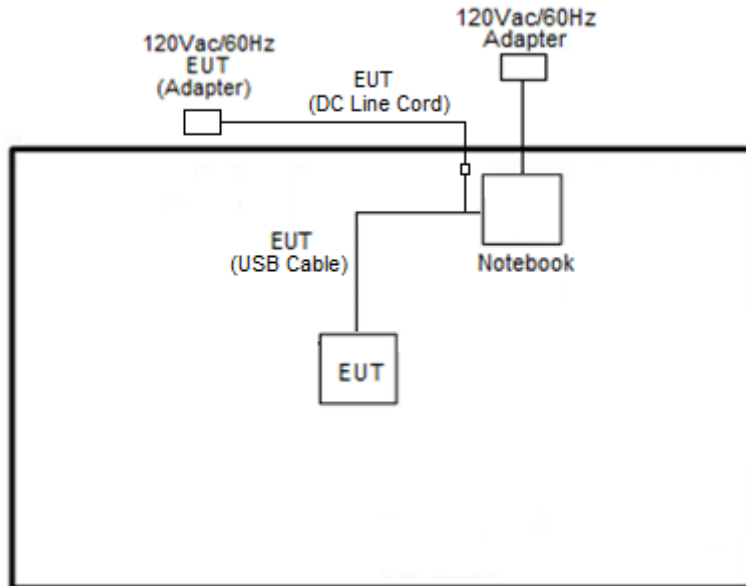

<AC Conducted Emission Mode>

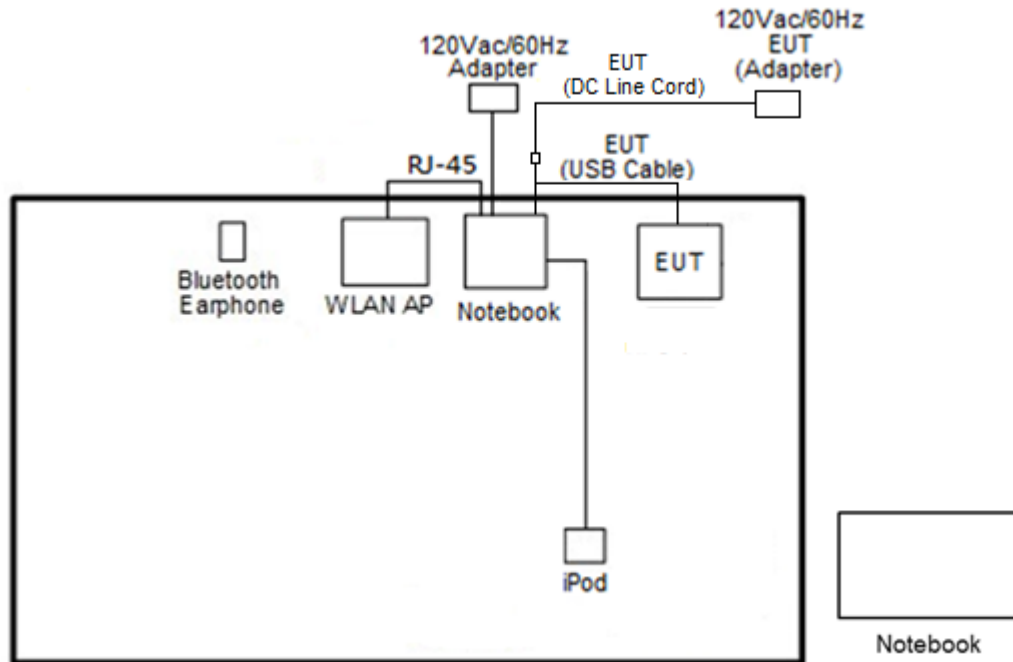

2.4 Support Unit used in test configuration and system

Item	Equipment	Trade Name	Model Name	FCC ID	Data Cable	Power Cord
1.	Bluetooth Earphone	Sony Ericsson	MW600	PY7DDA-2029	N/A	N/A
2.	WLAN AP	ASUS	RT-AC54U	MSQ-RTN54U	N/A	Unshielded, 1.8 m
3.	Notebook	DELL	Latitude E6320	FCC DoC/ Contains FCC ID: QDS-BRCM1054	N/A	AC I/P: Unshielded, 1.2 m DC O/P: Shielded, 1.8 m
4.	Notebook	DELL	P20G	FCC DoC/ Contains FCC ID: QDS-BRCM1051	N/A	AC I/P: Unshielded, 1.2 m DC O/P: Shielded, 1.8 m
5.	iPod	Apple	A1285	FCC DoC	Shielded, 1.0 m	N/A
6.	SD Card	SanDisk	MicroSD HC	FCC DoC	N/A	N/A



2.5 EUT Operation Test Setup

The RF test items, utility “QRCT” was installed in Notebook which was programmed in order to make the EUT get into the engineering modes to provide channel selection, power level, data rate and the application type and for continuous transmitting signals.

For TXBF mode, the modulation modes and data rates manipulated by the command lines in the engineering program made the EUT link to another EUT by power under the normal operation. The “ADB” software tool was used to enable the EUT to transmit signals continuously.

2.6 Measurement Results Explanation Example

For all conducted test items:

The offset level is set in the spectrum analyzer to compensate the RF cable loss and attenuator factor between EUT conducted output port and spectrum analyzer. With the offset compensation, the spectrum analyzer reading level is exactly the EUT RF output level.

Example:

The spectrum analyzer offset is derived from RF cable loss and attenuator factor.

Offset = RF cable loss + attenuator factor.

Following shows an offset computation example with cable loss 4.2 dB and 10dB attenuator.

$$\begin{aligned} \text{Offset(dB)} &= \text{RF cable loss(dB)} + \text{attenuator factor(dB)}. \\ &= 4.2 + 10 = 14.2 \text{ (dB)} \end{aligned}$$

3 Test Result

3.1 6dB and 99% Bandwidth Measurement

3.1.1 Limit of 6dB and 99% Bandwidth

The minimum 6 dB bandwidth shall be at least 500 kHz.

3.1.2 Measuring Instruments

See list of measuring equipment of this test report.

3.1.3 Test Procedures

1. The testing follows the ANSI C63.10 Section 6.9.3 (OBW) and 11.8.1 (6dB BW).
2. The RF output of EUT was connected to the spectrum analyzer by RF cable and attenuator. The path loss was compensated to the results for each measurement.
3. Set to the maximum power setting and enable the EUT transmit continuously.
4. Make the measurement with the spectrum analyzer's resolution bandwidth (RBW) = 100 kHz. Set the Video bandwidth (VBW) = 300 kHz. In order to make an accurate measurement. The 6 dB bandwidth must be greater than 500 kHz.
5. For 99% Bandwidth Measurement, the spectrum analyzer's resolution bandwidth (RBW) is set 1-5% of the emission bandwidth and set the Video bandwidth (VBW) $\geq 3 * RBW$.
6. Measure and record the results in the test report.

3.1.4 Test Setup





3.1.5 Test Result of 6dB and 99% Occupied Bandwidth

Test Engineer :	Allen Lin and Derek Hsu	Temperature :	21~25°C
		Relative Humidity :	51~54%

<CDD Mode>

2.4GHz Band										
Mod.	Data Rate	NTX	CH.	Freq. (MHz)	99% Occupied BW (MHz)		6dB BW (MHz)		6dB BW Limit (MHz)	Pass/Fail
					Ant 1	Ant 2	Ant 1	Ant 2		
11b	1Mbps	1	1	2412	13.22	12.94	8.51	8.03	0.50	Pass
11b	1Mbps	1	6	2437	13.90	13.34	8.05	8.05	0.50	Pass
11b	1Mbps	1	11	2462	13.82	12.60	7.55	7.53	0.50	Pass
11g	6Mbps	1	1	2412	16.88	16.88	16.04	16.04	0.50	Pass
11g	6Mbps	1	6	2437	16.88	16.88	15.70	15.68	0.50	Pass
11g	6Mbps	1	11	2462	16.68	16.73	15.10	15.68	0.50	Pass
HT20	MCS0	1	1	2412	18.03	18.03	16.90	16.04	0.50	Pass
HT20	MCS0	1	6	2437	18.13	18.18	16.08	15.42	0.50	Pass
HT20	MCS0	1	11	2462	17.83	18.28	15.14	15.94	0.50	Pass
HT40	MCS0	1	3	2422	36.56	36.56	35.08	35.05	0.50	Pass
HT40	MCS0	1	6	2437	36.56	36.56	35.08	35.72	0.50	Pass
HT40	MCS0	1	9	2452	36.56	36.66	35.72	35.60	0.50	Pass
11b	1Mbps	2	1	2412	14.64	13.20	8.03	7.57	0.50	Pass
11b	1Mbps	2	6	2437	13.89	13.29	7.55	8.05	0.50	Pass
11b	1Mbps	2	11	2462	12.89	12.12	7.05	7.07	0.50	Pass
11g	6Mbps	2	1	2412	17.03	16.83	15.92	15.72	0.50	Pass
11g	6Mbps	2	6	2437	16.88	16.78	16.02	15.68	0.50	Pass
11g	6Mbps	2	11	2462	16.68	16.63	15.12	15.10	0.50	Pass
HT20	MCS0	2	1	2412	18.18	17.93	16.90	16.86	0.50	Pass
HT20	MCS0	2	6	2437	18.08	18.53	16.32	16.04	0.50	Pass
HT20	MCS0	2	11	2462	17.78	17.88	15.12	15.68	0.50	Pass
HT40	MCS0	2	3	2422	36.36	36.46	33.85	35.08	0.50	Pass
HT40	MCS0	2	6	2437	36.56	37.46	35.08	35.08	0.50	Pass
HT40	MCS0	2	9	2452	36.76	36.56	35.88	35.08	0.50	Pass

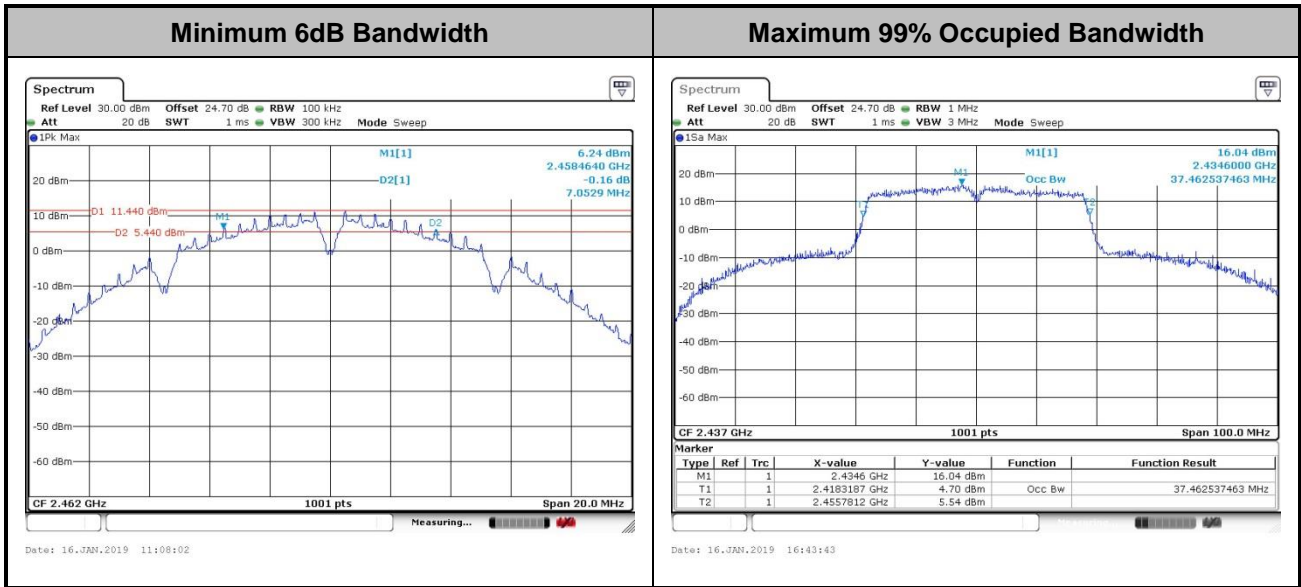

Note: The occupied channel bandwidth is maintained within the band of operation for all of the modulations.



<TXBF Mode>

2.4GHz Band										
Mod.	Data Rate	NTX	CH.	Freq. (MHz)	99% Occupied BW (MHz)		6dB BW (MHz)		6dB BW Limit (MHz)	Pass/Fail
					Ant 1	Ant 2	Ant 1	Ant 2		
VHT20	MCS0	2	1	2412	17.58	18.38	15.15	17.54	0.50	Pass
VHT20	MCS0	2	6	2437	17.58	18.93	15.15	17.16	0.50	Pass
VHT20	MCS0	2	11	2462	17.53	19.13	15.13	17.16	0.50	Pass
VHT40	MCS0	2	3	2422	36.66	37.06	33.77	35.29	0.50	Pass
VHT40	MCS0	2	6	2437	36.56	37.26	35.09	35.09	0.50	Pass
VHT40	MCS0	2	9	2452	36.66	37.26	32.77	35.64	0.50	Pass

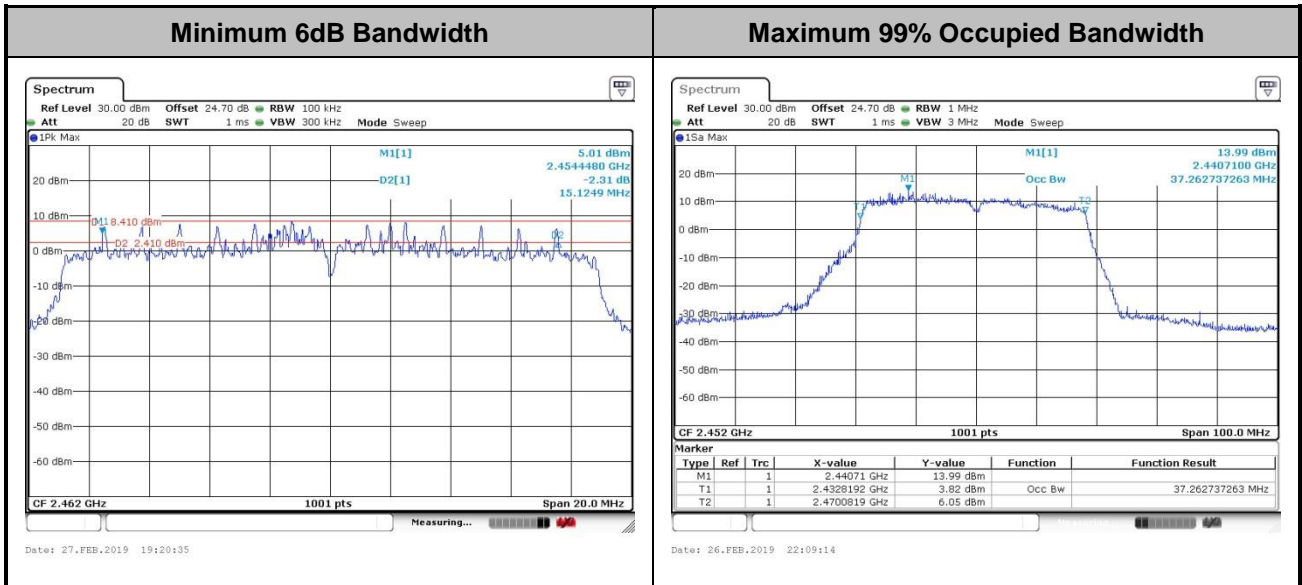

Note: The occupied channel bandwidth is maintained within the band of operation for all of the modulations.



3.2 Output Power Measurement

3.2.1 Limit of Output Power

For systems using digital modulation in the 2400-2483.5MHz, the limit for output power is 30dBm. If transmitting antenna with directional gain greater than 6dBi is used, the output power from the intentional radiator shall be reduced below the above stated value by the amount in dB that the directional gain of the antenna exceeds 6 dBi. In case of point-to-point operation, the limit has to be reduced by 1dB for every 3dB that the directional gain of the antenna exceeds 6dBi.

3.2.2 Measuring Instruments

See list of measuring equipment of this test report.

3.2.3 Test Procedures

<CDD Mode>

1. For Average Power, the testing follows the ANSI C63.10 Section 11.9.2.3.1 Method AVGPM.
2. The RF output of EUT was connected to the power meter by RF cable and attenuator. The path loss was compensated to the results for each measurement.
3. Set to the maximum power setting and enable the EUT transmit continuously.
4. Measure the conducted output power and record the results in the test report.
5. For MIMO mode, calculation method follows FCC KDB 662911 D01 Multiple Transmitter Output v02r01.

<TXBF Mode>

1. For Average Power, the testing follows the ANSI C63.10 Section 11.9.2.3.2 Method AVGPM-G.
2. The RF output of EUT was connected to the power meter by RF cable and attenuator. The path loss was compensated to the results for each measurement.
3. Set to the maximum power setting and enable the EUT transmit continuously.
4. Measure the conducted output power and record the results in the test report.
5. For MIMO mode, calculation method follows FCC KDB 662911 D01 Multiple Transmitter Output v02r01.

3.2.4 Test Setup

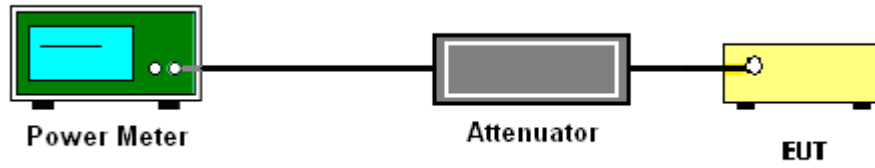



3.2.5 Test Result of Peak Output Power (Reporting Only)

Test Engineer :	Allen Lin and Derek Hsu	Temperature :	21~25°C
		Relative Humidity :	51~54%

<CDD Mode>

2.4GHz Band											
Mod.	Data Rate	N _{TX}	CH.	Freq. (MHz)	Peak Conducted Power (dBm)			DG (dBi)		EIRP Power (dBm)	
					Ant 1	Ant 2	SUM	Ant 1	Ant 2	Ant 1	Ant 2
11b	1Mbps	1	1	2412	23.40	23.46		2.76	2.64	26.16	26.10
11b	1Mbps	1	6	2437	23.85	23.70		2.76	2.64	26.61	26.34
11b	1Mbps	1	11	2462	23.41	22.67		2.76	2.64	26.17	25.31
11g	6Mbps	1	1	2412	23.38	21.55		2.76	2.64	26.14	24.19
11g	6Mbps	1	6	2437	23.21	23.29		2.76	2.64	25.97	25.93
11g	6Mbps	1	11	2462	22.27	21.47		2.76	2.64	25.03	24.11
HT20	MCS0	1	1	2412	23.12	21.52		2.76	2.64	25.88	24.16
HT20	MCS0	1	6	2437	25.68	25.38		2.76	2.64	28.44	28.02
HT20	MCS0	1	11	2462	21.95	21.36		2.76	2.64	24.71	24.00
HT40	MCS0	1	3	2422	22.79	24.04		2.76	2.64	25.55	26.68
HT40	MCS0	1	6	2437	23.44	21.45		2.76	2.64	26.20	24.09
HT40	MCS0	1	9	2452	19.17	21.40		2.76	2.64	21.93	24.04
VHT20	MCS0	1	1	2412	22.83	21.50		2.76	2.64	25.59	24.14
VHT20	MCS0	1	6	2437	25.65	25.35		2.76	2.64	28.41	27.99
VHT20	MCS0	1	11	2462	21.92	21.32		2.76	2.64	24.68	23.96
VHT40	MCS0	1	3	2422	22.74	24.00		2.76	2.64	25.50	26.64
VHT40	MCS0	1	6	2437	23.34	21.38		2.76	2.64	26.10	24.02
VHT40	MCS0	1	9	2452	19.15	21.36		2.76	2.64	21.91	24.00



2.4GHz Band											
Mod.	Data Rate	NTX	CH.	Freq. (MHz)	Peak Conducted Power (dBm)			DG (dBi)		EIRP Power (dBm)	
					Ant 1	Ant 2	SUM	Ant 1	Ant 2	Ant 1	Ant 2
11b	1Mbps	2	1	2412	23.48	23.58	26.54	2.76		29.30	
11b	1Mbps	2	6	2437	23.31	23.55	26.44	2.76		29.20	
11b	1Mbps	2	11	2462	22.53	22.30	25.43	2.76		28.19	
11g	6Mbps	2	1	2412	22.09	22.07	25.09	2.76		27.85	
11g	6Mbps	2	6	2437	23.31	23.44	26.39	2.76		29.15	
11g	6Mbps	2	11	2462	21.12	21.49	24.32	2.76		27.08	
HT20	MCS0	2	1	2412	21.27	21.49	24.39	2.76		27.15	
HT20	MCS0	2	6	2437	25.29	24.86	28.09	2.76		30.85	
HT20	MCS0	2	11	2462	20.45	21.06	23.78	2.76		26.54	
HT40	MCS0	2	3	2422	19.69	20.20	22.96	2.76		25.72	
HT40	MCS0	2	6	2437	20.05	19.83	22.95	2.76		25.71	
HT40	MCS0	2	9	2452	18.06	17.95	21.02	2.76		23.78	
VHT20	MCS0	2	1	2412	21.22	21.45	24.35	2.76		27.11	
VHT20	MCS0	2	6	2437	25.20	24.87	28.05	2.76		30.81	
VHT20	MCS0	2	11	2462	20.44	20.98	23.73	2.76		26.49	
VHT40	MCS0	2	3	2422	19.62	20.20	22.93	2.76		25.69	
VHT40	MCS0	2	6	2437	20.02	19.80	22.92	2.76		25.68	
VHT40	MCS0	2	9	2452	18.05	17.92	21.00	2.76		23.76	



3.2.6 Test Result of Average output Power

Test Engineer :	Allen Lin and Derek Hsu	Temperature :	21~25°C
		Relative Humidity :	51~54%

<CDD Mode>

2.4GHz Band																		
Mod.	Data Rate	NTX	CH.	Freq. (MHz)	Duty Factor (dB)		Average Conducted Power (dBm)			Conducted Power Limit (dBm)		DG (dBi)		EIRP Power (dBm)		EIRP Power Limit (dBm)		Pass /Fail
					Ant 1	Ant 2	Ant 1	Ant 2	SUM	Ant 1	Ant 2	Ant 1	Ant 2	Ant 1	Ant 2	Ant 1	Ant 2	
11b	1Mbps	1	1	2412	0.03	0.03	21.14	21.13		30.00	30.00	2.76	2.64	23.90	23.77	36.00	36.00	Pass
11b	1Mbps	1	6	2437	0.03	0.03	21.43	21.38		30.00	30.00	2.76	2.64	24.19	24.02	36.00	36.00	Pass
11b	1Mbps	1	11	2462	0.03	0.03	20.65	20.34		30.00	30.00	2.76	2.64	23.41	22.98	36.00	36.00	Pass
11g	6Mbps	1	1	2412	0.21	0.21	18.61	16.84		30.00	30.00	2.76	2.64	21.37	19.48	36.00	36.00	Pass
11g	6Mbps	1	6	2437	0.21	0.21	18.54	18.63		30.00	30.00	2.76	2.64	21.30	21.27	36.00	36.00	Pass
11g	6Mbps	1	11	2462	0.21	0.21	17.60	16.73		30.00	30.00	2.76	2.64	20.36	19.37	36.00	36.00	Pass
HT20	MCS0	1	1	2412	0.19	0.20	18.07	16.70		30.00	30.00	2.76	2.64	20.83	19.34	36.00	36.00	Pass
HT20	MCS0	1	6	2437	0.19	0.20	21.21	21.48		30.00	30.00	2.76	2.64	23.97	24.12	36.00	36.00	Pass
HT20	MCS0	1	11	2462	0.19	0.20	17.04	16.61		30.00	30.00	2.76	2.64	19.80	19.25	36.00	36.00	Pass
HT40	MCS0	1	3	2422	0.38	0.38	16.28	18.09		30.00	30.00	2.76	2.64	19.04	20.73	36.00	36.00	Pass
HT40	MCS0	1	6	2437	0.38	0.38	17.19	15.13		30.00	30.00	2.76	2.64	19.95	17.77	36.00	36.00	Pass
HT40	MCS0	1	9	2452	0.38	0.38	12.52	14.98		30.00	30.00	2.76	2.64	15.28	17.62	36.00	36.00	Pass
VHT20	MCS0	1	1	2412	0.21	0.20	17.99	16.66		30.00	30.00	2.76	2.64	20.75	19.30	36.00	36.00	Pass
VHT20	MCS0	1	6	2437	0.21	0.20	21.20	21.46		30.00	30.00	2.76	2.64	23.96	24.10	36.00	36.00	Pass
VHT20	MCS0	1	11	2462	0.21	0.20	16.99	16.58		30.00	30.00	2.76	2.64	19.75	19.22	36.00	36.00	Pass
VHT40	MCS0	1	3	2422	0.38	0.35	16.25	18.03		30.00	30.00	2.76	2.64	19.01	20.67	36.00	36.00	Pass
VHT40	MCS0	1	6	2437	0.38	0.35	17.13	15.06		30.00	30.00	2.76	2.64	19.89	17.70	36.00	36.00	Pass
VHT40	MCS0	1	9	2452	0.38	0.35	12.48	14.93		30.00	30.00	2.76	2.64	15.24	17.57	36.00	36.00	Pass



2.4GHz Band																		
Mod.	Data Rate	NTX	CH.	Freq. (MHz)	Duty Factor (dB)		Average Conducted Power (dBm)			Conducted Power Limit (dBm)		DG (dBi)		EIRP Power (dBm)		EIRP Power Limit (dBm)		Pass /Fail
					Ant 1	Ant 2	Ant 1	Ant 2	SUM	Ant 1	Ant 2	Ant 1	Ant 2	Ant 1	Ant 2	Ant 1	Ant 2	
11b	1Mbps	2	1	2412	0.04	0.04	21.36	21.42	24.40	30.00		2.76		27.16		36.00	Pass	
11b	1Mbps	2	6	2437	0.04	0.04	21.06	21.29	24.19	30.00		2.76		26.95		36.00	Pass	
11b	1Mbps	2	11	2462	0.04	0.04	19.60	19.92	22.77	30.00		2.76		25.53		36.00	Pass	
11g	6Mbps	2	1	2412	0.25	0.25	17.25	17.25	20.26	30.00		2.76		23.02		36.00	Pass	
11g	6Mbps	2	6	2437	0.25	0.25	18.54	18.63	21.60	30.00		2.76		24.36		36.00	Pass	
11g	6Mbps	2	11	2462	0.25	0.25	16.34	16.58	19.47	30.00		2.76		22.23		36.00	Pass	
HT20	MCS0	2	1	2412	0.23	0.23	16.48	16.61	19.56	30.00		2.76		22.32		36.00	Pass	
HT20	MCS0	2	6	2437	0.23	0.23	20.81	20.79	23.81	30.00		2.76		26.57		36.00	Pass	
HT20	MCS0	2	11	2462	0.23	0.23	15.59	15.95	18.78	30.00		2.76		21.54		36.00	Pass	
HT40	MCS0	2	3	2422	0.40	0.44	13.76	13.94	16.86	30.00		2.76		19.62		36.00	Pass	
HT40	MCS0	2	6	2437	0.40	0.44	13.72	13.83	16.79	30.00		2.76		19.55		36.00	Pass	
HT40	MCS0	2	9	2452	0.40	0.44	11.92	12.07	15.01	30.00		2.76		17.77		36.00	Pass	
VHT20	MCS0	2	1	2412	0.22	0.27	16.40	16.57	19.50	30.00		2.76		22.26		36.00	Pass	
VHT20	MCS0	2	6	2437	0.22	0.27	20.73	20.77	23.76	30.00		2.76		26.52		36.00	Pass	
VHT20	MCS0	2	11	2462	0.22	0.27	15.53	15.97	18.77	30.00		2.76		21.53		36.00	Pass	
VHT40	MCS0	2	3	2422	0.44	0.40	13.70	13.89	16.81	30.00		2.76		19.57		36.00	Pass	
VHT40	MCS0	2	6	2437	0.44	0.40	13.70	13.65	16.69	30.00		2.76		19.45		36.00	Pass	
VHT40	MCS0	2	9	2452	0.44	0.40	11.88	12.00	14.95	30.00		2.76		17.71		36.00	Pass	



<TXBF Mode>

2.4GHz Band																		
Mod.	Data Rate	NTX	CH.	Freq. (MHz)	Duty Factor (dB)		Average Conducted Power (dBm)			Conducted Power Limit (dBm)		DG (dBi)		EIRP Power (dBm)		EIRP Power Limit (dBm)		Pass /Fail
					Ant 1	Ant 2	Ant 1	Ant 2	SUM	Ant 1	Ant 2	Ant 1	Ant 2	Ant 1	Ant 2	Ant 1	Ant 2	
VHT20	MCS0	2	1	2412	0.00	0.00	19.50	21.20	23.44	30.00		5.71		29.15		36.00		Pass
VHT20	MCS0	2	6	2437	0.00	0.00	19.30	20.90	23.18	30.00		5.71		28.89		36.00		Pass
VHT20	MCS0	2	11	2462	0.00	0.00	18.00	20.20	22.25	30.00		5.71		27.96		36.00		Pass
VHT40	MCS0	2	3	2422	0.00	0.00	15.40	17.40	19.52	30.00		5.71		25.23		36.00		Pass
VHT40	MCS0	2	6	2437	0.00	0.00	20.70	21.70	24.24	30.00		5.71		29.95		36.00		Pass
VHT40	MCS0	2	9	2452	0.00	0.00	14.60	15.90	18.31	30.00		5.71		24.02		36.00		Pass



3.3 Power Spectral Density Measurement

3.3.1 Limit of Power Spectral Density

The peak power spectral density shall not be greater than 8dBm in any 3kHz band at any time interval of continuous transmission.

3.3.2 Measuring Instruments

See list of measuring equipment of this test report.

3.3.3 Test Procedures

<CDD Mode>

Method AVGPSD-2

1. The testing follows the ANSI C63.10 Section 11.10.5 Method AVGPSD-2.
2. The RF output of EUT was connected to the spectrum analyzer by RF cable and attenuator. The path loss was compensated to the results for each measurement.
3. Set to the maximum power setting and enable the EUT transmit continuously.
4. Make the measurement with the spectrum analyzer's resolution bandwidth (RBW) = 10 kHz. Video bandwidth VBW = 30 kHz In order to make an accurate measurement, set the span to 1.5 times DTS Channel Bandwidth. (6dB BW).
5. Number of points in sweep ≥ 2 Span / RBW. (This ensures that bin-to-bin spacing is \leq RBW/2, so that narrowband signals are not lost between frequency bins).
6. Detector = RMS, Sweep time = auto couple.
7. Trace average at least 100 traces in power averaging mode.
8. Add $10 \log(1/x)$, where x is the duty cycle, to the measured power in order to compute the average power during the actual transmission times. For example, add $10 \log(1/0.25) = 6$ dB if the duty cycle is 25 percent.
9. Measure and record the results in the test report.
10. For MIMO mode, calculation method follows FCC KDB 662911 D01 Multiple Transmitter Output v02r01.

Method (c): Measure and add $10 \log(N_{ANT})$ dB.

With this technique, spectrum measurements are performed at each output of the device, but rather than summing the spectra or the spectral peaks across the outputs, the quantity $10 \log(N_{ANT})$ dB is added to each spectrum value before comparing to the emission limit. The addition of $10 \log(N_{ANT})$ dB serves to apportion the emission limit among the N_{ANT} outputs so that each output is permitted to contribute no more than $1/N_{ANT}^{\text{th}}$ of the PSD limit .

<TXBF Mode>**Method AVGPSD-3**

1. The testing follows the ANSI C63.10 Section 11.10.7 Method AVGPSD-3.
2. The RF output of EUT was connected to the spectrum analyzer by RF cable and attenuator. The path loss was compensated to the results for each measurement.
3. Set to the maximum power setting and enable the EUT transmit continuously.
4. Make the measurement with the spectrum analyzer's resolution bandwidth (RBW) = 10 kHz. Video bandwidth VBW = 30 kHz In order to make an accurate measurement, set the span to 1.5 times DTS Channel Bandwidth. (6dB BW).
5. Number of points in sweep ≥ 2 Span / RBW. (This ensures that bin-to-bin spacing is \leq RBW/2, so that narrowband signals are not lost between frequency bins).
6. Detector = RMS, Sweep time = auto couple.
7. Trace mode = max hold.
8. Allow max hold to run for at least 60 seconds, or longer as needed to allow the trace to stabilize.
9. Measure and record the results in the test report.
10. For MIMO mode, calculation method follows FCC KDB 662911 D01 Multiple Transmitter Output v02r01.

Method (c): Measure and add $10 \log(N_{\text{ANT}})$ dB.

With this technique, spectrum measurements are performed at each output of the device, but rather than summing the spectra or the spectral peaks across the outputs, the quantity $10 \log(N_{\text{ANT}})$ dB is added to each spectrum value before comparing to the emission limit. The addition of $10 \log(N_{\text{ANT}})$ dB serves to apportion the emission limit among the N_{ANT} outputs so that each output is permitted to contribute no more than $1/N_{\text{ANT}}^{\text{th}}$ of the PSD limit .

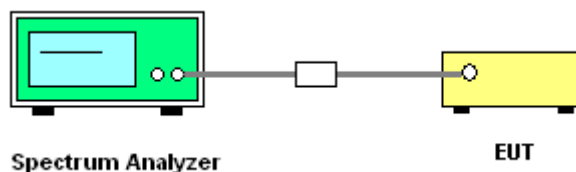
3.3.4 Test Setup



3.3.5 Test Result of Power Spectral Density

Test Engineer :	Allen Lin and Derek Hsu	Temperature :	21~25°C
		Relative Humidity :	51~54%

<CDD Mode>

2.4GHz Band														
Mod.	Data Rate	N _{TX}	CH.	Freq. (MHz)	Duty Factor (dB)		Average PSD (dBm/10kHz)			DG (dBi)		Average PSD Limit (dBm/3kHz)		Pass/Fail
					Ant 1	Ant 2	Ant 1	Ant 2	Worse + 3.01	Ant 1	Ant 2	Ant 1	Ant 2	
11b	1Mbps	1	1	2412	0.03	0.03	-5.39	-5.10		2.76	2.64	8.00	8.00	Pass
11b	1Mbps	1	6	2437	0.03	0.03	-3.98	-4.81		2.76	2.64	8.00	8.00	Pass
11b	1Mbps	1	11	2462	0.03	0.03	-4.72	-5.71		2.76	2.64	8.00	8.00	Pass
11g	6Mbps	1	1	2412	0.21	0.21	-10.96	-11.92		2.76	2.64	8.00	8.00	Pass
11g	6Mbps	1	6	2437	0.21	0.21	-10.53	-9.91		2.76	2.64	8.00	8.00	Pass
11g	6Mbps	1	11	2462	0.21	0.21	-10.86	-11.68		2.76	2.64	8.00	8.00	Pass
HT20	MCS0	1	1	2412	0.19	0.20	-10.87	-11.02		2.76	2.64	8.00	8.00	Pass
HT20	MCS0	1	6	2437	0.19	0.20	-8.25	-7.44		2.76	2.64	8.00	8.00	Pass
HT20	MCS0	1	11	2462	0.19	0.20	-8.08	-7.63		2.76	2.64	8.00	8.00	Pass
HT40	MCS0	1	3	2422	0.38	0.38	-9.83	-9.77		2.76	2.64	8.00	8.00	Pass
HT40	MCS0	1	6	2437	0.38	0.38	-10.51	-10.09		2.76	2.64	8.00	8.00	Pass
HT40	MCS0	1	9	2452	0.38	0.38	-10.19	-9.39		2.76	2.64	8.00	8.00	Pass
11b	1Mbps	2	1	2412	0.04	0.04	-5.01	-4.93	-1.92	5.71		8.00		Pass
11b	1Mbps	2	6	2437	0.04	0.04	-5.22	-4.56	-1.55	5.71		8.00		Pass
11b	1Mbps	2	11	2462	0.04	0.04	-5.94	-5.95	-2.93	5.71		8.00		Pass
11g	6Mbps	2	1	2412	0.25	0.25	-11.77	-11.65	-8.64	5.71		8.00		Pass
11g	6Mbps	2	6	2437	0.25	0.25	-10.17	-9.85	-6.84	5.71		8.00		Pass
11g	6Mbps	2	11	2462	0.25	0.25	-11.80	-11.90	-8.79	5.71		8.00		Pass
HT20	MCS0	2	1	2412	0.23	0.23	-12.80	-11.90	-8.89	5.71		8.00		Pass
HT20	MCS0	2	6	2437	0.23	0.23	-7.57	-7.80	-4.56	5.71		8.00		Pass
HT20	MCS0	2	11	2462	0.23	0.23	-12.08	-12.62	-9.07	5.71		8.00		Pass
HT40	MCS0	2	3	2422	0.40	0.44	-16.96	-16.46	-13.45	5.71		8.00		Pass
HT40	MCS0	2	6	2437	0.40	0.44	-10.01	-10.17	-7.00	5.71		8.00		Pass
HT40	MCS0	2	9	2452	0.40	0.44	-19.20	-18.74	-15.73	5.71		8.00		Pass



Worst Case Power Density (dBm/3kHz) for MIMO Ant. 1

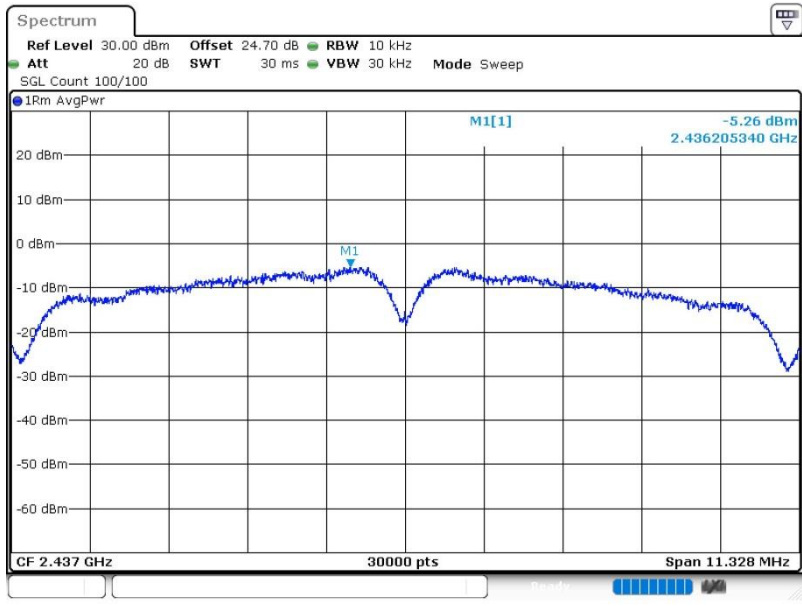

Date: 16.JAN.2019 15:04:28

Worst Case Power Density (dBm/3kHz) for MIMO Ant. 2

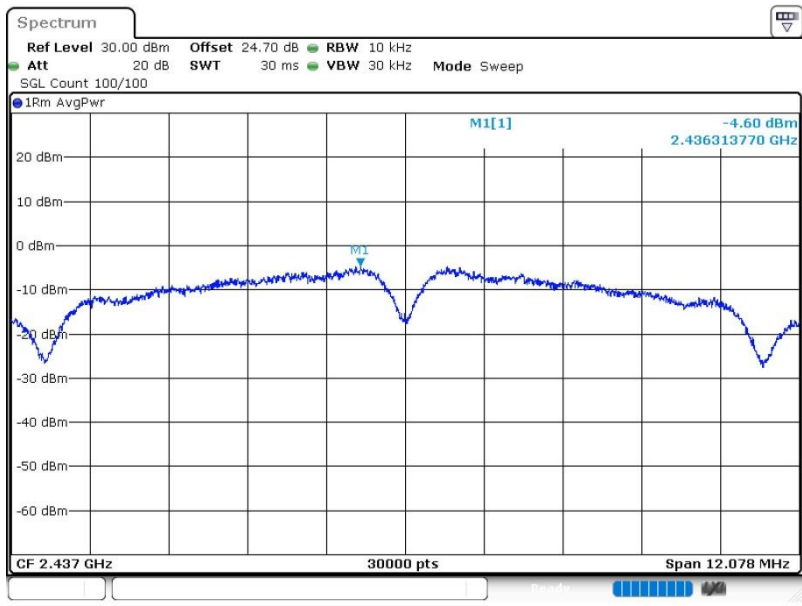

Date: 16.JAN.2019 15:05:14



<TXBF Mode>

2.4GHz Band														
Mod.	Data Rate	N _{TX}	CH.	Freq. (MHz)	Duty Factor (dB)		Average PSD (dBm/10kHz)			DG (dBi)		Average PSD Limit (dBm/3kHz)		Pass/Fail
					Ant 1	Ant 2	Ant 1	Ant 2	Worse + 3.01	Ant 1	Ant 2	Ant 1	Ant 2	
VHT20	MCS0	2	1	2412	0.00	0.00	-0.30	1.29	4.30	5.71	5.71	8.00	8.00	Pass
VHT20	MCS0	2	6	2437	0.00	0.00	-1.39	1.16	4.17	5.71	5.71	8.00	8.00	Pass
VHT20	MCS0	2	11	2462	0.00	0.00	-1.67	0.98	3.99	5.71	5.71	8.00	8.00	Pass
VHT40	MCS0	2	3	2422	0.00	0.00	-7.00	-5.56	-2.55	5.71	5.71	8.00	8.00	Pass
VHT40	MCS0	2	6	2437	0.00	0.00	-2.21	-1.13	1.88	5.71	5.71	8.00	8.00	Pass
VHT40	MCS0	2	9	2452	0.00	0.00	-8.75	-5.83	-2.82	5.71	5.71	8.00	8.00	Pass



Worst Case Power Density (dBm/3kHz) for MIMO Ant. 1

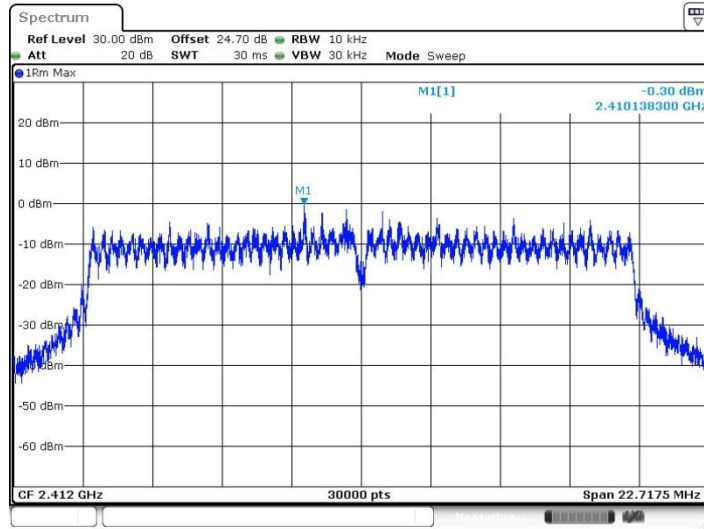

Date: 27.FEB.2019 19:04:08

Worst Case Power Density (dBm/3kHz) for MIMO Ant. 2

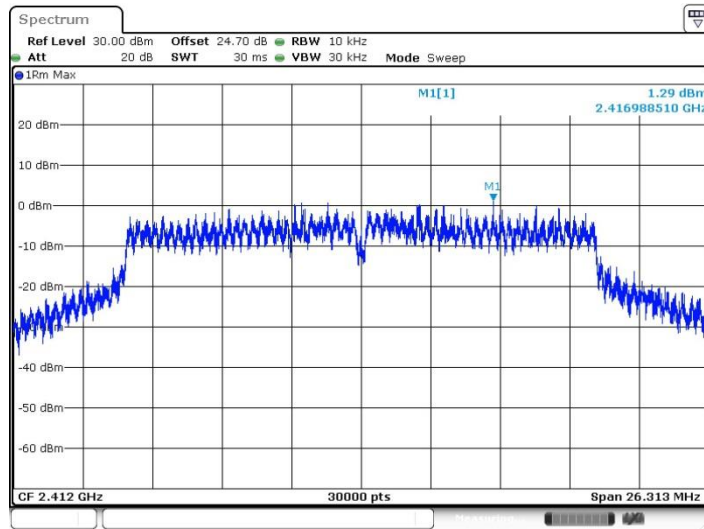

Date: 27.FEB.2019 19:05:53

3.4 Conducted Band Edges and Spurious Emission Measurement

3.4.1 Limit of Conducted Band Edges and Spurious Emission Measurement

In any 100 kHz bandwidth outside of the authorized frequency band, the emissions which fall in the non-restricted bands shall be attenuated at least 20 dB / 30dB relative to the maximum PSD level in 100 kHz by RF conducted measurement.

3.4.2 Measuring Instruments

See list of measuring equipment of this test report.

3.4.3 Test Procedures

1. The testing follows the ANSI C63.10 Section 11.11.3 Emission level measurement
2. The RF output of EUT was connected to the spectrum analyzer by RF cable and attenuator. The path loss was compensated to the results for each measurement.
3. Set to the maximum power setting and enable the EUT transmit continuously.
4. Set RBW = 100 kHz, VBW=300 kHz, Peak Detector. Unwanted Emissions measured in any 100 kHz bandwidth outside of the authorized frequency band shall be attenuated by at least 20 dB relative to the maximum in-band peak PSD level in 100 kHz when maximum peak conducted output power procedure is used. If the transmitter complies with the conducted power limits based on the use of RMS averaging over a time interval, the attenuation required under this paragraph shall be 30 dB instead of 20 dB per 15.247(d).
5. Measure and record the results in the test report.
6. The RF fundamental frequency should be excluded against the limit line in the operating frequency band.

3.4.4 Test Setup

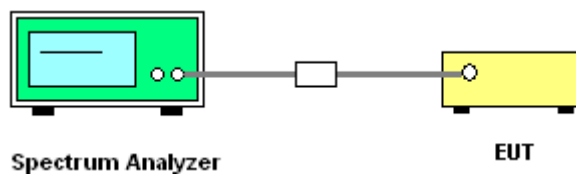

3.4.5 Test Result of Conducted Band Edges and Spurious Emission

Test Engineer :	Allen Lin and Derek Hsu	Temperature :	21~25°C
		Relative Humidity :	51~54%



<CDD Mode>

Number of TX = 1, Ant. 1 (Measured)

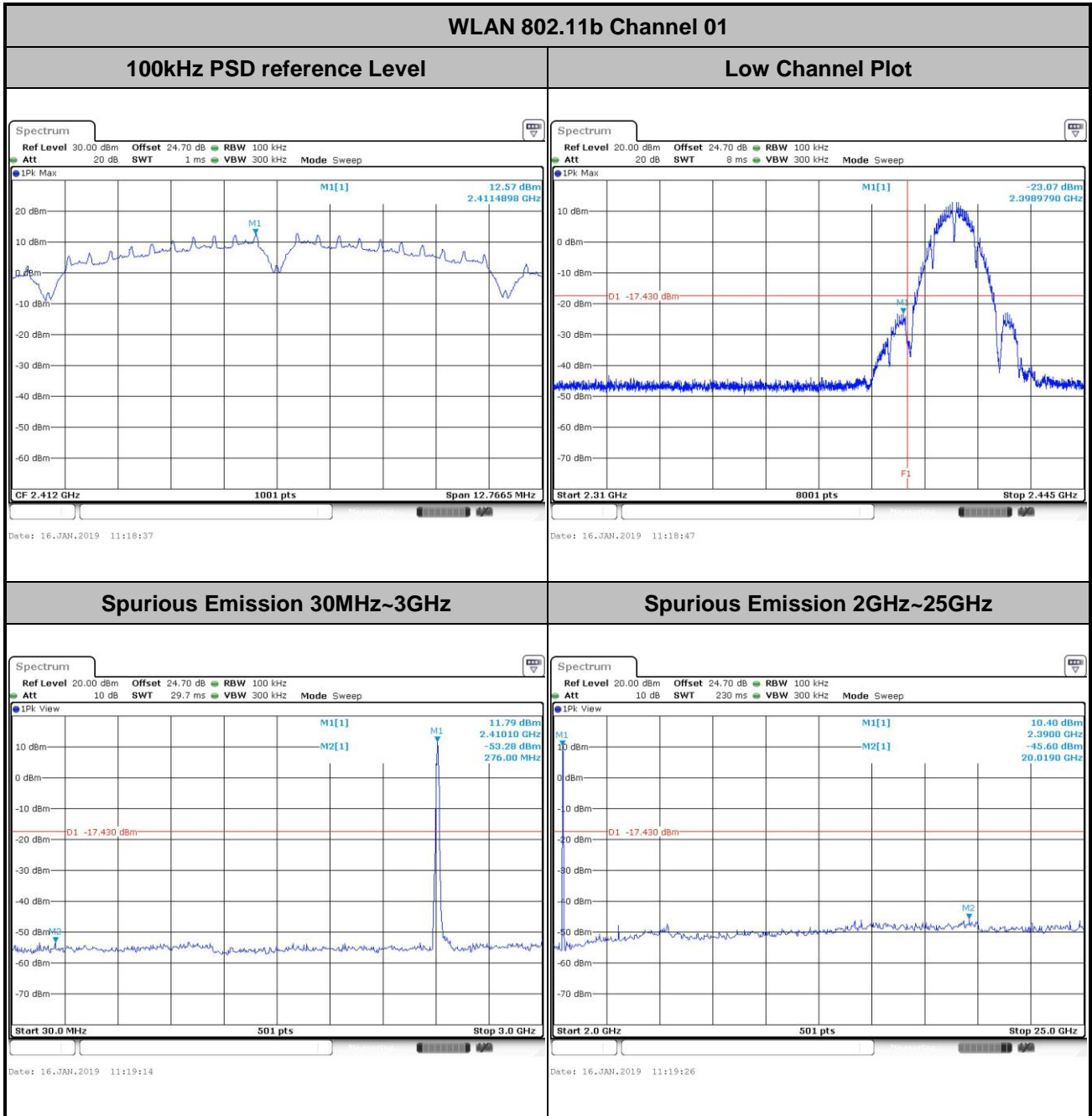



WLAN 802.11b Channel 06

100kHz PSD reference Level

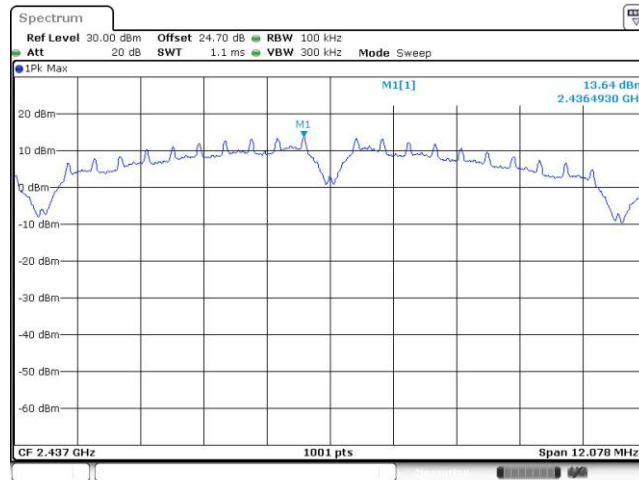

Date: 16.JAN.2019 10:10:31

Spurious Emission 30MHz~3GHz

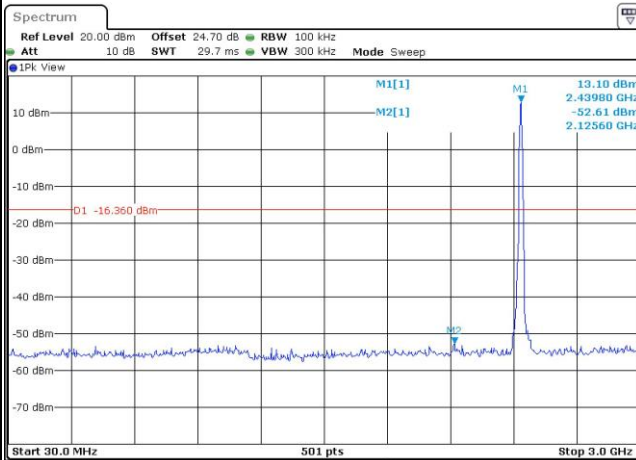

Date: 16.JAN.2019 10:11:31

Spurious Emission 2GHz~25GHz

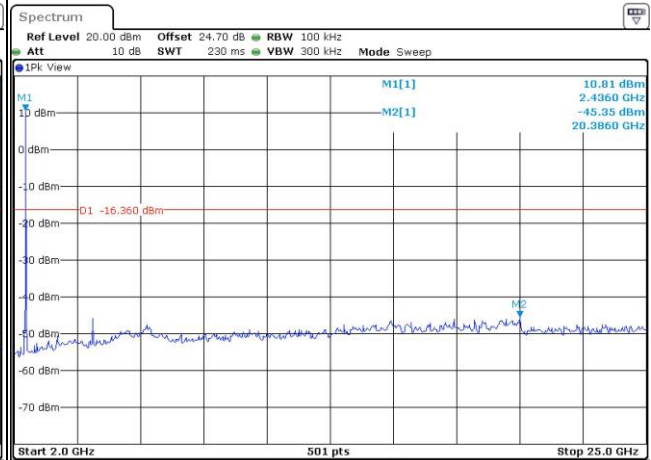

Date: 16.JAN.2019 10:11:43

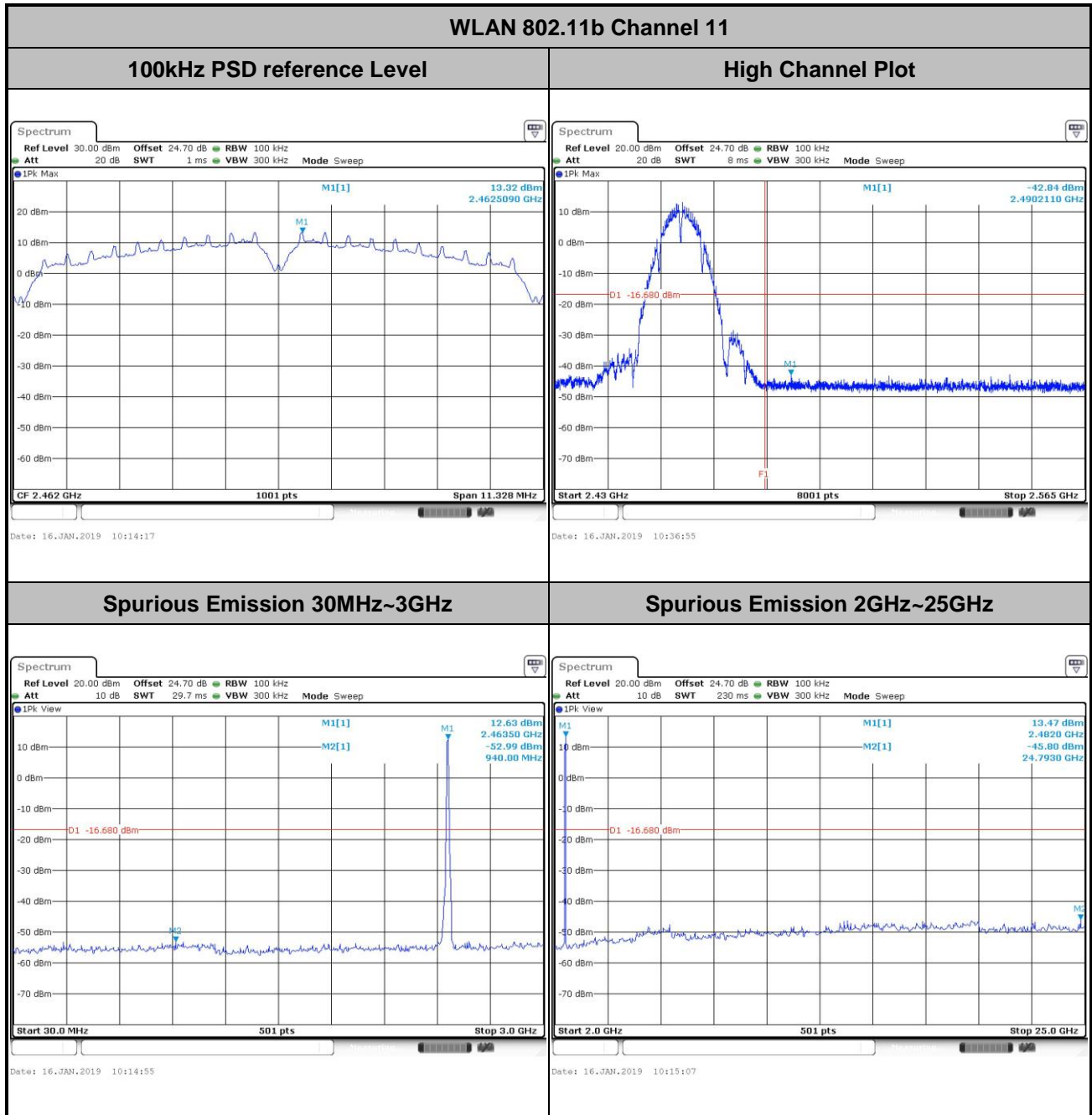



WLAN 802.11g Channel 01

100kHz PSD reference Level

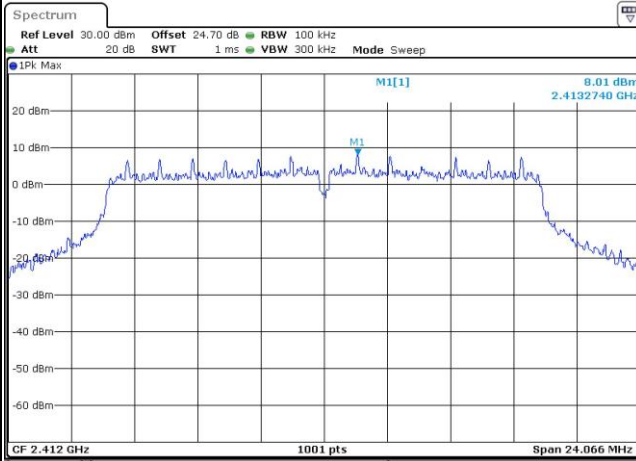

Date: 16.JAN.2019 11:36:40

Low Channel Plot

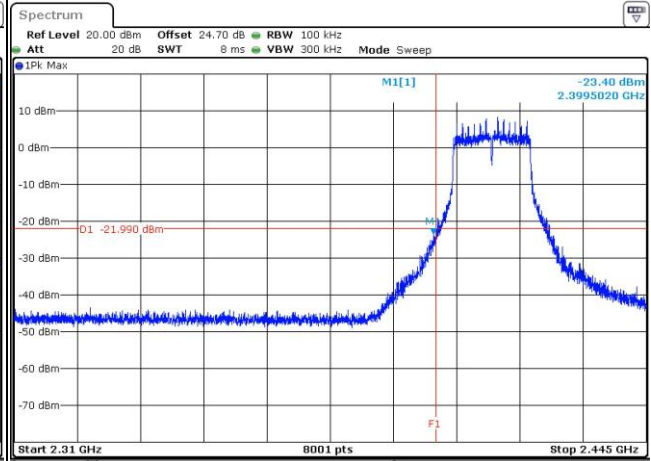

Date: 16.JAN.2019 11:36:59

Spurious Emission 30MHz~3GHz

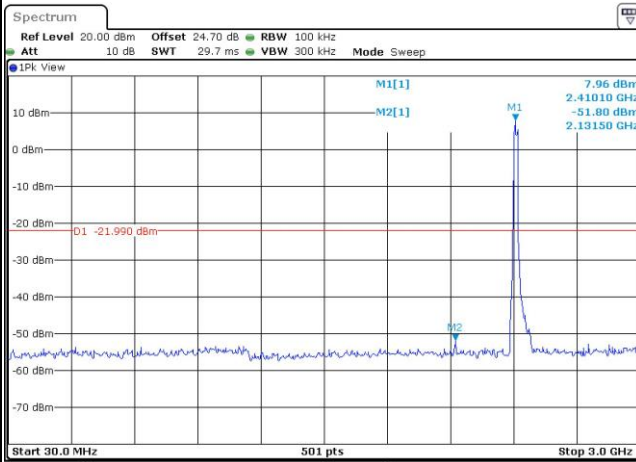

Date: 16.JAN.2019 12:29:24

Spurious Emission 2GHz~25GHz

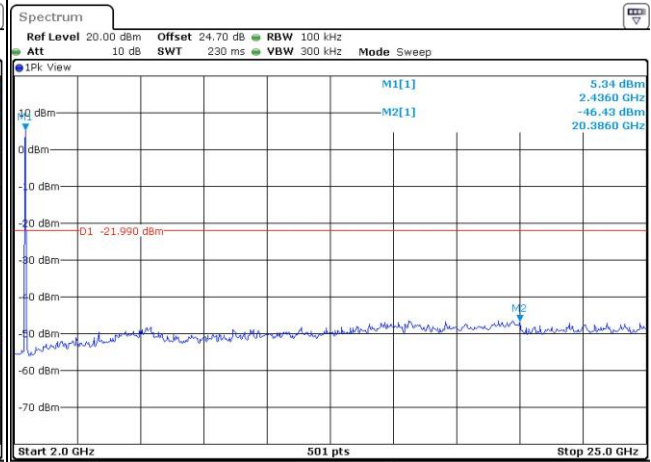

Date: 16.JAN.2019 12:29:37



WLAN 802.11g Channel 06

100kHz PSD reference Level

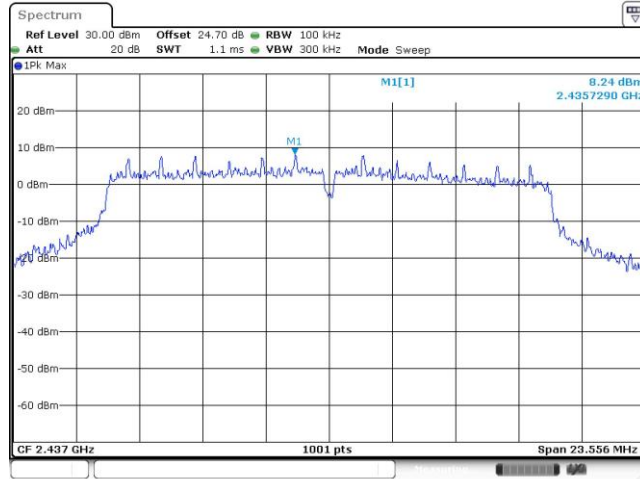

Spurious Emission 30MHz~3GHz

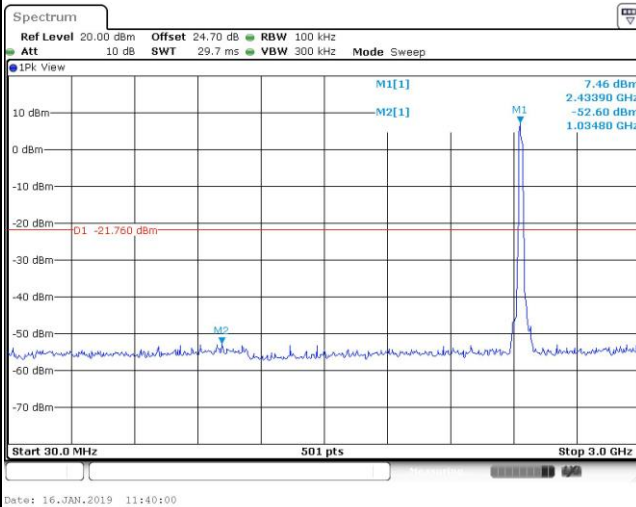

Spurious Emission 2GHz~25GHz

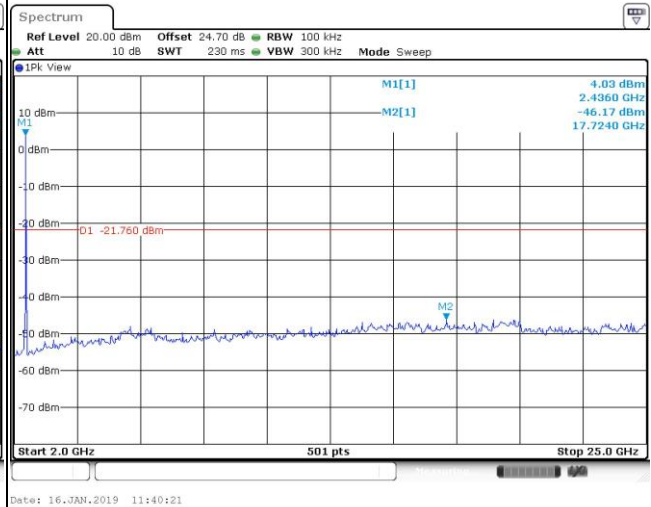



WLAN 802.11g Channel 11

100kHz PSD reference Level

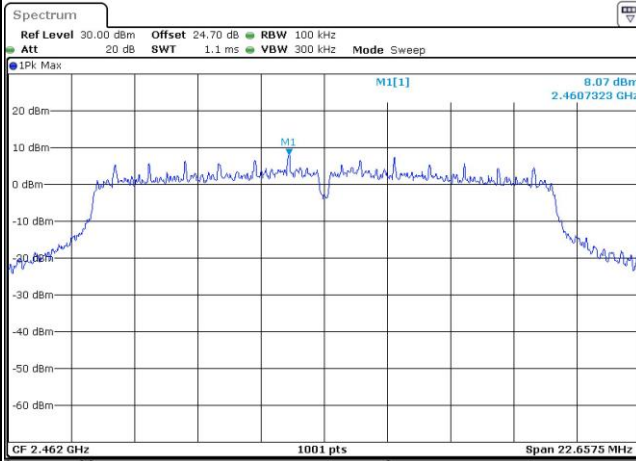

High Channel Plot

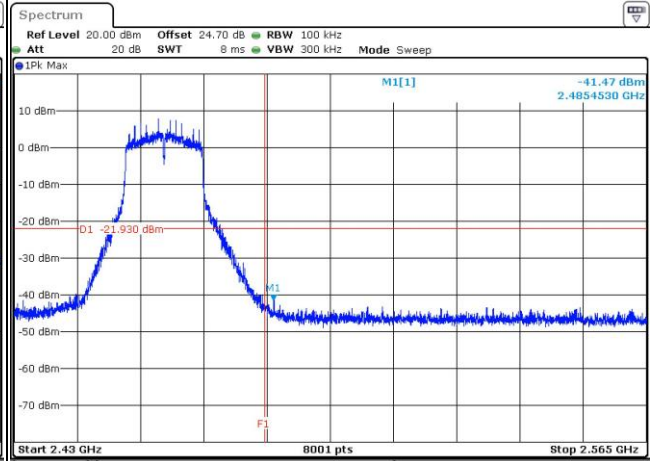

Spurious Emission 30MHz~3GHz

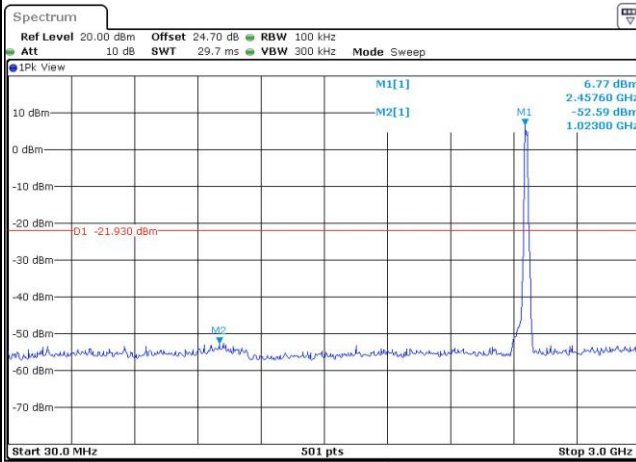

Spurious Emission 2GHz~25GHz

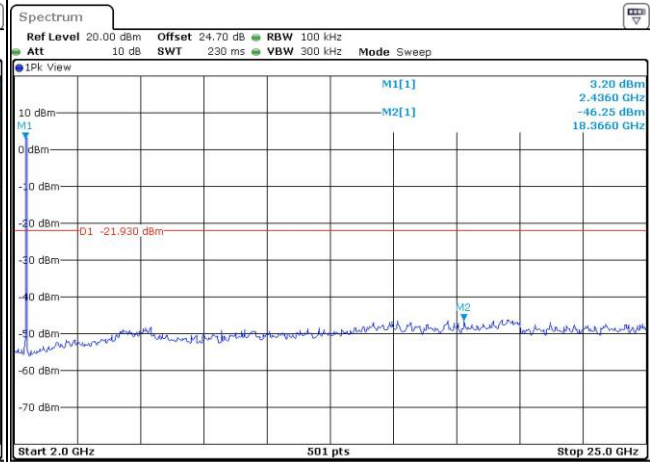

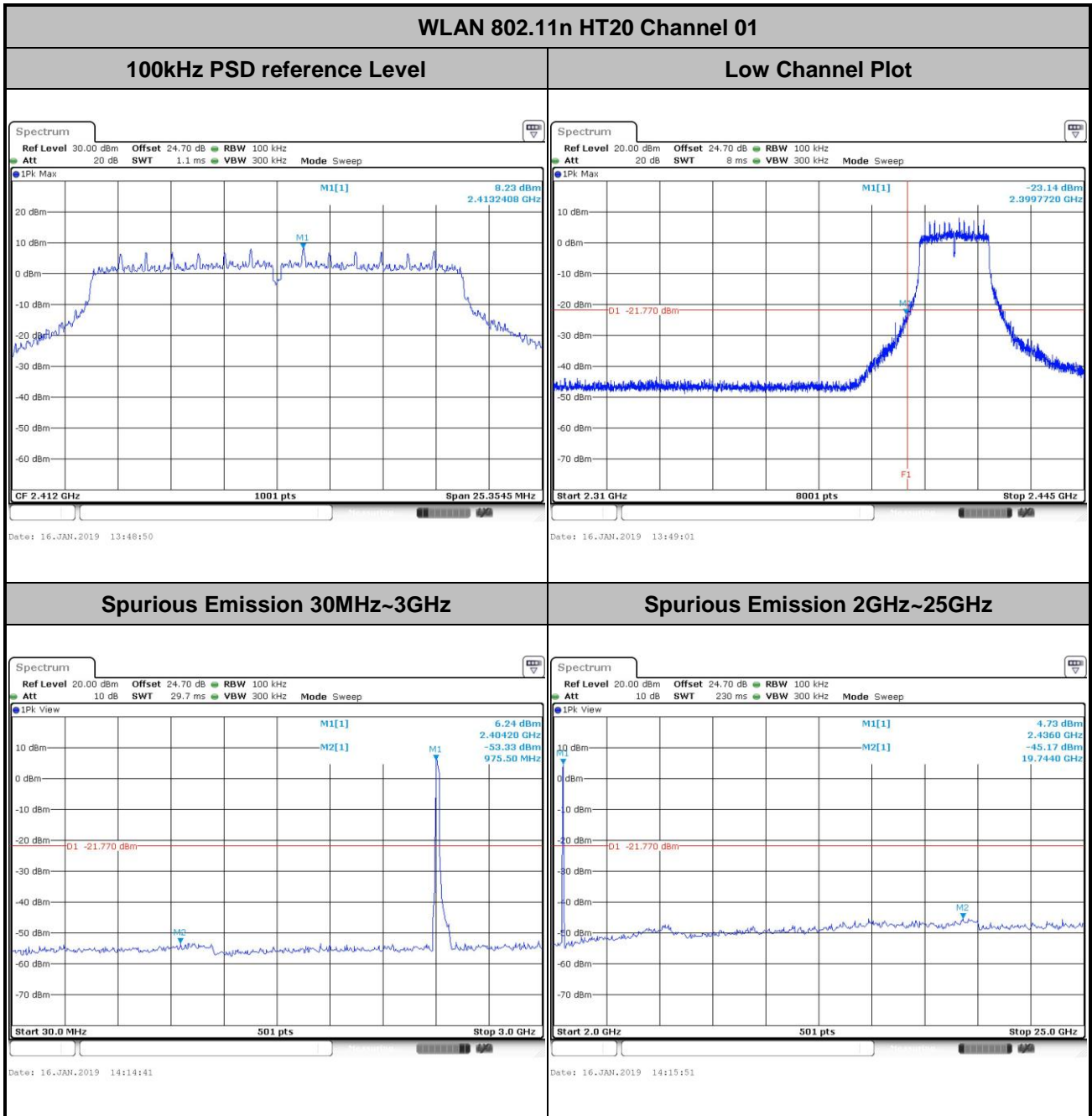



WLAN 802.11n HT20 Channel 06

100kHz PSD reference Level

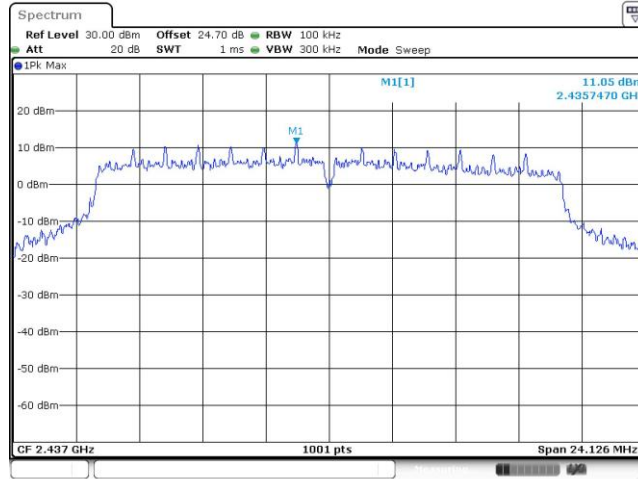

Date: 16.JAN.2019 13:53:44

Spurious Emission 30MHz~3GHz

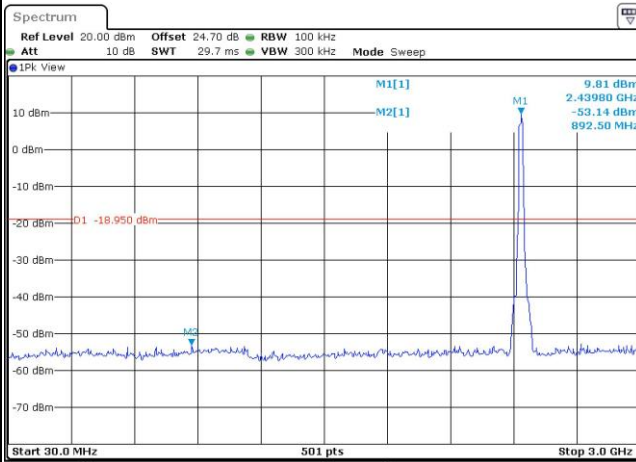

Date: 16.JAN.2019 13:54:53

Spurious Emission 2GHz~25GHz

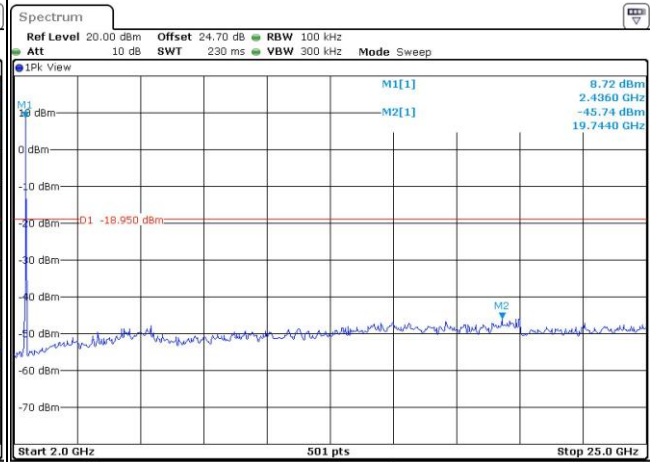

Date: 16.JAN.2019 13:55:28

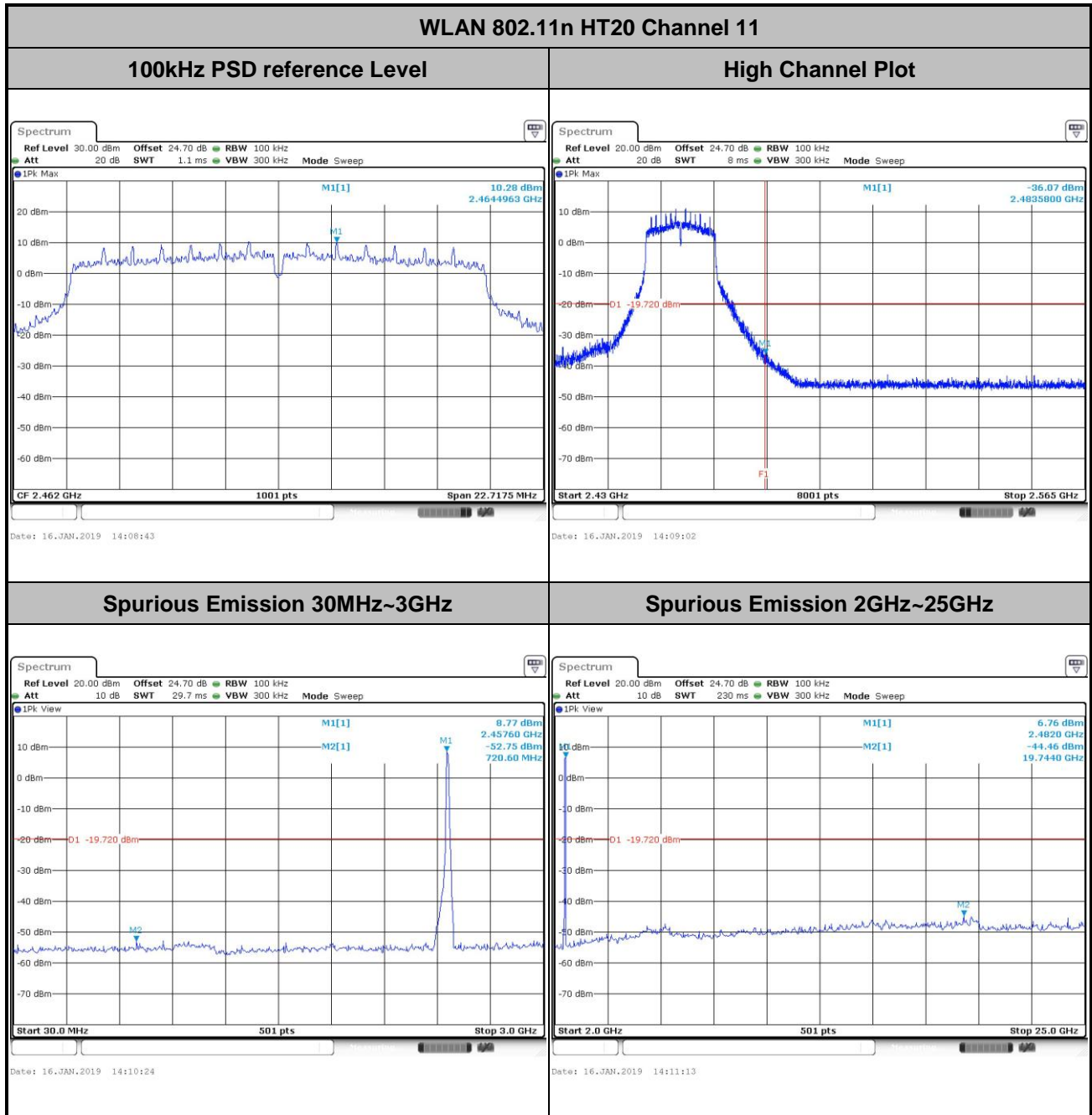

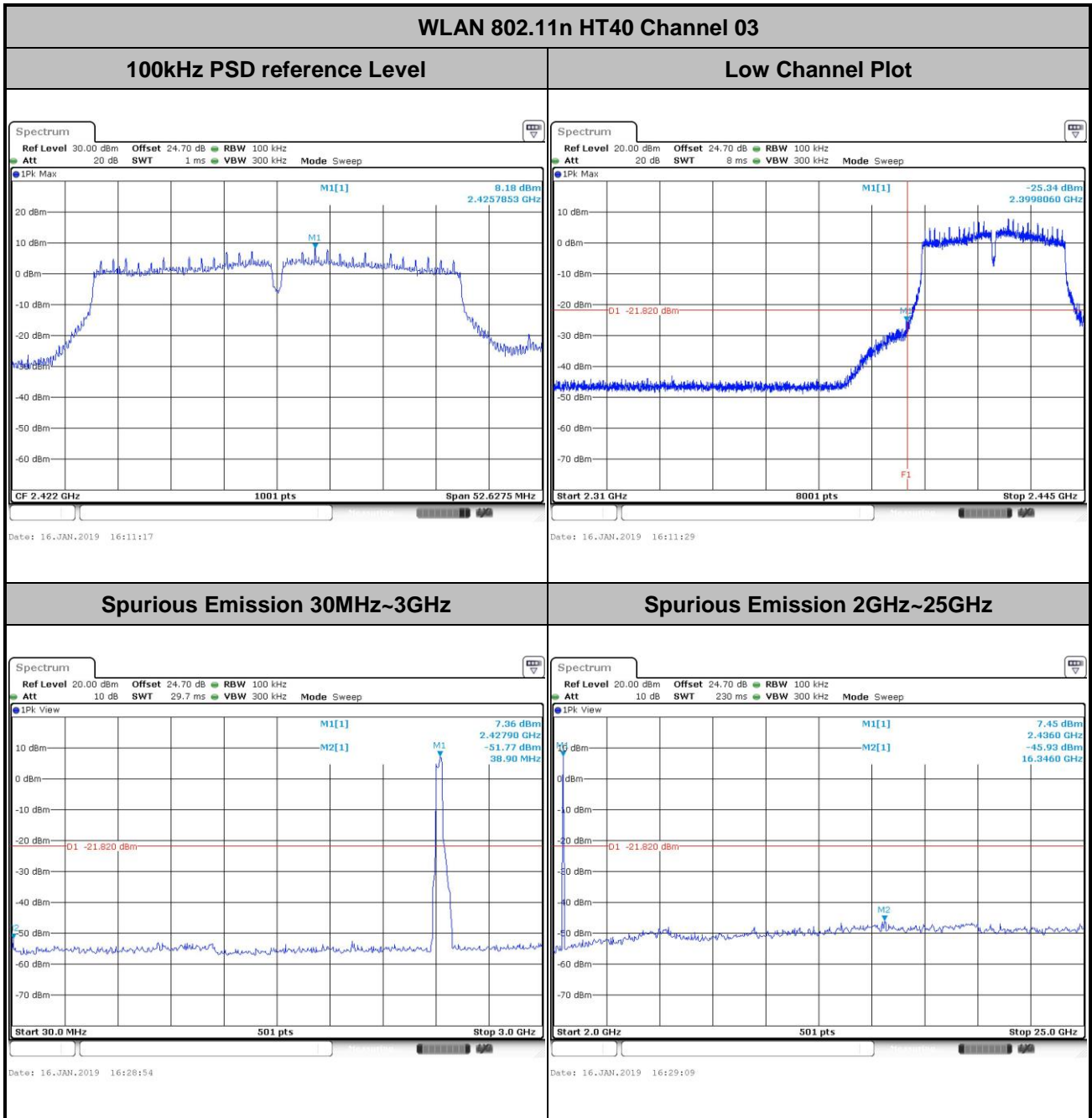



WLAN 802.11n HT40 Channel 06

100kHz PSD reference Level

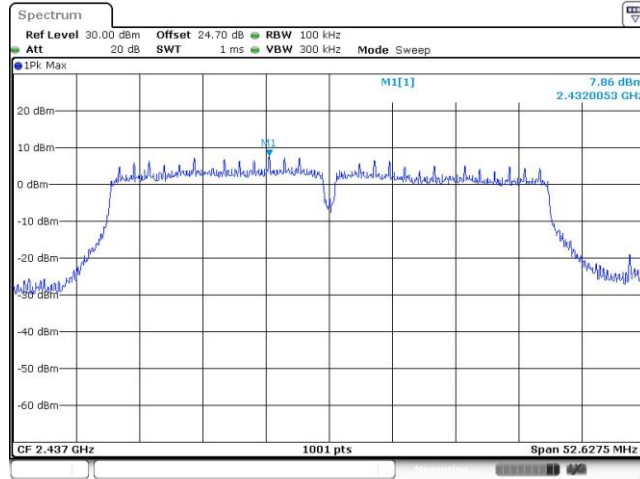

Spurious Emission 30MHz~3GHz

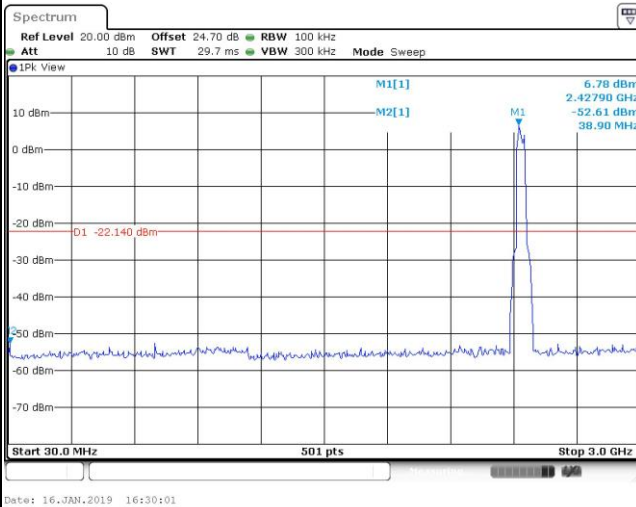

Spurious Emission 2GHz~25GHz

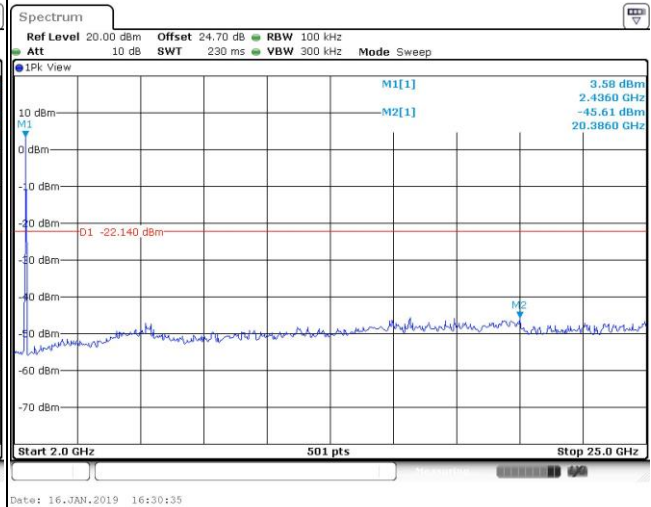

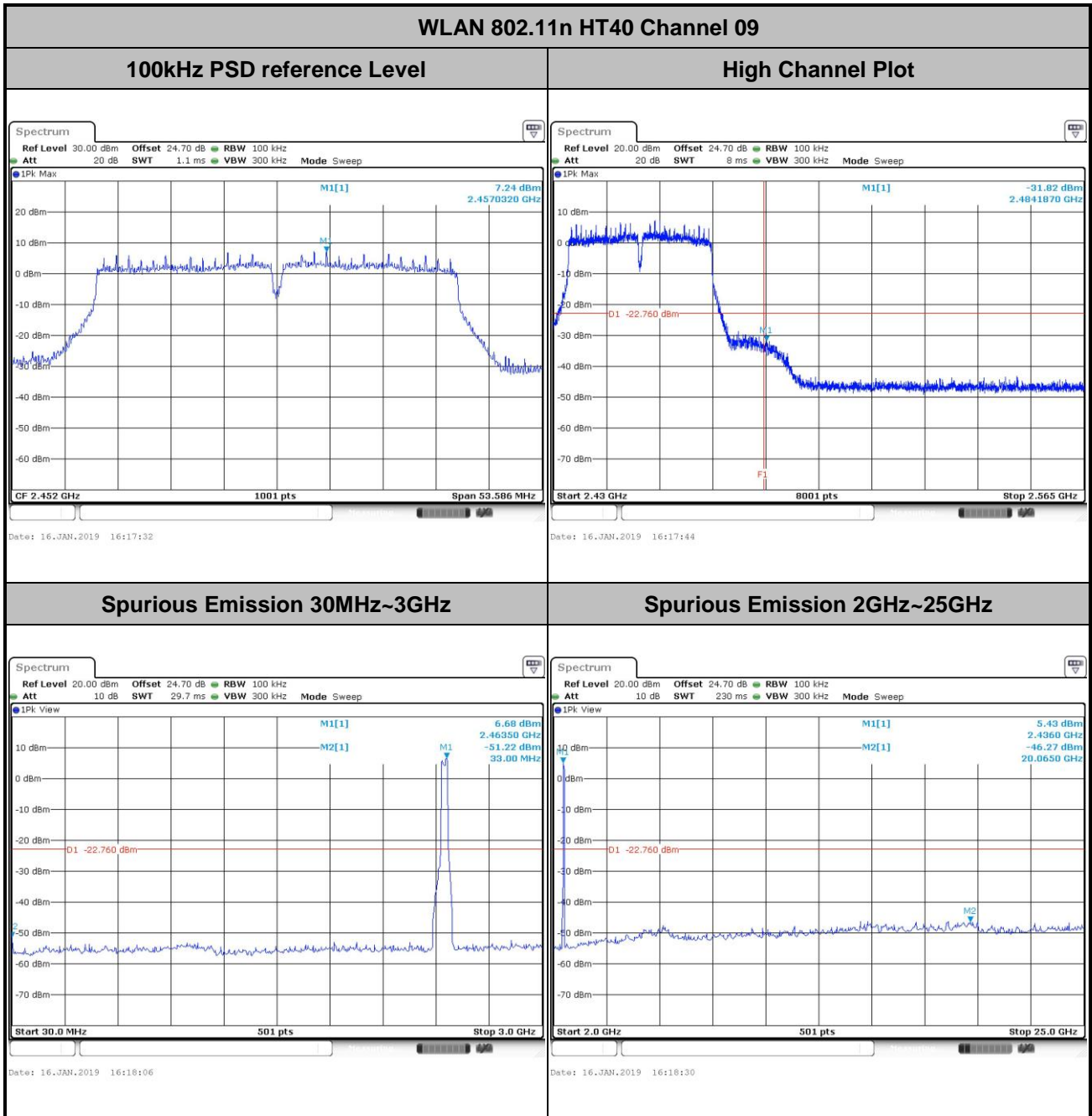



Number of TX = 1, Ant. 2 (Measured)

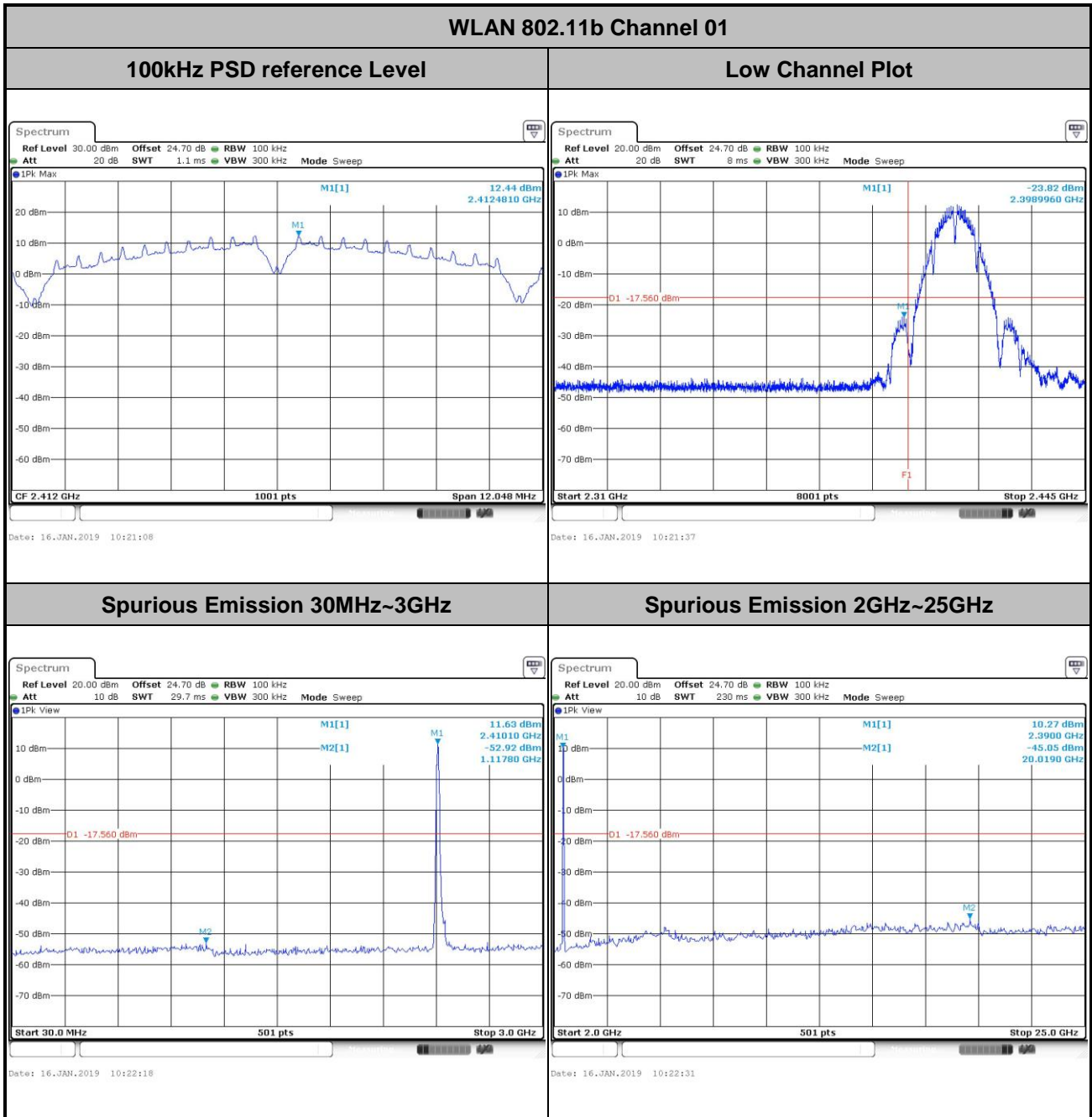



WLAN 802.11b Channel 06

100kHz PSD reference Level

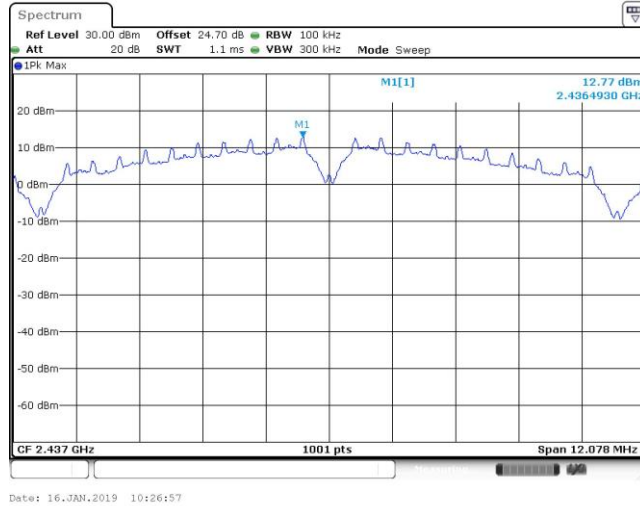

Spurious Emission 30MHz~3GHz

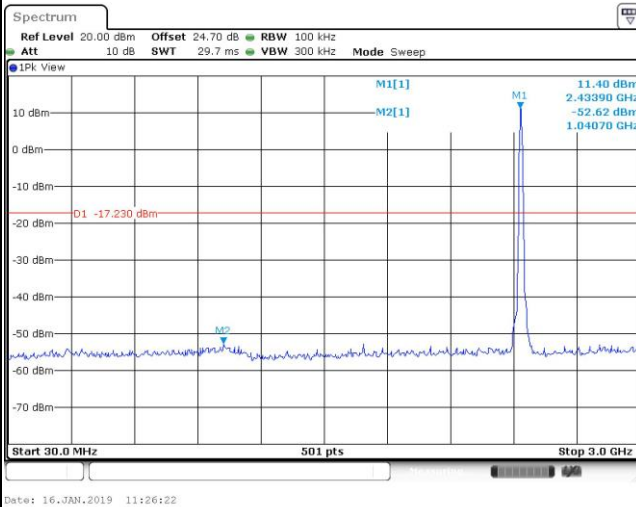

Spurious Emission 2GHz~25GHz

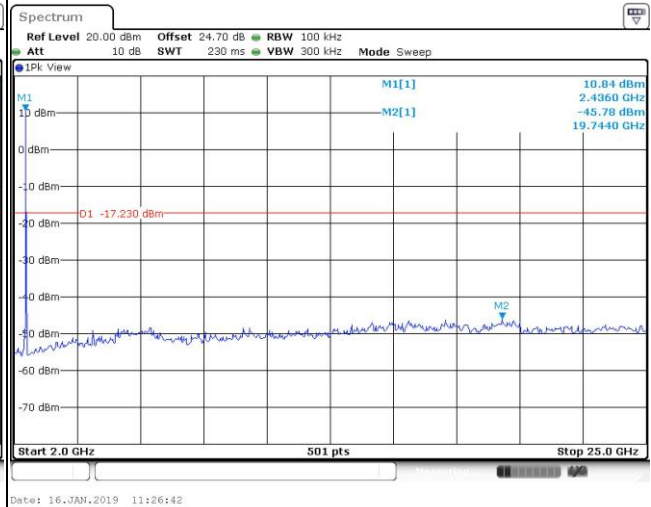



WLAN 802.11b Channel 11

100kHz PSD reference Level

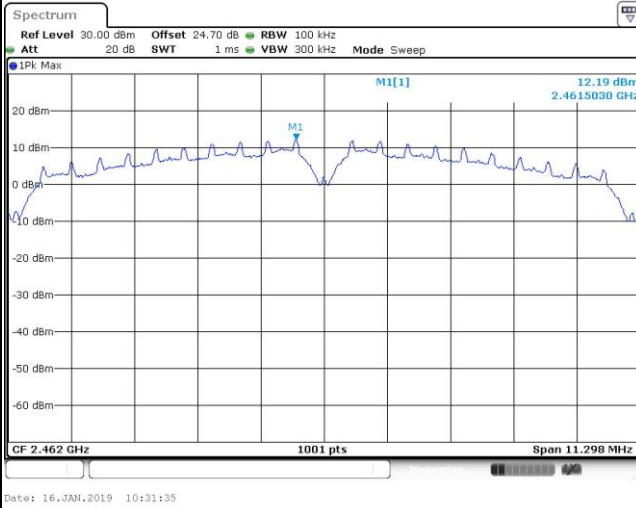

High Channel Plot

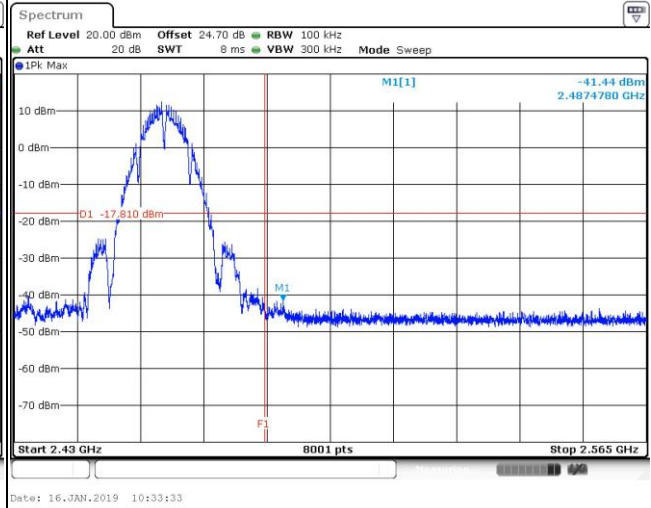

Spurious Emission 30MHz~3GHz

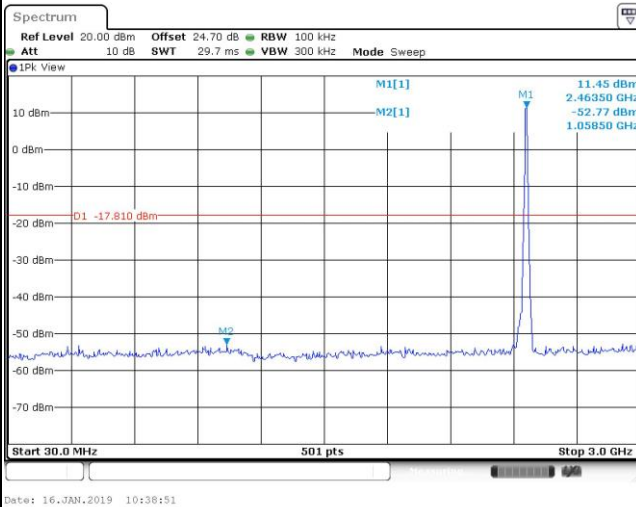

Spurious Emission 2GHz~25GHz

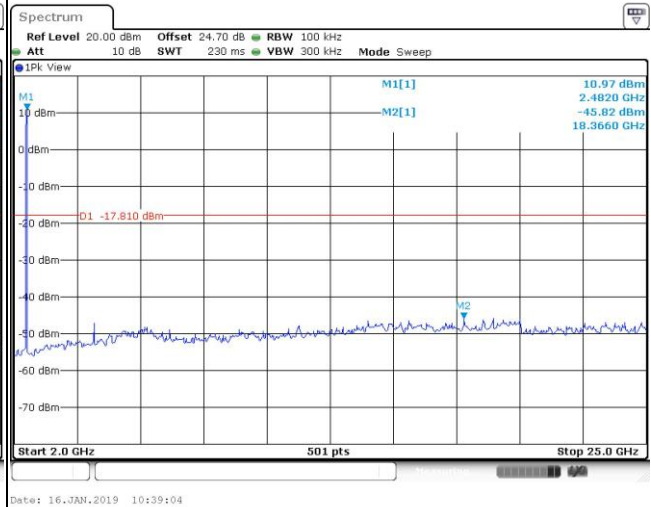



WLAN 802.11g Channel 01

100kHz PSD reference Level

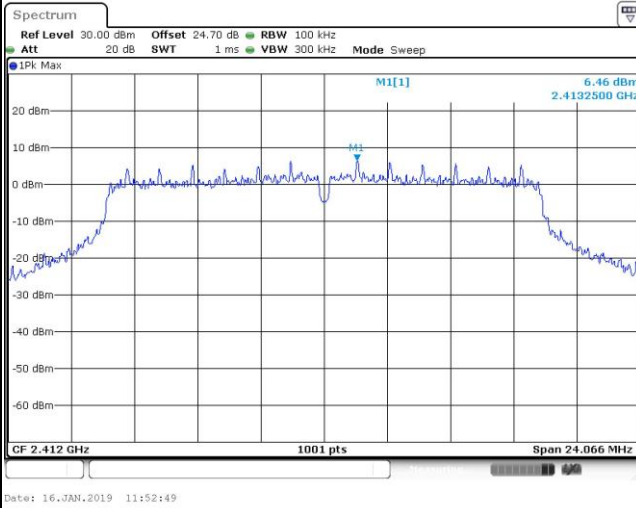

Low Channel Plot

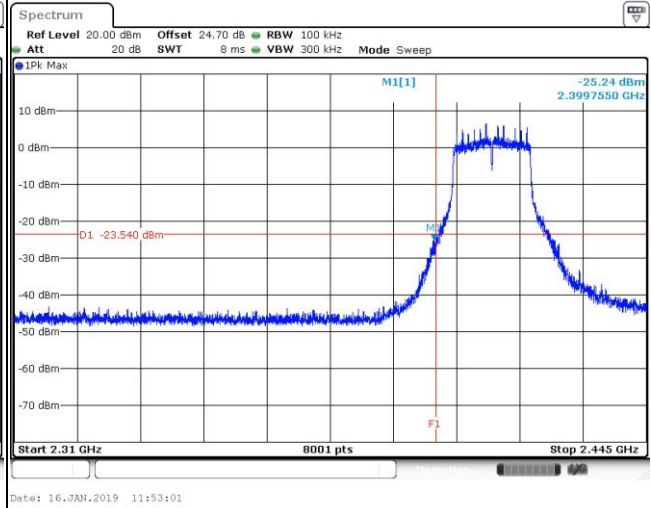

Spurious Emission 30MHz~3GHz

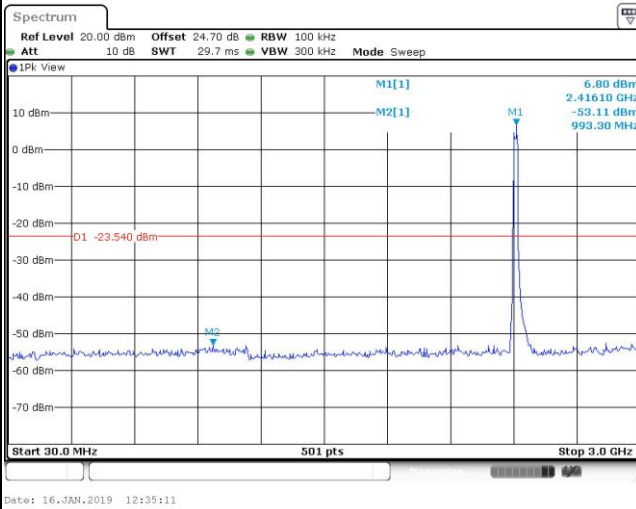

Spurious Emission 2GHz~25GHz

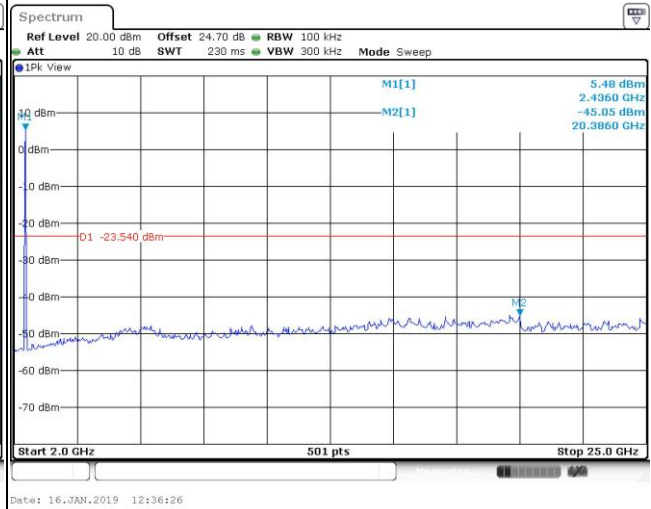



WLAN 802.11g Channel 06

100kHz PSD reference Level

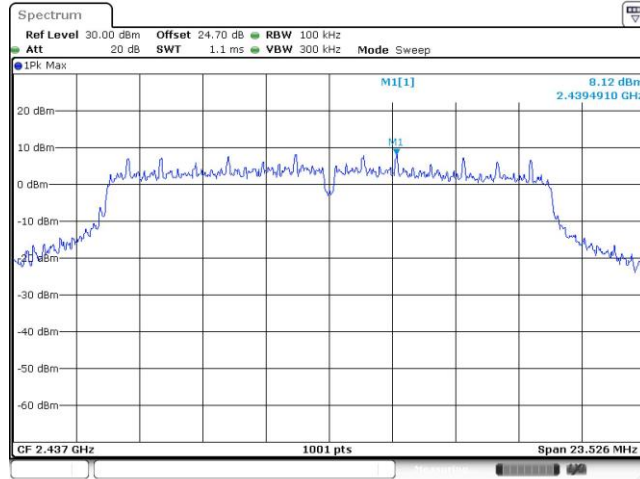

Spurious Emission 30MHz~3GHz

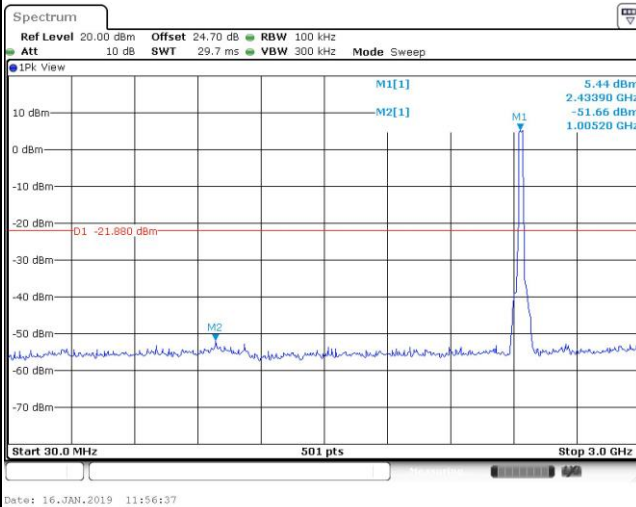

Spurious Emission 2GHz~25GHz

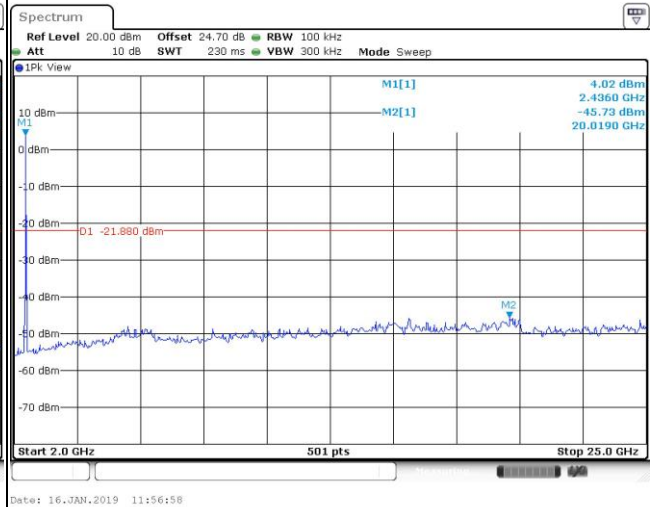



WLAN 802.11g Channel 11

100kHz PSD reference Level

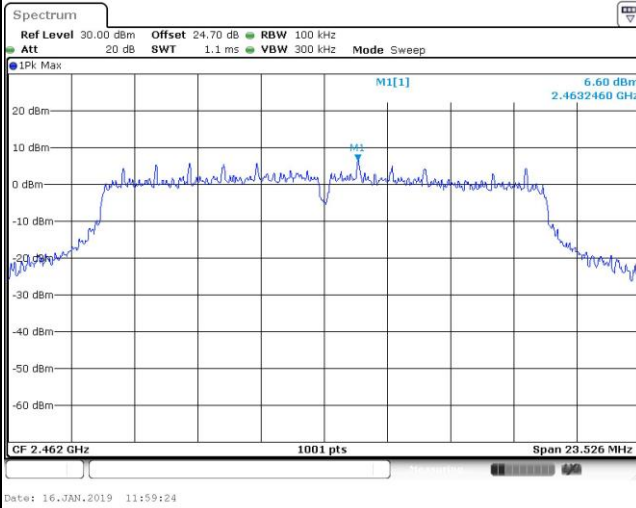

High Channel Plot

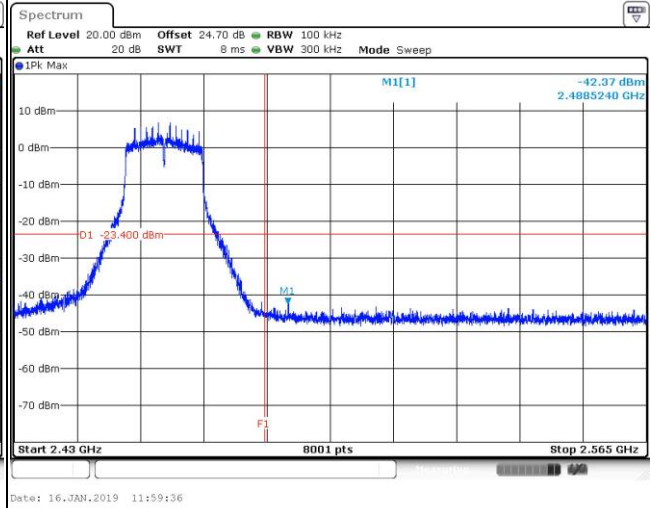

Spurious Emission 30MHz~3GHz

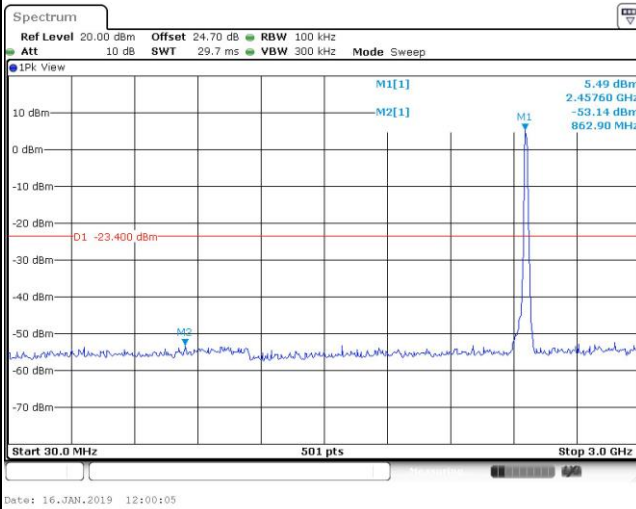

Spurious Emission 2GHz~25GHz

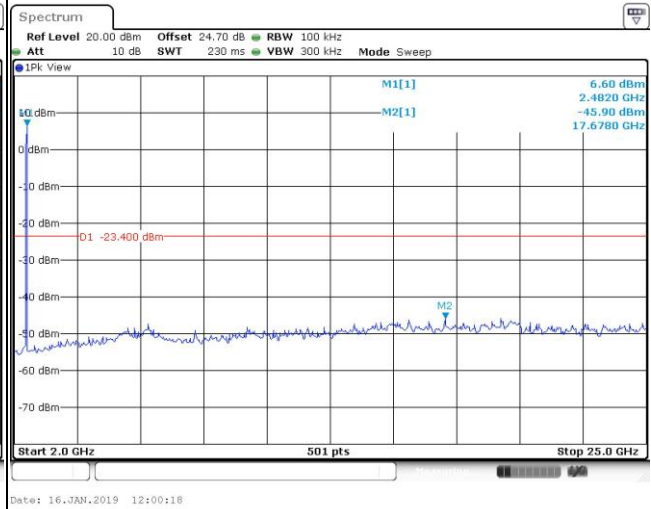

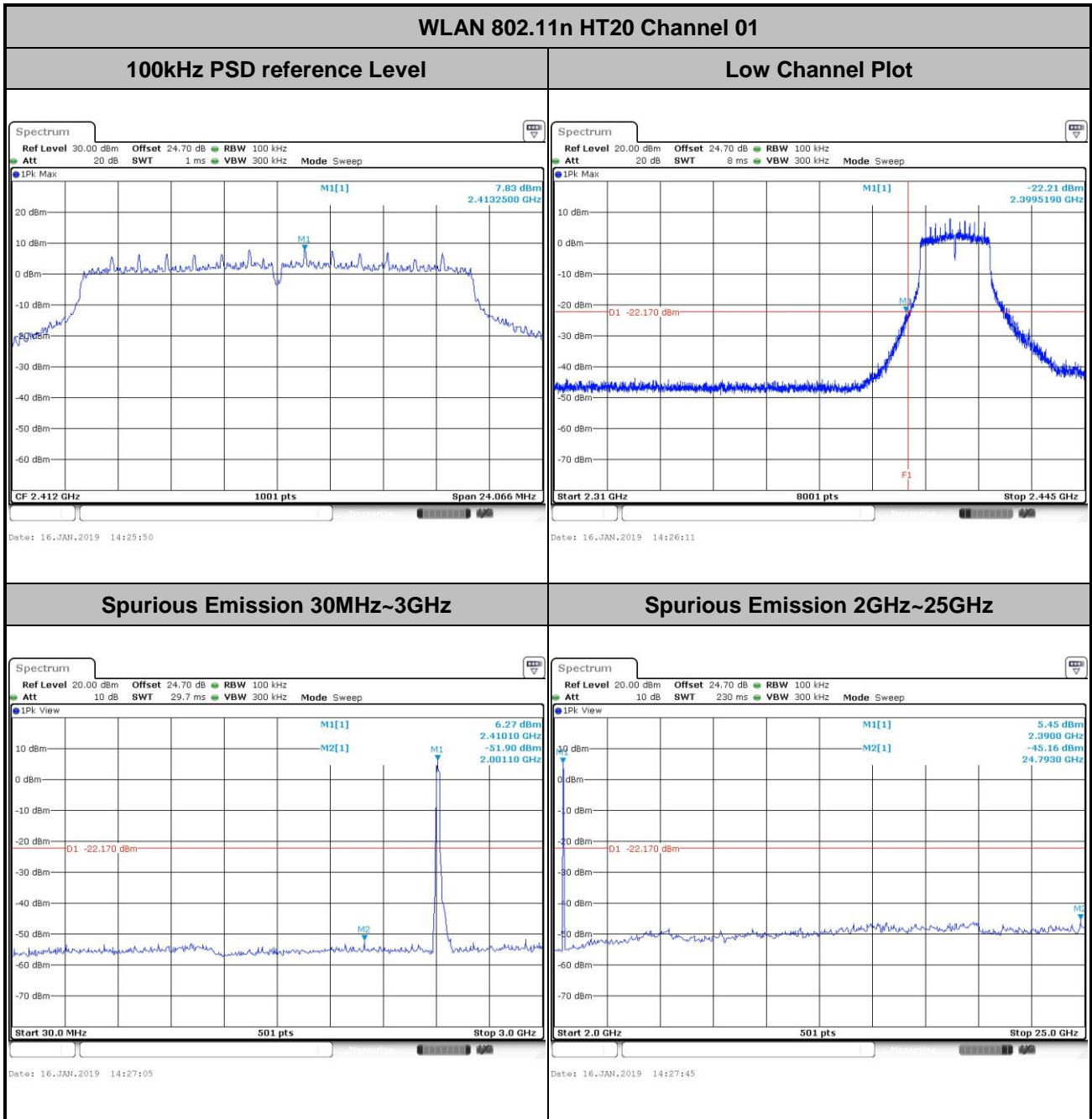



WLAN 802.11n HT20 Channel 06

100kHz PSD reference Level

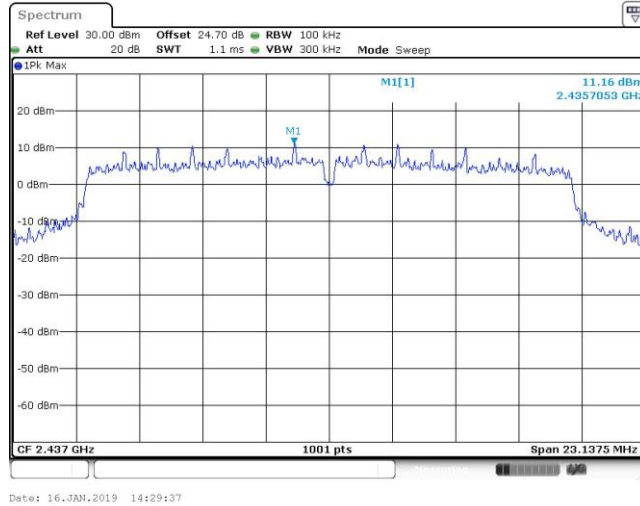

Spurious Emission 30MHz~3GHz

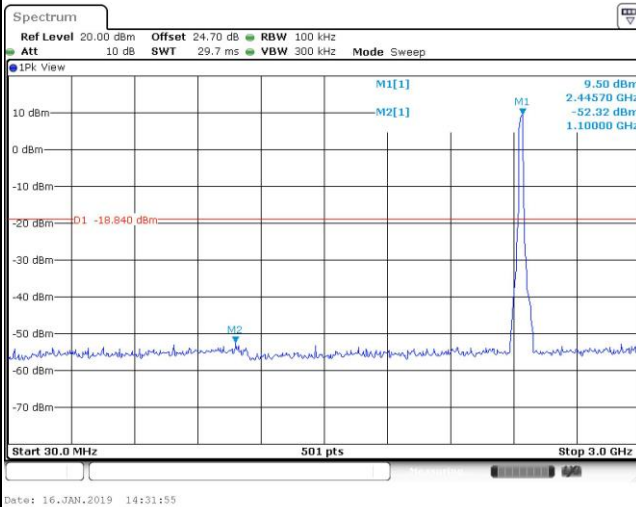

Spurious Emission 2GHz~25GHz

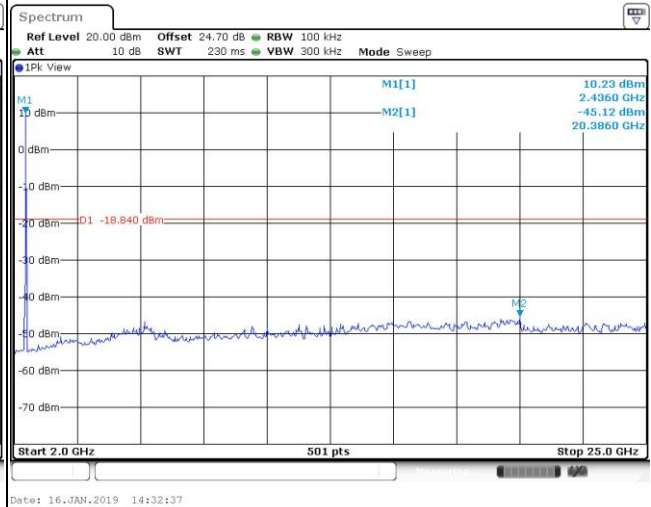

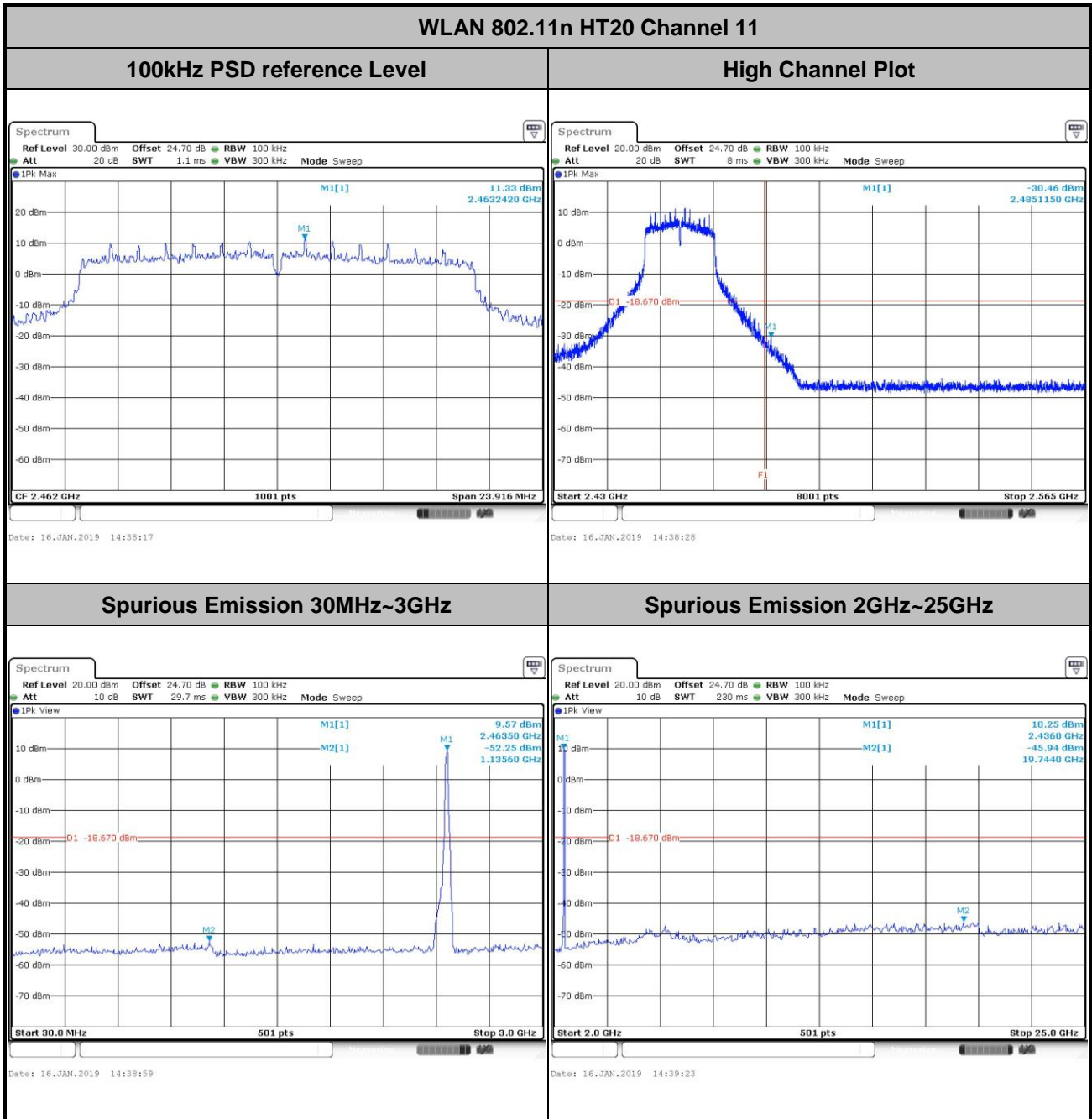

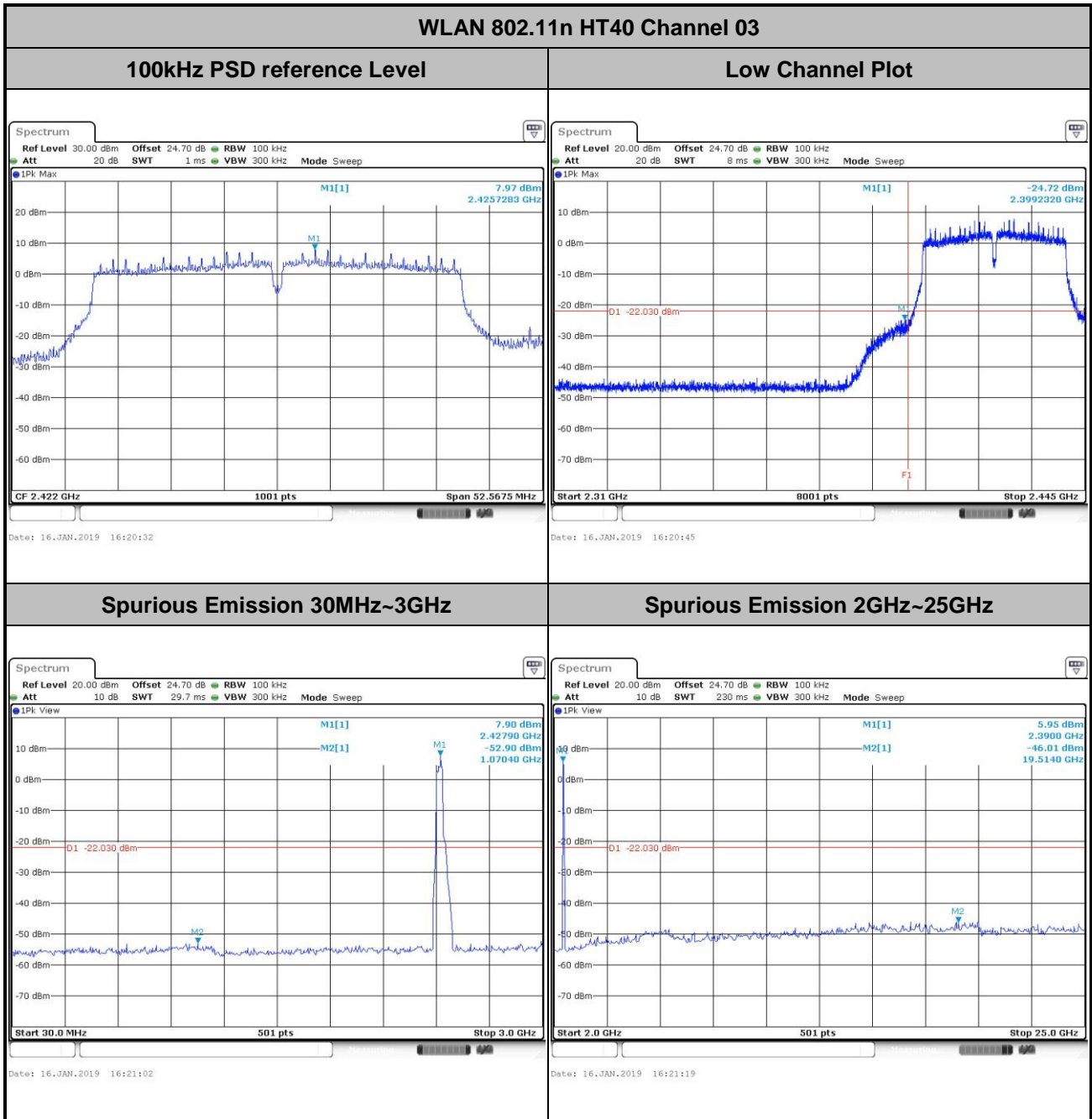



WLAN 802.11n HT40 Channel 06

100kHz PSD reference Level

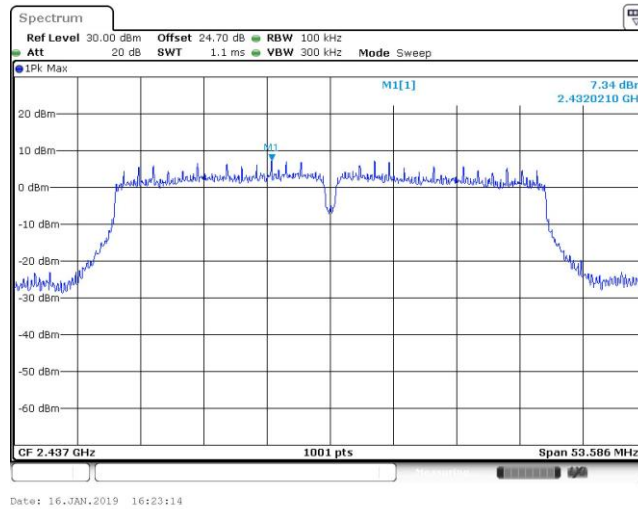

Spurious Emission 30MHz~3GHz

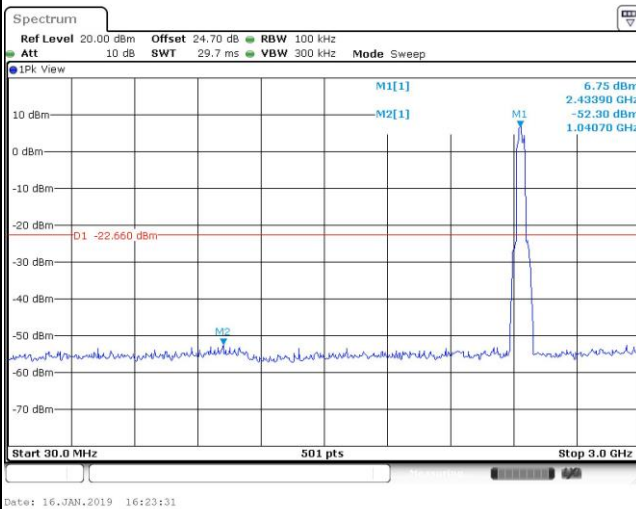

Spurious Emission 2GHz~25GHz

