



# FCC RADIO TEST REPORT

**FCC ID** : UZ7TC83BH  
**Equipment** : Mobile Computer  
**Brand Name** : ZEBRA  
**Model Name** : TC83BH  
**Applicant** : Zebra Technologies Corporation  
1 Zebra Plaza, Holtsville, NY 11742  
**Manufacturer** : Zebra Technologies Corporation  
1 Zebra Plaza, Holtsville, NY 11742  
**Standard** : FCC Part 15 Subpart C §15.247

The product was received on Nov. 01, 2018 and testing was started from Nov. 08, 2018 and completed on Mar. 11, 2019. We, SPORTON INTERNATIONAL INC. EMC & Wireless Communications Laboratory, would like to declare that the tested sample has been evaluated in accordance with the test procedures and has been in compliance with the applicable technical standards.

The report must not be used by the client to claim product certification, approval, or endorsement by TAF or any agency of government.

The test results in this report apply exclusively to the tested model / sample. Without written approval of SPORTON INTERNATIONAL INC. EMC & Wireless Communications Laboratory, the test report shall not be reproduced except in full.

Approved by: Jones Tsai

**SPORTON INTERNATIONAL INC. EMC & Wireless Communications Laboratory**

No. 52, Huaya 1st Rd., Guishan Dist., Taoyuan City, Taiwan (R.O.C.)



## Table of Contents

<b>History of this test report.....</b>	<b>3</b>
<b>Summary of Test Result.....</b>	<b>4</b>
<b>1 General Description.....</b>	<b>5</b>
1.1 Product Feature of Equipment Under Test.....	5
1.2 Product Specification of Equipment Under Test.....	6
1.3 Modification of EUT .....	6
1.4 Testing Location .....	6
1.5 Applicable Standards.....	7
<b>2 Test Configuration of Equipment Under Test.....</b>	<b>8</b>
2.1 Carrier Frequency Channel .....	8
2.2 Test Mode.....	9
2.3 Connection Diagram of Test System.....	11
2.4 Support Unit used in test configuration and system .....	12
2.5 EUT Operation Test Setup .....	12
2.6 Measurement Results Explanation Example.....	12
<b>3 Test Result.....</b>	<b>13</b>
3.1 6dB and 99% Bandwidth Measurement .....	13
3.2 Output Power Measurement.....	22
3.3 Power Spectral Density Measurement .....	24
3.4 Conducted Band Edges and Spurious Emission Measurement .....	32
3.5 Radiated Band Edges and Spurious Emission Measurement .....	41
3.6 AC Conducted Emission Measurement.....	45
3.7 Antenna Requirements.....	47
<b>4 List of Measuring Equipment .....</b>	<b>48</b>
<b>5 Uncertainty of Evaluation.....</b>	<b>50</b>
<b>Appendix A. AC Conducted Emission Test Result</b>	
<b>Appendix B. Radiated Spurious Emission</b>	
<b>Appendix C. Radiated Spurious Emission Plots</b>	
<b>Appendix D. Duty Cycle Plots</b>	
<b>Appendix E. Setup Photographs</b>	



### History of this test report

Report No.	Version	Description	Issued Date
FR8N0131-01B	01	Initial issue of report	Mar. 27, 2019



## Summary of Test Result

Report Clause	Ref Std. Clause	Test Items	Result (PASS/FAIL)	Remark
3.1	15.247(a)(2)	6dB Bandwidth	Pass	-
3.1	2.1049	99% Occupied Bandwidth	Reporting only	-
3.2	15.247(b)(3)	Peak Output Power	Pass	-
3.3	15.247(e)	Power Spectral Density	Pass	-
3.4	15.247(d)	Conducted Band Edges and Spurious Emission	Pass	-
3.5	15.247(d)	Radiated Band Edges and Spurious Emission	Pass	Under limit 5.20 dB at 895.700 MHz
3.6	15.207	AC Conducted Emission	Pass	Under limit 12.02 dB at 0.755 MHz
3.7	15.203 & 15.247(b)	Antenna Requirement	Pass	-

**Declaration of Conformity:**

The test results with all measurement uncertainty excluded are presented in accordance with the regulation limits or requirements declared by manufacturers.

**Comments and Explanations:**

The declared of product specification for EUT presented in the report are provided by the manufacturer, and the manufacturer takes all the responsibilities for the accuracy of product specification.

**Reviewed by: Wii Chang****Report Producer: Polly Tsai**



# 1 General Description

## 1.1 Product Feature of Equipment Under Test

Product Feature	
Equipment	Mobile Computer
Brand Name	ZEBRA
Model Name	TC83BH
FCC ID	UZ7TC83BH
Sample 1	EUT with Scanner 1 (SE4750SR)
Sample 2	EUT with Scanner 2 (SE4750MR)
Sample 3	EUT with Scanner 3 (SE4850)
EUT supports Radios application	NFC WLAN 11a/b/g/n HT20/HT40 WLAN 11ac VHT20/VHT40/VHT80 Bluetooth BR/EDR/LE
HW Version	EV
SW Version	01-12-13.00-OG-U00-PRD
FW Version	FUSION_QA_2_1.1.0.003_O
MFD	17-Oct-18
EUT Stage	Engineering Sample

Remark: The above EUT's information was declared by manufacturer.

Specification of Accessories				
Battery 1	Brand Name	Zebra	Part Number	BT-000380
Battery 2	Brand Name	Zebra	Part Number	82-176054-01
Headset 1	Brand Name	Zebra	Part Number	HDST-35MM-PTVP-01
Audio adapter cable 1	Brand Name	Zebra	Part Number	CBL-TC8X-AUDBJ-01
Headset 2	Brand Name	Zebra	Part Number	HS2100-OTH
HS2100 to Quick Disconnect Cable	Brand Name	Zebra	Part Number	CBL-HS2100-QDC1-01
Audio adapter cable 2	Brand Name	Zebra	Part Number	CBL-TC8X-AUDQD-01
Hand Strap	Brand Name	Zebra	Part Number	SG-TC8X-HDSTP-01
USB Cable	Brand Name	Zebra	Part Number	CBL-TC8X-USBCHG-01
Holster 1	Brand Name	Zebra	Part Number	SG-TC8X-QDHLST-01
Holster 2	Brand Name	Zebra	Part Number	SG-TC8X-PMHLST-01
Adapter	Brand Name	Zebra	Part Number	PWR-BUA5V16W0WW
DC Line Cord	Brand Name	Zebra	Part Number	CBL-DC-383A1-01

Remark: USB cable was modified, all test item with this modified cable.



## 1.2 Product Specification of Equipment Under Test

Standards-related Product Specification	
Tx/Rx Frequency Range	2402 MHz ~ 2480 MHz
Number of Channels	40
Carrier Frequency of Each Channel	40 Channel(37 hopping + 3 advertising channel)
Maximum Output Power to Antenna	3.30 dBm (0.0021 W) for 1Mbps 3.39 dBm (0.0022 W) for 2Mbps
99% Occupied Bandwidth	1.027 MHz for 1Mbps 2.038 MHz for 2Mbps
Antenna Type / Gain	Dipole Antenna type with gain 2.76 dBi
Type of Modulation	Bluetooth LE : GFSK

## 1.3 Modification of EUT

No modifications are made to the EUT during all test items.

## 1.4 Testing Location

Test Site	SPORTON INTERNATIONAL INC.	
Test Site Location	No.52, Huaya 1st Rd., Guishan Dist., Taoyuan City, Taiwan (R.O.C.) TEL: +886-3-327-3456 FAX: +886-3-328-4978	
Test Site No.	<b>Sporton Site No.</b>	
	TH05-HY	CO05-HY

**Note:** The test site complies with ANSI C63.4 2014 requirement.

Test Site	SPORTON INTERNATIONAL INC.	
Test Site Location	No.58, Aly. 75, Ln. 564, Wenhua 3rd, Rd., Guishan Dist., Taoyuan City, Taiwan (R.O.C.) TEL: +886-3-327-0868 FAX: +886-3-327-0855	
Test Site No.	<b>Sporton Site No.</b>	
	03CH13-HY	

**Note:** The test site complies with ANSI C63.4 2014 requirement.

FCC Designation No. TW1190 and TW0007



## **1.5 Applicable Standards**

According to the specifications of the manufacturer, the EUT must comply with the requirements of the following standards:

- ♦ FCC Part 15 Subpart C §15.247
- ♦ FCC KDB Publication No. 558074 D01 DTS Meas. Guidance v05r01
- ♦ FCC KDB 414788 D01 Radiated Test Site v01r01.
- ♦ ANSI C63.10-2013

**Remark:**

1. All test items were verified and recorded according to the standards and without any deviation during the test.
2. This EUT has also been tested and complied with the requirements of FCC Part 15, Subpart B, recorded in a separate test report.



## 2 Test Configuration of Equipment Under Test

### 2.1 Carrier Frequency Channel

Frequency Band	Channel	Freq. (MHz)	Channel	Freq. (MHz)
2400-2483.5 MHz	0	2402	21	2444
	1	2404	22	2446
	2	2406	23	2448
	3	2408	24	2450
	4	2410	25	2452
	5	2412	26	2454
	6	2414	27	2456
	7	2416	28	2458
	8	2418	29	2460
	9	2420	30	2462
	10	2422	31	2464
	11	2424	32	2466
	12	2426	33	2468
	13	2428	34	2470
	14	2430	35	2472
	15	2432	36	2474
	16	2434	37	2476
	17	2436	38	2478
	18	2438	39	2480
	19	2440	-	-
20	2442	-	-	





## 2.2 Test Mode

Channel	Frequency	Bluetooth – LE 1Mbps RF Average Output Power	
		Data Rate / Modulation	
		GFSK	
		1Mbps	
Ch00	2402MHz	1.00 dBm	
Ch19	2440MHz	0.98 dBm	
Ch39	2480MHz	1.71 dBm	

Channel	Frequency	Bluetooth – LE 1Mbps RF Peak Output Power	
		Data Rate / Modulation	
		GFSK	
		1Mbps	
Ch00	2402MHz	2.86 dBm	
Ch19	2440MHz	2.83 dBm	
Ch39	2480MHz	3.30 dBm	

Channel	Frequency	Bluetooth – LE 2Mbps RF Average Output Power	
		Data Rate / Modulation	
		GFSK	
		2Mbps	
Ch00	2402MHz	0.89 dBm	
Ch19	2440MHz	0.87 dBm	
Ch39	2480MHz	1.63 dBm	

Channel	Frequency	Bluetooth – LE 2Mbps RF Peak Output Power	
		Data Rate / Modulation	
		GFSK	
		2Mbps	
Ch00	2402MHz	2.76 dBm	
Ch19	2440MHz	2.69 dBm	
Ch39	2480MHz	3.39 dBm	



- a. The EUT has been associated with peripherals and configuration operated in a manner tended to maximize its emission characteristics in a typical application. Frequency range investigated: conduction emission (150 kHz to 30 MHz), radiation emission (9 kHz to the 10th harmonic of the highest fundamental frequency or to 40 GHz, whichever is lower). For radiated measurement, pre-scanned in three orthogonal panels, X, Y, Z. The worst cases (Y plane) were recorded in this report.
- b. AC power line Conducted Emission was tested under maximum output power.

The following summary table is showing all test modes to demonstrate in compliance with the standard.

Summary table of Test Cases	
Test Item	Data Rate / Modulation
	Bluetooth – LE / GFSK
<b>Conducted Test Cases</b>	Mode 1: Bluetooth Tx CH00_2402 MHz_1Mbps Mode 2: Bluetooth Tx CH19_2440 MHz_1Mbps Mode 3: Bluetooth Tx CH39_2480 MHz_1Mbps Mode 4: Bluetooth Tx CH00_2402 MHz_2Mbps Mode 5: Bluetooth Tx CH19_2440 MHz_2Mbps Mode 6: Bluetooth Tx CH39_2480 MHz_2Mbps
<b>Radiated Test Cases</b>	Mode 1: Bluetooth Tx CH00_2402 MHz_1Mbps Mode 2: Bluetooth Tx CH19_2440 MHz_1Mbps Mode 3: Bluetooth Tx CH39_2480 MHz_1Mbps Mode 4: Bluetooth Tx CH00_2402 MHz_2Mbps Mode 5: Bluetooth Tx CH19_2440 MHz_2Mbps Mode 6: Bluetooth Tx CH39_2480 MHz_2Mbps
<b>AC Conducted Emission</b>	Mode 1: Bluetooth Link + WLAN (2.4GHz) Link + Camera + USB Cable (Data Link with Notebook) (Notebook to SD Card) + Battery 2 + DC Line Cord + AC Adapter for Sample 3
<b>Remark:</b>	
1. Data Linking with Notebook means data application transferred mode between EUT and Notebook. 2. For Radiated Test Cases, the tests were performed with Battery 2 and Sample 3.	

## 2.3 Connection Diagram of Test System

<Bluetooth – LE Tx Mode>

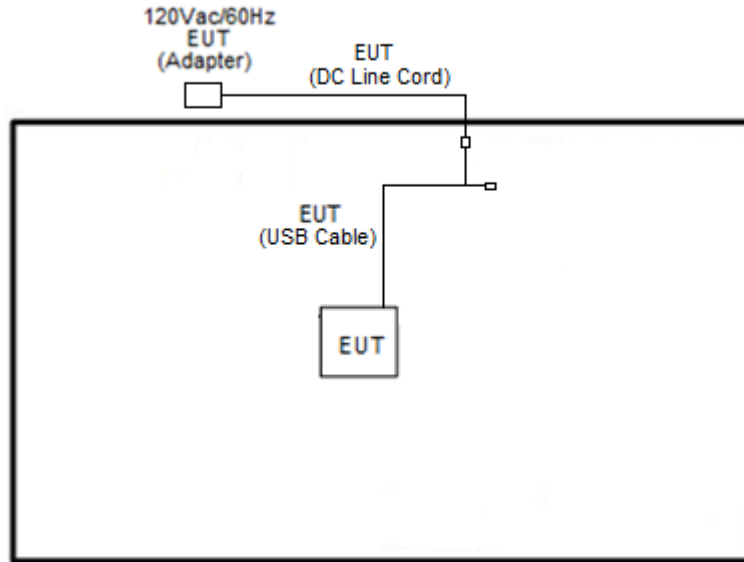

<AC Conducted Emission Mode>

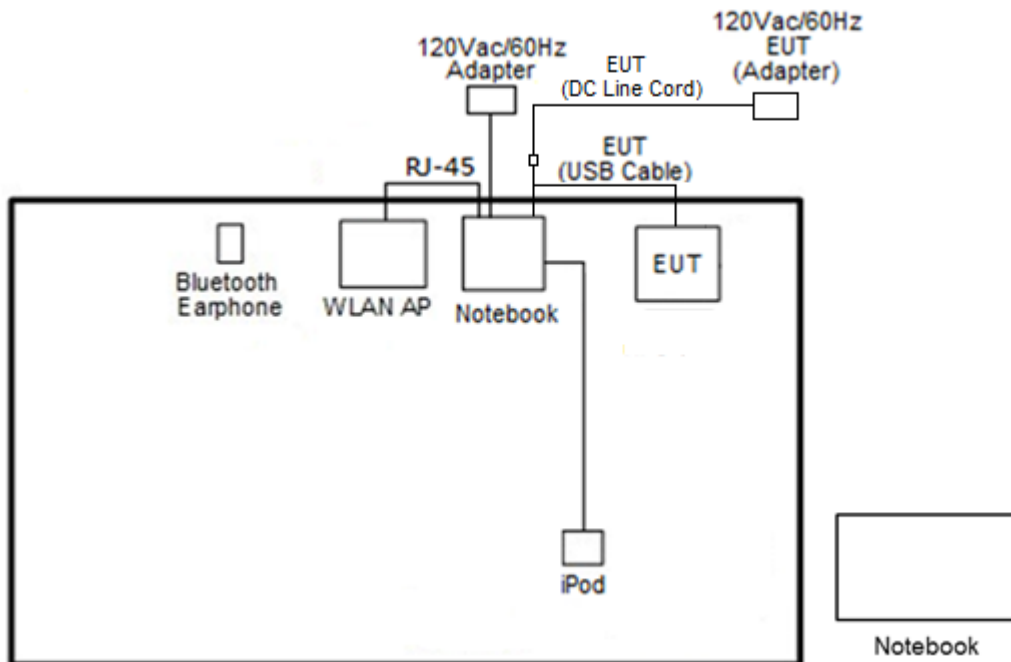

## 2.4 Support Unit used in test configuration and system

Item	Equipment	Trade Name	Model Name	FCC ID	Data Cable	Power Cord
1.	Bluetooth Earphone	Sony Ericsson	MW600	PY7DDA-2029	N/A	N/A
2.	WLAN AP	ASUS	RT-AC51U	MSQ-RTAC51U	N/A	Unshielded, 1.8m
3.	Notebook	DELL	Latitude E6320	FCC DoC/ Contains FCC ID: QDS-BRCM1054	N/A	AC I/P: Unshielded, 1.2 m DC O/P: Shielded, 1.8 m
4.	Notebook	DELL	P20G	FCC DoC/ Contains FCC ID: QDS-BRCM1051	N/A	AC I/P: Unshielded, 1.2 m DC O/P: Shielded, 1.8 m
5.	iPod	Apple	A1285	FCC DoC	Shielded, 1.0 m	N/A
6.	SD Card	SanDisk	MicroSD HC	FCC DoC	N/A	N/A

## 2.5 EUT Operation Test Setup

The RF test items, utility “QRCT” was installed in Notebook which was programmed in order to make the EUT get into the engineering modes to provide channel selection, power level, data rate and the application type and for continuous transmitting signals.

## 2.6 Measurement Results Explanation Example

**For all conducted test items:**

The offset level is set in the spectrum analyzer to compensate the RF cable loss and attenuator factor between EUT conducted output port and spectrum analyzer. With the offset compensation, the spectrum analyzer reading level is exactly the EUT RF output level.

Example :

The spectrum analyzer offset is derived from RF cable loss and attenuator factor.

*Offset = RF cable loss + attenuator factor.*

Following shows an offset computation example with cable loss 4.2 dB and 10dB attenuator.

$$\begin{aligned}
 \text{Offset}(dB) &= \text{RF cable loss}(dB) + \text{attenuator factor}(dB). \\
 &= 4.2 + 10 = 14.2 \text{ (dB)}
 \end{aligned}$$

### 3 Test Result

#### 3.1 6dB and 99% Bandwidth Measurement

##### 3.1.1 Limit of 6dB and 99% Bandwidth

The minimum 6 dB bandwidth shall be at least 500 kHz.

##### 3.1.2 Measuring Instruments

See list of measuring equipment of this test report.

##### 3.1.3 Test Procedures

1. The testing follows the ANSI C63.10 Section 6.9.3 (OBW) and 11.8.1 (6dB BW).
2. The RF output of EUT was connected to the spectrum analyzer by RF cable and attenuator. The path loss was compensated to the results for each measurement.
3. Set to the maximum power setting and enable the EUT transmit continuously.
4. Make the measurement with the spectrum analyzer's resolution bandwidth (RBW) = 100 kHz. Set the Video bandwidth (VBW) = 300 kHz. In order to make an accurate measurement. The 6 dB bandwidth must be greater than 500 kHz.
5. For 99% Bandwidth Measurement, the spectrum analyzer's resolution bandwidth (RBW) is set 1-5% of the emission bandwidth and set the Video bandwidth (VBW)  $\geq 3 * RBW$ .
6. Measure and record the results in the test report.

##### 3.1.4 Test Setup

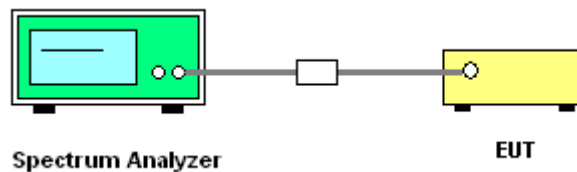



3.1.5 Test Result of 6dB Bandwidth

Test Engineer :	Shiang Wang and Derek Hsu	Temperature :	21~25°C
		Relative Humidity :	51~54%

Mod.	Data Rate	NTX	CH.	Freq. (MHz)	6dB BW (MHz)	6dB BW Limit (MHz)	Pass/Fail
BLE	1Mbps	1	0	2402	0.667	0.50	Pass
BLE	1Mbps	1	19	2440	0.665	0.50	Pass
BLE	1Mbps	1	39	2480	0.663	0.50	Pass
BLE	2Mbps	1	0	2402	1.139	0.50	Pass
BLE	2Mbps	1	19	2440	1.143	0.50	Pass
BLE	2Mbps	1	39	2480	1.147	0.50	Pass

<1Mbps>

6 dB Bandwidth Plot on Channel 00

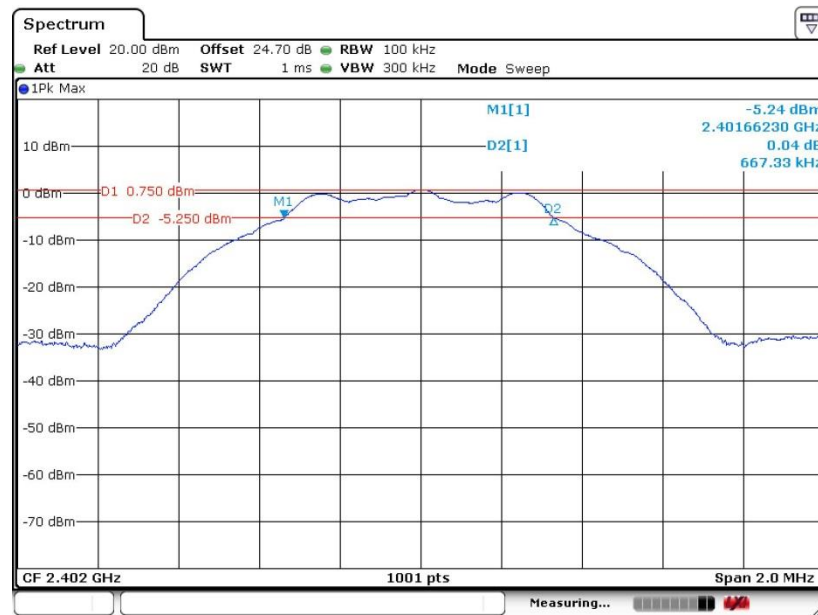

Date: 28.JAN.2019 16:00:50



### 6 dB Bandwidth Plot on Channel 19

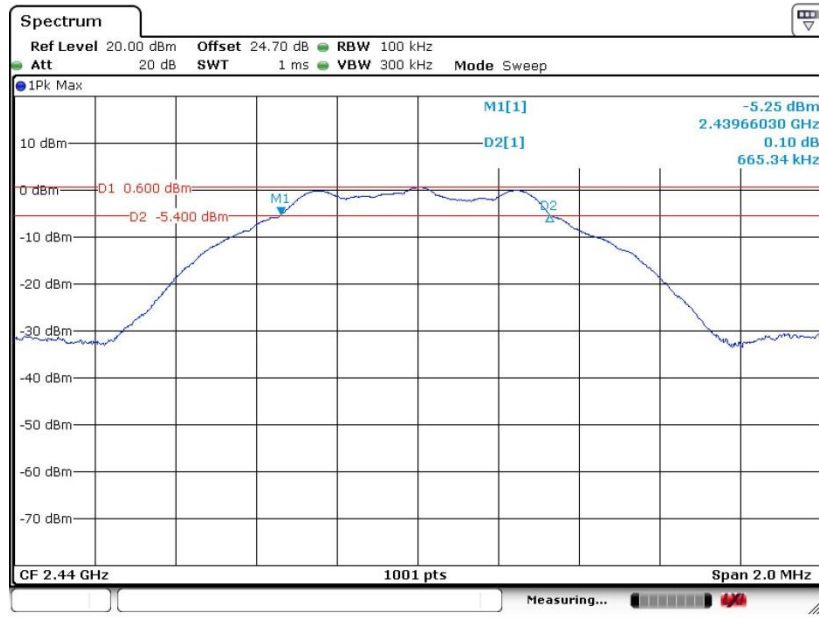

### 6 dB Bandwidth Plot on Channel 39

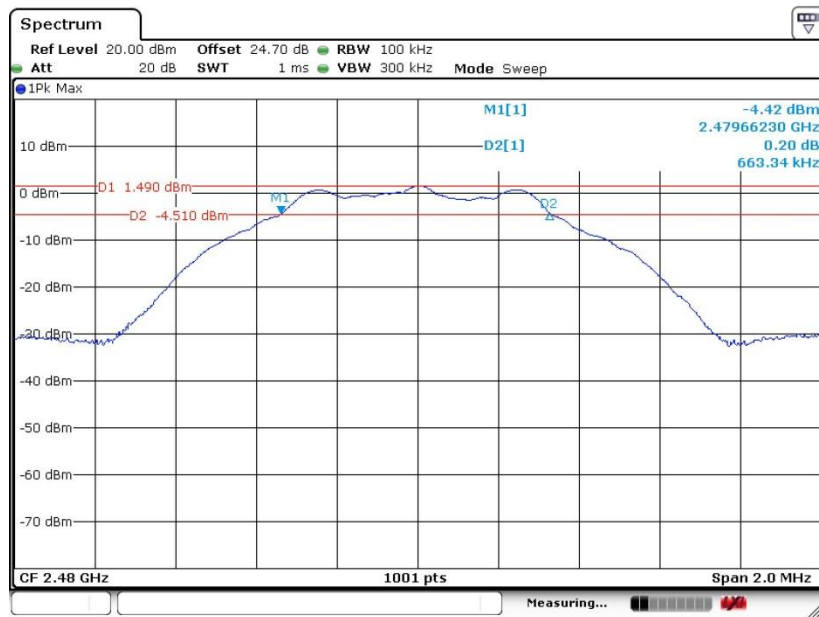



<2Mbps>

6 dB Bandwidth Plot on Channel 00

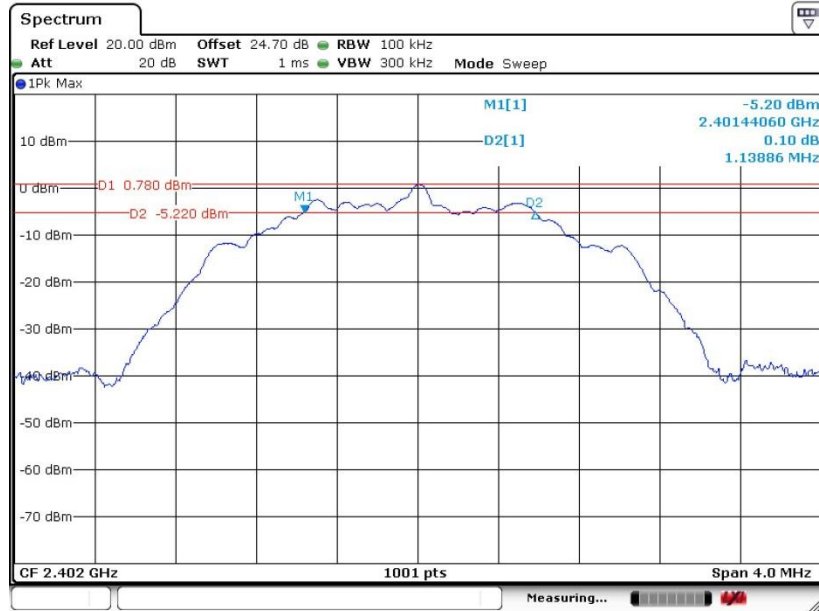

Date: 28.JAN.2019 16:19:07

6 dB Bandwidth Plot on Channel 19

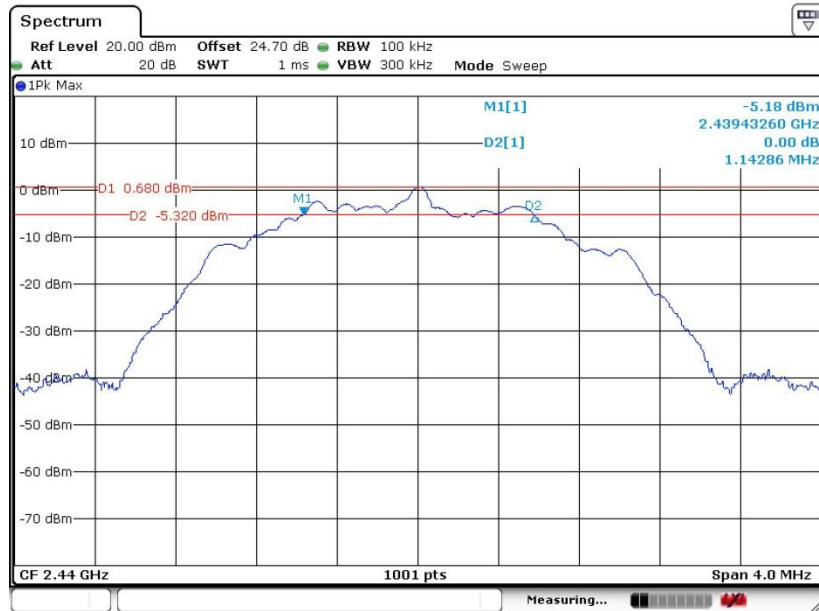

Date: 28.JAN.2019 16:11:20





6 dB Bandwidth Plot on Channel 39

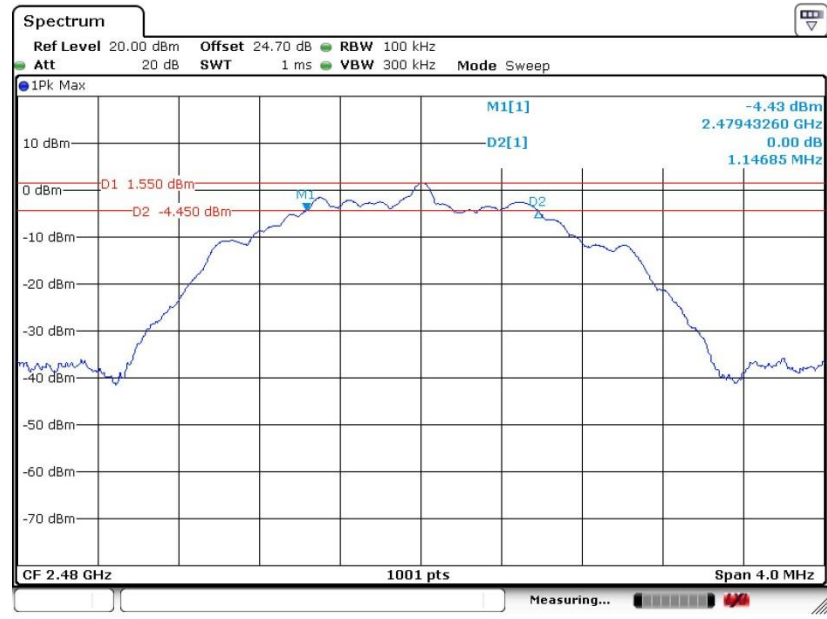

Date: 28.JAN.2019 16:25:36



3.1.6 Test Result of 99% Occupied Bandwidth

Test Engineer :	Shiang Wang and Derek Hsu	Temperature :	21~25°C
		Relative Humidity :	51~54%

Mod.	Data Rate	NTX	CH.	Freq. (MHz)	99% Occupied BW (MHz)	Pass/Fail
BLE	1Mbps	1	0	2402	1.027	Pass
BLE	1Mbps	1	19	2440	1.027	Pass
BLE	1Mbps	1	39	2480	1.027	Pass
BLE	2Mbps	1	0	2402	2.038	Pass
BLE	2Mbps	1	19	2440	2.034	Pass
BLE	2Mbps	1	39	2480	2.038	Pass

<1Mbps>

99% Bandwidth Plot on Channel 00

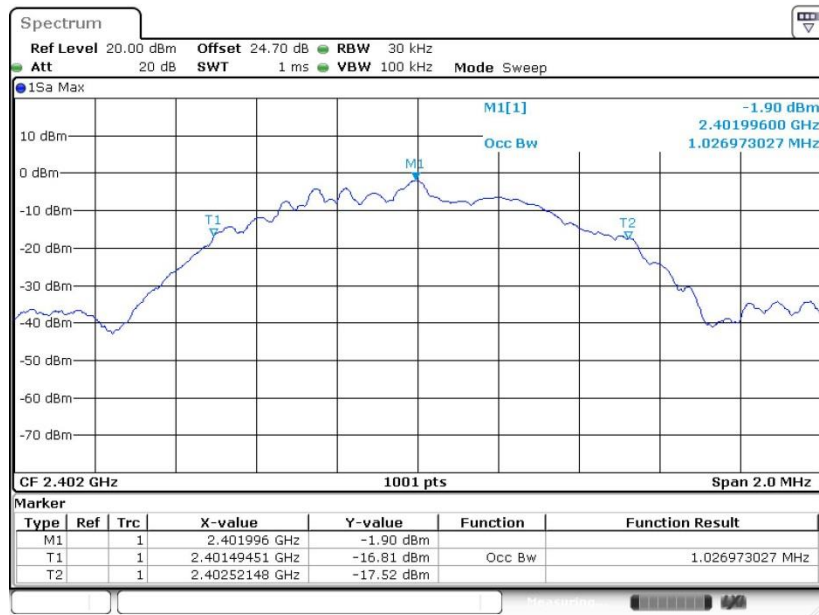

Date: 28.JAN.2019 16:02:41



99% Occupied Bandwidth Plot on Channel 19

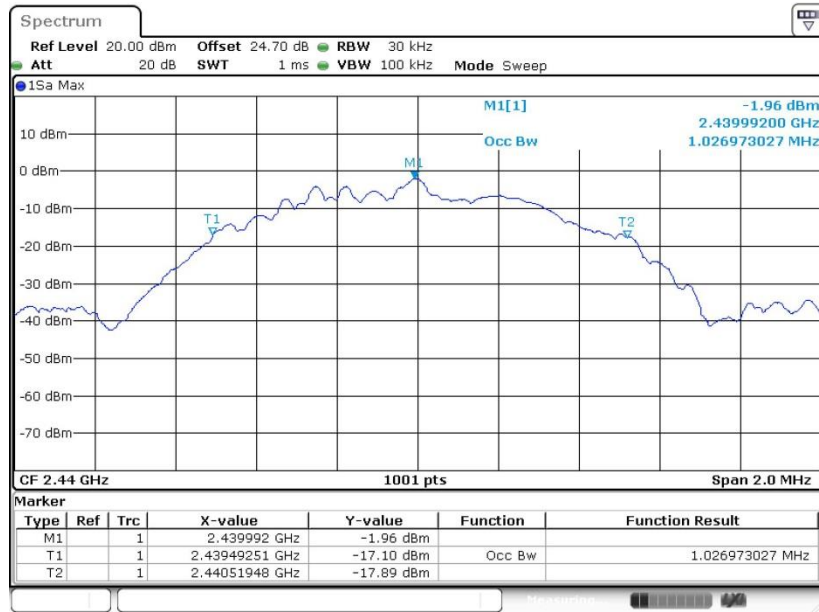

Date: 28.JAN.2019 16:04:37

99% Occupied Bandwidth Plot on Channel 39

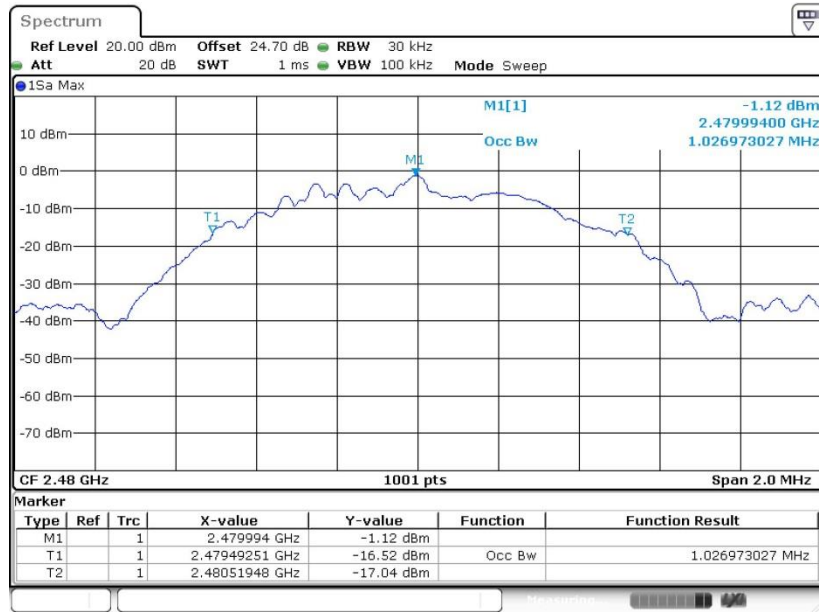

Date: 28.JAN.2019 16:06:26



<2Mbps>

99% Bandwidth Plot on Channel 00

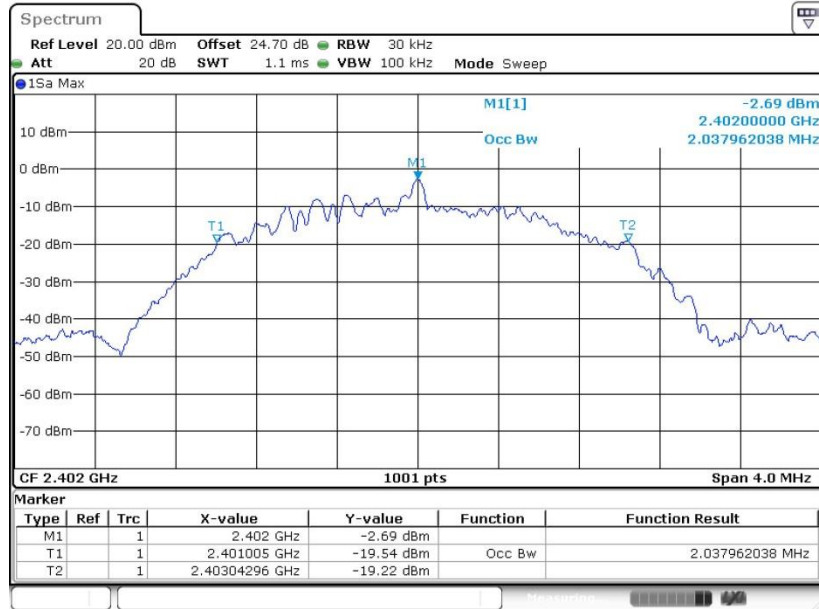

Date: 28.JAN.2019 16:23:42

99% Occupied Bandwidth Plot on Channel 19

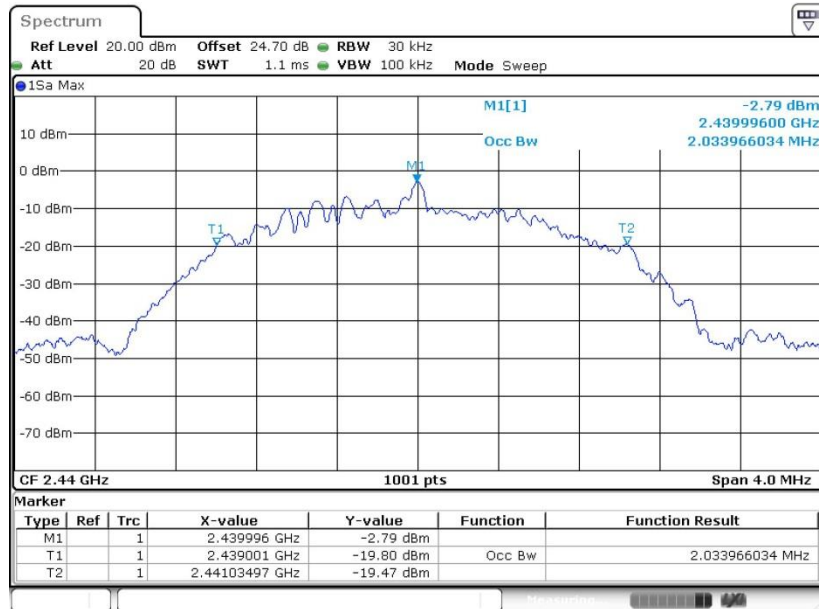

Date: 28.JAN.2019 16:14:33



99% Occupied Bandwidth Plot on Channel 39

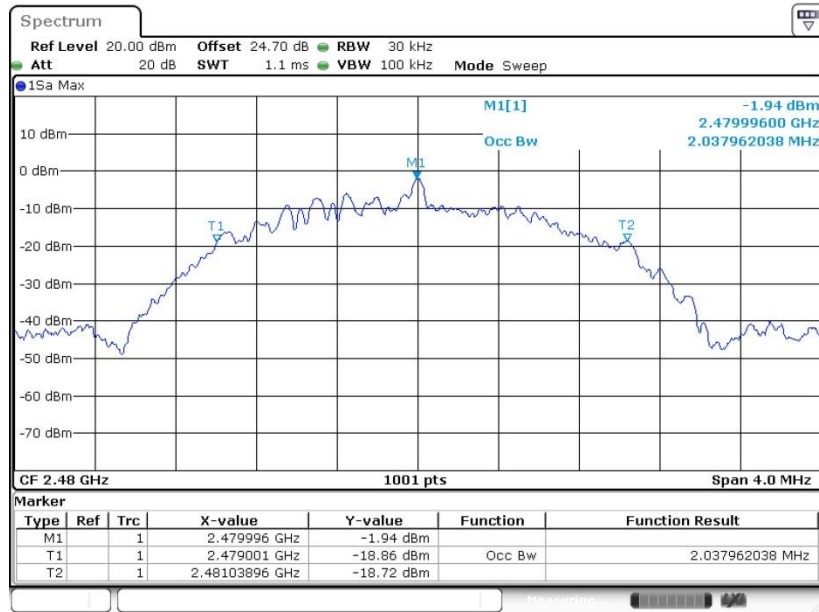

Date: 28.JAN.2019 16:17:28

Note : The occupied channel bandwidth is maintained within the band of operation for all of the modulations.

## 3.2 Output Power Measurement

### 3.2.1 Limit of Output Power

For systems using digital modulation in the 2400-2483.5MHz, the limit for peak output power is 30dBm. If transmitting antenna of directional gain greater than 6dBi is used, the peak output power from the intentional radiator shall be reduced below the above stated value by the amount in dB that the directional gain of the antenna exceeds 6 dBi. In case of point-to-point operation, the limit has to be reduced by 1dB for every 3dB that the directional gain of the antenna exceeds 6dBi.

### 3.2.2 Measuring Instruments

See list of measuring equipment of this test report.

### 3.2.3 Test Procedures

1. For Peak Power, the testing follows ANSI C63.10 Section 11.9.1.3 PKPM1.
2. For Average Power, the testing follows the Measurement Procedure of FCC KDB No. 558074 DTS D01 Meas. Guidance v05r01 section 9.2.3.1 Method AVGPM.
3. The RF output of EUT was connected to the power meter by RF cable and attenuator.
4. The path loss was compensated to the results for each measurement.
5. Set to the maximum power setting and enable the EUT transmit continuously.
6. Measure the conducted output power and record the results in the test report.

### 3.2.4 Test Setup

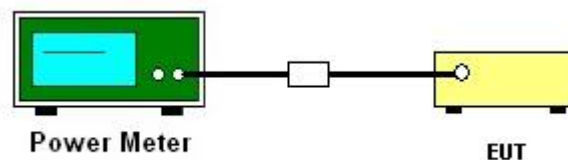



3.2.5 Test Result of Peak Output Power

Test Engineer :	Shiang Wang and Derek Hsu	Temperature :	21~25°C
		Relative Humidity :	51~54%

Mod.	Data Rate	NTX	CH.	Freq. (MHz)	Peak Conducted Power (dBm)	Conducted Power Limit (dBm)	DG (dBi)	EIRP Power (dBm)	EIRP Power Limit (dBm)	Pass /Fail
BLE	1Mbps	1	0	2402	2.86	30.00	2.76	5.62	36.00	Pass
BLE	1Mbps	1	19	2440	2.83	30.00	2.76	5.59	36.00	Pass
BLE	1Mbps	1	39	2480	3.30	30.00	2.76	6.06	36.00	Pass
BLE5.0	2Mbps	1	0	2402	2.76	30.00	2.76	5.52	36.00	Pass
BLE5.0	2Mbps	1	19	2440	2.69	30.00	2.76	5.45	36.00	Pass
BLE5.0	2Mbps	1	39	2480	3.39	30.00	2.76	6.15	36.00	Pass

3.2.6 Test Result of Average Output Power (Reporting Only)

Test Engineer :	Shiang Wang and Derek Hsu	Temperature :	21~25°C
		Relative Humidity :	51~54%

Mod.	Data Rate	NTX	CH.	Freq. (MHz)	Duty Factor (dB)	Average Conducted Power (dBm)
BLE	1Mbps	1	0	2402	2.03	1.00
BLE	1Mbps	1	19	2440	2.03	0.98
BLE	1Mbps	1	39	2480	2.03	1.71
BLE	2Mbps	1	0	2402	4.77	0.89
BLE	2Mbps	1	19	2440	4.77	0.87
BLE	2Mbps	1	39	2480	4.77	1.63

### 3.3 Power Spectral Density Measurement

#### 3.3.1 Limit of Power Spectral Density

The peak power spectral density shall not be greater than 8dBm in any 3kHz band at any time interval of continuous transmission.

#### 3.3.2 Measuring Instruments

See list of measuring equipment of this test report.

#### 3.3.3 Test Procedures

1. The testing follows the ANSI C63.10 Section 11.10.2 Method PKPSD.
2. The RF output of EUT was connected to the spectrum analyzer by RF cable and attenuator. The path loss was compensated to the results for each measurement.
3. Set to the maximum power setting and enable the EUT transmit continuously.
4. Make the measurement with the spectrum analyzer's resolution bandwidth (RBW) = 3 kHz. Video bandwidth VBW = 10 kHz In order to make an accurate measurement, set the span to 1.5 times DTS Channel Bandwidth. (6dB BW)
5. Detector = peak, Sweep time = auto couple, Trace mode = max hold, Allow trace to fully stabilize. Use the peak marker function to determine the maximum power level.
6. Measure and record the results in the test report.
7. The Measured power density (dBm)/ 100kHz is a reference level and used as 20dBc down limit line for Conducted Band Edges and Conducted Spurious Emission.

#### 3.3.4 Test Setup

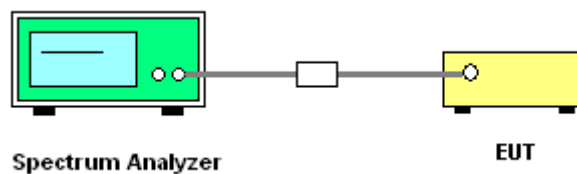





3.3.5 Test Result of Power Spectral Density

Test Engineer :	Shiang Wang and Derek Hsu	Temperature :	21~25°C
		Relative Humidity :	51~54%

Mod.	Data Rate	NTX	CH.	Freq. (MHz)	Peak PSD (dBm /100kHz)	Peak PSD (dBm /3kHz)	DG (dBi)	Peak PSD Limit (dBm /3kHz)	Pass/Fail
BLE	1Mbps	1	0	2402	0.75	-13.78	2.76	8.00	Pass
BLE	1Mbps	1	19	2440	0.61	-13.90	2.76	8.00	Pass
BLE	1Mbps	1	39	2480	1.50	-13.02	2.76	8.00	Pass
BLE	2Mbps	1	0	2402	0.76	-17.35	2.76	8.00	Pass
BLE	2Mbps	1	19	2440	0.65	-17.42	2.76	8.00	Pass
BLE	2Mbps	1	39	2480	1.53	-16.63	2.76	8.00	Pass

3.3.6 Test Result of Power Spectral Density Plots (100kHz)

<1Mbps>

PSD 100kHz Plot on Channel 00

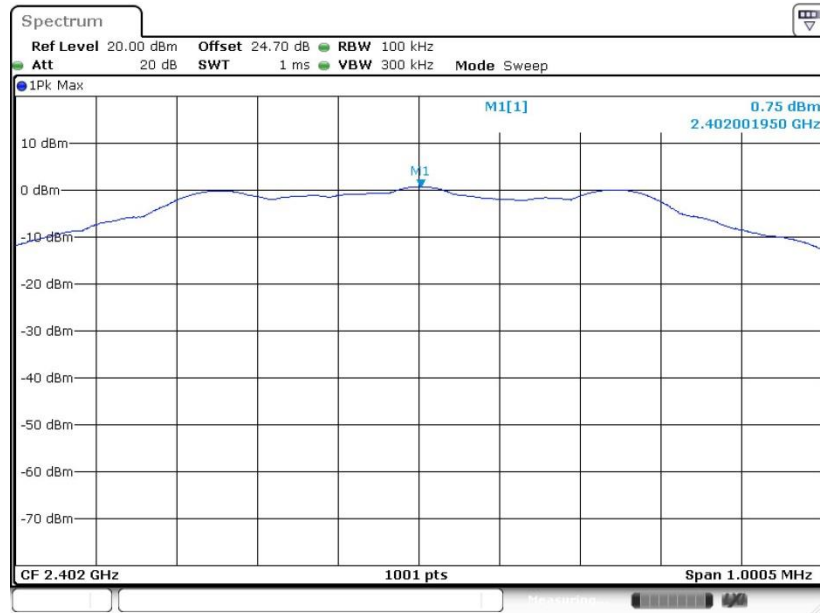

Date: 28.JAN.2019 16:01:22



PSD 100kHz Plot on Channel 19

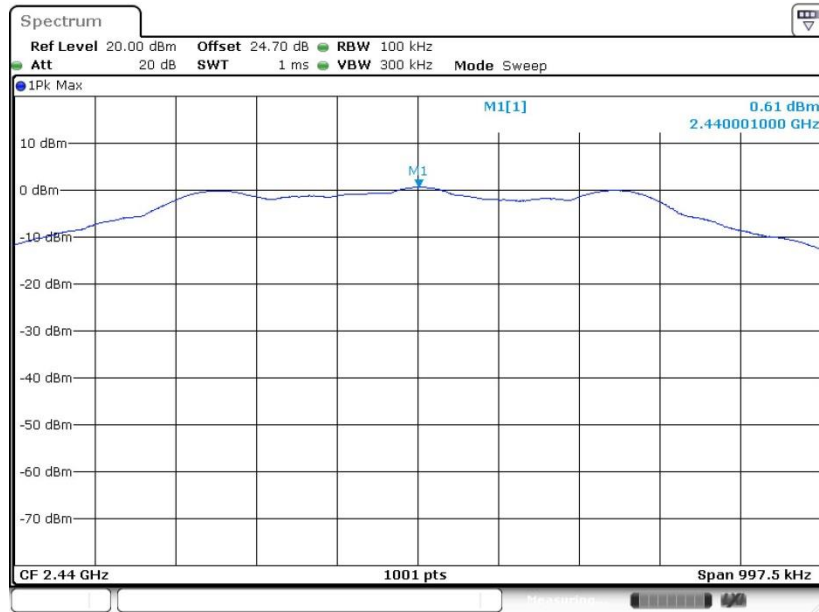

Date: 28.JAN.2019 16:03:48

PSD 100kHz Plot on Channel 39

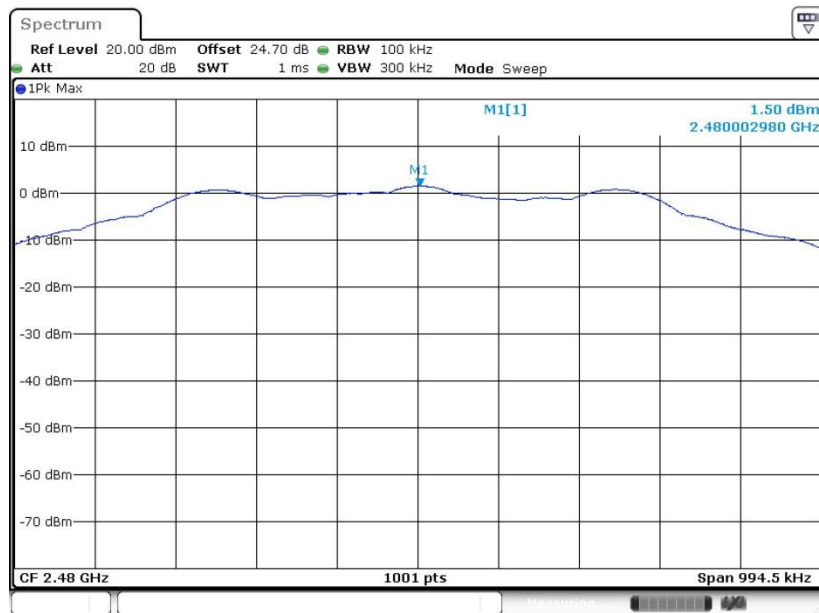

Date: 28.JAN.2019 16:05:40



<2Mbps>

PSD 100kHz Plot on Channel 00

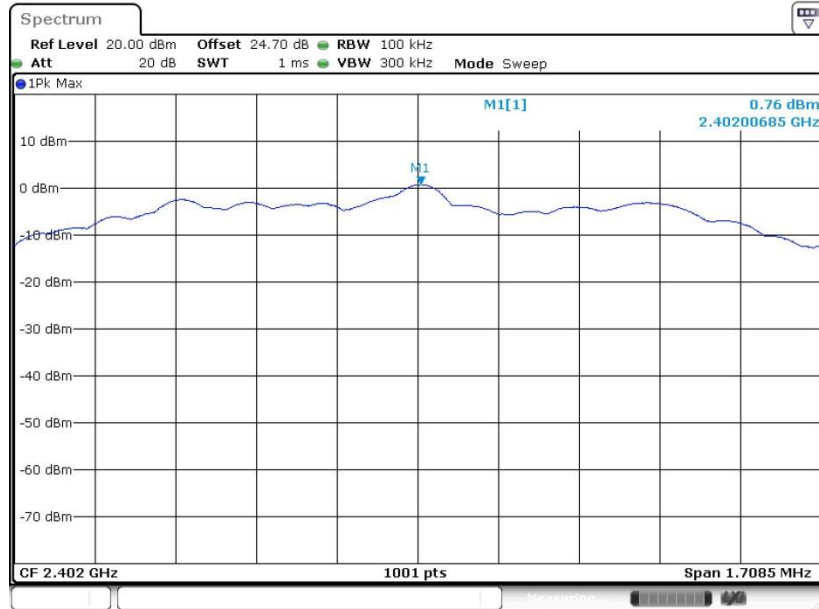

Date: 28.JAN.2019 16:21:36

PSD 100kHz Plot on Channel 19

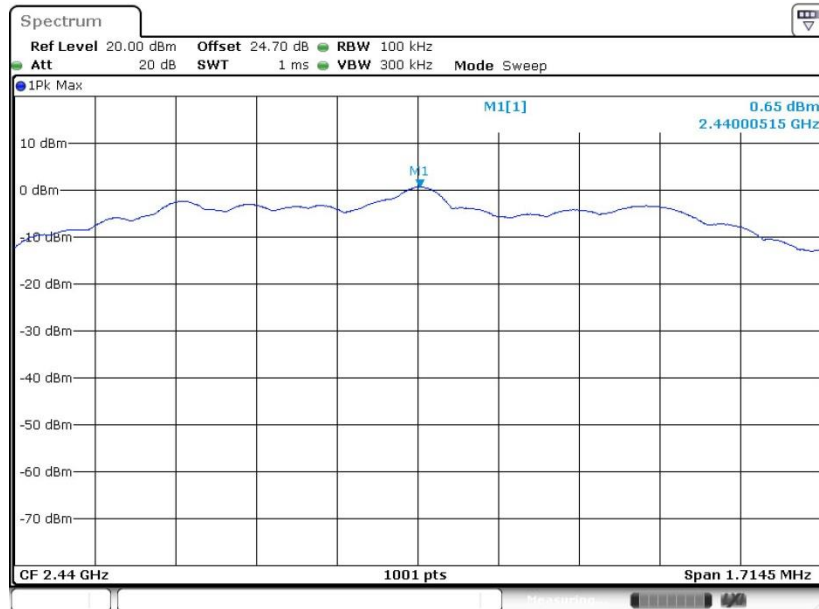

Date: 28.JAN.2019 16:11:53



PSD 100kHz Plot on Channel 39

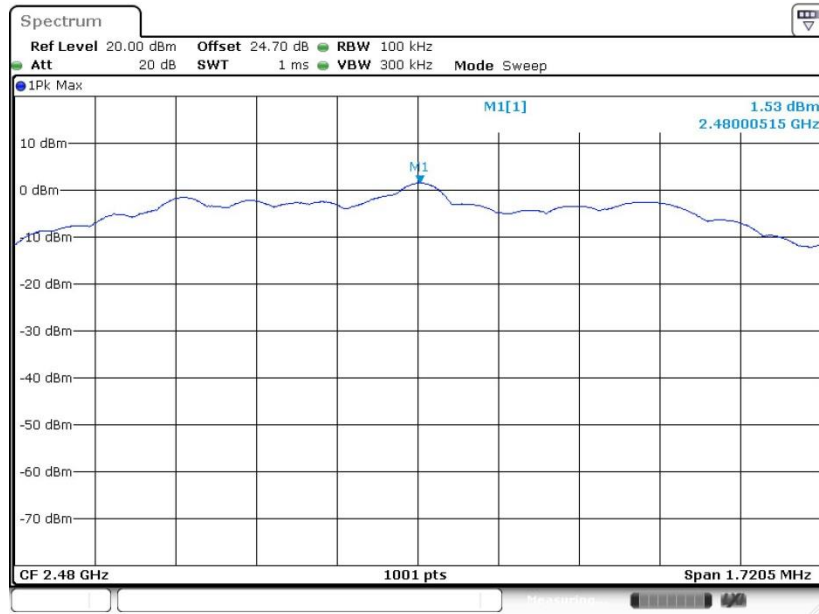

Date: 28.JAN.2019 16:26:27



### 3.3.7 Test Result of Power Spectral Density Plots (3kHz)

Test Engineer :	Shiang Wang and Derek Hsu	Temperature :	21~25°C
		Relative Humidity :	51~54%

<1Mbps>

PSD 3kHz Plot on Channel 00

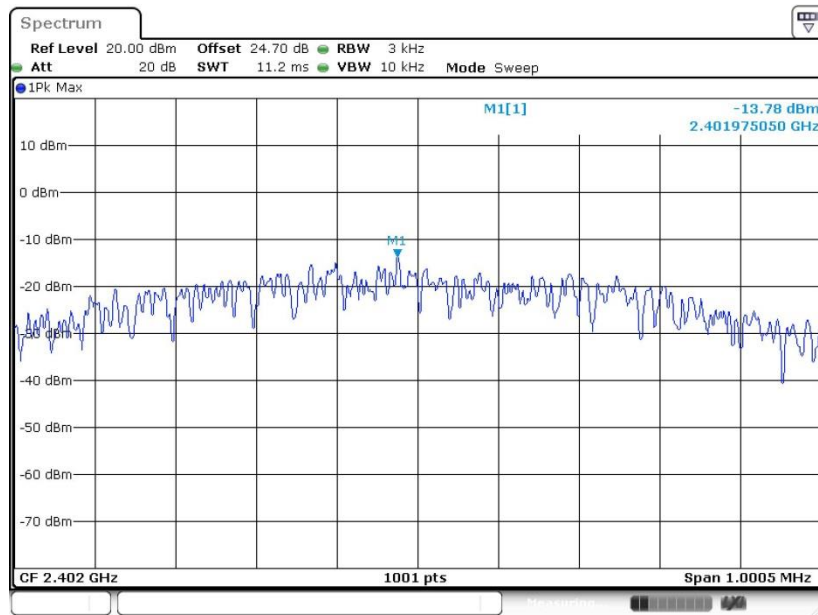

Date: 28.JAN.2019 16:01:12

PSD 3kHz Plot on Channel 19

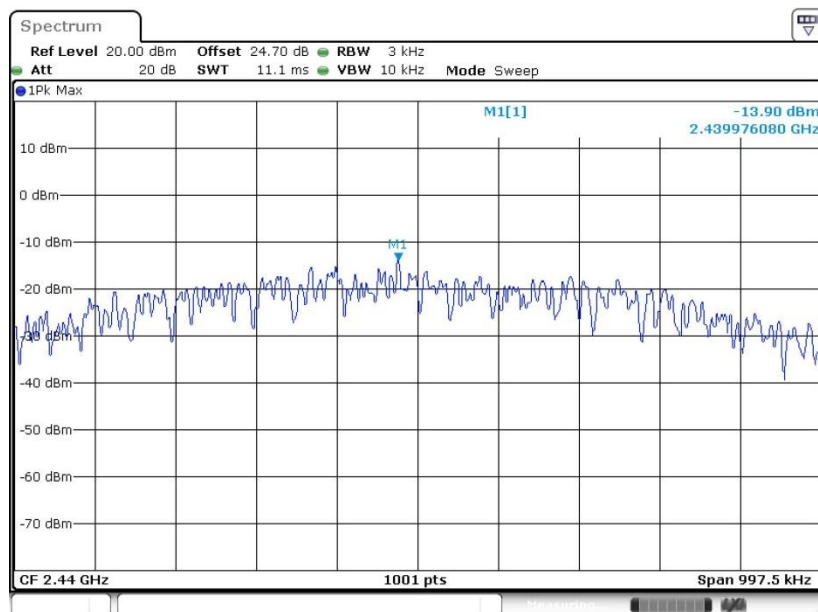

Date: 28.JAN.2019 16:03:36



PSD 3kHz Plot on Channel 39

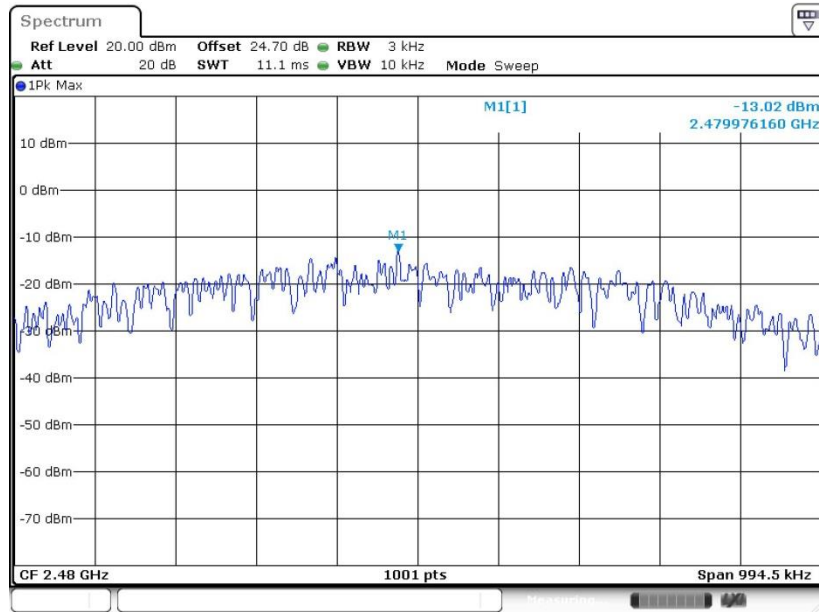

Date: 28.JAN.2019 16:05:30

<2Mbps>

PSD 3kHz Plot on Channel 00

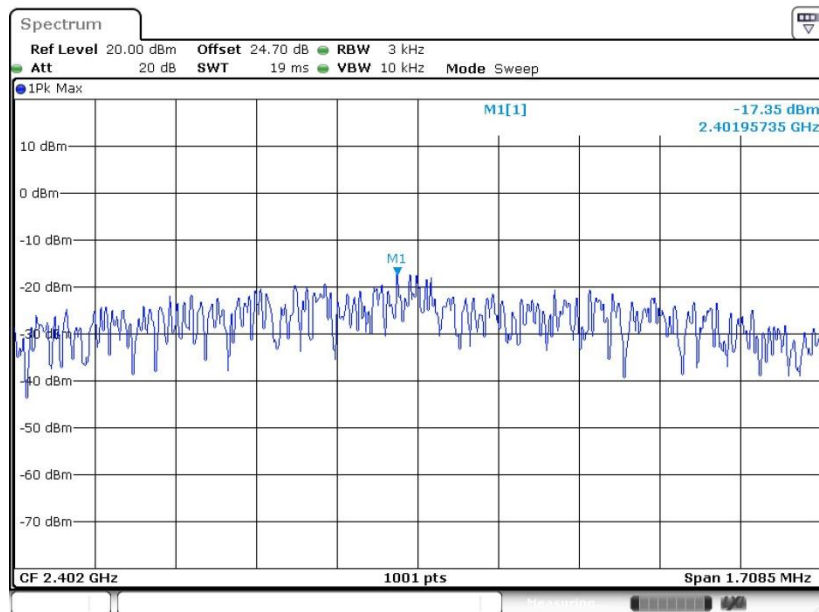

Date: 28.JAN.2019 16:21:22



PSD 3kHz Plot on Channel 19

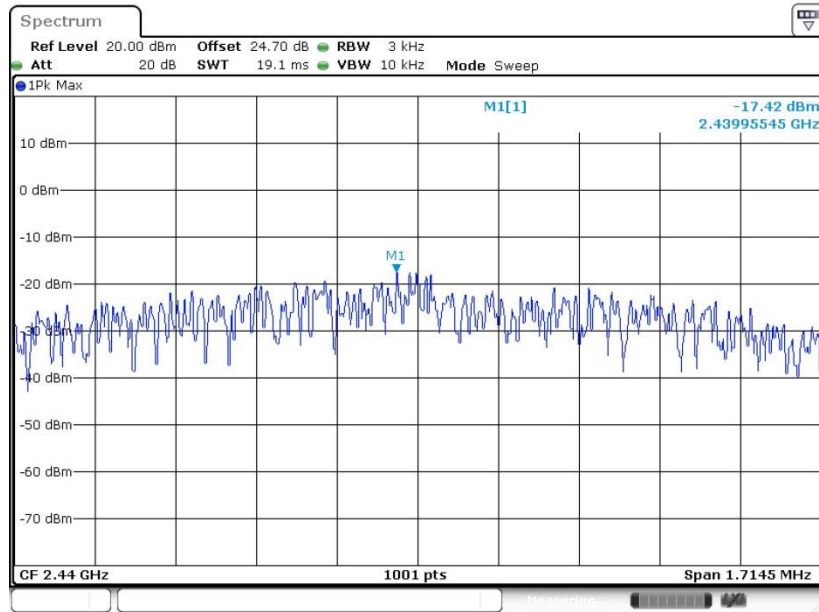

Date: 28.JAN.2019 16:11:43

PSD 3kHz Plot on Channel 39

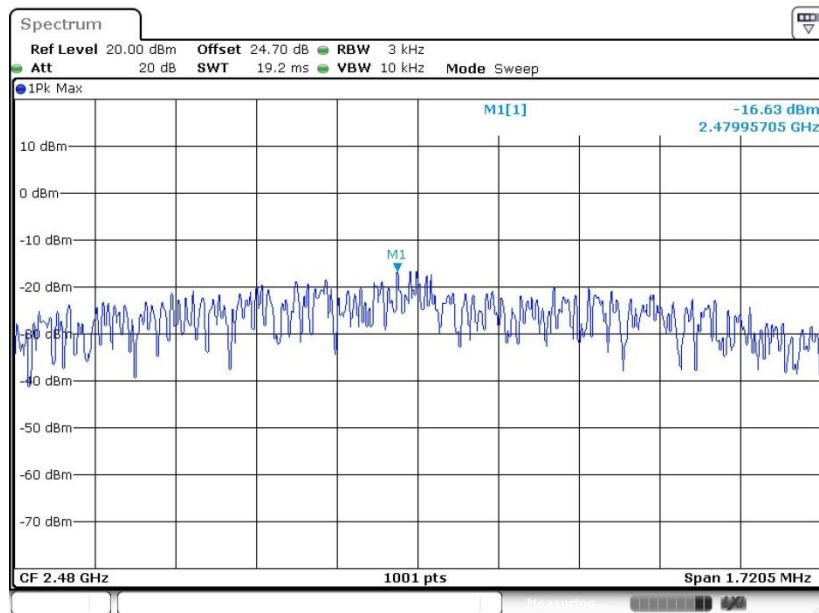

Date: 28.JAN.2019 16:26:17

## **3.4 Conducted Band Edges and Spurious Emission Measurement**

### **3.4.1 Limit of Conducted Band Edges and Spurious Emission**

All harmonics/spurious must be at least 20 dB down from the highest emission level within the authorized band.

### **3.4.2 Measuring Instruments**

See list of measuring equipment of this test report.

### **3.4.3 Test Procedure**

1. The testing follows the ANSI C63.10 Section 11.11.3 Emission level measurement.
2. The RF output of EUT was connected to the spectrum analyzer by RF cable and attenuator. The path loss was compensated to the results for each measurement.
3. Set to the maximum power setting and enable the EUT transmit continuously.
4. Set RBW = 100 kHz, VBW=300 kHz, Peak Detector. Unwanted Emissions measured in any 100 kHz bandwidth outside of the authorized frequency band shall be attenuated by at least 20 dB relative to the maximum in-band peak PSD level in 100 kHz when maximum peak conducted output power procedure is used. If the transmitter complies with the conducted power limits based on the use of RMS averaging over a time interval, the attenuation required under this paragraph shall be 30 dB instead of 20 dB.
5. Measure and record the results in the test report.
6. The RF fundamental frequency should be excluded against the limit line in the operating frequency band.

### **3.4.4 Test Setup**

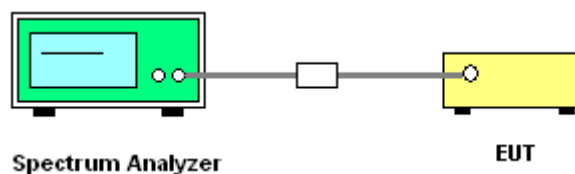





### 3.4.5 Test Result of Conducted Band Edges Plots

Test Engineer :	Shiang Wang and Derek Hsu	Temperature :	21~25°C
		Relative Humidity :	51~54%

<1Mbps>

#### Low Band Edge Plot on Channel 00

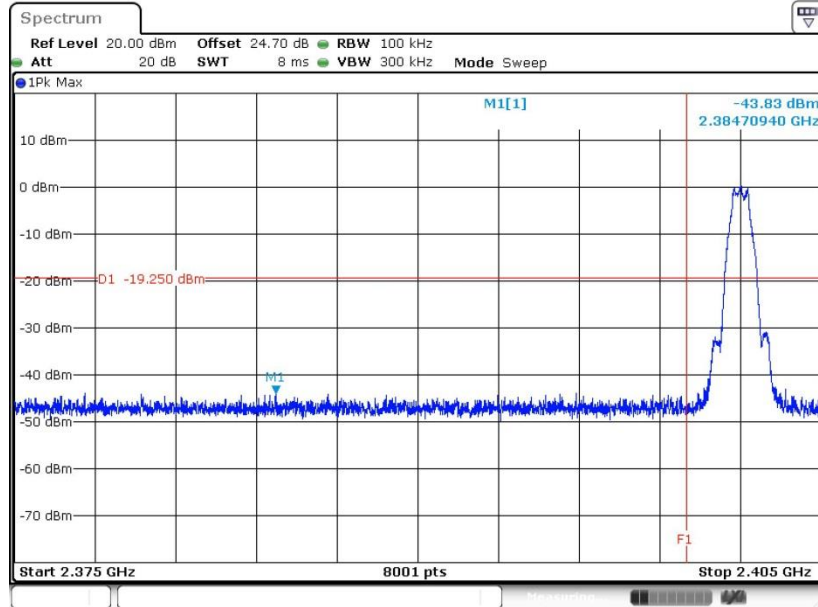

Date: 28.JAN.2019 16:01:33

#### High Band Edge Plot on Channel 39

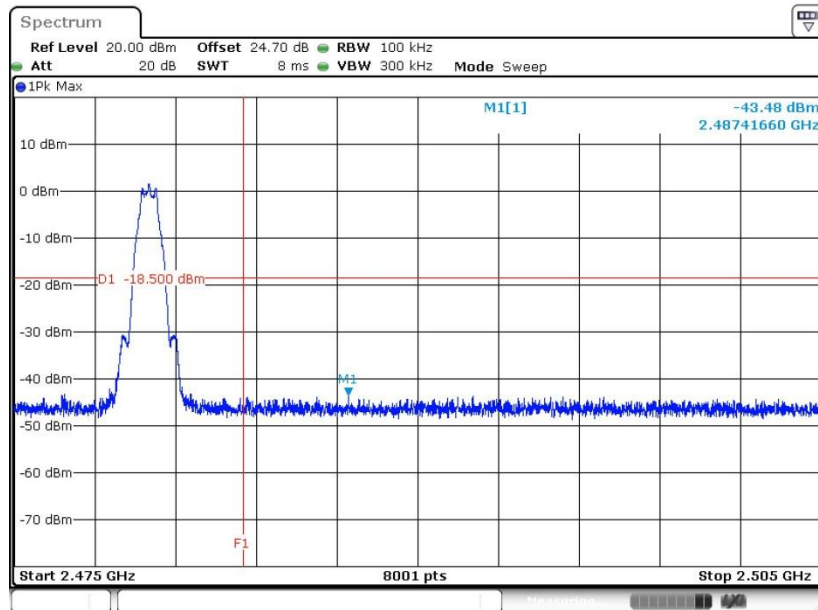

Date: 28.JAN.2019 16:05:51



<2Mbps>

Low Band Edge Plot on Channel 00

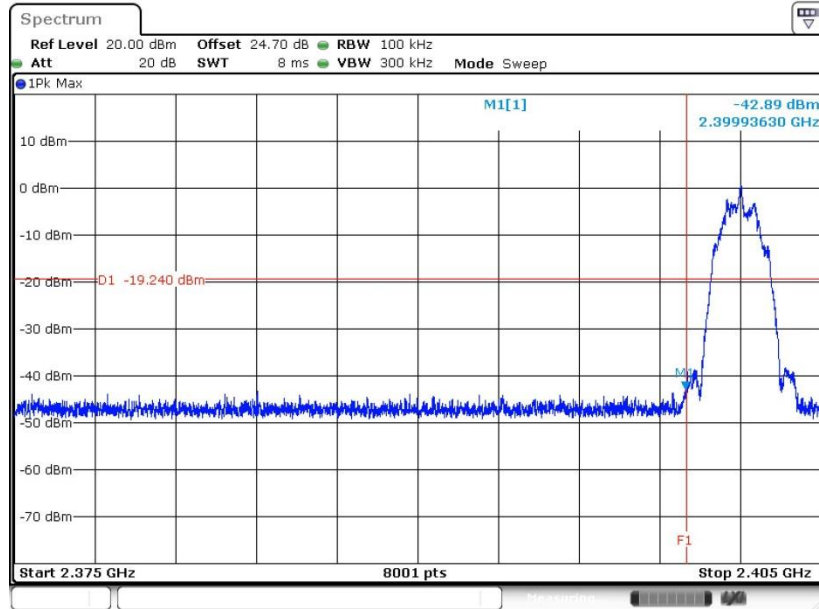

Date: 28.JAN.2019 16:21:46

High Band Edge Plot on Channel 39

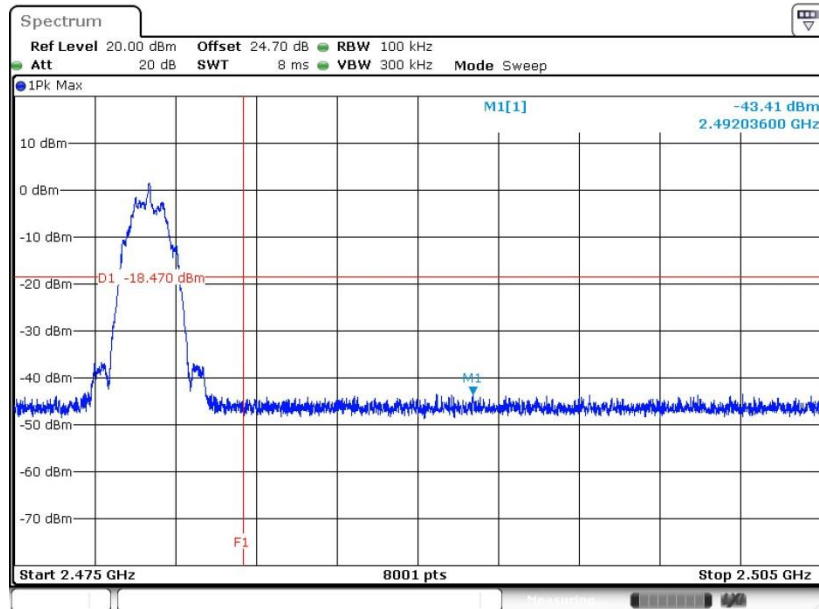

Date: 28.JAN.2019 16:26:40



### 3.4.6 Test Result of Conducted Spurious Emission Plots

Test Engineer :	Shiang Wang and Derek Hsu	Temperature :	21~25°C
		Relative Humidity :	51~54%

#### Conducted Spurious Emission Plot on Bluetooth LE 1Mbps GFSK Channel 00

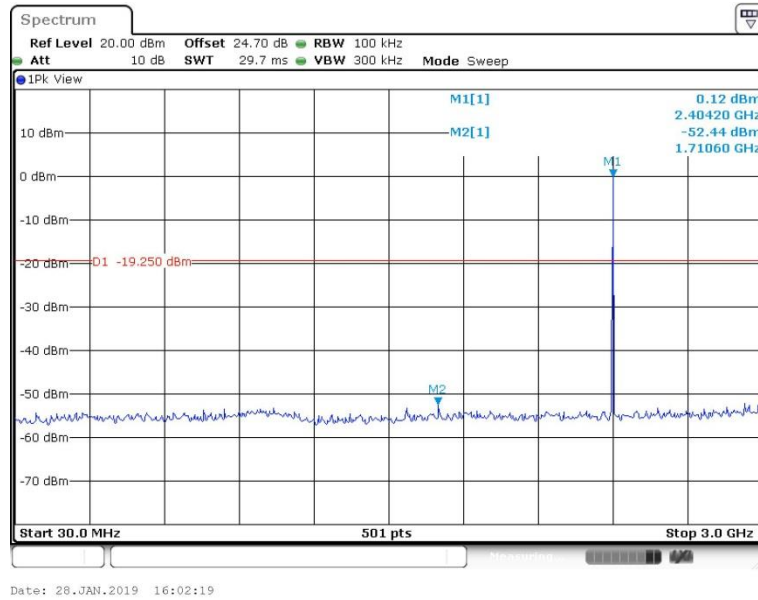

#### Conducted Spurious Emission Plot on Bluetooth LE 1Mbps GFSK Channel 00

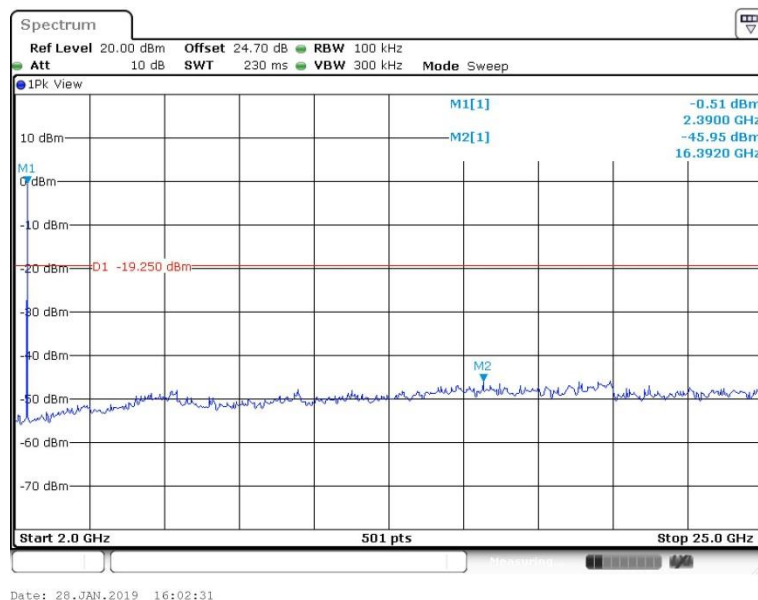



### Conducted Spurious Emission Plot on Bluetooth LE 1Mbps GFSK Channel 19

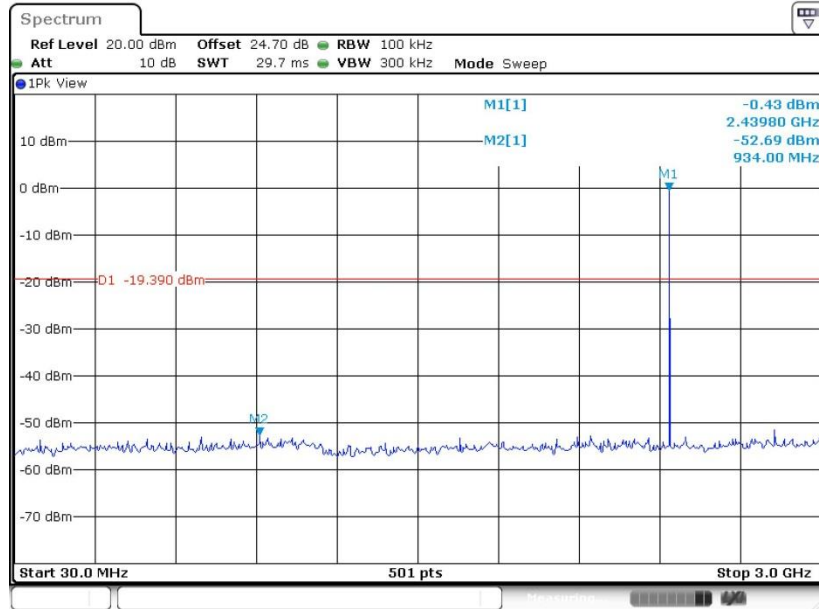

Date: 28.JAN.2019 16:04:11

### Conducted Spurious Emission Plot on Bluetooth LE 1Mbps GFSK Channel 19

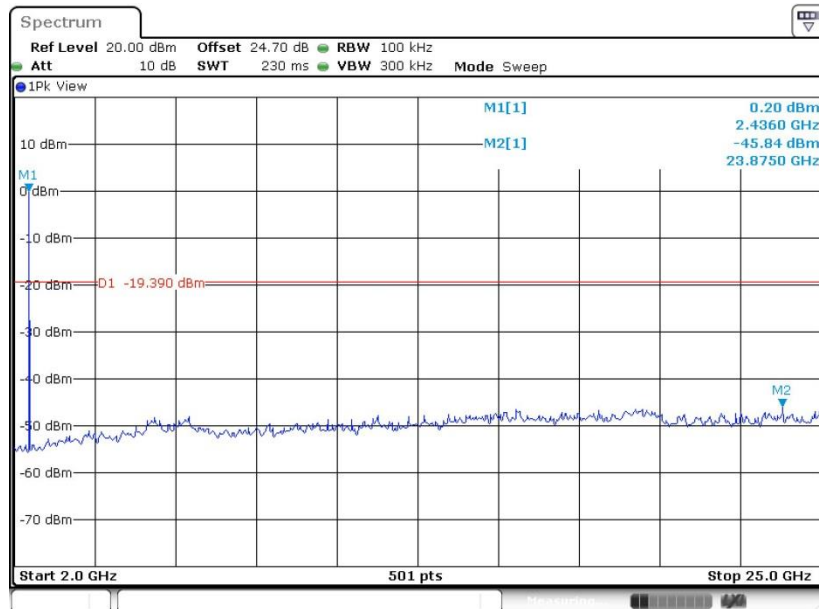

Date: 28.JAN.2019 16:04:24



### Conducted Spurious Emission Plot on Bluetooth LE 1Mbps GFSK Channel 39

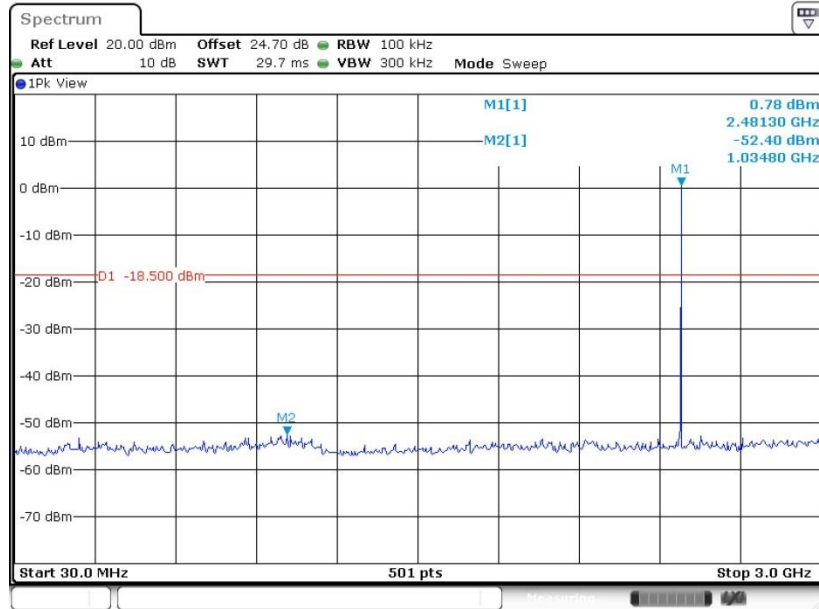

Date: 28.JAN.2019 16:06:04

### Conducted Spurious Emission Plot on Bluetooth LE 1Mbps GFSK Channel 39

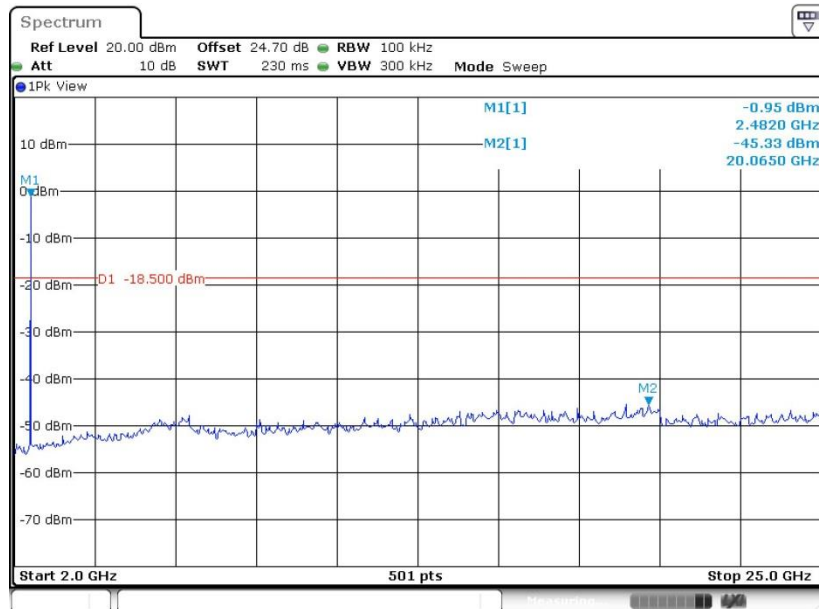

Date: 28.JAN.2019 16:06:16



### Conducted Spurious Emission Plot on Bluetooth LE 2Mbps GFSK Channel 00

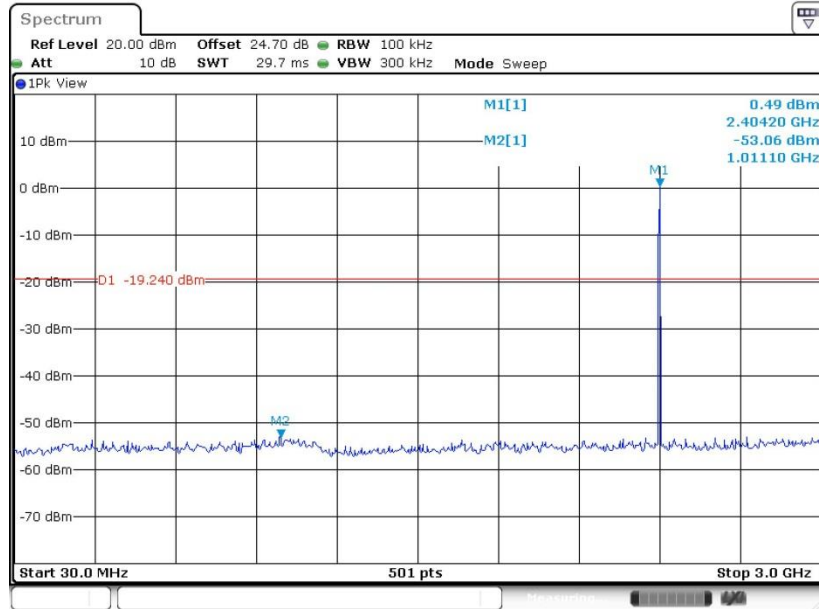

Date: 28.JAN.2019 16:22:06

### Conducted Spurious Emission Plot on Bluetooth LE 2Mbps GFSK Channel 00

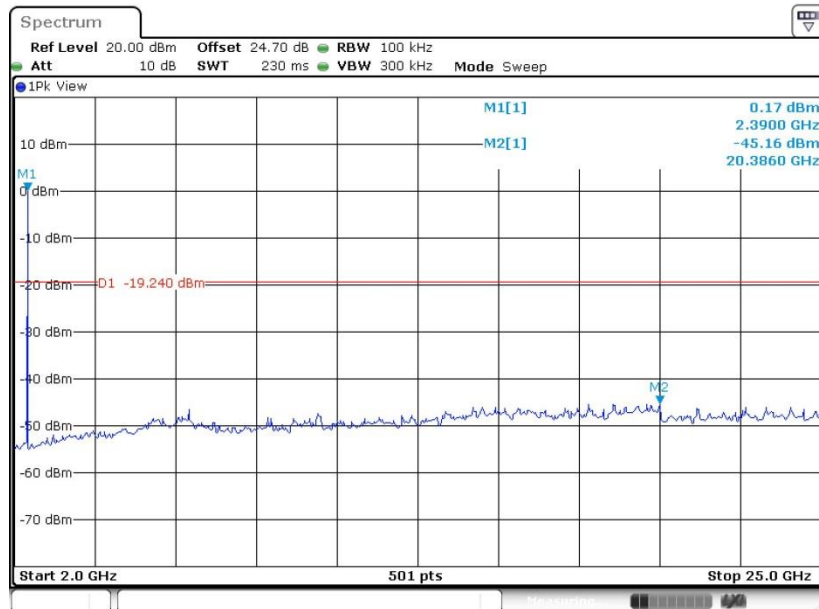

Date: 28.JAN.2019 16:23:06



### Conducted Spurious Emission Plot on Bluetooth LE 2Mbps GFSK Channel 19

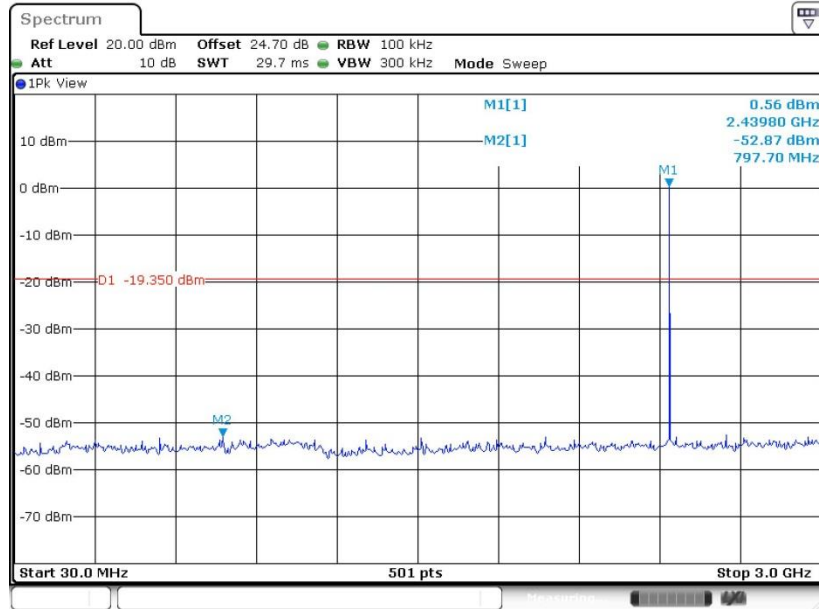

Date: 28.JAN.2019 16:13:03

### Conducted Spurious Emission Plot on Bluetooth LE 2Mbps GFSK Channel 19

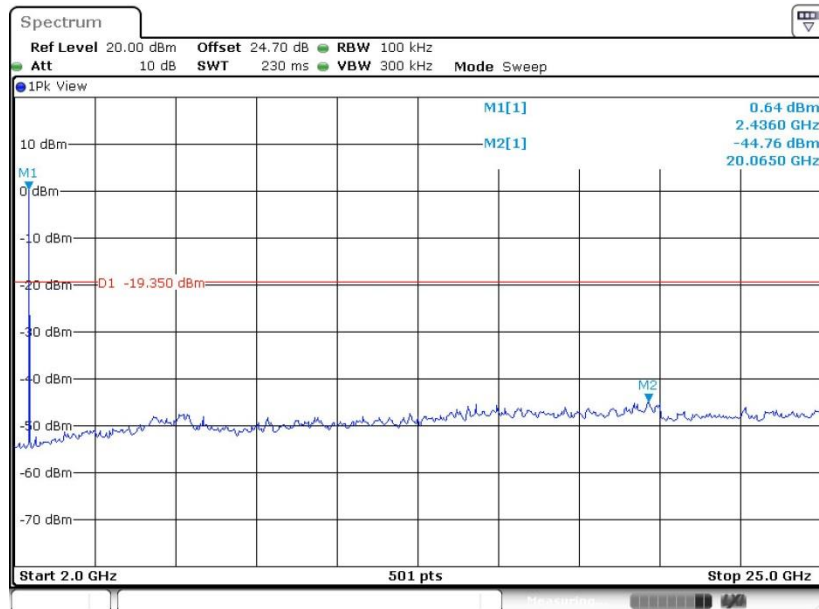

Date: 28.JAN.2019 16:14:03



Conducted Spurious Emission Plot on Bluetooth LE 2Mbps  
GFSK Channel 39

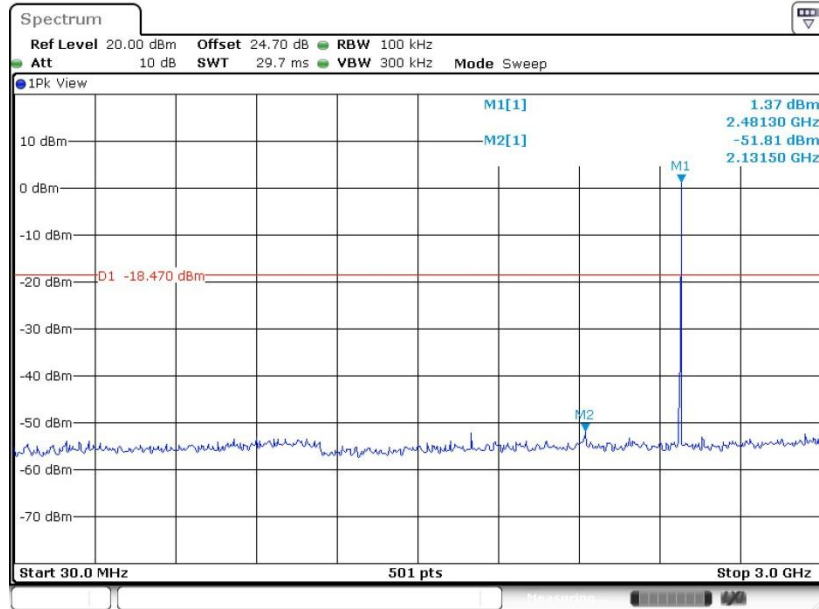

Date: 28.JAN.2019 16:26:52

Conducted Spurious Emission Plot on Bluetooth LE 2Mbps  
GFSK Channel 39

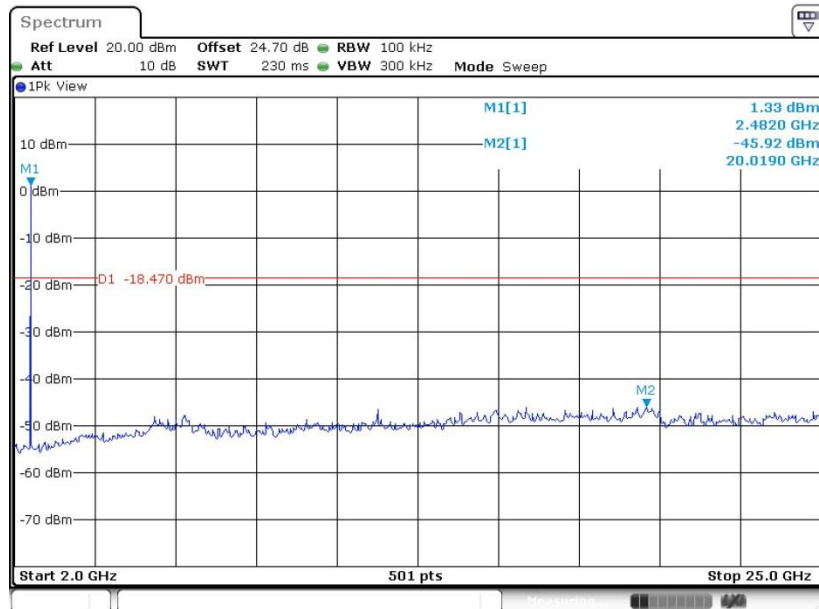

Date: 28.JAN.2019 16:27:03





### 3.5 Radiated Band Edges and Spurious Emission Measurement

#### 3.5.1 Limit of Radiated Band Edges and Spurious Emission

In any 100 kHz bandwidth outside the intentional radiator frequency band, all harmonics/spurious must be at least 20 dB below the highest emission level within the authorized band. If the output power of this device was measured by spectrum analyzer, the attenuation under this paragraph shall be 30 dB instead of 20 dB. In addition, radiated emissions which fall in the restricted bands must also comply with the limits as below.

Frequency (MHz)	Field Strength (microvolts/meter)	Measurement Distance (meters)
0.009 – 0.490	2400/F(kHz)	300
0.490 – 1.705	24000/F(kHz)	30
1.705 – 30.0	30	30
30 – 88	100	3
88 – 216	150	3
216 - 960	200	3
Above 960	500	3

#### 3.5.2 Measuring Instruments

See list of measuring equipment of this test report.



### 3.5.3 Test Procedures

1. The testing follows the ANSI C63.10 Section 11.12.1 Radiated emission measurements.
2. The EUT was arranged to its worst case and then tune the antenna tower (from 1 m to 4 m) and turntable (from 0 degree to 360 degrees) to find the maximum reading. A pre-amp and a high pass filter are used for the test in order to get better signal level.
3. The EUT was placed on a turntable with 0.8 meter for frequency below 1GHz and 1.5 meter for frequency above 1GHz respectively above ground.
4. The EUT was set 3 meters from the interference receiving antenna, which was mounted on the top of a variable height antenna tower.
5. Corrected Reading: Antenna Factor + Cable Loss + Read Level - Preamp Factor = Level
6. For testing below 1GHz, if the emission level of the EUT in peak mode was 3 dB lower than the limit specified, then peak values of EUT will be reported, otherwise, the emissions will be repeated one by one using the CISPR quasi-peak method and reported.
7. For testing above 1GHz, the emission level of the EUT in peak mode was 20dB lower than average limit (that means the emission level in average mode also complies with the limit in average mode), then peak values of EUT will be reported, otherwise, the emissions will be measured in average mode again and reported.
8. Use the following spectrum analyzer settings:
  - (1) Span shall wide enough to fully capture the emission being measured;
  - (2) Set RBW=100 kHz for  $f < 1$  GHz;  $VBW \geq RBW$ ; Sweep = auto; Detector function = peak; Trace = max hold;
  - (3) Set RBW = 1 MHz, VBW= 3MHz for  $f \geq 1$  GHz for peak measurement.  
For average measurement:
    - $VBW = 10$  Hz, when duty cycle is no less than 98 percent.
    - $VBW \geq 1/T$ , when duty cycle is less than 98 percent where T is the minimum transmission duration over which the transmitter is on and is transmitting at its maximum power control level for the tested mode of operation.

### 3.5.4 Test Setup

For radiated emissions below 30MHz

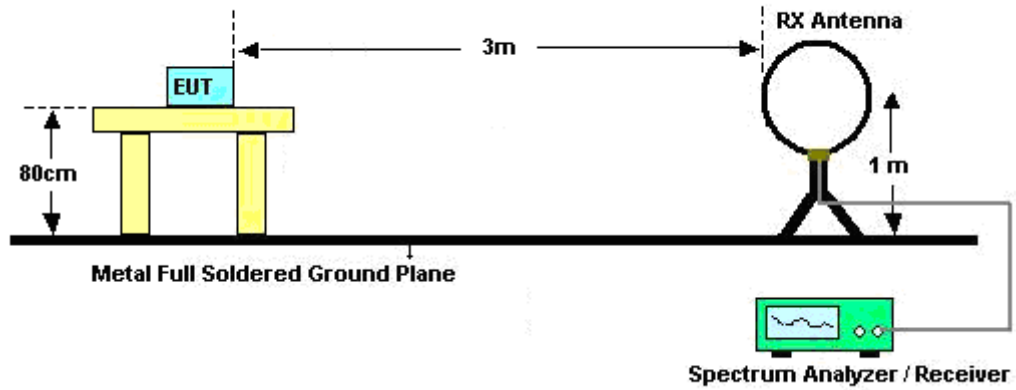

For radiated emissions from 30MHz to 1GHz

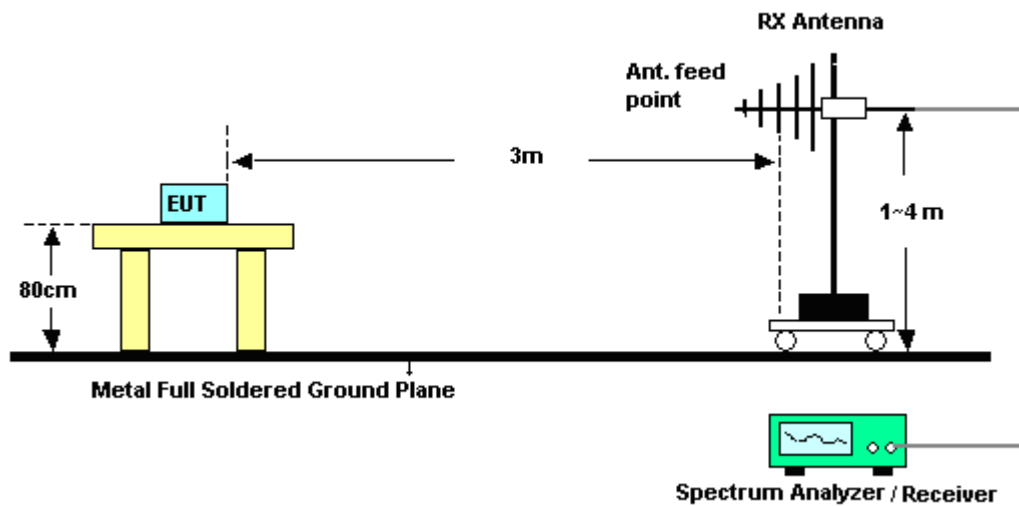

For radiated emissions above 1GHz

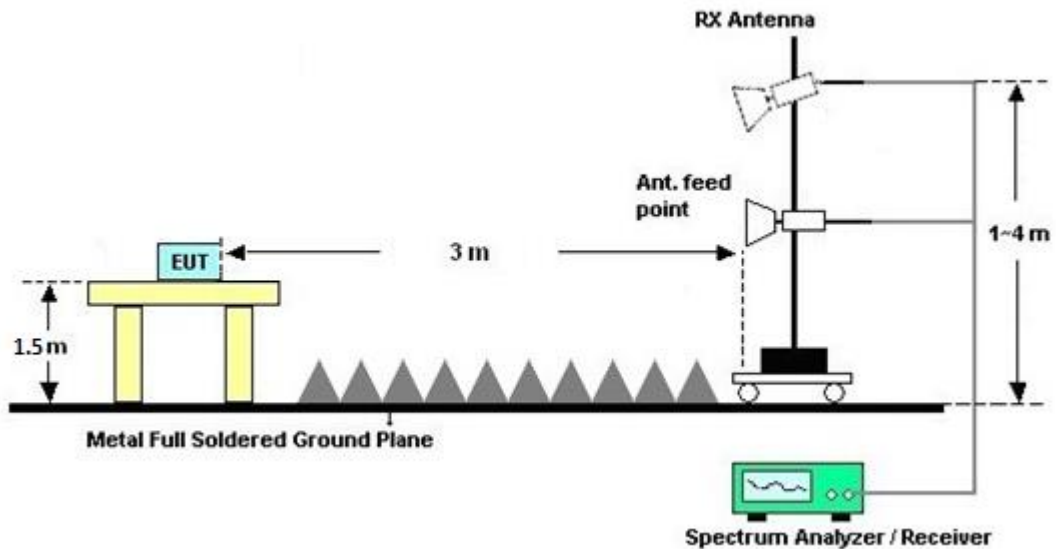

### 3.5.5 Test Results of Radiated Spurious Emissions (9 kHz ~ 30 MHz)

The low frequency, which started from 9 kHz to 30MHz, was pre-scanned and the result which was 20dB lower than the limit line was not reported.

There is a comparison data of both open-field test site and alternative test site - semi-Anechoic chamber according to 414788 D01 Radiated Test Site v01r01, and the result came out very similar.

### 3.5.6 Test Result of Radiated Spurious at Band Edges

Please refer to Appendix B and C.

### 3.5.7 Duty Cycle

Please refer to Appendix D.

### 3.5.8 Test Result of Radiated Spurious Emission (30MHz ~ 10th Harmonic)

Please refer to Appendix B and C.



### 3.6 AC Conducted Emission Measurement

#### 3.6.1 Limit of AC Conducted Emission

For equipment that is designed to be connected to the public utility (AC) power line, the radio frequency voltage that is conducted back onto the AC power line on any frequency or frequencies within the band 150 kHz to 30 MHz shall not exceed the limits in the following table.

Frequency of emission (MHz)	Conducted limit (dB $\mu$ V)	
	Quasi-peak	Average
0.15-0.5	66 to 56*	56 to 46*
0.5-5	56	46
5-30	60	50

\*Decreases with the logarithm of the frequency.

#### 3.6.2 Measuring Instruments

See list of measuring equipment of this test report.

#### 3.6.3 Test Procedures

1. The EUT was placed 0.4 meter from the conducting wall of the shielding room was kept at least 80 centimeters from any other grounded conducting surface.
2. Connect EUT to the power mains through a line impedance stabilization network (LISN).
3. All the support units are connecting to the other LISN.
4. The LISN provides 50 ohm coupling impedance for the measuring instrument.
5. The FCC states that a 50 ohm, 50 microhenry LISN should be used.
6. Both sides of AC line were checked for maximum conducted interference.
7. The frequency range from 150 kHz to 30 MHz was searched.
8. Set the test-receiver system to Peak Detect Function and specified bandwidth (IF Bandwidth = 9kHz) with Maximum Hold Mode. Then measurement is also conducted by Average Detector and Quasi-Peak Detector Function respectively.

### 3.6.4 Test Setup

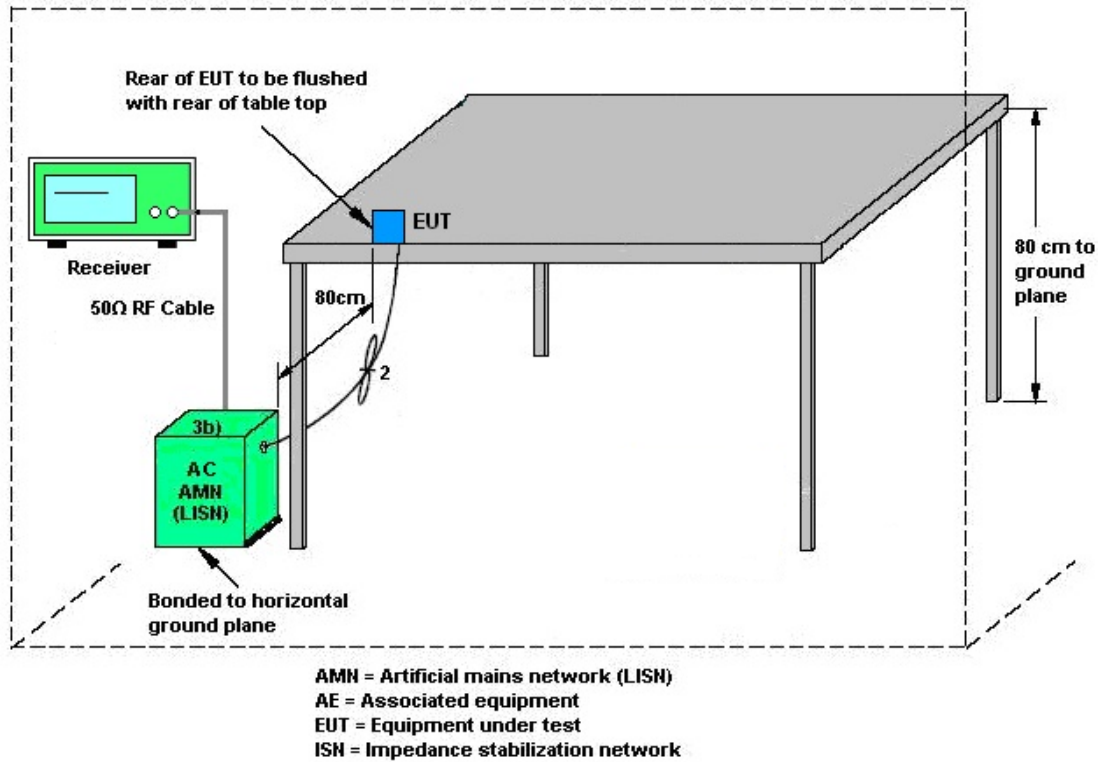

### 3.6.5 Test Result of AC Conducted Emission

Please refer to Appendix A.



## **3.7 Antenna Requirements**

### **3.7.1 Standard Applicable**

If directional gain of transmitting antennas is greater than 6dBi, the power shall be reduced by the same level in dB comparing to gain minus 6dBi. The use of a permanently attached antenna or of an antenna that uses a unique coupling to the intentional radiator shall be considered sufficient to comply with the rule.

### **3.7.2 Antenna Anti-Replacement Construction**

An embedded-in antenna design is used.

### **3.7.3 Antenna Gain**

The antenna peak gain of EUT is less than 6 dBi. Therefore, it is not necessary to reduce maximum peak output power limit.



## 4 List of Measuring Equipment

Instrument	Manufacturer	Model No.	Serial No.	Characteristics	Calibration Date	Test Date	Due Date	Remark
Power Meter	Anritsu	ML2495A	1132003	N/A	Aug. 16, 2018	Nov. 08, 2018~ Jan. 29, 2019	Aug. 15, 2019	Conducted (TH05-HY)
Power Sensor	Anritsu	MA2411B	1126017	300MHz~40GHz	Aug. 16, 2018	Nov. 08, 2018~ Jan. 29, 2019	Aug. 15, 2019	Conducted (TH05-HY)
Spectrum Analyzer	Rohde & Schwarz	FSP40	100055	9kHz~40GHz	Jun. 14, 2018	Nov. 08, 2018~ Jan. 29, 2019	Jun. 13, 2019	Conducted (TH05-HY)
Spectrum Analyzer	Rohde & Schwarz	FSV 30	100895	9kHz~30GHz	Apr. 20, 2018	Nov. 08, 2018~ Jan. 29, 2019	Apr. 19, 2019	Conducted (TH05-HY)
Switch Box & RF Cable	Burgeon	ETF-058	EC130048 4	N/A	Mar. 01, 2018	Nov. 08, 2018~ Jan. 29, 2019	Feb. 28, 2019	Conducted (TH05-HY)
Loop Antenna	TESEQ	HLA 6120	31244	9 kHz~30 MHz	Mar. 29, 2018	Dec. 06, 2018~ Mar. 11, 2019	Mar. 28, 2019	Radiation (03CH13-HY)
Horn Antenna	SCHWARZBECK	BBHA 9120 D	9120D-124 1	1GHz ~ 18GHz	Jun. 29, 2018	Dec. 06, 2018~ Mar. 11, 2019	Jun. 28, 2019	Radiation (03CH13-HY)
Bilog Antenna	TESEQ	CBL 6111D&00800 N1D01N-06	37059&01	30MHz~1GHz	Oct. 13, 2018	Dec. 06, 2018~ Mar. 11, 2019	Oct. 12, 2019	Radiation (03CH13-HY)
SHF-EHF Horn Antenna	SCHWARZBECK	BBHA 9170	BBHA9170 584	18GHz- 40GHz	Dec. 05, 2018	Dec. 06, 2018~ Mar. 11, 2019	Dec. 04, 2019	Radiation (03CH13-HY)
Preamplifier	Keysight	83017A	MY532700 80	1GHz~26.5GHz	Nov. 14, 2018	Dec. 06, 2018~ Mar. 11, 2019	Nov. 13, 2020	Radiation (03CH13-HY)
Preamplifier	MITEQ	AMF-7D-0010 1800-30-10P	1590074	1GHz~18GHz	May 21, 2018	Dec. 06, 2018~ Mar. 11, 2019	May 20, 2019	Radiation (03CH13-HY)
Amplifier	Sonoma-Instrument	310 N	187312	9KHz~1GHz	Dec. 04, 2018	Dec. 06, 2018~ Mar. 11, 2019	Dec. 03, 2019	Radiation (03CH13-HY)
Amplifier	MITEQ	TTA1840-35- HG	1871923	18GHz~40GHz, VSWR : 2.5:1 max	Jul. 16, 2018	Dec. 06, 2018~ Mar. 11, 2019	Jul. 15, 2019	Radiation (03CH13-HY)
RF Cable	HUBER + SUHNER	SUCOFLEX 104	MY9837/4 PE	30M~18GHz	Mar. 14, 2018	Dec. 06, 2018~ Mar. 11, 2019	Mar. 18, 2019	Radiation (03CH13-HY)
RF Cable	HUBER + SUHNER	SUCOFLEX 102	MY2859/2	30M~40GHz	Mar. 14, 2018	Dec. 06, 2018~ Mar. 11, 2019	Mar. 13, 2019	Radiation (03CH13-HY)
RF Cable	HUBER + SUHNER	SUCOFLEX 102	MY4274/2	30M~40GHz	Mar. 14, 2018	Dec. 06, 2018~ Mar. 11, 2019	Mar. 13, 2019	Radiation (03CH13-HY)
Spectrum Analyzer	Keysight	N9010A	MY553705 26	10Hz~44GHz	Mar. 15, 2018	Dec. 06, 2018~ Mar. 11, 2019	Mar. 14, 2019	Radiation (03CH13-HY)
Antenna Mast	EMEC	AM-BS-4500- B	N/A	1m~4m	N/A	Dec. 06, 2018~ Mar. 11, 2019	N/A	Radiation (03CH13-HY)
Turn Table	EMEC	TT2000	N/A	0~360 Degree	N/A	Dec. 06, 2018~ Mar. 11, 2019	N/A	Radiation (03CH13-HY)
Software	AUDIX	E3 6.2009-8-24c	RK-001124	N/A	N/A	Dec. 06, 2018~ Mar. 11, 2019	N/A	Radiation (03CH13-HY)
EMI Test Receiver	Keysight	N9038A (MXE)	MY541300 85	20Hz ~ 8.4GHz	Nov. 01, 2018	Dec. 06, 2018~ Mar. 11, 2019	Oct. 31, 2019	Radiation (03CH13-HY)
Filter	Wainwright	WHKX12-270 0-3000-18000 -60SS	SN2	3G High Pass	Jul. 16, 2018	Dec. 06, 2018~ Mar. 11, 2019	Jul. 15, 2019	Radiation (03CH13-HY)
Filter	Wainwright	WLKS1200-1 2SS	SN2	1.2G Low Pass	Mar. 23, 2018	Dec. 06, 2018~ Mar. 11, 2019	Mar. 22, 2019	Radiation (03CH13-HY)





Instrument	Manufacturer	Model No.	Serial No.	Characteristics	Calibration Date	Test Date	Due Date	Remark
AC Power Source	ChainTek	APC-1000W	N/A	N/A	N/A	Mar. 06, 2019	N/A	Conduction (CO05-HY)
EMI Test Receiver	Rohde & Schwarz	ESR3	102388	9KHz~3.6GHz	Nov. 12, 2018	Mar. 06, 2019	Nov. 11, 2019	Conduction (CO05-HY)
LISN	Rohde & Schwarz	ENV216	100080	9kHz~30MHz	Nov. 14, 2018	Mar. 06, 2019	Nov. 13, 2019	Conduction (CO05-HY)
LISN	Rohde & Schwarz	ENV216	100081	9kHz~30MHz	Nov. 09, 2018	Mar. 06, 2019	Nov. 08, 2019	Conduction (CO05-HY)
Software	Rohde & Schwarz	EMC32 V10.30	N/A	N/A	N/A	Mar. 06, 2019	N/A	Conduction (CO05-HY)
RF Cable	HUBER + SUHNER	RG 214/U	1358175	9kHz~30MHz	Sep. 14, 2018	Mar. 06, 2019	Sep. 13, 2019	Conduction (CO05-HY)
Pulse Limiter	SCHWARZBECK	VTSD 9561-F N	9561-F N00373	9kHz-200MHz	Nov. 08, 2018	Mar. 06, 2019	Nov. 07, 2019	Conduction (CO05-HY)



## 5 Uncertainty of Evaluation

### Uncertainty of Conducted Emission Measurement (150 kHz ~ 30 MHz)

Measuring Uncertainty for a Level of Confidence of 95% ( $U = 2Uc(y)$ )	2.2
---	-----

### Uncertainty of Radiated Emission Measurement (30 MHz ~ 1000 MHz)

Measuring Uncertainty for a Level of Confidence of 95% ( $U = 2Uc(y)$ )	4.9
---	-----

### Uncertainty of Radiated Emission Measurement (1000 MHz ~ 18000 MHz)

Measuring Uncertainty for a Level of Confidence of 95% ( $U = 2Uc(y)$ )	5.4
---	-----

### Uncertainty of Radiated Emission Measurement (18000 MHz ~ 40000 MHz)

Measuring Uncertainty for a Level of Confidence of 95% ( $U = 2Uc(y)$ )	4.3
---	-----



## Appendix A. AC Conducted Emission Test Results

Test Engineer :	Jimmy Chang	Temperature :	24~26°C
		Relative Humidity :	51~53%
Test Voltage :	120Vac / 60Hz	Phase :	Line

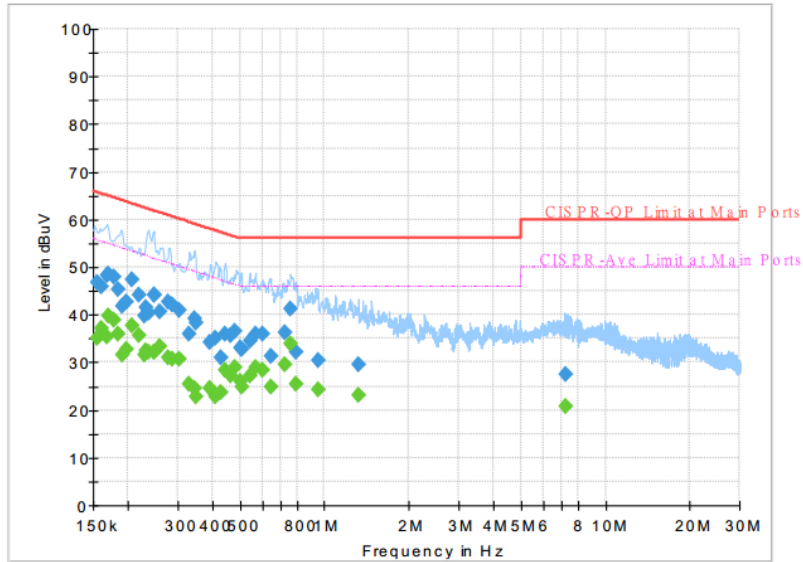

**Final Result :**

Frequency (MHz)	QuasiPeak (dBuV)	CAverage (dBuV)	Limit (dBuV)	Margin (dB)	Line	Filter	Corr. (dB)
0.154500	---	35.06	55.75	20.69	L1	OFF	19.5
0.154500	46.69	---	65.75	19.06	L1	OFF	19.5
0.161250	---	37.17	55.40	18.23	L1	OFF	19.5
0.161250	45.81	---	65.40	19.59	L1	OFF	19.5
0.168000	---	35.25	55.06	19.81	L1	OFF	19.5
0.168000	48.29	---	65.06	16.77	L1	OFF	19.5
0.170250	---	39.82	54.95	15.13	L1	OFF	19.5
0.170250	48.44	---	64.95	16.51	L1	OFF	19.5
0.177000	---	38.81	54.63	15.82	L1	OFF	19.5
0.177000	47.94	---	64.63	16.69	L1	OFF	19.5
0.183750	---	35.96	54.31	18.35	L1	OFF	19.5
0.183750	45.26	---	64.31	19.05	L1	OFF	19.5
0.190500	---	31.58	54.02	22.44	L1	OFF	19.5
0.190500	41.88	---	64.02	22.14	L1	OFF	19.5
0.197250	---	32.79	53.73	20.94	L1	OFF	19.5
0.197250	42.73	---	63.73	21.00	L1	OFF	19.5
0.206250	---	37.71	53.36	15.65	L1	OFF	19.5
0.206250	47.46	---	63.36	15.90	L1	OFF	19.5
0.217500	---	35.58	52.91	17.33	L1	OFF	19.5
0.217500	44.27	---	62.91	18.64	L1	OFF	19.5
0.228750	---	31.64	52.50	20.86	L1	OFF	19.5
0.228750	39.76	---	62.50	22.74	L1	OFF	19.5
0.231000	---	32.51	52.41	19.90	L1	OFF	19.5
0.231000	41.40	---	62.41	21.01	L1	OFF	19.5



Test Engineer :	Jimmy Chang	Temperature :	24~26°C
		Relative Humidity :	51~53%
Test Voltage :	120Vac / 60Hz	Phase :	Line

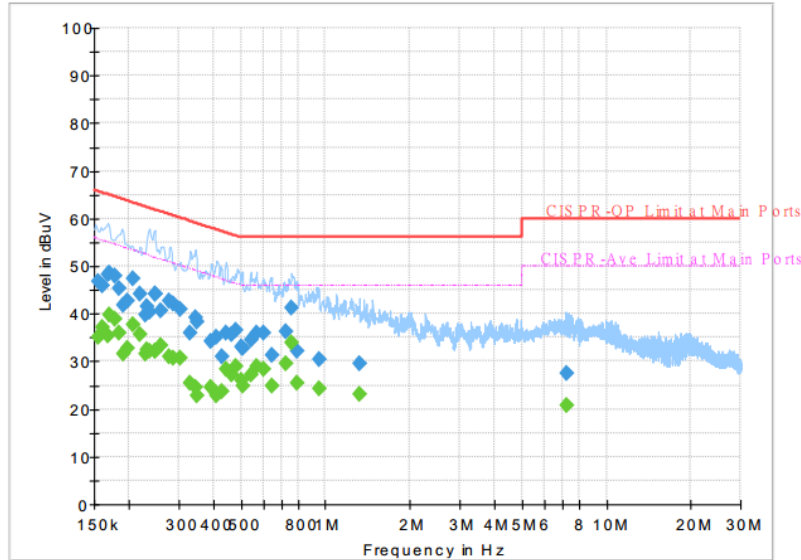

Final Result :

Frequency (MHz)	QuasiPeak (dBuV)	CAverage (dBuV)	Limit (dBuV)	Margin (dB)	Line	Filter	Corr. (dB)
0.235500	---	32.21	52.25	20.04	L1	OFF	19.5
0.235500	40.32	---	62.25	21.93	L1	OFF	19.5
0.246750	---	32.17	51.87	19.70	L1	OFF	19.5
0.246750	44.24	---	61.87	17.63	L1	OFF	19.5
0.249000	---	32.04	51.79	19.75	L1	OFF	19.5
0.249000	44.25	---	61.79	17.54	L1	OFF	19.5
0.258000	---	33.40	51.50	18.10	L1	OFF	19.5
0.258000	40.55	---	61.50	20.95	L1	OFF	19.5
0.278250	---	31.09	50.87	19.78	L1	OFF	19.5
0.278250	42.60	---	60.87	18.27	L1	OFF	19.5
0.287250	---	30.84	50.60	19.76	L1	OFF	19.5
0.287250	42.01	---	60.60	18.59	L1	OFF	19.5
0.305250	---	30.79	50.10	19.31	L1	OFF	19.5
0.305250	40.95	---	60.10	19.15	L1	OFF	19.5
0.330000	---	25.41	49.45	24.04	L1	OFF	19.5
0.330000	35.92	---	59.45	23.53	L1	OFF	19.5
0.345750	---	24.62	49.06	24.44	L1	OFF	19.5
0.345750	39.08	---	59.06	19.98	L1	OFF	19.5
0.348000	---	22.82	49.01	26.19	L1	OFF	19.5
0.348000	38.23	---	59.01	20.78	L1	OFF	19.5
0.390750	---	24.69	48.05	23.36	L1	OFF	19.5
0.390750	34.11	---	58.05	23.94	L1	OFF	19.5
0.411000	---	22.69	47.63	24.94	L1	OFF	19.5
0.411000	35.14	---	57.63	22.49	L1	OFF	19.5



Test Engineer :	Jimmy Chang	Temperature :	24~26°C
		Relative Humidity :	51~53%
Test Voltage :	120Vac / 60Hz	Phase :	Line

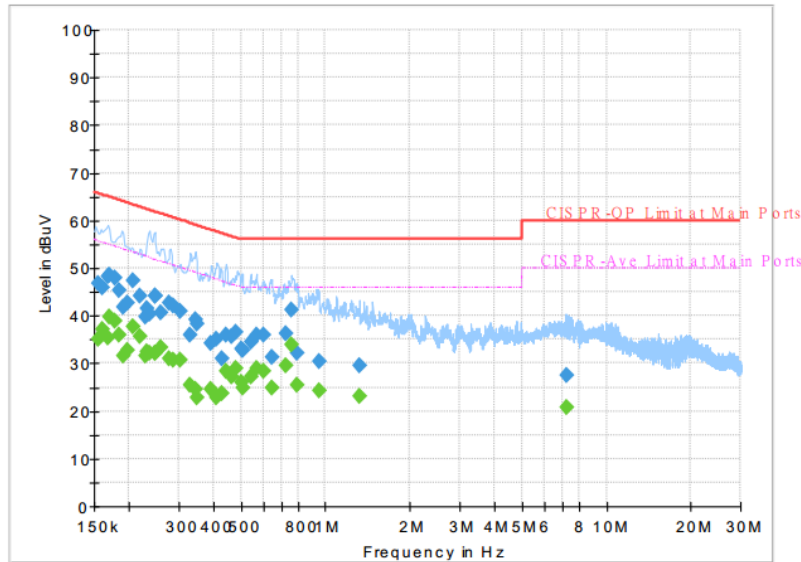

Final Result :

Frequency (MHz)	QuasiPeak (dBuV)	CAverage (dBuV)	Limit (dBuV)	Margin (dB)	Line	Filter	Corr. (dB)
0.426750	---	23.72	47.32	23.60	L1	OFF	19.5
0.426750	31.13	---	57.32	26.19	L1	OFF	19.5
0.442500	---	28.35	47.02	18.67	L1	OFF	19.5
0.442500	36.06	---	57.02	20.96	L1	OFF	19.5
0.465000	---	27.13	46.60	19.47	L1	OFF	19.5
0.465000	35.81	---	56.60	20.79	L1	OFF	19.5
0.478500	---	28.96	46.37	17.41	L1	OFF	19.5
0.478500	36.42	---	56.37	19.95	L1	OFF	19.5
0.503250	---	26.07	46.00	19.93	L1	OFF	19.5
0.503250	33.03	---	56.00	22.97	L1	OFF	19.5
0.507750	---	24.77	46.00	21.23	L1	OFF	19.5
0.507750	32.73	---	56.00	23.27	L1	OFF	19.5
0.543750	---	27.31	46.00	18.69	L1	OFF	19.5
0.543750	34.43	---	56.00	21.57	L1	OFF	19.5
0.568500	---	28.87	46.00	17.13	L1	OFF	19.5
0.568500	35.90	---	56.00	20.10	L1	OFF	19.5
0.602250	---	28.41	46.00	17.59	L1	OFF	19.5
0.602250	36.00	---	56.00	20.00	L1	OFF	19.5
0.645000	---	24.93	46.00	21.07	L1	OFF	19.5
0.645000	31.15	---	56.00	24.85	L1	OFF	19.5
0.719250	---	29.41	46.00	16.59	L1	OFF	19.5
0.719250	36.21	---	56.00	19.79	L1	OFF	19.5
0.755250	---	33.98	46.00	12.02	L1	OFF	19.5
0.755250	41.25	---	56.00	14.75	L1	OFF	19.5



Test Engineer :	Jimmy Chang	Temperature :	24~26°C
		Relative Humidity :	51~53%
Test Voltage :	120Vac / 60Hz	Phase :	Line

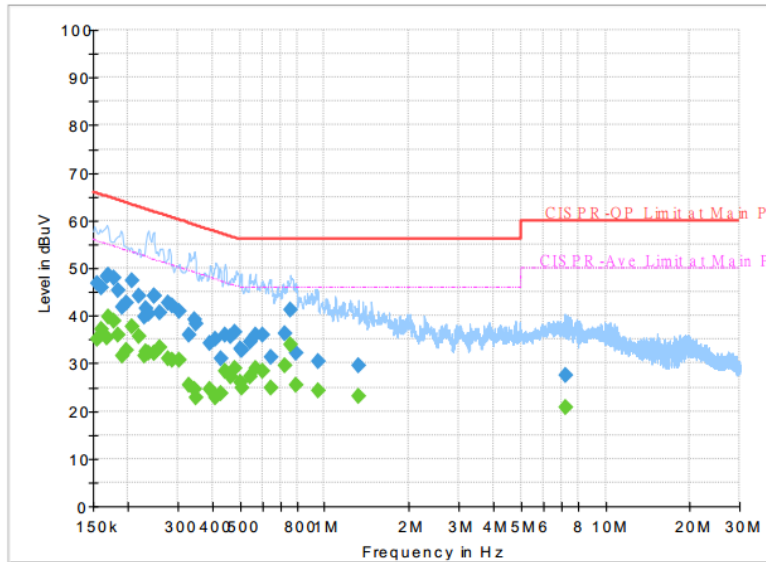

Final Result :

Frequency (MHz)	QuasiPeak (dBuV)	CAverage (dBuV)	Limit (dBuV)	Margin (dB)	Line	Filter	Corr. (dB)
0.793500	---	25.50	46.00	20.50	L1	OFF	19.5
0.793500	32.02	---	56.00	23.98	L1	OFF	19.5
0.946500	---	24.19	46.00	21.81	L1	OFF	19.5
0.946500	30.47	---	56.00	25.53	L1	OFF	19.5
1.322250	---	23.18	46.00	22.82	L1	OFF	19.6
1.322250	29.59	---	56.00	26.41	L1	OFF	19.6
7.199250	---	20.87	50.00	29.13	L1	OFF	19.7
7.199250	27.59	---	60.00	32.41	L1	OFF	19.7



Test Engineer :	Jimmy Chang	Temperature :	24~26°C
		Relative Humidity :	51~53%
Test Voltage :	120Vac / 60Hz	Phase :	Neutral

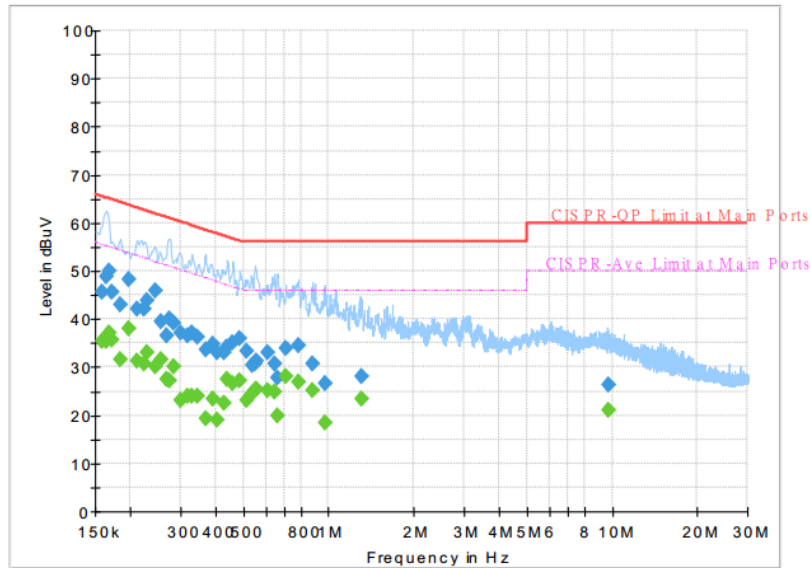

Final Result :

Frequency (MHz)	QuasiPeak (dBuV)	CAverage (dBuV)	Limit (dBuV)	Margin (dB)	Line	Filter	Corr. (dB)
0.159000	---	35.32	55.52	20.20	N	OFF	19.5
0.159000	45.63	---	65.52	19.89	N	OFF	19.5
0.163500	---	35.43	55.28	19.85	N	OFF	19.5
0.163500	48.90	---	65.28	16.38	N	OFF	19.5
0.168000	---	37.10	55.06	17.96	N	OFF	19.5
0.168000	49.91	---	65.06	15.15	N	OFF	19.5
0.172500	---	35.77	54.84	19.07	N	OFF	19.5
0.172500	45.61	---	64.84	19.23	N	OFF	19.5
0.183750	---	31.59	54.31	22.72	N	OFF	19.5
0.183750	43.10	---	64.31	21.21	N	OFF	19.5
0.197250	---	38.07	53.73	15.66	N	OFF	19.5
0.197250	48.17	---	63.73	15.56	N	OFF	19.5
0.210750	---	31.14	53.18	22.04	N	OFF	19.5
0.210750	41.96	---	63.18	21.22	N	OFF	19.5
0.224250	---	30.79	52.66	21.87	N	OFF	19.5
0.224250	42.13	---	62.66	20.53	N	OFF	19.5
0.228750	---	32.92	52.50	19.58	N	OFF	19.5
0.228750	44.00	---	62.50	18.50	N	OFF	19.5
0.244500	---	30.01	51.94	21.93	N	OFF	19.5
0.244500	46.04	---	61.94	15.90	N	OFF	19.5
0.255750	---	31.57	51.57	20.00	N	OFF	19.5
0.255750	39.59	---	61.57	21.98	N	OFF	19.5
0.269250	---	27.44	51.14	23.70	N	OFF	19.5
0.269250	36.41	---	61.14	24.73	N	OFF	19.5



Test Engineer :	Jimmy Chang	Temperature :	24~26°C
		Relative Humidity :	51~53%
Test Voltage :	120Vac / 60Hz	Phase :	Neutral

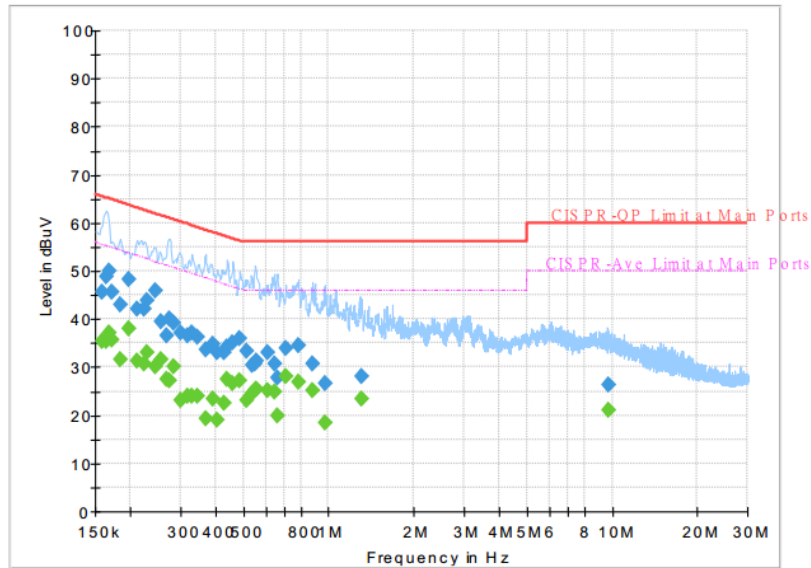

Final Result :

Frequency (MHz)	QuasiPeak (dBuV)	CAverage (dBuV)	Limit (dBuV)	Margin (dB)	Line	Filter	Corr. (dB)
0.273750	---	27.18	51.00	23.82	N	OFF	19.5
0.273750	39.99	---	61.00	21.01	N	OFF	19.5
0.285000	---	30.03	50.67	20.64	N	OFF	19.5
0.285000	39.18	---	60.67	21.49	N	OFF	19.5
0.300750	---	23.12	50.22	27.10	N	OFF	19.5
0.300750	37.02	---	60.22	23.20	N	OFF	19.5
0.316500	---	23.93	49.80	25.87	N	OFF	19.5
0.316500	36.43	---	59.80	23.37	N	OFF	19.5
0.330000	---	24.00	49.45	25.45	N	OFF	19.5
0.330000	37.25	---	59.45	22.20	N	OFF	19.5
0.343500	---	23.84	49.12	25.28	N	OFF	19.5
0.343500	36.22	---	59.12	22.90	N	OFF	19.5
0.368250	---	19.23	48.54	29.31	N	OFF	19.5
0.368250	33.53	---	58.54	25.01	N	OFF	19.5
0.388500	---	23.40	48.10	24.70	N	OFF	19.5
0.388500	34.94	---	58.10	23.16	N	OFF	19.5
0.406500	---	18.92	47.72	28.80	N	OFF	19.5
0.406500	32.91	---	57.72	24.81	N	OFF	19.5
0.426750	---	22.54	47.32	24.78	N	OFF	19.5
0.426750	33.03	---	57.32	24.29	N	OFF	19.5
0.440250	---	27.45	47.06	19.61	N	OFF	19.5
0.440250	34.15	---	57.06	22.91	N	OFF	19.5
0.460500	---	26.48	46.68	20.20	N	OFF	19.5
0.460500	35.03	---	56.68	21.65	N	OFF	19.5





Test Engineer :	Jimmy Chang	Temperature :	24~26°C
		Relative Humidity :	51~53%
Test Voltage :	120Vac / 60Hz	Phase :	Neutral

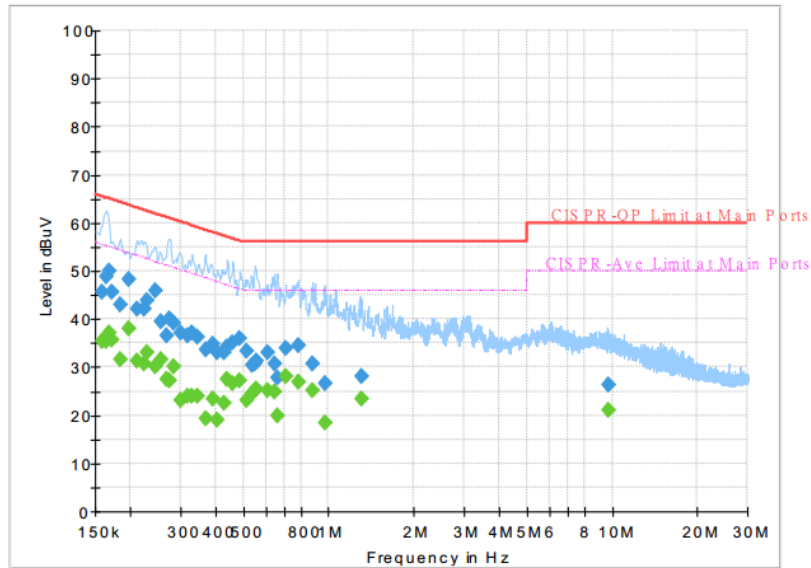

Final Result :

Frequency (MHz)	QuasiPeak (dBuV)	CAverage (dBuV)	Limit (dBuV)	Margin (dB)	Line	Filter	Corr. (dB)
0.485250	---	27.13	46.25	19.12	N	OFF	19.5
0.485250	35.84	---	56.25	20.41	N	OFF	19.5
0.514500	---	23.24	46.00	22.76	N	OFF	19.5
0.514500	33.47	---	56.00	22.53	N	OFF	19.5
0.534750	---	24.47	46.00	21.53	N	OFF	19.5
0.534750	30.36	---	56.00	25.64	N	OFF	19.5
0.550500	---	25.05	46.00	20.95	N	OFF	19.5
0.550500	30.68	---	56.00	25.32	N	OFF	19.5
0.555000	---	25.31	46.00	20.69	N	OFF	19.5
0.555000	31.28	---	56.00	24.72	N	OFF	19.5
0.609000	---	25.01	46.00	20.99	N	OFF	19.5
0.609000	33.01	---	56.00	22.99	N	OFF	19.5
0.642750	---	24.72	46.00	21.28	N	OFF	19.5
0.642750	30.63	---	56.00	25.37	N	OFF	19.5
0.660750	---	20.00	46.00	26.00	N	OFF	19.5
0.660750	27.73	---	56.00	28.27	N	OFF	19.5
0.708000	---	28.21	46.00	17.79	N	OFF	19.5
0.708000	34.00	---	56.00	22.00	N	OFF	19.5
0.782250	---	26.92	46.00	19.08	N	OFF	19.5
0.782250	34.54	---	56.00	21.46	N	OFF	19.5
0.874500	---	25.21	46.00	20.79	N	OFF	19.5
0.874500	30.71	---	56.00	25.29	N	OFF	19.5
0.966750	---	18.41	46.00	27.59	N	OFF	19.5
0.966750	26.72	---	56.00	29.28	N	OFF	19.5



Test Engineer :	Jimmy Chang	Temperature :	24~26°C
		Relative Humidity :	51~53%
Test Voltage :	120Vac / 60Hz	Phase :	Neutral

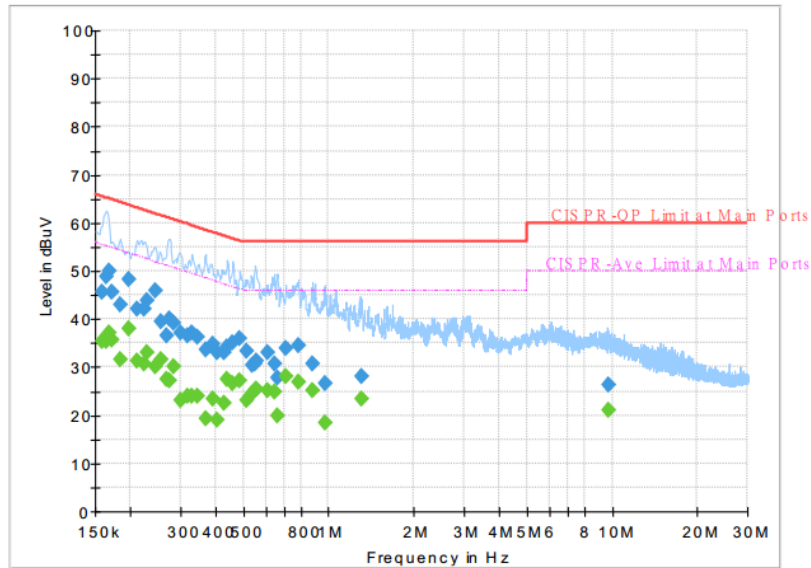

**Final Result :**

Frequency (MHz)	QuasiPeak (dBuV)	CAverage (dBuV)	Limit (dBuV)	Margin (dB)	Line	Filter	Corr. (dB)
1.304250	---	23.30	46.00	22.70	N	OFF	19.5
1.304250	28.18	---	56.00	27.82	N	OFF	19.5
9.656250	---	21.04	50.00	28.96	N	OFF	19.7
9.656250	26.40	---	60.00	33.60	N	OFF	19.7



## Appendix B. Radiated Spurious Emission

Test Engineer :	Alex Jheng, Fu Chen, and Wilson Wu	Temperature :	24~26°C
		Relative Humidity :	49~53%

### 2.4GHz 2400~2483.5MHz

#### BLE 1Mbps (Band Edge @ 3m)

BLE	Note	Frequency	Level	Over	Limit	Read	Antenna	Path	Preamp	Ant	Table	Peak	Pol.	
		( MHz )	( dBμV/m )	( dB )	Limit	Line	Level	Factor	Loss	Factor	Pos	Pos	Avg.	
					( dBμV/m )	( dBμV )	( dB/m )	( dB )	( dB )	( cm )	( deg )	( P/A )	( H/V )	
BLE CH 00 2402MHz		2359.56	53.12	-20.88	74	40.42	27.14	15.47	29.91	236	27	P	H	
		2367.96	44.09	-9.91	54	31.38	27.14	15.47	29.9	236	27	A	H	
	*	2402	97.83	-	-	84.98	27.23	15.51	29.89	236	27	P	H	
	*	2402	97.26	-	-	84.41	27.23	15.51	29.89	236	27	A	H	
													H	
														H
			2336.67	53.58	-20.42	74	40.95	27.1	15.44	29.91	346	43	P	V
			2349.9	44.03	-9.97	54	31.39	27.1	15.45	29.91	346	43	A	V
	*		2402	95.22	-	-	82.37	27.23	15.51	29.89	346	43	P	V
	*		2402	94.54	-	-	81.69	27.23	15.51	29.89	346	43	A	V
														V
													V	
BLE CH 19 2440MHz		2380.42	53.58	-20.42	74	40.8	27.19	15.49	29.9	260	27	P	H	
		2379.02	44.11	-9.89	54	31.33	27.19	15.49	29.9	260	27	A	H	
	*	2440	96.97	-	-	83.94	27.37	15.55	29.89	260	27	P	H	
	*	2440	96.39	-	-	83.36	27.37	15.55	29.89	260	27	A	H	
			2496.71	54.07	-19.93	74	40.82	27.5	15.62	29.87	260	27	P	H
			2491.25	44.74	-9.26	54	31.51	27.5	15.61	29.88	260	27	A	H
			2363.34	53.9	-20.1	74	41.2	27.14	15.47	29.91	331	43	P	V
			2364.32	44.29	-9.71	54	31.58	27.14	15.47	29.9	331	43	A	V
	*		2440	95.94	-	-	82.91	27.37	15.55	29.89	331	43	P	V
	*		2440	95.38	-	-	82.35	27.37	15.55	29.89	331	43	A	V
			2489.92	53.46	-20.54	74	40.23	27.5	15.61	29.88	331	43	P	V
		2487.12	44.77	-9.23	54	31.58	27.46	15.61	29.88	331	43	A	V	



<b>BLE CH 39 2480MHz</b>	*	2480	97.09	-	-	83.91	27.46	15.6	29.88	250	29	P	H
	*	2480	96.53	-	-	83.35	27.46	15.6	29.88	250	29	A	H
		2499.8	53.56	-20.44	74	40.31	27.5	15.62	29.87	250	29	P	H
		2496.2	44.5	-9.5	54	31.25	27.5	15.62	29.87	250	29	A	H
													H
													H
	*	2480	97.19	-	-	84.01	27.46	15.6	29.88	298	55	P	V
	*	2480	96.65	-	-	83.47	27.46	15.6	29.88	298	55	A	V
		2486.72	53.57	-20.43	74	40.38	27.46	15.61	29.88	298	55	P	V
		2490.36	44.64	-9.36	54	31.41	27.5	15.61	29.88	298	55	A	V
													V
													V
<b>Remark</b>	1. No other spurious found. 2. All results are PASS against Peak and Average limit line.												



**2.4GHz 2400~2483.5MHz**  
**BLE 1Mbps (Harmonic @ 3m)**

BLE	Note	Frequency ( MHz )	Level ( dBµV/m )	Over Limit ( dB )	Limit Line ( dBµV/m )	Read Level ( dBµV )	Antenna Factor ( dB/m )	Path Loss ( dB )	Preamp Factor ( dB )	Ant Pos ( cm )	Table Pos ( deg )	Peak Avg. ( P/A )	Pol. ( H/V )	
BLE CH 00 2402MHz		4804	35.14	-38.86	74	53.37	31.22	8.14	57.59	100	0	P	H	
													H	
													H	
													H	
			4804	35.4	-38.6	74	53.63	31.22	8.14	57.59	100	0	P	V
														V
														V
BLE CH 19 2440MHz		4880	36.83	-37.17	74	54.44	31.36	8.47	57.44	100	0	P	H	
		7320	41.78	-32.22	74	52.16	36.22	10.68	57.28	100	0	P	H	
													H	
													H	
			4880	35.8	-38.2	74	53.41	31.36	8.47	57.44	100	0	P	V
			7320	41.63	-32.37	74	52.01	36.22	10.68	57.28	100	0	P	V
														V
BLE CH 39 2480MHz		4960	36.81	-37.19	74	53.73	31.53	8.83	57.28	100	0	P	H	
		7440	42.82	-31.18	74	53.02	36.49	10.74	57.43	100	0	P	H	
													H	
													H	
			4960	36.27	-37.73	74	53.19	31.53	8.83	57.28	100	0	P	V
			7440	42.71	-31.29	74	52.91	36.49	10.74	57.43	100	0	P	V
														V
Remark	1. No other spurious found. 2. All results are PASS against Peak and Average limit line.													



Emission below 1GHz

2.4GHz BLE 1Mbps (LF)

BLE	Note	Frequency	Level	Over	Limit	Read	Antenna	Path	Preamp	Ant	Table	Peak	Pol.	
		( MHz )	( dBμV/m )	( dB )	( dBμV/m )	( dBμV )	( dB/m )	( dB )	( dB )	( cm )	( deg )	( P/A )	( H/V )	
2.4GHz BLE LF		133.95	34.2	-9.3	43.5	47.58	17.38	1.43	32.19	-	-	P	H	
		238.44	31.93	-14.07	46	45.2	16.97	1.9	32.14	-	-	P	H	
		255.45	34.02	-11.98	46	45.12	19.08	1.97	32.15	-	-	P	H	
		598.2	32.47	-13.53	46	36.38	25.42	2.91	32.24	-	-	P	H	
		827.1	33.56	-12.44	46	33.39	28.46	3.47	31.76	-	-	P	H	
		897.1	39	-7	46	37.86	29.01	3.55	31.42	100	0	P	H	
														H
														H
														H
														H
														H
														H
			40.53	30.86	-9.14	40	43.36	18.94	0.85	32.29	-	-	P	V
			59.16	31.03	-8.97	40	50.49	11.84	0.98	32.28	-	-	P	V
			254.91	29.49	-16.51	46	40.66	19.01	1.97	32.15	-	-	P	V
			399.4	33.54	-12.46	46	41.63	21.61	2.46	32.16	-	-	P	V
			895.7	40.8	-5.2	46	39.66	29.02	3.55	31.43	100	0	P	V
			996.5	41.46	-12.54	54	37.88	30.45	3.72	30.59	-	-	P	V
														V
														V
													V	
													V	
													V	
													V	
Remark	1. No other spurious found. 2. All results are PASS against limit line.													



2.4GHz 2400~2483.5MHz

BLE 2Mbps (Band Edge @ 3m)

BLE	Note	Frequency	Level	Over	Limit	Read	Antenna	Path	Preamp	Ant	Table	Peak	Pol.	
		( MHz )	( dBμV/m )	( dB )	( dBμV/m )	( dBμV )	( dB/m )	( dB )	( dB )	( cm )	( deg )	( P/A )	( H/V )	
BLE CH 00 2402MHz		2376.99	54.13	-19.87	74	41.36	27.19	15.48	29.9	205	22	P	H	
		2323.23	46.03	-7.97	54	33.46	27.05	15.43	29.91	205	22	A	H	
	*	2402	97.81	-	-	84.96	27.23	15.51	29.89	205	22	P	H	
	*	2402	96.59	-	-	83.74	27.23	15.51	29.89	205	22	A	H	
													H	
														H
			2382.03	53.01	-20.99	74	40.23	27.19	15.49	29.9	345	37	P	V
			2341.815	45.71	-8.29	54	33.07	27.1	15.45	29.91	345	37	A	V
	*		2402	94.75	-	-	81.9	27.23	15.51	29.89	345	37	P	V
	*		2402	93.41	-	-	80.56	27.23	15.51	29.89	345	37	A	V
														V
	BLE CH 19 2440MHz		2313.22	53.68	-20.32	74	41.18	27.01	15.41	29.92	229	25	P	H
		2358.02	45.58	-8.42	54	32.89	27.14	15.46	29.91	229	25	A	H	
*		2440	97.22	-	-	84.19	27.37	15.55	29.89	229	25	P	H	
*		2440	96.07	-	-	83.04	27.37	15.55	29.89	229	25	A	H	
			2498.74	53.68	-20.32	74	40.43	27.5	15.62	29.87	229	25	P	H
			2491.39	46.09	-7.91	54	32.86	27.5	15.61	29.88	229	25	A	H
			2383.36	53.35	-20.65	74	40.57	27.19	15.49	29.9	324	50	P	V
			2380.42	45.74	-8.26	54	32.96	27.19	15.49	29.9	324	50	A	V
*			2440	95.74	-	-	82.71	27.37	15.55	29.89	324	50	P	V
*			2440	94.37	-	-	81.34	27.37	15.55	29.89	324	50	A	V
			2494.61	53.99	-20.01	74	40.75	27.5	15.61	29.87	324	50	P	V
			2493.28	46.16	-7.84	54	32.92	27.5	15.61	29.87	324	50	A	V



<b>BLE CH 39 2480MHz</b>	*	2480	97.15	-	-	83.97	27.46	15.6	29.88	201	19	P	H
	*	2480	95.75	-	-	82.57	27.46	15.6	29.88	201	19	A	H
		2484.2	54.1	-19.9	74	40.92	27.46	15.6	29.88	201	19	P	H
		2496.32	46.28	-7.72	54	33.03	27.5	15.62	29.87	201	19	A	H
													H
													H
	*	2480	96.76	-	-	83.58	27.46	15.6	29.88	290	40	P	V
	*	2480	95.45	-	-	82.27	27.46	15.6	29.88	290	40	A	V
		2499.76	54.07	-19.93	74	40.82	27.5	15.62	29.87	290	40	P	V
		2488.24	46.36	-7.64	54	33.13	27.5	15.61	29.88	290	40	A	V
													V
													V
<b>Remark</b>	1. No other spurious found. 2. All results are PASS against Peak and Average limit line.												





2.4GHz 2400~2483.5MHz  
BLE 2Mbps (Harmonic @ 3m)

BLE	Note	Frequency ( MHz )	Level ( dBµV/m )	Over Limit ( dB )	Limit Line ( dBµV/m )	Read Level ( dBµV )	Antenna Factor ( dB/m )	Path Loss ( dB )	Preamp Factor ( dB )	Ant Pos ( cm )	Table Pos ( deg )	Peak Avg. ( P/A )	Pol. ( H/V )
BLE CH 00 2402MHz		4804	35.82	-38.18	74	54.05	31.22	8.14	57.59	100	0	P	H
													H
													H
													H
													V
													V
													V
BLE CH 19 2440MHz		4880	36.52	-37.48	74	54.13	31.36	8.47	57.44	100	0	P	H
		7320	42	-32	74	52.38	36.22	10.68	57.28	100	0	P	H
													H
													H
													V
													V
													V
BLE CH 39 2480MHz		4960	37.46	-36.54	74	54.38	31.53	8.83	57.28	100	0	P	H
		7440	42.78	-31.22	74	52.98	36.49	10.74	57.43	100	0	P	H
													H
													H
													V
													V
													V
Remark	1. No other spurious found. 2. All results are PASS against Peak and Average limit line.												



Emission below 1GHz

2.4GHz BLE 2Mbps (LF)

BLE	Note	Frequency	Level	Over	Limit	Read	Antenna	Path	Preamp	Ant	Table	Peak	Pol.	
		( MHz )	( dBμV/m )	( dB )	( dBμV/m )	( dBμV )	( dB/m )	( dB )	( dB )	( cm )	( deg )	( P/A )	( H/V )	
2.4GHz BLE LF		133.95	34.56	-8.94	43.5	47.94	17.38	1.43	32.19	100	0	P	H	
		236.55	32.41	-13.59	46	45.88	16.78	1.89	32.14	-	-	P	H	
		254.64	35.05	-10.95	46	46.25	18.98	1.97	32.15	-	-	P	H	
		724.9	32.07	-13.93	46	33.64	27.29	3.18	32.04	-	-	P	H	
		799.8	32.53	-13.47	46	32.99	28.02	3.41	31.89	-	-	P	H	
		891.5	33.38	-12.62	46	32.25	29.04	3.54	31.45	-	-	P	H	
														H
														H
														H
														H
														H
														H
			32.16	25.53	-14.47	40	33.85	23.22	0.75	32.29	100	0	P	V
			60.51	23.27	-16.73	40	42.79	11.78	0.97	32.27	-	-	P	V
			133.68	25.59	-17.91	43.5	38.97	17.38	1.43	32.19	-	-	P	V
			399.4	29.79	-16.21	46	37.88	21.61	2.46	32.16	-	-	P	V
			598.2	30.62	-15.38	46	34.53	25.42	2.91	32.24	-	-	P	V
			962.2	33.91	-20.09	54	30.23	30.85	3.71	30.88	-	-	P	V
														V
														V
													V	
													V	
													V	
													V	
Remark	1. No other spurious found. 2. All results are PASS against limit line.													



**Note symbol**

*	<b>Fundamental Frequency</b> which can be ignored. However, the level of any unwanted emissions shall not exceed the level of the fundamental frequency.
!	Test result is <b>over limit</b> line.
P/A	<b>Peak</b> or <b>Average</b>
H/V	<b>Horizontal</b> or <b>Vertical</b>



A calculation example for radiated spurious emission is shown as below:

BLE	Note	Frequency	Level	Over	Limit	Read	Antenna	Path	Preamp	Ant	Table	Peak	Pol.
		( MHz )	( dBμV/m )	( dB )	( dBμV/m )	( dBμV )	( dB/m )	( dB )	( dB )	( cm )	( deg )	( P/A )	( H/V )
BLE CH 00 2402MHz		2390	55.45	-18.55	74	54.51	32.22	4.58	35.86	103	308	P	H
		2390	43.54	-10.46	54	42.6	32.22	4.58	35.86	103	308	A	H

1. Path Loss(dB) = Cable loss(dB) + Filter loss(dB) + Attenuator loss(dB)
2. Level(dBμV/m) =  
Antenna Factor(dB/m) + Path Loss(dB) + Read Level(dBμV) - Preamp Factor(dB)
3. Over Limit(dB) = Level(dBμV/m) – Limit Line(dBμV/m)

**For Peak Limit @ 2390MHz:**

1. Level(dBμV/m)  
= Antenna Factor(dB/m) + Path Loss(dB) + Read Level(dBμV) - Preamp Factor(dB)  
= 32.22(dB/m) + 4.58(dB) + 54.51(dBμV) – 35.86 (dB)  
= 55.45 (dBμV/m)
2. Over Limit(dB)  
= Level(dBμV/m) – Limit Line(dBμV/m)  
= 55.45(dBμV/m) – 74(dBμV/m)  
= -18.55(dB)

**For Average Limit @ 2390MHz:**

1. Level(dBμV/m)  
= Antenna Factor(dB/m) + Path Loss(dB) + Read Level(dBμV) - Preamp Factor(dB)  
= 32.22(dB/m) + 4.58(dB) + 42.6(dBμV) – 35.86 (dB)  
= 43.54 (dBμV/m)
2. Over Limit(dB)  
= Level(dBμV/m) – Limit Line(dBμV/m)  
= 43.54(dBμV/m) – 54(dBμV/m)  
= -10.46(dB)

**Both peak and average measured complies with the limit line, so test result is “PASS”.**



## Appendix C. Radiated Spurious Emission Plots

Test Engineer :	Alex Jheng, Fu Chen, and Wilson Wu	Temperature :	24~26°C
		Relative Humidity :	49~53%

**Note symbol**

-L	Low channel location
-R	High channel location



2.4GHz 2400~2483.5MHz

BLE 1Mbps (Band Edge @ 3m)

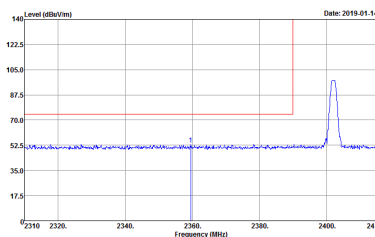
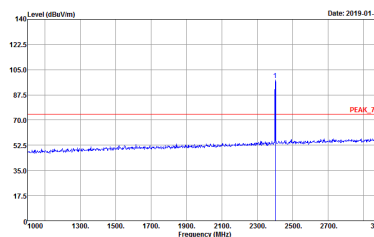
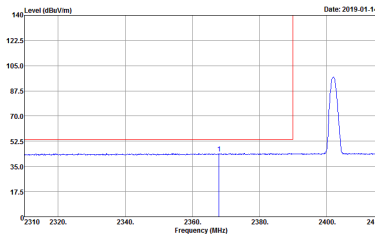
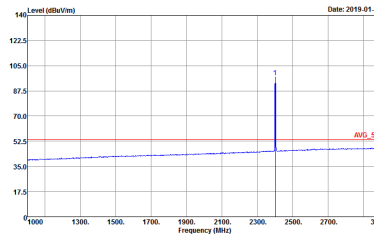
BLE	2.4GHz 2400~2483.5MHz Band Edge @ 3m	
BLE CH00 2402MHz		
	Horizontal	Fundamental
Peak	 <p>Site : 03CH13-HY            Condition : PEAK_BE_74 3m HORN_91200_1241 HORIZONTAL            Detector : Peak            Project : BN0131-01            Mode : 4            Power : Default</p>	 <p>Site : 03CH13-HY            Condition : PEAK_74 3m HORN_91200_1241 HORIZONTAL            Detector : Peak            Project : BN0131-01            Mode : 4            Power : Default</p>
Avg.	 <p>Site : 03CH13-HY            Condition : AVG_BE_54 3m HORN_91200_1241 HORIZONTAL            Detector : Peak            Project : BN0131-01            Mode : 4            Power : Default</p>	 <p>Site : 03CH13-HY            Condition : AVG_54 3m HORN_91200_1241 HORIZONTAL            Detector : Peak            Project : BN0131-01            Mode : 4            Power : Default</p>

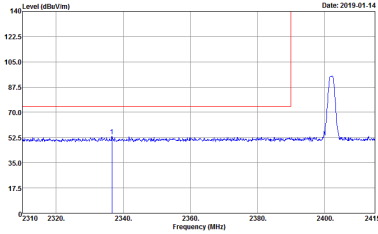
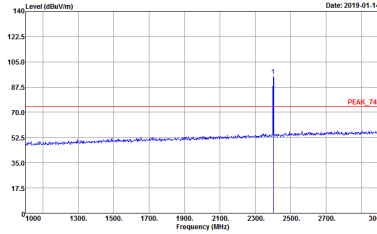
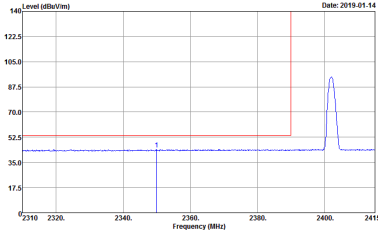
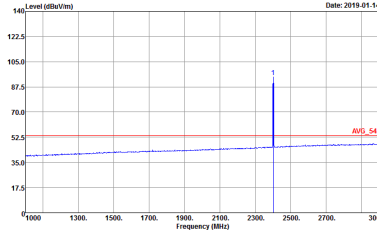

BLE	2.4GHz 2400~2483.5MHz Band Edge @ 3m	
BLE CH00 2402MHz		
	Vertical	Fundamental
<p><b>Peak</b></p>	 <p>Site : 03CH13-HY            Condition : PEAK_BE_74 3m HORN_91200_1241 VERTICAL            Detector : Peak            Project : BN0131-01            Mode : 4            Power : Default</p>	 <p>Site : 03CH13-HY            Condition : PEAK_74 3m HORN_91200_1241 VERTICAL            Detector : Peak            Project : BN0131-01            Mode : 4            Power : Default</p>
<p><b>Avg</b></p>	 <p>Site : 03CH13-HY            Condition : AVG_BE_54 3m HORN_91200_1241 VERTICAL            Detector : Peak            Project : BN0131-01            Mode : 4            Power : Default</p>	 <p>Site : 03CH13-HY            Condition : AVG_54 3m HORN_91200_1241 VERTICAL            Detector : Peak            Project : BN0131-01            Mode : 4            Power : Default</p>

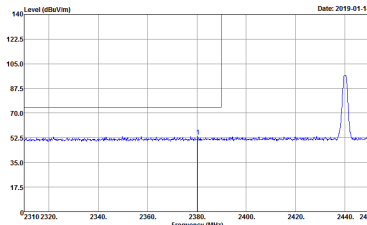
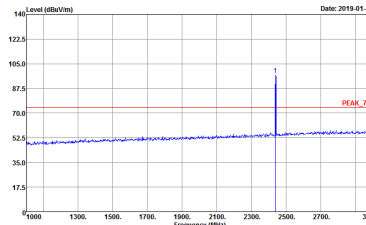
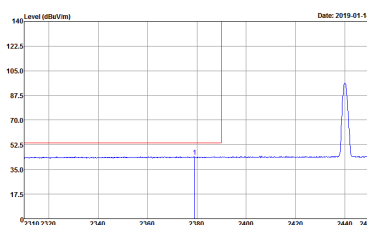
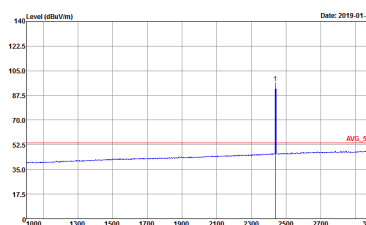

BLE	2.4GHz 2400~2483.5MHz Band Edge @ 3m	
BLE CH19 2440MHz - L		
	Horizontal	Fundamental
Peak	 <p>Level (dBm/1m) vs Frequency (MHz) plot showing a peak at 2440 MHz. The y-axis ranges from 17.5 to 140 dBm/1m, and the x-axis ranges from 2310 to 2450 MHz. A red line indicates the peak level at approximately 105 dBm/1m.</p> <p>Site : 03CH13-HV            Condition : PEAK_BE_74 3m HORN_9120D_1241 HORIZONTAL            Detector : Peak            Project : BN0131-01            Mode : 5            Power : Default</p>	 <p>Level (dBm/1m) vs Frequency (MHz) plot showing a peak at 2440 MHz. The y-axis ranges from 17.5 to 140 dBm/1m, and the x-axis ranges from 1000 to 3000 MHz. A red line indicates the peak level at approximately 105 dBm/1m.</p> <p>Site : 03CH13-HV            Condition : PEAK_74 3m HORN_9120D_1241 HORIZONTAL            Detector : Peak            Project : BN0131-01            Mode : 5            Power : Default</p>
Avg.	 <p>Level (dBm/1m) vs Frequency (MHz) plot showing an average level at 2440 MHz. The y-axis ranges from 17.5 to 140 dBm/1m, and the x-axis ranges from 2310 to 2450 MHz. A red line indicates the average level at approximately 55 dBm/1m.</p> <p>Site : 03CH13-HV            Condition : AVG_BE_54 3m HORN_9120D_1241 HORIZONTAL            Detector : Peak            Project : BN0131-01            Mode : 5            Power : Default</p>	 <p>Level (dBm/1m) vs Frequency (MHz) plot showing an average level at 2440 MHz. The y-axis ranges from 17.5 to 140 dBm/1m, and the x-axis ranges from 1000 to 3000 MHz. A red line indicates the average level at approximately 55 dBm/1m.</p> <p>Site : 03CH13-HV            Condition : AVG_54 3m HORN_9120D_1241 HORIZONTAL            Detector : Peak            Project : BN0131-01            Mode : 5            Power : Default</p>



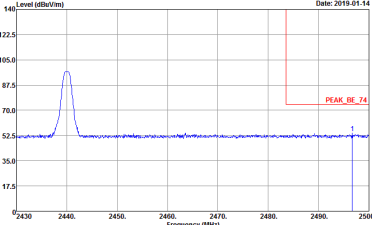
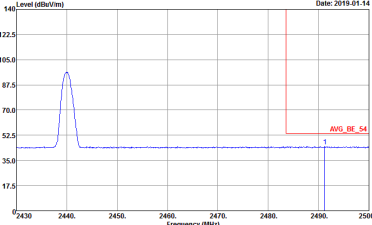

BLE	2.4GHz 2400~2483.5MHz Band Edge @ 3m	
BLE CH19 2440MHz - R		
	Horizontal	Fundamental
<p><b>Peak</b></p>	 <p>Site : 03CH13-HY            Condition : PEAK_BE_74 3m HORN_91200_1241 HORIZONTAL            Detector : Peak            Project : BN0131-01            Mode : S            Power : Default</p>	<p>Left blank</p>
<p><b>Avg.</b></p>	 <p>Site : 03CH13-HY            Condition : AVG_BE_54 3m HORN_91200_1241 HORIZONTAL            Detector : Peak            Project : BN0131-01            Mode : S            Power : Default</p>	<p>Left blank</p>

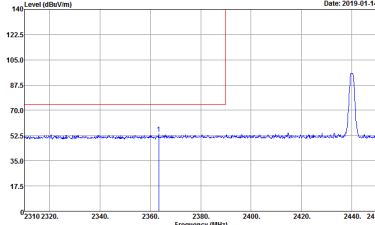
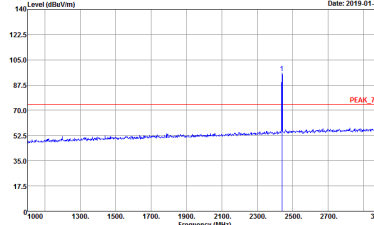
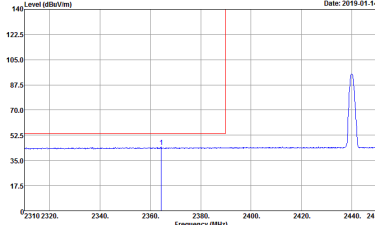
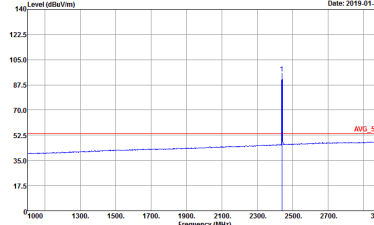

BLE	2.4GHz 2400~2483.5MHz Band Edge @ 3m	
BLE CH19 2440MHz - L		
	Vertical	Fundamental
<p><b>Peak</b></p>	 <p>Site : 03CH13-HY            Condition : PEAK_BE_74 3m HORN_91200_1241 VERTICAL            Detector : Peak            Project : BN0131-01            Mode : 5            Power : Default</p>	 <p>Site : 03CH13-HY            Condition : PEAK_74 3m HORN_91200_1241 VERTICAL            Detector : Peak            Project : BN0131-01            Mode : 5            Power : Default</p>
<p><b>Avg.</b></p>	 <p>Site : 03CH13-HY            Condition : AVG_BE_54 3m HORN_91200_1241 VERTICAL            Detector : Peak            Project : BN0131-01            Mode : 5            Power : Default</p>	 <p>Site : 03CH13-HY            Condition : AVG_54 3m HORN_91200_1241 VERTICAL            Detector : Peak            Project : BN0131-01            Mode : 5            Power : Default</p>

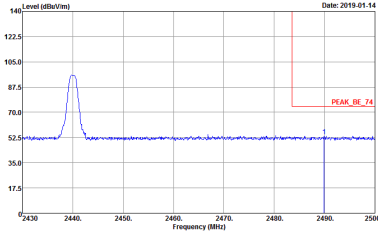
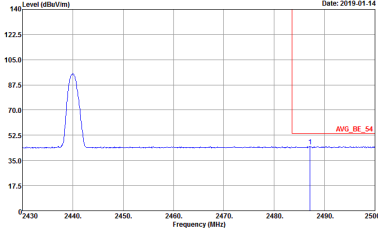

BLE	2.4GHz 2400~2483.5MHz Band Edge @ 3m	
BLE CH19 2440MHz - R		
	Vertical	Fundamental
<p><b>Peak</b></p>	 <p>Site : 03CH13-HY            Condition : PEAK_BE_74 3m HORN_9120D_1241 VERTICAL            RBW:1000.000kHz VBW:3000.000kHz SWF:Auto            Detector : Peak            Project : BN0131-01            Mode : S            Power : Default</p>	<p>Left blank</p>
<p><b>Avg.</b></p>	 <p>Site : 03CH13-HY            Condition : AVG_BE_54 3m HORN_9120D_1241 VERTICAL            RBW:1000.000kHz VBW:3.000kHz SWF:Auto            Detector : Peak            Project : BN0131-01            Mode : S            Power : Default</p>	<p>Left blank</p>

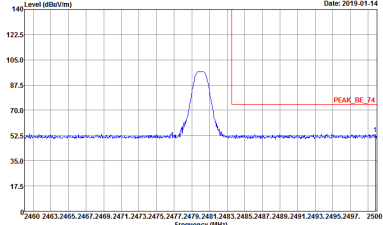
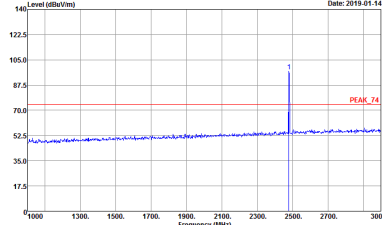
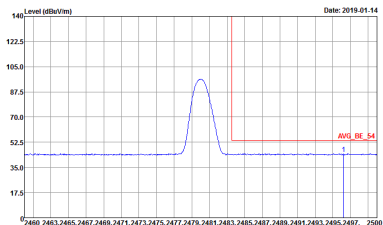
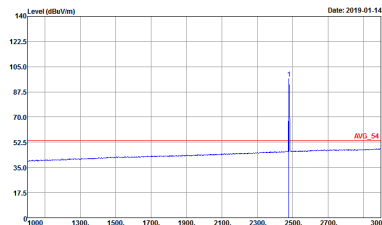

BLE	2.4GHz 2400~2483.5MHz Band Edge @ 3m	
BLE CH39 2480MHz		
Horizontal		Fundamental
Peak	 <p>Site : 03CH13-HY            Condition : PEAK_BE_74 3m HORN_91200_1241 HORIZONTAL            Detector : Peak            Project : BN0131-01            Mode : 6            Power : Default</p>	 <p>Site : 03CH13-HY            Condition : PEAK_74 3m HORN_91200_1241 HORIZONTAL            Detector : Peak            Project : BN0131-01            Mode : 6            Power : Default</p>
	 <p>Site : 03CH13-HY            Condition : AVG_BE_54 3m HORN_91200_1241 HORIZONTAL            Detector : Peak            Project : BN0131-01            Mode : 6            Power : Default</p>	 <p>Site : 03CH13-HY            Condition : AVG_54 3m HORN_91200_1241 HORIZONTAL            Detector : Peak            Project : BN0131-01            Mode : 6            Power : Default</p>
Avg.		

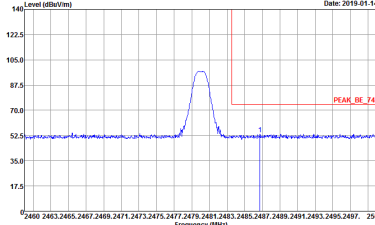
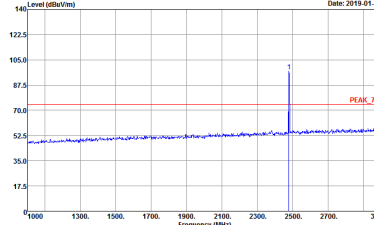
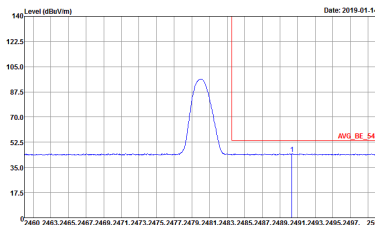
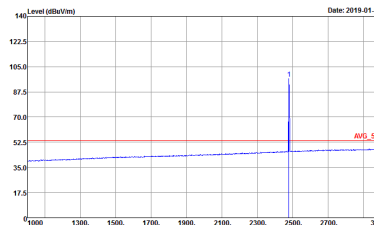

BLE	2.4GHz 2400~2483.5MHz Band Edge @ 3m	
BLE CH39 2480MHz		
Vertical		Fundamental
<p><b>Peak</b></p>	 <p>Site : 03CH13-HY            Condition : PEAK_BE_74 3m HORN_91200_1241 VERTICAL            Detector : Peak            Project : BN0131-01            Mode : 6            Power : Default</p>	 <p>Site : 03CH13-HY            Condition : PEAK_74 3m HORN_91200_1241 VERTICAL            Detector : Peak            Project : BN0131-01            Mode : 6            Power : Default</p>
	 <p>Site : 03CH13-HY            Condition : AVG_BE_54 3m HORN_91200_1241 VERTICAL            Detector : Peak            Project : BN0131-01            Mode : 6            Power : Default</p>	 <p>Site : 03CH13-HY            Condition : AVG_54 3m HORN_91200_1241 VERTICAL            Detector : Peak            Project : BN0131-01            Mode : 6            Power : Default</p>



2.4GHz 2400~2483.5MHz  
BLE 1Mbps (Harmonic @ 3m)

BLE	2.4GHz 2400~2483.5MHz Harmonic @ 3m	
	BLE CH00 2402MHz	
	Horizontal	Vertical
<b>Peak</b> <b>Avg.</b>	<p>Site : 03CH13-1FY Condition : PEAK_74 3m HORN_9120D_1241 HORIZONTAL Detector : Peak Project : 8N0131-01 Mode : 4 Power : Default</p>	<p>Site : 03CH13-1FY Condition : PEAK_74 3m HORN_9120D_1241 VERTICAL Detector : Peak Project : 8N0131-01 Mode : 4 Power : Default</p>



BLE	2.4GHz 2400~2483.5MHz Harmonic @ 3m	
	BLE CH19 2440MHz	
	Horizontal	Vertical
<b>Peak</b> <b>Avg.</b>	<p>Site : 03CH13-HY Condition : PEAK_74 3m HORN_9120D_1241 HORIZONTAL Detector : Peak Project : BN0131-01 Mode : 5 Power : Default</p>	<p>Site : 03CH13-HY Condition : PEAK_74 3m HORN_9120D_1241 VERTICAL Detector : Peak Project : BN0131-01 Mode : 5 Power : Default</p>

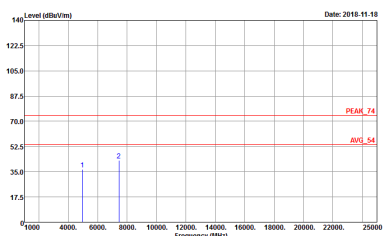
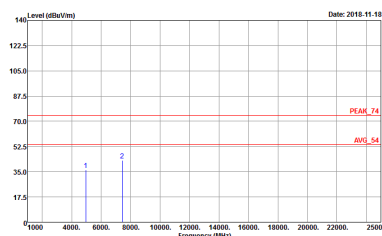

BLE	2.4GHz 2400~2483.5MHz Harmonic @ 3m	
BLE CH39 2480MHz		
	Horizontal	Vertical
<b>Peak</b>	 <p>Site : 03CH13-HY Condition : PEAK_74 3m HORN_9120D_1241 HORIZONTAL Detector : Peak Project : BN0131-01 Mode : 6 Power : Default</p>	 <p>Site : 03CH13-HY Condition : PEAK_74 3m HORN_9120D_1241 VERTICAL Detector : Peak Project : BN0131-01 Mode : 6 Power : Default</p>





Emission below 1GHz  
2.4GHz BLE 1Mbps (LF)

BLE	2.4GHz 2400~2483.5MHz	
	BLE LF	
	Horizontal	Vertical
QP / Peak	<p>Site : 03CH13-HY Condition : QP 3m B1LOG_37059401 HORIZONTAL Detector : Peak Project : 8N0131-01 Mode : S3</p>	<p>Site : 03CH13-HY Condition : QP 3m B1LOG_37059401 VERTICAL Detector : Peak Project : 8N0131-01 Mode : S3</p>



2.4GHz 2400~2483.5MHz

BLE 2Mbps (Band Edge @ 3m)

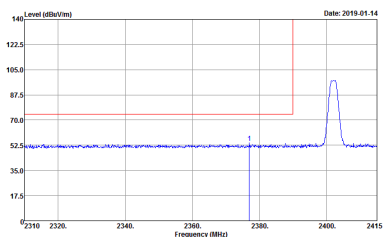
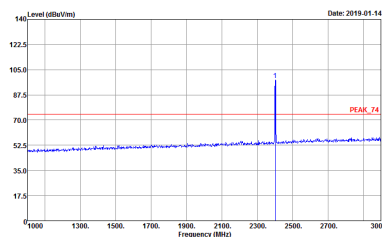
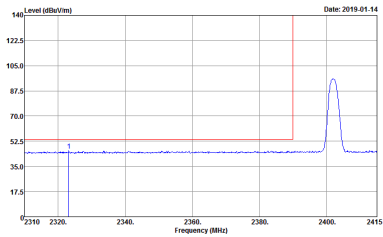
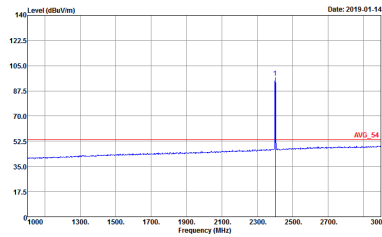
BLE	2.4GHz 2400~2483.5MHz Band Edge @ 3m	
BLE CH00 2402MHz		
	Horizontal	Fundamental
Peak	 <p>Site : 03CH13-HY            Condition : PEAK_BE_74 3m HORN_91200_1241 HORIZONTAL            Detector : Peak            Project : BN0131-01            Mode : 7            Power : Default</p>	 <p>Site : 03CH13-HY            Condition : PEAK_74 3m HORN_91200_1241 HORIZONTAL            Detector : Peak            Project : BN0131-01            Mode : 7            Power : Default</p>
Avg.	 <p>Site : 03CH13-HY            Condition : AVG_BE_54 3m HORN_91200_1241 HORIZONTAL            Detector : Peak            Project : BN0131-01            Mode : 7            Power : Default</p>	 <p>Site : 03CH13-HY            Condition : AVG_54 3m HORN_91200_1241 HORIZONTAL            Detector : Peak            Project : BN0131-01            Mode : 7            Power : Default</p>

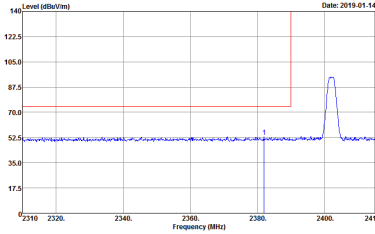
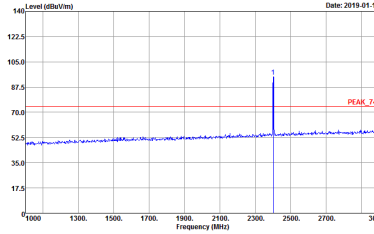
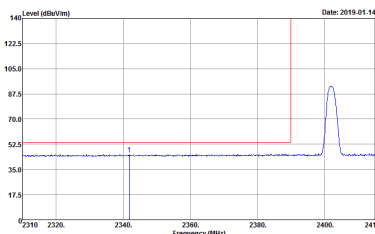
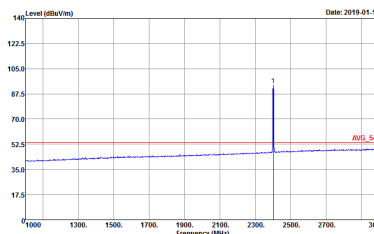

BLE	2.4GHz 2400~2483.5MHz Band Edge @ 3m	
BLE CH00 2402MHz		
	Vertical	Fundamental
<p><b>Peak</b></p>	 <p>Site : 03CH13-HY            Condition : PEAK_BE_74 3m HORN_91200_1241 VERTICAL            Detector : Peak            Project : BN0131-01            Mode : 7            Power : Default</p>	 <p>Site : 03CH13-HY            Condition : PEAK_74 3m HORN_91200_1241 VERTICAL            Detector : Peak            Project : BN0131-01            Mode : 7            Power : Default</p>
<p><b>Avg</b></p>	 <p>Site : 03CH13-HY            Condition : AVG_BE_54 3m HORN_91200_1241 VERTICAL            Detector : Peak            Project : BN0131-01            Mode : 7            Power : Default</p>	 <p>Site : 03CH13-HY            Condition : AVG_54 3m HORN_91200_1241 VERTICAL            Detector : Peak            Project : BN0131-01            Mode : 7            Power : Default</p>



BLE	2.4GHz 2400~2483.5MHz Band Edge @ 3m	
BLE CH19 2440MHz - L		
	Horizontal	Fundamental
<p><b>Peak</b></p>	<p>           Site : 03CH13-HV            Condition : PEAK_BE_74 3m HORN_9120D_1241 HORIZONTAL            Detector : Peak            Project : 8N0131-01            Mode : 8            Power : Default         </p>	<p>           Site : 03CH13-HV            Condition : PEAK_74 3m HORN_9120D_1241 HORIZONTAL            Detector : Peak            Project : 8N0131-01            Mode : 8            Power : Default         </p>
<p><b>Avg.</b></p>	<p>           Site : 03CH13-HV            Condition : AVG_BE_54 3m HORN_9120D_1241 HORIZONTAL            Detector : Peak            Project : 8N0131-01            Mode : 8            Power : Default         </p>	<p>           Site : 03CH13-HV            Condition : AVG_54 3m HORN_9120D_1241 HORIZONTAL            Detector : Peak            Project : 8N0131-01            Mode : 8            Power : Default         </p>

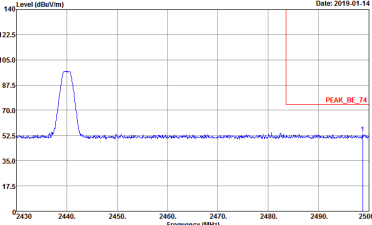
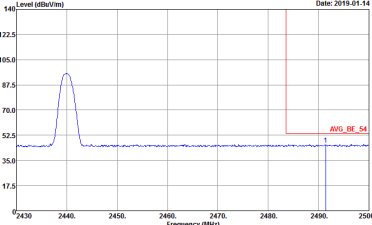

BLE	2.4GHz 2400~2483.5MHz Band Edge @ 3m	
BLE CH19 2440MHz - R		
Horizontal		Fundamental
<p><b>Peak</b></p>	 <p>Site : 03CH13-HY            Condition : PEAK_BE_74 3m HORN_91200_1241 HORIZONTAL            Detector : Peak            Project : BN0131-01            Mode : R            Power : default</p>	<p>Left blank</p>
<p><b>Avg.</b></p>	 <p>Site : 03CH13-HY            Condition : AVG_BE_54 3m HORN_91200_1241 HORIZONTAL            Detector : Peak            Project : BN0131-01            Mode : R            Power : default</p>	<p>Left blank</p>

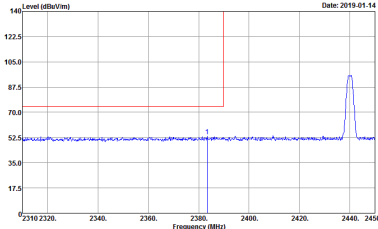
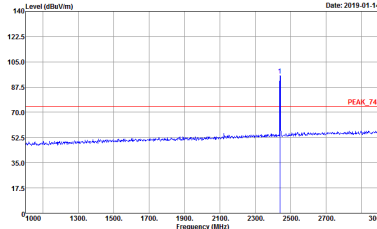
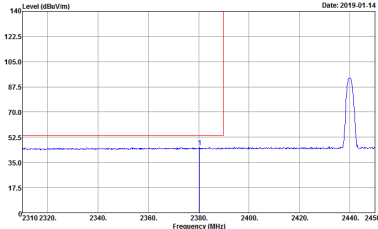
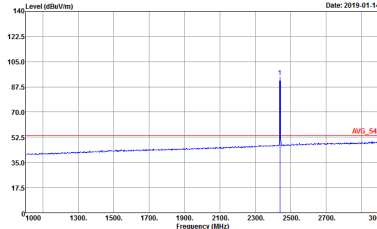

BLE	2.4GHz 2400~2483.5MHz Band Edge @ 3m	
BLE CH19 2440MHz - L		
	Vertical	Fundamental
Peak	 <p>Site : 03CH13-HY            Condition : PEAK_BE_74 3m HORN_91200_1241 VERTICAL            Detector : Peak            Project : BN0131-01            Mode : 8            Power : Default</p>	 <p>Site : 03CH13-HY            Condition : PEAK_74 3m HORN_91200_1241 VERTICAL            Detector : Peak            Project : BN0131-01            Mode : 8            Power : Default</p>
Avg.	 <p>Site : 03CH13-HY            Condition : AVG_BE_54 3m HORN_91200_1241 VERTICAL            Detector : Peak            Project : BN0131-01            Mode : 8            Power : Default</p>	 <p>Site : 03CH13-HY            Condition : AVG_54 3m HORN_91200_1241 VERTICAL            Detector : Peak            Project : BN0131-01            Mode : 8            Power : Default</p>

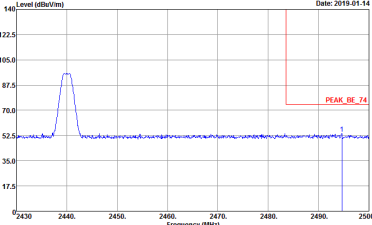
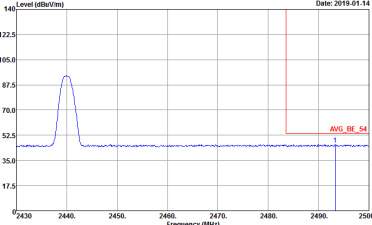

BLE	2.4GHz 2400~2483.5MHz Band Edge @ 3m	
BLE CH19 2440MHz - R		
	Vertical	Fundamental
<p><b>Peak</b></p>	 <p>Site : 03CH13-HY            Condition : PEAK_BE_74 3m HORN_91200_1241 VERTICAL            Detector : Peak            Project : BN0131-01            Mode : R            Power : default</p>	<p>Left blank</p>
<p><b>Avg.</b></p>	 <p>Site : 03CH13-HY            Condition : AVG_BE_54 3m HORN_91200_1241 VERTICAL            Detector : Peak            Project : BN0131-01            Mode : R            Power : default</p>	<p>Left blank</p>

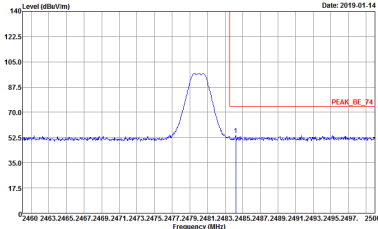
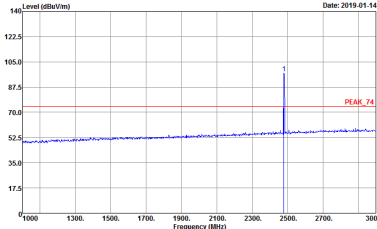
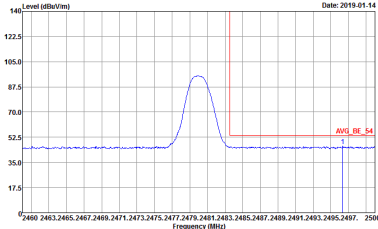
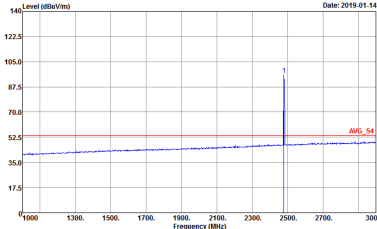

BLE	2.4GHz 2400~2483.5MHz Band Edge @ 3m	
BLE CH39 2480MHz		
Horizontal		Fundamental
<b>Peak</b>	 <p>Site : 03CH13-HY            Condition : PEAK_BE_74 3m HORN_91200_1241 HORIZONTAL            Detector : Peak            Project : BN0131-01            Mode : 9            Power : Default</p>	 <p>Site : 03CH13-HY            Condition : PEAK_74 3m HORN_91200_1241 HORIZONTAL            Detector : Peak            Project : BN0131-01            Mode : 9            Power : Default</p>
<b>Avg.</b>	 <p>Site : 03CH13-HY            Condition : AVG_BE_54 3m HORN_91200_1241 HORIZONTAL            Detector : Peak            Project : BN0131-01            Mode : 9            Power : Default</p>	 <p>Site : 03CH13-HY            Condition : AVG_54 3m HORN_91200_1241 HORIZONTAL            Detector : Peak            Project : BN0131-01            Mode : 9            Power : Default</p>



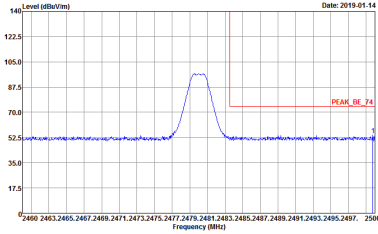
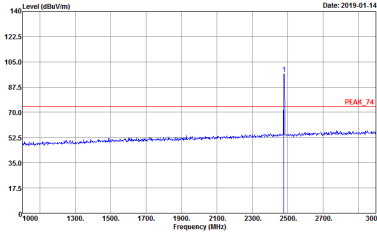
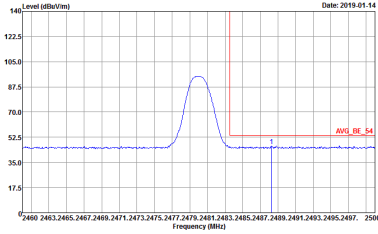
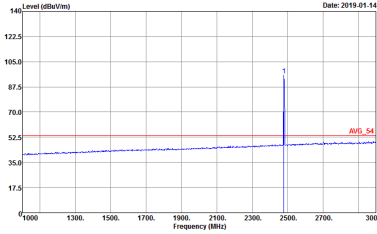

BLE	2.4GHz 2400~2483.5MHz Band Edge @ 3m	
BLE CH39 2480MHz		
Vertical		Fundamental
Peak	 <p>Site : 03CH13-HY            Condition : PEAK_BE_74 3m HORN_91200_1241 VERTICAL            Detector : Peak            Project : BN0131-01            Mode : 9            Power : Default</p>	 <p>Site : 03CH13-HY            Condition : PEAK_74 3m HORN_91200_1241 VERTICAL            Detector : Peak            Project : BN0131-01            Mode : 9            Power : Default</p>
	 <p>Site : 03CH13-HY            Condition : AVG_BE_54 3m HORN_91200_1241 VERTICAL            Detector : Peak            Project : BN0131-01            Mode : 9            Power : Default</p>	 <p>Site : 03CH13-HY            Condition : AVG_54 3m HORN_91200_1241 VERTICAL            Detector : Peak            Project : BN0131-01            Mode : 9            Power : Default</p>



2.4GHz 2400~2483.5MHz
BLE 2Mbps (Harmonic @ 3m)

Table with 2 columns: Horizontal and Vertical. Each column contains a spectral plot showing Level (dBuV/m) vs Frequency (MHz) with peak and average markers. Includes metadata like Site, Condition, Detector, Project, Mode, and Power.



BLE	2.4GHz 2400~2483.5MHz Harmonic @ 3m	
	BLE CH19 2440MHz	
	Horizontal	Vertical
<b>Peak</b> <b>Avg.</b>	<p>Site : 03CH13-HY Condition : PEAK_74 3m HORN_9120D_1241 HORIZONTAL Detector : Peak Project : BN0131-01 Mode : 8 Power : Default</p>	<p>Site : 03CH13-HY Condition : PEAK_74 3m HORN_9120D_1241 VERTICAL Detector : Peak Project : BN0131-01 Mode : 8 Power : Default</p>



BLE	2.4GHz 2400~2483.5MHz Harmonic @ 3m	
	BLE CH39 2480MHz	
	Horizontal	Vertical
<b>Peak</b>	<p>Site : 03CH13-HY Condition : PEAK_74 3m HORN_9120D_1241 HORIZONTAL Detector : Peak Project : BN0131-01 Mode : 9 Power : Default</p>	<p>Site : 03CH13-HY Condition : PEAK_74 3m HORN_9120D_1241 VERTICAL Detector : Peak Project : BN0131-01 Mode : 9 Power : Default</p>



Emission below 1GHz  
2.4GHz BLE 2Mbps (LF)

BLE	2.4GHz 2400~2483.5MHz	
	BLE LF	
	Horizontal	Vertical
QP / Peak	<p>Site : 03CH13-HY Condition : QP_3m_BILOG_37059401 HORIZONTAL Detector : Peak Project : 8N0131-01 Mode : S4</p>	<p>Site : 03CH13-HY Condition : QP_3m_BILOG_37059401 VERTICAL Detector : Peak Project : 8N0131-01 Mode : S4</p>



### Appendix D. Duty Cycle Plots

Band	Duty Cycle(%)	T(us)	1/T(kHz)	VBW Setting	Duty Factor(dB)
Bluetooth – LE for 1Mbps	62.70	395.00	2.53	3kHz	2.03
Bluetooth – LE for 2Mbps	33.33	210.00	4.76	10kHz	4.77

Bluetooth – LE for 1Mbps

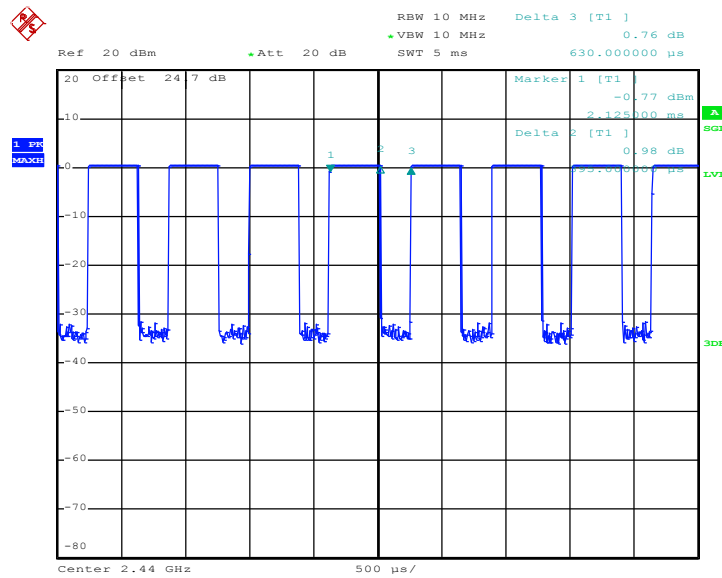

Date: 8.NOV.2018 06:46:52



Bluetooth – LE for 2Mbps

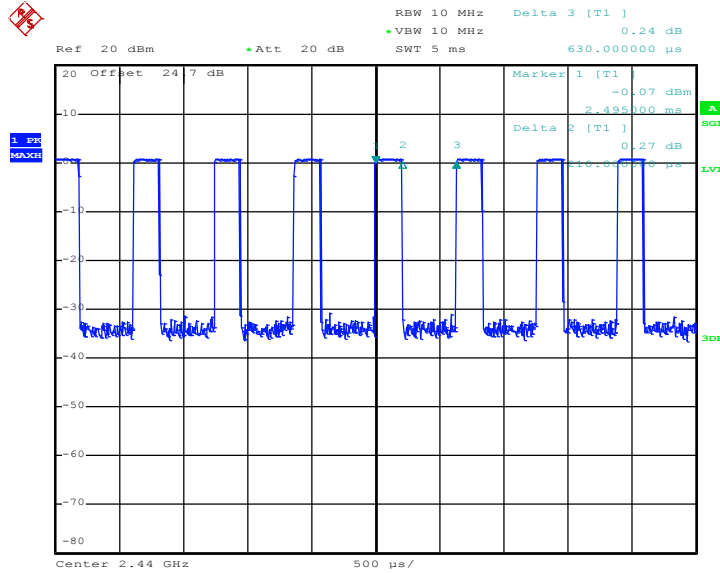

Date: 8.NOV.2018 06:47:26