



FCC RADIO TEST REPORT

FCC ID : UZ7TC83B0
Equipment : Mobile Computer
Brand Name : ZEBRA
Model name : TC83B0
Applicant : Zebra Technologies Corporation
1 Zebra Plaza, Holtsville, NY 11742
Manufacturer : Zebra Technologies Corporation
1 Zebra Plaza, Holtsville, NY 11742
Standard : FCC Part 15 Subpart E §15.407

The product was received on Nov. 01, 2018 and testing was started from Nov. 07, 2018 and completed on Mar. 21, 2019. We, SPORTON INTERNATIONAL INC. EMC & Wireless Communications Laboratory, would like to declare that the tested sample has been evaluated in accordance with the test procedures and has been in compliance with the applicable technical standards.

The report must not be used by the client to claim product certification, approval, or endorsement by TAF or any agency of government.

The test results in this report apply exclusively to the tested model / sample. Without written approval of SPORTON INTERNATIONAL INC. EMC & Wireless Communications Laboratory, the test report shall not be reproduced except in full.

Approved by: Jones Tsai

SPORTON INTERNATIONAL INC. EMC & Wireless Communications Laboratory

No. 52, Huaya 1st Rd., Guishan Dist., Taoyuan City, Taiwan (R.O.C.)



Table of Contents

History of this test report.....	3
Summary of Test Result.....	4
1 General Description	5
1.1 Product Feature of Equipment Under Test.....	5
1.2 Product Specification of Equipment Under Test.....	6
1.3 Modification of EUT	7
1.4 Testing Location	7
1.5 Applicable Standards.....	8
2 Test Configuration of Equipment Under Test	9
2.1 Carrier Frequency and Channel	9
2.2 Test Mode.....	10
2.3 Connection Diagram of Test System.....	17
2.4 Support Unit used in test configuration and system	18
2.5 EUT Operation Test Setup	19
2.6 Measurement Results Explanation Example.....	19
3 Test Result	20
3.1 6dB and 26dB and 99% Occupied Bandwidth Measurement	20
3.2 Maximum Conducted Output Power Measurement	26
3.3 Power Spectral Density Measurement	30
3.4 Unwanted Emissions Measurement.....	36
3.5 AC Conducted Emission Measurement.....	42
3.6 Automatically Discontinue Transmission	44
3.7 Antenna Requirements.....	45
4 List of Measuring Equipment.....	47
5 Uncertainty of Evaluation.....	49
Appendix A. AC Conducted Emission Test Result	
Appendix B. Radiated Spurious Emission	
Appendix C. Radiated Spurious Emission Plots	
Appendix D. Duty Cycle Plots	
Appendix E. Setup Photographs	



History of this test report

Report No.	Version	Description	Issued Date
FR8N0132-01F	01	Initial issue of report	Mar. 29, 2019



Summary of Test Result

Report Clause	Ref Std. Clause	Test Items	Result (PASS/FAIL)	Remark
3.1	15.403 (i)	6dB & 26dB Bandwidth	Pass	-
3.1	2.1049	99% Occupied Bandwidth	Reporting only	-
3.2	15.407 (a)	Maximum Conducted Output Power	Pass	-
3.3	15.407 (a)	Power Spectral Density	Pass	-
3.4	15.407(b)	Unwanted Emissions	Pass	Under limit 3.07 dB at 11570.000 MHz
3.5	15.207	AC Conducted Emission	Pass	Under limit 9.16 dB at 0.755 MHz
3.6	15.407 (c)	Automatically Discontinue Transmission	Pass	-
3.7	15.203 & 15.407 (a)	Antenna Requirement	Pass	-

Declaration of Conformity:

The test results with all measurement uncertainty excluded are presented in accordance with the regulation limits or requirements declared by manufacturers.

Comments and Explanations:

The declared of product specification for EUT presented in the report are provided by the manufacturer, and the manufacturer takes all the responsibilities for the accuracy of product specification.

Reviewed by: Wii Chang

Report Producer: Maggie Chiang



1 General Description

1.1 Product Feature of Equipment Under Test

Product Feature	
Equipment	Mobile Computer
Brand Name	ZEBRA
Model Name	TC83B0
FCC ID	UZ7TC83B0
Sample 1	EUT with Scanner 1 (SE4750SR)
Sample 2	EUT with Scanner 2 (SE4750MR)
Sample 3	EUT with Scanner 3 (SE4850)
Sample 4	EUT with Scanner 4 (SE965)
EUT supports Radios application	WLAN 11a/b/g/n HT20/HT40 WLAN 11ac VHT20/VHT40/VHT80 Bluetooth BR/EDR/LE
HW Version	EV
SW Version	01-12-13.00-OG-U00-PRD
FW Version	FUSION_QA_2_1.1.0.003_O
MFD	27-Jan-19
EUT Stage	Engineering Sample

Remark: The above EUT's information was declared by manufacturer.

Specification of Accessories				
Battery 1	Brand Name	Zebra	Part Number	BT-000380
Battery 2	Brand Name	Zebra	Part Number	82-176054-01
Headset 1	Brand Name	Zebra	Part Number	HDST-35MM-PTVP-01
Audio adapter cable 1	Brand Name	Zebra	Part Number	CBL-TC8X-AUDBJ-01
Headset 2	Brand Name	Zebra	Part Number	HS2100-OTH
HS2100 to Quick Disconnect Cable	Brand Name	Zebra	Part Number	CBL-HS2100-QDC1-01
Audio adapter cable 2	Brand Name	Zebra	Part Number	CBL-TC8X-AUDQD-01
Hand Strap	Brand Name	Zebra	Part Number	SG-TC8X-HDSTP-01
USB Cable	Brand Name	Zebra	Part Number	CBL-TC8X-USBCHG-01
Holster 1	Brand Name	Zebra	Part Number	SG-TC8X-QDHLST-01
Holster 2	Brand Name	Zebra	Part Number	SG-TC8X-PMHLST-01
Adapter	Brand Name	Zebra	Part Number	PWR-BUA5V16W0WW
DC Line Cord	Brand Name	Zebra	Part Number	CBL-DC-383A1-01

Remark: USB cable was modified, all test item with this modified cable.



1.2 Product Specification of Equipment Under Test

Standards-related Product Specification	
Tx/Rx Channel Frequency Range	5745 MHz ~ 5825 MHz
Maximum Output Power to Antenna <CDD Modes>	<p><Ant. 1> 802.11a : 17.40 dBm / 0.0550 W 802.11n HT20 : 17.69 dBm / 0.0587 W 802.11n HT40 : 16.97 dBm / 0.0498 W 802.11ac VHT20: 17.67 dBm / 0.0585 W 802.11ac VHT40: 16.96 dBm / 0.0497 W 802.11ac VHT80: 16.92 dBm / 0.0492 W</p> <p><Ant. 2> 802.11a : 18.24 dBm / 0.0667 W 802.11n HT20 : 18.13 dBm / 0.0650 W 802.11n HT40 : 17.99 dBm / 0.0630 W 802.11ac VHT20: 18.12 dBm / 0.0649 W 802.11ac VHT40: 17.96 dBm / 0.0625 W 802.11ac VHT80: 17.80 dBm / 0.0603 W</p> <p>MIMO <Ant. 1 + 2> 802.11a : 20.05 dBm / 0.1012 W 802.11n HT20 : 19.85 dBm / 0.0966 W 802.11n HT40 : 20.11 dBm / 0.1026 W 802.11ac VHT20: 19.83 dBm / 0.0962 W 802.11ac VHT40: 20.06 dBm / 0.1014 W 802.11ac VHT80: 19.91 dBm / 0.0979 W</p>
Maximum Output Power <TXBF Modes>	<p>MIMO <Ant. 1 + 2> 802.11ac VHT20: 20.25 dBm / 0.1059 W 802.11ac VHT40: 19.73 dBm / 0.0940 W 802.11ac VHT80: 19.31 dBm / 0.0853 W</p>
99% Occupied Bandwidth <CDD Modes>	<p><Ant. 1> 802.11a : 16.98 MHz 802.11n HT20 : 17.98 MHz 802.11n HT40 : 36.56 MHz 802.11ac VHT80 : 76.84 MHz</p> <p><Ant. 2> 802.11a : 16.83 MHz 802.11n HT20 : 17.98 MHz 802.11n HT40 : 36.56 MHz 802.11ac VHT80 : 76.72 MHz</p> <p>MIMO <Ant. 1> 802.11a : 16.83 MHz 802.11n HT20 : 17.98 MHz 802.11n HT40 : 36.66 MHz 802.11ac VHT80 : 76.72 MHz</p> <p>MIMO <Ant. 2> 802.11a : 16.73 MHz 802.11n HT20 : 17.93 MHz 802.11n HT40 : 36.56 MHz 802.11ac VHT80 : 76.72 MHz</p>



Standards-related Product Specification			
99% Occupied Bandwidth <TXBF Modes>	MIMO <Ant. 1> 802.11ac VHT20 : 17.68 MHz 802.11ac VHT40 : 37.06 MHz 802.11ac VHT80 : 77.32 MHz		
	MIMO <Ant. 2> 802.11ac VHT20 : 19.08 MHz 802.11ac VHT40 : 36.66 MHz 802.11ac VHT80 : 76.84 MHz		
Antenna Gain / Gain	<Ant. 1> : Dipole Antenna with gain 5.21 dBi <Ant. 2> : Dipole Antenna with gain 5.26 dBi		
Type of Modulation	802.11a/n : OFDM (BPSK / QPSK / 16QAM / 64QAM) 802.11ac : OFDM (BPSK / QPSK / 16QAM / 64QAM / 256QAM)		
Antenna Function Description		Ant. 1	Ant. 2
	802.11 a/n/ac	V	V
	802.11 a/n/ac MIMO	V	V
	802.11ac TXBF	V	V

Note: MIMO Ant. 1+2 is a calculated result from sum of the power MIMO Ant. 1 and MIMO Ant. 2.

1.3 Modification of EUT

No modifications are made to the EUT during all test items.

1.4 Testing Location

Test Site	SPORTON INTERNATIONAL INC.	
Test Site Location	No.52, Huaya 1st Rd., Guishan Dist., Taoyuan City, Taiwan (R.O.C.) TEL: +886-3-327-3456 FAX: +886-3-328-4978	
Test Site No.	Sporton Site No.	
	TH05-HY	CO05-HY

Note: The test site complies with ANSI C63.4 2014 requirement.

Test Site	SPORTON INTERNATIONAL INC.	
Test Site Location	No.58, Aly. 75, Ln. 564, Wenhua 3rd, Rd., Guishan Dist., Taoyuan City, Taiwan (R.O.C.) TEL: +886-3-327-0868 FAX: +886-3-327-0855	
Test Site No.	Sporton Site No.	
	03CH15-HY	

Note: The test site complies with ANSI C63.4 2014 requirement.

FCC Designation No. TW1190 and TW0007



1.5 Applicable Standards

According to the specifications of the manufacturer, the EUT must comply with the requirements of the following standards:

- ♦ FCC Part 15 Subpart E
- ♦ FCC KDB 789033 D02 General UNII Test Procedures New Rules v02r01.
- ♦ FCC KDB 414788 D01 Radiated Test Site v01r01.
- ♦ FCC KDB 662911 D01 Multiple Transmitter Output v02r01.
- ♦ ANSI C63.10-2013

Remark:

1. All test items were verified and recorded according to the standards and without any deviation during the test.
2. This EUT has also been tested and complied with the requirements of FCC Part 15, Subpart B, recorded in a separate test report.



2 Test Configuration of Equipment Under Test

- a. The EUT has been associated with peripherals and configuration operated in a manner tended to maximize its emission characteristics in a typical application. Frequency range investigated: conduction emission (150 kHz to 30 MHz), radiation emission (9 kHz to the 10th harmonic of the highest fundamental frequency or to 40 GHz, whichever is lower). For radiated measurement, pre-scanned in three orthogonal panels, X, Y, Z. The worst cases (Z Plane) were recorded in this report.

- b. AC power line Conducted Emission was tested under maximum output power.

2.1 Carrier Frequency and Channel

Frequency Band	Channel	Freq. (MHz)	Channel	Freq. (MHz)
5725-5850 MHz Band 4 (U-NII-3)	149	5745	157	5785
	151*	5755	159*	5795
	153	5765	161	5805
	155 [#]	5775	165	5825

Note:

- 1. The above Frequency and Channel in "*" were 802.11n HT40 and 802.11ac VHT40.
- 2. The above Frequency and Channel in "[#]" were 802.11ac VHT80.



2.2 Test Mode

Final test modes are considering the modulation and worse data rates as below table.

Single Mode

Modulation	Data Rate
802.11a	6 Mbps
802.11n HT20	MCS0
802.11n HT40	MCS0
802.11ac VHT20 (Covered by HT20)	MCS0
802.11ac VHT40 (Covered by HT40)	MCS0
802.11ac VHT80	MCS0

MIMO Mode

Modulation	Data Rate
802.11a	6 Mbps
802.11n HT20	MCS0
802.11n HT40	MCS0
802.11ac VHT20 (Covered by HT20)	MCS0
802.11ac VHT40 (Covered by HT40)	MCS0
802.11ac VHT80	MCS0

TXBF Mode

Modulation	Data Rate
802.11ac VHT20	MCS0
802.11ac VHT40	MCS0
802.11ac VHT80	MCS0

Test Cases	
AC Conducted Emission	Mode 1 : Bluetooth Link + WLAN (5GHz) Link + Scanner + USB Cable (Data Link with Notebook) (eMMC to Notebook) + DC Line Cord + Battery 1 + AC Adapter for Sample 3
Remark: For Radiated Test Cases, the tests were performed with Battery 2 and Sample 1.	



<CDD Mode>

Ch. #		Band IV : 5725-5850 MHz			
		802.11a	802.11n HT20	802.11n HT40	802.11ac VHT80
L	Low	149	149	151	-
M	Middle	157	157	-	155
H	High	165	165	159	-

<TXBF Mode>

Ch. #		Band IV : 5725-5850 MHz		
		802.11ac VHT20	802.11ac VHT40	802.11ac VHT80
L	Low	149	151	-
M	Middle	157	-	155
H	High	165	159	-

<CDD Mode>

<Ant. 1>

802.11a RF Output Power (dBm)										
Power vs. Channel			Power vs Data Rate							
Channel	Frequency (MHz)	Data Rate (bps)	channel	Data Rate (bps)						
		6M		9M	12M	18M	24M	36M	48M	54M
CH 149	5745	16.94	CH 165	17.29	17.27	17.37	17.39	17.17	17.25	17.26
CH 157	5785	16.45								
CH 165	5825	17.40								

802.11n HT20 RF Output Power (dBm)										
Power vs. Channel			Power vs Data Rate							
Channel	Frequency (MHz)	MCS Index	channel	MCS Index						
		MCS0		MCS1	MCS2	MCS3	MCS4	MCS5	MCS6	MCS7
CH 149	5745	16.82	CH 165	17.65	17.40	17.45	17.30	17.09	17.13	17.49
CH 157	5785	16.99								
CH 165	5825	17.69								



802.11n HT40 RF Output Power (dBm)										
Power vs. Channel			Power vs Data Rate							
Channel	Frequency (MHz)	MCS Index	channel	MCS Index						
		MCS0		MCS1	MCS2	MCS3	MCS4	MCS5	MCS6	MCS7
CH 151	5755	16.97	CH 151	16.96	16.63	16.62	16.53	16.54	16.46	16.53
CH 159	5795	16.77								

802.11ac VHT20 RF Output Power (dBm)											
Power vs. Channel			Power vs Data Rate								
Channel	Frequency (MHz)	MCS Index	channel	MCS Index							
		MCS0		MCS1	MCS2	MCS3	MCS4	MCS5	MCS6	MCS7	MCS8
CH 149	5745	16.79	CH 165	17.46	17.59	17.58	17.47	17.44	17.40	17.37	17.57
CH 157	5785	16.84									
CH 165	5825	17.67									

802.11ac VHT40 RF Output Power (dBm)												
Power vs. Channel			Power vs Data Rate									
Channel	Frequency (MHz)	MCS Index	channel	MCS Index								
		MCS0		MCS1	MCS2	MCS3	MCS4	MCS5	MCS6	MCS7	MCS8	MCS9
CH 151	5755	16.96	CH 151	16.93	16.94	16.63	16.61	16.58	16.51	16.39	16.76	16.75
CH 159	5795	16.74										

802.11ac VHT80 RF Output Power (dBm)												
Power vs. Channel			Power vs Data Rate									
Channel	Frequency (MHz)	MCS Index	channel	MCS Index								
		MCS0		MCS1	MCS2	MCS3	MCS4	MCS5	MCS6	MCS7	MCS8	MCS9
CH155	5775	16.92	CH155	16.51	16.57	16.52	16.55	16.50	16.50	16.61	16.48	16.67



<Ant. 2>

802.11a RF Output Power (dBm)										
Power vs. Channel			Power vs Data Rate							
Channel	Frequency (MHz)	Data Rate (bps)	channel	Data Rate (bps)						
		6M		9M	12M	18M	24M	36M	48M	54M
CH 149	5745	17.95	CH 165	18.13	18.16	18.20	18.20	17.91	17.99	18.07
CH 157	5785	17.81								
CH 165	5825	18.24								

802.11n HT20 RF Output Power (dBm)										
Power vs. Channel			Power vs Data Rate							
Channel	Frequency (MHz)	MCS Index	channel	MCS Index						
		MCS0		MCS1	MCS2	MCS3	MCS4	MCS5	MCS6	MCS7
CH 149	5745	17.90	CH 165	17.95	18.06	18.09	17.77	17.96	17.96	17.98
CH 157	5785	18.11								
CH 165	5825	18.13								

802.11n HT40 RF Output Power (dBm)										
Power vs. Channel			Power vs Data Rate							
Channel	Frequency (MHz)	MCS Index	channel	MCS Index						
		MCS0		MCS1	MCS2	MCS3	MCS4	MCS5	MCS6	MCS7
CH 151	5755	17.99	CH 151	17.97	17.97	17.97	17.97	17.90	17.97	17.91
CH 159	5795	17.90								

802.11ac VHT20 RF Output Power (dBm)											
Power vs. Channel			Power vs Data Rate								
Channel	Frequency (MHz)	MCS Index	channel	MCS Index							
		MCS0		MCS1	MCS2	MCS3	MCS4	MCS5	MCS6	MCS7	MCS8
CH 149	5745	17.87	CH 165	18.01	18.05	18.11	18.10	17.82	17.91	17.86	18.08
CH 157	5785	18.10									
CH 165	5825	18.12									



802.11ac VHT40 RF Output Power (dBm)												
Power vs. Channel			Power vs Data Rate									
Channel	Frequency (MHz)	MCS Index	channel	MCS Index								
		MCS0		MCS1	MCS2	MCS3	MCS4	MCS5	MCS6	MCS7	MCS8	MCS9
CH 151	5755	17.96	CH 151	17.90	17.94	17.94	17.92	17.90	17.93	17.91	17.92	17.93
CH 159	5795	17.88										

802.11ac VHT80 RF Output Power (dBm)												
Power vs. Channel			Power vs Data Rate									
Channel	Frequency (MHz)	MCS Index	channel	MCS Index								
		MCS0		MCS1	MCS2	MCS3	MCS4	MCS5	MCS6	MCS7	MCS8	MCS9
CH155	5775	17.80	CH155	17.75	17.79	17.79	17.77	17.77	17.78	17.77	17.79	17.79

<Ant. 1+2>

802.11a RF Output Power (dBm)											
Power vs. Channel			Power vs Data Rate								
Channel	Frequency (MHz)	Data Rate (bps)	channel	Data Rate (bps)							
		6M		9M	12M	18M	24M	36M	48M	54M	
CH 149	5745	20.05	CH 149	20.02	20.02	19.73	19.89	19.45	19.47	19.52	
CH 157	5785	19.86									
CH 165	5825	19.75									

802.11n HT20 RF Output Power (dBm)										
Power vs. Channel			Power vs Data Rate							
Channel	Frequency (MHz)	MCS Index	channel	MCS Index						
		MCS0		MCS1	MCS2	MCS3	MCS4	MCS5	MCS6	MCS7
CH 149	5745	19.85	CH 149	19.84	19.63	19.70	19.60	19.34	19.32	19.30
CH 157	5785	19.71								
CH 165	5825	19.61								



802.11n HT40 RF Output Power (dBm)										
Power vs. Channel			Power vs Data Rate							
Channel	Frequency (MHz)	MCS Index	channel	MCS Index						
		MCS0		MCS1	MCS2	MCS3	MCS4	MCS5	MCS6	MCS7
CH 151	5755	20.11	CH 151	20.06	20.04	20.09	19.98	20.02	20.03	20.04
CH 159	5795	19.98								

802.11ac VHT20 RF Output Power (dBm)											
Power vs. Channel			Power vs Data Rate								
Channel	Frequency (MHz)	MCS Index	channel	MCS Index							
		MCS0		MCS1	MCS2	MCS3	MCS4	MCS5	MCS6	MCS7	MCS8
CH 149	5745	19.83	CH 149	19.81	19.62	19.73	19.38	19.35	19.37	19.38	19.55
CH 157	5785	19.70									
CH 165	5825	19.60									

802.11ac VHT40 RF Output Power (dBm)												
Power vs. Channel			Power vs Data Rate									
Channel	Frequency (MHz)	MCS Index	channel	MCS Index								
		MCS0		MCS1	MCS2	MCS3	MCS4	MCS5	MCS6	MCS7	MCS8	MCS9
CH 151	5755	20.06	CH 151	20.01	19.99	19.66	19.64	19.56	19.57	19.64	19.59	19.56
CH 159	5795	19.90										

802.11ac VHT80 RF Output Power (dBm)												
Power vs. Channel			Power vs Data Rate									
Channel	Frequency (MHz)	MCS Index	channel	MCS Index								
		MCS0		MCS1	MCS2	MCS3	MCS4	MCS5	MCS6	MCS7	MCS8	MCS9
CH155	5775	19.91	CH155	19.90	19.90	19.88	19.90	19.90	19.89	19.90	19.63	19.55



<TXBF Mode>

802.11ac VHT20 RF Output Power (dBm)												
Power vs. Channel			Power vs Data Rate									
Channel	Frequency (MHz)	MCS Index	channel	MCS Index								
		MCS0		MCS1	MCS2	MCS3	MCS4	MCS5	MCS6	MCS7	MCS8	
CH 149	5745	20.25	CH 149									
CH 157	5785	20.15		19.65	20.01	19.97	20.22	20.22	20.19	20.19	19.62	
CH 165	5825	19.94										

802.11ac VHT40 RF Output Power (dBm)												
Power vs. Channel			Power vs Data Rate									
Channel	Frequency (MHz)	MCS Index	channel	MCS Index								
		MCS0		MCS1	MCS2	MCS3	MCS4	MCS5	MCS6	MCS7	MCS8	MCS9
CH 151	5755	19.73	CH 151									
CH 159	5795	19.64		18.86	19.02	19.07	19.58	19.58	19.58	19.52	19.64	19.58

802.11ac VHT80 RF Output Power (dBm)												
Power vs. Channel			Power vs Data Rate									
Channel	Frequency (MHz)	MCS Index	channel	MCS Index								
		MCS0		MCS1	MCS2	MCS3	MCS4	MCS5	MCS6	MCS7	MCS8	MCS9
CH155	5775	19.31	CH155	18.46	18.66	18.66	19.13	19.28	19.24	19.13	19.20	19.18

2.3 Connection Diagram of Test System

<WLAN Tx Mode>

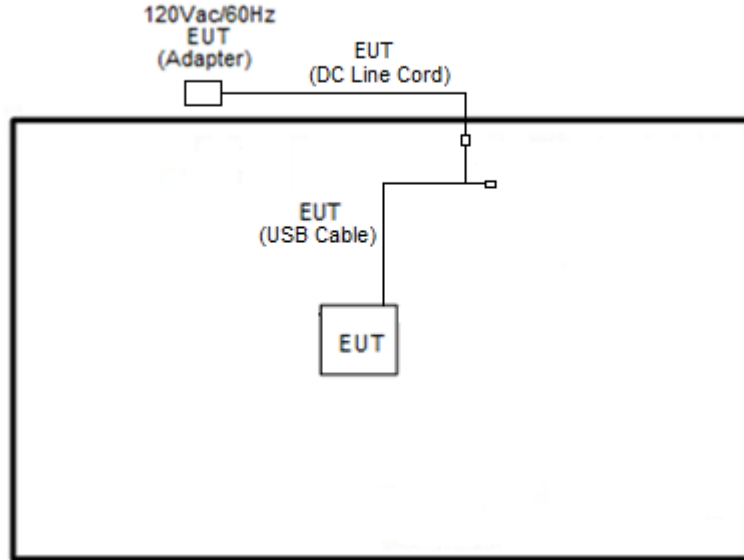

<WLAN TXBF Mode>

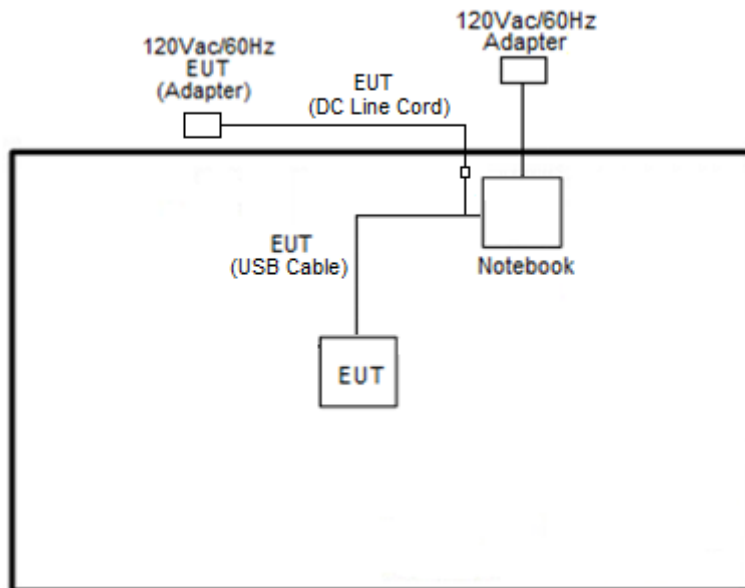

<AC Conducted Emission Mode>

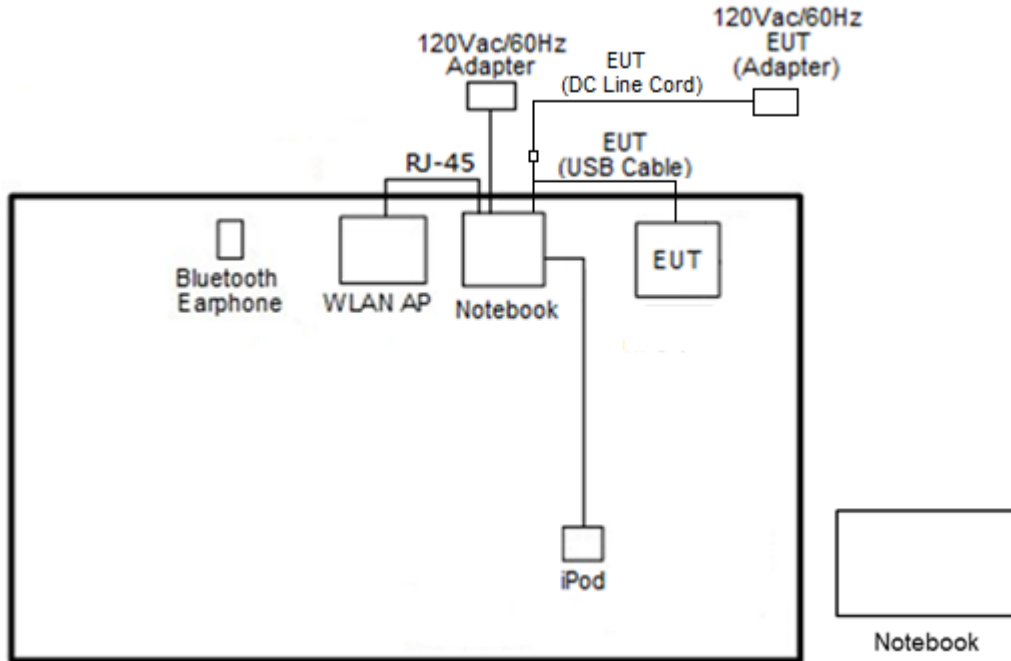

2.4 Support Unit used in test configuration and system

Item	Equipment	Trade Name	Model Name	FCC ID	Data Cable	Power Cord
1.	Bluetooth Earphone	Sony Ericsson	MW600	PY7DDA-2029	N/A	N/A
2.	WLAN AP	ASUS	RT-AC51U	MSQ-RTAC51U	N/A	Unshielded, 1.8 m
3.	Notebook	DELL	Latitude E6320	FCC DoC/ Contains FCC ID: QDS-BRCM1054	N/A	AC I/P: Unshielded, 1.2 m DC O/P: Shielded, 1.8 m
4.	Notebook	Lenovo	L570	N/A	N/A	AC I/P: Unshielded, 1.2 m DC O/P: Shielded, 1.8 m
5.	iPod	Apple	A1285	FCC DoC	Shielded, 1.0 m	N/A
6.	SD Card	SanDisk	MicroSD HC	FCC DoC	N/A	N/A



2.5 EUT Operation Test Setup

The RF test items, utility “QRCT” was installed in Notebook which was programmed in order to make the EUT get into the engineering modes to provide channel selection, power level, data rate and the application type and for continuous transmitting signals.

For TXBF mode, the modulation modes and data rates manipulated by the command lines in the engineering program made the EUT link to another EUT by power under the normal operation. The “ADB” software tool was used to enable the EUT to transmit signals continuously.

2.6 Measurement Results Explanation Example

For all conducted test items:

The offset level is set in the spectrum analyzer to compensate the RF cable loss and attenuator factor between EUT conducted output port and spectrum analyzer. With the offset compensation, the spectrum analyzer reading level is exactly the EUT RF output level.

Example :

The spectrum analyzer offset is derived from RF cable loss and attenuator factor.

Offset = RF cable loss + attenuator factor.

Following shows an offset computation example with cable loss 4.2 dB and 10dB attenuator.

$$\begin{aligned} \text{Offset(dB)} &= \text{RF cable loss(dB)} + \text{attenuator factor(dB)}. \\ &= 4.2 + 10 = 14.2 \text{ (dB)} \end{aligned}$$

3 Test Result

3.1 6dB and 26dB and 99% Occupied Bandwidth Measurement

3.1.1 Description of 6dB and 26dB and 99% Occupied Bandwidth

The minimum 6 dB bandwidth shall be at least 500 kHz.

26dB and 99% Occupied bandwidth are reporting only.

3.1.2 Measuring Instruments

See list of measuring equipment of this test report.

3.1.3 Test Procedures

1. The testing follows FCC KDB 789033 D02 General UNII Test Procedures New Rules v02r01. Section C) Emission bandwidth for the band 5.725-5.85GHz
2. Set RBW = 100kHz.
3. Set the VBW $\geq 3 \times$ RBW.
4. Detector = Peak.
5. Trace mode = max hold
6. Measure the maximum width of the emission that is 6 dB down from the peak of the emission.
7. Measure and record the results in the test report.

3.1.4 Test Setup

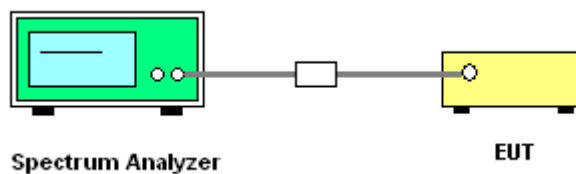



3.1.5 Test Result

Test Engineer :	Derek Hsu	Temperature :	21~25°C
		Relative Humidity :	51~54%

<CDD Mode>

Band IV												
Mod.	Data Rate	NTX	CH.	Freq. (MHz)	99% Bandwidth (MHz)		26dB Bandwidth (MHz)		6 dB Bandwidth (MHz)		6 dB Bandwidth Min. Limit (MHz)	Pass/Fail
					Ant 1	Ant 2	Ant 1	Ant 2	Ant 1	Ant 2		
11a	6Mbps	1	149	5745	16.88	16.83	24.46	24.58	15.68	15.88	0.5	Pass
11a	6Mbps	1	157	5785	16.88	16.83	24.46	24.88	16.28	15.68	0.5	Pass
11a	6Mbps	1	165	5825	16.83	16.78	24.64	24.04	15.78	15.68	0.5	Pass
HT20	MCS0	1	149	5745	17.98	17.98	25.44	25.95	16.73	15.83	0.5	Pass
HT20	MCS0	1	157	5785	17.98	17.98	25.77	25.77	16.88	15.39	0.5	Pass
HT20	MCS0	1	165	5825	17.93	17.93	25.83	25.48	16.53	16.48	0.5	Pass
HT40	MCS0	1	151	5755	36.56	36.56	42.20	42.08	36.23	35.87	0.5	Pass
HT40	MCS0	1	159	5795	36.56	36.56	41.84	41.48	36.05	35.78	0.5	Pass
VHT80	MCS0	1	155	5775	76.84	76.72	83.60	83.92	75.12	75.12	0.5	Pass
11a	6Mbps	2	149	5745	16.83	16.73	24.58	24.28	15.58	16.23	0.5	Pass
11a	6Mbps	2	157	5785	16.83	16.73	24.82	25.18	16.03	16.28	0.5	Pass
11a	6Mbps	2	165	5825	16.78	16.73	24.52	25.00	15.68	15.68	0.5	Pass
HT20	MCS0	2	149	5745	17.98	17.93	25.89	25.77	16.88	16.88	0.5	Pass
HT20	MCS0	2	157	5785	17.98	17.93	26.01	24.82	15.44	16.03	0.5	Pass
HT20	MCS0	2	165	5825	17.93	17.93	25.36	26.19	15.09	15.14	0.5	Pass
HT40	MCS0	2	151	5755	36.56	36.56	41.72	42.20	35.34	35.43	0.5	Pass
HT40	MCS0	2	159	5795	36.66	36.56	42.05	41.96	35.87	36.05	0.5	Pass
VHT80	MCS0	2	155	5775	76.72	76.72	83.60	83.28	75.12	75.12	0.5	Pass

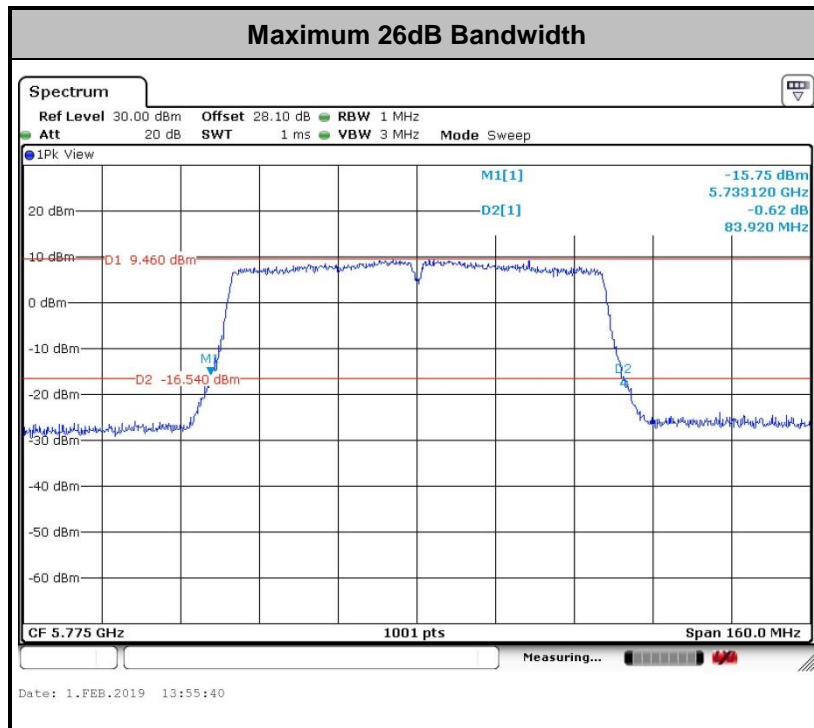
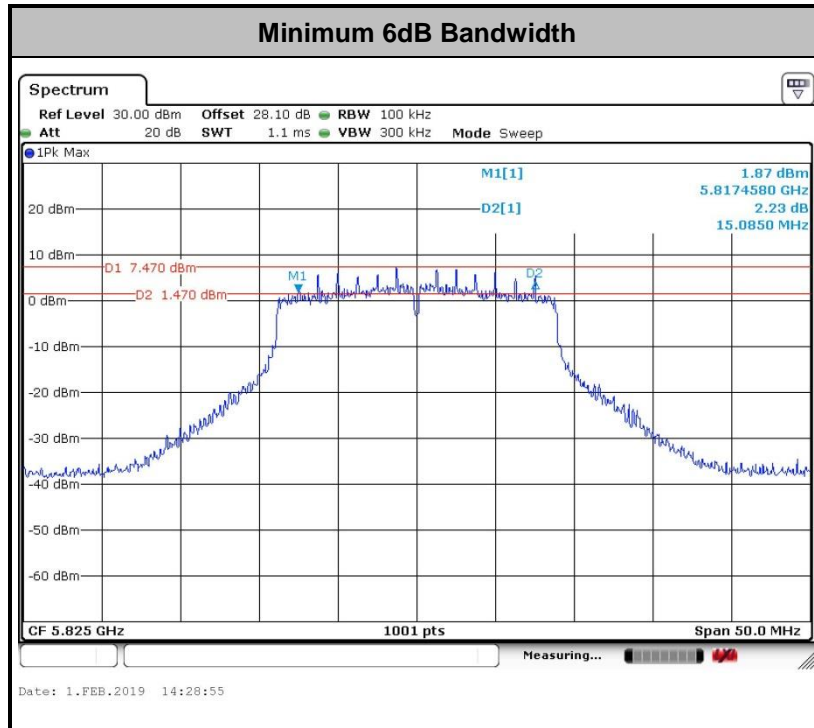

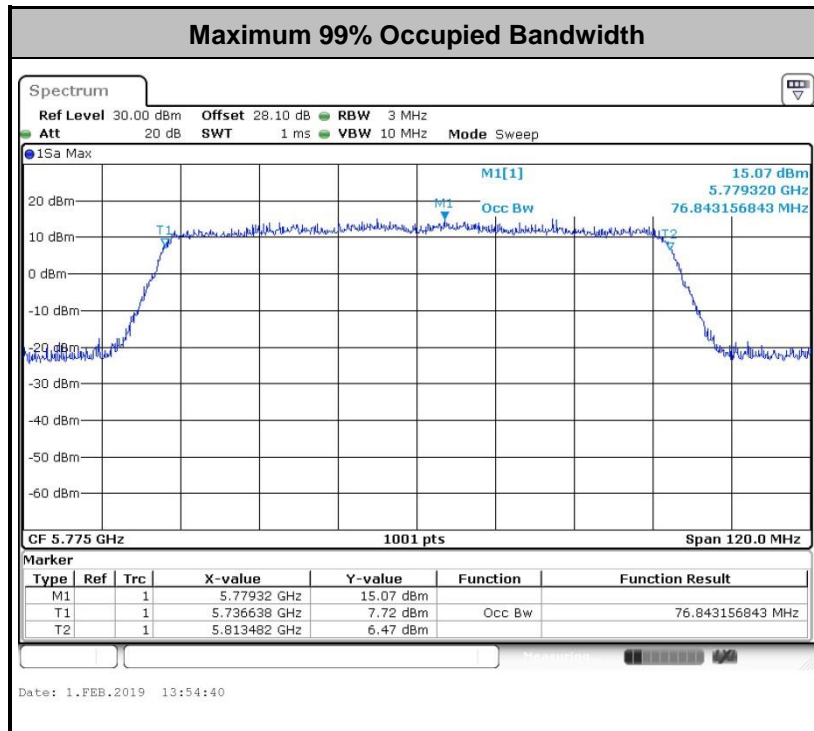

Note: The occupied channel bandwidth is maintained within the band of operation for all of the modulations.



<TXBF Mode>

Band IV												
Mod.	Data Rate	NTX	CH.	Freq. (MHz)	99% Bandwidth (MHz)		26dB Bandwidth (MHz)		6 dB Bandwidth (MHz)		6 dB Bandwidth Min. Limit (MHz)	Pass/Fail
					Ant 1	Ant 2	Ant 1	Ant 2	Ant 1	Ant 2		
VHT20	MCS0	2	149	5745	17.63	19.08	22.90	28.17	15.14	17.63	0.5	Pass
VHT20	MCS0	2	157	5785	17.68	19.08	23.08	27.51	15.09	17.33	0.5	Pass
VHT20	MCS0	2	165	5825	17.68	19.08	22.72	27.33	15.14	17.53	0.5	Pass
VHT40	MCS0	2	151	5755	36.76	36.56	42.08	42.20	35.07	36.32	0.5	Pass
VHT40	MCS0	2	159	5795	37.06	36.66	41.48	42.44	35.07	36.32	0.5	Pass
VHT80	MCS0	2	155	5775	77.32	76.84	83.28	83.76	75.12	75.12	0.5	Pass

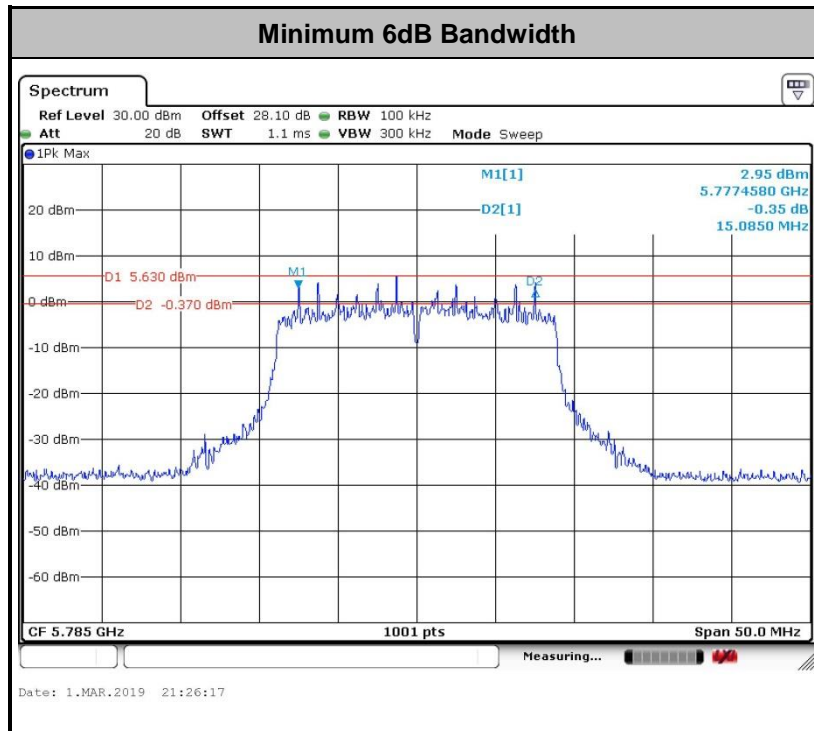

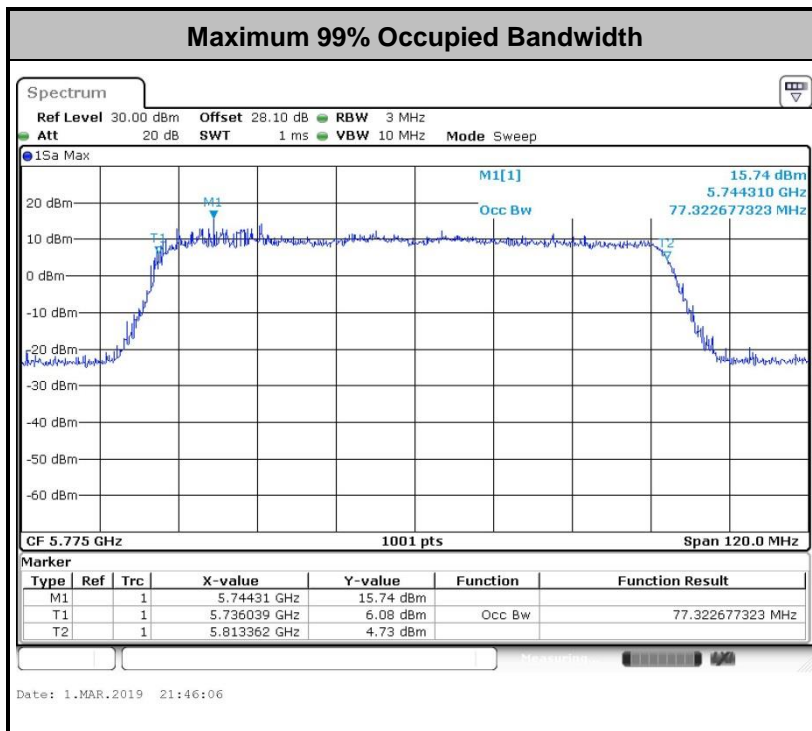
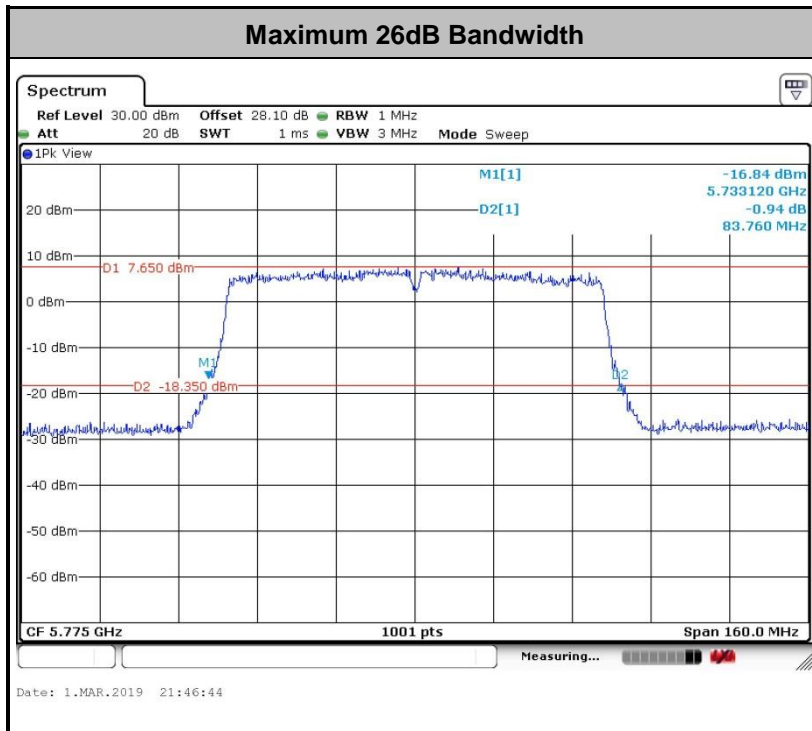

Note: The occupied channel bandwidth is maintained within the band of operation for all of the modulations.



3.2 Maximum Conducted Output Power Measurement

3.2.1 Limit of Maximum Conducted Output Power

For the band 5.725–5.85 GHz, the maximum conducted output power over the frequency band of operation shall not exceed 1 W.

If transmitting antennas of directional gain greater than 6 dBi are used, the peak output power shall be reduced by the amount in dB that the directional gain of the antenna exceeds 6 dBi.

3.2.2 Measuring Instruments

See list of measuring equipment of this test report.

3.2.3 Test Procedures

<CDD Modes>

The testing follows Method PM of FCC KDB 789033 D02 General UNII Test Procedures New Rules v02r01.

Method PM (Measurement using an RF average power meter):

1. Measurement is performed using a wideband RF power meter.
2. The EUT is configured to transmit continuously with a consistent duty cycle at its maximum power control level.
3. Measure the average power of the transmitter, and the average power is corrected with duty factor, $10 \log(1/x)$, where x is the duty cycle.

<TXBF Modes>

The testing follows Method PM-G of FCC KDB 789033 D02 General UNII Test Procedures New Rules v02r01 for TXBF modes.

Method PM-G (Measurement using a gated RF average power meter):

1. Measurement is performed using a wideband RF power meter.
2. The EUT is configured to transmit at its maximum power control level.
3. Measure the average power of the transmitter
4. Since the measurement is made only during the ON time of the transmitter, no duty cycle correction factor is required.

3.2.4 Test Setup

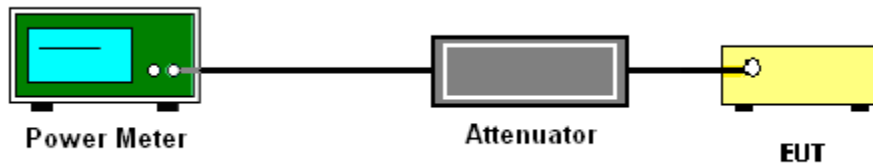

3.2.5 Test Result of Maximum Conducted Output Power

Test Engineer :	Derek Hsu	Temperature :	21~25°C
		Relative Humidity :	51~54%

<CDD Mode>

Band IV														
Mod.	Data Rate	NTX	CH.	Freq. (MHz)	Duty Factor (dB)		Average Conducted Power (dBm)			FCC Conducted Power Limit (dBm)		DG (dBi)		Pass/Fail
					Ant 1	Ant 2	Ant 1	Ant 2	SUM	Ant 1	Ant 2	Ant 1	Ant 2	
11a	6Mbps	1	149	5745	0.19	0.21	16.94	17.95		30.00	30.00	5.21	5.26	Pass
11a	6Mbps	1	157	5785	0.19	0.21	16.45	17.81		30.00	30.00	5.21	5.26	Pass
11a	6Mbps	1	165	5825	0.19	0.21	17.40	18.24		30.00	30.00	5.21	5.26	Pass
HT20	MCS0	1	149	5745	0.20	0.20	16.82	17.90		30.00	30.00	5.21	5.26	Pass
HT20	MCS0	1	157	5785	0.20	0.20	16.99	18.11		30.00	30.00	5.21	5.26	Pass
HT20	MCS0	1	165	5825	0.20	0.20	17.69	18.13		30.00	30.00	5.21	5.26	Pass
HT40	MCS0	1	151	5755	0.36	0.40	16.97	17.99		30.00	30.00	5.21	5.26	Pass
HT40	MCS0	1	159	5795	0.36	0.40	16.77	17.90		30.00	30.00	5.21	5.26	Pass
VHT20	MCS0	1	149	5745	0.20	0.20	16.79	17.87		30.00	30.00	5.21	5.26	Pass
VHT20	MCS0	1	157	5785	0.20	0.20	16.84	18.10		30.00	30.00	5.21	5.26	Pass
VHT20	MCS0	1	165	5825	0.20	0.20	17.67	18.12		30.00	30.00	5.21	5.26	Pass
VHT40	MCS0	1	151	5755	0.36	0.40	16.96	17.96		30.00	30.00	5.21	5.26	Pass
VHT40	MCS0	1	159	5795	0.36	0.40	16.74	17.88		30.00	30.00	5.21	5.26	Pass
VHT80	MCS0	1	155	5775	0.67	0.69	16.92	17.80		30.00	30.00	5.21	5.26	Pass



Band IV														
Mod.	Data Rate	NTX	CH.	Freq. (MHz)	Duty Factor (dB)		Average Conducted Power (dBm)			FCC Conducted Power Limit (dBm)		DG (dBi)		Pass/Fail
					Ant 1	Ant 2	Ant 1	Ant 2	SUM	Ant 1	Ant 2	Ant 1	Ant 2	
11a	6Mbps	2	149	5745	0.19	0.21	16.97	17.12	20.05	30.00	5.26	Pass		
11a	6Mbps	2	157	5785	0.19	0.21	16.94	16.76	19.86	30.00	5.26	Pass		
11a	6Mbps	2	165	5825	0.19	0.21	16.82	16.66	19.75	30.00	5.26	Pass		
HT20	MCS0	2	149	5745	0.22	0.19	16.85	16.83	19.85	30.00	5.26	Pass		
HT20	MCS0	2	157	5785	0.22	0.19	16.75	16.65	19.71	30.00	5.26	Pass		
HT20	MCS0	2	165	5825	0.22	0.19	16.70	16.50	19.61	30.00	5.26	Pass		
HT40	MCS0	2	151	5755	0.38	0.42	16.99	17.20	20.11	30.00	5.26	Pass		
HT40	MCS0	2	159	5795	0.38	0.42	16.91	17.03	19.98	30.00	5.26	Pass		
VHT20	MCS0	2	149	5745	0.23	0.20	16.88	16.76	19.83	30.00	5.26	Pass		
VHT20	MCS0	2	157	5785	0.23	0.20	16.73	16.64	19.70	30.00	5.26	Pass		
VHT20	MCS0	2	165	5825	0.23	0.20	16.61	16.56	19.60	30.00	5.26	Pass		
VHT40	MCS0	2	151	5755	0.42	0.37	16.98	17.11	20.06	30.00	5.26	Pass		
VHT40	MCS0	2	159	5795	0.42	0.37	16.84	16.93	19.90	30.00	5.26	Pass		
VHT80	MCS0	2	155	5775	0.70	0.67	16.97	16.83	19.91	30.00	5.26	Pass		



<TXBF Mode>

Band IV														
Mod.	Data Rate	NTX	CH.	Freq. (MHz)	Duty Factor (dB)		Average Conducted Power (dBm)			FCC Conducted Power Limit (dBm)		DG (dBi)		Pass/Fail
					Ant 1	Ant 2	Ant 1	Ant 2	SUM	Ant 1	Ant 2	Ant 1	Ant 2	
VHT20	MCS0	2	149	5745	0.00	0.00	16.60	17.80	20.25	27.75		8.25		Pass
VHT20	MCS0	2	157	5785	0.00	0.00	16.50	17.70	20.15	27.75		8.25		Pass
VHT20	MCS0	2	165	5825	0.00	0.00	16.40	17.40	19.94	27.75		8.25		Pass
VHT40	MCS0	2	151	5755	0.00	0.00	16.30	17.10	19.73	27.75		8.25		Pass
VHT40	MCS0	2	159	5795	0.00	0.00	16.10	17.10	19.64	27.75		8.25		Pass
VHT80	MCS0	2	155	5775	0.00	0.00	16.30	16.30	19.31	27.75		8.25		Pass



3.3 Power Spectral Density Measurement

3.3.1 Limit of Power Spectral Density

For the band 5.725–5.85 GHz, the maximum power spectral density shall not exceed 30 dBm in any 500-kHz band.

If transmitting antennas of directional gain greater than 6 dBi are used, the peak output power shall be reduced by the amount in dB that the directional gain of the antenna exceeds 6 dBi.

3.3.2 Measuring Instruments

See list of measuring equipment of this test report.

3.3.3 Test Procedures

The testing follows FCC KDB 789033 D02 General UNII Test Procedures New Rules v02r01. Section F) Maximum power spectral density.

<CDD Modes>

Method SA-2

(trace averaging across on and off times of the EUT transmissions, followed by duty cycle correction).

- Measure the duty cycle.
- Set span to encompass the entire emission bandwidth (EBW) of the signal.
- Set RBW = 300 kHz.
- Set VBW \geq 1 MHz.
- Number of points in sweep \geq 2 Span / RBW.
- Sweep time = auto.
- Detector = RMS
- Trace average at least 100 traces in power averaging mode.
- Add $10 \log(500\text{kHz}/\text{RBW})$ to the test result.
- Add $10 \log(1/x)$, where x is the duty cycle, to the measured power in order to compute the average power during the actual transmission times. For example, add $10 \log(1/0.25) = 6$ dB if the duty cycle is 25 percent.

<TXBF Modes>**# Method SA-3 #**

(power averaging (rms) detection with max hold):

- Set span to encompass the entire emission bandwidth (EBW) of the signal.
 - Set RBW = 300 kHz.
 - Set VBW \geq 1 MHz.
 - Number of points in sweep \geq 2 Span / RBW.
 - Sweep time \leq (number of points in sweep) \times T, when duty cycle is less than 98 percent where T is the minimum transmission duration over which the transmitter is on and is transmitting at its maximum power control level for the tested mode of operation.
 - Detector = power averaging (rms).
 - Trace mode = max hold.
 - Allow max hold to run for at least 60 seconds, or longer as needed to allow the trace to stabilize.
1. The RF output of EUT was connected to the spectrum analyzer by a low loss cable.
 2. Each plot has already offset with cable loss, and attenuator loss. Measure the PPSD and record it.
 3. For MIMO mode, calculation method follows FCC KDB 662911 D01 Multiple Transmitter Output v02r01.

Method (c): Measure and add $10 \log(N_{ANT})$ dB.

With this technique, spectrum measurements are performed at each output of the device, but rather than summing the spectra or the spectral peaks across the outputs, the quantity $10 \log(N_{ANT})$ dB is added to each spectrum value before comparing to the emission limit. The addition of $10 \log(N_{ANT})$ dB serves to apportion the emission limit among the N_{ANT} outputs so that each output is permitted to contribute no more than $1/N_{ANT}^{th}$ of the PSD limit.

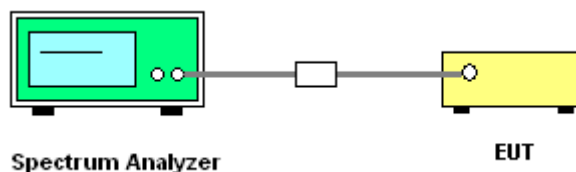
3.3.4 Test Setup



3.3.5 Test Result of Power Spectral Density

Test Engineer :	Derek Hsu	Temperature :	21~25°C
		Relative Humidity :	51~54%

<CDD Mode>

Band IV																
Mod.	Data Rate	NTX	CH.	Freq. (MHz)	Duty Factor (dB)		10log (500kHz /RBW) Factor (dB)		Average Power Density (dBm/500kHz)			Average PSD Limit (dBm/500kHz)		DG (dBi)		Pass /Fail
					Ant 1	Ant 2	Ant 1	Ant 2	Ant 1	Ant 2	SUM	Ant 1	Ant 2	Ant 1	Ant 2	
11a	6Mbps	1	149	5745	0.19	0.21	2.22	2.22	3.63	4.55		30.00	30.00	5.21	5.26	Pass
11a	6Mbps	1	157	5785	0.19	0.21	2.22	2.22	5.24	4.65		30.00	30.00	5.21	5.26	Pass
11a	6Mbps	1	165	5825	0.19	0.21	2.22	2.22	5.46	4.58		30.00	30.00	5.21	5.26	Pass
HT20	MCS0	1	149	5745	0.20	0.20	2.22	2.22	3.00	3.94		30.00	30.00	5.21	5.26	Pass
HT20	MCS0	1	157	5785	0.20	0.20	2.22	2.22	5.04	4.15	-	30.00	30.00	5.21	5.26	Pass
HT20	MCS0	1	165	5825	0.20	0.20	2.22	2.22	5.19	4.32		30.00	30.00	5.21	5.26	Pass
HT40	MCS0	1	151	5755	0.36	0.40	2.22	2.22	0.42	1.44		30.00	30.00	5.21	5.26	Pass
HT40	MCS0	1	159	5795	0.36	0.40	2.22	2.22	0.03	1.21		30.00	30.00	5.21	5.26	Pass
VHT80	MCS0	1	155	5775	0.67	0.69	2.22	2.22	-2.89	-1.80		30.00	30.00	5.21	5.26	Pass
11a	6Mbps	2	149	5745	0.19	0.21	2.22		3.83	3.79	6.84	27.75		8.25		Pass
11a	6Mbps	2	157	5785	0.19	0.21	2.22		3.78	3.51	6.79	27.75		8.25		Pass
11a	6Mbps	2	165	5825	0.19	0.21	2.22		3.63	3.34	6.64	27.75		8.25		Pass
HT20	MCS0	2	149	5745	0.22	0.19	2.22		3.05	2.82	6.06	27.75		8.25		Pass
HT20	MCS0	2	157	5785	0.22	0.19	2.22		3.37	2.94	6.38	27.75		8.25		Pass
HT20	MCS0	2	165	5825	0.22	0.19	2.22		3.30	2.65	6.31	27.75		8.25		Pass
HT40	MCS0	2	151	5755	0.38	0.42	2.22		0.62	0.15	3.63	27.75		8.25		Pass
HT40	MCS0	2	159	5795	0.38	0.42	2.22		0.24	0.08	3.25	27.75		8.25		Pass
VHT80	MCS0	2	155	5775	0.70	0.67	2.22		-2.53	-2.68	0.48	27.75		8.25		Pass



Worst Case Power Density (dBm/MHz) for MIMO Ant. 1

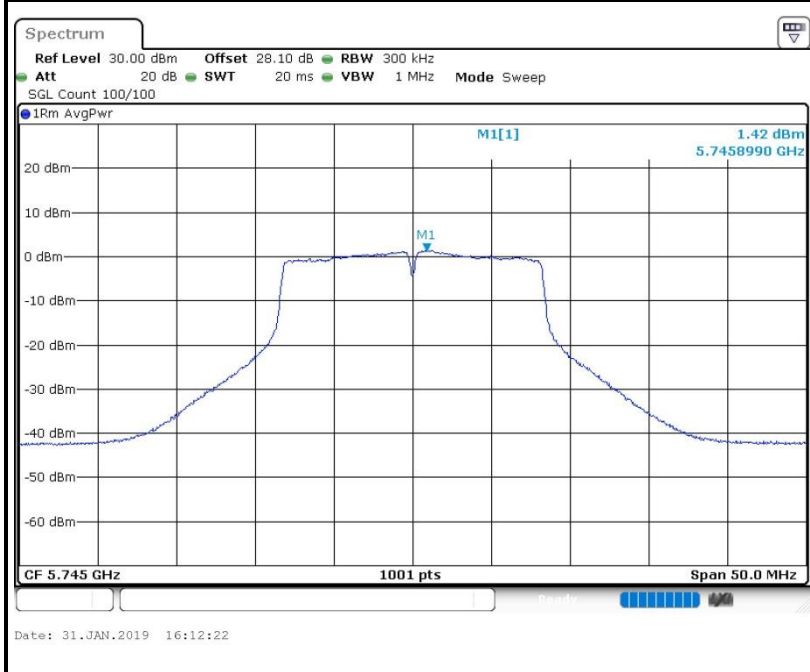

Worst Case Power Density (dBm/MHz) for MIMO Ant. 2

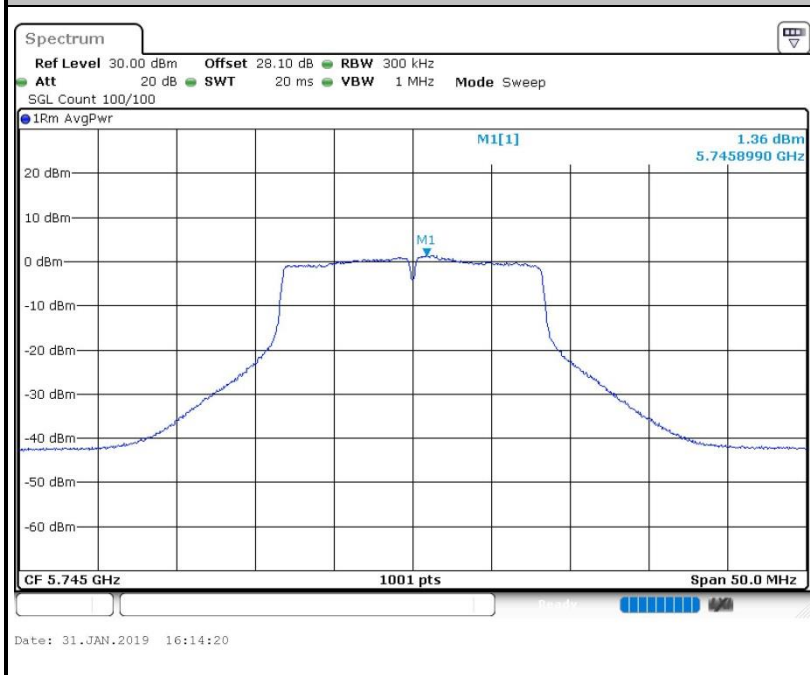



<TXBF Mode>

Band IV																
Mod.	Data Rate	NTX	CH.	Freq. (MHz)	Duty Factor (dB)		10log (500kHz /RBW) Factor (dB)		Average Power Density (dBm/500kHz)			Average PSD Limit (dBm/500kHz)		DG (dBi)		Pass /Fail
					Ant 1	Ant 2	Ant 1	Ant 2	Ant 1	Ant 2	SUM	Ant 1	Ant 2	Ant 1	Ant 2	
VHT20	MCS0	2	149	5745	0.00	0.00	2.22	6.25	6.90	9.91	27.75	8.25	Pass			
VHT20	MCS0	2	157	5785	0.00	0.00	2.22	6.26	7.51	10.52	27.75	8.25	Pass			
VHT20	MCS0	2	165	5825	0.00	0.00	2.22	5.91	7.63	10.64	27.75	8.25	Pass			
VHT40	MCS0	2	151	5755	0.00	0.00	2.22	2.38	3.35	6.36	27.75	8.25	Pass			
VHT40	MCS0	2	159	5795	0.00	0.00	2.22	3.84	3.83	6.85	27.75	8.25	Pass			
VHT80	MCS0	2	155	5775	0.00	0.00	2.22	5.96	-0.48	8.97	27.75	8.25	Pass			

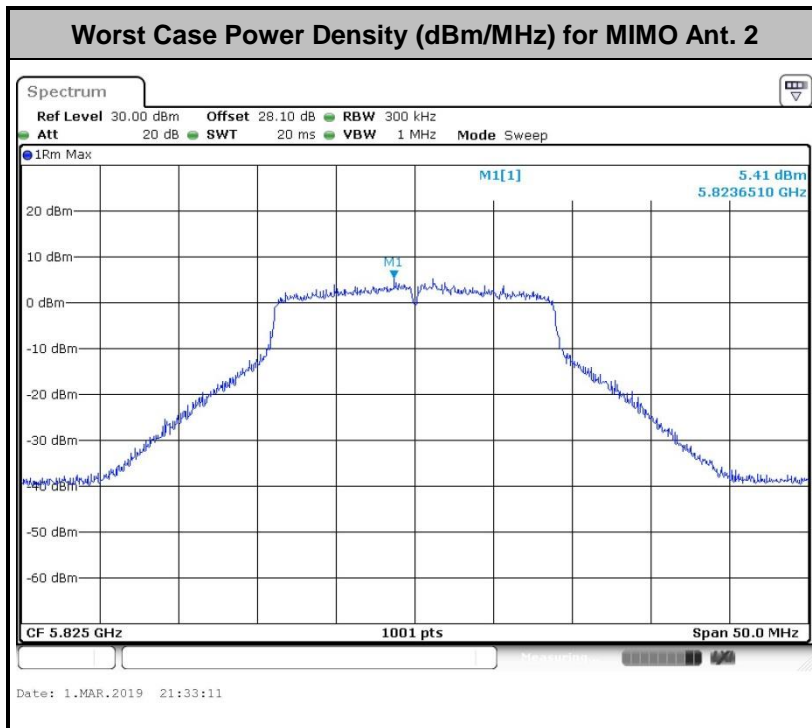
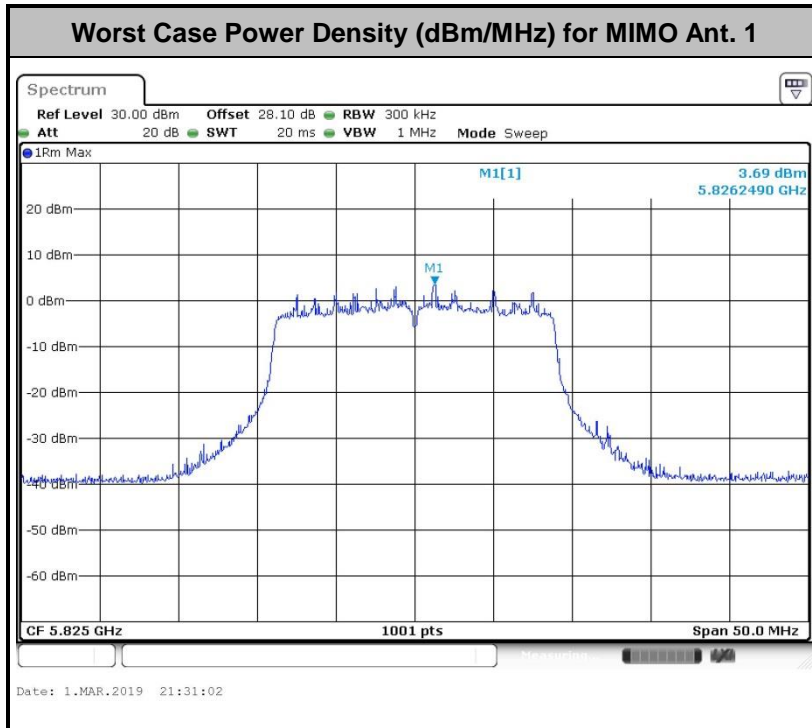



3.4 Unwanted Emissions Measurement

This section is to measure unwanted emissions through radiated measurement for band edge spurious emissions and out of band emissions measurement.

3.4.1 Limit of Unwanted Emissions

(1) For transmitters operating in the 5.725-5.85 GHz band:

15.407(b)(4)(i) All emissions shall be limited to a level of -27 dBm/MHz at 75 MHz or more above or below the band edge increasing linearly to 10 dBm/MHz at 25 MHz above or below the band edge, and from 25 MHz above or below the band edge increasing linearly to a level of 15.6 dBm/MHz at 5 MHz above or below the band edge, and from 5 MHz above or below the band edge increasing linearly to a level of 27 dBm/MHz at the band edge.

(2) Unwanted spurious emissions fallen in restricted bands shall comply with the general field strength limits as below table,

Frequency (MHz)	Field Strength (microvolts/meter)	Measurement Distance (meters)
0.009 – 0.490	2400/F(kHz)	300
0.490 – 1.705	24000/F(kHz)	30
1.705 – 30.0	30	30
30 – 88	100	3
88 – 216	150	3
216 - 960	200	3
Above 960	500	3

Note: The following formula is used to convert the EIRP to field strength.

$$E = \frac{1000000\sqrt{30P}}{3} \text{ } \mu\text{V/m, where P is the eirp (Watts)}$$

EIRP (dBm)	Field Strength at 3m (dBμV/m)
- 27	68.3



(3) KDB789033 D02 v02r01 G)2)c)

- (i) Section 15.407(b)(1) to (b)(3) specify the unwanted emission limits for the U-NII-1 and U-NII-2 bands. As specified, emissions above 1000 MHz that are outside of the restricted bands are subject to a peak emission limit of -27 dBm/MHz.³
- (ii) Section 15.407(b)(4) specifies the unwanted emission limit for the U-NII-3 band. A band emissions mask is specified in Section 15.407(b)(4)(i). The emission limits are in terms of a Peak detector. An alternative to the band emissions mask is specified in Section 15.407(b)(4)(ii). The alternative limits are based on the highest antenna gain specified in the filing. There are also marketing and importation restrictions for the devices using the alternative limit.⁴

Note 3: An out-of-band emission that complies with both the average and peak limits of Section 15.209 is not required to satisfy the -27 dBm/MHz peak emission limit.

Note 4: Only devices with antenna gains of 10 dBi or less may be approved using the emission limits specified in Section 15.247(d) till March 2, 2018; all other devices operating in this band must use the mask specified in Section 15.407(b)(4)(i).

3.4.2 Measuring Instruments

See list of measuring equipment of this test report.

3.4.3 Test Procedures

1. The testing follows FCC KDB 789033 D02 General UNII Test Procedures New Rules v02r01. Section G) Unwanted emissions measurement.

(1) Procedure for Unwanted Emissions Measurements Below 1000MHz

- RBW = 120 kHz
- VBW = 300 kHz
- Detector = Peak
- Trace mode = max hold

(2) Procedure for Peak Unwanted Emissions Measurements Above 1000 MHz

- RBW = 1 MHz
- VBW ≥ 3 MHz
- Detector = Peak
- Sweep time = auto
- Trace mode = max hold

(3) Procedures for Average Unwanted Emissions Measurements Above 1000MHz

- RBW = 1 MHz
- VBW = 10 Hz, when duty cycle is no less than 98 percent.
- VBW ≥ 1/T, when duty cycle is less than 98 percent where T is the minimum transmission duration over which the transmitter is on and is transmitting at its maximum power control level for the tested mode of operation.



2. The EUT was placed on a turntable with 0.8 meter for frequency below 1GHz and 1.5 meter for frequency above 1GHz respectively above ground.
3. The EUT was set 3 meters from the interference receiving antenna which was mounted on the top of a variable height antenna tower.
4. The antenna is a broadband antenna and its height is adjusted between one meter and four meters above ground to find the maximum value of the field strength for both horizontal polarization and vertical polarization of the antenna.
5. For each suspected emission, the EUT was arranged to its worst case and then adjust the antenna tower (from 1 m to 4 m) and turntable (from 0 degree to 360 degrees) to find the maximum reading.
6. For testing below 1GHz, if the emission level of the EUT in peak mode was 3 dB lower than the limit specified, then peak values of EUT will be reported, otherwise, the emissions will be repeated one by one using the CISPR quasi-peak method and reported.
7. For testing above 1GHz, the emission level of the EUT in peak mode was 20dB lower than average limit (that means the emission level in average mode also complies with the limit in average mode), then peak values of EUT will be reported, otherwise, the emissions will be measured in average mode again and reported.

3.4.4 Test Setup

For radiated emissions below 30MHz

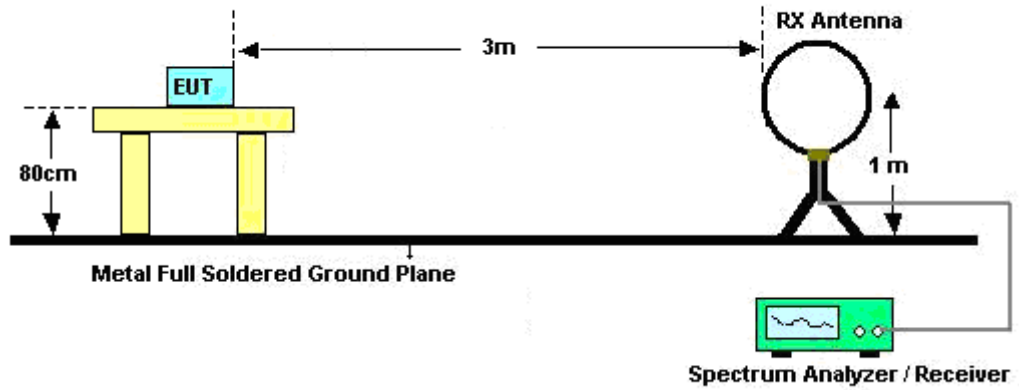

For radiated emissions from 30MHz to 1GHz

<CDD Mode>

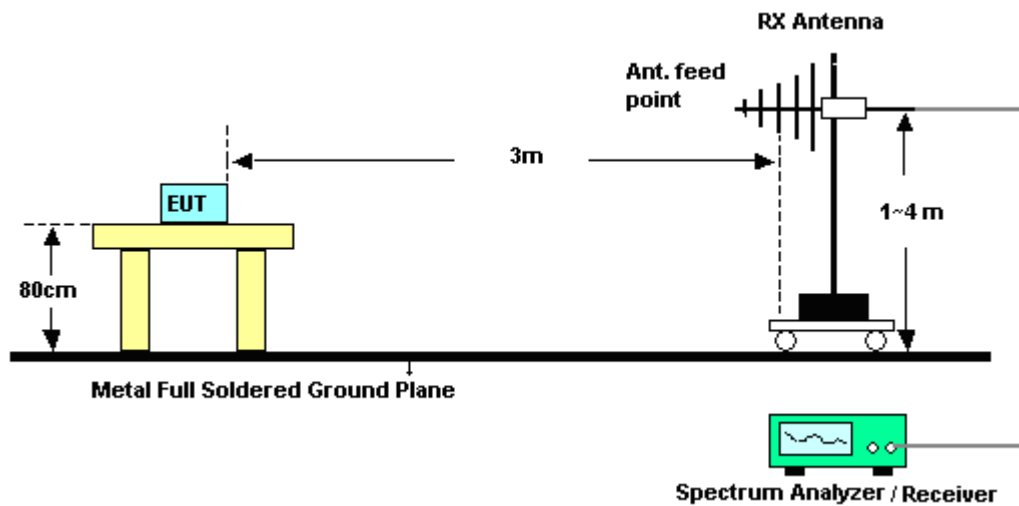

<TXBF Mode>

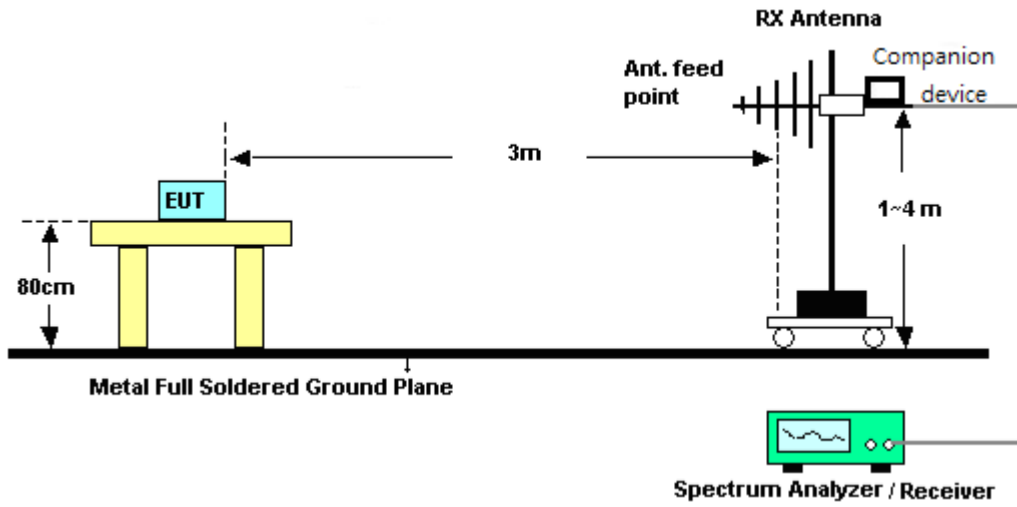

For radiated emissions above 1GHz

<CDD Mode>

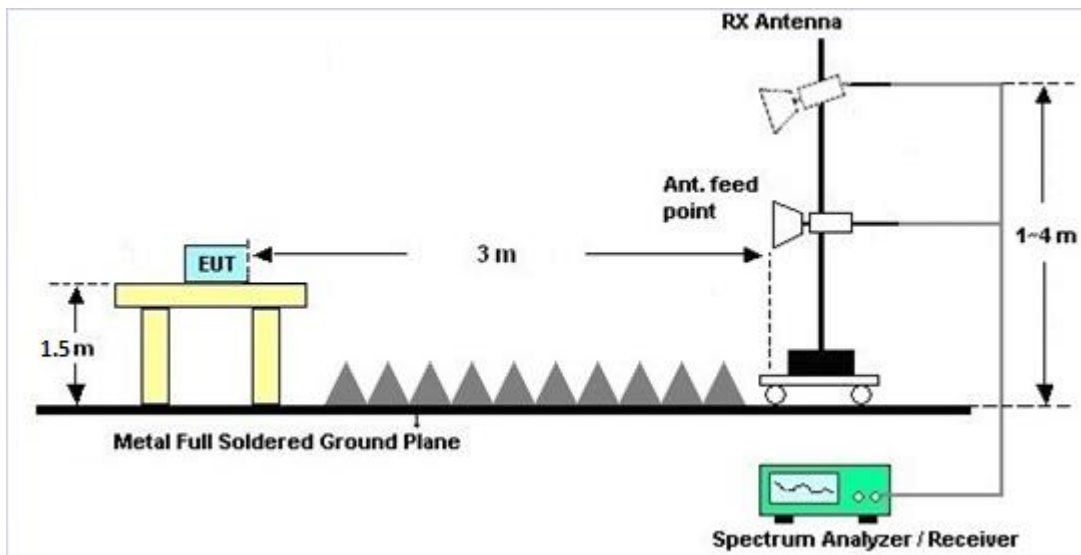

<TXBF Mode>

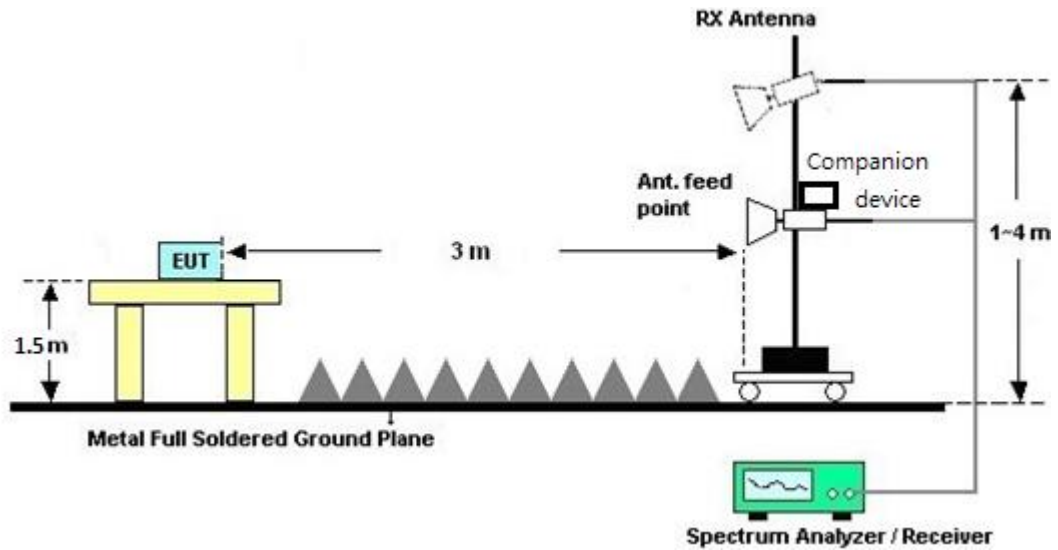

3.4.5 Test Results of Radiated Emissions (9 kHz ~ 30 MHz)

The low frequency, which started from 9 kHz to 30MHz, was pre-scanned and the result which was 20dB lower than the limit line was not reported.

There is a comparison data of both open-field test site and alternative test site - semi-Anechoic chamber according to 414788 D01 Radiated Test Site v01r01, and the result came out very similar.

3.4.6 Test Result of Radiated Band Edges

Please refer to Appendix B and C.

3.4.7 Duty Cycle

Please refer to Appendix D.

3.4.8 Test Result of Unwanted Radiated Emission (30MHz ~ 10th Harmonic)

Please refer to Appendix B and C.



3.5 AC Conducted Emission Measurement

3.5.1 Limit of AC Conducted Emission

For equipment that is designed to be connected to the public utility (AC) power line, the radio frequency voltage that is conducted back onto the AC power line on any frequency or frequencies within the band 150 kHz to 30 MHz shall not exceed the limits in the following table.

Frequency of emission (MHz)	Conducted limit (dB μ V)	
	Quasi-peak	Average
0.15-0.5	66 to 56*	56 to 46*
0.5-5	56	46
5-30	60	50

*Decreases with the logarithm of the frequency.

3.5.2 Measuring Instruments

See list of measuring equipment of this test report.

3.5.3 Test Procedures

1. The EUT was placed 0.4 meter from the conducting wall of the shielding room was kept at least 80 centimeters from any other grounded conducting surface.
2. Connect EUT to the power mains through a line impedance stabilization network (LISN).
3. All the support units are connecting to the other LISN.
4. The LISN provides 50 ohm coupling impedance for the measuring instrument.
5. The FCC states that a 50 ohm, 50 microhenry LISN should be used.
6. Both sides of AC line were checked for maximum conducted interference.
7. The frequency range from 150 kHz to 30 MHz was searched.
8. Set the test-receiver system to Peak Detect Function and specified bandwidth with Maximum Hold Mode.

3.5.4 Test Setup

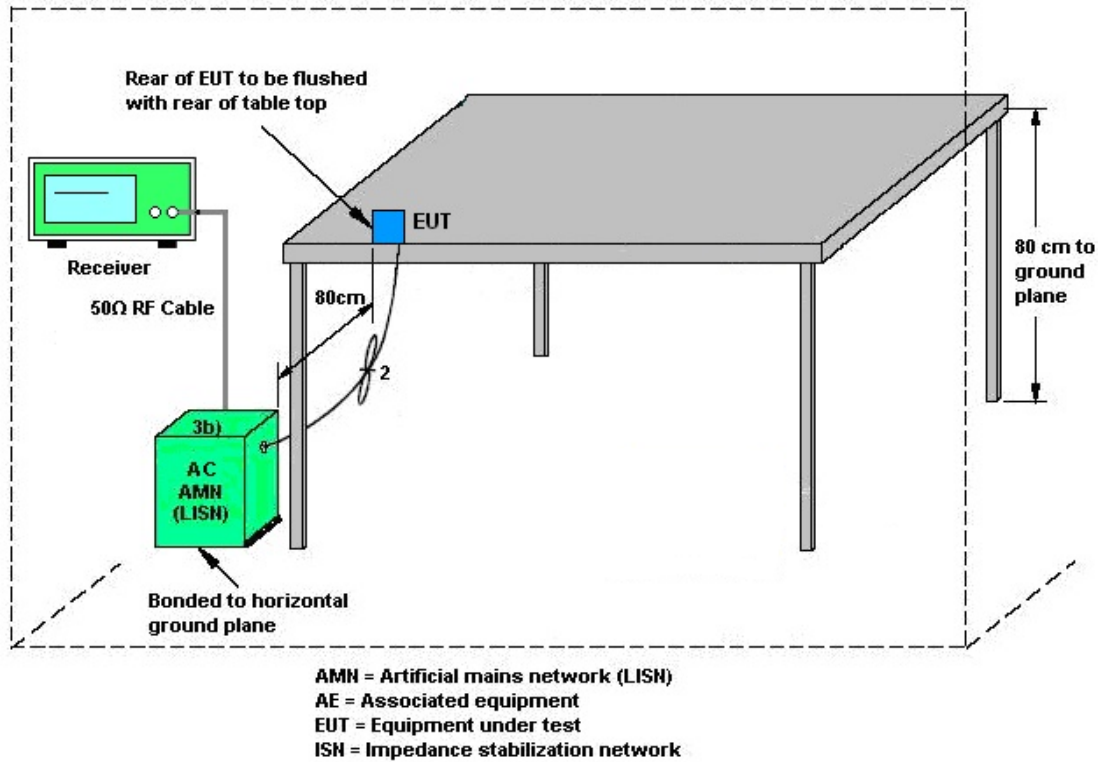

3.5.5 Test Result of AC Conducted Emission

Please refer to Appendix A.



3.6 Automatically Discontinue Transmission

3.6.1 Limit of Automatically Discontinue Transmission

The device shall automatically discontinue transmission in case of either absence of information to transmit or operational failure. These provisions are not intended to preclude the transmission of control or signaling information or the use of repetitive codes used by certain digital technologies to complete frame or burst intervals. Applicants shall include in their application for equipment authorization to describe how this requirement is met.

3.6.2 Measuring Instruments

See list of measuring equipment of this test report.

3.6.3 Test Result of Automatically Discontinue Transmission

While the EUT is not transmitting any information, the EUT can automatically discontinue transmission and become standby mode for power saving. The EUT can detect the controlling signal of ACK message transmitting from remote device and verify whether it shall resend or discontinue transmission.



3.7 Antenna Requirements

3.7.1 Standard Applicable

If transmitting antenna directional gain is greater than 6 dBi, both the peak transmit power and the peak power spectral density shall be reduced by the amount in dB that the directional gain of the antenna exceeds 6 dBi.

3.7.2 Antenna Anti-Replacement Construction

An embedded-in antenna design is used.

3.7.3 Antenna Gain

<CDD Mode>

FCC KDB 662911 D01 Multiple Transmitter Output v02r01

For CDD transmissions, directional gain is calculated as

Directional gain = GANT + Array Gain, where Array Gain is as follows.

For power spectral density (PSD) measurements on all devices,

Array Gain = 10 log(NANT/NSS=1) dB.

For power measurements on IEEE 802.11 devices,

Array Gain = 0 dB (i.e., no array gain) for NANT ≤ 4.

Directional gain may be calculated by using the formulas applicable to equal gain antennas with GANT set equal to the gain of the antenna having the highest gain;

The EUT supports CDD mode.

For power, the directional gain GANT is set equal to the antenna having the highest gain, i.e., F)2)f)i).

For PSD, the directional gain calculation is following F)2)f)ii) of KDB 662911 D01 v02r01.

The power and PSD limit should be modified if the directional gain of EUT is over 6 dBi,

The directional gain "DG" is calculated as following table.

<CDD Modes>						
			DG	DG	Power	PSD
	Ant. 1	Ant. 2	for	for	Limit	Limit
	(dBi)	(dBi)	Power	PSD	Reduction	Reduction
	(dBi)	(dBi)	(dBi)	(dBi)	(dB)	(dB)
Band IV	5.21	5.26	5.26	8.25	0.00	2.25

Power Limit Reduction = DG(Power) – 6dBi, (min = 0)

PSD Limit Reduction = DG(PSD) – 6dBi, (min = 0)

<TXBF Mode>

FCC KDB 662911 D01 Multiple Transmitter Output v02r01

For CDD transmissions, directional gain is calculated as

$$DirectionalGain = 10 \cdot \log \left[\frac{\sum_{j=1}^{N_{SS}} \left\{ \sum_{k=1}^{N_{ANT}} g_{j,k} \right\}^2}{N_{ANT}} \right]$$

where

Each antenna is driven by no more than one spatial stream;

N_{SS} = the number of independent spatial streams of data;

N_{ANT} = the total number of antennas

$g_{j,k} = 10^{G_k / 20}$ if the k th antenna is being fed by spatial stream j , or zero if it is not;
 G_k is the gain in dBi of the k th antenna.

The EUT supports beamforming for 802.11ac modes.

The directional gain calculation is following F)2)e)ii) of KDB 662911 D01 v02r01.

The power and PSD limit should be modified if the directional gain of EUT is over 6 dBi,

The directional gain “DG” is calculated as following table.

			DG	DG	Power	PSD
	Ant 1	Ant 2	for	for	Limit	Limit
	(dBi)	(dBi)	Power	PSD	Reduction	Reduction
	(dBi)	(dBi)	(dBi)	(dBi)	(dB)	(dB)
Band IV	5.21	5.26	8.25	8.25	2.25	2.25

$Power\ Limit\ Reduction = DG(Power) - 6dBi, (min = 0)$

$PSD\ Limit\ Reduction = DG(PSD) - 6dBi, (min = 0)$



4 List of Measuring Equipment

Instrument	Manufacturer	Model No.	Serial No.	Characteristics	Calibration Date	Test Date	Due Date	Remark
AC Power Source	ChainTek	APC-1000W	N/A	N/A	N/A	Mar. 06, 2019~ Mar. 19, 2019	N/A	Conduction (CO05-HY)
EMI Test Receiver	Rohde & Schwarz	ESR3	102388	9KHz~3.6GHz	Nov. 12, 2018	Mar. 06, 2019~ Mar. 19, 2019	Nov. 11, 2019	Conduction (CO05-HY)
LISN	Rohde & Schwarz	ENV216	100080	9kHz~30MHz	Nov. 14, 2018	Mar. 06, 2019~ Mar. 19, 2019	Nov. 13, 2019	Conduction (CO05-HY)
LISN	Rohde & Schwarz	ENV216	100081	9kHz~30MHz	Nov. 09, 2018	Mar. 06, 2019~ Mar. 19, 2019	Nov. 08, 2019	Conduction (CO05-HY)
Software	Rohde & Schwarz	EMC32 V10.30	N/A	N/A	N/A	Mar. 06, 2019~ Mar. 19, 2019	N/A	Conduction (CO05-HY)
RF Cable	HUBER + SUHNER	RG 214/U	1358175	9kHz~30MHz	Sep. 14, 2018	Mar. 06, 2019~ Mar. 19, 2019	Sep. 13, 2019	Conduction (CO05-HY)
Pulse Limiter	SCHWARZBE CK	VTSD 9561-F N	9561-F N00373	9kHz-200MHz	Nov. 08, 2018	Mar. 06, 2019~ Mar. 19, 2019	Nov. 07, 2019	Conduction (CO05-HY)
Loop Antenna	TESEQ	HLA 6120	31244	9 kHz~30 MHz	Mar. 29, 2018	Dec. 28, 2018~ Mar. 08, 2019	Mar. 28, 2019	Radiation (03CH15-HY)
Preamplifier	EMEC	EM18G40G	060715	18GHz ~ 40GHz	Dec. 06, 2018	Dec. 28, 2018~ Mar. 08, 2019	Dec. 05, 2019	Radiation (03CH15-HY)
Bilog Antenna	TESEQ	CBL6111D&0 0802N1D01N -06	47020&06	30MHz to 1GHz	Oct. 13, 2018	Dec. 28, 2018~ Mar. 08, 2019	Oct. 12, 2019	Radiation (03CH15-HY)
Horn Antenna	SCHWARZBE CK	BBHA 9120D	9120D-1620	1G~18GHz	Oct. 17, 2018	Dec. 28, 2018~ Mar. 08, 2019	Oct. 16, 2019	Radiation (03CH15-HY)
SHF-EHF Horn Antenna	SCHWARZBE CK	BBHA 9170	BBHA9170576	18GHz ~ 40GHz	May 08, 2018	Dec. 28, 2018~ Mar. 08, 2019	May 07, 2019	Radiation (03CH15-HY)
Amplifier	SONOMA	310N	363440	9kHz~1GHz	Dec. 28, 2018	Dec. 28, 2018~ Mar. 08, 2019	Dec. 27, 2019	Radiation (03CH15-HY)
Preamplifier	Jet-Power	JPA0118-55-3 03	171000180005 50006	1GHz~18GHz	Jul. 10, 2018	Dec. 28, 2018~ Mar. 08, 2019	Jul. 09, 2019	Radiation (03CH15-HY)
Preamplifier	Keysight	83017A	MY53270195	1GHz~26.5GHz	Aug. 23, 2018	Dec. 28, 2018~ Mar. 08, 2019	Aug. 22, 2019	Radiation (03CH15-HY)
EMI Test Receiver	Keysight	N9038A (MXE)	MY54130085	20Hz ~ 8.4GHz	Nov. 01, 2018	Dec. 28, 2018~ Mar. 08, 2019	Oct. 31, 2019	Radiation (03CH15-HY)
Spectrum Analyzer	Agilent	E4446A	MY50180136	3Hz~44GHz	Apr. 25, 2018	Dec. 28, 2018~ Mar. 08, 2019	Apr. 24, 2019	Radiation (03CH15-HY)
Antenna Mast	ChainTek	MBS-520-1	N/A	1m~4m	N/A	Dec. 28, 2018~ Mar. 08, 2019	N/A	Radiation (03CH15-HY)
Turn Table	ChainTek	T-200-S-1	N/A	0~360 Degree	N/A	Dec. 28, 2018~ Mar. 08, 2019	N/A	Radiation (03CH15-HY)
Software	Audix	E3 6.2009-8-24	RK-000451	N/A	N/A	Dec. 28, 2018~ Mar. 08, 2019	N/A	Radiation (03CH15-HY)



Instrument	Manufacturer	Model No.	Serial No.	Characteristics	Calibration Date	Test Date	Due Date	Remark
<CDD Mode>								
Power Meter	Anritsu	ML2495A	1132003	N/A	Aug. 16, 2018	Nov. 07, 2018~ Mar. 21, 2019	Aug. 15, 2019	Conducted (TH05-HY)
Power Sensor	Anritsu	MA2411B	1126017	300MHz~40GHz	Aug. 16, 2018	Nov. 07, 2018~ Mar. 21, 2019	Aug. 15, 2019	Conducted (TH05-HY)
Spectrum Analyzer	Rohde & Schwarz	FSV 30	100895	9kHz~30GHz	Apr. 20, 2018	Nov. 07, 2018~ Mar. 21, 2019	Apr. 19, 2019	Conducted (TH05-HY)
Switch Box & RF Cable	Burgeon	ETF-058	EC1300484	N/A	Mar. 01, 2018	Nov. 07, 2018~ Feb. 25, 2019	Feb. 28, 2019	Conducted (TH05-HY)
Switch Box & RF Cable	EM	EMSW18	SW1070903	N/A	Dec. 19, 2018	Feb. 26, 2019~ Mar. 21, 2019	Dec. 18, 2019	Conducted (TH05-HY)
<TXBF Mode>								
Power Sensor	DARE	RadiPower	15I00041SN O09	10MHz~6GHz	May 07, 2018	Nov. 29, 2018~ Mar. 20, 2019	May 06, 2019	Conducted (TH05-HY)
Spectrum Analyzer	Rohde & Schwarz	FSV 30	100895	9kHz~30GHz	Apr. 20, 2018	Nov. 29, 2018~ Mar. 20, 2019	Apr. 19, 2019	Conducted (TH05-HY)
Switch Box & RF Cable	Burgeon	ETF-058	EC1300484	N/A	Mar. 01, 2018	Nov. 29, 2018~ Mar. 20, 2019	Feb. 28, 2019	Conducted (TH05-HY)
Switch Box & RF Cable	EM	EMSW18	SW1070903	N/A	Dec. 19, 2018	Nov. 29, 2018~ Mar. 20, 2019	Dec. 18, 2019	Conducted (TH05-HY)



5 Uncertainty of Evaluation

Uncertainty of Conducted Emission Measurement (150kHz ~ 30MHz)

Measuring Uncertainty for a Level of Confidence of 95% ($U = 2Uc(y)$)	2.2
---	-----

Uncertainty of Radiated Emission Measurement (30 MHz ~ 1000 MHz)

Measuring Uncertainty for a Level of Confidence of 95% ($U = 2Uc(y)$)	5.2
---	-----

Uncertainty of Radiated Emission Measurement (1000 MHz ~ 18000 MHz)

Measuring Uncertainty for a Level of Confidence of 95% ($U = 2Uc(y)$)	5.5
---	-----

Uncertainty of Radiated Emission Measurement (18000 MHz ~ 40000 MHz)

Measuring Uncertainty for a Level of Confidence of 95% ($U = 2Uc(y)$)	5.2
---	-----



Appendix A. AC Conducted Emission Test Results

Test Engineer :	Jimmy Chang	Temperature :	24~26°C
		Relative Humidity :	51~53%
Test Voltage :	120Vac / 60Hz	Phase :	Line

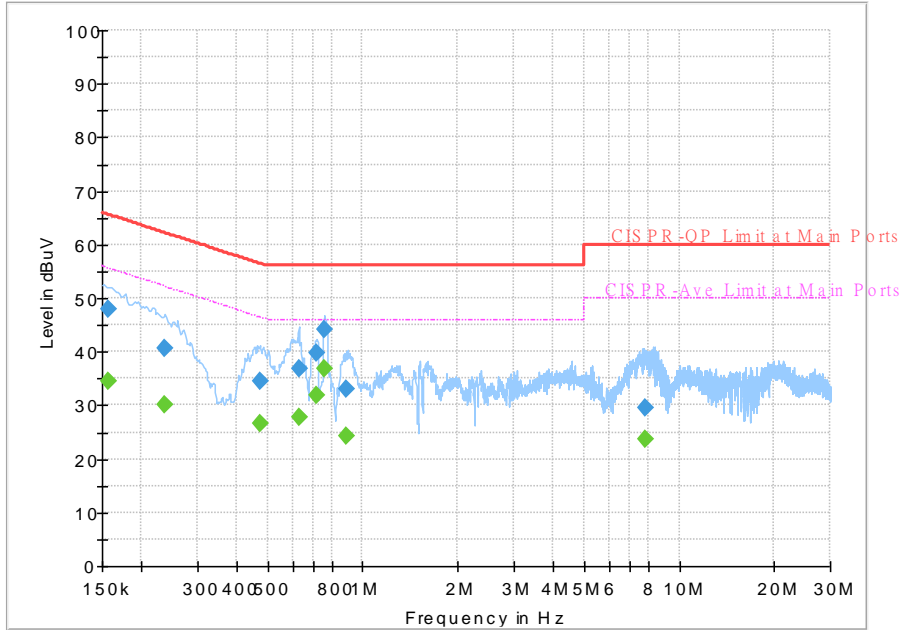

Final Result :

Frequency (MHz)	QuasiPeak (dBuV)	CAverage (dBuV)	Limit (dBuV)	Margin (dB)	Line	Filter	Corr. (dB)
0.156750	---	34.49	55.63	21.14	L1	OFF	19.5
0.156750	48.02	---	65.63	17.61	L1	OFF	19.5
0.237750	---	30.09	52.17	22.08	L1	OFF	19.5
0.237750	40.79	---	62.17	21.38	L1	OFF	19.5
0.471750	---	26.73	46.48	19.75	L1	OFF	19.5
0.471750	34.53	---	56.48	21.95	L1	OFF	19.5
0.627000	---	27.78	46.00	18.22	L1	OFF	19.5
0.627000	36.78	---	56.00	19.22	L1	OFF	19.5
0.714750	---	31.82	46.00	14.18	L1	OFF	19.5
0.714750	39.83	---	56.00	16.17	L1	OFF	19.5
0.755250	---	36.84	46.00	9.16	L1	OFF	19.5
0.755250	44.03	---	56.00	11.97	L1	OFF	19.5
0.885750	---	24.13	46.00	21.87	L1	OFF	19.5
0.885750	32.99	---	56.00	23.01	L1	OFF	19.5
7.838250	---	23.58	50.00	26.42	L1	OFF	19.7
7.838250	29.60	---	60.00	30.40	L1	OFF	19.7



Test Engineer :	Jimmy Chang	Temperature :	24~26°C
		Relative Humidity :	51~53%
Test Voltage :	120Vac / 60Hz	Phase :	Neutral

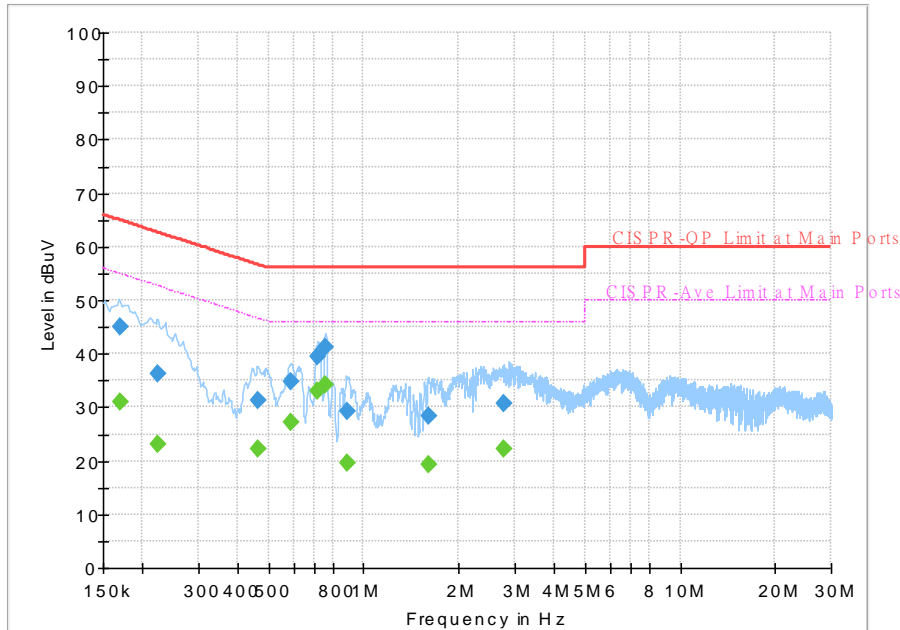

Final Result :

Frequency (MHz)	QuasiPeak (dBuV)	CAverage (dBuV)	Limit (dBuV)	Margin (dB)	Line	Filter	Corr. (dB)
0.170250	---	30.90	54.95	24.05	N	OFF	19.5
0.170250	45.16	---	64.95	19.79	N	OFF	19.5
0.224250	---	23.08	52.66	29.58	N	OFF	19.5
0.224250	36.34	---	62.66	26.32	N	OFF	19.5
0.462750	---	22.19	46.64	24.45	N	OFF	19.5
0.462750	31.25	---	56.64	25.39	N	OFF	19.5
0.591000	---	27.34	46.00	18.66	N	OFF	19.5
0.591000	34.66	---	56.00	21.34	N	OFF	19.5
0.717000	---	33.00	46.00	13.00	N	OFF	19.5
0.717000	39.51	---	56.00	16.49	N	OFF	19.5
0.759750	---	34.12	46.00	11.88	N	OFF	19.5
0.759750	41.08	---	56.00	14.92	N	OFF	19.5
0.890250	---	19.53	46.00	26.47	N	OFF	19.5
0.890250	29.23	---	56.00	26.77	N	OFF	19.5
1.605750	---	19.21	46.00	26.79	N	OFF	19.6
1.605750	28.39	---	56.00	27.61	N	OFF	19.6
2.782500	---	22.12	46.00	23.88	N	OFF	19.5
2.782500	30.76	---	56.00	25.24	N	OFF	19.5



Appendix B. Radiated Spurious Emission

Test Engineer :	Watt Tseng, Karl Hou, and BigShow Wang	Temperature :	24~26°C
		Relative Humidity :	47~58%

<CDD Mode>

Band 4 - 5725~5850MHz

WIFI 802.11a (Band Edge @ 3m)

WIFI Ant. 1	Note	Frequency (MHz)	Level (dBμV/m)	Over Limit (dB)	Limit Line (dBμV/m)	Read Level (dBμV)	Antenna Factor (dB/m)	Path Loss (dB)	Preamp Factor (dB)	Ant Pos (cm)	Table Pos (deg)	Peak Avg. (P/A)	Pol. (H/V)	
802.11a CH 149 5745MHz		5623.6	52.06	-16.14	68.2	41.31	31.77	9.19	30.21	100	23	P	H	
		5697.4	61.12	-42.16	103.28	50.24	31.8	9.33	30.25	100	23	P	H	
		5719.2	63.18	-47.4	110.58	52.14	31.93	9.37	30.26	100	23	P	H	
		5721.4	62.36	-51.63	113.99	51.32	31.93	9.37	30.26	100	23	P	H	
	*	5745	112.59	-	-	101.44	32	9.42	30.27	100	23	P	H	
	*	5745	104.2	-	-	93.05	32	9.42	30.27	100	23	A	H	
														H
														H
			5619.4	51.31	-16.89	68.2	40.56	31.77	9.19	30.21	100	68	P	V
			5699.2	57.44	-47.17	104.61	46.56	31.8	9.33	30.25	100	68	P	V
			5713	60.18	-48.66	108.84	49.21	31.87	9.36	30.26	100	68	P	V
			5720.4	60.07	-51.64	111.71	49.03	31.93	9.37	30.26	100	68	P	V
	*		5745	108.99	-	-	97.84	32	9.42	30.27	100	68	P	V
	*		5745	101.14	-	-	89.99	32	9.42	30.27	100	68	A	V
														V
														V



WIFI Ant. 1	Note	Frequency (MHz)	Level (dBμV/m)	Over Limit (dB)	Limit Line (dBμV/m)	Read Level (dBμV)	Antenna Factor (dB/m)	Path Loss (dB)	Preamp Factor (dB)	Ant Pos (cm)	Table Pos (deg)	Peak Avg. (P/A)	Pol. (H/V)
		5648.4	50.31	-17.89	68.2	39.56	31.73	9.24	30.22	100	48	P	H
		5672.8	50.71	-34.4	85.11	39.91	31.75	9.28	30.23	100	48	P	H
		5714.8	52.16	-57.19	109.35	41.19	31.87	9.36	30.26	100	48	P	H
		5722.6	54.2	-62.53	116.73	43.15	31.93	9.38	30.26	100	48	P	H
	*	5785	111.05	-	-	99.73	32.13	9.49	30.3	100	48	P	H
	*	5785	103.23	-	-	91.91	32.13	9.49	30.3	100	48	A	H
		5853	55.37	-59.99	115.36	43.92	32.2	9.58	30.33	100	48	P	H
		5865	54.31	-53.69	108	42.83	32.23	9.59	30.34	100	48	P	H
		5875.2	53.03	-52.02	105.05	41.49	32.27	9.61	30.34	100	48	P	H
		5925.4	52.02	-16.18	68.2	40.36	32.37	9.66	30.37	100	48	P	H
													H
													H
802.11a													
CH 157													
5785MHz		5635.8	49.79	-18.41	68.2	39.06	31.73	9.22	30.22	100	148	P	V
		5685.6	50.79	-43.79	94.58	39.93	31.8	9.31	30.25	100	148	P	V
		5718.4	50.5	-59.85	110.35	39.46	31.93	9.37	30.26	100	148	P	V
		5720	49.45	-61.35	110.8	38.41	31.93	9.37	30.26	100	148	P	V
	*	5785	107.87	-	-	96.55	32.13	9.49	30.3	100	148	P	V
	*	5785	99.7	-	-	88.38	32.13	9.49	30.3	100	148	A	V
		5851	53.76	-66.16	119.92	42.31	32.2	9.58	30.33	100	148	P	V
		5856.4	52.32	-58.09	110.41	40.84	32.23	9.58	30.33	100	148	P	V
		5889.2	52.19	-42.47	94.66	40.63	32.3	9.62	30.36	100	148	P	V
		5934.2	50.69	-17.51	68.2	39.02	32.37	9.67	30.37	100	148	P	V
													V
													V



WIFI Ant. 1	Note	Frequency (MHz)	Level (dBμV/m)	Over Limit (dB)	Limit Line (dBμV/m)	Read Level (dBμV)	Antenna Factor (dB/m)	Path Loss (dB)	Preamp Factor (dB)	Ant Pos (cm)	Table Pos (deg)	Peak Avg. (P/A)	Pol. (H/V)	
802.11a CH 165 5825MHz	*	5825	111.9	-	-	100.47	32.2	9.55	30.32	100	47	P	H	
	*	5825	104.1	-	-	92.67	32.2	9.55	30.32	100	47	A	H	
		5853.6	60.01	-53.98	113.99	48.53	32.23	9.58	30.33	100	47	P	H	
		5859	60.3	-49.38	109.68	48.82	32.23	9.59	30.34	100	47	P	H	
		5879	58.55	-43.68	102.23	47.01	32.27	9.61	30.34	100	47	P	H	
		5938	51.98	-16.22	68.2	40.31	32.37	9.68	30.38	100	47	P	H	
														H
														H
	*	5825	108.25	-	-	96.82	32.2	9.55	30.32	100	148	148	P	V
	*	5825	100.56	-	-	89.13	32.2	9.55	30.32	100	148	148	A	V
		5854	60.04	-53.04	113.08	48.56	32.23	9.58	30.33	100	148	148	P	V
		5859.4	57.64	-51.93	109.57	46.16	32.23	9.59	30.34	100	148	148	P	V
		5875.6	54.72	-50.03	104.75	43.18	32.27	9.61	30.34	100	148	148	P	V
		5932.6	51.84	-16.36	68.2	40.17	32.37	9.67	30.37	100	148	148	P	V
														V
														V
													V	
Remark	1. No other spurious found. 2. All results are PASS against Peak and Average limit line.													



Band 4 5725~5850MHz

WIFI 802.11a (Harmonic @ 3m)

WIFI Ant. 1	Note	Frequency (MHz)	Level (dBμV/m)	Over Limit (dB)	Limit Line (dBμV/m)	Read Level (dBμV)	Antenna Factor (dB/m)	Path Loss (dB)	Preamp Factor (dB)	Ant Pos (cm)	Table Pos (deg)	Peak Avg. (P/A)	Pol. (H/V)
802.11a CH 149 5745MHz		11490	49.95	-24.05	74	56.88	40.17	13.92	61.02	100	0	P	H
		17235	48.97	-19.23	68.2	49.91	40.7	17.88	59.52	100	0	P	H
													H
													H
		11490	54.79	-19.21	74	61.72	40.17	13.92	61.02	301	27	P	V
		11490	44.91	-9.09	54	51.84	40.17	13.92	61.02	301	27	A	V
		17235	49.1	-19.1	68.2	50.04	40.7	17.88	59.52	100	0	P	V
802.11a CH 157 5785MHz		11570	56.59	-17.41	74	63.58	40	13.95	60.94	102	164	P	H
		11570	46.14	-7.86	54	53.13	40	13.95	60.94	102	164	A	H
		17355	51.1	-17.1	68.2	51.01	41.4	18.06	59.37	100	0	P	H
													H
		11570	61.51	-12.49	74	68.5	40	13.95	60.94	207	166	P	V
		11570	50.81	-3.19	54	57.8	40	13.95	60.94	207	166	A	V
		17355	51.2	-17	68.2	51.11	41.4	18.06	59.37	100	0	P	V
802.11a CH 165 5825MHz		11650	55.98	-18.02	74	63.22	39.66	13.98	60.88	100	163	P	H
		11650	45.67	-8.33	54	52.91	39.66	13.98	60.88	100	163	A	H
		17475	52.24	-15.96	68.2	50.85	42.43	18.19	59.23	100	0	P	H
													H
		11650	60.46	-13.54	74	67.7	39.66	13.98	60.88	221	166	P	V
		11650	50.36	-3.64	54	57.6	39.66	13.98	60.88	221	166	A	V
		17475	51.01	-17.19	68.2	49.62	42.43	18.19	59.23	100	0	P	V
Remark	1. No other spurious found. 2. All results are PASS against Peak and Average limit line.												



Band 4 5725~5850MHz
WIFI 802.11n HT20 (Band Edge @ 3m)

WIFI Ant. 1	Note	Frequency (MHz)	Level (dBμV/m)	Over Limit (dB)	Limit Line (dBμV/m)	Read Level (dBμV)	Antenna Factor (dB/m)	Path Loss (dB)	Preamp Factor (dB)	Ant Pos (cm)	Table Pos (deg)	Peak Avg. (P/A)	Pol. (H/V)	
802.11n HT20 CH 149 5745MHz		5646.2	52.9	-15.3	68.2	42.15	31.73	9.24	30.22	100	23	P	H	
		5698.8	62.98	-41.34	104.32	52.1	31.8	9.33	30.25	100	23	P	H	
		5715.6	63.97	-45.6	109.57	53	31.87	9.36	30.26	100	23	P	H	
		5721.4	63.49	-50.5	113.99	52.45	31.93	9.37	30.26	100	23	P	H	
	*	5745	111.97	-	-	100.82	32	9.42	30.27	100	23	P	H	
	*	5745	104.05	-	-	92.9	32	9.42	30.27	100	23	A	H	
														H
														H
			5634	52.74	-15.46	68.2	42.02	31.73	9.21	30.22	100	64	P	V
			5698.4	58.52	-45.5	104.02	47.64	31.8	9.33	30.25	100	64	P	V
			5712.2	60.41	-48.21	108.62	49.44	31.87	9.36	30.26	100	64	P	V
			5724.4	61.22	-59.61	120.83	50.17	31.93	9.38	30.26	100	64	P	V
	*		5745	108.98	-	-	97.83	32	9.42	30.27	100	64	P	V
	*		5745	100.58	-	-	89.43	32	9.42	30.27	100	64	A	V
														V
													V	



WIFI Ant. 1	Note	Frequency (MHz)	Level (dBμV/m)	Over Limit (dB)	Limit Line (dBμV/m)	Read Level (dBμV)	Antenna Factor (dB/m)	Path Loss (dB)	Preamp Factor (dB)	Ant Pos (cm)	Table Pos (deg)	Peak Avg. (P/A)	Pol. (H/V)
		5621.8	50.19	-18.01	68.2	39.44	31.77	9.19	30.21	100	47	P	H
		5654.2	50.88	-20.44	71.32	40.16	31.7	9.25	30.23	100	47	P	H
		5718.8	51.78	-58.68	110.46	40.74	31.93	9.37	30.26	100	47	P	H
		5720.6	52.83	-59.34	112.17	41.79	31.93	9.37	30.26	100	47	P	H
	*	5785	111.46	-	-	100.14	32.13	9.49	30.3	100	47	P	H
	*	5785	103.24	-	-	91.92	32.13	9.49	30.3	100	47	A	H
		5854.6	57.17	-54.54	111.71	45.69	32.23	9.58	30.33	100	47	P	H
		5855.6	54.54	-56.09	110.63	43.06	32.23	9.58	30.33	100	47	P	H
		5899	52.1	-35.3	87.4	40.53	32.3	9.63	30.36	100	47	P	H
		5945.2	50.66	-17.54	68.2	38.95	32.4	9.69	30.38	100	47	P	H
802.11n													H
HT20													H
CH 157		5622.2	49.58	-18.62	68.2	38.83	31.77	9.19	30.21	100	148	P	V
5785MHz		5692.2	49.69	-49.76	99.45	38.82	31.8	9.32	30.25	100	148	P	V
		5713.2	51.13	-57.77	108.9	40.16	31.87	9.36	30.26	100	148	P	V
		5725	50.12	-72.08	122.2	39.07	31.93	9.38	30.26	100	148	P	V
	*	5785	107.66	-	-	96.34	32.13	9.49	30.3	100	148	P	V
	*	5785	99.7	-	-	88.38	32.13	9.49	30.3	100	148	A	V
		5853.4	52.73	-61.72	114.45	41.28	32.2	9.58	30.33	100	148	P	V
		5872.8	52.59	-53.23	105.82	41.06	32.27	9.6	30.34	100	148	P	V
		5876.2	51.6	-52.71	104.31	40.06	32.27	9.61	30.34	100	148	P	V
		5929.8	51.36	-16.84	68.2	39.69	32.37	9.67	30.37	100	148	P	V
													V
													V



WIFI Ant. 1	Note	Frequency (MHz)	Level (dBμV/m)	Over Limit (dB)	Limit Line (dBμV/m)	Read Level (dBμV)	Antenna Factor (dB/m)	Path Loss (dB)	Preamp Factor (dB)	Ant Pos (cm)	Table Pos (deg)	Peak Avg. (P/A)	Pol. (H/V)	
802.11n HT20 CH 165 5825MHz	*	5825	112.34	-	-	100.91	32.2	9.55	30.32	100	47	P	H	
	*	5825	104.4	-	-	92.97	32.2	9.55	30.32	100	47	A	H	
		5850.2	59.64	-62.1	121.74	48.19	32.2	9.58	30.33	100	47	P	H	
		5857.6	64.88	-45.19	110.07	53.39	32.23	9.59	30.33	100	47	P	H	
		5877	61.22	-42.49	103.71	49.68	32.27	9.61	30.34	100	47	P	H	
		5928.8	53.26	-14.94	68.2	41.59	32.37	9.67	30.37	100	47	P	H	
														H
														H
	*	5825	108.87	-	-	97.44	32.2	9.55	30.32	100	147	147	P	V
	*	5825	100.69	-	-	89.26	32.2	9.55	30.32	100	147	147	A	V
		5850.6	61.41	-59.42	120.83	49.96	32.2	9.58	30.33	100	147	147	P	V
		5867.4	60.2	-47.13	107.33	48.71	32.23	9.6	30.34	100	147	147	P	V
		5875.8	58.18	-46.43	104.61	46.64	32.27	9.61	30.34	100	147	147	P	V
		5930	51.78	-16.42	68.2	40.11	32.37	9.67	30.37	100	147	147	P	V
														V
														V
Remark	1. No other spurious found. 2. All results are PASS against Peak and Average limit line.													



**Band 4 5725~5850MHz
WIFI 802.11n HT20 (Harmonic @ 3m)**

WIFI Ant. 1	Note	Frequency (MHz)	Level (dBμV/m)	Over Limit (dB)	Limit Line (dBμV/m)	Read Level (dBμV)	Antenna Factor (dB/m)	Path Loss (dB)	Preamp Factor (dB)	Ant Pos (cm)	Table Pos (deg)	Peak Avg. (P/A)	Pol. (H/V)
802.11n HT20 CH 149 5745MHz		11490	52.8	-21.2	74	59.73	40.17	13.92	61.02	278	10	P	H
		11490	42.74	-11.26	54	49.67	40.17	13.92	61.02	278	10	A	H
		17235	49.54	-18.66	68.2	50.48	40.7	17.88	59.52	100	0	P	H
													H
		11490	54.72	-19.28	74	61.65	40.17	13.92	61.02	295	30	P	V
		11490	44.48	-9.52	54	51.41	40.17	13.92	61.02	295	30	A	V
		17235	48.51	-19.69	68.2	49.45	40.7	17.88	59.52	100	0	P	V
													V
802.11n HT20 CH 157 5785MHz		11570	57.43	-16.57	74	64.42	40	13.95	60.94	102	163	P	H
		11570	46.23	-7.77	54	53.22	40	13.95	60.94	102	163	A	H
		17355	51.24	-16.96	68.2	51.15	41.4	18.06	59.37	100	0	P	H
													H
		11570	61.67	-12.33	74	68.66	40	13.95	60.94	209	165	P	V
		11570	50.88	-3.12	54	57.87	40	13.95	60.94	209	165	A	V
		17355	50.82	-17.38	68.2	50.73	41.4	18.06	59.37	100	0	P	V
													V
802.11n HT20 CH 165 5825MHz		11650	56.31	-17.69	74	63.55	39.66	13.98	60.88	100	163	P	H
		11650	45.79	-8.21	54	53.03	39.66	13.98	60.88	100	163	A	H
		17475	51.68	-16.52	68.2	50.29	42.43	18.19	59.23	100	0	P	H
													H
		11650	60.18	-13.82	74	67.42	39.66	13.98	60.88	223	166	P	V
		11650	50.6	-3.4	54	57.84	39.66	13.98	60.88	223	166	A	V
		17475	50.69	-17.51	68.2	49.3	42.43	18.19	59.23	100	0	P	V
													V
Remark	1. No other spurious found. 2. All results are PASS against Peak and Average limit line.												



Band 4 5725~5850MHz
WIFI 802.11n HT40 (Band Edge @ 3m)

WIFI Ant. 1	Note	Frequency (MHz)	Level (dBμV/m)	Over Limit (dB)	Limit Line (dBμV/m)	Read Level (dBμV)	Antenna Factor (dB/m)	Path Loss (dB)	Preamp Factor (dB)	Ant Pos (cm)	Table Pos (deg)	Peak Avg. (P/A)	Pol. (H/V)
		5646.4	56.02	-12.18	68.2	45.27	31.73	9.24	30.22	100	23	P	H
		5694.2	64.75	-36.17	100.92	53.88	31.8	9.32	30.25	100	23	P	H
		5717.6	66.86	-43.27	110.13	55.82	31.93	9.37	30.26	100	23	P	H
		5723.2	67.39	-50.71	118.1	56.34	31.93	9.38	30.26	100	23	P	H
	*	5755	109.75	-	-	98.51	32.07	9.44	30.27	100	23	P	H
	*	5755	101.27	-	-	90.03	32.07	9.44	30.27	100	23	A	H
		5852	55.94	-61.7	117.64	44.49	32.2	9.58	30.33	100	23	P	H
		5859.6	56.34	-53.17	109.51	44.86	32.23	9.59	30.34	100	23	P	H
		5884.2	53.85	-44.52	98.37	42.32	32.27	9.62	30.36	100	23	P	H
		5942.4	51.13	-17.07	68.2	39.43	32.4	9.68	30.38	100	23	P	H
802.11n													H
HT40													H
CH 151		5642.6	53.31	-14.89	68.2	42.57	31.73	9.23	30.22	369	87	P	V
5755MHz		5698.4	60.39	-43.63	104.02	49.51	31.8	9.33	30.25	369	87	P	V
		5717.4	63.25	-46.82	110.07	52.27	31.87	9.37	30.26	369	87	P	V
		5723	63.56	-54.08	117.64	52.51	31.93	9.38	30.26	369	87	P	V
	*	5755	105.52	-	-	94.28	32.07	9.44	30.27	369	87	P	V
	*	5755	97.6	-	-	86.36	32.07	9.44	30.27	369	87	A	V
		5853.8	55.64	-57.9	113.54	44.16	32.23	9.58	30.33	369	87	P	V
		5868.2	53.05	-54.05	107.1	41.56	32.23	9.6	30.34	369	87	P	V
		5888	52.49	-43.06	95.55	40.93	32.3	9.62	30.36	369	87	P	V
		5940.8	52.33	-15.87	68.2	40.63	32.4	9.68	30.38	369	87	P	V
													V
													V



WIFI Ant. 1	Note	Frequency (MHz)	Level (dBμV/m)	Over Limit (dB)	Limit Line (dBμV/m)	Read Level (dBμV)	Antenna Factor (dB/m)	Path Loss (dB)	Preamp Factor (dB)	Ant Pos (cm)	Table Pos (deg)	Peak Avg. (P/A)	Pol. (H/V)
		5645.2	53.97	-14.23	68.2	43.23	31.73	9.23	30.22	240	316	P	H
		5691.8	58.73	-40.42	99.15	47.86	31.8	9.32	30.25	240	316	P	H
		5718	62.59	-47.65	110.24	51.55	31.93	9.37	30.26	240	316	P	H
		5725	63.34	-58.86	122.2	52.29	31.93	9.38	30.26	240	316	P	H
	*	5795	109.7	-	-	98.29	32.2	9.51	30.3	240	316	P	H
	*	5795	101.77	-	-	90.36	32.2	9.51	30.3	240	316	A	H
		5851.4	69.28	-49.73	119.01	57.83	32.2	9.58	30.33	240	316	P	H
		5858.8	68.61	-41.12	109.73	57.13	32.23	9.59	30.34	240	316	P	H
		5876	65.2	-39.26	104.46	53.66	32.27	9.61	30.34	240	316	P	H
		5931.8	57.33	-10.87	68.2	45.66	32.37	9.67	30.37	240	316	P	H
802.11n													H
HT40													H
CH 159		5627.4	52.08	-16.12	68.2	41.32	31.77	9.2	30.21	253	55	P	V
5795MHz		5699.6	54.5	-50.41	104.91	43.62	31.8	9.33	30.25	253	55	P	V
		5719	59.05	-51.47	110.52	48.01	31.93	9.37	30.26	253	55	P	V
		5725	59.63	-62.57	122.2	48.58	31.93	9.38	30.26	253	55	P	V
	*	5795	106.55	-	-	95.14	32.2	9.51	30.3	253	55	P	V
	*	5795	98.52	-	-	87.11	32.2	9.51	30.3	253	55	A	V
		5851	64.45	-55.47	119.92	53	32.2	9.58	30.33	253	55	P	V
		5858.4	63.72	-46.13	109.85	52.24	32.23	9.59	30.34	253	55	P	V
		5877	60.95	-42.76	103.71	49.41	32.27	9.61	30.34	253	55	P	V
		5926	54.98	-13.22	68.2	43.32	32.37	9.66	30.37	253	55	P	V
													V
													V
Remark	1. No other spurious found. 2. All results are PASS against Peak and Average limit line.												



**Band 4 5725~5850MHz
WIFI 802.11n HT40 (Harmonic @ 3m)**

WIFI Ant. 1	Note	Frequency (MHz)	Level (dBμV/m)	Over Limit (dB)	Limit Line (dBμV/m)	Read Level (dBμV)	Antenna Factor (dB/m)	Path Loss (dB)	Preamp Factor (dB)	Ant Pos (cm)	Table Pos (deg)	Peak Avg. (P/A)	Pol. (H/V)	
802.11n HT40 CH 151 5755MHz		11510	51.35	-22.65	74	58.21	40.2	13.93	60.99	287	347	P	H	
		11510	41.17	-12.83	54	48.03	40.2	13.93	60.99	287	347	A	H	
		17265	49.35	-18.85	68.2	50.1	40.8	17.93	59.48	100	0	P	H	
													H	
			11510	51.4	-22.6	74	58.26	40.2	13.93	60.99	317	3	P	V
			11510	42.15	-11.85	54	49.01	40.2	13.93	60.99	317	3	A	V
			17265	48.92	-19.28	68.2	49.67	40.8	17.93	59.48	100	0	P	V
802.11n HT40 CH 159 5795MHz		11590	48.01	-25.99	74	55.03	39.95	13.96	60.93	100	0	P	H	
		17385	51.58	-16.62	68.2	51.11	41.73	18.08	59.34	100	0	P	H	
													H	
													H	
			11590	48.7	-25.3	74	55.72	39.95	13.96	60.93	100	0	P	V
			17385	50.76	-17.44	68.2	50.29	41.73	18.08	59.34	100	0	P	V
													V	
Remark	1. No other spurious found.													
	2. All results are PASS against Peak and Average limit line.													



Band 4 5725~5850MHz
WIFI 802.11ac VHT80 (Band Edge @ 3m)

WIFI Ant. 1	Note	Frequency (MHz)	Level (dBμV/m)	Over Limit (dB)	Limit Line (dBμV/m)	Read Level (dBμV)	Antenna Factor (dB/m)	Path Loss (dB)	Preamp Factor (dB)	Ant Pos (cm)	Table Pos (deg)	Peak Avg. (P/A)	Pol. (H/V)
		5645.6	54.86	-13.34	68.2	44.12	31.73	9.23	30.22	249	315	P	H
		5695.8	61.11	-40.99	102.1	50.23	31.8	9.33	30.25	249	315	P	H
		5720	64.38	-46.42	110.8	53.34	31.93	9.37	30.26	249	315	P	H
		5724.4	64.64	-56.19	120.83	53.59	31.93	9.38	30.26	249	315	P	H
	*	5775	106.6	-	-	95.29	32.13	9.47	30.29	249	315	P	H
	*	5775	98.35	-	-	87.04	32.13	9.47	30.29	249	315	A	H
		5854	66.4	-46.68	113.08	54.92	32.23	9.58	30.33	249	315	P	H
		5855.2	65.79	-44.95	110.74	54.31	32.23	9.58	30.33	249	315	P	H
		5877	61.39	-42.32	103.71	49.85	32.27	9.61	30.34	249	315	P	H
		5937	53.71	-14.49	68.2	42.04	32.37	9.68	30.38	249	315	P	H
802.11ac													H
VHT80													H
CH 155		5644.2	50.89	-17.31	68.2	40.15	31.73	9.23	30.22	258	56	P	V
5775MHz		5693.6	56.52	-43.96	100.48	45.65	31.8	9.32	30.25	258	56	P	V
		5714.6	60.24	-49.05	109.29	49.27	31.87	9.36	30.26	258	56	P	V
		5724.8	61.73	-60.01	121.74	50.68	31.93	9.38	30.26	258	56	P	V
	*	5775	103.16	-	-	91.85	32.13	9.47	30.29	258	56	P	V
	*	5775	94.79	-	-	83.48	32.13	9.47	30.29	258	56	A	V
		5853.2	60.75	-54.15	114.9	49.3	32.2	9.58	30.33	258	56	P	V
		5856	60.48	-50.04	110.52	49	32.23	9.58	30.33	258	56	P	V
		5877	55.44	-48.27	103.71	43.9	32.27	9.61	30.34	258	56	P	V
		5928.8	52.03	-16.17	68.2	40.36	32.37	9.67	30.37	258	56	P	V
													V
													V
Remark	1. No other spurious found. 2. All results are PASS against Peak and Average limit line.												



Band 4 5725~5850MHz

WIFI 802.11ac VHT80 (Harmonic @ 3m)

WIFI Ant. 1	Note	Frequency (MHz)	Level (dBμV/m)	Over Limit (dB)	Limit Line (dBμV/m)	Read Level (dBμV)	Antenna Factor (dB/m)	Path Loss (dB)	Preamp Factor (dB)	Ant Pos (cm)	Table Pos (deg)	Peak Avg. (P/A)	Pol. (H/V)	
802.11ac VHT80 CH 155 5775MHz		11550	48.78	-25.22	74	55.74	40.05	13.95	60.96	100	0	P	H	
		17325	50.19	-18.01	68.2	50.51	41.07	18.02	59.41	100	0	P	H	
													H	
													H	
			11550	48.32	-25.68	74	55.28	40.05	13.95	60.96	100	0	P	V
			17325	50.18	-18.02	68.2	50.5	41.07	18.02	59.41	100	0	P	V
														V
Remark	1. No other spurious found. 2. All results are PASS against Peak and Average limit line.													



Emission below 1GHz
5GHz WIFI 802.11n HT20 (LF @ 3m)

WIFI Ant.	Note	Frequency (MHz)	Level (dBμV/m)	Over (dB)	Limit Line (dBμV/m)	Read Level (dBμV)	Antenna Factor (dB/m)	Path Loss (dB)	Preamp Factor (dB)	Ant Pos (cm)	Table Pos (deg)	Peak Avg. (P/A)	Pol. (H/V)	
5GHz 802.11n HT20 LF		84.27	29.08	-10.92	40	46.57	13.84	1.21	32.54	-	-	P	H	
		134.49	33.53	-9.97	43.5	47.13	17.44	1.46	32.5	100	0	P	H	
		288.39	25.91	-20.09	46	37.26	18.97	2.21	32.53	-	-	P	H	
		371.4	30.95	-15.05	46	40.17	20.94	2.39	32.55	-	-	P	H	
		677.3	28.77	-17.23	46	31.57	26.46	3.19	32.45	-	-	P	H	
		972.7	33.66	-20.34	54	29.81	30.91	3.96	31.02	-	-	P	H	
														H
														H
														H
														H
														H
														H
			70.23	34.03	-5.97	40	53.3	12.19	1.1	32.56	100	0	P	V
			153.93	28.04	-15.46	43.5	41.95	16.97	1.62	32.5	-	-	P	V
			269.22	25.01	-20.99	46	36.02	19.35	2.16	32.52	-	-	P	V
			421.8	29.99	-16.01	46	37.32	22.69	2.53	32.55	-	-	P	V
			513.5	28.91	-17.09	46	34.72	23.96	2.8	32.57	-	-	P	V
			931.4	32.55	-13.45	46	30.04	30.07	3.82	31.38	-	-	P	V
													V	
													V	
													V	
													V	
													V	
													V	
Remark	1. No other spurious found. 2. All results are PASS against limit line.													



Band 4 - 5725~5850MHz
WIFI 802.11a (Band Edge @ 3m)

WIFI	Note	Frequency	Level	Over	Limit	Read	Antenna	Path	Preamp	Ant	Table	Peak	Pol.	
Ant.				Limit	Line	Level	Factor	Loss	Factor	Pos	Pos	Avg.		
2		(MHz)	(dBμV/m)	(dB)	(dBμV/m)	(dBμV)	(dB/m)	(dB)	(dB)	(cm)	(deg)	(P/A)	(H/V)	
802.11a CH 149 5745MHz		5642.4	50.86	-17.34	68.2	40.12	31.73	9.23	30.22	100	30	P	H	
		5690.8	58.36	-40.06	98.42	47.49	31.8	9.32	30.25	100	30	P	H	
		5718.2	62.08	-48.22	110.3	51.04	31.93	9.37	30.26	100	30	P	H	
		5724.4	63.49	-57.34	120.83	52.44	31.93	9.38	30.26	100	30	P	H	
	*	5745	112.63	-	-	101.48	32	9.42	30.27	100	30	P	H	
	*	5745	105.07	-	-	93.92	32	9.42	30.27	100	30	A	H	
														H
														H
			5611.8	51.53	-16.67	68.2	40.77	31.8	9.17	30.21	100	69	P	V
			5695	56.87	-44.64	101.51	45.99	31.8	9.33	30.25	100	69	P	V
			5707.8	59.53	-47.86	107.39	48.57	31.87	9.35	30.26	100	69	P	V
			5725	59.61	-62.59	122.2	48.56	31.93	9.38	30.26	100	69	P	V
	*		5745	109.62	-	-	98.47	32	9.42	30.27	100	69	P	V
	*		5745	101.73	-	-	90.58	32	9.42	30.27	100	69	A	V
														V
													V	



WIFI Ant. 2	Note	Frequency (MHz)	Level (dBμV/m)	Over Limit (dB)	Limit Line (dBμV/m)	Read Level (dBμV)	Antenna Factor (dB/m)	Path Loss (dB)	Preamp Factor (dB)	Ant Pos (cm)	Table Pos (deg)	Peak Avg. (P/A)	Pol. (H/V)	
802.11a CH 157 5785MHz		5647.2	50.46	-17.74	68.2	39.71	31.73	9.24	30.22	100	328	P	H	
		5678.8	50.88	-38.67	89.55	40.06	31.75	9.3	30.23	100	328	P	H	
		5708	51.51	-55.93	107.44	40.55	31.87	9.35	30.26	100	328	P	H	
		5721.4	50.83	-63.16	113.99	39.79	31.93	9.37	30.26	100	328	P	H	
	*	5785	113.14	-	-	101.82	32.13	9.49	30.3	100	328	P	H	
	*	5785	104.82	-	-	93.5	32.13	9.49	30.3	100	328	A	H	
		5850.8	53.68	-66.7	120.38	42.23	32.2	9.58	30.33	100	328	P	H	
		5855.8	53.89	-56.69	110.58	42.41	32.23	9.58	30.33	100	328	P	H	
		5875.8	52.84	-51.77	104.61	41.3	32.27	9.61	30.34	100	328	P	H	
		5926.4	52.78	-15.42	68.2	41.11	32.37	9.67	30.37	100	328	P	H	
														H
														H
			5632.4	50.26	-17.94	68.2	39.5	31.77	9.21	30.22	100	68	P	V
			5699.2	49.55	-55.06	104.61	38.67	31.8	9.33	30.25	100	68	P	V
			5703	49.82	-56.22	106.04	38.86	31.87	9.34	30.25	100	68	P	V
			5723.8	49.29	-70.17	119.46	38.24	31.93	9.38	30.26	100	68	P	V
	*		5785	109.14	-	-	97.82	32.13	9.49	30.3	100	68	P	V
	*		5785	101.35	-	-	90.03	32.13	9.49	30.3	100	68	A	V
			5852.6	51.65	-64.62	116.27	40.2	32.2	9.58	30.33	100	68	P	V
			5860.8	51.96	-57.21	109.17	40.48	32.23	9.59	30.34	100	68	P	V
			5894.6	51.07	-39.59	90.66	39.5	32.3	9.63	30.36	100	68	P	V
			5932.4	50.96	-17.24	68.2	39.29	32.37	9.67	30.37	100	68	P	V
														V
														V



WIFI Ant. 2	Note	Frequency (MHz)	Level (dBµV/m)	Over Limit (dB)	Limit Line (dBµV/m)	Read Level (dBµV)	Antenna Factor (dB/m)	Path Loss (dB)	Preamp Factor (dB)	Ant Pos (cm)	Table Pos (deg)	Peak Avg. (P/A)	Pol. (H/V)	
802.11a CH 165 5825MHz	*	5825	112.13	-	-	100.7	32.2	9.55	30.32	100	25	P	H	
	*	5825	104.42	-	-	92.99	32.2	9.55	30.32	100	25	A	H	
		5853	67.24	-48.12	115.36	55.79	32.2	9.58	30.33	100	25	P	H	
		5859	67.13	-42.55	109.68	55.65	32.23	9.59	30.34	100	25	P	H	
		5877.4	63.43	-39.99	103.42	51.89	32.27	9.61	30.34	100	25	P	H	
		5926.4	52.48	-15.72	68.2	40.81	32.37	9.67	30.37	100	25	P	H	
														H
														H
	*	5825	110.14	-	-	98.71	32.2	9.55	30.32	100	66	66	P	V
	*	5825	102.31	-	-	90.88	32.2	9.55	30.32	100	66	66	A	V
		5850.2	65.27	-56.47	121.74	53.82	32.2	9.58	30.33	100	66	66	P	V
		5860.6	64.49	-44.74	109.23	53.01	32.23	9.59	30.34	100	66	66	P	V
		5877.6	62.21	-41.06	103.27	50.67	32.27	9.61	30.34	100	66	66	P	V
		5929	52.29	-15.91	68.2	40.62	32.37	9.67	30.37	100	66	66	P	V
														V
														V
														V
Remark	1. No other spurious found. 2. All results are PASS against Peak and Average limit line.													



Band 4 5725~5850MHz
WIFI 802.11a (Harmonic @ 3m)

WIFI Ant. 2	Note	Frequency (MHz)	Level (dBμV/m)	Over Limit (dB)	Limit Line (dBμV/m)	Read Level (dBμV)	Antenna Factor (dB/m)	Path Loss (dB)	Preamp Factor (dB)	Ant Pos (cm)	Table Pos (deg)	Peak Avg. (P/A)	Pol. (H/V)
802.11a CH 149 5745MHz		11490	48.43	-25.57	74	55.36	40.17	13.92	61.02	100	0	P	H
		17235	49.36	-18.84	68.2	50.3	40.7	17.88	59.52	100	0	P	H
													H
													H
		11490	49.91	-24.09	74	56.84	40.17	13.92	61.02	100	0	P	V
		17235	49.83	-18.37	68.2	50.77	40.7	17.88	59.52	100	0	P	V
													V
													V
802.11a CH 157 5785MHz		11570	57.71	-16.29	74	64.7	40	13.95	60.94	100	347	P	H
		11570	46.99	-7.01	54	53.98	40	13.95	60.94	100	347	A	H
		17355	51	-17.2	68.2	50.91	41.4	18.06	59.37	100	0	P	H
													H
		11570	61.4	-12.6	74	68.39	40	13.95	60.94	291	1	P	V
		11570	50.93	-3.07	54	57.92	40	13.95	60.94	291	1	A	V
		17355	49.92	-18.28	68.2	49.83	41.4	18.06	59.37	100	0	P	V
													V
802.11a CH 165 5825MHz		11650	48.83	-25.17	74	56.07	39.66	13.98	60.88	100	0	P	H
		17475	50.09	-18.11	68.2	48.7	42.43	18.19	59.23	100	0	P	H
													H
													H
		11650	47.86	-26.14	74	55.1	39.66	13.98	60.88	100	0	P	V
		17475	51.25	-16.95	68.2	49.86	42.43	18.19	59.23	100	0	P	V
													V
													V
Remark	1. No other spurious found. 2. All results are PASS against Peak and Average limit line.												



Band 4 5725~5850MHz
WIFI 802.11n HT20 (Band Edge @ 3m)

WIFI Ant. 2	Note	Frequency (MHz)	Level (dBμV/m)	Over Limit (dB)	Limit Line (dBμV/m)	Read Level (dBμV)	Antenna Factor (dB/m)	Path Loss (dB)	Preamp Factor (dB)	Ant Pos (cm)	Table Pos (deg)	Peak Avg. (P/A)	Pol. (H/V)	
802.11n HT20 CH 149 5745MHz		5644.8	52.91	-15.29	68.2	42.17	31.73	9.23	30.22	100	31	P	H	
		5696.6	62.11	-40.58	102.69	51.23	31.8	9.33	30.25	100	31	P	H	
		5706.6	63.74	-43.31	107.05	52.78	31.87	9.35	30.26	100	31	P	H	
		5724.8	66.85	-54.89	121.74	55.8	31.93	9.38	30.26	100	31	P	H	
	*	5745	112.52	-	-	101.37	32	9.42	30.27	100	31	P	H	
	*	5745	104.53	-	-	93.38	32	9.42	30.27	100	31	A	H	
														H
														H
			5621.4	50.17	-18.03	68.2	39.42	31.77	9.19	30.21	100	67	P	V
			5694.6	56.5	-44.72	101.22	45.62	31.8	9.33	30.25	100	67	P	V
			5719.4	58.99	-51.64	110.63	47.95	31.93	9.37	30.26	100	67	P	V
			5724.8	58.33	-63.41	121.74	47.28	31.93	9.38	30.26	100	67	P	V
	*		5745	109.53	-	-	98.38	32	9.42	30.27	100	67	P	V
	*		5745	101.3	-	-	90.15	32	9.42	30.27	100	67	A	V
														V
														V



WIFI Ant. 2	Note	Frequency (MHz)	Level (dBμV/m)	Over Limit (dB)	Limit Line (dBμV/m)	Read Level (dBμV)	Antenna Factor (dB/m)	Path Loss (dB)	Preamp Factor (dB)	Ant Pos (cm)	Table Pos (deg)	Peak Avg. (P/A)	Pol. (H/V)
		5603.6	50.89	-17.31	68.2	40.14	31.8	9.16	30.21	100	30	P	H
		5699.8	52.22	-52.83	105.05	41.34	31.8	9.33	30.25	100	30	P	H
		5720	57.48	-53.32	110.8	46.44	31.93	9.37	30.26	100	30	P	H
		5720	57.48	-53.32	110.8	46.44	31.93	9.37	30.26	100	30	P	H
	*	5785	112.69	-	-	101.37	32.13	9.49	30.3	100	30	P	H
	*	5785	104.49	-	-	93.17	32.13	9.49	30.3	100	30	A	H
		5850.6	57.41	-63.42	120.83	45.96	32.2	9.58	30.33	100	30	P	H
		5855.4	57.19	-53.5	110.69	45.71	32.23	9.58	30.33	100	30	P	H
		5875	53.36	-51.84	105.2	41.82	32.27	9.61	30.34	100	30	P	H
		5931.8	51.16	-17.04	68.2	39.49	32.37	9.67	30.37	100	30	P	H
													H
													H
802.11n													
HT20													
CH 157		5617.8	50.21	-17.99	68.2	39.47	31.77	9.18	30.21	100	67	P	V
5785MHz		5686.4	51.2	-43.97	95.17	40.34	31.8	9.31	30.25	100	67	P	V
		5715.4	50.59	-58.92	109.51	39.62	31.87	9.36	30.26	100	67	P	V
		5724.2	52.65	-67.73	120.38	41.6	31.93	9.38	30.26	100	67	P	V
	*	5785	109.88	-	-	98.56	32.13	9.49	30.3	100	67	P	V
	*	5785	102.11	-	-	90.79	32.13	9.49	30.3	100	67	A	V
		5854.4	54.12	-58.05	112.17	42.64	32.23	9.58	30.33	100	67	P	V
		5855.6	55.84	-54.79	110.63	44.36	32.23	9.58	30.33	100	67	P	V
		5877.6	53.85	-49.42	103.27	42.31	32.27	9.61	30.34	100	67	P	V
		5931	51.21	-16.99	68.2	39.54	32.37	9.67	30.37	100	67	P	V
													V
													V



WIFI Ant. 2	Note	Frequency (MHz)	Level (dBμV/m)	Over Limit (dB)	Limit Line (dBμV/m)	Read Level (dBμV)	Antenna Factor (dB/m)	Path Loss (dB)	Preamp Factor (dB)	Ant Pos (cm)	Table Pos (deg)	Peak Avg. (P/A)	Pol. (H/V)	
802.11n HT20 CH 165 5825MHz	*	5825	112.17	-	-	100.74	32.2	9.55	30.32	104	30	P	H	
	*	5825	104.38	-	-	92.95	32.2	9.55	30.32	104	30	A	H	
		5851.2	68.91	-50.55	119.46	57.46	32.2	9.58	30.33	104	30	P	H	
		5855.2	67.75	-42.99	110.74	56.27	32.23	9.58	30.33	104	30	P	H	
		5875	63.4	-41.8	105.2	51.86	32.27	9.61	30.34	104	30	P	H	
		5928.2	53.4	-14.8	68.2	41.73	32.37	9.67	30.37	104	30	P	H	
														H
														H
	*	5825	109.81	-	-	98.38	32.2	9.55	30.32	100	66	P	V	
	*	5825	101.92	-	-	90.49	32.2	9.55	30.32	100	66	A	V	
		5852	64.85	-52.79	117.64	53.4	32.2	9.58	30.33	100	66	P	V	
		5858.4	65.54	-44.31	109.85	54.06	32.23	9.59	30.34	100	66	P	V	
		5875.2	62.55	-42.5	105.05	51.01	32.27	9.61	30.34	100	66	P	V	
		5929.2	53.19	-15.01	68.2	41.52	32.37	9.67	30.37	100	66	P	V	
														V
														V
Remark	1. No other spurious found. 2. All results are PASS against Peak and Average limit line.													



Band 4 5725~5850MHz
WIFI 802.11n HT20 (Harmonic @ 3m)

WIFI Ant. 2	Note	Frequency (MHz)	Level (dBμV/m)	Over Limit (dB)	Limit Line (dBμV/m)	Read Level (dBμV)	Antenna Factor (dB/m)	Path Loss (dB)	Preamp Factor (dB)	Ant Pos (cm)	Table Pos (deg)	Peak Avg. (P/A)	Pol. (H/V)	
802.11n HT20 CH 149 5745MHz		11490	49.08	-24.92	74	56.01	40.17	13.92	61.02	100	0	P	H	
		17235	49.63	-18.57	68.2	50.57	40.7	17.88	59.52	100	0	P	H	
													H	
													H	
			11490	49.83	-24.17	74	56.76	40.17	13.92	61.02			P	V
			17235	48.48	-19.72	68.2	49.42	40.7	17.88	59.52	100	0	P	V
														V
802.11n HT20 CH 157 5785MHz		11570	48.42	-25.58	74	55.41	40	13.95	60.94	100	0	P	H	
		17355	50.12	-18.08	68.2	50.03	41.4	18.06	59.37	100	0	P	H	
													H	
													H	
			11570	50.73	-23.27	74	57.72	40	13.95	60.94	355	359	P	V
			11570	40.99	-13.01	54	47.98	40	13.95	60.94	355	359	A	V
			17355	49.91	-18.29	68.2	49.82	41.4	18.06	59.37	100	0	P	V
802.11n HT20 CH 165 5825MHz		11650	48.91	-25.09	74	56.15	39.66	13.98	60.88	100	0	P	H	
		17475	49.76	-18.44	68.2	48.37	42.43	18.19	59.23	100	0	P	H	
													H	
													H	
			11650	47.94	-26.06	74	55.18	39.66	13.98	60.88	100	0	P	V
			17475	50.47	-17.73	68.2	49.08	42.43	18.19	59.23	100	0	P	V
														V
Remark	1. No other spurious found.													
	2. All results are PASS against Peak and Average limit line.													



Band 4 5725~5850MHz
WIFI 802.11n HT40 (Band Edge @ 3m)

WIFI Ant. 2	Note	Frequency (MHz)	Level (dBμV/m)	Over Limit (dB)	Limit Line (dBμV/m)	Read Level (dBμV)	Antenna Factor (dB/m)	Path Loss (dB)	Preamp Factor (dB)	Ant Pos (cm)	Table Pos (deg)	Peak Avg. (P/A)	Pol. (H/V)
		5646	55.59	-12.61	68.2	44.84	31.73	9.24	30.22	100	31	P	H
		5695.4	63.56	-38.25	101.81	52.68	31.8	9.33	30.25	100	31	P	H
		5719	66.98	-43.54	110.52	55.94	31.93	9.37	30.26	100	31	P	H
		5724.4	67.03	-53.8	120.83	55.98	31.93	9.38	30.26	100	31	P	H
	*	5755	108.89	-	-	97.65	32.07	9.44	30.27	100	31	P	H
	*	5755	101.59	-	-	90.35	32.07	9.44	30.27	100	31	A	H
		5854.2	57.59	-55.03	112.62	46.11	32.23	9.58	30.33	100	31	P	H
		5857.2	54.11	-56.07	110.18	42.62	32.23	9.59	30.33	100	31	P	H
		5875.6	51.66	-53.09	104.75	40.12	32.27	9.61	30.34	100	31	P	H
		5936.4	51.03	-17.17	68.2	39.36	32.37	9.68	30.38	100	31	P	H
802.11n													H
HT40													H
CH 151		5616.4	51.78	-16.42	68.2	41.04	31.77	9.18	30.21	100	68	P	V
5755MHz		5696	59.78	-42.47	102.25	48.9	31.8	9.33	30.25	100	68	P	V
		5712.4	62.65	-46.02	108.67	51.68	31.87	9.36	30.26	100	68	P	V
		5724.6	63.98	-57.31	121.29	52.93	31.93	9.38	30.26	100	68	P	V
	*	5755	106.95	-	-	95.71	32.07	9.44	30.27	100	68	P	V
	*	5755	99.23	-	-	87.99	32.07	9.44	30.27	100	68	A	V
		5850.8	55.07	-65.31	120.38	43.62	32.2	9.58	30.33	100	68	P	V
		5856.6	53.41	-56.94	110.35	41.92	32.23	9.59	30.33	100	68	P	V
		5890.4	51.85	-41.92	93.77	40.29	32.3	9.62	30.36	100	68	P	V
		5946.8	51.24	-16.96	68.2	39.53	32.4	9.69	30.38	100	68	P	V
													V
													V



WIFI Ant. 2	Note	Frequency (MHz)	Level (dBμV/m)	Over Limit (dB)	Limit Line (dBμV/m)	Read Level (dBμV)	Antenna Factor (dB/m)	Path Loss (dB)	Preamp Factor (dB)	Ant Pos (cm)	Table Pos (deg)	Peak Avg. (P/A)	Pol. (H/V)
		5642.4	51.42	-16.78	68.2	40.68	31.73	9.23	30.22	100	35	P	H
		5699.6	58.12	-46.79	104.91	47.24	31.8	9.33	30.25	100	35	P	H
		5716	59.64	-50.04	109.68	48.67	31.87	9.36	30.26	100	35	P	H
		5723.6	62.03	-56.98	119.01	50.98	31.93	9.38	30.26	100	35	P	H
	*	5795	109.07	-	-	97.66	32.2	9.51	30.3	100	35	P	H
	*	5795	101.78	-	-	90.37	32.2	9.51	30.3	100	35	A	H
		5854.4	65.81	-46.36	112.17	54.33	32.23	9.58	30.33	100	35	P	H
		5856.2	64.11	-46.35	110.46	52.63	32.23	9.58	30.33	100	35	P	H
		5876.8	60.93	-42.93	103.86	49.39	32.27	9.61	30.34	100	35	P	H
		5930.6	52.22	-15.98	68.2	40.55	32.37	9.67	30.37	100	35	P	H
802.11n													H
HT40													H
CH 159		5617.4	50.94	-17.26	68.2	40.2	31.77	9.18	30.21	100	68	P	V
5795MHz		5684	51.69	-41.71	93.4	40.83	31.8	9.31	30.25	100	68	P	V
		5719.8	57.09	-53.65	110.74	46.05	31.93	9.37	30.26	100	68	P	V
		5722.8	59.11	-58.07	117.18	48.06	31.93	9.38	30.26	100	68	P	V
	*	5795	107.53	-	-	96.12	32.2	9.51	30.3	100	68	P	V
	*	5795	99.8	-	-	88.39	32.2	9.51	30.3	100	68	A	V
		5852.2	62.74	-54.44	117.18	51.29	32.2	9.58	30.33	100	68	P	V
		5862.2	62.78	-46	108.78	51.3	32.23	9.59	30.34	100	68	P	V
		5877.8	59.25	-43.87	103.12	47.71	32.27	9.61	30.34	100	68	P	V
		5935.8	52.77	-15.43	68.2	41.1	32.37	9.68	30.38	100	68	P	V
													V
													V
Remark	1. No other spurious found. 2. All results are PASS against Peak and Average limit line.												



**Band 4 5725~5850MHz
WIFI 802.11n HT40 (Harmonic @ 3m)**

WIFI Ant. 2	Note	Frequency (MHz)	Level (dBμV/m)	Over Limit (dB)	Limit Line (dBμV/m)	Read Level (dBμV)	Antenna Factor (dB/m)	Path Loss (dB)	Preamp Factor (dB)	Ant Pos (cm)	Table Pos (deg)	Peak Avg. (P/A)	Pol. (H/V)
802.11n HT40 CH 151 5755MHz		11510	48.51	-25.49	74	55.37	40.2	13.93	60.99	100	0	P	H
		17265	49.56	-18.64	68.2	50.31	40.8	17.93	59.48	100	0	P	H
													H
													H
		11510	48.93	-25.07	74	55.79	40.2	13.93	60.99	100	0	P	V
		17265	49.96	-18.24	68.2	50.71	40.8	17.93	59.48	100	0	P	V
													V
													V
802.11n HT40 CH 159 5795MHz		11590	48.7	-25.3	74	55.72	39.95	13.96	60.93	100	0	P	H
		17385	50.94	-17.26	68.2	50.47	41.73	18.08	59.34	100	0	P	H
													H
													H
		11590	48.26	-25.74	74	55.28	39.95	13.96	60.93	100	0	P	V
		17385	50.18	-18.02	68.2	49.71	41.73	18.08	59.34	100	0	P	V
													V
													V
Remark	1. No other spurious found. 2. All results are PASS against Peak and Average limit line.												



Band 4 5725~5850MHz
WIFI 802.11ac VHT80 (Band Edge @ 3m)

WIFI Ant. 2	Note	Frequency (MHz)	Level (dBμV/m)	Over Limit (dB)	Limit Line (dBμV/m)	Read Level (dBμV)	Antenna Factor (dB/m)	Path Loss (dB)	Preamp Factor (dB)	Ant Pos (cm)	Table Pos (deg)	Peak Avg. (P/A)	Pol. (H/V)
		5638.2	52.33	-15.87	68.2	41.6	31.73	9.22	30.22	100	31	P	H
		5693	62.29	-37.75	100.04	51.42	31.8	9.32	30.25	100	31	P	H
		5720	64.89	-45.91	110.8	53.85	31.93	9.37	30.26	100	31	P	H
		5723	64.92	-52.72	117.64	53.87	31.93	9.38	30.26	100	31	P	H
	*	5775	106.68	-	-	95.37	32.13	9.47	30.29	100	31	P	H
	*	5775	98.91	-	-	87.6	32.13	9.47	30.29	100	31	A	H
		5850	67.26	-54.94	122.2	55.81	32.2	9.58	30.33	100	31	P	H
		5857.2	65.25	-44.93	110.18	53.76	32.23	9.59	30.33	100	31	P	H
		5875	58.45	-46.75	105.2	46.91	32.27	9.61	30.34	100	31	P	H
		5934.4	51.95	-16.25	68.2	40.29	32.37	9.67	30.38	100	31	P	H
802.11ac													H
VHT80													H
CH 155		5601.4	51.59	-16.61	68.2	40.83	31.8	9.15	30.19	100	68	P	V
5775MHz		5697	57.19	-45.8	102.99	46.31	31.8	9.33	30.25	100	68	P	V
		5718.4	60.98	-49.37	110.35	49.94	31.93	9.37	30.26	100	68	P	V
		5723	61.64	-56	117.64	50.59	31.93	9.38	30.26	100	68	P	V
	*	5775	103.93	-	-	92.62	32.13	9.47	30.29	100	68	P	V
	*	5775	96.22	-	-	84.91	32.13	9.47	30.29	100	68	A	V
		5851.8	64.63	-53.47	118.1	53.18	32.2	9.58	30.33	100	68	P	V
		5856.4	63.08	-47.33	110.41	51.6	32.23	9.58	30.33	100	68	P	V
		5878.2	57.71	-45.11	102.82	46.17	32.27	9.61	30.34	100	68	P	V
		5943	52.7	-15.5	68.2	41	32.4	9.68	30.38	100	68	P	V
													V
													V
Remark	1. No other spurious found. 2. All results are PASS against Peak and Average limit line.												



**Band 4 5725~5850MHz
WIFI 802.11ac VHT80 (Harmonic @ 3m)**

WIFI Ant. 2	Note	Frequency (MHz)	Level (dBμV/m)	Over Limit (dB)	Limit Line (dBμV/m)	Read Level (dBμV)	Antenna Factor (dB/m)	Path Loss (dB)	Preamp Factor (dB)	Ant Pos (cm)	Table Pos (deg)	Peak Avg. (P/A)	Pol. (H/V)	
802.11ac VHT80 CH 155 5775MHz		11550	48.08	-25.92	74	55.04	40.05	13.95	60.96	100	0	P	H	
		17325	49.85	-18.35	68.2	50.17	41.07	18.02	59.41	100	0	P	H	
													H	
													H	
			11550	48.05	-25.95	74	55.01	40.05	13.95	60.96	100	0	P	V
			17325	49.99	-18.21	68.2	50.31	41.07	18.02	59.41	100	0	P	V
														V
														V
Remark	1. No other spurious found. 2. All results are PASS against Peak and Average limit line.													



Emission below 1GHz
5GHz WIFI 802.11a(LF @ 3m)

WIFI	Note	Frequency	Level	Over	Limit	Read	Antenna	Path	Preamp	Ant	Table	Peak	Pol.	
Ant.				Limit	Line	Level	Factor	Loss	Factor	Pos	Pos	Avg.		
2		(MHz)	(dBμV/m)	(dB)	(dBμV/m)	(dBμV)	(dB/m)	(dB)	(dB)	(cm)	(deg)	(P/A)	(H/V)	
5GHz 802.11a LF		85.08	29.39	-10.61	40	46.73	13.96	1.23	32.53	-	-	P	H	
		133.95	34.35	-9.15	43.5	47.96	17.43	1.46	32.5	100	0	P	H	
		266.52	24.76	-21.24	46	35.64	19.5	2.14	32.52	-	-	P	H	
		335	31.93	-14.07	46	42.32	19.91	2.24	32.54	-	-	P	H	
		509.3	33.29	-12.71	46	39.12	23.96	2.78	32.57	-	-	P	H	
		927.9	32.92	-13.08	46	30.58	29.94	3.81	31.41	-	-	P	H	
														H
														H
														H
														H
														H
														H
			69.69	34.19	-5.81	40	53.46	12.19	1.1	32.56	100	0	P	V
			133.95	29.58	-13.92	43.5	43.19	17.43	1.46	32.5	-	-	P	V
			275.43	26.23	-19.77	46	37.55	19.04	2.17	32.53	-	-	P	V
			423.2	28.76	-17.24	46	36.07	22.7	2.54	32.55	-	-	P	V
			737.5	31.78	-14.22	46	32.87	27.94	3.3	32.33	-	-	P	V
			979	34.15	-19.85	54	30.29	30.86	3.97	30.97	-	-	P	V
														V
														V
													V	
													V	
													V	
													V	
Remark	1. No other spurious found. 2. All results are PASS against limit line.													



Band 4 - 5725~5850MHz
WIFI 802.11a (Band Edge @ 3m)

WIFI	Note	Frequency	Level	Over	Limit	Read	Antenna	Path	Preamp	Ant	Table	Peak	Pol.	
Ant.				Limit	Line	Level	Factor	Loss	Factor	Pos	Pos	Avg.		
1+2		(MHz)	(dBμV/m)	(dB)	(dBμV/m)	(dBμV)	(dB/m)	(dB)	(dB)	(cm)	(deg)	(P/A)	(H/V)	
802.11a CH 149 5745MHz		5636.4	54.94	-13.26	68.2	44.21	31.73	9.22	30.22	250	318	P	H	
		5698.2	67.88	-35.99	103.87	57	31.8	9.33	30.25	250	318	P	H	
		5718.8	69.22	-41.24	110.46	58.18	31.93	9.37	30.26	250	318	P	H	
		5724.4	69.46	-51.37	120.83	58.41	31.93	9.38	30.26	250	318	P	H	
	*	5745	116.74	-	-	105.59	32	9.42	30.27	250	318	P	H	
	*	5745	108.98	-	-	97.83	32	9.42	30.27	250	318	A	H	
														H
														H
			5612.2	50.77	-17.43	68.2	40.01	31.8	9.17	30.21	253	69	P	V
			5698	58.49	-45.24	103.73	47.61	31.8	9.33	30.25	253	69	P	V
			5718	61.16	-49.08	110.24	50.12	31.93	9.37	30.26	253	69	P	V
			5723.2	62.43	-55.67	118.1	51.38	31.93	9.38	30.26	253	69	P	V
	*		5745	113.27	-	-	102.12	32	9.42	30.27	253	69	P	V
	*		5745	105.01	-	-	93.86	32	9.42	30.27	253	69	A	V
														V
													V	



WIFI Ant. 1+2	Note	Frequency (MHz)	Level (dBμV/m)	Over Limit (dB)	Limit Line (dBμV/m)	Read Level (dBμV)	Antenna Factor (dB/m)	Path Loss (dB)	Preamp Factor (dB)	Ant Pos (cm)	Table Pos (deg)	Peak Avg. (P/A)	Pol. (H/V)	
802.11a CH 157 5785MHz		5615.6	51.76	-16.44	68.2	41.02	31.77	9.18	30.21	100	29	P	H	
		5699.2	58.24	-46.37	104.61	47.36	31.8	9.33	30.25	100	29	P	H	
		5719.6	62.94	-47.75	110.69	51.9	31.93	9.37	30.26	100	29	P	H	
		5724.2	64.53	-55.85	120.38	53.48	31.93	9.38	30.26	100	29	P	H	
	*	5785	117.24	-	-	105.92	32.13	9.49	30.3	100	29	P	H	
	*	5785	109.63	-	-	98.31	32.13	9.49	30.3	100	29	A	H	
		5850	64.95	-57.25	122.2	53.5	32.2	9.58	30.33	100	29	P	H	
		5856.6	63.7	-46.65	110.35	52.21	32.23	9.59	30.33	100	29	P	H	
		5881.4	58.5	-41.95	100.45	46.96	32.27	9.61	30.34	100	29	P	H	
		5945.4	53.27	-14.93	68.2	41.56	32.4	9.69	30.38	100	29	P	H	
														H
														H
			5612.6	51.6	-16.6	68.2	40.84	31.8	9.17	30.21	343	85	P	V
			5697.6	53.18	-50.25	103.43	42.3	31.8	9.33	30.25	343	85	P	V
			5720	57.67	-53.13	110.8	46.63	31.93	9.37	30.26	343	85	P	V
			5724.8	59.31	-62.43	121.74	48.26	31.93	9.38	30.26	343	85	P	V
	*		5785	111.49	-	-	100.17	32.13	9.49	30.3	343	85	P	V
	*		5785	103.55	-	-	92.23	32.13	9.49	30.3	343	85	A	V
			5853.2	57.65	-57.25	114.9	46.2	32.2	9.58	30.33	343	85	P	V
			5855	56.86	-53.94	110.8	45.38	32.23	9.58	30.33	343	85	P	V
		5879.8	54.36	-47.27	101.63	42.82	32.27	9.61	30.34	343	85	P	V	
		5933.8	53.02	-15.18	68.2	41.35	32.37	9.67	30.37	343	85	P	V	
													V	
													V	



WiFi Ant. 1+2	Note	Frequency (MHz)	Level (dBμV/m)	Over Limit (dB)	Limit Line (dBμV/m)	Read Level (dBμV)	Antenna Factor (dB/m)	Path Loss (dB)	Preamp Factor (dB)	Ant Pos (cm)	Table Pos (deg)	Peak Avg. (P/A)	Pol. (H/V)	
802.11a CH 165 5825MHz	*	5825	116.33	-	-	104.9	32.2	9.55	30.32	100	30	P	H	
	*	5825	108.78	-	-	97.35	32.2	9.55	30.32	100	30	A	H	
		5854.8	57.04	-54.22	111.26	45.56	32.23	9.58	30.33	100	30	P	H	
		5855	55.93	-54.87	110.8	44.45	32.23	9.58	30.33	100	30	P	H	
		5880	54.94	-46.55	101.49	43.4	32.27	9.61	30.34	100	30	P	H	
		5935.4	51.62	-16.58	68.2	39.95	32.37	9.68	30.38	100	30	P	H	
														H
														H
	*	5825	110.76	-	-	99.33	32.2	9.55	30.32	352	81	P	V	
	*	5825	102.96	-	-	91.53	32.2	9.55	30.32	352	81	A	V	
		5852.2	52.79	-64.39	117.18	41.34	32.2	9.58	30.33	352	81	P	V	
		5871	52.21	-54.11	106.32	40.68	32.27	9.6	30.34	352	81	P	V	
		5924.4	51.27	-17.37	68.64	39.61	32.37	9.66	30.37	352	81	P	V	
		5927	51.24	-16.96	68.2	39.57	32.37	9.67	30.37	352	81	P	V	
														V
														V
													V	
Remark	<ol style="list-style-type: none"> No other spurious found. All results are PASS against Peak and Average limit line. 													



Band 4 5725~5850MHz
WIFI 802.11a (Harmonic @ 3m)

WIFI Ant. 1+2	Note	Frequency (MHz)	Level (dBμV/m)	Over Limit (dB)	Limit Line (dBμV/m)	Read Level (dBμV)	Antenna Factor (dB/m)	Path Loss (dB)	Preamp Factor (dB)	Ant Pos (cm)	Table Pos (deg)	Peak Avg. (P/A)	Pol. (H/V)
802.11a CH 149 5745MHz		11490	55.11	-18.89	74	62.04	40.17	13.92	61.02	284	7	P	H
		11490	46.01	-7.99	54	52.94	40.17	13.92	61.02	284	7	A	H
		17235	48.21	-19.99	68.2	49.15	40.7	17.88	59.52	100	0	P	H
													H
		11490	57.69	-16.31	74	64.62	40.17	13.92	61.02	316	6	P	V
		11490	48.03	-5.97	54	54.96	40.17	13.92	61.02	316	6	A	V
		17235	49.46	-18.74	68.2	50.4	40.7	17.88	59.52	100	0	P	V
802.11a CH 157 5785MHz		11570	57.96	-16.04	74	64.95	40	13.95	60.94	207	347	P	H
		11570	48.84	-5.16	54	55.83	40	13.95	60.94	207	347	A	H
		17355	50.69	-17.51	68.2	50.6	41.4	18.06	59.37	100	0	P	H
													H
		11570	59.74	-14.26	74	66.73	40	13.95	60.94	275	27	P	V
		11570	50.12	-3.88	54	57.11	40	13.95	60.94	275	27	A	V
		17355	48.27	-19.93	68.2	48.18	41.4	18.06	59.37	100	0	P	V
802.11a CH 165 5825MHz		11650	49.76	-24.24	74	57	39.66	13.98	60.88	100	0	P	H
		17475	50.48	-17.72	68.2	49.09	42.43	18.19	59.23	100	0	P	H
													H
													H
		11650	53.73	-20.27	74	60.97	39.66	13.98	60.88	290	24	P	V
		11650	43.98	-10.02	54	51.22	39.66	13.98	60.88	290	24	A	V
		17475	50.75	-17.45	68.2	49.36	42.43	18.19	59.23	100	0	P	V
Remark	1. No other spurious found. 2. All results are PASS against Peak and Average limit line.												



Band 4 5725~5850MHz
WIFI 802.11n HT20 (Band Edge @ 3m)

WIFI Ant. 1+2	Note	Frequency (MHz)	Level (dBμV/m)	Over Limit (dB)	Limit Line (dBμV/m)	Read Level (dBμV)	Antenna Factor (dB/m)	Path Loss (dB)	Preamp Factor (dB)	Ant Pos (cm)	Table Pos (deg)	Peak Avg. (P/A)	Pol. (H/V)	
802.11n HT20 CH 149 5745MHz		5643.4	53.64	-14.56	68.2	42.9	31.73	9.23	30.22	100	30	P	H	
		5695.8	65.33	-36.77	102.1	54.45	31.8	9.33	30.25	100	30	P	H	
		5716.8	66.64	-43.27	109.91	55.66	31.87	9.37	30.26	100	30	P	H	
		5720.2	66.21	-45.05	111.26	55.17	31.93	9.37	30.26	100	30	P	H	
	*	5745	116.32	-	-	105.17	32	9.42	30.27	100	30	P	H	
	*	5745	108.17	-	-	97.02	32	9.42	30.27	100	30	A	H	
														H
														H
			5638.6	51.37	-16.83	68.2	40.64	31.73	9.22	30.22	351	89	P	V
			5689.2	58.85	-38.39	97.24	47.98	31.8	9.32	30.25	351	89	P	V
			5714	62.4	-46.72	109.12	51.43	31.87	9.36	30.26	351	89	P	V
			5723.8	63.19	-56.27	119.46	52.14	31.93	9.38	30.26	351	89	P	V
	*		5745	111	-	-	99.85	32	9.42	30.27	351	89	P	V
	*		5745	102.89	-	-	91.74	32	9.42	30.27	351	89	A	V
														V
														V



WIFI Ant. 1+2	Note	Frequency (MHz)	Level (dBμV/m)	Over Limit (dB)	Limit Line (dBμV/m)	Read Level (dBμV)	Antenna Factor (dB/m)	Path Loss (dB)	Preamp Factor (dB)	Ant Pos (cm)	Table Pos (deg)	Peak Avg. (P/A)	Pol. (H/V)	
802.11n HT20 CH 157 5785MHz		5617.8	51.84	-16.36	68.2	41.1	31.77	9.18	30.21	100	30	P	H	
		5697.4	58.75	-44.53	103.28	47.87	31.8	9.33	30.25	100	30	P	H	
		5716.2	63.86	-45.88	109.74	52.89	31.87	9.36	30.26	100	30	P	H	
		5725	64.77	-57.43	122.2	53.72	31.93	9.38	30.26	100	30	P	H	
	*	5785	117.7	-	-	106.38	32.13	9.49	30.3	100	30	P	H	
	*	5785	109.99	-	-	98.67	32.13	9.49	30.3	100	30	A	H	
		5852.4	65.13	-51.6	116.73	53.68	32.2	9.58	30.33	100	30	P	H	
		5855.2	64.48	-46.26	110.74	53	32.23	9.58	30.33	100	30	P	H	
		5876.4	60.25	-43.91	104.16	48.71	32.27	9.61	30.34	100	30	P	H	
		5941.8	52.54	-15.66	68.2	40.84	32.4	9.68	30.38	100	30	P	H	
														H
														H
			5627.6	51.42	-16.78	68.2	40.66	31.77	9.2	30.21	360	85	P	V
			5698.6	53.9	-50.27	104.17	43.02	31.8	9.33	30.25	360	85	P	V
			5716.4	57.5	-52.29	109.79	46.52	31.87	9.37	30.26	360	85	P	V
			5724.6	59.1	-62.19	121.29	48.05	31.93	9.38	30.26	360	85	P	V
	*		5785	110.36	-	-	99.04	32.13	9.49	30.3	360	85	P	V
	*		5785	102.07	-	-	90.75	32.13	9.49	30.3	360	85	A	V
			5851.6	56.87	-61.68	118.55	45.42	32.2	9.58	30.33	360	85	P	V
			5857.4	55.59	-54.54	110.13	44.1	32.23	9.59	30.33	360	85	P	V
		5910.2	51.68	-27.44	79.12	40.07	32.33	9.65	30.37	360	85	P	V	
		5928.6	52.04	-16.16	68.2	40.37	32.37	9.67	30.37	360	85	P	V	
													V	
													V	



WIFI Ant. 1+2	Note	Frequency (MHz)	Level (dBμV/m)	Over Limit (dB)	Limit Line (dBμV/m)	Read Level (dBμV)	Antenna Factor (dB/m)	Path Loss (dB)	Preamp Factor (dB)	Ant Pos (cm)	Table Pos (deg)	Peak Avg. (P/A)	Pol. (H/V)	
802.11n HT20 CH 165 5825MHz	*	5825	116.21	-	-	104.78	32.2	9.55	30.32	100	29	P	H	
	*	5825	108.17	-	-	96.74	32.2	9.55	30.32	100	29	A	H	
		5852	66.11	-51.53	117.64	54.66	32.2	9.58	30.33	100	29	P	H	
		5855.6	65.84	-44.79	110.63	54.36	32.23	9.58	30.33	100	29	P	H	
		5879.6	63.07	-38.71	101.78	51.53	32.27	9.61	30.34	100	29	P	H	
		5925.8	53.41	-14.79	68.2	41.75	32.37	9.66	30.37	100	29	P	H	
														H
														H
	*	5825	110.54	-	-	99.11	32.2	9.55	30.32	355	80	P	V	
	*	5825	102.19	-	-	90.76	32.2	9.55	30.32	355	80	A	V	
		5850.4	64.35	-56.94	121.29	52.9	32.2	9.58	30.33	355	80	P	V	
		5856	62.59	-47.93	110.52	51.11	32.23	9.58	30.33	355	80	P	V	
		5875	59.9	-45.3	105.2	48.36	32.27	9.61	30.34	355	80	P	V	
		5947	52.25	-15.95	68.2	40.54	32.4	9.69	30.38	355	80	P	V	
														V
														V
Remark	1. No other spurious found. 2. All results are PASS against Peak and Average limit line.													



Band 4 5725~5850MHz
WIFI 802.11n HT20 (Harmonic @ 3m)

WIFI Ant. 1+2	Note	Frequency (MHz)	Level (dBμV/m)	Over Limit (dB)	Limit Line (dBμV/m)	Read Level (dBμV)	Antenna Factor (dB/m)	Path Loss (dB)	Preamp Factor (dB)	Ant Pos (cm)	Table Pos (deg)	Peak Avg. (P/A)	Pol. (H/V)
802.11n HT20 CH 149 5745MHz		11490	55.28	-18.72	74	62.21	40.17	13.92	61.02	249	9	P	H
		11490	46.12	-7.88	54	53.05	40.17	13.92	61.02	249	9	A	H
		17235	48.26	-19.94	68.2	49.2	40.7	17.88	59.52	100	0	P	H
													H
		11490	57.66	-16.34	74	64.59	40.17	13.92	61.02	316	5	P	V
		11490	48.03	-5.97	54	54.96	40.17	13.92	61.02	316	5	A	V
		17235	48.67	-19.53	68.2	49.61	40.7	17.88	59.52	100	0	P	V
													V
802.11n HT20 CH 157 5785MHz		11570	58.56	-15.44	74	65.55	40	13.95	60.94	221	348	P	H
		11570	48.86	-5.14	54	55.85	40	13.95	60.94	221	348	A	H
		17355	51.63	-16.57	68.2	51.54	41.4	18.06	59.37	100	0	P	H
													H
		11570	60.88	-13.12	74	67.87	40	13.95	60.94	286	2	P	V
		11570	50.08	-3.92	54	57.07	40	13.95	60.94	286	2	A	V
		17355	50.07	-18.13	68.2	49.98	41.4	18.06	59.37	100	0	P	V
													V
802.11n HT20 CH 165 5825MHz		11650	49.66	-24.34	74	56.9	39.66	13.98	60.88	100	0	P	H
		17475	50.35	-17.85	68.2	48.96	42.43	18.19	59.23	100	0	P	H
													H
													H
		11650	54.6	-19.4	74	61.84	39.66	13.98	60.88	299	23	P	V
		11650	44.15	-9.85	54	51.39	39.66	13.98	60.88	299	23	A	V
		17475	50.96	-17.24	68.2	49.57	42.43	18.19	59.23	100	0	P	V
													V
Remark	1. No other spurious found. 2. All results are PASS against Peak and Average limit line.												



**Band 4 5725~5850MHz
WIFI 802.11n HT40 (Band Edge @ 3m)**

WIFI Ant. 1+2	Note	Frequency (MHz)	Level (dBµV/m)	Over Limit (dB)	Limit Line (dBµV/m)	Read Level (dBµV)	Antenna Factor (dB/m)	Path Loss (dB)	Preamp Factor (dB)	Ant Pos (cm)	Table Pos (deg)	Peak Avg. (P/A)	Pol. (H/V)
		5646.8	57.02	-11.18	68.2	46.27	31.73	9.24	30.22	100	31	P	H
		5698.8	65.4	-38.92	104.32	54.52	31.8	9.33	30.25	100	31	P	H
		5717.6	67.33	-42.8	110.13	56.29	31.93	9.37	30.26	100	31	P	H
		5724.6	68.27	-53.02	121.29	57.22	31.93	9.38	30.26	100	31	P	H
	*	5755	115.35	-	-	104.11	32.07	9.44	30.27	100	31	P	H
	*	5755	107.71	-	-	96.47	32.07	9.44	30.27	100	31	A	H
		5854.4	57.99	-54.18	112.17	46.51	32.23	9.58	30.33	100	31	P	H
		5855.6	58.07	-52.56	110.63	46.59	32.23	9.58	30.33	100	31	P	H
		5882.6	52.97	-46.59	99.56	41.43	32.27	9.61	30.34	100	31	P	H
		5935.6	51.63	-16.57	68.2	39.96	32.37	9.68	30.38	100	31	P	H
802.11n													H
HT40													H
CH 151		5627.4	52.82	-15.38	68.2	42.06	31.77	9.2	30.21	298	73	P	V
5755MHz		5699.2	60.88	-43.73	104.61	50	31.8	9.33	30.25	298	73	P	V
		5717.2	63.4	-46.62	110.02	52.42	31.87	9.37	30.26	298	73	P	V
		5724.8	63.6	-58.14	121.74	52.55	31.93	9.38	30.26	298	73	P	V
	*	5755	109.83	-	-	98.59	32.07	9.44	30.27	298	73	P	V
	*	5755	102.09	-	-	90.85	32.07	9.44	30.27	298	73	A	V
		5851.2	53.01	-66.45	119.46	41.56	32.2	9.58	30.33	298	73	P	V
		5860.2	53.06	-56.28	109.34	41.58	32.23	9.59	30.34	298	73	P	V
		5885.2	52.56	-45.07	97.63	41.03	32.27	9.62	30.36	298	73	P	V
		5943	51.61	-16.59	68.2	39.91	32.4	9.68	30.38	298	73	P	V
													V
													V



WIFI Ant. 1+2	Note	Frequency (MHz)	Level (dBμV/m)	Over Limit (dB)	Limit Line (dBμV/m)	Read Level (dBμV)	Antenna Factor (dB/m)	Path Loss (dB)	Preamp Factor (dB)	Ant Pos (cm)	Table Pos (deg)	Peak Avg. (P/A)	Pol. (H/V)	
802.11n HT40 CH 159 5795MHz		5637.4	51.76	-16.44	68.2	41.03	31.73	9.22	30.22	100	29	P	H	
		5699.8	54.85	-50.2	105.05	43.97	31.8	9.33	30.25	100	29	P	H	
		5718	57.52	-52.72	110.24	46.48	31.93	9.37	30.26	100	29	P	H	
		5723.6	57.5	-61.51	119.01	46.45	31.93	9.38	30.26	100	29	P	H	
	*	5795	114.45	-	-	103.04	32.2	9.51	30.3	100	29	P	H	
	*	5795	106.59	-	-	95.18	32.2	9.51	30.3	100	29	A	H	
		5852.4	60.81	-55.92	116.73	49.36	32.2	9.58	30.33	100	29	P	H	
		5855.4	60.15	-50.54	110.69	48.67	32.23	9.58	30.33	100	29	P	H	
		5879.2	57.02	-45.06	102.08	45.48	32.27	9.61	30.34	100	29	P	H	
		5926.2	53.99	-14.21	68.2	42.32	32.37	9.67	30.37	100	29	P	H	
														H
														H
			5617.4	51.24	-16.96	68.2	40.5	31.77	9.18	30.21	250	64	P	V
			5699.6	50.88	-54.03	104.91	40	31.8	9.33	30.25	250	64	P	V
			5709.8	52.98	-54.97	107.95	42.02	31.87	9.35	30.26	250	64	P	V
			5724.8	53.22	-68.52	121.74	42.17	31.93	9.38	30.26	250	64	P	V
	*		5795	109.54	-	-	98.13	32.2	9.51	30.3	250	64	P	V
	*		5795	101.7	-	-	90.29	32.2	9.51	30.3	250	64	A	V
			5854.2	52.75	-59.87	112.62	41.27	32.23	9.58	30.33	250	64	P	V
			5855.8	57.76	-52.82	110.58	46.28	32.23	9.58	30.33	250	64	P	V
		5896.8	52.31	-36.72	89.03	40.74	32.3	9.63	30.36	250	64	P	V	
		5928.8	51.49	-16.71	68.2	39.82	32.37	9.67	30.37	250	64	P	V	
													V	
													V	
Remark	1. No other spurious found. 2. All results are PASS against Peak and Average limit line.													



**Band 4 5725~5850MHz
WIFI 802.11n HT40 (Harmonic @ 3m)**

WIFI Ant. 1+2	Note	Frequency (MHz)	Level (dBµV/m)	Over Limit (dB)	Limit Line (dBµV/m)	Read Level (dBµV)	Antenna Factor (dB/m)	Path Loss (dB)	Preamp Factor (dB)	Ant Pos (cm)	Table Pos (deg)	Peak Avg. (P/A)	Pol. (H/V)	
802.11n HT40 CH 151 5755MHz		11510	49.85	-24.15	74	56.71	40.2	13.93	60.99	100	0	P	H	
		17265	48.94	-19.26	68.2	49.69	40.8	17.93	59.48	100	0	P	H	
													H	
													H	
			11510	56.46	-17.54	74	63.32	40.2	13.93	60.99	301	2	P	V
			11510	46.12	-7.88	54	52.98	40.2	13.93	60.99	301	2	A	V
			17265	48.59	-19.61	68.2	49.34	40.8	17.93	59.48	100	0	P	V
														V
802.11n HT40 CH 159 5795MHz		11590	49.68	-24.32	74	56.7	39.95	13.96	60.93	100	0	P	H	
		17385	51.09	-17.11	68.2	50.62	41.73	18.08	59.34	100	0	P	H	
													H	
													H	
			11590	53.49	-20.51	74	60.51	39.95	13.96	60.93	299	1	P	V
			11590	43.17	-10.83	54	50.19	39.95	13.96	60.93	299	1	A	V
			17385	50.01	-18.19	68.2	49.54	41.73	18.08	59.34	100	0	P	V
														V
Remark	1. No other spurious found. 2. All results are PASS against Peak and Average limit line.													



Band 4 5725~5850MHz
WIFI 802.11ac VHT80 (Band Edge @ 3m)

WIFI Ant. 1+2	Note	Frequency (MHz)	Level (dBμV/m)	Over Limit (dB)	Limit Line (dBμV/m)	Read Level (dBμV)	Antenna Factor (dB/m)	Path Loss (dB)	Preamp Factor (dB)	Ant Pos (cm)	Table Pos (deg)	Peak Avg. (P/A)	Pol. (H/V)	
		5645.8	52.62	-15.58	68.2	41.88	31.73	9.23	30.22	100	28	P	H	
		5697.4	63.65	-39.63	103.28	52.77	31.8	9.33	30.25	100	28	P	H	
		5704	66.46	-39.86	106.32	55.5	31.87	9.34	30.25	100	28	P	H	
		5724.4	67.29	-53.54	120.83	56.24	31.93	9.38	30.26	100	28	P	H	
	*	5775	112.33	-	-	101.02	32.13	9.47	30.29	100	28	P	H	
	*	5775	104.38	-	-	93.07	32.13	9.47	30.29	100	28	A	H	
		5851.8	69	-49.1	118.1	57.55	32.2	9.58	30.33	100	28	P	H	
		5861.6	69.4	-39.55	108.95	57.92	32.23	9.59	30.34	100	28	P	H	
		5878.6	61.03	-41.5	102.53	49.49	32.27	9.61	30.34	100	28	P	H	
		5943.8	51.25	-16.95	68.2	39.54	32.4	9.69	30.38	100	28	P	H	
802.11ac VHT80 CH 155 5775MHz													H	
													H	
			5630.6	50.78	-17.42	68.2	40.02	31.77	9.21	30.22	238	71	P	V
			5697.2	56.56	-46.58	103.14	45.68	31.8	9.33	30.25	238	71	P	V
			5718.8	59.15	-51.31	110.46	48.11	31.93	9.37	30.26	238	71	P	V
			5723	62.11	-55.53	117.64	51.06	31.93	9.38	30.26	238	71	P	V
		*	5775	106.85	-	-	95.54	32.13	9.47	30.29	238	71	P	V
		*	5775	99.06	-	-	87.75	32.13	9.47	30.29	238	71	A	V
			5852	64.09	-53.55	117.64	52.64	32.2	9.58	30.33	238	71	P	V
			5862.6	62.98	-45.69	108.67	51.5	32.23	9.59	30.34	238	71	P	V
			5880.2	57.37	-43.97	101.34	45.83	32.27	9.61	30.34	238	71	P	V
			5937.6	50.79	-17.41	68.2	39.12	32.37	9.68	30.38	238	71	P	V
														V
														V
	Remark	1. No other spurious found. 2. All results are PASS against Peak and Average limit line.												



**Band 4 5725~5850MHz
WIFI 802.11ac VHT80 (Harmonic @ 3m)**

WIFI Ant. 1+2	Note	Frequency (MHz)	Level (dBµV/m)	Over Limit (dB)	Limit Line (dBµV/m)	Read Level (dBµV)	Antenna Factor (dB/m)	Path Loss (dB)	Preamp Factor (dB)	Ant Pos (cm)	Table Pos (deg)	Peak Avg. (P/A)	Pol. (H/V)	
802.11ac VHT80 CH 155 5775MHz		11550	49.09	-24.91	74	56.05	40.05	13.95	60.96	100	0	P	H	
		17325	49.49	-18.71	68.2	49.81	41.07	18.02	59.41	100	0	P	H	
													H	
													H	
			11550	49.65	-24.35	74	56.61	40.05	13.95	60.96	100	0	P	V
			17325	49.76	-18.44	68.2	50.08	41.07	18.02	59.41	100	0	P	V
														V
														V
Remark	1. No other spurious found. 2. All results are PASS against Peak and Average limit line.													



Emission below 1GHz
5GHz WIFI 802.11a (LF @ 3m)

WIFI	Note	Frequency	Level	Over	Limit	Read	Antenna	Path	Preamp	Ant	Table	Peak	Pol.	
Ant.				Limit	Line	Level	Factor	Loss	Factor	Pos	Pos	Avg.		
1+2		(MHz)	(dBμV/m)	(dB)	(dBμV/m)	(dBμV)	(dB/m)	(dB)	(dB)	(cm)	(deg)	(P/A)	(H/V)	
5GHz 802.11a LF		82.92	25.96	-14.04	40	43.58	13.72	1.2	32.54			P	H	
		135.3	33.92	-9.58	43.5	47.52	17.43	1.47	32.5	100	0	P	H	
		269.49	24.63	-21.37	46	35.64	19.35	2.16	32.52			P	H	
		388.9	34.15	-11.85	46	42.84	21.41	2.45	32.55			P	H	
		513.5	35.31	-10.69	46	41.12	23.96	2.8	32.57			P	H	
		883.8	31.78	-14.22	46	30.85	28.96	3.71	31.74			P	H	
														H
														H
														H
														H
														H
														H
			69.42	34	-6	40	53.28	12.19	1.09	32.56	100	0	P	V
			133.95	30.09	-13.41	43.5	43.7	17.43	1.46	32.5			P	V
			267.33	24.94	-21.06	46	35.86	19.45	2.15	32.52			P	V
			421.1	26.72	-19.28	46	34.07	22.67	2.53	32.55			P	V
			514.2	28.23	-17.77	46	34.04	23.96	2.8	32.57			P	V
			920.2	32.16	-13.84	46	30.27	29.59	3.78	31.48			P	V
														V
														V
													V	
													V	
													V	
													V	
Remark	1. No other spurious found. 2. All results are PASS against limit line.													



<TXBF Mode>

Band 4 - 5725~5850MHz

WIFI 802.11ac VHT20 (Band Edge @ 3m)

WIFI Ant. 1+2	Note	Frequency (MHz)	Level (dBμV/m)	Over Limit (dB)	Limit Line (dBμV/m)	Read Level (dBμV)	Antenna Factor (dB/m)	Path Loss (dB)	Preamp Factor (dB)	Ant Pos (cm)	Table Pos (deg)	Peak Avg. (P/A)	Pol. (H/V)	
802.11ac VHT20 CH 149 5745MHz		5644.8	54.04	-14.16	68.2	43.3	31.73	9.23	30.22	100	24	P	H	
		5694.2	61.1	-39.82	100.92	50.23	31.8	9.32	30.25	100	24	P	H	
		5711	62.93	-45.35	108.28	51.96	31.87	9.36	30.26	100	24	P	H	
		5724.8	63.35	-58.39	121.74	52.3	31.93	9.38	30.26	100	24	P	H	
	*	5745	113.83	-	-	102.68	32	9.42	30.27	100	24	P	H	
	*	5745	99.65	-	-	88.5	32	9.42	30.27	100	24	A	H	
														H
														H
			5646	51.63	-16.57	68.2	40.88	31.73	9.24	30.22	100	71	P	V
			5699.2	58.5	-46.11	104.61	47.62	31.8	9.33	30.25	100	71	P	V
			5718.6	60.4	-50.01	110.41	49.36	31.93	9.37	30.26	100	71	P	V
			5724.2	60.25	-60.13	120.38	49.2	31.93	9.38	30.26	100	71	P	V
	*		5745	110.21	-	-	99.06	32	9.42	30.27	100	71	P	V
	*		5745	95.49	-	-	84.34	32	9.42	30.27	100	71	A	V
														V
														V



WIFI Ant. 1+2	Note	Frequency (MHz)	Level (dBμV/m)	Over Limit (dB)	Limit Line (dBμV/m)	Read Level (dBμV)	Antenna Factor (dB/m)	Path Loss (dB)	Preamp Factor (dB)	Ant Pos (cm)	Table Pos (deg)	Peak Avg. (P/A)	Pol. (H/V)	
802.11ac VHT20 CH 157 5785MHz		5613.6	51.41	-16.79	68.2	40.64	31.8	9.18	30.21	100	24	P	H	
		5698	53.13	-50.6	103.73	42.25	31.8	9.33	30.25	100	24	P	H	
		5716	55.87	-53.81	109.68	44.9	31.87	9.36	30.26	100	24	P	H	
		5724.2	57	-63.38	120.38	45.95	31.93	9.38	30.26	100	24	P	H	
	*	5785	113.75	-	-	102.43	32.13	9.49	30.3	100	24	P	H	
	*	5785	99.46	-	-	88.14	32.13	9.49	30.3	100	24	A	H	
		5853.2	58.58	-56.32	114.9	47.13	32.2	9.58	30.33	100	24	P	H	
		5869.2	55.1	-51.72	106.82	43.61	32.23	9.6	30.34	100	24	P	H	
		5896.2	53.81	-35.66	89.47	42.24	32.3	9.63	30.36	100	24	P	H	
		5928.6	52.09	-16.11	68.2	40.42	32.37	9.67	30.37	100	24	P	H	
														H
														H
			5613.2	51.26	-16.94	68.2	40.5	31.8	9.17	30.21	100	71	P	V
			5694.8	51.09	-50.28	101.37	40.21	31.8	9.33	30.25	100	71	P	V
			5717.4	54.68	-55.39	110.07	43.7	31.87	9.37	30.26	100	71	P	V
			5725	56.22	-65.98	122.2	45.17	31.93	9.38	30.26	100	71	P	V
	*		5785	110.28	-	-	98.96	32.13	9.49	30.3	100	71	P	V
	*		5785	95.9	-	-	84.58	32.13	9.49	30.3	100	71	A	V
			5851	59.14	-60.78	119.92	47.69	32.2	9.58	30.33	100	71	P	V
			5857.2	58.33	-51.85	110.18	46.84	32.23	9.59	30.33	100	71	P	V
		5875.8	55.06	-49.55	104.61	43.52	32.27	9.61	30.34	100	71	P	V	
		5944.4	51.84	-16.36	68.2	40.13	32.4	9.69	30.38	100	71	P	V	
													V	
													V	



WiFi Ant. 1+2	Note	Frequency (MHz)	Level (dBμV/m)	Over Limit (dB)	Limit Line (dBμV/m)	Read Level (dBμV)	Antenna Factor (dB/m)	Path Loss (dB)	Preamp Factor (dB)	Ant Pos (cm)	Table Pos (deg)	Peak Avg. (P/A)	Pol. (H/V)	
802.11ac VHT20 CH 165 5825MHz	*	5825	114.05	-	-	102.62	32.2	9.55	30.32	100	24	P	H	
	*	5825	99.46	-	-	88.03	32.2	9.55	30.32	100	24	A	H	
		5854	63.84	-49.24	113.08	52.36	32.23	9.58	30.33	100	24	P	H	
		5855.2	63.22	-47.52	110.74	51.74	32.23	9.58	30.33	100	24	P	H	
		5875.2	60.27	-44.78	105.05	48.73	32.27	9.61	30.34	100	24	P	H	
		5925.2	52.99	-15.21	68.2	41.33	32.37	9.66	30.37	100	24	P	H	
														H
														H
	*	5825	109.91	-	-	98.48	32.2	9.55	30.32	100	71	71	P	V
	*	5825	95.58	-	-	84.15	32.2	9.55	30.32	100	71	71	A	V
		5853.2	65.04	-49.86	114.9	53.59	32.2	9.58	30.33	100	71	71	P	V
		5856.6	64.77	-45.58	110.35	53.28	32.23	9.59	30.33	100	71	71	P	V
		5876.2	62.36	-41.95	104.31	50.82	32.27	9.61	30.34	100	71	71	P	V
		5930.4	52.21	-15.99	68.2	40.54	32.37	9.67	30.37	100	71	71	P	V
														V
														V
Remark	1. No other spurious found. 2. All results are PASS against Peak and Average limit line.													



Band 4 5725~5850MHz
WIFI 802.11ac VHT20 (Harmonic @ 3m)

WIFI Ant. 1+2	Note	Frequency (MHz)	Level (dBμV/m)	Over Limit (dB)	Limit Line (dBμV/m)	Read Level (dBμV)	Antenna Factor (dB/m)	Path Loss (dB)	Preamp Factor (dB)	Ant Pos (cm)	Table Pos (deg)	Peak Avg. (P/A)	Pol. (H/V)	
802.11ac VHT20 CH 149 5745MHz		11490	49.06	-24.94	74	55.99	40.17	13.92	61.02	100	0	P	H	
		17235	49.25	-18.95	68.2	50.19	40.7	17.88	59.52	100	0	P	H	
													H	
													H	
			11490	54.16	-19.84	74	61.09	40.17	13.92	61.02	369	359	P	V
			11490	41.65	-12.35	54	48.58	40.17	13.92	61.02	369	359	A	V
			17235	49.7	-18.5	68.2	50.64	40.7	17.88	59.52	100	0	P	V
													V	
802.11ac VHT20 CH 157 5785MHz		11570	53.42	-20.58	74	60.41	40	13.95	60.94	272	298	P	H	
		11570	42.6	-11.4	54	49.59	40	13.95	60.94	272	298	A	H	
		17355	49.55	-18.65	68.2	49.46	41.4	18.06	59.37	100	0	P	H	
													H	
			11570	49.7	-24.3	74	56.69	40	13.95	60.94	100	0	P	V
			17355	49.08	-19.12	68.2	48.99	41.4	18.06	59.37	100	0	P	V
														V
													V	
802.11ac VHT20 CH 165 5825MHz		11650	47.01	-26.99	74	54.25	39.66	13.98	60.88	100	0	P	H	
		17475	51.43	-16.77	68.2	50.04	42.43	18.19	59.23	100	0	P	H	
													H	
													H	
			11650	47.88	-26.12	74	55.12	39.66	13.98	60.88	100	0	P	V
			17475	49.7	-18.5	68.2	48.31	42.43	18.19	59.23	100	0	P	V
														V
													V	
Remark	1. No other spurious found. 2. All results are PASS against Peak and Average limit line.													



Band 4 5725~5850MHz
WIFI 802.11ac VHT40 (Band Edge @ 3m)

WIFI Ant. 1+2	Note	Frequency (MHz)	Level (dBμV/m)	Over Limit (dB)	Limit Line (dBμV/m)	Read Level (dBμV)	Antenna Factor (dB/m)	Path Loss (dB)	Preamp Factor (dB)	Ant Pos (cm)	Table Pos (deg)	Peak Avg. (P/A)	Pol. (H/V)	
		5621.2	51.95	-16.25	68.2	41.2	31.77	9.19	30.21	263	320	P	H	
		5700	62.05	-43.15	105.2	51.16	31.8	9.34	30.25	263	320	P	H	
		5716.4	72.95	-36.84	109.79	61.97	31.87	9.37	30.26	263	320	P	H	
		5724.8	75.49	-46.25	121.74	64.44	31.93	9.38	30.26	263	320	P	H	
	*	5755	113.51	-	-	102.27	32.07	9.44	30.27	263	320	P	H	
	*	5755	104.97	-	-	93.73	32.07	9.44	30.27	263	320	A	H	
		5851.6	55.49	-63.06	118.55	44.04	32.2	9.58	30.33	263	320	P	H	
		5869.8	55.17	-51.48	106.65	43.68	32.23	9.6	30.34	263	320	P	H	
		5876.2	53.96	-50.35	104.31	42.42	32.27	9.61	30.34	263	320	P	H	
		5940.8	51.37	-16.83	68.2	39.67	32.4	9.68	30.38	263	320	P	H	
802.11ac VHT40 CH 151 5755MHz													H	
													H	
			5649.6	54.54	-13.66	68.2	43.82	31.7	9.24	30.22	253	64	P	V
			5695.4	64.68	-37.13	101.81	53.8	31.8	9.33	30.25	253	64	P	V
			5718.6	68.37	-42.04	110.41	57.33	31.93	9.37	30.26	253	64	P	V
			5722.6	69.18	-47.55	116.73	58.13	31.93	9.38	30.26	253	64	P	V
		*	5755	109.58	-	-	98.34	32.07	9.44	30.27	253	64	P	V
		*	5755	100.74	-	-	89.5	32.07	9.44	30.27	253	64	A	V
			5850.2	52.72	-69.02	121.74	41.27	32.2	9.58	30.33	253	64	P	V
			5858	59.89	-50.07	109.96	48.41	32.23	9.59	30.34	253	64	P	V
			5876.4	54.1	-50.06	104.16	42.56	32.27	9.61	30.34	253	64	P	V
			5930	52.03	-16.17	68.2	40.36	32.37	9.67	30.37	253	64	P	V
														V
														V



WIFI Ant. 1+2	Note	Frequency (MHz)	Level (dBµV/m)	Over Limit (dB)	Limit Line (dBµV/m)	Read Level (dBµV)	Antenna Factor (dB/m)	Path Loss (dB)	Preamp Factor (dB)	Ant Pos (cm)	Table Pos (deg)	Peak Avg. (P/A)	Pol. (H/V)	
802.11ac VHT40 CH 159 5795MHz		5634.8	51.29	-16.91	68.2	40.57	31.73	9.21	30.22	100	33	P	H	
		5692.6	56.92	-42.82	99.74	46.05	31.8	9.32	30.25	100	33	P	H	
		5718.2	60.74	-49.56	110.3	49.7	31.93	9.37	30.26	100	33	P	H	
		5723.4	61.83	-56.72	118.55	50.78	31.93	9.38	30.26	100	33	P	H	
	*	5795	111.14	-	-	99.73	32.2	9.51	30.3	100	33	P	H	
	*	5795	101.58	-	-	90.17	32.2	9.51	30.3	100	33	A	H	
		5850	67.8	-54.4	122.2	56.35	32.2	9.58	30.33	100	33	P	H	
		5855.8	66.66	-43.92	110.58	55.18	32.23	9.58	30.33	100	33	P	H	
		5877	62.3	-41.41	103.71	50.76	32.27	9.61	30.34	100	33	P	H	
		5928.8	54.27	-13.93	68.2	42.6	32.37	9.67	30.37	100	33	P	H	
														H
														H
			5631.8	51.18	-17.02	68.2	40.42	31.77	9.21	30.22	100	67	P	V
			5673.8	51.04	-34.81	85.85	40.23	31.75	9.29	30.23	100	67	P	V
			5715.2	54.23	-55.23	109.46	43.26	31.87	9.36	30.26	100	67	P	V
			5724.6	54.39	-66.9	121.29	43.34	31.93	9.38	30.26	100	67	P	V
	*		5795	106.3	-	-	94.89	32.2	9.51	30.3	100	67	P	V
	*		5795	97.05	-	-	85.64	32.2	9.51	30.3	100	67	A	V
			5850.8	52.63	-67.75	120.38	41.18	32.2	9.58	30.33	100	67	P	V
			5859.2	54.88	-54.74	109.62	43.4	32.23	9.59	30.34	100	67	P	V
		5893.8	53.16	-38.09	91.25	41.59	32.3	9.63	30.36	100	67	P	V	
		5939.4	52.53	-15.67	68.2	40.83	32.4	9.68	30.38	100	67	P	V	
													V	
													V	
Remark	1. No other spurious found. 2. All results are PASS against Peak and Average limit line.													



**Band 4 5725~5850MHz
WIFI 802.11ac VHT40 (Harmonic @ 3m)**

WIFI Ant. 1+2	Note	Frequency (MHz)	Level (dBµV/m)	Over Limit (dB)	Limit Line (dBµV/m)	Read Level (dBµV)	Antenna Factor (dB/m)	Path Loss (dB)	Preamp Factor (dB)	Ant Pos (cm)	Table Pos (deg)	Peak Avg. (P/A)	Pol. (H/V)	
802.11ac VHT40 CH 151 5755MHz		11510	47.83	-26.17	74	54.69	40.2	13.93	60.99	100	0	P	H	
		17265	48.88	-19.32	68.2	49.63	40.8	17.93	59.48	100	0	P	H	
													H	
													H	
			11510	48.53	-25.47	74	55.39	40.2	13.93	60.99	100	0	P	V
			17265	48.55	-19.65	68.2	49.3	40.8	17.93	59.48	100	0	P	V
														V
802.11ac VHT40 CH 159 5795MHz		11590	49.25	-24.75	74	56.27	39.95	13.96	60.93	100	0	P	H	
		17385	50.11	-18.09	68.2	49.64	41.73	18.08	59.34	100	0	P	H	
													H	
													H	
			11590	47.15	-26.85	74	54.17	39.95	13.96	60.93	100	0	P	V
			17385	50.26	-17.94	68.2	49.79	41.73	18.08	59.34	100	0	P	V
														V
Remark	1. No other spurious found.													
	2. All results are PASS against Peak and Average limit line.													



Band 4 5725~5850MHz
WIFI 802.11ac VHT80 (Band Edge @ 3m)

WIFI Ant. 1+2	Note	Frequency (MHz)	Level (dBμV/m)	Over Limit (dB)	Limit Line (dBμV/m)	Read Level (dBμV)	Antenna Factor (dB/m)	Path Loss (dB)	Preamp Factor (dB)	Ant Pos (cm)	Table Pos (deg)	Peak Avg. (P/A)	Pol. (H/V)	
		5649.2	56.64	-11.56	68.2	45.89	31.73	9.24	30.22	257	321	P	H	
		5698	69.3	-34.43	103.73	58.42	31.8	9.33	30.25	257	321	P	H	
		5708.6	72.84	-34.77	107.61	61.88	31.87	9.35	30.26	257	321	P	H	
		5722.8	75.56	-41.63	117.19	64.51	31.93	9.38	30.26	257	321	P	H	
	*	5775	110.8	-	-	99.49	32.13	9.47	30.29	257	321	P	H	
	*	5775	101.57	-	-	90.26	32.13	9.47	30.29	257	321	A	H	
		5851.4	74.75	-44.26	119.01	63.3	32.2	9.58	30.33	257	321	P	H	
		5858.8	72.73	-37	109.73	61.25	32.23	9.59	30.34	257	321	P	H	
		5879	66.21	-36.02	102.23	54.67	32.27	9.61	30.34	257	321	P	H	
		5925.6	54.02	-14.18	68.2	42.36	32.37	9.66	30.37	257	321	P	H	
802.11ac VHT80 CH 155 5775MHz													H	
													H	
			5644	53.46	-14.74	68.2	42.72	31.73	9.23	30.22	252	63	P	V
			5699.8	64.47	-40.58	105.05	53.59	31.8	9.33	30.25	252	63	P	V
			5719	67.96	-42.56	110.52	56.92	31.93	9.37	30.26	252	63	P	V
			5721.4	68.22	-45.77	113.99	57.18	31.93	9.37	30.26	252	63	P	V
		*	5775	107.49	-	-	96.18	32.13	9.47	30.29	252	63	P	V
		*	5775	97.78	-	-	86.47	32.13	9.47	30.29	252	63	A	V
			5850	70.32	-51.88	122.2	58.87	32.2	9.58	30.33	252	63	P	V
			5860.2	68.89	-40.45	109.34	57.41	32.23	9.59	30.34	252	63	P	V
			5875.8	62.26	-42.35	104.61	50.72	32.27	9.61	30.34	252	63	P	V
			5935.2	51.99	-16.21	68.2	40.32	32.37	9.68	30.38	252	63	P	V
														V
														V
	Remark	1. No other spurious found. 2. All results are PASS against Peak and Average limit line.												



Band 4 5725~5850MHz
WIFI 802.11ac VHT80 (Harmonic @ 3m)

WIFI Ant. 1+2	Note	Frequency (MHz)	Level (dBμV/m)	Over Limit (dB)	Limit Line (dBμV/m)	Read Level (dBμV)	Antenna Factor (dB/m)	Path Loss (dB)	Preamp Factor (dB)	Ant Pos (cm)	Table Pos (deg)	Peak Avg. (P/A)	Pol. (H/V)	
802.11ac VHT80 CH 155 5775MHz		11550	48.11	-25.89	74	55.07	40.05	13.95	60.96	100	0	P	H	
		17325	50	-18.2	68.2	50.32	41.07	18.02	59.41	100	0	P	H	
													H	
													H	
			11550	49.74	-24.26	74	56.7	40.05	13.95	60.96	100	0	P	V
			17325	48.91	-19.29	68.2	49.23	41.07	18.02	59.41	100	0	P	V
														V
														V
Remark	1. No other spurious found. 2. All results are PASS against Peak and Average limit line.													



Emission below 1GHz

5GHz WIFI 802.11ac VHT80 (LF @ 3m)

WIFI	Note	Frequency	Level	Over	Limit	Read	Antenna	Path	Preamp	Ant	Table	Peak	Pol.	
Ant.				Limit	Line	Level	Factor	Loss	Factor	Pos	Pos	Avg.		
1+2		(MHz)	(dBμV/m)	(dB)	(dBμV/m)	(dBμV)	(dB/m)	(dB)	(dB)	(cm)	(deg)	(P/A)	(H/V)	
5GHz 802.11ac VHT80 LF		68.34	25.72	-14.28	40	45.11	12.1	1.07	32.56	-	-	P	H	
		135.84	35.3	-8.2	43.5	48.89	17.43	1.48	32.5	100	0	P	H	
		263.01	34.33	-11.67	46	45.03	19.7	2.12	32.52	-	-	P	H	
		367.2	28.38	-17.62	46	37.69	20.87	2.37	32.55	-	-	P	H	
		719.3	34.33	-11.67	46	36.32	27.1	3.27	32.36	-	-	P	H	
		896.4	36.72	-9.28	46	35.65	29.02	3.72	31.67	-	-	P	H	
														H
														H
														H
														H
														H
														H
														H
														H
														H
			68.07	33.92	-6.08	40	53.39	12.02	1.07	32.56	100	0	P	V
			134.76	28.59	-14.91	43.5	42.18	17.44	1.47	32.5	-	-	P	V
			262.2	29.99	-16.01	46	40.65	19.75	2.11	32.52	-	-	P	V
		399.4	28.56	-17.44	46	36.83	21.78	2.5	32.55	-	-	P	V	
		599.6	33.05	-12.95	46	37.04	25.55	3.06	32.6	-	-	P	V	
		895.7	37.84	-8.16	46	36.77	29.02	3.72	31.67	-	-	P	V	
													V	
													V	
													V	
													V	
													V	
													V	
Remark	1. No other spurious found. 2. All results are PASS against limit line.													



Note symbol

*	Fundamental Frequency which can be ignored. However, the level of any unwanted emissions shall not exceed the level of the fundamental frequency.
!	Test result is over limit line.
P/A	Peak or Average
H/V	Horizontal or Vertical



A calculation example for radiated spurious emission is shown as below:

WIFI	Note	Frequency	Level	Over	Limit	Read	Antenna	Path	Preamp	Ant	Table	Peak	Pol.
Ant.				Limit	Line	Level	Factor	Loss	Factor	Pos	Pos	Avg.	
1		(MHz)	(dBμV/m)	(dB)	(dBμV/m)	(dBμV)	(dB/m)	(dB)	(dB)	(cm)	(deg)	(P/A)	(H/V)
802.11b		2390	55.45	-18.55	74	54.51	32.22	4.58	35.86	103	308	P	H
CH 01													
2412MHz		2390	43.54	-10.46	54	42.6	32.22	4.58	35.86	103	308	A	H

1. Path Loss(dB) = Cable loss(dB) + Filter loss(dB) + Attenuator loss(dB)
2. Level(dBμV/m) = Antenna Factor(dB/m) + Path Loss(dB) + Read Level(dBμV) - Preamp Factor(dB)
3. Over Limit(dB) = Level(dBμV/m) – Limit Line(dBμV/m)

For Peak Limit @ 2390MHz:

1. Level(dBμV/m)
= Antenna Factor(dB/m) + Path Loss(dB) + Read Level(dBμV) - Preamp Factor(dB)
= 32.22(dB/m) + 4.58(dB) + 54.51(dBμV) – 35.86 (dB)
= 55.45 (dBμV/m)
2. Over Limit(dB)
= Level(dBμV/m) – Limit Line(dBμV/m)
= 55.45(dBμV/m) – 74(dBμV/m)
= -18.55(dB)

For Average Limit @ 2390MHz:

1. Level(dBμV/m)
= Antenna Factor(dB/m) + Path Loss(dB) + Read Level(dBμV) - Preamp Factor(dB)
= 32.22(dB/m) + 4.58(dB) + 42.6(dBμV) – 35.86 (dB)
= 43.54 (dBμV/m)
2. Over Limit(dB) = Level(dBμV/m) – Limit Line(dBμV/m)
= 43.54(dBμV/m) – 54(dBμV/m)
= -10.46(dB)

Both peak and average measured complies with the limit line, so test result is “PASS”.



Appendix C. Radiated Spurious Emission Plots

Test Engineer :	Watt Tseng, Karl Hou, and BigShow Wang	Temperature :	24~26°C
		Relative Humidity :	47~58%

Note symbol

-L	Low channel location
-R	High channel location

<CDD Mode>

Band 4 - 5725~5850MHz

WIFI 802.11a (Band Edge @ 3m)

WIFI	Band 4 5725~5850MHz Band Edge @ 3m	
ANT	802.11a CH149 5745MHz	
1	Horizontal	Fundamental
Peak	<p>Site : 03CH15-HY Condition : PEAK_BE(84)_16-24 3m 91200_15_1620 HORIZONTAL Detector : Peak Project : 8N0132-01 Mode : 11 Setting : 17</p>	<p>Site : 03CH15-HY Condition : PEAK(UNII) 3m 91200_15_1620 HORIZONTAL Detector : Peak Project : 8N0132-01 Mode : 11 Setting : 17</p>

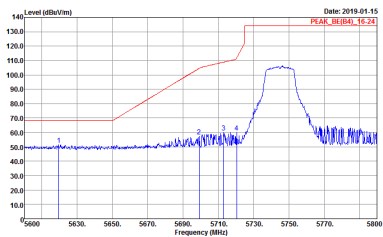
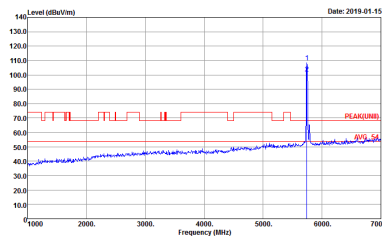

WIFI	Band 4 5725~5850MHz Band Edge @ 3m	
ANT	802.11a CH149 5745MHz	
1	Vertical	Fundamental
Peak	 <p>Date: 2019-01-15 PEAK_BE(B4)_16-24</p> <p>Site : 03CH15-14Y Condition : PEAK_BE(B4)_16-24 3m 91200_15_1620 VERTICAL RBW:1000.000KHz VBW:3000.000KHz SWT:Auto Detector : Peak Project : FR8N0132-01 Mode : 11 Setting : 17</p>	 <p>Date: 2019-01-15 PEAK(LINB) AVG-25</p> <p>Site : 03CH15-14Y Condition : PEAK(LINB) 3m 91200_15_1620 VERTICAL RBW:1000.000KHz VBW:3000.000KHz SWT:Auto Detector : Peak Project : FR8N0132-01 Mode : 11 Setting : 17</p>

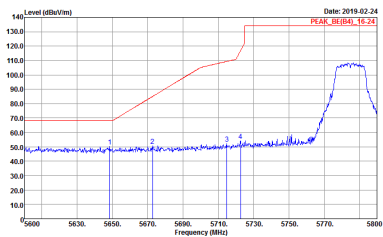
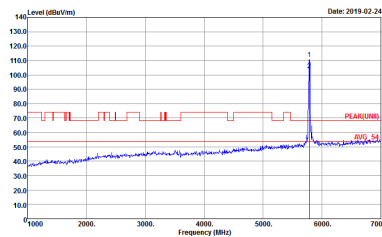
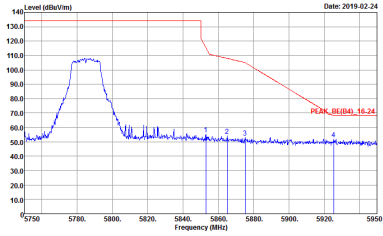

WIFI	Band 4 5725~5850MHz Band Edge @ 3m	
ANT	802.11a CH157 5785MHz	
1	Horizontal	Fundamental
<p>Peak</p>	 <p>Site : 03CH15-HY Condition : PEAK_BE(B4)_16-24 3m 91200_15_1620 HORIZONTAL Detector : Peak Project : 8N0132-01 Mode : 12</p>	 <p>Site : 03CH15-HY Condition : PEAK(LINII) 3m 91200_15_1620 HORIZONTAL Detector : Peak Project : 8N0132-01 Mode : 12</p>
<p>Peak</p>	 <p>Site : 03CH15-HY Condition : PEAK_BE(B4)_16-24 3m 91200_15_1620 HORIZONTAL Detector : Peak Project : 8N0132-01 Mode : 12</p>	<p>Left blank</p>



WIFI	Band 4 5725~5850MHz Band Edge @ 3m	
ANT	802.11a CH157 5785MHz	
1	Vertical	Fundamental
<p>Peak</p>	<p>Site : 03CH15-HY Condition : PEAK_BE(B4)_16-24 3m 91200_15_1620 VERTICAL Detector : Peak Project : 8N0132-01 Mode : 12</p>	<p>Site : 03CH15-HY Condition : PEAK(LINII) 3m 91200_15_1620 VERTICAL Detector : Peak Project : 8N0132-01 Mode : 12</p>
<p>Peak</p>	<p>Site : 03CH15-HY Condition : PEAK_BE(B4)_16-24 3m 91200_15_1620 VERTICAL Detector : Peak Project : 8N0132-01 Mode : 12</p>	<p>Left blank</p>



WIFI	Band 4 5725~5850MHz Band Edge @ 3m	
ANT	802.11a CH165 5825MHz	
1	Horizontal	Fundamental
Peak	<p>Site : 03CH15-11Y Condition : PEAK_BE(B4)_16-24 3m 91200_15_1620 HORIZONTAL Detector : Peak Project : FR8N0132-01 Mode : 13</p>	<p>Site : 03CH15-11Y Condition : PEAK(LINB) 3m 91200_15_1620 HORIZONTAL Detector : Peak Project : FR8N0132-01 Mode : 13</p>

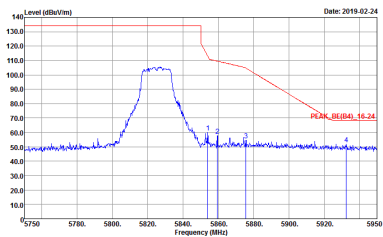
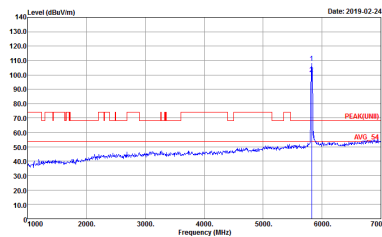

WIFI	Band 4 5725~5850MHz Band Edge @ 3m	
ANT	802.11a CH165 5825MHz	
1	Vertical	Fundamental
Peak	 <p>Site : 03CH15-11Y Condition : PEAK_BE(B4)_16-24 3m 91200_15_1620 VERTICAL Detector : Peak Project : FR8N0132-01 Mode : 13</p>	 <p>Site : 03CH15-11Y Condition : PEAK(LINII) 3m 91200_15_1620 VERTICAL Detector : Peak Project : FR8N0132-01 Mode : 13</p>



**Band 4 5725~5850MHz
WIFI 802.11n HT20 (Band Edge @ 3m)**

WIFI	Band 4 5725~5850MHz Band Edge @ 3m	
ANT	802.11n HT20 CH149 5745MHz	
1	Horizontal	Fundamental
Peak	<div style="display: flex; justify-content: space-around;"> <div style="width: 45%;"> <p>Site : 03CH15-HY Condition : PEAK_BE(84)_16-24 3m 91200_15_1620 HORIZONTAL Detector : Peak Project : 8N0132-01 Mode : 37 Setting : 17</p> </div> <div style="width: 45%;"> <p>Site : 03CH15-HY Condition : PEAK(UNIT) 3m 91200_15_1620 HORIZONTAL Detector : Peak Project : 8N0132-01 Mode : 37 Setting : 17</p> </div> </div>	

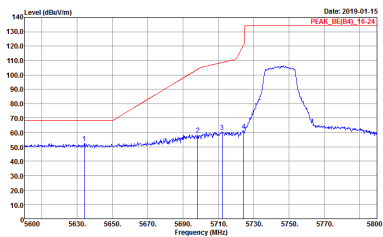
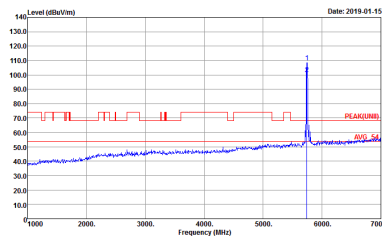

WIFI	Band 4 5725~5850MHz Band Edge @ 3m	
ANT	802.11n HT20 CH149 5745MHz	
1	Vertical	Fundamental
Peak	 <p>Date: 2019-01-15 PEAK_BE(B4)_16-24</p> <p>Site : 03CH15-11Y Condition : PEAK_BE(B4)_16-24 3m 91200_15_1620 VERTICAL : RBW:1000.000KHz VBW:3000.000KHz SWT:Auto Detector : Peak Project : FR8N0132-01 Mode : 37 Setting : 17</p>	 <p>Date: 2019-01-15 PEAK(LINB) AVG-25</p> <p>Site : 03CH15-11Y Condition : PEAK(LINB)_3m 91200_15_1620 VERTICAL : RBW:1000.000KHz VBW:3000.000KHz SWT:Auto Detector : Peak Project : FR8N0132-01 Mode : 37 Setting : 17</p>



WIFI	Band 4 5725~5850MHz Band Edge @ 3m	
ANT	802.11n HT20 CH157 5785MHz	
1	Horizontal	Fundamental
<p>Peak</p>	<p>Site : 03CH15-HY Condition : PEAK_BE(B4)_16-24 3m 91200_15_1620 HORIZONTAL Detector : Peak Project : BN0132-01 Mode : 3B</p>	<p>Site : 03CH15-HY Condition : PEAK(LINII) 3m 91200_15_1620 HORIZONTAL Detector : Peak Project : BN0132-01 Mode : 3B</p>
<p>Peak</p>	<p>Site : 03CH15-HY Condition : PEAK_BE(B4)_16-24 3m 91200_15_1620 HORIZONTAL Detector : Peak Project : BN0132-01 Mode : 3B</p>	<p>Left blank</p>

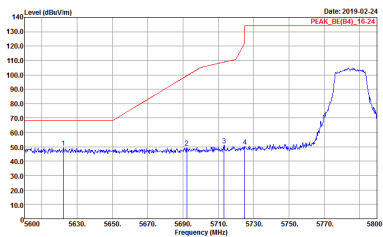
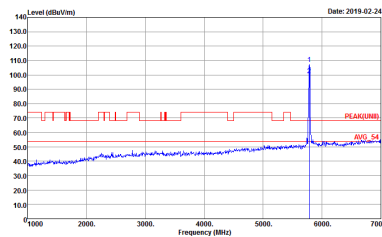
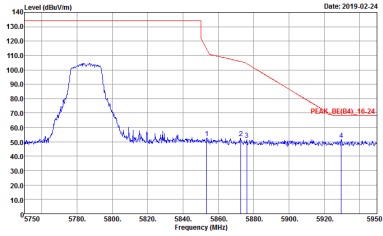

WIFI	Band 4 5725~5850MHz Band Edge @ 3m	
ANT	802.11n HT20 CH157 5785MHz	
1	Vertical	Fundamental
Peak	 <p>Date: 2019-02-24 PEAK_BE(B4)_16-24</p> <p>Site : 03CH15-HY Condition : PEAK_BE(B4)_16-24 3m 91200_15_1620 VERTICAL : RBW:1000.000KHz VBW:3000.000KHz SWT:Auto Detector : Peak Project : BN0132-01 Mode : 3B</p>	 <p>Date: 2019-02-24 PEAK(LNB) AVG 01</p> <p>Site : 03CH15-HY Condition : PEAK(LNB) 3m 91200_15_1620 VERTICAL : RBW:1000.000KHz VBW:3000.000KHz SWT:Auto Detector : Peak Project : BN0132-01 Mode : 3B</p>
Peak	 <p>Date: 2019-02-24 PEAK_BE(B4)_16-24</p> <p>Site : 03CH15-HY Condition : PEAK_BE(B4)_16-24 3m 91200_15_1620 VERTICAL : RBW:1000.000KHz VBW:3000.000KHz SWT:Auto Detector : Peak Project : BN0132-01 Mode : 3B</p>	Left blank



WIFI	Band 4 5725~5850MHz Band Edge @ 3m	
ANT	802.11n HT20 CH165 5825MHz	
1	Horizontal	Fundamental
Peak	<p>Site : 03CH15-11Y Condition : PEAK_BE(B4)_16-24 3m 91200_15_1620 HORIZONTAL Detector : Peak Project : 8N0132-01 Mode : 39</p>	<p>Site : 03CH15-11Y Condition : PEAK(LINII) 3m 91200_15_1620 HORIZONTAL Detector : Peak Project : 8N0132-01 Mode : 39</p>

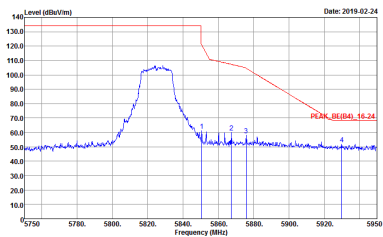
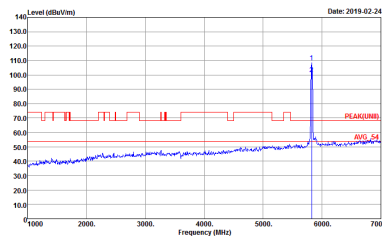

WIFI	Band 4 5725~5850MHz Band Edge @ 3m	
ANT	802.11n HT20 CH165 5825MHz	
1	Vertical	Fundamental
<p>Peak</p>	 <p>Site : 03CH15-11Y Condition : PEAK_BE(B4)_16-24 3m 91200_15_1620 VERTICAL Detector : Peak Project : 8N0132-01 Mode : 39</p>	 <p>Site : 03CH15-11Y Condition : PEAK(LINII) 3m 91200_15_1620 VERTICAL Detector : Peak Project : 8N0132-01 Mode : 39</p>



Band 4 5725~5850MHz
WIFI 802.11n HT40 (Band Edge @ 3m)

WIFI	Band 4 5725~5850MHz Band Edge @ 3m	
ANT	802.11n HT40 CH151 5755MHz	
1	Horizontal	Fundamental
Peak	<p>Site : 03CH15-HY Condition : PEAK_BE(B4)_16-24 3m 91200_15_1620 HORIZONTAL RBW:1000.000KHz VBW:3000.000KHz SWT:Auto Detector : Peak Project : 8N0132-01 Mode : 40 Setting : 16.5</p>	<p>Site : 03CH15-HY Condition : PEAK(UNIT) 3m 91200_15_1620 HORIZONTAL RBW:1000.000KHz VBW:3000.000KHz SWT:Auto Detector : Peak Project : 8N0132-01 Mode : 40 Setting : 16.5</p>
Peak	<p>Site : 03CH15-HY Condition : PEAK_BE(B4)_16-24 3m 91200_15_1620 HORIZONTAL RBW:1000.000KHz VBW:3000.000KHz SWT:Auto Detector : Peak Project : 8N0132-01 Mode : 40 Setting : 16.5</p>	Left blank

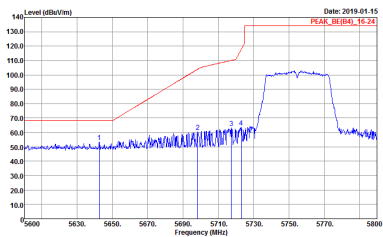
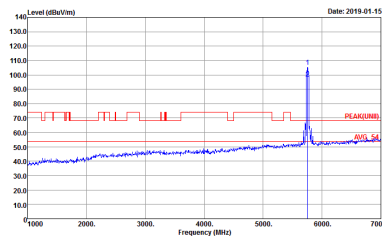
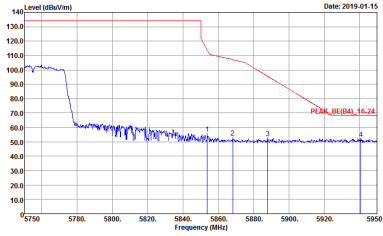

WIFI	Band 4 5725~5850MHz Band Edge @ 3m	
ANT	802.11n HT40 CH151 5755MHz	
1	Vertical	Fundamental
<p>Peak</p>	 <p>Site : 03CH15-HY Condition : PEAK_BE(B4)_16-24 3m 91200_15_1620 VERTICAL Detector : Peak Project : 8N0132-01 Mode : 40 Setting : 16.5</p>	 <p>Site : 03CH15-HY Condition : PEAK(LINII) 3m 91200_15_1620 VERTICAL Detector : Peak Project : 8N0132-01 Mode : 40 Setting : 16.5</p>
<p>Peak</p>	 <p>Site : 03CH15-HY Condition : PEAK_BE(B4)_16-24 3m 91200_15_1620 VERTICAL Detector : Peak Project : 8N0132-01 Mode : 40 Setting : 16.5</p>	<p>Left blank</p>



WIFI	Band 4 5725~5850MHz Band Edge @ 3m	
ANT	802.11n HT40 CH159 5795MHz	
1	Horizontal	Fundamental
<p>Peak</p>	<p>Date: 2019-01-15 PEAK_BE(B4)_16-24</p> <p>Site : 03CH15-HY Condition : PEAK_BE(B4)_16-24 3m 91200_15_1620 HORIZONTAL RBW:1000.000KHz VBW:3000.000KHz SWT:Auto Detector : Peak Project : 8N0132-01 Mode : 41 Setting : 16.5</p>	<p>Date: 2019-01-15 PEAK(B4)_16-24</p> <p>Site : 03CH15-HY Condition : PEAK(LINII) 3m 91200_15_1620 HORIZONTAL RBW:1000.000KHz VBW:3000.000KHz SWT:Auto Detector : Peak Project : 8N0132-01 Mode : 41 Setting : 16.5</p>
<p>Peak</p>	<p>Date: 2019-01-15 PEAK_BE(B4)_16-24</p> <p>Site : 03CH15-HY Condition : PEAK_BE(B4)_16-24 3m 91200_15_1620 HORIZONTAL RBW:1000.000KHz VBW:3000.000KHz SWT:Auto Detector : Peak Project : 8N0132-01 Mode : 41 Setting : 16.5</p>	<p>Left blank</p>

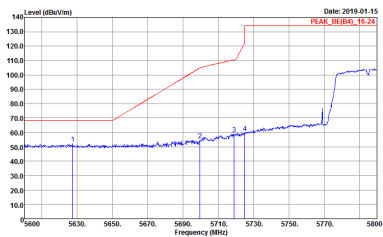
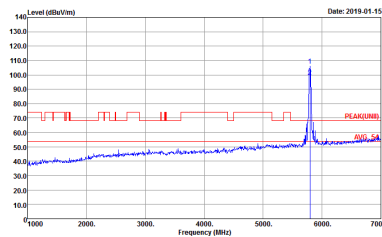
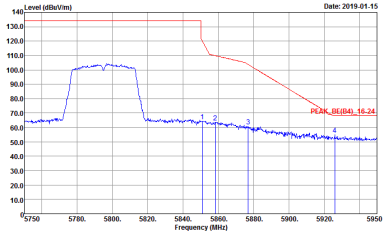

WIFI	Band 4 5725~5850MHz Band Edge @ 3m	
ANT	802.11n HT40 CH159 5795MHz	
1	Vertical	Fundamental
<p>Peak</p>	 <p>Site : 03CH15-HY Condition : PEAK_BE(84)_16-24 3m 91200_15_1620 VERTICAL RBW:1000.000KHz VBW:3000.000KHz SWT:Auto Detector : Peak Project : 8N0132-01 Mode : 41 Setting : 16.5</p>	 <p>Site : 03CH15-HY Condition : PEAK(LINII) 3m 91200_15_1620 VERTICAL RBW:1000.000KHz VBW:3000.000KHz SWT:Auto Detector : Peak Project : 8N0132-01 Mode : 41 Setting : 16.5</p>
<p>Peak</p>	 <p>Site : 03CH15-HY Condition : PEAK_BE(84)_16-24 3m 91200_15_1620 VERTICAL RBW:1000.000KHz VBW:3000.000KHz SWT:Auto Detector : Peak Project : 8N0132-01 Mode : 41 Setting : 16.5</p>	<p>Left blank</p>



Band 4 5725~5850MHz
WIFI 802.11ac VHT80 (Band Edge @ 3m)

WIFI	Band 4 5725~5850MHz Band Edge @ 3m	
ANT	802.11ac VHT80 CH155 5775MHz	
1	Horizontal	Fundamental
Peak	<p>Site : 03CH15-HY Condition : PEAK_BE(B4)_16-24 3m 91200_15_1620 HORIZONTAL RBW:1000.000KHz VBW:3000.000KHz SWT:Auto Detector : Peak Project : 8N0132-01 Mode : 42 Setting : 16.5</p>	<p>Site : 03CH15-HY Condition : PEAK(UNIT) 3m 91200_15_1620 HORIZONTAL RBW:1000.000KHz VBW:3000.000KHz SWT:Auto Detector : Peak Project : 8N0132-01 Mode : 42 Setting : 16.5</p>
Peak	<p>Site : 03CH15-HY Condition : PEAK_BE(B4)_16-24 3m 91200_15_1620 HORIZONTAL RBW:1000.000KHz VBW:3000.000KHz SWT:Auto Detector : Peak Project : 8N0132-01 Mode : 42 Setting : 16.5</p>	Left blank



WIFI	Band 4 5725~5850MHz Band Edge @ 3m	
ANT	802.11ac VHT80 CH155 5775MHz	
1	Vertical	Fundamental
<p>Peak</p>		
<p>Peak</p>		<p>Left blank</p>



Band 4 - 5725~5850MHz

WIFI 802.11a (Harmonic @ 3m)

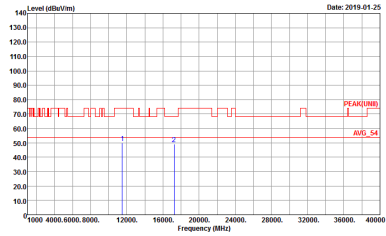
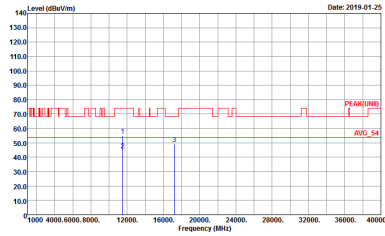
WIFI	Band 4 5725~5850MHz Harmonic @ 3m	
ANT	802.11a CH149 5745MHz	
1	Horizontal	Vertical
<p>Peak</p> <p>Avg.</p>	 <p>Site : 03CH15-HY Condition : PEAR(LINET) 3m 91200_15_1620 HORIZONTAL Detector : Peak Project : BN0132-01 Mode : 11</p>	 <p>Site : 03CH15-HY Condition : PEAR(LINET) 3m 91200_15_1620 VERTICAL Detector : Peak Project : BN0132-01 Mode : 11</p>

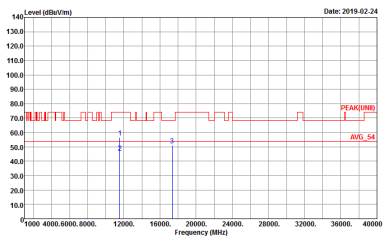
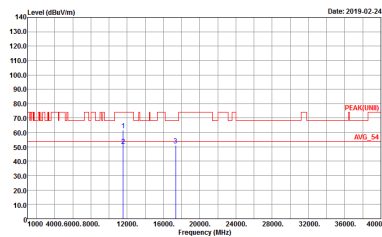

WIFI	Band 4 5725~5850MHz Harmonic @ 3m	
ANT	802.11a CH157 5785MHz	
1	Horizontal	Vertical
<p>Peak</p> <p>Avg.</p>	 <p>Site : 03CH15-11Y Condition : PEAK(LINE) 3m 9120D_15_1620 HORIZONTAL Detector : Peak Project : 8N0132-01 Mode : 12 Setting : 16.5</p>	 <p>Site : 03CH15-11Y Condition : PEAK(LINE) 3m 9120D_15_1620 VERTICAL Detector : Peak Project : 8N0132-01 Mode : 12 Setting : 16.5</p>



WIFI	Band 4 5725~5850MHz Harmonic @ 3m	
ANT	802.11a CH165 5825MHz	
1	Horizontal	Vertical
Peak Avg.	<p>Site : 03CH15-11Y Condition : PEAK(LINEI) 3m 9120D_15_1620 HORIZONTAL Detector : Peak Project : 8N0132-01 Mode : 15 Setting : 17.5</p>	<p>Site : 03CH15-11Y Condition : PEAK(LINEI) 3m 9120D_15_1620 VERTICAL Detector : Peak Project : 8N0132-01 Mode : 15 Setting : 17.5</p>



**Band 4 5725~5850MHz
WIFI 802.11n HT20 (Harmonic @ 3m)**

WIFI	Band 4 5725~5850MHz Harmonic @ 3m	
ANT	802.11n HT20 CH149 5745MHz	
1	Horizontal	Vertical
Peak Avg.	<p> Site : 03CH15-HY Condition : PEAK(LINII) 3m 91200_15_1620 HORIZONTAL Detector : Peak Project : 8N0132-01 Mode : 37 </p>	<p> Site : 03CH15-HY Condition : PEAK(LINII) 3m 91200_15_1620 VERTICAL Detector : Peak Project : 8N0132-01 Mode : 37 </p>

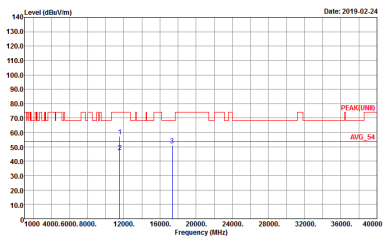
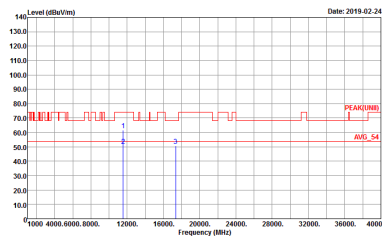

WIFI	Band 4 5725~5850MHz Harmonic @ 3m	
ANT	802.11n HT20 CH157 5785MHz	
1	Horizontal	Vertical
<p>Peak</p> <p>Avg.</p>	 <p>Site : 03CH15-11Y Condition : PEAK(LINE) 3m 9120D_15_1620 HORIZONTAL Detector : Peak Project : 8N0132-01 Mode : 38 Setting : 17</p>	 <p>Site : 03CH15-11Y Condition : PEAK(LINE) 3m 9120D_15_1620 VERTICAL Detector : Peak Project : 8N0132-01 Mode : 38 Setting : 17</p>

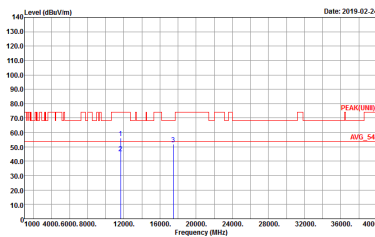
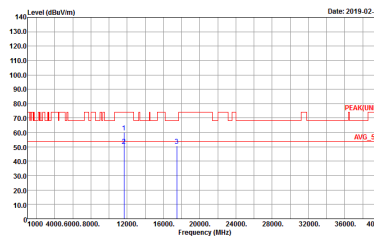

WIFI	Band 4 5725~5850MHz Harmonic @ 3m	
ANT	802.11n HT20 CH165 5825MHz	
1	Horizontal	Vertical
<p>Peak</p> <p>Avg.</p>	 <p>Site : 03CH15-11Y Condition : PEAK(LINEI) 3m 9120D_15_1620 HORIZONTAL Detector : Peak Project : 8N0132-01 Mode : 39 Setting : 18</p>	 <p>Site : 03CH15-11Y Condition : PEAK(LINEI) 3m 9120D_15_1620 VERTICAL Detector : Peak Project : 8N0132-01 Mode : 39 Setting : 18</p>



**Band 4 5725~5850MHz
WIFI 802.11n HT40 (Harmonic @ 3m)**

WIFI	Band 4 5725~5850MHz Harmonic @ 3m	
ANT	802.11n HT40 CH151 5755MHz	
1	Horizontal	Vertical
Peak Avg.	<p> Site : 03CH15-HY Condition : PEAK(LINII) 3m 91200_15_1620 HORIZONTAL Detector : Peak Project : 8N0132-01 Mode : 40 </p>	<p> Site : 03CH15-HY Condition : PEAK(LINII) 3m 91200_15_1620 VERTICAL Detector : Peak Project : 8N0132-01 Mode : 40 </p>



WIFI	Band 4 5725~5850MHz Harmonic @ 3m	
ANT	802.11n HT40 CH159 5795MHz	
1	Horizontal	Vertical
Peak Avg.	<p>Site : 03CH15-11Y Condition : PEAK(LINE1) 3m 91200_15_1620 HORIZONTAL Detector : Peak Project : 8N0132-01 Mode : -41</p>	<p>Site : 03CH15-11Y Condition : PEAK(LINE1) 3m 91200_15_1620 VERTICAL Detector : Peak Project : 8N0132-01 Mode : -41</p>



**Band 4 5725~5850MHz
WIFI 802.11ac VHT80 (Harmonic @ 3m)**

WIFI	Band 4 5725~5850MHz Harmonic @ 3m	
ANT	802.11ac VHT80 CH155 5775MHz	
1	Horizontal	Vertical
Peak Avg.		



Emission below 1GHz
5GHz WIFI 802.11n HT20 (LF)

WIFI	5GHz 5725-5850MHz	
ANT	802.11n HT20 LF	
1	Horizontal	Vertical
QP / Peak	<p>Site : 03CH15-HY Condition : QP 3m B1LOG_16_47020 HORIZONTAL Detector : Peak Project : 8N0132-01 Mode : 157</p>	<p>Site : 03CH15-HY Condition : QP 3m B1LOG_16_47020 VERTICAL Detector : Peak Project : 8N0132-01 Mode : 157</p>



Band 4 - 5725~5850MHz
WIFI 802.11a (Band Edge @ 3m)

WIFI	Band 4 5725~5850MHz Band Edge @ 3m	
ANT	802.11a CH149 5745MHz	
2	Horizontal	Fundamental
Peak	<p> Date: 2019-01-15 PEAK_RE (64, 16.24) </p> <p> Site : 09CH15-HY Condition : PEAK_RE(64)_16-24 3m 91200_15_1620 HORIZONTAL RBW:1000.000KHz VBW:3000.000KHz SWT:Auto Detector : Peak Project : 8N0132-01 Mode : 53 </p>	<p> Date: 2019-01-15 PEAK_LINB AVG_54 </p> <p> Site : 09CH15-HY Condition : PEAK(LINE) 3m 91200_15_1620 HORIZONTAL RBW:1000.000KHz VBW:3000.000KHz SWT:Auto Detector : Peak Project : 8N0132-01 Mode : 53 </p>

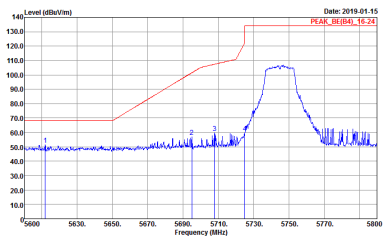
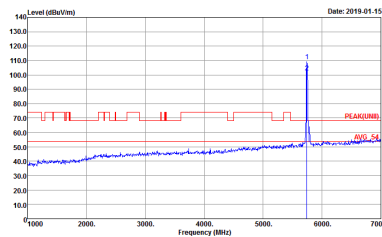

WIFI	Band 4 5725~5850MHz Band Edge @ 3m	
ANT	802.11a CH149 5745MHz	
2	Vertical	Fundamental
Peak	 <p>Date: 2019-01-15 PEAK_BE(B4)_16-24</p> <p>Site : 03CH15-14Y Condition : PEAK_BE(B4)_16-24 3m 91200_15_1620 VERTICAL RBW:1000.000KHz VBW:3000.000KHz SWT:Auto Detector : Peak Project : FR8N0132-01 Mode : 53</p>	 <p>Date: 2019-01-15 PEAK(LINB) AVG-24</p> <p>Site : 03CH15-14Y Condition : PEAK(LINB)_3m 91200_15_1620 VERTICAL RBW:1000.000KHz VBW:3000.000KHz SWT:Auto Detector : Peak Project : FR8N0132-01 Mode : 53</p>

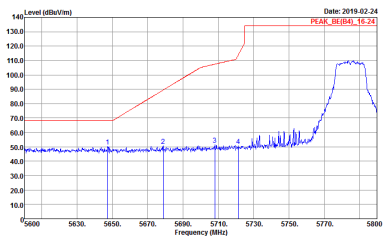
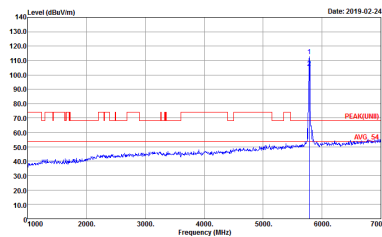
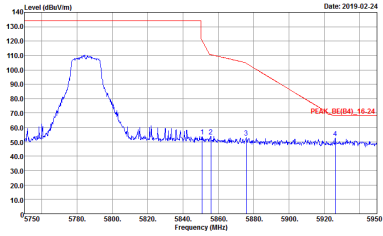

WIFI	Band 4 5725~5850MHz Band Edge @ 3m	
ANT	802.11a CH157 5785MHz	
2	Horizontal	Fundamental
<p>Peak</p>	 <p>Site : 03CH15-HY Condition : PEAK_BE(B4)_16-24 3m 91200_15_1620 HORIZONTAL Detector : Peak Project : BN0132-01 Mode : 54</p>	 <p>Site : 03CH15-HY Condition : PEAK(LINII) 3m 91200_15_1620 HORIZONTAL Detector : Peak Project : BN0132-01 Mode : 54</p>
<p>Peak</p>	 <p>Site : 03CH15-HY Condition : PEAK_BE(B4)_16-24 3m 91200_15_1620 HORIZONTAL Detector : Peak Project : BN0132-01 Mode : 54</p>	<p>Left blank</p>

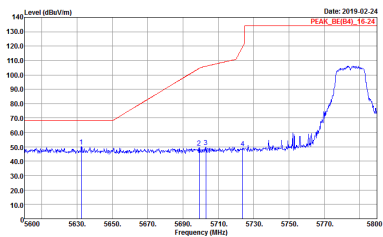
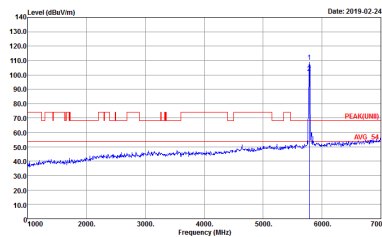
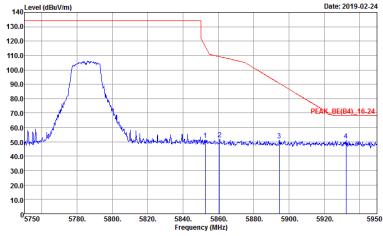

WIFI	Band 4 5725~5850MHz Band Edge @ 3m	
ANT	802.11a CH157 5785MHz	
2	Vertical	Fundamental
Peak	 <p>Site : 03CH15-HY Condition : PEAK_BE(B4)_16-24 3m 91200_15_1620 VERTICAL Detector : Peak Project : BN0132-01 Mode : 54</p>	 <p>Site : 03CH15-HY Condition : PEAK(LINII) 3m 91200_15_1620 VERTICAL Detector : Peak Project : BN0132-01 Mode : 54</p>
Peak	 <p>Site : 03CH15-HY Condition : PEAK_BE(B4)_16-24 3m 91200_15_1620 VERTICAL Detector : Peak Project : BN0132-01 Mode : 54</p>	Left blank

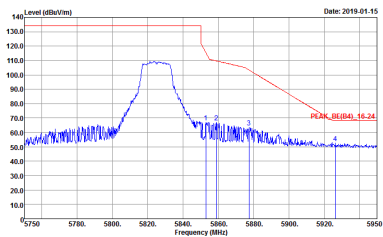
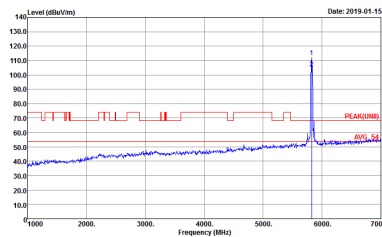

WIFI	Band 4 5725~5850MHz Band Edge @ 3m	
ANT	802.11a CH165 5825MHz	
2	Horizontal	Fundamental
Peak	 <p>Date: 2019-01-15</p> <p>Site : 03CH15-11Y Condition : PEAK_BE(B4)_16-24 3m 91200_15_1620 HORIZONTAL Detector : Peak Project : FR8N0132-01 Mode : 55</p>	 <p>Date: 2019-01-15</p> <p>Site : 03CH15-11Y Condition : PEAK(LINII) 3m 91200_15_1620 HORIZONTAL Detector : Peak Project : FR8N0132-01 Mode : 55</p>

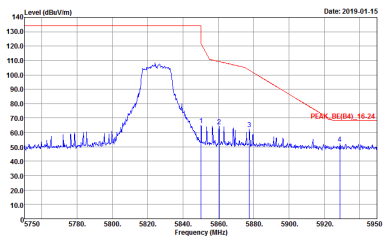
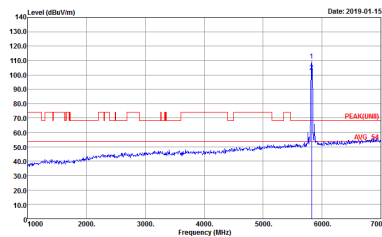

WIFI	Band 4 5725~5850MHz Band Edge @ 3m	
ANT	802.11a CH165 5825MHz	
2	Vertical	Fundamental
Peak	 <p>Site : 03CH15-11Y Condition : PEAK_BE(B4)_16-24 3m 91200_15_1620 VERTICAL Detector : Peak Project : FR8N0132-01 Mode : 55</p>	 <p>Site : 03CH15-11Y Condition : PEAK(UNII) 3m 91200_15_1620 VERTICAL Detector : Peak Project : FR8N0132-01 Mode : 55</p>



Band 4 5725~5850MHz
WIFI 802.11n HT20 (Band Edge @ 3m)

WIFI	Band 4 5725~5850MHz Band Edge @ 3m	
ANT	802.11n HT20 CH149 5745MHz	
2	Horizontal	Fundamental
Peak	<div style="display: flex; justify-content: space-around;"> <div style="width: 45%;"> <p>Site : 03CH15-HY Condition : PEAK_BE(84)_16-24 3m 91200_15_1620 HORIZONTAL Detector : Peak Project : 8N0132-01 Mode : 79</p> </div> <div style="width: 45%;"> <p>Site : 03CH15-HY Condition : PEAK(UNIT) 3m 91200_15_1620 HORIZONTAL Detector : Peak Project : 8N0132-01 Mode : 79</p> </div> </div>	

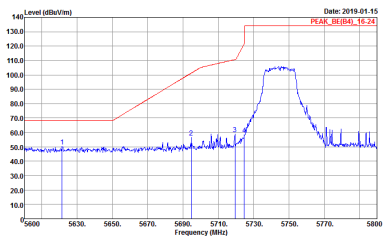
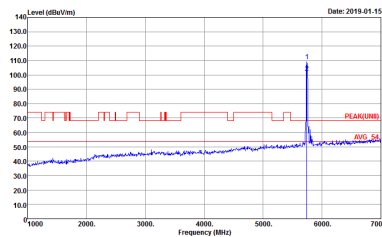

WIFI	Band 4 5725~5850MHz Band Edge @ 3m	
ANT	802.11n HT20 CH149 5745MHz	
2	Vertical	Fundamental
Peak	 <p>Site : 03CH15-11Y Condition : PEAK_BE(B4)_16-24 3m 91200_15_1620 VERTICAL Detector : Peak Project : FR8N0132-01 Mode : 79</p>	 <p>Site : 03CH15-11Y Condition : PEAK(LINII) 3m 91200_15_1620 VERTICAL Detector : Peak Project : FR8N0132-01 Mode : 79</p>

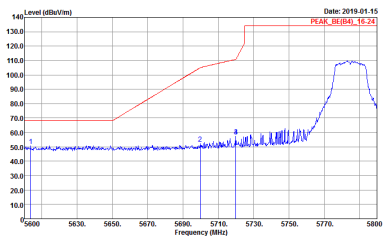
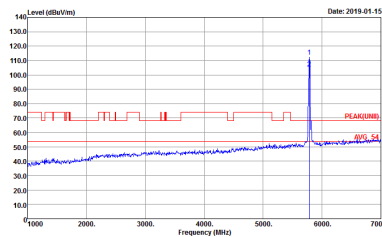
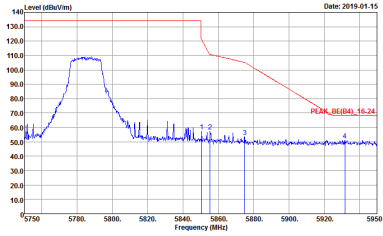

WIFI	Band 4 5725~5850MHz Band Edge @ 3m	
ANT	802.11n HT20 CH157 5785MHz	
2	Horizontal	Fundamental
Peak	 <p>Date: 2019-01-15 PEAK_BE(B4)_16-24</p> <p>Site : 03CH15-HY Condition : PEAK_BE(B4)_16-24 3m 91200_15_1620 HORIZONTAL : RBW:1000.000KHz VBW:3000.000KHz SWT:Auto Detector : Peak Project : BN0132-01 Mode : 80</p>	 <p>Date: 2019-01-15 PEAK(B4)_16-24</p> <p>Site : 03CH15-HY Condition : PEAK(LUNII) 3m 91200_15_1620 HORIZONTAL : RBW:1000.000KHz VBW:3000.000KHz SWT:Auto Detector : Peak Project : BN0132-01 Mode : 80</p>
Peak	 <p>Date: 2019-01-15 PEAK_BE(B4)_16-24</p> <p>Site : 03CH15-HY Condition : PEAK_BE(B4)_16-24 3m 91200_15_1620 HORIZONTAL : RBW:1000.000KHz VBW:3000.000KHz SWT:Auto Detector : Peak Project : BN0132-01 Mode : 80</p>	Left blank



WIFI	Band 4 5725~5850MHz Band Edge @ 3m	
ANT	802.11n HT20 CH157 5785MHz	
2	Vertical	Fundamental
<p>Peak</p>	<p>Site : 03CH15-HY Condition : PEAK_BE(B4)_16-24 3m 91200_15_1620 VERTICAL Detector : Peak Project : BN0132-01 Mode : 80</p>	<p>Site : 03CH15-HY Condition : PEAK(LINII) 3m 91200_15_1620 VERTICAL Detector : Peak Project : BN0132-01 Mode : 80</p>
<p>Peak</p>	<p>Site : 03CH15-HY Condition : PEAK_BE(B4)_16-24 3m 91200_15_1620 VERTICAL Detector : Peak Project : BN0132-01 Mode : 80</p>	<p>Left blank</p>

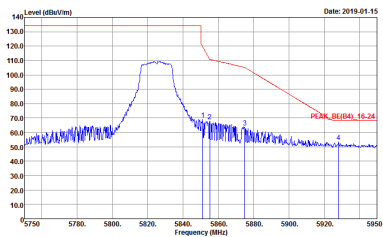
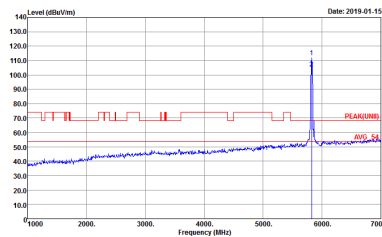

WIFI	Band 4 5725~5850MHz Band Edge @ 3m	
ANT	802.11n HT20 CH165 5825MHz	
2	Horizontal	Fundamental
Peak	 <p>Date: 2019-01-15</p> <p>Site : 03CH15-11Y Condition : PEAK_BE(B4)_16-24 3m 91200_15_1620 HORIZONTAL Detector : Peak Project : SN0132-01 Mode : 81</p>	 <p>Date: 2019-01-15</p> <p>Site : 03CH15-11Y Condition : PEAK(LINII) 3m 91200_15_1620 HORIZONTAL Detector : Peak Project : SN0132-01 Mode : 81</p>

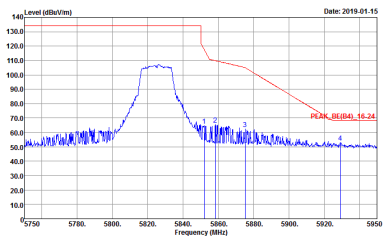
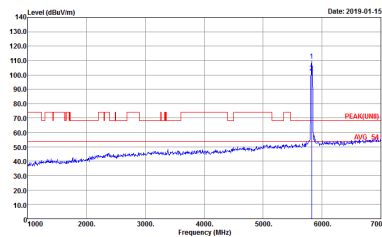

WIFI	Band 4 5725~5850MHz Band Edge @ 3m	
ANT	802.11n HT20 CH165 5825MHz	
2	Vertical	Fundamental
Peak	 <p>Site : 03CH15-11Y Condition : PEAK_BE(B4)_16-24 3m 91200_15_1620 VERTICAL Detector : Peak Project : FR8N0132-01 Mode : B1</p>	 <p>Site : 03CH15-11Y Condition : PEAK(UNII) 3m 91200_15_1620 VERTICAL Detector : Peak Project : FR8N0132-01 Mode : B1</p>



Band 4 5725~5850MHz
WIFI 802.11n HT40 (Band Edge @ 3m)

WIFI	Band 4 5725~5850MHz Band Edge @ 3m	
ANT	802.11n HT40 CH151 5755MHz	
2	Horizontal	Fundamental
Peak	<p>Site : 03CH15-HY Condition : PEAK_BE(B4)_16-24 3m 91200_15_1620 HORIZONTAL RBW:1000.000KHz VBW:3000.000KHz SWT:Auto Detector : Peak Project : 8N0132-01 Mode : 82</p>	<p>Site : 03CH15-HY Condition : PEAK(UNIT) 3m 91200_15_1620 HORIZONTAL RBW:1000.000KHz VBW:3000.000KHz SWT:Auto Detector : Peak Project : 8N0132-01 Mode : 82</p>
Peak	<p>Site : 03CH15-HY Condition : PEAK_BE(B4)_16-24 3m 91200_15_1620 HORIZONTAL RBW:1000.000KHz VBW:3000.000KHz SWT:Auto Detector : Peak Project : 8N0132-01 Mode : 82</p>	Left blank



WIFI	Band 4 5725~5850MHz Band Edge @ 3m	
ANT	802.11n HT40 CH151 5755MHz	
2	Vertical	Fundamental
<p>Peak</p>	<p>Date: 2019-01-15 PEAK_BE(B4)_16-24</p> <p>Site : 03CH15-HY Condition : PEAK_BE(B4)_16-24 3m 91200_15_1620 VERTICAL RBW:1000.000KHz VBW:3000.000KHz SWT:Auto Detector : Peak Project : BN0132-01 Mode : B2</p>	<p>Date: 2019-01-15 PEAK(B4)_16-24</p> <p>Site : 03CH15-HY Condition : PEAK(LUNII) 3m 91200_15_1620 VERTICAL RBW:1000.000KHz VBW:3000.000KHz SWT:Auto Detector : Peak Project : BN0132-01 Mode : B2</p>
<p>Peak</p>	<p>Date: 2019-01-15 PEAK_BE(B4)_16-24</p> <p>Site : 03CH15-HY Condition : PEAK_BE(B4)_16-24 3m 91200_15_1620 VERTICAL RBW:1000.000KHz VBW:3000.000KHz SWT:Auto Detector : Peak Project : BN0132-01 Mode : B2</p>	<p>Left blank</p>

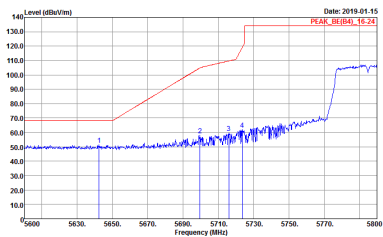
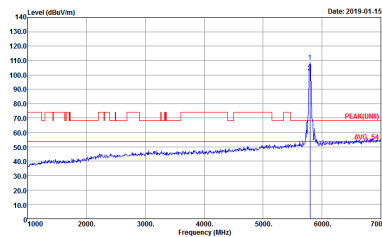
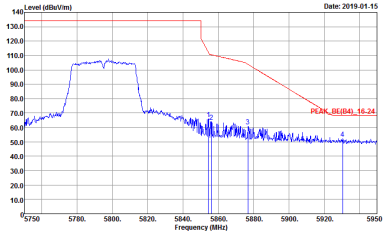

WIFI	Band 4 5725~5850MHz Band Edge @ 3m	
ANT	802.11n HT40 CH159 5795MHz	
2	Horizontal	Fundamental
<p>Peak</p>	 <p>Site : 03CH15-HY Condition : PEAK_BE(84)_16-24 3m 91200_15_1620 HORIZONTAL Detector : Peak Project : BN0132-01 Mode : 83</p>	 <p>Site : 03CH15-HY Condition : PEAK(LINII) 3m 91200_15_1620 HORIZONTAL Detector : Peak Project : BN0132-01 Mode : 83</p>
<p>Peak</p>	 <p>Site : 03CH15-HY Condition : PEAK_BE(84)_16-24 3m 91200_15_1620 HORIZONTAL Detector : Peak Project : BN0132-01 Mode : 83</p>	<p>Left blank</p>



WIFI	Band 4 5725~5850MHz Band Edge @ 3m	
ANT	802.11n HT40 CH159 5795MHz	
2	Vertical	Fundamental
<p>Peak</p>	<p>Site : 03CH15-HY Condition : PEAK_BE(B4)_16-24 3m 91200_15_1620 VERTICAL Detector : Peak Project : BN0132-01 Mode : 83</p>	<p>Site : 03CH15-HY Condition : PEAK(LINII) 3m 91200_15_1620 VERTICAL Detector : Peak Project : BN0132-01 Mode : 83</p>
<p>Peak</p>	<p>Site : 03CH15-HY Condition : PEAK_BE(B4)_16-24 3m 91200_15_1620 VERTICAL Detector : Peak Project : BN0132-01 Mode : 83</p>	<p>Left blank</p>



Band 4 5725~5850MHz
WIFI 802.11ac VHT80 (Band Edge @ 3m)

WIFI	Band 4 5725~5850MHz Band Edge @ 3m	
ANT	802.11ac VHT80 CH155 5775MHz	
2	Horizontal	Fundamental
<p>Peak</p>	<p>Site : 03CH15-HY Condition : PEAK_BE(B4)_16-24 3m 91200_15_1620 HORIZONTAL RBW:1000.000KHz VBW:3000.000KHz SWT:Auto Detector : Peak Project : 8N0132-01 Mode : 84</p>	<p>Site : 03CH15-HY Condition : PEAK(UNIT) 3m 91200_15_1620 HORIZONTAL RBW:1000.000KHz VBW:3000.000KHz SWT:Auto Detector : Peak Project : 8N0132-01 Mode : 84</p>
<p>Peak</p>	<p>Site : 03CH15-HY Condition : PEAK_BE(B4)_16-24 3m 91200_15_1620 HORIZONTAL RBW:1000.000KHz VBW:3000.000KHz SWT:Auto Detector : Peak Project : 8N0132-01 Mode : 84</p>	<p align="center">Left blank</p>

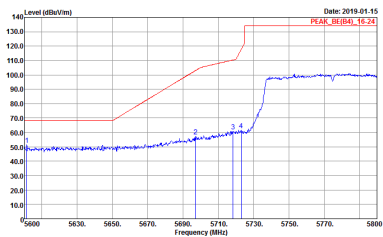
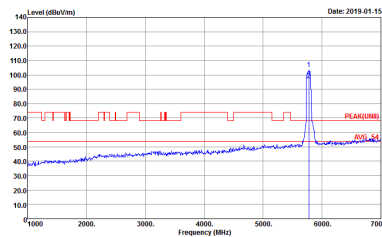
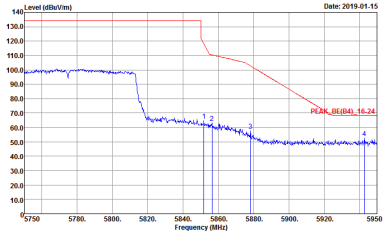

WIFI	Band 4 5725~5850MHz Band Edge @ 3m	
ANT	802.11ac VHT80 CH155 5775MHz	
2	Vertical	Fundamental
<p>Peak</p>	 <p>Site : 03CH15-HY Condition : PEAK_BE(B4)_16-24 3m 91200_15_1620 VERTICAL Detector : Peak Project : BN0132-01 Mode : B4</p>	 <p>Site : 03CH15-HY Condition : PEAK(LINII) 3m 91200_15_1620 VERTICAL Detector : Peak Project : BN0132-01 Mode : B4</p>
<p>Peak</p>	 <p>Site : 03CH15-HY Condition : PEAK_BE(B4)_16-24 3m 91200_15_1620 VERTICAL Detector : Peak Project : BN0132-01 Mode : B4</p>	<p>Left blank</p>



Band 4 - 5725~5850MHz

WIFI 802.11a (Harmonic @ 3m)

WIFI	Band 4 5725~5850MHz Harmonic @ 3m	
ANT	802.11a CH149 5745MHz	
2	Horizontal	Vertical
Peak Avg.	<p>Site : 03CH15-HY Condition : PEAR(LINE1) 3m 91200_15_1620 HORIZONTAL Detector : Peak Project : BN0132-01 Mode : S3</p>	<p>Site : 03CH15-HY Condition : PEAR(LINE1) 3m 91200_15_1620 VERTICAL Detector : Peak Project : BN0132-01 Mode : S3</p>

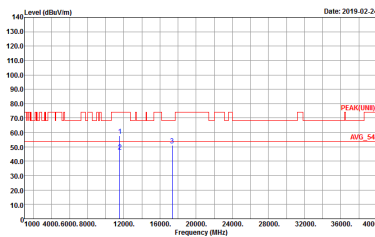
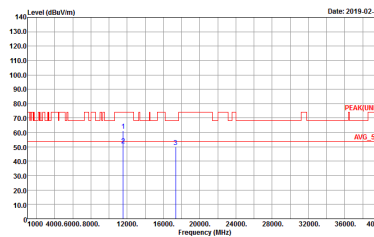

WIFI	Band 4 5725~5850MHz Harmonic @ 3m	
ANT	802.11a CH157 5785MHz	
2	Horizontal	Vertical
<p>Peak</p> <p>Avg.</p>	 <p>Site : 03CH15-11Y Condition : PEAK(LINE) 3m 9120D_15_1620 HORIZONTAL Detector : Peak Project : BN0132-01 Mode : 54 Setting : 18</p>	 <p>Site : 03CH15-11Y Condition : PEAK(LINE) 3m 9120D_15_1620 VERTICAL Detector : Peak Project : BN0132-01 Mode : 54 Setting : 18</p>



WIFI	Band 4 5725~5850MHz Harmonic @ 3m	
ANT	802.11a CH165 5825MHz	
2	Horizontal	Vertical
Peak Avg.	<p>Site : 03CHES-11Y Condition : PEAK(LINEI) 3m 9120D_15_1620 HORIZONTAL Detector : Peak Project : 8N0132-01 Mode : 55</p>	<p>Site : 03CHES-11Y Condition : PEAK(LINEI) 3m 9120D_15_1620 VERTICAL Detector : Peak Project : 8N0132-01 Mode : 55</p>



Band 4 5725~5850MHz
WIFI 802.11n HT20 (Harmonic @ 3m)

Table with 3 columns: WIFI, ANT, and test results for Horizontal and Vertical orientations. Includes spectral plots and metadata like Site, Condition, and Project.

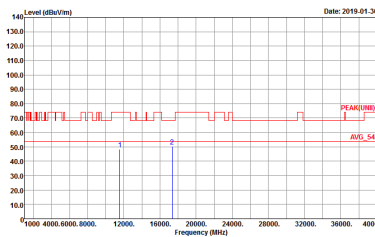
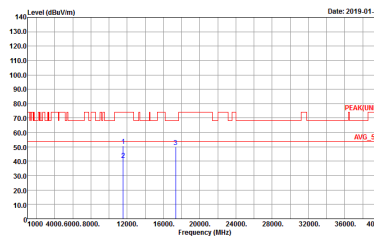

WIFI	Band 4 5725~5850MHz Harmonic @ 3m	
ANT	802.11n HT20 CH157 5785MHz	
2	Horizontal	Vertical
<p>Peak</p> <p>Avg.</p>	 <p>Site : 03CH15-11Y Condition : PEAK(LINEI) 3m 9120D_15_1620 HORIZONTAL Detector : Peak Project : 8N0132-01 Mode : 80</p>	 <p>Site : 03CH15-11Y Condition : PEAK(LINEI) 3m 9120D_15_1620 VERTICAL Detector : Peak Project : 8N0132-01 Mode : 80</p>

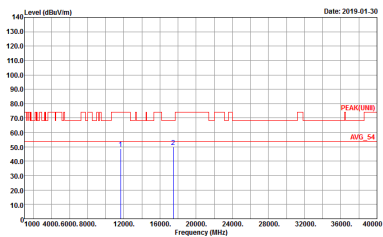
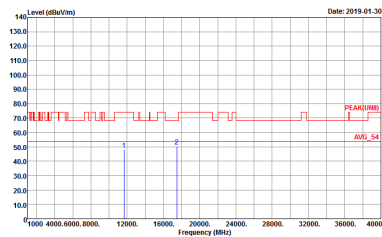

WIFI	Band 4 5725~5850MHz Harmonic @ 3m	
ANT	802.11n HT20 CH165 5825MHz	
2	Horizontal	Vertical
<p>Peak</p> <p>Avg.</p>	 <p>Site : 03CH15-11Y Condition : PEAK(LINE1) 3m 9120D_15_1620 HORIZONTAL Detector : Peak Project : 8N0132-01 Mode : 81</p>	 <p>Site : 03CH15-11Y Condition : PEAK(LINE1) 3m 9120D_15_1620 VERTICAL Detector : Peak Project : 8N0132-01 Mode : 81</p>



Band 4 5725~5850MHz
WIFI 802.11n HT40 (Harmonic @ 3m)

WIFI	Band 4 5725~5850MHz Harmonic @ 3m	
ANT	802.11n HT40 CH151 5755MHz	
2	Horizontal	Vertical
Peak Avg.	<p>Site : 03CH15-HY Condition : PEAK(LINII) 3m 91200_15_1620 HORIZONTAL Detector : Peak Project : 8N0132-01 Mode : 82</p>	<p>Site : 03CH15-HY Condition : PEAK(LINII) 3m 91200_15_1620 VERTICAL Detector : Peak Project : 8N0132-01 Mode : 82</p>

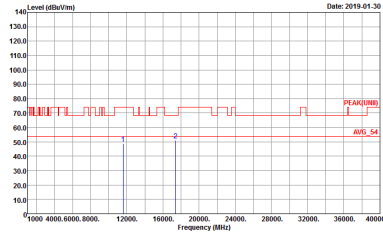
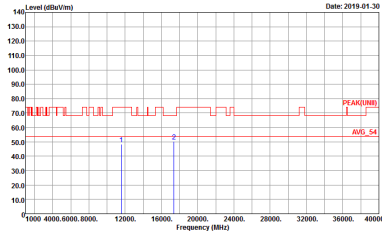

WIFI	Band 4 5725~5850MHz Harmonic @ 3m	
ANT	802.11n HT40 CH159 5795MHz	
2	Horizontal	Vertical
<p>Peak</p> <p>Avg.</p>	 <p>Site : 03CH15-11Y Condition : PEAK(LINE1) 3m 91200_15_1620 HORIZONTAL Detector : Peak Project : 8N0132-01 Mode : 83</p>	 <p>Site : 03CH15-11Y Condition : PEAK(LINE1) 3m 91200_15_1620 VERTICAL Detector : Peak Project : 8N0132-01 Mode : 83</p>

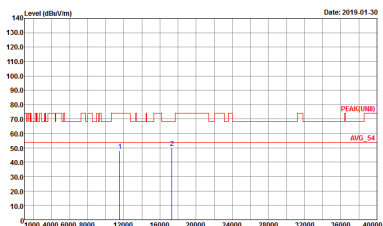
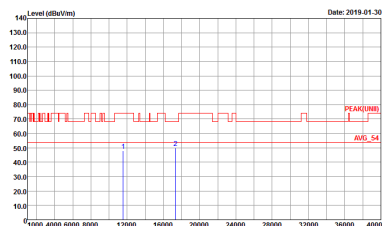

**Band 4 5725~5850MHz
WIFI 802.11ac VHT80 (Harmonic @ 3m)**

WIFI	Band 4 5725~5850MHz Harmonic @ 3m	
ANT	802.11ac VHT80 CH155 5775MHz	
2	Horizontal	Vertical
<p>Peak Avg.</p>	 <p>Site : 03CH15-HY Condition : PEAK(LINII) 3m 91200_15_1620 HORIZONTAL Detector : Peak Project : 8N0132-01 Mode : 84</p>	 <p>Site : 03CH15-HY Condition : PEAK(LINII) 3m 91200_15_1620 VERTICAL Detector : Peak Project : 8N0132-01 Mode : 84</p>



Emission below 1GHz

5GHz WIFI 802.11a (LF)

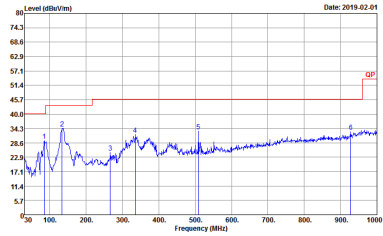
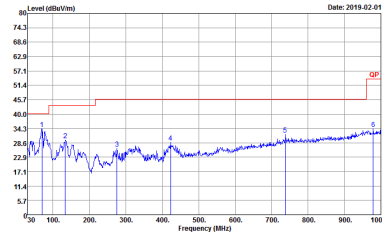
WIFI	5GHz 5725~5850MHz	
ANT	802.11a LF	
2	Horizontal	Vertical
QP / Peak	 <p>Site : 03CH15-HY Condition : QP 3m B1LOG_16_47020 HORIZONTAL Detector : Peak Project : 8N0132-01 Mode : 159</p>	 <p>Site : 03CH15-HY Condition : QP 3m B1LOG_16_47020 VERTICAL Detector : Peak Project : 8N0132-01 Mode : 159</p>



Band 4 - 5725~5850MHz
WIFI 802.11a (Band Edge @ 3m)

WIFI	Band 4 5725~5850MHz Band Edge @ 3m	
ANT	802.11a CH149 5745MHz	
1+2	Horizontal	Fundamental
Peak	<p>Site : 09CH15-HY Condition : PEAK_REF(84)_16-24 3m 91200_15_1620 HORIZONTAL RBW:1000.000KHz VBW:3000.000KHz SWT:Auto Detector : Peak Project : 8N0132-01 Mode : 147</p>	<p>Site : 09CH15-HY Condition : PEAK(LINE) 3m 91200_15_1620 HORIZONTAL RBW:1000.000KHz VBW:3000.000KHz SWT:Auto Detector : Peak Project : 8N0132-01 Mode : 147</p>

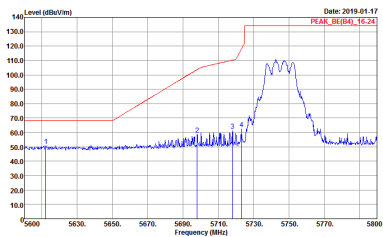
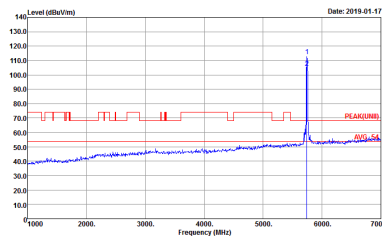

WIFI	Band 4 5725~5850MHz Band Edge @ 3m	
ANT	802.11a CH149 5745MHz	
1+2	Vertical	Fundamental
Peak	 <p>Site : 03CH15-14Y Condition : PEAK_BE(B4)_16-24 3m 91200_15_1620 VERTICAL Detector : Peak Project : 8N0132-01 Mode : 147</p>	 <p>Site : 03CH15-14Y Condition : PEAK(LINII) 3m 91200_15_1620 VERTICAL Detector : Peak Project : 8N0132-01 Mode : 147</p>



WIFI	Band 4 5725~5850MHz Band Edge @ 3m	
ANT	802.11a CH157 5785MHz	
1+2	Horizontal	Fundamental
<p>Peak</p>	<p>Date: 2019-01-18 PEAK_BE(B4)_16-24</p> <p>Site : 03CH15-HY Condition : PEAK_BE(B4)_16-24 3m 91200_15_1620 HORIZONTAL RBW:1000.000KHz VBW:3000.000KHz SWT:Auto Detector : Peak Project : BN0132-01 Mode : 14B</p>	<p>Date: 2019-01-18 PEAK(B4)_16-24</p> <p>Site : 03CH15-HY Condition : PEAK(LUNII) 3m 91200_15_1620 HORIZONTAL RBW:1000.000KHz VBW:3000.000KHz SWT:Auto Detector : Peak Project : BN0132-01 Mode : 14B</p>
<p>Peak</p>	<p>Date: 2019-01-18 PEAK_BE(B4)_16-24</p> <p>Site : 03CH15-HY Condition : PEAK_BE(B4)_16-24 3m 91200_15_1620 HORIZONTAL RBW:1000.000KHz VBW:3000.000KHz SWT:Auto Detector : Peak Project : BN0132-01 Mode : 14B</p>	<p>Left blank</p>

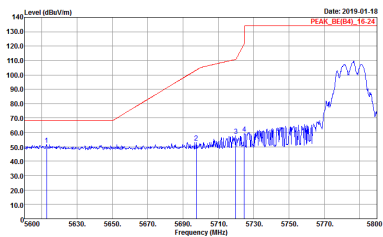
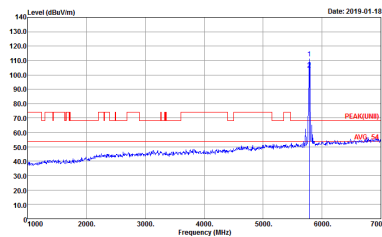
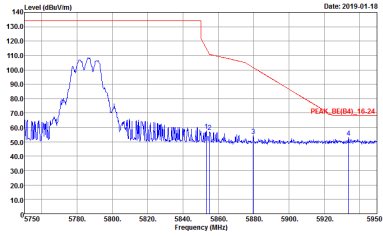

WIFI	Band 4 5725~5850MHz Band Edge @ 3m	
ANT	802.11a CH157 5785MHz	
1+2	Vertical	Fundamental
<p>Peak</p>	 <p>Date: 2019-01-18 PEAK_BE(B4)_16-24</p> <p>Site : 03CH15-HY Condition : PEAK_BE(B4)_16-24 3m 91200_15_1620 VERTICAL : RBW:1000.000KHz VBW:3000.000KHz SWT:Auto Detector : Peak Project : 8N0132-01 Mode : 14B</p>	 <p>Date: 2019-01-18 PEAK(B4)_16-24</p> <p>Site : 03CH15-HY Condition : PEAK(LUNII) 3m 91200_15_1620 VERTICAL : RBW:1000.000KHz VBW:3000.000KHz SWT:Auto Detector : Peak Project : 8N0132-01 Mode : 14B</p>
<p>Peak</p>	 <p>Date: 2019-01-18 PEAK_BE(B4)_16-24</p> <p>Site : 03CH15-HY Condition : PEAK_BE(B4)_16-24 3m 91200_15_1620 VERTICAL : RBW:1000.000KHz VBW:3000.000KHz SWT:Auto Detector : Peak Project : 8N0132-01 Mode : 14B</p>	<p>Left blank</p>

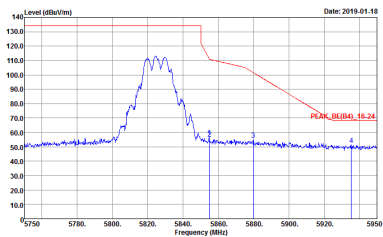
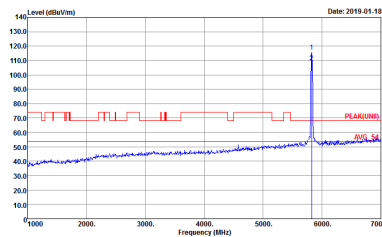

WIFI	Band 4 5725~5850MHz Band Edge @ 3m	
ANT	802.11a CH165 5825MHz	
1+2	Horizontal	Fundamental
Peak	 <p>Date: 2019-01-18</p> <p>Site : 03CH15-14Y Condition : PEAK_BE(B4)_16-24 3m 91200_15_1620 HORIZONTAL Detector : Peak Project : FR8N0132-01 Mode : 149</p>	 <p>Date: 2019-01-18</p> <p>Site : 03CH15-14Y Condition : PEAK(LINII) 3m 91200_15_1620 HORIZONTAL Detector : Peak Project : FR8N0132-01 Mode : 149</p>

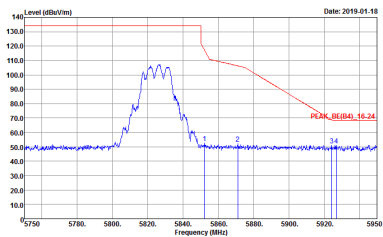
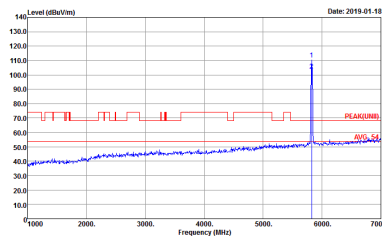

WIFI	Band 4 5725~5850MHz Band Edge @ 3m	
ANT	802.11a CH165 5825MHz	
1+2	Vertical	Fundamental
Peak	 <p>Date: 2019-01-18</p> <p>Site : 03CH15-14Y Condition : PEAK_BE(B4)_16-24 3m 91200_15_1620 VERTICAL Detector : Peak Project : 8N0132-01 Mode : 149</p>	 <p>Date: 2019-01-18</p> <p>Site : 03CH15-14Y Condition : PEAK(UNII) 3m 91200_15_1620 VERTICAL Detector : Peak Project : 8N0132-01 Mode : 149</p>



Band 4 5725~5850MHz
WIFI 802.11n HT20 (Band Edge @ 3m)

WIFI	Band 4 5725~5850MHz Band Edge @ 3m	
ANT	802.11n HT20 CH149 5745MHz	
1+2	Horizontal	Fundamental
Peak	<p>Site : 03CH15-HY Condition : PEAK_BE(84)_16-24 3m 91200_15_1620 HORIZONTAL Detector : RBW:1000.000KHz VBW:3000.000KHz SWT:Auto Project : 8N0132-01 Mode : 150</p>	<p>Site : 03CH15-HY Condition : PEAK(UNIT) 3m 91200_15_1620 HORIZONTAL Detector : RBW:1000.000KHz VBW:3000.000KHz SWT:Auto Project : 8N0132-01 Mode : 150</p>

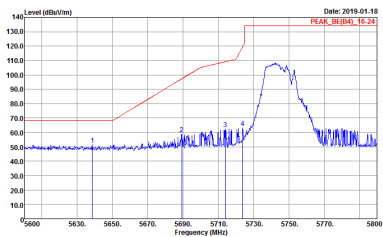
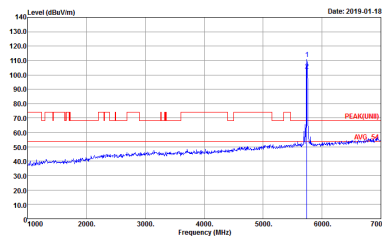

WIFI	Band 4 5725~5850MHz Band Edge @ 3m	
ANT	802.11n HT20 CH149 5745MHz	
1+2	Vertical	Fundamental
Peak	 <p>Date: 2019-01-18 PEAK_BE(B4)_16-24</p> <p>Site : 03CH15-14Y Condition : PEAK_BE(B4)_16-24 3m 91200_15_1620 VERTICAL RBW:1000.000KHz VBW:3000.000KHz SWT:Auto Detector : Peak Project : 8N0132-01 Mode : 150</p>	 <p>Date: 2019-01-18 PEAK(FUNB) 805-24</p> <p>Site : 03CH15-14Y Condition : PEAK(FUNB)_16-24 3m 91200_15_1620 VERTICAL RBW:1000.000KHz VBW:3000.000KHz SWT:Auto Detector : Peak Project : 8N0132-01 Mode : 150</p>

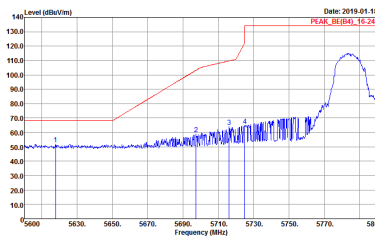
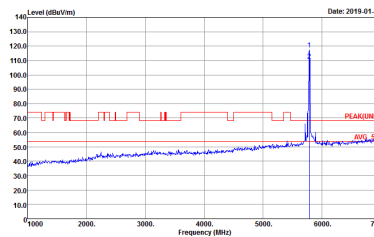
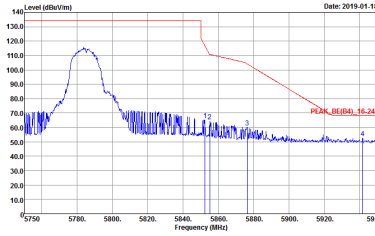

WIFI	Band 4 5725~5850MHz Band Edge @ 3m	
ANT	802.11n HT20 CH157 5785MHz	
1+2	Horizontal	Fundamental
<p>Peak</p>	 <p>Date: 2019-01-18 PEAK_BE(B4)_16-24</p> <p>Site : 03CH15-HY Condition : PEAK_BE(B4)_16-24 3m 91200_15_1620 HORIZONTAL : RBW:1000.000KHz VBW:3000.000KHz SWT:Auto Detector : Peak Project : 8N0132-01 Mode : 151</p>	 <p>Date: 2019-01-18 PEAK(B4)_16-24</p> <p>Site : 03CH15-HY Condition : PEAK(LUNII) 3m 91200_15_1620 HORIZONTAL : RBW:1000.000KHz VBW:3000.000KHz SWT:Auto Detector : Peak Project : 8N0132-01 Mode : 151</p>
<p>Peak</p>	 <p>Date: 2019-01-18 PEAK_BE(B4)_16-24</p> <p>Site : 03CH15-HY Condition : PEAK_BE(B4)_16-24 3m 91200_15_1620 HORIZONTAL : RBW:1000.000KHz VBW:3000.000KHz SWT:Auto Detector : Peak Project : 8N0132-01 Mode : 151</p>	<p>Left blank</p>



WIFI	Band 4 5725~5850MHz Band Edge @ 3m	
ANT	802.11n HT20 CH157 5785MHz	
1+2	Vertical	Fundamental
<p>Peak</p>	<p>Site : 03CH15-HY Condition : PEAK_BE(B4)_16-24 3m 91200_15_1620 VERTICAL Detector : Peak Project : 8N0132-01 Mode : 151</p>	<p>Site : 03CH15-HY Condition : PEAK(LINII) 3m 91200_15_1620 VERTICAL Detector : Peak Project : 8N0132-01 Mode : 151</p>
<p>Peak</p>	<p>Site : 03CH15-HY Condition : PEAK_BE(B4)_16-24 3m 91200_15_1620 VERTICAL Detector : Peak Project : 8N0132-01 Mode : 151</p>	<p>Left blank</p>

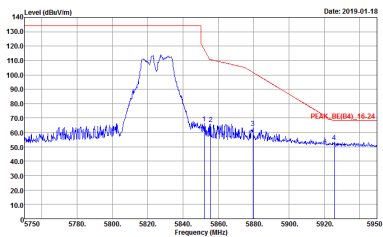
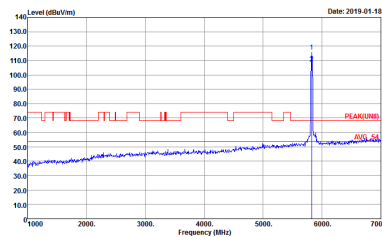

WIFI	Band 4 5725~5850MHz Band Edge @ 3m	
ANT	802.11n HT20 CH165 5825MHz	
1+2	Horizontal	Fundamental
Peak	 <p>Site : 03CH15-11Y Condition : PEAK_BE(B4)_16-24 3m 91200_15_1620 HORIZONTAL Detector : Peak Project : FR8N0132-01 Mode : 152</p>	 <p>Site : 03CH15-11Y Condition : PEAK(LINII) 3m 91200_15_1620 HORIZONTAL Detector : Peak Project : FR8N0132-01 Mode : 152</p>

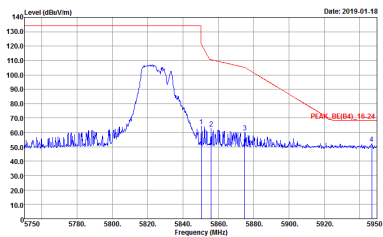
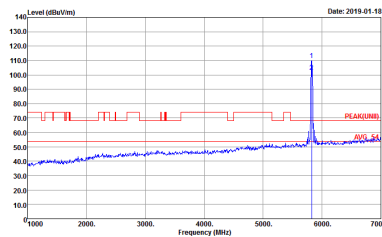

WIFI	Band 4 5725~5850MHz Band Edge @ 3m	
ANT	802.11n HT20 CH165 5825MHz	
1+2	Vertical	Fundamental
Peak	 <p>Site : 03CH15-11Y Condition : PEAK_BE(B4)_16-24 3m 91200_15_1620 VERTICAL Detector : Peak Project : FR8N0132-01 Mode : 152</p>	 <p>Site : 03CH15-11Y Condition : PEAK(FUNB) 3m 91200_15_1620 VERTICAL Detector : Peak Project : FR8N0132-01 Mode : 152</p>



Band 4 5725~5850MHz
WIFI 802.11n HT40 (Band Edge @ 3m)

WIFI	Band 4 5725~5850MHz Band Edge @ 3m	
ANT	802.11n HT40 CH151 5755MHz	
1+2	Horizontal	Fundamental
Peak	<p>Site : 03CH15-HY Condition : PEAK_BE(B4)_16-24 3m 91200_15_1620 HORIZONTAL RBW:1000.000KHz VBW:3000.000KHz SWT:Auto Detector : Peak Project : 8N0132-01 Mode : 153</p>	<p>Site : 03CH15-HY Condition : PEAK(UNIT) 3m 91200_15_1620 HORIZONTAL RBW:1000.000KHz VBW:3000.000KHz SWT:Auto Detector : Peak Project : 8N0132-01 Mode : 153</p>
Peak	<p>Site : 03CH15-HY Condition : PEAK_BE(B4)_16-24 3m 91200_15_1620 HORIZONTAL RBW:1000.000KHz VBW:3000.000KHz SWT:Auto Detector : Peak Project : 8N0132-01 Mode : 153</p>	Left blank



WIFI	Band 4 5725~5850MHz Band Edge @ 3m	
ANT	802.11n HT40 CH151 5755MHz	
1+2	Vertical	Fundamental
<p>Peak</p>	<p>Date: 2019-01-18 PEAK_BE(B4)_16-24</p> <p>Site : 03CH15-HY Condition : PEAK_BE(B4)_16-24 3m 91200_15_1620 VERTICAL RBW:1000.000KHz VBW:3000.000KHz SWT:Auto Detector : Peak Project : 8N0132-01 Mode : 153</p>	<p>Date: 2019-01-18 PEAK(B4)_16-24</p> <p>Site : 03CH15-HY Condition : PEAK(LUNII) 3m 91200_15_1620 VERTICAL RBW:1000.000KHz VBW:3000.000KHz SWT:Auto Detector : Peak Project : 8N0132-01 Mode : 153</p>
<p>Peak</p>	<p>Date: 2019-01-18 PEAK_BE(B4)_16-24</p> <p>Site : 03CH15-HY Condition : PEAK_BE(B4)_16-24 3m 91200_15_1620 VERTICAL RBW:1000.000KHz VBW:3000.000KHz SWT:Auto Detector : Peak Project : 8N0132-01 Mode : 153</p>	<p>Left blank</p>

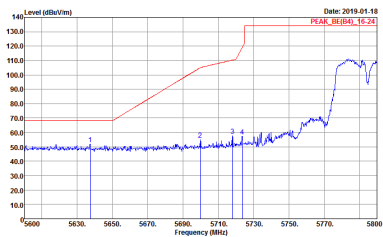
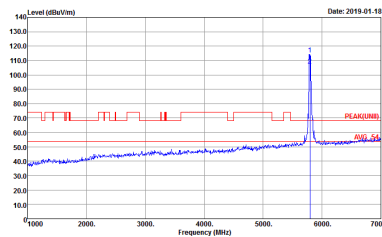
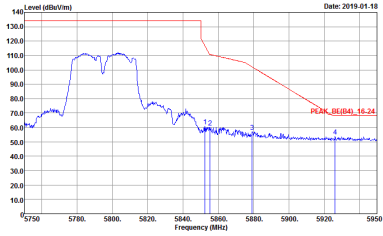

WIFI	Band 4 5725~5850MHz Band Edge @ 3m	
ANT	802.11n HT40 CH159 5795MHz	
1+2	Horizontal	Fundamental
<p>Peak</p>	 <p>Date: 2019-01-18 PEAK_BE(B4)_16-24</p> <p>Site : 03CH15-HY Condition : PEAK_BE(B4)_16-24 3m 91200_15_1620 HORIZONTAL RBW:1000.000KHz VBW:3000.000KHz SWT:Auto Detector : Peak Project : 8N0132-01 Mode : 154</p>	 <p>Date: 2019-01-18 PEAK(B4)</p> <p>Site : 03CH15-HY Condition : PEAK(LUNII) 3m 91200_15_1620 HORIZONTAL RBW:1000.000KHz VBW:3000.000KHz SWT:Auto Detector : Peak Project : 8N0132-01 Mode : 154</p>
<p>Peak</p>	 <p>Date: 2019-01-18 PEAK_BE(B4)_16-24</p> <p>Site : 03CH15-HY Condition : PEAK_BE(B4)_16-24 3m 91200_15_1620 HORIZONTAL RBW:1000.000KHz VBW:3000.000KHz SWT:Auto Detector : Peak Project : 8N0132-01 Mode : 154</p>	<p>Left blank</p>

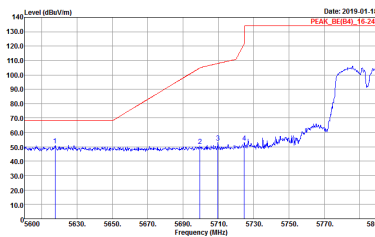
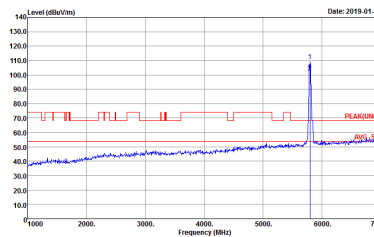
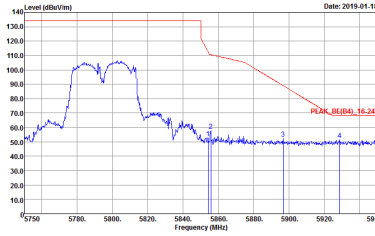

WIFI	Band 4 5725~5850MHz Band Edge @ 3m	
ANT	802.11n HT40 CH159 5795MHz	
1+2	Vertical	Fundamental
<p>Peak</p>	 <p>Date: 2019-01-18 PEAK_BE(B4)_16-24</p> <p>Site : 03CH15-HY Condition : PEAK_BE(B4)_16-24 3m 91200_15_1620 VERTICAL : RBW:1000.000KHz VBW:3000.000KHz SWT:Auto Detector : Peak Project : 8N0132-01 Mode : 154</p>	 <p>Date: 2019-01-18 PEAK(B4)_16-24</p> <p>Site : 03CH15-HY Condition : PEAK(LUNII) 3m 91200_15_1620 VERTICAL : RBW:1000.000KHz VBW:3000.000KHz SWT:Auto Detector : Peak Project : 8N0132-01 Mode : 154</p>
<p>Peak</p>	 <p>Date: 2019-01-18 PEAK_BE(B4)_16-24</p> <p>Site : 03CH15-HY Condition : PEAK_BE(B4)_16-24 3m 91200_15_1620 VERTICAL : RBW:1000.000KHz VBW:3000.000KHz SWT:Auto Detector : Peak Project : 8N0132-01 Mode : 154</p>	<p>Left blank</p>



Band 4 5725~5850MHz
WIFI 802.11ac VHT80 (Band Edge @ 3m)

WIFI	Band 4 5725~5850MHz Band Edge @ 3m	
ANT	802.11ac VHT80 CH155 5775MHz	
1+2	Horizontal	Fundamental
Peak	<p>Site : 03CH15-HY Condition : PEAK_BE(B4)_16-24 3m 91200_15_1620 HORIZONTAL RBW:1000.000KHz VBW:3000.000KHz SWT:Auto Detector : Peak Project : 8N0132-01 Mode : 155</p>	<p>Site : 03CH15-HY Condition : PEAK(UNIT) 3m 91200_15_1620 HORIZONTAL RBW:1000.000KHz VBW:3000.000KHz SWT:Auto Detector : Peak Project : 8N0132-01 Mode : 155</p>
Peak	<p>Site : 03CH15-HY Condition : PEAK_BE(B4)_16-24 3m 91200_15_1620 HORIZONTAL RBW:1000.000KHz VBW:3000.000KHz SWT:Auto Detector : Peak Project : 8N0132-01 Mode : 155</p>	Left blank

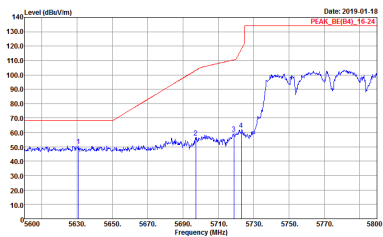
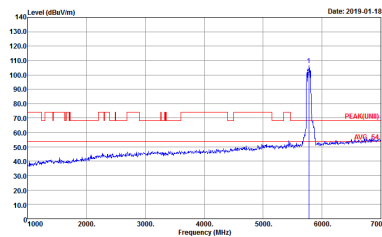

WIFI	Band 4 5725~5850MHz Band Edge @ 3m	
ANT	802.11ac VHT80 CH155 5775MHz	
1+2	Vertical	Fundamental
<p>Peak</p>	 <p>Date: 2019-01-18 PEAK_BE(B4)_16-24</p> <p>Site : 03CH15-HY Condition : PEAK_BE(B4)_16-24 3m 91200_15_1620 VERTICAL : RBW:1000.000KHz VBW:3000.000KHz SWT:Auto Detector : Peak Project : 8N0132-01 Mode : 155</p>	 <p>Date: 2019-01-18 PEAK(B4)_16-24</p> <p>Site : 03CH15-HY Condition : PEAK(LUNII) 3m 91200_15_1620 VERTICAL : RBW:1000.000KHz VBW:3000.000KHz SWT:Auto Detector : Peak Project : 8N0132-01 Mode : 155</p>
<p>Peak</p>	 <p>Date: 2019-01-18 PEAK_BE(B4)_16-24</p> <p>Site : 03CH15-HY Condition : PEAK_BE(B4)_16-24 3m 91200_15_1620 VERTICAL : RBW:1000.000KHz VBW:3000.000KHz SWT:Auto Detector : Peak Project : 8N0132-01 Mode : 155</p>	<p>Left blank</p>



Band 4 - 5725~5850MHz
WIFI 802.11a (Harmonic @ 3m)

WIFI	Band 4 5725~5850MHz Harmonic @ 3m	
ANT	802.11a CH149 5745MHz	
1+2	Horizontal	Vertical
Peak Avg.	<p>Site : 03CH15-HY Condition : PEAR(LINET) 3m 91200_15_1620 HORIZONTAL Detector : Peak Project : BN0132-01 Mode : 147</p>	<p>Site : 03CH15-HY Condition : PEAR(LINET) 3m 91200_15_1620 VERTICAL Detector : Peak Project : BN0132-01 Mode : 147</p>

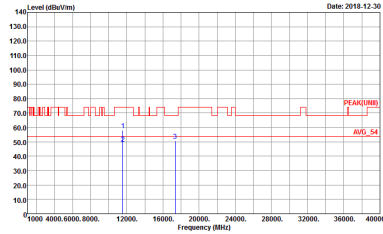
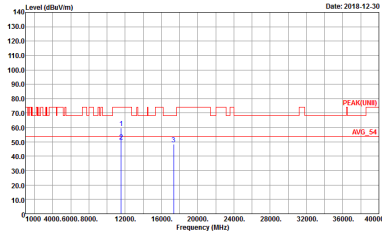

WIFI	Band 4 5725~5850MHz Harmonic @ 3m	
ANT	802.11a CH157 5785MHz	
1+2	Horizontal	Vertical
<p>Peak</p> <p>Avg.</p>	 <p>Site : 03CH15-11Y Condition : PEAK(LINEI) 3m 9120D_15_1620 HORIZONTAL Detector : Peak Project : 8N0132-01 Mode : 14B Setting : 19.5</p>	 <p>Site : 03CH15-11Y Condition : PEAK(LINEI) 3m 9120D_15_1620 VERTICAL Detector : Peak Project : 8N0132-01 Mode : 14B Setting : 19.5</p>

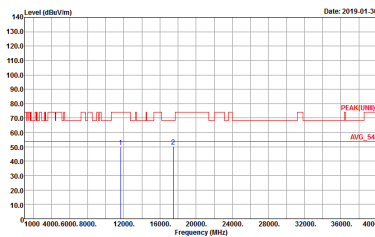
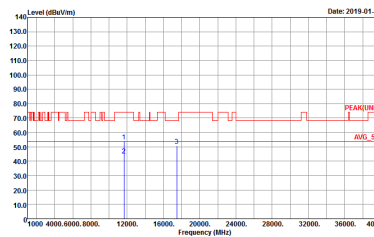

WIFI	Band 4 5725~5850MHz Harmonic @ 3m	
ANT	802.11a CH165 5825MHz	
1+2	Horizontal	Vertical
<p>Peak</p> <p>Avg.</p>	 <p>Site : 03CHES-149 Condition : PEAK(LINE) 3m 9120D_15_1620 HORIZONTAL Detector : Peak Project : 8N0132-01 Mode : 149</p>	 <p>Site : 03CHES-149 Condition : PEAK(LINE) 3m 9120D_15_1620 VERTICAL Detector : Peak Project : 8N0132-01 Mode : 149</p>



**Band 4 5725~5850MHz
WIFI 802.11n HT20 (Harmonic @ 3m)**

WIFI	Band 4 5725~5850MHz Harmonic @ 3m	
ANT	802.11n HT20 CH149 5745MHz	
1+2	Horizontal	Vertical
Peak Avg.	<p>Site : 03CH15-HY Condition : PEAK(LINII) 3m 91200_15_1620 HORIZONTAL Detector : Peak Project : 8N0132-01 Mode : 150</p>	<p>Site : 03CH15-HY Condition : PEAK(LINII) 3m 91200_15_1620 VERTICAL Detector : Peak Project : 8N0132-01 Mode : 150</p>



WIFI	Band 4 5725~5850MHz Harmonic @ 3m	
ANT	802.11n HT20 CH157 5785MHz	
1+2	Horizontal	Vertical
Peak Avg.	<p>Site : 03CH15-11Y Condition : PEAK(LINE1) 3m 9120D_15_1620 HORIZONTAL Detector : Peak Project : 8N0132-01 Mode : 151</p>	<p>Site : 03CH15-11Y Condition : PEAK(LINE1) 3m 9120D_15_1620 VERTICAL Detector : Peak Project : 8N0132-01 Mode : 151</p>

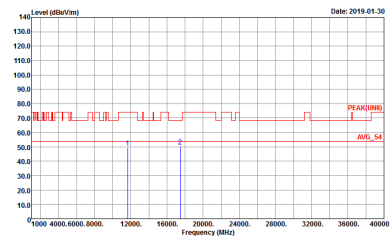
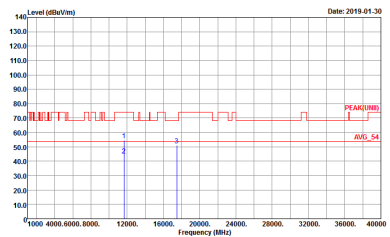

WIFI	Band 4 5725~5850MHz Harmonic @ 3m	
ANT	802.11n HT20 CH165 5825MHz	
1+2	Horizontal	Vertical
Peak Avg.	 <p>Date: 2019-01-30</p> <p>Site : 03CH15-11Y Condition : PEAK(UWB) 3m 9120D_15_1620 HORIZONTAL Detector : Peak Project : 8N0132-01 Mode : 15Z</p>	 <p>Date: 2019-01-30</p> <p>Site : 03CH15-11Y Condition : PEAK(UWB) 3m 9120D_15_1620 VERTICAL Detector : Peak Project : 8N0132-01 Mode : 15Z</p>