



FCC RADIO TEST REPORT

FCC ID : UZ7TC77HL
Equipment : Touch computer
Brand Name : Zebra
Model Name : TC77HL
Applicant : Zebra Technologies Corporation
1 Zebra Plaza, Holtsville, NY 11742
Manufacturer : Zebra Technologies Corporation
1 Zebra Plaza, Holtsville, NY 11742
Standard : FCC Part 15 Subpart C §15.247

The product was received on Jul. 25, 2018 and testing was started from May 28, 2018 and completed on Sep. 11, 2018. We, SPORTON INTERNATIONAL INC., would like to declare that the tested sample has been evaluated in accordance with the test procedures and has been in compliance with the applicable technical standards.

The report must not be used by the client to claim product certification, approval, or endorsement by TAF or any agency of government.

The test results in this report apply exclusively to the tested model / sample. Without written approval of SPORTON INTERNATIONAL INC. EMC & Wireless Communications Laboratory, the test report shall not be reproduced except in full.

Approved by: Joseph Lin

SPORTON INTERNATIONAL INC. EMC & Wireless Communications Laboratory
No. 52, Huaya 1st Rd., Guishan Dist., Taoyuan City, Taiwan (R.O.C.)



Table of Contents

History of this test report..... 3

Summary of Test Result..... 4

1 General Description 5

 1.1 Product Feature of Equipment Under Test..... 5

 1.2 Product Specification of Equipment Under Test..... 6

 1.3 Modification of EUT 7

 1.4 Testing Location 8

 1.5 Applicable Standards..... 8

2 Test Configuration of Equipment Under Test 9

 2.1 Carrier Frequency and Channel 9

 2.2 Test Mode..... 10

 2.3 Connection Diagram of Test System..... 19

 2.4 Support Unit used in test configuration and system 22

 2.5 EUT Operation Test Setup 23

 2.6 Measurement Results Explanation Example..... 23

3 Test Result 24

 3.1 6dB and 99% Bandwidth Measurement 24

 3.2 Output Power Measurement..... 28

 3.3 Power Spectral Density Measurement 37

 3.4 Conducted Band Edges and Spurious Emission Measurement 43

 3.5 Radiated Band Edges and Spurious Emission Measurement 104

 3.6 AC Conducted Emission Measurement..... 109

 3.7 Antenna Requirements 111

4 List of Measuring Equipment..... 113

5 Uncertainty of Evaluation 115

Appendix A. AC Conducted Emission Test Result

Appendix B. Radiated Spurious Emission

Appendix C. Radiated Spurious Emission Plots

Appendix D. Duty Cycle Plots

Appendix E. Setup Photographs



Summary of Test Result

Report Clause	Ref Std. Clause	Test Items	Result (PASS/FAIL)	Remark
3.1	15.247(a)(2)	6dB Bandwidth	Pass	-
3.1	2.1049	99% Occupied Bandwidth	Reporting only	-
3.2	15.247(b)	Power Output Measurement	Pass	-
3.3	15.247(e)	Power Spectral Density	Pass	-
3.4	15.247(d)	Conducted Band Edges	Pass	-
		Conducted Spurious Emission	Pass	-
3.5	15.247(d)	Radiated Band Edges and Radiated Spurious Emission	Pass	Under limit 1.06 dB at 2390.000 MHz
3.6	15.207	AC Conducted Emission	Pass	Under limit 5.84 dB at 0.773 MHz
3.7	15.203 & 15.247(b)	Antenna Requirement	Pass	-

Reviewed by: Wii Chang

Report Producer: Natasha Hsieh



1 General Description

1.1 Product Feature of Equipment Under Test

Product Feature	
Equipment	Touch computer
Brand Name	Zebra
Model Name	TC77HL
FCC ID	UZ7TC77HL
EUT supports Radios application	GSM/EGPRS/WCDMA/HSPA/LTE/NFC/GNSS WLAN 11a/b/g/n HT20/HT40 WLAN 11ac VHT20/VHT40/VHT80 Bluetooth BR/EDR/LE
HW Version	DV
SW Version	Android version 8.1.0
FW Version	91-09-14.00-OG-U00-STD
MFD	06JUL18
EUT Stage	Engineering Sample

Remark: The above EUT's information was declared by manufacturer..

Specification of Accessories				
AC Adapter	Brand Name	Zebra	Part Number	PWR-BUA5V16W0WW
4 PIN DC power cable	Brand Name	Zebra	Part Number	CBL-DC-383A1-01
AC Power cable	Brand Name	Zebra	Part Number	50-16000-182R
Snap-On USB/Charge Cable	Brand Name	Zebra	Part Number	CBL-TC7X-USB1-01
Snap-On Charging Cable Cup	Brand Name	Zebra	Part Number	CHG-TC7X-CBL1-01
Battery 1	Brand Name	Zebra	Part Number	BT-000318-01
Battery 2 (Falcon 1S3P Battery Pack)	Brand Name	Zebra	Part Number	BT-000318-51
Battery 3	Brand Name	Symbol	Part Number	82-171249-02
Earphone 1	Brand Name	Zebra	Part Number	HDST-35MM-PTVP-01
Earphone 2	Brand Name	Zebra	Part Number	HS2100-OTH
Snap-on 3.5MM Audio Jack Adapter	Brand Name	Symbol	Part Number	ADP-TC7X-AUD35-01
3.5mm Jack 43"(1.1m) Standard Cable	Brand Name	Zebra	Part Number	CBL-HS2100-3MS1-01
Holster	Brand Name	Zebra	Part Number	SG-TC7X-HLSTR1-02
Rigid Holster	Brand Name	Zebra	Part Number	SG-TC7X-RHLSTR1-01



1.2 Product Specification of Equipment Under Test

Standards-related Product Specification	
Tx/Rx Channel Frequency Range	2412 MHz ~ 2462 MHz
Maximum (Average) Output Power to antenna <CDD Mode>	<p><Ant. 1> 802.11b : 22.63 dBm (0.1832 W) 802.11g : 20.45 dBm (0.1109 W) 802.11n HT20 : 20.33 dBm (0.1079 W) 802.11n HT40 : 17.45 dBm (0.0556 W) 802.11ac VHT20 : 20.35 dBm(0.1084 W) 802.11ac VHT40 : 17.52 dBm(0.0565 W)</p> <p><Ant. 2> 802.11b : 22.85 dBm (0.1928 W) 802.11g : 20.87 dBm (0.1222 W) 802.11n HT20 : 20.71 dBm (0.1178 W) 802.11n HT40 : 17.02 dBm (0.0504 W) 802.11ac VHT20 : 20.75 dBm(0.1189 W) 802.11ac VHT40 : 17.06 dBm(0.0508 W)</p> <p><MIMO Ant. 1 + 2> 802.11b : 25.49 dBm (0.3540 W) 802.11g : 23.91 dBm (0.2460 W) 802.11n HT20 : 23.88 dBm (0.2443 W) 802.11n HT40 : 19.11 dBm (0.0815 W) 802.11ac VHT20 : 23.89 dBm(0.2449 W) 802.11ac VHT40 : 19.19 dBm(0.0830 W)</p>
Maximum Average Output Power to antenna <TXBF Mode>	<p><MIMO Ant. 1 + 2> 802.11ac VHT20 : 22.19 dBm(0.1656 W) 802.11ac VHT40 : 19.01 dBm(0.0796 W)</p>
99% Occupied Bandwidth <CDD Mode>	<p><Ant. 1> 802.11b : 14.74MHz 802.11g : 18.73MHz 802.11n HT20 : 19.33MHz 802.11n HT40 : 36.46MHz</p> <p><Ant. 2> 802.11b : 15.43MHz 802.11g : 21.63MHz 802.11n HT20 : 21.58MHz 802.11n HT40 : 36.46MHz</p> <p><MIMO Ant. 1> 802.11b : 14.74MHz 802.11g : 20.98MHz 802.11n HT20 : 20.33MHz 802.11n HT40 : 36.46MHz</p> <p><MIMO Ant. 2> 802.11b : 15.83MHz 802.11g : 23.63MHz 802.11n HT20 : 22.78MHz 802.11n HT40 : 36.46MHz</p>

Standards-related Product Specification			
99% Occupied Bandwidth <TXBF Mode>	<MIMO Ant. 1> 802.11n VHT20 : 18.78MHz 802.11n VHT40 : 36.56MHz <MIMO Ant. 2> 802.11n VHT20 : 18.58MHz 802.11n VHT40 : 36.46MHz		
Antenna Type / Gain	<Ant. 1>PIFA Antenna with gain 1.6 dBi <Ant. 2>PIFA Antenna with gain 1.7 dBi		
Type of Modulation	802.11b : DSSS (DBPSK / DQPSK / CCK) 802.11g/n : OFDM (BPSK / QPSK / 16QAM / 64QAM) 802.11ac: OFDM (BPSK / QPSK / 16QAM / 64QAM / 256QAM)		
Antenna Function Description		Ant. 1	Ant. 2
	802.11 b/g/n/ac	V	V
	802.11 b/g/n/ac MIMO	V	V
	802.11 ac TXBF	V	V

Note: MIMO Ant. 1+2 is a calculated result from sum of the power MIMO Ant. 1 and MIMO Ant. 2.

1.3 Modification of EUT

No modifications are made to the EUT during all test items.



1.4 Testing Location

Sporton Lab is accredited to ISO 17025 by Taiwan Accreditation Foundation (TAF code : 1190) and the FCC designation No. TW1190 under the FCC 2.948(e) by Mutual Recognition Agreement (MRA) in FCC Test.

Test Site	SPORTON INTERNATIONAL INC.		
Test Site Location	No.52, Huaya 1st Rd., Guishan Dist., Taoyuan City, Taiwan (R.O.C.) TEL: +886-3-327-3456 FAX: +886-3-328-4978		
Test Site No.	Sporton Site No.		
	TH05-HY	CO05-HY	03CH07-HY

Note: The test site complies with ANSI C63.4 2014 requirement.

1.5 Applicable Standards

According to the specifications of the manufacturer, the EUT must comply with the requirements of the following standards:

- ♦ FCC Part 15 Subpart C §15.247
- ♦ FCC KDB Publication No. 558074 D01 DTS Meas. Guidance v05
- ♦ FCC KDB 414788 D01 Radiated Test Site v01r01.
- ♦ FCC KDB 662911 D01 Multiple Transmitter Output v02r01.
- ♦ ANSI C63.10-2013

Remark:

1. All test items were verified and recorded according to the standards and without any deviation during the test.
2. This EUT has also been tested and complied with the requirements of FCC Part 15, Subpart B, recorded in a separate test report.



2 Test Configuration of Equipment Under Test

- a. The EUT has been associated with peripherals and configuration operated in a manner tended to maximize its emission characteristics in a typical application. Frequency range investigated: conduction emission (150 kHz to 30 MHz), radiation emission (9 kHz to the 10th harmonic of the highest fundamental frequency or to 40 GHz, whichever is lower). For radiated measurement, pre-scanned in three orthogonal panels, X, Y, Z. The worst cases (X plane) were recorded in this report.

- b. AC power line Conducted Emission was tested under maximum output power.

2.1 Carrier Frequency and Channel

Frequency Band	Channel	Freq. (MHz)	Channel	Freq. (MHz)
2400-2483.5 MHz	1	2412	7	2442
	2	2417	8	2447
	3	2422	9	2452
	4	2427	10	2457
	5	2432	11	2462
	6	2437		



2.2 Test Mode

Final test modes are considering the modulation and worse data rates as below table.

Single Mode

Modulation	Data Rate
802.11b	1 Mbps
802.11g	6 Mbps
802.11n HT20 (Covered by VHT20)	MCS0
802.11n HT40 (Covered by VHT40)	MCS0
802.11ac VHT20	MCS0
802.11ac VHT40	MCS0

MIMO Mode

Modulation	Data Rate
802.11b	1 Mbps
802.11g	6 Mbps
802.11n HT20 (Covered by VHT20)	MCS0
802.11n HT40 (Covered by VHT40)	MCS0
802.11ac VHT20	MCS0
802.11ac VHT40	MCS0

TXBF Mode

Modulation	Data Rate
802.11ac VHT20	MCS0
802.11ac VHT40	MCS0

Test Cases	
AC Conducted Emission	<p>Mode 1 :NFC Link + WLAN (2.4GHz) Link + Bluetooth Link + Earphone 1 with Audio Adapter connect to EUT + Charging Only Cable + AC Adapter</p> <p>Mode 2 :NFC Link + WLAN (2.4GHz) Link + Bluetooth Link + Snap on USB Cable Data Link with Notebook + Copy Data from Notebook to EDA (eMMC) + AC Adapter</p> <p>Mode 3 :NFC Link + WLAN (2.4GHz) Link + Bluetooth Link + Earphone 2 with Audio Adapter connect to EUT + Charging Only Cable + AC Adapter</p>
Remark: The worst case of conducted emission is mode 2.	



<CDD Modes>

<Ant. 1>

802.11b RF Avg Output Power (dBm)						
Power vs. Channel			Power vs Data Rate			
Channel	Frequency (MHz)	Data Rate (bps)	Channel	Data Rate (bps)		
		1M		2M	5.5M	11M
Duty Cycle (%)		98.59		97.20	95.28	92.46
CH 01	2412	21.81	CH 06	22.62	22.51	22.35
CH 02	2417	21.05				
CH 06	2437	22.63				
CH 10	2457	21.63				
CH 11	2462	21.88				

802.11g RF Avg Output Power (dBm)										
Power vs. Channel			Power vs Data Rate							
Channel	Frequency (MHz)	Data Rate (bps)	Channel	Data Rate (bps)						
		6M		9Mbps	12Mbps	18Mbps	24Mbps	36Mbps	48Mbps	54Mbps
Duty Cycle (%)		92.72		92.03	89.74	87.13	83.18	75.83	71.13	70.93
CH 01	2412	16.37	CH 06	20.28	20.31	20.34	20.44	20.32	20.39	20.25
CH 02	2417	20.01								
CH 06	2437	20.45								
CH 10	2457	19.49								
CH 11	2462	17.93								



802.11n HT20 RF Avg Output Power (dBm)										
Power vs. Channel			Power vs Data Rate							
Channel	Frequency (MHz)	MCS Index	Channel	MCS Index						
		MCS 0		MCS 1	MCS 2	MCS 3	MCS 4	MCS 5	MCS 6	MCS 7
Duty Cycle (%)		92.25		89.95	84.69	81.55	77.88	73.12	70.93	69.51
CH 01	2412	15.71	CH 06	20.06	20.23	20.26	20.20	20.27	20.31	20.26
CH 02	2417	19.86								
CH 06	2437	20.33								
CH 10	2457	19.27								
CH 11	2462	17.78								

802.11n HT40 RF Avg Output Power (dBm)										
Power vs. Channel			Power vs Data Rate							
Channel	Frequency (MHz)	MCS Index	Channel	MCS Index						
		MCS 0		MCS 1	MCS 2	MCS 3	MCS 4	MCS 5	MCS 6	MCS 7
Duty Cycle (%)		86.40		82.83	75.89	72.22	63.01	59.52	58.47	56.25
CH 03	2422	16.31	CH 06	16.78	16.81	16.75	16.77	16.69	16.70	16.77
CH 04	2427	17.45								
CH 06	2437	16.91								
CH 08	2447	16.26								
CH 09	2452	15.75								



802.11ac VHT20 RF Avg Output Power (dBm)											
Power vs. Channel			Power vs Data Rate								
Channel	Frequency (MHz)	MCS Index	Channel	MCS Index							
		MCS 0		MCS 1	MCS 2	MCS 3	MCS 4	MCS 5	MCS 6	MCS 7	MCS 8
Duty Cycle (%)		92.31		89.13	84.85	82.69	78.76	73.68	72.00	69.05	67.00
CH 01	2412	15.75	CH 06	20.15	20.24	20.24	20.22	20.33	20.25	20.33	20.25
CH 02	2417	19.94									
CH 06	2437	20.35									
CH 10	2457	19.33									
CH 11	2462	17.83									

802.11ac VHT40 RF Avg Output Power (dBm)												
Power vs. Channel			Power vs Data Rate									
Channel	Frequency (MHz)	MCS Index	Channel	MCS Index								
		MCS 0		MCS 1	MCS 2	MCS 3	MCS 4	MCS 5	MCS 6	MCS 7	MCS 8	MCS 9
Duty Cycle (%)		85.83		83.84	72.96	71.74	62.50	61.60	58.68	57.39	53.77	53.62
CH 03	2422	16.36	CH 06	16.75	16.93	16.74	16.89	16.62	16.74	16.68	16.77	16.56
CH 04	2427	17.52										
CH 06	2437	16.97										
CH 08	2447	16.34										
CH 09	2452	15.81										



<Ant. 2>

802.11b RF Avg Output Power (dBm)						
Power vs. Channel			Power vs Data Rate			
Channel	Frequency (MHz)	Data Rate (bps)	Channel	Data Rate (bps)		
		1M		2M	5.5M	11M
Duty Cycle (%)		98.59		98.13	95.28	92.37
CH 01	2412	14.81	CH 06	22.63	22.65	22.49
CH 02	2417	22.34				
CH 06	2437	22.85				
CH 10	2457	22.72				
CH 11	2462	21.71				

802.11g RF Avg Output Power (dBm)										
Power vs. Channel			Power vs Data Rate							
Channel	Frequency (MHz)	Data Rate (bps)	Channel	Data Rate (bps)						
		6M		9Mbps	12Mbps	18Mbps	24Mbps	36Mbps	48Mbps	54Mbps
Duty Cycle (%)		92.11		92.00	90.43	87.00	83.18	78.45	70.83	69.32
CH 01	2412	16.26	CH 06	20.50	20.46	20.85	20.78	20.29	20.54	20.53
CH 02	2417	19.19								
CH 06	2437	20.87								
CH 10	2457	19.47								
CH 11	2462	15.37								

802.11n HT20 RF Avg Output Power (dBm)										
Power vs. Channel			Power vs Data Rate							
Channel	Frequency (MHz)	MCS Index	Channel	MCS Index						
		MCS 0		MCS 1	MCS 2	MCS 3	MCS 4	MCS 5	MCS 6	MCS 7
Duty Cycle (%)		92.25		90.00	86.84	83.17	78.57	72.83	70.59	67.47
CH 01	2412	15.00	CH 06	20.27	20.70	20.62	20.39	20.41	20.48	20.56
CH 02	2417	19.05								
CH 06	2437	20.71								
CH 10	2457	19.30								
CH 11	2462	19.43								



802.11n HT40 RF Avg Output Power (dBm)										
Power vs. Channel			Power vs Data Rate							
Channel	Frequency (MHz)	MCS Index	Channel	MCS Index						
		MCS 0		MCS 1	MCS 2	MCS 3	MCS 4	MCS 5	MCS 6	MCS 7
Duty Cycle (%)		86.29		82.83	77.98	72.22	65.96	59.52	58.33	55.75
CH 03	2422	14.44	CH 06	16.68	16.53	16.55	16.42	16.50	16.56	16.58
CH 04	2427	15.19								
CH 06	2437	17.02								
CH 08	2447	16.04								
CH 09	2452	16.15								

802.11ac VHT20 RF Avg Output Power (dBm)											
Power vs. Channel			Power vs Data Rate								
Channel	Frequency (MHz)	MCS Index	Channel	MCS Index							
		MCS 0		MCS 1	MCS 2	MCS 3	MCS 4	MCS 5	MCS 6	MCS 7	MCS 8
Duty Cycle (%)		92.31		91.21	84.69	81.90	76.72	74.47	72.00	70.73	64.52
CH 01	2412	15.04	CH 06	20.23	20.72	20.73	20.51	20.41	20.44	20.34	20.51
CH 02	2417	19.07									
CH 06	2437	20.75									
CH 10	2457	19.35									
CH 11	2462	19.47									

802.11ac VHT40 RF Avg Output Power (dBm)												
Power vs. Channel			Power vs Data Rate									
Channel	Frequency (MHz)	MCS Index	Channel	MCS Index								
		MCS 0		MCS 1	MCS 2	MCS 3	MCS 4	MCS 5	MCS 6	MCS 7	MCS 8	MCS 9
Duty Cycle (%)		85.83		81.19	76.58	71.74	66.67	62.40	59.17	57.52	53.77	52.34
CH 03	2422	14.49	CH 06	16.85	16.69	16.62	16.41	16.36	16.50	16.45	16.50	16.49
CH 04	2427	15.26										
CH 06	2437	17.06										
CH 08	2447	16.11										
CH 09	2452	16.22										



MIMO <Ant. 1+2>

802.11b RF Avg Output Power (dBm)						
Power vs. Channel			Power vs Data Rate			
Channel	Frequency (MHz)	Data Rate (bps)	Channel	Data Rate (bps)		
		1M		2M	5.5M	11M
CH 01	2412	17.83	CH 06	25.04	25.48	25.21
CH 02	2417	24.05				
CH 06	2437	25.49				
CH 10	2457	24.38				
CH 11	2462	20.64				

802.11g RF Avg Output Power (dBm)										
Power vs. Channel			Power vs Data Rate							
Channel	Frequency (MHz)	Data Rate (bps)	Channel	Data Rate (bps)						
		6M		9Mbps	12Mbps	18Mbps	24Mbps	36Mbps	48Mbps	54Mbps
CH 01	2412	18.47	CH 06	23.36	23.42	23.75	23.65	23.29	23.36	23.38
CH 02	2417	21.70								
CH 06	2437	23.91								
CH 10	2457	21.70								
CH 11	2462	21.12								

802.11n HT20 RF Avg Output Power (dBm)										
Power vs. Channel			Power vs Data Rate							
Channel	Frequency (MHz)	MCS Index	Channel	MCS Index						
		MCS0		MCS1	MCS2	MCS3	MCS4	MCS5	MCS6	MCS7
CH 01	2412	16.43	CH 06	23.22	23.78	23.69	23.36	23.34	23.36	23.39
CH 02	2417	22.21								
CH 06	2437	23.88								
CH 10	2457	22.05								
CH 11	2462	19.95								



802.11n HT40 RF Output Power (dBm)										
Power vs. Channel			Power vs Data Rate							
Channel	Frequency (MHz)	MCS Index	Channel	MCS Index						
		MCS0		MCS1	MCS2	MCS3	MCS4	MCS5	MCS6	MCS7
CH 03	2422	15.45	CH 06	16.68	16.53	16.55	16.42	16.50	16.56	16.58
CH 04	2427	16.36								
CH 06	2437	19.11								
CH 08	2447	18.44								
CH 09	2452	18.02								

802.11ac VHT20 RF Avg Output Power (dBm)											
Power vs. Channel			Power vs Data Rate								
Channel	Frequency (MHz)	MCS Index	Channel	MCS Index							
		MCS 0		MCS 1	MCS 2	MCS 3	MCS 4	MCS 5	MCS 6	MCS 7	MCS 8
CH 01	2412	16.54	CH 06	23.22	23.75	23.78	23.36	23.36	23.41	23.36	23.41
CH 02	2417	22.25									
CH 06	2437	23.89									
CH 10	2457	22.14									
CH 11	2462	19.97									

802.11ac VHT40 RF Avg Output Power (dBm)												
Power vs. Channel			Power vs Data Rate									
Channel	Frequency (MHz)	MCS Index	Channel	MCS Index								
		MCS 0		MCS 1	MCS 2	MCS 3	MCS 4	MCS 5	MCS 6	MCS 7	MCS 8	MCS 9
CH 03	2422	15.48	CH 06	18.71	18.67	18.90	18.65	18.51	18.57	18.49	18.67	18.55
CH 04	2427	16.42										
CH 06	2437	19.19										
CH 08	2447	18.48										
CH 09	2452	18.04										



<TXBF Modes>

MIMO <Ant. 1+2>

802.11ac VHT20 RF Avg Output Power (dBm)											
Power vs. Channel			Power vs Data Rate								
Channel	Frequency (MHz)	MCS Index	Channel	MCS Index							
		MCS 0		MCS 1	MCS 2	MCS 3	MCS 4	MCS 5	MCS 6	MCS 7	MCS 8
CH 01	2412	16.36	CH 06	22.09	22.09	22.02	21.99	21.92	21.99	21.99	21.82
CH 02	2417	21.57									
CH 06	2437	22.19									
CH 10	2457	21.21									
CH 11	2462	19.56									

802.11ac VHT40 RF Avg Output Power (dBm)												
Power vs. Channel			Power vs Data Rate									
Channel	Frequency (MHz)	MCS Index	Channel	MCS Index								
		MCS 0		MCS 1	MCS 2	MCS 3	MCS 4	MCS 5	MCS 6	MCS 7	MCS 8	MCS 9
CH 03	2422	15.27	CH 06	18.91	18.91	18.81	18.81	18.86	18.81	18.81	18.71	18.66
CH 04	2427	16.22										
CH 06	2437	19.01										
CH 08	2447	18.26										
CH 09	2452	17.91										

2.3 Connection Diagram of Test System

<Radiated Emission Mode>

<CDD Mode with Earphone 1>

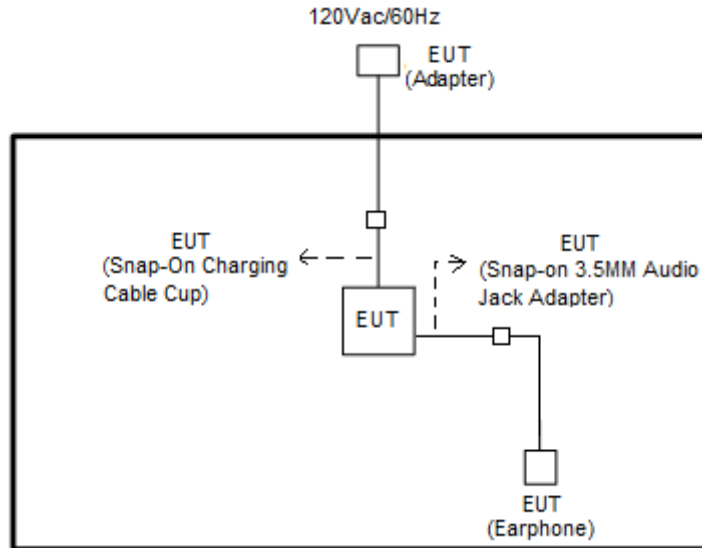

<CDD Mode with Earphone 2>

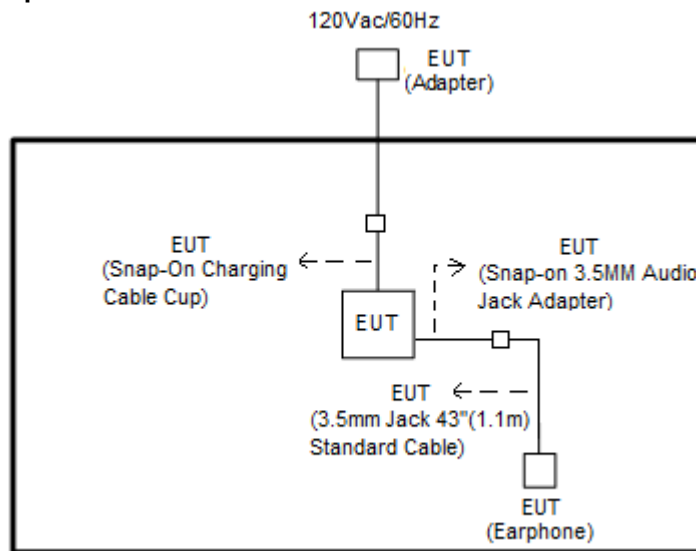

<CDD Mode with Notebook>

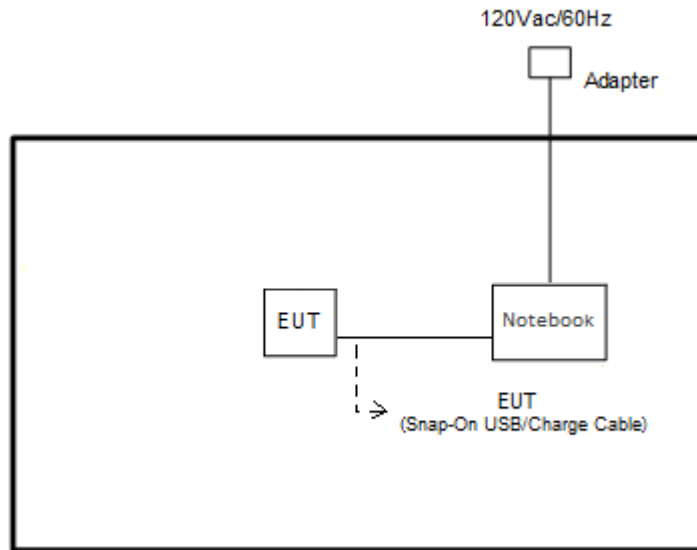

<TXBF Mode>

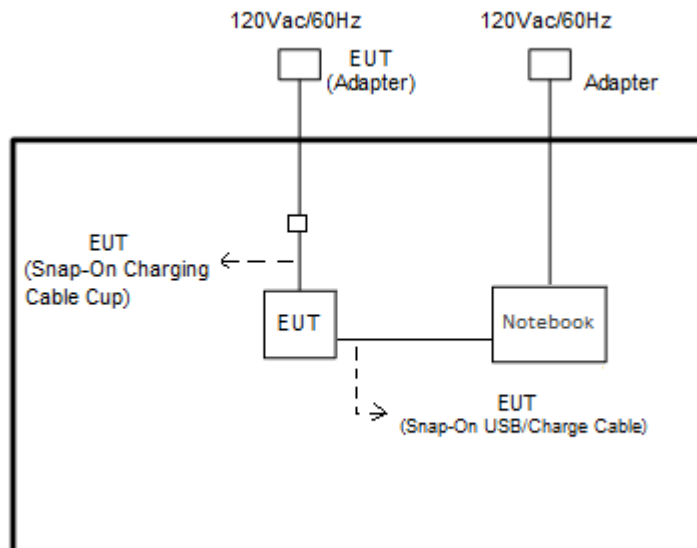

<AC Conducted Emission for Earphone 1>

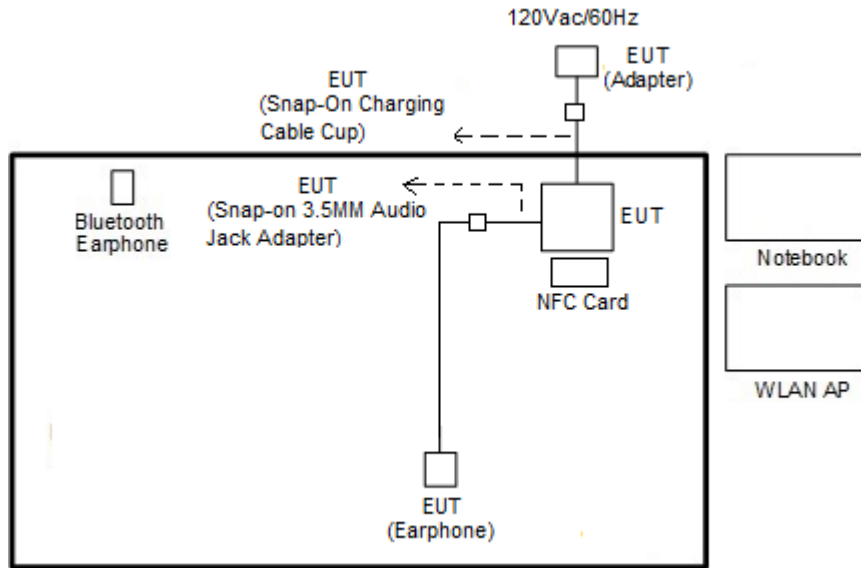

<AC Conducted Emission for Earphone 2>

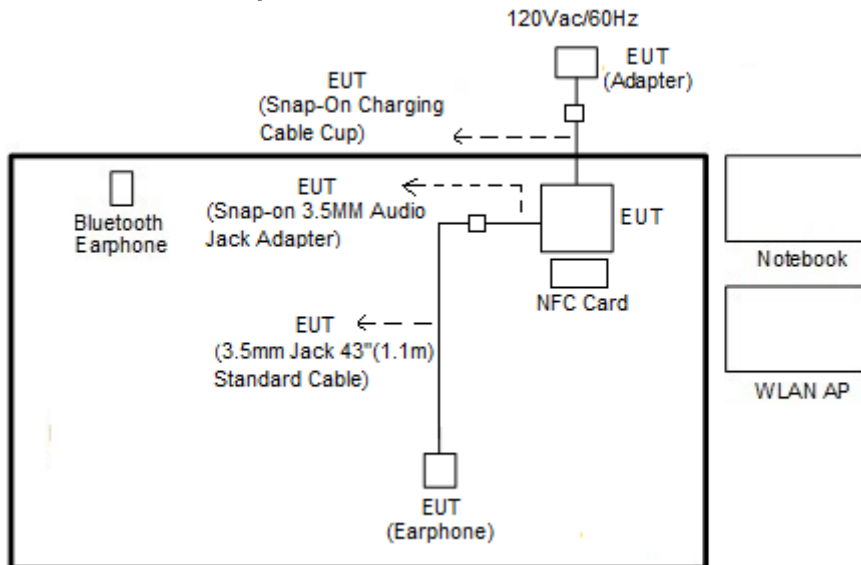

<AC Conducted Emission for data link mode>

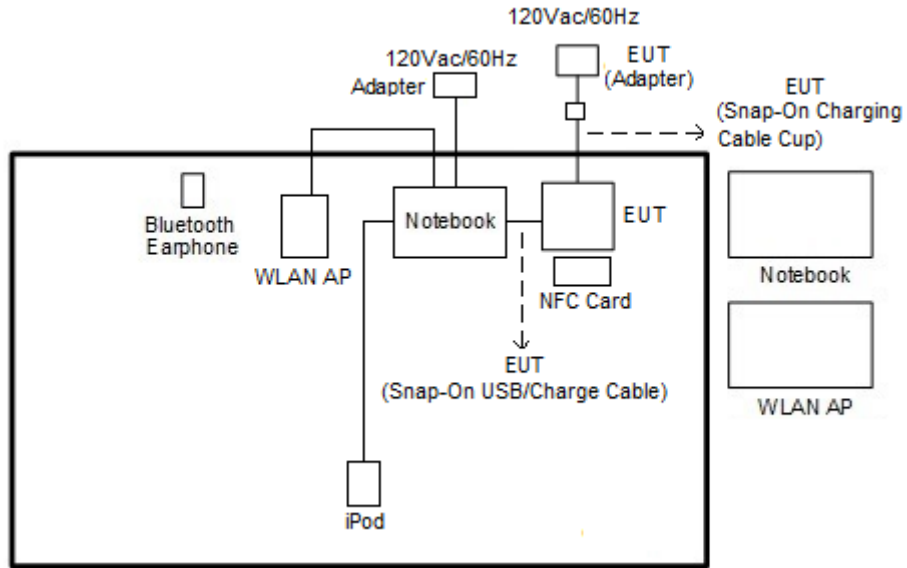

2.4 Support Unit used in test configuration and system

Item	Equipment	Trade Name	Model Name	FCC ID	Data Cable	Power Cord
1.	Bluetooth Earphone	Sony Ericsson	MW600	PY7DDA-2029	N/A	N/A
2.	WLAN AP	ASUS	RT-AC66U	MSQ-RTAC66U	N/A	Unshielded, 1.8 m
3.	iPod	Apple	A1285	FCC DoC	Shielded, 1.0 m	N/A
4.	Notebook	DELL	Latitude E6320	FCC DoC/ Contains FCC ID: QDS-BRCM1054	N/A	AC I/P: Unshielded, 1.2 m DC O/P: Shielded, 1.8 m
5.	SD Card	SanDisk	MicroSD HC	FCC DoC	N/A	N/A
6.	NFC Card	Metro Taipei	Easy Card	N/A	N/A	N/A



2.5 EUT Operation Test Setup

The RF test items, utility “QRCT” was installed in Notebook which was programmed in order to make the EUT get into the engineering modes to provide channel selection, power level, data rate and the application type and for continuous transmitting signals.

For TXBF mode, the modulation modes and data rates manipulated by the command lines in the engineering program made the EUT link to another EUT by power under the normal operation. The “ADB” software tool was used to enable the EUT to transmit signals continuously.

2.6 Measurement Results Explanation Example

For all conducted test items:

The offset level is set in the spectrum analyzer to compensate the RF cable loss and attenuator factor between EUT conducted output port and spectrum analyzer. With the offset compensation, the spectrum analyzer reading level is exactly the EUT RF output level.

Example:

The spectrum analyzer offset is derived from RF cable loss and attenuator factor.

Offset = RF cable loss + attenuator factor.

Following shows an offset computation example with cable loss 4.2 dB and 10dB attenuator.

$$\begin{aligned} \text{Offset(dB)} &= \text{RF cable loss(dB)} + \text{attenuator factor(dB)}. \\ &= 4.2 + 10 = 14.2 \text{ (dB)} \end{aligned}$$

3 Test Result

3.1 6dB and 99% Bandwidth Measurement

3.1.1 Limit of 6dB and 99% Bandwidth

The minimum 6 dB bandwidth shall be at least 500 kHz.

3.1.2 Measuring Instruments

See list of measuring equipment of this test report.

3.1.3 Test Procedures

1. The testing follows FCC KDB Publication No. 558074 DTS D01 Meas. Guidance v05.
2. The RF output of EUT was connected to the spectrum analyzer by RF cable and attenuator. The path loss was compensated to the results for each measurement.
3. Set to the maximum power setting and enable the EUT transmit continuously.
4. Make the measurement with the spectrum analyzer's resolution bandwidth (RBW) = 100 kHz. Set the Video bandwidth (VBW) = 300 kHz. In order to make an accurate measurement. The 6 dB bandwidth must be greater than 500 kHz.
5. For 99% Bandwidth Measurement, the spectrum analyzer's resolution bandwidth (RBW) is set 1-5% of the emission bandwidth and set the Video bandwidth (VBW) $\geq 3 * RBW$.
6. Measure and record the results in the test report.

3.1.4 Test Setup

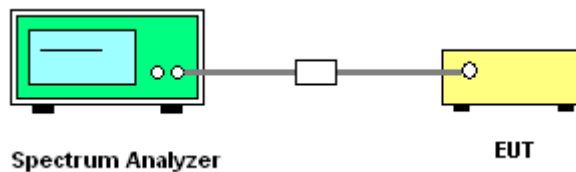



3.1.5 Test Result of 6dB and 99% Occupied Bandwidth

<CDD Mode>

2.4GHz Band										
Mod.	Data Rate	NTX	CH.	Freq. (MHz)	99% Occupied BW (MHz)		6dB BW (MHz)		6dB BW Limit (MHz)	Pass/Fail
					Ant 1	Ant 2	Ant 1	Ant 2		
11b	1Mbps	1	1	2412	14.14	12.99	8.05	8.03	0.50	Pass
11b	1Mbps	1	6	2437	14.74	15.43	8.07	8.07	0.50	Pass
11b	1Mbps	1	11	2462	14.24	14.14	8.07	8.05	0.50	Pass
11g	6Mbps	1	1	2412	16.88	16.78	16.26	15.66	0.50	Pass
11g	6Mbps	1	6	2437	18.73	21.63	15.25	15.35	0.50	Pass
11g	6Mbps	1	11	2462	16.83	16.63	15.13	16.00	0.50	Pass
VHT20	MCS0	1	1	2412	18.08	17.93	16.78	16.78	0.50	Pass
VHT20	MCS0	1	6	2437	19.33	21.58	15.96	16.16	0.50	Pass
VHT20	MCS0	1	11	2462	17.98	19.23	15.13	16.14	0.50	Pass
VHT40	MCS0	1	3	2422	36.46	36.46	35.13	35.13	0.50	Pass
VHT40	MCS0	1	6	2437	36.36	36.46	35.13	35.09	0.50	Pass
VHT40	MCS0	1	9	2452	36.46	36.46	35.72	35.72	0.50	Pass
11b	1Mbps	2	1	2412	13.04	12.84	8.03	8.01	0.50	Pass
11b	1Mbps	2	6	2437	14.74	15.83	8.53	8.53	0.50	Pass
11b	1Mbps	2	11	2462	12.84	13.04	7.05	7.05	0.50	Pass
11g	6Mbps	2	1	2412	16.83	16.73	15.92	15.90	0.50	Pass
11g	6Mbps	2	6	2437	20.98	23.63	15.31	15.70	0.50	Pass
11g	6Mbps	2	11	2462	17.08	16.88	15.11	15.33	0.50	Pass
VHT20	MCS0	2	1	2412	17.98	17.83	16.78	16.04	0.50	Pass
VHT20	MCS0	2	6	2437	20.33	22.78	16.34	16.90	0.50	Pass
VHT20	MCS0	2	11	2462	17.93	17.83	15.11	15.96	0.50	Pass
VHT40	MCS0	2	3	2422	36.36	36.36	35.13	35.13	0.50	Pass
VHT40	MCS0	2	6	2437	36.46	36.46	35.13	35.09	0.50	Pass
VHT40	MCS0	2	9	2452	36.46	36.46	35.72	35.68	0.50	Pass

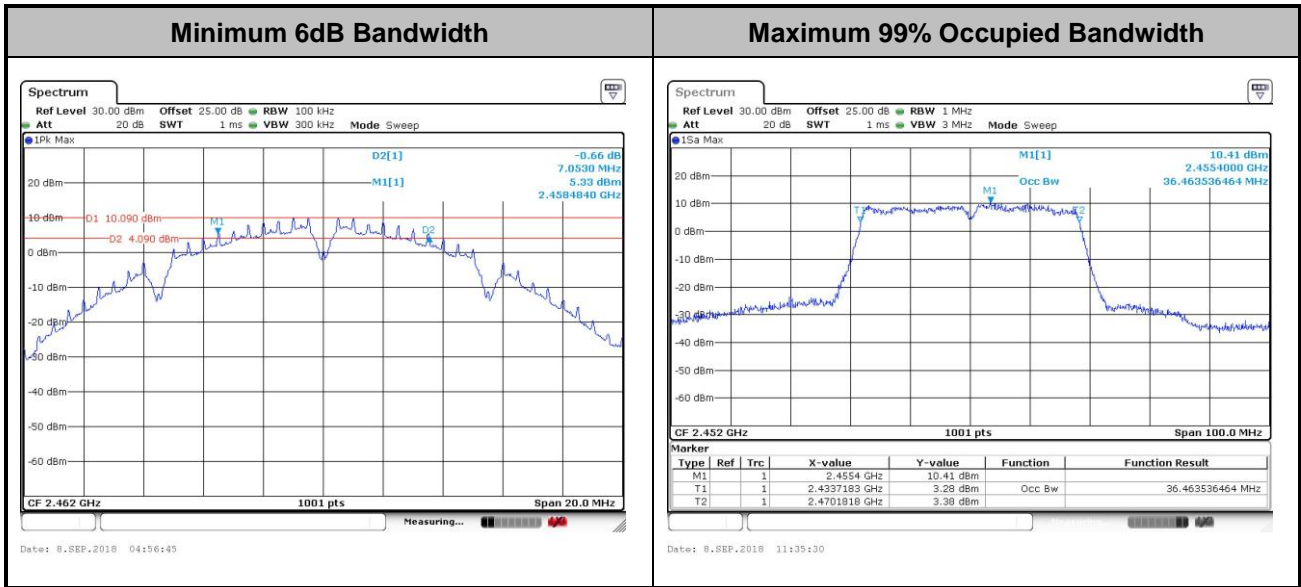

Note : The occupied channel bandwidth is maintained within the band of operation for all of the modulations.



<TXBF Modes>

2.4GHz Band										
Mod.	Data Rate	NTX	CH.	Freq. (MHz)	99% Occupied BW (MHz)		6dB BW (MHz)		6dB BW Limit (MHz)	Pass/Fail
					Ant 1	Ant 2	Ant 1	Ant 2		
VHT20	MCS0	2	1	2412	17.98	17.88	16.78	16.64	0.50	Pass
VHT20	MCS0	2	6	2437	18.78	18.58	15.94	16.52	0.50	Pass
VHT20	MCS0	2	11	2462	17.73	17.78	15.09	16.54	0.50	Pass
VHT40	MCS0	2	3	2422	36.36	36.46	35.13	35.13	0.50	Pass
VHT40	MCS0	2	6	2437	36.36	36.36	35.13	35.09	0.50	Pass
VHT40	MCS0	2	9	2452	36.56	36.46	35.72	35.72	0.50	Pass

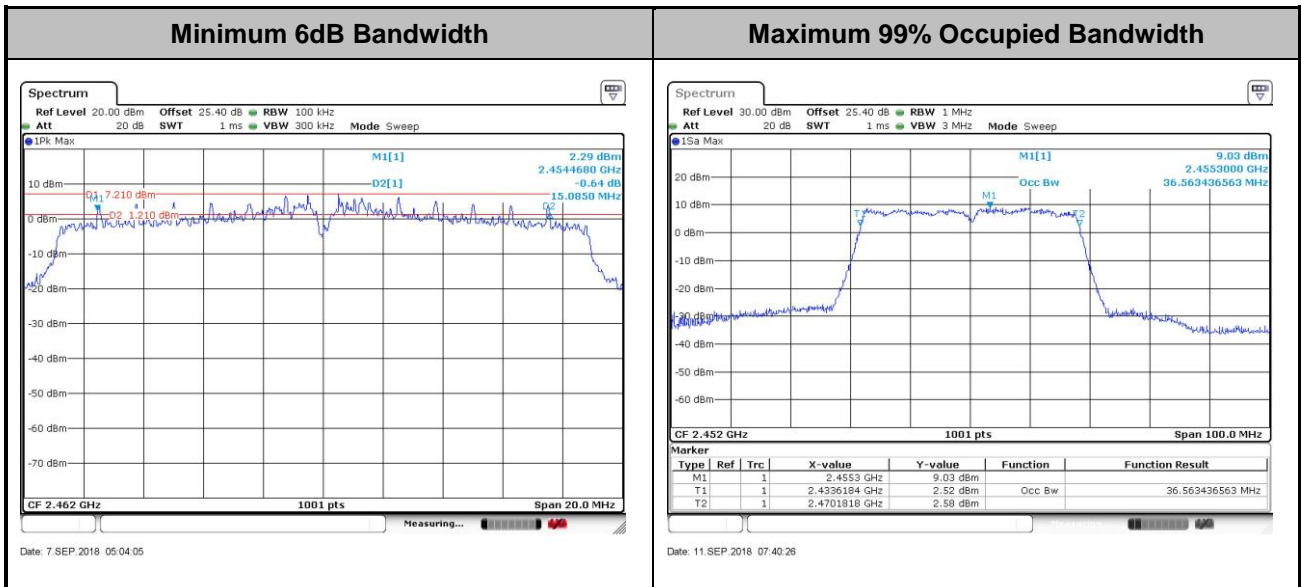

Note : The occupied channel bandwidth is maintained within the band of operation for all of the modulations.



3.2 Output Power Measurement

3.2.1 Limit of Output Power

For systems using digital modulation in the 2400-2483.5MHz, the limit for output power is 30dBm. If transmitting antenna with directional gain greater than 6dBi is used, the output power from the intentional radiator shall be reduced below the above stated value by the amount in dB that the directional gain of the antenna exceeds 6 dBi. In case of point-to-point operation, the limit has to be reduced by 1dB for every 3dB that the directional gain of the antenna exceeds 6dBi.

3.2.2 Measuring Instruments

See list of measuring equipment of this test report.

3.2.3 Test Procedures

<CDD Modes>

1. For Peak Power, the testing follows the Measurement Procedure of FCC KDB No. 558074 DTS D01 Meas. Guidance v05 section 9.1.3 PKPM1 Peak power meter method.
2. For Average Power, the testing follows the Measurement Procedure of FCC KDB No. 558074 DTS D01 Meas. Guidance v05 section 9.2.3.1 Method AVGPM.
3. The RF output of EUT was connected to the power meter by RF cable and attenuator. The path loss was compensated to the results for each measurement.
4. Set to the maximum power setting and enable the EUT transmit continuously.
5. Measure the conducted output power and record the results in the test report.
6. For MIMO mode, calculation method follows FCC KDB 662911 D01 Multiple Transmitter Output v02r01.

<TXBF Modes>

1. The testing follows the Measurement Procedure of FCC KDB No. 558074 DTS D01 Meas. Guidance v05 section 9.2.3.2 Method AVGPM-G.
2. The RF output of EUT was connected to the power meter by RF cable and attenuator. The path loss was compensated to the results for each measurement.
3. Set to the maximum power setting and enable the EUT transmit continuously.
4. Measure the conducted output power and record the results in the test report.
5. For MIMO mode, calculation method follows FCC KDB 662911 D01 Multiple Transmitter Output v02r01.

3.2.4 Test Setup

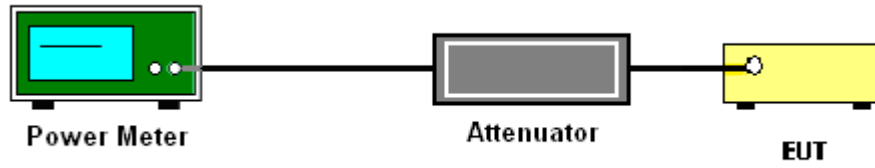



3.2.5 Test Result of Peak Output Power (Reporting Only)

<CDD Modes>

2.4GHz Band											
Mod.	Data Rate	NTX	CH.	Freq. (MHz)	Peak Conducted Power (dBm)			DG (dBi)		EIRP Power (dBm)	
					Ant 1	Ant 2	SUM	Ant 1	Ant 2	Ant 1	Ant 2
11b	1Mbps	1	1	2412	24.15	17.70		1.60	1.70	25.75	19.40
11b	1Mbps	1	2	2417	23.43	24.15		1.60	1.70	25.03	25.85
11b	1Mbps	1	6	2437	24.79	24.68		1.60	1.70	26.39	26.38
11b	1Mbps	1	10	2457	23.90	24.78		1.60	1.70	25.50	26.48
11b	1Mbps	1	11	2462	24.14	23.85		1.60	1.70	25.74	25.55
11g	6Mbps	1	1	2412	21.04	20.88		1.60	1.70	22.64	22.58
11g	6Mbps	1	2	2417	23.82	23.01		1.60	1.70	25.42	24.71
11g	6Mbps	1	6	2437	24.15	24.26		1.60	1.70	25.75	25.96
11g	6Mbps	1	10	2457	23.46	23.22		1.60	1.70	25.06	24.92
11g	6Mbps	1	11	2462	22.25	20.00		1.60	1.70	23.85	21.70
HT20	MCS0	1	1	2412	20.40	19.87		1.60	1.70	22.00	21.57
HT20	MCS0	1	2	2417	23.75	23.06		1.60	1.70	25.35	24.76
HT20	MCS0	1	6	2437	24.04	24.27		1.60	1.70	25.64	25.97
HT20	MCS0	1	10	2457	23.39	23.30		1.60	1.70	24.99	25.00
HT20	MCS0	1	11	2462	22.25	23.42		1.60	1.70	23.85	25.12
HT40	MCS0	1	3	2422	22.08	20.30		1.60	1.70	23.68	22.00
HT40	MCS0	1	4	2427	22.69	20.97		1.60	1.70	24.29	22.67
HT40	MCS0	1	6	2437	22.23	22.18		1.60	1.70	23.83	23.88
HT40	MCS0	1	8	2447	22.03	21.71		1.60	1.70	23.63	23.41
HT40	MCS0	1	9	2452	21.82	21.77		1.60	1.70	23.42	23.47



2.4GHz Band											
Mod.	Data Rate	NTX	CH.	Freq. (MHz)	Peak Conducted Power (dBm)			DG (dBi)		EIRP Power (dBm)	
					Ant 1	Ant 2	SUM	Ant 1	Ant 2	Ant 1	Ant 2
VHT20	MCS0	1	1	2412	20.41	19.90		1.60	1.70	22.01	21.60
VHT20	MCS0	1	2	2417	23.83	23.11		1.60	1.70	25.43	24.81
VHT20	MCS0	1	6	2437	24.06	24.31		1.60	1.70	25.66	26.01
VHT20	MCS0	1	10	2457	23.43	23.33		1.60	1.70	25.03	25.03
VHT20	MCS0	1	11	2462	22.30	23.45		1.60	1.70	23.90	25.15
VHT40	MCS0	1	3	2422	22.12	20.37		1.60	1.70	23.72	22.07
VHT40	MCS0	1	4	2427	22.71	21.01		1.60	1.70	24.31	22.71
VHT40	MCS0	1	6	2437	22.25	22.25		1.60	1.70	23.85	23.95
VHT40	MCS0	1	8	2447	22.10	21.76		1.60	1.70	23.70	23.46
VHT40	MCS0	1	9	2452	21.85	21.80		1.60	1.70	23.45	23.50
11b	1Mbps	2	1	2412	17.32	17.81	20.58	1.70		22.28	
11b	1Mbps	2	2	2417	23.33	23.19	26.27	1.70		27.97	
11b	1Mbps	2	6	2437	24.28	24.78	27.55	1.70		29.25	
11b	1Mbps	2	10	2457	23.75	23.52	26.65	1.70		28.35	
11b	1Mbps	2	11	2462	20.22	20.36	23.30	1.70		25.00	
11g	6Mbps	2	1	2412	20.14	20.37	23.27	1.70		24.97	
11g	6Mbps	2	2	2417	22.61	22.79	25.71	1.70		27.41	
11g	6Mbps	2	6	2437	24.25	24.42	27.35	1.70		29.05	
11g	6Mbps	2	10	2457	22.88	22.73	25.82	1.70		27.52	
11g	6Mbps	2	11	2462	22.23	22.33	25.29	1.70		26.99	



2.4GHz Band											
Mod.	Data Rate	NTX	CH.	Freq. (MHz)	Peak Conducted Power (dBm)			DG (dBi)		EIRP Power (dBm)	
					Ant 1	Ant 2	SUM	Ant 1	Ant 2	Ant 1	Ant 2
HT20	MCS0	2	1	2412	18.24	18.32	21.29	1.70		22.99	
HT20	MCS0	2	2	2417	23.05	23.08	26.08	1.70		27.78	
HT20	MCS0	2	6	2437	24.21	24.41	27.32	1.70		29.02	
HT20	MCS0	2	10	2457	23.03	23.03	26.04	1.70		27.74	
HT20	MCS0	2	11	2462	21.50	21.31	24.42	1.70		26.12	
HT40	MCS0	2	3	2422	18.49	19.08	21.81	1.70		23.51	
HT40	MCS0	2	4	2427	19.10	19.70	22.42	1.70		24.12	
HT40	MCS0	2	6	2437	21.56	21.71	24.65	1.70		26.35	
HT40	MCS0	2	8	2447	21.60	21.40	24.51	1.70		26.21	
HT40	MCS0	2	9	2452	21.36	21.11	24.25	1.70		25.95	
VHT20	MCS0	2	1	2412	18.26	18.50	21.39	1.70		23.09	
VHT20	MCS0	2	2	2417	23.08	23.12	26.11	1.70		27.81	
VHT20	MCS0	2	6	2437	24.25	24.48	27.38	1.70		29.08	
VHT20	MCS0	2	10	2457	23.16	23.05	26.12	1.70		27.82	
VHT20	MCS0	2	11	2462	21.55	21.32	24.45	1.70		26.15	
VHT40	MCS0	2	3	2422	18.63	19.14	21.90	1.70		23.60	
VHT40	MCS0	2	4	2427	19.11	19.76	22.46	1.70		24.16	
VHT40	MCS0	2	6	2437	21.59	21.74	24.68	1.70		26.38	
VHT40	MCS0	2	8	2447	21.69	21.46	24.59	1.70		26.29	
VHT40	MCS0	2	9	2452	21.47	21.12	24.31	1.70		26.01	



3.2.6 Test Result of Average output Power

<CDD Mode>

2.4GHz Band																		
Mod.	Data Rate	NTX	CH.	Freq. (MHz)	Duty Factor (dB)		Average Conducted Power (dBm)			Conducted Power Limit (dBm)		DG (dBi)		EIRP Power (dBm)		EIRP Power Limit (dBm)		Pass /Fail
					Ant 1	Ant 2	Ant 1	Ant 2	SUM	Ant 1	Ant 2	Ant 1	Ant 2	Ant 1	Ant 2	Ant 1	Ant 2	
11b	1Mbps	1	1	2412	0.06	0.06	21.81	14.81		30.00	30.00	1.60	1.70	23.41	16.51	36.00	36.00	Pass
11b	1Mbps	1	2	2417	0.06	0.06	21.05	22.34		30.00	30.00	1.60	1.70	22.65	24.04	36.00	36.00	Pass
11b	1Mbps	1	6	2437	0.06	0.06	22.63	22.85		30.00	30.00	1.60	1.70	24.23	24.55	36.00	36.00	Pass
11b	1Mbps	1	10	2457	0.06	0.06	21.63	22.72		30.00	30.00	1.60	1.70	23.23	24.42	36.00	36.00	Pass
11b	1Mbps	1	11	2462	0.06	0.06	21.88	21.71		30.00	30.00	1.60	1.70	23.48	23.41	36.00	36.00	Pass
11g	6Mbps	1	1	2412	0.33	0.36	16.37	16.26		30.00	30.00	1.60	1.70	17.97	17.96	36.00	36.00	Pass
11g	6Mbps	1	2	2417	0.33	0.36	20.01	19.19		30.00	30.00	1.60	1.70	21.61	20.89	36.00	36.00	Pass
11g	6Mbps	1	6	2437	0.33	0.36	20.45	20.87		30.00	30.00	1.60	1.70	22.05	22.57	36.00	36.00	Pass
11g	6Mbps	1	10	2457	0.33	0.36	19.49	19.47		30.00	30.00	1.60	1.70	21.09	21.17	36.00	36.00	Pass
11g	6Mbps	1	11	2462	0.33	0.36	17.93	15.37		30.00	30.00	1.60	1.70	19.53	17.07	36.00	36.00	Pass
HT20	MCS0	1	1	2412	0.35	0.35	15.71	15.00		30.00	30.00	1.60	1.70	17.31	16.70	36.00	36.00	Pass
HT20	MCS0	1	2	2417	0.35	0.35	19.86	19.05		30.00	30.00	1.60	1.70	21.46	20.75	36.00	36.00	Pass
HT20	MCS0	1	6	2437	0.35	0.35	20.33	20.71		30.00	30.00	1.60	1.70	21.93	22.41	36.00	36.00	Pass
HT20	MCS0	1	10	2457	0.35	0.35	19.27	19.30		30.00	30.00	1.60	1.70	20.87	21.00	36.00	36.00	Pass
HT20	MCS0	1	11	2462	0.35	0.35	17.78	19.43		30.00	30.00	1.60	1.70	19.38	21.13	36.00	36.00	Pass
HT40	MCS0	1	3	2422	0.63	0.64	16.31	14.44		30.00	30.00	1.60	1.70	17.91	16.14	36.00	36.00	Pass
HT40	MCS0	1	4	2427	0.63	0.64	17.45	15.19		30.00	30.00	1.60	1.70	19.05	16.89	36.00	36.00	Pass
HT40	MCS0	1	6	2437	0.63	0.64	16.91	17.02		30.00	30.00	1.60	1.70	18.51	18.72	36.00	36.00	Pass
HT40	MCS0	1	8	2447	0.63	0.64	16.26	16.04		30.00	30.00	1.60	1.70	17.86	17.74	36.00	36.00	Pass
HT40	MCS0	1	9	2452	0.63	0.64	15.75	16.15		30.00	30.00	1.60	1.70	17.35	17.85	36.00	36.00	Pass



2.4GHz Band																		
Mod.	Data Rate	NTX	CH.	Freq. (MHz)	Duty Factor (dB)		Average Conducted Power (dBm)			Conducted Power Limit (dBm)		DG (dBi)		EIRP Power (dBm)		EIRP Power Limit (dBm)		Pass /Fail
					Ant 1	Ant 2	Ant 1	Ant 2	SUM	Ant 1	Ant 2	Ant 1	Ant 2	Ant 1	Ant 2	Ant 1	Ant 2	
VHT20	MCS0	1	1	2412	0.35	0.35	15.75	15.04		30.00	30.00	1.60	1.70	17.35	16.74	36.00	36.00	Pass
VHT20	MCS0	1	2	2417	0.35	0.35	19.94	19.07		30.00	30.00	1.60	1.70	21.54	20.77	36.00	36.00	Pass
VHT20	MCS0	1	6	2437	0.35	0.35	20.35	20.75		30.00	30.00	1.60	1.70	21.95	22.45	36.00	36.00	Pass
VHT20	MCS0	1	10	2457	0.35	0.35	19.33	19.35		30.00	30.00	1.60	1.70	20.93	21.05	36.00	36.00	Pass
VHT20	MCS0	1	11	2462	0.35	0.35	17.83	19.47		30.00	30.00	1.60	1.70	19.43	21.17	36.00	36.00	Pass
VHT40	MCS0	1	3	2422	0.66	0.66	16.36	14.49		30.00	30.00	1.60	1.70	17.96	16.19	36.00	36.00	Pass
VHT40	MCS0	1	4	2427	0.66	0.66	17.52	15.26		30.00	30.00	1.60	1.70	19.12	16.96	36.00	36.00	Pass
VHT40	MCS0	1	6	2437	0.66	0.66	16.97	17.06		30.00	30.00	1.60	1.70	18.57	18.76	36.00	36.00	Pass
VHT40	MCS0	1	8	2447	0.66	0.66	16.34	16.11		30.00	30.00	1.60	1.70	17.94	17.81	36.00	36.00	Pass
VHT40	MCS0	1	9	2452	0.66	0.66	15.81	16.22		30.00	30.00	1.60	1.70	17.41	17.92	36.00	36.00	Pass
11b	1Mbps	2	1	2412	0.07	0.06	14.74	14.90	17.83	30.00		1.70		19.53		36.00		Pass
11b	1Mbps	2	2	2417	0.07	0.06	21.02	21.05	24.05	30.00		1.70		25.75		36.00		Pass
11b	1Mbps	2	6	2437	0.07	0.06	22.20	22.74	25.49	30.00		1.70		27.19		36.00		Pass
11b	1Mbps	2	10	2457	0.07	0.06	21.52	21.21	24.38	30.00		1.70		26.08		36.00		Pass
11b	1Mbps	2	11	2462	0.07	0.06	17.51	17.75	20.64	30.00		1.70		22.34		36.00		Pass
11g	6Mbps	2	1	2412	0.27	0.31	15.45	15.47	18.47	30.00		1.70		20.17		36.00		Pass
11g	6Mbps	2	2	2417	0.27	0.31	18.67	18.71	21.70	30.00		1.70		23.40		36.00		Pass
11g	6Mbps	2	6	2437	0.27	0.31	20.74	21.06	23.91	30.00		1.70		25.61		36.00		Pass
11g	6Mbps	2	10	2457	0.27	0.31	18.82	18.56	21.70	30.00		1.70		23.40		36.00		Pass
11g	6Mbps	2	11	2462	0.27	0.31	18.09	18.13	21.12	30.00		1.70		22.82		36.00		Pass



2.4GHz Band																	
Mod.	Data Rate	NTX	CH.	Freq. (MHz)	Duty Factor (dB)		Average Conducted Power (dBm)			Conducted Power Limit (dBm)		DG (dBi)		EIRP Power (dBm)		EIRP Power Limit (dBm)	Pass /Fail
					Ant 1	Ant 2	Ant 1	Ant 2	SUM	Ant 1	Ant 2	Ant 1	Ant 2	Ant 1	Ant 2		
HT20	MCS0	2	1	2412	0.38	0.35	13.48	13.35	16.43	30.00		1.70		18.13	36.00	Pass	
HT20	MCS0	2	2	2417	0.38	0.35	19.20	19.20	22.21	30.00		1.70		23.91	36.00	Pass	
HT20	MCS0	2	6	2437	0.38	0.35	20.73	21.00	23.88	30.00		1.70		25.58	36.00	Pass	
HT20	MCS0	2	10	2457	0.38	0.35	19.08	19.00	22.05	30.00		1.70		23.75	36.00	Pass	
HT20	MCS0	2	11	2462	0.38	0.35	17.09	16.79	19.95	30.00		1.70		21.65	36.00	Pass	
HT40	MCS0	2	3	2422	0.70	0.60	12.19	12.68	15.45	30.00		1.70		17.15	36.00	Pass	
HT40	MCS0	2	4	2427	0.70	0.60	13.17	13.52	16.36	30.00		1.70		18.06	36.00	Pass	
HT40	MCS0	2	6	2437	0.70	0.60	16.14	16.06	19.11	30.00		1.70		20.81	36.00	Pass	
HT40	MCS0	2	8	2447	0.70	0.60	15.60	15.25	18.44	30.00		1.70		20.14	36.00	Pass	
HT40	MCS0	2	9	2452	0.70	0.60	15.18	14.84	18.02	30.00		1.70		19.72	36.00	Pass	
VHT20	MCS0	2	1	2412	0.38	0.32	13.61	13.44	16.54	30.00		1.70		18.24	36.00	Pass	
VHT20	MCS0	2	2	2417	0.38	0.32	19.24	19.23	22.25	30.00		1.70		23.95	36.00	Pass	
VHT20	MCS0	2	6	2437	0.38	0.32	20.76	20.99	23.89	30.00		1.70		25.59	36.00	Pass	
VHT20	MCS0	2	10	2457	0.38	0.32	19.24	19.01	22.14	30.00		1.70		23.84	36.00	Pass	
VHT20	MCS0	2	11	2462	0.38	0.32	17.08	16.83	19.97	30.00		1.70		21.67	36.00	Pass	
VHT40	MCS0	2	3	2422	0.66	0.63	12.18	12.74	15.48	30.00		1.70		17.18	36.00	Pass	
VHT40	MCS0	2	4	2427	0.66	0.63	13.16	13.64	16.42	30.00		1.70		18.12	36.00	Pass	
VHT40	MCS0	2	6	2437	0.66	0.63	16.11	16.24	19.19	30.00		1.70		20.89	36.00	Pass	
VHT40	MCS0	2	8	2447	0.66	0.63	15.57	15.36	18.48	30.00		1.70		20.18	36.00	Pass	
VHT40	MCS0	2	9	2452	0.66	0.63	15.17	14.89	18.04	30.00		1.70		19.74	36.00	Pass	



<TXBF Mode>

2.4GHz Band																		
Mod.	Data Rate	NTX	CH.	Freq. (MHz)	Duty Factor (dB)		Average Conducted Power (dBm)			Conducted Power Limit (dBm)		DG (dBi)		EIRP Power (dBm)		EIRP Power Limit (dBm)		Pass /Fail
					Ant 1	Ant 2	Ant 1	Ant 2	SUM	Ant 1	Ant 2	Ant 1	Ant 2	Ant 1	Ant 2	Ant 1	Ant 2	
VHT20	MCS0	2	1	2412	0.00	0.00	13.20	13.50	16.36	30.00	30.00	4.66	4.66	21.02	21.02	36.00	36.00	Pass
VHT20	MCS0	2	6	2437	0.00	0.00	18.00	20.10	22.19	30.00	30.00	4.66	4.66	26.85	26.85	36.00	36.00	Pass
VHT20	MCS0	2	11	2462	0.00	0.00	16.50	16.60	19.56	30.00	30.00	4.66	4.66	24.22	24.22	36.00	36.00	Pass
VHT40	MCS0	2	3	2422	0.00	0.00	11.90	12.60	15.27	30.00	30.00	4.66	4.66	19.93	19.93	36.00	36.00	Pass
VHT40	MCS0	2	6	2437	0.00	0.00	15.90	16.10	19.01	30.00	30.00	4.66	4.66	23.67	23.67	36.00	36.00	Pass
VHT40	MCS0	2	9	2452	0.00	0.00	15.00	14.80	17.91	30.00	30.00	4.66	4.66	22.57	22.57	36.00	36.00	Pass



3.3 Power Spectral Density Measurement

3.3.1 Limit of Power Spectral Density

The peak power spectral density shall not be greater than 8dBm in any 3kHz band at any time interval of continuous transmission.

3.3.2 Measuring Instruments

See list of measuring equipment of this test report.

3.3.3 Test Procedures

<CDD Modes>

Method AVGPSD-2

1. The testing follows Measurement Procedure 10.5 Method AVGPSD-2 of FCC KDB Publication No. 558074 D01 DTS Meas. Guidance v05.
2. The RF output of EUT was connected to the spectrum analyzer by RF cable and attenuator. The path loss was compensated to the results for each measurement.
3. Set to the maximum power setting and enable the EUT transmit continuously.
4. Make the measurement with the spectrum analyzer's resolution bandwidth (RBW) = 10 kHz. Video bandwidth VBW = 30 kHz In order to make an accurate measurement, set the span to 1.5 times DTS Channel Bandwidth. (6dB BW).
5. Number of points in sweep ≥ 2 Span / RBW. (This ensures that bin-to-bin spacing is \leq RBW/2, so that narrowband signals are not lost between frequency bins).
6. Detector = RMS, Sweep time = auto couple.
7. Trace average at least 100 traces in power averaging mode.
8. Add $10 \log(1/x)$, where x is the duty cycle, to the measured power in order to compute the average power during the actual transmission times. For example, add $10 \log(1/0.25) = 6$ dB if the duty cycle is 25 percent.
9. Measure and record the results in the test report.
10. For MIMO mode, calculation method follows FCC KDB 662911 D01 Multiple Transmitter Output v02r01.

Method (c): Measure and add $10 \log(N_{ANT})$ dB.

With this technique, spectrum measurements are performed at each output of the device, but rather than summing the spectra or the spectral peaks across the outputs, the quantity $10 \log(N_{ANT})$ dB is added to each spectrum value before comparing to the emission limit. The addition of $10 \log(N_{ANT})$ dB serves to apportion the emission limit among the N_{ANT} outputs so that each output is permitted to contribute no more than $1/N_{ANT}^{th}$ of the PSD limit .

<TXBF Modes>**Method AVGPSD-3**

1. The testing follows Measurement Procedure 10.7 Method AVGPSD-3 of FCC KDB Publication No. 558074 D01 DTS Meas. Guidance v05.
2. The RF output of EUT was connected to the spectrum analyzer by RF cable and attenuator. The path loss was compensated to the results for each measurement.
3. Set to the maximum power setting and enable the EUT transmit continuously.
4. Make the measurement with the spectrum analyzer's resolution bandwidth (RBW) = 10 kHz. Video bandwidth VBW = 30 kHz In order to make an accurate measurement, set the span to 1.5 times DTS Channel Bandwidth. (6dB BW).
5. Number of points in sweep ≥ 2 Span / RBW. (This ensures that bin-to-bin spacing is \leq RBW/2, so that narrowband signals are not lost between frequency bins).
6. Detector = RMS, Sweep time = auto couple.
7. Trace mode = max hold.
8. Allow max hold to run for at least 60 seconds, or longer as needed to allow the trace to stabilize.
9. Measure and record the results in the test report.
10. For MIMO mode, calculation method follows FCC KDB 662911 D01 Multiple Transmitter Output v02r01.

Method (c): Measure and add $10 \log(N_{\text{ANT}})$ dB.

With this technique, spectrum measurements are performed at each output of the device, but rather than summing the spectra or the spectral peaks across the outputs, the quantity $10 \log(N_{\text{ANT}})$ dB is added to each spectrum value before comparing to the emission limit. The addition of $10 \log(N_{\text{ANT}})$ dB serves to apportion the emission limit among the N_{ANT} outputs so that each output is permitted to contribute no more than $1/N_{\text{ANT}}^{\text{th}}$ of the PSD limit .

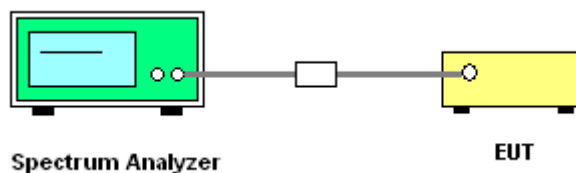
3.3.4 Test Setup



3.3.5 Test Result of Power Spectral Density

<CDD Mode>

2.4GHz Band														
Mod.	Data Rate	NTX	CH.	Freq. (MHz)	Duty Factor (dB)		Average PSD (dBm/3kHz)			DG (dBi)		Average PSD Limit (dBm/3kHz)		Pass/Fail
					Ant 1	Ant 2	Ant 1	Ant 2	Worse + 3.01	Ant 1	Ant 2	Ant 1	Ant 2	
11b	1Mbps	1	1	2412	0.06	0.06	-4.42	-10.87		1.60	1.70	8.00	8.00	Pass
11b	1Mbps	1	6	2437	0.06	0.06	-3.43	-3.07		1.60	1.70	8.00	8.00	Pass
11b	1Mbps	1	11	2462	0.06	0.06	-4.17	-4.10		1.60	1.70	8.00	8.00	Pass
11g	6Mbps	1	1	2412	0.33	0.36	-12.04	-11.95		1.60	1.70	8.00	8.00	Pass
11g	6Mbps	1	6	2437	0.33	0.36	-7.47	-7.26		1.60	1.70	8.00	8.00	Pass
11g	6Mbps	1	11	2462	0.33	0.36	-9.65	-12.62		1.60	1.70	8.00	8.00	Pass
VHT20	MCS0	1	1	2412	0.35	0.35	-12.89	-13.43		1.60	1.70	8.00	8.00	Pass
VHT20	MCS0	1	6	2437	0.35	0.35	-8.14	-7.74		1.60	1.70	8.00	8.00	Pass
VHT20	MCS0	1	11	2462	0.35	0.35	-10.07	-8.39		1.60	1.70	8.00	8.00	Pass
VHT40	MCS0	1	3	2422	0.66	0.66	-14.60	-16.10		1.60	1.70	8.00	8.00	Pass
VHT40	MCS0	1	6	2437	0.66	0.66	-13.87	-13.67		1.60	1.70	8.00	8.00	Pass
VHT40	MCS0	1	9	2452	0.66	0.66	-15.84	-15.53		1.60	1.70	8.00	8.00	Pass
11b	1Mbps	2	1	2412	0.07	0.06	-11.17	-10.64	-7.63	4.66		8.00		Pass
11b	1Mbps	2	6	2437	0.07	0.06	-3.53	-3.24	-0.23	4.66		8.00		Pass
11b	1Mbps	2	11	2462	0.07	0.06	-7.72	-7.90	-4.71	4.66		8.00		Pass
11g	6Mbps	2	1	2412	0.27	0.31	-9.93	-12.67	-6.92	4.66		8.00		Pass
11g	6Mbps	2	6	2437	0.27	0.31	-7.18	-6.70	-3.69	4.66		8.00		Pass
11g	6Mbps	2	11	2462	0.27	0.31	-9.38	-10.03	-6.37	4.66		8.00		Pass
VHT20	MCS0	2	1	2412	0.38	0.32	-14.85	-14.99	-11.84	4.66		8.00		Pass
VHT20	MCS0	2	6	2437	0.38	0.32	-7.51	-7.40	-4.39	4.66		8.00		Pass
VHT20	MCS0	2	11	2462	0.38	0.32	-10.10	-11.03	-7.09	4.66		8.00		Pass
VHT40	MCS0	2	3	2422	0.66	0.63	-16.75	-17.87	-13.74	4.66		8.00		Pass
VHT40	MCS0	2	6	2437	0.66	0.63	-14.04	-14.80	-11.03	4.66		8.00		Pass
VHT40	MCS0	2	9	2452	0.66	0.63	-13.82	-16.22	-10.81	4.66		8.00		Pass



<CDD Modes>

Worst Case Power Density (dBm/3kHz) for MIMO Ant. 1

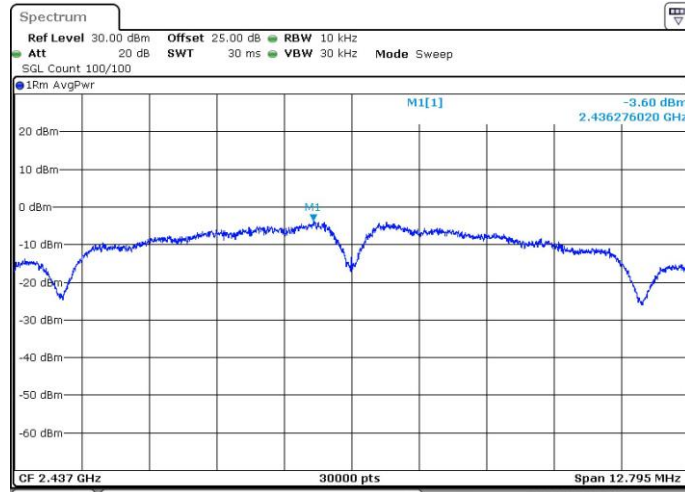

Worst Case Power Density (dBm/3kHz) for MIMO Ant. 2

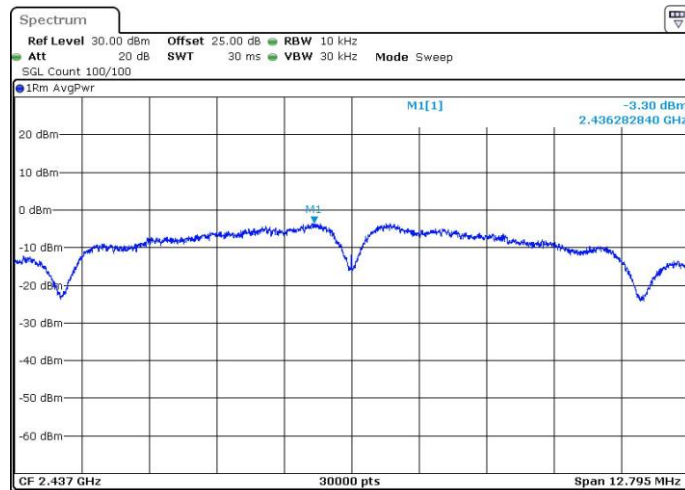



<TXBF Modes>

2.4GHz Band														
Mod.	Data Rate	NTX	CH.	Freq. (MHz)	Duty Factor (dB)		Average PSD (dBm/3kHz)			DG (dBi)		Average PSD Limit (dBm/3kHz)		Pass/Fail
					Ant 1	Ant 2	Ant 1	Ant 2	Worse + 3.01	Ant 1	Ant 2	Ant 1	Ant 2	
VHT20	MCS0	2	1	2412	0.00	0.00	-6.55	-6.25	-3.24	4.66		8.00		Pass
VHT20	MCS0	2	6	2437	0.00	0.00	1.02	1.91	4.92	4.66		8.00		Pass
VHT20	MCS0	2	11	2462	0.00	0.00	-2.76	-3.65	0.25	4.66		8.00		Pass
VHT40	MCS0	2	3	2422	0.00	0.00	-11.68	-10.15	-7.14	4.66		8.00		Pass
VHT40	MCS0	2	6	2437	0.00	0.00	-6.24	-7.77	-3.23	4.66		8.00		Pass
VHT40	MCS0	2	9	2452	0.00	0.00	-8.38	-8.73	-5.37	4.66		8.00		Pass



Worst Case Power Density (dBm/3kHz) for MIMO Ant. 1

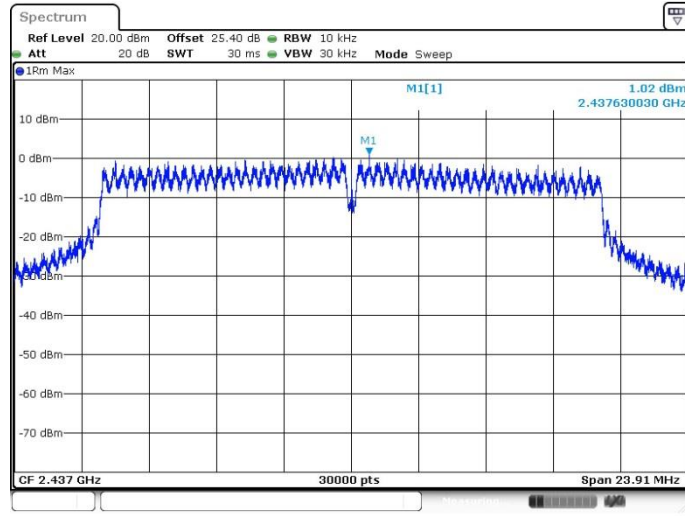

Date: 11 SEP.2018 06:59:49

Worst Case Power Density (dBm/3kHz) for MIMO Ant. 2

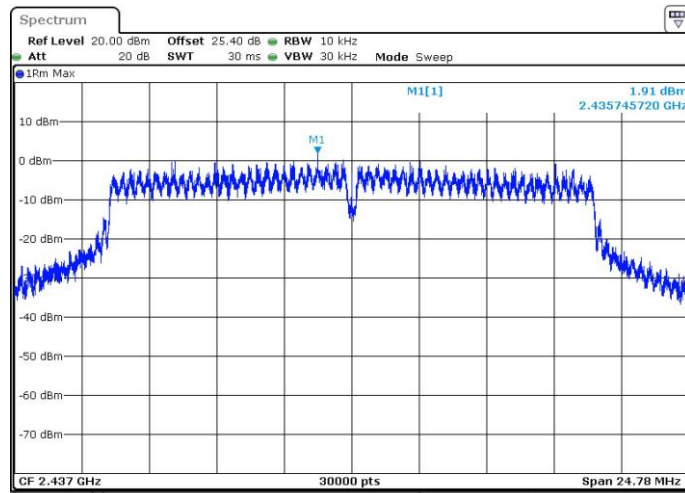

Date: 11 SEP.2018 07:02:16

3.4 Conducted Band Edges and Spurious Emission Measurement

3.4.1 Limit of Conducted Band Edges and Spurious Emission Measurement

In any 100 kHz bandwidth outside of the authorized frequency band, the emissions which fall in the non-restricted bands shall be attenuated at least 20 dB / 30dB relative to the maximum PSD level in 100 kHz by RF conducted measurement.

3.4.2 Measuring Instruments

See list of measuring equipment of this test report.

3.4.3 Test Procedures

1. The testing follows FCC KDB Publication No. 558074 D01 DTS Meas. Guidance v05.
2. The RF output of EUT was connected to the spectrum analyzer by RF cable and attenuator. The path loss was compensated to the results for each measurement.
3. Set to the maximum power setting and enable the EUT transmit continuously.
4. Set RBW = 100 kHz, VBW=300 kHz, Peak Detector. Unwanted Emissions measured in any 100 kHz bandwidth outside of the authorized frequency band shall be attenuated by at least 20 dB relative to the maximum in-band peak PSD level in 100 kHz when maximum peak conducted output power procedure is used. If the transmitter complies with the conducted power limits based on the use of RMS averaging over a time interval, the attenuation required under this paragraph shall be 30 dB instead of 20 dB per 15.247(d).
5. Measure and record the results in the test report.
6. The RF fundamental frequency should be excluded against the limit line in the operating frequency band.

3.4.4 Test Setup

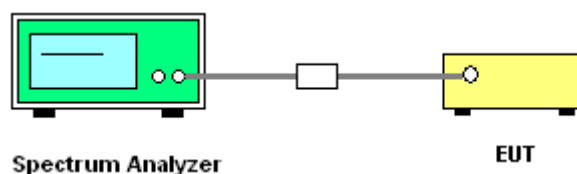



3.4.5 Test Result of Conducted Band Edges and Spurious Emission

Test Engineer :	Rebecca Li, Lena Lo, Derek Hsu, Shiang Wang, and Allen Lin	Temperature :	21~25°C
		Relative Humidity :	51~54%

<CDD Mode>

Number of TX = 1, Ant. 1 (Measured)

Test Mode :	802.11b	Test Channel :	01
-------------	---------	----------------	----

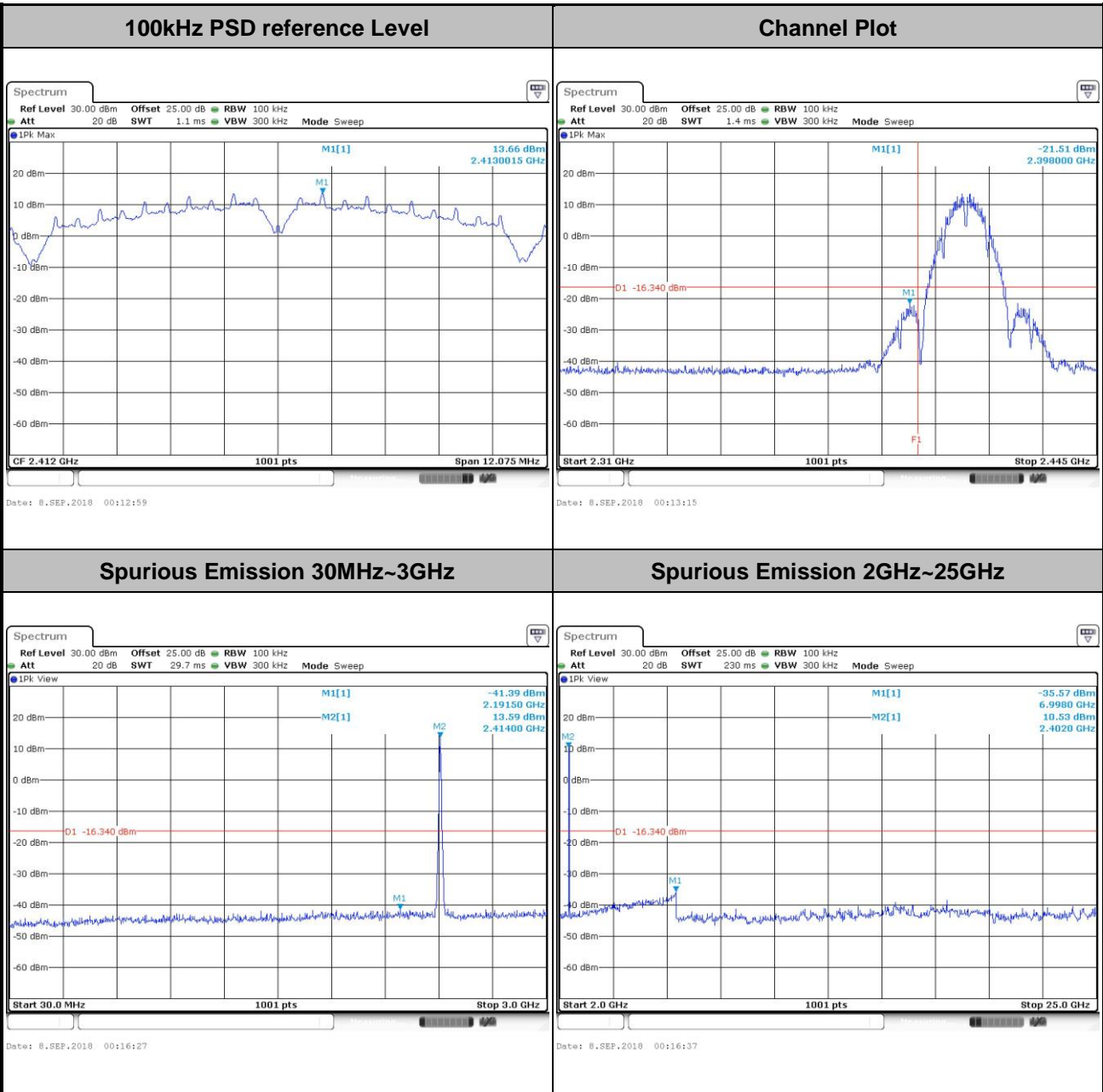



Test Mode :	802.11b	Test Channel :	06
-------------	---------	----------------	----

100kHz PSD reference Level

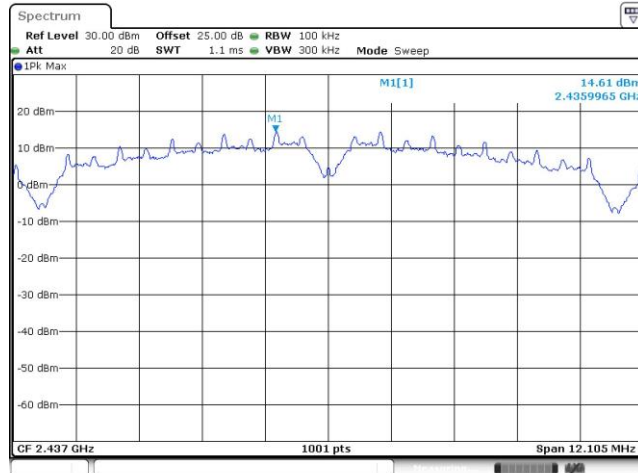

Date: 8.SEP.2018 00:25:43

Spurious Emission 30MHz~3GHz

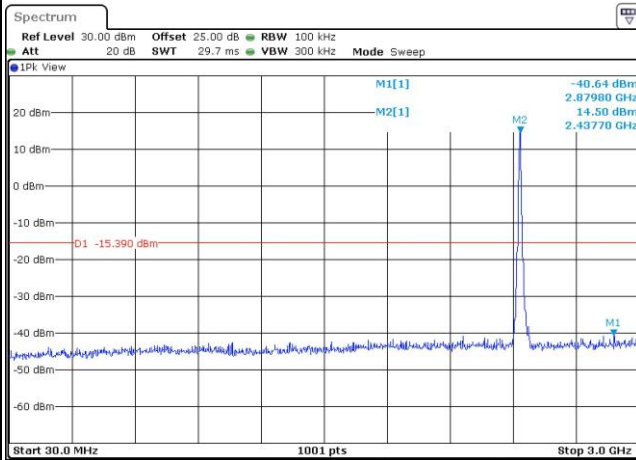

Date: 8.SEP.2018 00:26:03

Spurious Emission 2GHz~25GHz

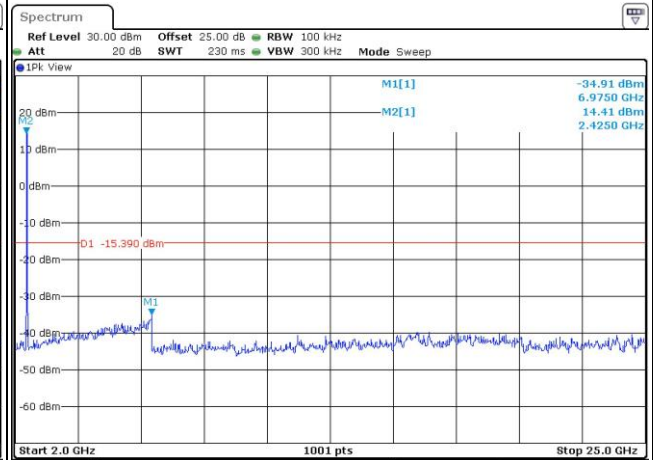

Date: 8.SEP.2018 00:26:13



Test Mode :	802.11b	Test Channel :	11
-------------	---------	----------------	----

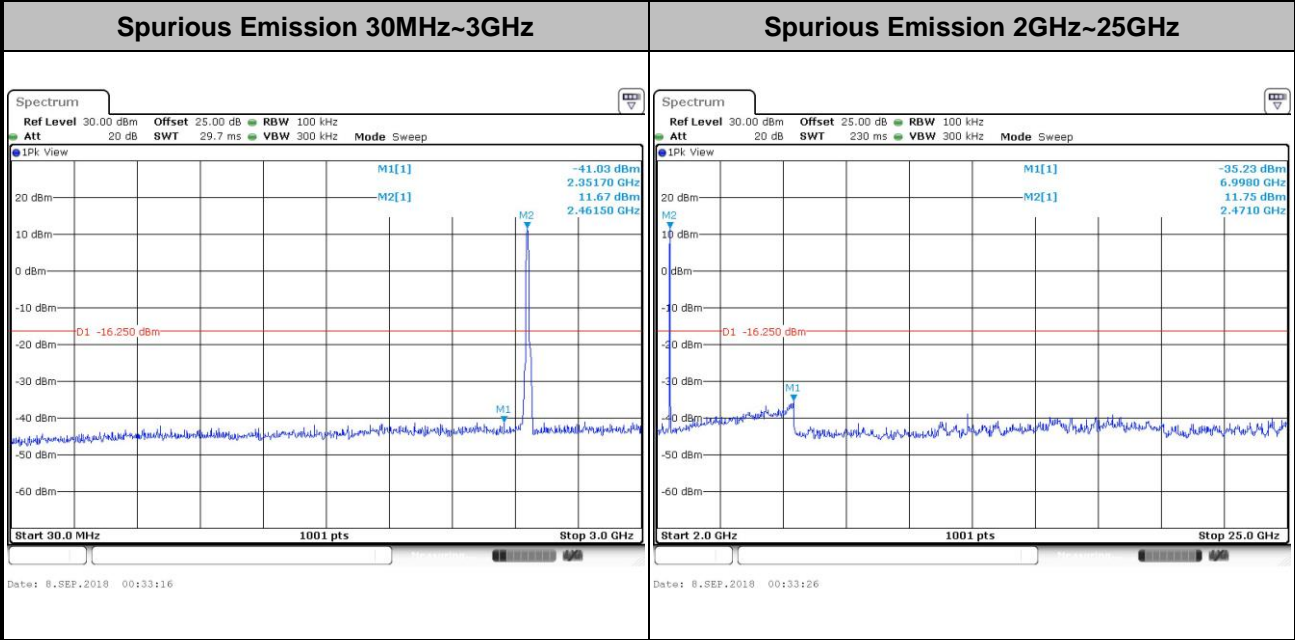
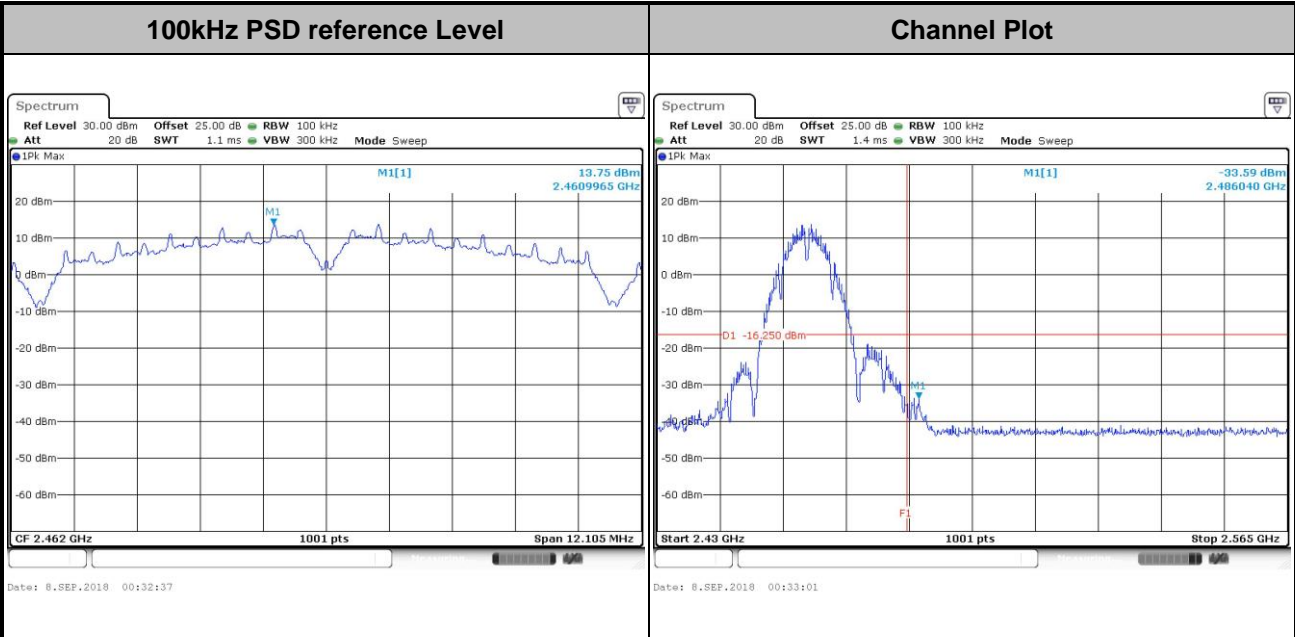



Test Mode : 802.11g Test Channel : 01

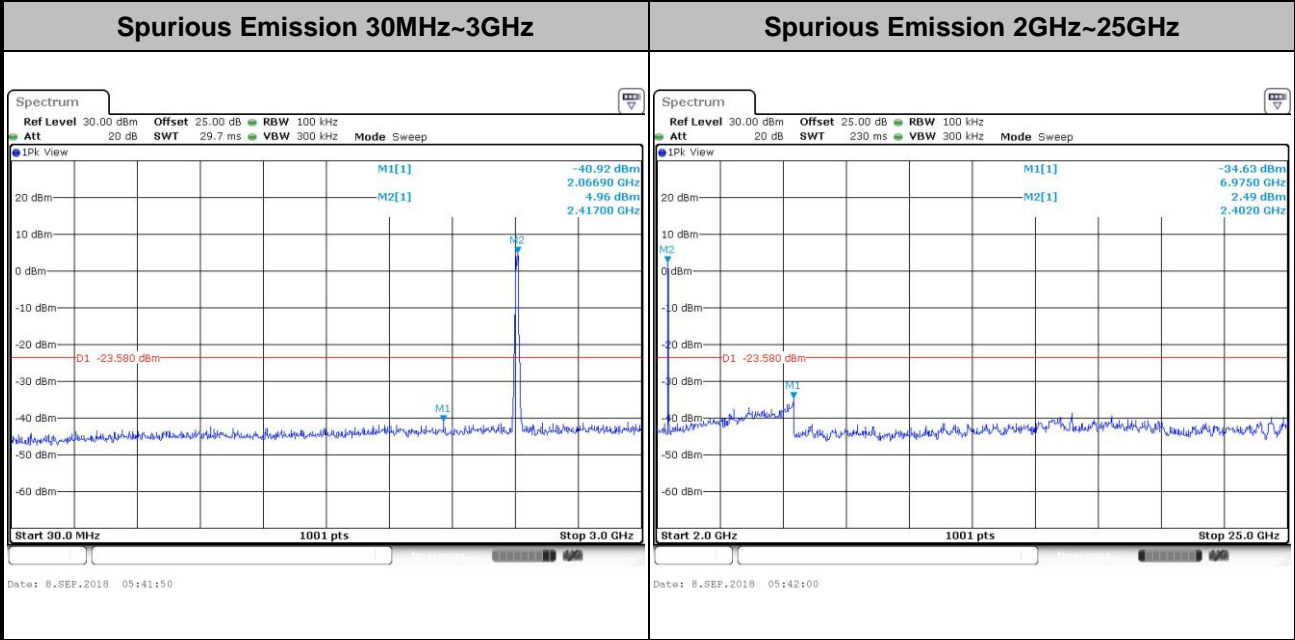
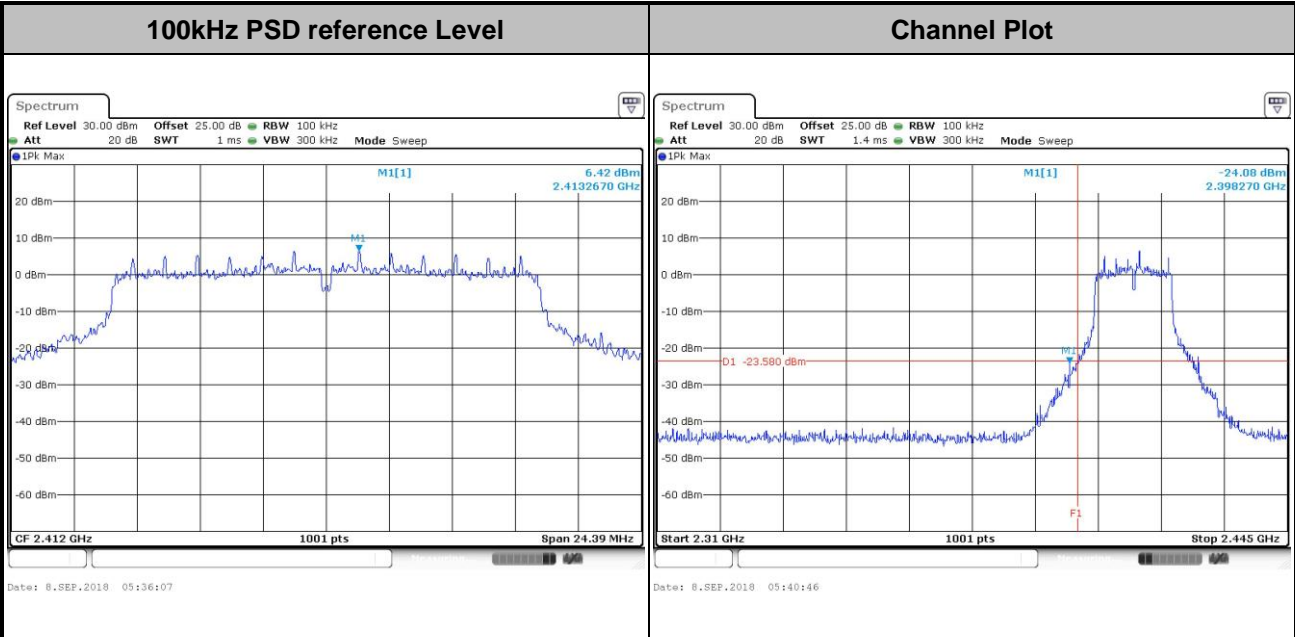



Test Mode :	802.11g	Test Channel :	06
-------------	---------	----------------	----

100kHz PSD reference Level

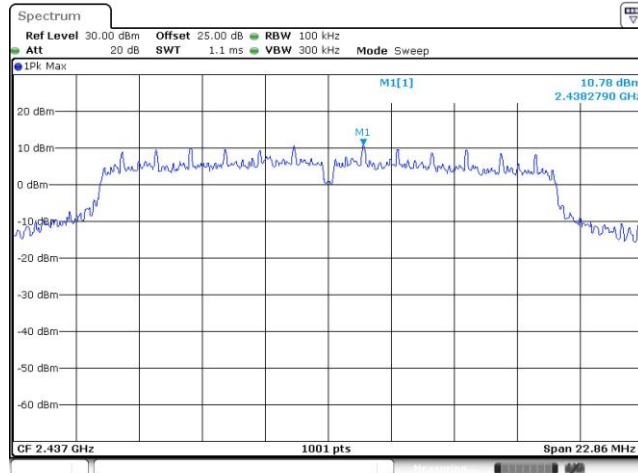

Date: 8.SEP.2018 06:05:01

Spurious Emission 30MHz~3GHz

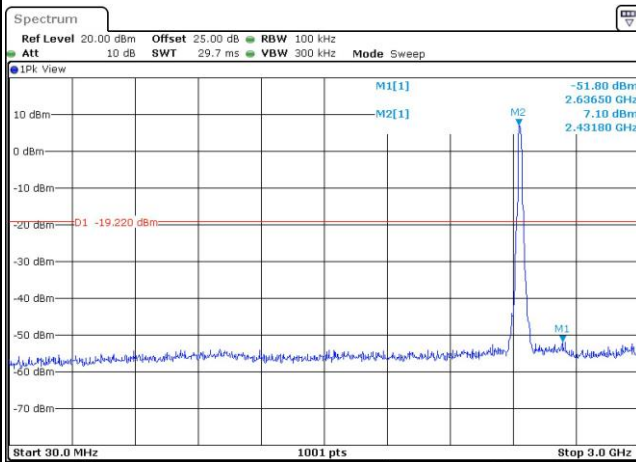

Date: 8.SEP.2018 18:13:40

Spurious Emission 2GHz~25GHz

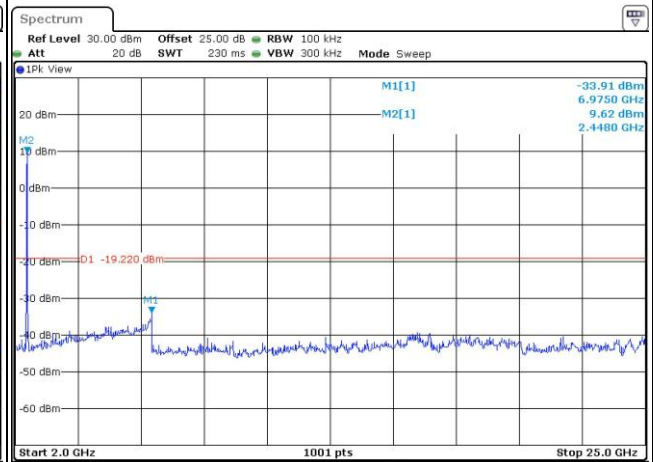

Date: 8.SEP.2018 06:05:34



Test Mode :	802.11g	Test Channel :	11
-------------	---------	----------------	----

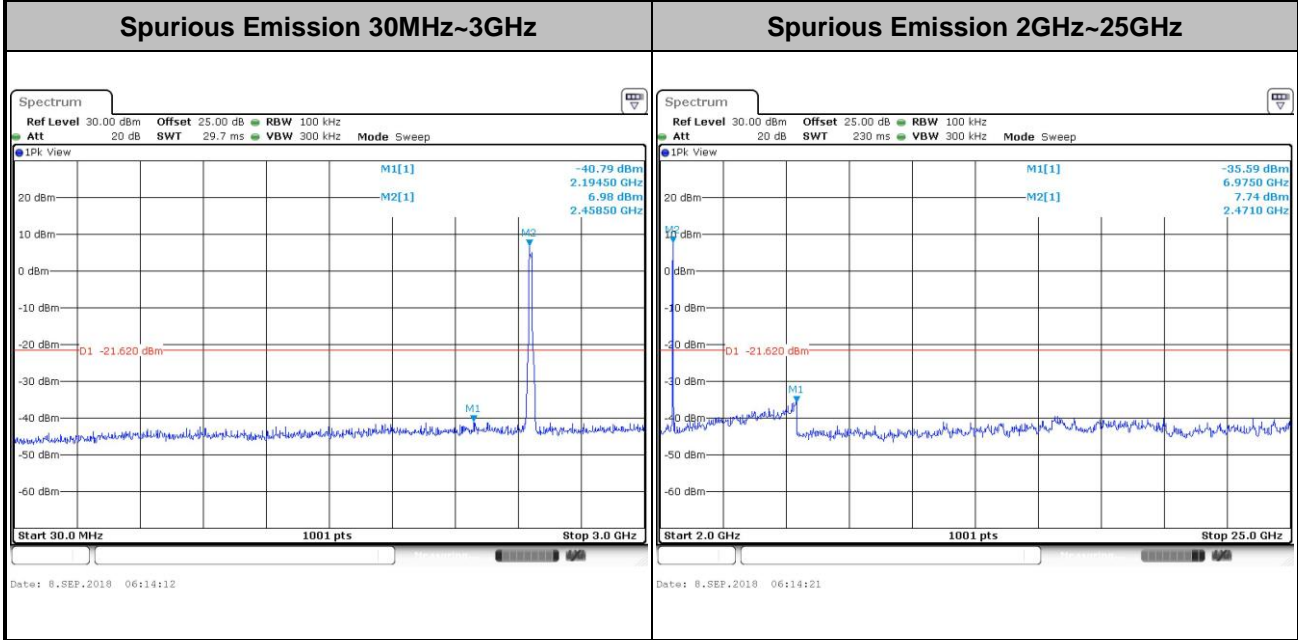
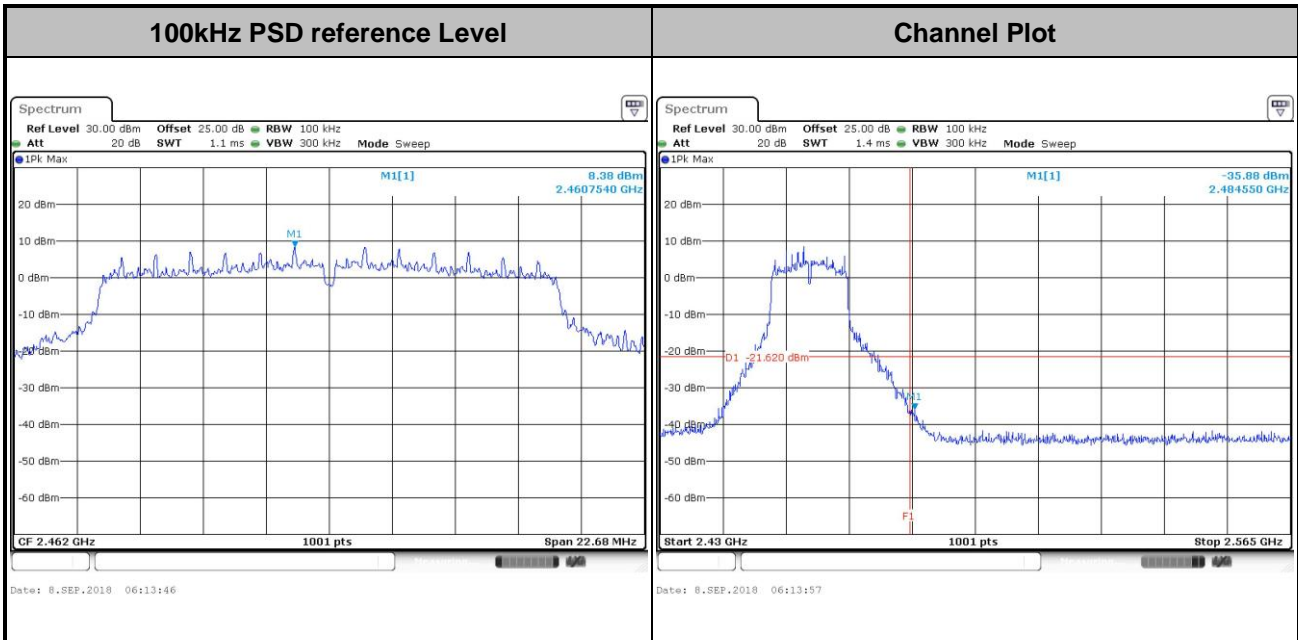



Test Mode :	802.11ac VHT20	Test Channel :	01
-------------	----------------	----------------	----

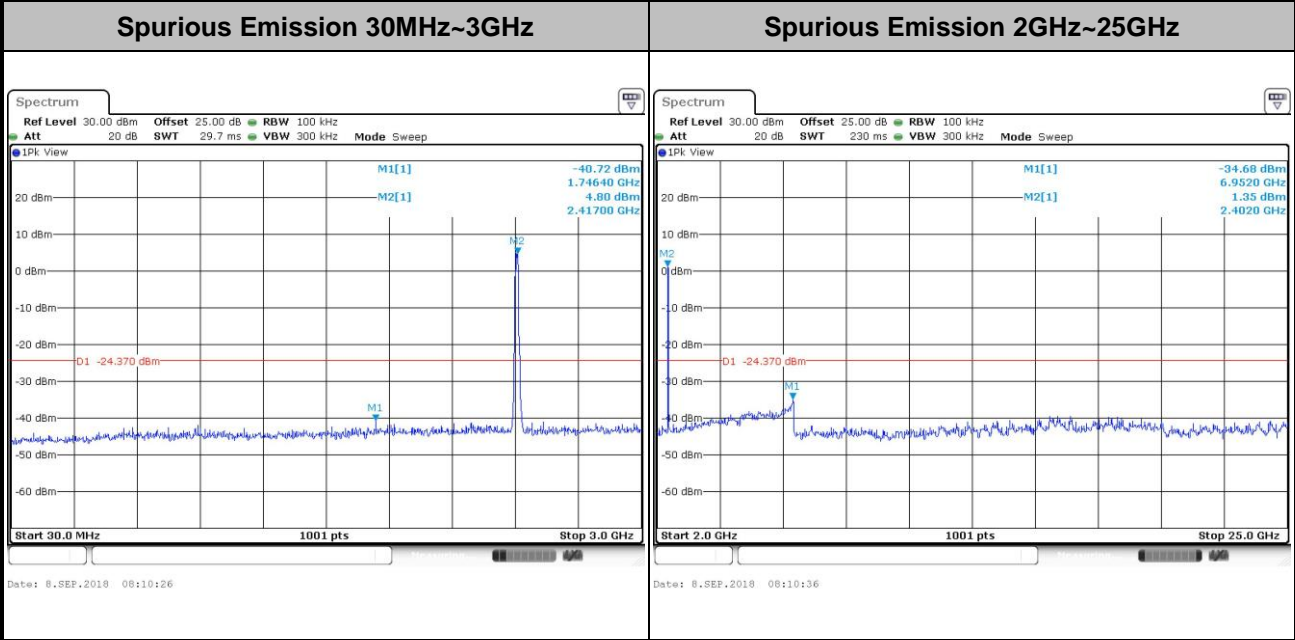
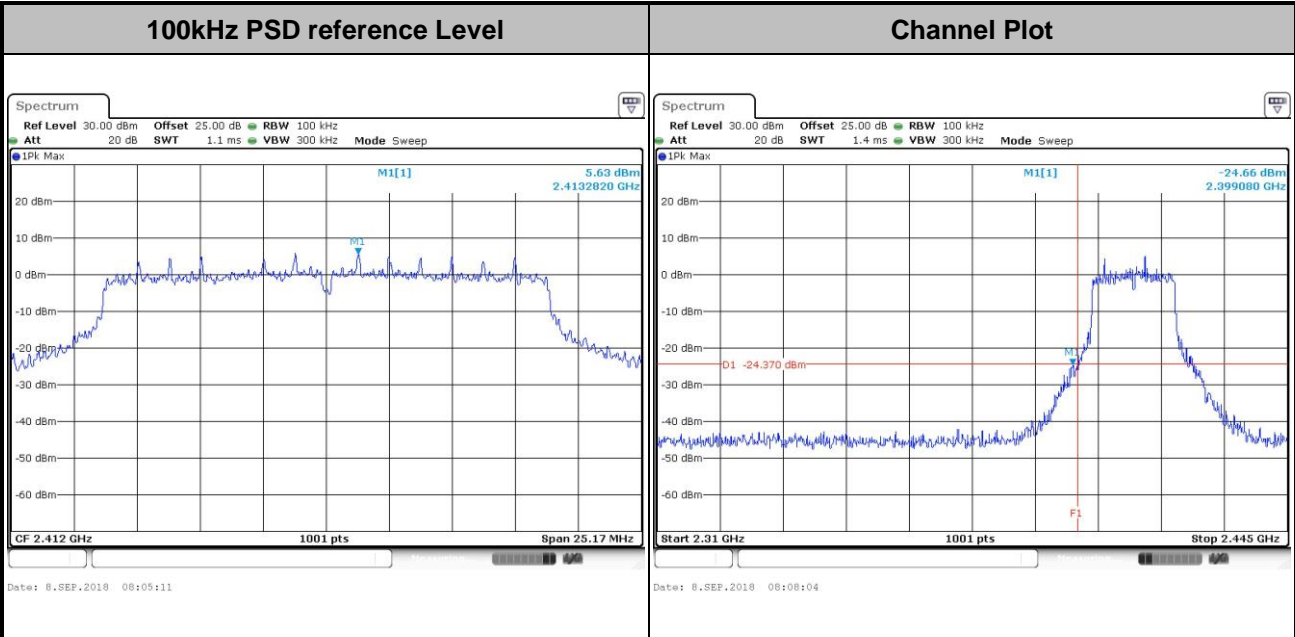



Test Mode :	802.11ac VHT20	Test Channel :	06
-------------	----------------	----------------	----

100kHz PSD reference Level

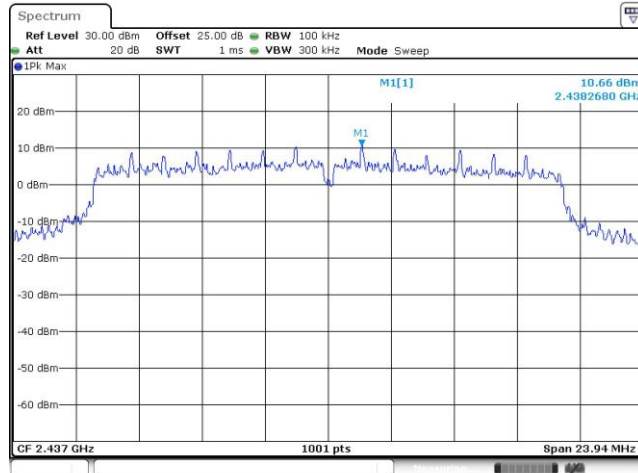

Date: 8.SEP.2018 10:01:03

Spurious Emission 30MHz~3GHz

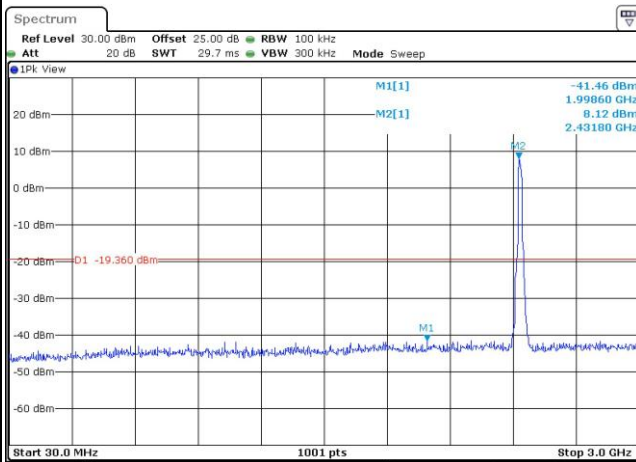

Date: 8.SEP.2018 10:03:13

Spurious Emission 2GHz~25GHz

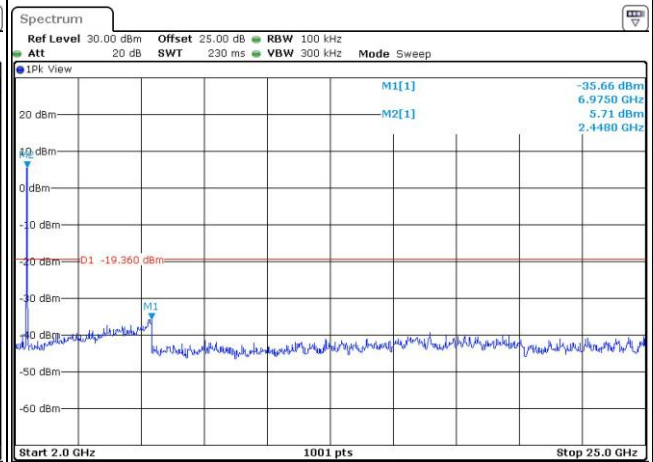

Date: 8.SEP.2018 10:03:23



Test Mode :	802.11ac VHT20	Test Channel :	11
-------------	----------------	----------------	----

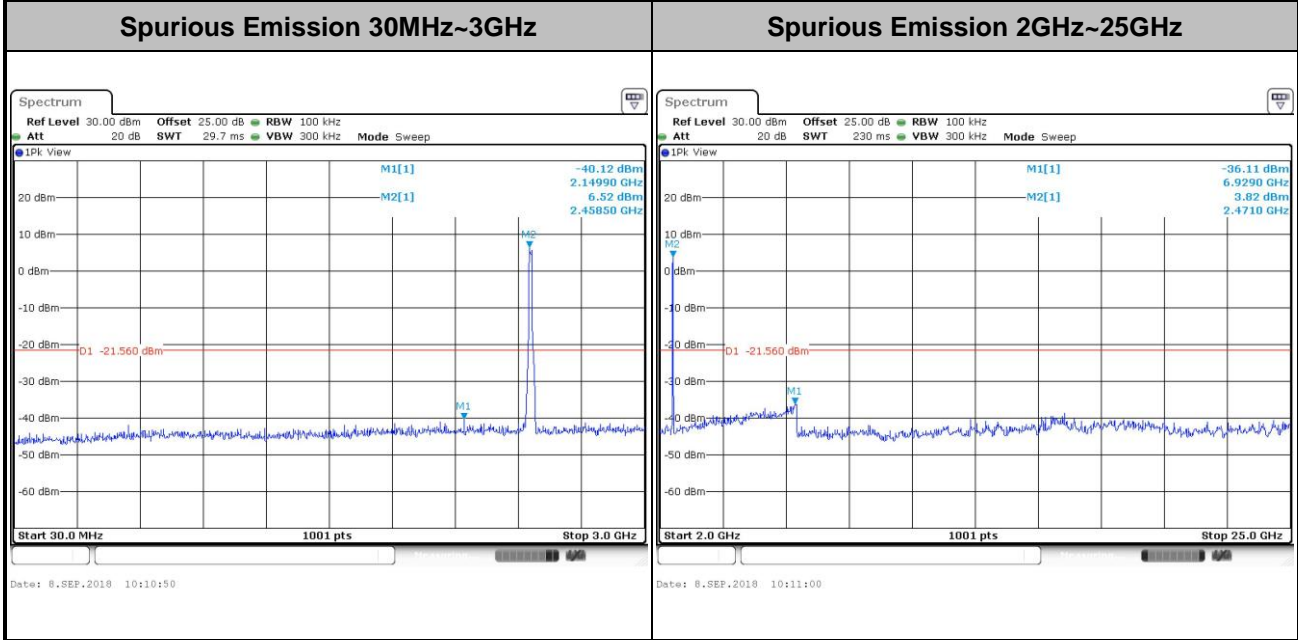
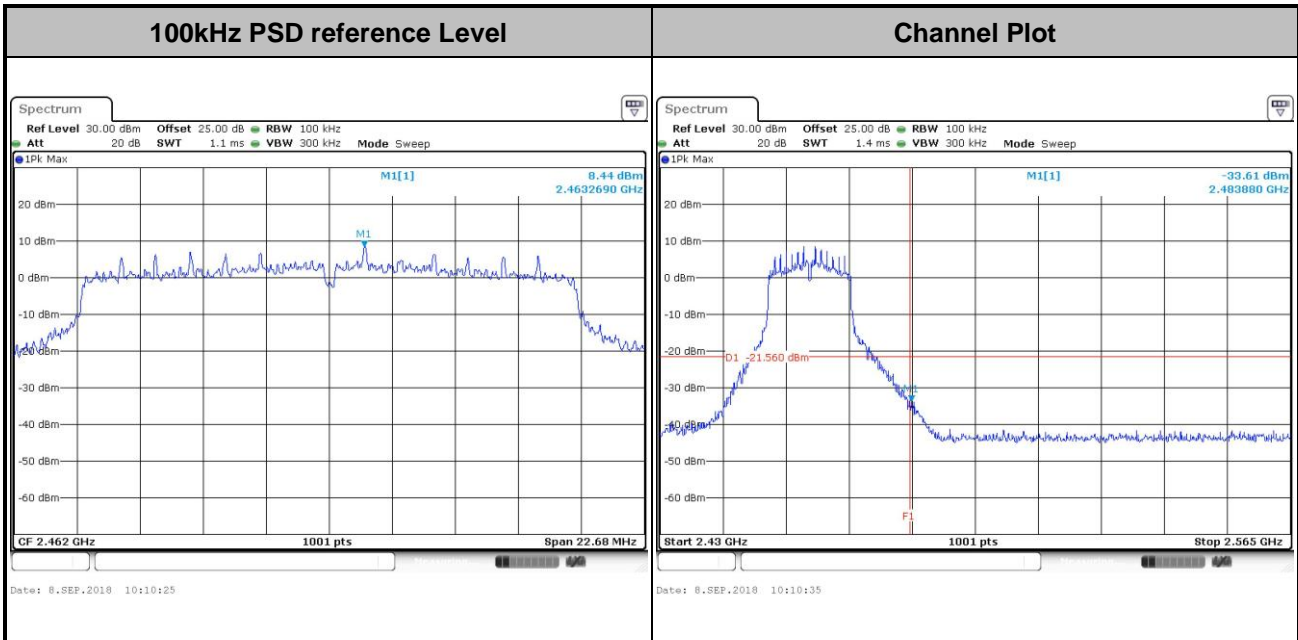



Test Mode : 802.11ac VHT40 Test Channel : 03

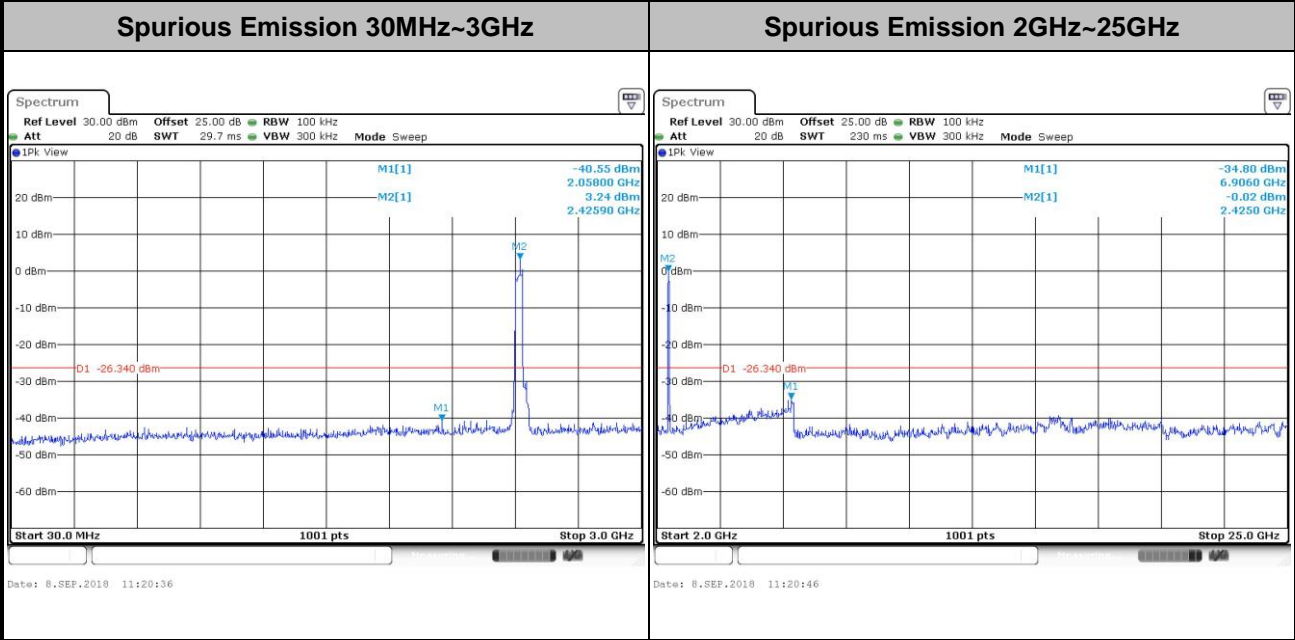
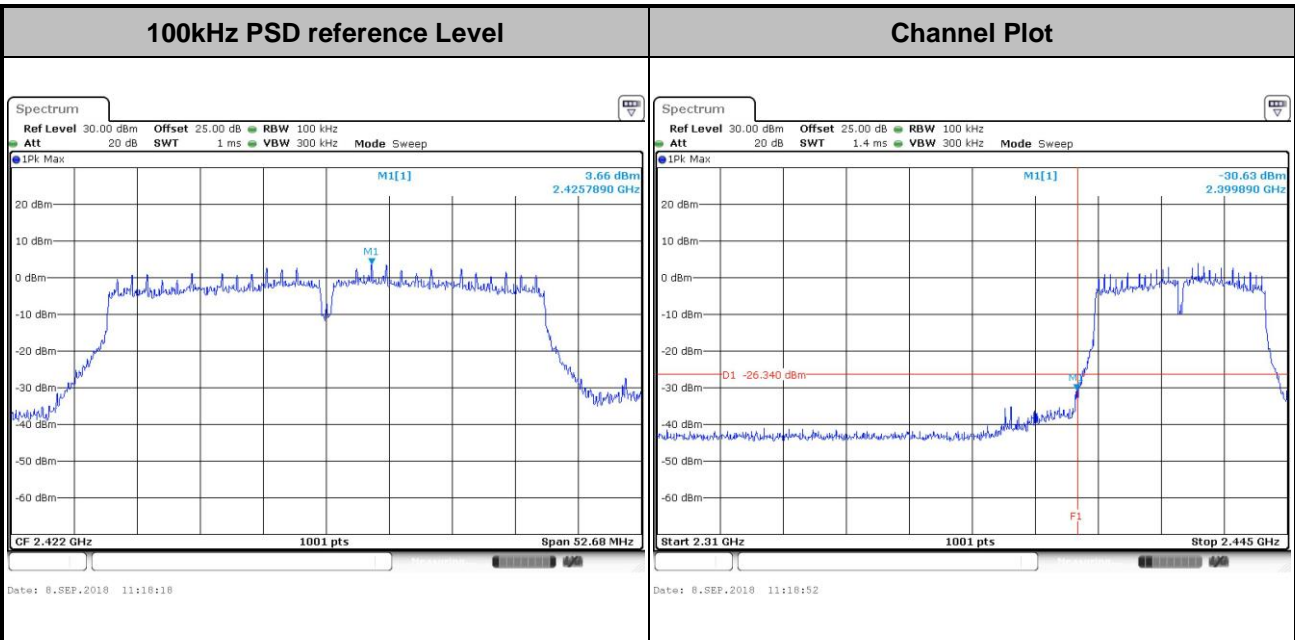



Test Mode :	802.11ac VHT40	Test Channel :	06
-------------	----------------	----------------	----

100kHz PSD reference Level



Date: 8.SEP.2018 11:24:42

Spurious Emission 30MHz~3GHz

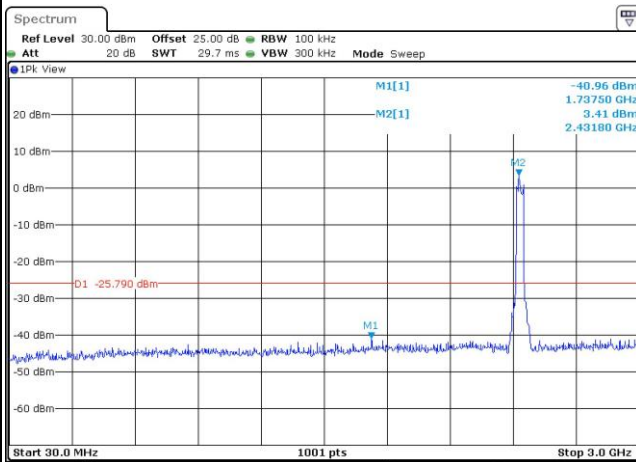

Date: 8.SEP.2018 11:26:18

Spurious Emission 2GHz~25GHz

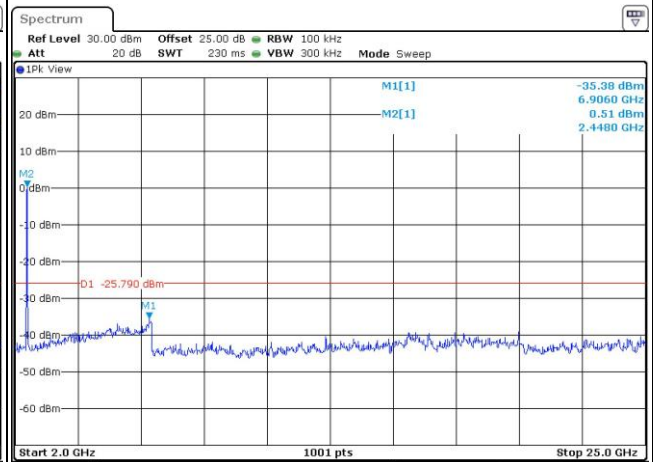

Date: 8.SEP.2018 11:26:28



Test Mode : 802.11ac VHT40 Test Channel : 09

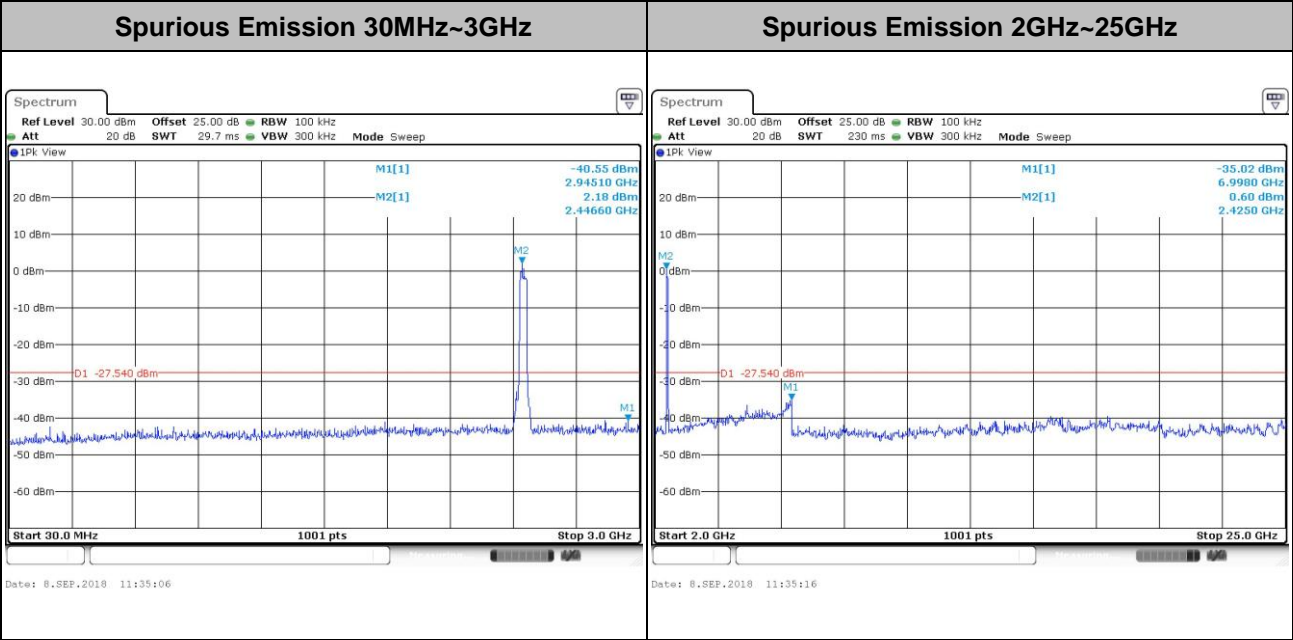
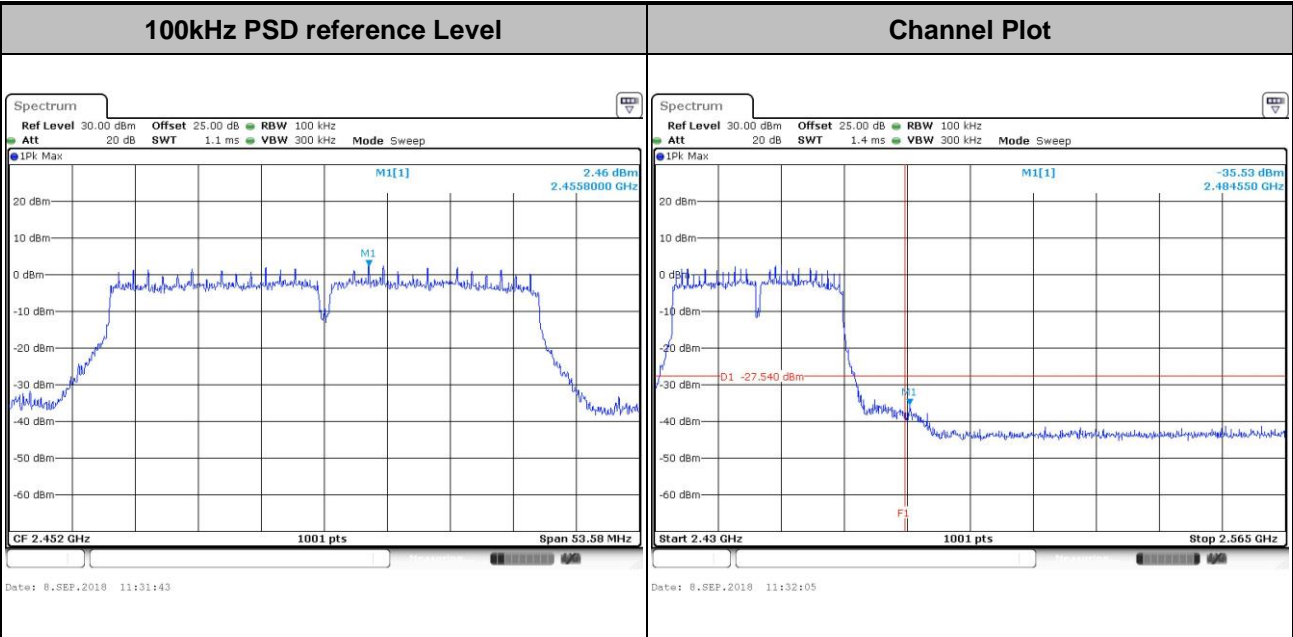



Number of TX = 1, Ant. 2 (Measured)

Test Mode :	802.11b	Test Channel :	01
-------------	---------	----------------	----

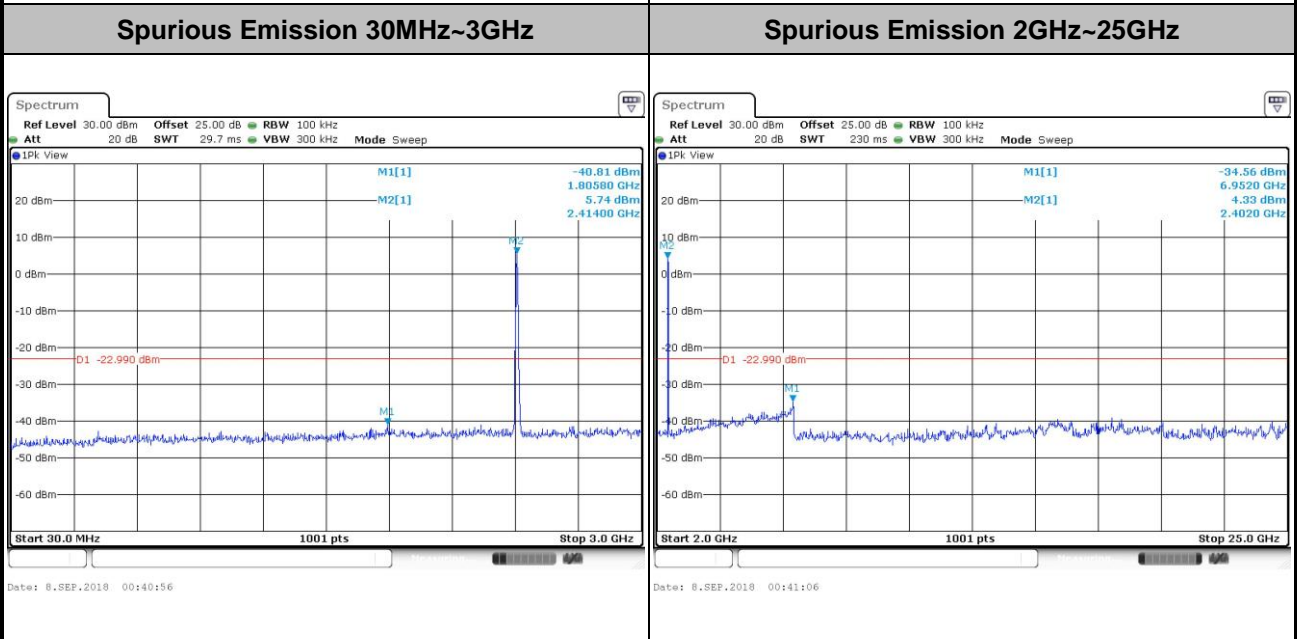
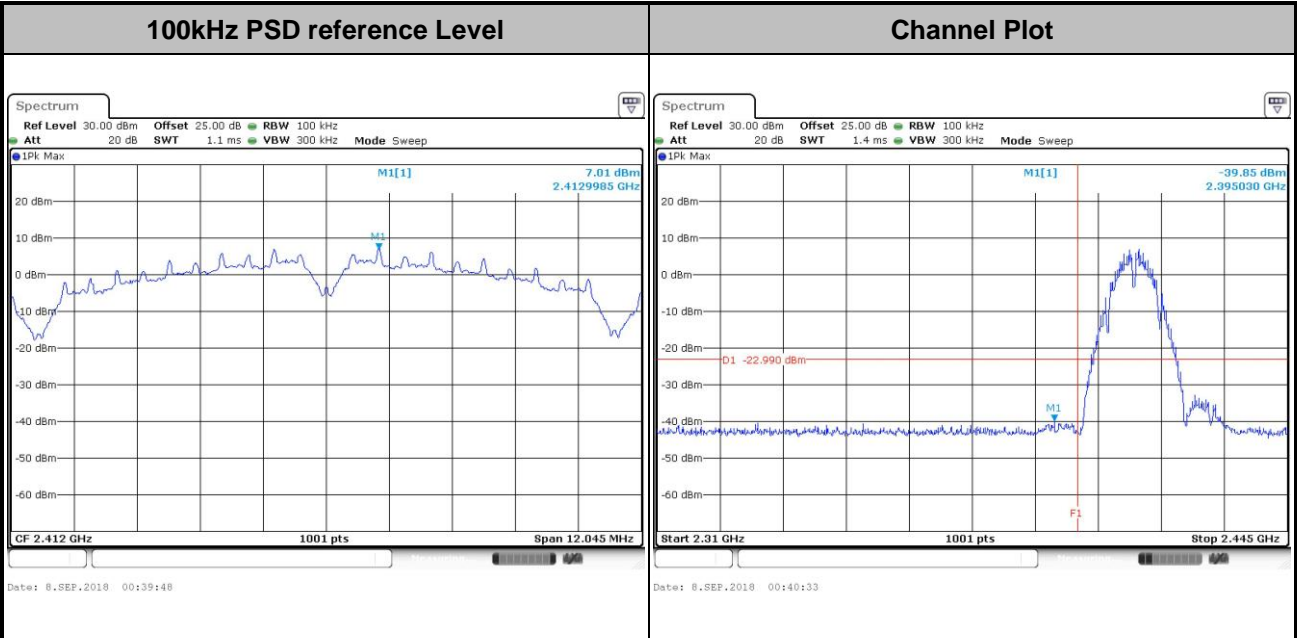



Test Mode :	802.11b	Test Channel :	06
-------------	---------	----------------	----

100kHz PSD reference Level

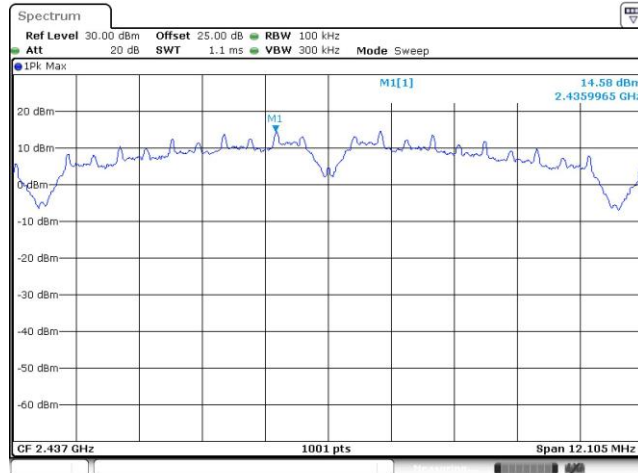

Date: 8.SEP.2018 00:44:59

Spurious Emission 30MHz~3GHz

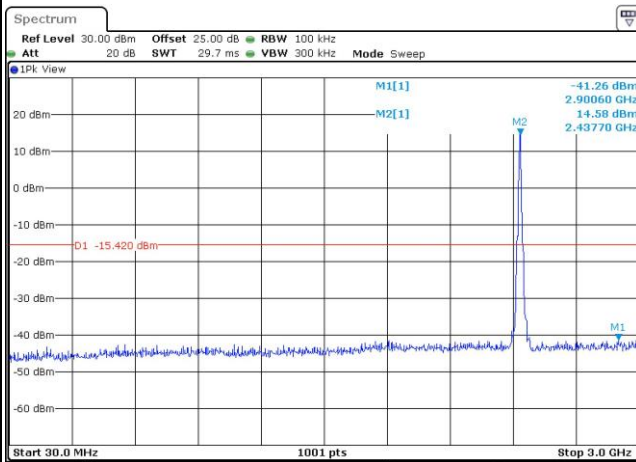

Date: 8.SEP.2018 00:45:41

Spurious Emission 2GHz~25GHz

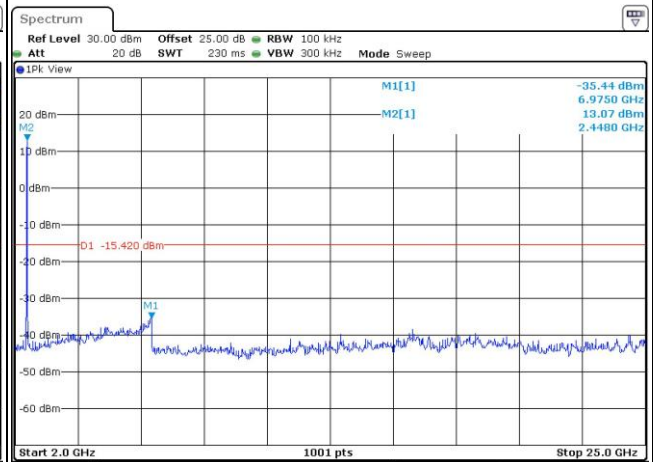

Date: 8.SEP.2018 00:45:50



Test Mode :	802.11b	Test Channel :	11
-------------	---------	----------------	----

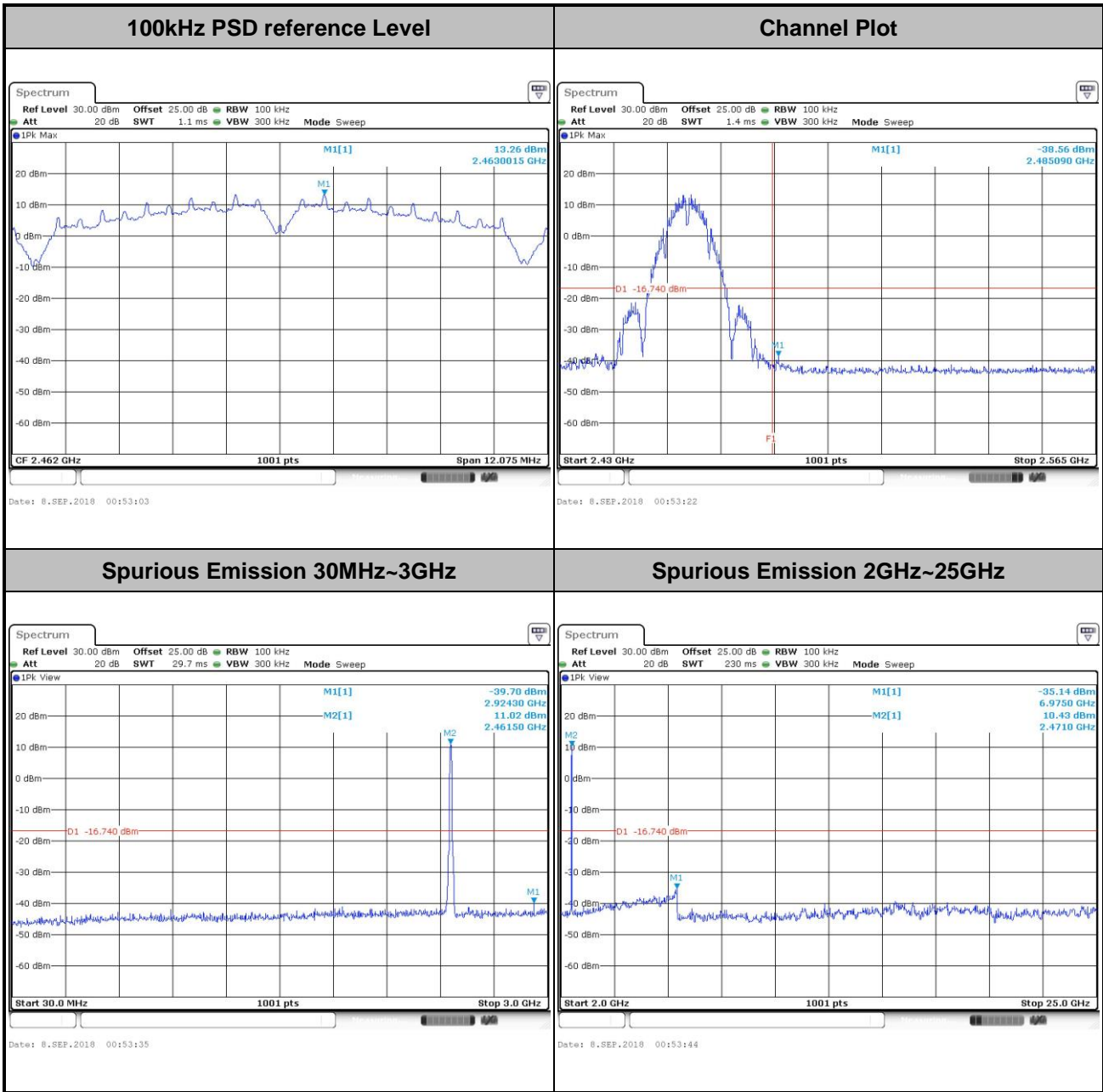



Test Mode :	802.11g	Test Channel :	01
-------------	---------	----------------	----

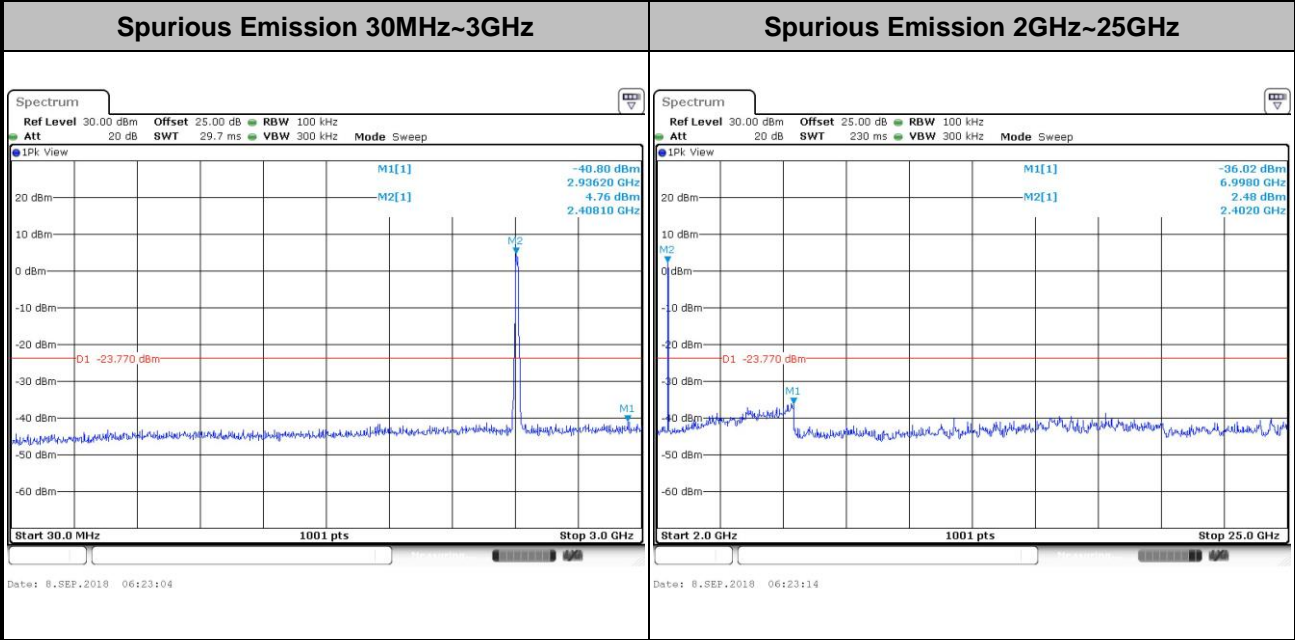
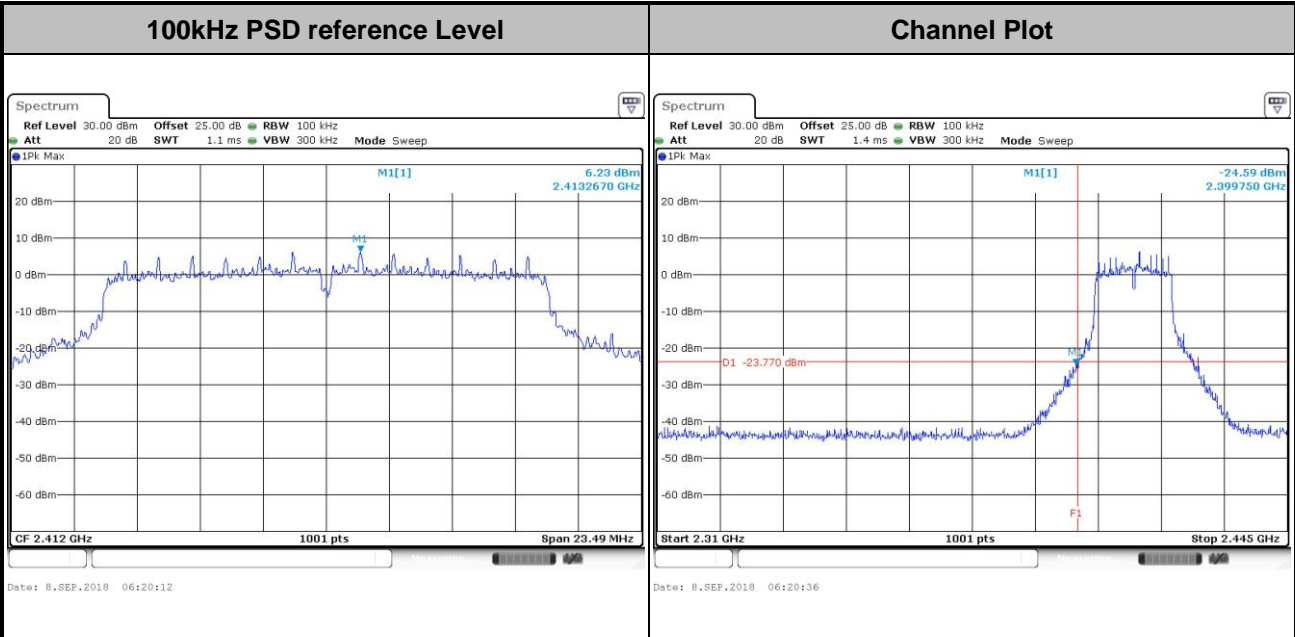



Test Mode :	802.11g	Test Channel :	06
-------------	---------	----------------	----

100kHz PSD reference Level

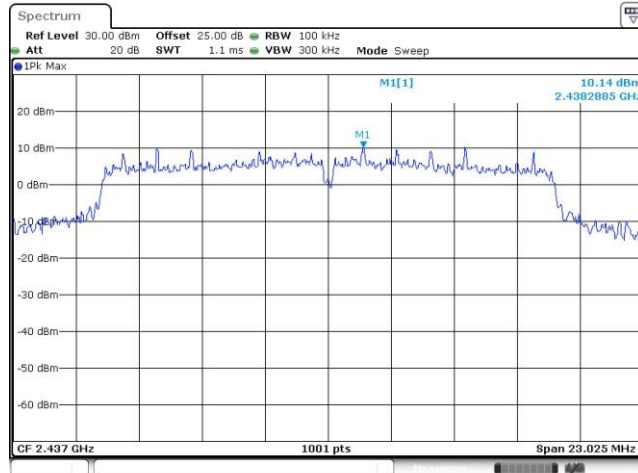

Spurious Emission 30MHz~3GHz

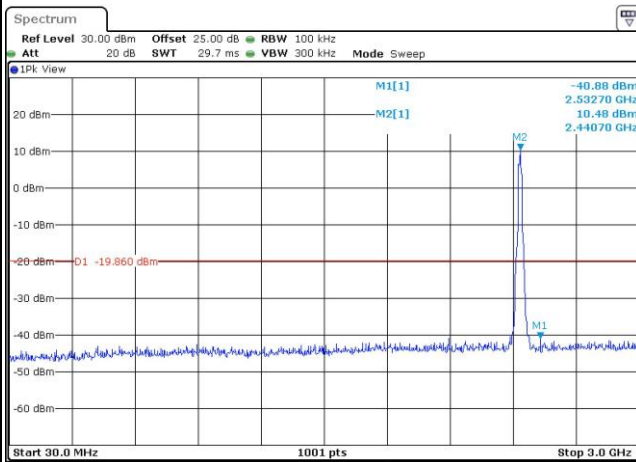

Spurious Emission 2GHz~25GHz

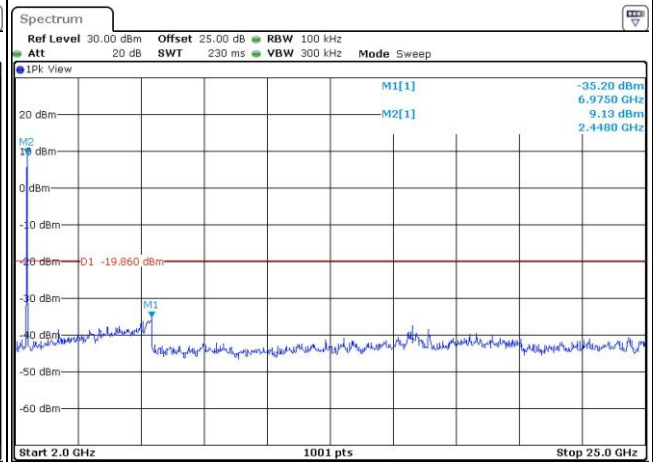



Test Mode :	802.11g	Test Channel :	11
-------------	---------	----------------	----

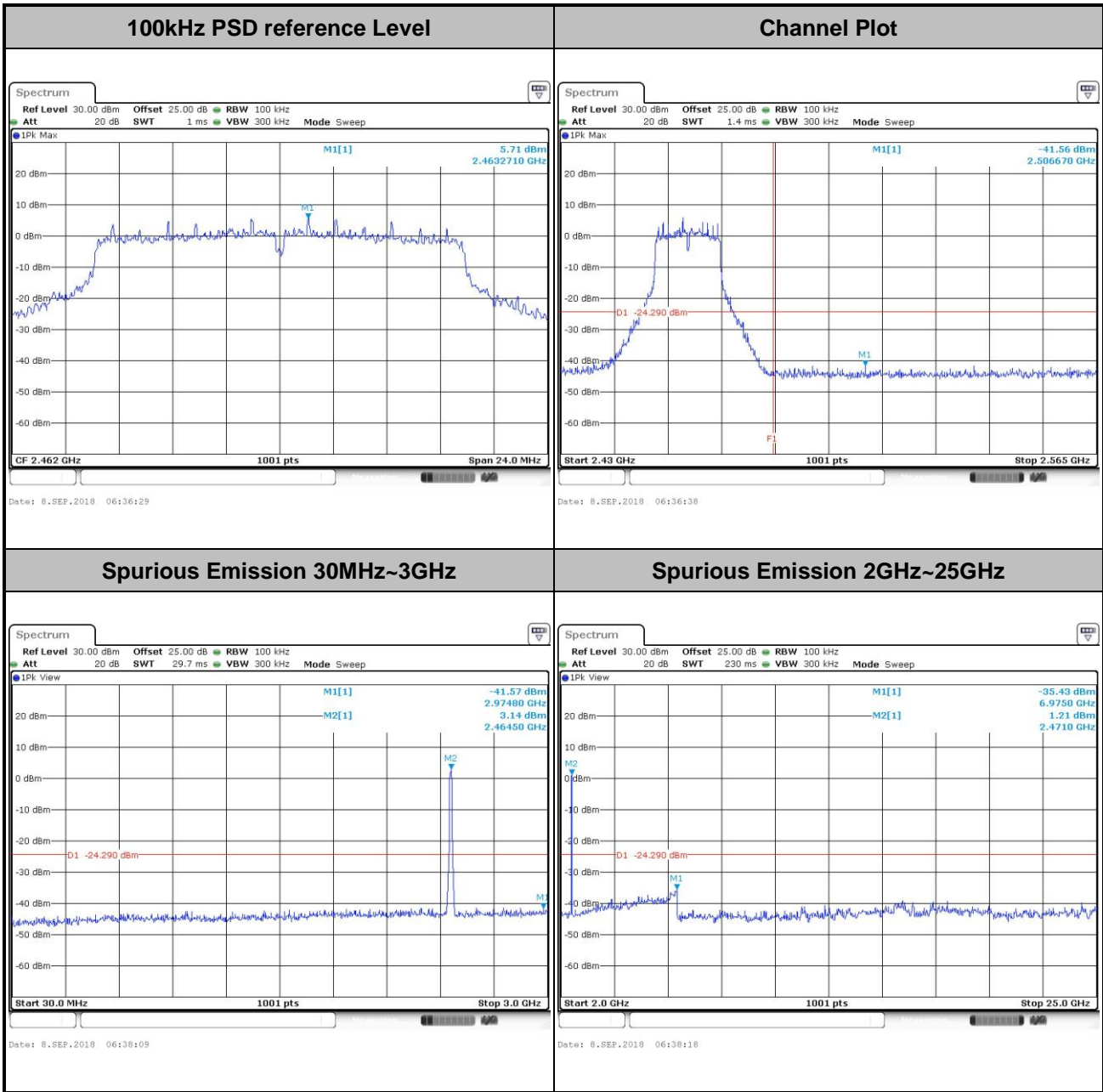



Test Mode : 802.11ac VHT20 Test Channel : 01

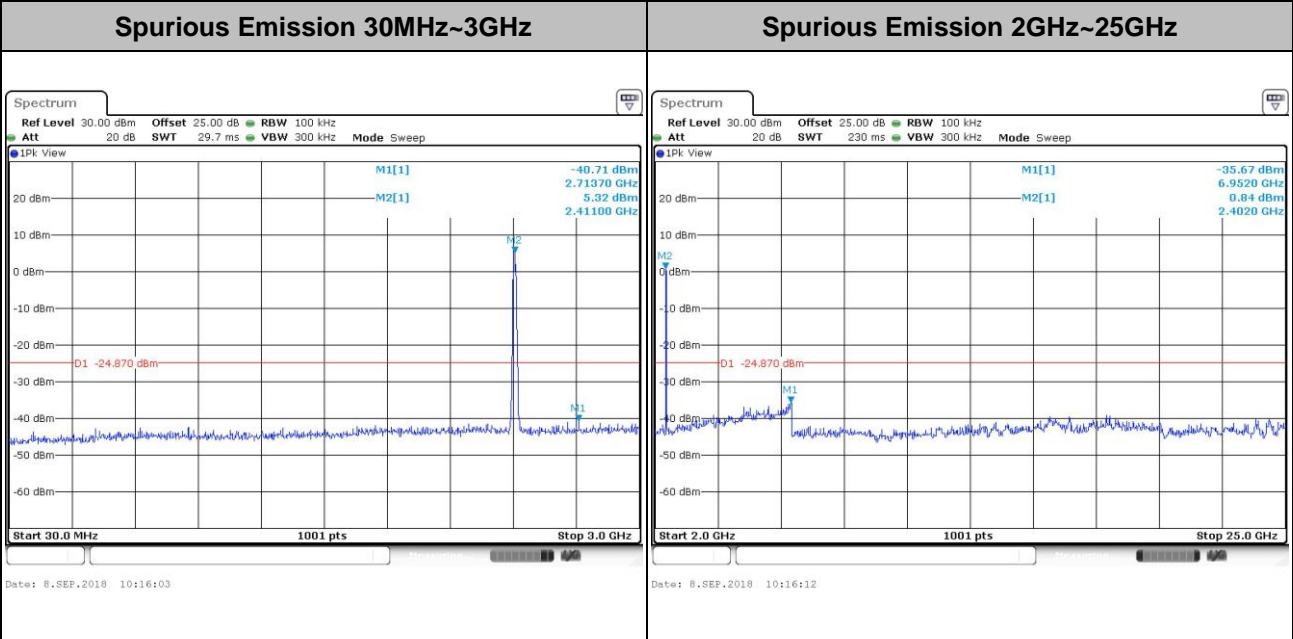
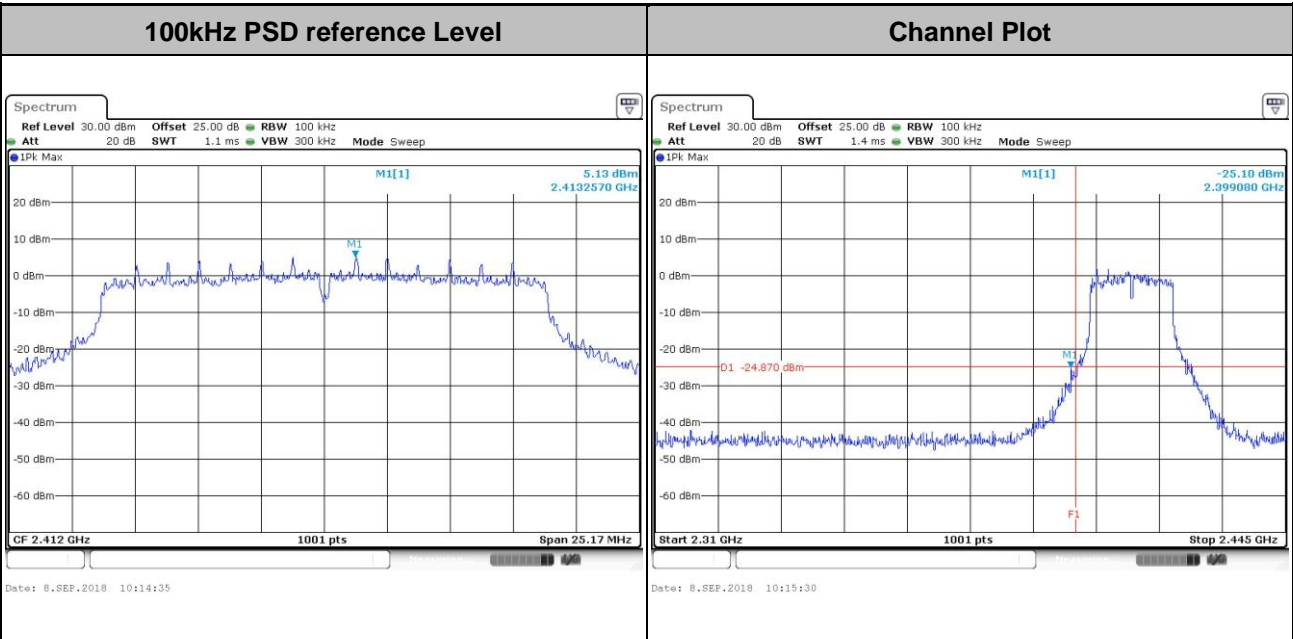



Test Mode :	802.11ac VHT20	Test Channel :	06
-------------	----------------	----------------	----

100kHz PSD reference Level

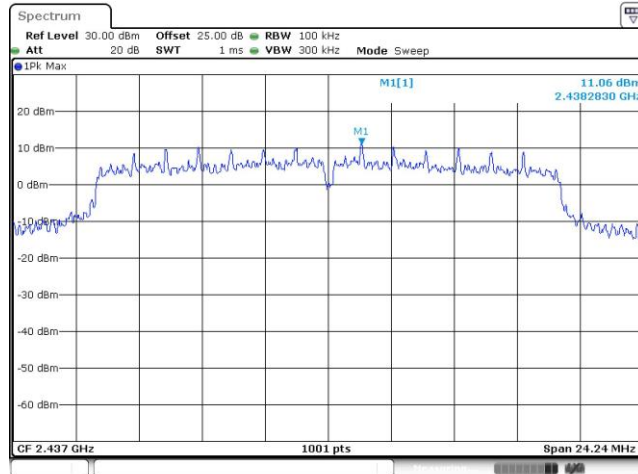

Date: 8.SEP.2018 10:19:31

Spurious Emission 30MHz~3GHz

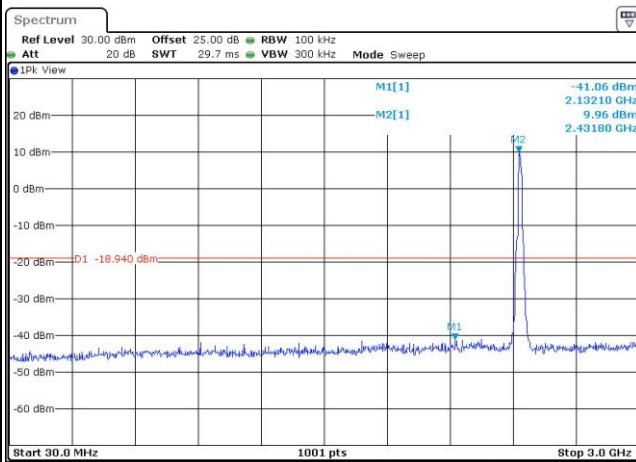

Date: 8.SEP.2018 10:20:20

Spurious Emission 2GHz~25GHz

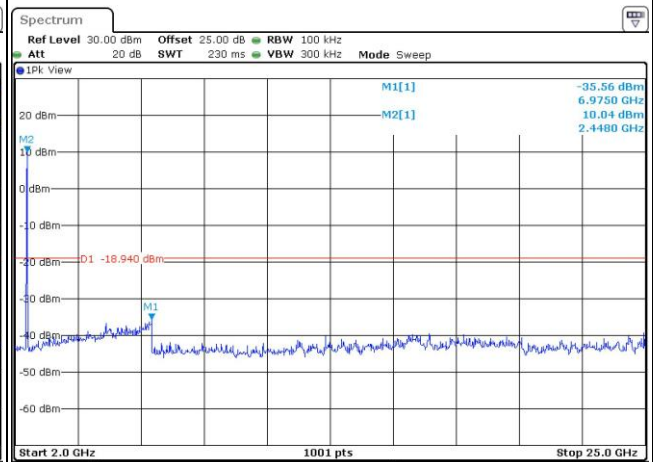

Date: 8.SEP.2018 10:20:30



Test Mode : 802.11ac VHT20 Test Channel : 11

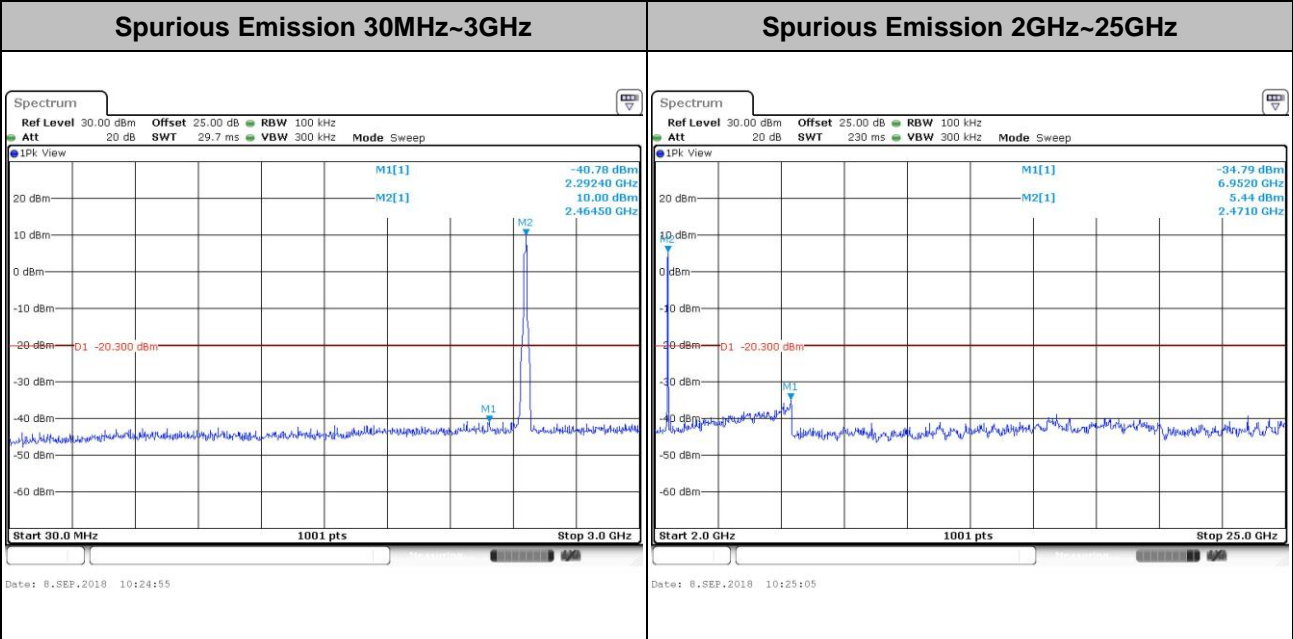
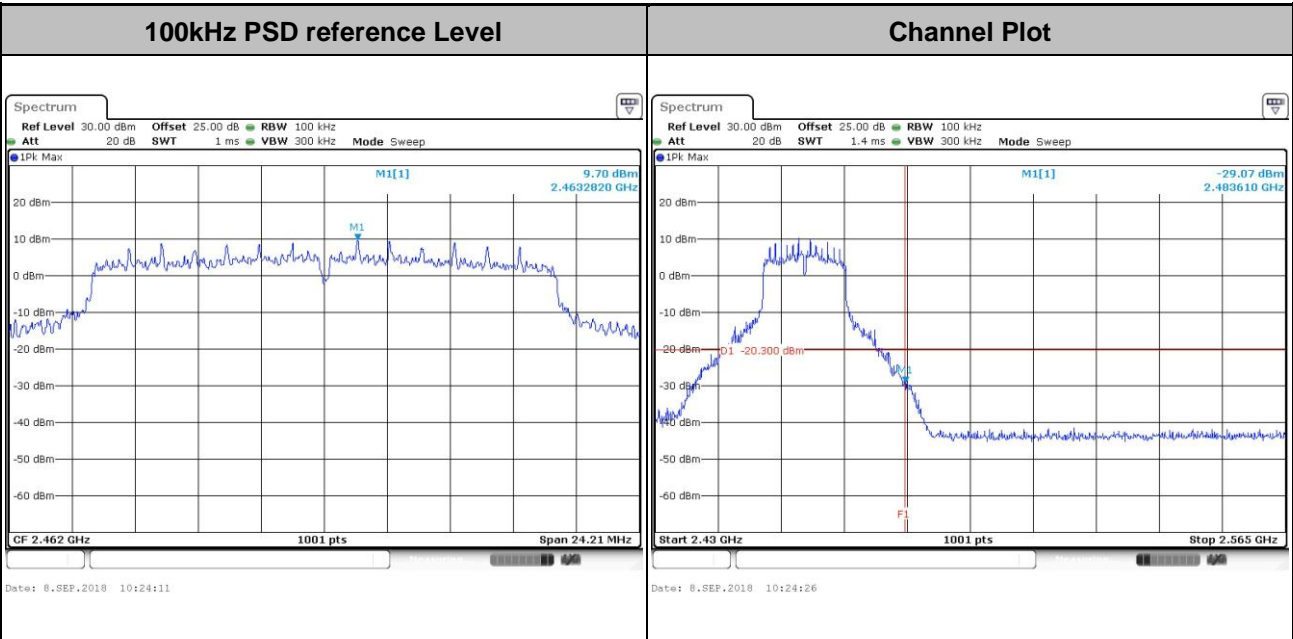



Test Mode : 802.11ac VHT40 Test Channel : 03

100kHz PSD reference Level Channel Plot

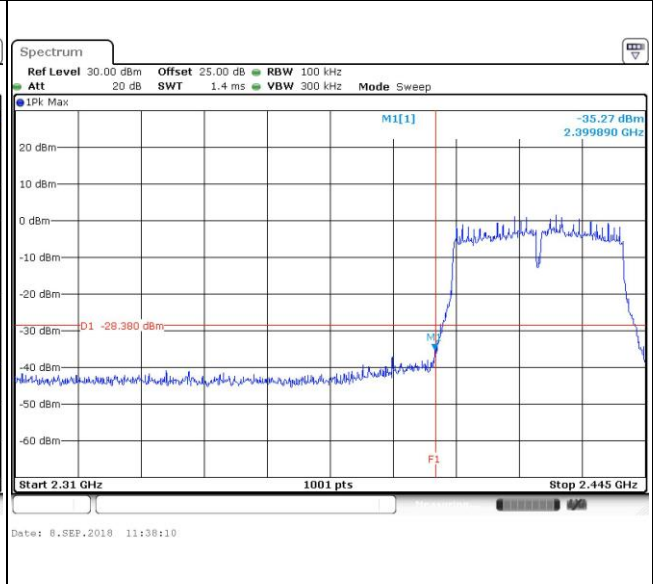
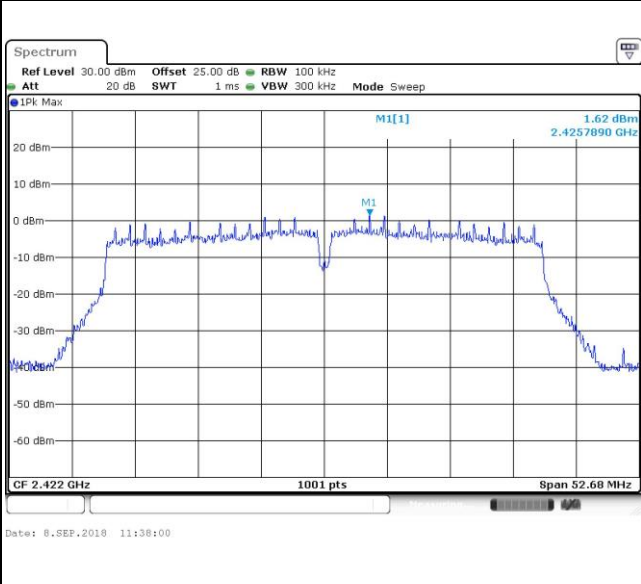

Spurious Emission 30MHz~3GHz

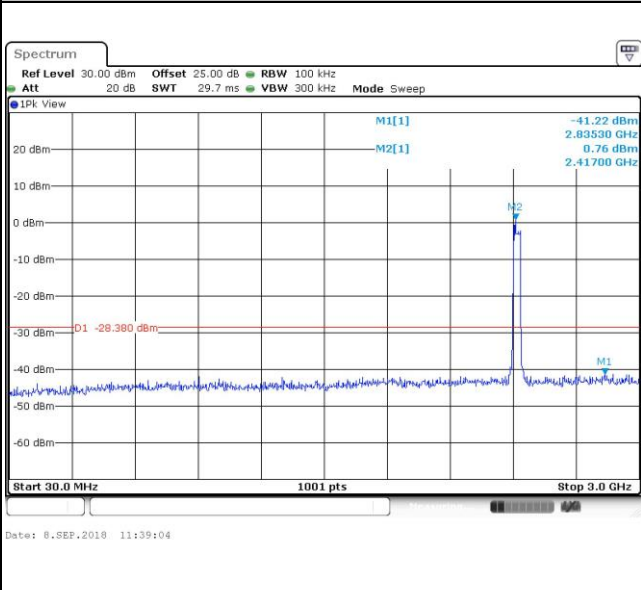

Spurious Emission 2GHz~25GHz

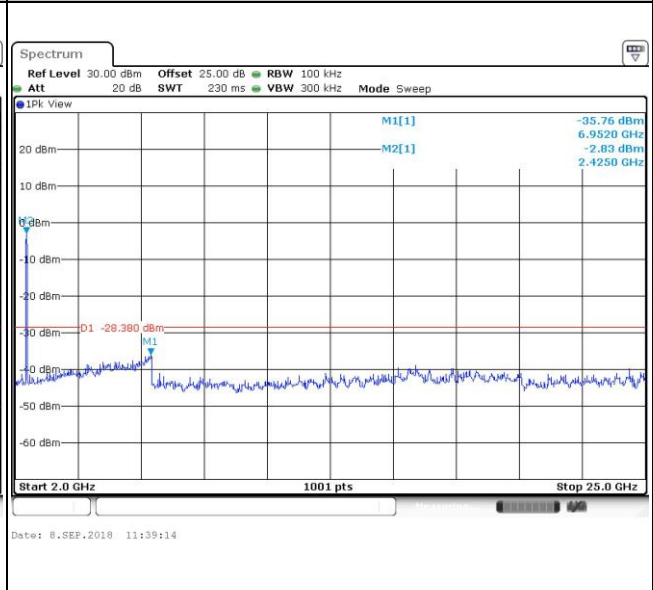



Test Mode :	802.11ac VHT40	Test Channel :	06
-------------	----------------	----------------	----

100kHz PSD reference Level

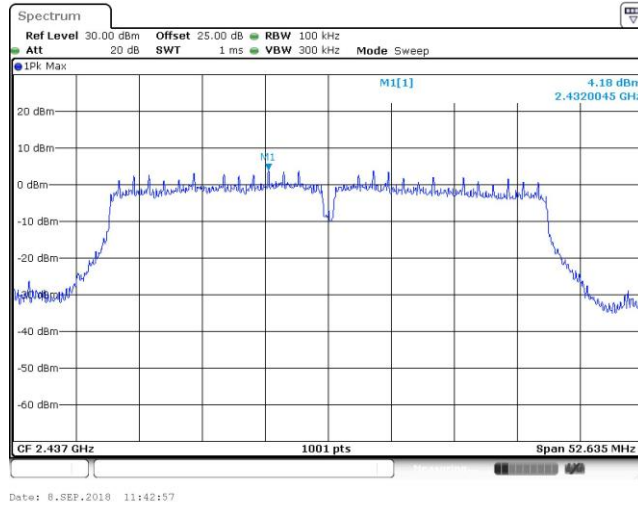

Spurious Emission 30MHz~3GHz

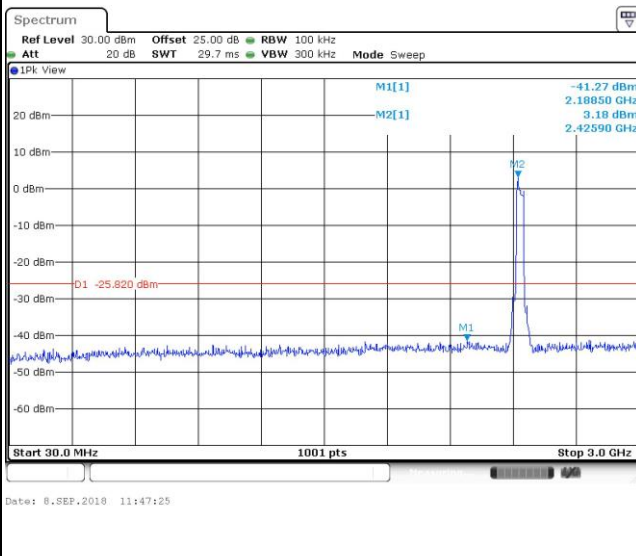

Spurious Emission 2GHz~25GHz

