



# FCC RADIO TEST REPORT

FCC ID : UZ7TC77HL  
Equipment : Touch Computer  
Brand Name : Zebra  
Model Name : TC77HL  
Applicant : Zebra Technologies Corporation  
1 Zebra Plaza Holtsville, NY 11742  
Manufacturer : Zebra Technologies Corporation  
1 Zebra Plaza Holtsville, NY 11742  
Standard : FCC Part 15 Subpart C §15.247

The product was received on Jul. 25, 2018 and testing was started from Aug. 07, 2018 and completed on Sep. 09, 2018. We, SPORTON INTERNATIONAL INC., would like to declare that the tested sample has been evaluated in accordance with the test procedures and has been in compliance with the applicable technical standards.

The report must not be used by the client to claim product certification, approval, or endorsement by TAF or any agency of government.

The test results in this report apply exclusively to the tested model / sample. Without written approval of SPORTON INTERNATIONAL INC. EMC & Wireless Communications Laboratory, the test report shall not be reproduced except in full.

Reviewed by: Joseph Lin

**SPORTON INTERNATIONAL INC. EMC & Wireless Communications Laboratory**

No. 52, Huaya 1st Rd., Guishan Dist., Taoyuan City, Taiwan (R.O.C.)



## Table of Contents

<b>History of this test report.....</b>	<b>3</b>
<b>Summary of Test Result.....</b>	<b>4</b>
<b>1 General Description.....</b>	<b>5</b>
1.1 Product Feature of Equipment Under Test.....	5
1.2 Product Specification of Equipment Under Test.....	6
1.3 Modification of EUT .....	6
1.4 Testing Location .....	6
1.5 Applicable Standards.....	6
<b>2 Test Configuration of Equipment Under Test.....</b>	<b>7</b>
2.1 Carrier Frequency Channel .....	7
2.2 Test Mode.....	8
2.3 Connection Diagram of Test System.....	10
2.4 Support Unit used in test configuration and system .....	12
2.5 EUT Operation Test Setup .....	12
2.6 Measurement Results Explanation Example.....	12
<b>3 Test Result.....</b>	<b>13</b>
3.1 6dB and 99% Bandwidth Measurement .....	13
3.2 Output Power Measurement.....	22
3.3 Power Spectral Density Measurement .....	24
3.4 Conducted Band Edges and Spurious Emission Measurement .....	32
3.5 Radiated Band Edges and Spurious Emission Measurement .....	41
3.6 AC Conducted Emission Measurement.....	45
3.7 Antenna Requirements.....	47
<b>4 List of Measuring Equipment .....</b>	<b>48</b>
<b>5 Uncertainty of Evaluation.....</b>	<b>50</b>
<b>Appendix A. AC Conducted Emission Test Result</b>	
<b>Appendix B. Radiated Spurious Emission</b>	
<b>Appendix C. Radiated Spurious Emission Plots</b>	
<b>Appendix D. Duty Cycle Plots</b>	
<b>Appendix E. Setup Photographs</b>	



### History of this test report

Report No.	Version	Description	Issued Date
FR872506B	01	Initial issue of report	Sep. 19, 2018



## Summary of Test Result

Report Clause	Ref Std. Clause	Test Items	Result (PASS/FAIL)	Remark
3.1	15.247(a)(2)	6dB Bandwidth	Pass	-
3.1	2.1049	99% Occupied Bandwidth	Reporting only	-
3.2	15.247(b)(3)	Peak Output Power	Pass	-
3.3	15.247(e)	Power Spectral Density	Pass	-
3.4	15.247(d)	Conducted Band Edges and Spurious Emission	Pass	-
3.5	15.247(d)	Radiated Band Edges and Spurious Emission	Pass	Under limit 6.49 dB at 2351.300 MHz
3.6	15.207	AC Conducted Emission	Pass	Under limit 5.84 dB at 0.773 MHz
3.7	15.203 & 15.247(b)	Antenna Requirement	Pass	-

**Reviewed by: Wii Chang**

**Report Producer: Yimin Ho**



# 1 General Description

## 1.1 Product Feature of Equipment Under Test

Product Feature	
Equipment	Touch Computer
Brand Name	Zebra
Model Name	TC77HL
FCC ID	UZ7TC77HL
EUT supports Radios application	GSM/EGPRS/WCDMA/HSPA/LTE/NFC/GNSS WLAN 11a/b/g/n HT20/HT40 WLAN 11ac VHT20/VHT40/VHT80 Bluetooth BR/EDR/LE
HW Version	DV
SW Version	Android version 8.1.0
FW Version	91-09-14.00-OG-U00-STD
MFD	06JUL18
EUT Stage	Engineering Sample

Remark: The above EUT's information was declared by manufacturer.

Specification of Accessories				
AC Adapter	Brand Name	Zebra	Part Number	PWR-BUA5V16W0WW
4 PIN DC power cable	Brand Name	Zebra	Part Number	CBL-DC-383A1-01
AC Power cable	Brand Name	Zebra	Part Number	50-16000-182R
Snap-On USB/Charge Cable	Brand Name	Zebra	Part Number	CBL-TC7X-USB1-01
Snap-On Charging Cable Cup	Brand Name	Zebra	Part Number	CHG-TC7X-CBL1-01
Battery 1	Brand Name	Zebra	Part Number	BT-000318-01
Battery 2 (Falcon 1S3P Battery Pack)	Brand Name	Zebra	Part Number	BT-000318-51
Battery 3	Brand Name	Symbol	Part Number	82-171249-02
Earphone 1	Brand Name	Zebra	Part Number	HDST-35MM-PTVP-01
Earphone 2	Brand Name	Zebra	Part Number	HS2100-OTH
Snap-on 3.5MM Audio Jack Adapter	Brand Name	Symbol	Part Number	ADP-TC7X-AUD35-01
3.5mm Jack 43"(1.1m) Standard Cable	Brand Name	Zebra	Part Number	CBL-HS2100-3MS1-01
Holster	Brand Name	Zebra	Part Number	SG-TC7X-HLSTR1-02
Rigid Holster	Brand Name	Zebra	Part Number	SG-TC7X-RHLSTR1-01



### 1.2 Product Specification of Equipment Under Test

Standards-related Product Specification	
Tx/Rx Frequency Range	2402 MHz ~ 2480 MHz
Number of Channels	40
Carrier Frequency of Each Channel	40 Channel(37 hopping + 3 advertising channel)
Maximum Output Power to Antenna	3.67 dBm (0.0023 W) for 1Mbps 3.52 dBm (0.0022 W) for 2Mbps
99% Occupied Bandwidth	1.270MHz for 1Mbps 2.038MHz for 2Mbps
Antenna Type / Gain	PIFA Antenna type with gain 1.60 dBi
Type of Modulation	Bluetooth LE : GFSK

### 1.3 Modification of EUT

No modifications are made to the EUT during all test items.

### 1.4 Testing Location

Sporton Lab is accredited to ISO 17025 by Taiwan Accreditation Foundation (TAF code : 1190) and the FCC designation No. TW1190 under the FCC 2.948(e) by Mutual Recognition Agreement (MRA) in FCC Test.

Test Site	SPORTON INTERNATIONAL INC.		
Test Site Location	No.52, Huaya 1st Rd., Guishan Dist., Taoyuan City, Taiwan (R.O.C.) TEL: +886-3-327-3456 FAX: +886-3-328-4978		
Test Site No.	Sporton Site No.		
	TH05-HY	CO05-HY	03CH07-HY

Note: The test site complies with ANSI C63.4 2014 requirement.

### 1.5 Applicable Standards

According to the specifications of the manufacturer, the EUT must comply with the requirements of the following standards:

- ♦ FCC Part 15 Subpart C §15.247
- ♦ FCC KDB Publication No. 558074 D01 DTS Meas. Guidance v05
- ♦ FCC KDB 414788 D01 Radiated Test Site v01r01.
- ♦ ANSI C63.10-2013

**Remark:**

1. All test items were verified and recorded according to the standards and without any deviation during the test.
2. This EUT has also been tested and complied with the requirements of FCC Part 15, Subpart B, recorded in a separate test report.



## 2 Test Configuration of Equipment Under Test

### 2.1 Carrier Frequency Channel

Frequency Band	Channel	Freq. (MHz)	Channel	Freq. (MHz)
2400-2483.5 MHz	0	2402	21	2444
	1	2404	22	2446
	2	2406	23	2448
	3	2408	24	2450
	4	2410	25	2452
	5	2412	26	2454
	6	2414	27	2456
	7	2416	28	2458
	8	2418	29	2460
	9	2420	30	2462
	10	2422	31	2464
	11	2424	32	2466
	12	2426	33	2468
	13	2428	34	2470
	14	2430	35	2472
	15	2432	36	2474
	16	2434	37	2476
	17	2436	38	2478
	18	2438	39	2480
	19	2440	-	-
20	2442	-	-	



### 2.2 Test Mode

Channel	Frequency	Bluetooth – LE 1Mbps RF Average Output Power	
		Data Rate / Modulation	
		GFSK	
		1Mbps	
Ch00	2402MHz	1.99	dBm
Ch19	2440MHz	1.74	dBm
Ch39	2480MHz	1.35	dBm

Channel	Frequency	Bluetooth – LE 1Mbps RF Peak Output Power	
		Data Rate / Modulation	
		GFSK	
		1Mbps	
Ch00	2402MHz	3.67	dBm
Ch19	2440MHz	3.40	dBm
Ch39	2480MHz	2.99	dBm

Channel	Frequency	Bluetooth – LE 2Mbps RF Average Output Power	
		Data Rate / Modulation	
		GFSK	
		1Mbps	
Ch00	2402MHz	1.98	dBm
Ch19	2440MHz	1.72	dBm
Ch39	2480MHz	1.34	dBm

Channel	Frequency	Bluetooth – LE 2Mbps RF Peak Output Power	
		Data Rate / Modulation	
		GFSK	
		1Mbps	
Ch00	2402MHz	3.52	dBm
Ch19	2440MHz	3.35	dBm
Ch39	2480MHz	2.95	dBm





- a. The EUT has been associated with peripherals and configuration operated in a manner tended to maximize its emission characteristics in a typical application. Frequency range investigated: conduction emission (150 kHz to 30 MHz), radiation emission (9 kHz to the 10th harmonic of the highest fundamental frequency or to 40 GHz, whichever is lower). For radiated measurement, pre-scanned in three orthogonal panels, X, Y, Z. The worst cases (X plane) were recorded in this report.
- b. AC power line Conducted Emission was tested under maximum output power.

The following summary table is showing all test modes to demonstrate in compliance with the standard.

Summary table of Test Cases	
Test Item	Data Rate / Modulation
	Bluetooth – LE / GFSK
<b>Conducted Test Cases</b>	Mode 1: Bluetooth Tx CH00_2402 MHz_1Mbps Mode 2: Bluetooth Tx CH19_2440 MHz_1Mbps Mode 3: Bluetooth Tx CH39_2480 MHz_1Mbps Mode 4: Bluetooth Tx CH00_2402 MHz_2Mbps Mode 5: Bluetooth Tx CH19_2440 MHz_2Mbps Mode 6: Bluetooth Tx CH39_2480 MHz_2Mbps
<b>Radiated Test Cases</b>	Mode 1: Bluetooth Tx CH00_2402 MHz_1Mbps Mode 2: Bluetooth Tx CH19_2440 MHz_1Mbps Mode 3: Bluetooth Tx CH39_2480 MHz_1Mbps Mode 4: Bluetooth Tx CH00_2402 MHz_2Mbps Mode 5: Bluetooth Tx CH19_2440 MHz_2Mbps Mode 6: Bluetooth Tx CH39_2480 MHz_2Mbps
<b>AC Conducted Emission</b>	Mode 1 :NFC Link + WLAN (2.4GHz) Link + Bluetooth Link + Earphone 1 with Audio Adapter connect to EUT + Charging Only Cable + AC Adapter Mode 2 :NFC Link + WLAN (2.4GHz) Link + Bluetooth Link + Snap on USB Cable Data Link with Notebook + Copy Data from Notebook to EDA (eMMC) + AC Adapter Mode 3 :NFC Link + WLAN (2.4GHz) Link + Bluetooth Link + Earphone 2 with Audio Adapter connect to EUT + Charging Only Cable + AC Adapter
<b>Remark:</b>	
1. The worst case of conducted emission is mode 2. 2. For Radiated Test Cases, the tests were performed with Earphone 1.	

## 2.3 Connection Diagram of Test System

### <Radiated Emission Mode>

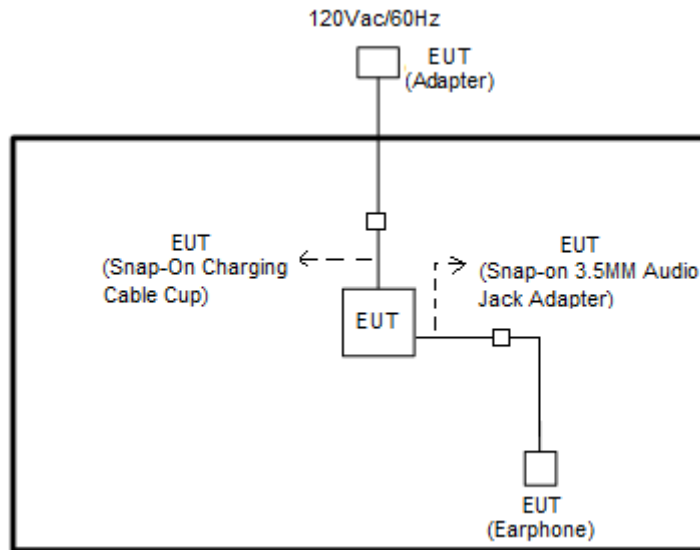

### <AC Conducted Emission for Earphone 1>

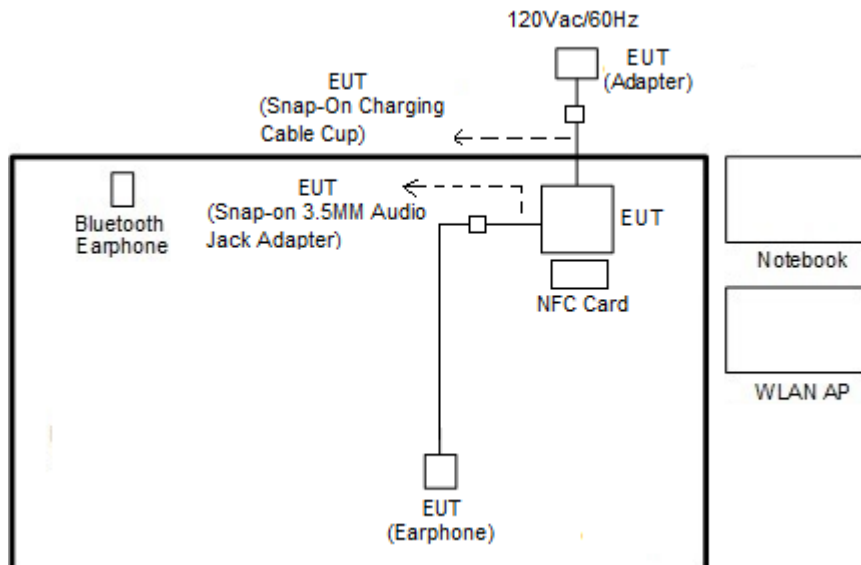

<AC Conducted Emission for Earphone 2>

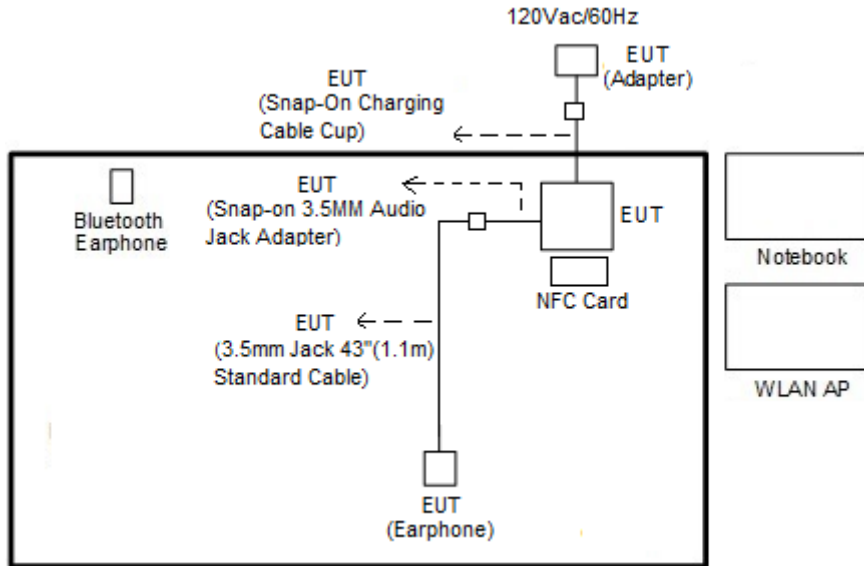

<AC Conducted Emission for data link mode>

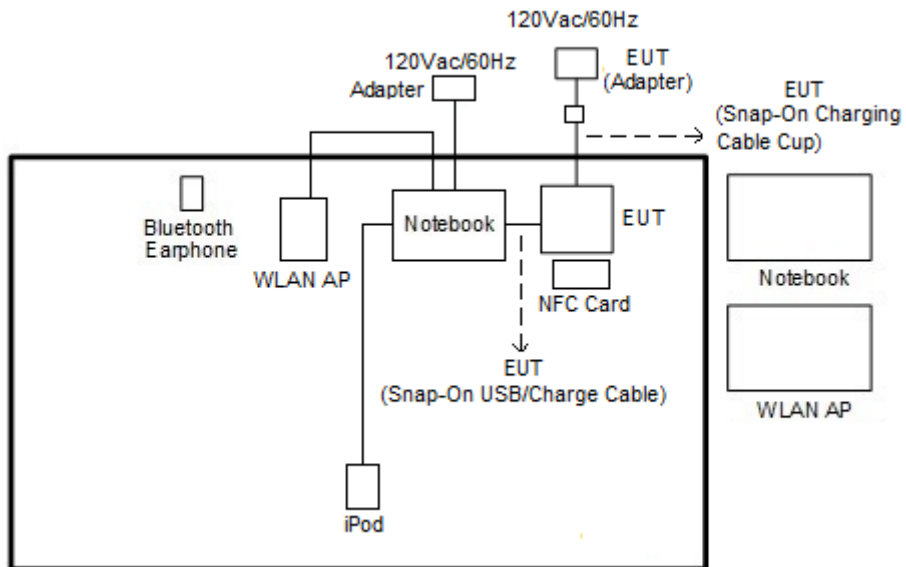



## 2.4 Support Unit used in test configuration and system

Item	Equipment	Trade Name	Model Name	FCC ID	Data Cable	Power Cord
1.	Bluetooth Earphone	Sony Ericsson	MW600	PY7DDA-2029	N/A	N/A
2.	WLAN AP	ASUS	RT-AC66U	MSQ-RTAC66U	N/A	Unshielded, 1.8 m
3.	iPod	Apple	A1285	FCC DoC	Shielded, 1.0 m	N/A
4.	Notebook	DELL	Latitude E6320	FCC DoC/ Contains FCC ID: QDS-BRCM1054	N/A	AC I/P: Unshielded, 1.2 m DC O/P: Shielded, 1.8 m
5.	SD Card	SanDisk	MicroSD HC	FCC DoC	N/A	N/A
6.	NFC Card	Metro Taipei	Easy Card	N/A	N/A	N/A

## 2.5 EUT Operation Test Setup

The RF test items, utility "QRCT" was installed in Notebook which was programmed in order to make the EUT get into the engineering modes to provide channel selection, power level, data rate and the application type and for continuous transmitting signals.

## 2.6 Measurement Results Explanation Example

**For all conducted test items:**

The offset level is set in the spectrum analyzer to compensate the RF cable loss and attenuator factor between EUT conducted output port and spectrum analyzer. With the offset compensation, the spectrum analyzer reading level is exactly the EUT RF output level.

Example :

The spectrum analyzer offset is derived from RF cable loss and attenuator factor.

*Offset = RF cable loss + attenuator factor.*

Following shows an offset computation example with cable loss 4.2 dB and 10dB attenuator.

$$\begin{aligned} \text{Offset(dB)} &= \text{RF cable loss(dB)} + \text{attenuator factor(dB)}. \\ &= 4.2 + 10 = 14.2 \text{ (dB)} \end{aligned}$$

### 3 Test Result

#### 3.1 6dB and 99% Bandwidth Measurement

##### 3.1.1 Limit of 6dB and 99% Bandwidth

The minimum 6 dB bandwidth shall be at least 500 kHz.

##### 3.1.2 Measuring Instruments

See list of measuring equipment of this test report.

##### 3.1.3 Test Procedures

1. The testing follows FCC KDB Publication No. 558074 D01 DTS Meas. Guidance v05.
2. The RF output of EUT was connected to the spectrum analyzer by RF cable and attenuator. The path loss was compensated to the results for each measurement.
3. Set to the maximum power setting and enable the EUT transmit continuously.
4. Make the measurement with the spectrum analyzer's resolution bandwidth (RBW) = 100 kHz. Set the Video bandwidth (VBW) = 300 kHz. In order to make an accurate measurement. The 6 dB bandwidth must be greater than 500 kHz.
5. For 99% Bandwidth Measurement, the spectrum analyzer's resolution bandwidth (RBW) is set 1-5% of the emission bandwidth and set the Video bandwidth (VBW)  $\geq 3 * RBW$ .
6. Measure and record the results in the test report.

##### 3.1.4 Test Setup

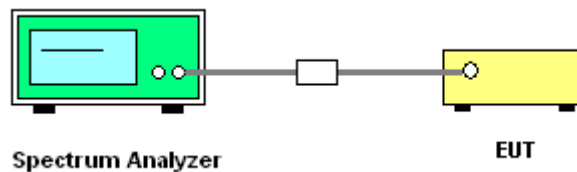



3.1.5 Test Result of 6dB Bandwidth

Mod.	Data Rate	N <sub>TX</sub>	CH.	Freq. (MHz)	6dB BW (MHz)	6dB BW Limit (MHz)	Pass/Fail
BLE	1Mbps	1	0	2402	0.667	0.50	Pass
BLE	1Mbps	1	19	2440	0.667	0.50	Pass
BLE	1Mbps	1	39	2480	0.665	0.50	Pass
BLE	2Mbps	1	0	2402	1.139	0.50	Pass
BLE	2Mbps	1	19	2440	1.151	0.50	Pass
BLE	2Mbps	1	39	2480	1.147	0.50	Pass

<1Mbps>

6 dB Bandwidth Plot on Channel 00

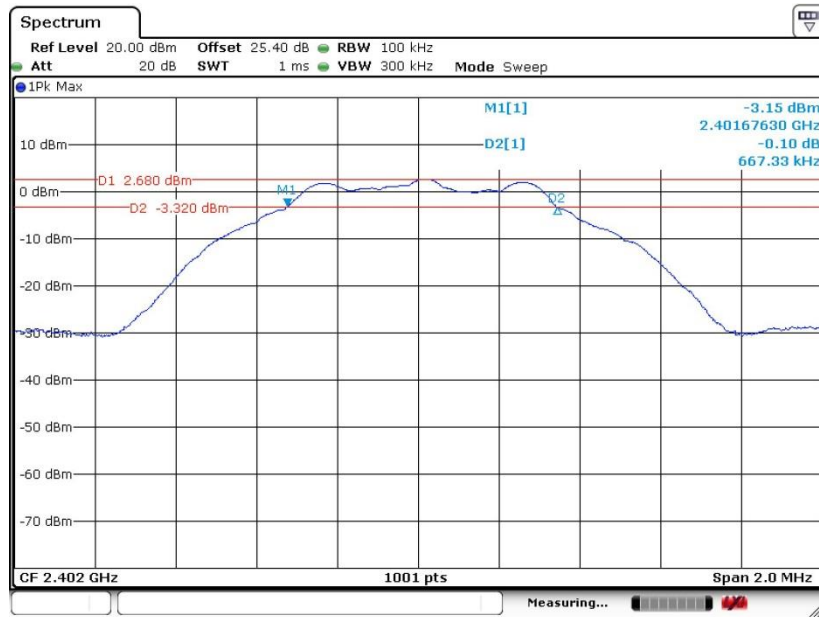

Date: 9.SEP.2018 22:57:00



6 dB Bandwidth Plot on Channel 19

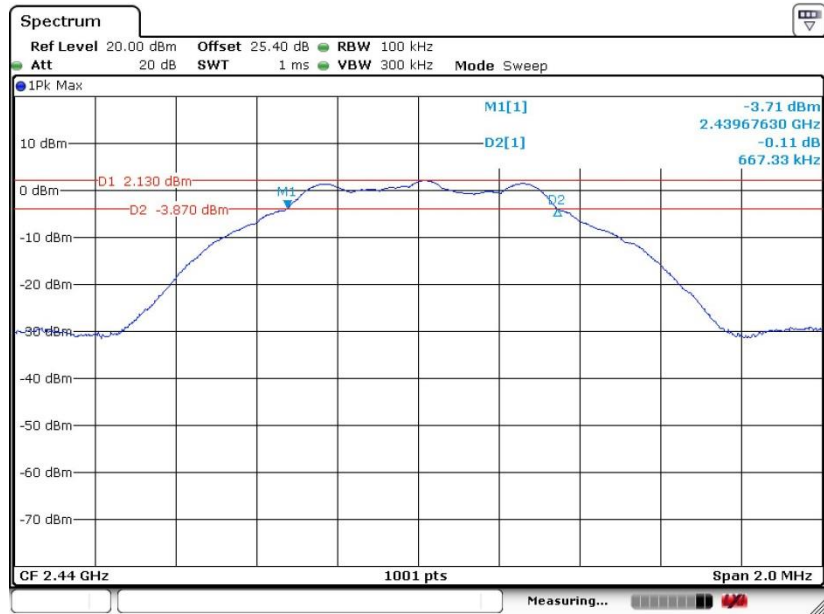

Date: 9.SEP.2018 23:03:28

6 dB Bandwidth Plot on Channel 39

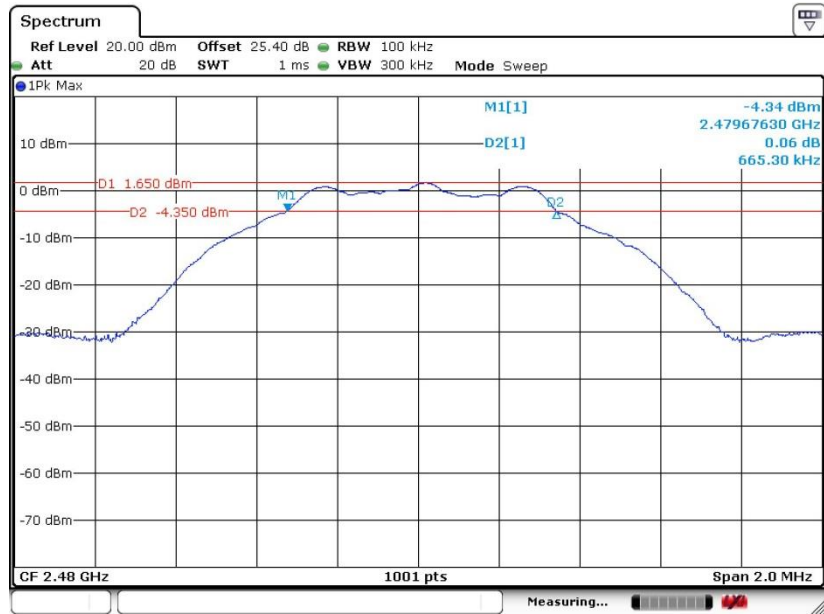

Date: 9.SEP.2018 23:07:36



<2Mbps>

6 dB Bandwidth Plot on Channel 00

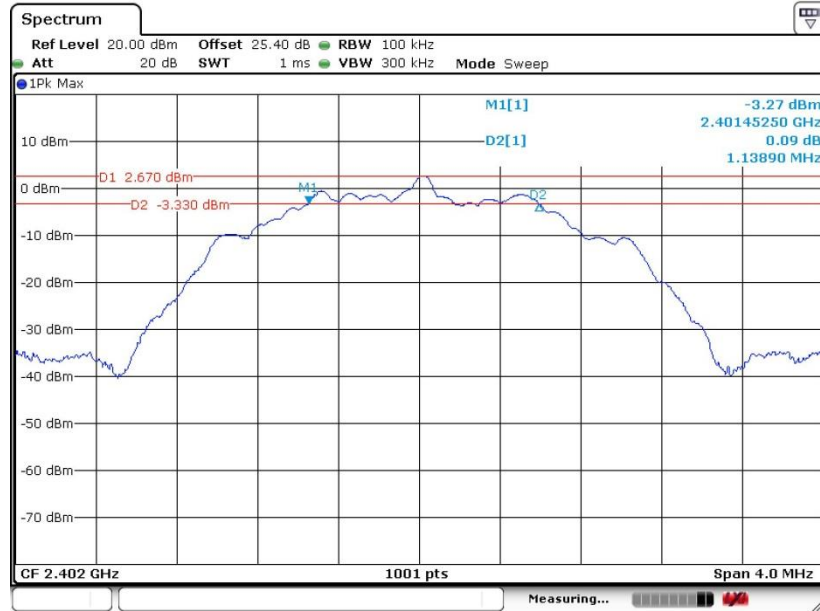

Date: 9.SEP.2018 23:12:51

6 dB Bandwidth Plot on Channel 19

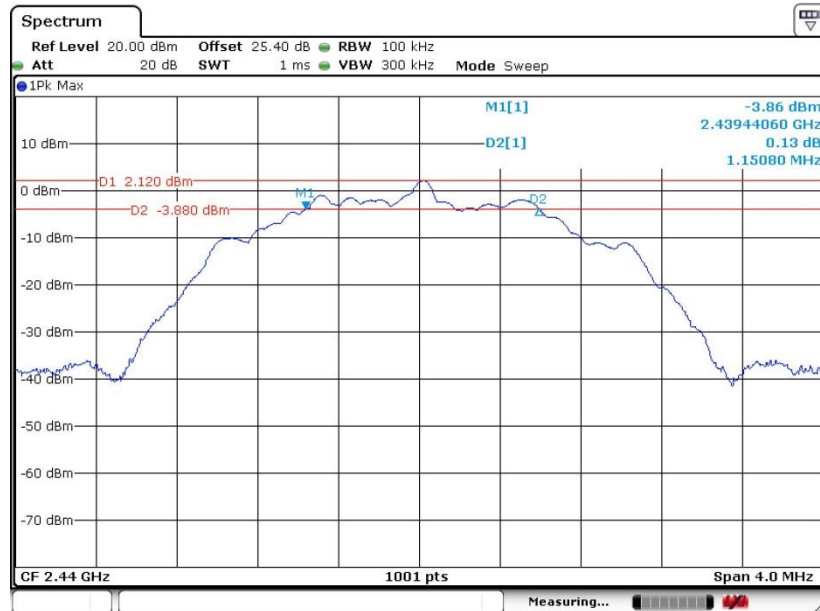

Date: 9.SEP.2018 23:17:42





6 dB Bandwidth Plot on Channel 39

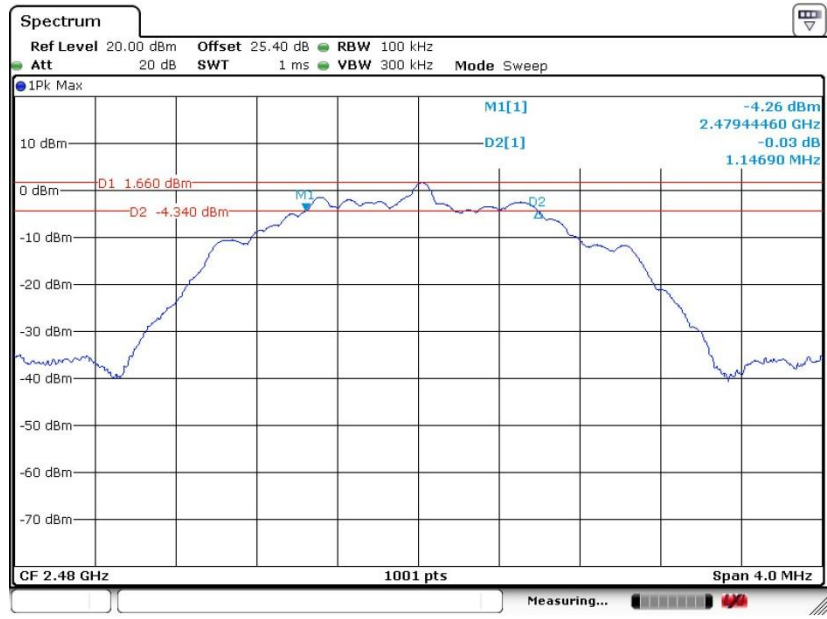

Date: 9.SEP.2018 23:21:09



3.1.6 Test Result of 99% Occupied Bandwidth

Mod.	Data Rate	NTX	CH.	Freq. (MHz)	99% Occupied BW (MHz)	Pass/Fail
BLE	1Mbps	1	0	2402	1.025	Pass
BLE	1Mbps	1	19	2440	1.027	Pass
BLE	1Mbps	1	39	2480	1.027	Pass
BLE	2Mbps	1	0	2402	2.034	Pass
BLE	2Mbps	1	19	2440	2.034	Pass
BLE	2Mbps	1	39	2480	2.038	Pass

<1Mbps>

99% Bandwidth Plot on Channel 00

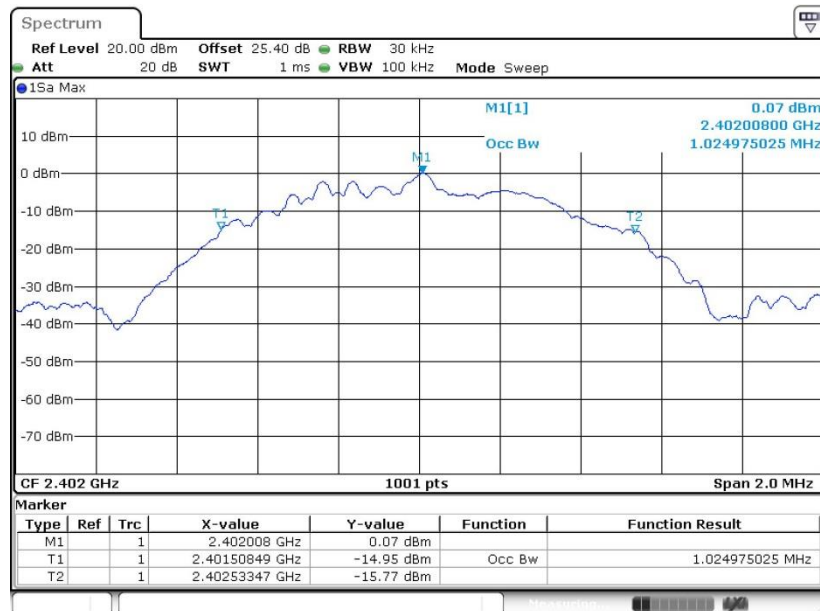

Date: 9.SEP.2018 23:01:34



99% Occupied Bandwidth Plot on Channel 19

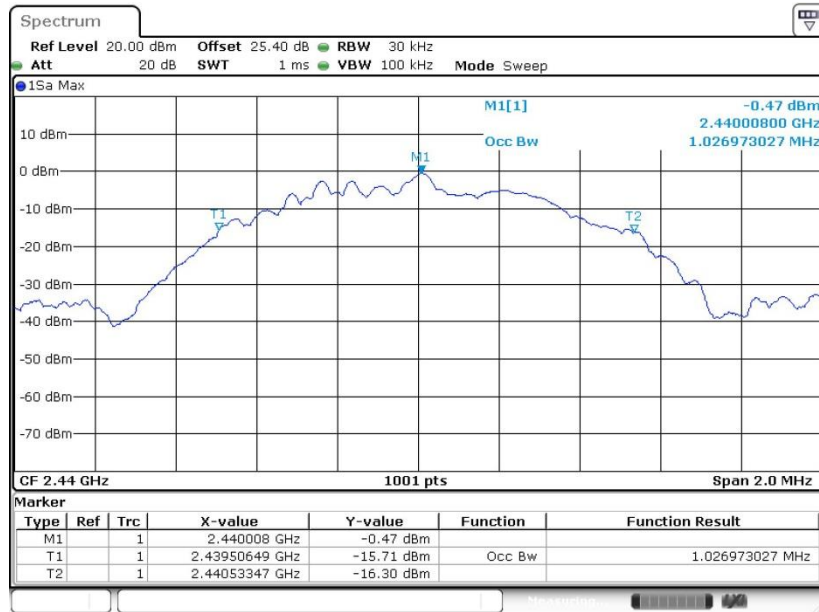

Date: 9.SEP.2018 23:05:02

99% Occupied Bandwidth Plot on Channel 39

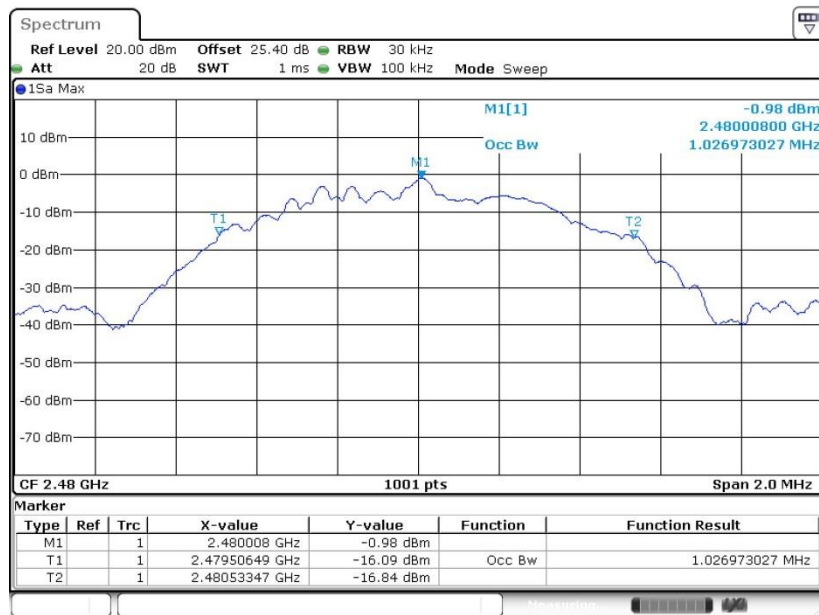

Date: 9.SEP.2018 23:09:47



<2Mbps>

99% Bandwidth Plot on Channel 00

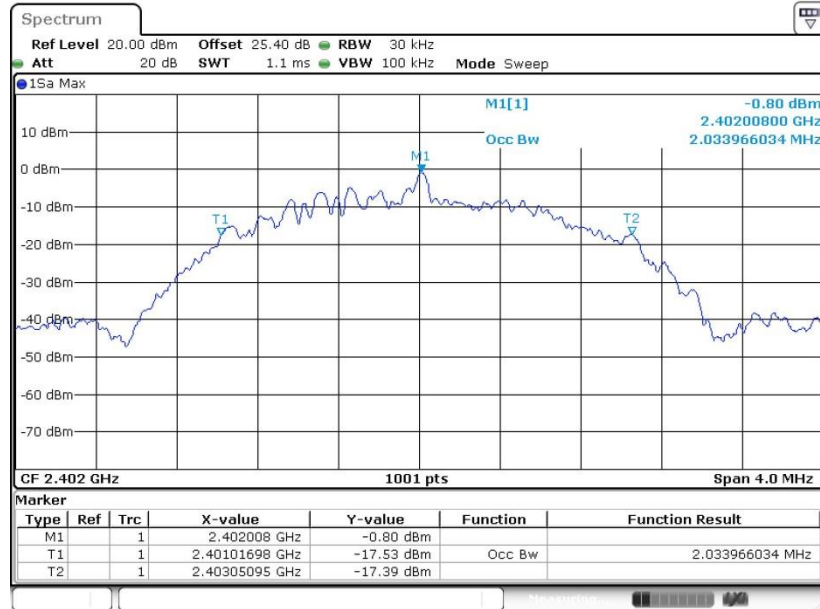

Date: 9.SEP.2018 23:15:56

99% Occupied Bandwidth Plot on Channel 19

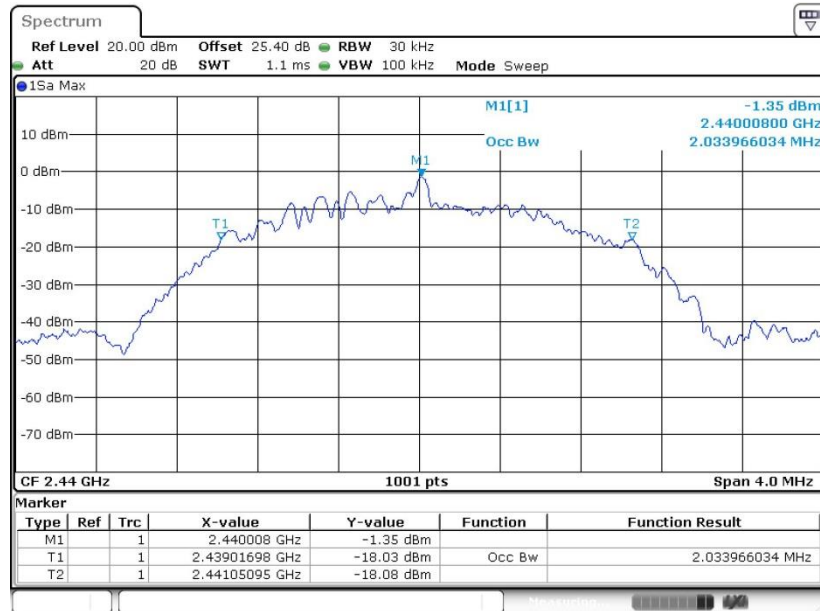

Date: 9.SEP.2018 23:19:05



99% Occupied Bandwidth Plot on Channel 39

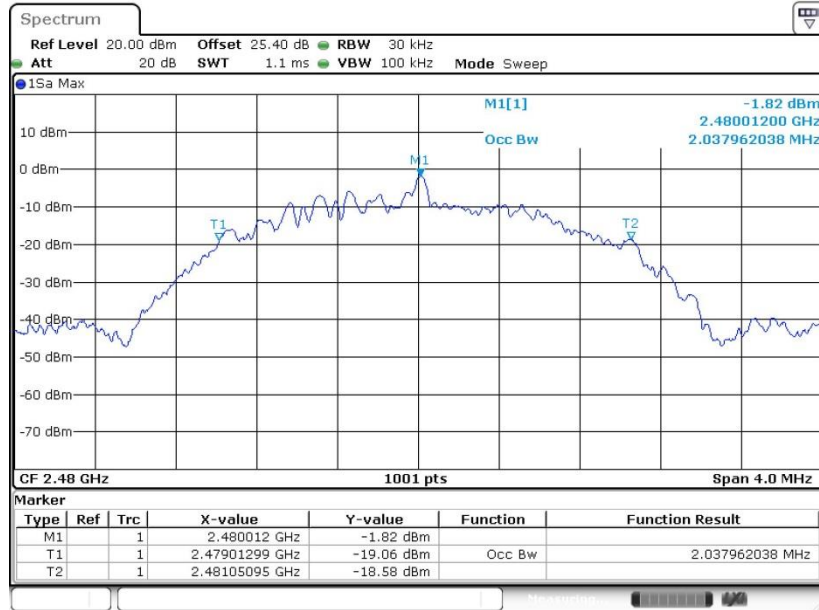

Date: 9.SEP.2018 23:22:47

Note : The occupied channel bandwidth is maintained within the band of operation for all of the modulations.

## 3.2 Output Power Measurement

### 3.2.1 Limit of Output Power

For systems using digital modulation in the 2400-2483.5MHz, the limit for peak output power is 30dBm. If transmitting antenna of directional gain greater than 6dBi is used, the peak output power from the intentional radiator shall be reduced below the above stated value by the amount in dB that the directional gain of the antenna exceeds 6 dBi. In case of point-to-point operation, the limit has to be reduced by 1dB for every 3dB that the directional gain of the antenna exceeds 6dBi.

### 3.2.2 Measuring Instruments

See list of measuring equipment of this test report.

### 3.2.3 Test Procedures

1. For Peak Power, the testing follows the Measurement Procedure of FCC KDB No. 558074 DTS D01 Meas. Guidance v05 section 9.1.3 PKPM1 Peak power meter method.
2. For Average Power, the testing follows the Measurement Procedure of FCC KDB No. 558074 DTS D01 Meas. Guidance v05 section 9.2.3.1 Method AVGPM.
3. The RF output of EUT was connected to the power meter by RF cable and attenuator.
4. The path loss was compensated to the results for each measurement.
5. Set to the maximum power setting and enable the EUT transmit continuously.
6. Measure the conducted output power and record the results in the test report.

### 3.2.4 Test Setup

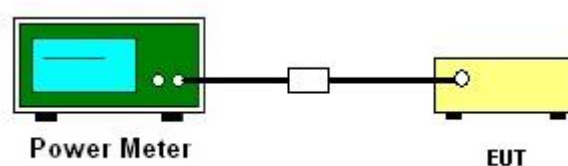



3.2.5 Test Result of Peak Output Power

Mod.	Data Rate	NTX	CH.	Freq. (MHz)	Peak Conducted Power (dBm)	Conducted Power Limit (dBm)	DG (dBi)	EIRP Power (dBm)	EIRP Power Limit (dBm)	Pass /Fail
BLE	1Mbps	1	0	2402	3.67	30.00	1.60	5.27	36.00	Pass
BLE	1Mbps	1	19	2440	3.40	30.00	1.60	5.00	36.00	Pass
BLE	1Mbps	1	39	2480	2.99	30.00	1.60	4.59	36.00	Pass
BLE	2Mbps	1	0	2402	3.52	30.00	1.60	5.12	36.00	Pass
BLE	2Mbps	1	19	2440	3.35	30.00	1.60	4.95	36.00	Pass
BLE	2Mbps	1	39	2480	2.95	30.00	1.60	4.55	36.00	Pass

3.2.6 Test Result of Average Output Power (Reporting Only)

Mod.	Data Rate	NTX	CH.	Freq. (MHz)	Duty Factor (dB)	Average Conducted Power (dBm)
BLE	1Mbps	1	0	2402	2.06	1.99
BLE	1Mbps	1	19	2440	2.06	1.74
BLE	1Mbps	1	39	2480	2.06	1.35
BLE	2Mbps	1	0	2402	4.88	1.98
BLE	2Mbps	1	19	2440	4.88	1.72
BLE	2Mbps	1	39	2480	4.88	1.34

### 3.3 Power Spectral Density Measurement

#### 3.3.1 Limit of Power Spectral Density

The peak power spectral density shall not be greater than 8dBm in any 3kHz band at any time interval of continuous transmission.

#### 3.3.2 Measuring Instruments

See list of measuring equipment of this test report.

#### 3.3.3 Test Procedures

1. The testing follows Measurement Procedure 10.2 Method PKPSD of FCC KDB Publication No. 558074 D01 DTS Meas. Guidance v05
2. The RF output of EUT was connected to the spectrum analyzer by RF cable and attenuator. The path loss was compensated to the results for each measurement.
3. Set to the maximum power setting and enable the EUT transmit continuously.
4. Make the measurement with the spectrum analyzer's resolution bandwidth (RBW) = 3 kHz. Video bandwidth VBW = 10 kHz In order to make an accurate measurement, set the span to 1.5 times DTS Channel Bandwidth. (6dB BW)
5. Detector = peak, Sweep time = auto couple, Trace mode = max hold, Allow trace to fully stabilize. Use the peak marker function to determine the maximum power level.
6. Measure and record the results in the test report.
7. The Measured power density (dBm)/ 100kHz is a reference level and used as 20dBc down limit line for Conducted Band Edges and Conducted Spurious Emission.

#### 3.3.4 Test Setup

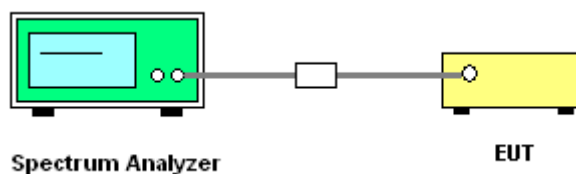





3.3.5 Test Result of Power Spectral Density

Mod.	Data Rate	NTX	CH.	Freq. (MHz)	Peak PSD (dBm /100kHz)	Peak PSD (dBm /3kHz)	DG (dBi)	Peak PSD Limit (dBm /3kHz)	Pass/Fail
BLE	1Mbps	1	0	2402	2.69	-11.84	1.60	8.00	Pass
BLE	1Mbps	1	19	2440	2.10	-12.39	1.60	8.00	Pass
BLE	1Mbps	1	39	2480	1.66	-12.87	1.60	8.00	Pass
BLE	2Mbps	1	0	2402	2.67	-15.50	1.60	8.00	Pass
BLE	2Mbps	1	19	2440	2.08	-16.03	1.60	8.00	Pass
BLE	2Mbps	1	39	2480	1.63	-16.51	1.60	8.00	Pass

3.3.6 Test Result of Power Spectral Density Plots (100kHz)

<1Mbps>

PSD 100kHz Plot on Channel 00

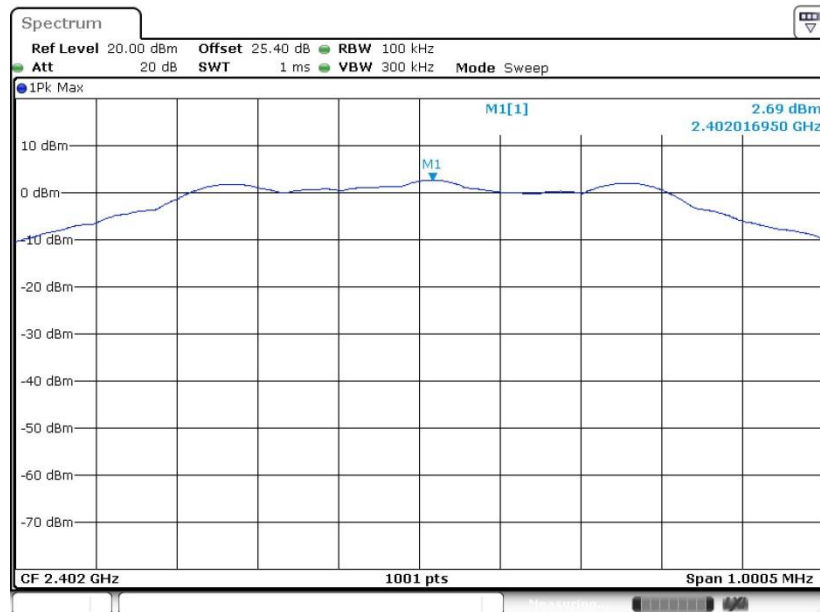

Date: 9.SEP.2018 22:58:03



PSD 100kHz Plot on Channel 19

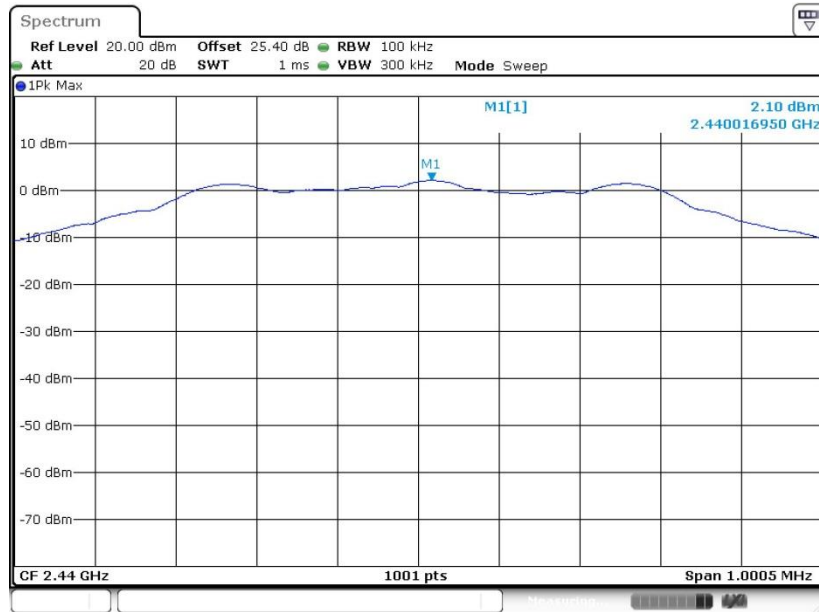

Date: 9.SEP.2018 23:04:05

PSD 100kHz Plot on Channel 39

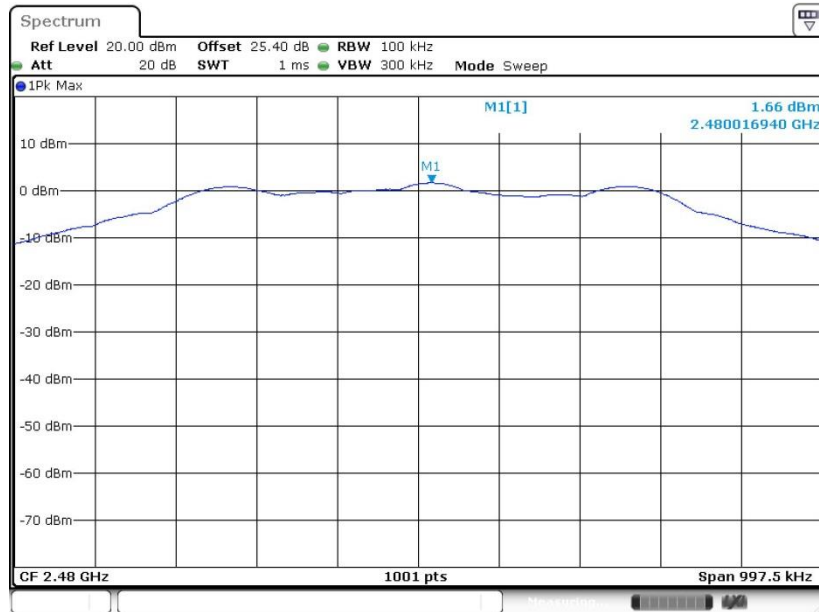

Date: 9.SEP.2018 23:08:15



<2Mbps>

PSD 100kHz Plot on Channel 00

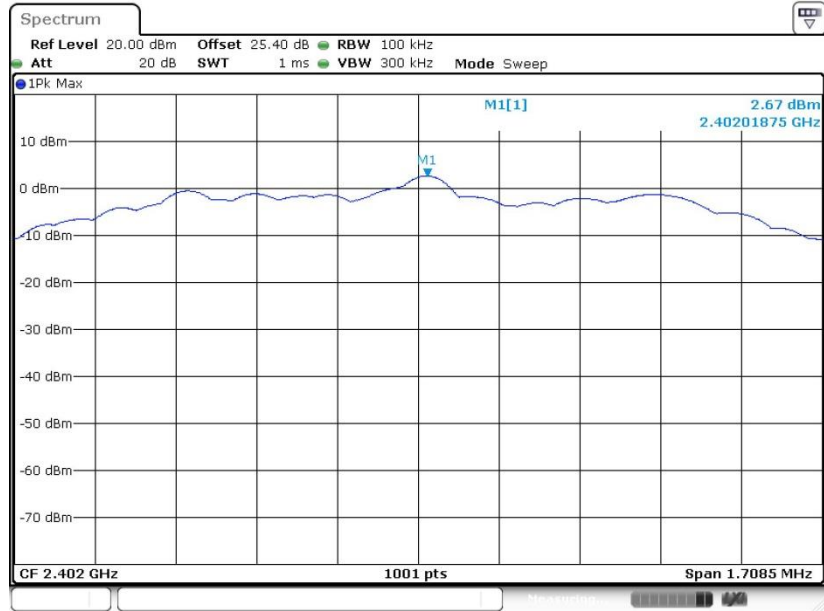

Date: 9.SEP.2018 23:14:10

PSD 100kHz Plot on Channel 19

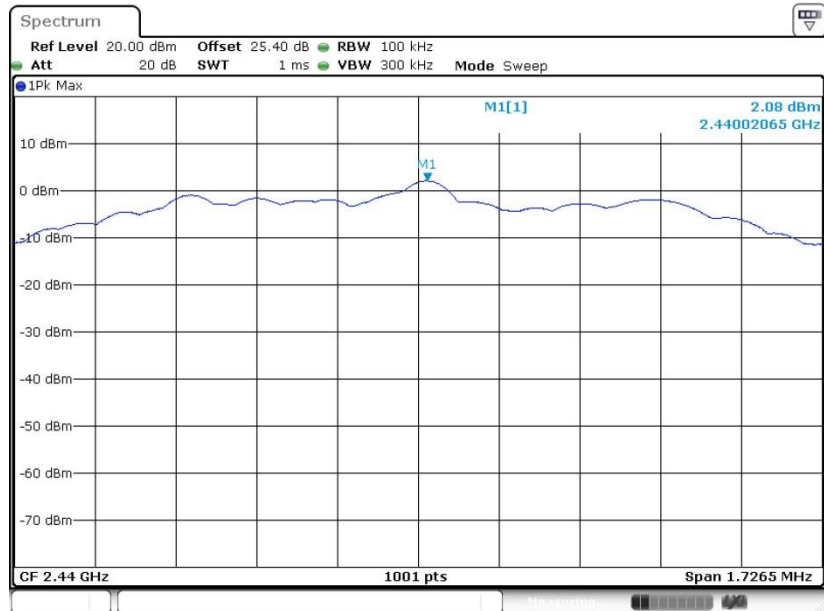

Date: 9.SEP.2018 23:18:22



PSD 100kHz Plot on Channel 39

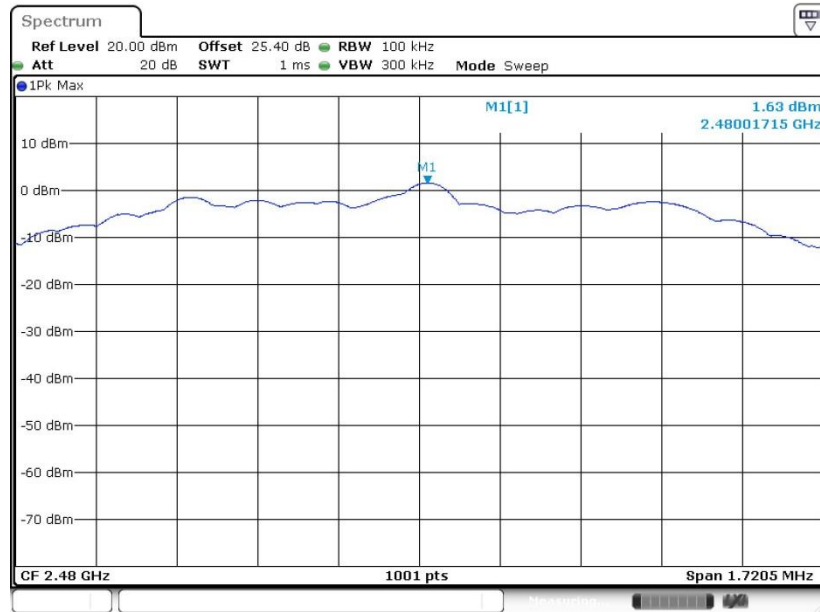

Date: 9.SEP.2018 23:21:46

3.3.7 Test Result of Power Spectral Density Plots (3kHz)

<1Mbps>

PSD 3kHz Plot on Channel 00

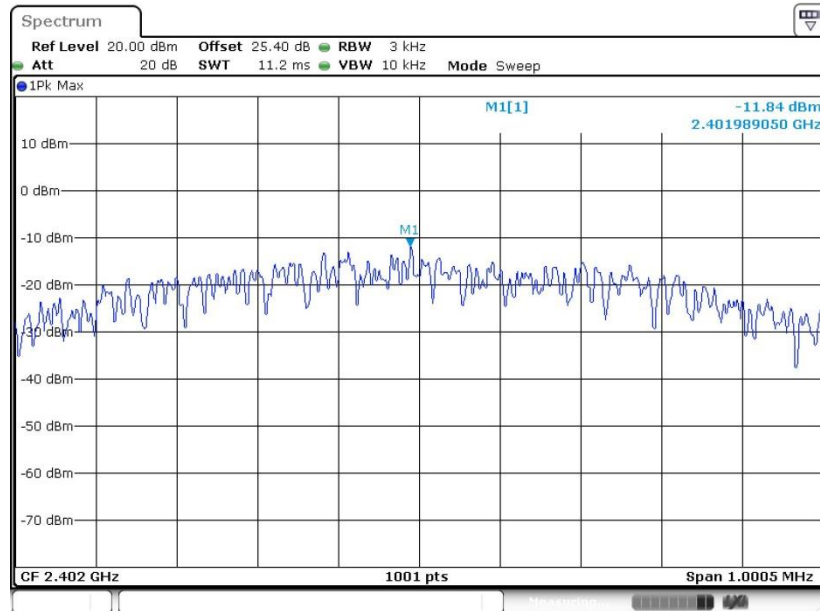

Date: 9.SEP.2018 22:57:44



PSD 3kHz Plot on Channel 19

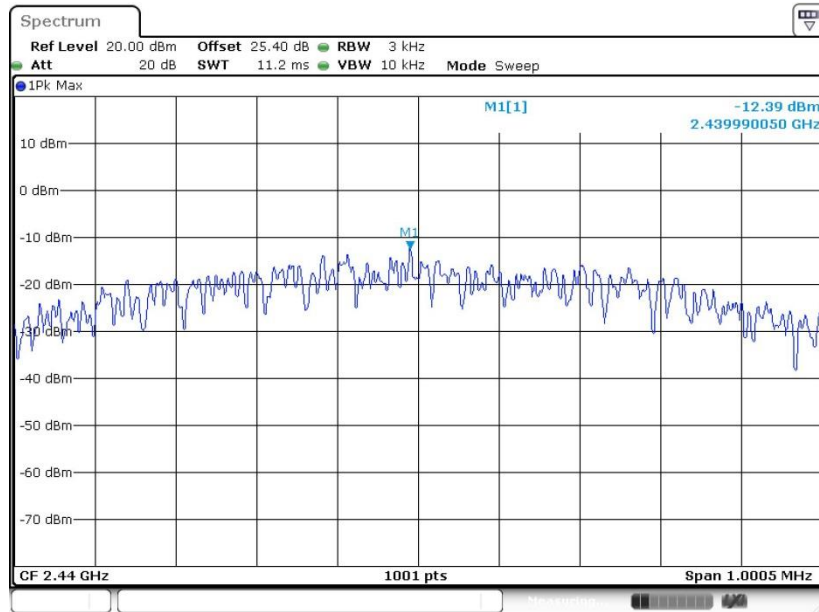

Date: 9.SEP.2018 23:03:50

PSD 3kHz Plot on Channel 39

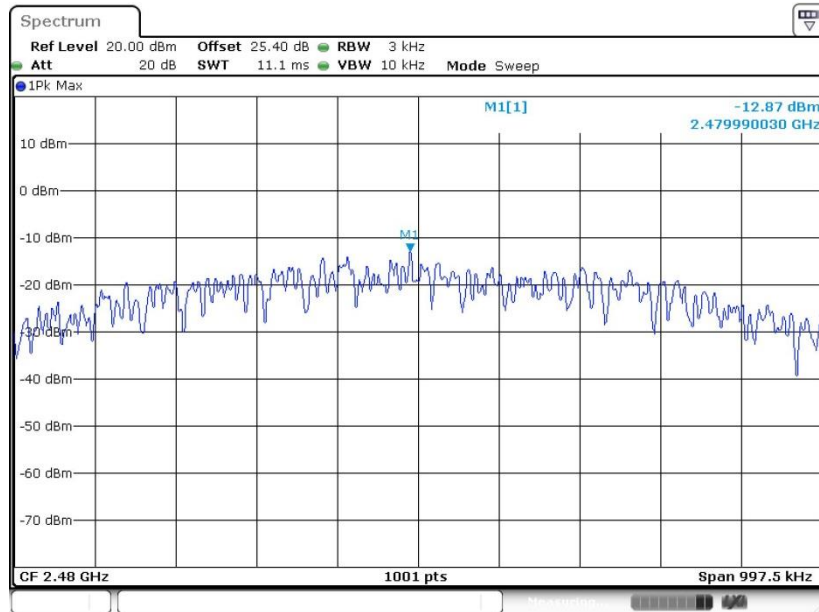

Date: 9.SEP.2018 23:08:00



<2Mbps>

PSD 3kHz Plot on Channel 00

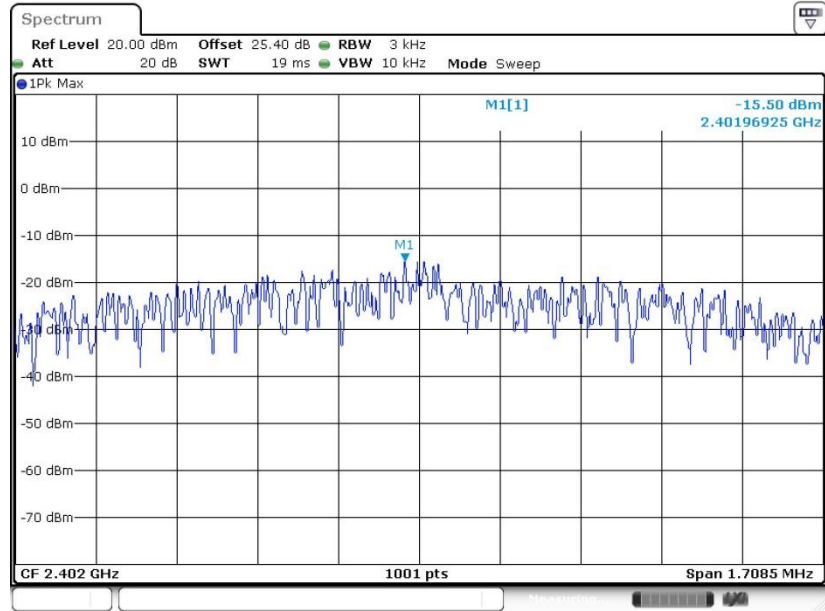

Date: 9.SEP.2018 23:13:45

PSD 3kHz Plot on Channel 19

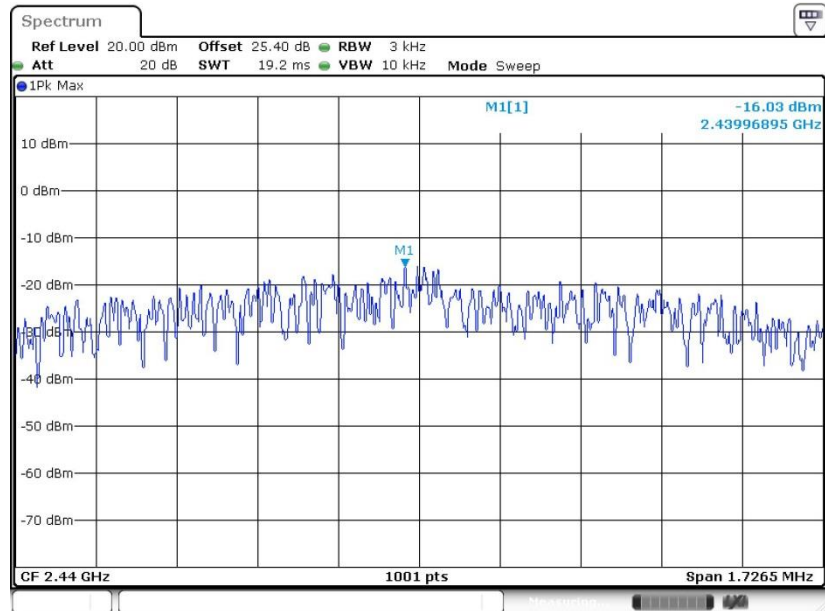

Date: 9.SEP.2018 23:18:09



PSD 3kHz Plot on Channel 39

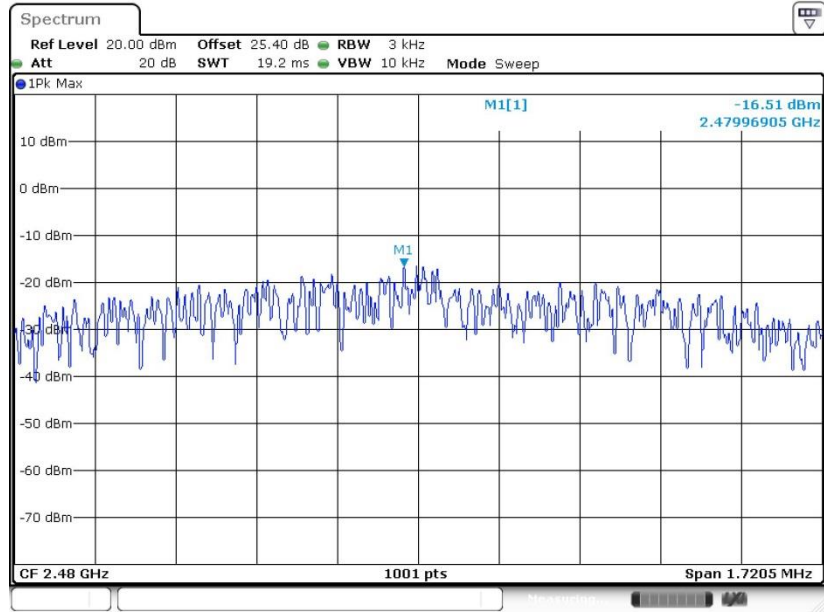

Date: 9.SEP.2018 23:21:27

## 3.4 Conducted Band Edges and Spurious Emission Measurement

### 3.4.1 Limit of Conducted Band Edges and Spurious Emission

All harmonics/spurious must be at least 20 dB down from the highest emission level within the authorized band.

### 3.4.2 Measuring Instruments

See list of measuring equipment of this test report.

### 3.4.3 Test Procedure

1. The testing follows FCC KDB Publication No. 558074 D01 DTS Meas. Guidance v05
2. The RF output of EUT was connected to the spectrum analyzer by RF cable and attenuator. The path loss was compensated to the results for each measurement.
3. Set to the maximum power setting and enable the EUT transmit continuously.
4. Set RBW = 100 kHz, VBW=300 kHz, Peak Detector. Unwanted Emissions measured in any 100 kHz bandwidth outside of the authorized frequency band shall be attenuated by at least 20 dB relative to the maximum in-band peak PSD level in 100 kHz when maximum peak conducted output power procedure is used. If the transmitter complies with the conducted power limits based on the use of RMS averaging over a time interval, the attenuation required under this paragraph shall be 30 dB instead of 20 dB.
5. Measure and record the results in the test report.
6. The RF fundamental frequency should be excluded against the limit line in the operating frequency band.

### 3.4.4 Test Setup







### 3.4.5 Test Result of Conducted Band Edges Plots

<1Mbps>

#### Low Band Edge Plot on Channel 00

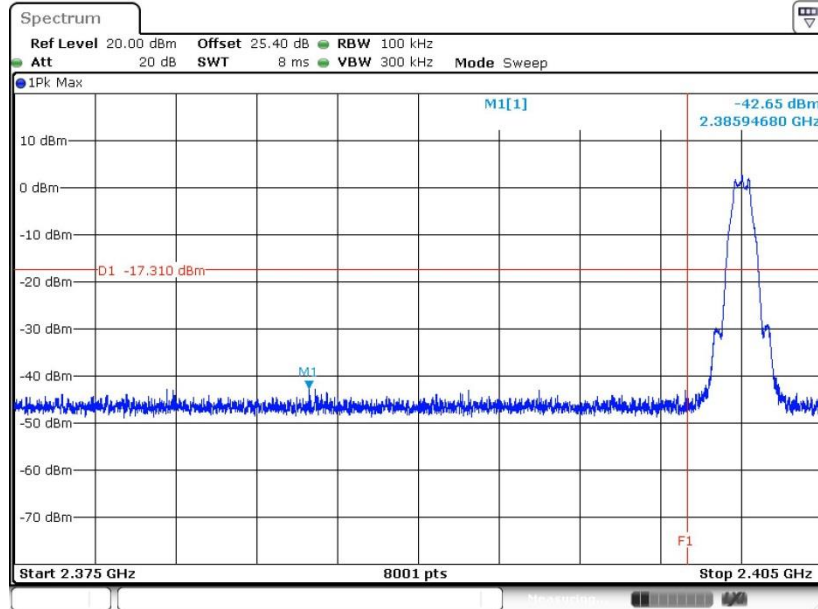

Date: 9.SEP.2018 22:58:19

#### High Band Edge Plot on Channel 39

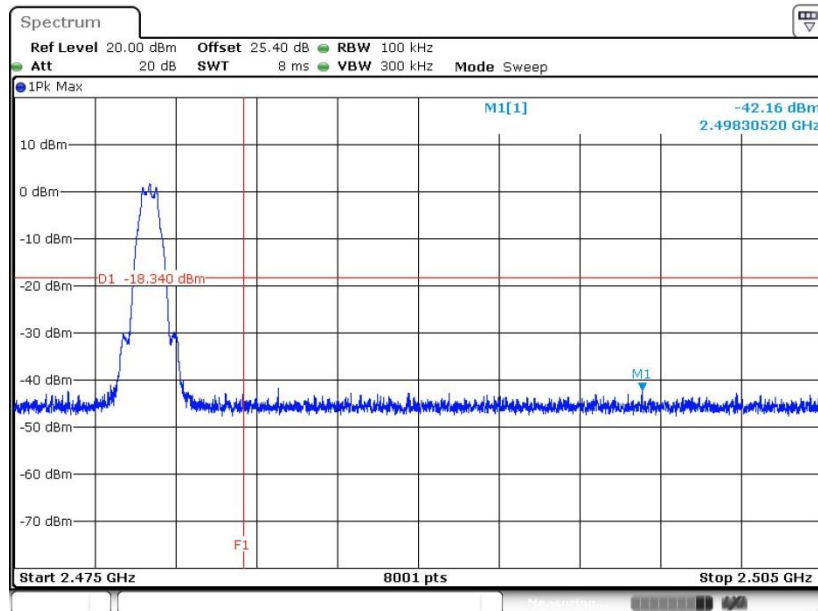

Date: 9.SEP.2018 23:08:28



<2Mbps>

Low Band Edge Plot on Channel 00

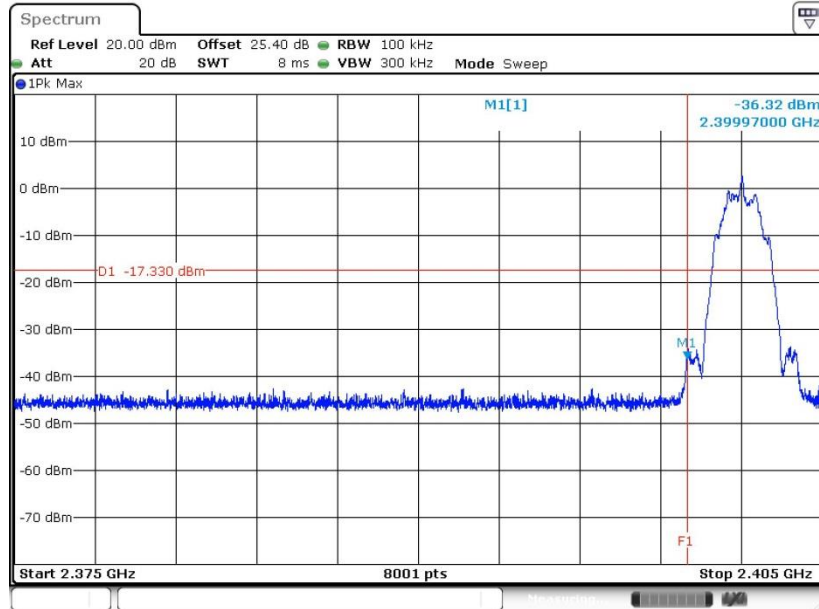

Date: 9.SEP.2018 23:14:41

High Band Edge Plot on Channel 39

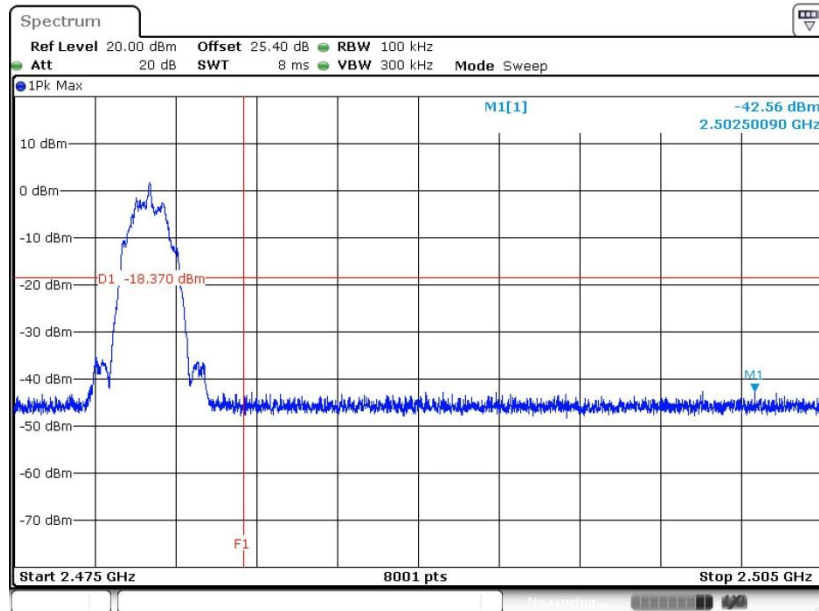

Date: 9.SEP.2018 23:22:00



### 3.4.6 Test Result of Conducted Spurious Emission Plots

#### Conducted Spurious Emission Plot on Bluetooth LE 1Mbps GFSK Channel 00

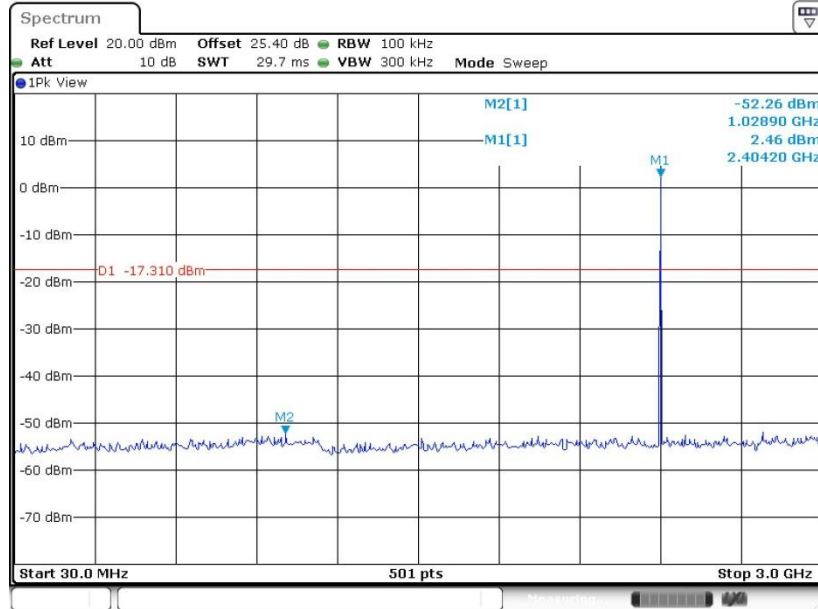

Date: 9.SEP.2018 23:00:52

#### Conducted Spurious Emission Plot on Bluetooth LE 1Mbps GFSK Channel 00

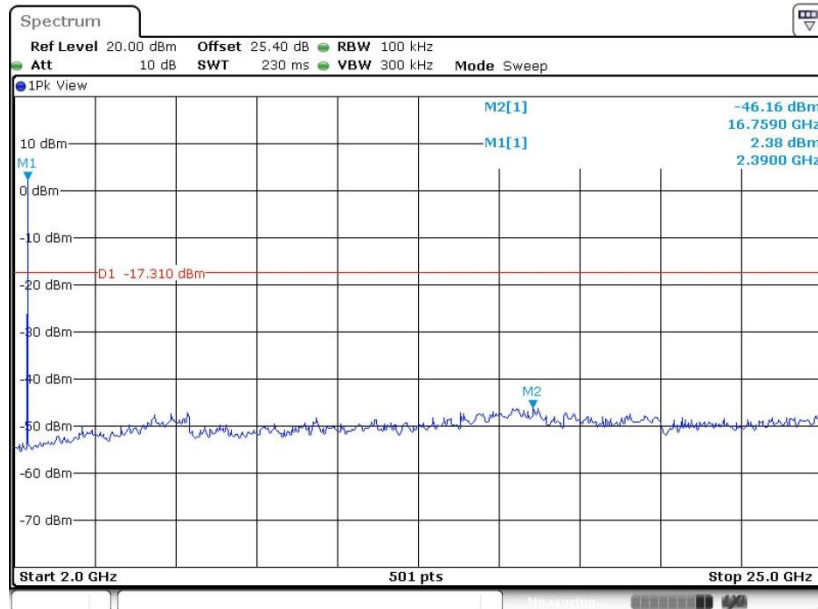

Date: 9.SEP.2018 23:01:08



### Conducted Spurious Emission Plot on Bluetooth LE 1Mbps GFSK Channel 19

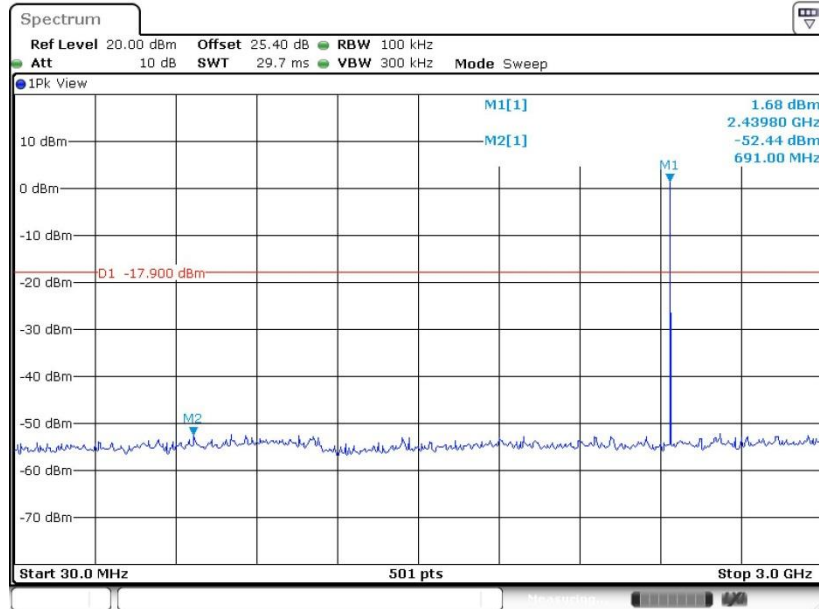

Date: 9.SEP.2018 23:04:32

### Conducted Spurious Emission Plot on Bluetooth LE 1Mbps GFSK Channel 19

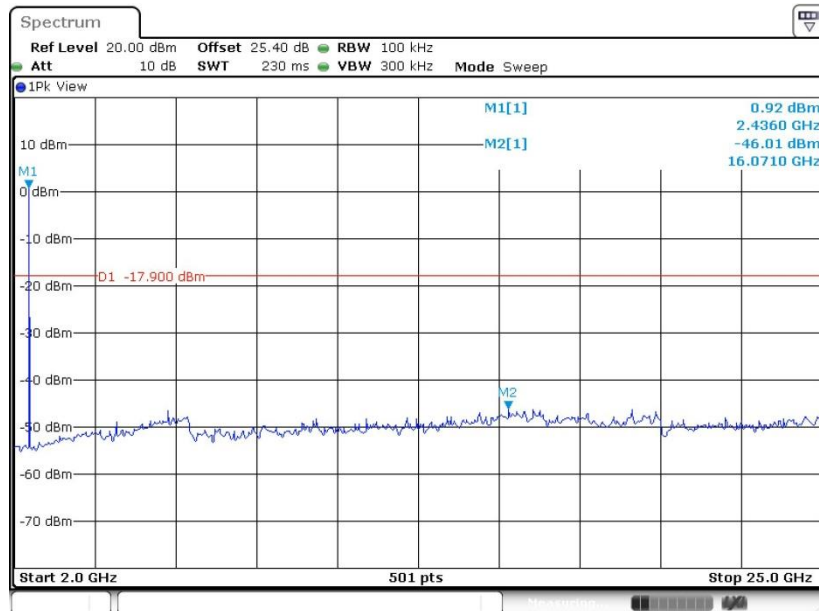

Date: 9.SEP.2018 23:04:47



### Conducted Spurious Emission Plot on Bluetooth LE 1Mbps GFSK Channel 39

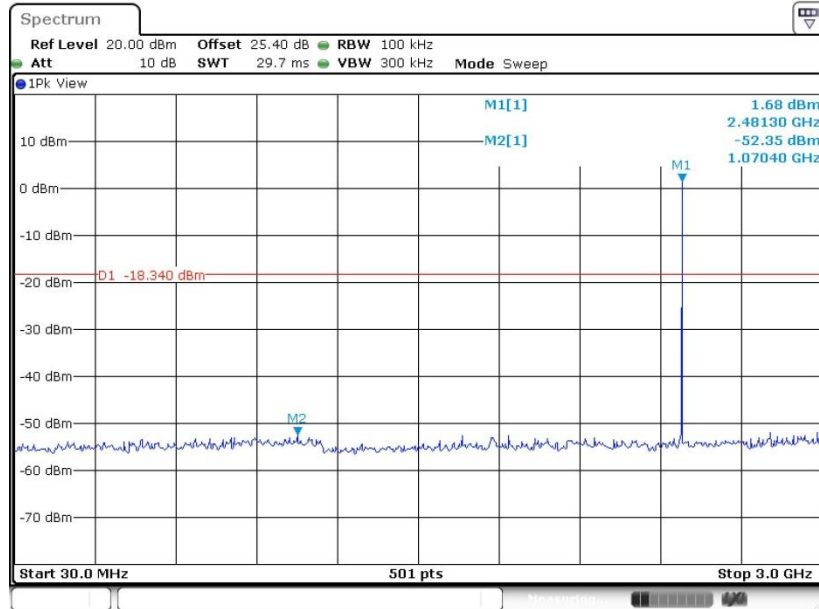

Date: 9.SEP.2018 23:09:00

### Conducted Spurious Emission Plot on Bluetooth LE 1Mbps GFSK Channel 39

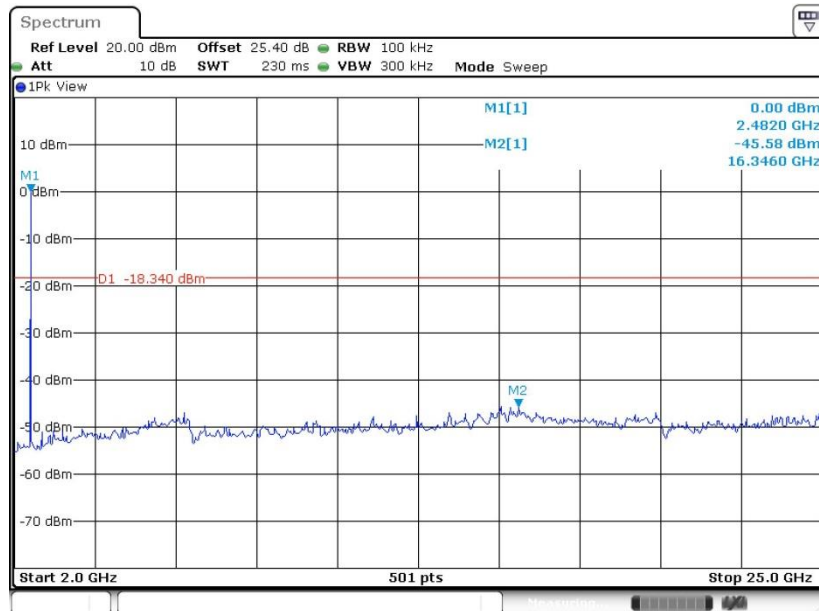

Date: 9.SEP.2018 23:09:17



### Conducted Spurious Emission Plot on Bluetooth LE 2Mbps GFSK Channel 00

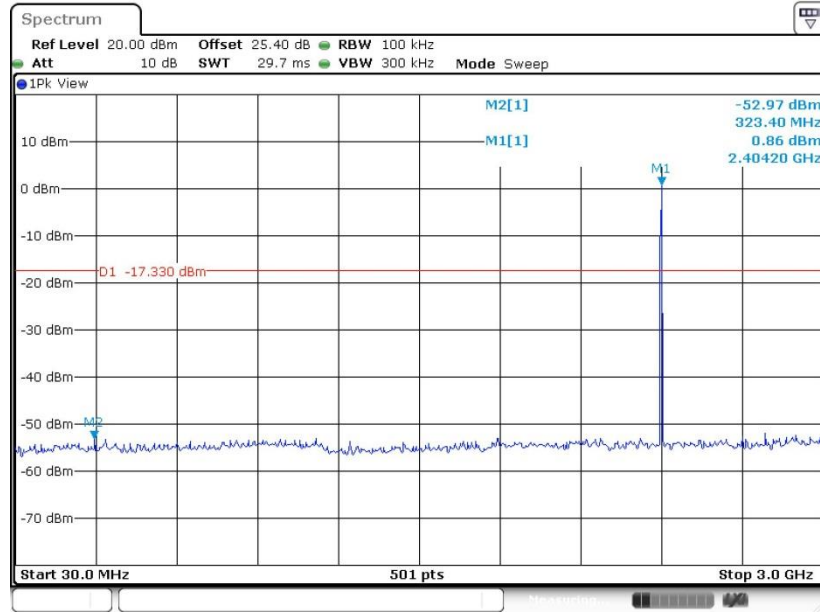

Date: 9.SEP.2018 23:15:05

### Conducted Spurious Emission Plot on Bluetooth LE 2Mbps GFSK Channel 00

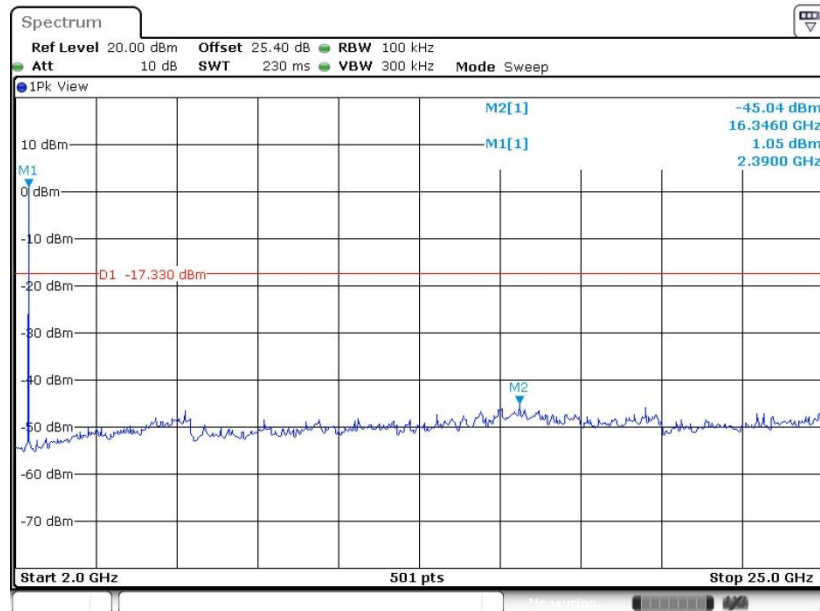

Date: 9.SEP.2018 23:15:32



### Conducted Spurious Emission Plot on Bluetooth LE 2Mbps GFSK Channel 19

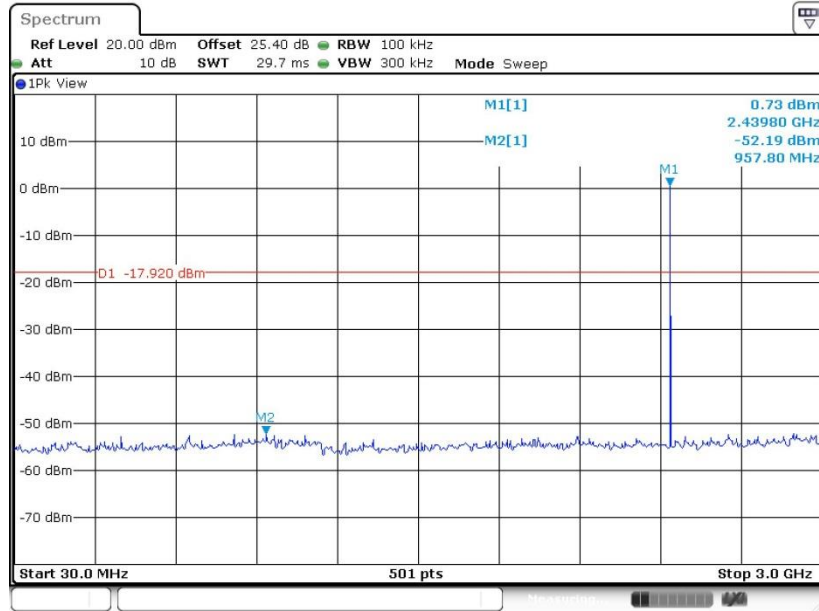

Date: 9.SEP.2018 23:18:39

### Conducted Spurious Emission Plot on Bluetooth LE 2Mbps GFSK Channel 19

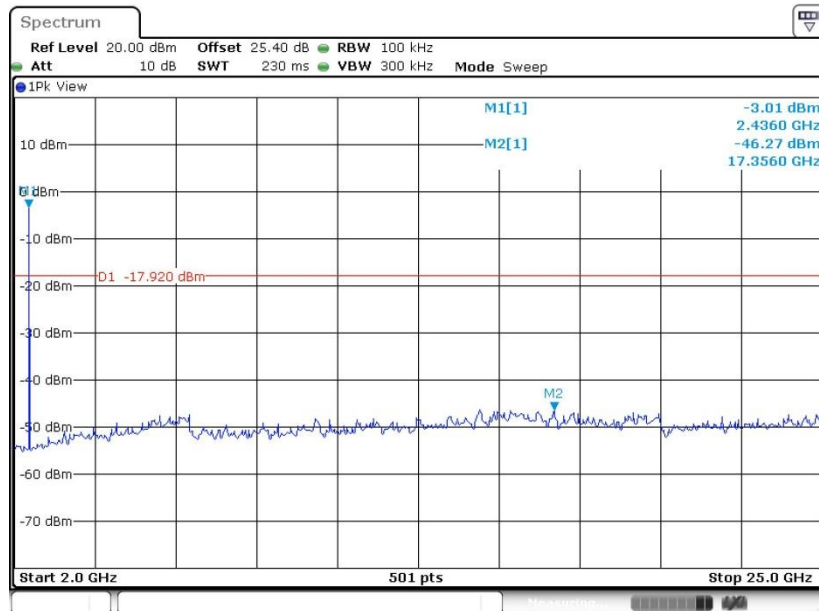

Date: 9.SEP.2018 23:18:51



### Conducted Spurious Emission Plot on Bluetooth LE 2Mbps GFSK Channel 39

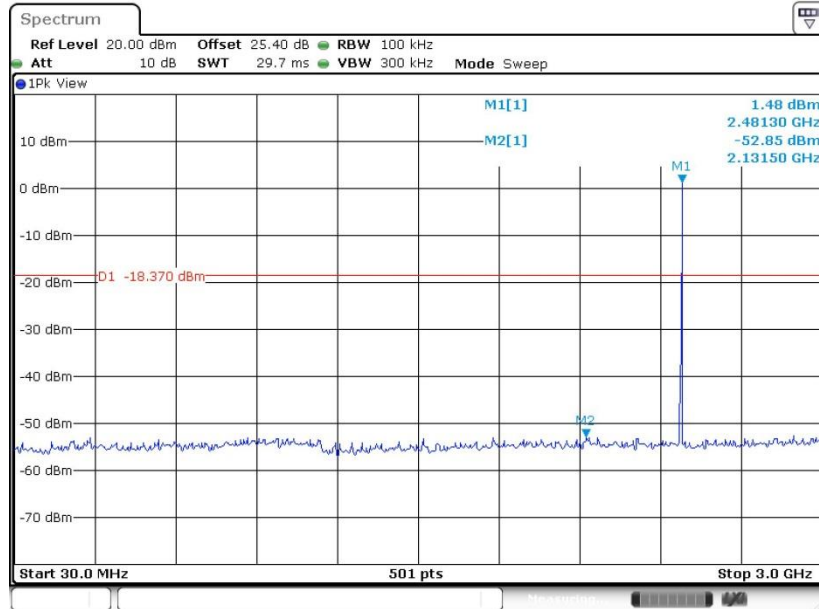

Date: 9.SEP.2018 23:22:16

### Conducted Spurious Emission Plot on Bluetooth LE 2Mbps GFSK Channel 39

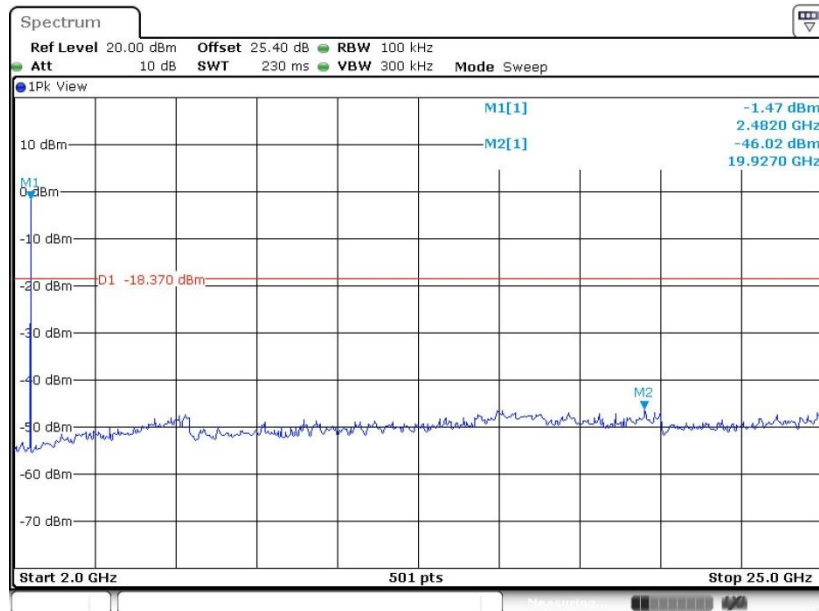

Date: 9.SEP.2018 23:22:32





### 3.5 Radiated Band Edges and Spurious Emission Measurement

#### 3.5.1 Limit of Radiated Band Edges and Spurious Emission

In any 100 kHz bandwidth outside the intentional radiator frequency band, all harmonics/spurious must be at least 20 dB below the highest emission level within the authorized band. If the output power of this device was measured by spectrum analyzer, the attenuation under this paragraph shall be 30 dB instead of 20 dB. In addition, radiated emissions which fall in the restricted bands must also comply with the limits as below.

Frequency (MHz)	Field Strength (microvolts/meter)	Measurement Distance (meters)
0.009 – 0.490	2400/F(kHz)	300
0.490 – 1.705	24000/F(kHz)	30
1.705 – 30.0	30	30
30 – 88	100	3
88 – 216	150	3
216 - 960	200	3
Above 960	500	3

#### 3.5.2 Measuring Instruments

See list of measuring equipment of this test report.



### 3.5.3 Test Procedures

1. The testing follows FCC KDB Publication No. 558074 D01 DTS Meas. Guidance v05
2. The EUT was arranged to its worst case and then tune the antenna tower (from 1 m to 4 m) and turntable (from 0 degree to 360 degrees) to find the maximum reading. A pre-amp and a high pass filter are used for the test in order to get better signal level.
3. The EUT was placed on a turntable with 0.8 meter for frequency below 1GHz and 1.5 meter for frequency above 1GHz respectively above ground.
4. The EUT was set 3 meters from the interference receiving antenna, which was mounted on the top of a variable height antenna tower.
5. Corrected Reading: Antenna Factor + Cable Loss + Read Level - Preamp Factor = Level
6. For testing below 1GHz, if the emission level of the EUT in peak mode was 3 dB lower than the limit specified, then peak values of EUT will be reported, otherwise, the emissions will be repeated one by one using the CISPR quasi-peak method and reported.
7. For testing above 1GHz, the emission level of the EUT in peak mode was 20dB lower than average limit (that means the emission level in average mode also complies with the limit in average mode), then peak values of EUT will be reported, otherwise, the emissions will be measured in average mode again and reported.
8. Use the following spectrum analyzer settings:
  - (1) Span shall wide enough to fully capture the emission being measured;
  - (2) Set RBW=100 kHz for  $f < 1$  GHz;  $VBW \geq RBW$ ; Sweep = auto; Detector function = peak; Trace = max hold;
  - (3) Set RBW = 1 MHz, VBW= 3MHz for  $f \geq 1$  GHz for peak measurement.  
For average measurement:
    - $VBW = 10$  Hz, when duty cycle is no less than 98 percent.
    - $VBW \geq 1/T$ , when duty cycle is less than 98 percent where T is the minimum transmission duration over which the transmitter is on and is transmitting at its maximum power control level for the tested mode of operation.

### 3.5.4 Test Setup

For radiated emissions below 30MHz

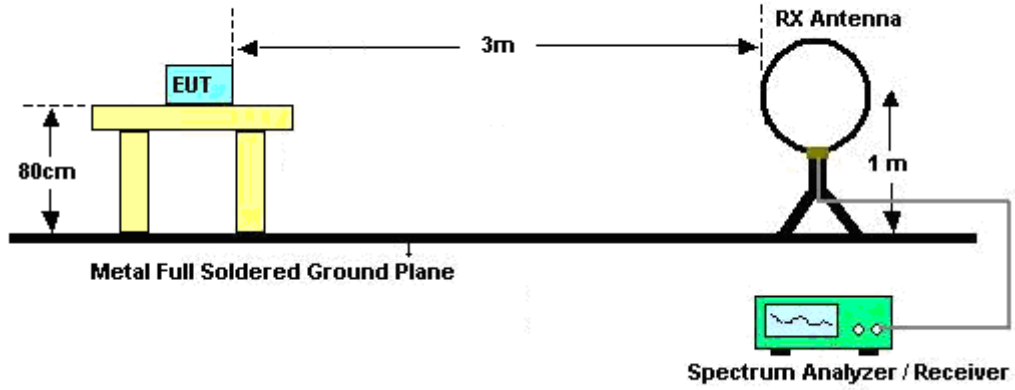

For radiated emissions from 30MHz to 1GHz

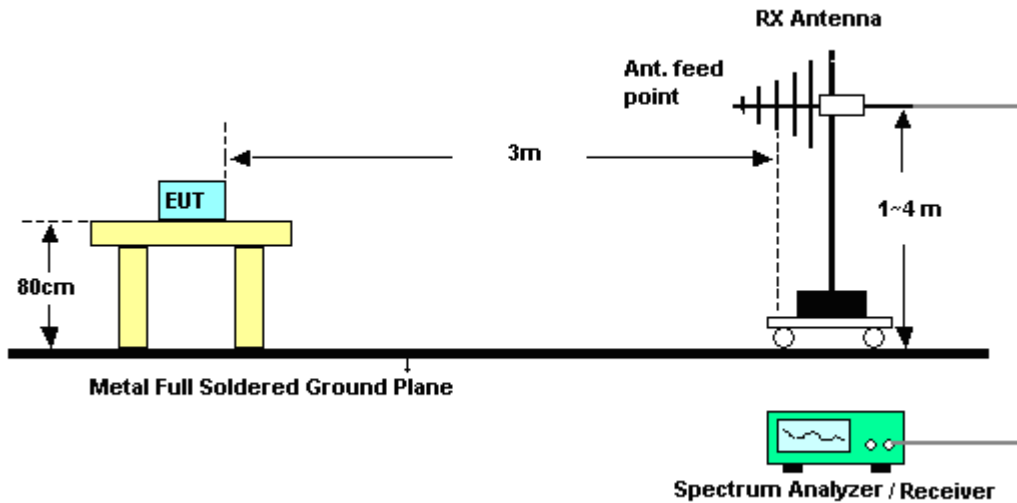

For radiated emissions above 1GHz

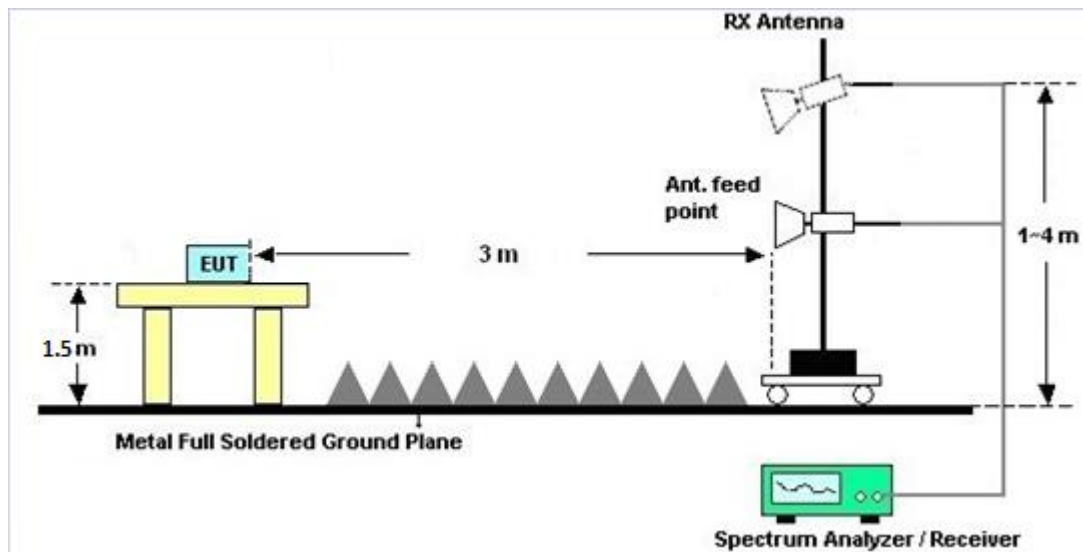

### 3.5.5 Test Results of Radiated Spurious Emissions (9 kHz ~ 30 MHz)

The low frequency, which started from 9 kHz to 30MHz, was pre-scanned and the result which was 20dB lower than the limit line was not reported.

There is a comparison data of both open-field test site and alternative test site - semi-Anechoic chamber according to 414788 D01 Radiated Test Site v01r01, and the result came out very similar.

### 3.5.6 Test Result of Radiated Spurious at Band Edges

Please refer to Appendix B and C.

### 3.5.7 Duty Cycle

Please refer to Appendix D.

### 3.5.8 Test Result of Radiated Spurious Emission (30MHz ~ 10th Harmonic)

Please refer to Appendix B and C.



### 3.6 AC Conducted Emission Measurement

#### 3.6.1 Limit of AC Conducted Emission

For equipment that is designed to be connected to the public utility (AC) power line, the radio frequency voltage that is conducted back onto the AC power line on any frequency or frequencies within the band 150 kHz to 30 MHz shall not exceed the limits in the following table.

Frequency of emission (MHz)	Conducted limit (dB $\mu$ V)	
	Quasi-peak	Average
0.15-0.5	66 to 56*	56 to 46*
0.5-5	56	46
5-30	60	50

\*Decreases with the logarithm of the frequency.

For terminal test result, the testing follows FCC KDB 174176.

#### 3.6.2 Measuring Instruments

See list of measuring equipment of this test report.

#### 3.6.3 Test Procedures

1. The EUT was placed 0.4 meter from the conducting wall of the shielding room was kept at least 80 centimeters from any other grounded conducting surface.
2. Connect EUT to the power mains through a line impedance stabilization network (LISN).
3. All the support units are connecting to the other LISN.
4. The LISN provides 50 ohm coupling impedance for the measuring instrument.
5. The FCC states that a 50 ohm, 50 microhenry LISN should be used.
6. Both sides of AC line were checked for maximum conducted interference.
7. The frequency range from 150 kHz to 30 MHz was searched.
8. Set the test-receiver system to Peak Detect Function and specified bandwidth (IF Bandwidth = 9kHz) with Maximum Hold Mode. Then measurement is also conducted by Average Detector and Quasi-Peak Detector Function respectively.

### 3.6.4 Test Setup

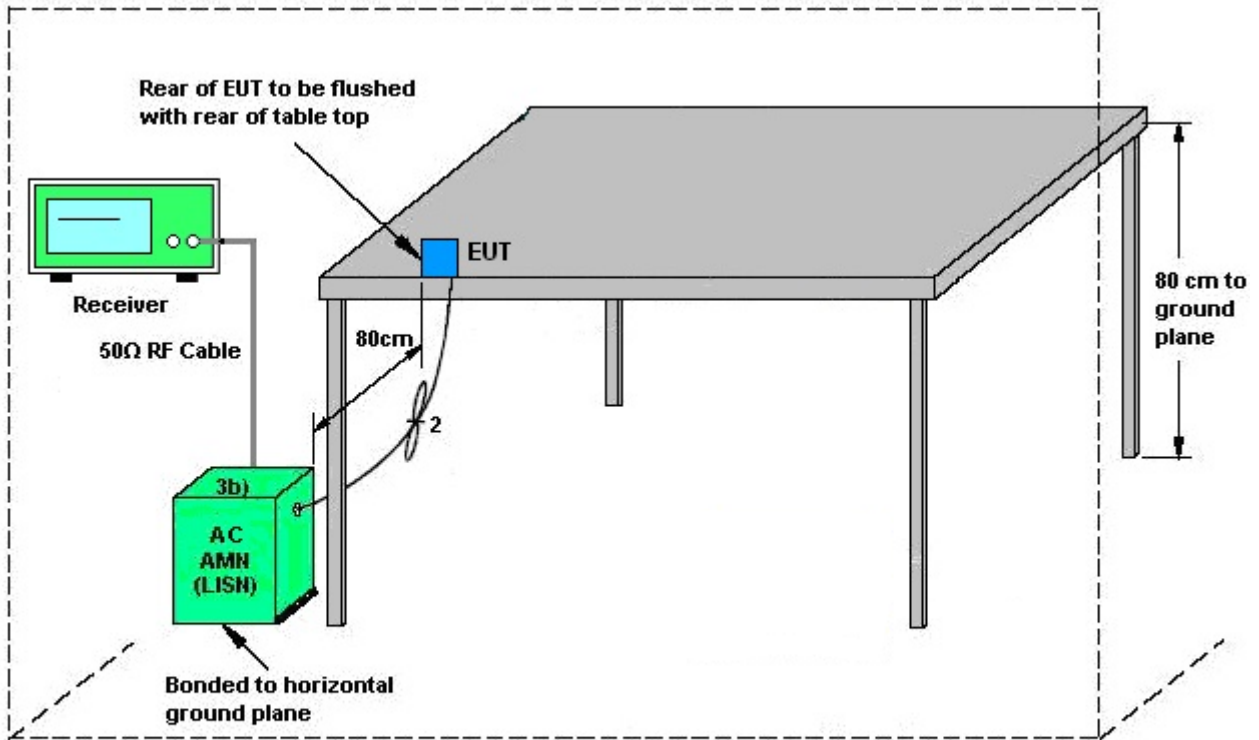

AMN = Artificial mains network (LISN)  
 AE = Associated equipment  
 EUT = Equipment under test  
 ISN = Impedance stabilization network

### 3.6.5 Test Result of AC Conducted Emission

Please refer to Appendix A.



## **3.7 Antenna Requirements**

### **3.7.1 Standard Applicable**

If directional gain of transmitting antennas is greater than 6dBi, the power shall be reduced by the same level in dB comparing to gain minus 6dBi. The use of a permanently attached antenna or of an antenna that uses a unique coupling to the intentional radiator shall be considered sufficient to comply with the rule.

### **3.7.2 Antenna Anti-Replacement Construction**

An embedded-in antenna design is used.

### **3.7.3 Antenna Gain**

The antenna peak gain of EUT is less than 6 dBi. Therefore, it is not necessary to reduce maximum peak output power limit.



## 4 List of Measuring Equipment

Instrument	Manufacturer	Model No.	Serial No.	Characteristics	Calibration Date	Test Date	Due Date	Remark
Power Meter	Agilent	E4416A	GB412923 44	N/A	Dec. 20, 2017	Sep. 07, 2018 ~ Sep. 09, 2018	Dec. 19, 2018	Conducted (TH05-HY)
Power Sensor	Agilent	E9327A	US404415 48	50MHz~18GHz	Dec. 20, 2017	Sep. 07, 2018 ~ Sep. 09, 2018	Dec. 19, 2018	Conducted (TH05-HY)
Spectrum Analyzer	Rohde & Schwarz	FSP30	101067	9kHz ~ 30GHz	Nov. 13, 2017	Sep. 07, 2018 ~ Sep. 09, 2018	Nov. 12, 2018	Conducted (TH05-HY)
Switch Box & RF Cable	Burgeon	ETF-058	EC130048 4	N/A	Mar. 01, 2018	Sep. 07, 2018 ~ Sep. 09, 2018	Feb. 28, 2019	Conducted (TH05-HY)
AC Power Source	ChainTek	APC-1000W	N/A	N/A	N/A	Aug. 07, 2018 ~ Aug. 11, 2018	N/A	Conduction (CO05-HY)
EMI Test Receiver	Rohde & Schwarz	ESR3	102388	9KHz~3.6GHz	Dec. 08, 2017	Aug. 07, 2018 ~ Aug. 11, 2018	Dec. 07, 2018	Conduction (CO05-HY)
LISN	Rohde & Schwarz	ENV216	100080	9kHz~30MHz	Nov. 30, 2017	Aug. 07, 2018 ~ Aug. 11, 2018	Nov. 29, 2018	Conduction (CO05-HY)
LISN	Rohde & Schwarz	ENV216	100081	9kHz~30MHz	Dec. 08, 2017	Aug. 07, 2018 ~ Aug. 11, 2018	Dec. 07, 2018	Conduction (CO05-HY)
Software	Rohde & Schwarz	EMC32 V10.30	N/A	N/A	N/A	Aug. 07, 2018 ~ Aug. 11, 2018	N/A	Conduction (CO05-HY)
LF Cable	HUBER + SUHNER	RG-214/U	LF01	N/A	Jan. 03, 2018	Aug. 07, 2018 ~ Aug. 11, 2018	Jan. 02, 2019	Conduction (CO05-HY)
Pulse Limiter	Rohde & Schwarz	ESH3-Z2	100851	N/A	Jan. 03, 2018	Aug. 07, 2018 ~ Aug. 11, 2018	Jan. 02, 2019	Conduction (CO05-HY)
Bilog Antenna	TESEQ	CBL 6111D&00800 N1D01N-06	35419&03	30MHz to 1GHz	Dec. 18, 2017	Aug. 07, 2018 ~ Sep. 05, 2018	Dec. 17, 2018	Radiation (03CH07-HY)
Double Ridge Horn Antenna	EMCO	3117	00066583	1GHz~18GHz	Aug. 06, 2018	Aug. 07, 2018 ~ Sep. 05, 2018	Aug. 05, 2019	Radiation (03CH07-HY)
Loop Antenna	Rohde & Schwarz	HFH2-Z2	100315	9 kHz~30 MHz	Nov. 10, 2017	Aug. 07, 2018 ~ Sep. 05, 2018	Nov. 09, 2018	Radiation (03CH07-HY)
Preamplifier	MITEQ	AMF-7D-0010 1800-30-10P	1590075	1GHz ~ 18GHz	Apr. 25, 2018	Aug. 07, 2018 ~ Sep. 05, 2018	Apr. 24, 2019	Radiation (03CH07-HY)
Preamplifier	COM-POWER	PA-103A	161241	10MHz-1GHz	May 21, 2018	Aug. 07, 2018 ~ Sep. 05, 2018	May 20, 2019	Radiation (03CH07-HY)
Preamplifier	Agilent	8449B	3008A023 62	1GHz~ 26.5GHz	Oct. 30, 2017	Aug. 07, 2018 ~ Sep. 05, 2018	Oct. 29, 2018	Radiation (03CH07-HY)
Spectrum Analyzer	Agilent	N9010A	MY534701 18	10Hz~44GHz	Apr. 17, 2018	Aug. 07, 2018 ~ Sep. 05, 2018	Apr. 16, 2019	Radiation (03CH07-HY)
Filter	Microwave	H1G013G1	SN477215	1.0G High Pass	Dec. 07, 2017	Aug. 07, 2018 ~ Sep. 05, 2018	Dec. 06, 2018	Radiation (03CH07-HY)
Filter	Wainwright	WLKS1200-8 SS	SN3	1.2G Low Pass	Nov. 21, 2017	Aug. 07, 2018 ~ Sep. 05, 2018	Nov. 20, 2018	Radiation (03CH07-HY)
Filter	Microwave	H3G018G1	SN477220	3.0G High Pass	Nov. 21, 2017	Aug. 07, 2018 ~ Sep. 05, 2018	Nov. 20, 2018	Radiation (03CH07-HY)
Filter	Microwave	WHKX7.0/26. 5G-6SS	SN4	7G High Pass	Nov. 21, 2017	Aug. 07, 2018 ~ Sep. 05, 2018	Nov. 20, 2018	Radiation (03CH07-HY)





Instrument	Manufacturer	Model No.	Serial No.	Characteristics	Calibration Date	Test Date	Due Date	Remark
RF Cable	HUBER + SUHNER	SUCOFLEX 104	MY24971/4, MY28655/4	9KHz~30MHz	Jan. 02, 2018	Aug. 07, 2018 ~ Sep. 05, 2018	Jan. 01, 2019	Radiation (03CH07-HY)
RF Cable	HUBER + SUHNER	SUCOFLEX 104	MY28655/4, MY24971/4, MY15682/4	30MHz~1GHz	Feb. 27, 2018	Aug. 07, 2018 ~ Sep. 05, 2018	Feb. 26, 2019	Radiation (03CH07-HY)
RF Cable	HUBER + SUHNER	SUCOFLEX 104	MY28655/4, MY24971/4, MY15682/4	1GHz~18GHz	Feb. 27, 2018	Aug. 07, 2018 ~ Sep. 05, 2018	Feb. 26, 2019	Radiation (03CH07-HY)
RF Cable	HUBER + SUHNER	SUCOFLEX 102	MY2858/2	18GHz~40GHz	Feb. 27, 2018	Aug. 07, 2018 ~ Sep. 05, 2018	Feb. 26, 2019	Radiation (03CH07-HY)
Antenna Mast	Max-Full	MFA520BS	N/A	1m~4m	N/A	Aug. 07, 2018 ~ Sep. 05, 2018	N/A	Radiation (03CH07-HY)
Turn Table	ChainTek	Chaintek 3000	N/A	0~360 Degree	N/A	Aug. 07, 2018 ~ Sep. 05, 2018	N/A	Radiation (03CH07-HY)
Amplifier	MITEQ	TTA1840-35-HG	1871923	18GHz~40GHz, VSWR : 2.5:1 max	Jul. 16, 2018	Aug. 07, 2018 ~ Sep. 05, 2018	Jul. 15, 2019	Radiation (03CH07-HY)
SHF-EHF Horn Antenna	SCHWARZBECK	BBHA 9170	BBHA91702 51	18GHz- 40GHz	Nov. 10, 2017	Aug. 07, 2018 ~ Sep. 05, 2018	Nov. 09, 2018	Radiation (03CH07-HY)
EMI Test Receiver	Agilent	N9038A(MXE)	MY5329005 3	20Hz to 26.5GHz	Jan. 16, 2018	Aug. 07, 2018 ~ Sep. 05, 2018	Jan. 15, 2019	Radiation (03CH07-HY)
Software	Audix	E3 6.2009-8-24	8050400465 6H	N/A	N/A	Aug. 07, 2018 ~ Sep. 05, 2018	N/A	Radiation (03CH07-HY)



## 5 Uncertainty of Evaluation

### Uncertainty of Conducted Emission Measurement (150 kHz ~ 30 MHz)

Measuring Uncertainty for a Level of Confidence of 95% ( $U = 2Uc(y)$ )	2.2
---	-----

### Uncertainty of Radiated Emission Measurement (30 MHz ~ 1000 MHz)

Measuring Uncertainty for a Level of Confidence of 95% ( $U = 2Uc(y)$ )	5.7
---	-----

### Uncertainty of Radiated Emission Measurement (1000 MHz ~ 18000 MHz)

Measuring Uncertainty for a Level of Confidence of 95% ( $U = 2Uc(y)$ )	5.5
---	-----

### Uncertainty of Radiated Emission Measurement (18000 MHz ~ 40000 MHz)

Measuring Uncertainty for a Level of Confidence of 95% ( $U = 2Uc(y)$ )	5.2
---	-----

## Appendix A. AC Conducted Emission Test Results

<Original test result with NFC antenna>

Test Mode :	Mode 1	Temperature :	25~27°C
Test Engineer :	Kai-Chun Chu	Relative Humidity :	50~52%
Test Voltage :	120Vac / 60Hz	Phase :	Line

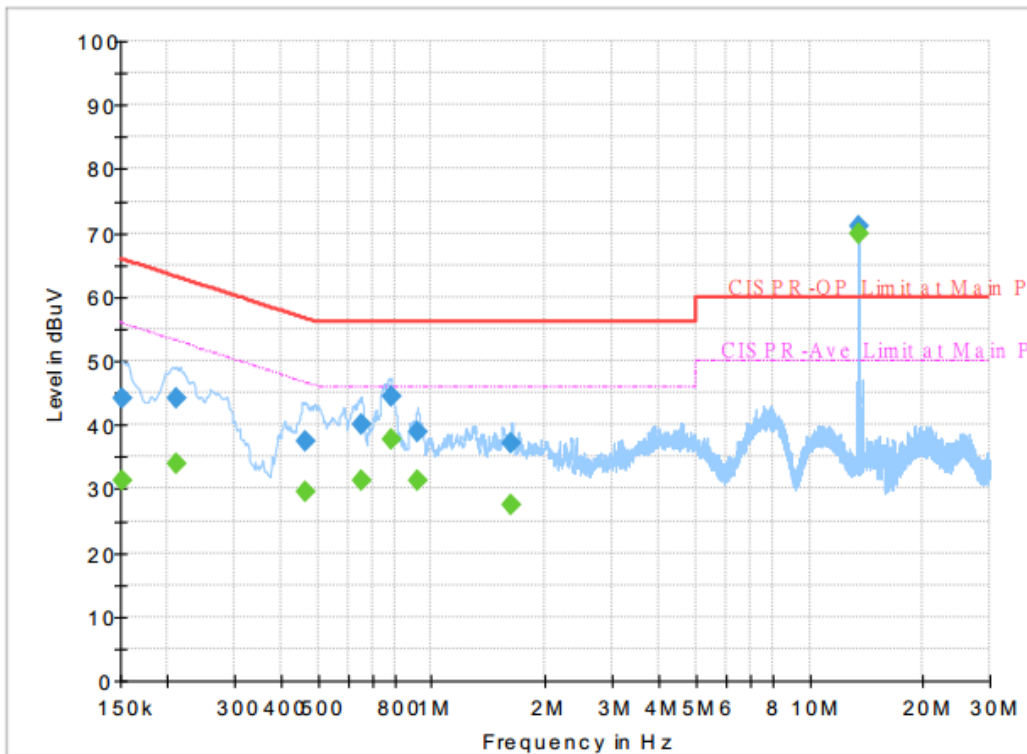

### Final Result

Frequency (MHz)	QuasiPeak (dBμV)	CAverage (dBμV)	Limit (dBμV)	Margin (dB)	Line	Filter	Corr. (dB)
0.152250	---	31.25	55.88	24.63	L1	OFF	19.5
0.152250	44.13	---	65.88	21.75	L1	OFF	19.5
0.210750	---	34.00	53.18	19.18	L1	OFF	19.5
0.210750	44.23	---	63.18	18.95	L1	OFF	19.5
0.462750	---	29.63	46.64	17.01	L1	OFF	19.5
0.462750	37.37	---	56.64	19.27	L1	OFF	19.5
0.649500	---	31.17	46.00	14.83	L1	OFF	19.5
0.649500	40.12	---	56.00	15.88	L1	OFF	19.5
0.780000	---	37.77	46.00	8.23	L1	OFF	19.5
0.780000	44.48	---	56.00	11.52	L1	OFF	19.5
0.919500	---	31.21	46.00	14.79	L1	OFF	19.5
0.919500	38.82	---	56.00	17.18	L1	OFF	19.5
1.630500	---	27.49	46.00	18.51	L1	OFF	19.6
1.630500	37.08	---	56.00	18.92	L1	OFF	19.6
13.560000	---	70.00	50.00	-20.00	L1	OFF	19.7
13.560000	70.91	---	60.00	-10.91	L1	OFF	19.7



Test Mode :	Mode 1	Temperature :	25~27°C
Test Engineer :	Kai-Chun Chu	Relative Humidity :	50~52%
Test Voltage :	120Vac / 60Hz	Phase :	Neutral

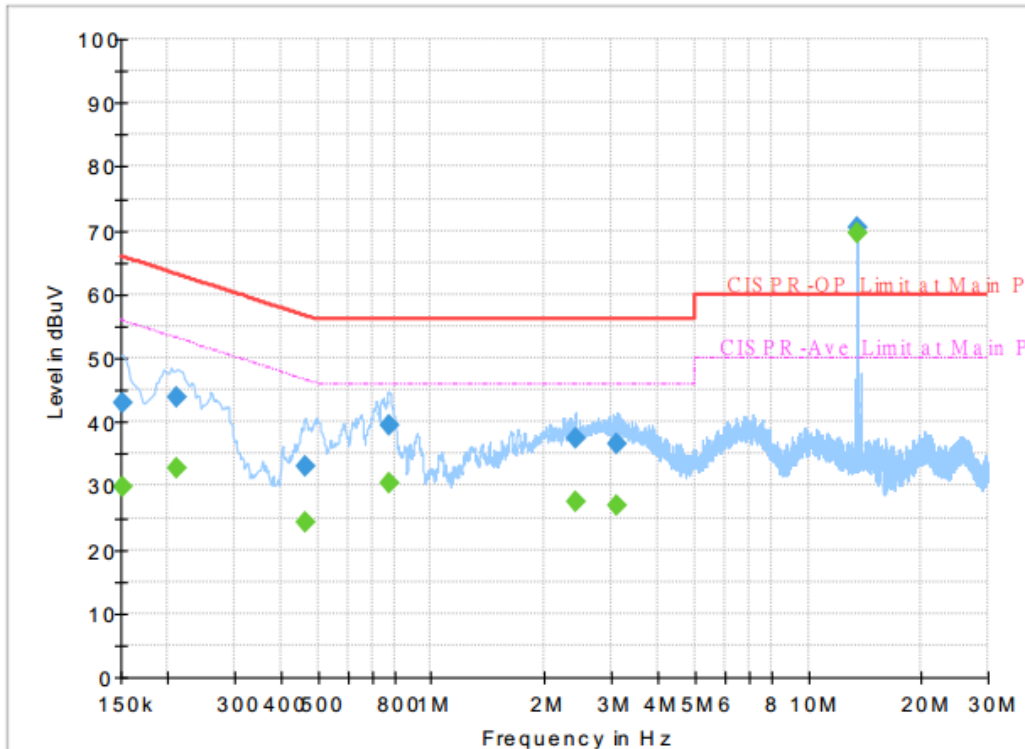

Final Result

Frequency (MHz)	QuasiPeak (dBμV)	CAverage (dBμV)	Limit (dBμV)	Margin (dB)	Line	Filter	Corr. (dB)
0.152250	---	29.87	55.88	26.01	N	OFF	19.5
0.152250	42.92	---	65.88	22.96	N	OFF	19.5
0.210750	---	32.68	53.18	20.50	N	OFF	19.5
0.210750	43.89	---	63.18	19.29	N	OFF	19.5
0.462750	---	24.15	46.64	22.49	N	OFF	19.5
0.462750	33.12	---	56.64	23.52	N	OFF	19.5
0.771000	---	30.42	46.00	15.58	N	OFF	19.5
0.771000	39.34	---	56.00	16.66	N	OFF	19.5
2.411250	---	27.51	46.00	18.49	N	OFF	19.5
2.411250	37.31	---	56.00	18.69	N	OFF	19.5
3.124500	---	26.82	46.00	19.18	N	OFF	19.6
3.124500	36.60	---	56.00	19.40	N	OFF	19.6
13.560000	---	69.52	50.00	-19.52	N	OFF	19.8
13.560000	70.59	---	60.00	-10.59	N	OFF	19.8



<Terminal test result with dummy load>

Test Mode :	Mode 1	Temperature :	25~27°C
Test Engineer :	Kai-Chun Chu	Relative Humidity :	50~52%
Test Voltage :	120Vac / 60Hz	Phase :	Line

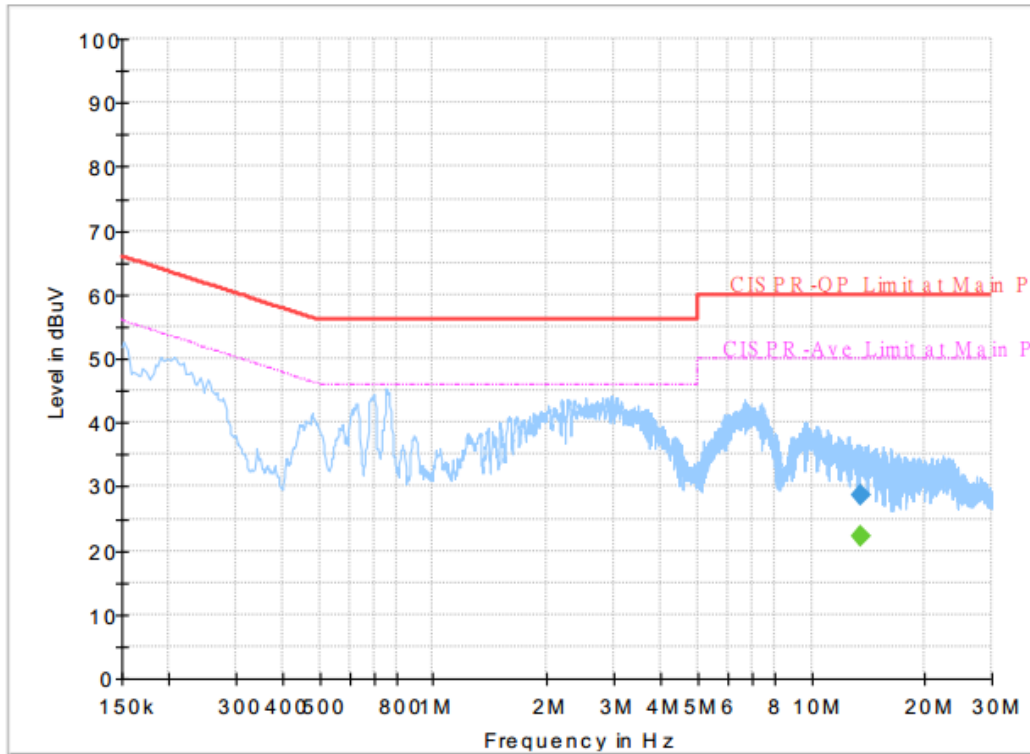

Final Result

Frequency (MHz)	QuasiPeak (dBμV)	CAverage (dBμV)	Limit (dBμV)	Margin (dB)	Line	Filter	Corr. (dB)
13.560000	---	22.20	50.00	27.80	L1	OFF	19.7
13.560000	28.57	---	60.00	31.43	L1	OFF	19.7



Test Mode :	Mode 1	Temperature :	25~27°C
Test Engineer :	Kai-Chun Chu	Relative Humidity :	50~52%
Test Voltage :	120Vac / 60Hz	Phase :	Neutral

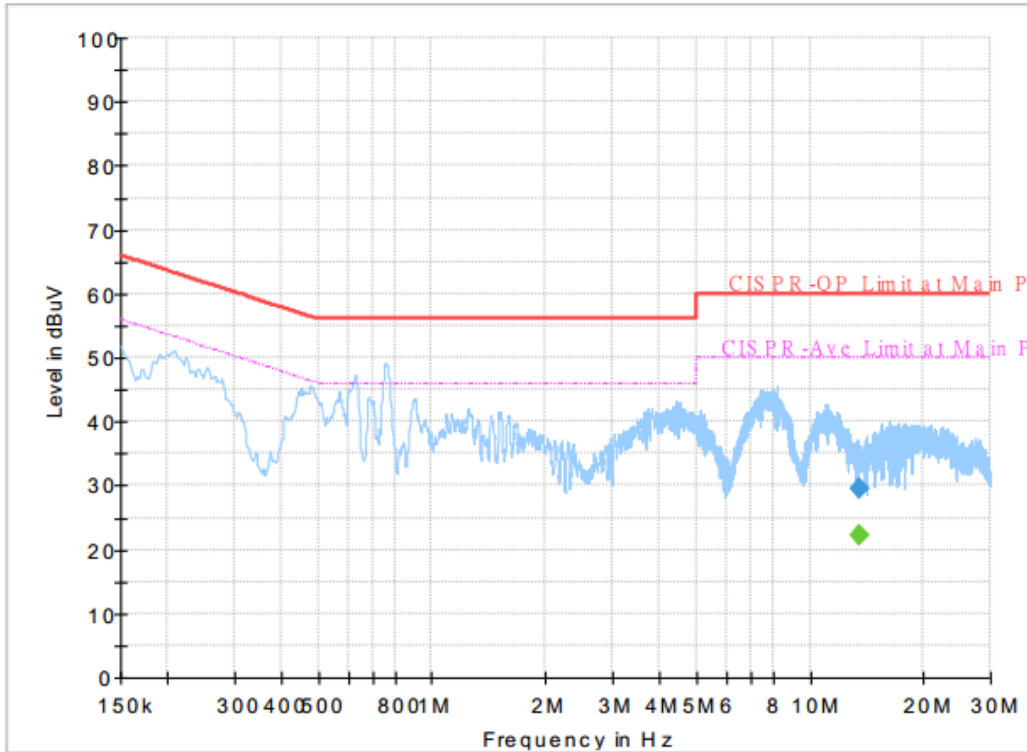

**Final Result**

Frequency (MHz)	QuasiPeak (dBμV)	CAverage (dBμV)	Limit (dBμV)	Margin (dB)	Line	Filter	Corr. (dB)
13.560000	---	22.27	50.00	27.73	N	OFF	19.8
13.560000	29.39	---	60.00	30.61	N	OFF	19.8



<Original test result with NFC antenna>

Test Mode :	Mode 2	Temperature :	25~27°C
Test Engineer :	Kai-Chun Chu	Relative Humidity :	50~52%
Test Voltage :	120Vac / 60Hz	Phase :	Line

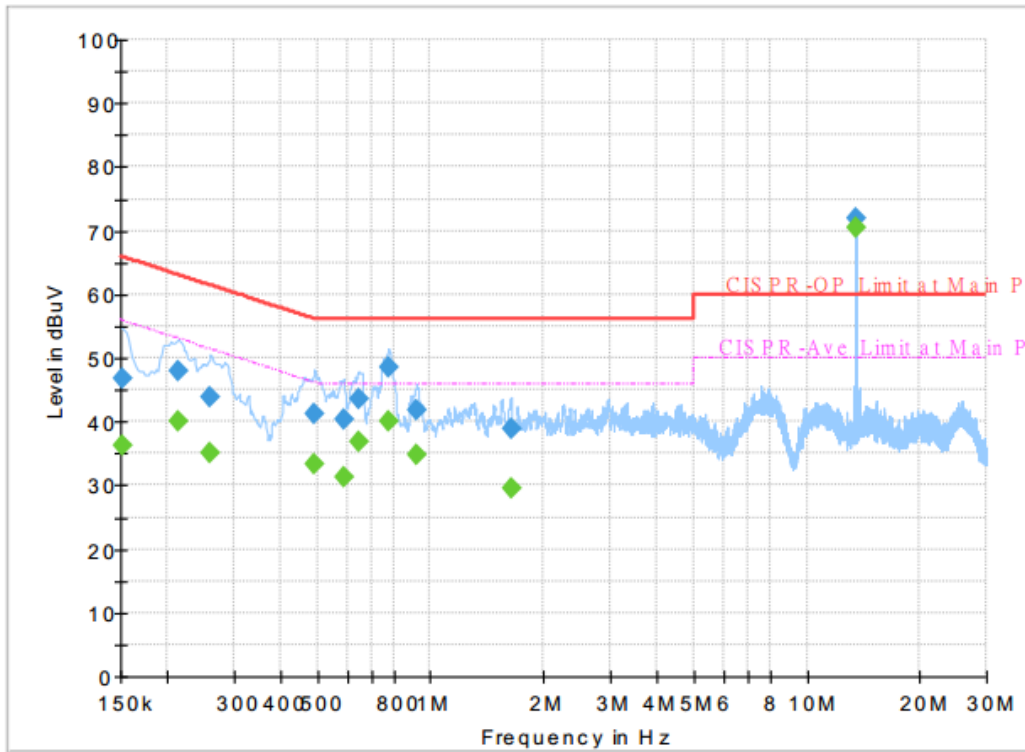

Final Result

Frequency (MHz)	QuasiPeak (dBμV)	CAverage (dBμV)	Limit (dBμV)	Margin (dB)	Line	Filter	Corr. (dB)
0.152250	---	36.20	55.88	19.68	L1	OFF	19.5
0.152250	46.85	---	65.88	19.03	L1	OFF	19.5
0.213000	---	40.19	53.09	12.90	L1	OFF	19.5
0.213000	48.09	---	63.09	15.00	L1	OFF	19.5
0.260250	---	35.09	51.42	16.33	L1	OFF	19.5
0.260250	43.76	---	61.42	17.66	L1	OFF	19.5
0.492000	---	33.25	46.13	12.88	L1	OFF	19.5
0.492000	41.28	---	56.13	14.85	L1	OFF	19.5
0.586500	---	31.28	46.00	14.72	L1	OFF	19.5
0.586500	40.21	---	56.00	15.79	L1	OFF	19.5
0.642750	---	36.84	46.00	9.16	L1	OFF	19.5
0.642750	43.59	---	56.00	12.41	L1	OFF	19.5
0.773250	---	40.16	46.00	5.84	L1	OFF	19.5
0.773250	48.66	---	56.00	7.34	L1	OFF	19.5
0.917250	---	34.80	46.00	11.20	L1	OFF	19.5
0.917250	41.89	---	56.00	14.11	L1	OFF	19.5
1.635000	---	29.51	46.00	16.49	L1	OFF	19.6
1.635000	38.96	---	56.00	17.04	L1	OFF	19.6
13.560000	---	70.57	50.00	-20.57	L1	OFF	19.7
13.560000	71.84	---	60.00	-11.84	L1	OFF	19.7



Test Mode :	Mode 2	Temperature :	25~27°C
Test Engineer :	Kai-Chun Chu	Relative Humidity :	50~52%
Test Voltage :	120Vac / 60Hz	Phase :	Neutral

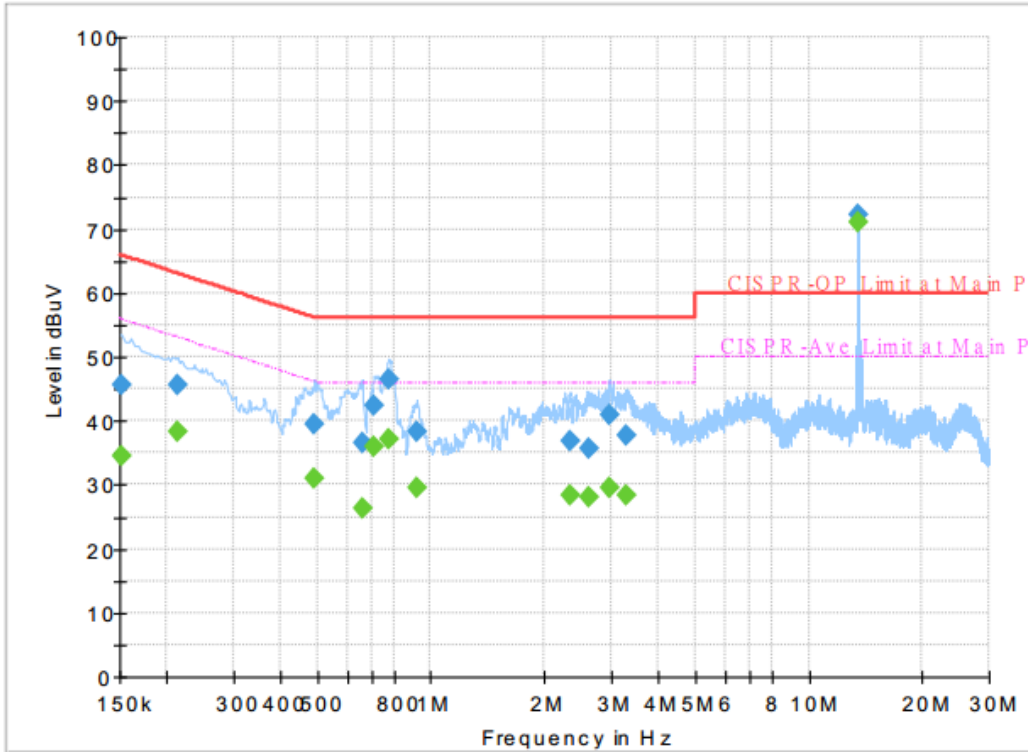

Final Result

Frequency (MHz)	QuasiPeak (dBμV)	CAverage (dBμV)	Limit (dBμV)	Margin (dB)	Line	Filter	Corr. (dB)
0.152250	---	34.58	55.88	21.30	N	OFF	19.5
0.152250	45.50	---	65.88	20.38	N	OFF	19.5
0.213000	---	38.17	53.09	14.92	N	OFF	19.5
0.213000	45.71	---	63.09	17.38	N	OFF	19.5
0.492000	---	31.02	46.13	15.11	N	OFF	19.5
0.492000	39.54	---	56.13	16.59	N	OFF	19.5
0.656250	---	26.45	46.00	19.55	N	OFF	19.5
0.656250	36.66	---	56.00	19.34	N	OFF	19.5
0.710250	---	35.90	46.00	10.10	N	OFF	19.5
0.710250	42.46	---	56.00	13.54	N	OFF	19.5
0.773250	---	37.16	46.00	8.84	N	OFF	19.5
0.773250	46.50	---	56.00	9.50	N	OFF	19.5
0.919500	---	29.43	46.00	16.57	N	OFF	19.5
0.919500	38.17	---	56.00	17.83	N	OFF	19.5
2.328000	---	28.50	46.00	17.50	N	OFF	19.5
2.328000	36.89	---	56.00	19.11	N	OFF	19.5
2.629500	---	28.03	46.00	17.97	N	OFF	19.5
2.629500	35.59	---	56.00	20.41	N	OFF	19.5
2.955750	---	29.60	46.00	16.40	N	OFF	19.6
2.955750	41.02	---	56.00	14.98	N	OFF	19.6
3.306750	---	28.48	46.00	17.52	N	OFF	19.6
3.306750	37.58	---	56.00	18.42	N	OFF	19.6
13.560000	---	70.94	50.00	-20.94	N	OFF	19.8
13.560000	72.12	---	60.00	-12.12	N	OFF	19.8



<Terminal test result with dummy load>

Test Mode :	Mode 2	Temperature :	25~27°C
Test Engineer :	Kai-Chun Chu	Relative Humidity :	50~52%
Test Voltage :	120Vac / 60Hz	Phase :	Line

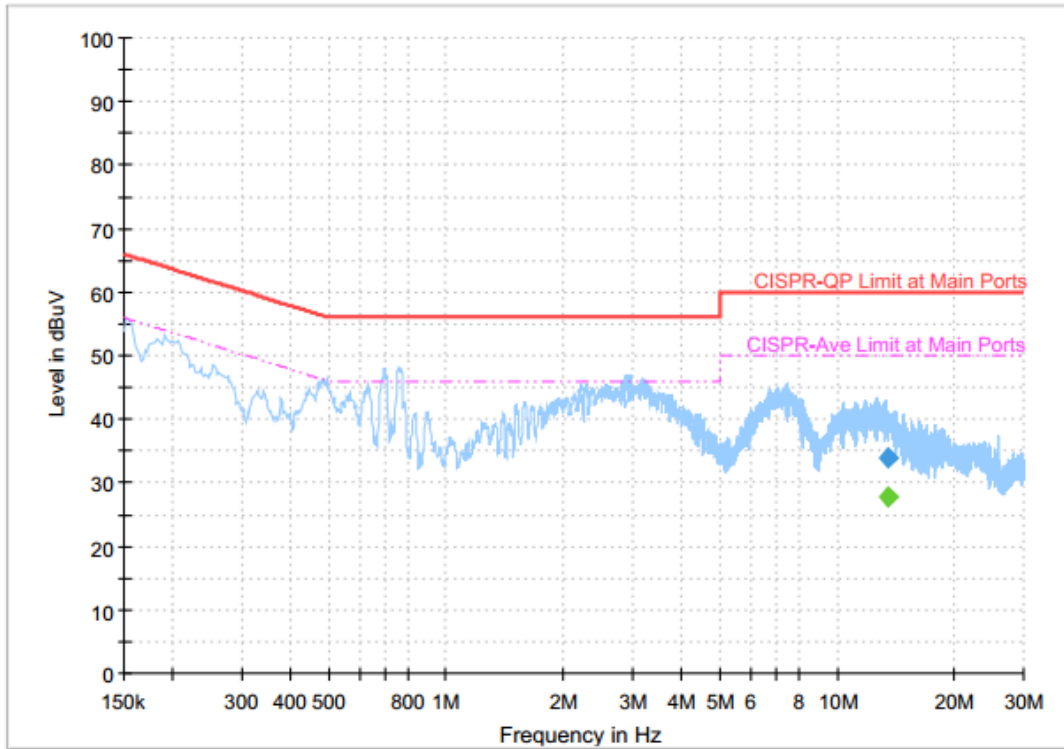

**Final Result**

Frequency (MHz)	QuasiPeak (dB $\mu$ V)	CAverage (dB $\mu$ V)	Limit (dB $\mu$ V)	Margin (dB)	Line	Filter	Corr. (dB)
13.560000	---	27.73	50.00	22.27	L1	OFF	19.7
13.560000	33.82	---	60.00	26.18	L1	OFF	19.7



Test Mode :	Mode 2	Temperature :	25~27°C
Test Engineer :	Kai-Chun Chu	Relative Humidity :	50~52%
Test Voltage :	120Vac / 60Hz	Phase :	Neutral

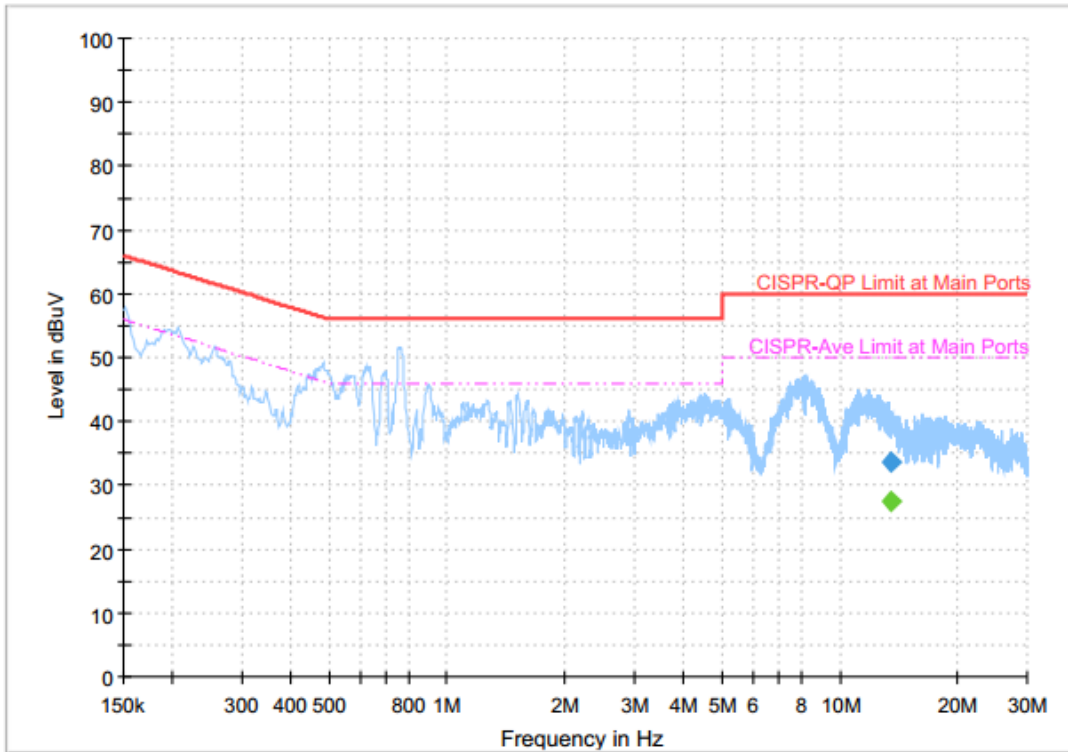

Final Result

Frequency (MHz)	QuasiPeak (dBμV)	CAverage (dBμV)	Limit (dBμV)	Margin (dB)	Line	Filter	Corr. (dB)
13.560000	---	27.56	50.00	22.44	N	OFF	19.8
13.560000	33.69	---	60.00	26.31	N	OFF	19.8



<Original test result with NFC antenna>

Test Mode :	Mode 3	Temperature :	25~27°C
Test Engineer :	Kai-Chun Chu	Relative Humidity :	50~52%
Test Voltage :	120Vac / 60Hz	Phase :	Line

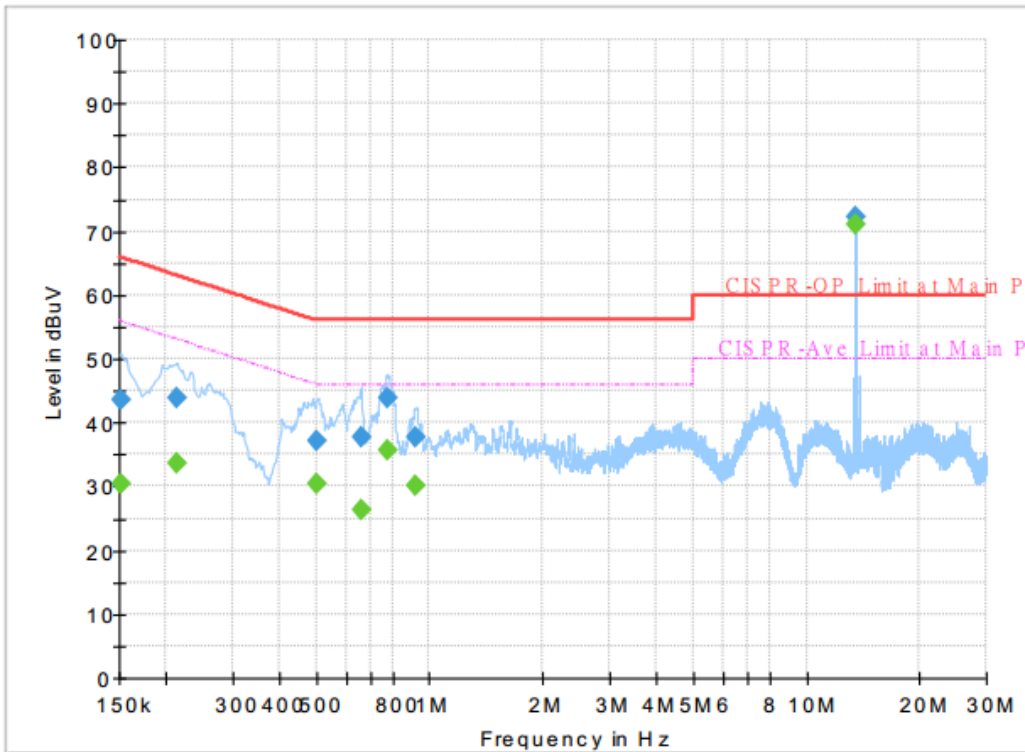

Final Result

Frequency (MHz)	QuasiPeak (dBμV)	CAverage (dBμV)	Limit (dBμV)	Margin (dB)	Line	Filter	Corr. (dB)
0.152250	---	30.37	55.88	25.51	L1	OFF	19.5
0.152250	43.59	---	65.88	22.29	L1	OFF	19.5
0.213000	---	33.56	53.09	19.53	L1	OFF	19.5
0.213000	43.99	---	63.09	19.10	L1	OFF	19.5
0.503250	---	30.33	46.00	15.67	L1	OFF	19.5
0.503250	37.02	---	56.00	18.98	L1	OFF	19.5
0.656250	---	26.42	46.00	19.58	L1	OFF	19.5
0.656250	37.76	---	56.00	18.24	L1	OFF	19.5
0.773250	---	35.61	46.00	10.39	L1	OFF	19.5
0.773250	43.77	---	56.00	12.23	L1	OFF	19.5
0.921750	---	30.21	46.00	15.79	L1	OFF	19.5
0.921750	37.83	---	56.00	18.17	L1	OFF	19.5
13.560000	---	71.16	50.00	-21.16	L1	OFF	19.7
13.560000	72.11	---	60.00	-12.11	L1	OFF	19.7



Test Mode :	Mode 3	Temperature :	25~27°C
Test Engineer :	Kai-Chun Chu	Relative Humidity :	50~52%
Test Voltage :	120Vac / 60Hz	Phase :	Neutral

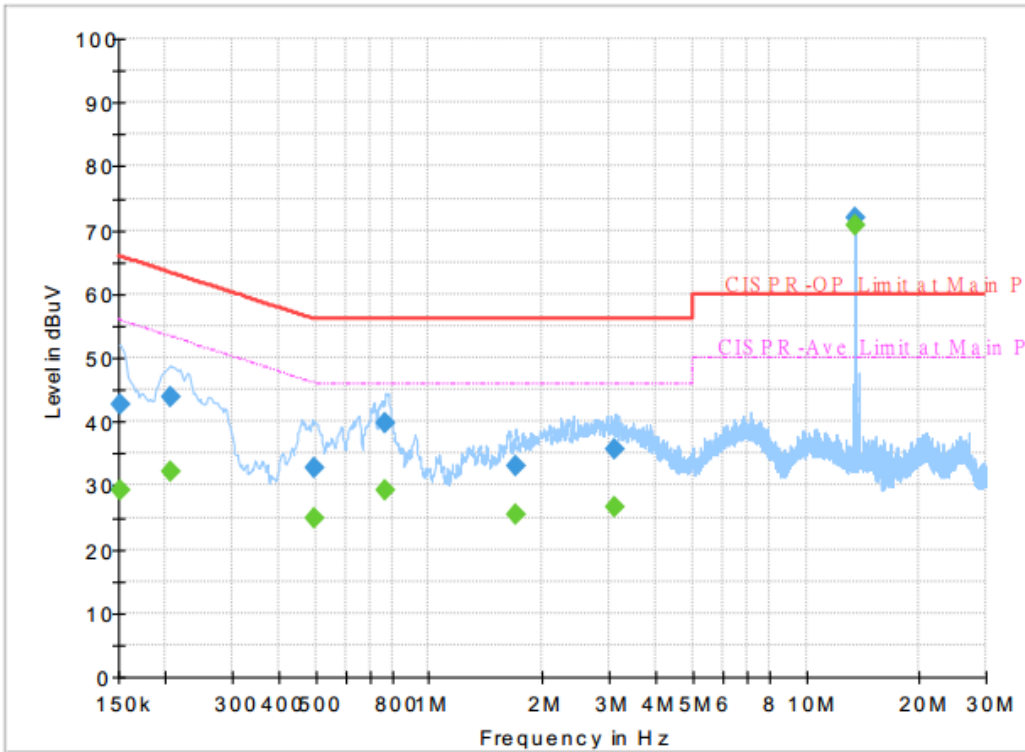

Final Result

Frequency (MHz)	QuasiPeak (dBuV)	CAverage (dBuV)	Limit (dBuV)	Margin (dB)	Line	Filter	Corr. (dB)
0.152250	---	29.18	55.88	26.70	N	OFF	19.5
0.152250	42.59	---	65.88	23.29	N	OFF	19.5
0.206250	---	32.19	53.36	21.17	N	OFF	19.5
0.206250	44.00	---	63.36	19.36	N	OFF	19.5
0.494250	---	24.76	46.10	21.34	N	OFF	19.5
0.494250	32.68	---	56.10	23.42	N	OFF	19.5
0.768750	---	29.36	46.00	16.64	N	OFF	19.5
0.768750	39.72	---	56.00	16.28	N	OFF	19.5
1.698000	---	25.48	46.00	20.52	N	OFF	19.5
1.698000	33.12	---	56.00	22.88	N	OFF	19.5
3.124500	---	26.62	46.00	19.38	N	OFF	19.6
3.124500	35.58	---	56.00	20.42	N	OFF	19.6
13.560000	---	70.80	50.00	-20.80	N	OFF	19.8
13.560000	71.89	---	60.00	-11.89	N	OFF	19.8



<Terminal test result with dummy load>

Test Mode :	Mode 3	Temperature :	25~27°C
Test Engineer :	Kai-Chun Chu	Relative Humidity :	50~52%
Test Voltage :	120Vac / 60Hz	Phase :	Line

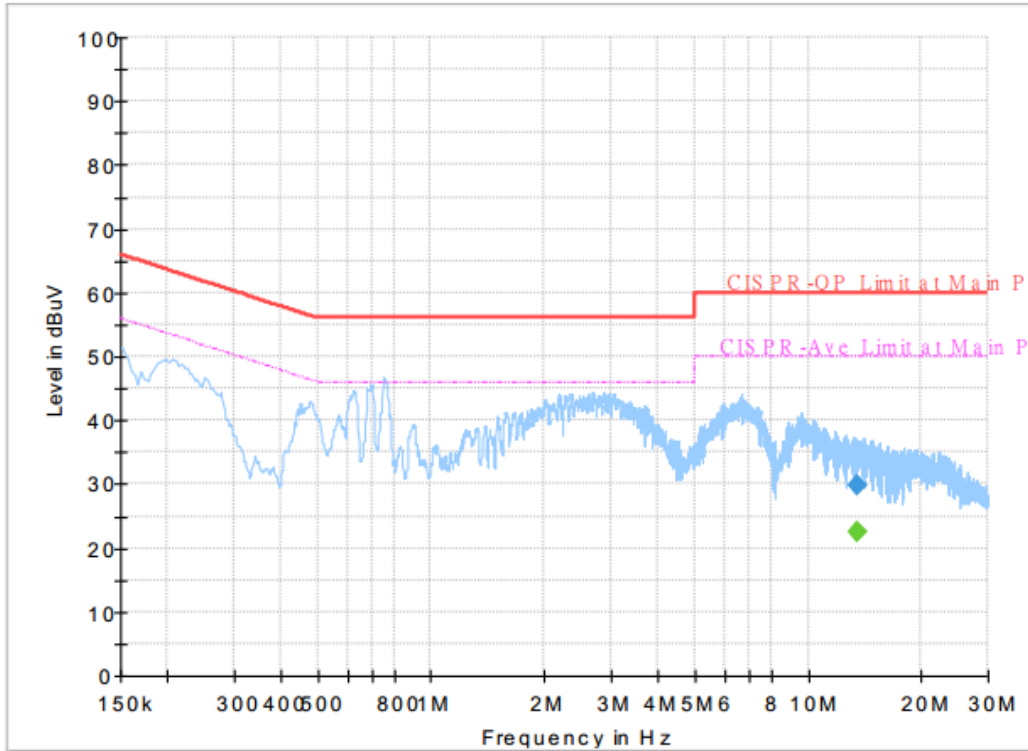

Final Result

Frequency (MHz)	QuasiPeak (dB $\mu$ V)	CAverage (dB $\mu$ V)	Limit (dB $\mu$ V)	Margin (dB)	Line	Filter	Corr. (dB)
13.560000	---	22.55	50.00	27.45	L1	OFF	19.7
13.560000	29.77	---	60.00	30.23	L1	OFF	19.7



Test Mode :	Mode 3	Temperature :	25~27°C
Test Engineer :	Kai-Chun Chu	Relative Humidity :	50~52%
Test Voltage :	120Vac / 60Hz	Phase :	Neutral

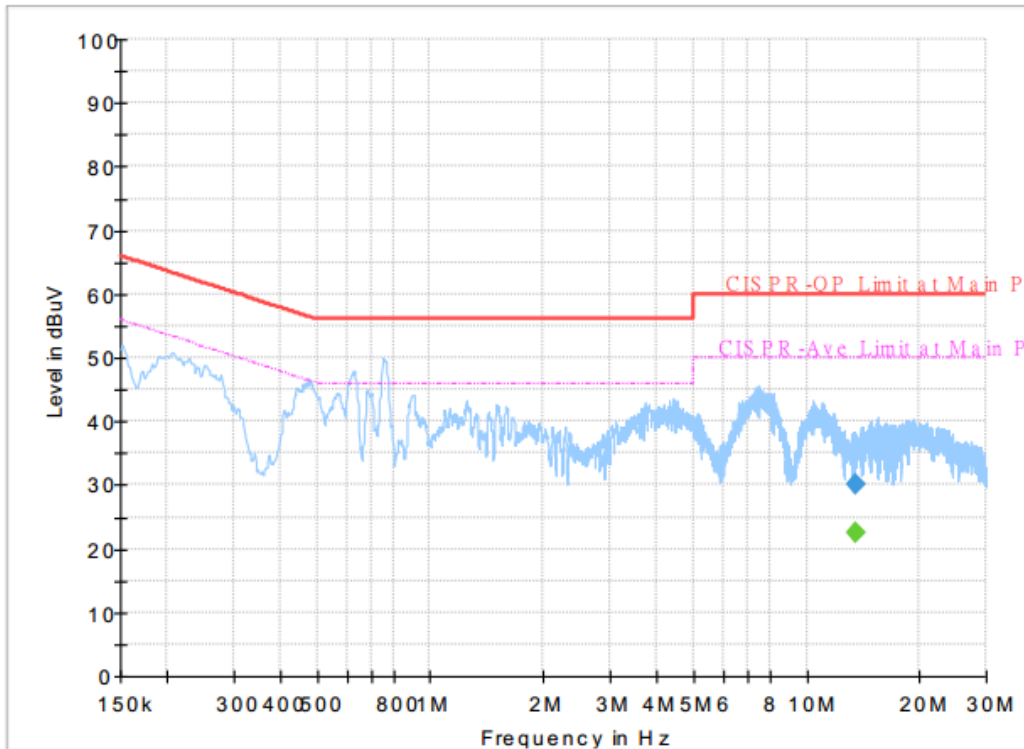

Final Result

Frequency (MHz)	QuasiPeak (dBμV)	CAverage (dBμV)	Limit (dBμV)	Margin (dB)	Line	Filter	Corr. (dB)
13.560000	---	22.49	50.00	27.51	N	OFF	19.8
13.560000	30.09	---	60.00	29.91	N	OFF	19.8



## Appendix B. Radiated Spurious Emission

Test Engineer :	Jesse Wang, Stan Hsieh and Nick Yu	Temperature :	24~26°C
		Relative Humidity :	51~53%

2.4GHz 2400~2483.5MHz

BLE 1Mbps (Band Edge @ 3m)

BLE	Note	Frequency	Level	Over	Limit	Read	Antenna	Path	Preamp	Ant	Table	Peak	Pol.	
		( MHz )	( dBμV/m )	( dB )	Limit	Level	Factor	Loss	Factor	Pos	Pos	Avg.		
					Line	( dBμV )	( dB/m )	( dB )	( dB )	( cm )	( deg )	( P/A )	( H/V )	
BLE CH 00 2402MHz		2377.83	54.03	-19.97	74	39.79	31.91	17.37	35.04	100	261	P	H	
		2372.685	44.97	-9.03	54	30.73	31.91	17.37	35.04	100	261	A	H	
	*	2402	94.44	-	-	80.11	31.95	17.43	35.05	100	261	P	H	
	*	2402	94.2	-	-	79.87	31.95	17.43	35.05	100	261	A	H	
													H	
														H
			2374.155	54.08	-19.92	74	39.84	31.91	17.37	35.04	116	231	P	V
			2374.89	45.15	-8.85	54	30.91	31.91	17.37	35.04	116	231	A	V
	*		2402	92.04	-	-	77.71	31.95	17.43	35.05	116	231	P	V
	*		2402	91.68	-	-	77.35	31.95	17.43	35.05	116	231	A	V
														V
														V
BLE CH 19 2440MHz		2376.5	55.76	-18.24	74	41.52	31.91	17.37	35.04	168	263	P	H	
		2380.28	45.19	-8.81	54	30.89	31.91	17.43	35.04	168	263	A	H	
	*	2440	92.02	-	-	77.51	32.08	17.49	35.06	168	263	P	H	
	*	2440	91.54	-	-	77.03	32.08	17.49	35.06	168	263	A	H	
			2490.48	54.77	-19.23	74	40.09	32.2	17.55	35.07	168	263	P	H
			2498.81	45.37	-8.63	54	30.7	32.2	17.55	35.08	168	263	A	H
			2360.12	54.35	-19.65	74	40.14	31.87	17.37	35.03	100	240	P	V
			2375.66	45.1	-8.9	54	30.86	31.91	17.37	35.04	100	240	A	V
	*		2440	89.97	-	-	75.46	32.08	17.49	35.06	100	240	P	V
	*		2440	89.47	-	-	74.96	32.08	17.49	35.06	100	240	A	V
			2487.82	53.86	-20.14	74	39.18	32.2	17.55	35.07	100	240	P	V
			2498.81	45.29	-8.71	54	30.62	32.2	17.55	35.08	100	240	A	V



<b>BLE CH 39 2480MHz</b>	*	2480	92.15	-	-	77.51	32.16	17.55	35.07	100	261	P	H
	*	2480	91.36	-	-	76.72	32.16	17.55	35.07	100	261	A	H
		2491.12	54.06	-19.94	74	39.38	32.2	17.55	35.07	100	261	P	H
		2494.64	45.59	-8.41	54	30.92	32.2	17.55	35.08	100	261	A	H
													H
													H
	*	2480	90.4	-	-	75.76	32.16	17.55	35.07	100	236	P	V
	*	2480	89.01	-	-	74.37	32.16	17.55	35.07	100	236	A	V
		2495.6	53.94	-20.06	74	39.27	32.2	17.55	35.08	100	236	P	V
		2489.12	45.29	-8.71	54	30.61	32.2	17.55	35.07	100	236	A	V
													V
													V
<b>Remark</b>	1. No other spurious found. 2. All results are PASS against Peak and Average limit line.												





2.4GHz 2400~2483.5MHz

BLE 1Mbps (Harmonic @ 3m)

BLE	Note	Frequency ( MHz )	Level ( dBµV/m )	Over Limit ( dB )	Limit Line ( dBµV/m )	Read Level ( dBµV )	Antenna Factor ( dB/m )	Path Loss ( dB )	Preamp Factor ( dB )	Ant Pos ( cm )	Table Pos ( deg )	Peak Avg. ( P/A )	Pol. ( H/V )
BLE CH 00 2402MHz		4804	43.61	-30.39	74	57.44	34.62	10.93	59.38	100	0	P	H
													H
													H
													H
		4804	42.83	-31.17	74	56.66	34.62	10.93	59.38	100	0	P	V
													V
													V
BLE CH 19 2440MHz		4880	43.09	-30.91	74	56.65	34.65	11.03	59.24	100	0	P	H
		7320	42.51	-31.49	74	51.28	35.73	13.66	58.16	100	0	P	H
													H
													H
		4880	41.79	-32.21	74	55.35	34.65	11.03	59.24	100	0	P	V
		7320	42.53	-31.47	74	51.3	35.73	13.66	58.16	100	0	P	V
													V
BLE CH 39 2480MHz		4960	42.67	-31.33	74	55.91	34.69	11.14	59.07	100	0	P	H
		7440	43.34	-30.66	74	52.17	35.71	13.79	58.33	100	0	P	H
													H
													H
		4960	42.88	-31.12	74	56.12	34.69	11.14	59.07	100	0	P	V
		7440	42.43	-31.57	74	51.26	35.71	13.79	58.33	100	0	P	V
													V
Remark	1. No other spurious found. 2. All results are PASS against Peak and Average limit line.												



Emission below 1GHz

2.4GHz BLE 1Mbps (LF)

BLE	Note	Frequency	Level	Over	Limit	Read	Antenna	Path	Preamp	Ant	Table	Peak	Pol.	
		( MHz )	( dBμV/m )	( dB )	( dBμV/m )	( dBμV )	( dB/m )	( dB )	( dB )	( cm )	( deg )	( P/A )	( H/V )	
2.4GHz BLE LF		30.27	21.81	-18.19	40	27.23	24.6	1.33	31.35	-	-	P	H	
		74.28	22.44	-17.56	40	39.57	12.75	1.71	31.59	-	-	P	H	
		152.85	31.09	-12.41	43.5	43.45	16.89	2.25	31.5	100	0	P	H	
		391	28.39	-17.61	46	34.93	21.34	3.27	31.15	-	-	P	H	
		888.7	31.19	-14.81	46	28.01	28.82	4.89	30.53	-	-	P	H	
		958	32.19	-13.81	46	26.85	30.8	5.05	30.51	-	-	P	H	
													H	
													H	
													H	
													H	
													H	
													H	
			30	31.81	-8.19	40	37.23	24.6	1.33	31.35	100	0	P	V
			73.2	29.43	-10.57	40	46.64	12.67	1.71	31.59	-	-	P	V
			96.96	30.72	-12.78	43.5	45.09	15.45	1.74	31.56	-	-	P	V
			776.7	29.9	-16.1	46	28.09	27.96	4.46	30.61	-	-	P	V
			876.8	30.98	-15.02	46	27.71	28.92	4.89	30.54	-	-	P	V
			956.6	32.73	-13.27	46	27.5	30.69	5.05	30.51	-	-	P	V
														V
														V
													V	
													V	
													V	
													V	
Remark	1. No other spurious found. 2. All results are PASS against limit line.													



2.4GHz 2400~2483.5MHz

BLE 2Mbps (Band Edge @ 3m)

BLE	Note	Frequency	Level	Over	Limit	Read	Antenna	Path	Preamp	Ant	Table	Peak	Pol.	
		( MHz )	( dBµV/m )	( dB )	( dBµV/m )	( dBµV )	( dB/m )	( dB )	( dB )	( cm )	( deg )	( P/A )	( H/V )	
BLE CH 00 2402MHz		2327.22	54.16	-19.84	74	39.74	32.13	17.31	35.02	100	261	P	H	
		2316.09	47.32	-6.68	54	32.91	32.12	17.31	35.02	100	261	A	H	
	*	2402	94.7	-	-	80.16	32.16	17.43	35.05	100	261	P	H	
	*	2402	93.62	-	-	79.08	32.16	17.43	35.05	100	261	A	H	
													H	
														H
			2370.375	54.56	-19.44	74	40.08	32.15	17.37	35.04	100	244	P	V
			2339.085	47.17	-6.83	54	32.75	32.14	17.31	35.03	100	244	A	V
	*		2402	93.77	-	-	79.23	32.16	17.43	35.05	100	244	P	V
	*		2402	92.49	-	-	77.95	32.16	17.43	35.05	100	244	A	V
														V
														V
BLE CH 19 2440MHz		2355.36	54.99	-19.01	74	40.51	32.14	17.37	35.03	110	284	P	H	
		2351.3	47.51	-6.49	54	33.03	32.14	17.37	35.03	110	284	A	H	
	*	2440	91.58	-	-	76.97	32.18	17.49	35.06	110	284	P	H	
	*	2440	90.17	-	-	75.56	32.18	17.49	35.06	110	284	A	H	
			2493.49	53.65	-20.35	74	38.98	32.2	17.55	35.08	110	284	P	H
			2487.82	46.82	-7.18	54	32.14	32.2	17.55	35.07	110	284	A	H
			2340.24	54.21	-19.79	74	39.73	32.14	17.37	35.03	100	240	P	V
			2373.56	47.03	-6.97	54	32.55	32.15	17.37	35.04	100	240	A	V
	*		2440	92.45	-	-	77.84	32.18	17.49	35.06	100	240	P	V
	*		2440	91.03	-	-	76.42	32.18	17.49	35.06	100	240	A	V
			2489.5	53.86	-20.14	74	39.18	32.2	17.55	35.07	100	240	P	V
			2495.38	47.5	-6.5	54	32.83	32.2	17.55	35.08	100	240	A	V



<b>BLE CH 39 2480MHz</b>	*	2480	91.64	-	-	76.97	32.19	17.55	35.07	100	260	P	H
	*	2480	90.16	-	-	75.49	32.19	17.55	35.07	100	260	A	H
		2486	54.52	-19.48	74	39.85	32.19	17.55	35.07	100	260	P	H
		2491	47	-7	54	32.32	32.2	17.55	35.07	100	260	A	H
													H
													H
	*	2480	91.95	-	-	77.28	32.19	17.55	35.07	100	236	P	V
	*	2480	90.4	-	-	75.73	32.19	17.55	35.07	100	236	A	V
		2496.84	53.98	-20.02	74	39.31	32.2	17.55	35.08	100	236	P	V
		2489.68	46.7	-7.3	54	32.02	32.2	17.55	35.07	100	236	A	V
													V
													V
<b>Remark</b>	1. No other spurious found. 2. All results are PASS against Peak and Average limit line.												



2.4GHz 2400~2483.5MHz  
BLE 2Mbps (Harmonic @ 3m)

BLE	Note	Frequency ( MHz )	Level ( dBμV/m )	Over Limit ( dB )	Limit Line ( dBμV/m )	Read Level ( dBμV )	Antenna Factor ( dB/m )	Path Loss ( dB )	Preamp Factor ( dB )	Ant Pos ( cm )	Table Pos ( deg )	Peak Avg. ( P/A )	Pol. ( H/V )
BLE CH 00 2402MHz		4804	43.76	-30.24	74	57.59	34.62	10.93	59.38	100	0	P	H
													H
													H
													H
		4804	42.8	-31.2	74	56.63	34.62	10.93	59.38	100	0	P	V
													V
													V
BLE CH 19 2440MHz		4880	42.27	-31.73	74	55.83	34.65	11.03	59.24	100	0	P	H
		7320	42.71	-31.29	74	51.48	35.73	13.66	58.16	100	0	P	H
													H
													H
		4880	42.12	-31.88	74	55.68	34.65	11.03	59.24	100	0	P	V
		7320	42.41	-31.59	74	51.18	35.73	13.66	58.16	100	0	P	V
													V
BLE CH 39 2480MHz		4960	42.27	-31.73	74	55.51	34.69	11.14	59.07	100	0	P	H
		7440	43.46	-30.54	74	52.29	35.71	13.79	58.33	100	0	P	H
													H
													H
		4960	43.05	-30.95	74	56.29	34.69	11.14	59.07	100	0	P	V
		7440	44.37	-29.63	74	53.2	35.71	13.79	58.33	100	0	P	V
													V
Remark	1. No other spurious found.												
	2. All results are PASS against Peak and Average limit line.												



Emission below 1GHz

2.4GHz BLE 2Mbps (LF)

BLE	Note	Frequency	Level	Over	Limit	Read	Antenna	Path	Preamp	Ant	Table	Peak	Pol.	
		( MHz )	( dBμV/m )	( dB )	( dBμV/m )	( dBμV )	( dB/m )	( dB )	( dB )	( cm )	( deg )	( P/A )	( H/V )	
2.4GHz BLE LF		30.54	21.63	-18.37	40	27.57	24.09	1.33	31.36	-	-	P	H	
		73.74	21.23	-18.77	40	38.44	12.67	1.71	31.59	-	-	P	H	
		153.12	31.28	-12.22	43.5	43.64	16.89	2.25	31.5	100	0	P	H	
		391.7	28.31	-17.69	46	34.8	21.38	3.27	31.14	-	-	P	H	
		857.9	31.72	-14.28	46	28.55	28.98	4.74	30.55	-	-	P	H	
		955.9	32.78	-13.22	46	27.55	30.69	5.05	30.51	-	-	P	H	
														H
														H
														H
														H
														H
														H
			30	32.77	-7.23	40	38.19	24.6	1.33	31.35	100	0	P	V
			74.28	30.25	-9.75	40	47.38	12.75	1.71	31.59	-	-	P	V
			97.77	30.44	-13.06	43.5	44.67	15.58	1.75	31.56	-	-	P	V
			796.3	29.96	-16.04	46	27.99	27.96	4.6	30.59	-	-	P	V
			873.3	30.84	-15.16	46	27.55	28.95	4.88	30.54	-	-	P	V
			959.4	32.25	-13.75	46	26.86	30.85	5.05	30.51	-	-	P	V
														V
														V
													V	
													V	
													V	
													V	
Remark	1. No other spurious found. 2. All results are PASS against limit line.													



**Note symbol**

*	<b>Fundamental Frequency</b> which can be ignored. However, the level of any unwanted emissions shall not exceed the level of the fundamental frequency.
!	Test result is <b>over limit</b> line.
P/A	<b>Peak</b> or <b>Average</b>
H/V	<b>Horizontal</b> or <b>Vertical</b>



A calculation example for radiated spurious emission is shown as below:

BLE	Note	Frequency	Level	Over	Limit	Read	Antenna	Path	Preamp	Ant	Table	Peak	Pol.
		( MHz )	( dBμV/m )	( dB )	( dBμV/m )	( dBμV )	( dB/m )	( dB )	( dB )	( cm )	( deg )	( P/A )	( H/V )
BLE CH 00 2402MHz		2390	55.45	-18.55	74	54.51	32.22	4.58	35.86	103	308	P	H
		2390	43.54	-10.46	54	42.6	32.22	4.58	35.86	103	308	A	H

1. Path Loss(dB) = Cable loss(dB) + Filter loss(dB) + Attenuator loss(dB)
2. Level(dBμV/m) =  
Antenna Factor(dB/m) + Path Loss(dB) + Read Level(dBμV) - Preamp Factor(dB)
3. Over Limit(dB) = Level(dBμV/m) – Limit Line(dBμV/m)

**For Peak Limit @ 2390MHz:**

1. Level(dBμV/m)  
= Antenna Factor(dB/m) + Path Loss(dB) + Read Level(dBμV) - Preamp Factor(dB)  
= 32.22(dB/m) + 4.58(dB) + 54.51(dBμV) – 35.86 (dB)  
= 55.45 (dBμV/m)
2. Over Limit(dB)  
= Level(dBμV/m) – Limit Line(dBμV/m)  
= 55.45(dBμV/m) – 74(dBμV/m)  
= -18.55(dB)

**For Average Limit @ 2390MHz:**

1. Level(dBμV/m)  
= Antenna Factor(dB/m) + Path Loss(dB) + Read Level(dBμV) - Preamp Factor(dB)  
= 32.22(dB/m) + 4.58(dB) + 42.6(dBμV) – 35.86 (dB)  
= 43.54 (dBμV/m)
2. Over Limit(dB)  
= Level(dBμV/m) – Limit Line(dBμV/m)  
= 43.54(dBμV/m) – 54(dBμV/m)  
= -10.46(dB)

Both peak and average measured complies with the limit line, so test result is “PASS”.