



# FCC RADIO TEST REPORT

FCC ID : UZ7TC77HL  
Equipment : Touch computer  
Brand Name : Zebra  
Model Name : TC77HL  
Applicant : Zebra Technologies Corporation  
1 Zebra Plaza Holtsville, NY 11742  
Manufacturer : Zebra Technologies Corporation  
1 Zebra Plaza Holtsville, NY 11742  
Standard : FCC 47 CFR Part 2, and 90(S)

The product was received on Jul. 25, 2018 and testing was started from Aug. 15, 2018 and completed on Aug. 26, 2018. We, SPORTON INTERNATIONAL INC., would like to declare that the tested sample has been evaluated in accordance with the test procedures given in ANSI / TIA-603-E and has been in compliance with the applicable technical standards.

The report must not be used by the client to claim product certification, approval, or endorsement by TAF or any agency of government.

The test results in this report apply exclusively to the tested model / sample. Without written approval of SPORTON INTERNATIONAL INC. EMC & Wireless Communications Laboratory, the test report shall not be reproduced except in full.

Approved by: Joseph Lin

**SPORTON INTERNATIONAL INC. EMC & Wireless Communications Laboratory**  
No. 52, Huaya 1st Rd., Guishan Dist., Taoyuan City, Taiwan (R.O.C.)



## Table of Contents

History of this test report.....	3
Summary of Test Result.....	4
<b>1 General Description .....</b>	<b>5</b>
1.1 Feature of Equipment Under Test.....	5
1.2 Product Specification of Equipment Under Test .....	6
1.3 Modification of EUT .....	6
1.4 Emission Designator .....	6
1.5 Testing Site.....	7
1.6 Applied Standards .....	7
<b>2 Test Configuration of Equipment Under Test .....</b>	<b>8</b>
2.1 Test Mode.....	8
2.2 Connection Diagram of Test System .....	9
2.3 Support Unit used in test configuration and system.....	9
2.4 Measurement Results Explanation Example .....	9
2.5 Frequency List of Low/Middle/High Channels.....	10
<b>3 Conducted Test Items.....</b>	<b>11</b>
3.1 Measuring Instruments.....	11
3.2 Conducted Output Power Measurement and ERP Measurement .....	12
3.3 Peak-to-Average Ratio .....	13
3.4 99% Occupied Bandwidth and 26dB Bandwidth Measurement.....	14
3.5 Emissions Mask Measurement .....	15
3.6 Emissions Mask – Out Of Band Emissions Measurement.....	16
3.7 Frequency Stability Measurement.....	17
3.8 Field Strength of Spurious Radiation Measurement .....	18
<b>4 List of Measuring Equipment.....</b>	<b>20</b>
<b>5 Uncertainty of Evaluation .....</b>	<b>21</b>
<b>Appendix A. Test Results of Conducted Test</b>	
<b>Appendix B. Test Results of ERP and Radiated Test</b>	
<b>Appendix C. Setup Photographs</b>	



### History of this test report

Report No.	Version	Description	Issued Date
FG872506D	01	Initial issue of report	Sep. 19, 2018



### Summary of Test Result

Report Clause	Ref Std. Clause	Test Items	Result (PASS/FAIL)	Remark
3.2	§2.1046 §90.635	Conducted Output Power and Effective Radiated Power	Pass	-
3.3	-	Peak-to-Average Ratio	Reporting only	-
3.4	§2.1049 §90.209	Occupied Bandwidth and 26dB Bandwidth	Reporting only	-
3.5	§2.1051 §90.691	Emission masks – In-band emissions	Pass	-
3.6	§2.1051 §90.691	Emission masks – Out of band emissions	Pass	-
3.7	§2.1055 §90.213	Frequency Stability for Temperature & Voltage	Pass	-
3.8	§2.1053 §90.691	Field Strength of Spurious Radiation	Pass	Under limit 35.60 dB at 4072.000 MHz

Reviewed by: Wii Chang

Report Producer: Polly Tsai



# 1 General Description

## 1.1 Feature of Equipment Under Test

Product Feature	
Equipment	Touch computer
Brand Name	Zebra
Model Name	TC77HL
FCC ID	UZ7TC77HL
EUT supports Radios application	GSM/EGPRS/WCDMA/HSPA/LTE/NFC/GNSS WLAN 11a/b/g/n HT20/HT40 WLAN 11ac VHT20/VHT40/VHT80 Bluetooth BR/EDR/LE
HW Version	DV
SW Version	Android version 8.1.0
FW Version	91-09-14.00-OG-U00-STD
MFD	06JUL18
EUT Stage	Engineering Sample

Remark: The above EUT's information was declared by manufacturer.

Specification of Accessories				
AC Adapter	Brand Name	Zebra	Part Number	PWR-BUA5V16W0WW
4 PIN DC power cable	Brand Name	Zebra	Part Number	CBL-DC-383A1-01
AC Power cable	Brand Name	Zebra	Part Number	50-16000-182R
Snap-On USB/Charge Cable	Brand Name	Zebra	Part Number	CBL-TC7X-USB1-01
Snap-On Charging Cable Cup	Brand Name	Zebra	Part Number	CHG-TC7X-CBL1-01
Battery 1	Brand Name	Zebra	Part Number	BT-000318-01
Battery 2 (Falcon 1S3P Battery Pack)	Brand Name	Zebra	Part Number	BT-000318-51
Battery 3	Brand Name	Symbol	Part Number	82-171249-02
Earphone 1	Brand Name	Zebra	Part Number	HDST-35MM-PTVP-01
Earphone 2	Brand Name	Zebra	Part Number	HS2100-OTH
Snap-on 3.5MM Audio Jack Adapter	Brand Name	Symbol	Part Number	ADP-TC7X-AUD35-01
3.5mm Jack 43"(1.1m) Standard Cable	Brand Name	Zebra	Part Number	CBL-HS2100-3MS1-01
Holster	Brand Name	Zebra	Part Number	SG-TC7X-HLSTR1-02
Rigid Holster	Brand Name	Zebra	Part Number	SG-TC7X-RHLSTR1-01



### 1.2 Product Specification of Equipment Under Test

Product Specification subjective to this standard	
Tx Frequency	LTE Band 26 : 814.7 ~ 823.3 MHz
Rx Frequency	LTE Band 26 : 859.7 ~ 868.3 MHz
Bandwidth	1.4MHz / 3MHz / 5MHz / 10MHz / 15MHz
Maximum Output Power to Antenna	23.67 dBm
Antenna Type	PIFA Antenna
Antenna Gain	1.87 dBi
Type of Modulation	QPSK / 16QAM / 64QAM

### 1.3 Modification of EUT

No modifications are made to the EUT during all test items.

### 1.4 Emission Designator

LTE Band 26		QPSK		16QAM		64QAM	
BW (MHz)	Frequency Range (MHz)	Emission Designator (99%OBW)	Frequency Tolerance (ppm)	Emission Designator (99%OBW)	Frequency Tolerance (ppm)	Emission Designator (99%OBW)	Frequency Tolerance (ppm)
1.4	814.7 ~ 823.3	1M09G7D	-	1M09W7D	-	1M09W7D	-
3	815.5 ~ 822.5	2M72G7D	-	2M72W7D	-	2M73W7D	-
5	816.5 ~ 821.5	4M50G7D	-	4M50W7D	-	4M51W7D	-
10	819.0	9M07G7D	0.0101	8M95W7D	-	9M01W7D	-
15	821.5	13M5G7D	0.0095	13M5W7D	-	13M5W7D	-



### 1.5 Testing Site

Sporton Lab is accredited to ISO 17025 by Taiwan Accreditation Foundation (TAF code : 1190) and the FCC designation No. TW1190 and TW0007 under the FCC 2.948(e) by Mutual Recognition Agreement (MRA) in FCC Test.

<b>Test Site</b>	SPORTON INTERNATIONAL INC.
<b>Test Site Location</b>	No.52, Huaya 1st Rd., Guishan Dist., Taoyuan City, Taiwan (R.O.C.) TEL: +886-3-327-3456 FAX: +886-3-328-4978
<b>Test Site No.</b>	<b>Sporton Site No.</b> TH05-HY

**Note:** The test site complies with ANSI C63.4 2014 requirement.

<b>Test Site</b>	SPORTON INTERNATIONAL INC.
<b>Test Site Location</b>	No.58, Aly. 75, Ln. 564, Wenhua 3rd, Rd., Guishan Dist., Taoyuan City, Taiwan (R.O.C.) TEL: +886-3-327-0868 FAX: +886-3-327-0855
<b>Test Site No.</b>	<b>Sporton Site No.</b> 03CH10-HY

**Note:** The test site complies with ANSI C63.4 2014 requirement.

### 1.6 Applied Standards

According to the specifications of the manufacturer, the EUT must comply with the requirements of the following standards:

- ♦ FCC 47 CFR Part 2, 90
- ♦ ANSI / TIA-603-E
- ♦ ANSI C63.26-2015
- ♦ FCC KDB 971168 D01 Power Meas. License Digital Systems v03r01
- ♦ FCC KDB 412172 D01 Determining ERP and EIRP v01r01
- ♦ Interim Guidance for Equipment Authorization of Devices with Channel Bandwidths Combined Across Two Contiguous Service Rule Allocations OET/Lab/EACB, June 6, 2013

**Remark:**

1. All test items were verified and recorded according to the standards and without any deviation during the test.
2. This EUT has also been tested and complied with the requirements of FCC Part 15, Subpart B, recorded in a separate test report.



## 2 Test Configuration of Equipment Under Test

### 2.1 Test Mode

During all testing, EUT is in link mode with base station emulator at maximum power level.

For radiated measurement, pre-scanned in three orthogonal panels, X, Y, Z. The worst cases (Y plane) were recorded in this report.

Frequency range investigated for radiated emission is 30 MHz to 9000 MHz.

Conducted Test Cases	Band	Bandwidth (MHz)						Modulation			RB #			Test Channel		
		1.4	3	5	10	15	20	QPSK	16QAM	64QAM	1	Half	Full	L	M	H
Max. Output Power	26	v	v	v	v	v	-	v	v	v	v	v	v	v	v	v
Peak-to-Average Ratio	26					v	-	v	v	v	v		v	v	v	v
26dB and 99% Bandwidth	26	v	v	v	v	v	-	v	v	v			v	v	v	v
Emission masks In-band emissions	26	v	v	v	v	v	-	v	v	v	v		v	v		v
Emission masks – Out of band emissions	26	v	v	v	v	v	-	v	v	v	v			v	v	v
Frequency Stability	26	-	-		v	v	-	v	v	v			v		v	
E.R.P.	26					v	-	v	v	v	v			v	v	v
Radiated Spurious Emission	26	Worst Case											v	v	v	
Remark	<ol style="list-style-type: none"> <li>The mark "v " means that this configuration is chosen for testing</li> <li>The mark "- " means that this bandwidth is not supported.</li> <li>LTE Band26 transmit frequency for part22 rule is 824MHz-849MHz, for part90 rule is 814MHz-824MHz. ERP over 15MHz bandwidth complies the ERP limit line of part22 rule, therefore ERP of the partial frequency spectrum which falls within part 22 also complies.</li> <li>The radiated test cases were performance with Battery 1, Earphone 1, and SIM 1.</li> </ol>															



## 2.2 Connection Diagram of Test System

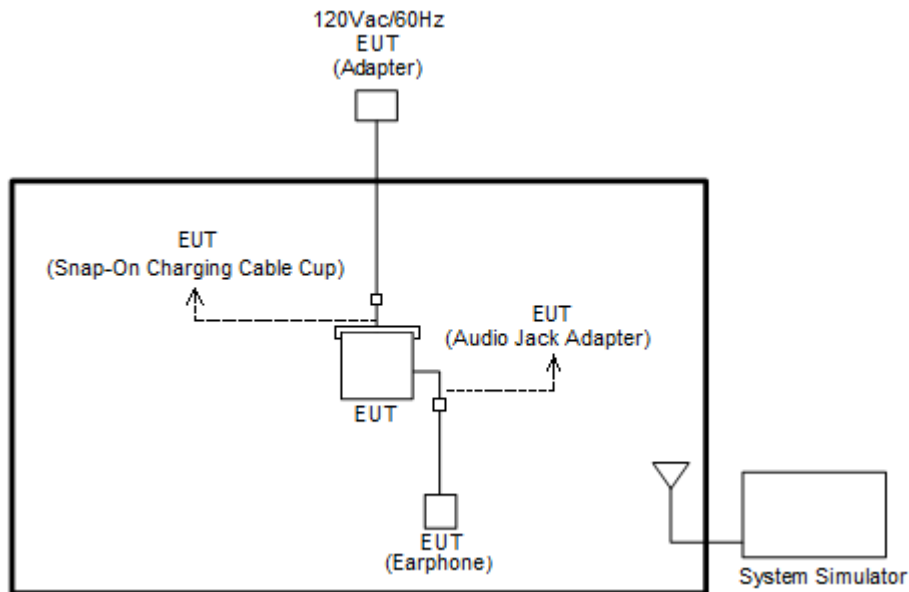

## 2.3 Support Unit used in test configuration and system

Item	Equipment	Trade Name	Model No.	FCC ID	Data Cable	Power Cord
1.	System Simulator	Anritsu	MT8820C	N/A	N/A	Unshielded, 1.8 m

## 2.4 Measurement Results Explanation Example

### For all conducted test items:

The offset level is set in the spectrum analyzer to compensate the RF cable loss and attenuator factor between RF conducted output port and spectrum analyzer. With the offset compensation, the spectrum analyzer reading level will be exactly the RF output level.

The spectrum analyzer offset is derived from RF cable loss and attenuator factor.

*Offset = RF cable loss + attenuator factor.*

The following shows an offset computation example with RF cable loss 4.2 dB and a 10dB attenuator.

Example :

$$\begin{aligned} \text{Offset(dB)} &= \text{RF cable loss(dB)} + \text{attenuator factor(dB)}. \\ &= 4.2 + 10 = 14.2 \text{ (dB)} \end{aligned}$$



## 2.5 Frequency List of Low/Middle/High Channels

LTE Band 26 Channel and Frequency List				
BW [MHz]	Channel/Frequency(MHz)	Lowest	Middle	Highest
15	Channel	26765	-	-
	Frequency	821.5	-	-
10	Channel	-	26740	-
	Frequency	-	819	-
5	Channel	26715	26740	26765
	Frequency	816.5	819	821.5
3	Channel	26705	26740	26775
	Frequency	815.5	819	822.5
1.4	Channel	26697	26740	26783
	Frequency	814.7	819	823.3

### 3 Conducted Test Items

#### 3.1 Measuring Instruments

See list of measuring instruments of this test report.

##### 3.1.1 Test Setup

##### 3.1.2 Conducted Output Power

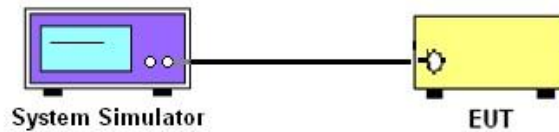

##### 3.1.3 Peak-to-Average Ratio, Occupied Bandwidth, Conducted Band-Edge, Emission Mask, Emissions Mask – Out Of Band Emissions, and Conducted Spurious Emission

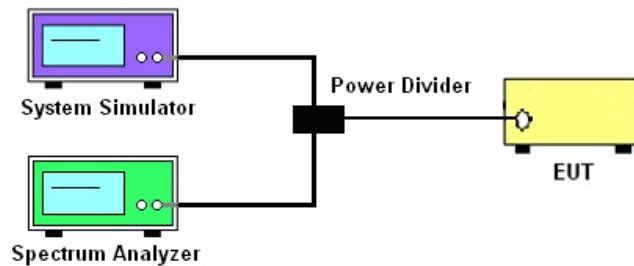

##### 3.1.4 Frequency Stability

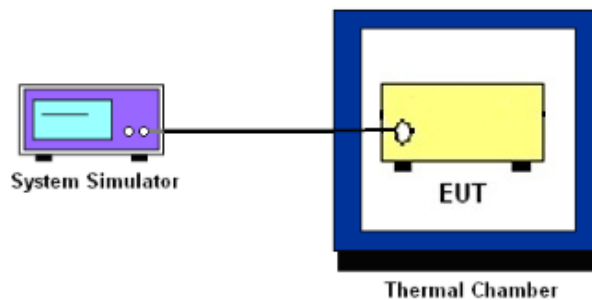

##### 3.1.5 Test Result of Conducted Test

Please refer to Appendix A.



## 3.2 Conducted Output Power Measurement and ERP Measurement

### 3.2.1 Description of the Conducted Output Power Measurement and ERP Measurement

A system simulator was used to establish communication with the EUT. Its parameters were set to enforce EUT transmitting at the maximum power. The measured power in the radio frequency on the transmitter output terminals shall be reported.

The ERP of mobile transmitters must not exceed 7 Watts for LTE Band 26.

According to KDB 412172 D01 Power Approach,

$EIRP = P_T + G_T - L_C$ , where

$P_T$  = transmitter output power in dBm

$G_T$  = gain of the transmitting antenna in dBi

$L_C$  = signal attenuation in the connecting cable between the transmitter and antenna in dB

### 3.2.2 Test Procedures

1. The transmitter output port was connected to the system simulator.
2. Set EUT at maximum power through system simulator.
3. Select lowest, middle, and highest channels for each band and different modulation.
4. Measure and record the power level from the system simulator.



### **3.3 Peak-to-Average Ratio**

#### **3.3.1 Description of the PAR Measurement**

Reporting only

#### **3.3.2 Test Procedures**

1. The EUT was connected to spectrum and system simulator via a power divider.
2. Set the CCDF (Complementary Cumulative Distribution Function) option in spectrum analyzer.
3. The highest RF powers were measured and recorded the maximum PAPR level associated with a probability of 0.1 %.
4. Record the deviation as Peak to Average Ratio.



## **3.4 99% Occupied Bandwidth and 26dB Bandwidth Measurement**

### **3.4.1 Description of (Occupied) Bandwidth Limitations Measurement**

The 99% occupied bandwidth is the width of a frequency band such that, below the lower and above the upper frequency limits, the mean powers emitted are each equal to a specified percentage 0.5% of the total mean transmitted power.

The emission bandwidth is defined as the width of the signal between two points, located at the 2 sides of the carrier frequency, outside of which all emissions are attenuated at least 26 dB below the transmitter power.

### **3.4.2 Test Procedures**

1. The EUT was connected to spectrum analyzer and system simulator via a power divider.
2. The 26dB and 99% occupied bandwidth (BW) of the middle channel for the highest RF power with full RB sizes were measured.



### 3.5 Emissions Mask Measurement

#### 3.5.1 Description of Emissions Mask Measurement

Equipment used in this licensed to EA or non-EA systems shall comply with the emission mask provisions of FCC Part 90.691.(a)

(a) Out-of-band emission requirement shall apply only to the “outer” channels included in an EA license and to spectrum adjacent to interior channels used by incumbent licensees. The emission limits are as follows:

(1) For any frequency removed from the EA licensee's frequency block by up to and including 37.5 kHz, the power of any emission shall be attenuated below the transmitter power (P) in watts by at least  $116 \text{ Log}_{10}(f/6.1)$  decibels or  $50 + 10 \text{ Log}_{10}(P)$  decibels or 80 decibels, whichever is the lesser attenuation, where f is the frequency removed from the center of the outer channel in the block in kilohertz and where f is greater than 12.5 kHz.

(2) For any frequency removed from the EA licensee's frequency block greater than 37.5 kHz, the power of any emission shall be attenuated below the transmitter power (P) in watts by at least  $43 + 10 \text{ Log}_{10}(P)$  decibels or 80 decibels, whichever is the lesser attenuation, where f is the frequency removed from the center of the outer channel in the block in kilohertz and where f is greater than 37.5 kHz.

#### 3.5.2 Test Procedures

1. The EUT was connected to spectrum analyzer and base station via power divider.
2. The emissions mask of low and high channels for the highest RF powers were measured.
3. The measured RBW and the VBW set 3 times of RBW are then set in spectrum analyzer, and
4. the RBW correction factor  $10 \log (1\% \text{ of } \text{OBW}/\text{measured RBW})(\text{dB})$  was compensated, if required.
5. The test results were shown below plots with a correction offset factor including cable loss, insertion loss of power divider.



### 3.6 Emissions Mask – Out Of Band Emissions Measurement

#### 3.6.1 Description of Conducted Emissions Out of band emissions measurement

The power of any emission FCC Part 90.691 (a)(2) on any frequency removed from the assigned frequency by out of the authorized bandwidth at least  $43 + 10 \log (P)$  dB. It is measured by means of a calibrated spectrum analyzer and scanned from 30 MHz up to a frequency including its 10<sup>th</sup> harmonic.

#### 3.6.2 Test Procedures

1. The EUT was connected to spectrum analyzer and system simulator via a power divider.
2. The RF output of EUT was connected to the spectrum analyzer by RF cable and attenuator. The path loss was compensated to the results for each measurement.
3. The middle channel for the highest RF power within the transmitting frequency was measured.
4. The conducted spurious emission for the whole frequency range was taken.
5. Make the measurement with the spectrum analyzer's RBW = 1MHz, VBW = 3MHz, taking the record of maximum spurious emission.
6. The RF fundamental frequency should be excluded against the limit line in the operating frequency band.
7. The limit line is derived from  $43 + 10\log(P)$ dB below the transmitter power P(Watts)





## **3.7 Frequency Stability Measurement**

### **3.7.1 Description of Frequency Stability Measurement**

The frequency stability shall be sufficient to ensure that the fundamental emission stays within the authorized frequency block.

### **3.7.2 Measuring Instruments**

The measuring equipment is listed in the section 4 of this test report.

### **3.7.3 Test Procedures for Temperature Variation**

1. The EUT was set up in the thermal chamber and connected with the base station.
1. With power OFF, the temperature was decreased to -30°C and the EUT was stabilized for three hours. Power was applied and the maximum change in frequency was recorded within one minute.
2. With power OFF, the temperature was raised in 10°C step up to 50°C. The EUT was stabilized at each step for at least half an hour. Power was applied and the maximum frequency change was recorded within one minute.

### **3.7.4 Test Procedures for Voltage Variation**

1. The EUT was placed in a temperature chamber at 20±5° C and connected with the base station.
2. The power supply voltage to the EUT was varied from BEP to 115% of the nominal value measured at the input to the EUT.
3. The variation in frequency was measured for the worst case.



## 3.8 Field Strength of Spurious Radiation Measurement

### 3.8.1 Description of Field Strength of Spurious Radiated Measurement

The radiated spurious emission was measured by substitution method according to ANSI / TIA-603-E. The power of any emission FCC Part 90.691 on any frequency removed from the assigned frequency by more than 250 percent of the authorized bandwidth at least  $43 + 10 \log (P)$  dB. The spectrum is scanned from 30 MHz up to a frequency including its 10th harmonic.

The power of any emission outside of the authorized operating frequency ranges must be attenuated below the transmitter power (P) by a factor of at least  $43+10\log_{10}(P[\text{Watts}])$  dB. The spectrum is scanned from 30 MHz up to a frequency including its 10th harmonic.

### 3.8.2 Test Procedures

4. The EUT was placed on a turntable with 0.8 meter for frequency below 1GHz and 1.5 meter for frequency above 1GHz respectively above ground.
5. The EUT was set 3 meters from the receiving antenna, which was mounted on the antenna tower.
6. The table was rotated 360 degrees to determine the position of the highest spurious emission.
7. The height of the receiving antenna is varied between one meter and four meters to search the maximum spurious emission for both horizontal and vertical polarizations.
8. Make the measurement with the spectrum analyzer's RBW = 1MHz, VBW = 3MHz, Sweep = 500ms, Taking the record of maximum spurious emission.
9. A horn antenna was substituted in place of the EUT and was driven by a signal generator.
10. Tune the output power of signal generator to the same emission level with EUT maximum spurious emission.
11. Taking the record of output power at antenna port.
12. Repeat step 7 to step 8 for another polarization.
13.  $\text{EIRP (dBm)} = \text{S.G. Power} - \text{Tx Cable Loss} + \text{Tx Antenna Gain}$
14.  $\text{ERP (dBm)} = \text{EIRP} - 2.15$
15. The RF fundamental frequency should be excluded against the limit line in the operating frequency band.
16. The limit line is derived from  $43 + 10\log(P)$  dB below the transmitter power P(Watts)

### 3.8.3 Test Setup

For radiated test from 30MHz to 1GHz

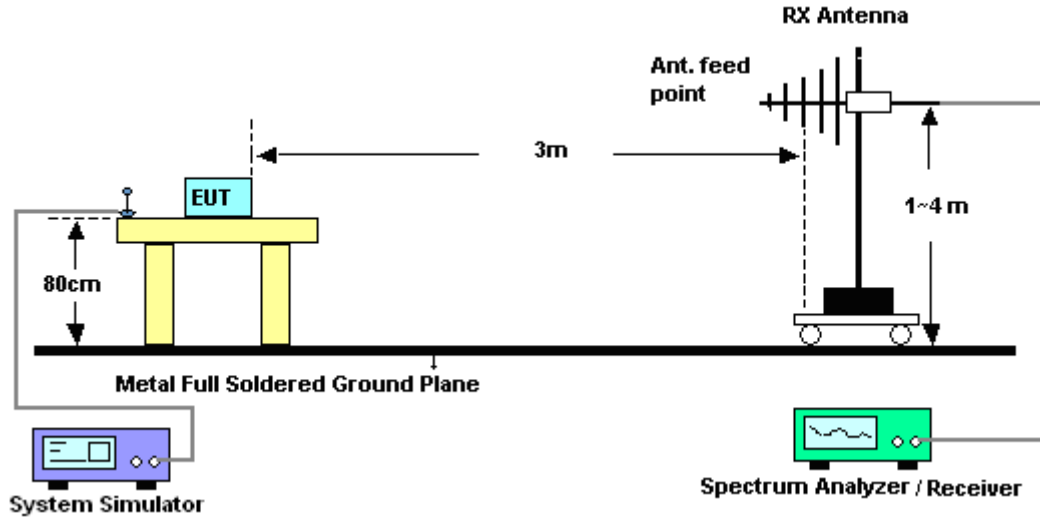

For radiated test above 1GHz

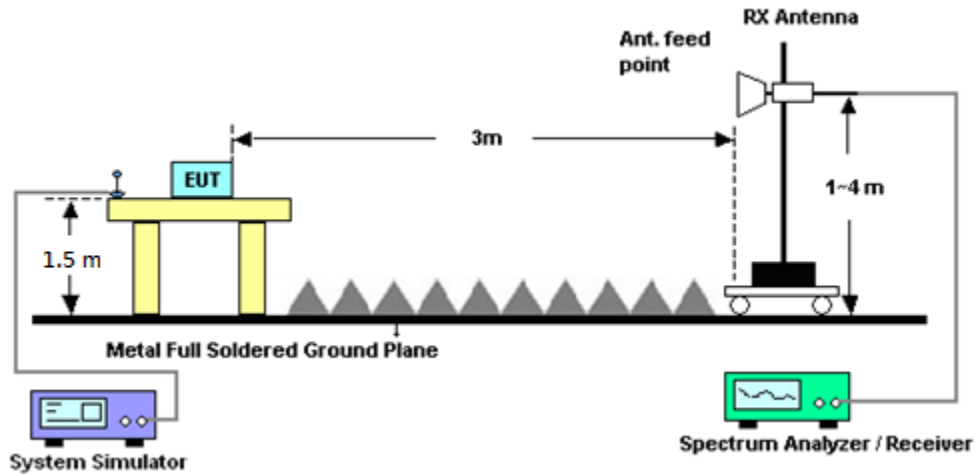

### 3.8.4 Test Result of Field Strength of Spurious Radiated

Please refer to Appendix B.



## 4 List of Measuring Equipment

Instrument	Manufacturer	Model No.	Serial No.	Characteristics	Calibration Date	Test Date	Due Date	Remark
LTE Base Station	Anritsu	MT8820C	6201432821	GSM/GPRS /WCDMA/LTE	Oct. 13, 2017	Aug. 15, 2018~ Aug. 24, 2018	Oct. 12, 2018	Conducted (TH05-HY)
Spectrum Analyzer	Rohde & Schwarz	FSV40	101397	10Hz~40GHz	Nov. 07, 2017	Aug. 15, 2018~ Aug. 24, 2018	Nov. 06, 2018	Conducted (TH05-HY)
Temperature Chamber	ESPEC	SH-641	92013720	-30°C~70°C	Aug. 28, 2017	Aug. 15, 2018~ Aug. 24, 2018	Aug. 27, 2018	Conducted (TH05-HY)
Programmable Power Supply	GW Instek	PSS-2005	EL890001	1V~20V 0.5A~5A	Oct. 06, 2017	Aug. 15, 2018~ Aug. 24, 2018	Oct. 05, 2018	Conducted (TH05-HY)
Coupler	Warison	1-18GHz 20dB 25WSMA Directional Coupler	#B	1G~18GHz	Dec. 04, 2017	Aug. 15, 2018~ Aug. 24, 2018	Dec. 03, 2018	Conducted (TH05-HY)
Amplifier	SONOMA	310N	187311	9kHz~1GHz	Oct. 19, 2017	Aug. 23, 2018~ Aug. 26, 2018	Oct. 18, 2018	Radiation (03CH10-HY)
Bilog Antenna	TESEQ	CBL 6111D&00800 N1D01N-06	35413&02	30MHz~1GHz	Dec. 18, 2017	Aug. 23, 2018~ Aug. 26, 2018	Dec. 17, 2018	Radiation (03CH10-HY)
Horn Antenna	SCHWARZBE CK	BBHA 9120 D	9120D-1325	1GHz ~ 18GHz	Sep. 27, 2017	Aug. 23, 2018~ Aug. 26, 2018	Sep. 26, 2018	Radiation (03CH10-HY)
Preamplifier	Keysight	83017A	MY53270078	1GHz~26.5GHz	Oct. 25, 2017	Aug. 23, 2018~ Aug. 26, 2018	Oct. 24, 2018	Radiation (03CH10-HY)
Spectrum Analyzer	Keysight	N9010A	MY54200485	10Hz ~ 44GHz	Oct. 31, 2017	Aug. 23, 2018~ Aug. 26, 2018	Oct. 30, 2018	Radiation (03CH10-HY)
Antenna Mast	EMEC	AM-BS-4500-B	N/A	1~4m	N/A	Aug. 23, 2018~ Aug. 26, 2018	N/A	Radiation (03CH10-HY)
Turn Table	EMEC	TT 2200	N/A	0~360 Degree	N/A	Aug. 23, 2018~ Aug. 26, 2018	N/A	Radiation (03CH10-HY)
Software	Audix	E3 6.2009-8-24	RK-001042	N/A	N/A	Aug. 23, 2018~ Aug. 26, 2018	N/A	Radiation (03CH10-HY)
RF Cable	HUBER + SUHNER	SUCOFLEX 104 / 102	MY11692/4PE, MY11693/4PE, MY2855/2	30M-1G	Nov. 14, 2017	Aug. 23, 2018~ Aug. 26, 2018	Nov. 13, 2018	Radiation (03CH10-HY)
RF Cable	HUBER + SUHNER	SUCOFLEX 104 / 102	MY11692/4PE, MY11693/4PE, MY2855/2	1G-18G	Nov. 14, 2017	Aug. 23, 2018~ Aug. 26, 2018	Nov. 13, 2018	Radiation (03CH10-HY)



## 5 Uncertainty of Evaluation

### Uncertainty of Radiated Emission Measurement (30 MHz ~ 1000 MHz)

Measuring Uncertainty for a Level of Confidence of 95% ( $U = 2Uc(y)$ )	3.17
-------------------------------------------------------------------------	------

### Uncertainty of Radiated Emission Measurement (1 GHz ~ 18 GHz)

Measuring Uncertainty for a Level of Confidence of 95% ( $U = 2Uc(y)$ )	3.48
-------------------------------------------------------------------------	------

### Uncertainty of Radiated Emission Measurement (18 GHz ~ 40 GHz)

Measuring Uncertainty for a Level of Confidence of 95% ( $U = 2Uc(y)$ )	4.00
-------------------------------------------------------------------------	------



## Appendix A. Test Results of Conducted Test

### Conducted Output Power(Average power)

LTE Band 26 Maximum Average Power [dBm]						
BW [MHz]	RB Size	RB Offset	Mod	Lowest	Middle	Highest
15	1	0	QPSK	23.58	-	-
15	1	37		23.43	-	-
15	1	74		23.51	-	-
15	36	0		22.57	-	-
15	36	20		22.52	-	-
15	36	39		22.54	-	-
15	75	0		22.56	-	-
15	1	0	16-QAM	22.75	-	-
15	1	37		22.82	-	-
15	1	74		22.88	-	-
15	36	0		21.63	-	-
15	36	20		21.70	-	-
15	36	39		21.63	-	-
15	75	0		21.67	-	-
15	1	0	64-QAM	21.69	-	-
15	1	37		21.74	-	-
15	1	74		21.81	-	-
15	36	0		20.64	-	-
15	36	20		20.75	-	-
15	36	39		20.69	-	-
15	75	0		20.33	-	-
10	1	0	QPSK	-	23.64	-
10	1	25		-	23.51	-
10	1	49		-	23.54	-
10	25	0		-	22.37	-
10	25	12		-	22.46	-
10	25	25		-	22.37	-
10	50	0		-	22.43	-
10	1	0	16-QAM	-	22.88	-
10	1	25		-	22.71	-
10	1	49		-	22.80	-
10	25	0		-	21.68	-
10	25	12		-	21.50	-
10	25	25		-	21.58	-
10	50	0		-	21.66	-
10	1	0	64-QAM	-	21.59	-
10	1	25		-	21.75	-
10	1	49		-	21.75	-
10	25	0		-	20.52	-
10	25	12		-	20.70	-
10	25	25		-	20.57	-
10	50	0		-	20.57	-



LTE Band 26 Maximum Average Power [dBm]						
BW [MHz]	RB Size	RB Offset	Mod	Lowest	Middle	Highest
5	1	0	QPSK	23.53	23.64	23.59
5	1	12		23.23	23.47	23.46
5	1	24		23.45	23.39	23.55
5	12	0		22.30	22.42	22.38
5	12	7		22.55	22.50	22.46
5	12	13		22.52	22.39	22.31
5	25	0		22.42	22.52	22.36
5	1	0	16-QAM	22.57	22.85	22.73
5	1	12		22.69	22.75	22.76
5	1	24		22.71	22.89	22.87
5	12	0		21.48	21.63	21.53
5	12	7		21.50	21.50	21.63
5	12	13		21.44	21.61	21.55
5	25	0		21.67	21.49	21.67
5	1	0	64-QAM	21.54	21.77	21.73
5	1	12		21.66	21.63	21.76
5	1	24		21.78	21.84	21.77
5	12	0		20.47	20.67	20.45
5	12	7		20.61	20.57	20.69
5	12	13		20.68	20.60	20.55
5	25	0		20.25	20.65	20.57
3	1	0	QPSK	23.57	23.51	23.55
3	1	8		23.38	23.32	23.48
3	1	14		23.43	23.59	23.39
3	8	0		22.47	22.41	22.40
3	8	4		22.49	22.46	22.45
3	8	7		22.36	22.48	22.46
3	15	0		22.38	22.57	22.41
3	1	0	16-QAM	22.63	22.73	22.73
3	1	8		22.81	22.86	22.75
3	1	14		22.88	22.92	22.96
3	8	0		21.53	21.63	21.60
3	8	4		21.65	21.65	21.52
3	8	7		21.51	21.49	21.48
3	15	0		21.53	21.59	21.49
3	1	0	64-QAM	21.49	21.65	21.68
3	1	8		21.59	21.72	21.72
3	1	14		21.72	21.78	21.86
3	8	0		20.52	20.57	20.40
3	8	4		20.57	20.63	20.73
3	8	7		20.52	20.63	20.54
3	15	0		20.22	20.68	20.62



LTE Band 26 Maximum Average Power [dBm]						
BW [MHz]	RB Size	RB Offset	Mod	Lowest	Middle	Highest
1.4	1	0	QPSK	23.49	23.67	23.47
1.4	1	3		23.37	23.48	23.29
1.4	1	5		23.32	23.57	23.51
1.4	3	0		23.39	23.50	23.56
1.4	3	1		23.32	23.42	23.33
1.4	3	3		23.49	23.58	23.48
1.4	6	0		22.44	22.38	22.48
1.4	1	0	16-QAM	22.70	22.84	22.82
1.4	1	3		22.67	22.88	22.80
1.4	1	5		22.71	22.75	22.86
1.4	3	0		22.49	22.39	22.41
1.4	3	1		22.71	22.89	22.80
1.4	3	3		22.68	22.75	22.72
1.4	6	0		21.63	21.55	21.58
1.4	1	0	64-QAM	21.65	21.66	21.67
1.4	1	3		21.59	21.80	21.79
1.4	1	5		21.77	21.87	21.88
1.4	3	0		21.59	21.68	21.71
1.4	3	1		21.74	21.63	21.69
1.4	3	3		21.69	21.73	21.81
1.4	6	0		20.20	20.54	20.50





# LTE Band 26\_Part 90S

## Peak-to-Average Ratio

Mode	LTE Band 26 / 10MHz				
Mod.	QPSK		16QAM		Limit: 13dB
RB Size	1RB	Full RB	1RB	Full RB	Result
Lowest CH	-	-	-	-	PASS
Middle CH	3.65	4.87	5.07	6.26	
Highest CH	-	-	-	-	
Mode	LTE Band 26 / 10MHz				
Mod.	64QAM				Limit: 13dB
RB Size	1RB	Full RB			Result
Lowest CH			-	-	PASS
Middle CH	6.75	6.72	-	-	
Highest CH			-	-	

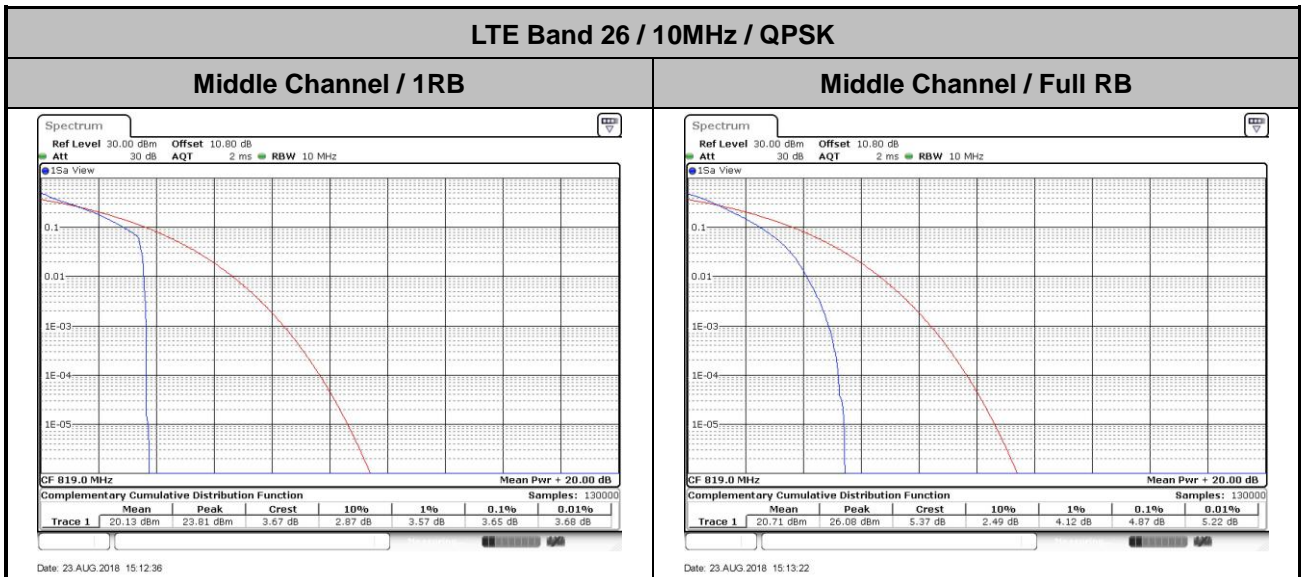



LTE Band 26 / 10MHz / 16QAM

Middle Channel / 1RB

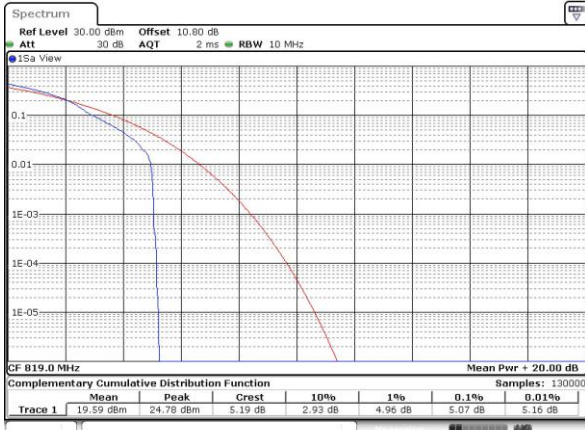

Date: 23 AUG 2018 15:12:54

Middle Channel / Full RB



Date: 23 AUG 2018 15:13:10

LTE Band 26 / 10MHz / 64QAM

Middle Channel / 1RB



Date: 23 AUG 2018 15:13:34

Middle Channel / Full RB

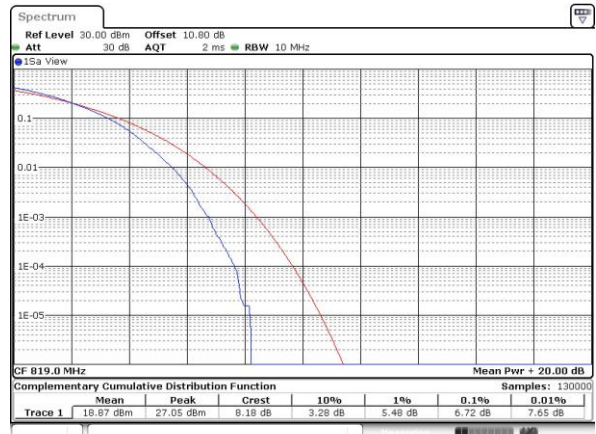

Date: 23 AUG 2018 15:16:07



**26dB Bandwidth**

Mode	LTE Band 26 : 26dB BW(MHz)											
BW	1.4MHz		3MHz		5MHz		10MHz		15MHz		20MHz	
Mod.	QPSK	16QAM	QPSK	16QAM	QPSK	16QAM	QPSK	16QAM	QPSK	16QAM	QPSK	16QAM
Lowest CH	1.23	1.22	3.03	3.03	4.92	4.91	-	-	14.52	14.60	-	-
Middle CH	1.22	1.23	3.03	3.05	4.90	4.91	9.81	9.77	-	-	-	-
Highest CH	1.22	1.21	3.03	3.03	4.98	4.91	-	-	-	-	-	-
Mode	LTE Band 26 : 26dB BW(MHz)											
BW	1.4MHz		3MHz		5MHz		10MHz		15MHz		20MHz	
Mod.	64QAM		64QAM		64QAM		64QAM		64QAM		64QAM	
Lowest CH	1.23	-	2.99	-	4.88	-	-	-	14.42	-	-	-
Middle CH	1.23	-	3.01	-	4.98	-	9.97	-	-	-	-	-
Highest CH	1.23	-	3.06	-	4.81	-	-	-	-	-	-	-



LTE Band 26

Lowest Channel / 1.4MHz / QPSK

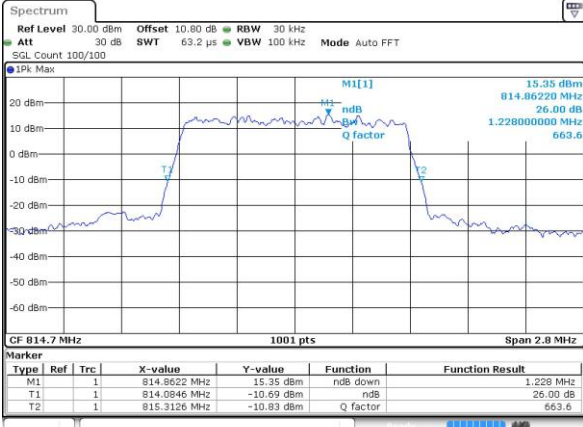

Date: 23 AUG 2018 15:00:12

Lowest Channel / 1.4MHz / 16QAM

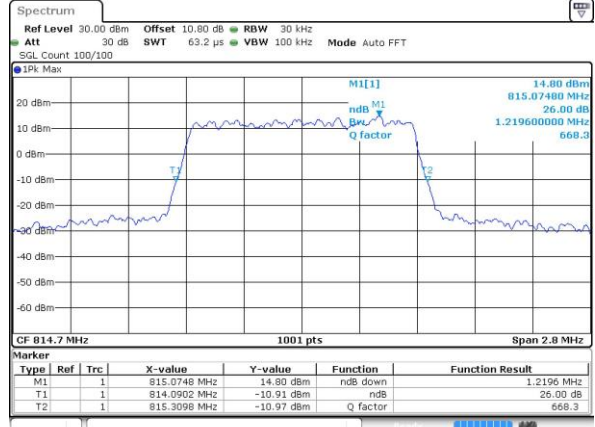

Date: 23 AUG 2018 15:00:01

Middle Channel / 1.4MHz / QPSK

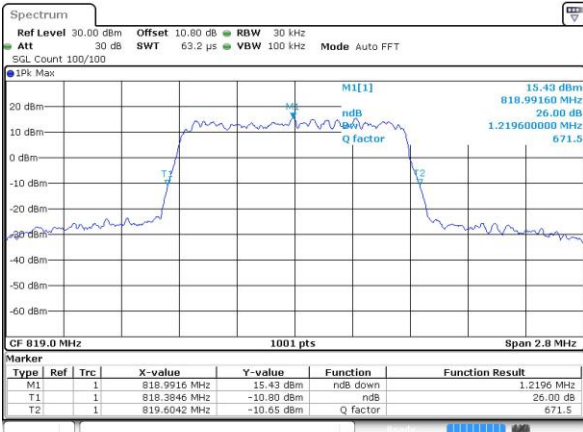

Date: 23 AUG 2018 15:02:50

Middle Channel / 1.4MHz / 16QAM

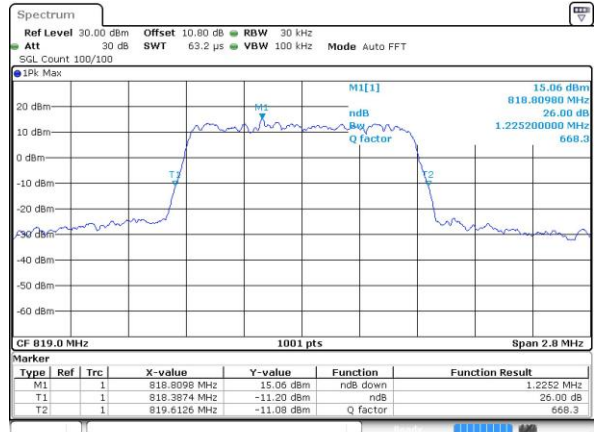

Date: 23 AUG 2018 15:03:01

Highest Channel / 1.4MHz / QPSK

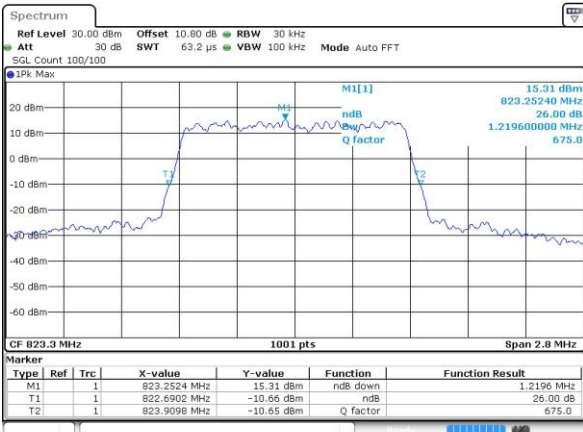

Date: 23 AUG 2018 15:05:38

Highest Channel / 1.4MHz / 16QAM

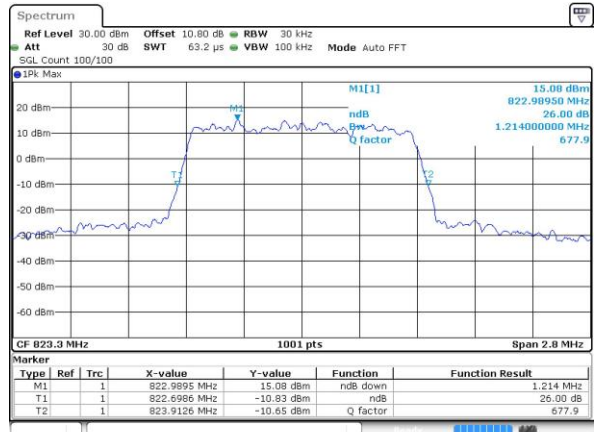

Date: 23 AUG 2018 15:05:50



LTE Band 26

Lowest Channel / 3MHz / QPSK

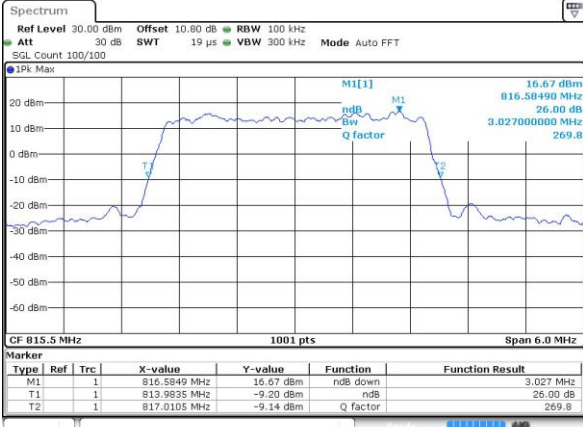

Date: 23 AUG 2018 13:38:33

Lowest Channel / 3MHz / 16QAM

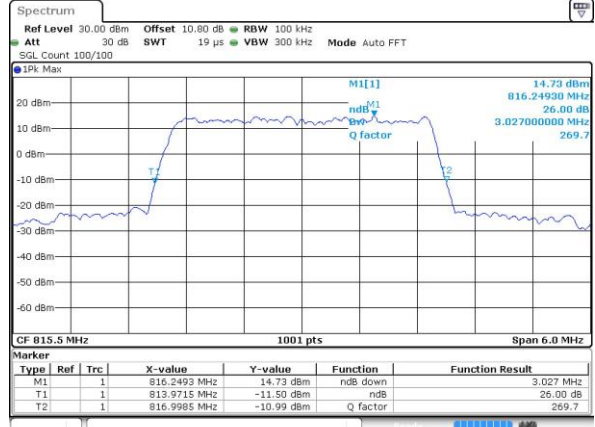

Date: 23 AUG 2018 13:38:45

Middle Channel / 3MHz / QPSK

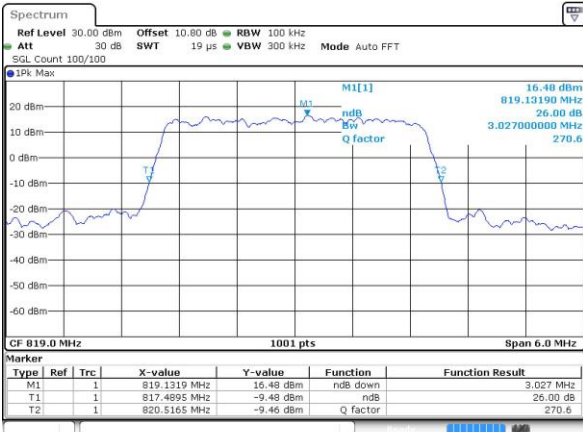

Date: 23 AUG 2018 13:41:36

Middle Channel / 3MHz / 16QAM

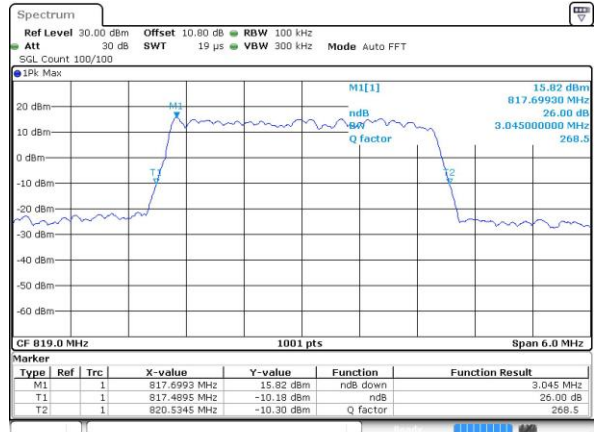

Date: 23 AUG 2018 13:41:47

Highest Channel / 3MHz / QPSK

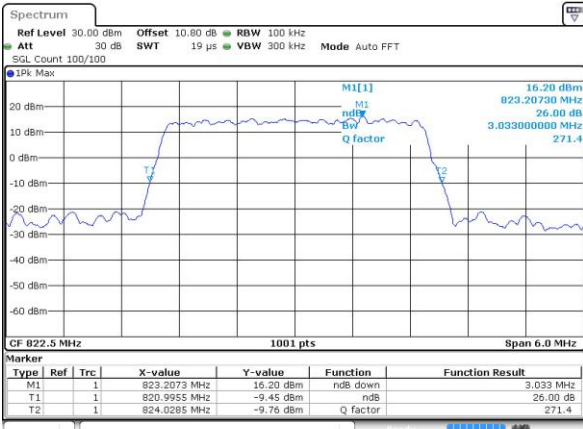

Date: 23 AUG 2018 13:44:25

Highest Channel / 3MHz / 16QAM

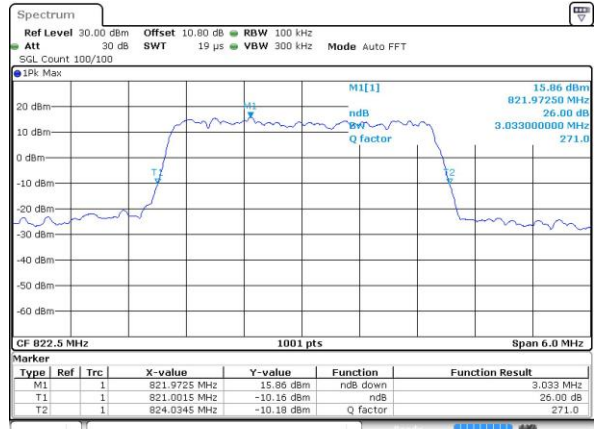

Date: 23 AUG 2018 13:44:36



LTE Band 26

Lowest Channel / 5MHz / QPSK

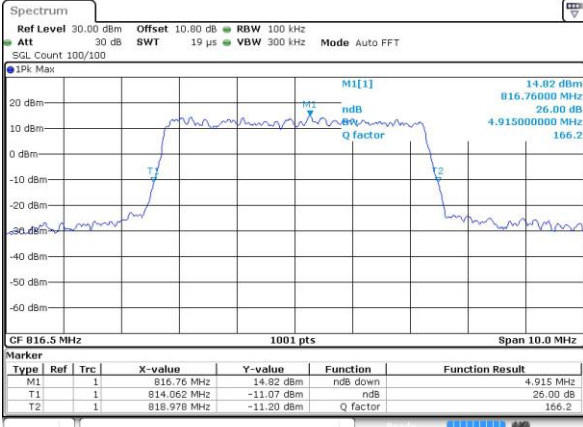

Date: 23 AUG 2018 13:47:13

Lowest Channel / 5MHz / 16QAM

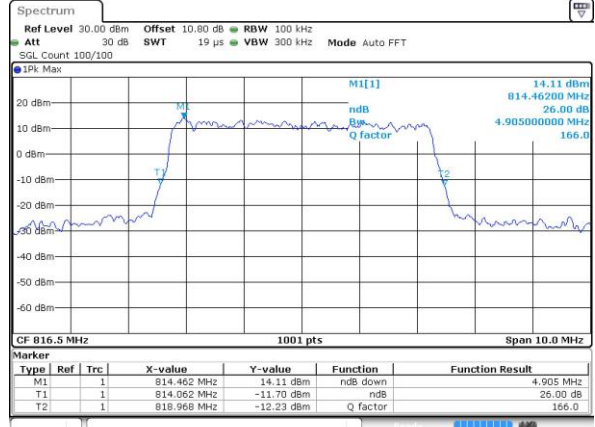

Date: 23 AUG 2018 13:47:25

Middle Channel / 5MHz / QPSK

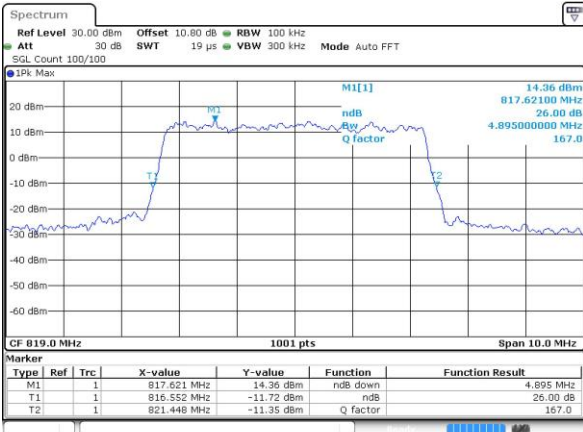

Date: 23 AUG 2018 13:50:02

Middle Channel / 5MHz / 16QAM

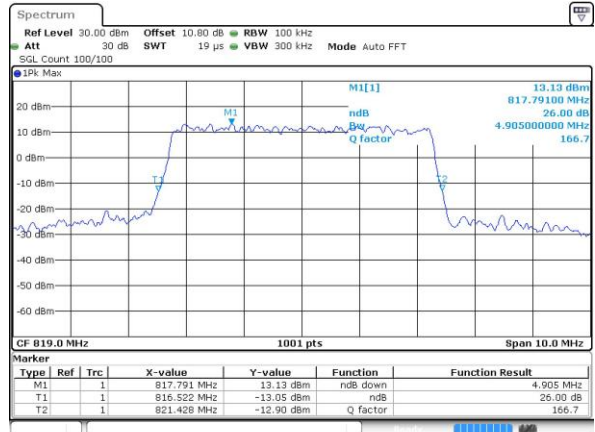

Date: 23 AUG 2018 13:50:14

Highest Channel / 5MHz / QPSK

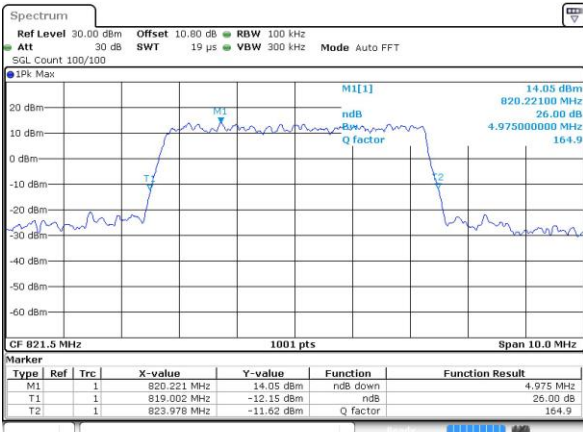

Date: 23 AUG 2018 13:52:51

Highest Channel / 5MHz / 16QAM

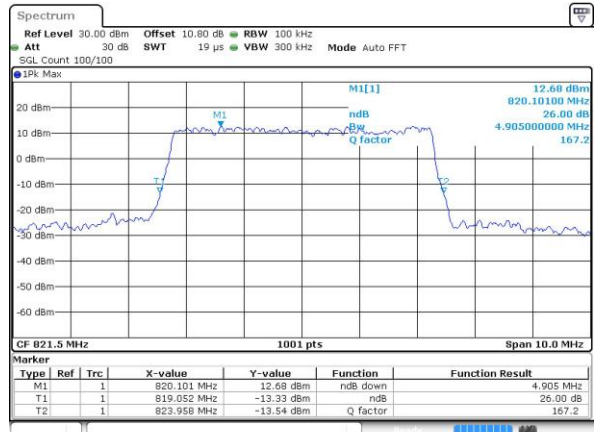

Date: 23 AUG 2018 13:53:02





LTE Band 26

Middle Channel / 10MHz / QPSK

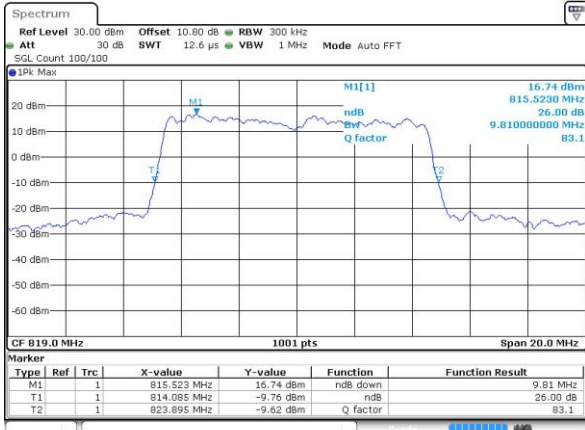

Date: 23 AUG 2018 13:55:40

Middle Channel / 10MHz / 16QAM

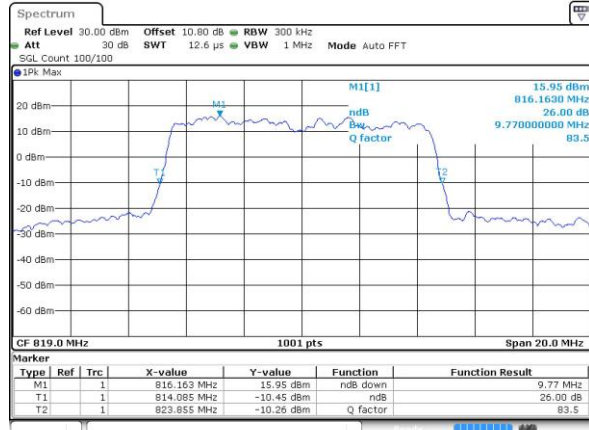

Date: 23 AUG 2018 13:55:51

Lowest Channel / 15MHz / QPSK

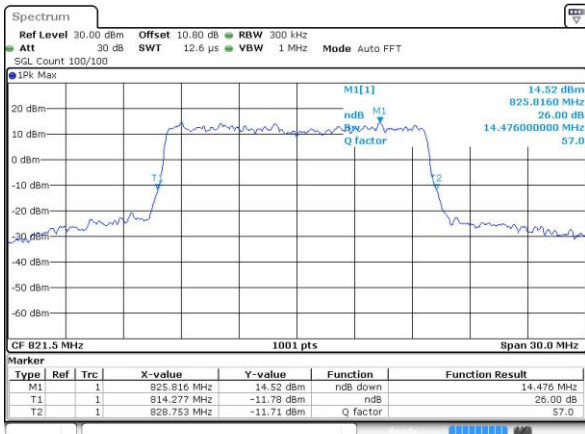

Date: 23 AUG 2018 13:58:29

Lowest Channel / 15MHz / 16QAM

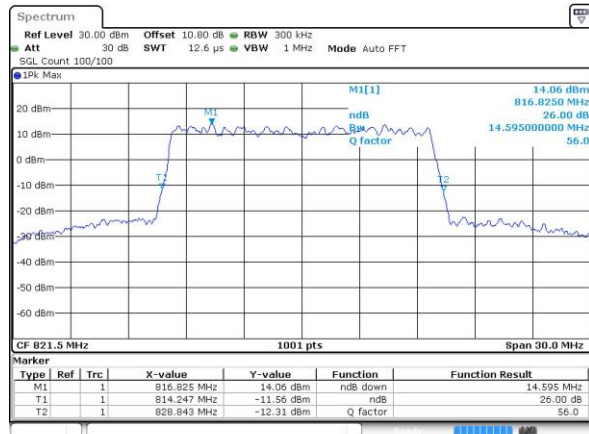

Date: 23 AUG 2018 13:58:40



LTE Band 26

Lowest Channel / 1.4MHz / 64QAM

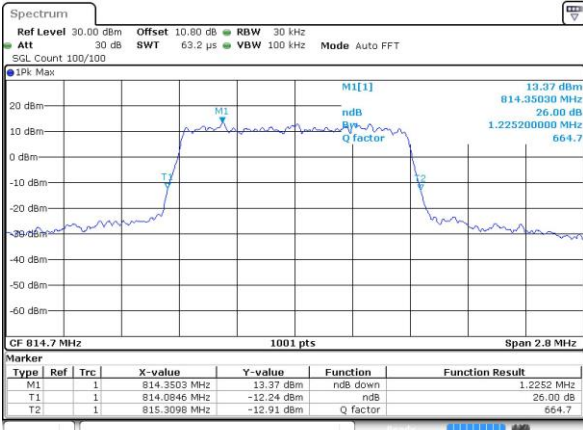

Date: 23 AUG 2018 13:34:08

Lowest Channel / 3MHz / 64QAM

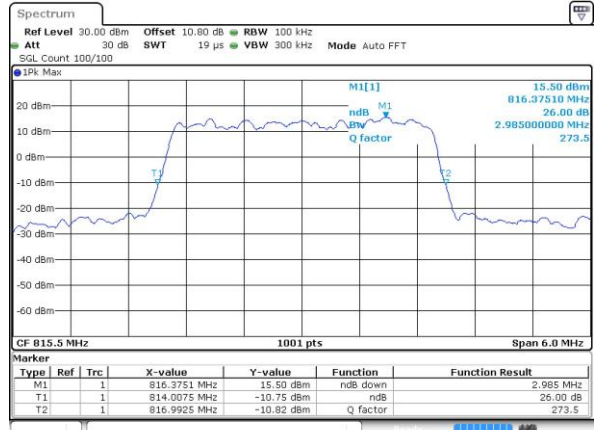

Date: 23 AUG 2018 13:20:50

Middle Channel / 1.4MHz / 64QAM

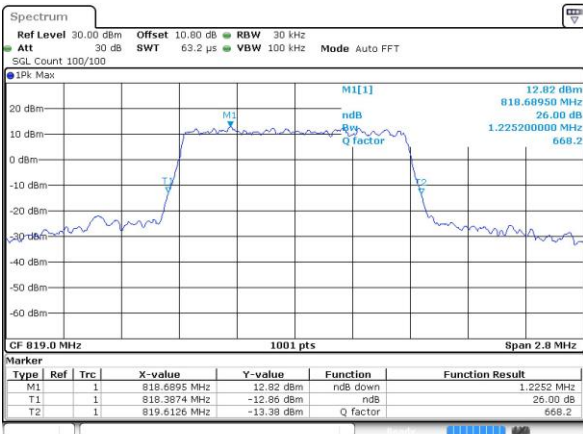

Date: 23 AUG 2018 13:35:33

Middle Channel / 3MHz / 64QAM

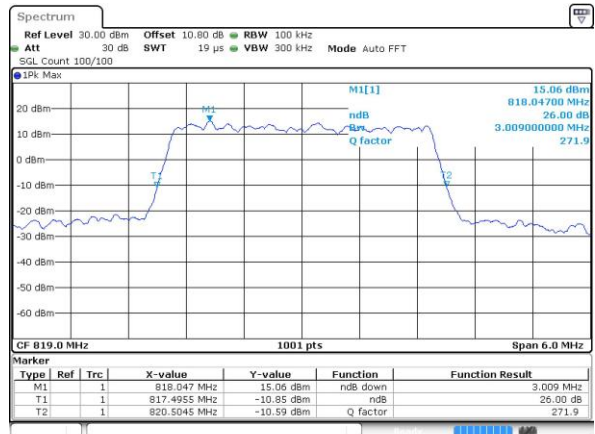

Date: 23 AUG 2018 13:22:15

Highest Channel / 1.4MHz / 64QAM

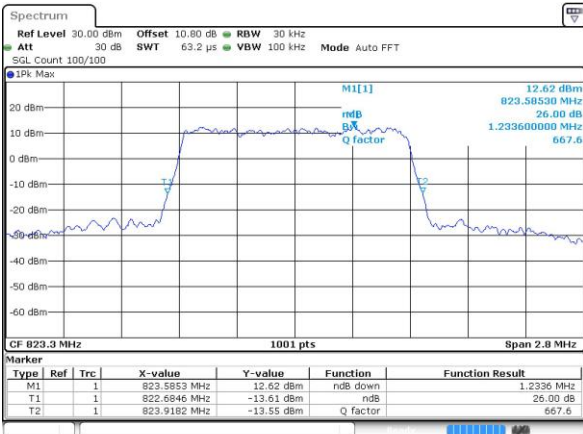

Date: 23 AUG 2018 13:36:57

Highest Channel / 3MHz / 64QAM

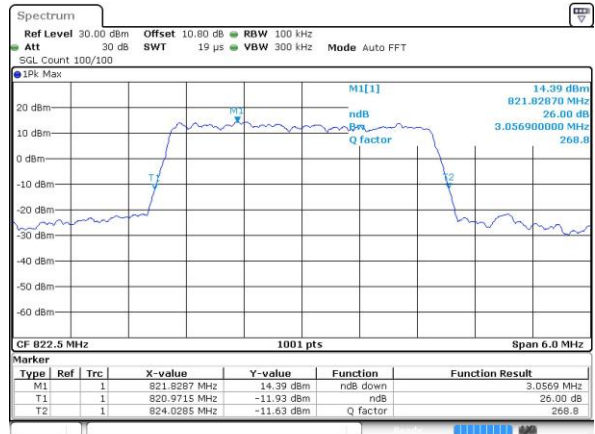

Date: 23 AUG 2018 13:23:39





LTE Band 26

Lowest Channel / 5MHz / 64QAM

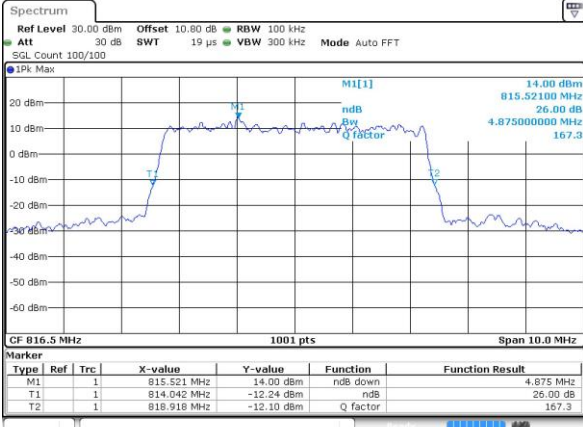

Date: 23 AUG 2018 13:25:03

Middle Channel / 5MHz / 64QAM

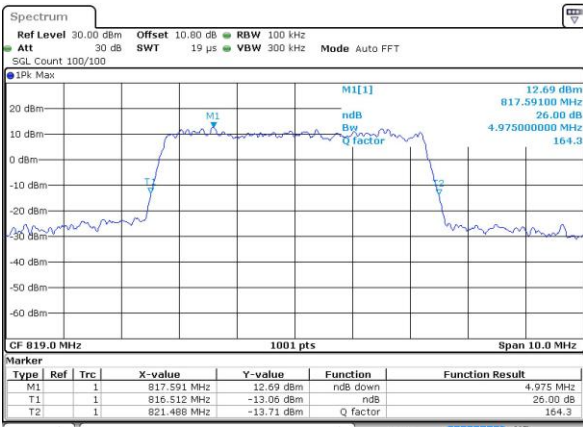

Date: 23 AUG 2018 13:26:28

Middle Channel / 10MHz / 64QAM

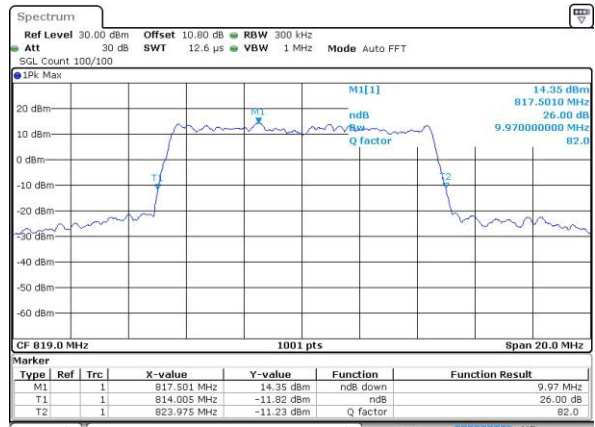

Date: 23 AUG 2018 13:29:16

Highest Channel / 5MHz / 64QAM

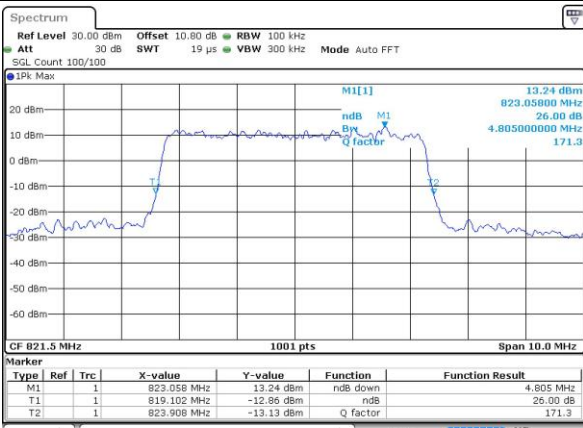

Date: 23 AUG 2018 13:27:52



LTE Band 26

Middle Channel / 15MHz / 64QAM

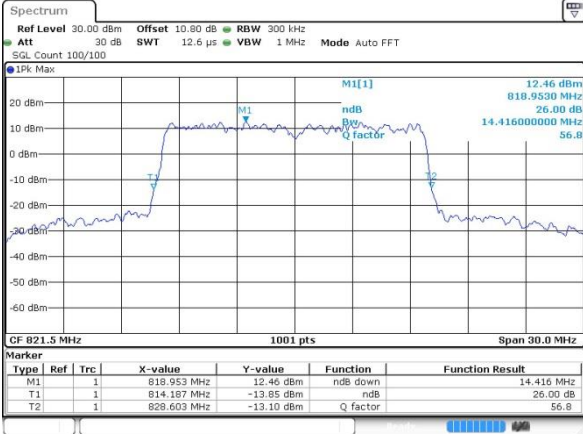

Date: 23 AUG 2018 13:30:41



Occupied Bandwidth

Mode	LTE Band 26 : 99%OBW(MHz)											
BW	1.4MHz		3MHz		5MHz		10MHz		15MHz		20MHz	
Mod.	QPSK	16QAM	QPSK	16QAM	QPSK	16QAM	QPSK	16QAM	QPSK	16QAM	QPSK	16QAM
Lowest CH	1.09	1.09	2.72	2.7	4.5	4.47	-	-	13.46	13.46	-	-
Middle CH	1.08	1.09	2.72	2.72	4.49	4.49	9.07	8.95	-	-	-	-
Highest CH	1.09	1.09	2.71	2.7	4.49	4.5	-	-	-	-	-	-
Mode	LTE Band 26 : 99%OBW(MHz)											
BW	1.4MHz		3MHz		5MHz		10MHz		15MHz		20MHz	
Mod.	64QAM		64QAM		64QAM		64QAM		64QAM		64QAM	
Lowest CH	1.09	-	2.73	-	4.50	-	-	-	13.52	-	-	-
Middle CH	1.09	-	2.73	-	4.50	-	9.01	-	-	-	-	-
Highest CH	1.09	-	2.73	-	4.51	-	-	-	-	-	-	-



LTE Band 26

Lowest Channel / 1.4MHz / QPSK

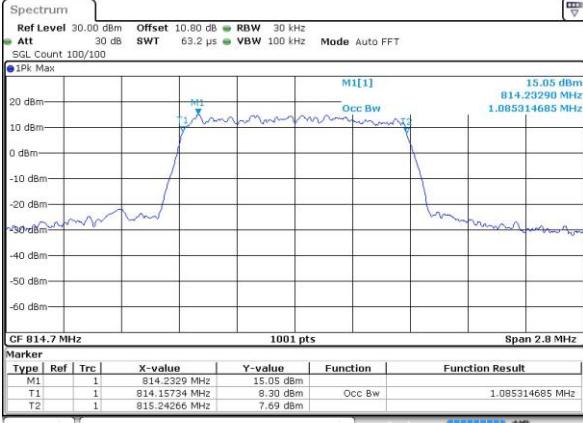

Lowest Channel / 1.4MHz / 16QAM

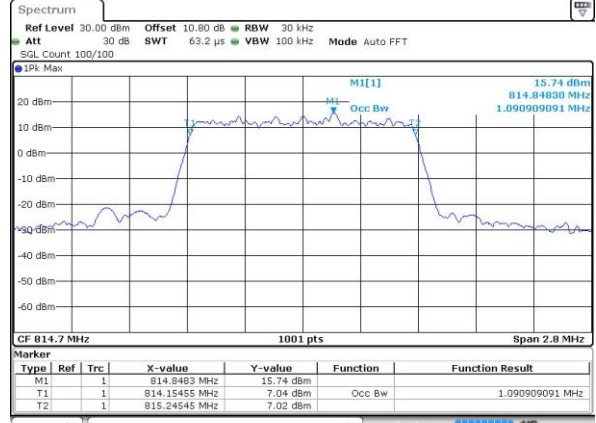

Middle Channel / 1.4MHz / QPSK

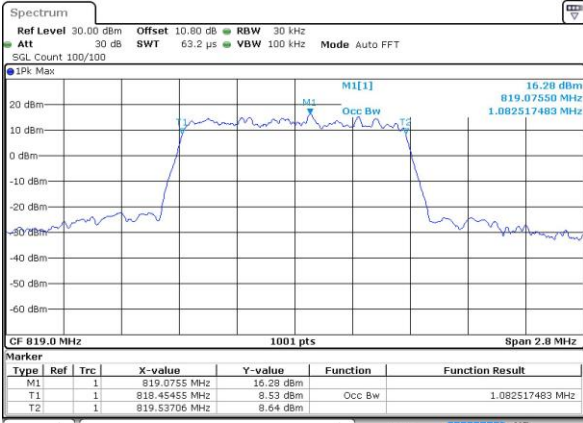

Middle Channel / 1.4MHz / 16QAM

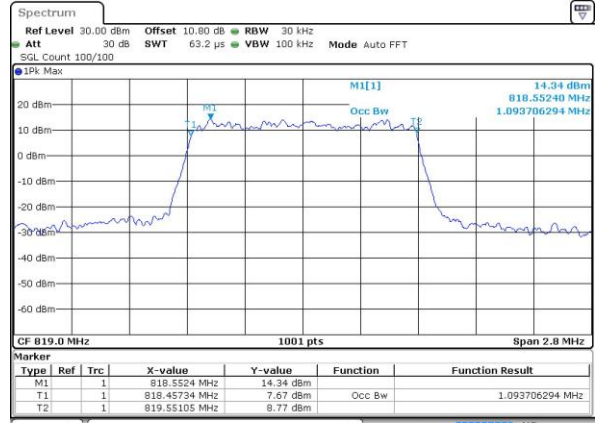

Highest Channel / 1.4MHz / QPSK

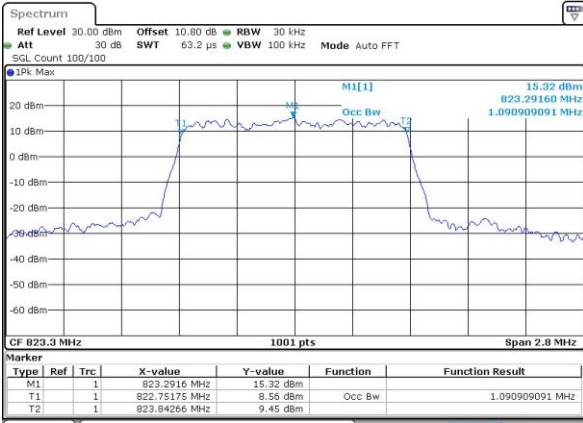

Highest Channel / 1.4MHz / 16QAM

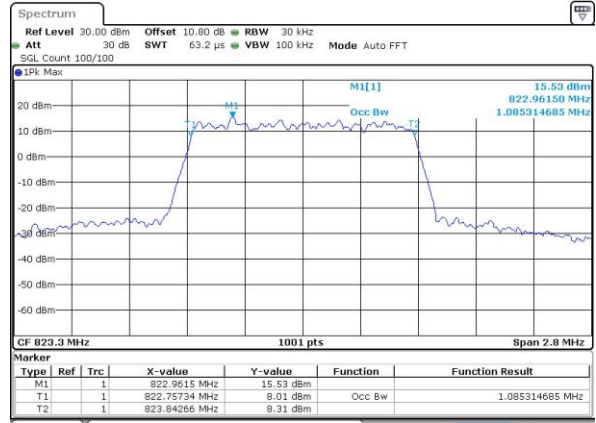



LTE Band 26

Lowest Channel / 3MHz / QPSK

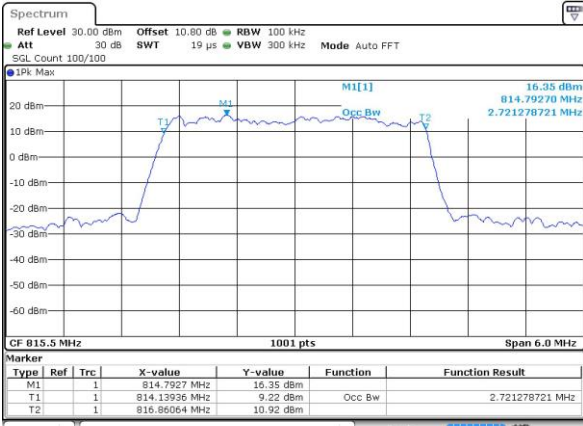

Date: 23 AUG 2018 13:38:10

Lowest Channel / 3MHz / 16QAM

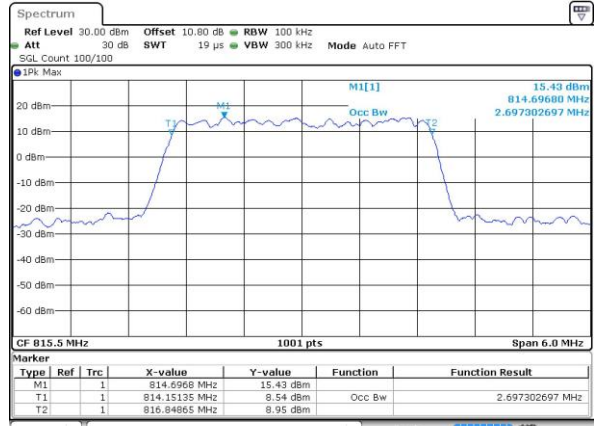

Date: 23 AUG 2018 13:38:22

Middle Channel / 3MHz / QPSK

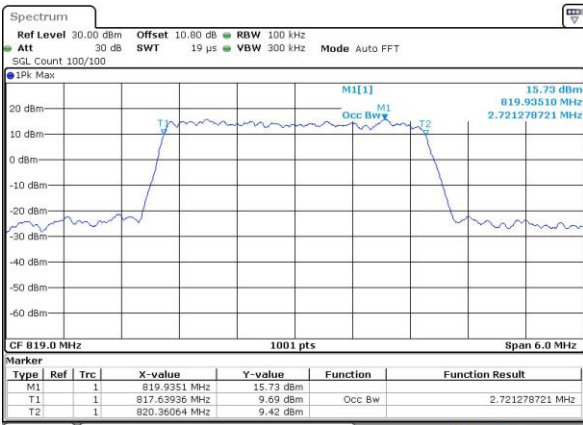

Date: 23 AUG 2018 13:40:59

Middle Channel / 3MHz / 16QAM

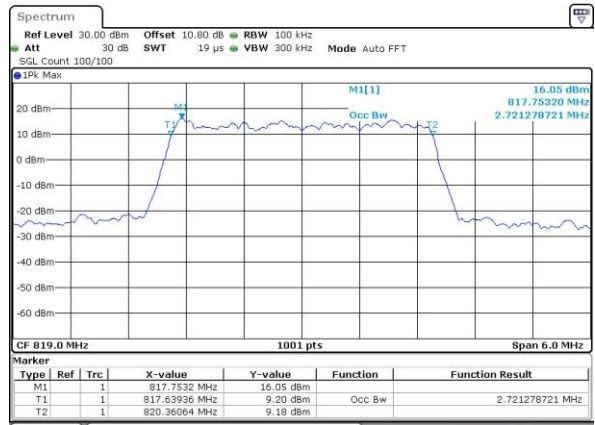

Date: 23 AUG 2018 13:41:11

Highest Channel / 3MHz / QPSK

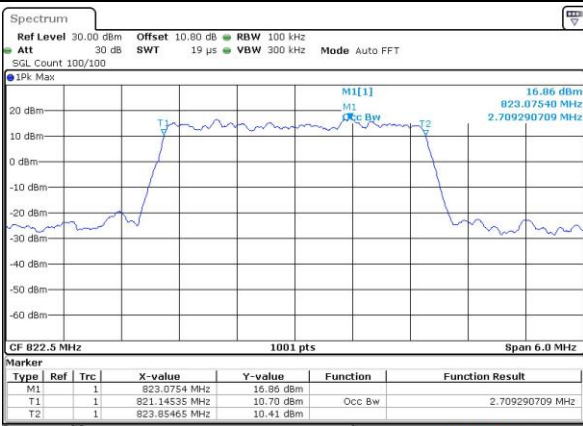

Date: 23 AUG 2018 13:44:02

Highest Channel / 3MHz / 16QAM

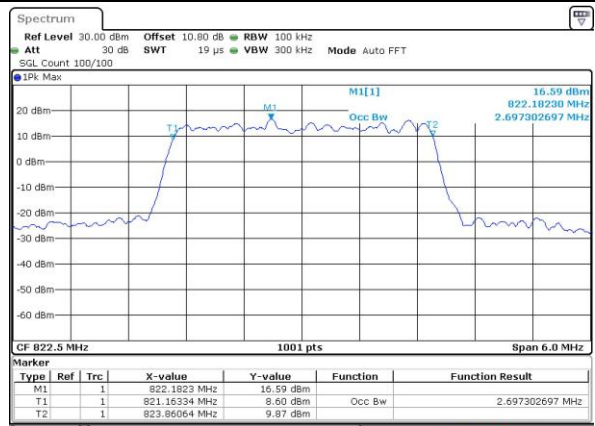

Date: 23 AUG 2018 13:44:13



LTE Band 26

Lowest Channel / 5MHz / QPSK

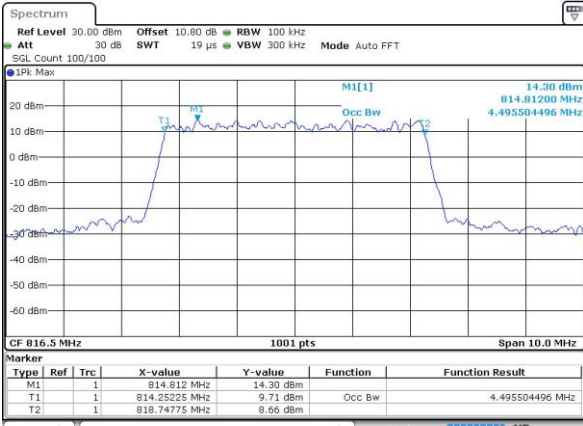

Date: 23 AUG 2018 13:46:51

Lowest Channel / 5MHz / 16QAM

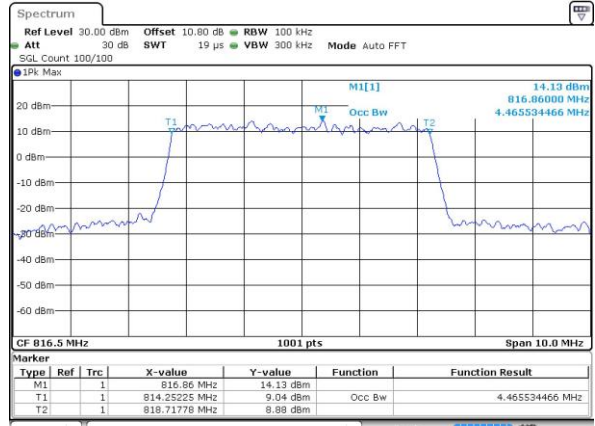

Date: 23 AUG 2018 13:47:02

Middle Channel / 5MHz / QPSK

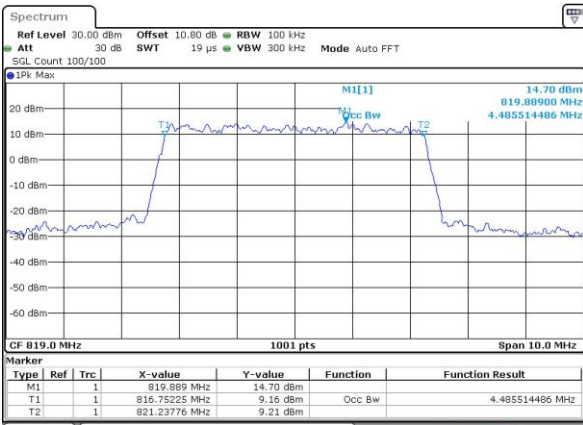

Date: 23 AUG 2018 13:49:39

Middle Channel / 5MHz / 16QAM

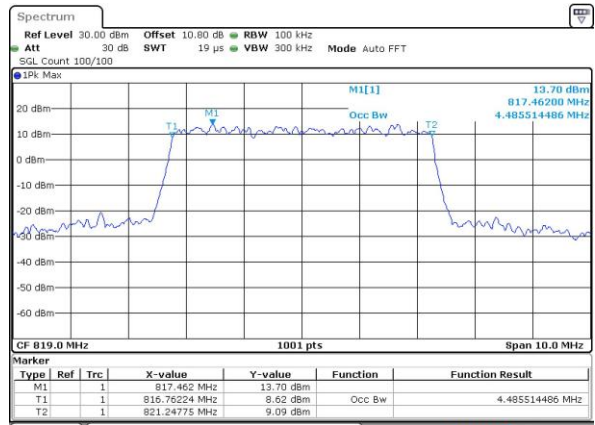

Date: 23 AUG 2018 13:49:51

Highest Channel / 5MHz / QPSK

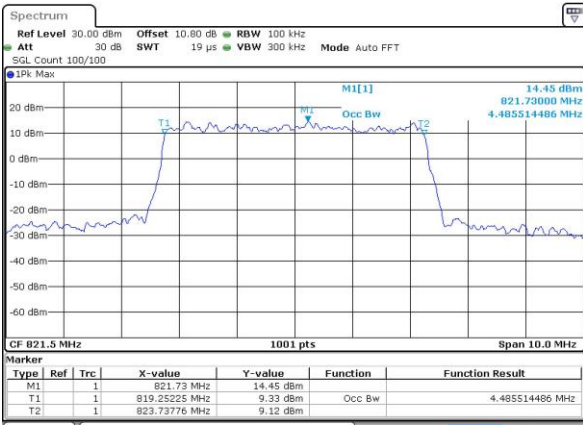

Date: 23 AUG 2018 13:52:28

Highest Channel / 5MHz / 16QAM

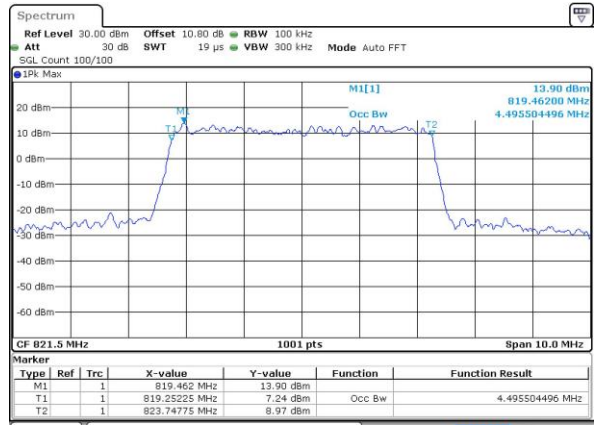

Date: 23 AUG 2018 13:52:40



LTE Band 26

Middle Channel / 10MHz / QPSK

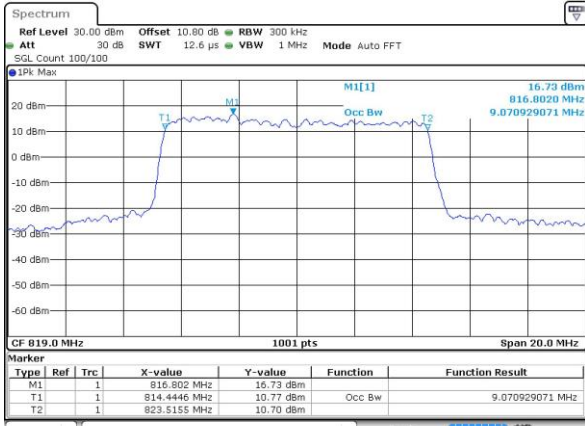

Date: 23 AUG 2018 13:55:17

Middle Channel / 10MHz / 16QAM

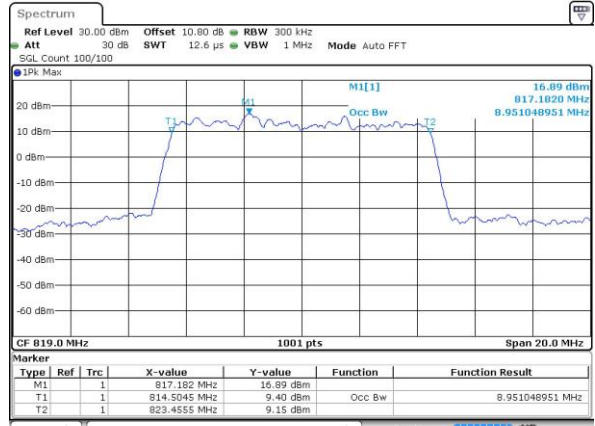

Date: 23 AUG 2018 13:55:28

LTE Band 26

Lowest Channel / 15MHz / QPSK

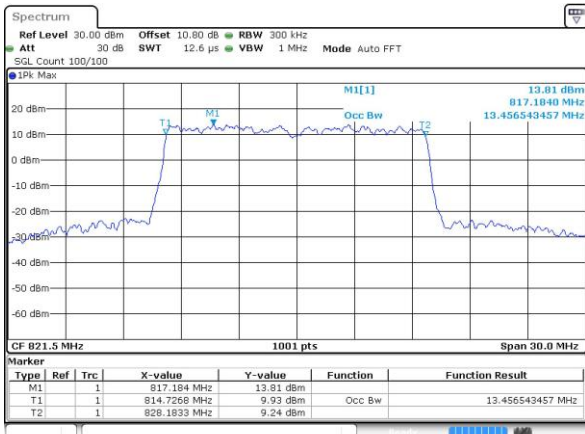

Date: 23 AUG 2018 13:58:06

Lowest Channel / 15MHz / 16QAM

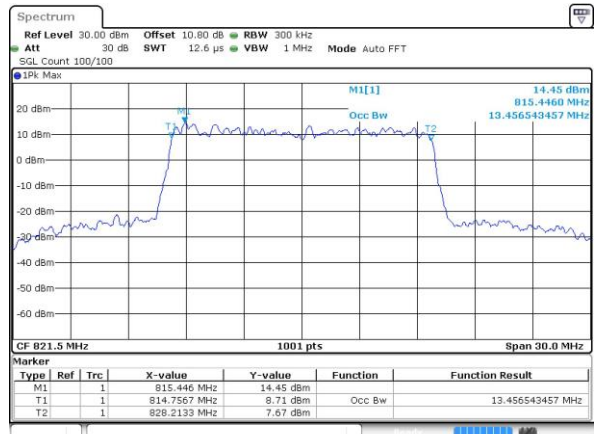

Date: 23 AUG 2018 13:58:17





LTE Band 26

Lowest Channel / 1.4MHz / 64QAM

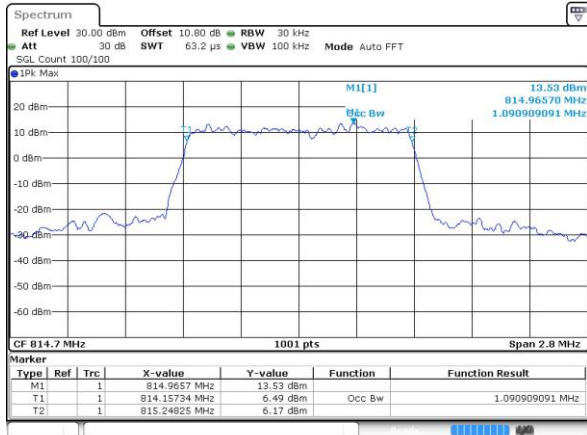

Date: 23 AUG 2018 13:33:57

Lowest Channel / 3MHz / 64QAM

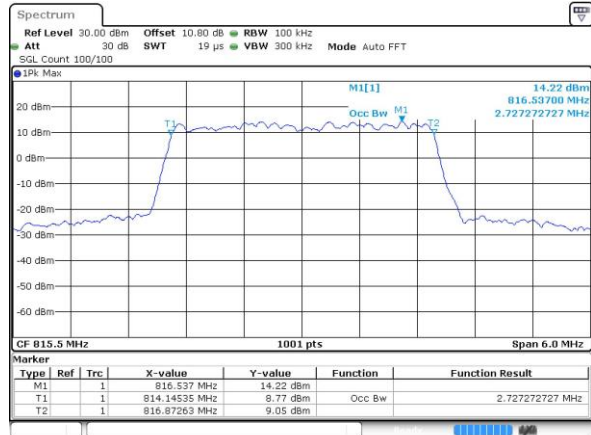

Date: 23 AUG 2018 13:20:39

Middle Channel / 1.4MHz / 64QAM

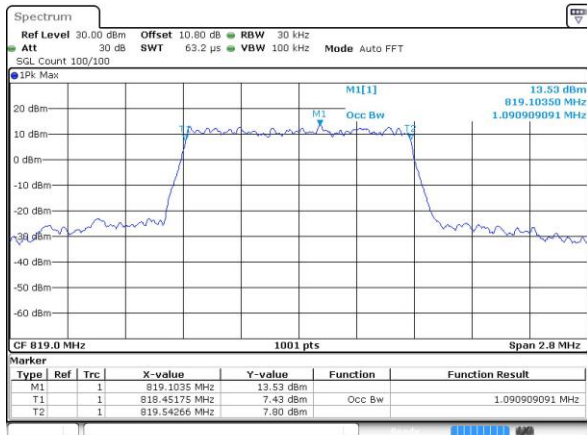

Date: 23 AUG 2018 13:35:21

Middle Channel / 3MHz / 64QAM

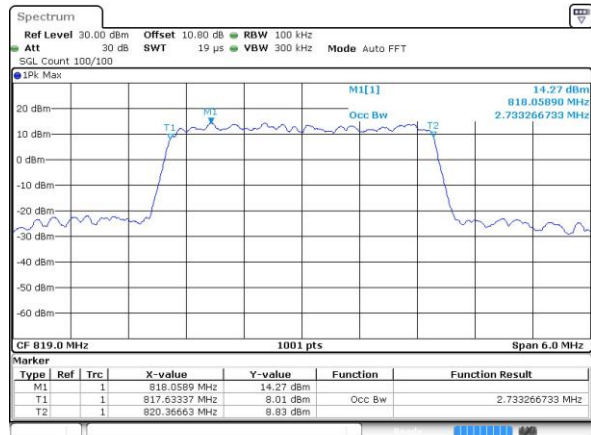

Date: 23 AUG 2018 13:22:03

Highest Channel / 1.4MHz / 64QAM

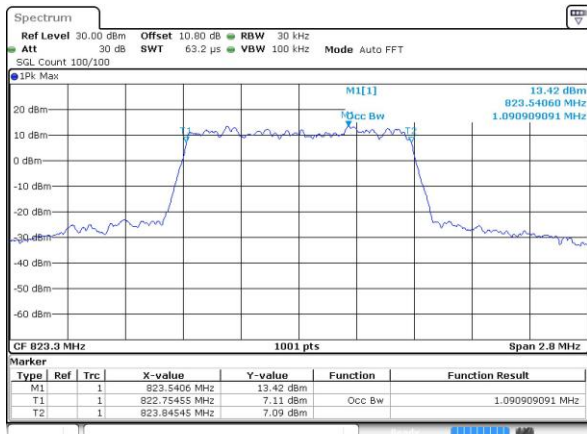

Date: 23 AUG 2018 13:36:46

Highest Channel / 3MHz / 64QAM

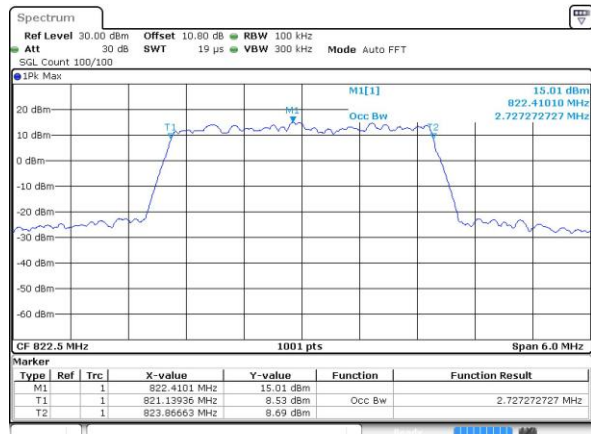

Date: 23 AUG 2018 13:23:28





LTE Band 26

Lowest Channel / 5MHz / 64QAM

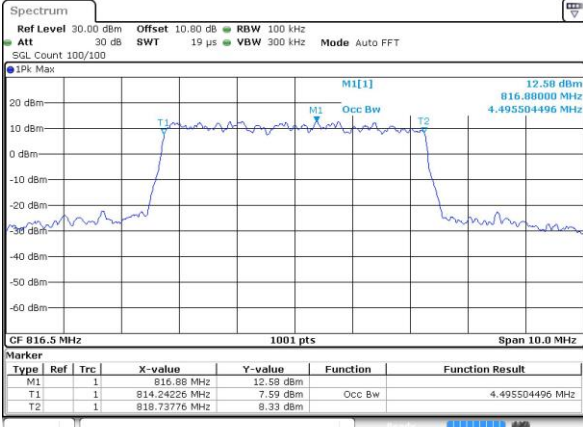

Date: 23 AUG 2018 13:24:52

Middle Channel / 5MHz / 64QAM

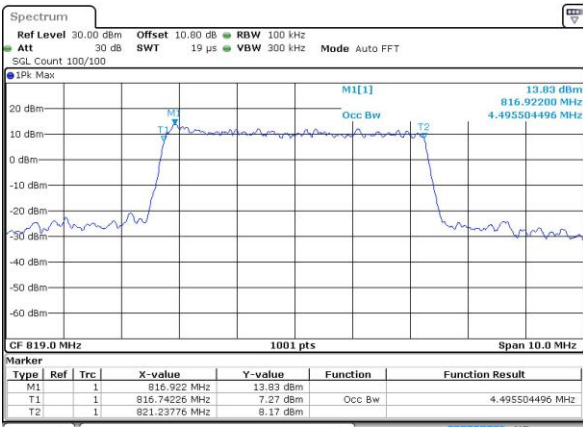

Date: 23 AUG 2018 13:26:16

Middle Channel / 10MHz / 64QAM

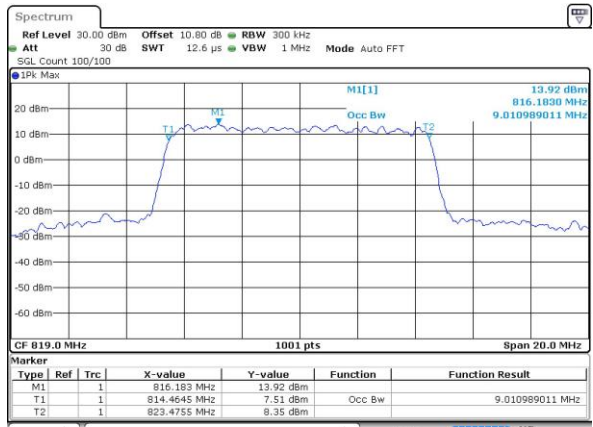

Date: 23 AUG 2018 13:29:05

Highest Channel / 5MHz / 64QAM

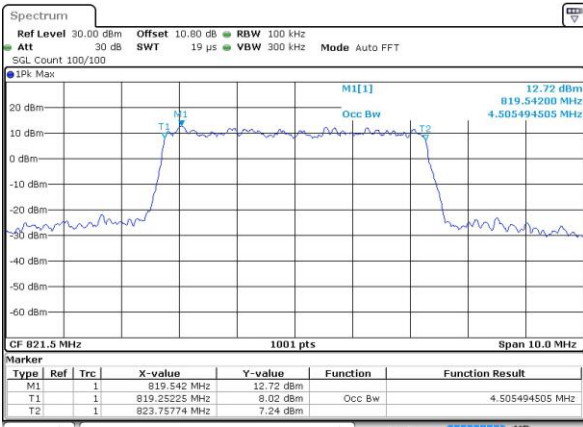

Date: 23 AUG 2018 13:27:41



LTE Band 26

Middle Channel / 15MHz / 64QAM

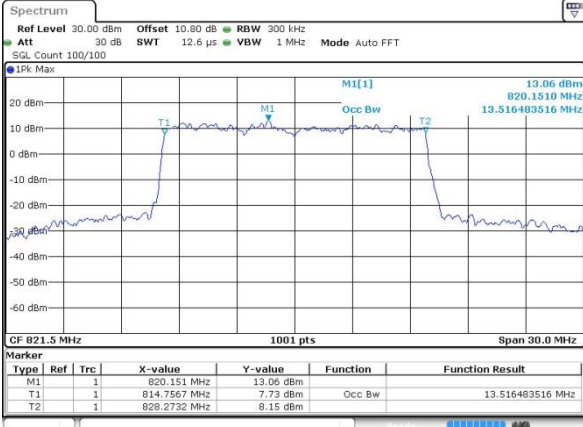

Date: 23 AUG 2018 13:30:29



Conducted Band Edge

LTE Band 26 / 1.4MHz / QPSK

Lowest Band Edge / 1RB

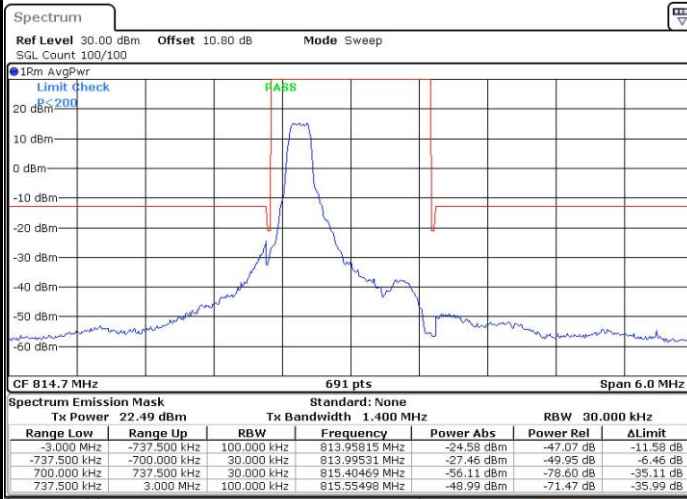

Date: 23 AUG 2018 12:18:15

Highest Band Edge / 1RB

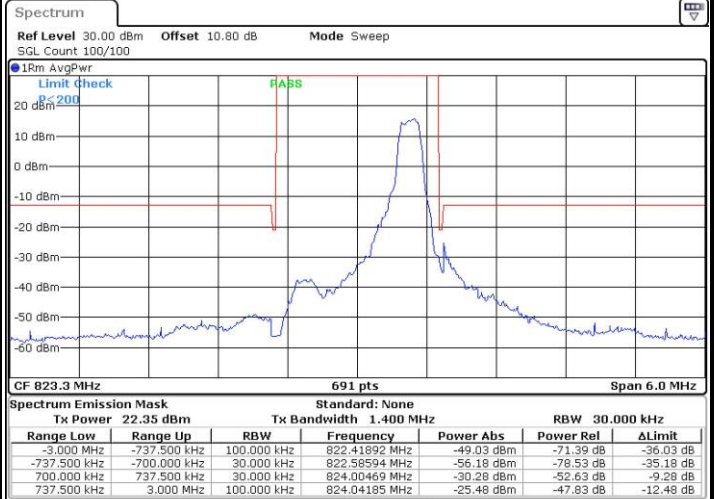

Date: 23 AUG 2018 12:22:58

Lowest Band Edge / Full RB

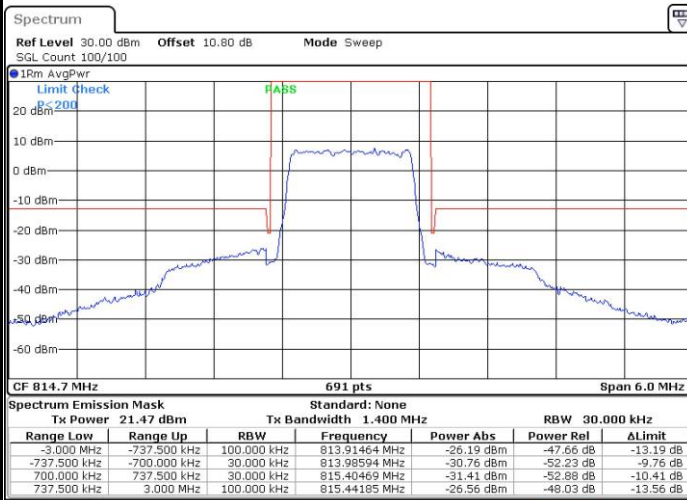

Date: 23 AUG 2018 12:20:36

Highest Band Edge / Full RB

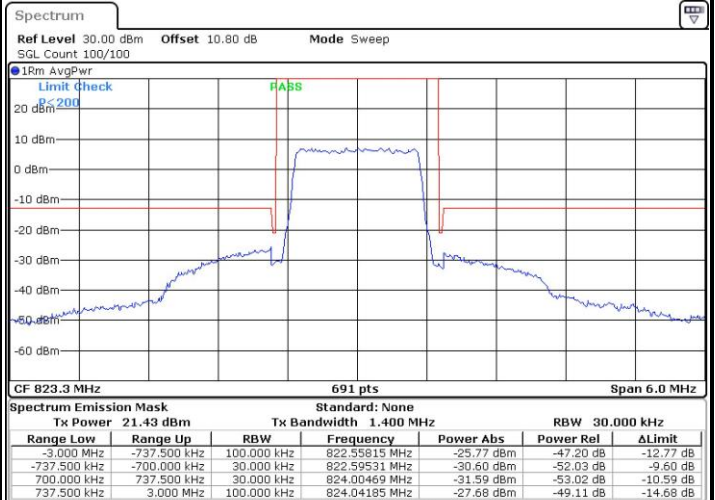

Date: 23 AUG 2018 12:25:17



LTE Band 26 / 1.4MHz / 16QAM

Lowest Band Edge / 1 RB

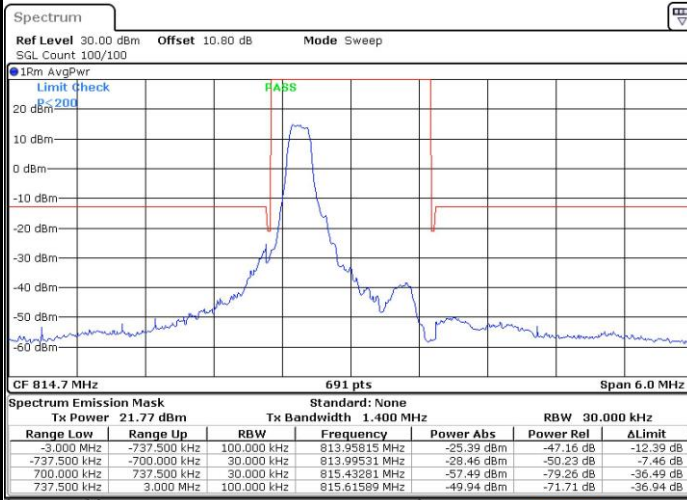

Date: 23 AUG 2018 12:19:25

Highest Band Edge / 1 RB

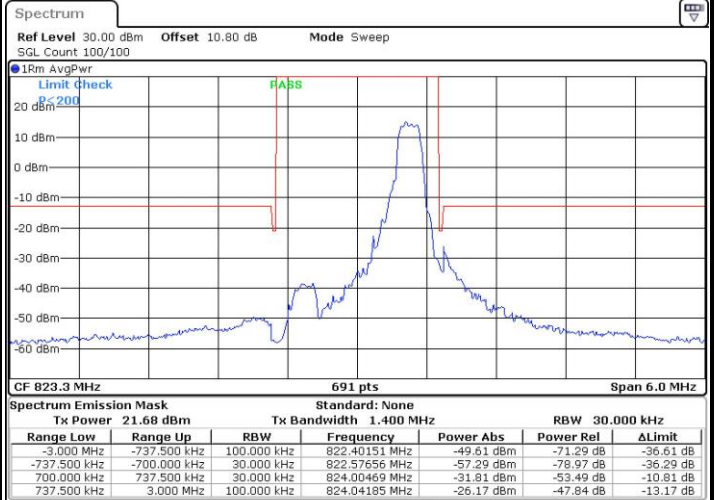

Date: 23 AUG 2018 12:24:07

Lowest Band Edge / Full RB



Date: 23 AUG 2018 12:21:46

Highest Band Edge / Full RB

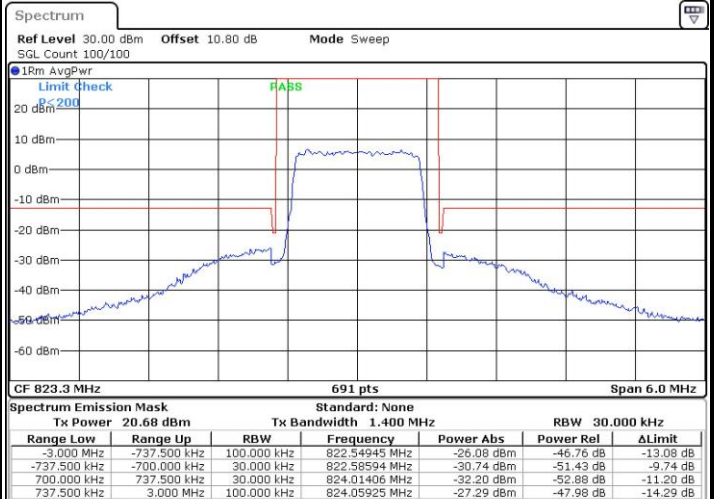

Date: 23 AUG 2018 12:26:27



LTE Band 26 / 1.4MHz / 64QAM

Lowest Band Edge / 1 RB

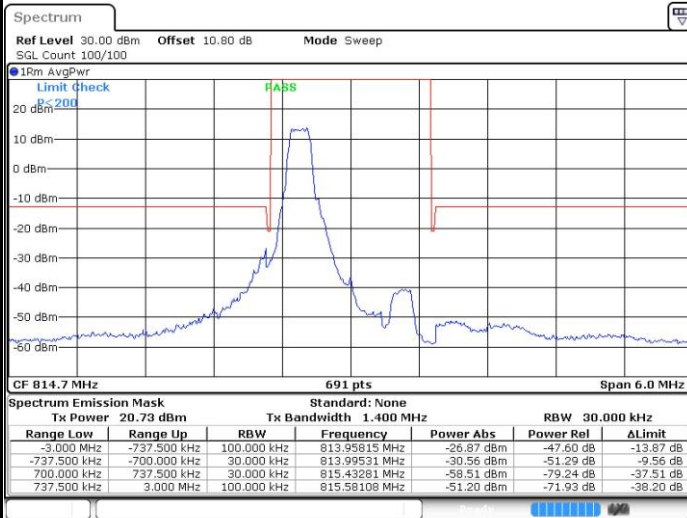

Date: 23 AUG 2018 13:00:30

Highest Band Edge / 1 RB

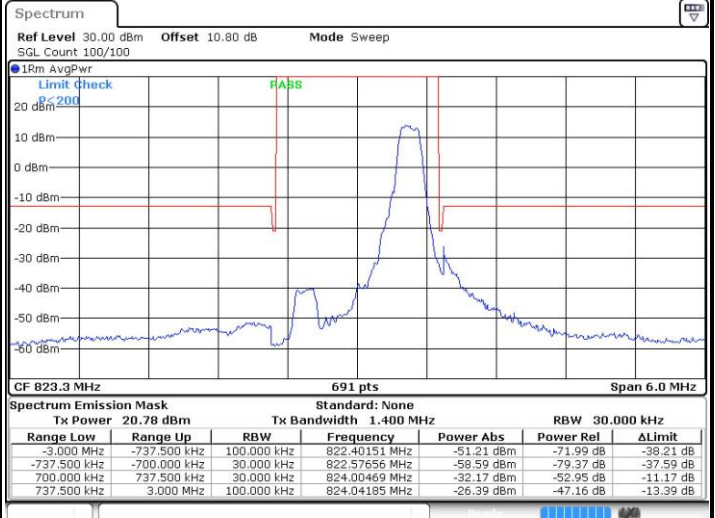

Date: 23 AUG 2018 13:02:51

Lowest Band Edge / Full RB

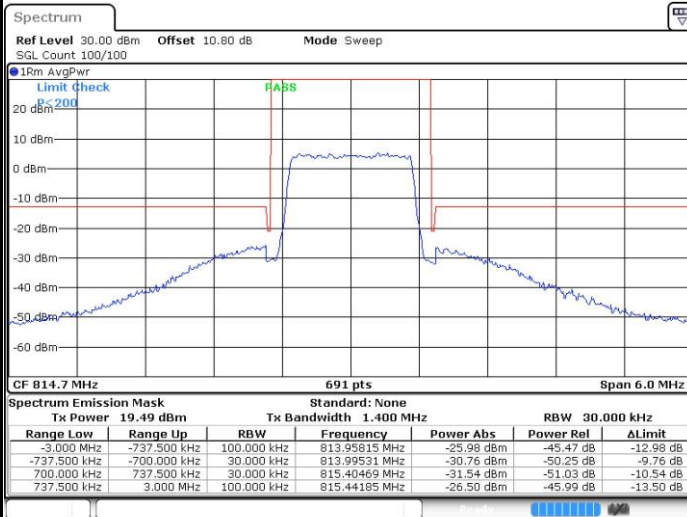

Date: 23 AUG 2018 13:01:40

Highest Band Edge / Full RB

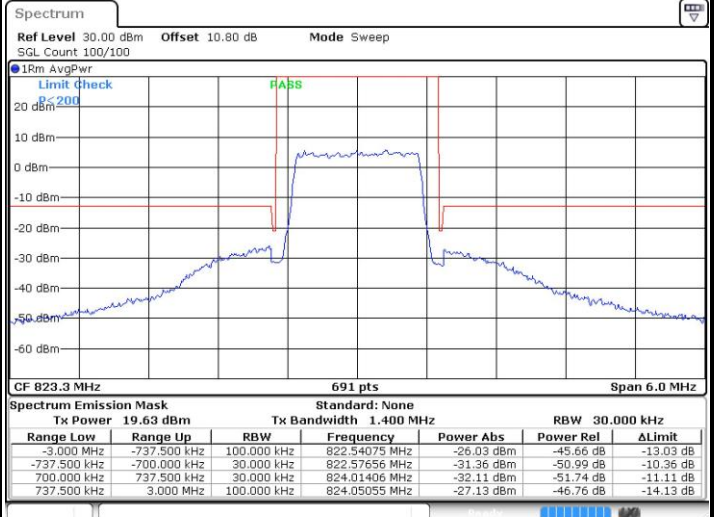

Date: 23 AUG 2018 13:04:01





LTE Band 26 / 3MHz / QPSK

Lowest Band Edge / 1RB

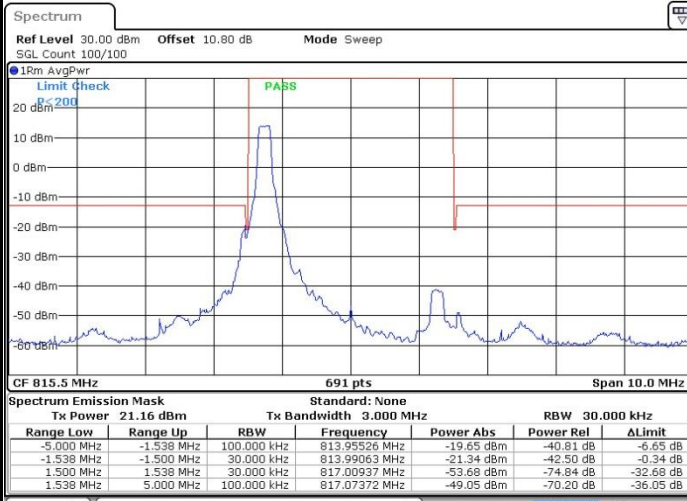

Date: 23 AUG 2018 20:50:49

Highest Band Edge / 1 RB

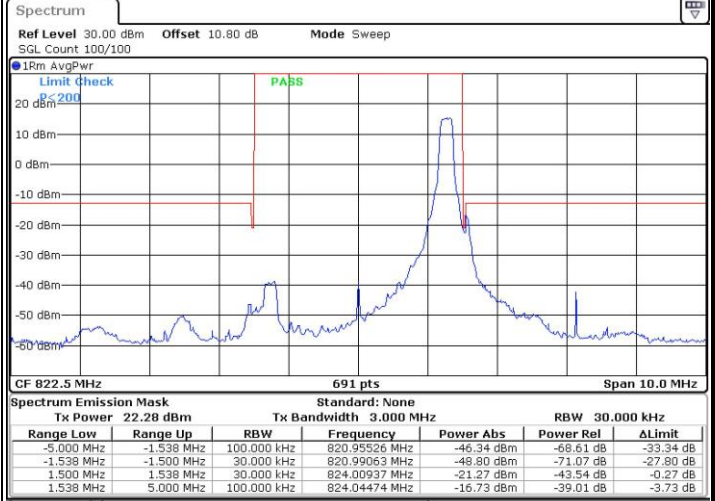

Date: 23 AUG 2018 12:32:21

Lowest Band Edge / Full RB

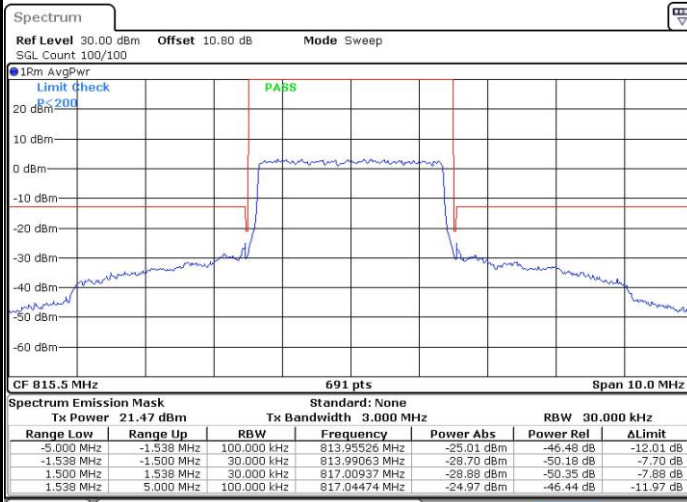

Date: 23 AUG 2018 12:29:59

Highest Band Edge / Full RB

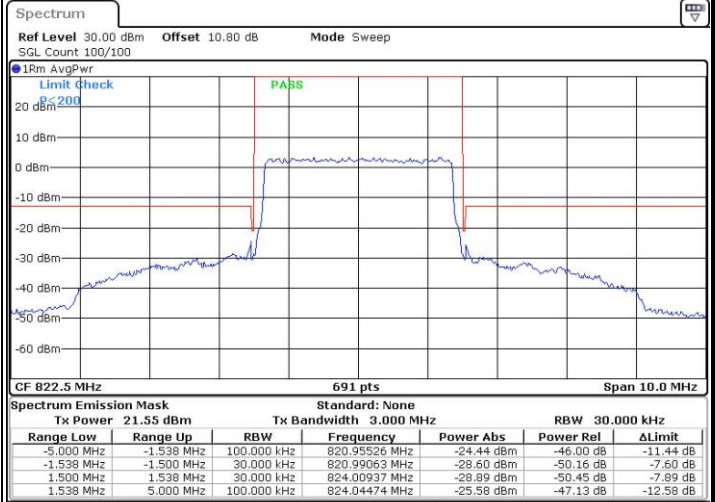

Date: 23 AUG 2018 12:34:42