

# FCC RADIO TEST REPORT

FCC ID : UZ7TC77HL  
Equipment : Touch computer  
Brand Name : Zebra  
Model Name : TC77HL  
Applicant : Zebra Technologies Corporation  
1 Zebra Plaza Holtsville, NY 11742  
Manufacturer : Zebra Technologies Corporation  
1 Zebra Plaza Holtsville, NY 11742  
Standard : FCC 47 CFR Part 2, 90(R)

The product was received on Jul. 25, 2018 and testing was started from Aug. 15, 2018 and completed on Sep. 06, 2018. We, SPORTON INTERNATIONAL INC., would like to declare that the tested sample has been evaluated in accordance with the test procedures given in ANSI / TIA-603-E and has been in compliance with the applicable technical standards.

The report must not be used by the client to claim product certification, approval, or endorsement by TAF or any agency of government.

The test results in this report apply exclusively to the tested model / sample. Without written approval of SPORTON INTERNATIONAL INC. EMC & Wireless Communications Laboratory, the test report shall not be reproduced except in full.



Approved by: Joseph Lin

**SPORTON INTERNATIONAL INC. EMC & Wireless Communications Laboratory**  
No. 52, Huaya 1st Rd., Guishan Dist., Taoyuan City, Taiwan (R.O.C.)



## Table of Contents

History of this test report.....	3
Summary of Test Result.....	4
<b>1 General Description .....</b>	<b>5</b>
1.1 Product Feature of Equipment Under Test.....	5
1.2 Product Specification of Equipment Under Test.....	6
1.3 Modification of EUT .....	6
1.4 Emission Designator .....	6
1.5 Testing Site .....	7
1.6 Applied Standards .....	7
<b>2 Test Configuration of Equipment Under Test .....</b>	<b>8</b>
2.1 Test Mode .....	8
2.2 Connection Diagram of Test System.....	9
2.3 Support Unit used in test configuration and system .....	9
2.4 Measurement Results Explanation Example.....	9
2.5 Frequency List of Low/Middle/High Channels .....	10
<b>3 Conducted Test Items.....</b>	<b>11</b>
3.1 Measuring Instruments .....	11
3.2 Conducted Output Power Measurement and ERP.....	12
3.3 Peak-to-Average Ratio .....	13
3.4 Occupied Bandwidth.....	15
3.5 Conducted Band Edge Measurement .....	16
3.6 Emission Mask.....	17
3.7 Conducted Spurious Emission .....	18
3.8 Frequency Stability Measurement .....	19
<b>4 Radiated Test Items .....</b>	<b>20</b>
4.1 Measuring Instruments .....	20
4.2 Radiated Spurious Emission Measurement .....	21
<b>5 List of Measuring Equipment.....</b>	<b>22</b>
<b>6 Uncertainty of Evaluation .....</b>	<b>23</b>
<b>Appendix A. Test Results of Conducted Test</b>	
<b>Appendix B. Test Results of ERP and Radiated Test</b>	
<b>Appendix C. Test Setup Photographs</b>	



**Summary of Test Result**

Report Clause	Ref Std. Clause	Test Items	Result (PASS/FAIL)	Remark
3.2	§2.1046	Conducted Output Power	Reporting only	-
	§90.542 (a)(7)	Effective Radiated Power	Pass	-
3.3	-	Peak-to-Average Ratio	Reporting only	-
3.4	§2.1049	Occupied Bandwidth	Reporting only	-
3.5	§2.1053 §90.543 (e)(2)(3)	Conducted Band Edge Measurement	Pass	-
3.6	§2.1051 §90.210 (n)	Emission Mask	Pass	-
3.7	§2.1053 §90.543 (e)(3)	Conducted Spurious Emission	Pass	-
3.8	§2.1055 §90.539 (e)	Frequency Stability Temperature & Voltage	Pass	-
4.2	§2.1053 §90.543 (e)(3) §90.543 (f)	Radiated Spurious Emission	Pass	Under limit 7.46 dB at 1584.000 MHz

**Reviewed by: Wii Chang****Report Producer: Maggie Chiang**

# 1 General Description

## 1.1 Product Feature of Equipment Under Test

Product Feature	
Equipment	Touch computer
Brand Name	Zebra
Model Name	TC77HL
FCC ID	UZ7TC77HL
EUT supports Radios application	GSM/EGPRS/WCDMA/HSPA/LTE/NFC/GNSS WLAN 11a/b/g/n HT20/HT40 WLAN 11ac VHT20/VHT40/VHT80 Bluetooth BR/EDR/LE
HW Version	DV
SW Version	Android version 8.1.0
FW Version	91-09-14.00-OG-U00-STD
MFD	06JUL18
EUT Stage	Engineering Sample

**Remark:** The above EUT's information was declared by manufacturer.

Specification of Accessories				
AC Adapter	Brand Name	Zebra	Part Number	PWR-BUA5V16W0WW
4 PIN DC power cable	Brand Name	Zebra	Part Number	CBL-DC-383A1-01
AC Power cable	Brand Name	Zebra	Part Number	50-16000-182R
Snap-On USB/Charge Cable	Brand Name	Zebra	Part Number	CBL-TC7X-USB1-01
Snap-On Charging Cable Cup	Brand Name	Zebra	Part Number	CHG-TC7X-CBL1-01
Battery 1	Brand Name	Zebra	Part Number	BT-000318-01
Battery 2 (Falcon 1S3P Battery Pack)	Brand Name	Zebra	Part Number	BT-000318-51
Battery 3	Brand Name	Symbol	Part Number	82-171249-02
Earphone 1	Brand Name	Zebra	Part Number	HDST-35MM-PTVP-01
Earphone 2	Brand Name	Zebra	Part Number	HS2100-OTH
Snap-on 3.5MM Audio Jack Adapter	Brand Name	Symbol	Part Number	ADP-TC7X-AUD35-01
3.5mm Jack 43"(1.1m) Standard Cable	Brand Name	Zebra	Part Number	CBL-HS2100-3MS1-01
Holster	Brand Name	Zebra	Part Number	SG-TC7X-HLSTR1-02
Rigid Holster	Brand Name	Zebra	Part Number	SG-TC7X-RHLSTR1-01



## 1.2 Product Specification of Equipment Under Test

Product Feature	
Tx Frequency	LTE Band 14 :790.5 MHz ~ 795.5 MHz
Rx Frequency	LTE Band 14 :760.5 MHz ~ 765.5 MHz
Bandwidth	5MHz / 10MHz
Maximum Output Power to Antenna	24.01dBm
Antenna Type	PIFA Antenna
Antenna Gain	0.59 dBi
Type of Modulation	QPSK / 16QAM / 64QAM

## 1.3 Modification of EUT

No modifications are made to the EUT during all test items.

## 1.4 Emission Designator

LTE Band 14		QPSK			16QAM			64QAM		
BW (MHz)	Frequency Range (MHz)	Emission Designator (99%OBW)	Frequency Tolerance (ppm)	Maximum ERP(W)	Emission Designator (99%OBW)	Frequency Tolerance (ppm)	Maximum ERP(W)	Emission Designator (99%OBW)	Frequency Tolerance (ppm)	Maximum ERP(W)
5	790.5 ~ 795.5	4M51G7D	-	0.2500	4M52W7D	-	0.2037	4M51W7D	-	0.1607
10	793	9M05G7D	0.0097	0.2518	9M05W7D	-	0.2113	9M07W7D	-	0.1656

## 1.5 Testing Site

Sporton Lab is accredited to ISO 17025 by Taiwan Accreditation Foundation (TAF code : 1190) and the FCC designation No. TW1190 and TW0007 under the FCC 2.948(e) by Mutual Recognition Agreement (MRA) in FCC Test.

<b>Test Site</b>	SPORTON INTERNATIONAL INC.
<b>Test Site Location</b>	No.52, Huaya 1st Rd., Guishan Dist., Taoyuan City, Taiwan (R.O.C.) TEL: +886-3-327-3456 FAX: +886-3-328-4978
<b>Test Site No.</b>	<b>Sporton Site No.</b>
	TH05-HY

**Note:** The test site complies with ANSI C63.4 2014 requirement.

<b>Test Site</b>	SPORTON INTERNATIONAL INC.
<b>Test Site Location</b>	No.58, Aly. 75, Ln. 564, Wenhua 3rd, Rd., Guishan Dist., Taoyuan City, Taiwan (R.O.C.) TEL: +886-3-327-0868 FAX: +886-3-327-0855
<b>Test Site No.</b>	<b>Sporton Site No.</b>
	03CH10-HY

**Note:** The test site complies with ANSI C63.4 2014 requirement.

## 1.6 Applied Standards

According to the specifications of the manufacturer, the EUT must comply with the requirements of the following standards:

- ♦ ANSI C63.26-2015
- ♦ 47 CFR Part 2, Part 90(R)
- ♦ ANSI / TIA-603-E
- ♦ FCC KDB 971168 D01 Power Meas. License Digital Systems v03r01
- ♦ FCC KDB 412172 D01 Determining ERP and EIRP v01r01

**Remark:**

1. All test items were verified and recorded according to the standards and without any deviation during the test.
2. This EUT has also been tested and complied with the requirements of FCC Part 15, Subpart B, recorded in a separate test report.



## 2 Test Configuration of Equipment Under Test

### 2.1 Test Mode

Antenna port conducted and radiated test items listed below are performed according to KDB 971168 D01 Power Meas. License Digital Systems v03r01 with maximum output power.

For radiated measurement, pre-scanned in three orthogonal panels, X, Y, Z. The worst cases (Y plane) were recorded in this report.

Conducted Test Cases	Band	Bandwidth (MHz)						Modulation			RB #			Test Channel		
		1.4	3	5	10	15	20	QPSK	16QAM	64QAM	1	Half	Full	L	M	H
Max. Output Power	14	-	-	V	V	-	-	V	V	V	V	V	V	V	V	V
Peak-to-Average Ratio	14	-	-		V	-	-	V	V	V	V		V	V	V	V
26dB and 99% Bandwidth	14	-	-	V	V	-	-	V	V	V			V	V	V	V
Conducted Band Edge	14	-	-	V	V	-	-	V	V	V	V		V	V		V
Emission Mask	14	-	-	V	V	-	-	V	V	V	V		V	V	V	V
Conducted Spurious Emission	14	-	-	V	V	-	-	V	V	V	V			V	V	V
Frequency Stability	14	-	-		V	-	-	V	V	V			V		V	
E.R.P	14	-	-	V	V	-	-	V	V	V	V			V	V	V
Radiated Spurious Emission	14	Worst Case											V	V	V	
Remark	<ol style="list-style-type: none"> <li>The mark "v " means that this configuration is chosen for testing</li> <li>The mark "- " means that this bandwidth is not supported.</li> <li>The device is investigated from 30MHz to 10 times of fundamental signal for radiated spurious emission test under different RB size/offset and modulations in exploratory test. Subsequently, only the worst case emissions are reported.</li> <li>The radiated test cases were performance with Battery 1, Earphone 1, and SIM 1.</li> </ol>															



## 2.2 Connection Diagram of Test System

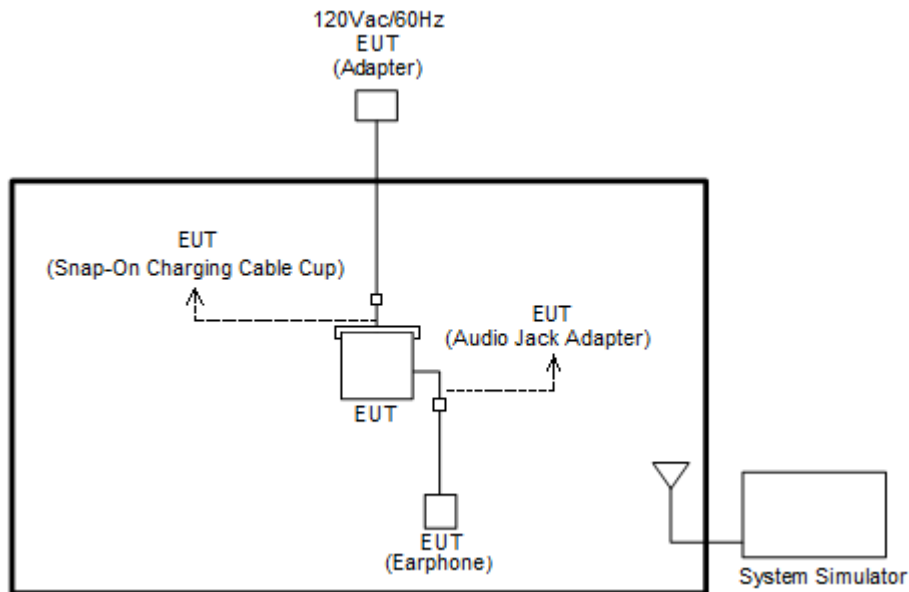

## 2.3 Support Unit used in test configuration and system

Item	Equipment	Trade Name	Model No.	FCC ID	Data Cable	Power Cord
1.	System Simulator	Anritsu	MT8820C	N/A	N/A	Unshielded, 1.8 m

## 2.4 Measurement Results Explanation Example

### For all conducted test items:

The offset level is set in the spectrum analyzer to compensate the RF cable loss and attenuator factor between EUT conducted output port and spectrum analyzer. With the offset compensation, the spectrum analyzer reading level is exactly the EUT RF output level.

The spectrum analyzer offset is derived from RF cable loss and attenuator factor.

*Offset = RF cable loss + attenuator factor.*

Following shows an offset computation example with cable loss 4.5 dB and 10dB attenuator.

Example :

$$\begin{aligned} \text{Offset(dB)} &= \text{RF cable loss(dB)} + \text{attenuator factor(dB)}. \\ &= 4.5 + 10 = 14.5 \text{ (dB)} \end{aligned}$$



## 2.5 Frequency List of Low/Middle/High Channels

LTE Band 14 Channel and Frequency List				
BW [MHz]	Channel/Frequency(MHz)	Lowest	Middle	Highest
10	Channel	-	23330	-
	Frequency	-	793	-
5	Channel	23305	23330	23355
	Frequency	790.5	793	795.5

### 3 Conducted Test Items

#### 3.1 Measuring Instruments

The measuring equipment is listed in the section 5 of this test report

##### 3.1.1 Test Setup

##### 3.1.2 Conducted Output Power



##### 3.1.3 Peak-to-Average Ratio, Occupied Bandwidth, Conducted Band-Edge, Emission Mask, and Conducted Spurious Emission

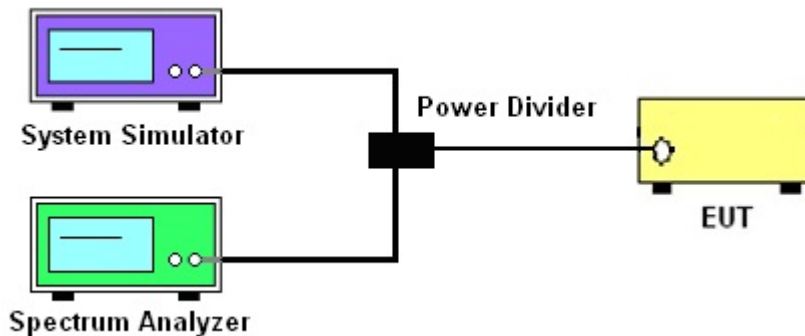

##### 3.1.4 Frequency Stability

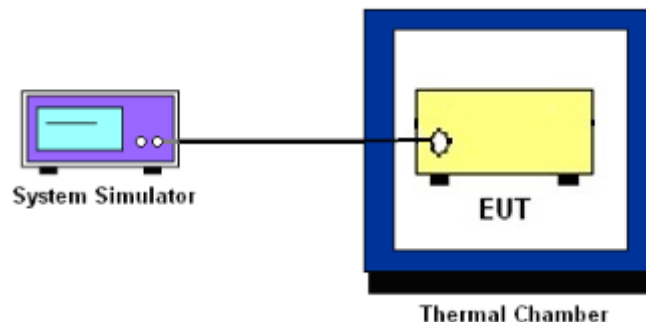

##### 3.1.5 Test Result of Conducted Test

Please refer to Appendix A.



## **3.2 Conducted Output Power Measurement and ERP**

### **3.2.1 Description of the Conducted Output Power Measurement and ERP Measurement**

A base station simulator was used to establish communication with the EUT. Its parameters were set to transmit the maximum power on the EUT. The measured power in the radio frequency on the transmitter output terminals shall be reported.

The ERP of mobile transmitters must not exceed 3 Watts for LTE Band 14.

According to KDB 412172 D01 Power Approach,

$EIRP = P_T + G_T - L_C$ ,  $ERP = EIRP - 2.15$ , where

$P_T$  = transmitter output power in dBm

$G_T$  = gain of the transmitting antenna in dBi

$L_C$  = signal attenuation in the connecting cable between the transmitter and antenna in dB

### **3.2.2 Test Procedures**

1. The transmitter output port was connected to the system simulator.
2. Set EUT at maximum power through the system simulator.
3. Select lowest, middle, and highest channels for each band and different modulation.
4. Measure and record the power level from the system simulator.



### **3.3 Peak-to-Average Ratio**

#### **3.3.1 Description of the PAR Measurement**

Power Complementary Cumulative Distribution Function (CCDF) curves provide a means for characterizing the power peaks of a digitally modulated signal on a statistical basis. A CCDF curve depicts the probability of the peak signal amplitude exceeding the average power level. Most contemporary measurement instrumentation include the capability to produce CCDF curves for an input signal provided that the instrument's resolution bandwidth can be set wide enough to accommodate the entire input signal bandwidth. In measuring transmissions in this band using an average power technique, the peak-to-average ratio (PAR) of the transmission may not exceed 13 dB.

#### **3.3.2 Test Procedures**

The testing follows FCC KDB 971168 D01 v03r01 Section 5.7.1

1. The EUT was connected to spectrum and system simulator via a power divider.
2. Set the CCDF (Complementary Cumulative Distribution Function) option in spectrum analyzer.
3. The highest RF powers were measured and recorded the maximum PAPR level associated with a probability of 0.1 %.
4. Record the deviation as Peak to Average Ratio.



### **3.3.3 Description of the PAR Measurement**

Power Complementary Cumulative Distribution Function (CCDF) curves provide a means for characterizing the power peaks of a digitally modulated signal on a statistical basis. A CCDF curve depicts the probability of the peak signal amplitude exceeding the average power level. Most contemporary measurement instrumentation include the capability to produce CCDF curves for an input signal provided that the instrument's resolution bandwidth can be set wide enough to accommodate the entire input signal bandwidth. In measuring transmissions in this band using an average power technique, the peak-to-average ratio (PAR) of the transmission may not exceed 13 dB.

### **3.3.4 Test Procedures**

The testing follows FCC KDB 971168 D01 v03r01 Section 5.7.1

5. The EUT was connected to spectrum and system simulator via a power divider.
6. Set the CCDF (Complementary Cumulative Distribution Function) option in spectrum analyzer.
7. The highest RF powers were measured and recorded the maximum PAPR level associated with a probability of 0.1 %.
8. Record the deviation as Peak to Average Ratio.



## **3.4 Occupied Bandwidth**

### **3.4.1 Description of Occupied Bandwidth Measurement**

The occupied bandwidth is the width of a frequency band such that, below the lower and above the upper frequency limits, the mean powers emitted are each equal to a specified percentage 0.5% of the total mean transmitted power.

The 26 dB emission bandwidth is defined as the frequency range between two points, one above and one below the carrier frequency, at which the spectral density of the emission is attenuated 26 dB below the maximum in-band spectral density of the modulated signal. Spectral density (power per unit bandwidth) is to be measured with a detector of resolution bandwidth equal to approximately 1.0% of the emission bandwidth.

### **3.4.2 Test Procedures**

The testing follows FCC KDB 971168 D01 v03r01 Section 4.2

1. The EUT was connected to spectrum analyzer and system simulator via a power divider.
2. The spectrum analyzer center frequency is set to the nominal EUT channel center frequency. The span range for the spectrum analyzer shall be between two and five times the anticipated OBW.
3. The nominal resolution bandwidth (RBW) shall be in the range of 1 to 5 % of the anticipated OBW, and the VBW shall be at least 3 times the RBW.
4. Set the detection mode to peak, and the trace mode to max hold.
5. Determine the reference value: Set the EUT to transmit a modulated signal. Allow the trace to stabilize. Set the spectrum analyzer marker to the highest level of the displayed trace.  
(this is the reference value)
6. Determine the “-26 dB down amplitude” as equal to (Reference Value – X).
7. Place two markers, one at the lowest and the other at the highest frequency of the envelope of the spectral display such that each marker is at or slightly below the “-X dB down amplitude” determined in step 6. If a marker is below this “-X dB down amplitude” value it shall be placed as close as possible to this value. The OBW is the positive frequency difference between the two markers.
8. Use the 99 % power bandwidth function of the spectrum analyzer and report the measured bandwidth.

## 3.5 Conducted Band Edge Measurement

### 3.5.1 Description of Conducted Band Edge Measurement

90.543(e)

- (1) On all frequencies between 769-775 MHz and 799-805 MHz, by a factor not less than  $76 + 10 \log (P)$  dB in a 6.25 kHz band segment, for base and fixed stations.
- (2) On all frequencies between 769-775 MHz and 799-805 MHz, by a factor not less than  $65 + 10 \log (P)$  dB in a 6.25 kHz band segment, for mobile and portable stations.
- (3) On any frequency between 775-788 MHz, above 805 MHz, and below 758 MHz, by at least  $43 + 10 \log (P)$  dB.

### 3.5.2 Test Procedures

The testing follows FCC KDB 971168 D01 v03r01 Section 6.0.

1. The EUT was connected to spectrum analyzer and system simulator via a power divider.
2. The band edges of low and high channels for the highest RF powers were measured.
3. Set RBW  $\geq 1\%$  EBW in the 1MHz band immediately outside and adjacent to the band edge.
4. Beyond the 1 MHz band from the band edge, RBW=1MHz was used.
5. Set spectrum analyzer with RMS detector.
6. The RF fundamental frequency should be excluded against the limit line in the operating frequency band.
7. Checked that all the results comply with the emission limit line.

The limit line is derived from  $43 + 10\log(P)$ dB below the transmitter power P(Watts)





## **3.6 Emission Mask**

### **3.6.1 Description of Emissions Mask Measurement**

Transmitters designed must meet the emission mask comply with the emission mask provisions of FCC Part 90.210(n).

### **3.6.2 Test Procedures**

The testing follows FCC KDB 971168 D01 v03r01 Section 6.0.

1. The EUT was connected to spectrum analyzer and system simulator via a power divider.
2. The power of the modulated signal was measured on a spectrum analyzer using an RMS and 10 second sweep time in order to maximize the level.
3. The RF fundamental frequency should be excluded against the limit line in the operating frequency band.



## **3.7 Conducted Spurious Emission**

### **3.7.1 Description of Conducted Spurious Emission Measurement**

The power of any emission outside of the authorized operating frequency ranges must be lower than the transmitter power (P) by a factor of at least  $43 + 10 \log (P)$  dB.

It is measured by means of a calibrated spectrum analyzer and scanned from 30MHz up to a frequency including its 10<sup>th</sup> harmonic.

### **3.7.2 Test Procedures**

The testing follows FCC KDB 971168 D01 v03r01 Section 6.0.

1. The EUT was connected to spectrum analyzer and base station via power divider.
2. The RF output of EUT was connected to the spectrum analyzer by RF cable and attenuator. The path loss was compensated to the results for each measurement.
3. The middle channel for the highest RF power within the transmitting frequency was measured.
4. The conducted spurious emission for the whole frequency range was taken.
5. Make the measurement with the spectrum analyzer's RBW = 1MHz, VBW = 3MHz.
6. Set spectrum analyzer with RMS detector.
7. Taking the record of maximum spurious emission.
8. The RF fundamental frequency should be excluded against the limit line in the operating frequency band.
9. The limit line is derived from  $43 + 10\log(P)$ dB below the transmitter power P(Watts)



## **3.8 Frequency Stability Measurement**

### **3.8.1 Description of Frequency Stability Measurement**

The frequency stability shall be sufficient to ensure that the fundamental emission stays within the authorized frequency block.

### **3.8.2 Test Procedures for Temperature Variation**

The testing follows FCC KDB 971168 D01 v03r01 Section 9.0.

1. The EUT was set up in the thermal chamber and connected with the base station.
2. With power OFF, the temperature was decreased to -30°C and the EUT was stabilized before testing. Power was applied and the maximum change in frequency was recorded within one minute.
3. With power OFF, the temperature was raised in 10°C step up to 50°C. The EUT was stabilized at each step for at least half an hour. Power was applied and the maximum frequency change was recorded within one minute.

### **3.8.3 Test Procedures for Voltage Variation**

The testing follows FCC KDB 971168 D01 v03r01 Section 9.0.

1. The EUT was placed in a temperature chamber at 20±5° C and connected with the base station.
2. The power supply voltage to the EUT was varied from 85% to 115% of the nominal value measured at the input to the EUT.
3. The variation in frequency was measured for the worst case.

## 4 Radiated Test Items

### 4.1 Measuring Instruments

See list of measuring instruments of this test report.

#### 4.1.1 Test Setup

For radiated test from 30MHz to 1GHz

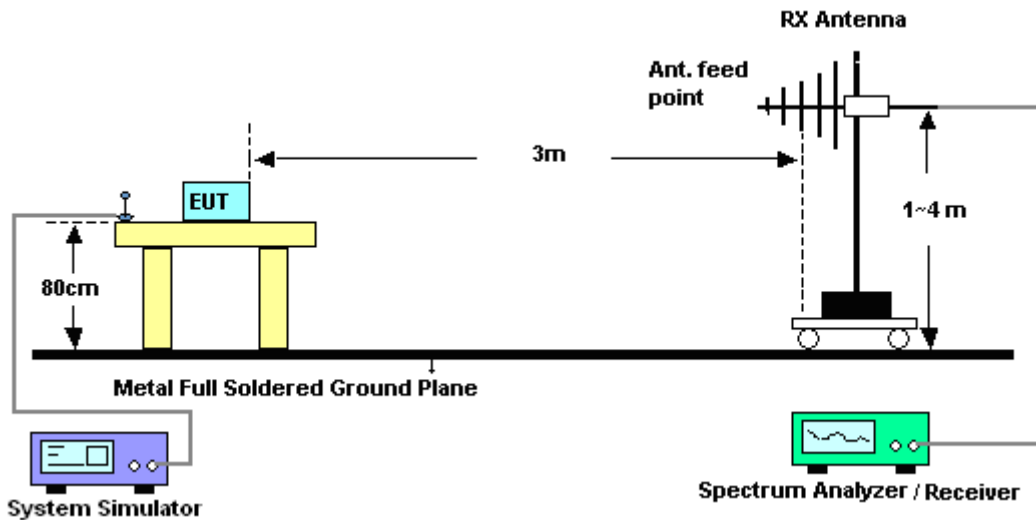

For radiated test above 1GHz

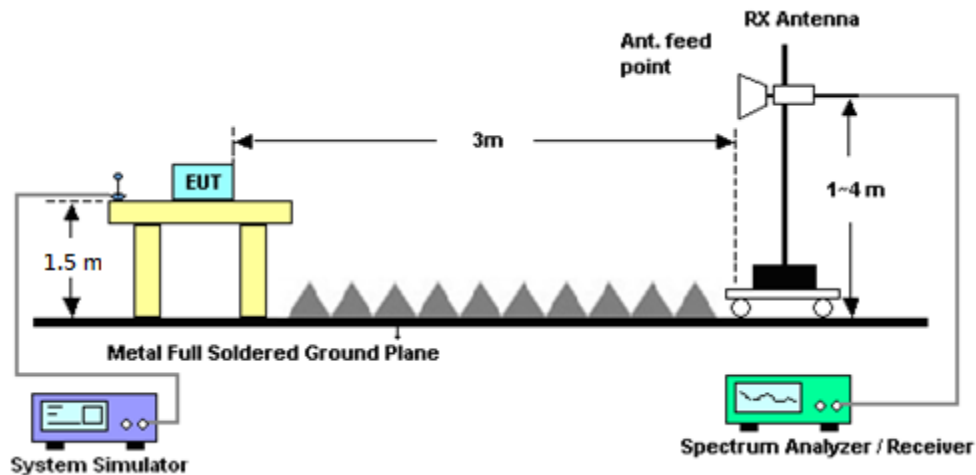

#### 4.1.2 Test Result of Radiated Test

Please refer to Appendix B.



## **4.2 Radiated Spurious Emission Measurement**

### **4.2.1 Description of Radiated Spurious Emission**

The radiated spurious emission was measured by substitution method according to ANSI / TIA-603-E. The power of any emission outside of the authorized operating frequency ranges must be attenuated below the transmitter power (P) by a factor of at least  $43 + 10 \log (P)$  dB.

For operations in the 758-775 MHz and 788-805 MHz bands, all emissions including harmonics in the band 1559–1610 MHz shall be limited to -70 dBW/MHz equivalent isotropically radiated power (EIRP) for wideband signals, and -80 dBW EIRP for discrete emissions of less than 700 Hz bandwidth. For the purpose of equipment authorization, a transmitter shall be tested with an antenna that is representative of the type that will be used with the equipment in normal operation.

The spectrum is scanned from 30 MHz up to a frequency including its 10th harmonic.

### **4.2.2 Test Procedures**

The testing follows FCC KDB 971168 D01 v03r01 Section 5.8 and ANSI / TIA-603-E Section 2.2.12.

1. The EUT was placed on a turntable with 0.8 meter for frequency below 1GHz and 1.5 meter for frequency above 1GHz respectively above ground.
2. The EUT was set 3 meters from the receiving antenna, which was mounted on the antenna tower.
3. The table was rotated 360 degrees to determine the position of the highest spurious emission.
4. The height of the receiving antenna is varied between one meter and four meters to search the maximum spurious emission for both horizontal and vertical polarizations.
5. Make the measurement with the spectrum analyzer's RBW = 1MHz, VBW = 3MHz, Sweep = 500ms, Taking the record of maximum spurious emission.
6. A horn antenna was substituted in place of the EUT and was driven by a signal generator.
7. Tune the output power of signal generator to the same emission level with EUT maximum spurious emission.
8. Taking the record of output power at antenna port.
9. Repeat step 7 to step 8 for another polarization.
10. The RF fundamental frequency should be excluded against the limit line in the operating frequency band.
11. The limit line is derived from  $43 + 10\log(P)$ dB below the transmitter power P(Watts)

## 5 List of Measuring Equipment

Instrument	Manufacturer	Model No.	Serial No.	Characteristics	Calibration Date	Test Date	Due Date	Remark
LTE Base Station	Anritsu	MT8820C	6201432821	GSM/GPRS /WCDMA/LTE	Oct. 13, 2017	Aug. 15, 2018~ Aug. 24, 2018	Oct. 12, 2018	Conducted (TH05-HY)
Spectrum Analyzer	Rohde & Schwarz	FSV40	101397	10Hz~40GHz	Nov. 07, 2017	Aug. 15, 2018~ Aug. 24, 2018	Nov. 06, 2018	Conducted (TH05-HY)
Temperature Chamber	ESPEC	SH-641	92013720	-30°C~70°C	Aug. 28, 2017	Aug. 15, 2018~ Aug. 24, 2018	Aug. 27, 2018	Conducted (TH05-HY)
Programmable Power Supply	GW Instek	PSS-2005	EL890001	1V~20V 0.5A~5A	Oct. 06, 2017	Aug. 15, 2018~ Aug. 24, 2018	Oct. 05, 2018	Conducted (TH05-HY)
Coupler	Warison	1-18GHz 20dB 25WSMA Directional Coupler	#B	1G~18GHz	Dec. 04, 2017	Aug. 15, 2018~ Aug. 24, 2018	Dec. 03, 2018	Conducted (TH05-HY)
Amplifier	SONOMA	310N	187311	9kHz~1GHz	Oct. 19, 2017	Aug. 23, 2018~ Sep. 06, 2018	Oct. 18, 2018	Radiation (03CH10-HY)
Bilog Antenna	TESEQ	CBL 6111D&00800 N1D01N-06	35413&02	30MHz~1GHz	Dec. 18, 2017	Aug. 23, 2018~ Sep. 06, 2018	Dec. 17, 2018	Radiation (03CH10-HY)
Horn Antenna	SCHWARZBE CK	BBHA 9120 D	9120D-1325	1GHz ~ 18GHz	Sep. 27, 2017	Aug. 23, 2018~ Sep. 06, 2018	Sep. 26, 2018	Radiation (03CH10-HY)
Preamplifier	Keysight	83017A	MY53270078	1GHz~26.5GHz	Oct. 25, 2017	Aug. 23, 2018~ Sep. 06, 2018	Oct. 24, 2018	Radiation (03CH10-HY)
Spectrum Analyzer	Keysight	N9010A	MY54200485	10Hz ~ 44GHz	Oct. 31, 2017	Aug. 23, 2018~ Sep. 06, 2018	Oct. 30, 2018	Radiation (03CH10-HY)
Antenna Mast	EMEC	AM-BS-4500-B	N/A	1~4m	N/A	Aug. 23, 2018~ Sep. 06, 2018	N/A	Radiation (03CH10-HY)
Turn Table	EMEC	TT 2200	N/A	0~360 Degree	N/A	Aug. 23, 2018~ Sep. 06, 2018	N/A	Radiation (03CH10-HY)
Software	Audix	E3 6.2009-8-24	RK-001042	N/A	N/A	Aug. 23, 2018~ Sep. 06, 2018	N/A	Radiation (03CH10-HY)
RF Cable	HUBER + SUHNER	SUCOFLEX 104 / 102	MY11692/4PE, MY11693/4PE, MY2855/2	30M-1G	Nov. 14, 2017	Aug. 23, 2018~ Sep. 06, 2018	Nov. 13, 2018	Radiation (03CH10-HY)
RF Cable	HUBER + SUHNER	SUCOFLEX 104 / 102	MY11692/4PE, MY11693/4PE, MY2855/2	1G-18G	Nov. 14, 2017	Aug. 23, 2018~ Sep. 06, 2018	Nov. 13, 2018	Radiation (03CH10-HY)



## 6 Uncertainty of Evaluation

### Uncertainty of Radiated Emission Measurement (30 MHz ~ 1000 MHz)

Measuring Uncertainty for a Level of Confidence of 95% ( $U = 2Uc(y)$ )	3.17
-------------------------------------------------------------------------	------

### Uncertainty of Radiated Emission Measurement (1 GHz ~ 18 GHz)

Measuring Uncertainty for a Level of Confidence of 95% ( $U = 2Uc(y)$ )	3.48
-------------------------------------------------------------------------	------

### Uncertainty of Radiated Emission Measurement (18 GHz ~ 40 GHz)

Measuring Uncertainty for a Level of Confidence of 95% ( $U = 2Uc(y)$ )	4.00
-------------------------------------------------------------------------	------



## Appendix A. Test Results of Conducted Test

### Conducted Output Power(Average power)

LTE Band 14 Maximum Average Power [dBm]						
BW [MHz]	RB Size	RB Offset	Mod	Lowest	Middle	Highest
10	1	0	QPSK		<b>24.01</b>	
10	1	25			23.91	
10	1	49			23.73	
10	25	0			22.98	
10	25	12			22.94	
10	25	25			22.90	
10	50	0			22.93	
10	1	0	16-QAM	-	23.17	-
10	1	25			23.25	
10	1	49			23.05	
10	25	0			22.06	
10	25	12			22.04	
10	25	25			22.00	
10	50	0			22.05	
10	1	0	64-QAM		22.13	
10	1	25			22.19	
10	1	49			21.99	
10	25	0			21.09	
10	25	12			21.05	
10	25	25			21.00	
10	50	0			21.05	
5	1	0	QPSK	23.97	23.98	23.90
5	1	12		23.74	23.63	23.79
5	1	24		23.66	23.61	23.57
5	12	0		22.80	22.73	22.81
5	12	7		22.73	22.77	22.77
5	12	13		22.78	22.63	22.69
5	25	0		22.85	22.66	22.71
5	1	0	16-QAM	23.09	22.92	23.01
5	1	12		22.97	22.94	22.99
5	1	24		23.03	23.02	22.97
5	12	0		21.77	21.89	21.82
5	12	7		21.77	21.85	21.78
5	12	13		21.80	21.85	21.69
5	25	0		21.85	21.90	21.76
5	1	0	64-QAM	21.97	21.93	21.95
5	1	12		21.91	22.06	22.02
5	1	24		21.85	21.89	21.90
5	12	0		20.95	20.90	20.96
5	12	7		20.79	20.82	20.96
5	12	13		20.76	20.93	20.89
5	25	0		20.84	20.94	20.76





## LTE Band 14

### Peak-to-Average Ratio

Mode	LTE Band 14 / 10MHz				
Mod.	QPSK		16QAM		Limit: 13dB
RB Size	1RB	Full RB	1RB	Full RB	Result
Lowest CH					PASS
Middle CH	3.51	4.78	4.61	6	
Highest CH					
Mode	LTE Band 14 / 10MHz				
Mod.	64QAM				Limit: 13dB
RB Size	1RB	Full RB			Result
Lowest CH					PASS
Middle CH	6.12	6.61			
Highest CH					



LTE Band 14 / 10MHz / QPSK

Middle Channel/ 1RB

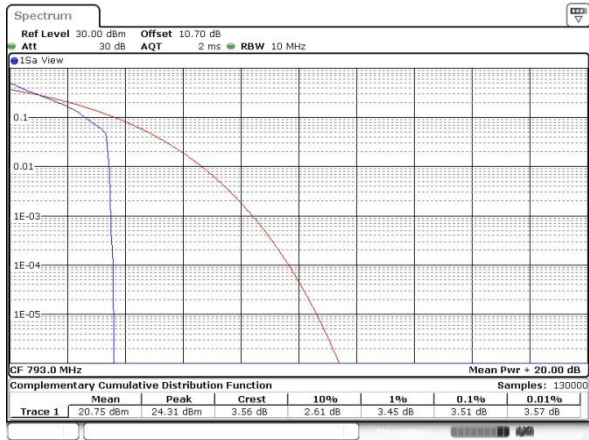

Date: 20 AUG 2018 00:47:43

Middle Channel / Full RB

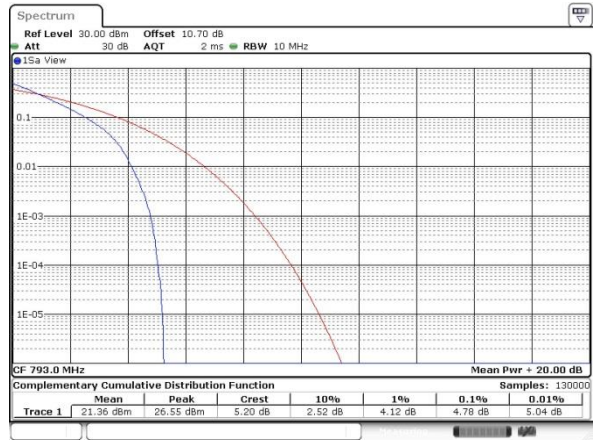

Date: 20 AUG 2018 00:47:55

LTE Band 14 / 10MHz / 16QAM

Middle Channel/ 1RB



Date: 20 AUG 2018 00:47:21

Middle Channel / Full RB



Date: 20 AUG 2018 00:47:33

LTE Band 14 / 10MHz / 64QAM

Middle Channel/ 1RB



Date: 20 AUG 2018 00:48:06

Middle Channel / Full RB

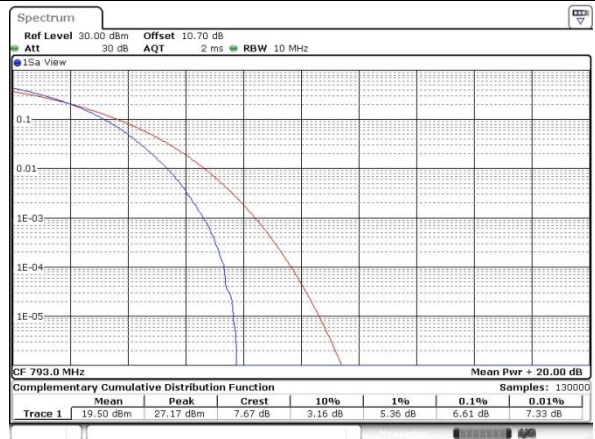

Date: 20 AUG 2018 00:48:18



**26dB Bandwidth**

Mode	LTE Band 14 : 26dB BW(MHz)											
BW	1.4MHz		3MHz		5MHz		10MHz		15MHz		20MHz	
Mod.	QPSK	16QAM	QPSK	16QAM	QPSK	16QAM	QPSK	16QAM	QPSK	16QAM	QPSK	16QAM
Lowest CH	-	-	-	-	4.83	4.88	-	-	-	-	-	-
Middle CH	-	-	-	-	4.91	4.96	9.83	9.85	-	-	-	-
Highest CH	-	-	-	-	4.98	4.91	-	-	-	-	-	-
Mode	LTE Band 14 : 26dB BW(MHz)											
BW	1.4MHz		3MHz		5MHz		10MHz		15MHz		20MHz	
Mod.	64QAM		64QAM		64QAM		64QAM		64QAM		64QAM	
Lowest CH	-	-	-	-	4.89	-	-	-	-	-	-	-
Middle CH	-	-	-	-	4.91	-	9.81	-	-	-	-	-
Highest CH	-	-	-	-	4.95	-	-	-	-	-	-	-



LTE Band 14

Lowest Channel / 5MHz / QPSK

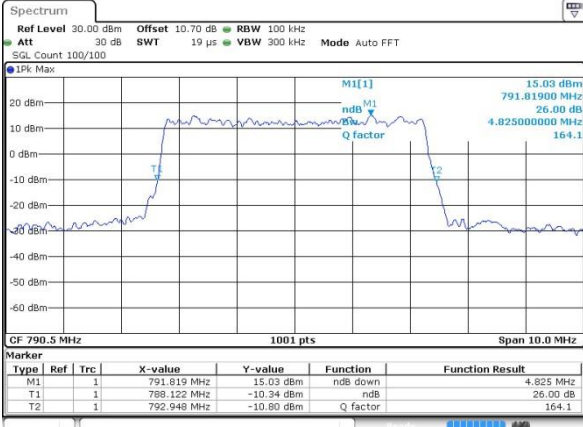

Date: 20 AUG 2018 00:43:15

Lowest Channel / 5MHz / 16QAM

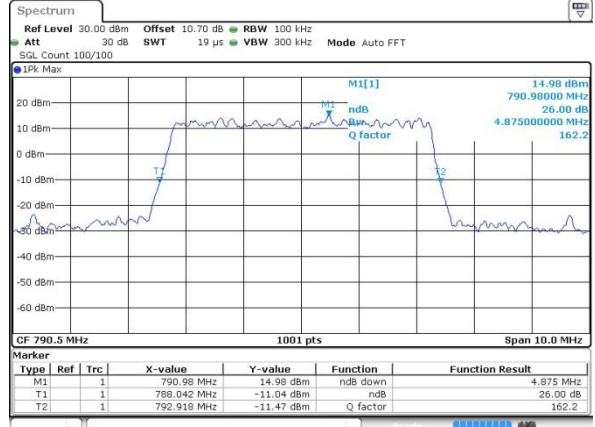

Date: 20 AUG 2018 00:43:04

Middle Channel / 5MHz / QPSK

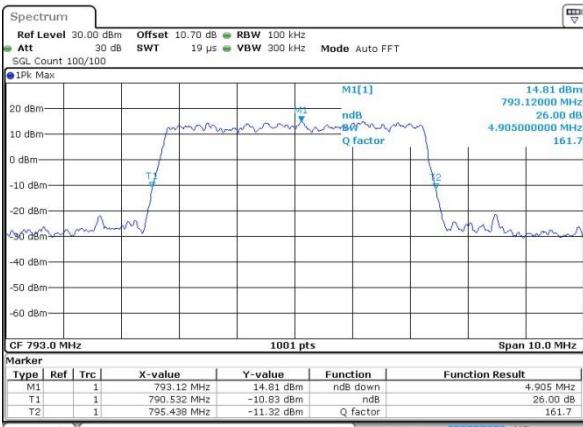

Date: 20 AUG 2018 00:43:26

Middle Channel / 5MHz / 16QAM

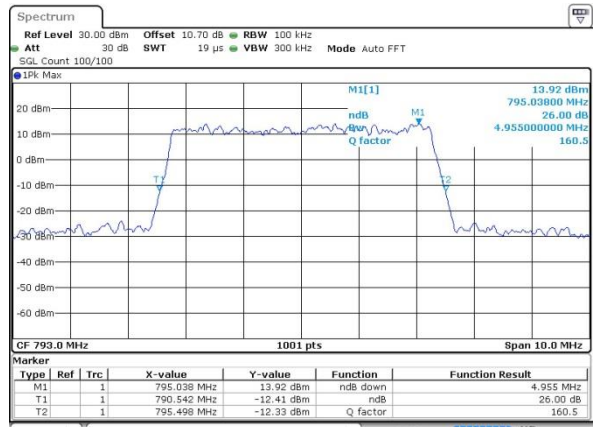

Date: 20 AUG 2018 00:43:38

Highest Channel / 5MHz / QPSK

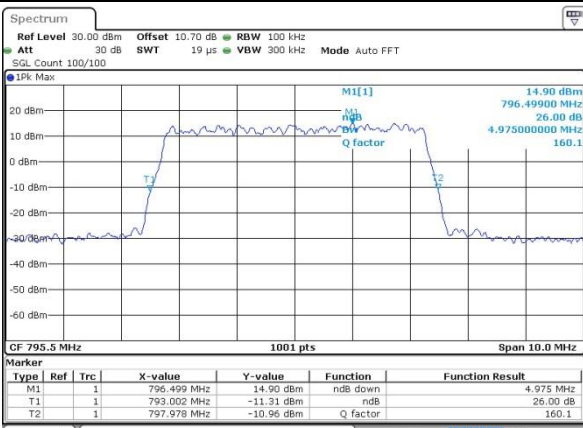

Date: 20 AUG 2018 00:45:32

Highest Channel / 5MHz / 16QAM

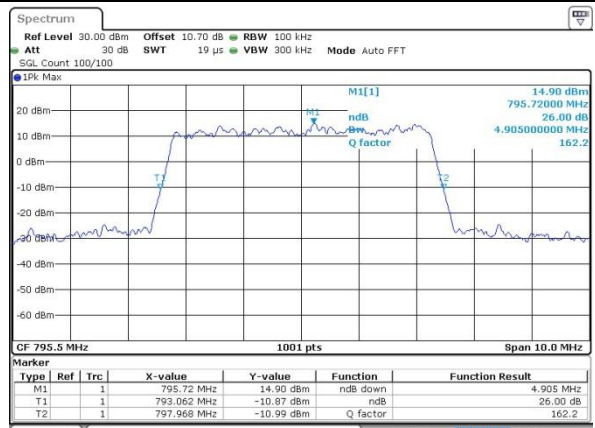

Date: 20 AUG 2018 00:45:21



LTE Band 14

Middle Channel / 10MHz / QPSK

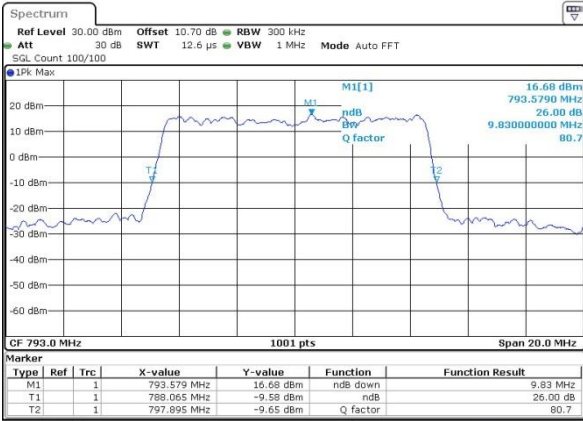

Date: 20 AUG 2018 00:46:41

Middle Channel / 10MHz / 16QAM

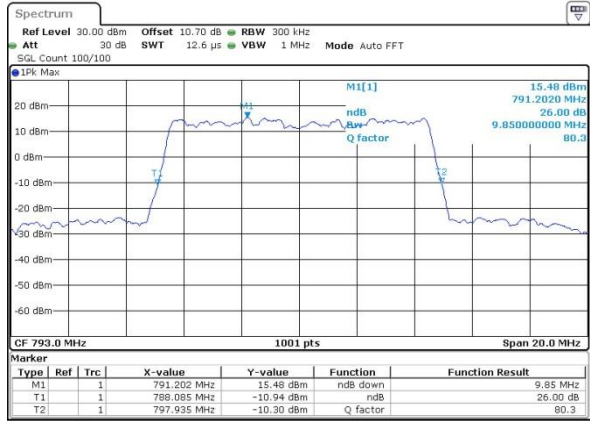

Date: 20 AUG 2018 00:46:30



LTE Band 14

Lowest Channel / 5MHz / 64QAM

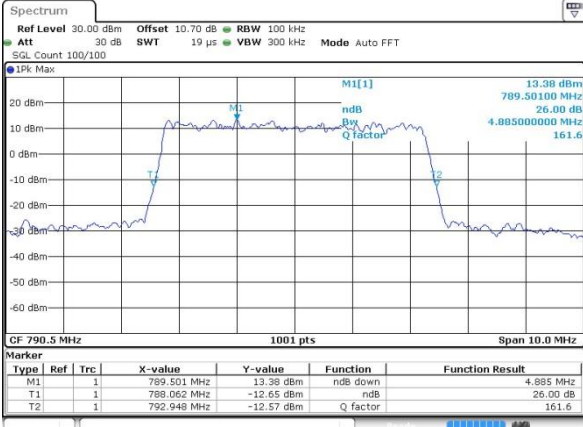

Date: 20 AUG 2018 00:42:52

Middle Channel / 5MHz / 64QAM

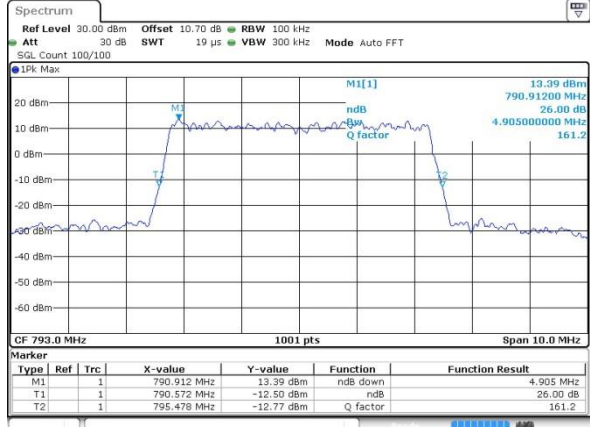

Date: 20 AUG 2018 00:43:49

Highest Channel / 5MHz / 64QAM

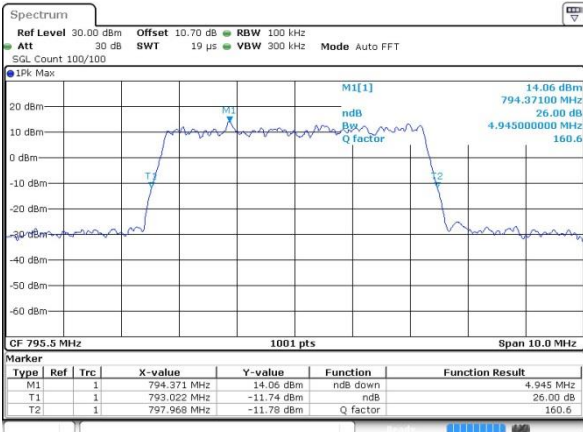

Date: 20 AUG 2018 00:45:10

LTE Band 14

Middle Channel / 10MHz / 64QAM

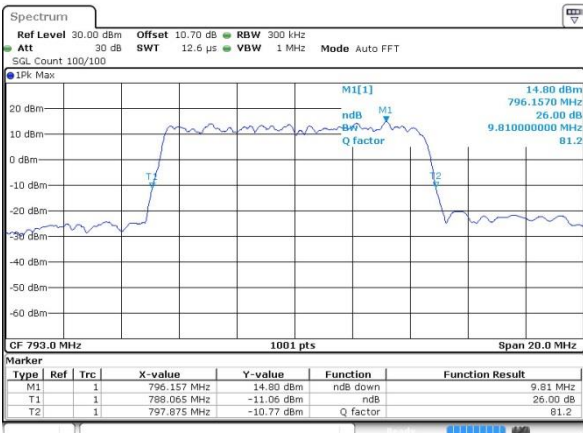

Date: 20 AUG 2018 00:46:18





**Occupied Bandwidth**

Mode	LTE Band 14 : 99%OBW(MHz)											
BW	1.4MHz		3MHz		5MHz		10MHz		15MHz		20MHz	
Mod.	QPSK	16QAM	QPSK	16QAM	QPSK	16QAM	QPSK	16QAM	QPSK	16QAM	QPSK	16QAM
Lowest CH	-	-	-	-	4.48	4.5	-	-	-	-	-	-
Middle CH	-	-	-	-	4.51	4.52	9.05	9.05	-	-	-	-
Highest CH	-	-	-	-	4.51	4.49	-	-	-	-	-	-
Mode	LTE Band 14 : 99%OBW(MHz)											
BW	1.4MHz		3MHz		5MHz		10MHz		15MHz		20MHz	
Mod.	64QAM		64QAM		64QAM		64QAM		64QAM		64QAM	
Lowest CH	-	-	-	-	4.49	-	-	-	-	-	-	-
Middle CH	-	-	-	-	4.49	-	9.07	-	-	-	-	-
Highest CH	-	-	-	-	4.51	-	-	-	-	-	-	-



LTE Band 14

Lowest Channel / 5MHz / QPSK

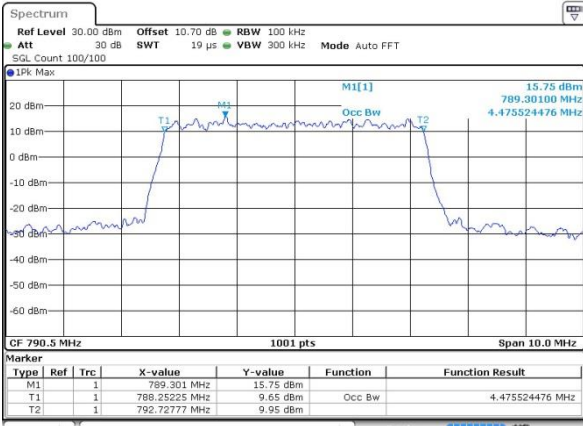

Date: 20 AUG 2018 00:42:18

Lowest Channel / 5MHz / 16QAM

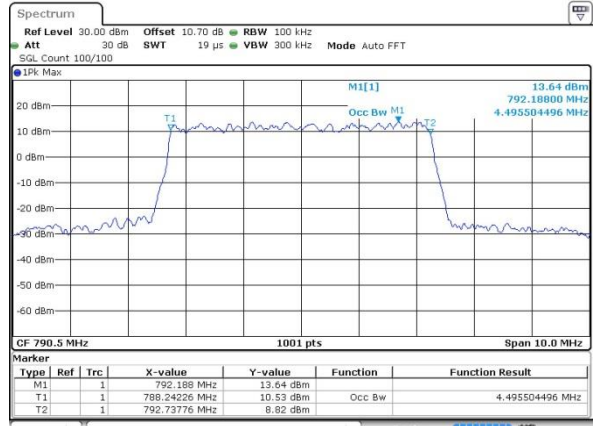

Date: 20 AUG 2018 00:42:29

Middle Channel / 5MHz / QPSK

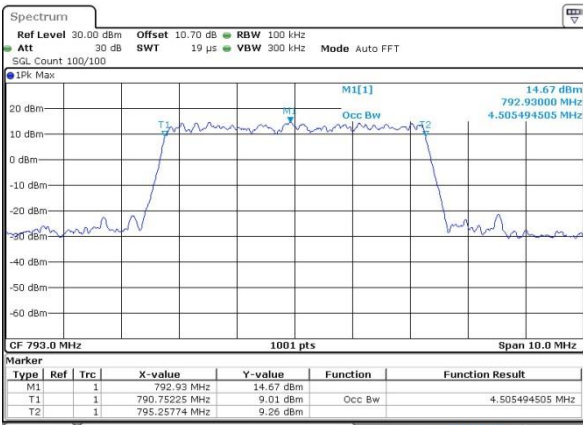

Date: 20 AUG 2018 00:44:24

Middle Channel / 5MHz / 16QAM

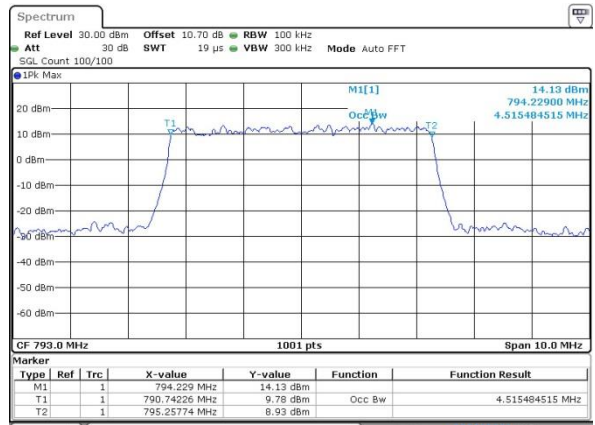

Date: 20 AUG 2018 00:44:12

Highest Channel / 5MHz / QPSK

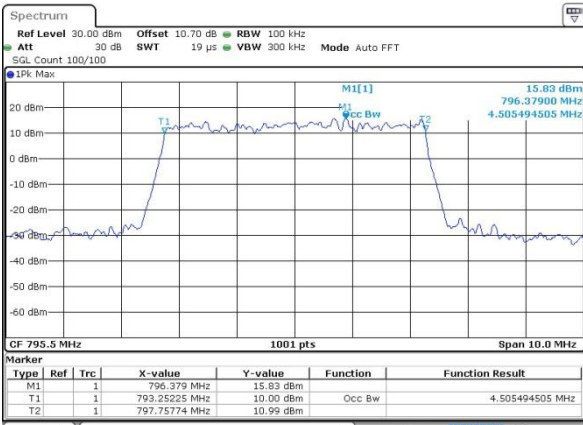

Date: 20 AUG 2018 00:44:36

Highest Channel / 5MHz / 16QAM

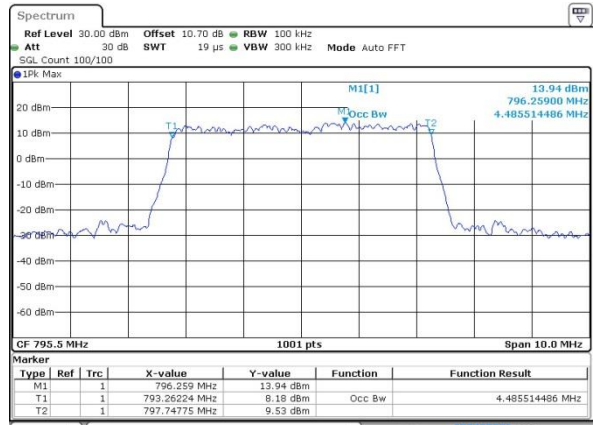

Date: 20 AUG 2018 00:44:47





LTE Band 14

Middle Channel / 10MHz / QPSK

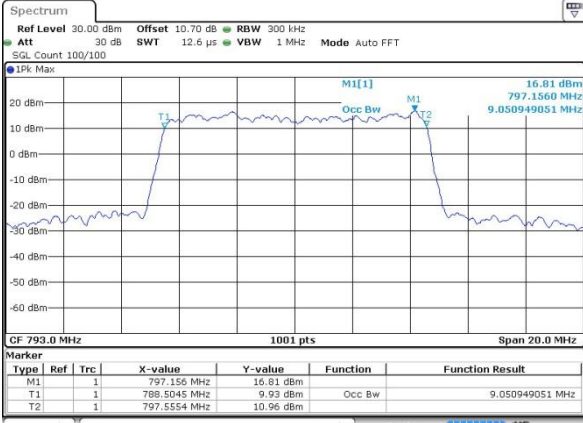

Middle Channel / 10MHz / 16QAM

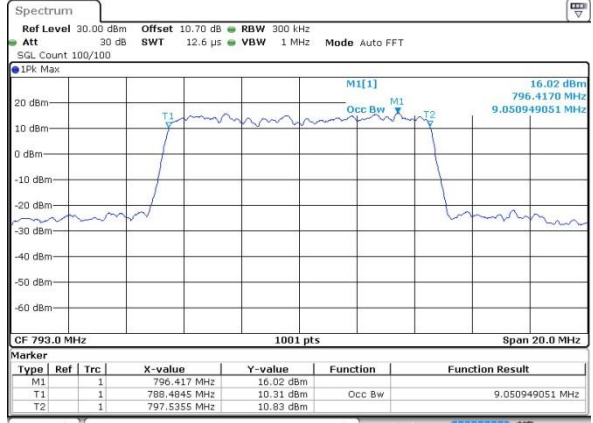



LTE Band 14

Lowest Channel / 5MHz / 64QAM

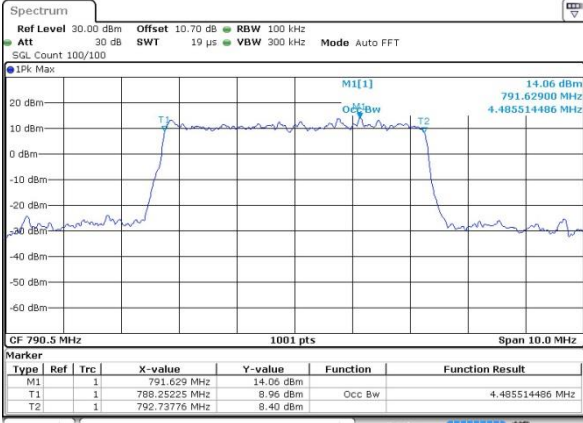

Date: 20 AUG 2018 00:42:41

Middle Channel / 5MHz / 64QAM

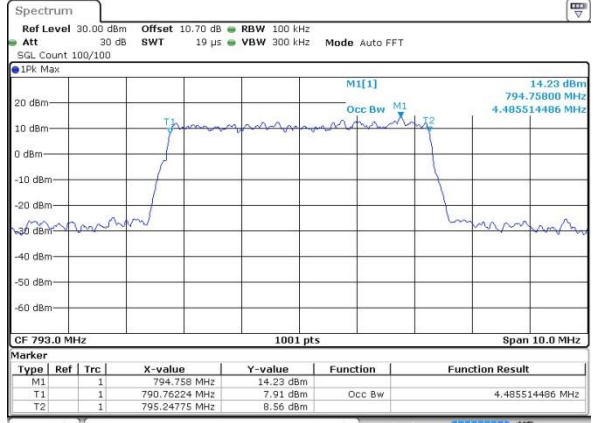

Date: 20 AUG 2018 00:44:01

Highest Channel / 5MHz / 64QAM

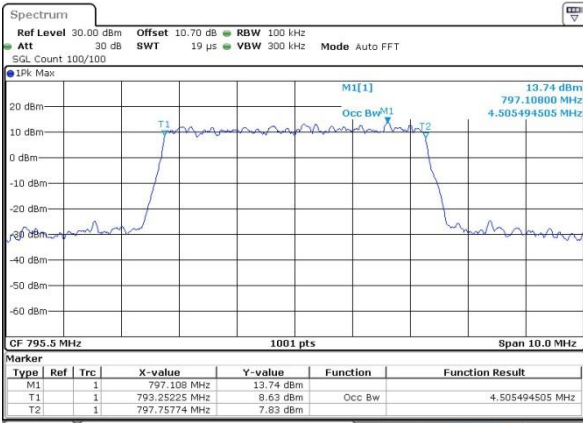

Date: 20 AUG 2018 00:44:58

LTE Band 14

Middle Channel / 10MHz / 64QAM

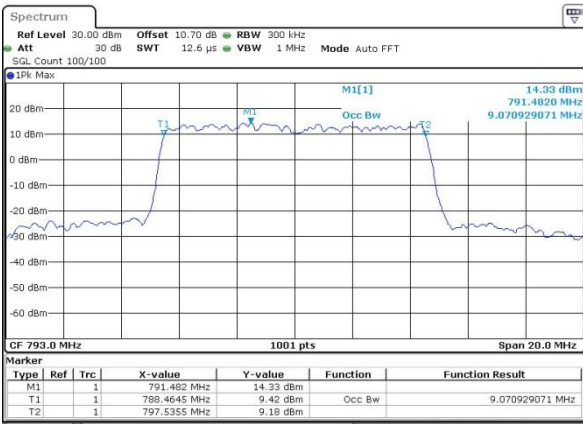

Date: 20 AUG 2018 00:46:07



# Conducted Band Edge

## LTE Band 14 / 5MHz / QPSK

### Lowest Band Edge / 1 RB

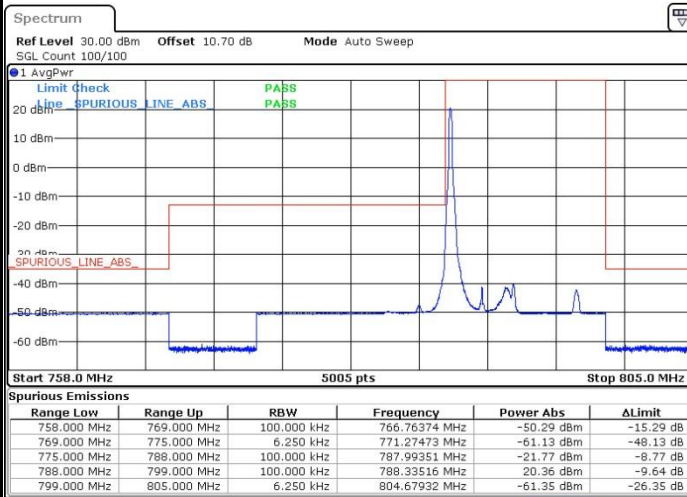

Date: 16 AUG 2018 18:20:45

### Highest Band Edge / 1 RB

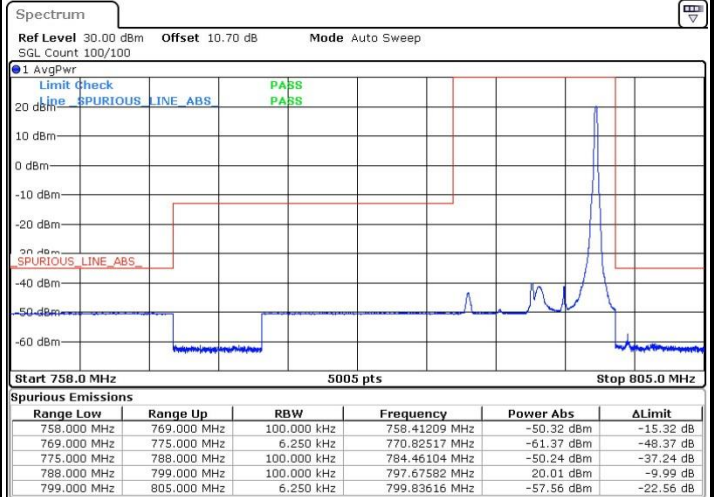

Date: 16 AUG 2018 18:30:46

### Lowest Band Edge / Full RB



Date: 16 AUG 2018 18:25:45

### Highest Band Edge / Full RB



Date: 16 AUG 2018 18:35:46



LTE Band 14 / 5MHz / 16QAM

Lowest Band Edge / 1 RB

Highest Band Edge / 1 RB

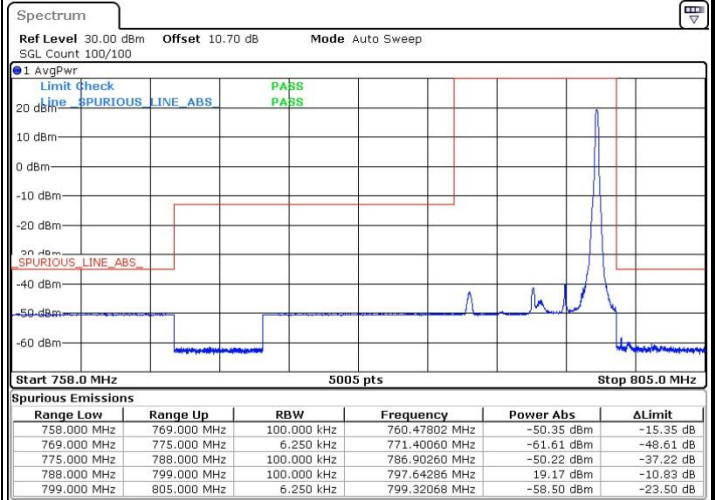
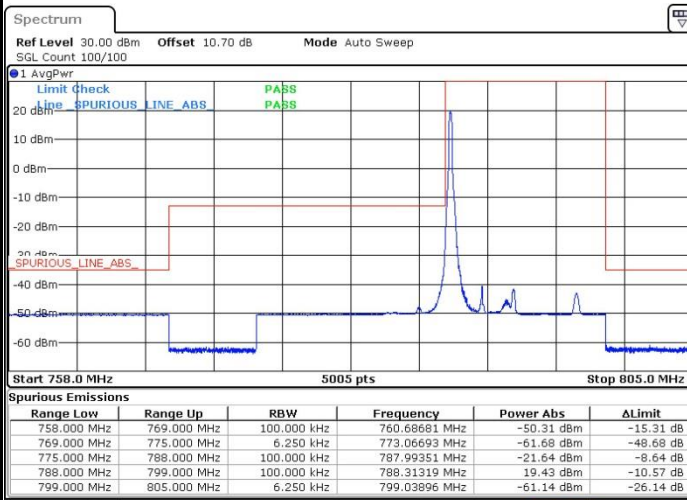

Date: 16 AUG 2018 18:22:25

Date: 16 AUG 2018 18:32:26

Lowest Band Edge / Full RB

Highest Band Edge / Full RB

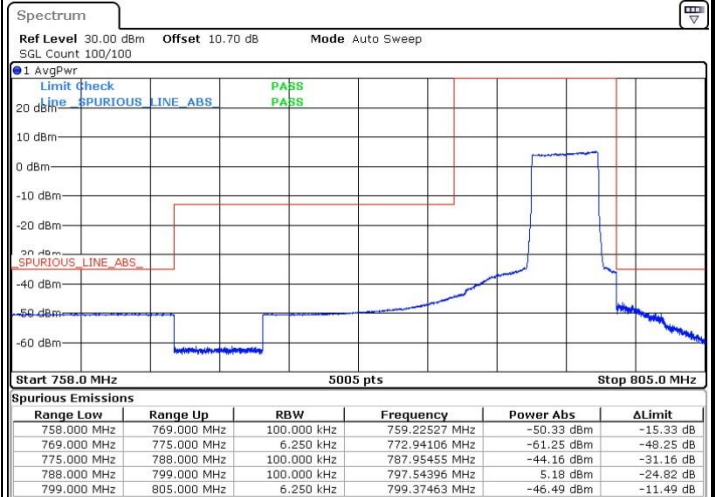
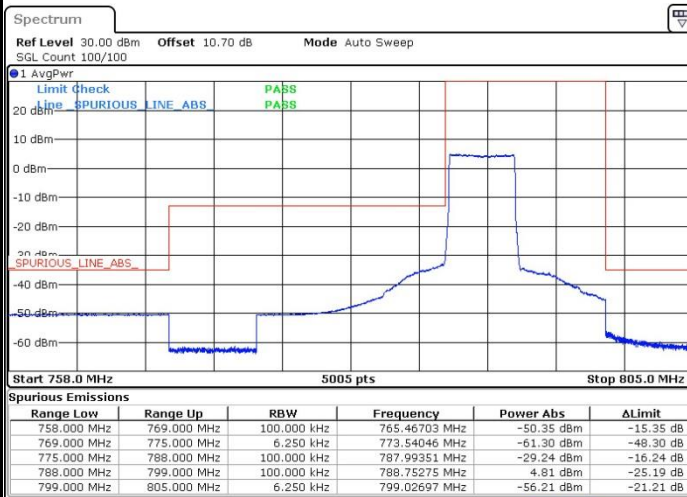

Date: 16 AUG 2018 18:27:25

Date: 16 AUG 2018 18:37:26



LTE Band 14 / 5MHz / 64QAM

Lowest Band Edge / 1 RB

Highest Band Edge / 1 RB

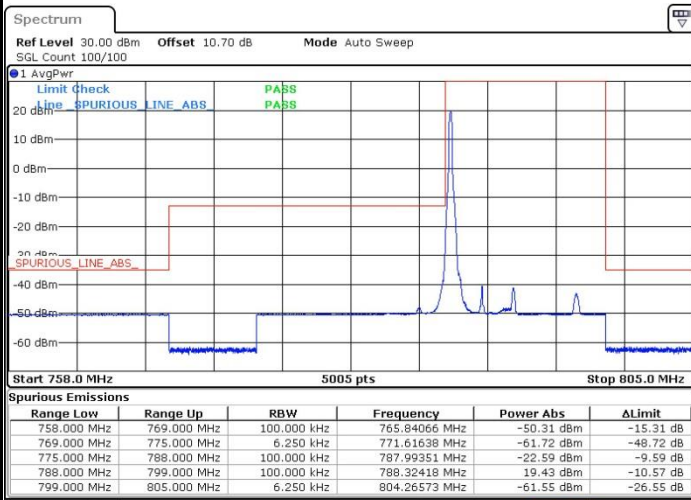

Date: 16 AUG 2018 18:24:05

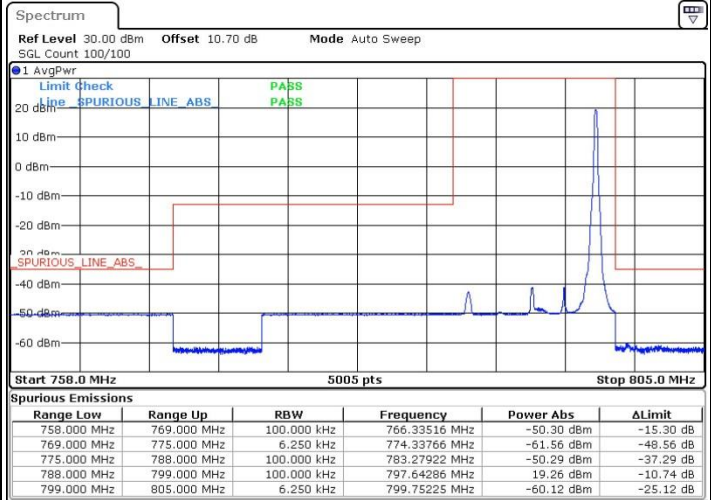

Date: 16 AUG 2018 18:34:06

Lowest Band Edge / Full RB

Highest Band Edge / Full RB

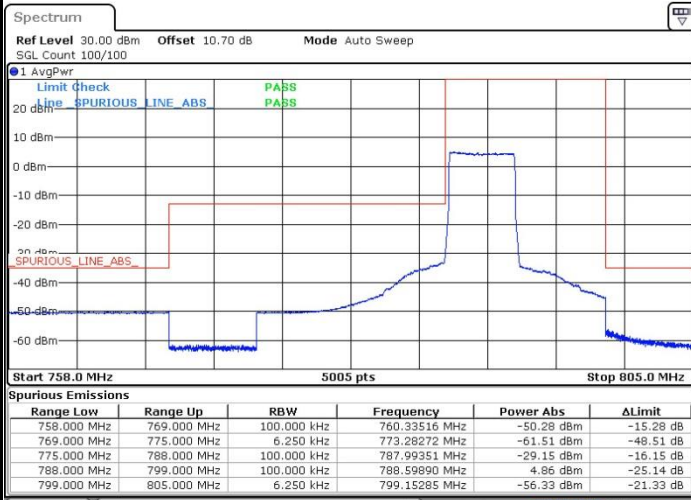

Date: 16 AUG 2018 18:29:05

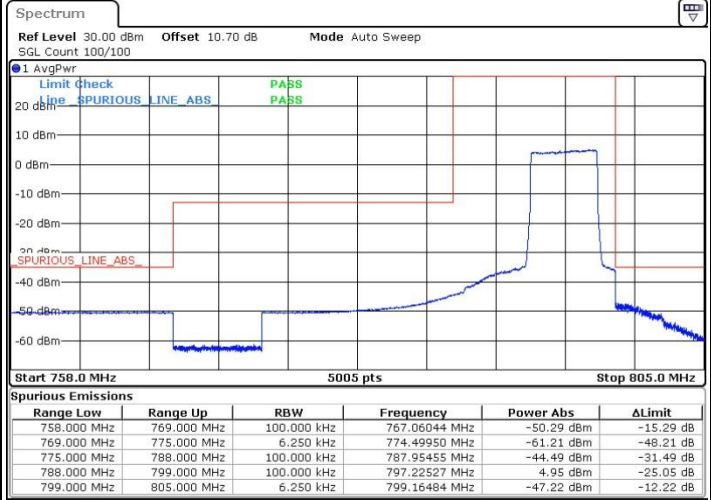

Date: 16 AUG 2018 18:39:06





LTE Band 14 / 10MHz / QPSK

Lowest Band Edge / 1 RB

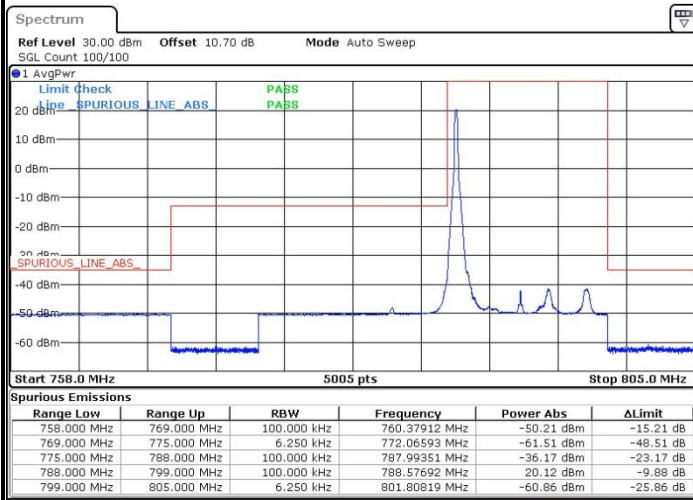

Date: 16.AUG.2018 18:40:46

Highest Band Edge / 1 RB

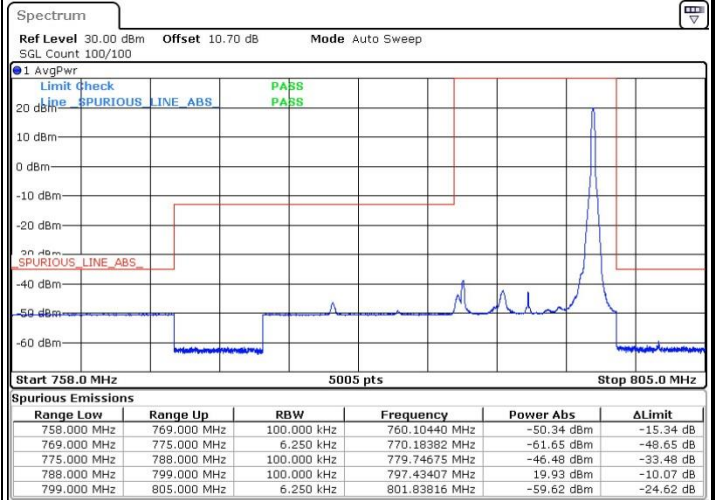

Date: 16.AUG.2018 18:45:46

Band Edge / Full RB

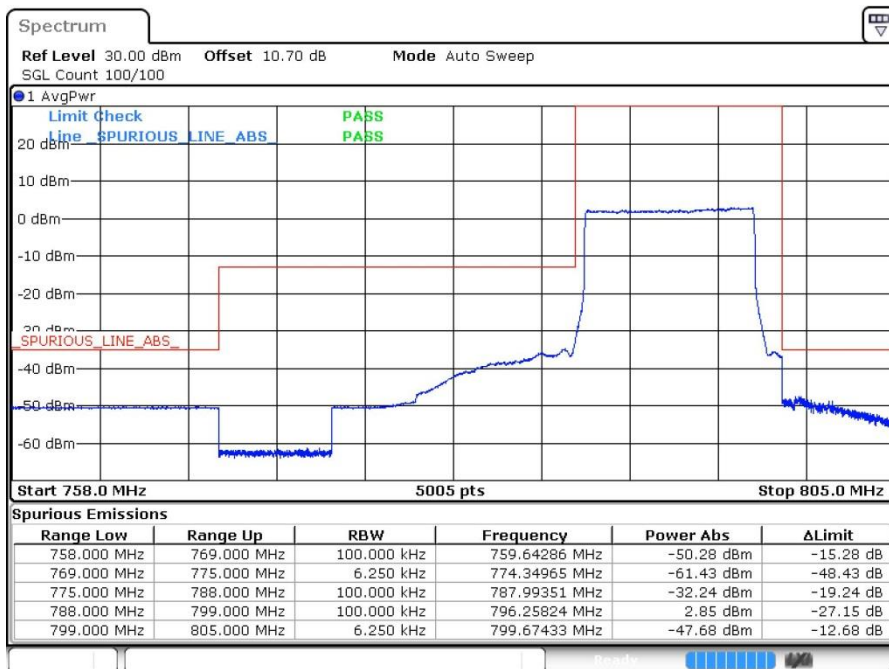

Date: 16.AUG.2018 18:50:47



LTE Band 14 / 10MHz / 16QAM

Lowest Band Edge / 1 RB

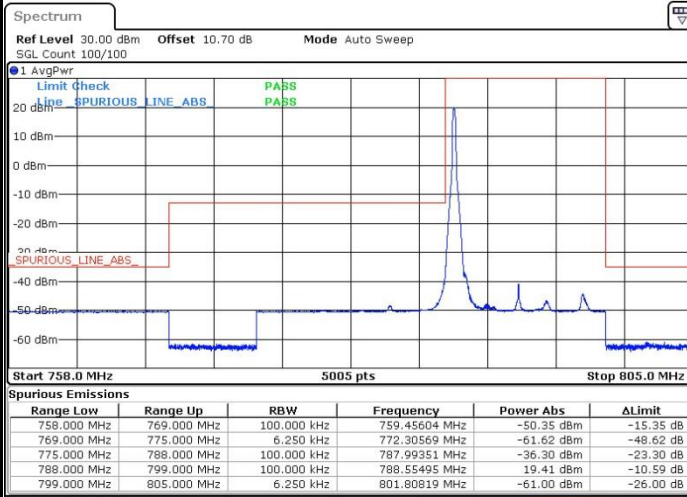

Date: 16.AUG.2018 18:42:26

Highest Band Edge / 1 RB

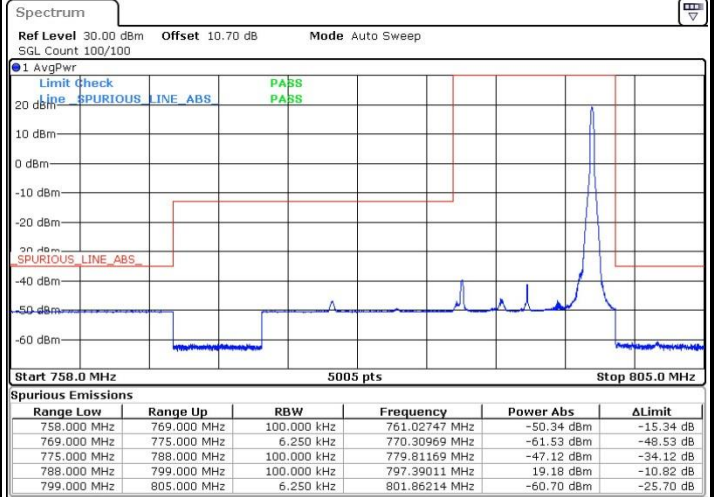

Date: 16.AUG.2018 18:47:26

Band Edge / Full RB

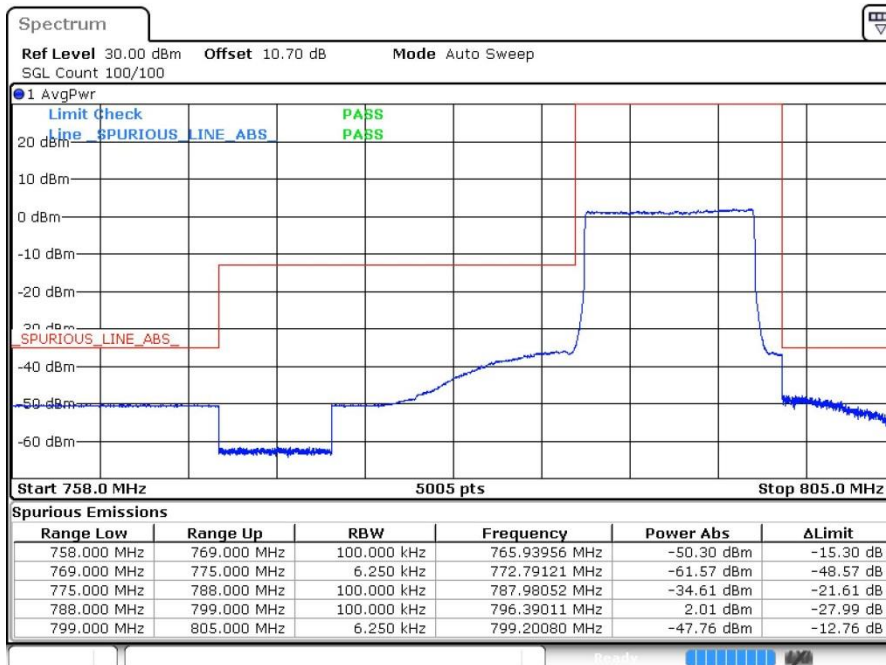

Date: 16.AUG.2018 18:52:27



LTE Band 14 / 10MHz / 64QAM

Lowest Band Edge / 1 RB

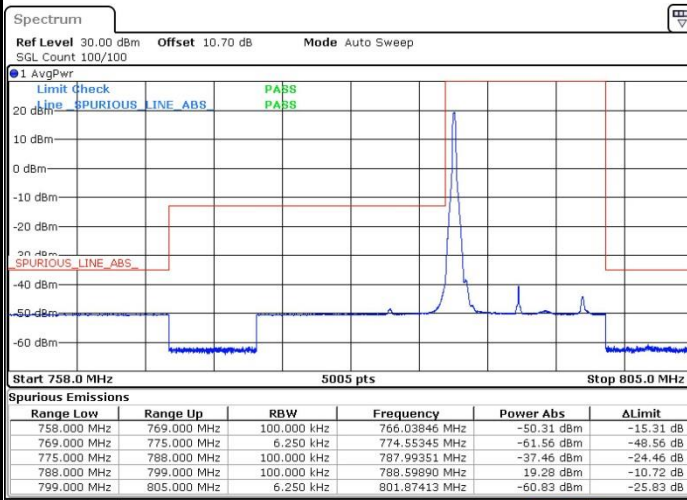

Date: 16.AUG.2018 18:44:06

Highest Band Edge / 1 RB

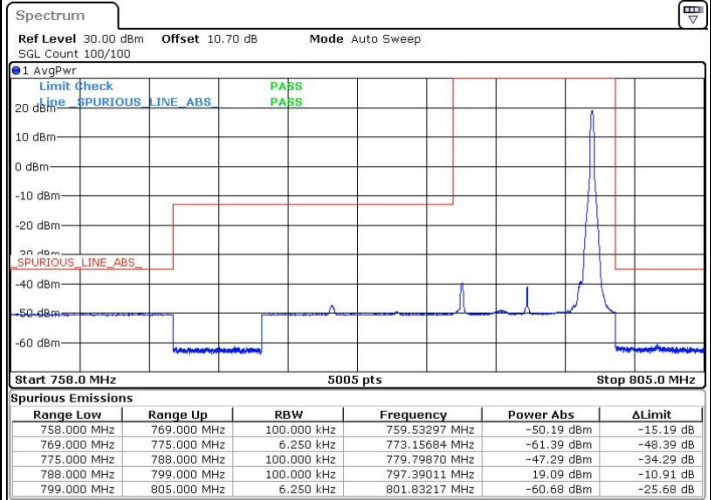

Date: 16.AUG.2018 18:49:07

Band Edge / Full RB

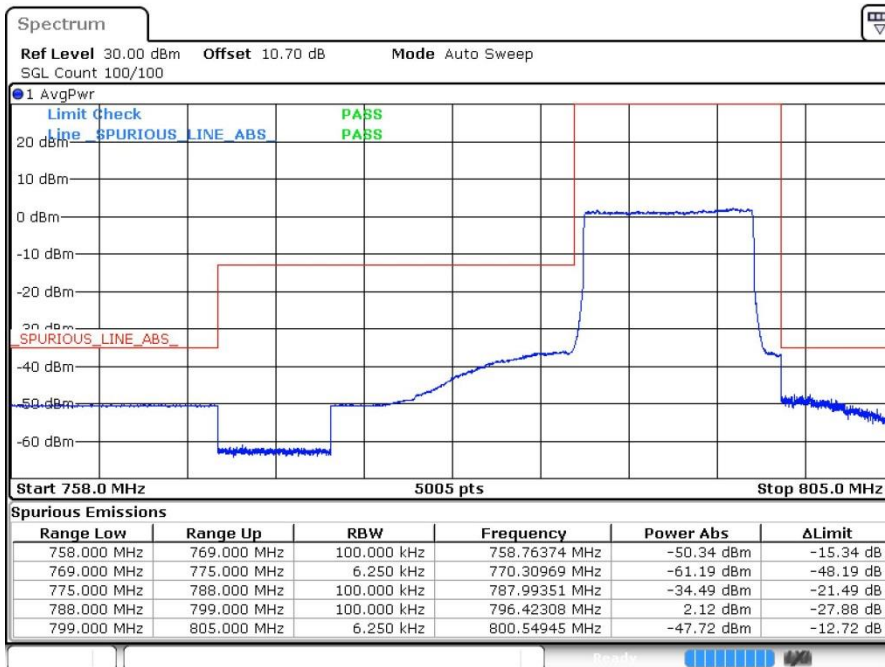

Date: 16.AUG.2018 18:54:07





# Conducted Spurious Emission

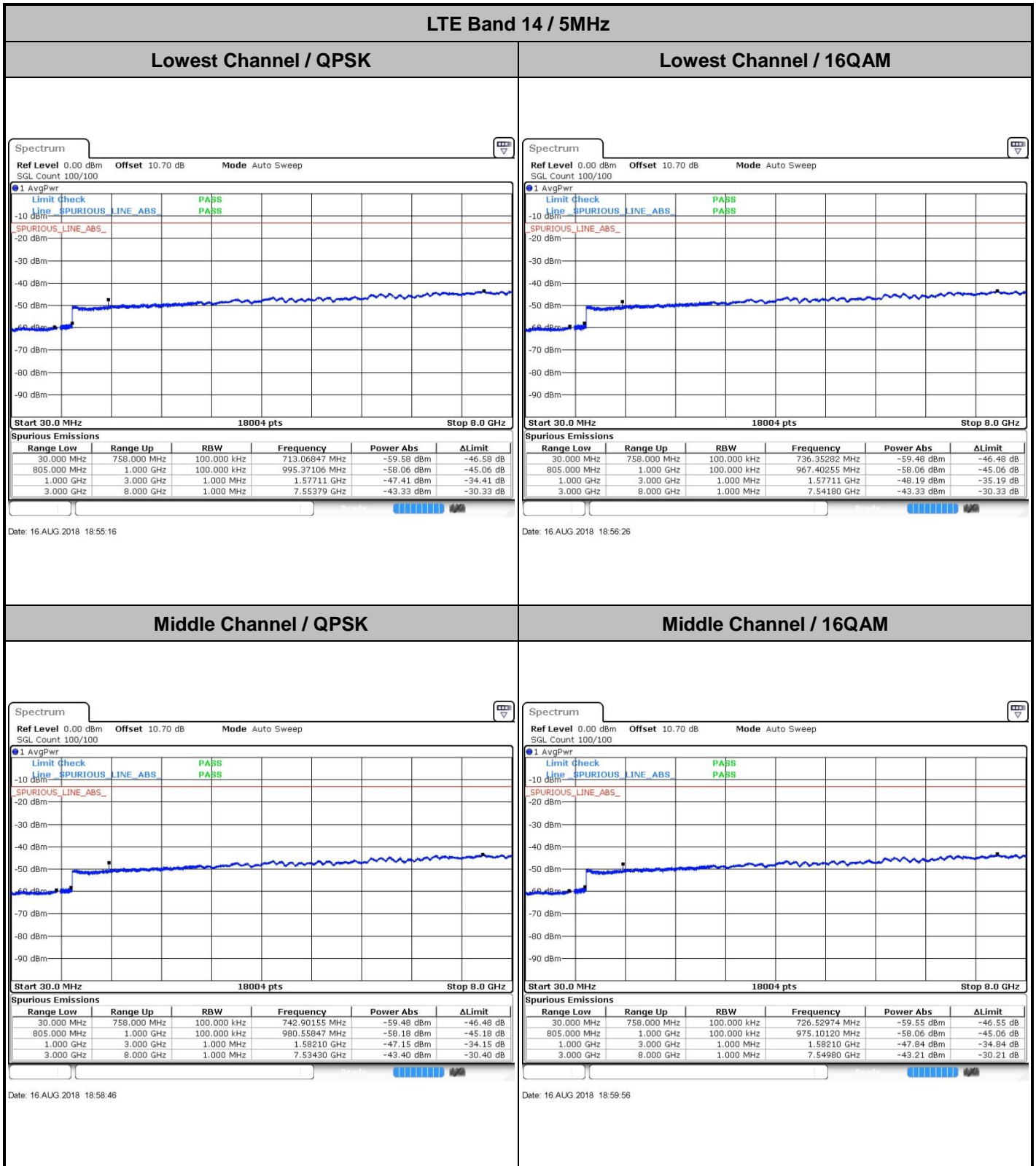



LTE Band 14 / 5MHz

Highest Channel / QPSK

Highest Channel / 16QAM

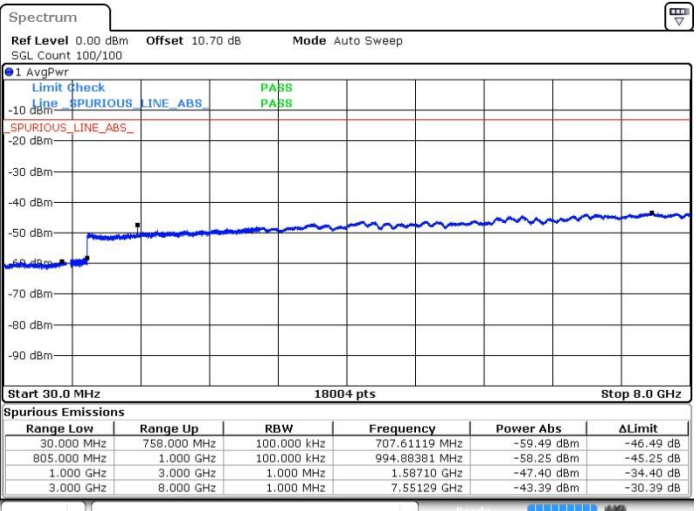
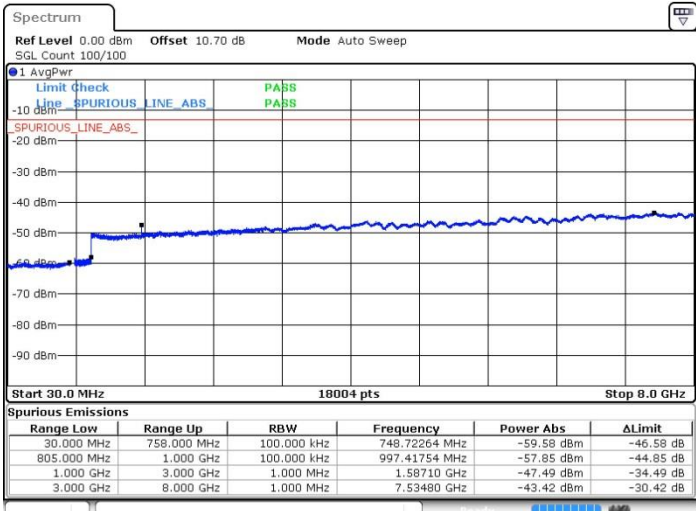

Date: 16 AUG 2018 19:02:15

Date: 16 AUG 2018 19:03:25

LTE Band 14 / 10MHz

Middle Channel / QPSK

Middle Channel / 16QAM

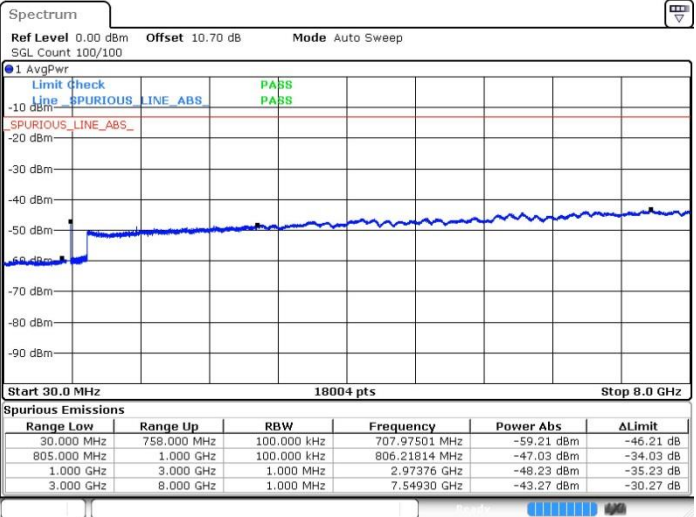
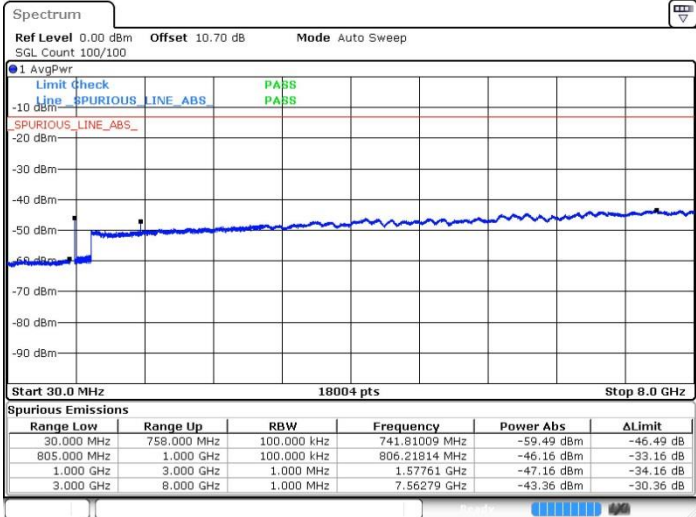

Date: 16 AUG 2018 19:05:45

Date: 16 AUG 2018 19:06:55



LTE Band 14 / 5MHz

Lowest Channel / 64QAM

Middle Channel / 64QAM

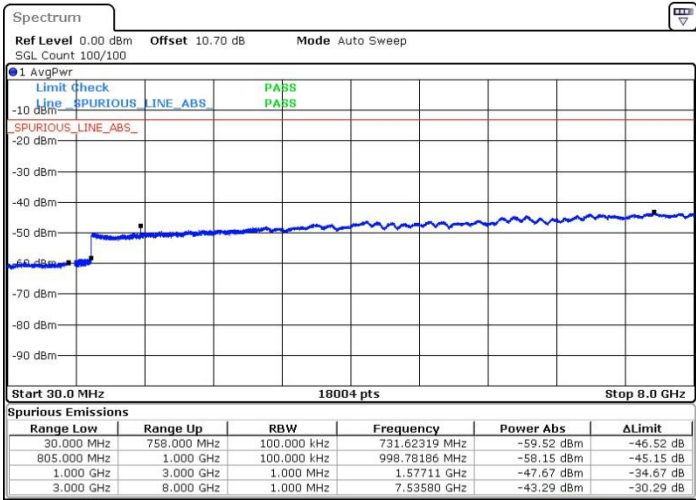

Date: 16 AUG 2018 18:57:36

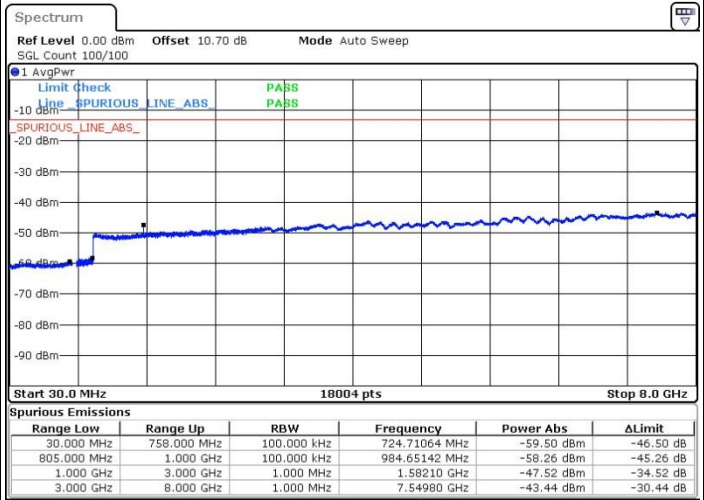

Date: 16 AUG 2018 19:01:06

Highest Channel / 64QAM

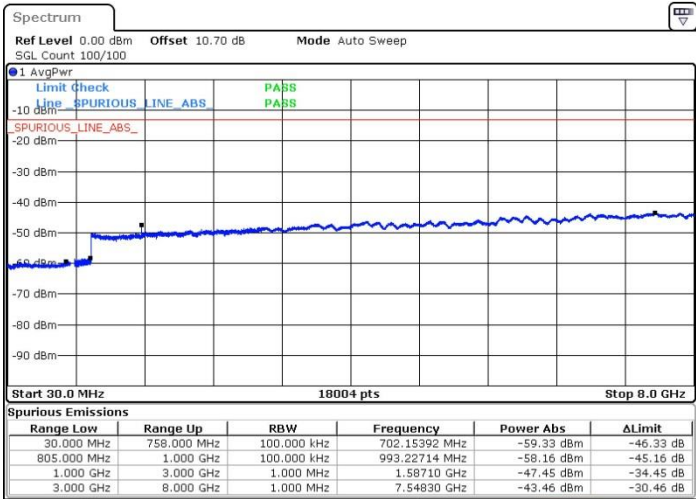

Date: 16 AUG 2018 19:04:35



LTE Band 14 / 10MHz

Middle Channel / 64QAM

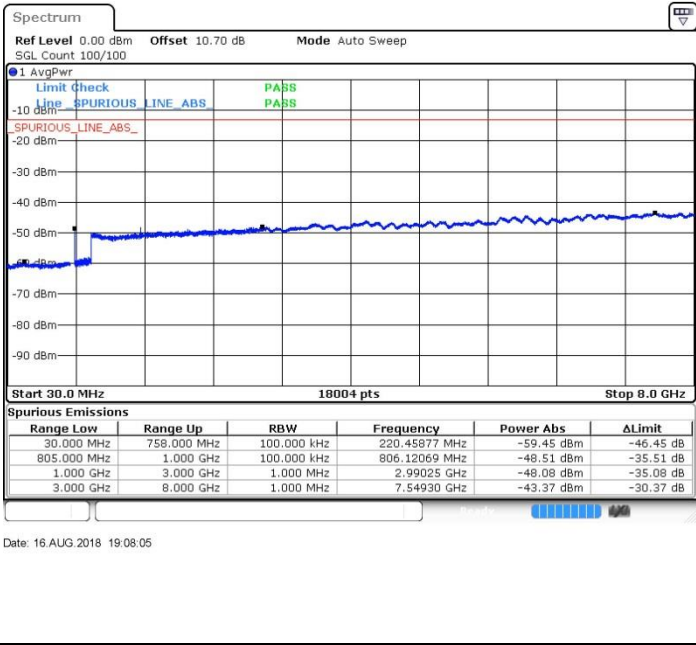



**Frequency Stability**

Test Conditions		LTE Band 14 (QPSK) / Middle Channel	Limit
Temperature (°C)	Voltage (Volt)	BW 10MHz	Note 2.
		Deviation (ppm)	Result
50	Normal Voltage	0.0004	PASS
40	Normal Voltage	0.0001	
30	Normal Voltage	0.0029	
20(Ref.)	Normal Voltage	0.0000	
10	Normal Voltage	0.0008	
0	Normal Voltage	0.0093	
-10	Normal Voltage	0.0078	
-20	Normal Voltage	0.0034	
-30	Normal Voltage	0.0032	
20	Maximum Voltage	0.0010	
20	Normal Voltage	0.0000	
20	Battery End Point	0.0097	

**Note:**

- 1. Normal Voltage =3.8 V. ; Battery End Point (BEP) =3.5 V. ; Maximum Voltage =4.2 V.
- 2. The frequency fundamental emissions stay within the authorized frequency block.



## Appendix B. Test Results of ERP and Radiated Test

### ERP

LTE Band 14 / 5MHz (Average) (GT - LC = 0.59 dB)							
Channel	Mode	RB		Conducted		ERP	
		Size	Offset	Power (dBm)	Power (Watts)	ERP(dBm)	ERP(W)
Lowest	QPSK	1	0	23.97	0.2495	22.41	0.1742
Middle		1	0	23.98	0.2500	22.42	0.1746
Highest		1	0	23.90	0.2455	22.34	0.1714
Lowest	16QAM	1	0	23.09	0.2037	21.53	0.1422
Middle		1	0	22.92	0.1959	21.36	0.1368
Highest		1	0	23.01	0.2000	21.45	0.1396
Lowest	64QAM	1	12	21.91	0.1552	20.35	0.1084
Middle		1	12	22.06	0.1607	20.50	0.1122
Highest		1	12	22.02	0.1592	20.46	0.1112
Limit	ERP < 3W			Result		PASS	

LTE Band 14 / 10MHz (Average) (GT - LC = 0.59 dB)							
Channel	Mode	RB		Conducted		ERP	
		Size	Offset	Power (dBm)	Power (Watts)	ERP(dBm)	ERP(W)
Lowest	QPSK	-	-	-	-	-	-
Middle		1	0	24.01	0.2518	22.45	0.1758
Highest		-	-	-	-	-	-
Lowest	16QAM	-	-	-	-	-	-
Middle		1	25	23.25	0.2113	21.69	0.1476
Highest		-	-	-	-	-	-
Lowest	64QAM	-	-	-	-	-	-
Middle		1	25	22.19	0.1656	20.63	0.1156
Highest		-	-	-	-	-	-
Limit	ERP < 3W			Result		PASS	



**Radiated Spurious Emission**

**LTE Band 14**

LTE Band 14 / 10MHz / QPSK									
Channel	Frequency ( MHz )	EIRP ( dBm )	Limit ( dBm )	Over Limit ( dB )	SPA Reading (dBm)	S.G. Power ( dBm )	TX Cable loss ( dB )	TX Antenna Gain (dBi)	Polarization (H/V)
Middle	1576	-54.87	-42.15	-12.72	-61.55	-60.33	0.79	8.40	H
	2368	-60.67	-13	-47.67	-72.18	-68.12	1.02	10.62	H
	3152	-54.85	-13	-41.85	-68.86	-63.12	1.11	11.53	H
	3944	-43.99	-13	-30.99	-59.73	-53.11	1.39	12.66	H
									H
									H
									H
	1576	-57.03	-42.15	-14.88	-63.68	-62.49	0.79	8.40	V
	2368	-61.87	-13	-48.87	-73.69	-69.32	1.02	10.62	V
	3152	-56.97	-13	-43.97	-71.17	-65.24	1.11	11.53	V
	3944	-53.61	-13	-40.61	-70.06	-62.73	1.39	12.66	V
									V
									V
									V

Remark: Spurious emissions within 30-1000MHz were found more than 20dB below limit line.



LTE Band 14 / 5MHz / QPSK									
Channel	Frequency ( MHz )	EIRP ( dBm )	Limit ( dBm )	Over Limit ( dB )	SPA Reading (dBm)	S.G. Power ( dBm )	TX Cable loss ( dB )	TX Antenna Gain (dBi)	Polarization (H/V)
Lowest	1576	-50.75	-42.15	-8.60	-59.53	-56.21	0.79	8.40	H
	2368	-57.76	-13	-44.76	-71.36	-65.21	1.02	10.62	H
	3152	-53.23	-13	-40.23	-69.18	-61.50	1.11	11.53	H
	3944	-44.57	-13	-31.57	-62.38	-53.69	1.39	12.66	H
									H
									H
									H
	1576	-50.64	-42.15	-8.49	-58.91	-56.10	0.79	8.40	V
	2368	-58.37	-13	-45.37	-72.51	-65.82	1.02	10.62	V
	3152	-55.31	-13	-42.31	-71.66	-63.58	1.11	11.53	V
	3944	-49.57	-13	-36.57	-67.79	-58.69	1.39	12.66	V
									V
									V
									V
Middle	1584	-51.38	-42.15	-9.23	-59.94	-56.87	0.80	8.44	H
	2376	-59.29	-13	-46.29	-72.92	-66.75	1.02	10.63	H
	3160	-53.89	-13	-40.89	-70.12	-62.18	1.11	11.55	H
	3952	-44.50	-13	-31.50	-62.59	-53.61	1.40	12.66	H
									H
									H
									H
	1584	-49.61	-42.15	-7.46	-58.22	-55.10	0.80	8.44	V
	2376	-59.43	-13	-46.43	-72.98	-66.89	1.02	10.63	V
	3160	-54.59	-13	-41.59	-70.46	-62.88	1.11	11.55	V
	3952	-46.37	-13	-33.37	-65.1	-55.48	1.40	12.66	V
									V
									V
									V





LTE Band 14 / 5MHz / QPSK									
Channel	Frequency ( MHz )	EIRP ( dBm )	Limit ( dBm )	Over Limit ( dB )	SPA Reading (dBm)	S.G. Power ( dBm )	TX Cable loss ( dB )	TX Antenna Gain (dBi)	Polarization (H/V)
Highest	1584	-50.25	-42.15	-8.10	-58.77	-55.74	0.80	8.44	H
	2384	-57.67	-13	-44.67	-70.75	-65.14	1.02	10.64	H
	3176	-55.26	-13	-42.26	-71.34	-63.59	1.11	11.59	H
	3968	-48.49	-13	-35.49	-66.3	-57.60	1.41	12.67	H
									H
									H
									H
	1584	-52.74	-42.15	-10.59	-61.4	-58.23	0.80	8.44	V
	2384	-58.01	-13	-45.01	-72.36	-65.48	1.02	10.64	V
	3176	-58.56	-13	-45.56	-74.43	-66.89	1.11	11.59	V
	3968	-56.29	-13	-43.29	-74.97	-65.40	1.41	12.67	V
									V
									V
									V

Remark: Spurious emissions within 30-1000MHz were found more than 20dB below limit line.