



FCC RADIO TEST REPORT

FCC ID : UZ7TC77HL
Equipment : Touch Computer
Brand Name : Zebra
Model name : TC77HL
Applicant : Zebra Technologies Corporation
1 Zebra Plaza Holtsville, NY 11742
Manufacturer : Zebra Technologies Corporation
1 Zebra Plaza Holtsville, NY 11742
Standard : FCC Part 15 Subpart E §15.407

The product was received on Jul. 25, 2018 and testing was started from May 28, 2018 and completed on Sep. 10, 2018. We, SPORTON INTERNATIONAL INC., would like to declare that the tested sample has been evaluated in accordance with the test procedures and has been in compliance with the applicable technical standards.

The report must not be used by the client to claim product certification, approval, or endorsement by TAF or any agency of government.

The test results in this report apply exclusively to the tested model / sample. Without written approval of SPORTON INTERNATIONAL INC. EMC & Wireless Communications Laboratory, the test report shall not be reproduced except in full.

Approved by: Joseph Lin

SPORTON INTERNATIONAL INC. EMC & Wireless Communications Laboratory
No. 52, Huaya 1st Rd., Guishan Dist., Taoyuan City, Taiwan (R.O.C.)



Table of Contents

History of this test report.....	3
Summary of Test Result.....	4
1 General Description	5
1.1 Product Feature of Equipment Under Test.....	5
1.2 Product Specification of Equipment Under Test.....	6
1.3 Modification of EUT	7
1.4 Testing Location	8
1.5 Applicable Standards.....	8
2 Test Configuration of Equipment Under Test	9
2.1 Carrier Frequency and Channel	9
2.2 Test Mode.....	10
2.3 Connection Diagram of Test System.....	19
2.4 Support Unit used in test configuration and system	21
2.5 EUT Operation Test Setup	22
2.6 Measurement Results Explanation Example.....	22
3 Test Result	23
3.1 6dB and 26dB and 99% Occupied Bandwidth Measurement	23
3.2 Maximum Conducted Output Power Measurement	29
3.3 Power Spectral Density Measurement	33
3.4 Unwanted Emissions Measurement.....	39
3.5 AC Conducted Emission Measurement.....	45
3.6 Automatically Discontinue Transmission	47
3.7 Antenna Requirements.....	48
4 List of Measuring Equipment.....	50
5 Uncertainty of Evaluation.....	52
Appendix A. AC Conducted Emission Test Result	
Appendix B. Radiated Spurious Emission	
Appendix C. Radiated Spurious Emission Plots	
Appendix D. Duty Cycle Plots	
Appendix E. Setup Photographs	



History of this test report

Report No.	Version	Description	Issued Date
FR872506F	01	Initial issue of report	Sep. 19, 2018



Summary of Test Result

Report Clause	Ref Std. Clause	Test Items	Result (PASS/FAIL)	Remark
3.1	15.403 (i)	6dB & 26dB Bandwidth	Pass	-
3.1	2.1049	99% Occupied Bandwidth	Reporting only	-
3.2	15.407 (a)	Maximum Conducted Output Power	Pass	-
3.3	15.407 (a)	Power Spectral Density	Pass	-
3.4	15.407(b)	Unwanted Emissions	Pass	Under limit 1.28 dB at 5642.800 MHz
3.5	15.207	AC Conducted Emission	Pass	Under limit 6.22 dB at 0.773 MHz
3.6	15.407 (c)	Automatically Discontinue Transmission	Pass	-
3.7	15.203 & 15.407 (a)	Antenna Requirement	Pass	-

Reviewed by: Wii Chang

Report Producer: Polly Tsai



1 General Description

1.1 Product Feature of Equipment Under Test

Product Feature	
Equipment	Touch Computer
Brand Name	Zebra
Model Name	TC77HL
FCC ID	UZ7TC77HL
EUT supports Radios application	GSM/EGPRS/WCDMA/HSPA/LTE/NFC/GNSS WLAN 11a/b/g/n HT20/HT40 WLAN 11ac VHT20/VHT40/VHT80 Bluetooth BR/EDR/LE
HW Version	DV
SW Version	Android version 8.1.0
FW Version	91-09-14.00-OG-U00-STD
MFD	06JUL18
EUT Stage	Engineering Sample

Remark: The above EUT's information was declared by manufacturer.

Specification of Accessories				
AC Adapter	Brand Name	Zebra	Part Number	PWR-BUA5V16W0WW
4 PIN DC power cable	Brand Name	Zebra	Part Number	CBL-DC-383A1-01
AC Power cable	Brand Name	Zebra	Part Number	50-16000-182R
Snap-On USB/Charge Cable	Brand Name	Zebra	Part Number	CBL-TC7X-USB1-01
Snap-On Charging Cable Cup	Brand Name	Zebra	Part Number	CHG-TC7X-CBL1-01
Battery 1	Brand Name	Zebra	Part Number	BT-000318-01
Battery 2 (Falcon 1S3P Battery Pack)	Brand Name	Zebra	Part Number	BT-000318-51
Battery 3	Brand Name	Symbol	Part Number	82-171249-02
Earphone 1	Brand Name	Zebra	Part Number	HDST-35MM-PTVP-01
Earphone 2	Brand Name	Zebra	Part Number	HS2100-OTH
Snap-on 3.5MM Audio Jack Adapter	Brand Name	Symbol	Part Number	ADP-TC7X-AUD35-01
3.5mm Jack 43"(1.1m) Standard Cable	Brand Name	Zebra	Part Number	CBL-HS2100-3MS1-01
Holster	Brand Name	Zebra	Part Number	SG-TC7X-HLSTR1-02
Rigid Holster	Brand Name	Zebra	Part Number	SG-TC7X-RHLSTR1-01



1.2 Product Specification of Equipment Under Test

Standards-related Product Specification	
Tx/Rx Channel Frequency Range	5745 MHz ~ 5825 MHz
Maximum Output Power to Antenna <CDD Modes>	<p><5745 MHz ~ 5825 MHz></p> <p><Ant. 1> 802.11a : 20.41 dBm / 0.1099 W 802.11n HT20 : 20.17 dBm / 0.1040 W 802.11n HT40 : 20.11 dBm / 0.1026 W 802.11ac VHT20: 20.23 dBm / 0.1054 W 802.11ac VHT40: 20.22 dBm / 0.1052 W 802.11ac VHT80: 20.11 dBm / 0.1026 W</p> <p><Ant. 2> 802.11a : 17.39 dBm / 0.0548 W 802.11n HT20 : 17.27 dBm / 0.0533 W 802.11n HT40 : 17.09 dBm / 0.0512 W 802.11ac VHT20: 17.30 dBm / 0.0537 W 802.11ac VHT40: 17.12 dBm / 0.0515 W 802.11ac VHT80: 17.11 dBm / 0.0514 W</p> <p>MIMO <Ant. 1 + 2> 802.11a : 21.73 dBm / 0.1489 W 802.11n HT20 : 21.67 dBm / 0.1469 W 802.11n HT40 : 21.81 dBm / 0.1517 W 802.11ac VHT20: 21.75 dBm / 0.1496 W 802.11ac VHT40: 21.89 dBm / 0.1545 W 802.11ac VHT80: 21.65 dBm / 0.1462 W</p>
Maximum Output Power <TXBF Modes>	<p><5745 MHz ~ 5825 MHz></p> <p>MIMO <Ant. 1 + 2> 802.11ac VHT20: 21.44 dBm / 0.1393 W 802.11ac VHT40: 21.53 dBm / 0.1422 W 802.11ac VHT80: 21.25 dBm / 0.1334 W</p>

Standards-related Product Specification													
99% Occupied Bandwidth <CDD Modes>	<Ant. 1> 802.11a : 18.28 MHz 802.11ac VHT20 : 18.93 MHz 802.11ac VHT40 : 36.86 MHz 802.11ac VHT80 : 76.36 MHz <Ant. 2> 802.11a : 16.83 MHz 802.11ac VHT20 : 17.98 MHz 802.11ac VHT40 : 36.56 MHz 802.11ac VHT80 : 76.24 MHz MIMO <Ant. 1> 802.11a : 16.98 MHz 802.11ac VHT20 : 18.08 MHz 802.11ac VHT40 : 36.46 MHz 802.11ac VHT80 : 75.88 MHz MIMO <Ant. 2> 802.11a : 16.83 MHz 802.11ac VHT20 : 17.98 MHz 802.11ac VHT40 : 36.56 MHz 802.11ac VHT80 : 76.12 MHz												
99% Occupied Bandwidth <TXBF Modes>	MIMO <Ant. 1> 802.11ac VHT20 : 18.08 MHz 802.11ac VHT40 : 36.76 MHz 802.11ac VHT80 : 76.72 MHz MIMO <Ant. 2> 802.11ac VHT20 : 18.08 MHz 802.11ac VHT40 : 36.66 MHz 802.11ac VHT80 : 76.72 MHz												
Antenna Gain / Gain	<Ant. 1> : PIFA Antenna with gain 3.00 dBi <Ant. 2> : PIFA Antenna with gain 3.50 dBi												
Type of Modulation	802.11a/n : OFDM (BPSK / QPSK / 16QAM / 64QAM) 802.11ac : OFDM (BPSK / QPSK / 16QAM / 64QAM / 256QAM)												
Antenna Function Description	<table border="1"> <thead> <tr> <th></th> <th>Ant. 1</th> <th>Ant. 2</th> </tr> </thead> <tbody> <tr> <td>802.11 a/n/ac</td> <td>V</td> <td>V</td> </tr> <tr> <td>802.11 a/n/ac MIMO</td> <td>V</td> <td>V</td> </tr> <tr> <td>802.11ac TXBF</td> <td>V</td> <td>V</td> </tr> </tbody> </table>		Ant. 1	Ant. 2	802.11 a/n/ac	V	V	802.11 a/n/ac MIMO	V	V	802.11ac TXBF	V	V
	Ant. 1	Ant. 2											
802.11 a/n/ac	V	V											
802.11 a/n/ac MIMO	V	V											
802.11ac TXBF	V	V											

Note: MIMO Ant. 1+2 is a calculated result from sum of the power MIMO Ant. 1 and MIMO Ant. 2.

1.3 Modification of EUT

No modifications are made to the EUT during all test items.



1.4 Testing Location

Sporton Lab is accredited to ISO 17025 by Taiwan Accreditation Foundation (TAF code : 1190) and the FCC designation No. TW1190 under the FCC 2.948(e) by Mutual Recognition Agreement (MRA) in FCC Test.

Test Site	SPORTON INTERNATIONAL INC.		
Test Site Location	No.52, Huaya 1st Rd., Guishan Dist., Taoyuan City, Taiwan (R.O.C.) TEL: +886-3-327-3456 FAX: +886-3-328-4978		
Test Site No.	Sporton Site No.		
	TH05-HY	CO05-HY	03CH07-HY

Note: The test site complies with ANSI C63.4 2014 requirement.

1.5 Applicable Standards

According to the specifications of the manufacturer, the EUT must comply with the requirements of the following standards:

- ♦ FCC Part 15 Subpart E
- ♦ FCC KDB 789033 D02 General UNII Test Procedures New Rules v02r01.
- ♦ FCC KDB 414788 D01 Radiated Test Site v01r01.
- ♦ FCC KDB 662911 D01 Multiple Transmitter Output v02r01.
- ♦ ANSI C63.10-2013

Remark:

1. All test items were verified and recorded according to the standards and without any deviation during the test.
2. This EUT has also been tested and complied with the requirements of FCC Part 15, Subpart B, recorded in a separate test report.



2 Test Configuration of Equipment Under Test

- a. The EUT has been associated with peripherals and configuration operated in a manner tended to maximize its emission characteristics in a typical application. Frequency range investigated: conduction emission (150 kHz to 30 MHz), radiation emission (9 kHz to the 10th harmonic of the highest fundamental frequency or to 40 GHz, whichever is lower). For radiated measurement, pre-scanned in three orthogonal panels, X, Y, Z. The worst cases (Z plane) were recorded in this report.
- b. AC power line Conducted Emission was tested under maximum output power.

2.1 Carrier Frequency and Channel

Frequency Band	Channel	Freq. (MHz)	Channel	Freq. (MHz)
5725-5850 MHz Band 4 (U-NII-3)	149	5745	157	5785
	151*	5755	159*	5795
	153	5765	161	5805
	155 [#]	5775	165	5825

Note:

1. The above Frequency and Channel in "*" were 802.11n HT40 and 802.11ac VHT40.
2. The above Frequency and Channel in "[#]" were 802.11ac VHT80.



2.2 Test Mode

Final test modes are considering the modulation and worse data rates as below table.

Single Mode

Modulation	Data Rate
802.11a	6 Mbps
802.11n HT20 (Covered by VHT20)	MCS0
802.11n HT40 (Covered by VHT40)	MCS0
802.11ac VHT20	MCS0
802.11ac VHT40	MCS0
802.11ac VHT80	MCS0

MIMO Mode

Modulation	Data Rate
802.11a	6 Mbps
802.11n HT20 (Covered by VHT20)	MCS0
802.11n HT40 (Covered by VHT40)	MCS0
802.11ac VHT20	MCS0
802.11ac VHT40	MCS0
802.11ac VHT80	MCS0

TXBF Mode

Modulation	Data Rate
802.11ac VHT20	MCS0
802.11ac VHT40	MCS0
802.11ac VHT80	MCS0



Test Cases	
AC Conducted Emission	Mode 1 : NFC Link + WLAN (5GHz) Link + Bluetooth Link + Earphone 1 with Audio Adapter connect to EUT + Charging Only Cable + AC Adapter Mode 2 : NFC Link + WLAN (5GHz) Link + Bluetooth Link + Snap on USB Cable Data Link with Notebook + Copy Data from Notebook to EDA (eMMC) + AC Adapter Mode 3 : NFC Link + WLAN (5GHz) Link + Bluetooth Link + Earphone 2 with Audio Adapter connect to EUT + Charging Only Cable + AC Adapter
Remark: The worst case of conducted emission is mode 2	

Ch. #		Band IV : 5725-5850 MHz			
		802.11a	802.11ac VHT20	802.11ac VHT40	802.11ac VHT80
L	Low	149	149	151	-
M	Middle	157	157	-	155
H	High	165	165	159	-



<CDD Mode>

<Ant. 1>

802.11a RF Output Power (dBm)										
Power vs. Channel			Power vs Data Rate							
Channel	Frequency (MHz)	Data Rate (bps)	channel	Data Rate (bps)						
		6M		9M	12M	18M	24M	36M	48M	54M
Duty Cycle (%)		92.72		92.37	92.04	87.28	86.18	80.79	76.03	69.66
CH 149	5745	20.28	CH 165	20.18	20.04	20.20	19.98	20.03	20.13	20.35
CH 157	5785	20.37								
CH 165	5825	20.41								

802.11n HT20 RF Output Power (dBm)										
Power vs. Channel			Power vs Data Rate							
Channel	Frequency (MHz)	MCS Index	channel	MCS Index						
		MCS0		MCS1	MCS2	MCS3	MCS4	MCS5	MCS6	MCS7
Duty Cycle (%)		92.91		90.74	88.42	85.86	79.05	75.84	74.25	72.61
CH 149	5745	20.07	CH 157	19.85	19.96	19.97	20.15	20.06	20.03	20.02
CH 157	5785	20.17								
CH 165	5825	20.12								

802.11n HT40 RF Output Power (dBm)										
Power vs. Channel			Power vs Data Rate							
Channel	Frequency (MHz)	MCS Index	channel	MCS Index						
		MCS0		MCS1	MCS2	MCS3	MCS4	MCS5	MCS6	MCS7
Duty Cycle (%)		86.99		84.83	79.58	74.58	67.14	64.41	62.50	60.09
CH 151	5755	20.06	CH 159	20.09	20.10	20.03	19.96	19.83	19.85	19.84
CH 159	5795	20.11								



802.11ac VHT20 RF Output Power (dBm)											
Power vs. Channel			Power vs Data Rate								
Channel	Frequency (MHz)	MCS Index	channel	MCS Index							
		MCS0		MCS1	MCS2	MCS3	MCS4	MCS5	MCS6	MCS7	MCS8
Duty Cycle (%)		92.93		91.85	86.72	84.43	80.95	76.23	74.56	73.42	70.42
CH 149	5745	20.12									
CH 157	5785	20.23	CH 157	20.04	20.15	20.22	20.17	20.18	20.19	20.19	20.07
CH 165	5825	20.22									

802.11ac VHT40 RF Output Power (dBm)												
Power vs. Channel			Power vs Data Rate									
Channel	Frequency (MHz)	MCS Index	channel	MCS Index								
		MCS0		MCS1	MCS2	MCS3	MCS4	MCS5	MCS6	MCS7	MCS8	MCS9
Duty Cycle (%)		85.77		85.05	80.42	74.03	69.57	64.73	62.07	60.55	57.71	55.17
CH 151	5755	20.15										
CH 159	5795	20.22	CH 159	20.14	20.15	20.06	19.98	19.89	19.98	19.97	19.86	19.91

802.11ac VHT80 RF Output Power (dBm)												
Power vs. Channel			Power vs Data Rate									
Channel	Frequency (MHz)	MCS Index	channel	MCS Index								
		MCS0		MCS1	MCS2	MCS3	MCS4	MCS5	MCS6	MCS7	MCS8	MCS9
Duty Cycle (%)		85.71		76.56	72.61	68.18	59.39	56.85	55.03	53.33	50.57	49.70
CH155	5775	20.11	CH155	19.90	19.80	20.10	20.08	20.03	20.06	20.06	20.07	20.09



<Ant. 2>

802.11a RF Output Power (dBm)										
Power vs. Channel			Power vs Data Rate							
Channel	Frequency (MHz)	Data Rate (bps)	channel	Data Rate (bps)						
		6M		9M	12M	18M	24M	36M	48M	54M
Duty Cycle (%)		93.36		92.62	91.30	88.50	86.18	81.25	76.67	74.25
CH 149	5745	17.27	CH 157							
CH 157	5785	17.39		17.33	17.34	17.38	17.27	17.36	17.26	17.34
CH 165	5825	17.33								

802.11n HT20 RF Output Power (dBm)										
Power vs. Channel			Power vs Data Rate							
Channel	Frequency (MHz)	MCS Index	channel	MCS Index						
		MCS0		MCS1	MCS2	MCS3	MCS4	MCS5	MCS6	MCS7
Duty Cycle (%)		92.25		90.37	88.89	85.76	80.14	75.98	74.25	73.08
CH 149	5745	17.16	CH 157							
CH 157	5785	17.27		17.16	16.97	17.00	17.14	17.06	17.13	16.94
CH 165	5825	17.25								

802.11n HT40 RF Output Power (dBm)										
Power vs. Channel			Power vs Data Rate							
Channel	Frequency (MHz)	MCS Index	channel	MCS Index						
		MCS0		MCS1	MCS2	MCS3	MCS4	MCS5	MCS6	MCS7
Duty Cycle (%)		85.60		85.22	79.58	75.43	68.61	63.60	62.22	60.09
CH 151	5755	17.04	CH 159							
CH 159	5795	17.09		85.22	79.58	75.43	68.61	63.60	62.22	60.09



802.11ac VHT20 RF Output Power (dBm)											
Power vs. Channel			Power vs Data Rate								
Channel	Frequency (MHz)	MCS Index	channel	MCS Index							
		MCS0		MCS1	MCS2	MCS3	MCS4	MCS5	MCS6	MCS7	MCS8
Duty Cycle (%)		92.31		91.11	86.82	84.43	80.95	76.92	74.12	73.42	69.93
CH 149	5745	17.17									
CH 157	5785	17.30	CH 157	17.15	17.26	17.24	17.26	17.28	17.29	17.27	17.28
CH 165	5825	17.29									

802.11ac VHT40 RF Output Power (dBm)												
Power vs. Channel			Power vs Data Rate									
Channel	Frequency (MHz)	MCS Index	channel	MCS Index								
		MCS0		MCS1	MCS2	MCS3	MCS4	MCS5	MCS6	MCS7	MCS8	MCS9
Duty Cycle (%)		87.20		84.62	80.42	75.71	69.06	64.46	60.76	59.46	56.86	56.57
CH 151	5755	17.07										
CH 159	5795	17.12	CH 159	84.62	80.42	75.71	69.06	64.46	60.76	59.46	56.86	56.57

802.11ac VHT80 RF Output Power (dBm)												
Power vs. Channel			Power vs Data Rate									
Channel	Frequency (MHz)	MCS Index	channel	MCS Index								
		MCS0		MCS1	MCS2	MCS3	MCS4	MCS5	MCS6	MCS7	MCS8	MCS9
Duty Cycle (%)		85.71		76.56	69.94	67.92	61.26	56.63	55.03	53.63	50.29	49.70
CH155	5775	17.11	CH155	17.07	17.06	17.06	17.04	16.90	16.95	17.05	16.95	16.99



MIMO <Ant. 1+2>

802.11a RF Output Power (dBm)										
Power vs. Channel			Power vs Data Rate							
Channel	Frequency (MHz)	Data Rate (bps)	channel	Data Rate (bps)						
		6M		9M	12M	18M	24M	36M	48M	54M
Duty Cycle (%)										
CH 149	5745	21.73	CH 149							
CH 157	5785	21.72		21.50	21.41	21.54	21.41	21.52	21.60	21.57
CH 165	5825	21.67								

802.11n HT20 RF Output Power (dBm)										
Power vs. Channel			Power vs Data Rate							
Channel	Frequency (MHz)	MCS Index	channel	MCS Index						
		MCS0		MCS1	MCS2	MCS3	MCS4	MCS5	MCS6	MCS7
Duty Cycle (%)										
CH 149	5745	21.67	CH 149							
CH 157	5785	21.65		21.37	21.59	21.57	21.38	21.37	21.36	21.33
CH 165	5825	21.63								

802.11n HT40 RF Output Power (dBm)										
Power vs. Channel			Power vs Data Rate							
Channel	Frequency (MHz)	MCS Index	channel	MCS Index						
		MCS0		MCS1	MCS2	MCS3	MCS4	MCS5	MCS6	MCS7
Duty Cycle (%)										
CH 151	5755	21.81	CH 151							
CH 159	5795	21.73		21.66	21.56	21.52	21.44	21.38	21.32	21.39



802.11ac VHT20 RF Output Power (dBm)											
Power vs. Channel			Power vs Data Rate								
Channel	Frequency (MHz)	MCS Index	channel	MCS Index							
		MCS0		MCS1	MCS2	MCS3	MCS4	MCS5	MCS6	MCS7	MCS8
Duty Cycle (%)											
CH 149	5745	21.75									
CH 157	5785	21.68	CH 149	21.38	21.65	21.63	21.45	21.38	21.38	21.37	21.27
CH 165	5825	21.65									

802.11ac VHT40 RF Output Power (dBm)												
Power vs. Channel			Power vs Data Rate									
Channel	Frequency (MHz)	MCS Index	channel	MCS Index								
		MCS0		MCS1	MCS2	MCS3	MCS4	MCS5	MCS6	MCS7	MCS8	MCS9
Duty Cycle (%)												
CH 151	5755	21.89										
CH 159	5795	21.80	CH 151	21.68	21.58	21.54	21.45	21.43	21.43	21.41	21.39	21.39

802.11ac VHT80 RF Output Power (dBm)												
Power vs. Channel			Power vs Data Rate									
Channel	Frequency (MHz)	MCS Index	channel	MCS Index								
		MCS0		MCS1	MCS2	MCS3	MCS4	MCS5	MCS6	MCS7	MCS8	MCS9
Duty Cycle (%)												
CH155	5775	21.65	CH155	21.63	21.64	21.60	21.57	21.45	21.57	21.60	21.50	21.52



<TXBF Mode>

MIMO <Ant. 1+2>

802.11ac VHT20 RF Output Power (dBm)												
Power vs. Channel			Power vs Data Rate									
Channel	Frequency (MHz)	MCS Index	channel	MCS Index								
		MCS0		MCS1	MCS2	MCS3	MCS4	MCS5	MCS6	MCS7	MCS8	
Duty Cycle (%)												
CH 149	5745	21.40										
CH 157	5785	21.44	CH 157	21.42	21.40	21.43	21.38	21.34	21.33	21.40	21.33	
CH 165	5825	21.21										

802.11ac VHT40 RF Output Power (dBm)												
Power vs. Channel			Power vs Data Rate									
Channel	Frequency (MHz)	MCS Index	channel	MCS Index								
		MCS0		MCS1	MCS2	MCS3	MCS4	MCS5	MCS6	MCS7	MCS8	MCS9
Duty Cycle (%)												
CH 151	5755	21.53										
CH 159	5795	21.41	CH 151	21.34	21.44	21.48	21.48	21.48	21.43	21.43	21.43	21.43

802.11ac VHT80 RF Output Power (dBm)												
Power vs. Channel			Power vs Data Rate									
Channel	Frequency (MHz)	MCS Index	channel	MCS Index								
		MCS0		MCS1	MCS2	MCS3	MCS4	MCS5	MCS6	MCS7	MCS8	MCS9
Duty Cycle (%)												
CH155	5775	21.25	CH155	20.75	20.75	20.81	20.91	20.91	20.91	20.95	20.95	20.95

2.3 Connection Diagram of Test System

<Radiated Emission Mode>
 <CDD Mode with Earphone 1>

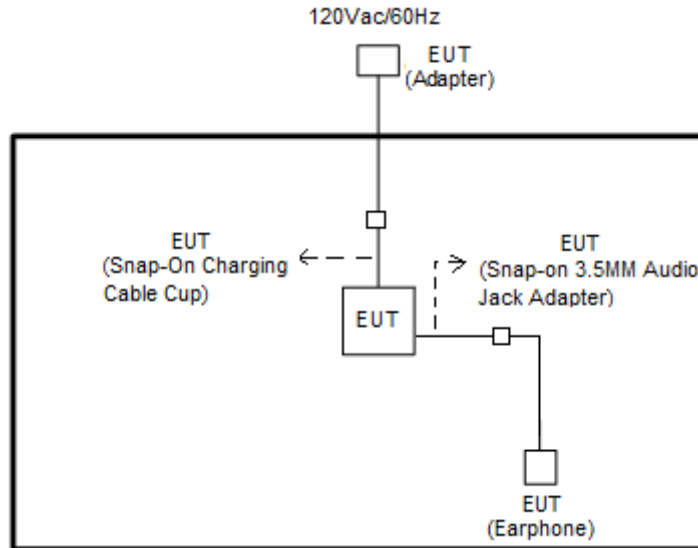

<TXBF Mode>

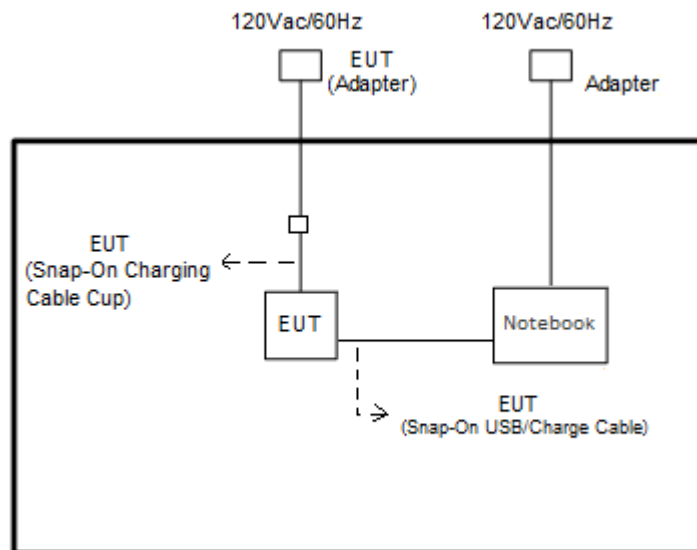

<AC Conducted Emission for Earphone 1>

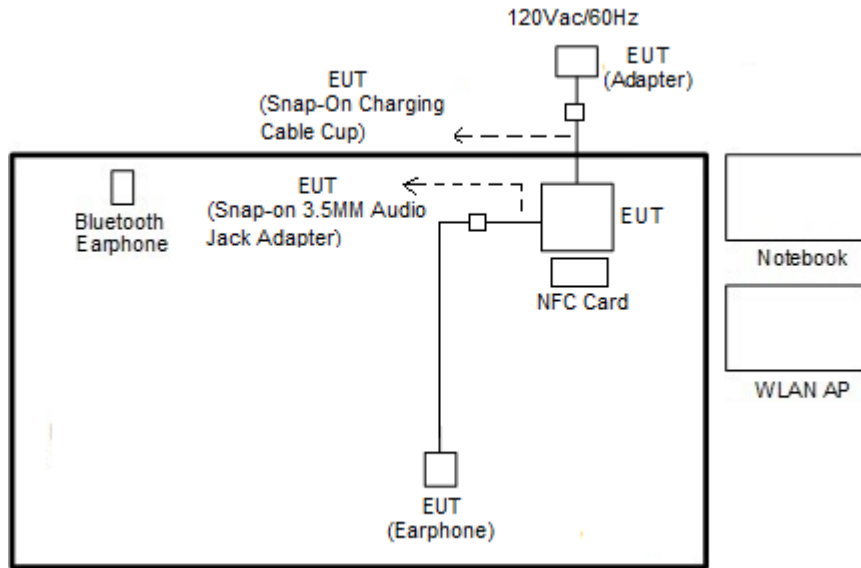

<AC Conducted Emission for Earphone 2>

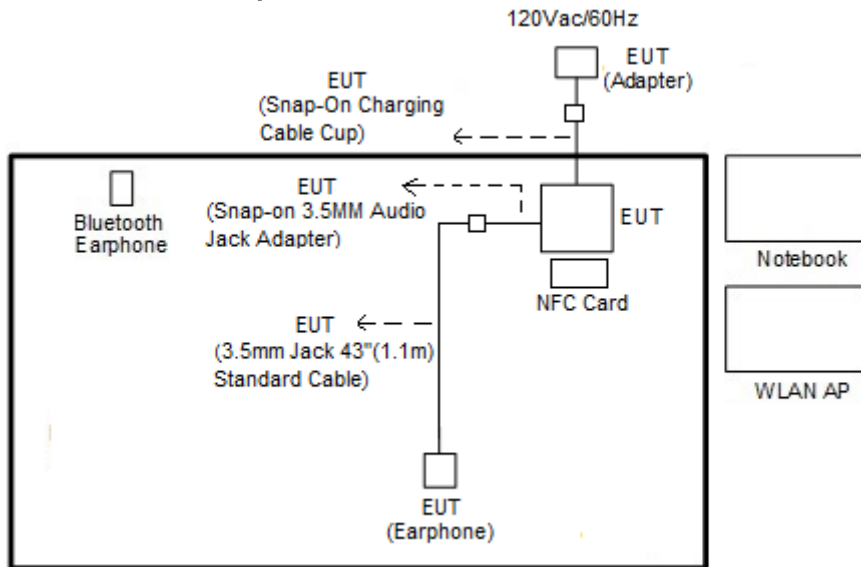

<AC Conducted Emission for data link mode>

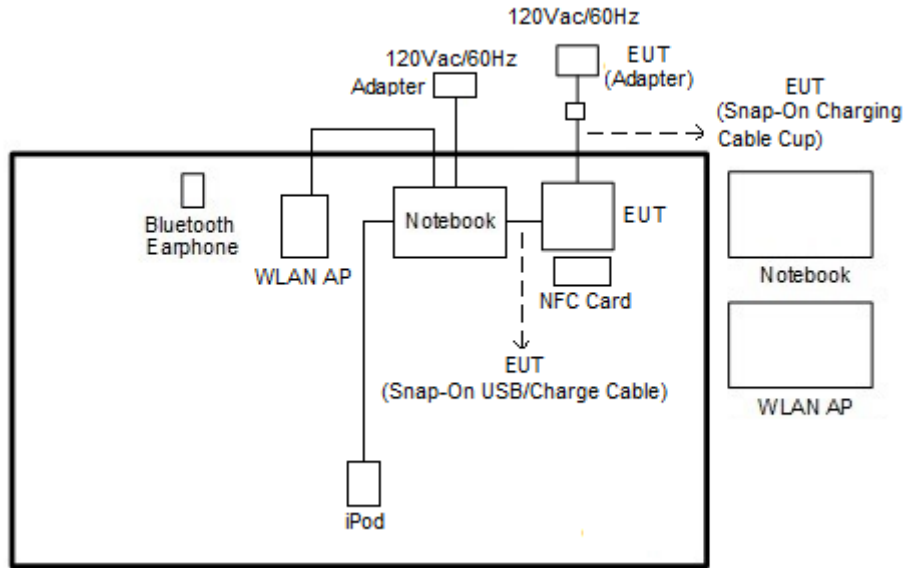

2.4 Support Unit used in test configuration and system

Item	Equipment	Trade Name	Model Name	FCC ID	Data Cable	Power Cord
1.	WLAN AP	ASUS	RT-AC66U	MSQ-RTAC66U	N/A	Unshielded, 1.8 m
2.	Bluetooth Earphone	Sony Ericsson	MW600	PY7DDA-2029	N/A	N/A
3.	iPod	Apple	A1285	FCC DoC	Shielded, 1.0 m	N/A
4.	Notebook	DELL	Latitude E6320	FCC DoC/ Contains FCC ID: QDS-BRCM1054	N/A	AC I/P: Unshielded, 1.2 m DC O/P: Shielded, 1.8 m
5.	Notebook	DELL	Latitude E3340	FCC DoC/ Contains FCC ID: PD97260NGU	N/A	AC I/P: Unshielded, 1.2 m DC O/P: Shielded, 1.8 m
6.	Notebook	DELL	P79G	FCC DoC	N/A	AC I/P: Unshielded, 1.2 m DC O/P: Shielded, 1.8 m
7.	SD Card	SanDisk	MicroSD HC	FCC DoC	N/A	N/A
8.	NFC Card	N/A	N/A	N/A	N/A	N/A



2.5 EUT Operation Test Setup

The RF test items, utility “QRCT” was installed in Notebook which was programmed in order to make the EUT get into the engineering modes to provide channel selection, power level, data rate and the application type and for continuous transmitting signals.

For TXBF mode, the modulation modes and data rates manipulated by the command lines in the engineering program made the EUT link to another EUT by power under the normal operation. The “ADB” software tool was used to enable the EUT to transmit signals continuously.

2.6 Measurement Results Explanation Example

For all conducted test items:

The offset level is set in the spectrum analyzer to compensate the RF cable loss and attenuator factor between EUT conducted output port and spectrum analyzer. With the offset compensation, the spectrum analyzer reading level is exactly the EUT RF output level.

Example :

The spectrum analyzer offset is derived from RF cable loss and attenuator factor.

Offset = RF cable loss + attenuator factor.

Following shows an offset computation example with cable loss 4.2 dB and 10dB attenuator.

$$\begin{aligned} \text{Offset(dB)} &= \text{RF cable loss(dB)} + \text{attenuator factor(dB)}. \\ &= 4.2 + 10 = 14.2 \text{ (dB)} \end{aligned}$$

3 Test Result

3.1 6dB and 26dB and 99% Occupied Bandwidth Measurement

3.1.1 Description of 6dB and 26dB and 99% Occupied Bandwidth

The minimum 6 dB bandwidth shall be at least 500 kHz.

26dB and 99% Occupied bandwidth are reporting only.

3.1.2 Measuring Instruments

See list of measuring equipment of this test report.

3.1.3 Test Procedures

1. The testing follows FCC KDB 789033 D02 General UNII Test Procedures New Rules v02r01. Section C) Emission bandwidth for the band 5.725-5.85GHz
2. Set RBW = 100kHz.
3. Set the VBW $\geq 3 \times$ RBW.
4. Detector = Peak.
5. Trace mode = max hold
6. Measure the maximum width of the emission that is 6 dB down from the peak of the emission.
7. Measure and record the results in the test report.

3.1.4 Test Setup

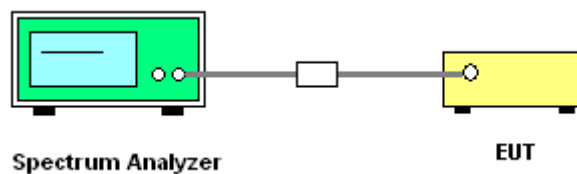



3.1.5 Test Result of 6dB Bandwidth

Test Engineer :	Rebecca Li, Lena Lo, Derek Hsu, and AnAn Wu	Temperature :	21~25°C
		Relative Humidity :	51~54%

<CDD Mode>

Mod.	Data Rate	NTX	CH.	Freq. (MHz)	99% Bandwidth (MHz)		26dB Bandwidth (MHz)		6 dB Bandwidth (MHz)		6 dB Bandwidth Min. Limit (MHz)		Pass/Fail
					Ant 1	Ant 2	Ant 1	Ant 2	Ant 1	Ant 2	Ant 1	Ant 2	
11a	6Mbps	1	149	5745	17.48	16.78	29.82	25.77	15.28	15.63	0.5	Pass	
11a	6Mbps	1	157	5785	17.88	16.83	31.42	26.47	15.28	15.53	0.5	Pass	
11a	6Mbps	1	165	5825	18.28	16.73	32.57	25.27	15.13	15.33	0.5	Pass	
VHT20	MCS0	1	149	5745	18.93	17.98	32.52	26.37	16.53	16.53	0.5	Pass	
VHT20	MCS0	1	157	5785	18.63	17.98	31.27	25.87	16.53	16.53	0.5	Pass	
VHT20	MCS0	1	165	5825	18.58	17.88	31.42	26.07	16.48	16.53	0.5	Pass	
VHT40	MCS0	1	151	5755	36.86	36.56	42.53	41.99	35.86	35.26	0.5	Pass	
VHT40	MCS0	1	159	5795	36.66	36.56	42.53	41.81	35.26	35.26	0.5	Pass	
VHT80	MCS0	1	155	5775	76.36	76.24	110.77	84.08	75.16	75.16	0.5	Pass	
11a	6Mbps	2	149	5745	16.98	16.83	25.87	25.67	15.63	16.03	0.5	Pass	
11a	6Mbps	2	157	5785	16.93	16.78	25.87	25.43	16.28	15.38	0.5	Pass	
11a	6Mbps	2	165	5825	16.83	16.78	25.87	25.23	15.68	15.09	0.5	Pass	
VHT20	MCS0	2	149	5745	18.03	17.93	26.27	26.77	15.93	16.53	0.5	Pass	
VHT20	MCS0	2	157	5785	18.08	17.98	27.07	25.77	15.98	16.53	0.5	Pass	
VHT20	MCS0	2	165	5825	18.08	17.98	26.87	25.67	16.88	16.53	0.5	Pass	
VHT40	MCS0	2	151	5755	36.46	36.56	41.81	42.08	35.16	35.46	0.5	Pass	
VHT40	MCS0	2	159	5795	36.46	36.56	41.81	42.26	35.26	35.66	0.5	Pass	
VHT80	MCS0	2	155	5775	75.88	76.12	84.08	83.60	75.16	75.04	0.5	Pass	

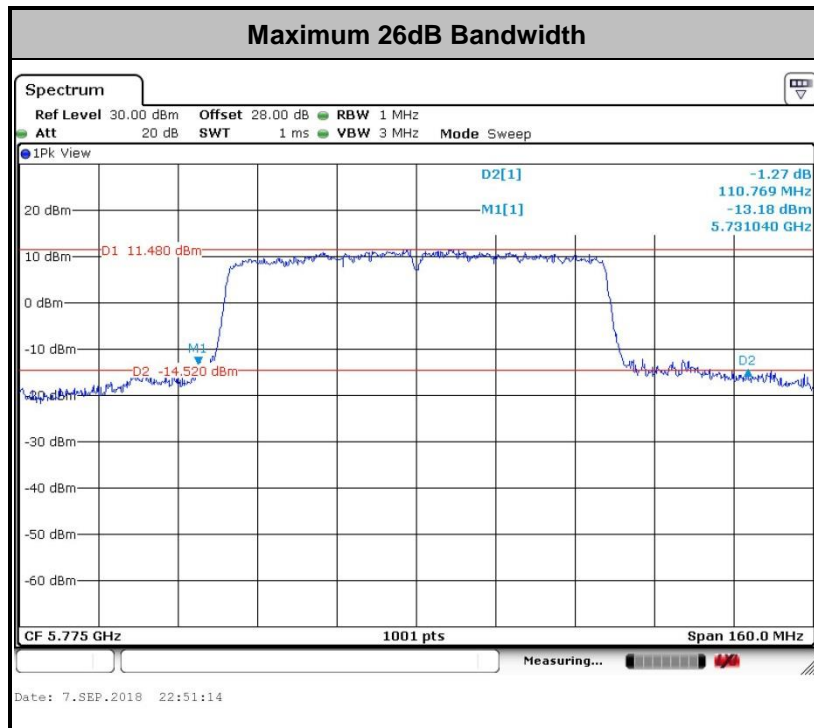
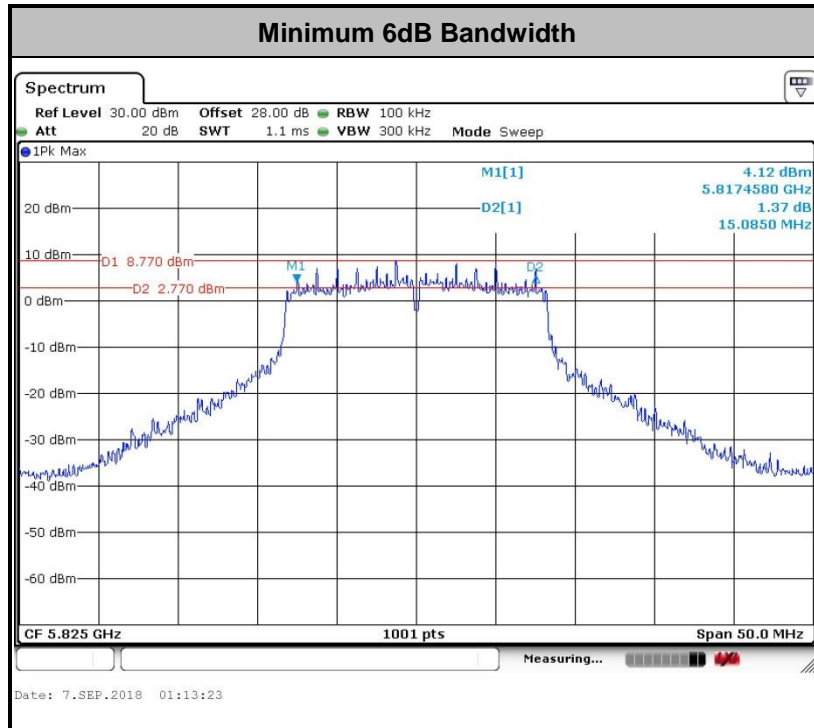

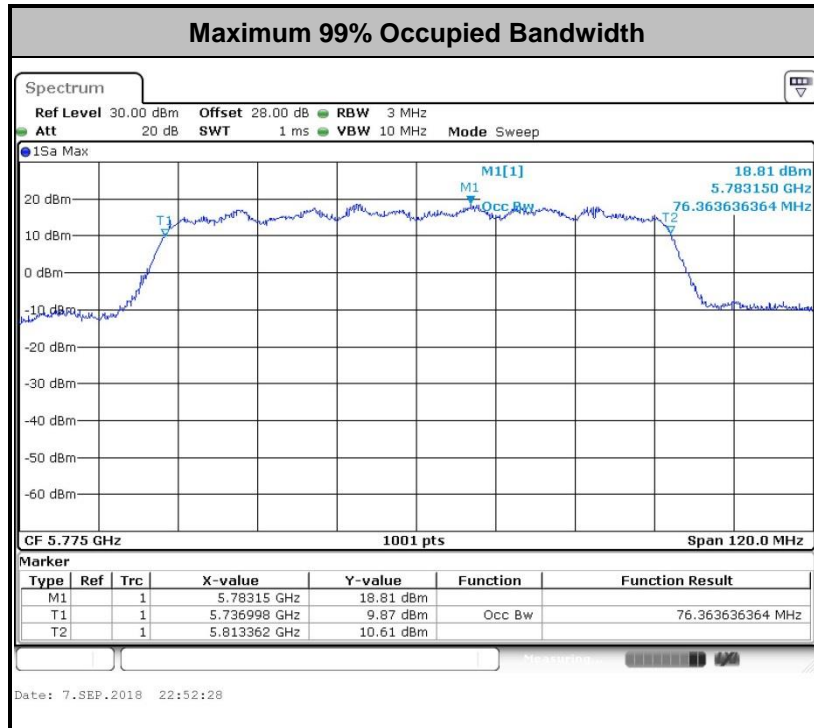

Note: The occupied channel bandwidth is maintained within the band of operation for all of the modulations.



<TXBF Modes>

Mod.	Data Rate	NTX	CH.	Freq. (MHz)	99% Bandwidth (MHz)		26dB Bandwidth (MHz)		6 dB Bandwidth (MHz)		6 dB Bandwidth Min. Limit (MHz)	Pass/Fail
					Ant 1	Ant 2	Ant 1	Ant 2	Ant 1	Ant 2		
VHT20	MCS0	2	149	5745	17.98	18.08	27.27	27.92	15.68	17.53	0.5	Pass
VHT20	MCS0	2	157	5785	18.08	18.08	27.17	27.57	16.83	16.23	0.5	Pass
VHT20	MCS0	2	165	5825	18.03	17.98	26.62	26.92	16.33	16.93	0.5	Pass
VHT40	MCS0	2	151	5755	36.66	36.66	42.08	42.08	35.66	35.86	0.5	Pass
VHT40	MCS0	2	159	5795	36.76	36.66	42.17	48.28	35.36	35.87	0.5	Pass
VHT80	MCS0	2	155	5775	76.72	76.72	83.76	85.03	75.12	75.12	0.5	Pass

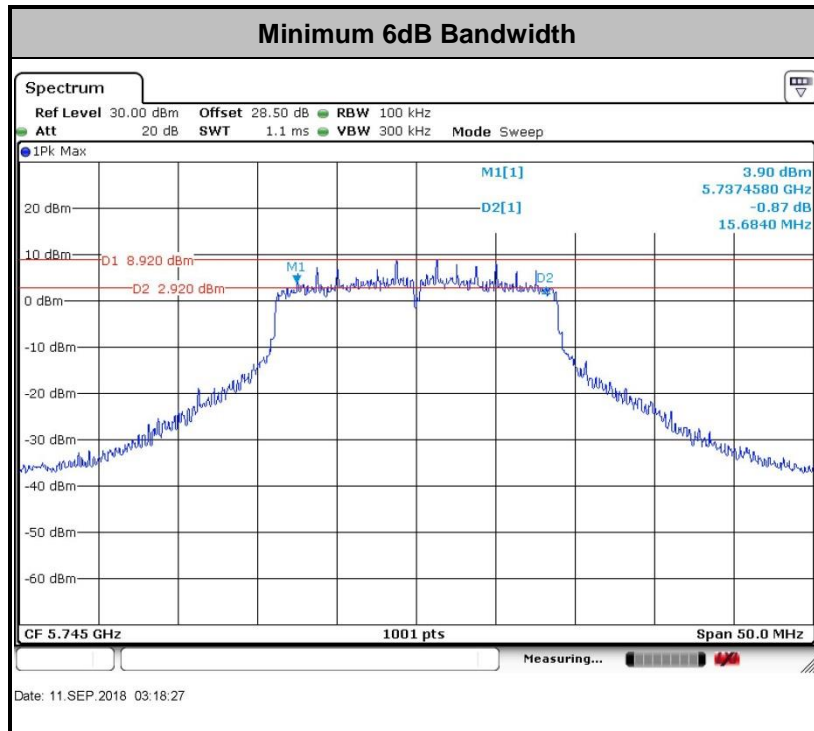

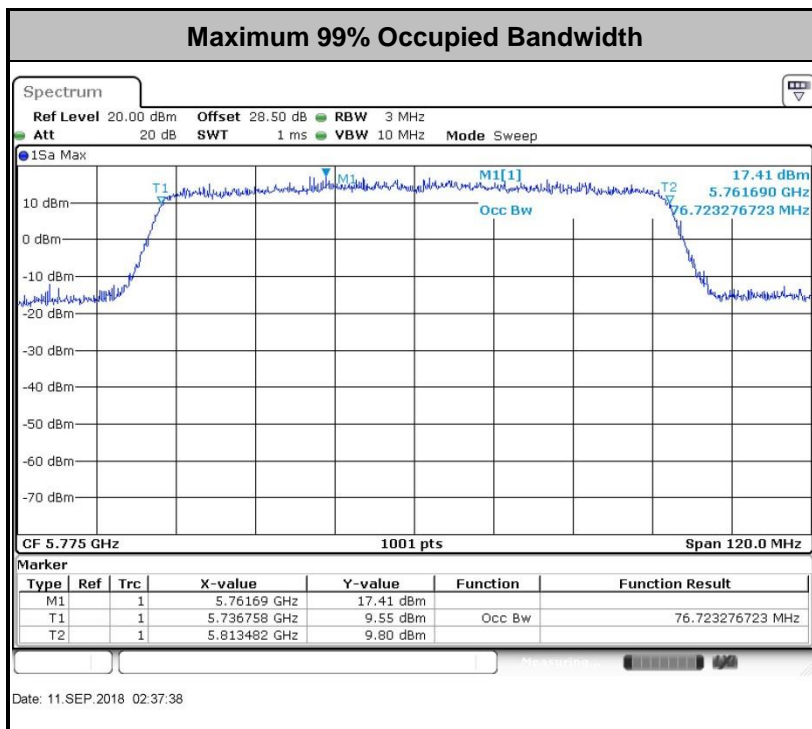
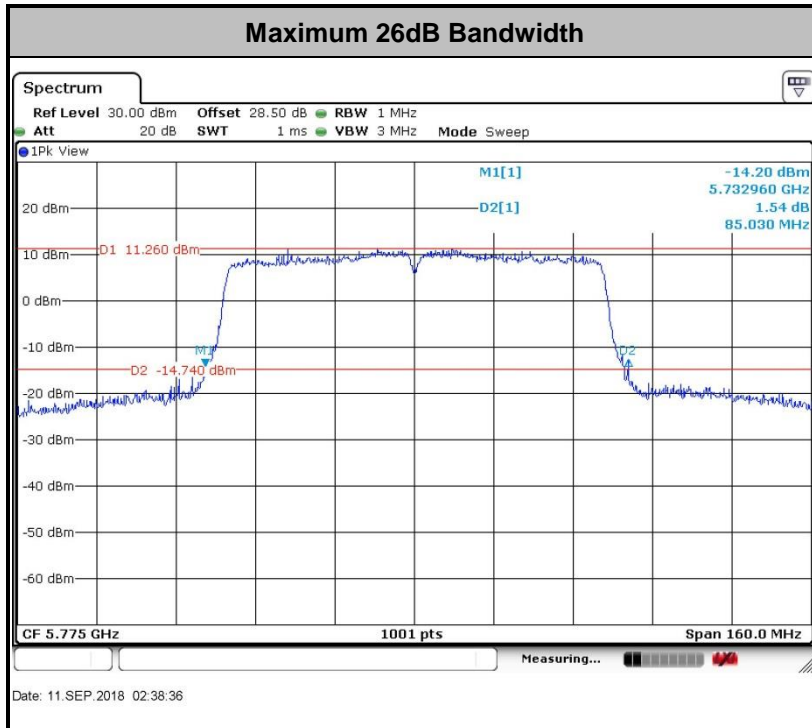

Note: The occupied channel bandwidth is maintained within the band of operation for all of the modulations.



3.2 Maximum Conducted Output Power Measurement

3.2.1 Limit of Maximum Conducted Output Power

For the band 5.725–5.85 GHz, the maximum conducted output power over the frequency band of operation shall not exceed 1 W.

If transmitting antennas of directional gain greater than 6 dBi are used, the peak output power shall be reduced by the amount in dB that the directional gain of the antenna exceeds 6 dBi.

3.2.2 Measuring Instruments

See list of measuring equipment of this test report.

3.2.3 Test Procedures

<CDD Modes>

The testing follows Method PM of FCC KDB 789033 D02 General UNII Test Procedures New Rules v02r01.

Method PM (Measurement using an RF average power meter):

1. Measurement is performed using a wideband RF power meter.
2. The EUT is configured to transmit continuously with a consistent duty cycle at its maximum power control level.
3. Measure the average power of the transmitter, and the average power is corrected with duty factor, $10 \log(1/x)$, where x is the duty cycle.

<TXBF Modes>

The testing follows Method PM-G of FCC KDB 789033 D02 General UNII Test Procedures New Rules v02r01 for TXBF modes.

Method PM-G (Measurement using a gated RF average power meter):

1. Measurement is performed using a wideband RF power meter.
2. The EUT is configured to transmit at its maximum power control level.
3. Measure the average power of the transmitter
4. Since the measurement is made only during the ON time of the transmitter, no duty cycle correction factor is required.

3.2.4 Test Setup

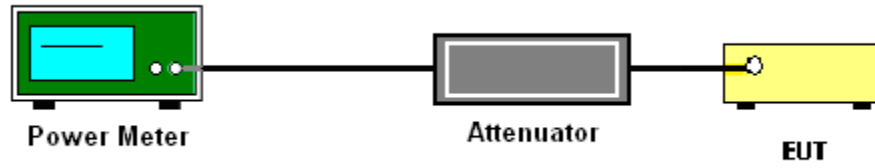



3.2.5 Test Result of Maximum Conducted Output Power

<CDD Mode>

Mod.	Data Rate	NTX	CH.	Freq. (MHz)	Duty Factor (dB)		Average Conducted Power (dBm)			FCC Conducted Power Limit (dBm)		DG (dBi)		Pass/Fail
					Ant 1	Ant 2	Ant 1	Ant 2	SUM	Ant 1	Ant 2	Ant 1	Ant 2	
11a	6Mbps	1	149	5745	0.33	0.30	20.28	17.27		30.00	30.00	2.97	3.49	Pass
11a	6Mbps	1	157	5785	0.33	0.30	20.37	17.39		30.00	30.00	2.97	3.49	Pass
11a	6Mbps	1	165	5825	0.33	0.30	20.41	17.33		30.00	30.00	2.97	3.49	Pass
HT20	MCS0	1	149	5745	0.32	0.00	20.07	17.16		30.00	30.00	2.97	3.49	Pass
HT20	MCS0	1	157	5785	0.32	0.00	20.17	17.27		30.00	30.00	2.97	3.49	Pass
HT20	MCS0	1	165	5825	0.32	0.00	20.12	17.25		30.00	30.00	2.97	3.49	Pass
HT40	MCS0	1	151	5755	0.61	0.68	20.06	17.04		30.00	30.00	2.97	3.49	Pass
HT40	MCS0	1	159	5795	0.61	0.68	20.11	17.09		30.00	30.00	2.97	3.49	Pass
VHT20	MCS0	1	149	5745	0.32	0.35	20.12	17.17		30.00	30.00	2.97	3.49	Pass
VHT20	MCS0	1	157	5785	0.32	0.35	20.23	17.30		30.00	30.00	2.97	3.49	Pass
VHT20	MCS0	1	165	5825	0.32	0.35	20.22	17.29		30.00	30.00	2.97	3.49	Pass
VHT40	MCS0	1	151	5755	0.67	0.59	20.15	17.07		30.00	30.00	2.97	3.49	Pass
VHT40	MCS0	1	159	5795	0.67	0.59	20.22	17.12		30.00	30.00	2.97	3.49	Pass
VHT80	MCS0	1	155	5775	0.67	0.67	20.11	17.11		30.00	30.00	2.97	3.49	Pass
11a	6Mbps	2	149	5745	0.27	0.33	18.67	18.76	21.73	30.00		3.49		Pass
11a	6Mbps	2	157	5785	0.27	0.33	18.58	18.84	21.72	30.00		3.49		Pass
11a	6Mbps	2	165	5825	0.27	0.33	18.52	18.79	21.67	30.00		3.49		Pass
HT20	MCS0	2	149	5745	0.32	0.35	18.51	18.80	21.67	30.00		3.49		Pass
HT20	MCS0	2	157	5785	0.32	0.35	18.57	18.71	21.65	30.00		3.49		Pass
HT20	MCS0	2	165	5825	0.32	0.35	18.54	18.70	21.63	30.00		3.49		Pass
HT40	MCS0	2	151	5755	0.64	0.57	18.72	18.89	21.81	30.00		3.49		Pass
HT40	MCS0	2	159	5795	0.64	0.57	18.56	18.88	21.73	30.00		3.49		Pass
VHT20	MCS0	2	149	5745	0.32	0.29	18.72	18.77	21.75	30.00		3.49		Pass
VHT20	MCS0	2	157	5785	0.32	0.29	18.63	18.71	21.68	30.00		3.49		Pass
VHT20	MCS0	2	165	5825	0.32	0.29	18.62	18.66	21.65	30.00		3.49		Pass
VHT40	MCS0	2	151	5755	0.67	0.59	18.77	18.99	21.89	30.00		3.49		Pass
VHT40	MCS0	2	159	5795	0.67	0.59	18.67	18.91	21.80	30.00		3.49		Pass
VHT80	MCS0	2	155	5775	0.61	0.67	18.55	18.73	21.65	30.00		3.49		Pass



<TXBF Mode>

Mod.	Data Rate	NTX	CH.	Freq. (MHz)	Duty Factor (dB)		Average Conducted Power (dBm)			FCC Conducted Power Limit (dBm)		DG (dBi)		Pass/Fail
					Ant 1	Ant 2	Ant 1	Ant 2	SUM	Ant 1	Ant 2	Ant 1	Ant 2	
VHT20	MCS0	2	149	5745	0.00	0.00	17.80	18.90	21.40	29.76	6.24	Pass		
VHT20	MCS0	2	157	5785	0.00	0.00	17.90	18.90	21.44	29.76	6.24	Pass		
VHT20	MCS0	2	165	5825	0.00	0.00	17.50	18.80	21.21	29.76	6.24	Pass		
VHT40	MCS0	2	151	5755	0.00	0.00	18.10	18.90	21.53	29.76	6.24	Pass		
VHT40	MCS0	2	159	5795	0.00	0.00	17.70	19.00	21.41	29.76	6.24	Pass		
VHT80	MCS0	2	155	5775	0.00	0.00	17.60	18.80	21.25	29.76	6.24	Pass		



3.3 Power Spectral Density Measurement

3.3.1 Limit of Power Spectral Density

For the band 5.725–5.85 GHz, the maximum power spectral density shall not exceed 30 dBm in any 500-kHz band.

If transmitting antennas of directional gain greater than 6 dBi are used, the peak output power shall be reduced by the amount in dB that the directional gain of the antenna exceeds 6 dBi.

3.3.2 Measuring Instruments

See list of measuring equipment of this test report.

3.3.3 Test Procedures

The testing follows FCC KDB 789033 D02 General UNII Test Procedures New Rules v02r01. Section F) Maximum power spectral density.

<CDD Modes>

Method SA-2

(trace averaging across on and off times of the EUT transmissions, followed by duty cycle correction).

- Measure the duty cycle.
- Set span to encompass the entire emission bandwidth (EBW) of the signal.
- Set RBW = 300 kHz.
- Set VBW \geq 1 MHz.
- Number of points in sweep \geq 2 Span / RBW.
- Sweep time = auto.
- Detector = RMS
- Trace average at least 100 traces in power averaging mode.
- Add $10 \log(500\text{kHz}/\text{RBW})$ to the test result.
- Add $10 \log(1/x)$, where x is the duty cycle, to the measured power in order to compute the average power during the actual transmission times. For example, add $10 \log(1/0.25) = 6$ dB if the duty cycle is 25 percent.

<TXBF Modes>**# Method SA-3 #**

(power averaging (rms) detection with max hold):

- Set span to encompass the entire emission bandwidth (EBW) of the signal.
 - Set RBW = 300 kHz.
 - Set VBW \geq 1 MHz.
 - Number of points in sweep \geq 2 Span / RBW.
 - Sweep time \leq (number of points in sweep) \times T, when duty cycle is less than 98 percent where T is the minimum transmission duration over which the transmitter is on and is transmitting at its maximum power control level for the tested mode of operation.
 - Detector = power averaging (rms).
 - Trace mode = max hold.
 - Allow max hold to run for at least 60 seconds, or longer as needed to allow the trace to stabilize.
1. The RF output of EUT was connected to the spectrum analyzer by a low loss cable.
 2. Each plot has already offset with cable loss, and attenuator loss. Measure the PPSD and record it.
 3. For MIMO mode, calculation method follows FCC KDB 662911 D01 Multiple Transmitter Output v02r01.

Method (c): Measure and add $10 \log(N_{ANT})$ dB.

With this technique, spectrum measurements are performed at each output of the device, but rather than summing the spectra or the spectral peaks across the outputs, the quantity $10 \log(N_{ANT})$ dB is added to each spectrum value before comparing to the emission limit. The addition of $10 \log(N_{ANT})$ dB serves to apportion the emission limit among the N_{ANT} outputs so that each output is permitted to contribute no more than $1/N_{ANT}^{th}$ of the PSD limit.

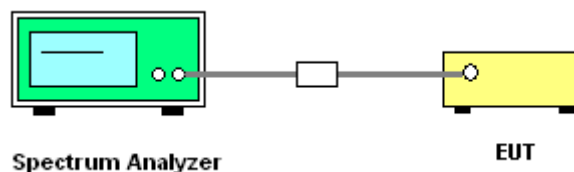
3.3.4 Test Setup



3.3.5 Test Result of Power Spectral Density

Test Engineer :	Rebecca Li, Lena Lo, Derek Hsu, and AnAn Wu	Temperature :	21~25°C
		Relative Humidity :	51~54%

<CDD Modes>

Mod.	Data Rate	NTX	CH.	Freq. (MHz)	Duty Factor (dB)		10log (500kHz /RBW) Factor (dB)		Average Power Density (dBm/500kHz)			Average PSD Limit (dBm/500kHz)		DG (dBi)		Pass /Fail
					Ant 1	Ant 2	Ant 1	Ant 2	Ant 1	Ant 2	SUM	Ant 1	Ant 2	Ant 1	Ant 2	
11a	6Mbps	1	149	5745	0.33	0.30	2.22	2.22	6.92	3.81		30.00	30.00	2.97	3.49	Pass
11a	6Mbps	1	157	5785	0.33	0.30	2.22	2.22	6.99	3.85		30.00	30.00	2.97	3.49	Pass
11a	6Mbps	1	165	5825	0.33	0.30	2.22	2.22	7.44	4.10		30.00	30.00	2.97	3.49	Pass
VHT20	MCS0	1	149	5745	0.32	0.35	2.22	2.22	7.00	3.31		30.00	30.00	2.97	3.49	Pass
VHT20	MCS0	1	157	5785	0.32	0.35	2.22	2.22	6.66	3.68		30.00	30.00	2.97	3.49	Pass
VHT20	MCS0	1	165	5825	0.32	0.35	2.22	2.22	6.53	3.41		30.00	30.00	2.97	3.49	Pass
VHT40	MCS0	1	151	5755	0.67	0.59	2.22	2.22	3.55	0.34		30.00	30.00	2.97	3.49	Pass
VHT40	MCS0	1	159	5795	0.67	0.59	2.22	2.22	3.17	0.89		30.00	30.00	2.97	3.49	Pass
VHT80	MCS0	1	155	5775	0.67	0.67	2.22	2.22	0.29	-2.27		30.00	30.00	2.97	3.49	Pass
11a	6Mbps	2	149	5745	0.27	0.33	2.22	2.22	5.71	5.64	8.72	29.76		6.24		Pass
11a	6Mbps	2	157	5785	0.27	0.33	2.22	2.22	5.54	5.58	8.59	29.76		6.24		Pass
11a	6Mbps	2	165	5825	0.27	0.33	2.22	2.22	5.45	5.64	8.65	29.76		6.24		Pass
VHT20	MCS0	2	149	5745	0.32	0.29	2.22	2.22	5.47	5.16	8.48	29.76		6.24		Pass
VHT20	MCS0	2	157	5785	0.32	0.29	2.22	2.22	5.46	5.01	8.47	29.76		6.24		Pass
VHT20	MCS0	2	165	5825	0.32	0.29	2.22	2.22	4.54	5.28	8.29	29.76		6.24		Pass
VHT40	MCS0	2	151	5755	0.67	0.59	2.22	2.22	2.79	2.23	5.80	29.76		6.24		Pass
VHT40	MCS0	2	159	5795	0.67	0.59	2.22	2.22	2.44	2.34	5.45	29.76		6.24		Pass
VHT80	MCS0	2	155	5775	0.61	0.67	2.22	2.22	-0.98	-1.13	2.03	29.76		6.24		Pass

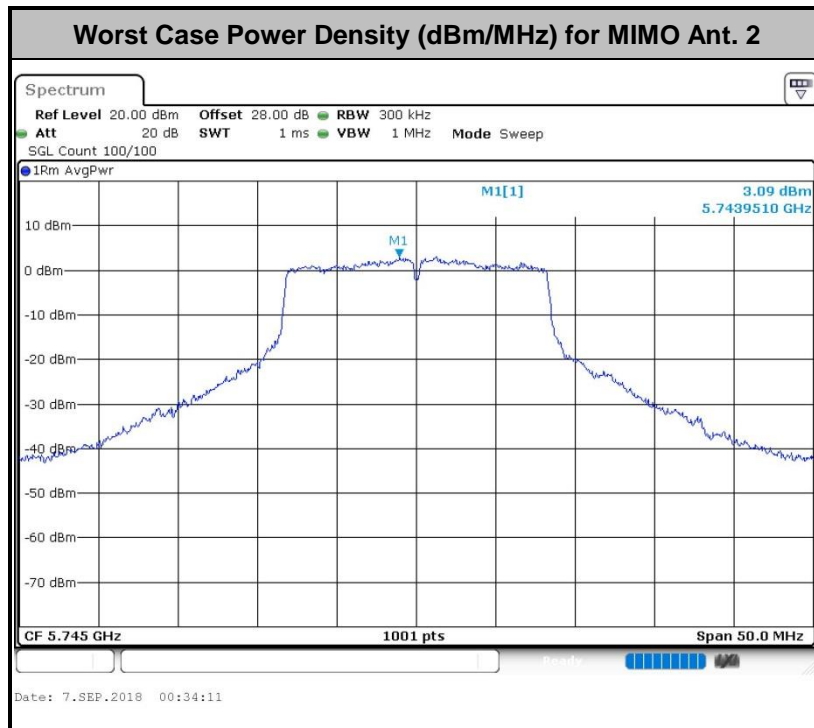
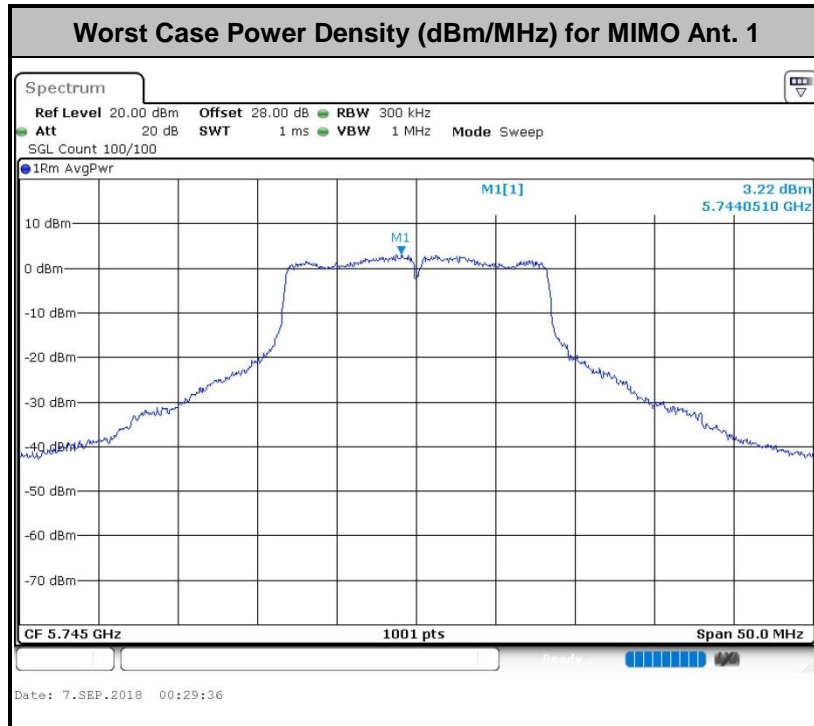



<TXBF Modes>

Mod.	Data Rate	NTX	CH.	Freq. (MHz)	Duty Factor (dB)		10log (500kHz /RBW) Factor (dB)		Average Power Density (dBm/500kHz)			Average PSD Limit (dBm/500kHz)		DG (dBi)		Pass /Fail
					Ant 1	Ant 2	Ant 1	Ant 2	Ant 1	Ant 2	SUM	Ant 1	Ant 2	Ant 1	Ant 2	
VHT20	MCS0	2	149	5745	0.00	0.00	2.22	7.96	8.71	11.72	29.76	29.76	6.24	6.24	Pass	
VHT20	MCS0	2	157	5785	0.00	0.00	2.22	7.95	8.45	11.46	29.76	29.76	6.24	6.24	Pass	
VHT20	MCS0	2	165	5825	0.00	0.00	2.22	7.55	8.43	11.44	29.76	29.76	6.24	6.24	Pass	
VHT40	MCS0	2	151	5755	0.00	0.00	2.22	4.03	3.31	7.04	29.76	29.76	6.24	6.24	Pass	
VHT40	MCS0	2	159	5795	0.00	0.00	2.22	3.55	3.07	6.56	29.76	29.76	6.24	6.24	Pass	
VHT80	MCS0	2	155	5775	0.00	0.00	2.22	0.91	1.80	4.81	29.76	29.76	6.24	6.24	Pass	



Worst Case Power Density (dBm/MHz) for MIMO Ant. 1

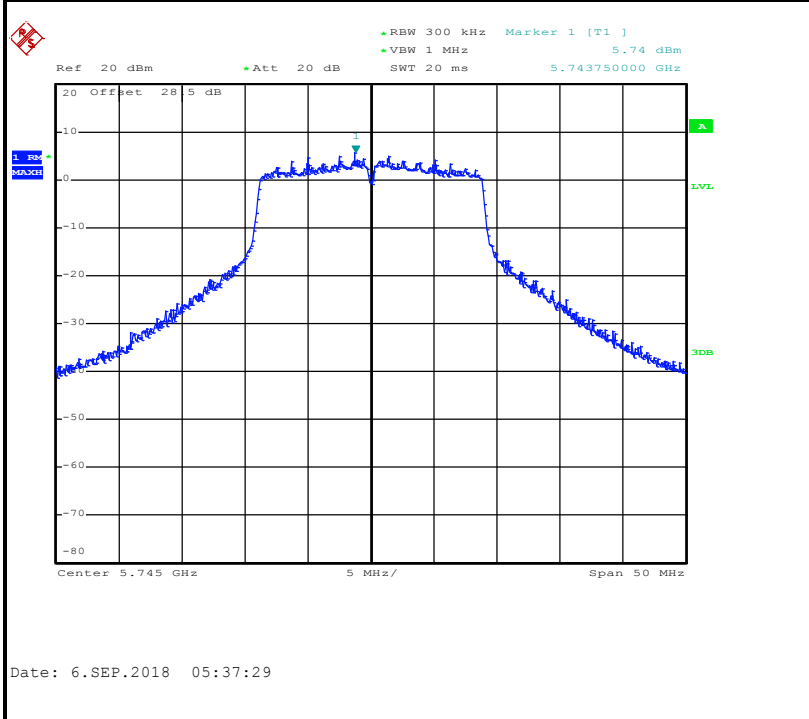

Worst Case Power Density (dBm/MHz) for MIMO Ant. 2

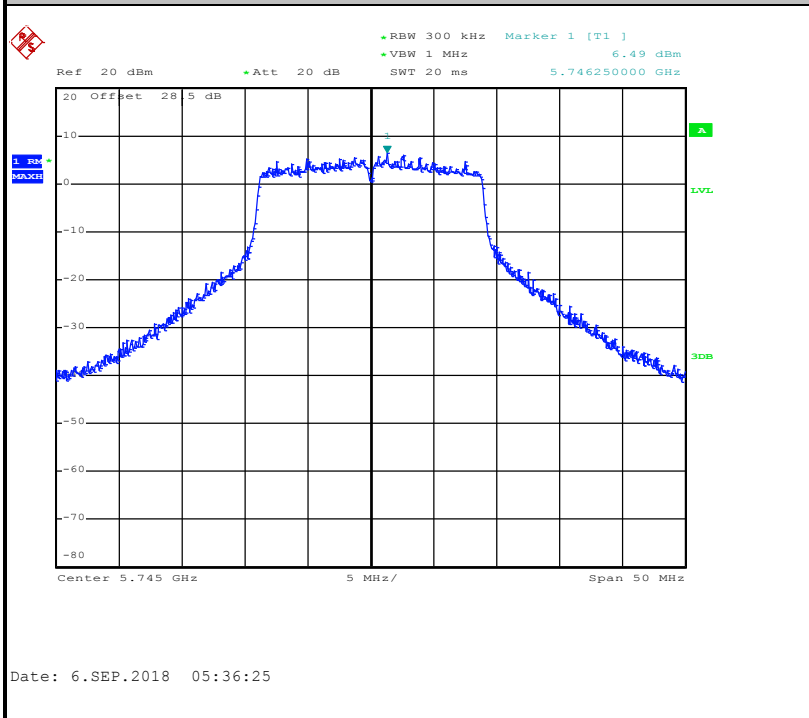



3.4 Unwanted Emissions Measurement

This section is to measure unwanted emissions through radiated measurement for band edge spurious emissions and out of band emissions measurement.

3.4.1 Limit of Unwanted Emissions

- (1) For transmitters operating in the 5.725-5.85 GHz band:
 15.407(b)(4)(i) All emissions shall be limited to a level of -27 dBm/MHz at 75 MHz or more above or below the band edge increasing linearly to 10 dBm/MHz at 25 MHz above or below the band edge, and from 25 MHz above or below the band edge increasing linearly to a level of 15.6 dBm/MHz at 5 MHz above or below the band edge, and from 5 MHz above or below the band edge increasing linearly to a level of 27 dBm/MHz at the band edge.
- (2) Unwanted spurious emissions fallen in restricted bands shall comply with the general field strength limits as below table,

Frequency (MHz)	Field Strength (microvolts/meter)	Measurement Distance (meters)
0.009 – 0.490	2400/F(kHz)	300
0.490 – 1.705	24000/F(kHz)	30
1.705 – 30.0	30	30
30 – 88	100	3
88 – 216	150	3
216 - 960	200	3
Above 960	500	3

Note: The following formula is used to convert the EIRP to field strength.

$$E = \frac{1000000\sqrt{30P}}{3} \text{ } \mu\text{V/m, where P is the eirp (Watts)}$$

EIRP (dBm)	Field Strength at 3m (dBμV/m)
- 27	68.3



(3) KDB789033 D02 v02r01 G)2)c)

- (i) Section 15.407(b)(1) to (b)(3) specify the unwanted emission limits for the U-NII-1 and U-NII-2 bands. As specified, emissions above 1000 MHz that are outside of the restricted bands are subject to a peak emission limit of -27 dBm/MHz.³
- (ii) Section 15.407(b)(4) specifies the unwanted emission limit for the U-NII-3 band. A band emissions mask is specified in Section 15.407(b)(4)(i). The emission limits are in terms of a Peak detector. An alternative to the band emissions mask is specified in Section 15.407(b)(4)(ii). The alternative limits are based on the highest antenna gain specified in the filing. There are also marketing and importation restrictions for the devices using the alternative limit.⁴

Note 3: An out-of-band emission that complies with both the average and peak limits of Section 15.209 is not required to satisfy the -27 dBm/MHz peak emission limit.

Note 4: Only devices with antenna gains of 10 dBi or less may be approved using the emission limits specified in Section 15.247(d) till March 2, 2018; all other devices operating in this band must use the mask specified in Section 15.407(b)(4)(i).

3.4.2 Measuring Instruments

See list of measuring equipment of this test report.

3.4.3 Test Procedures

1. The testing follows FCC KDB 789033 D02 General UNII Test Procedures New Rules v02r01. Section G) Unwanted emissions measurement.

(1) Procedure for Unwanted Emissions Measurements Below 1000MHz

- RBW = 120 kHz
- VBW = 300 kHz
- Detector = Peak
- Trace mode = max hold

(2) Procedure for Peak Unwanted Emissions Measurements Above 1000 MHz

- RBW = 1 MHz
- VBW ≥ 3 MHz
- Detector = Peak
- Sweep time = auto
- Trace mode = max hold

(3) Procedures for Average Unwanted Emissions Measurements Above 1000MHz

- RBW = 1 MHz
- VBW = 10 Hz, when duty cycle is no less than 98 percent.
- VBW ≥ 1/T, when duty cycle is less than 98 percent where T is the minimum transmission duration over which the transmitter is on and is transmitting at its maximum power control level for the tested mode of operation.



2. The EUT was placed on a turntable with 0.8 meter for frequency below 1GHz and 1.5 meter for frequency above 1GHz respectively above ground.
3. The EUT was set 3 meters from the interference receiving antenna which was mounted on the top of a variable height antenna tower.
4. The antenna is a broadband antenna and its height is adjusted between one meter and four meters above ground to find the maximum value of the field strength for both horizontal polarization and vertical polarization of the antenna.
5. For each suspected emission, the EUT was arranged to its worst case and then adjust the antenna tower (from 1 m to 4 m) and turntable (from 0 degree to 360 degrees) to find the maximum reading.
6. For testing below 1GHz, if the emission level of the EUT in peak mode was 3 dB lower than the limit specified, then peak values of EUT will be reported, otherwise, the emissions will be repeated one by one using the CISPR quasi-peak method and reported.
7. For testing above 1GHz, the emission level of the EUT in peak mode was 20dB lower than average limit (that means the emission level in average mode also complies with the limit in average mode), then peak values of EUT will be reported, otherwise, the emissions will be measured in average mode again and reported.

3.4.4 Test Setup

For radiated emissions below 30MHz

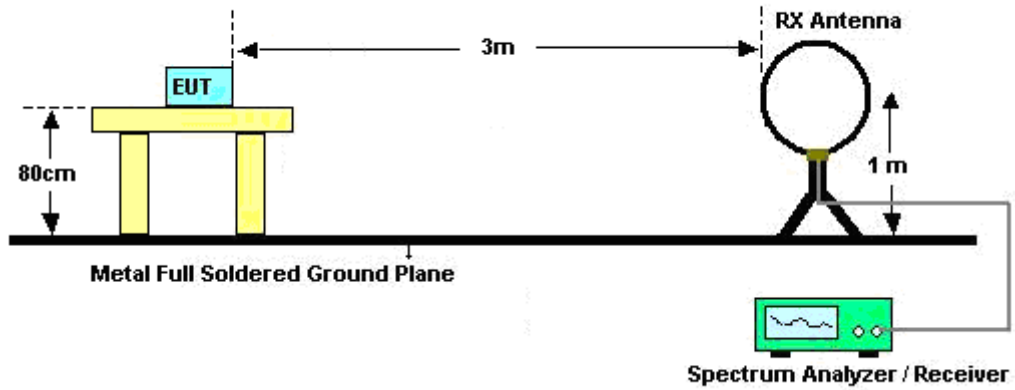

For radiated emissions from 30MHz to 1GHz

<CDD Mode>

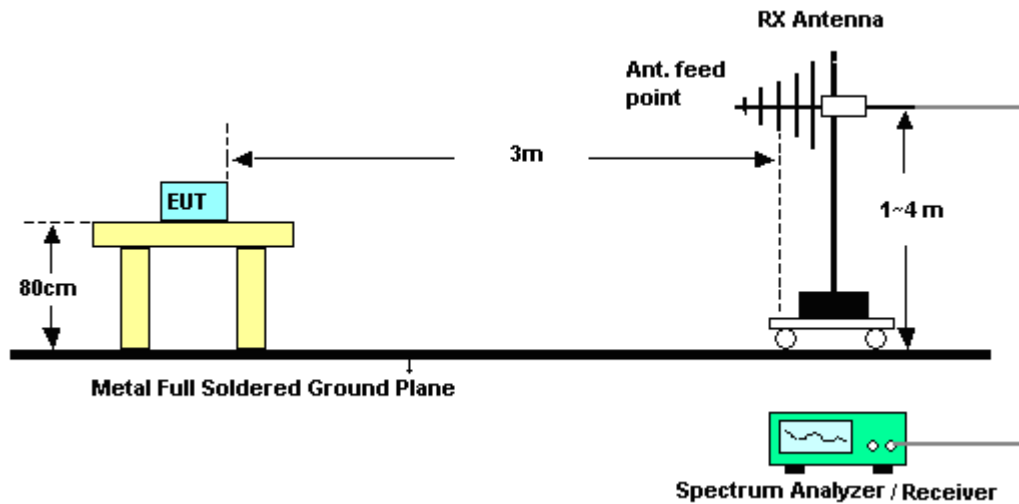

<TXBF Modes>

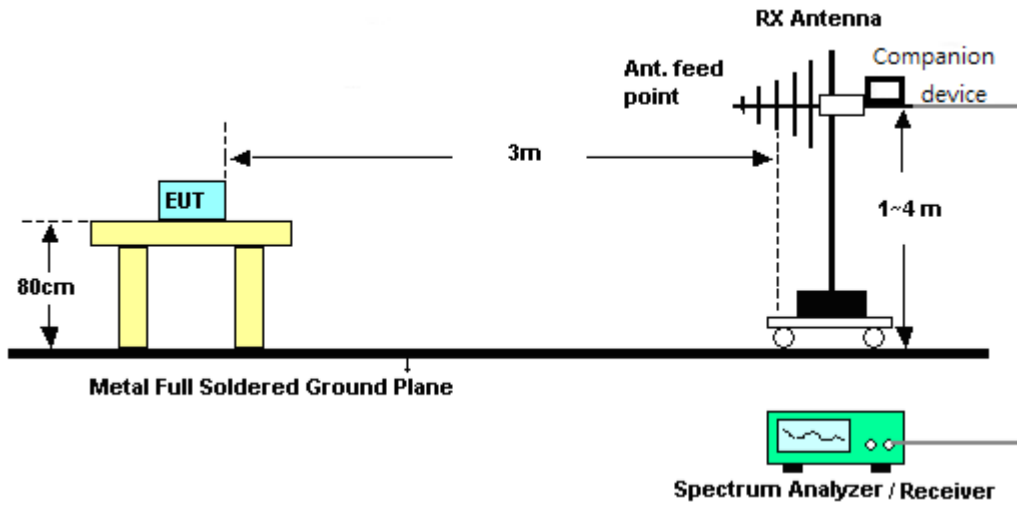

For radiated emissions above 1GHz

<CDD Mode>

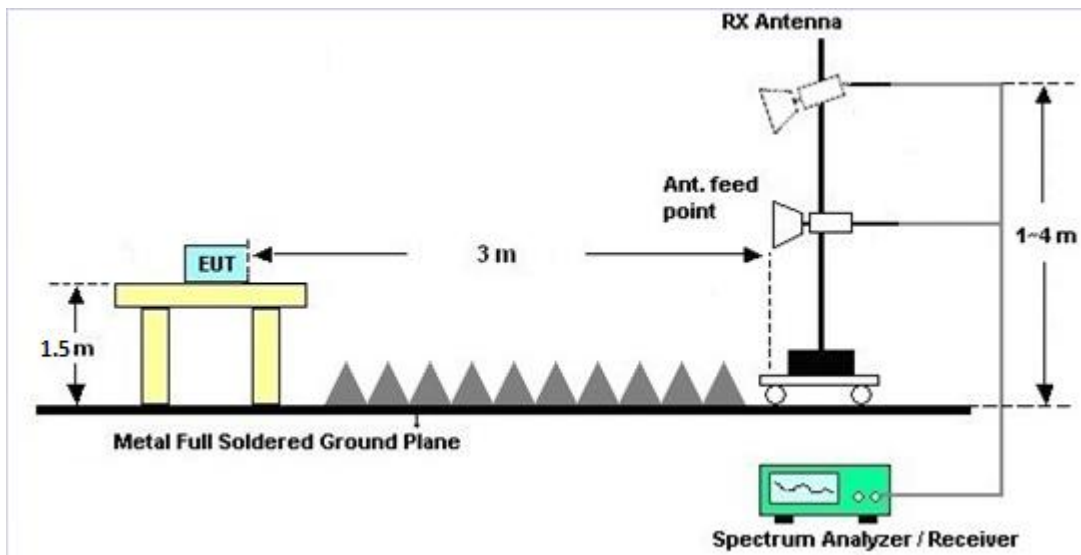

<TXBF Modes>

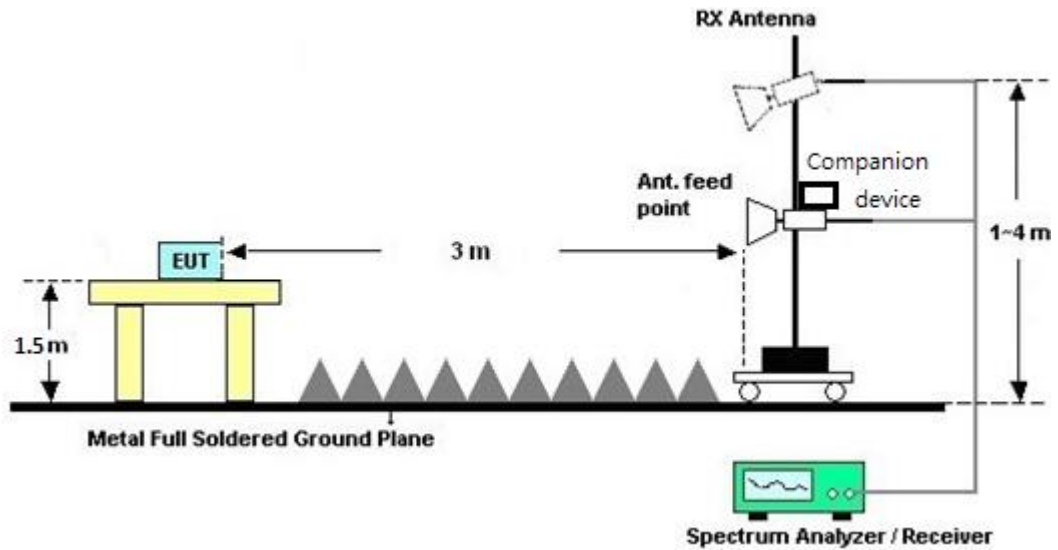

3.4.5 Test Results of Radiated Emissions (9 kHz ~ 30 MHz)

The low frequency, which started from 9 kHz to 30MHz, was pre-scanned and the result which was 20dB lower than the limit line was not reported.

There is a comparison data of both open-field test site and alternative test site - semi-Anechoic chamber according to 414788 D01 Radiated Test Site v01r01, and the result came out very similar.

3.4.6 Test Result of Radiated Band Edges

Please refer to Appendix B and C.

3.4.7 Duty Cycle

Please refer to Appendix D.

3.4.8 Test Result of Unwanted Radiated Emission (30MHz ~ 10th Harmonic)

Please refer to Appendix B and C.



3.5 AC Conducted Emission Measurement

3.5.1 Limit of AC Conducted Emission

For equipment that is designed to be connected to the public utility (AC) power line, the radio frequency voltage that is conducted back onto the AC power line on any frequency or frequencies within the band 150 kHz to 30 MHz shall not exceed the limits in the following table.

Frequency of emission (MHz)	Conducted limit (dB μ V)	
	Quasi-peak	Average
0.15-0.5	66 to 56*	56 to 46*
0.5-5	56	46
5-30	60	50

*Decreases with the logarithm of the frequency.

For terminal test result, the testing follows FCC KDB 174176.

3.5.2 Measuring Instruments

See list of measuring equipment of this test report.

3.5.3 Test Procedures

1. The EUT was placed 0.4 meter from the conducting wall of the shielding room was kept at least 80 centimeters from any other grounded conducting surface.
2. Connect EUT to the power mains through a line impedance stabilization network (LISN).
3. All the support units are connecting to the other LISN.
4. The LISN provides 50 ohm coupling impedance for the measuring instrument.
5. The FCC states that a 50 ohm, 50 microhenry LISN should be used.
6. Both sides of AC line were checked for maximum conducted interference.
7. The frequency range from 150 kHz to 30 MHz was searched.
8. Set the test-receiver system to Peak Detect Function and specified bandwidth with Maximum Hold Mode.

3.5.4 Test Setup

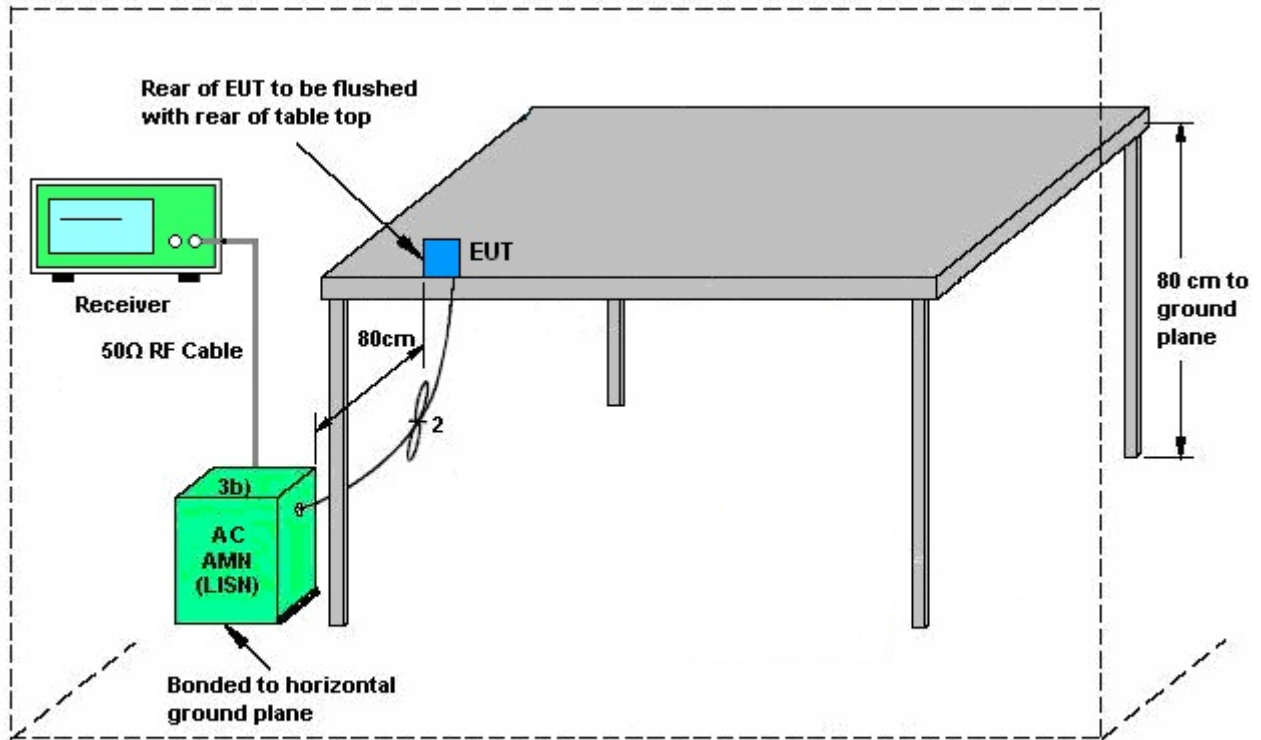

AMN = Artificial mains network (LISN)
 AE = Associated equipment
 EUT = Equipment under test
 ISN = Impedance stabilization network

3.5.5 Test Result of AC Conducted Emission

Please refer to Appendix A.



3.6 Automatically Discontinue Transmission

3.6.1 Limit of Automatically Discontinue Transmission

The device shall automatically discontinue transmission in case of either absence of information to transmit or operational failure. These provisions are not intended to preclude the transmission of control or signaling information or the use of repetitive codes used by certain digital technologies to complete frame or burst intervals. Applicants shall include in their application for equipment authorization to describe how this requirement is met.

3.6.2 Measuring Instruments

See list of measuring equipment of this test report.

3.6.3 Test Result of Automatically Discontinue Transmission

While the EUT is not transmitting any information, the EUT can automatically discontinue transmission and become standby mode for power saving. The EUT can detect the controlling signal of ACK message transmitting from remote device and verify whether it shall resend or discontinue transmission.



3.7 Antenna Requirements

3.7.1 Standard Applicable

If transmitting antenna directional gain is greater than 6 dBi, both the peak transmit power and the peak power spectral density shall be reduced by the amount in dB that the directional gain of the antenna exceeds 6 dBi.

3.7.2 Antenna Anti-Replacement Construction

An embedded-in antenna design is used.

3.7.3 Antenna Gain

<CDD Modes>

FCC KDB 662911 D01 Multiple Transmitter Output v02r01

For CDD transmissions, directional gain is calculated as

Directional gain = GANT + Array Gain, where Array Gain is as follows.

For power spectral density (PSD) measurements on all devices,

Array Gain = 10 log(NANT/NSS=1) dB.

For power measurements on IEEE 802.11 devices,

Array Gain = 0 dB (i.e., no array gain) for NANT ≤ 4.

Directional gain may be calculated by using the formulas applicable to equal gain antennas with GANT set equal to the gain of the antenna having the highest gain;

The EUT supports CDD mode.

For power, the directional gain GANT is set equal to the antenna having the highest gain, i.e., F)2)f)i).

For PSD, the directional gain calculation is following F)2)f)ii) of KDB 662911 D01 v02r01.

The power and PSD limit should be modified if the directional gain of EUT is over 6 dBi,

The directional gain "DG" is calculated as following table.

<CDD Modes>						
			DG	DG	Power	PSD
	Ant. 1	Ant. 2	for	for	Limit	Limit
	(dBi)	(dBi)	Power	PSD	Reduction	Reduction
			(dBi)	(dBi)	(dB)	(dB)
Band IV	3.00	3.50	3.50	6.26	0.00	0.26

Power Limit Reduction = DG(Power) – 6dBi, (min = 0)

PSD Limit Reduction = DG(PSD) – 6dBi, (min = 0)

TXBF modes

FCC KDB 662911 D01 Multiple Transmitter Output v02r01

For CDD transmissions, directional gain is calculated as

$$DirectionalGain = 10 \cdot \log \left[\frac{\sum_{j=1}^{N_{SS}} \left\{ \sum_{k=1}^{N_{ANT}} g_{j,k} \right\}^2}{N_{ANT}} \right]$$

where

Each antenna is driven by no more than one spatial stream;

N_{SS} = the number of independent spatial streams of data;

N_{ANT} = the total number of antennas

$g_{j,k} = 10^{G_k / 20}$ if the k th antenna is being fed by spatial stream j , or zero if it is not;
 G_k is the gain in dBi of the k th antenna.

The EUT supports beamforming for 802.11ac modes.

The directional gain calculation is following F)2)e)ii) of KDB 662911 D01 v02r01.

The power and PSD limit should be modified if the directional gain of EUT is over 6 dBi,

The directional gain “DG” is calculated as following table.

			DG	DG	Power	PSD
			for	for	Limit	Limit
	Ant 1	Ant 2	Power	PSD	Reduction	Reduction
	(dBi)	(dBi)	(dBi)	(dBi)	(dB)	(dB)
Band IV	3.00	3.50	6.26	6.26	0.26	0.26

$Power\ Limit\ Reduction = DG(Power) - 6dBi, (min = 0)$

$PSD\ Limit\ Reduction = DG(PSD) - 6dBi, (min = 0)$



4 List of Measuring Equipment

Instrument	Manufacturer	Model No.	Serial No.	Characteristics	Calibration Date	Test Date	Due Date	Remark
Power Meter	Anritsu	ML2495A	0932001	N/A	Sep. 26, 2017	May 28, 2018~ Sep. 10, 2018	Sep. 25, 2018	Conducted (TH05-HY)
Power Sensor	Anritsu	MA2411B	0846202	300MHz~40GHz	Sep. 26, 2017	May 28, 2018~ Sep. 10, 2018	Sep. 25, 2018	Conducted (TH05-HY)
Spectrum Analyzer	Rohde & Schwarz	FSP30	101067	9kHz ~ 30GHz	Nov. 13, 2017	May 28, 2018~ Sep. 10, 2018	Nov. 12, 2018	Conducted (TH05-HY)
Spectrum Analyzer	Rohde & Schwarz	FSV 30	100895	9kHz ~ 30GHz	Apr. 20, 2018	May 28, 2018~ Sep. 10, 2018	Apr. 19, 2019	Conducted (TH05-HY)
Switch Box & RF Cable	Burgeon	ETF-058	EC1300484	N/A	Mar. 01, 2018	May 28, 2018~ Sep. 10, 2018	Feb. 28, 2019	Conducted (TH05-HY)
AC Power Source	ChainTek	APC-1000W	N/A	N/A	N/A	Aug. 07, 2018~ Aug. 11, 2018	N/A	Conduction (CO05-HY)
EMI Test Receiver	Rohde & Schwarz	ESR3	102388	9KHz~3.6GHz	Dec. 08, 2017	Aug. 07, 2018~ Aug. 11, 2018	Dec. 07, 2018	Conduction (CO05-HY)
LISN	Rohde & Schwarz	ENV216	100080	9kHz~30MHz	Nov. 30, 2017	Aug. 07, 2018~ Aug. 11, 2018	Nov. 29, 2018	Conduction (CO05-HY)
LISN	Rohde & Schwarz	ENV216	100081	9kHz~30MHz	Dec. 08, 2017	Aug. 07, 2018~ Aug. 11, 2018	Dec. 07, 2018	Conduction (CO05-HY)
Software	Rohde & Schwarz	EMC32 V10.30	N/A	N/A	N/A	Aug. 07, 2018~ Aug. 11, 2018	N/A	Conduction (CO05-HY)
LF Cable	HUBER + SUHNER	RG-214/U	LF01	N/A	Jan. 03, 2018	Aug. 07, 2018~ Aug. 11, 2018	Jan. 02, 2019	Conduction (CO05-HY)
Pulse Limiter	Rohde & Schwarz	ESH3-Z2	100851	N/A	Jan. 03, 2018	Aug. 07, 2018~ Aug. 11, 2018	Jan. 02, 2019	Conduction (CO05-HY)
Bilog Antenna	TESEQ	CBL 6111D&0080 0N1D01N-0 6	35419&03	30MHz to 1GHz	Dec. 18, 2017	Aug. 07, 2018~ Sep. 05, 2018	Dec. 17, 2018	Radiation (03CH07-HY)
Double Ridge Horn Antenna	EMCO	3117	00066583	1GHz~18GHz	Aug. 06, 2018	Aug. 07, 2018~ Sep. 05, 2018	Aug. 05, 2019	Radiation (03CH07-HY)
Loop Antenna	Rohde & Schwarz	HFH2-Z2	100315	9 kHz~30 MHz	Nov. 10, 2017	Aug. 07, 2018~ Sep. 05, 2018	Nov. 09, 2018	Radiation (03CH07-HY)
Preamplifier	MITEQ	AMF-7D-00 101800-30-1 0P	1590075	1GHz ~ 18GHz	Apr. 25, 2018	Aug. 07, 2018~ Sep. 05, 2018	Apr. 24, 2019	Radiation (03CH07-HY)
Preamplifier	COM-POWER	PA-103A	161241	10MHz-1GHz	May 21, 2018	Aug. 07, 2018~ Sep. 05, 2018	May 20, 2019	Radiation (03CH07-HY)
Preamplifier	Agilent	8449B	3008A02362	1GHz~ 26.5GHz	Oct. 30, 2017	Aug. 07, 2018~ Sep. 05, 2018	Oct. 29, 2018	Radiation (03CH07-HY)
Spectrum Analyzer	Agilent	N9010A	MY5347011 8	10Hz~44GHz	Apr. 17, 2018	Aug. 07, 2018~ Sep. 05, 2018	Apr. 16, 2019	Radiation (03CH07-HY)
Filter	Microwave	H1G013G1	SN477215	1.0G High Pass	Dec. 07, 2017	Aug. 07, 2018~ Sep. 05, 2018	Dec. 06, 2018	Radiation (03CH07-HY)
Filter	Wainwright	WLKS1200- 8SS	SN3	1.2G Low Pass	Nov. 21, 2017	Aug. 07, 2018~ Sep. 05, 2018	Nov. 20, 2018	Radiation (03CH07-HY)
Filter	Microwave	H3G018G1	SN477220	3.0G High Pass	Nov. 21, 2017	Aug. 07, 2018~ Sep. 05, 2018	Nov. 20, 2018	Radiation (03CH07-HY)



Instrument	Manufacturer	Model No.	Serial No.	Characteristics	Calibration Date	Test Date	Due Date	Remark
Filter	Microwave	WHKX7.0/2 6.5G-6SS	SN4	7G High Pass	Nov. 21, 2017	Aug. 07, 2018~ Sep. 05, 2018	Nov. 20, 2018	Radiation (03CH07-HY)
RF Cable	HUBER + SUHNER	SUCOFLEX 104	MY24971/4, MY28655/4	9KHz~30MHz	Jan. 02, 2018	Aug. 07, 2018~ Sep. 05, 2018	Jan. 01, 2019	Radiation (03CH07-HY)
RF Cable	HUBER + SUHNER	SUCOFLEX 104	MY28655/4, MY24971/4, MY15682/4	30MHz~1GHz	Feb. 27, 2018	Aug. 07, 2018~ Sep. 05, 2018	Feb. 26, 2019	Radiation (03CH07-HY)
RF Cable	HUBER + SUHNER	SUCOFLEX 104	MY28655/4, MY24971/4, MY15682/4	1GHz~18GHz	Feb. 27, 2018	Aug. 07, 2018~ Sep. 05, 2018	Feb. 26, 2019	Radiation (03CH07-HY)
RF Cable	HUBER + SUHNER	SUCOFLEX 102	MY2858/2	18GHz~40GHz	Feb. 27, 2018	Aug. 07, 2018~ Sep. 05, 2018	Feb. 26, 2019	Radiation (03CH07-HY)
Antenna Mast	Max-Full	MFA520BS	N/A	1m~4m	N/A	Aug. 07, 2018~ Sep. 05, 2018	N/A	Radiation (03CH07-HY)
Turn Table	ChainTek	Chaintek 3000	N/A	0~360 Degree	N/A	Aug. 07, 2018~ Sep. 05, 2018	N/A	Radiation (03CH07-HY)
Amplifier	MITEQ	TTA1840-35 -HG	1871923	18GHz~40GHz, VSWR : 2.5:1 max	Jul. 16, 2018	Aug. 07, 2018~ Sep. 05, 2018	Jul. 15, 2019	Radiation (03CH07-HY)
SHF-EHF Horn Antenna	SCHWARZBE CK	BBHA 9170	BBHA91702 51	18GHz- 40GHz	Nov. 10, 2017	Aug. 07, 2018~ Sep. 05, 2018	Nov. 09, 2018	Radiation (03CH07-HY)
EMI Test Receiver	Agilent	N9038A(MX E)	MY5329005 3	20Hz to 26.5GHz	Jan. 16, 2018	Aug. 07, 2018~ Sep. 05, 2018	Jan. 15, 2019	Radiation (03CH07-HY)
Software	Audix	E3 6.2009-8 -24	8050400465 6H	N/A	N/A	Aug. 07, 2018~ Sep. 05, 2018	N/A	Radiation (03CH07-HY)



5 Uncertainty of Evaluation

Uncertainty of Conducted Emission Measurement (150kHz ~ 30MHz)

Measuring Uncertainty for a Level of Confidence of 95% ($U = 2Uc(y)$)	2.70
---	------

Uncertainty of Radiated Emission Measurement (30 MHz ~ 1000 MHz)

Measuring Uncertainty for a Level of Confidence of 95% ($U = 2Uc(y)$)	5.70
---	------

Uncertainty of Radiated Emission Measurement (1000 MHz ~ 18000 MHz)

Measuring Uncertainty for a Level of Confidence of 95% ($U = 2Uc(y)$)	5.50
---	------

Uncertainty of Radiated Emission Measurement (18000 MHz ~ 40000 MHz)

Measuring Uncertainty for a Level of Confidence of 95% ($U = 2Uc(y)$)	5.20
---	------



Appendix A. AC Conducted Emission Test Results

<Original test result with NFC antenna>

Test Mode :	Mode 1	Temperature :	25~27°C
Test Engineer :	Kai-Chun Chu	Relative Humidity :	50~52%
Test Voltage :	120Vac / 60Hz	Phase :	Line

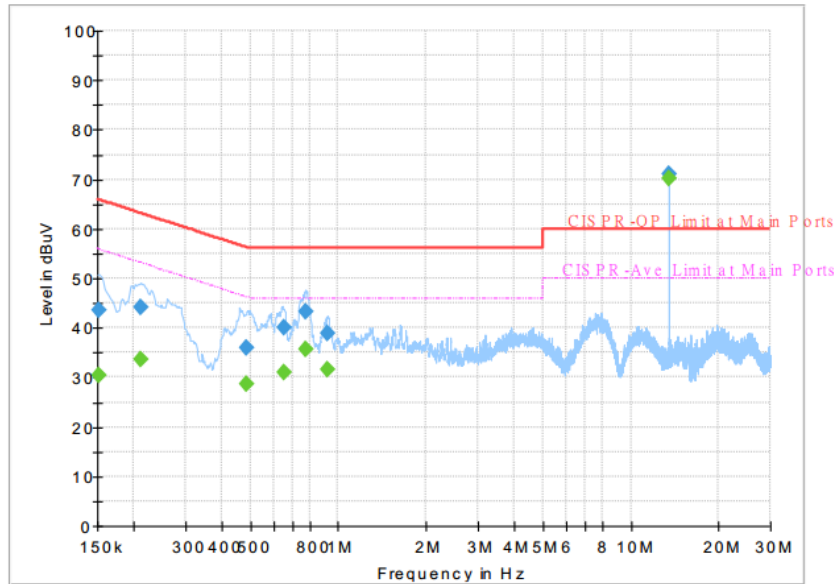

Final Result

Frequency (MHz)	QuasiPeak (dBuV)	CAverage (dBuV)	Limit (dBuV)	Margin (dB)	Line	Filter	Corr. (dB)
0.152250	---	30.31	55.88	25.57	L1	OFF	19.5
0.152250	43.59	---	65.88	22.29	L1	OFF	19.5
0.210750	---	33.72	53.18	19.46	L1	OFF	19.5
0.210750	44.03	---	63.18	19.15	L1	OFF	19.5
0.487500	---	28.57	46.21	17.64	L1	OFF	19.5
0.487500	36.03	---	56.21	20.18	L1	OFF	19.5
0.649500	---	30.98	46.00	15.02	L1	OFF	19.5
0.649500	40.07	---	56.00	15.93	L1	OFF	19.5
0.773250	---	35.79	46.00	10.21	L1	OFF	19.5
0.773250	43.21	---	56.00	12.79	L1	OFF	19.5
0.917250	---	31.54	46.00	14.46	L1	OFF	19.5
0.917250	38.83	---	56.00	17.17	L1	OFF	19.5
13.560000	---	70.05	50.00	-20.05	L1	OFF	19.7
13.560000	70.96	---	60.00	-10.96	L1	OFF	19.7



Test Mode :	Mode 1	Temperature :	25~27°C
Test Engineer :	Kai-Chun Chu	Relative Humidity :	50~52%
Test Voltage :	120Vac / 60Hz	Phase :	Neutral

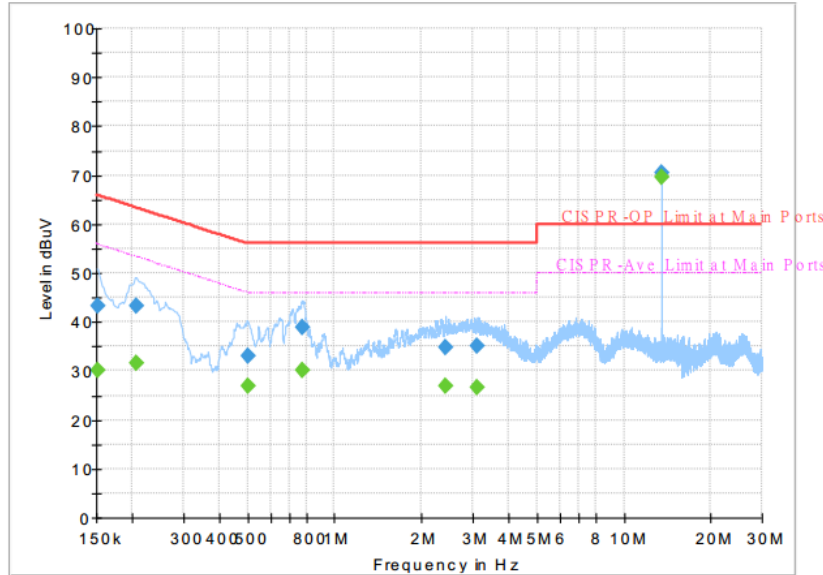

Final Result

Frequency (MHz)	QuasiPeak (dBuV)	CAverage (dBuV)	Limit (dBuV)	Margin (dB)	Line	Filter	Corr. (dB)
0.152250	---	30.00	55.88	25.88	N	OFF	19.5
0.152250	43.28	---	65.88	22.60	N	OFF	19.5
0.206250	---	31.72	53.36	21.64	N	OFF	19.5
0.206250	43.33	---	63.36	20.03	N	OFF	19.5
0.501000	---	26.95	46.00	19.05	N	OFF	19.5
0.501000	33.14	---	56.00	22.86	N	OFF	19.5
0.771000	---	30.12	46.00	15.88	N	OFF	19.5
0.771000	38.77	---	56.00	17.23	N	OFF	19.5
2.413500	---	26.97	46.00	19.03	N	OFF	19.5
2.413500	34.90	---	56.00	21.10	N	OFF	19.5
3.124500	---	26.58	46.00	19.42	N	OFF	19.6
3.124500	35.10	---	56.00	20.90	N	OFF	19.6
13.560000	---	69.55	50.00	-19.55	N	OFF	19.8
13.560000	70.61	---	60.00	-10.61	N	OFF	19.8



<Terminal test result with dummy load>

Test Mode :	Mode 1	Temperature :	25~27°C
Test Engineer :	Kai-Chun Chu	Relative Humidity :	50~52%
Test Voltage :	120Vac / 60Hz	Phase :	Line

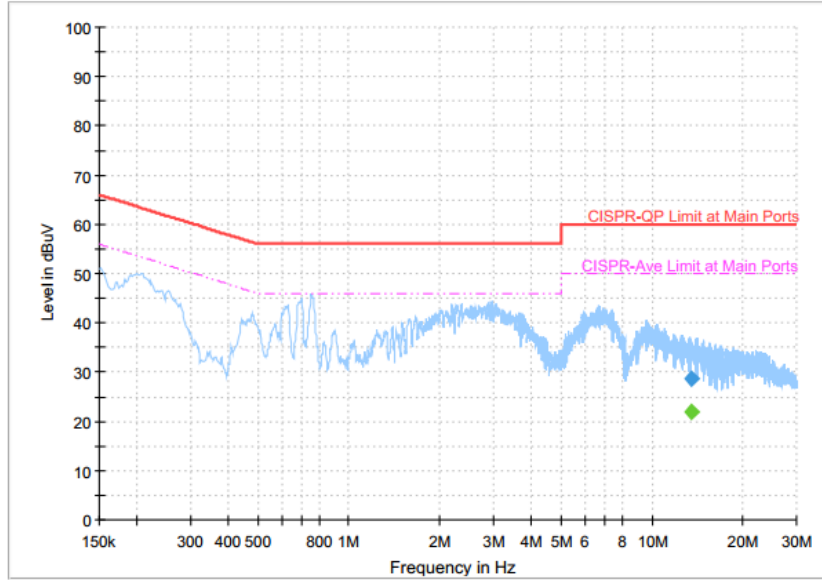

Final Result

Frequency (MHz)	QuasiPeak (dBuV)	CAverage (dBuV)	Limit (dBuV)	Margin (dB)	Line	Filter	Corr. (dB)
13.560000	---	21.98	50.00	28.02	L1	OFF	19.7
13.560000	28.75	---	60.00	31.25	L1	OFF	19.7



Test Mode :	Mode 1	Temperature :	25~27°C
Test Engineer :	Kai-Chun Chu	Relative Humidity :	50~52%
Test Voltage :	120Vac / 60Hz	Phase :	Neutral

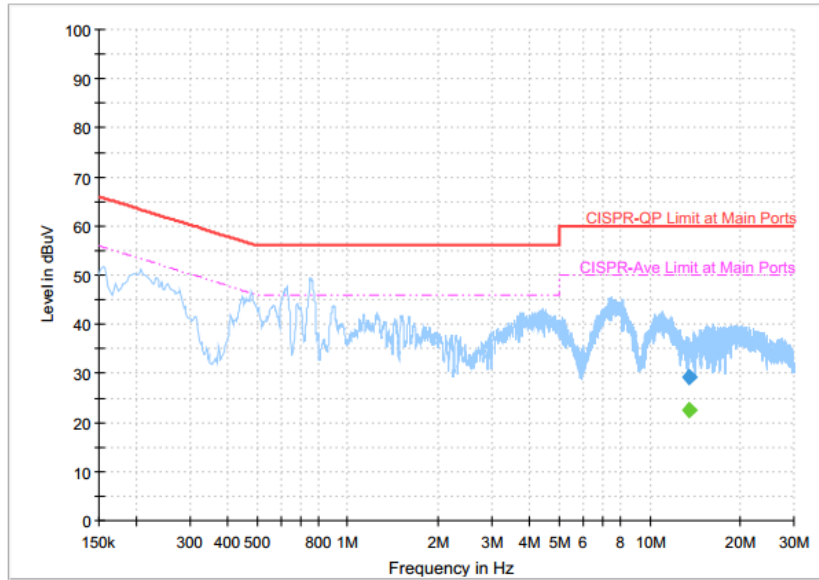

Final Result

Frequency (MHz)	QuasiPeak (dBuV)	CAverage (dBuV)	Limit (dBuV)	Margin (dB)	Line	Filter	Corr. (dB)
13.560000	---	22.49	50.00	27.51	N	OFF	19.8
13.560000	29.31	---	60.00	30.69	N	OFF	19.8



<Original test result with NFC antenna>

Test Mode :	Mode 2	Temperature :	25~27°C
Test Engineer :	Kai-Chun Chu	Relative Humidity :	50~52%
Test Voltage :	120Vac / 60Hz	Phase :	Line

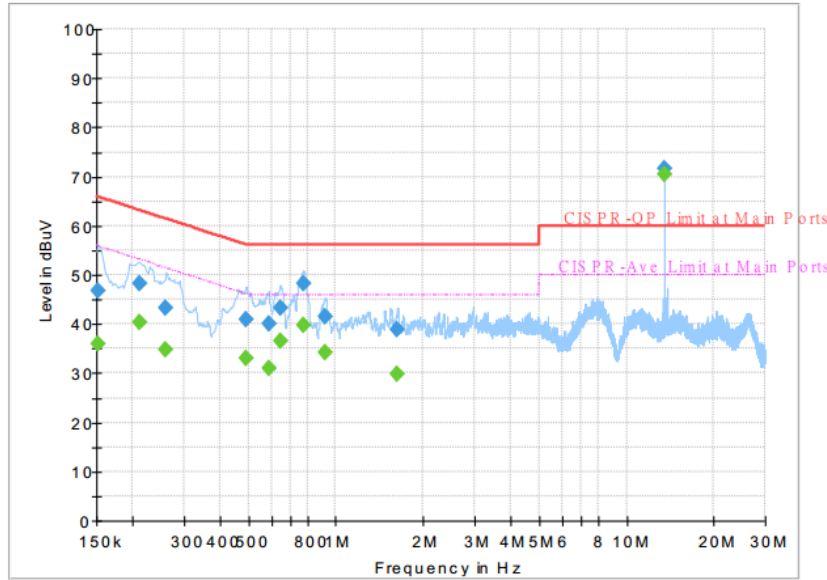

Final Result

Frequency (MHz)	QuasiPeak (dBuV)	CAverage (dBuV)	Limit (dBuV)	Margin (dB)	Line	Filter	Corr. (dB)
0.152250	---	36.04	55.88	19.84	L1	OFF	19.5
0.152250	46.75	---	65.88	19.13	L1	OFF	19.5
0.210750	---	40.39	53.18	12.79	L1	OFF	19.5
0.210750	48.26	---	63.18	14.92	L1	OFF	19.5
0.260250	---	34.76	51.42	16.66	L1	OFF	19.5
0.260250	43.39	---	61.42	18.03	L1	OFF	19.5
0.492000	---	32.97	46.13	13.16	L1	OFF	19.5
0.492000	40.84	---	56.13	15.29	L1	OFF	19.5
0.586500	---	31.05	46.00	14.95	L1	OFF	19.5
0.586500	39.93	---	56.00	16.07	L1	OFF	19.5
0.642750	---	36.50	46.00	9.50	L1	OFF	19.5
0.642750	43.26	---	56.00	12.74	L1	OFF	19.5
0.773250	---	39.78	46.00	6.22	L1	OFF	19.5
0.773250	48.31	---	56.00	7.69	L1	OFF	19.5
0.919500	---	34.23	46.00	11.77	L1	OFF	19.5
0.919500	41.60	---	56.00	14.40	L1	OFF	19.5
1.630500	---	29.89	46.00	16.11	L1	OFF	19.6
1.630500	38.81	---	56.00	17.19	L1	OFF	19.6
13.560000	---	70.46	50.00	-20.46	L1	OFF	19.7
13.560000	71.74	---	60.00	-11.74	L1	OFF	19.7



Test Mode :	Mode 2	Temperature :	25~27°C
Test Engineer :	Kai-Chun Chu	Relative Humidity :	50~52%
Test Voltage :	120Vac / 60Hz	Phase :	Neutral

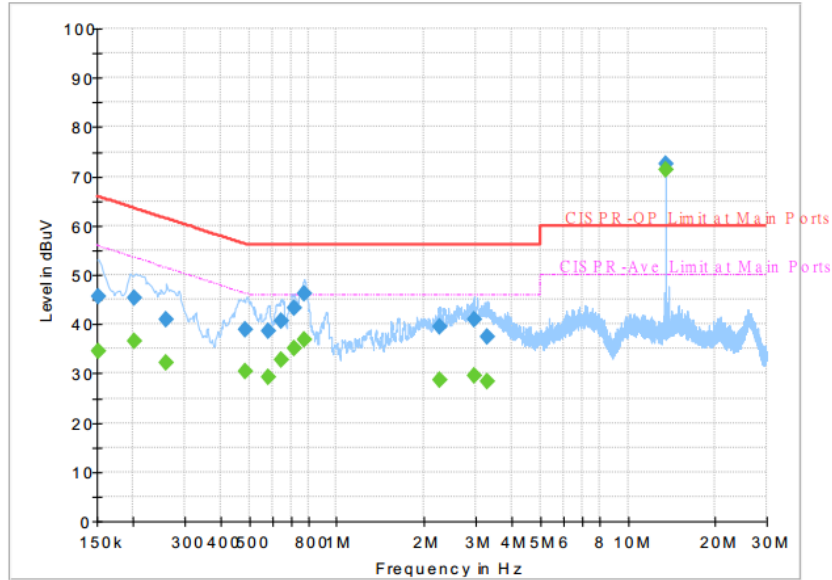

Final Result

Frequency (MHz)	QuasiPeak (dBuV)	CAverage (dBuV)	Limit (dBuV)	Margin (dB)	Line	Filter	Corr. (dB)
0.152250	---	34.51	55.88	21.37	N	OFF	19.5
0.152250	45.52	---	65.88	20.36	N	OFF	19.5
0.201750	---	36.47	53.54	17.07	N	OFF	19.5
0.201750	45.18	---	63.54	18.36	N	OFF	19.5
0.260250	---	32.30	51.42	19.12	N	OFF	19.5
0.260250	40.98	---	61.42	20.44	N	OFF	19.5
0.487500	---	30.50	46.21	15.71	N	OFF	19.5
0.487500	38.84	---	56.21	17.37	N	OFF	19.5
0.582000	---	29.37	46.00	16.63	N	OFF	19.5
0.582000	38.71	---	56.00	17.29	N	OFF	19.5
0.642750	---	32.78	46.00	13.22	N	OFF	19.5
0.642750	40.66	---	56.00	15.34	N	OFF	19.5
0.714750	---	34.94	46.00	11.06	N	OFF	19.5
0.714750	43.18	---	56.00	12.82	N	OFF	19.5
0.773250	---	36.83	46.00	9.17	N	OFF	19.5
0.773250	46.18	---	56.00	9.82	N	OFF	19.5
2.251500	---	28.55	46.00	17.45	N	OFF	19.4
2.251500	39.35	---	56.00	16.65	N	OFF	19.4
2.955750	---	29.54	46.00	16.46	N	OFF	19.6
2.955750	40.88	---	56.00	15.12	N	OFF	19.6
3.306750	---	28.36	46.00	17.64	N	OFF	19.6
3.306750	37.31	---	56.00	18.69	N	OFF	19.6
13.560000	---	71.24	50.00	-21.24	N	OFF	19.8
13.560000	72.44	---	60.00	-12.44	N	OFF	19.8



<Terminal test result with dummy load>

Test Mode :	Mode 2	Temperature :	25~27°C
Test Engineer :	Kai-Chun Chu	Relative Humidity :	50~52%
Test Voltage :	120Vac / 60Hz	Phase :	Line

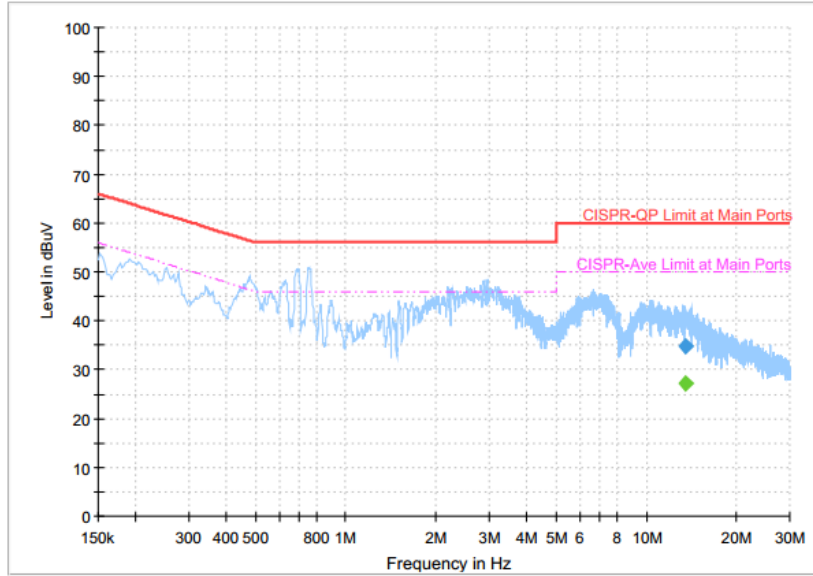

Final Result

Frequency (MHz)	QuasiPeak (dBuV)	CAverage (dBuV)	Limit (dBuV)	Margin (dB)	Line	Filter	Corr. (dB)
13.560000	---	27.32	50.00	22.68	L1	OFF	19.7
13.560000	34.88	---	60.00	25.12	L1	OFF	19.7



Test Mode :	Mode 2	Temperature :	25~27°C
Test Engineer :	Kai-Chun Chu	Relative Humidity :	50~52%
Test Voltage :	120Vac / 60Hz	Phase :	Neutral

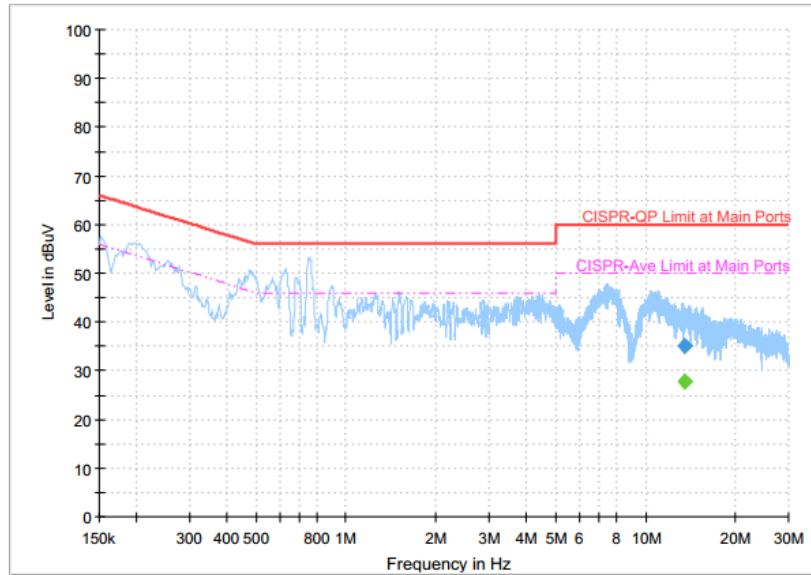

Final Result

Frequency (MHz)	QuasiPeak (dBuV)	CAverage (dBuV)	Limit (dBuV)	Margin (dB)	Line	Filter	Corr. (dB)
13.560000	---	27.87	50.00	22.13	N	OFF	19.8
13.560000	35.04	---	60.00	24.96	N	OFF	19.8



<Original test result with NFC antenna>

Test Mode :	Mode 3	Temperature :	25~27°C
Test Engineer :	Kai-Chun Chu	Relative Humidity :	50~52%
Test Voltage :	120Vac / 60Hz	Phase :	Line

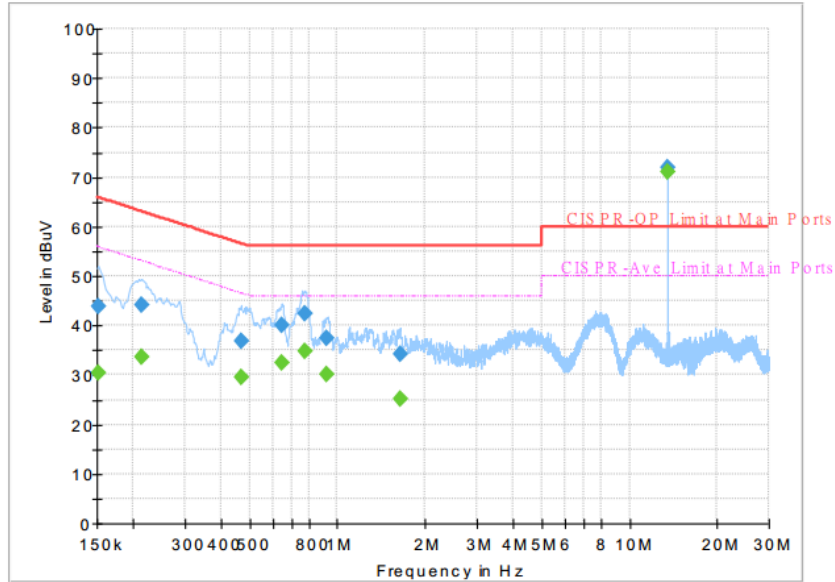

Final Result

Frequency (MHz)	QuasiPeak (dBuV)	CAverage (dBuV)	Limit (dBuV)	Margin (dB)	Line	Filter	Corr. (dB)
0.152250	---	30.36	55.88	25.52	L1	OFF	19.5
0.152250	43.74	---	65.88	22.14	L1	OFF	19.5
0.213000	---	33.73	53.09	19.36	L1	OFF	19.5
0.213000	44.23	---	63.09	18.86	L1	OFF	19.5
0.467250	---	29.44	46.56	17.12	L1	OFF	19.5
0.467250	36.98	---	56.56	19.58	L1	OFF	19.5
0.645000	---	32.60	46.00	13.40	L1	OFF	19.5
0.645000	40.14	---	56.00	15.86	L1	OFF	19.5
0.771000	---	34.68	46.00	11.32	L1	OFF	19.5
0.771000	42.48	---	56.00	13.52	L1	OFF	19.5
0.921750	---	30.11	46.00	15.89	L1	OFF	19.5
0.921750	37.30	---	56.00	18.70	L1	OFF	19.5
1.637250	---	25.15	46.00	20.85	L1	OFF	19.6
1.637250	34.24	---	56.00	21.76	L1	OFF	19.6
13.560000	---	71.10	50.00	-21.10	L1	OFF	19.7
13.560000	72.06	---	60.00	-12.06	L1	OFF	19.7



Test Mode :	Mode 3	Temperature :	25~27°C
Test Engineer :	Kai-Chun Chu	Relative Humidity :	50~52%
Test Voltage :	120Vac / 60Hz	Phase :	Neutral

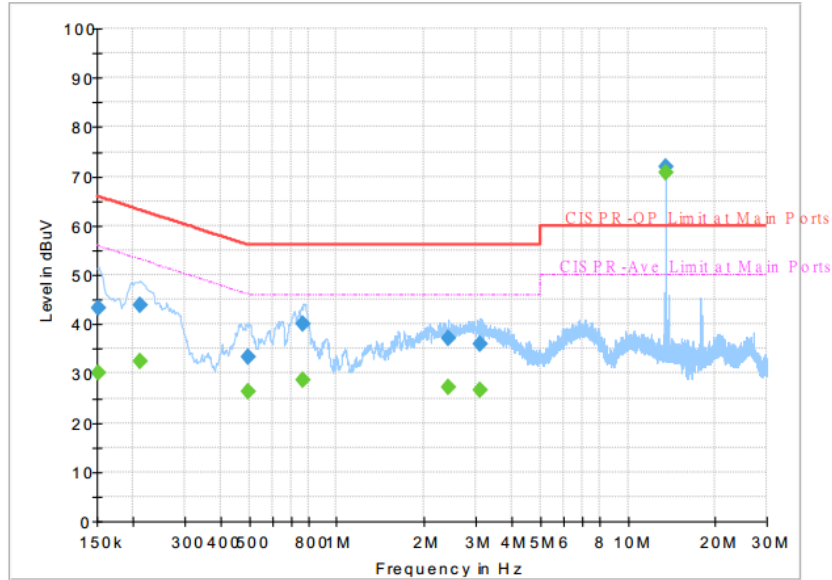

Final Result

Frequency (MHz)	QuasiPeak (dBuV)	CAverage (dBuV)	Limit (dBuV)	Margin (dB)	Line	Filter	Corr. (dB)
0.152250	---	30.08	55.88	25.80	N	OFF	19.5
0.152250	43.36	---	65.88	22.52	N	OFF	19.5
0.210750	---	32.47	53.18	20.71	N	OFF	19.5
0.210750	43.91	---	63.18	19.27	N	OFF	19.5
0.498750	---	26.21	46.02	19.81	N	OFF	19.5
0.498750	33.45	---	56.02	22.57	N	OFF	19.5
0.768750	---	28.80	46.00	17.20	N	OFF	19.5
0.768750	40.18	---	56.00	15.82	N	OFF	19.5
2.413500	---	27.30	46.00	18.70	N	OFF	19.5
2.413500	37.11	---	56.00	18.89	N	OFF	19.5
3.124500	---	26.53	46.00	19.47	N	OFF	19.6
3.124500	35.96	---	56.00	20.04	N	OFF	19.6
13.560000	---	70.75	50.00	-20.75	N	OFF	19.8
13.560000	71.84	---	60.00	-11.84	N	OFF	19.8



<Terminal test result with dummy load>

Test Mode :	Mode 3	Temperature :	25~27°C
Test Engineer :	Kai-Chun Chu	Relative Humidity :	50~52%
Test Voltage :	120Vac / 60Hz	Phase :	Line

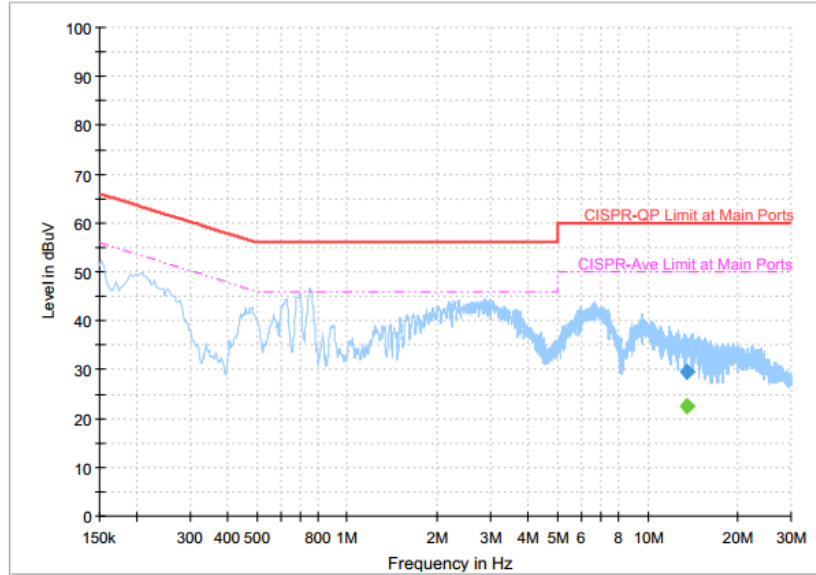

Final Result

Frequency (MHz)	QuasiPeak (dBuV)	CAverage (dBuV)	Limit (dBuV)	Margin (dB)	Line	Filter	Corr. (dB)
13.560000	---	22.59	50.00	27.41	L1	OFF	19.7
13.560000	29.48	---	60.00	30.52	L1	OFF	19.7



Test Mode :	Mode 3	Temperature :	25~27°C
Test Engineer :	Kai-Chun Chu	Relative Humidity :	50~52%
Test Voltage :	120Vac / 60Hz	Phase :	Neutral

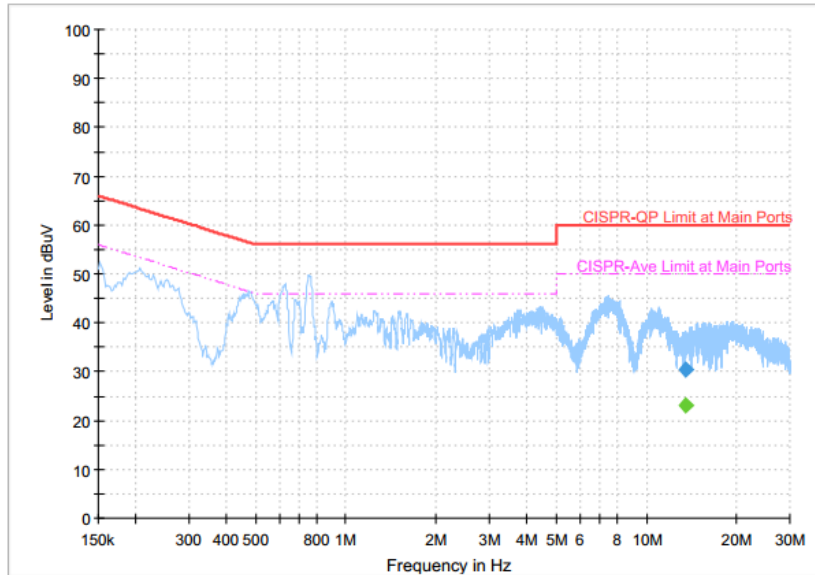

Final Result

Frequency (MHz)	QuasiPeak (dBuV)	CAverage (dBuV)	Limit (dBuV)	Margin (dB)	Line	Filter	Corr. (dB)
13.560000	---	22.97	50.00	27.03	N	OFF	19.8
13.560000	30.44	---	60.00	29.56	N	OFF	19.8



Appendix B. Radiated Spurious Emission

Test Engineer :	Jesse Wang, Stan Hsieh, and Nick Yu	Temperature :	24~26°C
		Relative Humidity :	51~53%

<CDD Mode>
<For Earphone 1>

Band 4 - 5725~5850MHz
WIFI 802.11a (Band Edge @ 3m)

WIFI	Note	Frequency	Level	Over	Limit	Read	Antenna	Path	Preamp	Ant	Table	Peak	Pol.	
Ant. 1		(MHz)	(dBµV/m)	Limit (dB)	Line (dBµV/m)	Level (dBµV)	Factor (dB/m)	Loss (dB)	Factor (dB)	Pos (cm)	Pos (deg)	Avg. (P/A)	(H/V)	
802.11a CH 149 5745MHz		5648.2	53.01	-15.19	68.2	41.68	35.09	11.43	35.19	198	24	P	H	
		5685.2	61.91	-32.37	94.28	50.48	35.17	11.46	35.2	198	24	P	H	
		5719.8	71.11	-39.63	110.74	59.6	35.21	11.5	35.2	198	24	P	H	
		5725	81.86	-40.34	122.2	70.35	35.21	11.5	35.2	198	24	P	H	
	*	5745	115.77	-	-	104.21	35.24	11.53	35.21	198	24	P	H	
	*	5745	108.31	-	-	96.75	35.24	11.53	35.21	198	24	A	H	
														H
														H
			5629	52.08	-16.12	68.2	40.77	35.07	11.43	35.19	319	278	P	V
			5689.6	58.38	-39.15	97.53	46.95	35.17	11.46	35.2	319	278	P	V
			5719.4	65.71	-44.92	110.63	54.2	35.21	11.5	35.2	319	278	P	V
			5724.4	77.01	-43.82	120.83	65.5	35.21	11.5	35.2	319	278	P	V
	*		5745	112.24	-	-	100.68	35.24	11.53	35.21	319	278	P	V
	*		5745	104.66	-	-	93.1	35.24	11.53	35.21	319	278	A	V
														V
													V	



WIFI	Note	Frequency	Level	Over	Limit	Read	Antenna	Path	Preamp	Ant	Table	Peak	Pol.	
Ant.				Limit	Line	Level	Factor	Loss	Factor	Pos	Pos	Avg.		
1		(MHz)	(dBµV/m)	(dB)	(dBµV/m)	(dBµV)	(dB/m)	(dB)	(dB)	(cm)	(deg)	(P/A)	(H/V)	
802.11a CH 157 5785MHz		5638.4	50.82	-17.38	68.2	39.49	35.09	11.43	35.19	206	23	P	H	
		5697.4	53.68	-49.6	103.28	42.25	35.17	11.46	35.2	206	23	P	H	
		5710.8	55.83	-52.4	108.23	44.34	35.19	11.5	35.2	206	23	P	H	
		5724.4	59.11	-61.72	120.83	47.6	35.21	11.5	35.2	206	23	P	H	
	*	5785	115.18	-	-	103.55	35.29	11.56	35.22	206	23	P	H	
	*	5785	107.78	-	-	96.15	35.29	11.56	35.22	206	23	A	H	
		5852.8	55.26	-60.56	115.82	43.51	35.38	11.6	35.23	206	23	P	H	
		5857.4	58.76	-51.37	110.13	46.98	35.41	11.6	35.23	206	23	P	H	
		5893	53.14	-38.7	91.84	41.27	35.46	11.65	35.24	206	23	P	H	
		5926.8	52.07	-16.13	68.2	40.12	35.5	11.69	35.24	206	23	P	H	
														H
														H
			5626.4	51.71	-16.49	68.2	40.39	35.07	11.43	35.18	286	306	P	V
			5654.4	50.78	-20.69	71.47	39.42	35.12	11.43	35.19	286	306	P	V
			5707	53.11	-54.05	107.16	41.62	35.19	11.5	35.2	286	306	P	V
			5724.4	56.41	-64.42	120.83	44.9	35.21	11.5	35.2	286	306	P	V
	*		5785	112.21	-	-	100.58	35.29	11.56	35.22	286	306	P	V
	*		5785	104.51	-	-	92.88	35.29	11.56	35.22	286	306	A	V
			5850.8	55.33	-65.05	120.38	43.58	35.38	11.6	35.23	286	306	P	V
			5857.8	53.87	-56.14	110.01	42.1	35.41	11.6	35.24	286	306	P	V
		5880	50.88	-50.61	101.49	39.04	35.43	11.65	35.24	286	306	P	V	
		5938	50.08	-18.12	68.2	38.14	35.5	11.69	35.25	286	306	P	V	
													V	
													V	



WIFI	Note	Frequency	Level	Over	Limit	Read	Antenna	Path	Preamp	Ant	Table	Peak	Pol.	
Ant.				Limit	Line	Level	Factor	Loss	Factor	Pos	Pos	Avg.		
1		(MHz)	(dBμV/m)	(dB)	(dBμV/m)	(dBμV)	(dB/m)	(dB)	(dB)	(cm)	(deg)	(P/A)	(H/V)	
802.11a CH 165 5825MHz	*	5825	115.01	-	-	103.27	35.36	11.6	35.22	203	23	P	H	
	*	5825	107.23	-	-	95.49	35.36	11.6	35.22	203	23	A	H	
		5850.6	66.9	-53.93	120.83	55.15	35.38	11.6	35.23	203	23	P	H	
		5858.2	66.53	-43.37	109.9	54.76	35.41	11.6	35.24	203	23	P	H	
		5879	62.44	-39.79	102.23	50.6	35.43	11.65	35.24	203	23	P	H	
		5945	51.07	-17.13	68.2	39.05	35.53	11.74	35.25	203	23	P	H	
														H
														H
	*	5825	111.55	-	-	99.81	35.36	11.6	35.22	305	295	P	V	
	*	5825	103.95	-	-	92.21	35.36	11.6	35.22	305	295	A	V	
		5852	62.28	-55.36	117.64	50.53	35.38	11.6	35.23	305	295	P	V	
		5859	62	-47.68	109.68	50.23	35.41	11.6	35.24	305	295	P	V	
		5877.2	57.84	-45.73	103.57	46	35.43	11.65	35.24	305	295	P	V	
		5936.8	49.32	-18.88	68.2	37.38	35.5	11.69	35.25	305	295	P	V	
														V
														V
														V
	Remark	1. No other spurious found. 2. All results are PASS against Peak and Average limit line.												



Band 4 5725~5850MHz
WIFI 802.11a (Harmonic @ 3m)

WIFI	Note	Frequency	Level	Over	Limit	Read	Antenna	Path	Preamp	Ant	Table	Peak	Pol.
Ant.				Limit	Line	Level	Factor	Loss	Factor	Pos	Pos	Avg.	
1		(MHz)	(dBµV/m)	(dB)	(dBµV/m)	(dBµV)	(dB/m)	(dB)	(dB)	(cm)	(deg)	(P/A)	(H/V)
802.11a CH 149 5745MHz		11490	52.63	-21.37	74	53.15	38.38	18.44	57.34	100	318	P	H
		11490	43.22	-10.78	54	43.74	38.38	18.44	57.34	100	318	A	H
		17235	52.25	-15.95	68.2	44.43	41.77	21.8	55.75	100	0	P	H
													H
		11490	49.49	-24.51	74	50.01	38.38	18.44	57.34	100	0	P	V
		17235	53.31	-14.89	68.2	45.49	41.77	21.8	55.75	100	0	P	V
802.11a CH 157 5785MHz		11570	49.89	-24.11	74	50.09	38.46	18.54	57.2	100	0	P	H
		17355	53.45	-14.75	68.2	45.66	41.61	21.91	55.73	100	0	P	H
													H
													H
		11570	49.85	-24.15	74	50.05	38.46	18.54	57.2	100	0	P	V
		17355	54.16	-14.04	68.2	46.37	41.61	21.91	55.73	100	0	P	V
802.11a CH 165 5825MHz		11650	54.13	-19.87	74	54.09	38.51	18.64	57.11	100	318	P	H
		11650	44.55	-9.45	54	44.51	38.51	18.64	57.11	100	318	A	H
													H
													H
		17475	53.01	-15.19	68.2	45.26	41.45	22.01	55.71	100	0	P	V
		11650	54.48	-19.52	74	54.44	38.51	18.64	57.11	100	241	P	V
		11650	44.65	-9.35	54	44.61	38.51	18.64	57.11	100	241	A	V
	17475	53.07	-15.13	68.2	45.32	41.45	22.01	55.71	100	0	P	V	
Remark	1. No other spurious found. 2. All results are PASS against Peak and Average limit line.												



Band 4 5725~5850MHz
WIFI 802.11ac VHT20 (Band Edge @ 3m)

WIFI	Note	Frequency	Level	Over	Limit	Read	Antenna	Path	Preamp	Ant	Table	Peak	Pol.	
Ant.				Limit	Line	Level	Factor	Loss	Factor	Pos	Pos	Avg.		
1		(MHz)	(dBμV/m)	(dB)	(dBμV/m)	(dBμV)	(dB/m)	(dB)	(dB)	(cm)	(deg)	(P/A)	(H/V)	
802.11ac VHT20 CH 149 5745MHz		5644	51.79	-16.41	68.2	40.46	35.09	11.43	35.19	197	24	P	H	
		5700	62.79	-42.41	105.2	51.36	35.17	11.46	35.2	197	24	P	H	
		5719.6	72.87	-37.82	110.69	61.36	35.21	11.5	35.2	197	24	P	H	
		5724.6	82.79	-38.5	121.29	71.28	35.21	11.5	35.2	197	24	P	H	
	*	5745	115.54	-	-	103.98	35.24	11.53	35.21	197	24	P	H	
	*	5745	107.81	-	-	96.25	35.24	11.53	35.21	197	24	A	H	
														H
														H
			5640.6	50.32	-17.88	68.2	38.99	35.09	11.43	35.19	330	296	P	V
			5698.8	60.07	-44.25	104.32	48.64	35.17	11.46	35.2	330	296	P	V
			5720	69.76	-41.04	110.8	58.25	35.21	11.5	35.2	330	296	P	V
			5723.6	78.96	-40.05	119.01	67.45	35.21	11.5	35.2	330	296	P	V
	*		5745	112.7	-	-	101.14	35.24	11.53	35.21	330	296	P	V
	*		5745	104.97	-	-	93.41	35.24	11.53	35.21	330	296	A	V
													V	
													V	



WIFI	Note	Frequency	Level	Over	Limit	Read	Antenna	Path	Preamp	Ant	Table	Peak	Pol.	
Ant.				Limit	Line	Level	Factor	Loss	Factor	Pos	Pos	Avg.		
1		(MHz)	(dBµV/m)	(dB)	(dBµV/m)	(dBµV)	(dB/m)	(dB)	(dB)	(cm)	(deg)	(P/A)	(H/V)	
802.11ac VHT20 CH 157 5785MHz		5643.6	51.48	-16.72	68.2	40.15	35.09	11.43	35.19	192	23	P	H	
		5692.2	53.53	-45.92	99.45	42.1	35.17	11.46	35.2	192	23	P	H	
		5719.4	59.41	-51.22	110.63	47.9	35.21	11.5	35.2	192	23	P	H	
		5722.6	59.52	-57.21	116.73	48.01	35.21	11.5	35.2	192	23	P	H	
	*	5785	114.95	-	-	103.32	35.29	11.56	35.22	192	23	P	H	
	*	5785	107.17	-	-	95.54	35.29	11.56	35.22	192	23	A	H	
		5852.2	58.48	-58.7	117.18	46.73	35.38	11.6	35.23	192	23	P	H	
		5855.8	59.09	-51.49	110.58	47.31	35.41	11.6	35.23	192	23	P	H	
		5884.6	52.7	-45.37	98.07	40.86	35.43	11.65	35.24	192	23	P	H	
		5928.6	50.95	-17.25	68.2	39	35.5	11.69	35.24	192	23	P	H	
														H
														H
			5604.8	51.24	-16.96	68.2	39.98	35.04	11.4	35.18	296	297	P	V
			5687.2	50.99	-44.77	95.76	39.56	35.17	11.46	35.2	296	297	P	V
			5716.2	55	-54.74	109.74	43.51	35.19	11.5	35.2	296	297	P	V
			5722	55.74	-59.62	115.36	44.23	35.21	11.5	35.2	296	297	P	V
	*		5785	112.28	-	-	100.65	35.29	11.56	35.22	296	297	P	V
	*		5785	104.48	-	-	92.85	35.29	11.56	35.22	296	297	A	V
			5850.6	54.32	-66.51	120.83	42.57	35.38	11.6	35.23	296	297	P	V
			5860.6	52.55	-56.68	109.23	40.73	35.41	11.65	35.24	296	297	P	V
		5875.6	50.27	-54.48	104.75	38.43	35.43	11.65	35.24	296	297	P	V	
		5927.8	49.48	-18.72	68.2	37.53	35.5	11.69	35.24	296	297	P	V	
													V	
													V	



WIFI	Note	Frequency	Level	Over	Limit	Read	Antenna	Path	Preamp	Ant	Table	Peak	Pol.	
Ant.				Limit	Line	Level	Factor	Loss	Factor	Pos	Pos	Avg.		
1		(MHz)	(dBμV/m)	(dB)	(dBμV/m)	(dBμV)	(dB/m)	(dB)	(dB)	(cm)	(deg)	(P/A)	(H/V)	
802.11ac VHT20 CH 165 5825MHz	*	5825	114.6	-	-	102.86	35.36	11.6	35.22	201	23	P	H	
	*	5825	106.51	-	-	94.77	35.36	11.6	35.22	201	23	A	H	
		5850	70.38	-51.82	122.2	58.63	35.38	11.6	35.23	201	23	P	H	
		5856.8	66.35	-43.95	110.3	54.57	35.41	11.6	35.23	201	23	P	H	
		5876.8	61.21	-42.65	103.86	49.37	35.43	11.65	35.24	201	23	P	H	
		5932	52.42	-15.78	68.2	40.47	35.5	11.69	35.24	201	23	P	H	
														H
														H
	*	5825	111.18	-	-	99.44	35.36	11.6	35.22	300	289	P	V	
	*	5825	103.19	-	-	91.45	35.36	11.6	35.22	300	289	A	V	
		5850	68.38	-53.82	122.2	56.63	35.38	11.6	35.23	300	289	P	V	
		5862.4	63.03	-45.7	108.73	51.21	35.41	11.65	35.24	300	289	P	V	
		5890.4	55.62	-38.15	93.77	43.75	35.46	11.65	35.24	300	289	P	V	
		5940.2	49.75	-18.45	68.2	37.73	35.53	11.74	35.25	300	289	P	V	
														V
													V	
Remark	1. No other spurious found. 2. All results are PASS against Peak and Average limit line.													



Band 4 5725~5850MHz
WIFI 802.11ac VHT20 (Harmonic @ 3m)

WIFI	Note	Frequency	Level	Over	Limit	Read	Antenna	Path	Preamp	Ant	Table	Peak	Pol.
Ant.				Limit	Line	Level	Factor	Loss	Factor	Pos	Pos	Avg.	
1		(MHz)	(dBμV/m)	(dB)	(dBμV/m)	(dBμV)	(dB/m)	(dB)	(dB)	(cm)	(deg)	(P/A)	(H/V)
802.11ac VHT20 CH 149 5745MHz		11490	52.45	-21.55	74	52.97	38.38	18.44	57.34	100	318	P	H
		11490	42.83	-11.17	54	43.35	38.38	18.44	57.34	100	318	A	H
		17235	52.57	-15.63	68.2	44.75	41.77	21.8	55.75	100	0	P	H
													H
		11490	49.2	-24.8	74	49.72	38.38	18.44	57.34	100	0	P	V
		17235	53.24	-14.96	68.2	45.42	41.77	21.8	55.75	100	0	P	V
													V
802.11ac VHT20 CH 157 5785MHz		11570	49.25	-24.75	74	49.45	38.46	18.54	57.2	100	0	P	H
		17355	53.7	-14.5	68.2	45.91	41.61	21.91	55.73	100	0	P	H
													H
													H
		11570	49.87	-24.13	74	50.07	38.46	18.54	57.2	100	0	P	V
		17355	53.68	-14.52	68.2	45.89	41.61	21.91	55.73	100	0	P	V
													V
802.11ac VHT20 CH 165 5825MHz		11650	54.38	-19.62	74	54.34	38.51	18.64	57.11	100	318	P	H
		11650	43.96	-10.04	54	43.92	38.51	18.64	57.11	100	318	A	H
		17475	53.24	-14.96	68.2	45.49	41.45	22.01	55.71	100	0	P	H
													H
		11650	54.27	-19.73	74	54.23	38.51	18.64	57.11	100	241	P	V
		11650	43.98	-10.02	54	43.94	38.51	18.64	57.11	100	241	A	V
		17475	52.58	-15.62	68.2	44.83	41.45	22.01	55.71	100	0	P	V
												V	
Remark	1. No other spurious found. 2. All results are PASS against Peak and Average limit line.												



Band 4 5725~5850MHz
WIFI 802.11ac VHT40 (Band Edge @ 3m)

WIFI	Note	Frequency	Level	Over	Limit	Read	Antenna	Path	Preamp	Ant	Table	Peak	Pol.
Ant.				Limit	Line	Level	Factor	Loss	Factor	Pos	Pos	Avg.	
1		(MHz)	(dBμV/m)	(dB)	(dBμV/m)	(dBμV)	(dB/m)	(dB)	(dB)	(cm)	(deg)	(P/A)	(H/V)
		5633.8	54.3	-13.9	68.2	42.97	35.09	11.43	35.19	197	23	P	H
		5693.4	67.66	-32.67	100.33	56.23	35.17	11.46	35.2	197	23	P	H
		5719	84.6	-25.92	110.52	73.09	35.21	11.5	35.2	197	23	P	H
		5724.4	86.71	-34.12	120.83	75.2	35.21	11.5	35.2	197	23	P	H
	*	5755	113.55	-	-	101.97	35.26	11.53	35.21	197	23	P	H
	*	5755	105.66	-	-	94.08	35.26	11.53	35.21	197	23	A	H
		5853	54.28	-61.08	115.36	42.53	35.38	11.6	35.23	197	23	P	H
		5855.6	56.01	-54.62	110.63	44.23	35.41	11.6	35.23	197	23	P	H
		5875.2	56.47	-48.58	105.05	44.63	35.43	11.65	35.24	197	23	P	H
		5934.8	49.93	-18.27	68.2	37.99	35.5	11.69	35.25	197	23	P	H
802.11ac													H
VHT40													H
CH 151		5644.4	52.32	-15.88	68.2	40.99	35.09	11.43	35.19	341	296	P	V
5755MHz		5699.2	63.35	-41.26	104.61	51.92	35.17	11.46	35.2	341	296	P	V
		5718	80.52	-29.72	110.24	69.01	35.21	11.5	35.2	341	296	P	V
		5724	82.32	-37.6	119.92	70.81	35.21	11.5	35.2	341	296	P	V
	*	5755	110.73	-	-	99.15	35.26	11.53	35.21	341	296	P	V
	*	5755	102.7	-	-	91.12	35.26	11.53	35.21	341	296	A	V
		5854.8	51.98	-59.28	111.26	40.2	35.41	11.6	35.23	341	296	P	V
		5871.6	51.19	-54.96	106.15	39.35	35.43	11.65	35.24	341	296	P	V
		5899.2	50.43	-36.82	87.25	38.56	35.46	11.65	35.24	341	296	P	V
		5944.8	48.74	-19.46	68.2	36.72	35.53	11.74	35.25	341	296	P	V
													V
													V



WIFI	Note	Frequency	Level	Over	Limit	Read	Antenna	Path	Preamp	Ant	Table	Peak	Pol.	
Ant.				Limit	Line	Level	Factor	Loss	Factor	Pos	Pos	Avg.		
1		(MHz)	(dBμV/m)	(dB)	(dBμV/m)	(dBμV)	(dB/m)	(dB)	(dB)	(cm)	(deg)	(P/A)	(H/V)	
802.11ac VHT40 CH 159 5795MHz		5648.6	51.15	-17.05	68.2	39.82	35.09	11.43	35.19	205	25	P	H	
		5674.6	54.98	-31.46	86.44	43.57	35.14	11.46	35.19	205	25	P	H	
		5714.6	58.96	-50.33	109.29	47.47	35.19	11.5	35.2	205	25	P	H	
		5720.4	58.97	-52.74	111.71	47.46	35.21	11.5	35.2	205	25	P	H	
	*	5795	113.05	-	-	101.4	35.31	11.56	35.22	205	25	P	H	
	*	5795	105.25	-	-	93.6	35.31	11.56	35.22	205	25	A	H	
		5850	64.13	-58.07	122.2	52.38	35.38	11.6	35.23	205	25	P	H	
		5855.6	62.89	-47.74	110.63	51.11	35.41	11.6	35.23	205	25	P	H	
		5877.4	58.45	-44.97	103.42	46.61	35.43	11.65	35.24	205	25	P	H	
		5925.8	51.61	-16.59	68.2	39.66	35.5	11.69	35.24	205	25	P	H	
														H
														H
			5638.6	51.52	-16.68	68.2	40.19	35.09	11.43	35.19	298	281	P	V
			5694.6	53.09	-48.13	101.22	41.66	35.17	11.46	35.2	298	281	P	V
			5715.8	56.07	-53.56	109.63	44.58	35.19	11.5	35.2	298	281	P	V
			5721.2	55.16	-58.38	113.54	43.65	35.21	11.5	35.2	298	281	P	V
	*		5795	110.08	-	-	98.43	35.31	11.56	35.22	298	281	P	V
	*		5795	102.05	-	-	90.4	35.31	11.56	35.22	298	281	A	V
			5850.8	59.75	-60.63	120.38	48	35.38	11.6	35.23	298	281	P	V
			5855.8	59.16	-51.42	110.58	47.38	35.41	11.6	35.23	298	281	P	V
		5877	54.93	-48.78	103.71	43.09	35.43	11.65	35.24	298	281	P	V	
		5939.8	49.62	-18.58	68.2	37.65	35.53	11.69	35.25	298	281	P	V	
													V	
													V	
Remark	1. No other spurious found. 2. All results are PASS against Peak and Average limit line.													



**Band 4 5725~5850MHz
WIFI 802.11ac VHT40 (Harmonic @ 3m)**

WIFI	Note	Frequency	Level	Over	Limit	Read	Antenna	Path	Preamp	Ant	Table	Peak	Pol.
Ant.				Limit	Line	Level	Factor	Loss	Factor	Pos	Pos	Avg.	
1		(MHz)	(dBµV/m)	(dB)	(dBµV/m)	(dBµV)	(dB/m)	(dB)	(dB)	(cm)	(deg)	(P/A)	(H/V)
802.11ac VHT40 CH 151 5755MHz		11510	49.42	-24.58	74	49.83	38.4	18.49	57.3	100	0	P	H
		17265	53.75	-14.45	68.2	45.94	41.73	21.83	55.75	100	0	P	H
													H
													H
		11510	48.64	-25.36	74	49.05	38.4	18.49	57.3	100	0	P	V
		17265	52.63	-15.57	68.2	44.82	41.73	21.83	55.75	100	0	P	V
													V
802.11ac VHT40 CH 159 5795MHz		11590	48.35	-25.65	74	48.47	38.47	18.59	57.18	100	0	P	H
		17385	52.72	-15.48	68.2	44.94	41.56	21.94	55.72	100	0	P	H
													H
													H
		11590	48.57	-25.43	74	48.69	38.47	18.59	57.18	100	0	P	V
		17385	53.41	-14.79	68.2	45.63	41.56	21.94	55.72	100	0	P	V
													V
Remark	1. No other spurious found.												
	2. All results are PASS against Peak and Average limit line.												



**Band 4 5725~5850MHz
WIFI 802.11ac VHT80 (Band Edge @ 3m)**

WIFI	Note	Frequency	Level	Over	Limit	Read	Antenna	Path	Preamp	Ant	Table	Peak	Pol.
Ant.				Limit	Line	Level	Factor	Loss	Factor	Pos	Pos	Avg.	
1		(MHz)	(dBμV/m)	(dB)	(dBμV/m)	(dBμV)	(dB/m)	(dB)	(dB)	(cm)	(deg)	(P/A)	(H/V)
		5648.6	61.17	-7.03	68.2	49.84	35.09	11.43	35.19	205	23	P	H
		5695	80.7	-20.81	101.51	69.27	35.17	11.46	35.2	205	23	P	H
		5720	84.58	-26.22	110.8	73.07	35.21	11.5	35.2	205	23	P	H
		5720.2	84.97	-26.29	111.26	73.46	35.21	11.5	35.2	205	23	P	H
	*	5775	110.22	-	-	98.62	35.29	11.53	35.22	205	23	P	H
	*	5775	102.25	-	-	90.65	35.29	11.53	35.22	205	23	A	H
		5850.6	79.93	-40.9	120.83	68.18	35.38	11.6	35.23	205	23	P	H
		5858.8	79.87	-29.86	109.73	68.1	35.41	11.6	35.24	205	23	P	H
		5875	71.76	-33.44	105.2	59.92	35.43	11.65	35.24	205	23	P	H
		5929.2	55.99	-12.21	68.2	44.04	35.5	11.69	35.24	205	23	P	H
802.11ac													H
VHT80													H
CH 155		5644.6	57.91	-10.29	68.2	46.58	35.09	11.43	35.19	343	296	P	V
5775MHz		5695.4	75.05	-26.76	101.81	63.62	35.17	11.46	35.2	343	296	P	V
		5717.4	79.44	-30.63	110.07	67.95	35.19	11.5	35.2	343	296	P	V
		5720.6	80.56	-31.61	112.17	69.05	35.21	11.5	35.2	343	296	P	V
	*	5775	106.88	-	-	95.28	35.29	11.53	35.22	343	296	P	V
	*	5775	99.5	-	-	87.9	35.29	11.53	35.22	343	296	A	V
		5853.8	73.64	-39.9	113.54	61.86	35.41	11.6	35.23	343	296	P	V
		5858.8	71.98	-37.75	109.73	60.21	35.41	11.6	35.24	343	296	P	V
		5876.6	66.83	-37.18	104.01	54.99	35.43	11.65	35.24	343	296	P	V
		5931	50.48	-17.72	68.2	38.53	35.5	11.69	35.24	343	296	P	V
													V
													V
Remark	1. No other spurious found. 2. All results are PASS against Peak and Average limit line.												



Band 4 5725~5850MHz

WIFI 802.11ac VHT80 (Harmonic @ 3m)

WIFI	Note	Frequency	Level	Over	Limit	Read	Antenna	Path	Preamp	Ant	Table	Peak	Pol.	
Ant.				Limit	Line	Level	Factor	Loss	Factor	Pos	Pos	Avg.		
1		(MHz)	(dBμV/m)	(dB)	(dBμV/m)	(dBμV)	(dB/m)	(dB)	(dB)	(cm)	(deg)	(P/A)	(H/V)	
802.11ac VHT80 CH 155 5775MHz		11550	48.47	-25.53	74	48.72	38.44	18.54	57.23	100	0	P	H	
		17325	55.13	-13.07	68.2	47.33	41.66	21.88	55.74	100	0	P	H	
													H	
													H	
			11550	48.41	-25.59	74	48.66	38.44	18.54	57.23	100	0	P	V
			17325	53.2	-15	68.2	45.4	41.66	21.88	55.74	100	0	P	V
														V
													V	
Remark	1. No other spurious found. 2. All results are PASS against Peak and Average limit line.													



Emission below 1GHz

5GHz WIFI 802.11ac VHT80 (LF @ 3m)

WIFI	Note	Frequency	Level	Over	Limit	Read	Antenna	Path	Preamp	Ant	Table	Peak	Pol.	
Ant.				Limit	Line	Level	Factor	Loss	Factor	Pos	Pos	Avg.		
1		(MHz)	(dBμV/m)	(dB)	(dBμV/m)	(dBμV)	(dB/m)	(dB)	(dB)	(cm)	(deg)	(P/A)	(H/V)	
5GHz 802.11ac VHT80 LF		103.98	23.98	-19.52	43.5	37.12	16.39	2.03	31.56	-	-	P	H	
		151.77	31.52	-11.98	43.5	43.83	16.94	2.25	31.5	100	0	P	H	
		297.57	26.93	-19.07	46	36.25	19.12	2.86	31.3	-	-	P	H	
		388.2	26.97	-19.03	46	33.62	21.23	3.27	31.15	-	-	P	H	
		887.3	31.21	-14.79	46	28.02	28.83	4.89	30.53	-	-	P	H	
		974.8	33.17	-20.83	54	27.78	30.84	5.06	30.51	-	-	P	H	
														H
														H
														H
														H
														H
														H
														H
														H
														H
			30	31.73	-8.27	40	37.15	24.6	1.33	31.35	100	0	P	V
			72.93	29.26	-10.74	40	46.55	12.59	1.71	31.59	-	-	P	V
			102.9	30.29	-13.21	43.5	43.56	16.25	2.04	31.56	-	-	P	V
			388.9	26.54	-19.46	46	33.15	21.27	3.27	31.15	-	-	P	V
			875.4	31.32	-14.68	46	28.04	28.93	4.89	30.54	-	-	P	V
		973.4	33.36	-20.64	54	27.97	30.84	5.06	30.51	-	-	P	V	
													V	
													V	
													V	
													V	
													V	
													V	
Remark	1. No other spurious found. 2. All results are PASS against limit line.													



Band 4 - 5725~5850MHz
WIFI 802.11a (Band Edge @ 3m)

WIFI	Note	Frequency	Level	Over	Limit	Read	Antenna	Path	Preamp	Ant	Table	Peak	Pol.	
Ant.				Limit	Line	Level	Factor	Loss	Factor	Pos	Pos	Avg.		
2		(MHz)	(dBμV/m)	(dB)	(dBμV/m)	(dBμV)	(dB/m)	(dB)	(dB)	(cm)	(deg)	(P/A)	(H/V)	
802.11a CH 149 5745MHz		5648.6	52.53	-15.67	68.2	41.2	35.09	11.43	35.19	202	284	P	H	
		5689.6	62.1	-35.43	97.53	50.67	35.17	11.46	35.2	202	284	P	H	
		5719.8	74.5	-36.24	110.74	62.99	35.21	11.5	35.2	202	284	P	H	
		5725	84.32	-37.88	122.2	72.81	35.21	11.5	35.2	202	284	P	H	
	*	5745	117.19	-	-	105.63	35.24	11.53	35.21	202	284	P	H	
	*	5745	109.43	-	-	97.87	35.24	11.53	35.21	202	284	A	H	
														H
														H
			5641.6	53	-15.2	68.2	41.67	35.09	11.43	35.19	375	43	P	V
			5667.4	51.52	-29.59	81.11	40.11	35.14	11.46	35.19	375	43	P	V
			5717.2	72.37	-37.65	110.02	60.88	35.19	11.5	35.2	375	43	P	V
			5724.6	80.7	-40.59	121.29	69.19	35.21	11.5	35.2	375	43	P	V
	*		5745	115.29	-	-	103.73	35.24	11.53	35.21	375	43	P	V
	*		5745	107.56	-	-	96	35.24	11.53	35.21	375	43	A	V
														V
														V



WIFI	Note	Frequency	Level	Over	Limit	Read	Antenna	Path	Preamp	Ant	Table	Peak	Pol.	
Ant.				Limit	Line	Level	Factor	Loss	Factor	Pos	Pos	Avg.		
2		(MHz)	(dBµV/m)	(dB)	(dBµV/m)	(dBµV)	(dB/m)	(dB)	(dB)	(cm)	(deg)	(P/A)	(H/V)	
802.11a CH 157 5785MHz		5603.4	51.15	-17.05	68.2	39.89	35.04	11.4	35.18	211	315	P	H	
		5695.4	53.8	-48.01	101.81	42.37	35.17	11.46	35.2	211	315	P	H	
		5714.6	60.03	-49.26	109.29	48.54	35.19	11.5	35.2	211	315	P	H	
		5721.6	57.85	-56.6	114.45	46.34	35.21	11.5	35.2	211	315	P	H	
	*	5785	118.01	-	-	106.38	35.29	11.56	35.22	211	315	P	H	
	*	5785	110.07	-	-	98.44	35.29	11.56	35.22	211	315	A	H	
		5852.2	59.1	-58.08	117.18	47.35	35.38	11.6	35.23	211	315	P	H	
		5857.4	58.12	-52.01	110.13	46.34	35.41	11.6	35.23	211	315	P	H	
		5876.8	55.54	-48.32	103.86	43.7	35.43	11.65	35.24	211	315	P	H	
		5930.8	52.39	-15.81	68.2	40.44	35.5	11.69	35.24	211	315	P	H	
														H
														H
			5634.4	51.52	-16.68	68.2	40.19	35.09	11.43	35.19	352	42	P	V
			5671.6	51.66	-32.56	84.22	40.25	35.14	11.46	35.19	352	42	P	V
			5710	51.12	-56.88	108	39.63	35.19	11.5	35.2	352	42	P	V
			5724	50.48	-69.44	119.92	38.97	35.21	11.5	35.2	352	42	P	V
	*		5785	115.5	-	-	103.87	35.29	11.56	35.22	352	42	P	V
	*		5785	107.69	-	-	96.06	35.29	11.56	35.22	352	42	A	V
			5853.6	49.13	-64.86	113.99	37.35	35.41	11.6	35.23	352	42	P	V
			5864.8	49.59	-58.46	108.05	37.77	35.41	11.65	35.24	352	42	P	V
		5920.4	50.37	-21.22	71.59	38.44	35.48	11.69	35.24	352	42	P	V	
		5926.4	49.16	-19.04	68.2	37.21	35.5	11.69	35.24	352	42	P	V	
													V	
													V	



WIFI	Note	Frequency	Level	Over	Limit	Read	Antenna	Path	Preamp	Ant	Table	Peak	Pol.	
Ant.				Limit	Line	Level	Factor	Loss	Factor	Pos	Pos	Avg.		
2		(MHz)	(dBμV/m)	(dB)	(dBμV/m)	(dBμV)	(dB/m)	(dB)	(dB)	(cm)	(deg)	(P/A)	(H/V)	
802.11a CH 165 5825MHz	*	5825	117.43	-	-	105.69	35.36	11.6	35.22	220	314	P	H	
	*	5825	109.83	-	-	98.09	35.36	11.6	35.22	220	314	A	H	
		5852.8	74.51	-41.31	115.82	62.76	35.38	11.6	35.23	220	314	P	H	
		5855.4	71.59	-39.1	110.69	59.81	35.41	11.6	35.23	220	314	P	H	
		5878.6	61.75	-40.78	102.53	49.91	35.43	11.65	35.24	220	314	P	H	
		5930.8	51.51	-16.69	68.2	39.56	35.5	11.69	35.24	220	314	P	H	
														H
														H
	*	5825	114.76	-	-	103.02	35.36	11.6	35.22	347	41	P	V	
	*	5825	106.97	-	-	95.23	35.36	11.6	35.22	347	41	A	V	
		5850.2	67.86	-53.88	121.74	56.11	35.38	11.6	35.23	347	41	P	V	
		5855.6	62.57	-48.06	110.63	50.79	35.41	11.6	35.23	347	41	P	V	
		5878.4	51.13	-51.54	102.67	39.29	35.43	11.65	35.24	347	41	P	V	
		5931.4	49.98	-18.22	68.2	38.03	35.5	11.69	35.24	347	41	P	V	
														V
														V
													V	
Remark	1. No other spurious found. 2. All results are PASS against Peak and Average limit line.													



Band 4 5725~5850MHz
WIFI 802.11a (Harmonic @ 3m)

WIFI	Note	Frequency	Level	Over	Limit	Read	Antenna	Path	Preamp	Ant	Table	Peak	Pol.
Ant.				Limit	Line	Level	Factor	Loss	Factor	Pos	Pos	Avg.	
2		(MHz)	(dBμV/m)	(dB)	(dBμV/m)	(dBμV)	(dB/m)	(dB)	(dB)	(cm)	(deg)	(P/A)	(H/V)
802.11a CH 149 5745MHz		11490	48.65	-25.35	74	49.17	38.38	18.44	57.34	100	0	P	H
		17235	52.78	-15.42	68.2	44.96	41.77	21.8	55.75	100	0	P	H
													H
													H
		11490	48.81	-25.19	74	49.33	38.38	18.44	57.34	100	0	P	V
		17235	52.75	-15.45	68.2	44.93	41.77	21.8	55.75	100	0	P	V
													V
													V
802.11a CH 157 5785MHz		11570	48.05	-25.95	74	48.25	38.46	18.54	57.2	100	0	P	H
		17355	52.99	-15.21	68.2	45.2	41.61	21.91	55.73	100	0	P	H
													H
													H
		11570	47.91	-26.09	74	48.11	38.46	18.54	57.2	100	0	P	V
		17355	53.81	-14.39	68.2	46.02	41.61	21.91	55.73	100	0	P	V
													V
													V
802.11a CH 165 5825MHz		11650	49.45	-24.55	74	49.41	38.51	18.64	57.11	100	0	P	H
		17475	53.11	-15.09	68.2	45.36	41.45	22.01	55.71	100	0	P	H
													H
													H
		11650	48.7	-25.3	74	48.66	38.51	18.64	57.11	100	0	P	V
		17475	53.25	-14.95	68.2	45.5	41.45	22.01	55.71	100	0	P	V
													V
													V
Remark	1. No other spurious found. 2. All results are PASS against Peak and Average limit line.												



Band 4 5725~5850MHz
WIFI 802.11ac VHT20 (Band Edge @ 3m)

WIFI	Note	Frequency	Level	Over	Limit	Read	Antenna	Path	Preamp	Ant	Table	Peak	Pol.	
Ant.				Limit	Line	Level	Factor	Loss	Factor	Pos	Pos	Avg.		
2		(MHz)	(dBμV/m)	(dB)	(dBμV/m)	(dBμV)	(dB/m)	(dB)	(dB)	(cm)	(deg)	(P/A)	(H/V)	
802.11ac VHT20 CH 149 5745MHz		5637	52.57	-15.63	68.2	41.24	35.09	11.43	35.19	222	312	P	H	
		5698	66.14	-37.59	103.73	54.71	35.17	11.46	35.2	222	312	P	H	
		5720	79.31	-31.49	110.8	67.8	35.21	11.5	35.2	222	312	P	H	
		5725	86.83	-35.37	122.2	75.32	35.21	11.5	35.2	222	312	P	H	
	*	5745	117.61	-	-	106.05	35.24	11.53	35.21	222	312	P	H	
	*	5745	109.83	-	-	98.27	35.24	11.53	35.21	222	312	A	H	
														H
														H
			5644.6	50.61	-17.59	68.2	39.28	35.09	11.43	35.19	376	44	P	V
			5696.6	57.01	-45.68	102.69	45.58	35.17	11.46	35.2	376	44	P	V
			5720	76.73	-34.07	110.8	65.22	35.21	11.5	35.2	376	44	P	V
			5723.6	82.88	-36.13	119.01	71.37	35.21	11.5	35.2	376	44	P	V
	*		5745	115.07	-	-	103.51	35.24	11.53	35.21	376	44	P	V
	*		5745	107.25	-	-	95.69	35.24	11.53	35.21	376	44	A	V
													V	
													V	



WIFI	Note	Frequency	Level	Over	Limit	Read	Antenna	Path	Preamp	Ant	Table	Peak	Pol.
Ant.				Limit	Line	Level	Factor	Loss	Factor	Pos	Pos	Avg.	
2		(MHz)	(dBµV/m)	(dB)	(dBµV/m)	(dBµV)	(dB/m)	(dB)	(dB)	(cm)	(deg)	(P/A)	(H/V)
		5614	51.35	-16.85	68.2	40.09	35.04	11.4	35.18	211	315	P	H
		5694.4	54.99	-46.08	101.07	43.56	35.17	11.46	35.2	211	315	P	H
		5719.6	61.95	-48.74	110.69	50.44	35.21	11.5	35.2	211	315	P	H
		5724	62.18	-57.74	119.92	50.67	35.21	11.5	35.2	211	315	P	H
	*	5785	117.76	-	-	106.13	35.29	11.56	35.22	211	315	P	H
	*	5785	109.89	-	-	98.26	35.29	11.56	35.22	211	315	A	H
		5853.6	60.44	-53.55	113.99	48.66	35.41	11.6	35.23	211	315	P	H
		5856.8	60.73	-49.57	110.3	48.95	35.41	11.6	35.23	211	315	P	H
		5876.4	57.24	-46.92	104.16	45.4	35.43	11.65	35.24	211	315	P	H
		5949.4	50.5	-17.7	68.2	38.48	35.53	11.74	35.25	211	315	P	H
802.11ac													H
VHT20													H
CH 157		5627	50.95	-17.25	68.2	39.63	35.07	11.43	35.18	352	40	P	V
5785MHz		5663.4	51.23	-26.92	78.15	39.84	35.12	11.46	35.19	352	40	P	V
		5708.8	50.43	-57.24	107.67	38.94	35.19	11.5	35.2	352	40	P	V
		5723.6	53.02	-65.99	119.01	41.51	35.21	11.5	35.2	352	40	P	V
	*	5785	115.15	-	-	103.52	35.29	11.56	35.22	352	40	P	V
	*	5785	107.38	-	-	95.75	35.29	11.56	35.22	352	40	A	V
		5850.6	49.7	-71.13	120.83	37.95	35.38	11.6	35.23	352	40	P	V
		5855	49.62	-61.18	110.8	37.84	35.41	11.6	35.23	352	40	P	V
		5909.4	49.86	-29.85	79.71	37.93	35.48	11.69	35.24	352	40	P	V
		5932.2	50.48	-17.72	68.2	38.53	35.5	11.69	35.24	352	40	P	V
													V
													V



WIFI	Note	Frequency	Level	Over	Limit	Read	Antenna	Path	Preamp	Ant	Table	Peak	Pol.	
Ant.				Limit	Line	Level	Factor	Loss	Factor	Pos	Pos	Avg.		
2		(MHz)	(dBμV/m)	(dB)	(dBμV/m)	(dBμV)	(dB/m)	(dB)	(dB)	(cm)	(deg)	(P/A)	(H/V)	
802.11ac VHT20 CH 165 5825MHz	*	5825	117.72	-	-	105.98	35.36	11.6	35.22	218	314	P	H	
	*	5825	109.76	-	-	98.02	35.36	11.6	35.22	218	314	A	H	
		5850	77.77	-44.43	122.2	66.02	35.38	11.6	35.23	218	314	P	H	
		5855	70.37	-40.43	110.8	58.59	35.41	11.6	35.23	218	314	P	H	
		5875.6	62.47	-42.28	104.75	50.63	35.43	11.65	35.24	218	314	P	H	
		5937.2	52.56	-15.64	68.2	40.62	35.5	11.69	35.25	218	314	P	H	
														H
														H
	*	5825	115.71	-	-	103.97	35.36	11.6	35.22	364	41	P	V	
	*	5825	106.77	-	-	95.03	35.36	11.6	35.22	364	41	A	V	
		5850	75.79	-46.41	122.2	64.04	35.38	11.6	35.23	364	41	P	V	
		5855.2	67.07	-43.67	110.74	55.29	35.41	11.6	35.23	364	41	P	V	
		5879.6	52.45	-49.33	101.78	40.61	35.43	11.65	35.24	364	41	P	V	
		5932.4	50.01	-18.19	68.2	38.06	35.5	11.69	35.24	364	41	P	V	
													V	
													V	
Remark	1. No other spurious found. 2. All results are PASS against Peak and Average limit line.													



Band 4 5725~5850MHz
WIFI 802.11ac VHT20 (Harmonic @ 3m)

WIFI	Note	Frequency	Level	Over	Limit	Read	Antenna	Path	Preamp	Ant	Table	Peak	Pol.
Ant.				Limit	Line	Level	Factor	Loss	Factor	Pos	Pos	Avg.	
2		(MHz)	(dBµV/m)	(dB)	(dBµV/m)	(dBµV)	(dB/m)	(dB)	(dB)	(cm)	(deg)	(P/A)	(H/V)
802.11ac VHT20 CH 149 5745MHz		11490	49.6	-24.4	74	50.12	38.38	18.44	57.34	100	0	P	H
		17235	52.96	-15.24	68.2	45.14	41.77	21.8	55.75	100	0	P	H
													H
													H
		11490	48.67	-25.33	74	49.19	38.38	18.44	57.34	100	0	P	V
		17235	52.65	-15.55	68.2	44.83	41.77	21.8	55.75	100	0	P	V
													V
802.11ac VHT20 CH 157 5785MHz		11570	47.96	-26.04	74	48.16	38.46	18.54	57.2	100	0	P	H
		17355	53.4	-14.8	68.2	45.61	41.61	21.91	55.73	100	0	P	H
													H
													H
		11570	49.08	-24.92	74	49.28	38.46	18.54	57.2	100	0	P	V
		17355	53.29	-14.91	68.2	45.5	41.61	21.91	55.73	100	0	P	V
													V
802.11ac VHT20 CH 165 5825MHz		11650	48.56	-25.44	74	48.52	38.51	18.64	57.11	100	0	P	H
		17475	53.4	-14.8	68.2	45.65	41.45	22.01	55.71	100	0	P	H
													H
													H
		11650	49.23	-24.77	74	49.19	38.51	18.64	57.11	100	0	P	V
		17475	53.18	-15.02	68.2	45.43	41.45	22.01	55.71	100	0	P	V
													V
Remark	1. No other spurious found.												
	2. All results are PASS against Peak and Average limit line.												



Band 4 5725~5850MHz
WIFI 802.11ac VHT40 (Band Edge @ 3m)

WIFI	Note	Frequency	Level	Over	Limit	Read	Antenna	Path	Preamp	Ant	Table	Peak	Pol.
Ant.				Limit	Line	Level	Factor	Loss	Factor	Pos	Pos	Avg.	
2		(MHz)	(dBμV/m)	(dB)	(dBμV/m)	(dBμV)	(dB/m)	(dB)	(dB)	(cm)	(deg)	(P/A)	(H/V)
		5646	55.37	-12.83	68.2	44.04	35.09	11.43	35.19	222	313	P	H
		5698.8	75.58	-28.74	104.32	64.15	35.17	11.46	35.2	222	313	P	H
		5719	89.12	-21.4	110.52	77.61	35.21	11.5	35.2	222	313	P	H
		5725	92.33	-29.87	122.2	80.82	35.21	11.5	35.2	222	313	P	H
	*	5755	116.15	-	-	104.57	35.26	11.53	35.21	222	313	P	H
	*	5755	108.29	-	-	96.71	35.26	11.53	35.21	222	313	A	H
		5850.8	58.71	-61.67	120.38	46.96	35.38	11.6	35.23	222	313	P	H
		5873.4	58.51	-47.14	105.65	46.67	35.43	11.65	35.24	222	313	P	H
		5883	55.86	-43.4	99.26	44.02	35.43	11.65	35.24	222	313	P	H
		5931	51.18	-17.02	68.2	39.23	35.5	11.69	35.24	222	313	P	H
802.11ac													H
VHT40													H
CH 151		5648.4	53.84	-14.36	68.2	42.51	35.09	11.43	35.19	356	40	P	V
5755MHz		5699.2	68.64	-35.97	104.61	57.21	35.17	11.46	35.2	356	40	P	V
		5719.8	84.87	-25.87	110.74	73.36	35.21	11.5	35.2	356	40	P	V
		5723.6	87.78	-31.23	119.01	76.27	35.21	11.5	35.2	356	40	P	V
	*	5755	113.89	-	-	102.31	35.26	11.53	35.21	356	40	P	V
	*	5755	105.94	-	-	94.36	35.26	11.53	35.21	356	40	A	V
		5850.6	54.5	-66.33	120.83	42.75	35.38	11.6	35.23	356	40	P	V
		5856.8	54.65	-55.65	110.3	42.87	35.41	11.6	35.23	356	40	P	V
		5897.8	51.76	-36.53	88.29	39.89	35.46	11.65	35.24	356	40	P	V
		5942	49.16	-19.04	68.2	37.14	35.53	11.74	35.25	356	40	P	V
													V
													V



WIFI	Note	Frequency	Level	Over	Limit	Read	Antenna	Path	Preamp	Ant	Table	Peak	Pol.	
Ant.				Limit	Line	Level	Factor	Loss	Factor	Pos	Pos	Avg.		
2		(MHz)	(dBµV/m)	(dB)	(dBµV/m)	(dBµV)	(dB/m)	(dB)	(dB)	(cm)	(deg)	(P/A)	(H/V)	
802.11ac VHT40 CH 159 5795MHz		5640.2	52.79	-15.41	68.2	41.46	35.09	11.43	35.19	223	314	P	H	
		5696.6	58.76	-43.93	102.69	47.33	35.17	11.46	35.2	223	314	P	H	
		5718.4	66.99	-43.36	110.35	55.48	35.21	11.5	35.2	223	314	P	H	
		5722.6	69.48	-47.25	116.73	57.97	35.21	11.5	35.2	223	314	P	H	
	*	5795	116	-	-	104.35	35.31	11.56	35.22	223	314	P	H	
	*	5795	108.16	-	-	96.51	35.31	11.56	35.22	223	314	A	H	
		5852.6	73.04	-43.23	116.27	61.29	35.38	11.6	35.23	223	314	P	H	
		5855.2	71.03	-39.71	110.74	59.25	35.41	11.6	35.23	223	314	P	H	
		5875	63.95	-41.25	105.2	52.11	35.43	11.65	35.24	223	314	P	H	
		5940.2	54.06	-14.14	68.2	42.04	35.53	11.74	35.25	223	314	P	H	
														H
														H
			5641.2	52.11	-16.09	68.2	40.78	35.09	11.43	35.19	368	41	P	V
			5684	54.58	-38.82	93.4	43.15	35.17	11.46	35.2	368	41	P	V
			5713.8	55.77	-53.3	109.07	44.28	35.19	11.5	35.2	368	41	P	V
			5721	55.11	-57.97	113.08	43.6	35.21	11.5	35.2	368	41	P	V
	*		5795	113.16	-	-	101.51	35.31	11.56	35.22	368	41	P	V
	*		5795	105.33	-	-	93.68	35.31	11.56	35.22	368	41	A	V
			5850.2	62.59	-59.15	121.74	50.84	35.38	11.6	35.23	368	41	P	V
			5855	58.48	-52.32	110.8	46.7	35.41	11.6	35.23	368	41	P	V
		5897.8	54.91	-33.38	88.29	43.04	35.46	11.65	35.24	368	41	P	V	
		5938.4	50.81	-17.39	68.2	38.87	35.5	11.69	35.25	368	41	P	V	
													V	
													V	
Remark	1. No other spurious found. 2. All results are PASS against Peak and Average limit line.													



Band 4 5725~5850MHz
WIFI 802.11ac VHT40 (Harmonic @ 3m)

WIFI	Note	Frequency	Level	Over	Limit	Read	Antenna	Path	Preamp	Ant	Table	Peak	Pol.
Ant.				Limit	Line	Level	Factor	Loss	Factor	Pos	Pos	Avg.	
2		(MHz)	(dBµV/m)	(dB)	(dBµV/m)	(dBµV)	(dB/m)	(dB)	(dB)	(cm)	(deg)	(P/A)	(H/V)
802.11ac VHT40 CH 151 5755MHz		11510	48.2	-25.8	74	48.61	38.4	18.49	57.3	100	0	P	H
		17265	52.25	-15.95	68.2	44.44	41.73	21.83	55.75	100	0	P	H
													H
													H
		11510	49.08	-24.92	74	49.49	38.4	18.49	57.3	100	0	P	V
		17265	52.95	-15.25	68.2	45.14	41.73	21.83	55.75	100	0	P	V
802.11ac VHT40 CH 159 5795MHz		11590	47.76	-26.24	74	47.88	38.47	18.59	57.18	100	0	P	H
		17385	53.46	-14.74	68.2	45.68	41.56	21.94	55.72	100	0	P	H
													H
													H
		11590	48.5	-25.5	74	48.62	38.47	18.59	57.18	100	0	P	V
		17385	52.9	-15.3	68.2	45.12	41.56	21.94	55.72	100	0	P	V
Remark	1. No other spurious found.												
	2. All results are PASS against Peak and Average limit line.												



Band 4 5725~5850MHz
WIFI 802.11ac VHT80 (Band Edge @ 3m)

WIFI	Note	Frequency	Level	Over	Limit	Read	Antenna	Path	Preamp	Ant	Table	Peak	Pol.
Ant.				Limit	Line	Level	Factor	Loss	Factor	Pos	Pos	Avg.	
2		(MHz)	(dBμV/m)	(dB)	(dBμV/m)	(dBμV)	(dB/m)	(dB)	(dB)	(cm)	(deg)	(P/A)	(H/V)
		5642.8	66.92	-1.28	68.2	55.59	35.09	11.43	35.19	221	314	P	H
		5695	85.76	-15.75	101.51	74.33	35.17	11.46	35.2	221	314	P	H
		5719	88.66	-21.86	110.52	77.15	35.21	11.5	35.2	221	314	P	H
		5720.6	89.61	-22.56	112.17	78.1	35.21	11.5	35.2	221	314	P	H
	*	5775	112.54	-	-	100.94	35.29	11.53	35.22	221	314	P	H
	*	5775	105.17	-	-	93.57	35.29	11.53	35.22	221	314	A	H
		5851	84.68	-35.24	119.92	72.93	35.38	11.6	35.23	221	314	P	H
		5863.2	83.56	-24.94	108.5	71.74	35.41	11.65	35.24	221	314	P	H
		5875	77.22	-27.98	105.2	65.38	35.43	11.65	35.24	221	314	P	H
		5925.8	62.35	-5.85	68.2	50.4	35.5	11.69	35.24	221	314	P	H
802.11ac													H
VHT80													H
CH 155		5645	66.44	-1.76	68.2	55.11	35.09	11.43	35.19	353	40	P	V
5775MHz		5686.2	75.82	-19.2	95.02	64.39	35.17	11.46	35.2	353	40	P	V
		5718.8	77.95	-32.51	110.46	66.44	35.21	11.5	35.2	353	40	P	V
		5724.6	80.27	-41.02	121.29	68.76	35.21	11.5	35.2	353	40	P	V
	*	5775	110.46	-	-	98.86	35.29	11.53	35.22	353	40	P	V
	*	5775	102.93	-	-	91.33	35.29	11.53	35.22	353	40	A	V
		5851.2	70.65	-48.81	119.46	58.9	35.38	11.6	35.23	353	40	P	V
		5870.6	73.29	-33.14	106.43	61.45	35.43	11.65	35.24	353	40	P	V
		5879.4	70.61	-31.32	101.93	58.77	35.43	11.65	35.24	353	40	P	V
		5930	56.97	-11.23	68.2	45.02	35.5	11.69	35.24	353	40	P	V
													V
													V
Remark	1. No other spurious found. 2. All results are PASS against Peak and Average limit line.												



Band 4 5725~5850MHz
WIFI 802.11ac VHT80 (Harmonic @ 3m)

WIFI	Note	Frequency	Level	Over	Limit	Read	Antenna	Path	Preamp	Ant	Table	Peak	Pol.
Ant.				Limit	Line	Level	Factor	Loss	Factor	Pos	Pos	Avg.	
2		(MHz)	(dBμV/m)	(dB)	(dBμV/m)	(dBμV)	(dB/m)	(dB)	(dB)	(cm)	(deg)	(P/A)	(H/V)
802.11ac VHT80 CH 155 5775MHz		11550	48.84	-25.16	74	49.09	38.44	18.54	57.23	100	0	P	H
		17325	53.13	-15.07	68.2	45.33	41.66	21.88	55.74	100	0	P	H
													H
													H
		11550	48.11	-25.89	74	48.36	38.44	18.54	57.23	100	0	P	V
		17325	53.66	-14.54	68.2	45.86	41.66	21.88	55.74	100	0	P	V
													V
													V
Remark	1. No other spurious found. 2. All results are PASS against Peak and Average limit line.												



Emission below 1GHz

5GHz WIFI 802.11ac VHT80 (LF @ 3m)

WIFI	Note	Frequency	Level	Over	Limit	Read	Antenna	Path	Preamp	Ant	Table	Peak	Pol.	
Ant.				Limit	Line	Level	Factor	Loss	Factor	Pos	Pos	Avg.		
2		(MHz)	(dBμV/m)	(dB)	(dBμV/m)	(dBμV)	(dB/m)	(dB)	(dB)	(cm)	(deg)	(P/A)	(H/V)	
5GHz 802.11ac VHT80 LF		73.74	23.19	-16.81	40	40.4	12.67	1.71	31.59	-	-	P	H	
		152.04	31.44	-12.06	43.5	43.75	16.94	2.25	31.5	100	0	P	H	
		291.9	27.28	-18.72	46	36.74	18.99	2.86	31.31	-	-	P	H	
		386.1	27.74	-18.26	46	34.47	21.16	3.26	31.15	-	-	P	H	
		761.3	29.32	-16.68	46	27.63	27.85	4.46	30.62	-	-	P	H	
														H
														H
														H
														H
														H
														H
														H
														H
														H
														H
			30	31.65	-8.35	40	37.07	24.6	1.33	31.35	100	0	P	V
			96.96	30.65	-12.85	43.5	45.02	15.45	1.74	31.56	-	-	P	V
			217.92	23.21	-22.79	46	36.97	15.28	2.38	31.42	-	-	P	V
		391	26.73	-19.27	46	33.27	21.34	3.27	31.15	-	-	P	V	
		748	29.08	-16.92	46	27.52	27.74	4.46	30.64	-	-	P	V	
													V	
													V	
													V	
													V	
													V	
													V	
													V	
Remark	1. No other spurious found. 2. All results are PASS against limit line.													



Band 4 - 5725~5850MHz
WIFI 802.11a (Band Edge @ 3m)

WIFI	Note	Frequency	Level	Over	Limit	Read	Antenna	Path	Preamp	Ant	Table	Peak	Pol.	
Ant.				Limit	Line	Level	Factor	Loss	Factor	Pos	Pos	Avg.		
1+2		(MHz)	(dBμV/m)	(dB)	(dBμV/m)	(dBμV)	(dB/m)	(dB)	(dB)	(cm)	(deg)	(P/A)	(H/V)	
802.11a CH 149 5745MHz		5636	51.66	-16.54	68.2	40.33	35.09	11.43	35.19	100	328	P	H	
		5699	55.51	-48.95	104.46	44.08	35.17	11.46	35.2	100	328	P	H	
		5719.6	74.59	-36.1	110.69	63.08	35.21	11.5	35.2	100	328	P	H	
		5724.6	85.26	-36.03	121.29	73.75	35.21	11.5	35.2	100	328	P	H	
	*	5745	118.66	-	-	107.1	35.24	11.53	35.21	100	328	P	H	
	*	5745	111.31	-	-	99.75	35.24	11.53	35.21	100	328	A	H	
														H
														H
			5644.8	51.18	-17.02	68.2	39.85	35.09	11.43	35.19	376	42	P	V
			5699.4	51.53	-53.23	104.76	40.1	35.17	11.46	35.2	376	42	P	V
			5720	70.86	-39.94	110.8	59.35	35.21	11.5	35.2	376	42	P	V
			5725	83.84	-38.36	122.2	72.33	35.21	11.5	35.2	376	42	P	V
	*		5745	117.41	-	-	105.85	35.24	11.53	35.21	376	42	P	V
	*		5745	109.62	-	-	98.06	35.24	11.53	35.21	376	42	A	V
														V
														V



WIFI	Note	Frequency	Level	Over	Limit	Read	Antenna	Path	Preamp	Ant	Table	Peak	Pol.	
Ant.				Limit	Line	Level	Factor	Loss	Factor	Pos	Pos	Avg.		
1+2		(MHz)	(dBµV/m)	(dB)	(dBµV/m)	(dBµV)	(dB/m)	(dB)	(dB)	(cm)	(deg)	(P/A)	(H/V)	
802.11a CH 157 5785MHz		5634.4	51.98	-16.22	68.2	40.65	35.09	11.43	35.19	100	323	P	H	
		5689	51.98	-45.11	97.09	40.55	35.17	11.46	35.2	100	323	P	H	
		5713.4	54.01	-54.94	108.95	42.52	35.19	11.5	35.2	100	323	P	H	
		5721.8	54.9	-60	114.9	43.39	35.21	11.5	35.2	100	323	P	H	
	*	5785	119.53	-	-	107.9	35.29	11.56	35.22	100	323	P	H	
	*	5785	111.5	-	-	99.87	35.29	11.56	35.22	100	323	A	H	
		5854.2	52.59	-60.03	112.62	40.81	35.41	11.6	35.23	100	323	P	H	
		5855.2	52.3	-58.44	110.74	40.52	35.41	11.6	35.23	100	323	P	H	
		5876.2	51.18	-53.13	104.31	39.34	35.43	11.65	35.24	100	323	P	H	
		5934	51.86	-16.34	68.2	39.91	35.5	11.69	35.24	100	323	P	H	
														H
														H
			5640.6	51.39	-16.81	68.2	40.06	35.09	11.43	35.19	350	40	P	V
			5660.2	52.08	-23.69	75.77	40.69	35.12	11.46	35.19	350	40	P	V
			5717.2	50.6	-59.42	110.02	39.11	35.19	11.5	35.2	350	40	P	V
			5724.4	50.1	-70.73	120.83	38.59	35.21	11.5	35.2	350	40	P	V
	*		5785	116.96	-	-	105.33	35.29	11.56	35.22	350	40	P	V
	*		5785	109.39	-	-	97.76	35.29	11.56	35.22	350	40	A	V
			5855	50.07	-60.73	110.8	38.29	35.41	11.6	35.23	350	40	P	V
			5866.8	51	-56.49	107.49	39.18	35.41	11.65	35.24	350	40	P	V
		5903.8	50.3	-33.55	83.85	38.39	35.46	11.69	35.24	350	40	P	V	
		5946.8	50.03	-18.17	68.2	38.01	35.53	11.74	35.25	350	40	P	V	
													V	
													V	



WIFI	Note	Frequency	Level	Over	Limit	Read	Antenna	Path	Preamp	Ant	Table	Peak	Pol.	
Ant.				Limit	Line	Level	Factor	Loss	Factor	Pos	Pos	Avg.		
1+2		(MHz)	(dBμV/m)	(dB)	(dBμV/m)	(dBμV)	(dB/m)	(dB)	(dB)	(cm)	(deg)	(P/A)	(H/V)	
802.11a CH 165 5825MHz	*	5825	118.28	-	-	106.54	35.36	11.6	35.22	101	328	P	H	
	*	5825	111.01	-	-	99.27	35.36	11.6	35.22	101	328	A	H	
		5850	72.94	-49.26	122.2	61.19	35.38	11.6	35.23	101	328	P	H	
		5855.4	67.04	-43.65	110.69	55.26	35.41	11.6	35.23	101	328	P	H	
		5876.8	54.26	-49.6	103.86	42.42	35.43	11.65	35.24	101	328	P	H	
		5949.6	51.8	-16.4	68.2	39.78	35.53	11.74	35.25	101	328	P	H	
														H
														H
	*	5825	116.63	-	-	104.89	35.36	11.6	35.22	330	42	P	V	
	*	5825	109.14	-	-	97.4	35.36	11.6	35.22	330	42	A	V	
		5852.8	69.64	-46.18	115.82	57.89	35.38	11.6	35.23	330	42	P	V	
		5855.4	61.6	-49.09	110.69	49.82	35.41	11.6	35.23	330	42	P	V	
		5880	50.63	-50.86	101.49	38.79	35.43	11.65	35.24	330	42	P	V	
		5945.4	50.26	-17.94	68.2	38.24	35.53	11.74	35.25	330	42	P	V	
														V
														V
													V	
Remark	1. No other spurious found. 2. All results are PASS against Peak and Average limit line.													



Band 4 5725~5850MHz
WIFI 802.11a (Harmonic @ 3m)

WIFI	Note	Frequency	Level	Over	Limit	Read	Antenna	Path	Preamp	Ant	Table	Peak	Pol.
Ant.				Limit	Line	Level	Factor	Loss	Factor	Pos	Pos	Avg.	
1+2		(MHz)	(dBμV/m)	(dB)	(dBμV/m)	(dBμV)	(dB/m)	(dB)	(dB)	(cm)	(deg)	(P/A)	(H/V)
802.11a CH 149 5745MHz		11490	56.07	-17.93	74	56.59	38.38	18.44	57.34	100	237	P	H
		11490	45.81	-8.19	54	46.33	38.38	18.44	57.34	100	237	A	H
		17235	52.46	-15.74	68.2	44.64	41.77	21.8	55.75	100	0	P	H
													H
		11490	54.76	-19.24	74	55.28	38.38	18.44	57.34	100	3	P	V
		11490	45.5	-8.5	54	46.02	38.38	18.44	57.34	100	3	A	V
		17235	52.73	-15.47	68.2	44.91	41.77	21.8	55.75	100	0	P	V
802.11a CH 157 5785MHz		11570	55.78	-18.22	74	55.98	38.46	18.54	57.2	100	238	P	H
		11570	46.16	-7.84	54	46.36	38.46	18.54	57.2	100	238	A	H
		17355	53.02	-15.18	68.2	45.23	41.61	21.91	55.73	100	0	P	H
													H
		11570	54.07	-19.93	74	54.27	38.46	18.54	57.2	100	2	P	V
		11570	44.72	-9.28	54	44.92	38.46	18.54	57.2	100	2	A	V
		17355	52.81	-15.39	68.2	45.02	41.61	21.91	55.73	100	0	P	V
802.11a CH 165 5825MHz		11650	58.24	-15.76	74	58.2	38.51	18.64	57.11	100	238	P	H
		11650	48.15	-5.85	54	48.11	38.51	18.64	57.11	100	238	A	H
		17475	51.76	-16.44	68.2	44.01	41.45	22.01	55.71	100	0	P	H
													H
		11650	57.85	-16.15	74	57.81	38.51	18.64	57.11	100	241	P	V
		11650	47.69	-6.31	54	47.65	38.51	18.64	57.11	100	241	A	V
		17475	51.26	-16.94	68.2	43.51	41.45	22.01	55.71	100	0	P	V
Remark	1. No other spurious found. 2. All results are PASS against Peak and Average limit line.												



**Band 4 5725~5850MHz
WIFI 802.11ac VHT20 (Band Edge @ 3m)**

WIFI	Note	Frequency	Level	Over	Limit	Read	Antenna	Path	Preamp	Ant	Table	Peak	Pol.	
Ant.				Limit	Line	Level	Factor	Loss	Factor	Pos	Pos	Avg.		
1+2		(MHz)	(dBμV/m)	(dB)	(dBμV/m)	(dBμV)	(dB/m)	(dB)	(dB)	(cm)	(deg)	(P/A)	(H/V)	
802.11ac VHT20 CH 149 5745MHz		5650	54.33	-13.87	68.2	42.97	35.12	11.43	35.19	100	319	P	H	
		5698	69.11	-34.62	103.73	57.7	35.15	11.46	35.2	100	319	P	H	
		5720	81.16	-29.64	110.8	69.68	35.18	11.5	35.2	100	319	P	H	
		5723.6	88.83	-30.18	119.01	77.35	35.18	11.5	35.2	100	319	P	H	
	*	5745	120.06	-	-	108.55	35.19	11.53	35.21	100	319	P	H	
	*	5745	112.31	-	-	100.8	35.19	11.53	35.21	100	319	A	H	
														H
														H
			5639	51.43	-16.77	68.2	40.08	35.11	11.43	35.19	100	288	P	V
			5698.8	61.89	-42.43	104.32	50.48	35.15	11.46	35.2	100	288	P	V
			5719.8	70.42	-40.32	110.74	58.94	35.18	11.5	35.2	100	288	P	V
			5724.8	84.76	-36.98	121.74	73.28	35.18	11.5	35.2	100	288	P	V
	*		5745	116.43	-	-	104.92	35.19	11.53	35.21	100	288	P	V
	*		5745	108.4	-	-	96.89	35.19	11.53	35.21	100	288	A	V
														V
													V	



WIFI	Note	Frequency	Level	Over	Limit	Read	Antenna	Path	Preamp	Ant	Table	Peak	Pol.	
Ant.				Limit	Line	Level	Factor	Loss	Factor	Pos	Pos	Avg.		
1+2		(MHz)	(dBµV/m)	(dB)	(dBµV/m)	(dBµV)	(dB/m)	(dB)	(dB)	(cm)	(deg)	(P/A)	(H/V)	
802.11ac VHT20 CH 157 5785MHz		5648.6	51.08	-17.12	68.2	39.73	35.11	11.43	35.19	100	320	P	H	
		5697.6	57.79	-45.64	103.43	46.38	35.15	11.46	35.2	100	320	P	H	
		5719.4	62	-48.63	110.63	50.52	35.18	11.5	35.2	100	320	P	H	
		5722.4	63.67	-52.6	116.27	52.19	35.18	11.5	35.2	100	320	P	H	
	*	5785	120.13	-	-	108.57	35.22	11.56	35.22	100	320	P	H	
	*	5785	112.43	-	-	100.87	35.22	11.56	35.22	100	320	A	H	
		5850.8	59.48	-60.9	120.38	47.83	35.28	11.6	35.23	100	320	P	H	
		5855.6	60.8	-49.83	110.63	49.14	35.29	11.6	35.23	100	320	P	H	
		5875.6	54.81	-49.94	104.75	43.1	35.3	11.65	35.24	100	320	P	H	
		5944.8	50.49	-17.71	68.2	38.64	35.36	11.74	35.25	100	320	P	H	
														H
														H
			5631	51.54	-16.66	68.2	40.2	35.1	11.43	35.19	100	288	P	V
			5657.4	51.98	-21.72	73.7	40.62	35.12	11.43	35.19	100	288	P	V
			5719.2	59.27	-51.31	110.58	47.79	35.18	11.5	35.2	100	288	P	V
			5720.2	56.58	-54.68	111.26	45.1	35.18	11.5	35.2	100	288	P	V
	*		5785	115.67	-	-	104.11	35.22	11.56	35.22	100	288	P	V
	*		5785	107.97	-	-	96.41	35.22	11.56	35.22	100	288	A	V
			5853.4	54.49	-59.96	114.45	42.84	35.28	11.6	35.23	100	288	P	V
			5855.6	54.87	-55.76	110.63	43.21	35.29	11.6	35.23	100	288	P	V
		5881	51.95	-48.79	100.74	40.24	35.3	11.65	35.24	100	288	P	V	
		5925	49.46	-18.74	68.2	37.67	35.34	11.69	35.24	100	288	P	V	
													V	
													V	



WIFI	Note	Frequency	Level	Over	Limit	Read	Antenna	Path	Preamp	Ant	Table	Peak	Pol.	
Ant.				Limit	Line	Level	Factor	Loss	Factor	Pos	Pos	Avg.		
1+2		(MHz)	(dBμV/m)	(dB)	(dBμV/m)	(dBμV)	(dB/m)	(dB)	(dB)	(cm)	(deg)	(P/A)	(H/V)	
802.11ac VHT20 CH 165 5825MHz	*	5825	119.52	-	-	107.88	35.26	11.6	35.22	100	317	P	H	
	*	5825	111.76	-	-	100.12	35.26	11.6	35.22	100	317	A	H	
		5850	80.6	-41.6	122.2	68.95	35.28	11.6	35.23	100	317	P	H	
		5855.8	70.18	-40.4	110.58	58.52	35.29	11.6	35.23	100	317	P	H	
		5877.2	65.06	-38.51	103.57	53.35	35.3	11.65	35.24	100	317	P	H	
		5928.6	52.9	-15.3	68.2	41.11	35.34	11.69	35.24	100	317	P	H	
														H
														H
	*	5825	115.4	-	-	103.76	35.26	11.6	35.22	101	284	P	V	
	*	5825	107.53	-	-	95.89	35.26	11.6	35.22	101	284	A	V	
		5850	74.77	-47.43	122.2	63.12	35.28	11.6	35.23	101	284	P	V	
		5858.2	64.02	-45.88	109.9	52.37	35.29	11.6	35.24	101	284	P	V	
		5880.6	58.66	-42.38	101.04	46.95	35.3	11.65	35.24	101	284	P	V	
		5929.8	49.84	-18.36	68.2	38.05	35.34	11.69	35.24	101	284	P	V	
														V
													V	
Remark	1. No other spurious found. 2. All results are PASS against Peak and Average limit line.													



Band 4 5725~5850MHz
WIFI 802.11ac VHT20 (Harmonic @ 3m)

WIFI	Note	Frequency	Level	Over	Limit	Read	Antenna	Path	Preamp	Ant	Table	Peak	Pol.
Ant.				Limit	Line	Level	Factor	Loss	Factor	Pos	Pos	Avg.	
1+2		(MHz)	(dBμV/m)	(dB)	(dBμV/m)	(dBμV)	(dB/m)	(dB)	(dB)	(cm)	(deg)	(P/A)	(H/V)
802.11ac VHT20 CH 149 5745MHz		11490	56.08	-17.92	74	56.89	38.09	18.44	57.34	100	316	P	H
		11490	45.42	-8.58	54	46.23	38.09	18.44	57.34	100	316	A	H
		17235	53.87	-14.33	68.2	46.64	41.18	21.8	55.75	100	0	P	H
													H
		11490	54.99	-19.01	74	55.8	38.09	18.44	57.34	100	1	P	V
		11490	45.18	-8.82	54	45.99	38.09	18.44	57.34	100	1	A	V
		17235	53	-15.2	68.2	45.77	41.18	21.8	55.75	100	0	P	V
													V
802.11ac VHT20 CH 157 5785MHz		11570	52.89	-21.11	74	53.34	38.21	18.54	57.2	100	260	P	H
		11570	42.45	-11.55	54	42.9	38.21	18.54	57.2	100	260	A	H
		17355	53.66	-14.54	68.2	46.51	40.97	21.91	55.73	100	0	P	H
													H
		11570	52.66	-21.34	74	53.11	38.21	18.54	57.2	100	2	P	V
		11570	41.84	-12.16	54	42.29	38.21	18.54	57.2	100	2	A	V
		17355	52.69	-15.51	68.2	45.54	40.97	21.91	55.73	100	0	P	V
													V
802.11ac VHT20 CH 165 5825MHz		11650	58.27	-15.73	74	58.42	38.32	18.64	57.11	100	256	P	H
		11650	47.68	-6.32	54	47.83	38.32	18.64	57.11	100	256	A	H
		17475	53.14	-15.06	68.2	46.08	40.76	22.01	55.71	100	0	P	H
													H
		11650	57.28	-16.72	74	57.43	38.32	18.64	57.11	100	2	P	V
		11650	46.2	-7.8	54	46.35	38.32	18.64	57.11	100	2	A	V
		17475	52.46	-15.74	68.2	45.4	40.76	22.01	55.71	100	0	P	V
													V
Remark	1. No other spurious found. 2. All results are PASS against Peak and Average limit line.												



Band 4 5725~5850MHz
WIFI 802.11ac VHT40 (Band Edge @ 3m)

WIFI	Note	Frequency	Level	Over	Limit	Read	Antenna	Path	Preamp	Ant	Table	Peak	Pol.
Ant.				Limit	Line	Level	Factor	Loss	Factor	Pos	Pos	Avg.	
1+2		(MHz)	(dBμV/m)	(dB)	(dBμV/m)	(dBμV)	(dB/m)	(dB)	(dB)	(cm)	(deg)	(P/A)	(H/V)
		5649.6	54.94	-13.26	68.2	43.58	35.12	11.43	35.19	101	328	P	H
		5698.8	68.26	-36.06	104.32	56.83	35.17	11.46	35.2	101	328	P	H
		5712.8	87.6	-21.19	108.79	76.11	35.19	11.5	35.2	101	328	P	H
		5724.2	87.48	-32.9	120.38	75.97	35.21	11.5	35.2	101	328	P	H
	*	5755	115.9	-	-	104.32	35.26	11.53	35.21	101	328	P	H
	*	5755	108.36	-	-	96.78	35.26	11.53	35.21	101	328	A	H
		5855	53.76	-57.04	110.8	41.98	35.41	11.6	35.23	101	328	P	H
		5855.2	53.81	-56.93	110.74	42.03	35.41	11.6	35.23	101	328	P	H
		5880.8	51.36	-49.53	100.89	39.52	35.43	11.65	35.24	101	328	P	H
		5941.8	50.4	-17.8	68.2	38.38	35.53	11.74	35.25	101	328	P	H
802.11ac													H
VHT40													H
CH 151		5635	52.62	-15.58	68.2	41.29	35.09	11.43	35.19	337	42	P	V
5755MHz		5699.2	60.28	-44.33	104.61	48.85	35.17	11.46	35.2	337	42	P	V
		5720	83.24	-27.56	110.8	71.73	35.21	11.5	35.2	337	42	P	V
		5724.4	83.98	-36.85	120.83	72.47	35.21	11.5	35.2	337	42	P	V
	*	5755	114.15	-	-	102.57	35.26	11.53	35.21	337	42	P	V
	*	5755	106.13	-	-	94.55	35.26	11.53	35.21	337	42	A	V
		5852.2	49.82	-67.36	117.18	38.07	35.38	11.6	35.23	337	42	P	V
		5867.8	50.53	-56.68	107.21	38.71	35.41	11.65	35.24	337	42	P	V
		5907.2	50.09	-31.25	81.34	38.16	35.48	11.69	35.24	337	42	P	V
		5944.4	49.24	-18.96	68.2	37.22	35.53	11.74	35.25	337	42	P	V
													V
													V



WIFI	Note	Frequency	Level	Over	Limit	Read	Antenna	Path	Preamp	Ant	Table	Peak	Pol.	
Ant.				Limit	Line	Level	Factor	Loss	Factor	Pos	Pos	Avg.		
1+2		(MHz)	(dBμV/m)	(dB)	(dBμV/m)	(dBμV)	(dB/m)	(dB)	(dB)	(cm)	(deg)	(P/A)	(H/V)	
802.11ac VHT40 CH 159 5795MHz		5633	51.32	-16.88	68.2	39.99	35.09	11.43	35.19	100	323	P	H	
		5697.4	57.06	-46.22	103.28	45.63	35.17	11.46	35.2	100	323	P	H	
		5719.6	66.08	-44.61	110.69	54.57	35.21	11.5	35.2	100	323	P	H	
		5725	68.51	-53.69	122.2	57	35.21	11.5	35.2	100	323	P	H	
	*	5795	116.72	-	-	105.07	35.31	11.56	35.22	100	323	P	H	
	*	5795	108.75	-	-	97.1	35.31	11.56	35.22	100	323	A	H	
		5850	74.57	-47.63	122.2	62.82	35.38	11.6	35.23	100	323	P	H	
		5856.2	74	-36.46	110.46	62.22	35.41	11.6	35.23	100	323	P	H	
		5875	62.81	-42.39	105.2	50.97	35.43	11.65	35.24	100	323	P	H	
		5928.8	51.98	-16.22	68.2	40.03	35.5	11.69	35.24	100	323	P	H	
														H
														H
			5603.6	52.36	-15.84	68.2	41.1	35.04	11.4	35.18	368	43	P	V
			5697.4	55.67	-47.61	103.28	44.24	35.17	11.46	35.2	368	43	P	V
			5715.8	59.19	-50.44	109.63	47.7	35.19	11.5	35.2	368	43	P	V
			5723.2	56.45	-61.65	118.1	44.94	35.21	11.5	35.2	368	43	P	V
	*		5795	115.37	-	-	103.72	35.31	11.56	35.22	368	43	P	V
	*		5795	107.32	-	-	95.67	35.31	11.56	35.22	368	43	A	V
			5850.8	65.38	-55	120.38	53.63	35.38	11.6	35.23	368	43	P	V
			5856.4	63.85	-46.56	110.41	52.07	35.41	11.6	35.23	368	43	P	V
		5911.4	53.44	-24.79	78.23	41.51	35.48	11.69	35.24	368	43	P	V	
		5945.2	50.87	-17.33	68.2	38.85	35.53	11.74	35.25	368	43	P	V	
													V	
													V	
Remark	1. No other spurious found. 2. All results are PASS against Peak and Average limit line.													



**Band 4 5725~5850MHz
WIFI 802.11ac VHT40 (Harmonic @ 3m)**

WIFI	Note	Frequency	Level	Over	Limit	Read	Antenna	Path	Preamp	Ant	Table	Peak	Pol.
Ant.				Limit	Line	Level	Factor	Loss	Factor	Pos	Pos	Avg.	
1+2		(MHz)	(dBμV/m)	(dB)	(dBμV/m)	(dBμV)	(dB/m)	(dB)	(dB)	(cm)	(deg)	(P/A)	(H/V)
802.11ac VHT40 CH 151 5755MHz		11510	49.95	-24.05	74	50.36	38.4	18.49	57.3	100	0	P	H
		17265	52.22	-15.98	68.2	44.41	41.73	21.83	55.75	100	0	P	H
													H
													H
		11510	49.87	-24.13	74	50.28	38.4	18.49	57.3	100	0	P	V
		17263	52.03	-16.17	68.2	44.22	41.73	21.83	55.75	100	0	P	V
													V
802.11ac VHT40 CH 159 5795MHz		11590	52.02	-21.98	74	52.14	38.47	18.59	57.18	100	238	P	H
		11590	43.6	-10.4	54	43.72	38.47	18.59	57.18	100	238	A	H
		17385	51.88	-16.32	68.2	44.1	41.56	21.94	55.72	100	0	P	H
													H
		11587	49.39	-24.61	74	49.51	38.47	18.59	57.18	100	0	P	V
		17385	51.85	-16.35	68.2	44.07	41.56	21.94	55.72	100	0	P	V
													V
Remark	1. No other spurious found.												
	2. All results are PASS against Peak and Average limit line.												



Band 4 5725~5850MHz
WIFI 802.11ac VHT80 (Band Edge @ 3m)

WIFI	Note	Frequency	Level	Over	Limit	Read	Antenna	Path	Preamp	Ant	Table	Peak	Pol.	
Ant.				Limit	Line	Level	Factor	Loss	Factor	Pos	Pos	Avg.		
1+2		(MHz)	(dBμV/m)	(dB)	(dBμV/m)	(dBμV)	(dB/m)	(dB)	(dB)	(cm)	(deg)	(P/A)	(H/V)	
802.11ac VHT80 CH 155 5775MHz		5647.2	64.75	-3.45	68.2	53.42	35.09	11.43	35.19	100	328	P	H	
		5698.2	83.23	-20.64	103.87	71.8	35.17	11.46	35.2	100	328	P	H	
		5720	87.61	-23.19	110.8	76.1	35.21	11.5	35.2	100	328	P	H	
		5720.4	88.45	-23.26	111.71	76.94	35.21	11.5	35.2	100	328	P	H	
	*	5775	112.73	-	-	101.13	35.29	11.53	35.22	100	328	P	H	
	*	5775	105.52	-	-	93.92	35.29	11.53	35.22	100	328	A	H	
		5851.4	84.22	-34.79	119.01	72.47	35.38	11.6	35.23	100	328	P	H	
		5861.2	83.3	-25.76	109.06	71.48	35.41	11.65	35.24	100	328	P	H	
		5879	76.93	-25.3	102.23	65.09	35.43	11.65	35.24	100	328	P	H	
		5929	61.74	-6.46	68.2	49.79	35.5	11.69	35.24	100	328	P	H	
														H
														H
			5647	63.36	-4.84	68.2	52.03	35.09	11.43	35.19	372	42	P	V
			5674.6	75.33	-11.11	86.44	63.92	35.14	11.46	35.19	372	42	P	V
			5720	79.46	-31.34	110.8	67.95	35.21	11.5	35.2	372	42	P	V
			5723.2	80.28	-37.82	118.1	68.77	35.21	11.5	35.2	372	42	P	V
	*		5775	111.41	-	-	99.81	35.29	11.53	35.22	372	42	P	V
	*		5775	103.44	-	-	91.84	35.29	11.53	35.22	372	42	A	V
			5854	76.79	-36.29	113.08	65.01	35.41	11.6	35.23	372	42	P	V
			5871.8	76.73	-29.36	106.09	64.89	35.43	11.65	35.24	372	42	P	V
		5875	73.07	-32.13	105.2	61.23	35.43	11.65	35.24	372	42	P	V	
		5932.8	55.84	-12.36	68.2	43.89	35.5	11.69	35.24	372	42	P	V	
													V	
													V	
Remark	1. No other spurious found. 2. All results are PASS against Peak and Average limit line.													



Band 4 5725~5850MHz
WIFI 802.11ac VHT80 (Harmonic @ 3m)

WIFI	Note	Frequency	Level	Over	Limit	Read	Antenna	Path	Preamp	Ant	Table	Peak	Pol.	
Ant.				Limit	Line	Level	Factor	Loss	Factor	Pos	Pos	Avg.		
1+2		(MHz)	(dBμV/m)	(dB)	(dBμV/m)	(dBμV)	(dB/m)	(dB)	(dB)	(cm)	(deg)	(P/A)	(H/V)	
802.11ac VHT80 CH 155 5775MHz		11550	48.43	-25.57	74	48.68	38.44	18.54	57.23	100	0	P	H	
		17325	53.6	-14.6	68.2	45.8	41.66	21.88	55.74	100	0	P	H	
													H	
													H	
			11550	47.8	-26.2	74	48.05	38.44	18.54	57.23	100	0	P	V
			17325	53.16	-15.04	68.2	45.36	41.66	21.88	55.74	100	0	P	V
														V
Remark	1. No other spurious found. 2. All results are PASS against Peak and Average limit line.													



<TXBF Mode>

Band 4 - 5725~5850MHz

WIFI 802.11ac VHT20 (Band Edge @ 3m)

WIFI	Note	Frequency	Level	Over	Limit	Read	Antenna	Path	Preamp	Ant	Table	Peak	Pol.	
Ant.				Limit	Line	Level	Factor	Loss	Factor	Pos	Pos	Avg.		
1+2		(MHz)	(dBμV/m)	(dB)	(dBμV/m)	(dBμV)	(dB/m)	(dB)	(dB)	(cm)	(deg)	(P/A)	(H/V)	
802.11ac VHT20 CH 149 5745MHz		5632.4	52.94	-15.26	68.2	41.6	35.1	11.43	35.19	100	329	P	H	
		5699.8	63.45	-41.6	105.05	52.04	35.15	11.46	35.2	100	329	P	H	
		5720	73.98	-36.82	110.8	62.5	35.18	11.5	35.2	100	329	P	H	
		5724.6	81.68	-39.61	121.29	70.2	35.18	11.5	35.2	100	329	P	H	
	*	5745	118.18	-	-	106.67	35.19	11.53	35.21	100	329	P	H	
	*	5745	109.05	-	-	97.54	35.19	11.53	35.21	100	329	A	H	
														H
														H
			5648.8	52.48	-15.72	68.2	41.13	35.11	11.43	35.19	100	299	P	V
			5696.8	64.68	-38.16	102.84	53.27	35.15	11.46	35.2	100	299	P	V
			5719.8	72.46	-38.28	110.74	60.98	35.18	11.5	35.2	100	299	P	V
			5725	77.97	-44.23	122.2	66.49	35.18	11.5	35.2	100	299	P	V
	*		5745	115.25	-	-	103.74	35.19	11.53	35.21	100	299	P	V
	*		5745	106.37	-	-	94.86	35.19	11.53	35.21	100	299	A	V
														V
														V



WiFi	Note	Frequency	Level	Over	Limit	Read	Antenna	Path	Preamp	Ant	Table	Peak	Pol.	
Ant.				Limit	Line	Level	Factor	Loss	Factor	Pos	Pos	Avg.		
1+2		(MHz)	(dBµV/m)	(dB)	(dBµV/m)	(dBµV)	(dB/m)	(dB)	(dB)	(cm)	(deg)	(P/A)	(H/V)	
802.11ac VHT20 CH 157 5785MHz		5646.6	52.13	-16.07	68.2	40.78	35.11	11.43	35.19	100	329	P	H	
		5698	56.59	-47.14	103.73	45.18	35.15	11.46	35.2	100	329	P	H	
		5712.4	61.14	-47.53	108.67	49.67	35.17	11.5	35.2	100	329	P	H	
		5723	54.43	-63.21	117.64	42.95	35.18	11.5	35.2	100	329	P	H	
	*	5785	118.43	-	-	106.87	35.22	11.56	35.22	100	329	P	H	
	*	5785	110.21	-	-	98.65	35.22	11.56	35.22	100	329	A	H	
		5850.8	62.1	-58.28	120.38	50.45	35.28	11.6	35.23	100	329	P	H	
		5861	61.71	-47.41	109.12	50.01	35.29	11.65	35.24	100	329	P	H	
		5877	58.86	-44.85	103.71	47.15	35.3	11.65	35.24	100	329	P	H	
		5940	50.9	-17.3	68.2	39.1	35.36	11.69	35.25	100	329	P	H	
														H
														H
			5621	51.54	-16.66	68.2	40.19	35.1	11.43	35.18	100	298	P	V
			5698.4	53.72	-50.3	104.02	42.31	35.15	11.46	35.2	100	298	P	V
			5716	56.88	-52.8	109.68	45.41	35.17	11.5	35.2	100	298	P	V
			5724.2	58.41	-61.97	120.38	46.93	35.18	11.5	35.2	100	298	P	V
	*		5785	115.39	-	-	103.83	35.22	11.56	35.22	100	298	P	V
	*		5785	106.28	-	-	94.72	35.22	11.56	35.22	100	298	A	V
			5853.2	57.15	-57.75	114.9	45.5	35.28	11.6	35.23	100	298	P	V
			5865	55.58	-52.42	108	43.88	35.29	11.65	35.24	100	298	P	V
		5894.4	54.19	-36.62	90.81	42.46	35.32	11.65	35.24	100	298	P	V	
		5938.6	50.22	-17.98	68.2	38.42	35.36	11.69	35.25	100	298	P	V	
													V	
													V	



WIFI	Note	Frequency	Level	Over	Limit	Read	Antenna	Path	Preamp	Ant	Table	Peak	Pol.	
Ant.				Limit	Line	Level	Factor	Loss	Factor	Pos	Pos	Avg.		
1+2		(MHz)	(dBμV/m)	(dB)	(dBμV/m)	(dBμV)	(dB/m)	(dB)	(dB)	(cm)	(deg)	(P/A)	(H/V)	
802.11ac VHT20 CH 165 5825MHz	*	5825	119.38	-	-	107.74	35.26	11.6	35.22	104	328	P	H	
	*	5825	109.76	-	-	98.12	35.26	11.6	35.22	104	328	A	H	
		5850	75.58	-46.62	122.2	63.93	35.28	11.6	35.23	104	328	P	H	
		5856.8	68.33	-41.97	110.3	56.67	35.29	11.6	35.23	104	328	P	H	
		5880.4	64.2	-36.99	101.19	52.49	35.3	11.65	35.24	104	328	P	H	
		5948.4	51.43	-16.77	68.2	39.58	35.36	11.74	35.25	104	328	P	H	
														H
														H
	*	5825	114.96	-	-	103.32	35.26	11.6	35.22	103	301	P	V	
	*	5825	105.57	-	-	93.93	35.26	11.6	35.22	103	301	A	V	
		5850	71.08	-51.12	122.2	59.43	35.28	11.6	35.23	103	301	P	V	
		5856.4	63.27	-47.14	110.41	51.61	35.29	11.6	35.23	103	301	P	V	
		5880.2	56.24	-45.1	101.34	44.53	35.3	11.65	35.24	103	301	P	V	
		5926.4	49.87	-18.33	68.2	38.08	35.34	11.69	35.24	103	301	P	V	
														V
													V	
Remark	1. No other spurious found. 2. All results are PASS against Peak and Average limit line.													



Band 4 5725~5850MHz
WIFI 802.11ac VHT20 (Harmonic @ 3m)

WIFI	Note	Frequency	Level	Over	Limit	Read	Antenna	Path	Preamp	Ant	Table	Peak	Pol.
Ant.				Limit	Line	Level	Factor	Loss	Factor	Pos	Pos	Avg.	
1+2		(MHz)	(dBµV/m)	(dB)	(dBµV/m)	(dBµV)	(dB/m)	(dB)	(dB)	(cm)	(deg)	(P/A)	(H/V)
802.11ac VHT20 CH 149 5745MHz		11488	49.97	-24.03	74	50.78	38.09	18.44	57.34	100	0	P	H
		17230	51.93	-16.27	68.2	44.7	41.18	21.8	55.75	100	0	P	H
													H
													H
		11488	48.48	-25.52	74	49.29	38.09	18.44	57.34	100	0	P	V
		17230	52.02	-16.18	68.2	44.79	41.18	21.8	55.75	100	0	P	V
													V
802.11ac VHT20 CH 157 5785MHz		11570	49.9	-24.1	74	50.35	38.21	18.54	57.2	100	0	P	H
		17355	52.25	-15.95	68.2	45.1	40.97	21.91	55.73	100	0	P	H
													H
													H
		11570	48.83	-25.17	74	49.28	38.21	18.54	57.2	100	0	P	V
		17355	52.22	-15.98	68.2	45.07	40.97	21.91	55.73	100	0	P	V
													V
802.11ac VHT20 CH 165 5825MHz		11650	55.55	-18.45	74	55.7	38.32	18.64	57.11	100	332	P	H
		11650	45.34	-8.66	54	45.49	38.32	18.64	57.11	100	332	A	H
		17475	52.47	-15.73	68.2	45.41	40.76	22.01	55.71	100	0	P	H
													H
		11650	52.9	-21.1	74	53.05	38.32	18.64	57.11	100	243	P	V
		11650	44.12	-9.88	54	44.27	38.32	18.64	57.11	100	243	A	V
		17475	52.48	-15.72	68.2	45.42	40.76	22.01	55.71	100	0	P	V
												V	
Remark	1. No other spurious found. 2. All results are PASS against Peak and Average limit line.												



Band 4 5725~5850MHz
WIFI 802.11ac VHT40 (Band Edge @ 3m)

WIFI	Note	Frequency	Level	Over	Limit	Read	Antenna	Path	Preamp	Ant	Table	Peak	Pol.
Ant.				Limit	Line	Level	Factor	Loss	Factor	Pos	Pos	Avg.	
1+2		(MHz)	(dBµV/m)	(dB)	(dBµV/m)	(dBµV)	(dB/m)	(dB)	(dB)	(cm)	(deg)	(P/A)	(H/V)
		5646.8	52.39	-15.81	68.2	41.04	35.11	11.43	35.19	104	325	P	H
		5697.2	74.17	-28.97	103.14	62.76	35.15	11.46	35.2	104	325	P	H
		5717.8	86.19	-23.99	110.18	74.71	35.18	11.5	35.2	104	325	P	H
		5722.2	90.61	-25.21	115.82	79.13	35.18	11.5	35.2	104	325	P	H
	*	5755	113.39	-	-	101.86	35.21	11.53	35.21	104	325	P	H
	*	5755	105.05	-	-	93.52	35.21	11.53	35.21	104	325	A	H
		5850.4	57.1	-64.19	121.29	45.45	35.28	11.6	35.23	104	325	P	H
		5856	54.9	-55.62	110.52	43.24	35.29	11.6	35.23	104	325	P	H
		5875	51.46	-53.74	105.2	39.75	35.3	11.65	35.24	104	325	P	H
		5947.8	50.59	-17.61	68.2	38.74	35.36	11.74	35.25	104	325	P	H
802.11ac													H
VHT40													H
CH 151		5641.2	54.08	-14.12	68.2	42.73	35.11	11.43	35.19	100	298	P	V
5755MHz		5696.6	68.96	-33.73	102.69	57.55	35.15	11.46	35.2	100	298	P	V
		5719	87.88	-22.64	110.52	76.4	35.18	11.5	35.2	100	298	P	V
		5724.2	86.02	-34.36	120.38	74.54	35.18	11.5	35.2	100	298	P	V
	*	5755	112.26	-	-	100.73	35.21	11.53	35.21	100	298	P	V
	*	5755	104.47	-	-	92.94	35.21	11.53	35.21	100	298	A	V
		5851.4	52.57	-66.44	119.01	40.92	35.28	11.6	35.23	100	298	P	V
		5856	53.09	-57.43	110.52	41.43	35.29	11.6	35.23	100	298	P	V
		5875	50.39	-54.81	105.2	38.68	35.3	11.65	35.24	100	298	P	V
		5934.6	49.41	-18.79	68.2	37.63	35.34	11.69	35.25	100	298	P	V
													V
													V



WIFI	Note	Frequency	Level	Over	Limit	Read	Antenna	Path	Preamp	Ant	Table	Peak	Pol.	
Ant.				Limit	Line	Level	Factor	Loss	Factor	Pos	Pos	Avg.		
1+2		(MHz)	(dBμV/m)	(dB)	(dBμV/m)	(dBμV)	(dB/m)	(dB)	(dB)	(cm)	(deg)	(P/A)	(H/V)	
802.11ac VHT40 CH 159 5795MHz		5621.8	51.55	-16.65	68.2	40.2	35.1	11.43	35.18	100	326	P	H	
		5695	58.9	-42.61	101.51	47.49	35.15	11.46	35.2	100	326	P	H	
		5719.6	65.66	-45.03	110.69	54.18	35.18	11.5	35.2	100	326	P	H	
		5725	68.68	-53.52	122.2	57.2	35.18	11.5	35.2	100	326	P	H	
	*	5795	113.78	-	-	102.21	35.23	11.56	35.22	100	326	P	H	
	*	5795	105.91	-	-	94.34	35.23	11.56	35.22	100	326	A	H	
		5850.6	69.75	-51.08	120.83	58.1	35.28	11.6	35.23	100	326	P	H	
		5856.8	68.98	-41.32	110.3	57.32	35.29	11.6	35.23	100	326	P	H	
		5875	61.5	-43.7	105.2	49.79	35.3	11.65	35.24	100	326	P	H	
		5925	52.15	-16.05	68.2	40.36	35.34	11.69	35.24	100	326	P	H	
														H
														H
			5623	50.92	-17.28	68.2	39.57	35.1	11.43	35.18	106	300	P	V
			5699.8	58.86	-46.19	105.05	47.45	35.15	11.46	35.2	106	300	P	V
			5715.8	64.49	-45.14	109.63	53.02	35.17	11.5	35.2	106	300	P	V
			5724.8	65.99	-55.75	121.74	54.51	35.18	11.5	35.2	106	300	P	V
	*		5795	112.58	-	-	101.01	35.23	11.56	35.22	106	300	P	V
	*		5795	103.62	-	-	92.05	35.23	11.56	35.22	106	300	A	V
			5850.6	69.79	-51.04	120.83	58.14	35.28	11.6	35.23	106	300	P	V
			5855	68.57	-42.23	110.8	56.91	35.29	11.6	35.23	106	300	P	V
		5876	62.2	-42.26	104.46	50.49	35.3	11.65	35.24	106	300	P	V	
		5935.4	51.12	-17.08	68.2	39.34	35.34	11.69	35.25	106	300	P	V	
													V	
													V	
Remark	1. No other spurious found. 2. All results are PASS against Peak and Average limit line.													



**Band 4 5725~5850MHz
WIFI 802.11ac VHT40 (Harmonic @ 3m)**

WIFI	Note	Frequency	Level	Over	Limit	Read	Antenna	Path	Preamp	Ant	Table	Peak	Pol.
Ant.				Limit	Line	Level	Factor	Loss	Factor	Pos	Pos	Avg.	
1+2		(MHz)	(dBµV/m)	(dB)	(dBµV/m)	(dBµV)	(dB/m)	(dB)	(dB)	(cm)	(deg)	(P/A)	(H/V)
802.11ac VHT40 CH 151 5755MHz		11510	47.81	-26.19	74	48.52	38.1	18.49	57.3	100	0	P	H
		17265	52.25	-15.95	68.2	45.05	41.12	21.83	55.75	100	0	P	H
													H
													H
		11510	48.47	-25.53	74	49.18	38.1	18.49	57.3	100	0	P	V
		17265	52.5	-15.7	68.2	45.3	41.12	21.83	55.75	100	0	P	V
													V
802.11ac VHT40 CH 159 5795MHz		11590	46.76	-27.24	74	47.11	38.24	18.59	57.18	100	0	P	H
		17385	52.49	-15.71	68.2	45.36	40.91	21.94	55.72	100	0	P	H
													H
													H
		11590	46.62	-27.38	74	46.97	38.24	18.59	57.18	100	0	P	V
		17385	52.64	-15.56	68.2	45.51	40.91	21.94	55.72	100	0	P	V
													V
Remark	1. No other spurious found.												
	2. All results are PASS against Peak and Average limit line.												



Band 4 5725~5850MHz
WIFI 802.11ac VHT80 (Band Edge @ 3m)

WIFI	Note	Frequency	Level	Over	Limit	Read	Antenna	Path	Preamp	Ant	Table	Peak	Pol.	
Ant.				Limit	Line	Level	Factor	Loss	Factor	Pos	Pos	Avg.		
1+2		(MHz)	(dBμV/m)	(dB)	(dBμV/m)	(dBμV)	(dB/m)	(dB)	(dB)	(cm)	(deg)	(P/A)	(H/V)	
802.11ac VHT80 CH 155 5775MHz		5643.6	64.3	-3.9	68.2	52.95	35.11	11.43	35.19	100	328	P	H	
		5700	82.17	-23.03	105.2	70.76	35.15	11.46	35.2	100	328	P	H	
		5712	85.09	-23.47	108.56	73.62	35.17	11.5	35.2	100	328	P	H	
		5723.6	86.98	-32.03	119.01	75.5	35.18	11.5	35.2	100	328	P	H	
	*	5775	110.45	-	-	98.92	35.22	11.53	35.22	100	328	P	H	
	*	5775	102.85	-	-	91.32	35.22	11.53	35.22	100	328	A	H	
		5850.6	83.31	-37.52	120.83	71.66	35.28	11.6	35.23	100	328	P	H	
		5858	80.69	-29.27	109.96	69.04	35.29	11.6	35.24	100	328	P	H	
		5875	74.33	-30.87	105.2	62.62	35.3	11.65	35.24	100	328	P	H	
		5929.2	60.33	-7.87	68.2	48.54	35.34	11.69	35.24	100	328	P	H	
														H
														H
			5649.6	63.53	-4.67	68.2	52.17	35.12	11.43	35.19	113	299	P	V
			5688.2	82.58	-13.92	96.5	71.17	35.15	11.46	35.2	113	299	P	V
			5720	82.72	-28.08	110.8	71.24	35.18	11.5	35.2	113	299	P	V
			5723	85.36	-32.28	117.64	73.88	35.18	11.5	35.2	113	299	P	V
	*		5775	108.59	-	-	97.06	35.22	11.53	35.22	113	299	P	V
	*		5775	100.76	-	-	89.23	35.22	11.53	35.22	113	299	A	V
			5851	78.24	-41.68	119.92	66.59	35.28	11.6	35.23	113	299	P	V
			5855.2	77.15	-33.59	110.74	65.49	35.29	11.6	35.23	113	299	P	V
		5875.8	70.95	-33.66	104.61	59.24	35.3	11.65	35.24	113	299	P	V	
		5933.6	52.9	-15.3	68.2	41.11	35.34	11.69	35.24	113	299	P	V	
													V	
													V	
Remark	1. No other spurious found. 2. All results are PASS against Peak and Average limit line.													



**Band 4 5725~5850MHz
WIFI 802.11ac VHT80 (Harmonic @ 3m)**

WIFI	Note	Frequency	Level	Over	Limit	Read	Antenna	Path	Preamp	Ant	Table	Peak	Pol.	
Ant.				Limit	Line	Level	Factor	Loss	Factor	Pos	Pos	Avg.		
1+2		(MHz)	(dBμV/m)	(dB)	(dBμV/m)	(dBμV)	(dB/m)	(dB)	(dB)	(cm)	(deg)	(P/A)	(H/V)	
802.11ac VHT80 CH 155 5775MHz		11550	47.38	-26.62	74	47.89	38.18	18.54	57.23	100	0	P	H	
		17325	52.81	-15.39	68.2	45.64	41.03	21.88	55.74	100	0	P	H	
													H	
													H	
			11550	46.81	-27.19	74	47.32	38.18	18.54	57.23	100	0	P	V
			17325	52.97	-15.23	68.2	45.8	41.03	21.88	55.74	100	0	P	V
														V
Remark	1. No other spurious found. 2. All results are PASS against Peak and Average limit line.													



Note symbol

*	Fundamental Frequency which can be ignored. However, the level of any unwanted emissions shall not exceed the level of the fundamental frequency.
!	Test result is over limit line.
P/A	Peak or Average
H/V	Horizontal or Vertical



A calculation example for radiated spurious emission is shown as below:

WIFI Ant. 1	Note	Frequency (MHz)	Level (dBμV/m)	Over Limit (dB)	Limit Line (dBμV/m)	Read Level (dBμV)	Antenna Factor (dB/m)	Path Loss (dB)	Preamp Factor (dB)	Ant Pos (cm)	Table Pos (deg)	Peak Avg. (P/A)	Pol. (H/V)
802.11b CH 01		2390	55.45	-18.55	74	54.51	32.22	4.58	35.86	103	308	P	H
2412MHz		2390	43.54	-10.46	54	42.6	32.22	4.58	35.86	103	308	A	H

1. Path Loss(dB) = Cable loss(dB) + Filter loss(dB) + Attenuator loss(dB)
2. Level(dBμV/m) = Antenna Factor(dB/m) + Path Loss(dB) + Read Level(dBμV) - Preamp Factor(dB)
3. Over Limit(dB) = Level(dBμV/m) – Limit Line(dBμV/m)

For Peak Limit @ 2390MHz:

1. Level(dBμV/m)
= Antenna Factor(dB/m) + Path Loss(dB) + Read Level(dBμV) - Preamp Factor(dB)
= 32.22(dB/m) + 4.58(dB) + 54.51(dBμV) – 35.86 (dB)
= 55.45 (dBμV/m)
2. Over Limit(dB)
= Level(dBμV/m) – Limit Line(dBμV/m)
= 55.45(dBμV/m) – 74(dBμV/m)
= -18.55(dB)

For Average Limit @ 2390MHz:

1. Level(dBμV/m)
= Antenna Factor(dB/m) + Path Loss(dB) + Read Level(dBμV) - Preamp Factor(dB)
= 32.22(dB/m) + 4.58(dB) + 42.6(dBμV) – 35.86 (dB)
= 43.54 (dBμV/m)
2. Over Limit(dB) = Level(dBμV/m) – Limit Line(dBμV/m)
= 43.54(dBμV/m) – 54(dBμV/m)
= -10.46(dB)

Both peak and average measured complies with the limit line, so test result is “PASS”.



Appendix C. Radiated Spurious Emission Plots

Test Engineer :	Jesse Wang, Stan Hsieh, and Nick Yu	Temperature :	24~26°C
		Relative Humidity :	51~53%

Note symbol

-L	Low channel location
-R	High channel location



<CDD Mode>
<For Earphone 1>

Band 4 - 5725~5850MHz
WIFI 802.11a (Band Edge @ 3m)

WIFI	Band 4 5725~5850MHz Band Edge @ 3m	
ANT	802.11a CH149 5745MHz	
1	Horizontal	Fundamental
Peak	<p>Site : 03CH07-HY Condition : PEAK_BE(84)_16-24 3m HF_ANT_08075962 HORIZONTAL Detector : Peak Project : 872506 Mode : 34</p>	<p>Site : 03CH07-HY Condition : PEAK(UNIT) 3m HF_ANT_08075962 HORIZONTAL Detector : Peak Project : 872506 Mode : 34</p>



WIFI	Band 4 5725~5850MHz Band Edge @ 3m	
ANT	802.11a CH149 5745MHz	
1	Vertical	Fundamental
Peak	<p> Date: 2018-08-09 PEAK_BE(B4)_16-24 </p> <p> Site : 03CH07-HY Condition : PEAK_BE(B4)_16-24 3m HF_ANT_00075962 VERTICAL RBW:1000.000kHz VBW:3000.000kHz SWT:Auto Detector : Peak Project : 872506 Mode : 34 </p>	<p> Date: 2018-08-09 PEAK_UN(LI)_3m </p> <p> Site : 03CH07-HY Condition : PEAK_UN(LI)_3m HF_ANT_00075962 VERTICAL RBW:1000.000kHz VBW:3000.000kHz SWT:Auto Detector : Peak Project : 872506 Mode : 34 </p>

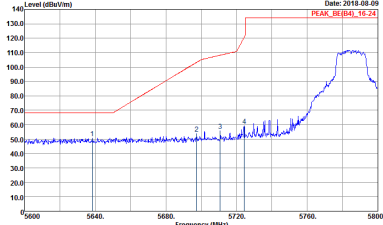
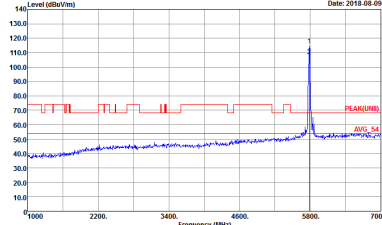
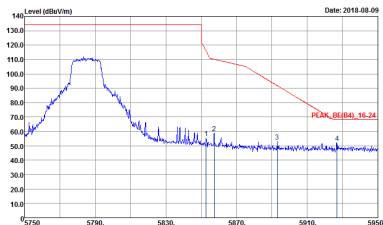

WIFI	Band 4 5725~5850MHz Band Edge @ 3m	
ANT	802.11a CH157 5785MHz	
1	Horizontal	Fundamental
Peak	 <p>Site : 03CH07-HY Condition : PEAK_BE(B4)_16-24 3m HF_ANT_00075962 HORIZONTAL Detector : Peak Project : 872506 Mode : 35</p>	 <p>Site : 03CH07-HY Condition : PEAK(UNLI) 3m HF_ANT_00075962 HORIZONTAL Detector : Peak Project : 872506 Mode : 35</p>
Peak	 <p>Site : 03CH07-HY Condition : PEAK_BE(B4)_16-24 3m HF_ANT_00075962 HORIZONTAL Detector : Peak Project : 872506 Mode : 35</p>	Left blank



WIFI	Band 4 5725~5850MHz Band Edge @ 3m	
ANT	802.11a CH157 5785MHz	
1	Vertical	Fundamental
Peak	<p>Site : 03CH07-HY Condition : PEAK_BE(04)_16-24 3m HF_ANT_00075962 VERTICAL Detector : Peak Project : 872506 Mode : 35</p>	<p>Site : 03CH07-HY Condition : PEAK(UNLI)_3m HF_ANT_00075962 VERTICAL Detector : Peak Project : 872506 Mode : 35</p>
Peak	<p>Site : 03CH07-HY Condition : PEAK_BE(04)_16-24 3m HF_ANT_00075962 VERTICAL Detector : Peak Project : 872506 Mode : 35</p>	Left blank

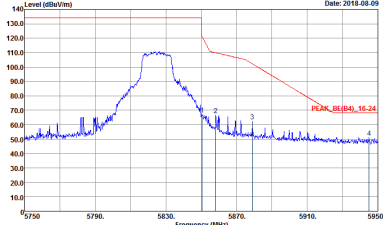
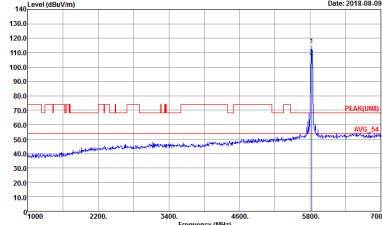

WIFI	Band 4 5725~5850MHz Band Edge @ 3m	
ANT	802.11a CH165 5825MHz	
1	Horizontal	Fundamental
Peak	 <p> Site : 03CH07-HY Condition : PEAK_BE(B4)_16-24 3m HF_ANT_00075962 HORIZONTAL Detector : Peak Project : 872506 Mode : 36 </p>	 <p> Site : 03CH07-HY Condition : PEAK(UH1) 3m HF_ANT_00075962 HORIZONTAL Detector : Peak Project : 872506 Mode : 36 </p>

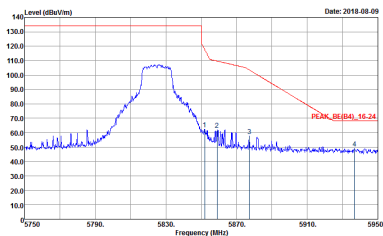
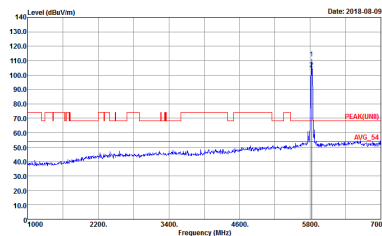

WIFI	Band 4 5725~5850MHz Band Edge @ 3m	
ANT	802.11a CH165 5825MHz	
1	Vertical	Fundamental
Peak	 <p>Date: 2018-08-09</p> <p>Site : 03CH07-HY Condition : PEAK_BE(B4)_16-24 3m HF_ANT_00075962 VERTICAL RBW:1000.000kHz VBW:3000.000kHz SWT:Auto Detector : Peak Project : 872506 Mode : 36</p>	 <p>Date: 2018-08-09</p> <p>Site : 03CH07-HY Condition : PEAK(UNLI) 3m HF_ANT_00075962 VERTICAL RBW:1000.000kHz VBW:3000.000kHz SWT:Auto Detector : Peak Project : 872506 Mode : 36</p>



Band 4 5725~5850MHz
WIFI 802.11ac VHT20 (Band Edge @ 3m)

Table with 2 columns: WIFI (Band 4 5725~5850MHz Band Edge @ 3m), ANT (802.11ac VHT20 CH149 5745MHz). Row 1: 1, Horizontal, Fundamental. Includes spectral plots and technical details like Site, Condition, Detector, Project, Mode.



WIFI	Band 4 5725~5850MHz Band Edge @ 3m	
ANT	802.11ac VHT20 CH149 5745MHz	
1	Vertical	Fundamental
Peak Avg.	<div style="display: flex; justify-content: space-around;"> <div style="width: 45%;"> <p style="font-size: small;">Date: 2018-08-09 PEAK_BE(B4)_16-24</p> <p style="font-size: x-small;">Site : 03CH07-HY Condition : PEAK_BE(B4)_16-24 3m HF_ANT_00075962 VERTICAL RBW:1000.000kHz VBW:3000.000kHz SWT:Auto Detector : Peak Project : 872506 Mode : 37</p> </div> <div style="width: 45%;"> <p style="font-size: small;">Date: 2018-08-09 PEAK_UN(LI)</p> <p style="font-size: x-small;">Site : 03CH07-HY Condition : PEAK_UN(LI) 3m HF_ANT_00075962 VERTICAL RBW:1000.000kHz VBW:3000.000kHz SWT:Auto Detector : Peak Project : 872506 Mode : 37</p> </div> </div>	



WIFI	Band 4 5725~5850MHz Band Edge @ 3m	
ANT	802.11ac VHT20 CH157 5785MHz	
1	Horizontal	Fundamental
Peak	<p>Date: 2018-08-09 PEAK_BE(84)_16-24</p> <pre> Site : 03CH07-HY Condition : PEAK_BE(84)_16-24 3m HF_ANT_00075962 HORIZONTAL Detector : Peak Project : 872506 Mode : 38 </pre>	<p>Date: 2018-08-09 PEAK(UNLI)_3m HF_ANT_00075962 HORIZONTAL</p> <pre> Site : 03CH07-HY Condition : PEAK(UNLI)_3m HF_ANT_00075962 HORIZONTAL Detector : Peak Project : 872506 Mode : 38 </pre>
Peak	<p>Date: 2018-08-09 PEAK_BE(84)_16-24</p> <pre> Site : 03CH07-HY Condition : PEAK_BE(84)_16-24 3m HF_ANT_00075962 HORIZONTAL Detector : Peak Project : 872506 Mode : 38 </pre>	Left blank



WIFI	Band 4 5725~5850MHz Band Edge @ 3m	
ANT	802.11ac VHT20 CH157 5785MHz	
1	Vertical	Fundamental
Peak	<p>Date: 2018-08-09 PEAK_BE(04)_16-24</p> <pre> Site : 03CH07-HY Condition : PEAK_BE(04)_16-24 3m HF_ANT_00075962 VERTICAL Detector : Peak Project : 872506 Mode : 38 </pre>	<p>Date: 2018-08-09 PEAK(UNLI)</p> <pre> Site : 03CH07-HY Condition : PEAK(UNLI) 3m HF_ANT_00075962 VERTICAL Detector : Peak Project : 872506 Mode : 38 </pre>
Peak	<p>Date: 2018-08-09 PEAK_BE(04)_16-24</p> <pre> Site : 03CH07-HY Condition : PEAK_BE(04)_16-24 3m HF_ANT_00075962 VERTICAL Detector : Peak Project : 872506 Mode : 38 </pre>	Left blank



WIFI	Band 4 5725~5850MHz Band Edge @ 3m	
ANT	802.11ac VHT20 CH165 5825MHz	
1	Horizontal	Fundamental
Peak	<p>Site : 03CH07-HY Condition : PEAK_BE(B4)_16-24 3m HF_ANT_00075962 HORIZONTAL RBW:1000.000kHz VBW:3000.000kHz SWT:Auto Detector : Peak Project : 872506 Mode : 39</p>	<p>Site : 03CH07-HY Condition : PEAK(UNLI) 3m HF_ANT_00075962 HORIZONTAL RBW:1000.000kHz VBW:3000.000kHz SWT:Auto Detector : Peak Project : 872506 Mode : 39</p>



WIFI	Band 4 5725~5850MHz Band Edge @ 3m	
ANT	802.11ac VHT20 CH165 5825MHz	
1	Vertical	Fundamental
Peak Avg.	<p>Site : 03CH07-HY Condition : PEAK_BE(B4)_16-24 3m HF_ANT_00075962 VERTICAL RBW:1000.000kHz VBW:3000.000kHz SWT:Auto Detector : Peak Project : 872506 Mode : 39</p>	<p>Site : 03CH07-HY Condition : PEAK(UNLI) 3m HF_ANT_00075962 VERTICAL RBW:1000.000kHz VBW:3000.000kHz SWT:Auto Detector : Peak Project : 872506 Mode : 39</p>



Band 4 5725~5850MHz
WIFI 802.11ac VHT40 (Band Edge @ 3m)

WIFI	Band 4 5725~5850MHz Band Edge @ 3m																																																																																																					
ANT	802.11ac VHT40 CH151 5755MHz																																																																																																					
1	Horizontal	Fundamental																																																																																																				
Peak	<p>Site : 03CH07-HY Condition : PEAK_BE(B4)_16-24 3m HF_ANT_00075962 HORIZONTAL Detector : Peak Project : 872506 Mode : 40</p> <table border="1"> <thead> <tr> <th>Peak</th> <th>Freq MHz</th> <th>Level dBuV/m</th> <th>Over Limit</th> <th>Limit</th> <th>ReadAntenna Level</th> <th>Cable Preamp Loss</th> <th>A/Pos</th> <th>T/Pos</th> <th>Remark</th> </tr> <tr> <th></th> <th>MHz</th> <th>dBuV/m</th> <th>dB</th> <th>dBuV/m</th> <th>dBuV</th> <th>dB/m</th> <th>dB</th> <th>cm</th> <th>deg</th> </tr> </thead> <tbody> <tr> <td>1</td> <td>5633.80</td> <td>54.30</td> <td>-13.90</td> <td>68.20</td> <td>42.97</td> <td>35.09</td> <td>11.43</td> <td>35.19</td> <td>197 23 Peak</td> </tr> <tr> <td>2</td> <td>5693.48</td> <td>67.66</td> <td>-32.67</td> <td>100.33</td> <td>56.23</td> <td>35.17</td> <td>11.46</td> <td>35.20</td> <td>197 23 Peak</td> </tr> <tr> <td>3</td> <td>5755.00</td> <td>86.68</td> <td>-25.92</td> <td>110.52</td> <td>73.09</td> <td>35.23</td> <td>11.50</td> <td>35.20</td> <td>197 23 Peak</td> </tr> <tr> <td>4</td> <td>5724.48</td> <td>86.71</td> <td>-34.12</td> <td>120.83</td> <td>75.20</td> <td>35.21</td> <td>11.50</td> <td>35.20</td> <td>197 23 Peak</td> </tr> </tbody> </table>	Peak	Freq MHz	Level dBuV/m	Over Limit	Limit	ReadAntenna Level	Cable Preamp Loss	A/Pos	T/Pos	Remark		MHz	dBuV/m	dB	dBuV/m	dBuV	dB/m	dB	cm	deg	1	5633.80	54.30	-13.90	68.20	42.97	35.09	11.43	35.19	197 23 Peak	2	5693.48	67.66	-32.67	100.33	56.23	35.17	11.46	35.20	197 23 Peak	3	5755.00	86.68	-25.92	110.52	73.09	35.23	11.50	35.20	197 23 Peak	4	5724.48	86.71	-34.12	120.83	75.20	35.21	11.50	35.20	197 23 Peak	<p>Site : 03CH07-HY Condition : PEAK(UNI) 3m HF_ANT_00075962 HORIZONTAL Detector : Peak Project : 872506 Mode : 40</p> <table border="1"> <thead> <tr> <th>Peak</th> <th>Freq MHz</th> <th>Level dBuV/m</th> <th>Over Limit</th> <th>Limit</th> <th>ReadAntenna Level</th> <th>Cable Preamp Loss</th> <th>A/Pos</th> <th>T/Pos</th> <th>Remark</th> </tr> <tr> <th></th> <th>MHz</th> <th>dBuV/m</th> <th>dB</th> <th>dBuV/m</th> <th>dBuV</th> <th>dB/m</th> <th>dB</th> <th>cm</th> <th>deg</th> </tr> </thead> <tbody> <tr> <td>1 *</td> <td>5755.00</td> <td>113.55</td> <td>45.35</td> <td>68.20</td> <td>101.97</td> <td>35.26</td> <td>11.53</td> <td>35.21</td> <td>197 23 Peak</td> </tr> <tr> <td>2 *</td> <td>5755.00</td> <td>105.66</td> <td>51.66</td> <td>54.00</td> <td>94.08</td> <td>35.26</td> <td>11.53</td> <td>35.21</td> <td>197 23 Average</td> </tr> </tbody> </table>	Peak	Freq MHz	Level dBuV/m	Over Limit	Limit	ReadAntenna Level	Cable Preamp Loss	A/Pos	T/Pos	Remark		MHz	dBuV/m	dB	dBuV/m	dBuV	dB/m	dB	cm	deg	1 *	5755.00	113.55	45.35	68.20	101.97	35.26	11.53	35.21	197 23 Peak	2 *	5755.00	105.66	51.66	54.00	94.08	35.26	11.53	35.21	197 23 Average
Peak	Freq MHz	Level dBuV/m	Over Limit	Limit	ReadAntenna Level	Cable Preamp Loss	A/Pos	T/Pos	Remark																																																																																													
	MHz	dBuV/m	dB	dBuV/m	dBuV	dB/m	dB	cm	deg																																																																																													
1	5633.80	54.30	-13.90	68.20	42.97	35.09	11.43	35.19	197 23 Peak																																																																																													
2	5693.48	67.66	-32.67	100.33	56.23	35.17	11.46	35.20	197 23 Peak																																																																																													
3	5755.00	86.68	-25.92	110.52	73.09	35.23	11.50	35.20	197 23 Peak																																																																																													
4	5724.48	86.71	-34.12	120.83	75.20	35.21	11.50	35.20	197 23 Peak																																																																																													
Peak	Freq MHz	Level dBuV/m	Over Limit	Limit	ReadAntenna Level	Cable Preamp Loss	A/Pos	T/Pos	Remark																																																																																													
	MHz	dBuV/m	dB	dBuV/m	dBuV	dB/m	dB	cm	deg																																																																																													
1 *	5755.00	113.55	45.35	68.20	101.97	35.26	11.53	35.21	197 23 Peak																																																																																													
2 *	5755.00	105.66	51.66	54.00	94.08	35.26	11.53	35.21	197 23 Average																																																																																													
Peak	<p>Site : 03CH07-HY Condition : PEAK_BE(B4)_16-24 3m HF_ANT_00075962 HORIZONTAL Detector : Peak Project : 872506 Mode : 40</p> <table border="1"> <thead> <tr> <th>Peak</th> <th>Freq MHz</th> <th>Level dBuV/m</th> <th>Over Limit</th> <th>Limit</th> <th>ReadAntenna Level</th> <th>Cable Preamp Loss</th> <th>A/Pos</th> <th>T/Pos</th> <th>Remark</th> </tr> <tr> <th></th> <th>MHz</th> <th>dBuV/m</th> <th>dB</th> <th>dBuV/m</th> <th>dBuV</th> <th>dB/m</th> <th>dB</th> <th>cm</th> <th>deg</th> </tr> </thead> <tbody> <tr> <td>1</td> <td>5853.00</td> <td>54.28</td> <td>-61.00</td> <td>115.36</td> <td>42.53</td> <td>35.38</td> <td>11.60</td> <td>35.23</td> <td>197 23 Peak</td> </tr> <tr> <td>2</td> <td>5855.68</td> <td>56.01</td> <td>-54.62</td> <td>110.63</td> <td>44.23</td> <td>35.41</td> <td>11.60</td> <td>35.23</td> <td>197 23 Peak</td> </tr> <tr> <td>3</td> <td>5875.20</td> <td>56.47</td> <td>-48.50</td> <td>105.05</td> <td>44.63</td> <td>35.43</td> <td>11.65</td> <td>35.24</td> <td>197 23 Peak</td> </tr> <tr> <td>4</td> <td>5934.00</td> <td>49.93</td> <td>-18.27</td> <td>68.00</td> <td>37.99</td> <td>35.50</td> <td>11.69</td> <td>35.25</td> <td>197 23 Peak</td> </tr> </tbody> </table>	Peak	Freq MHz	Level dBuV/m	Over Limit	Limit	ReadAntenna Level	Cable Preamp Loss	A/Pos	T/Pos	Remark		MHz	dBuV/m	dB	dBuV/m	dBuV	dB/m	dB	cm	deg	1	5853.00	54.28	-61.00	115.36	42.53	35.38	11.60	35.23	197 23 Peak	2	5855.68	56.01	-54.62	110.63	44.23	35.41	11.60	35.23	197 23 Peak	3	5875.20	56.47	-48.50	105.05	44.63	35.43	11.65	35.24	197 23 Peak	4	5934.00	49.93	-18.27	68.00	37.99	35.50	11.69	35.25	197 23 Peak	Left blank																																								
Peak	Freq MHz	Level dBuV/m	Over Limit	Limit	ReadAntenna Level	Cable Preamp Loss	A/Pos	T/Pos	Remark																																																																																													
	MHz	dBuV/m	dB	dBuV/m	dBuV	dB/m	dB	cm	deg																																																																																													
1	5853.00	54.28	-61.00	115.36	42.53	35.38	11.60	35.23	197 23 Peak																																																																																													
2	5855.68	56.01	-54.62	110.63	44.23	35.41	11.60	35.23	197 23 Peak																																																																																													
3	5875.20	56.47	-48.50	105.05	44.63	35.43	11.65	35.24	197 23 Peak																																																																																													
4	5934.00	49.93	-18.27	68.00	37.99	35.50	11.69	35.25	197 23 Peak																																																																																													



WIFI	Band 4 5725~5850MHz Band Edge @ 3m																																																																																																	
ANT	802.11ac VHT40 CH151 5755MHz																																																																																																	
1	Vertical	Fundamental																																																																																																
Peak	<p>Site : 03CH07-HY Condition : PEAK_BE(04)_16-24 3m HF_ANT_00075962 VERTICAL Detector : Peak Project : 872506 Mode : 40</p> <table border="1"> <thead> <tr> <th>Over</th> <th>Limit</th> <th>ReadAntenna</th> <th>Cable</th> <th>Preamp</th> <th>A/Pos</th> <th>T/Pos</th> <th>Remark</th> </tr> <tr> <th>Freq</th> <th>Level</th> <th>Line</th> <th>Level</th> <th>Factor</th> <th>Loss</th> <th>Factor</th> <th></th> </tr> <tr> <th>MHz</th> <th>dBuV/m</th> <th>dB</th> <th>dBuV/m</th> <th>dBuV</th> <th>dB/m</th> <th>dB</th> <th>cm deg</th> </tr> </thead> <tbody> <tr> <td>1</td> <td>5644.40</td> <td>52.32</td> <td>-15.00</td> <td>68.20</td> <td>48.99</td> <td>35.89</td> <td>11.43 35.19 341 296 Peak</td> </tr> <tr> <td>2</td> <td>5699.20</td> <td>63.35</td> <td>-41.26</td> <td>104.61</td> <td>51.92</td> <td>35.17</td> <td>11.46 35.20 341 296 Peak</td> </tr> <tr> <td>3</td> <td>5718.00</td> <td>80.52</td> <td>-29.72</td> <td>110.24</td> <td>69.01</td> <td>35.21</td> <td>11.50 35.20 341 296 Peak</td> </tr> <tr> <td>4</td> <td>5724.00</td> <td>82.32</td> <td>-37.60</td> <td>119.92</td> <td>70.81</td> <td>35.23</td> <td>11.50 35.20 341 296 Peak</td> </tr> </tbody> </table>	Over	Limit	ReadAntenna	Cable	Preamp	A/Pos	T/Pos	Remark	Freq	Level	Line	Level	Factor	Loss	Factor		MHz	dBuV/m	dB	dBuV/m	dBuV	dB/m	dB	cm deg	1	5644.40	52.32	-15.00	68.20	48.99	35.89	11.43 35.19 341 296 Peak	2	5699.20	63.35	-41.26	104.61	51.92	35.17	11.46 35.20 341 296 Peak	3	5718.00	80.52	-29.72	110.24	69.01	35.21	11.50 35.20 341 296 Peak	4	5724.00	82.32	-37.60	119.92	70.81	35.23	11.50 35.20 341 296 Peak	<p>Site : 03CH07-HY Condition : PEAK(UNLI) 3m HF_ANT_00075962 VERTICAL Detector : Peak Project : 872506 Mode : 40</p> <table border="1"> <thead> <tr> <th>Over</th> <th>Limit</th> <th>ReadAntenna</th> <th>Cable</th> <th>Preamp</th> <th>A/Pos</th> <th>T/Pos</th> <th>Remark</th> </tr> <tr> <th>Freq</th> <th>Level</th> <th>Line</th> <th>Level</th> <th>Factor</th> <th>Loss</th> <th>Factor</th> <th></th> </tr> <tr> <th>MHz</th> <th>dBuV/m</th> <th>dB</th> <th>dBuV/m</th> <th>dBuV</th> <th>dB</th> <th>dB</th> <th>cm deg</th> </tr> </thead> <tbody> <tr> <td>1</td> <td>5755.00</td> <td>110.73</td> <td>42.53</td> <td>68.20</td> <td>99.15</td> <td>35.26</td> <td>11.53 35.21 341 296 Peak</td> </tr> <tr> <td>2</td> <td>5755.00</td> <td>102.70</td> <td>48.70</td> <td>54.00</td> <td>91.12</td> <td>35.26</td> <td>11.53 35.21 341 296 Average</td> </tr> </tbody> </table>	Over	Limit	ReadAntenna	Cable	Preamp	A/Pos	T/Pos	Remark	Freq	Level	Line	Level	Factor	Loss	Factor		MHz	dBuV/m	dB	dBuV/m	dBuV	dB	dB	cm deg	1	5755.00	110.73	42.53	68.20	99.15	35.26	11.53 35.21 341 296 Peak	2	5755.00	102.70	48.70	54.00	91.12	35.26	11.53 35.21 341 296 Average
Over	Limit	ReadAntenna	Cable	Preamp	A/Pos	T/Pos	Remark																																																																																											
Freq	Level	Line	Level	Factor	Loss	Factor																																																																																												
MHz	dBuV/m	dB	dBuV/m	dBuV	dB/m	dB	cm deg																																																																																											
1	5644.40	52.32	-15.00	68.20	48.99	35.89	11.43 35.19 341 296 Peak																																																																																											
2	5699.20	63.35	-41.26	104.61	51.92	35.17	11.46 35.20 341 296 Peak																																																																																											
3	5718.00	80.52	-29.72	110.24	69.01	35.21	11.50 35.20 341 296 Peak																																																																																											
4	5724.00	82.32	-37.60	119.92	70.81	35.23	11.50 35.20 341 296 Peak																																																																																											
Over	Limit	ReadAntenna	Cable	Preamp	A/Pos	T/Pos	Remark																																																																																											
Freq	Level	Line	Level	Factor	Loss	Factor																																																																																												
MHz	dBuV/m	dB	dBuV/m	dBuV	dB	dB	cm deg																																																																																											
1	5755.00	110.73	42.53	68.20	99.15	35.26	11.53 35.21 341 296 Peak																																																																																											
2	5755.00	102.70	48.70	54.00	91.12	35.26	11.53 35.21 341 296 Average																																																																																											
Peak	<p>Site : 03CH07-HY Condition : PEAK_BE(04)_16-24 3m HF_ANT_00075962 VERTICAL Detector : Peak Project : 872506 Mode : 40</p> <table border="1"> <thead> <tr> <th>Over</th> <th>Limit</th> <th>ReadAntenna</th> <th>Cable</th> <th>Preamp</th> <th>A/Pos</th> <th>T/Pos</th> <th>Remark</th> </tr> <tr> <th>Freq</th> <th>Level</th> <th>Line</th> <th>Level</th> <th>Factor</th> <th>Loss</th> <th>Factor</th> <th></th> </tr> <tr> <th>MHz</th> <th>dBuV/m</th> <th>dB</th> <th>dBuV/m</th> <th>dBuV</th> <th>dB/m</th> <th>dB</th> <th>cm deg</th> </tr> </thead> <tbody> <tr> <td>1</td> <td>5854.80</td> <td>51.98</td> <td>-59.28</td> <td>111.26</td> <td>40.20</td> <td>35.41</td> <td>11.60 35.23 341 296 Peak</td> </tr> <tr> <td>2</td> <td>5871.60</td> <td>51.19</td> <td>-54.96</td> <td>106.15</td> <td>39.35</td> <td>35.43</td> <td>11.65 35.24 341 296 Peak</td> </tr> <tr> <td>3</td> <td>5899.20</td> <td>50.43</td> <td>-56.82</td> <td>107.25</td> <td>38.56</td> <td>35.46</td> <td>11.65 35.24 341 296 Peak</td> </tr> <tr> <td>4</td> <td>5944.80</td> <td>48.74</td> <td>-19.46</td> <td>68.20</td> <td>36.72</td> <td>35.53</td> <td>11.74 35.25 341 296 Peak</td> </tr> </tbody> </table>	Over	Limit	ReadAntenna	Cable	Preamp	A/Pos	T/Pos	Remark	Freq	Level	Line	Level	Factor	Loss	Factor		MHz	dBuV/m	dB	dBuV/m	dBuV	dB/m	dB	cm deg	1	5854.80	51.98	-59.28	111.26	40.20	35.41	11.60 35.23 341 296 Peak	2	5871.60	51.19	-54.96	106.15	39.35	35.43	11.65 35.24 341 296 Peak	3	5899.20	50.43	-56.82	107.25	38.56	35.46	11.65 35.24 341 296 Peak	4	5944.80	48.74	-19.46	68.20	36.72	35.53	11.74 35.25 341 296 Peak	Left blank																																								
Over	Limit	ReadAntenna	Cable	Preamp	A/Pos	T/Pos	Remark																																																																																											
Freq	Level	Line	Level	Factor	Loss	Factor																																																																																												
MHz	dBuV/m	dB	dBuV/m	dBuV	dB/m	dB	cm deg																																																																																											
1	5854.80	51.98	-59.28	111.26	40.20	35.41	11.60 35.23 341 296 Peak																																																																																											
2	5871.60	51.19	-54.96	106.15	39.35	35.43	11.65 35.24 341 296 Peak																																																																																											
3	5899.20	50.43	-56.82	107.25	38.56	35.46	11.65 35.24 341 296 Peak																																																																																											
4	5944.80	48.74	-19.46	68.20	36.72	35.53	11.74 35.25 341 296 Peak																																																																																											

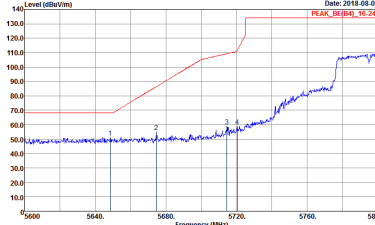
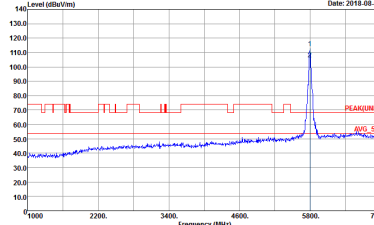
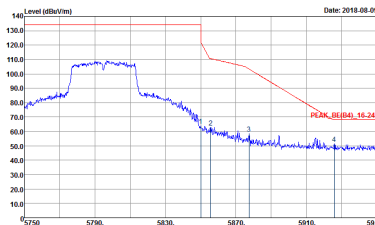

WIFI	Band 4 5725~5850MHz Band Edge @ 3m	
ANT	802.11ac VHT40 CH159 5795MHz	
1	Horizontal	Fundamental
Peak	 <p>Site : 03CH07-HY Condition : PEAK_BE(84)_16-24 3m HF_ANT_00075962 HORIZONTAL Detector : Peak Project : 872506 Mode : 41</p>	 <p>Site : 03CH07-HY Condition : PEAK(UNII) 3m HF_ANT_00075962 HORIZONTAL Detector : Peak Project : 872506 Mode : 41</p>
Peak	 <p>Site : 03CH07-HY Condition : PEAK_BE(84)_16-24 3m HF_ANT_00075962 HORIZONTAL Detector : Peak Project : 872506 Mode : 41</p>	Left blank



WIFI	Band 4 5725~5850MHz Band Edge @ 3m	
ANT	802.11ac VHT40 CH159 5795MHz	
1	Vertical	Fundamental
Peak	<p>Site : 03CH07-HY Condition : PEAK_BE(04)_16-24 3m HF_ANT_00075962 VERTICAL Detector : Peak Project : 872506 Mode : 41</p>	<p>Site : 03CH07-HY Condition : PEAK(UNLI) 3m HF_ANT_00075962 VERTICAL Detector : Peak Project : 872506 Mode : 41</p>
Peak	<p>Site : 03CH07-HY Condition : PEAK_BE(04)_16-24 3m HF_ANT_00075962 VERTICAL Detector : Peak Project : 872506 Mode : 41</p>	Left blank

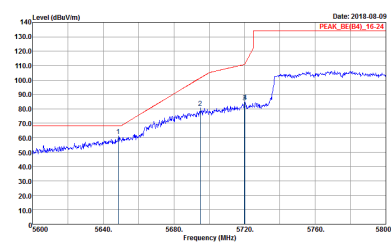
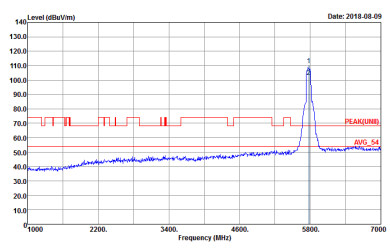
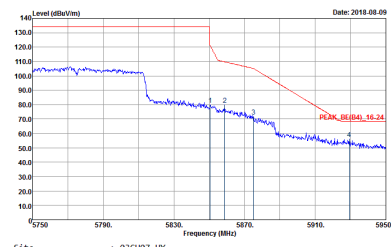

Band 4 5725~5850MHz
WIFI 802.11ac VHT80 (Band Edge @ 3m)

WIFI	Band 4 5725~5850MHz Band Edge @ 3m	
ANT	802.11ac VHT80 CH155 5775MHz	
1	Horizontal	Fundamental
<p align="center">Peak</p>	 <p>Site : 03CH07-HY Condition : PEAK_BE(B4)_16-24 3m HF_ANT_00075962 HORIZONTAL RBW:1000.000kHz VBW:3000.000kHz SMT:Auto Detector : Peak Project : 872506 Mode : 42</p>	 <p>Site : 03CH07-HY Condition : PEAK(UMB) 3m HF_ANT_00075962 HORIZONTAL RBW:1000.000kHz VBW:3000.000kHz SMT:Auto Detector : Peak Project : 872506 Mode : 42</p>
<p align="center">Peak</p>	 <p>Site : 03CH07-HY Condition : PEAK_BE(B4)_16-24 3m HF_ANT_00075962 HORIZONTAL RBW:1000.000kHz VBW:3000.000kHz SMT:Auto Detector : Peak Project : 872506 Mode : 42</p>	<p align="center">Left blank</p>



WIFI	Band 4 5725~5850MHz Band Edge @ 3m	
ANT	802.11ac VHT80 CH155 5775MHz	
1	Vertical	Fundamental
Peak	<p>Date: 2018-08-09 PEAK_BE(04)_16-24</p> <pre> Site : 03CH07-HY Condition : PEAK_BE(04)_16-24 3m HF_ANT_00075962 VERTICAL Detector : Peak Project : 872506 Mode : 42 </pre>	<p>Date: 2018-08-09 PEAK(04)_16-24</p> <pre> Site : 03CH07-HY Condition : PEAK(UNLI) 3m HF_ANT_00075962 VERTICAL Detector : Peak Project : 872506 Mode : 42 </pre>
Peak	<p>Date: 2018-08-09 PEAK_BE(04)_16-24</p> <pre> Site : 03CH07-HY Condition : PEAK_BE(04)_16-24 3m HF_ANT_00075962 VERTICAL Detector : Peak Project : 872506 Mode : 42 </pre>	Left blank

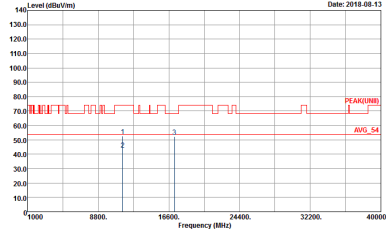
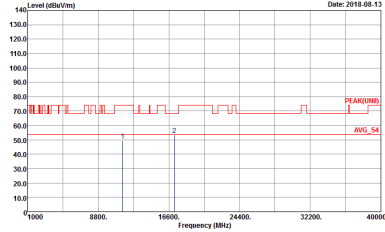

Band 4 - 5725~5850MHz
WIFI 802.11a (Harmonic @ 3m)

WIFI	Band 4 5725~5850MHz Harmonic @ 3m	
ANT	802.11a CH149 5745MHz	
1	Horizontal	Vertical
<p>Peak</p> <p>Avg.</p>	 <p>Site : 03CM07-HY Condition : PEAK(UNII) 3m SHF-EHF_131029 HORIZONTAL Detector : Peak Project : 872506 Mode : 34</p>	 <p>Site : 03CM07-HY Condition : PEAK(UNII) 3m SHF-EHF_131029 VERTICAL Detector : Peak Project : 872506 Mode : 34</p>

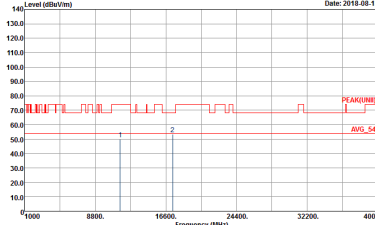
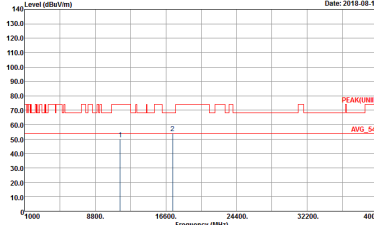

WIFI	Band 4 5725~5850MHz Harmonic @ 3m	
ANT	802.11a CH157 5785MHz	
1	Horizontal	Vertical
<p>Peak Avg.</p>	 <p>Site : 03CH07-HY Condition : PEAK(UNII) 3m SHF-EHF_131029 HORIZONTAL Detector : Peak Project : 872506 Mode : 35</p>	 <p>Site : 03CH07-HY Condition : PEAK(UNII) 3m SHF-EHF_131029 VERTICAL Detector : Peak Project : 872506 Mode : 35</p>



WIFI	Band 4 5725~5850MHz Harmonic @ 3m	
ANT	802.11a CH165 5825MHz	
1	Horizontal	Vertical
Peak Avg.	<p>Site : 03CH07-HY Condition : PEAK(UNI) 3m SHF-EHF_131029 VERTICAL Detector : Peak Project : 872506 Mode : 36</p>	<p>Site : 03CH07-HY Condition : PEAK(UNI) 3m SHF-EHF_131029 VERTICAL Detector : Peak Project : 872506 Mode : 36</p>



**Band 4 5725~5850MHz
WIFI 802.11ac VHT20 (Harmonic @ 3m)**

WIFI	Band 4 5725~5850MHz Harmonic @ 3m	
ANT	802.11ac VHT20 CH149 5745MHz	
1	Horizontal	Vertical
Peak Avg.	<p>Site : 03CH07-HY Condition : PEAK(UNIT) 3m SHF-EHF_131029 HORIZONTAL Detector : Peak Project : 872506 Mode : 37</p>	<p>Site : 03CH07-HY Condition : PEAK(UNIT) 3m SHF-EHF_131029 VERTICAL Detector : Peak Project : 872506 Mode : 37</p>

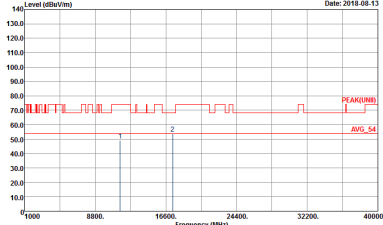
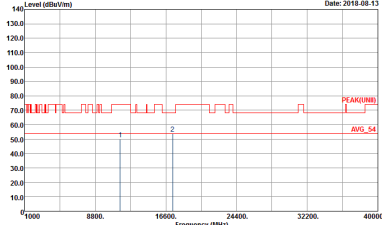

WIFI	Band 4 5725~5850MHz Harmonic @ 3m	
ANT	802.11ac VHT20 CH157 5785MHz	
1	Horizontal	Vertical
<p>Peak Avg.</p>	 <p>Site : 03CH07-HY Condition : PEAK(UNI) 3m SHF-EHF_131029 HORIZONTAL Detector : Peak Project : 872506 Mode : 38</p>	 <p>Site : 03CH07-HY Condition : PEAK(UNI) 3m SHF-EHF_131029 VERTICAL Detector : Peak Project : 872506 Mode : 38</p>



WIFI	Band 4 5725~5850MHz Harmonic @ 3m	
ANT	802.11ac VHT20 CH165 5825MHz	
1	Horizontal	Vertical
Peak Avg.	<p>Site : 03CH07-HY Condition : PEAK(UNI) 3m SHF-EHF_131029 HORIZONTAL Detector : Peak Project : 872506 Mode : 39</p>	<p>Site : 03CH07-HY Condition : PEAK(UNI) 3m SHF-EHF_131029 VERTICAL Detector : Peak Project : 872506 Mode : 39</p>



**Band 4 5725~5850MHz
WIFI 802.11ac VHT40 (Harmonic @ 3m)**

WIFI	Band 4 5725~5850MHz Harmonic @ 3m	
ANT	802.11ac VHT40 CH151 5755MHz	
1	Horizontal	Vertical
Peak Avg.	<p>Site : 03CH07-HY Condition : PEAK(UNIT) 3m SHF-EHF_131029 HORIZONTAL Detector : Peak Project : 872506 Mode : 40</p>	<p>Site : 03CH07-HY Condition : PEAK(UNIT) 3m SHF-EHF_131029 VERTICAL Detector : Peak Project : 872506 Mode : 40</p>

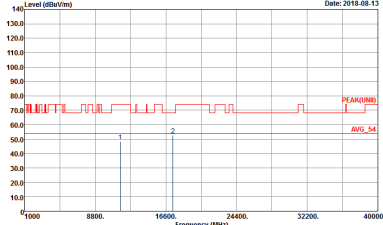
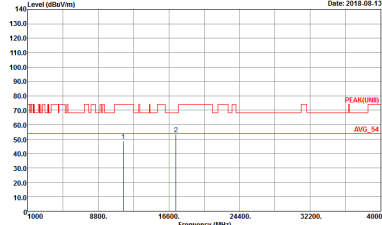

WIFI	Band 4 5725~5850MHz Harmonic @ 3m	
ANT	802.11ac VHT40 CH159 5795MHz	
1	Horizontal	Vertical
Peak Avg.	 <p>Site : 03CH07-HY Condition : PEAK(UNI) 3m SHF-EHF_131029 HORIZONTAL Detector : Peak Project : 872506 Mode : 41</p>	 <p>Site : 03CH07-HY Condition : PEAK(UNI) 3m SHF-EHF_131029 VERTICAL Detector : Peak Project : 872506 Mode : 41</p>



Band 4 5725~5850MHz
WIFI 802.11ac VHT80 (Harmonic @ 3m)

Table with 2 columns: WIFI (Band 4 5725~5850MHz Harmonic @ 3m), ANT (802.11ac VHT80 CH155 5775MHz). It contains two sub-tables for 'Horizontal' and 'Vertical' orientations, each with a spectrum plot and associated metadata like Site, Condition, and Project.



Emission below 1GHz
5GHz WIFI 802.11ac VHT80 (LF)

WIFI	5GHz 5725~5850MHz	
ANT	802.11ac VHT80 LF	
1	Horizontal	Vertical
QP / Peak	<p>Site : 03CM07-HY Condition : QP 3m LF-ANT-35419(6) HORIZONTAL Detector : Peak Project : 872506 Mode : 159</p>	<p>Site : 03CM07-HY Condition : QP 3m LF-ANT-35419(6) VERTICAL Detector : Peak Project : 872506 Mode : 159</p>



Band 4 - 5725~5850MHz
WIFI 802.11a (Band Edge @ 3m)

WIFI	Band 4 5725~5850MHz Band Edge @ 3m	
ANT	802.11a CH149 5745MHz	
2	Horizontal	Fundamental
Peak	<p>Site : 03C807-HY Condition : PEAK_BE(B4)_16-24 3m HF_ANT_00075962 HORIZONTAL RBM:1000.000kHz VBM:3000.000kHz SMT:Auto Detector : Peak Project : 872506 Mode : 76</p>	<p>Site : 03C807-HY Condition : PEAK(UNIT) 3m HF_ANT_00075962 HORIZONTAL RBM:1000.000kHz VBM:3000.000kHz SMT:Auto Detector : Peak Project : 872506 Mode : 76</p>



WIFI	Band 4 5725~5850MHz Band Edge @ 3m	
ANT	802.11a CH149 5745MHz	
2	Vertical	Fundamental
Peak	<p>Site : 03CH07-HY Condition : PEAK_BE(B4)_16-24 3m HF_ANT_00075962 VERTICAL RBW:1000.000kHz VBW:3000.000kHz SWT:Auto Detector : Peak Project : 872506 Mode : 76</p>	<p>Site : 03CH07-HY Condition : PEAK(UNLI) 3m HF_ANT_00075962 VERTICAL RBW:1000.000kHz VBW:3000.000kHz SWT:Auto Detector : Peak Project : 872506 Mode : 76</p>



WIFI	Band 4 5725~5850MHz Band Edge @ 3m	
ANT	802.11a CH157 5785MHz	
2	Horizontal	Fundamental
Peak	<p>Date: 2018-08-10 PEAK_BE(84)_16-24</p> <pre> Site : 03CH07-HY Condition : PEAK_BE(84)_16-24 3m HF_ANT_00075962 HORIZONTAL Detector : Peak Project : 872506 Mode : 77 </pre>	<p>Date: 2018-08-10 PEAK(UNLI)_3m HF_ANT_00075962 HORIZONTAL</p> <pre> Site : 03CH07-HY Condition : PEAK(UNLI)_3m HF_ANT_00075962 HORIZONTAL Detector : Peak Project : 872506 Mode : 77 </pre>
Peak	<p>Date: 2018-08-10 PEAK_BE(84)_16-24</p> <pre> Site : 03CH07-HY Condition : PEAK_BE(84)_16-24 3m HF_ANT_00075962 HORIZONTAL Detector : Peak Project : 872506 Mode : 77 </pre>	Left blank



WIFI	Band 4 5725~5850MHz Band Edge @ 3m	
ANT	802.11a CH157 5785MHz	
2	Vertical	Fundamental
Peak	<p>Site : 03CH07-HY Condition : PEAK_BE(04)_16-24 3m HF_ANT_00075962 VERTICAL Detector : Peak Project : 872506 Mode : 77</p>	<p>Site : 03CH07-HY Condition : PEAK(UNLI)_3m HF_ANT_00075962 VERTICAL Detector : Peak Project : 872506 Mode : 77</p>
Peak	<p>Site : 03CH07-HY Condition : PEAK_BE(04)_16-24 3m HF_ANT_00075962 VERTICAL Detector : Peak Project : 872506 Mode : 77</p>	Left blank



WIFI	Band 4 5725~5850MHz Band Edge @ 3m	
ANT	802.11a CH165 5825MHz	
2	Horizontal	Fundamental
Peak	<p>Site : 03CH07-HY Condition : PEAK_BE(B4)_16-24 3m HF_ANT_00075962 HORIZONTAL RBW:1000.000kHz VBW:3000.000kHz SWT:Auto Detector : Peak Project : 872506 Mode : 78</p>	<p>Site : 03CH07-HY Condition : PEAK(UNLI) 3m HF_ANT_00075962 HORIZONTAL RBW:1000.000kHz VBW:3000.000kHz SWT:Auto Detector : Peak Project : 872506 Mode : 78</p>



WIFI	Band 4 5725~5850MHz Band Edge @ 3m	
ANT	802.11a CH165 5825MHz	
2	Vertical	Fundamental
Peak	<p>Site : 03CH07-HY Condition : PEAK_BE(B4)_16-24 3m HF_ANT_00075962 VERTICAL RBW:1000.000kHz VBW:3000.000kHz SWT:Auto Detector : Peak Project : 872506 Mode : 78</p>	<p>Site : 03CH07-HY Condition : PEAK(UNLI) 3m HF_ANT_00075962 VERTICAL RBW:1000.000kHz VBW:3000.000kHz SWT:Auto Detector : Peak Project : 872506 Mode : 78</p>



**Band 4 5725~5850MHz
WIFI 802.11ac VHT20 (Band Edge @ 3m)**

WIFI	Band 4 5725~5850MHz Band Edge @ 3m	
ANT	802.11ac VHT20 CH149 5745MHz	
2	Horizontal	Fundamental
Peak	<p>Site : 03CH07-HY Condition : PEAK_BE(84)_16-24 3m HF_ANT_00075962 HORIZONTAL Detector : Peak Project : 872506 Mode : 79</p>	<p>Site : 03CH07-HY Condition : PEAK(UMB)_16-24 3m HF_ANT_00075962 HORIZONTAL Detector : Peak Project : 872506 Mode : 79</p>



WIFI	Band 4 5725~5850MHz Band Edge @ 3m	
ANT	802.11ac VHT20 CH149 5745MHz	
2	Vertical	Fundamental
Peak Avg.	<p> Site : 03CH07-HY Condition : PEAK_BE(B4)_16-24 3m HF_ANT_00075962 VERTICAL RBW:1000.000kHz VBW:3000.000kHz SWT:Auto Detector : Peak Project : 872506 Mode : 79 </p>	<p> Site : 03CH07-HY Condition : PEAK(UNLI) 3m HF_ANT_00075962 VERTICAL RBW:1000.000kHz VBW:3000.000kHz SWT:Auto Detector : Peak Project : 872506 Mode : 79 </p>



WIFI	Band 4 5725~5850MHz Band Edge @ 3m	
ANT	802.11ac VHT20 CH157 5785MHz	
2	Horizontal	Fundamental
Peak	<p> Site : 03CH07-HY Condition : PEAK_BE(B4)_16-24 3m HF_ANT_00075962 HORIZONTAL Detector : Peak Project : 872506 Mode : 80 </p>	<p> Site : 03CH07-HY Condition : PEAK(UNLI) 3m HF_ANT_00075962 HORIZONTAL Detector : Peak Project : 872506 Mode : 80 </p>
Peak	<p> Site : 03CH07-HY Condition : PEAK_BE(B4)_16-24 3m HF_ANT_00075962 HORIZONTAL Detector : Peak Project : 872506 Mode : 80 </p>	Left blank



WIFI	Band 4 5725~5850MHz Band Edge @ 3m	
ANT	802.11ac VHT20 CH157 5785MHz	
2	Vertical	Fundamental
Peak	<p>Date: 2018-08-10 PEAK_BE(04)_16-20</p> <pre> Site : 03CH07-HY Condition : PEAK_BE(04)_16-24 3m HF_ANT_00075962 VERTICAL Detector : Peak Project : 872506 Mode : 00 </pre>	<p>Date: 2018-08-10 PEAK(UNLI)_3m HF_ANT_00075962 VERTICAL</p> <pre> Site : 03CH07-HY Condition : PEAK(UNLI)_3m HF_ANT_00075962 VERTICAL Detector : Peak Project : 872506 Mode : 00 </pre>
Peak	<p>Date: 2018-08-10 PEAK_BE(04)_16-24</p> <pre> Site : 03CH07-HY Condition : PEAK_BE(04)_16-24 3m HF_ANT_00075962 VERTICAL Detector : Peak Project : 872506 Mode : 00 </pre>	Left blank

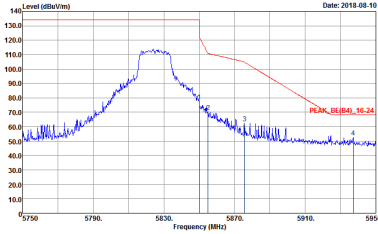
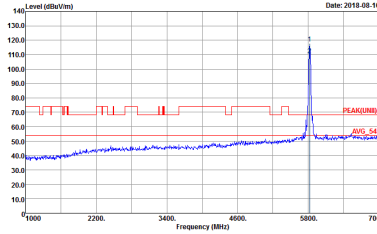

WIFI	Band 4 5725~5850MHz Band Edge @ 3m	
ANT	802.11ac VHT20 CH165 5825MHz	
2	Horizontal	Fundamental
Peak	 <p>Site : 03CH07-HY Condition : PEAK_BE(B4)_16-24 3m HF_ANT_00075962 HORIZONTAL RBW:1000.000kHz VBW:3000.000kHz SWT:Auto Detector : Peak Project : 872506 Mode : 81</p>	 <p>Site : 03CH07-HY Condition : PEAK(UNLI) 3m HF_ANT_00075962 HORIZONTAL RBW:1000.000kHz VBW:3000.000kHz SWT:Auto Detector : Peak Project : 872506 Mode : 81</p>



WIFI	Band 4 5725~5850MHz Band Edge @ 3m	
ANT	802.11ac VHT20 CH165 5825MHz	
2	Vertical	Fundamental
Peak Avg.	<p> Site : 03CH07-HY Condition : PEAK_BE(B4)_16-24 3m HF_ANT_00075962 VERTICAL RBW:1000.000kHz VBW:3000.000kHz SWT:Auto Detector : Peak Project : 872506 Mode : 81 </p>	<p> Site : 03CH07-HY Condition : PEAK(UNLI) 3m HF_ANT_00075962 VERTICAL RBW:1000.000kHz VBW:3000.000kHz SWT:Auto Detector : Peak Project : 872506 Mode : 81 </p>

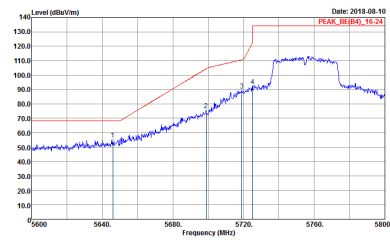
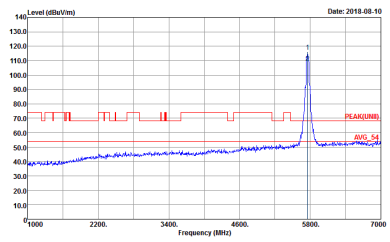
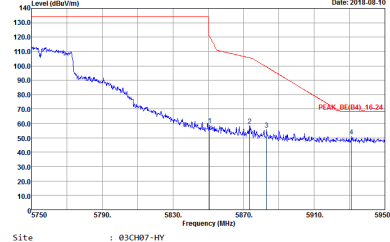

Band 4 5725~5850MHz
WIFI 802.11ac VHT40 (Band Edge @ 3m)

WIFI	Band 4 5725~5850MHz Band Edge @ 3m	
ANT	802.11ac VHT40 CH151 5755MHz	
2	Horizontal	Fundamental
Peak	 <p>Site : 03CH07-HY Condition : PEAK_BE(B4)_16-24 3m HF_ANT_00075962 HORIZONTAL RBW:1000.000kHz VBW:3000.000kHz SMT:Auto Detector : Peak Project : 872506 Mode : 82</p>	 <p>Site : 03CH07-HY Condition : PEAK(UMB)_3m HF_ANT_00075962 HORIZONTAL RBW:1000.000kHz VBW:3000.000kHz SMT:Auto Detector : Peak Project : 872506 Mode : 82</p>
Peak	 <p>Site : 03CH07-HY Condition : PEAK_BE(B4)_16-24 3m HF_ANT_00075962 HORIZONTAL RBW:1000.000kHz VBW:3000.000kHz SMT:Auto Detector : Peak Project : 872506 Mode : 82</p>	Left blank



WIFI	Band 4 5725~5850MHz Band Edge @ 3m	
ANT	802.11ac VHT40 CH151 5755MHz	
2	Vertical	Fundamental
Peak	<p>Date: 2018-08-10 PEAK_BE(04)_16-24</p> <p>Site : 03CH07-HY Condition : PEAK_BE(04)_16-24 3m HF_ANT_00075962 VERTICAL Detector : Peak Project : 872506 Mode : 82</p>	<p>Date: 2018-08-10 PEAK(UNLI)_3m HF_ANT_00075962 VERTICAL</p> <p>Site : 03CH07-HY Condition : PEAK(UNLI)_3m HF_ANT_00075962 VERTICAL Detector : Peak Project : 872506 Mode : 82</p>
Peak	<p>Date: 2018-08-10 PEAK_BE(04)_16-24</p> <p>Site : 03CH07-HY Condition : PEAK_BE(04)_16-24 3m HF_ANT_00075962 VERTICAL Detector : Peak Project : 872506 Mode : 82</p>	Left blank

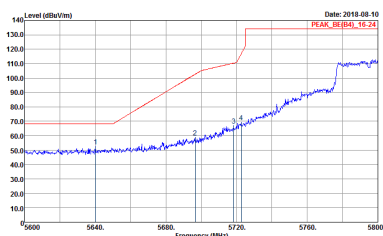
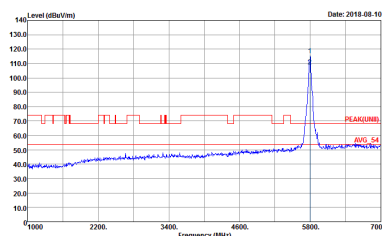
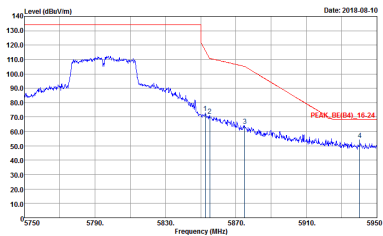

WIFI	Band 4 5725~5850MHz Band Edge @ 3m	
ANT	802.11ac VHT40 CH159 5795MHz	
2	Horizontal	Fundamental
<p>Peak</p>	 <p>Site : 03CH07-HY Condition : PEAK_BE(84)_16-24 3m HF_ANT_00075962 HORIZONTAL Detector : Peak Project : 872506 Mode : 83</p>	 <p>Site : 03CH07-HY Condition : PEAK(UNII) 3m HF_ANT_00075962 HORIZONTAL Detector : Peak Project : 872506 Mode : 83</p>
<p>Peak</p>	 <p>Site : 03CH07-HY Condition : PEAK_BE(84)_16-24 3m HF_ANT_00075962 HORIZONTAL Detector : Peak Project : 872506 Mode : 83</p>	<p>Left blank</p>



WIFI	Band 4 5725~5850MHz Band Edge @ 3m	
ANT	802.11ac VHT40 CH159 5795MHz	
2	Vertical	Fundamental
Peak	<p>Site : 03CH07-HY Condition : PEAK_BE(B4)_16-24 3m HF_ANT_00075962 VERTICAL Detector : Peak Project : 872506 Mode : 83</p>	<p>Site : 03CH07-HY Condition : PEAK(UNLI) 3m HF_ANT_00075962 VERTICAL Detector : Peak Project : 872506 Mode : 83</p>
Peak	<p>Site : 03CH07-HY Condition : PEAK_BE(B4)_16-24 3m HF_ANT_00075962 VERTICAL Detector : Peak Project : 872506 Mode : 83</p>	Left blank



Band 4 5725~5850MHz
WIFI 802.11ac VHT80 (Band Edge @ 3m)

WIFI	Band 4 5725~5850MHz Band Edge @ 3m	
ANT	802.11ac VHT80 CH155 5775MHz	
2	Horizontal	Fundamental
Peak	<p>Site : 03CH07-HY Condition : PEAK_BE(B4)_16-24 3m HF_ANT_00075962 HORIZONTAL RBW:1000.000kHz VBW:3000.000kHz SMT:Auto Detector : Peak Project : 872506 Mode : S4</p>	<p>Site : 03CH07-HY Condition : PEAK(UM) 3m HF_ANT_00075962 HORIZONTAL RBW:1000.000kHz VBW:3000.000kHz SMT:Auto Detector : Peak Project : 872506 Mode : S4</p>
Peak	<p>Site : 03CH07-HY Condition : PEAK_BE(B4)_16-24 3m HF_ANT_00075962 HORIZONTAL RBW:1000.000kHz VBW:3000.000kHz SMT:Auto Detector : Peak Project : 872506 Mode : S4</p>	Left blank



WIFI	Band 4 5725~5850MHz Band Edge @ 3m	
ANT	802.11ac VHT80 CH155 5775MHz	
2	Vertical	Fundamental
Peak	<p> Site : 03CH07-HY Condition : PEAK_BE(04)_16-24 3m HF_ANT_00075962 VERTICAL Detector : RBM:1000.000kHz VBM:3000.000kHz SWT:Auto Project : Peak Mode : 84 </p>	<p> Site : 03CH07-HY Condition : PEAK(UNLI) 3m HF_ANT_00075962 VERTICAL Detector : RBM:1000.000kHz VBM:3000.000kHz SWT:Auto Project : Peak Mode : 84 </p>
Peak	<p> Site : 03CH07-HY Condition : PEAK_BE(04)_16-24 3m HF_ANT_00075962 VERTICAL Detector : RBM:1000.000kHz VBM:3000.000kHz SWT:Auto Project : Peak Mode : 84 </p>	Left blank

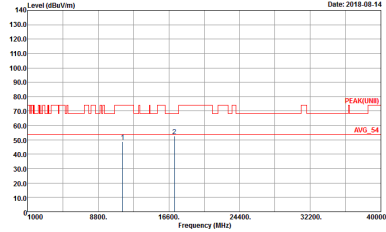
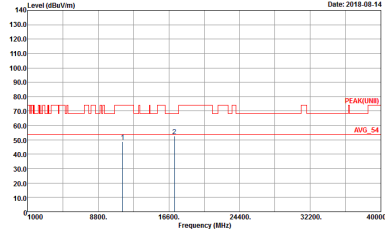

Band 4 - 5725~5850MHz
WIFI 802.11a (Harmonic @ 3m)

WIFI	Band 4 5725~5850MHz Harmonic @ 3m	
ANT	802.11a CH149 5745MHz	
2	Horizontal	Vertical
<p>Peak</p> <p>Avg.</p>	 <p>Site : 03CM07-HY Condition : PEAK(UNII) 3m SHF-EHF_131029 HORIZONTAL Detector : Peak Project : 872506 Mode : 76</p>	 <p>Site : 03CM07-HY Condition : PEAK(UNII) 3m SHF-EHF_131029 VERTICAL Detector : Peak Project : 872506 Mode : 76</p>



WIFI	Band 4 5725~5850MHz Harmonic @ 3m	
ANT	802.11a CH157 5785MHz	
2	Horizontal	Vertical
Peak Avg.	<p>Site : 03CH07-HY Condition : PEAK(UNII) 3m SHF-EHF_131029 HORIZONTAL Detector : Peak Project : 872506 Mode : 77</p>	<p>Site : 03CH07-HY Condition : PEAK(UNII) 3m SHF-EHF_131029 VERTICAL Detector : Peak Project : 872506 Mode : 77</p>



WIFI	Band 4 5725~5850MHz Harmonic @ 3m	
ANT	802.11a CH165 5825MHz	
2	Horizontal	Vertical
Peak Avg.	<p>Site : 03CH07-HY Condition : PEAK(UNI) 3m SHF-EHF_131029 HORIZONTAL Detector : Peak Project : 872506 Mode : 78</p>	<p>Site : 03CH07-HY Condition : PEAK(UNI) 3m SHF-EHF_131029 VERTICAL Detector : Peak Project : 872506 Mode : 78</p>



Band 4 5725~5850MHz
WIFI 802.11ac VHT20 (Harmonic @ 3m)

Table with 3 columns: WIFI, ANT, and 2 (Horizontal/Vertical). It contains two spectral plots showing Level (dBu/m) vs Frequency (MHz) for Horizontal and Vertical orientations. Includes metadata like Site, Condition, Detector, Project, and Mode.

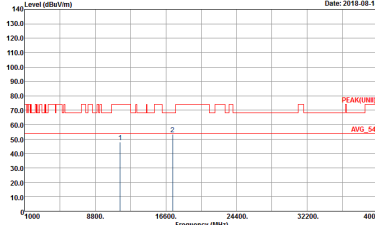
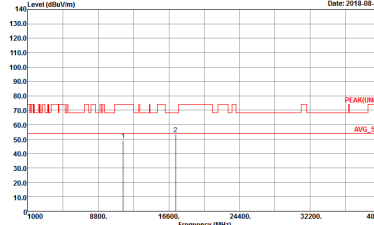

WIFI	Band 4 5725~5850MHz Harmonic @ 3m	
ANT	802.11ac VHT20 CH157 5785MHz	
2	Horizontal	Vertical
<p>Peak Avg.</p>	 <p>Site : 03CH07-HY Condition : PEAK(UNI) 3m SHF-EHF_131029 HORIZONTAL Detector : Peak Project : 872506 Mode : 80</p>	 <p>Site : 03CH07-HY Condition : PEAK(UNI) 3m SHF-EHF_131029 VERTICAL Detector : Peak Project : 872506 Mode : 80</p>



WIFI	Band 4 5725~5850MHz Harmonic @ 3m	
ANT	802.11ac VHT20 CH165 5825MHz	
2	Horizontal	Vertical
Peak Avg.	<p>Site : 03CH07-HY Condition : PEAK(UNI) 3m SHF-EHF_131029 HORIZONTAL Detector : Peak Project : 872506 Mode : 81</p>	<p>Site : 03CH07-HY Condition : PEAK(UNI) 3m SHF-EHF_131029 VERTICAL Detector : Peak Project : 872506 Mode : 81</p>



**Band 4 5725~5850MHz
WIFI 802.11ac VHT40 (Harmonic @ 3m)**

WIFI	Band 4 5725~5850MHz Harmonic @ 3m	
ANT	802.11ac VHT40 CH151 5755MHz	
2	Horizontal	Vertical
Peak Avg.	<p>Site : 03CH07-HY Condition : PEAK(UNIT) 3m SHF-EHF_131029 HORIZONTAL Detector : Peak Project : 872506 Mode : 82</p>	<p>Site : 03CH07-HY Condition : PEAK(UNIT) 3m SHF-EHF_131029 VERTICAL Detector : Peak Project : 872506 Mode : 82</p>

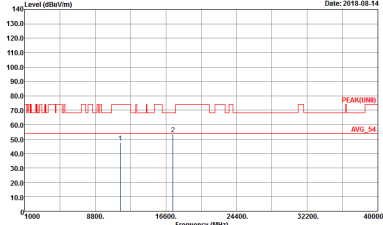
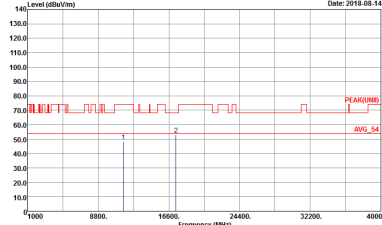

WIFI	Band 4 5725~5850MHz Harmonic @ 3m	
ANT	802.11ac VHT40 CH159 5795MHz	
2	Horizontal	Vertical
<p>Peak Avg.</p>	 <p>Site : 03CH07-HY Condition : PEAK(UNI) 3m SHF-EHF_131029 HORIZONTAL Detector : Peak Project : 872506 Mode : 83</p>	 <p>Site : 03CH07-HY Condition : PEAK(UNI) 3m SHF-EHF_131029 VERTICAL Detector : Peak Project : 872506 Mode : 83</p>



Band 4 5725~5850MHz
WIFI 802.11ac VHT80 (Harmonic @ 3m)

Table with 2 columns: Horizontal and Vertical. Each column contains a spectral plot of Level (dBu/m) vs Frequency (MHz) and associated test parameters like Site, Condition, Detector, Project, and Mode.



Emission below 1GHz
5GHz WIFI 802.11ac VHT80 (LF)

WIFI	5GHz 5725~5850MHZ	
ANT	802.11ac VHT80 LF	
2	Horizontal	Vertical
QP / Peak	<p>Site : 03CM07-HY Condition : QP 3m LF-ANT-35419(6) HORIZONTAL Detector : Peak Project : 872506 Mode : 161</p>	<p>Site : 03CM07-HY Condition : QP 3m LF-ANT-35419(6) VERTICAL Detector : Peak Project : 872506 Mode : 161</p>



Band 4 - 5725~5850MHz
WIFI 802.11a (Band Edge @ 3m)

Table with 2 columns: Horizontal and Fundamental. Contains spectral plots and technical details for Peak detection at 5725MHz and 5745MHz.



WIFI	Band 4 5725~5850MHz Band Edge @ 3m	
ANT	802.11a CH149 5745MHz	
1+2	Vertical	Fundamental
Peak	<p>Site : 03CH07-HY Condition : PEAK_BE(B4)_16-24 3m HF_ANT_00075962 VERTICAL RBW:1000.000kHz VBW:3000.000kHz SWT:Auto Detector : Peak Project : 872506 Mode : 147</p>	<p>Site : 03CH07-HY Condition : PEAK_UN(LI)_3m HF_ANT_00075962 VERTICAL RBW:1000.000kHz VBW:3000.000kHz SWT:Auto Detector : Peak Project : 872506 Mode : 147</p>



WIFI	Band 4 5725~5850MHz Band Edge @ 3m	
ANT	802.11a CH157 5785MHz	
1+2	Horizontal	Fundamental
Peak	<p>Date: 2018.08.15 PEAK_BE(84)_16-24</p> <p>Site : 03CH07-HY Condition : PEAK_BE(84)_16-24 3m HF_ANT_00075962 HORIZONTAL Detector : Peak Project : 872506 Mode : 148</p>	<p>Date: 2018.08.15</p> <p>Site : 03CH07-HY Condition : PEAK(UNLI) 3m HF_ANT_00075962 HORIZONTAL Detector : Peak Project : 872506 Mode : 148</p>
Peak	<p>Date: 2018.08.15 PEAK_BE(84)_16-24</p> <p>Site : 03CH07-HY Condition : PEAK_BE(84)_16-24 3m HF_ANT_00075962 HORIZONTAL Detector : Peak Project : 872506 Mode : 148</p>	Left blank



WIFI	Band 4 5725~5850MHz Band Edge @ 3m	
ANT	802.11a CH157 5785MHz	
1+2	Vertical	Fundamental
Peak	<p>Date: 2018-08-15 PEAK_BE(04)_16-24</p> <pre> Site : 03CH07-HY Condition : PEAK_BE(04)_16-24 3m HF_ANT_00075962 VERTICAL Detector : Peak Project : 872506 Mode : 148 </pre>	<p>Date: 2018-08-15 PEAK(UNLI)</p> <pre> Site : 03CH07-HY Condition : PEAK(UNLI) 3m HF_ANT_00075962 VERTICAL Detector : Peak Project : 872506 Mode : 148 </pre>
Peak	<p>Date: 2018-08-15 PEAK_BE(04)_16-24</p> <pre> Site : 03CH07-HY Condition : PEAK_BE(04)_16-24 3m HF_ANT_00075962 VERTICAL Detector : Peak Project : 872506 Mode : 148 </pre>	Left blank

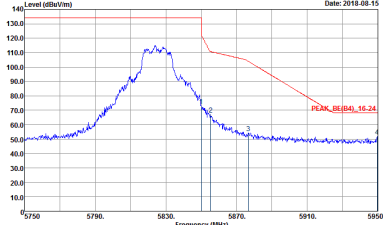
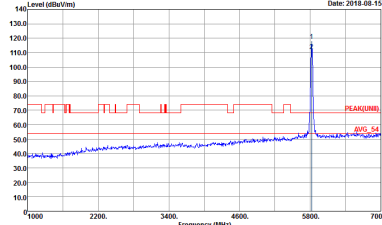

WIFI	Band 4 5725~5850MHz Band Edge @ 3m	
ANT	802.11a CH165 5825MHz	
1+2	Horizontal	Fundamental
Peak	 <p>Site : 03CH07-HY Condition : PEAK_BE(B4)_16-24 3m HF_ANT_00075962 HORIZONTAL Detector : Peak Project : 872506 Mode : 149</p>	 <p>Site : 03CH07-HY Condition : PEAK(UNLI) 3m HF_ANT_00075962 HORIZONTAL Detector : Peak Project : 872506 Mode : 149</p>



WIFI	Band 4 5725~5850MHz Band Edge @ 3m	
ANT	802.11a CH165 5825MHz	
1+2	Vertical	Fundamental
Peak	<p> Site : 03CH07-HY Condition : PEAK_BE(B4)_16-24 3m HF_ANT_00075962 VERTICAL RBW:1000.000kHz VBW:3000.000kHz SWT:Auto Detector : Peak Project : 872506 Mode : 149 </p>	<p> Site : 03CH07-HY Condition : PEAK(UNLI) 3m HF_ANT_00075962 VERTICAL RBW:1000.000kHz VBW:3000.000kHz SWT:Auto Detector : Peak Project : 872506 Mode : 149 </p>



Band 4 5725~5850MHz
WIFI 802.11ac VHT20 (Band Edge @ 3m)

Table with 2 columns: WIFI (Band 4 5725~5850MHz Band Edge @ 3m), ANT (802.11ac VHT20 CH149 5745MHz). Row 1+2 shows Peak analysis for Horizontal and Fundamental signals with associated graphs and metadata.