



FCC RF Test Report

APPLICANT : Zebra Technologies Corporation
EQUIPMENT : Touch computer
BRAND NAME : Zebra
MODEL NAME : TC75EK
FCC ID : UZ7TC75EK
STANDARD : FCC Part 15 Subpart C §15.225
CLASSIFICATION : (DXX) Low Power Communication Device Transmitter

The testing was completed on Sep. 20, 2016. We, SPORTON INTERNATIONAL INC., would like to declare that the tested sample has been evaluated in accordance with the test procedures and has been in compliance with the applicable technical standards.

The test results in this report apply exclusively to the tested model / sample. Without written approval of SPORTON INTERNATIONAL INC., the test report shall not be reproduced except in full.

Reviewed by: Joseph Lin / Supervisor

Approved by: Jones Tsai / Manager



SPORTON INTERNATIONAL INC.

No. 52, Hwa Ya 1st Rd., Hwa Ya Technology Park, Kwei-Shan District, Tao Yuan City, Taiwan, R.O.C.



TABLE OF CONTENTS

SUMMARY OF THE TEST RESULT4

1. GENERAL INFORMATION.....5

1.1 Applicant..... 5

1.2 Manufacturer 5

1.3 Product Feature of Equipment Under Test 5

1.4 Product Specification of Equipment Under Test 6

1.5 Modification of EUT 6

1.6 Testing Location 7

1.7 Applicable Standards..... 7

2. TEST CONFIGURATION OF EQUIPMENT UNDER TEST8

2.1 Descriptions of Test Mode 8

2.2 Connection Diagram of Test System 8

2.3 Table for Supporting Units 10

2.4 EUT Operation Test Setup 10

3. TEST RESULTS.....11

3.1 AC Power Line Conducted Emissions Measurement 11

3.2 20dB and 99% OBW Spectrum Bandwidth Measurement..... 13

3.3 Frequency Stability Measurement 14

3.4 Field Strength of Fundamental Emissions and Mask Measurement..... 15

3.5 Radiated Emissions Measurement 17

3.6 Antenna Requirements..... 20

4. LIST OF MEASURING EQUIPMENT21

APPENDIX A. SETUP PHOTOGRAPHS OF EUT

APPENDIX B. TEST RESULTS OF CONDUCTED EMISSION TEST

APPENDIX C. TEST RESULTS OF CONDUCTED TEST ITEMS

C1. Test Result of 20dB Spectrum Bandwidth

C2. Test Result of Frequency Stability

APPENDIX D. TEST RESULTS OF RADIATED TEST ITEMS

D1. Test Result of Field Strength of Fundamental Emissions

D2. Results of Radiated Emissions (9 kHz~30MHz)

D3. Results of Radiated Emissions (30MHz~1GHz)



REVISION HISTORY

REPORT NO.	VERSION	DESCRIPTION	ISSUED DATE
FR672834D	Rev. 01	Initial issue of report	Sep. 29, 2016
FR672834D	Rev. 02	Revising the specification of accessories.	Oct. 04, 2016
FR672834D	Rev. 03	Revising the Adapter information in specification of accessories.	Oct. 07, 2016



SUMMARY OF THE TEST RESULT

Applied Standard: 47 CFR FCC Part 15 Subpart C				
Part	FCC Rule	Description of Test	Result	Under Limit
3.1	15.207	AC Power Line Conducted Emissions	Complies	3.20 dB at 0.758MHz
3.2	15.215(c)	20dB Spectrum Bandwidth	Complies	-
	-	99% OBW Spectrum Bandwidth	Complies	-
3.3	15.225(e)	Frequency Stability	Complies	-
3.4	15.225(a)(b)(c)	Field Strength of Fundamental Emissions	Complies	58.49 dB at 13.560 MHz
3.5	15.225(d) 15.209	Radiated Emissions	Complies	6.92 dB at 153.660 MHz for Peak
3.6	15.203	Antenna Requirements	Complies	-

Test Items	Uncertainty	Remark
AC Power Line Conducted Emissions	±2.70dB	Confidence levels of 95%
Radiated Emissions (30MHz~1000MHz)	±5.70dB	Confidence levels of 95%



1. GENERAL INFORMATION

1.1 Applicant

Zebra Technologies Corporation
1 Zebra Plaza Holtsville, NY 11742

1.2 Manufacturer

Wistron Corporation
21F, No. 88, Sec. 1, Hsin Tai Wu Rd., Hsichih Dist, New Taipei City 221, Taiwan R.O.C.

1.3 Product Feature of Equipment Under Test

Product Feature	
Equipment	Touch computer
Brand Name	Zebra
Model Name	TC75EK
FCC ID	UZ7TC75EK
EUT supports Radios application	CDMA/EV-DO/GSM/EGPRS/WCDMA/HSPA/LTE/NFC WLAN 11a/b/g/n HT20/HT40 WLAN 11ac VHT20/VHT40/VHT80 Bluetooth BR/EDR/LE
HW Version	DV
SW Version	Android version 6.0.1
FW Version	91-10-01-MG-00
MFD	14JUL16
EUT Stage	Engineering sample

Remark: The above EUT's information was declared by manufacturer. Please refer to the specifications or user's manual for more detailed description.



Specification of Accessories				
AC Adapter	Brand Name	Zebra	Part Number	PWR-BUA5V16W0WW
Snap-On USB/Charge Cable	Brand Name	Symbol	Part Number	CBL-TC7X-USB1-01
Snap-On Charging Cable Cup	Brand Name	Symbol	Part Number	CHG-TC7X-CBL1-01
Battery	Brand Name	Zebra	Part Number	BT-000318-01
Earphone 1	Brand Name	Zebra	Part Number	HDST-35MM-PTVP-01
Earphone 2	Brand Name	Zebra	Part Number	HS2100-OTH
Earphone 3	Brand Name	Zebra	Part Number	HS3100-OTH
Snap-on 3.5MM Audio Nugget	Brand Name	Symbol	Part Number	ADP-TC7X-AUD35-01
3.5mm Jack 43"(1.1m) Standard Cable	Brand Name	Zebra	Part Number	CBL-HS2100-3MS1-01
Soft Holster	Brand Name	Zebra	Part Number	SG-TC7X-HLSTR1-01
Rigid Holster	Brand Name	Zebra	Part Number	SG-TC7X-RHLSTR1-01
Power Cord	Brand Name	LOROM	Part Number	50-16000-182R
Cable line	Brand Name	Zebra	Part Number	CBL-DC-383A1-01

1.4 Product Specification of Equipment Under Test

Standards-related Product Specification	
Tx/Rx Frequency Range	13.553 ~ 13.567MHz
Channel Number	1
20dBW	2.64 KHz
99%OBW	2.24 KHz
Antenna Type	Loop Antenna
Type of Modulation	ASK

Remark: The above EUT's information was declared by manufacturer. Please refer to the specifications or user's manual for more detailed description.

1.5 Modification of EUT

No modifications are made to the EUT during all test items.



1.6 Testing Location

Sporton Lab is accredited to ISO 17025 by Taiwan Accreditation Foundation (TAF code : 1190) and the FCC designation No. TW1022 under the FCC 2.948(e) by Mutual Recognition Agreement (MRA) in FCC Test.

Test Site	SPORTON INTERNATIONAL INC.		
Test Site Location	No. 52, Hwa Ya 1 st Rd., Hwa Ya Technology Park, Kwei-Shan District, Tao Yuan City, Taiwan, R.O.C. TEL: +886-3-3273456 / FAX: +886-3-3284978		
Test Site No.	Sporton Site No.		
	TH03-HY	CO05-HY	03CH07-HY
Test Engineer	William Liao	Arthur Hsieh	James Chiu
Temperature°C	22 ~ 24	22~24	21~23
Relative Humidity%	53 ~ 55	51~53	57~61

Note: The test site complies with ANSI C63.4 2014 requirement.

1.7 Applicable Standards

According to the specifications of the manufacturer, the EUT must comply with the requirements of the following standards:

- ♦ FCC Part 15 Subpart C §15.225
- ♦ ANSI C63.10-2013

2. TEST CONFIGURATION OF EQUIPMENT UNDER TEST

2.1 Descriptions of Test Mode

Investigation has been done on all the possible configurations for searching the worst cases.

The following table is a list of the test modes shown in this test report.

Test Items	
AC Power Line Conducted Emissions	Field Strength of Fundamental Emissions
20dB Spectrum Bandwidth	Frequency Stability
Radiated Emissions 9kHz~30MHz	Radiated Emissions 30MHz~1GHz

The EUT pre-scanned in four NFC type, A, B, F, V. The worst type (type F) was recorded in this report. Pre-scanned tests, X, Y, Z in three orthogonal panels to determine the final configuration (Z plane as worst plane) from all possible combinations.

2.2 Connection Diagram of Test System

<AC Conducted Emission for charging mode>

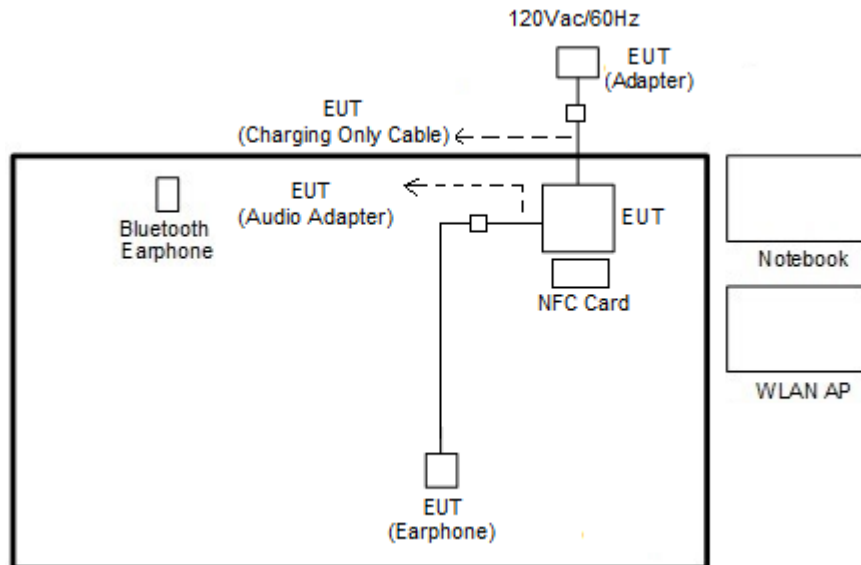

<AC Conducted Emission for data link mode>

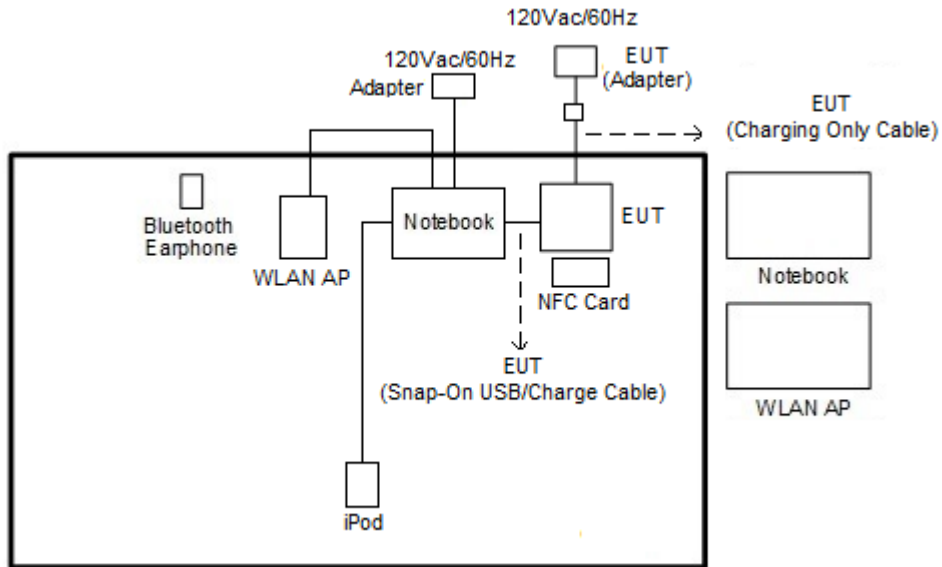

<For Fundamental Emissions and Mask and Radiated Emissions Measurement>

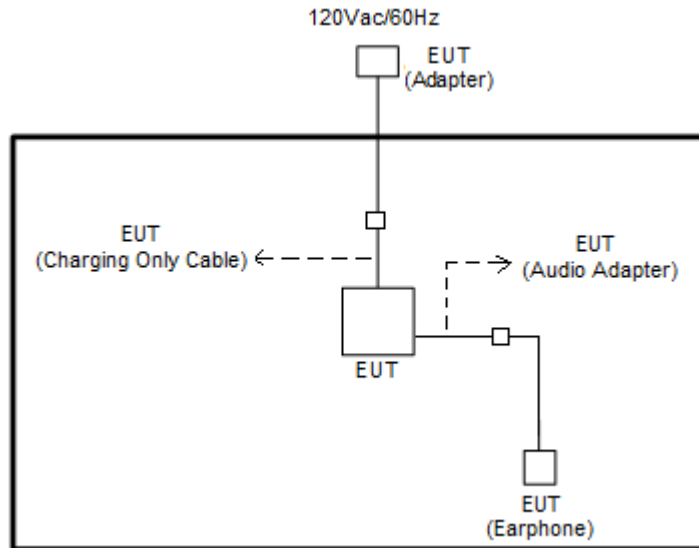



2.3 Table for Supporting Units

Support Unit	Manufacturer	Model	FCC ID
WLAN AP	D-Link	DIR-628	KA2DIR628A2
Bluetooth Earphone	Sony Ericsson	MW600	PY7DDA-2029
Notebook	DELL	Latitude E6320	FCC DoC/ Contains FCC ID: QDS-BRCM1054
Notebook	DELL	P20G	FCC DoC/ Contains FCC ID: QDS-BRCM1051
iPod	Apple	A1285	FCC DoC
NFC Card	Metro Taipei	Easy Card	N/A
SD Card	SanDisk	MicroSD HC	FCC DoC

2.4 EUT Operation Test Setup

The EUT was programmed to be in continuously transmitting mode.

The ancillary equipment, NFC card, is used to make the EUT (NFC) continuously transmit at 13.56MHz and is placed around 3 cm gap to the EUT.



3. TEST RESULTS

3.1 AC Power Line Conducted Emissions Measurement

3.1.1 Limit of AC Conducted Emission

For equipment that is designed to be connected to the public utility (AC) power line, the radio frequency voltage that is conducted back onto the AC power line on any frequency or frequencies within the band 150 kHz to 30 MHz shall not exceed the limits in the following table.

Frequency of Emission (MHz)	Conducted Limit (dBµV)	
	Quasi-Peak	Average
0.15-0.5	66 to 56*	56 to 46*
0.5-5	56	46
5-30	60	50

*Decreases with the logarithm of the frequency.

For terminal test result, the testing follows FCC KDB 174176.

3.1.2 Measuring Instruments

See list of measuring instruments of this test report.

3.1.3 Test Procedures

1. The EUT was placed 0.4 meter from the conducting wall of the shielding room, and it was kept at least 80 centimeters from any other grounded conducting surface.
2. Connect EUT to the power mains through a line impedance stabilization network (LISN).
3. All the support units are connecting to the other LISN.
4. The LISN provides 50 ohm coupling impedance for the measuring instrument.
5. The FCC states that a 50 ohm, 50 microhenry LISN should be used.
6. Both sides of AC line were checked for maximum conducted interference.
7. The frequency range from 150 kHz to 30 MHz was searched.
8. Set the test-receiver system to Peak Detect Function and specified bandwidth (IF Bandwidth = 9kHz) with Maximum Hold Mode. Then measurement is also conducted by Average Detector and Quasi-Peak Detector Function respectively.

3.1.4 Test setup

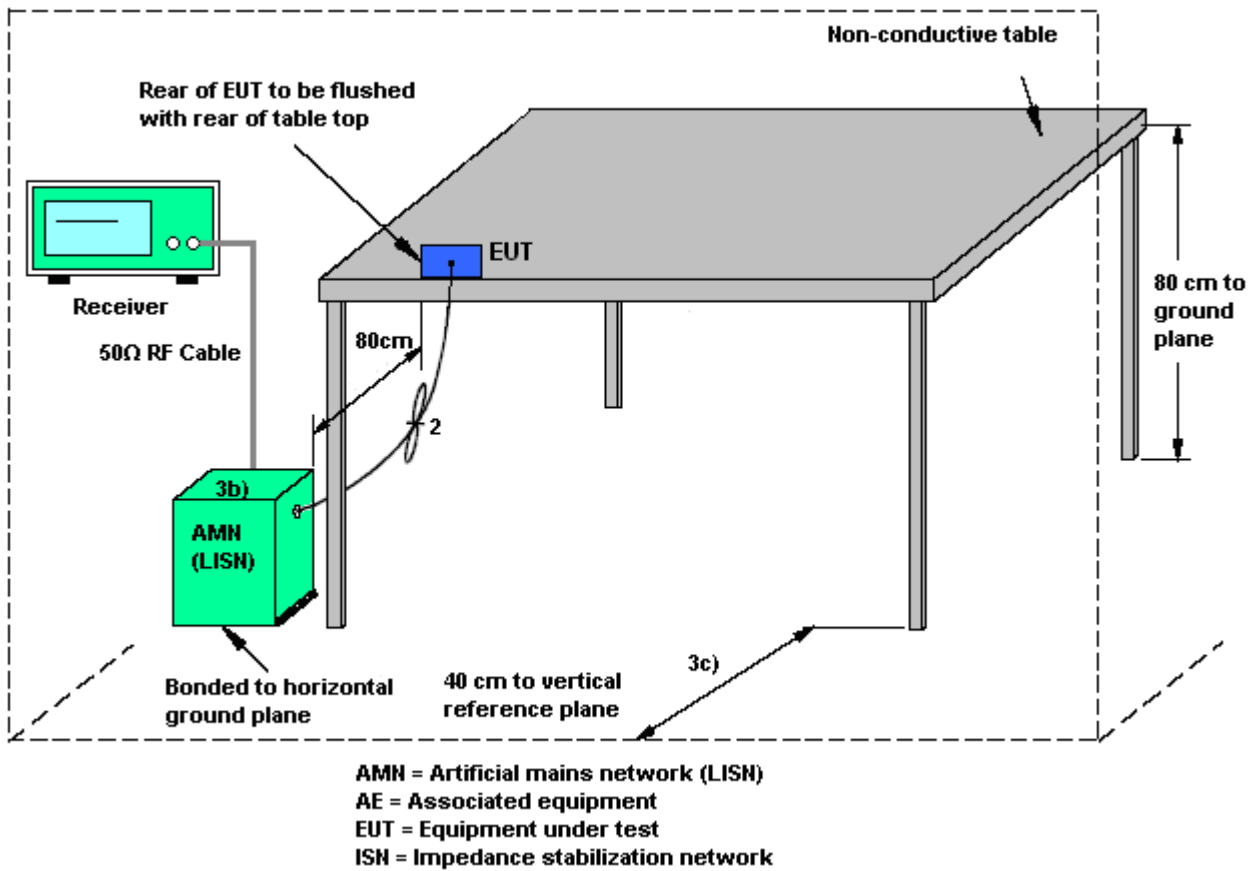

3.1.5 Test Result of AC Conducted Emission

Please refer to Appendix B.

3.2 20dB and 99% OBW Spectrum Bandwidth Measurement

3.2.1 Limit

Intentional radiators must be designed to ensure that the 20dB and 99% emission bandwidth in the specific band 13.553~13.567MHz.

3.2.2 Measuring Instruments

See list of measuring instruments of this test report.

3.2.3 Test Procedures

1. The spectrum analyzer connected via a receive antenna placed near the EUT in peak Max hold mode.
2. The resolution bandwidth of 1 kHz and the video bandwidth of 3 kHz were used.
3. Measured the spectrum width with power higher than 20dB below carrier.
4. Measured the 99% OBW.

3.2.4 Test Setup

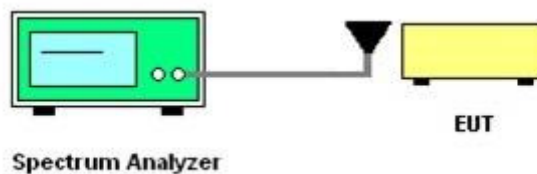

3.2.5 Test Result of Conducted Test Items

Please refer to Appendix C.

3.3 Frequency Stability Measurement

3.3.1 Limit

The frequency tolerance of the carrier signal shall be maintained within +/- 0.01% (100ppm) of the operating frequency over a temperature variation of -20 degrees to +50 degrees C at normal supply voltage, and for a variation in the primary supply voltage from 85% to 115% of the rated supply voltage at a temperature of 20 degrees C. For battery operated equipment, the equipment tests shall be performed using a new battery.

3.3.2 Measuring Instruments

See list of measuring instruments of this test report.

3.3.3 Test Procedures

1. The spectrum analyzer connected via a receive antenna placed near the EUT.
2. EUT have transmitted signal and fixed channelize.
3. Set the spectrum analyzer span to view the entire emissions bandwidth.
4. Set RBW = 1 kHz, VBW = 3 kHz with peak detector and maxhold settings.
5. The f_c is declaring of channel frequency. Then the frequency error formula is $(f_c - f) / f_c \times 10^6$ ppm and the limit is less than ± 100 ppm.
6. Extreme temperature rule is -20°C~50°C.

3.3.4 Test Setup

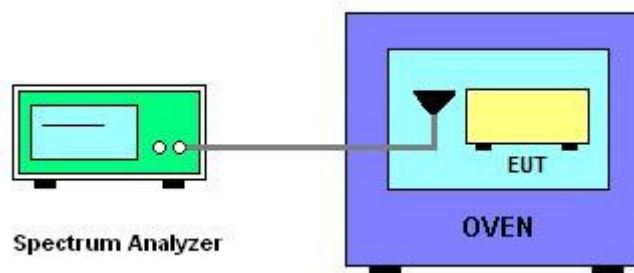

3.3.5 Test Result of Conducted Test Items

Please refer to Appendix C.

3.4 Field Strength of Fundamental Emissions and Mask Measurement

3.4.1 Limit

Rules and specifications	FCC CFR 47 Part 15 section 15.225 IC RSS-210 B.6			
	Description			
Description	Compliance with the spectrum mask is tested with RBW set to 9kHz.			
Freq. of Emission (MHz)	Field Strength (μV/m) at 30m	Field Strength (dBμV/m) at 30m	Field Strength (dBμV/m) at 10m	Field Strength (dBμV/m) at 3m
1.705~13.110	30	29.5	48.58	69.5
13.110~13.410	106	40.5	59.58	80.5
13.410~13.553	334	50.5	69.58	90.5
13.553~13.567	15848	84.0	103.08	124.0
13.567~13.710	334	50.5	69.58	90.5
13.710~14.010	106	40.5	59.58	80.5
14.010~30.000	30	29.5	48.58	69.5

3.4.2 Measuring Instruments

See list of measuring instruments of this test report.

3.4.3 Test Procedures

1. Configure the EUT according to ANSI C63.10. The EUT was placed on the top of the turntable 0.8 meter above ground. The phase center of the loop receiving antenna mounted antenna tower was placed 3 meters far away from the turntable.
2. Power on the EUT and all the supporting units. The turntable was rotated by 360 degrees to determine the position of the highest radiation.
3. The height of the receiving antenna was fixed at one meter above ground to find the maximum emissions field strength.
4. For Fundamental emissions, use the receiver to measure QP reading.

5. When the radiated emissions limits are expressed in terms of the average value of the emissions, and pulsed operation is employed, the measurement field strength shall be determined by averaging over one complete pulse train, including blanking intervals, as long as the pulse train does not exceed 0.1 seconds. As an alternative (provided the transmitter operates for longer than 0.1 seconds) or in cases where the pulse train exceeds 0.1 seconds, the measured field strength shall be determined from the average absolute voltage during a 0.1 second interval during which the field strength is at its maximum value.
6. Compliance with the spectrum mask is tested with RBW set to 9kHz.
Note: Emission level (dB μ V/m) = 20 log Emission level (μ V/m).

3.4.4 Test Setup

For radiated emissions below 30MHz

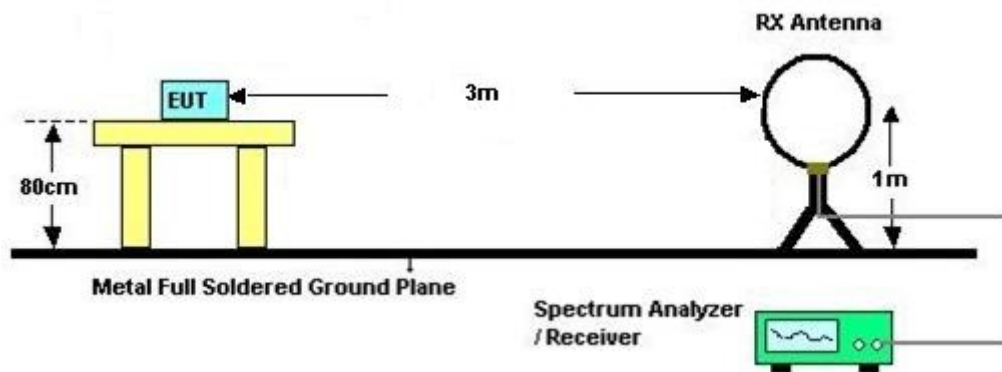

3.4.5 Test Result of Field Strength of Fundamental Emissions and Mask

Please refer to Appendix D.

3.5 Radiated Emissions Measurement

3.5.1 Limit

The field strength of any emissions which appear outside of 13.110 ~14.010MHz band shall not exceed the general radiated emissions limits.

Frequencies (MHz)	Field Strength ($\mu\text{V/m}$)	Measurement Distance (meters)
0.009~0.490	2400/F(kHz)	300
0.490~1.705	24000/F(kHz)	30
1.705~30.0	30	30
30~88	100	3
88~216	150	3
216~960	200	3
Above 960	500	3

3.5.2 Measuring Instruments

See list of measuring instruments of this test report.

3.5.3 Measuring Instrument Setting

The following table is the setting of receiver.

Receiver Parameter	Setting
Attenuation	Auto
Frequency Range: 9kHz~150kHz	RBW 200Hz for QP
Frequency Range: 150kHz~30MHz	RBW 9kHz for QP
Frequency Range: 30MHz~1000MHz	RBW 120kHz for Peak

Note: The emission limits shown in the above table are based on measurements employing a CISPR quasi-peak detector except for the frequency bands 9-90 kHz, 110-490 kHz. Radiated emission limits in these two bands are based on measurements employing an average detector.



3.5.4 Test Procedures

1. Configure the EUT according to ANSI C63.10. The EUT was placed on the top of the turntable 0.8 meter above ground. The phase center of the receiving antenna mounted on the top of a height-variable antenna tower was placed 3 meters far away from the turntable.
1. Power on the EUT and all the supporting units. The turntable was rotated by 360 degrees to determine the position of the highest radiation.
2. The height of the broadband receiving antenna was varied between one meter and four meters above ground to find the maximum emissions field strength of both horizontal and vertical polarization.
3. For each suspected emissions, the antenna tower was scan (from 1 M to 4 M) and then the turntable was rotated (from 0 degree to 360 degrees) to find the maximum reading.
4. Set the test-receiver system to Peak or CISPR quasi-peak Detect Function with specified bandwidth under Maximum Hold Mode.
5. When the radiated emissions limits are expressed in terms of the average value of the emissions, and pulsed operation is employed, the measurement field strength shall be determined by averaging over one complete pulse train, including blanking intervals, as long as the pulse train does not exceed 0.1 seconds. As an alternative (provided the transmitter operates for longer than 0.1 seconds) or in cases where the pulse train exceeds 0.1 seconds, the measured field strength shall be determined from the average absolute voltage during a 0.1 second interval during which the field strength is at its maximum value.
6. In case the emission is lower than 30MHz, loop antenna has to be used for measurement and the recorded data should be QP measured by receiver. Antenna Requirements

3.5.5 Test Setup

For radiated emissions below 30MHz

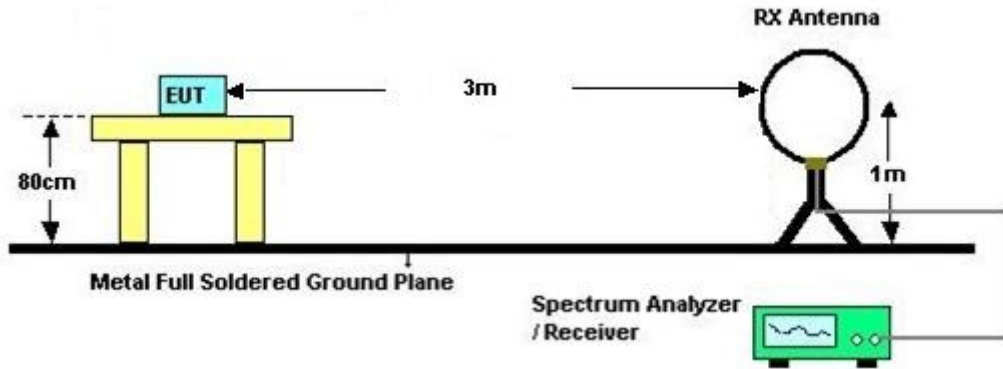

For radiated emissions above 30MHz

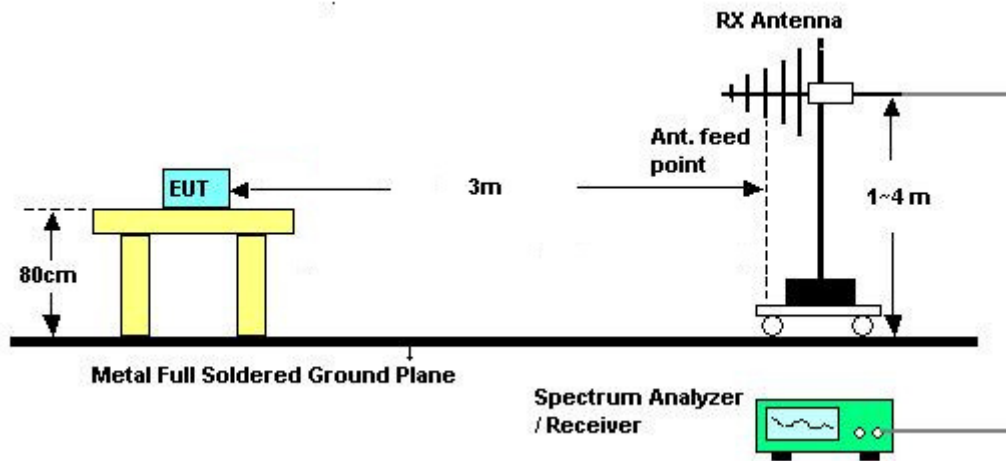

3.5.6 Test Result of Radiated Emissions Measurement

Please refer to Appendix D.



3.6 Antenna Requirements

3.6.1 Standard Applicable

Except for special regulations, the Low-power Radio-frequency Devices must not be equipped with any jacket for installing an antenna with extension cable. An intentional radiator shall be designed to ensure that no antenna other than that furnished by the responsible party shall be used with the device. The use of a permanently attached antenna or of an antenna that uses a unique coupling to the intentional radiator shall be considered sufficient to comply with the provisions of this Section. The manufacturer may design the unit so that the user can replace a broken antenna, but the use of a standard antenna jack or electrical connector is prohibited.

The use of a permanently attached antenna or of an antenna that uses a unique coupling to the intentional radiator shall be considered sufficient to comply with the FCC rule.

3.6.2 Antenna Anti-Replacement Construction

An embedded-in antenna design is used.



4. LIST OF MEASURING EQUIPMENT

Instrument	Manufacturer	Model No.	Serial No.	Characteristics	Calibration Date	Test Date	Due Date	Remark
AC Power Source	AC POWER	AFC-500W	F104070011	50Hz~60Hz	Dec. 02, 2015	Aug. 19, 2016	Dec. 01, 2016	Conducted (TH03-HY)
Spectrum Analyzer	Rohde & Schwarz	FSP30	101329	9kHz~30GHz	Jun. 27, 2016	Aug. 19, 2016	Jun. 26, 2017	Conducted (TH03-HY)
Temperature Chamber	ESPEC	SU-641	92013721	-30℃ ~70℃	Nov. 20, 2015	Aug. 19, 2016	Nov. 19, 2016	Conducted (TH03-HY)
AC Power Source	ChainTek	APC-1000W	N/A	N/A	N/A	Sep. 06, 2016 ~ Sep. 20, 2016	N/A	Conduction (CO05-HY)
EMI Test Receiver	Rohde & Schwarz	ESCI 7	100724	9kHz~7GHz	Aug. 30, 2016	Sep. 06, 2016 ~ Sep. 20, 2016	Aug. 29, 2017	Conduction (CO05-HY)
LISN	Rohde & Schwarz	ENV216	100080	9kHz~30MHz	Dec. 02, 2015	Sep. 06, 2016 ~ Sep. 20, 2016	Dec. 01, 2016	Conduction (CO05-HY)
LISN	Rohde & Schwarz	ENV216	100081	9kHz~30MHz	Dec. 14, 2015	Sep. 06, 2016 ~ Sep. 20, 2016	Dec. 13, 2016	Conduction (CO05-HY)
Bilog Antenna	TESEQ	CBL 6111D	35419	30MHz to 1GHz	Jan. 13, 2016	Aug. 21, 2016	Jan. 12, 2017	Radiation (03CH07-HY)
EMI Test Receiver	Keysight	N9038A (MXE)	MY54130085	20Hz ~ 8.4GHz	Nov. 04, 2015	Aug. 21, 2016	Nov. 03, 2016	Radiation (03CH07-HY)
Loop Antenna	Rohde & Schwarz	HFH2-Z2	100315	9 kHz~30 MHz	Sep. 02, 2015	Aug. 21, 2016	Sep. 01, 2016	Radiation (03CH07-HY)
Preamplifier	MITEQ	AMF-7D-001 01800-30-10 P	1590075	1GHz ~ 18GHz	Apr. 15, 2016	Aug. 21, 2016	Apr. 14, 2017	Radiation (03CH07-HY)
Spectrum Analyzer	Agilent	N9010A	MY53470118	10Hz~44GHz	Feb. 27, 2016	Aug. 21, 2016	Feb. 26, 2017	Radiation (03CH07-HY)
Antenna Mast	Max-Full	MFA520BS	N/A	1m~4m	N/A	Aug. 21, 2016	N/A	Radiation (03CH07-HY)
Turn Table	ChainTek	Chaintek 3000	N/A	0~360 Degree	N/A	Aug. 21, 2016	N/A	Radiation (03CH07-HY)
Preamplifier	COM-POWER	PA-103A	161241	10MHz~1GHz	Mar. 18, 2016	Aug. 21, 2016	Mar. 17, 2017	Radiation (03CH07-HY)

Appendix B. Test Results of Conducted Emission Test

<Original test result with NFC antenna>

Test Mode :	Mode 1	Test Voltage :	120Vac / 60Hz
Function Type :	NFC Link + WLAN (2.4GHz) Link + Bluetooth Link + Earphone 1 with Audio Adapter connect to EUT + Charging Only Cable + AC Adapter		

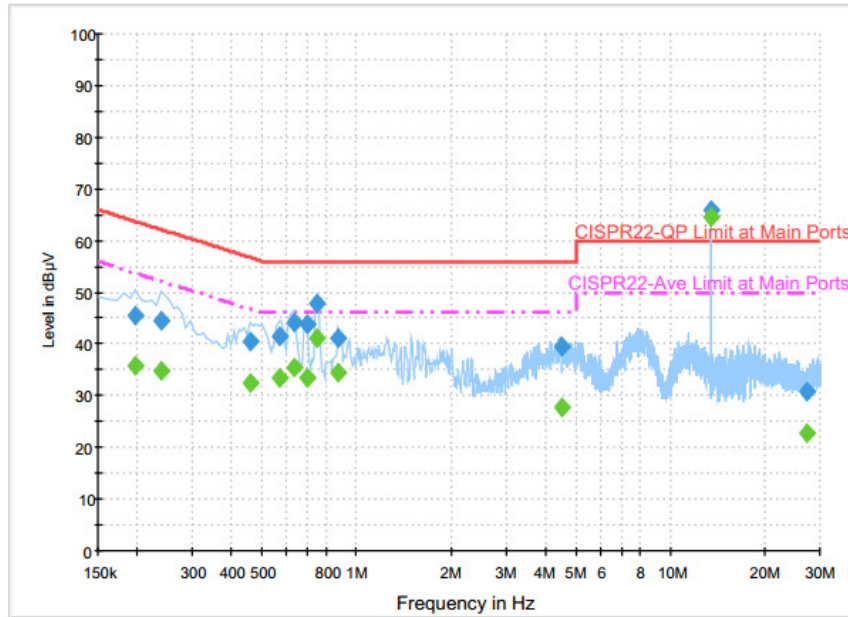

Final Result : Quasi-Peak

Frequency (MHz)	Quasi-Peak (dBµV)	Filter	Line	Corr. (dB)	Margin (dB)	Limit (dBµV)
0.198000	45.5	Off	L1	19.6	18.2	63.7
0.238000	44.4	Off	L1	19.6	17.8	62.2
0.462000	40.5	Off	L1	19.6	16.2	56.7
0.566000	41.4	Off	L1	19.6	14.6	56.0
0.630000	44.1	Off	L1	19.6	11.9	56.0
0.694000	43.8	Off	L1	19.6	12.2	56.0
0.750000	48.0	Off	L1	19.6	8.0	56.0
0.878000	41.2	Off	L1	19.6	14.8	56.0
4.534000	39.3	Off	L1	19.7	16.7	56.0
13.558000	65.9	Off	L1	19.8	-5.9	60.0
27.118000	30.9	Off	L1	19.9	29.1	60.0



Test Mode :	Mode 1	Test Voltage :	120Vac / 60Hz
Function Type :	NFC Link + WLAN (2.4GHz) Link + Bluetooth Link + Earphone 1 with Audio Adapter connect to EUT + Charging Only Cable + AC Adapter		

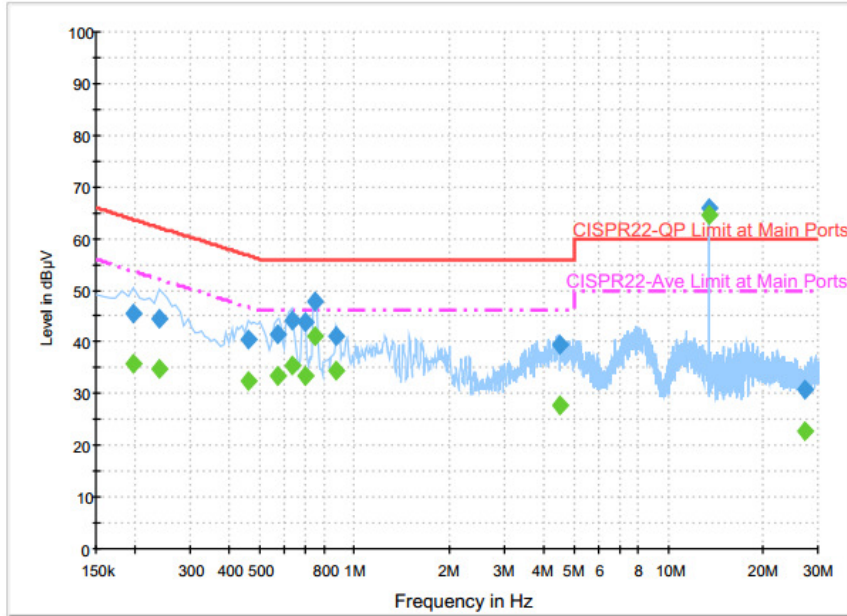

Final Result : Average

Frequency (MHz)	Average (dBµV)	Filter	Line	Corr. (dB)	Margin (dB)	Limit (dBµV)
0.198000	35.7	Off	L1	19.6	18.0	53.7
0.238000	34.7	Off	L1	19.6	17.5	52.2
0.462000	32.3	Off	L1	19.6	14.4	46.7
0.566000	33.4	Off	L1	19.6	12.6	46.0
0.630000	35.3	Off	L1	19.6	10.7	46.0
0.694000	33.6	Off	L1	19.6	12.4	46.0
0.750000	41.1	Off	L1	19.6	4.9	46.0
0.878000	34.4	Off	L1	19.6	11.6	46.0
4.534000	27.8	Off	L1	19.7	18.2	46.0
13.558000	64.6	Off	L1	19.8	-14.6	50.0
27.118000	22.6	Off	L1	19.9	27.4	50.0



Test Mode :	Mode 1	Test Voltage :	120Vac / 60Hz
Function Type :	NFC Link + WLAN (2.4GHz) Link + Bluetooth Link + Earphone 1 with Audio Adapter connect to EUT + Charging Only Cable + AC Adapter		

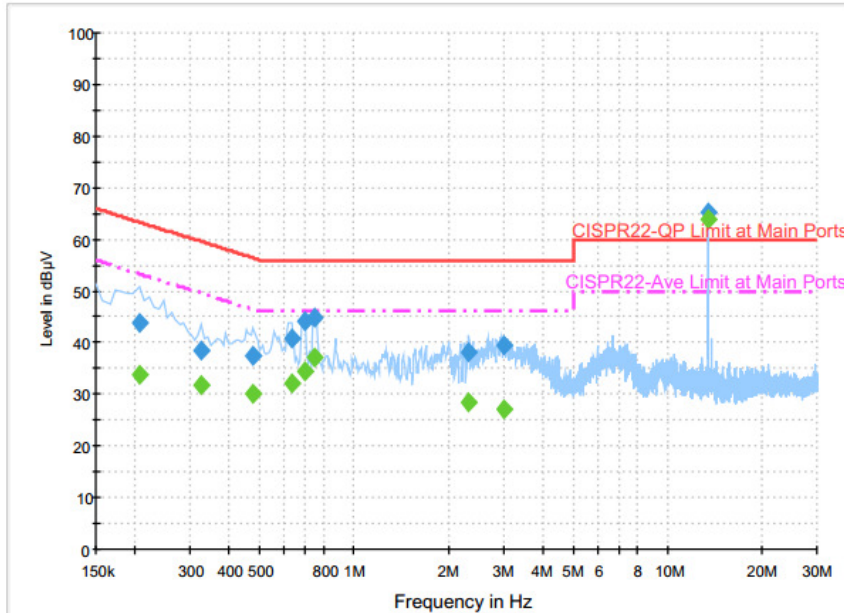

Final Result : Quasi-Peak

Frequency (MHz)	Quasi-Peak (dBµV)	Filter	Line	Corr. (dB)	Margin (dB)	Limit (dBµV)
0.206000	44.0	Off	N	19.6	19.4	63.4
0.326000	38.6	Off	N	19.6	21.0	59.6
0.478000	37.6	Off	N	19.6	18.8	56.4
0.630000	40.9	Off	N	19.6	15.1	56.0
0.694000	44.2	Off	N	19.6	11.8	56.0
0.750000	44.7	Off	N	19.6	11.3	56.0
2.326000	38.1	Off	N	18.6	17.9	56.0
3.022000	39.3	Off	N	19.5	16.7	56.0
13.558000	65.3	Off	N	19.8	-5.3	60.0

Final Result : Average

Frequency (MHz)	Average (dBµV)	Filter	Line	Corr. (dB)	Margin (dB)	Limit (dBµV)
0.206000	33.9	Off	N	19.6	19.5	53.4
0.326000	31.8	Off	N	19.6	17.8	49.6
0.478000	30.1	Off	N	19.6	16.3	46.4
0.630000	31.9	Off	N	19.6	14.1	46.0
0.694000	34.5	Off	N	19.6	11.5	46.0
0.750000	37.1	Off	N	19.6	8.9	46.0
2.326000	28.4	Off	N	18.6	17.6	46.0
3.022000	27.2	Off	N	19.5	18.8	46.0
13.558000	63.8	Off	N	19.8	-13.8	50.0

<Terminal test result with dummy load>

Test Mode :	NFC Tx	Test Voltage :	120Vac / 60Hz
Function Type :	NFC Link + WLAN (2.4GHz) Link + Bluetooth Link + Earphone 1 with Audio Adapter connect to EUT + Charging Only Cable + AC Adapter		

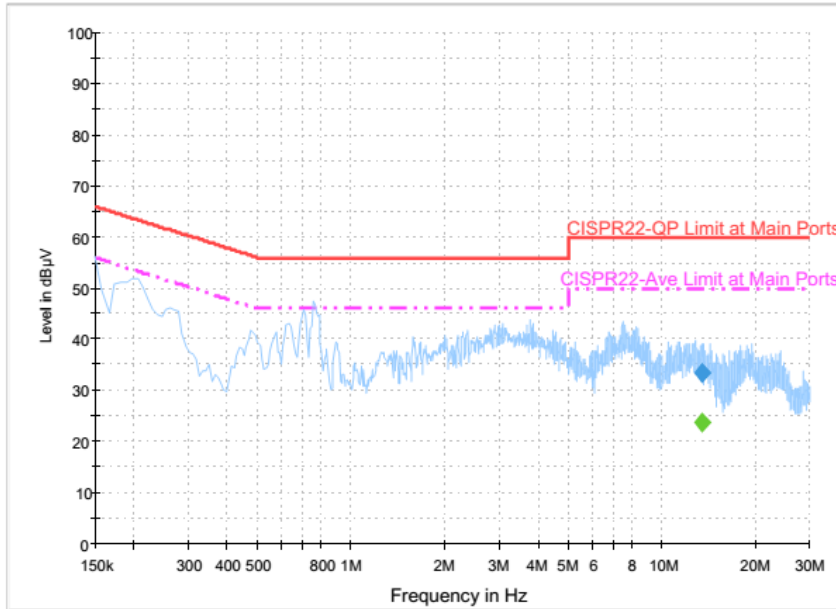

Final Result : Quasi-Peak

Frequency (MHz)	Quasi-Peak (dBµV)	Filter	Line	Corr. (dB)	Margin (dB)	Limit (dBµV)
13.558000	33.5	Off	L1	19.8	26.5	60.0

Final Result : Average

Frequency (MHz)	Average (dBµV)	Filter	Line	Corr. (dB)	Margin (dB)	Limit (dBµV)
13.558000	23.6	Off	L1	19.8	26.4	50.0



Test Mode :	NFC Tx	Test Voltage :	120Vac / 60Hz
Function Type :	NFC Link + WLAN (2.4GHz) Link + Bluetooth Link + Earphone 1 with Audio Adapter connect to EUT + Charging Only Cable + AC Adapter		

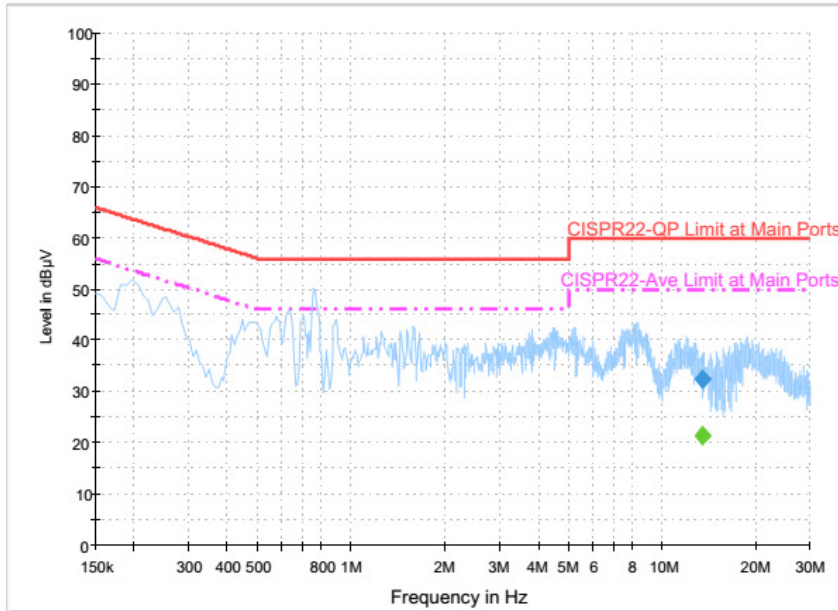

Final Result : Quasi-Peak

Frequency (MHz)	Quasi-Peak (dBµV)	Filter	Line	Corr. (dB)	Margin (dB)	Limit (dBµV)
13.558000	32.3	Off	N	19.8	27.7	60.0

Final Result : Average

Frequency (MHz)	Average (dBµV)	Filter	Line	Corr. (dB)	Margin (dB)	Limit (dBµV)
13.558000	21.5	Off	N	19.8	28.5	50.0

<Original test result with NFC antenna>

Test Mode :	Mode 2	Test Voltage :	120Vac / 60Hz
Function Type :	NFC Link + WLAN (5GHz) Link + Bluetooth Link with Earphone 3 + Snap on USB Cable Data Link with Notebook + Copy Data from Notebook to EDA (SD Card) + AC Adapter		

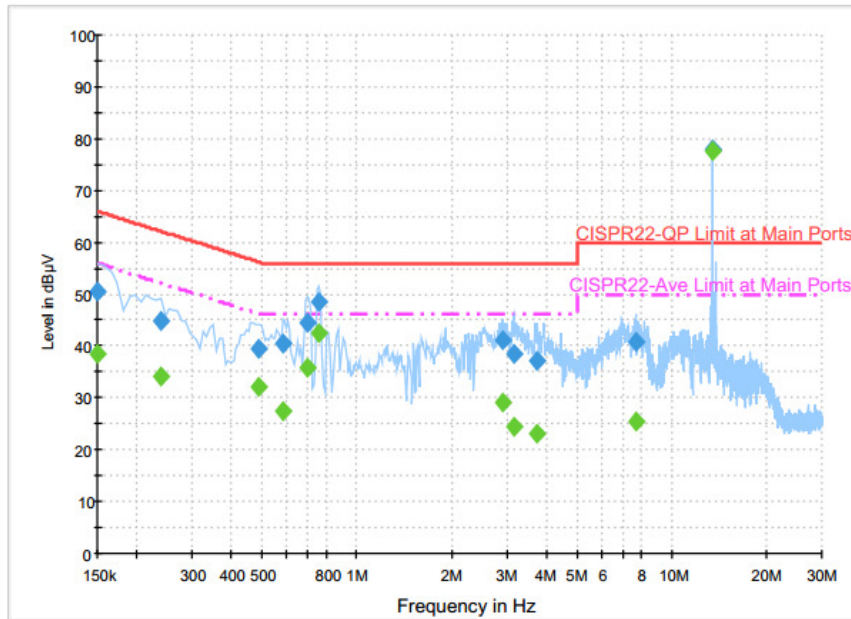

Final Result : Quasi-Peak

Frequency (MHz)	Quasi-Peak (dBµV)	Filter	Line	Corr. (dB)	Margin (dB)	Limit (dBµV)
0.150000	50.5	Off	L1	19.6	15.5	66.0
0.238000	44.8	Off	L1	19.6	17.4	62.2
0.486000	39.4	Off	L1	19.6	16.8	56.2
0.582000	40.6	Off	L1	19.6	15.4	56.0
0.694000	44.5	Off	L1	19.6	11.5	56.0
0.758000	48.6	Off	L1	19.6	7.4	56.0
2.902000	41.3	Off	L1	19.5	14.7	56.0
3.150000	38.3	Off	L1	19.6	17.7	56.0
3.750000	37.0	Off	L1	19.7	19.0	56.0
7.678000	40.9	Off	L1	19.7	19.1	60.0
13.558000	78.0	Off	L1	19.8	-18.0	60.0



Test Mode :	Mode 2	Test Voltage :	120Vac / 60Hz
Function Type :	NFC Link + WLAN (5GHz) Link + Bluetooth Link with Earphone 3 + Snap on USB Cable Data Link with Notebook + Copy Data from Notebook to EDA (SD Card) + AC Adapter		

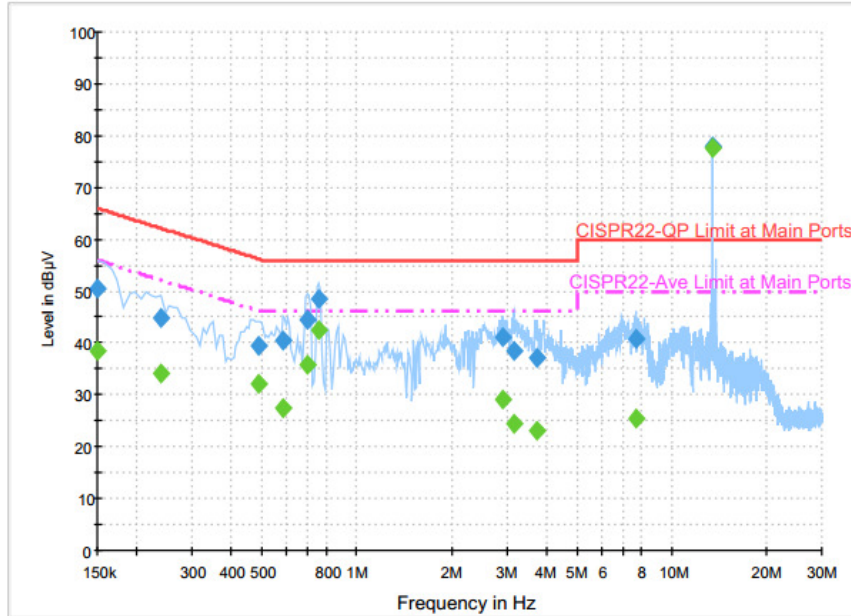

Final Result : Average

Frequency (MHz)	Average (dBµV)	Filter	Line	Corr. (dB)	Margin (dB)	Limit (dBµV)
0.150000	38.4	Off	L1	19.6	17.6	56.0
0.238000	34.1	Off	L1	19.6	18.1	52.2
0.486000	32.0	Off	L1	19.6	14.2	46.2
0.582000	27.5	Off	L1	19.6	18.5	46.0
0.694000	35.8	Off	L1	19.6	10.2	46.0
0.758000	42.6	Off	L1	19.6	3.4	46.0
2.902000	29.1	Off	L1	19.5	16.9	46.0
3.150000	24.4	Off	L1	19.6	21.6	46.0
3.750000	23.1	Off	L1	19.7	22.9	46.0
7.678000	25.4	Off	L1	19.7	24.6	50.0
13.558000	77.7	Off	L1	19.8	-27.7	50.0



Test Mode :	Mode 2	Test Voltage :	120Vac / 60Hz
Function Type :	NFC Link + WLAN (5GHz) Link + Bluetooth Link with Earphone 3 + Snap on USB Cable Data Link with Notebook + Copy Data from Notebook to EDA (SD Card) + AC Adapter		

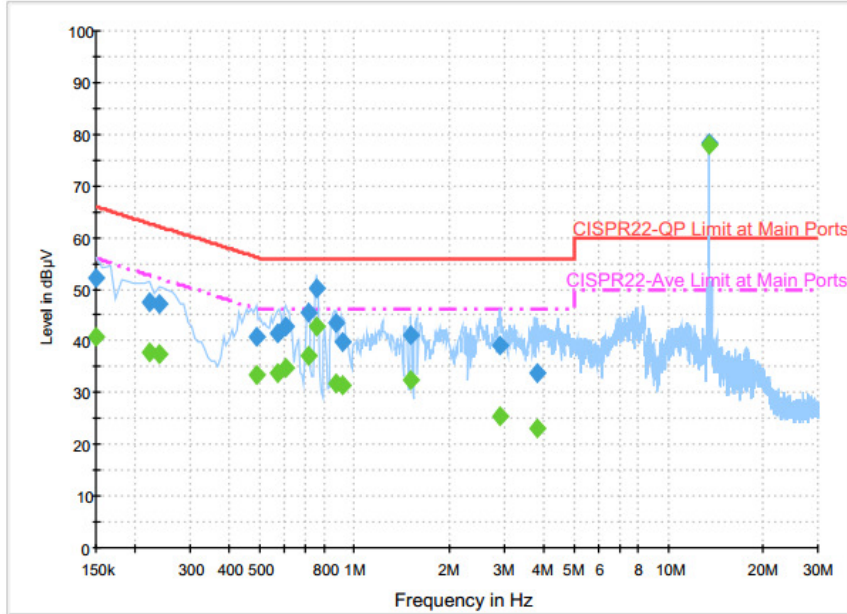

Final Result : Quasi-Peak

Frequency (MHz)	Quasi-Peak (dBµV)	Filter	Line	Corr. (dB)	Margin (dB)	Limit (dBµV)
0.150000	52.2	Off	N	19.6	13.8	66.0
0.222000	47.5	Off	N	19.6	15.2	62.7
0.238000	47.2	Off	N	19.6	15.0	62.2
0.486000	40.7	Off	N	19.6	15.5	56.2
0.566000	41.3	Off	N	19.6	14.7	56.0
0.606000	42.9	Off	N	19.6	13.1	56.0
0.710000	45.6	Off	N	19.6	10.4	56.0
0.758000	50.3	Off	N	19.6	5.7	56.0
0.870000	43.6	Off	N	19.6	12.4	56.0
0.918000	39.8	Off	N	19.6	16.2	56.0
1.510000	41.3	Off	N	19.6	14.7	56.0
2.910000	39.0	Off	N	19.5	17.0	56.0
3.838000	33.6	Off	N	19.6	22.4	56.0
13.558000	78.2	Off	N	19.8	-18.2	60.0



Test Mode :	Mode 2	Test Voltage :	120Vac / 60Hz
Function Type :	NFC Link + WLAN (5GHz) Link + Bluetooth Link with Earphone 3 + Snap on USB Cable Data Link with Notebook + Copy Data from Notebook to EDA (SD Card) + AC Adapter		

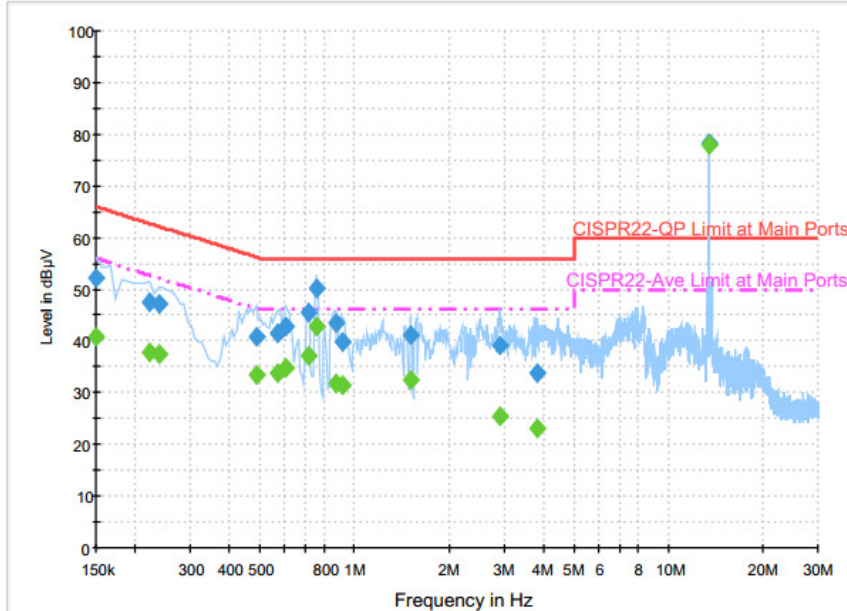

Final Result : Average

Frequency (MHz)	Average (dBµV)	Filter	Line	Corr. (dB)	Margin (dB)	Limit (dBµV)
0.150000	40.8	Off	N	19.6	15.2	56.0
0.222000	37.8	Off	N	19.6	14.9	52.7
0.238000	37.4	Off	N	19.6	14.8	52.2
0.486000	33.3	Off	N	19.6	12.9	46.2
0.566000	33.7	Off	N	19.6	12.3	46.0
0.606000	34.7	Off	N	19.6	11.3	46.0
0.710000	37.1	Off	N	19.6	8.9	46.0
0.758000	42.8	Off	N	19.6	3.2	46.0
0.870000	31.7	Off	N	19.6	14.3	46.0
0.918000	31.4	Off	N	19.6	14.6	46.0
1.510000	32.3	Off	N	19.6	13.7	46.0
2.910000	25.3	Off	N	19.5	20.7	46.0
3.838000	23.0	Off	N	19.6	23.0	46.0
13.558000	78.0	Off	N	19.8	-28.0	50.0

<Terminal test result with dummy load>

Test Mode :	NFC Tx	Test Voltage :	120Vac / 60Hz
Function Type :	NFC Link + WLAN (5GHz) Link + Bluetooth Link with Earphone 3 + Snap on USB Cable Data Link with Notebook + Copy Data from Notebook to EDA (SD Card) + AC Adapter		

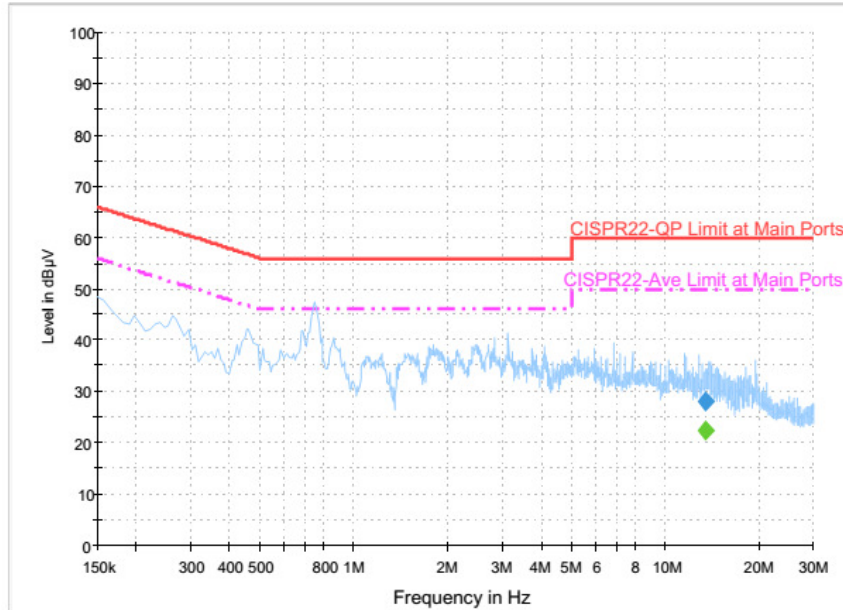

Final Result : Quasi-Peak

Frequency (MHz)	Quasi-Peak (dBµV)	Filter	Line	Corr. (dB)	Margin (dB)	Limit (dBµV)
13.558000	28.2	Off	L1	19.8	31.8	60.0

Final Result : Average

Frequency (MHz)	Average (dBµV)	Filter	Line	Corr. (dB)	Margin (dB)	Limit (dBµV)
13.558000	22.5	Off	L1	19.8	27.5	50.0



Test Mode :	NFC Tx	Test Voltage :	120Vac / 60Hz
Function Type :	NFC Link + WLAN (5GHz) Link + Bluetooth Link with Earphone 3 + Snap on USB Cable Data Link with Notebook + Copy Data from Notebook to EDA (SD Card) + AC Adapter		

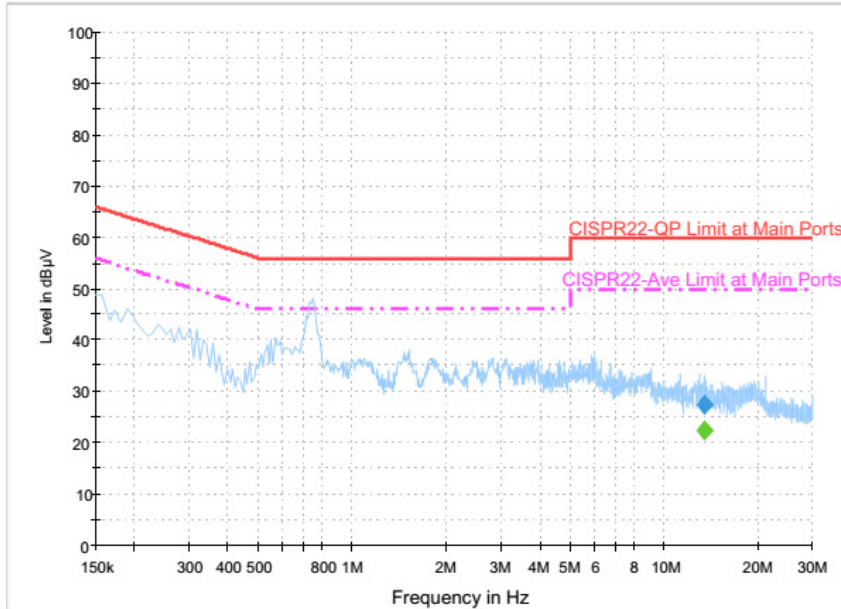

Final Result : Quasi-Peak

Frequency (MHz)	Quasi-Peak (dBµV)	Filter	Line	Corr. (dB)	Margin (dB)	Limit (dBµV)
13.558000	27.4	Off	N	19.8	32.6	60.0

Final Result : Average

Frequency (MHz)	Average (dBµV)	Filter	Line	Corr. (dB)	Margin (dB)	Limit (dBµV)
13.558000	22.4	Off	N	19.8	27.6	50.0



<Original test result with NFC antenna>

Test Mode :	Mode 3	Test Voltage :	120Vac / 60Hz
Function Type :	NFC Link + WLAN (2.4GHz) Link + Bluetooth Link + Earphone 2 with Audio Adapter connect to EUT + Charging Only Cable + AC Adapter		

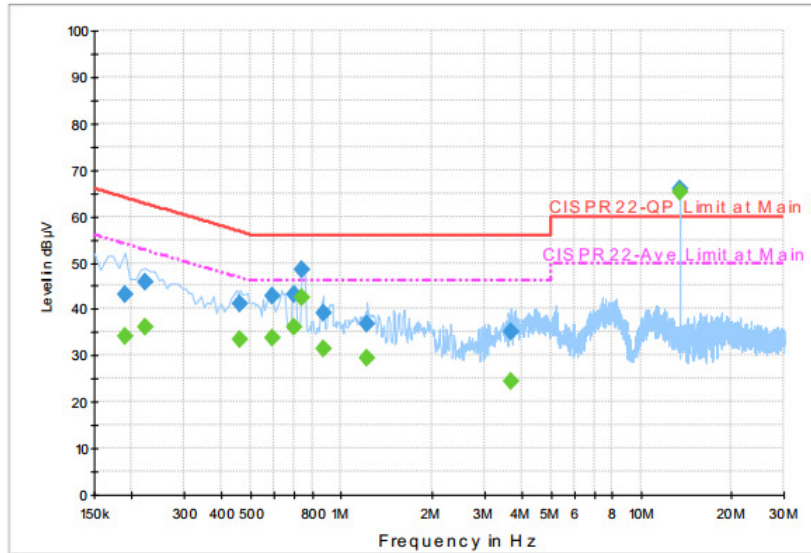

Final Result : Quasi-Peak

Frequency (MHz)	Quasi-Peak (dBµV)	Filter	Line	Corr. (dB)	Margin (dB)	Limit (dBµV)
0.190000	43.2	Off	L1	19.6	20.8	64.0
0.222000	45.8	Off	L1	19.6	16.9	62.7
0.462000	41.2	Off	L1	19.6	15.5	56.7
0.590000	42.7	Off	L1	19.6	13.3	56.0
0.694000	43.2	Off	L1	19.6	12.8	56.0
0.742000	48.5	Off	L1	19.6	7.5	56.0
0.870000	39.2	Off	L1	19.6	16.8	56.0
1.222000	36.6	Off	L1	19.6	19.4	56.0
3.702000	35.1	Off	L1	19.7	20.9	56.0
13.558000	65.8	Off	L1	19.8	-5.8	60.0

Final Result : Average

Frequency (MHz)	Average (dBµV)	Filter	Line	Corr. (dB)	Margin (dB)	Limit (dBµV)
0.190000	34.0	Off	L1	19.6	20.0	54.0
0.222000	36.3	Off	L1	19.6	16.4	52.7
0.462000	33.3	Off	L1	19.6	13.4	46.7
0.590000	33.9	Off	L1	19.6	12.1	46.0
0.694000	36.2	Off	L1	19.6	9.8	46.0
0.742000	42.6	Off	L1	19.6	3.4	46.0
0.870000	31.4	Off	L1	19.6	14.6	46.0
1.222000	29.4	Off	L1	19.6	16.6	46.0
3.702000	24.3	Off	L1	19.7	21.7	46.0
13.558000	65.4	Off	L1	19.8	-15.4	50.0



Test Mode :	Mode 3	Test Voltage :	120Vac / 60Hz
Function Type :	NFC Link + WLAN (2.4GHz) Link + Bluetooth Link + Earphone 2 with Audio Adapter connect to EUT + Charging Only Cable + AC Adapter		

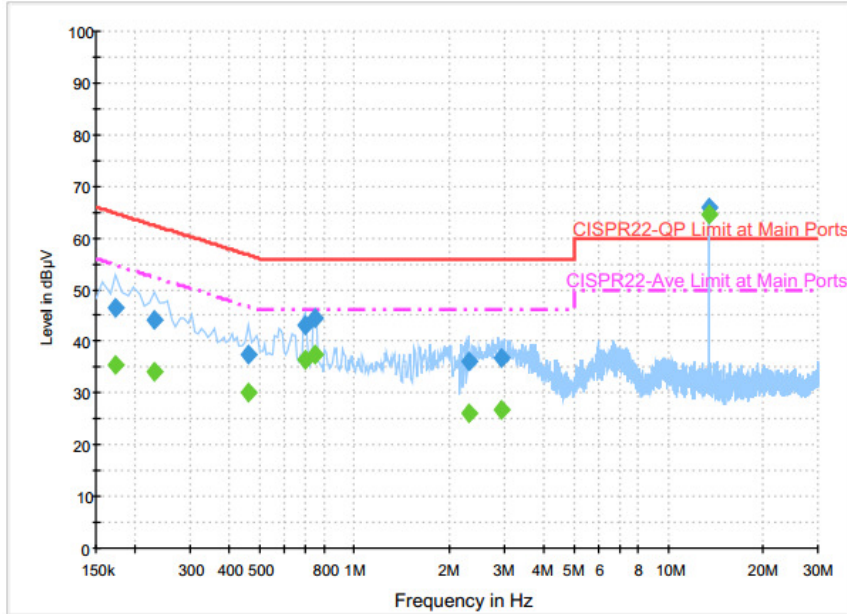

Final Result : Quasi-Peak

Frequency (MHz)	Quasi-Peak (dBµV)	Filter	Line	Corr. (dB)	Margin (dB)	Limit (dBµV)
0.174000	46.5	Off	N	19.6	18.3	64.8
0.230000	44.2	Off	N	19.6	18.2	62.4
0.462000	37.5	Off	N	19.6	19.2	56.7
0.694000	43.2	Off	N	19.6	12.8	56.0
0.750000	44.4	Off	N	19.6	11.6	56.0
2.318000	36.2	Off	N	18.6	19.8	56.0
2.942000	36.9	Off	N	19.5	19.1	56.0
13.558000	66.0	Off	N	19.8	-6.0	60.0

Final Result : Average

Frequency (MHz)	Average (dBµV)	Filter	Line	Corr. (dB)	Margin (dB)	Limit (dBµV)
0.174000	35.4	Off	N	19.6	19.4	54.8
0.230000	34.0	Off	N	19.6	18.4	52.4
0.462000	30.2	Off	N	19.6	16.5	46.7
0.694000	36.5	Off	N	19.6	9.5	46.0
0.750000	37.5	Off	N	19.6	8.5	46.0
2.318000	25.9	Off	N	18.6	20.1	46.0
2.942000	26.9	Off	N	19.5	19.1	46.0
13.558000	64.7	Off	N	19.8	-14.7	50.0

<Terminal test result with dummy load>

Test Mode :	NFC Tx	Test Voltage :	120Vac / 60Hz
Function Type :	NFC Link + WLAN (2.4GHz) Link + Bluetooth Link + Earphone 2 with Audio Adapter connect to EUT + Charging Only Cable + AC Adapter		

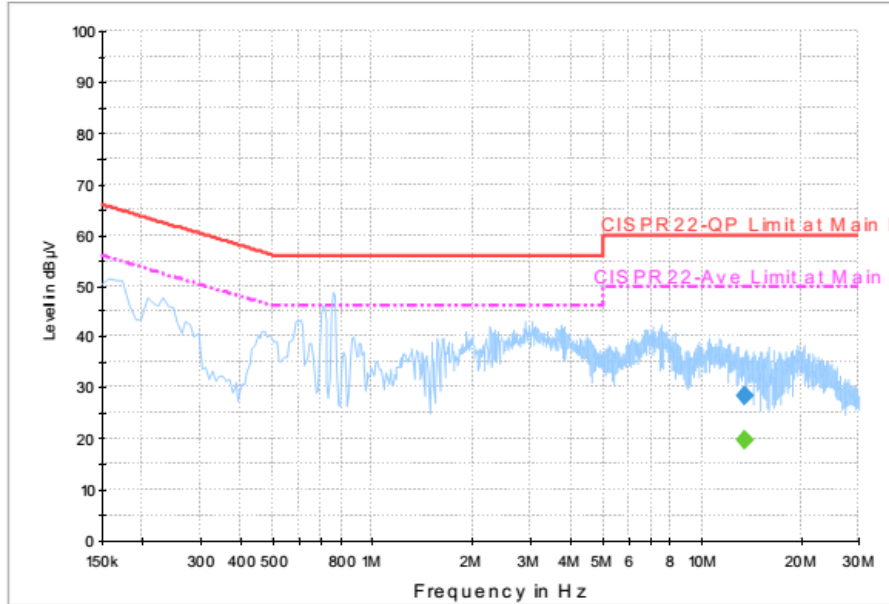

Final Result : Quasi-Peak

Frequency (MHz)	Quasi-Peak (dBµV)	Filter	Line	Corr. (dB)	Margin (dB)	Limit (dBµV)
13.558000	28.4	Off	L1	19.8	31.6	60.0

Final Result : Average

Frequency (MHz)	Average (dBµV)	Filter	Line	Corr. (dB)	Margin (dB)	Limit (dBµV)
13.558000	19.8	Off	L1	19.8	30.2	50.0

Test Mode :	NFC Tx	Test Voltage :	120Vac / 60Hz
Function Type :	NFC Link + WLAN (2.4GHz) Link + Bluetooth Link + Earphone 2 with Audio Adapter connect to EUT + Charging Only Cable + AC Adapter		

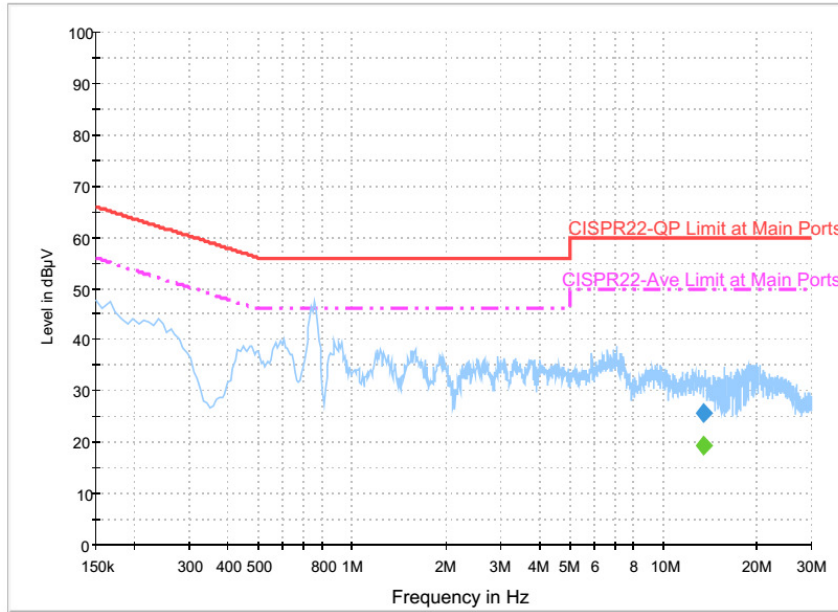

Final Result : Quasi-Peak

Frequency (MHz)	Quasi-Peak (dBµV)	Filter	Line	Corr. (dB)	Margin (dB)	Limit (dBµV)
13.558000	25.8	Off	N	19.8	34.2	60.0

Final Result : Average

Frequency (MHz)	Average (dBµV)	Filter	Line	Corr. (dB)	Margin (dB)	Limit (dBµV)
13.558000	19.5	Off	N	19.8	30.5	50.0

(1) with antenna

Remark: 13.558MHz is the NFC RF fundamental signal.

(2) with dummy load

Remark: Only the fundamental NFC signal needs to be retested per C63.4.



Appendix C. Test Results of Conducted Test Items

C1. Test Result of 20dB Spectrum Bandwidth

Test mode	NFC Tx	Test Frequency (MHz)	13.56
20dB Bandwidth (kHz)	2.640	99% OccupiedBW(kHz)	2.240
Frequency range (MHz)	$f_L > 13.553$	13.55868	Test Result
	$f_H < 13.567$	13.56132	



C2. Test Result of Frequency Stability

Voltage vs. Frequency Stability		Temperature vs. Frequency Stability		
Voltage (Vac)	Measurement Frequency (MHz)	Temperature (°C)	Time	Measurement Frequency (MHz)
120	13.560000	-20	0	13.560060
102	13.560000		2	13.560130
138	13.560000		5	13.560120
			10	13.560120
		-10	0	13.560080
			2	13.560080
			5	13.560080
			10	13.560080
		0	0	13.560120
			2	13.560120
			5	13.560120
			10	13.560120
		10	0	13.560000
			2	13.560000
			5	13.560000
			10	13.560000
		20	0	13.560000
			2	13.560010
			5	13.560000
			10	13.560000
		30	0	13.560010
			2	13.560000
			5	13.560000
			10	13.560000
		40	0	13.560000
			2	13.560000
			5	13.560000
			10	13.560000



Voltage vs. Frequency Stability		Temperature vs. Frequency Stability		
Voltage (Vac)	Measurement Frequency (MHz)	Temperature (°C)	Time	Measurement Frequency (MHz)
		50	0	13.560000
			2	13.560000
			5	13.560000
			10	13.560000
Max.Deviation (MHz)	0.000000	Max.Deviation (MHz)		0.000130
Max.Deviation (ppm)	0.0000	Max.Deviation (ppm)		9.5870
Limit	FS < ±100 ppm	Limit		FS < ±100 ppm
Test Result	PASS	Test Result		PASS



Appendix D. Test Results of Radiated Test Items

D1. Test Result of Field Strength of Fundamental Emissions

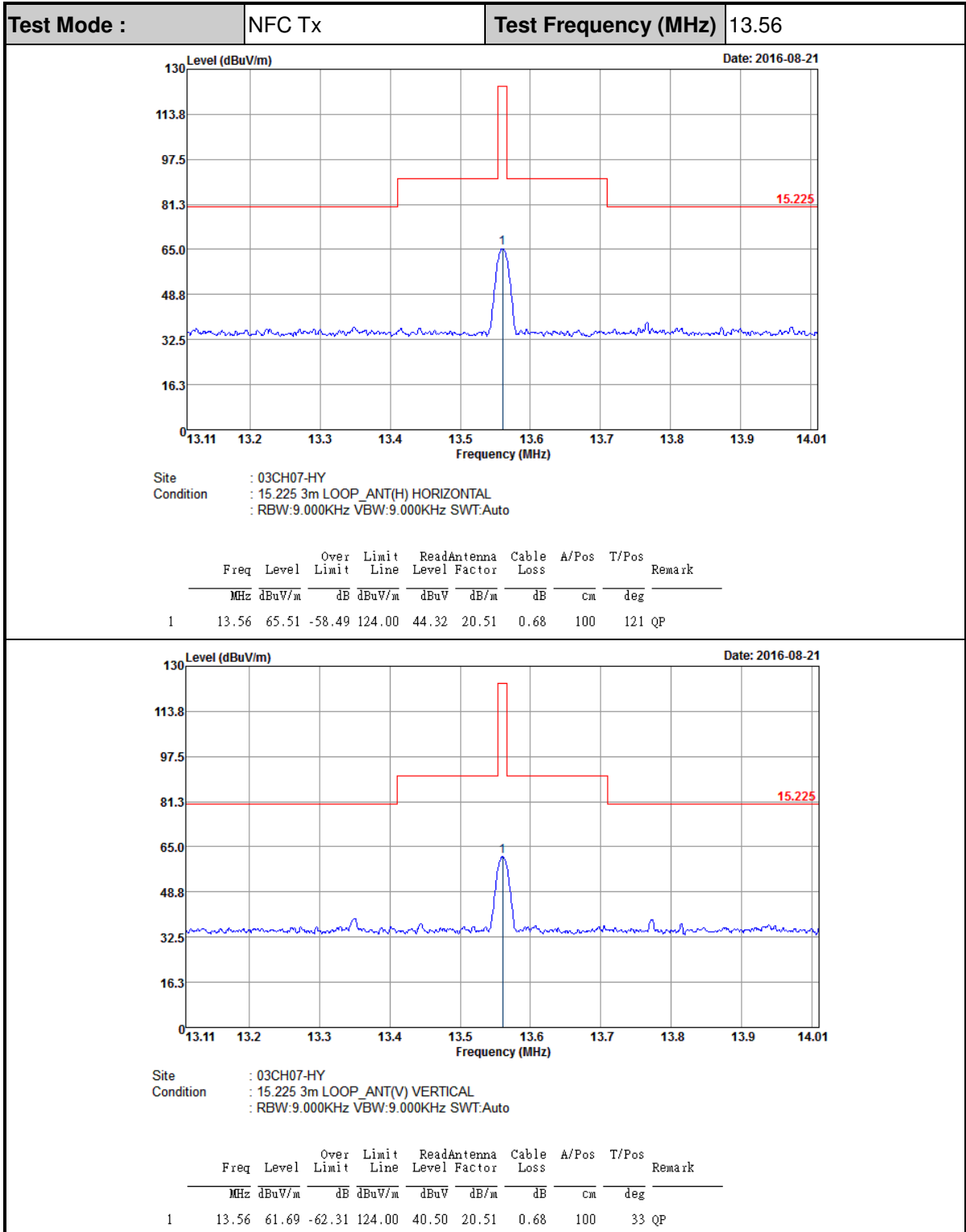



D2. Results of Radiated Spurious Emissions (9 kHz~30MHz)

Test Mode :		NFC Tx			Polarization :		Horizontal		
Frequency (MHz)	Level (dBμV/m)	Over Limit (dB)	Limit Line (dBμV/m)	Read Level (dBμV)	Antenna Factor (dB)	Cable Loss (dB)	Ant Pos (cm)	Table Pos (deg)	Remark
0.00931	44.44	-83.79	128.23	20.86	22.9	0.68	-	-	Average
0.0645	51.43	-59.98	111.41	31.75	19	0.68	-	-	Average
0.09034	33.04	-75.45	108.49	13.56	18.8	0.68	-	-	QP
0.129	45.76	-59.63	105.39	26.29	18.79	0.68	-	-	Average
0.15068	41.27	-62.77	104.04	21.82	18.77	0.68	-	-	Average
0.50502	43.69	-29.85	73.54	24.39	18.62	0.68	100	11	QP
10.008	36.4	-33.1	69.5	15.92	19.8	0.68	-	-	QP
13.56	64.42	-	-	43.23	20.51	0.68	-	-	QP
20.752	38.46	-31.04	69.5	15.54	21.85	1.07	-	-	QP
28.705	38.67	-30.83	69.5	15.28	22.32	1.07	-	-	QP

Test Mode :		NFC Tx			Polarization :		Vertical		
Frequency (MHz)	Level (dBμV/m)	Over Limit (dB)	Limit Line (dBμV/m)	Read Level (dBμV)	Antenna Factor (dB)	Cable Loss (dB)	Ant Pos (cm)	Table Pos (deg)	Remark
0.00925	40.06	-88.22	128.28	16.48	22.9	0.68	-	-	Average
0.06012	41.3	-70.72	112.02	21.62	19	0.68	-	-	Average
0.09032	36.36	-72.13	108.49	16.88	18.8	0.68	-	-	QP
0.12012	39.47	-66.54	106.01	20	18.79	0.68	-	-	Average
0.15884	38.65	-64.93	103.58	19.2	18.77	0.68	-	-	Average
0.50502	40.97	-32.57	73.54	21.67	18.62	0.68	-	-	QP
12.872	36.55	-32.95	69.5	15.5	20.37	0.68	-	-	QP
13.56	61.03	-	-	39.84	20.51	0.68	-	-	QP
20.68	38.26	-31.24	69.5	15.35	21.84	1.07	-	-	QP
27.4	39.09	-30.41	69.5	15.78	22.24	1.07	100	119	QP

Note:

1. 13.56 MHz is fundamental signal which can be ignored.
2. The amplitude of spurious emissions which are attenuated by more than 20dB below the permissible value has no need to be reported.
3. Distance extrapolation factor = 40 log (specific distance / test distance) (dB);
4. Limit line = specific limits (dBμV) + distance extrapolation factor.



D3. Results of Radiated Spurious Emissions (30MHz~1GHz)

Test Mode :	NFC Tx	Polarization :	Horizontal
--------------------	--------	-----------------------	------------

Frequency (MHz)	Level (dB μ V/m)	Over Limit (dB)	Limit Line (dB μ V/m)	Read Level (dB μ V)	Antenna Factor (dB)	Cable Loss (dB)	Preamp Factor (dB)	Ant Pos (cm)	Table Pos (deg)	Remark
30	28.81	-11.19	40	33.09	26	1.07	31.35	-	-	Peak
153.66	36.58	-6.92	43.5	48.81	17.49	1.78	31.5	100	0	Peak
226.02	31.68	-14.32	46	44.16	16.88	2.07	31.43	-	-	Peak
320.3	32.47	-13.53	46	40.94	20.37	2.41	31.25	-	-	Peak
762.7	30.96	-15.04	46	30.45	27.33	3.82	30.64	-	-	Peak
955.2	34.01	-11.99	46	30.26	30.21	4.07	30.53	-	-	Peak

Test Mode :	NFC Tx	Polarization :	Vertical
--------------------	--------	-----------------------	----------

Frequency (MHz)	Level (dB μ V/m)	Over Limit (dB)	Limit Line (dB μ V/m)	Read Level (dB μ V)	Antenna Factor (dB)	Cable Loss (dB)	Preamp Factor (dB)	Ant Pos (cm)	Table Pos (deg)	Remark
30	32.09	-7.91	40	36.37	26	1.07	31.35	-	-	Peak
76.71	32.91	-7.09	40	49.73	13.46	1.28	31.56	100	0	Peak
102.09	34.89	-8.61	43.5	48.28	16.58	1.55	31.52	-	-	Peak
329.4	26.91	-19.09	46	35.11	20.63	2.41	31.24	-	-	Peak
703.2	29.34	-16.66	46	29.87	26.45	3.74	30.72	-	-	Peak
944	33.84	-12.16	46	30.24	30.06	4.07	30.53	-	-	Peak

Note:

1. The amplitude of spurious emissions which are attenuated by more than 20dB below the permissible value has no need to be reported.
2. Emission level (dB μ V/m) = 20 log Emission level (μ V/m).
3. Corrected Reading: Antenna Factor + Cable Loss + Read Level - Preamp Factor= Level.