



# FCC RF Test Report

**APPLICANT** : Zebra Technologies Corporation  
**EQUIPMENT** : Touch computer  
**BRAND NAME** : Zebra  
**MODEL NAME** : TC75EK  
**FCC ID** : UZ7TC75EK  
**STANDARD** : FCC Part 15 Subpart E §15.407  
**CLASSIFICATION** : (NII) Unlicensed National Information Infrastructure

The product was received on Jul. 28, 2016 and testing was completed on Sep. 09, 20. We, SPORTON INTERNATIONAL INC., would like to declare that the tested sample has been evaluated in accordance with the test procedures and has been in compliance with the applicable technical standards.

The test results in this report apply exclusively to the tested model / sample. Without written approval of SPORTON INTERNATIONAL INC., the test report shall not be reproduced except in full.

Reviewed by: Joseph Lin / Supervisor

Approved by: Jones Tsai / Manager



## **SPORTON INTERNATIONAL INC.**

**No. 52, Hwa Ya 1<sup>st</sup> Rd., Hwa Ya Technology Park, Kwei-Shan District, Tao Yuan City, Taiwan, R.O.C.**

**SPORTON INTERNATIONAL INC.**

TEL : 886-3-327-3456

FAX : 886-3-328-4978

FCC ID : UZ7TC75EK

Page Number : 1 of 61

Report Issued Date : Oct. 07, 2016

Report Version : Rev. 03

Report Template No.: BU5-FR15EWLB4 AC MA Version 1.4



# TABLE OF CONTENTS

**REVISION HISTORY ..... 3**

**SUMMARY OF TEST RESULT ..... 4**

**1 GENERAL DESCRIPTION ..... 5**

    1.1 Applicant ..... 5

    1.2 Manufacturer ..... 5

    1.3 Product Feature of Equipment Under Test ..... 5

    1.4 Product Specification of Equipment Under Test ..... 6

    1.5 Modification of EUT ..... 7

    1.6 Testing Location ..... 7

    1.7 Applicable Standards ..... 8

**2 TEST CONFIGURATION OF EQUIPMENT UNDER TEST ..... 9**

    2.1 Carrier Frequency and Channel ..... 9

    2.2 Pre-Scanned RF Power ..... 10

    2.3 Test Mode ..... 18

    2.4 Connection Diagram of Test System ..... 19

    2.5 Support Unit used in test configuration and system ..... 20

    2.6 EUT Operation Test Setup ..... 21

    2.7 Measurement Results Explanation Example ..... 21

**3 TEST RESULT ..... 22**

    3.1 6dB and 26dB and 99% Occupied Bandwidth Measurement ..... 22

    3.2 Maximum Conducted Output Power Measurement ..... 27

    3.3 Power Spectral Density Measurement ..... 29

    3.4 Unwanted Emissions Measurement ..... 33

    3.5 AC Conducted Emission Measurement ..... 38

    3.6 Frequency Stability Measurement ..... 55

    3.7 Automatically Discontinue Transmission ..... 56

    3.8 Antenna Requirements ..... 57

**4 LIST OF MEASURING EQUIPMENT ..... 59**

**5 UNCERTAINTY OF EVALUATION ..... 61**

**APPENDIX A. CONDUCTED TEST RESULTS**

**APPENDIX B. RADIATED SPURIOUS EMISSION**

**APPENDIX C. RADIATED SPURIOUS EMISSION PLOTS**

**APPENDIX D. DUTY CYCLE PLOTS**

**APPENDIX E. SETUP PHOTOGRAPHS**



### REVISION HISTORY

REPORT NO.	VERSION	DESCRIPTION	ISSUED DATE
FR672834F	Rev. 01	Initial issue of report	Sep. 29, 2016
FR672834E	Rev. 02	Detail changes list as below : 1. Adding the applied standard in the section 1.7 and the specification of accessories 2. Updating average power in appendix A	Oct. 05, 2016
FR672834E	Rev. 03	Revising the Adapter information in specification of accessories.	Oct. 07, 2016



### SUMMARY OF TEST RESULT

Report Section	FCC Rule	Description	Limit	Result	Remark
3.1	15.403(i)	6dB, 26dB and 99% Occupied Bandwidth	> 500kHz	Pass	-
3.2	15.407(a)	Maximum Conducted Output Power	≤ 30 dBm	Pass	-
3.3	15.407(a)	Power Spectral Density	≤ 30 dBm/500kHz	Pass	-
3.4	15.407(b)	Unwanted Emissions	15.407(b)(4)(i) & 15.209(a)	Pass	Under limit 4.67 dB at 149.340 MHz
3.5	15.207	AC Conducted Emission	15.207(a)	Pass	Under limit 3.20 dB at 0.758 MHz
3.6	15.407(g)	Frequency Stability	Within Operation Band	Pass	-
3.7	15.407(c)	Automatically Discontinue Transmission	Discontinue Transmission	Pass	-
3.8	15.203 & 15.407(a)	Antenna Requirement	N/A	Pass	-



# 1 General Description

## 1.1 Applicant

**Zebra Technologies Corporation**  
1 Zebra Plaza Holtsville, NY 11742

## 1.2 Manufacturer

**Wistron Corporation**  
21F, No. 88, Sec. 1, Hsin Tai Wu Rd., Hsichih Dist, New Taipei City 221, Taiwan R.O.C.

## 1.3 Product Feature of Equipment Under Test

Product Feature	
Equipment	Touch computer
Brand Name	Zebra
Model Name	TC75EK
FCC ID	UZ7TC75EK
EUT supports Radios application	CDMA/EV-DO/GSM/EGPRS/WCDMA/HSPA/LTE/NFC WLAN 11a/b/g/n HT20/HT40 WLAN 11ac VHT20/VHT40/VHT80 Bluetooth BR/EDR/LE
HW Version	DV
SW Version	Android version 6.0.1
FW Version	91-10-01-MG-00
MFD	14JUL16
EUT Stage	Engineering sample

**Remark:** The above EUT's information was declared by manufacturer. Please refer to the specifications or user's manual for more detailed description.

Specification of Accessories				
AC Adapter	Brand Name	Zebra	Part Number	PWR-BUA5V16W0WW
Snap-On USB/Charge Cable	Brand Name	Symbol	Part Number	CBL-TC7X-USB1-01
Snap-On Charging Cable Cup	Brand Name	Symbol	Part Number	CHG-TC7X-CBL1-01
Battery	Brand Name	Zebra	Part Number	BT-000318-01
Earphone 1	Brand Name	Zebra	Part Number	HDST-35MM-PTVP-01
Earphone 2	Brand Name	Zebra	Part Number	HS2100-OTH
Earphone 3	Brand Name	Zebra	Part Number	HS3100-OTH
Snap-on 3.5MM Audio Nugget	Brand Name	Symbol	Part Number	ADP-TC7X-AUD35-01
3.5mm Jack 43"(1.1m) Standard Cable	Brand Name	Zebra	Part Number	CBL-HS2100-3MS1-01
Soft Holster	Brand Name	Zebra	Part Number	SG-TC7X-HLSTR1-01
Rigid Holster	Brand Name	Zebra	Part Number	SG-TC7X-RHLSTR1-01
Power Cord	Brand Name	LOROM	Part Number	50-16000-182R
Cable line	Brand Name	Zebra	Part Number	CBL-DC-383A1-01



### 1.4 Product Specification of Equipment Under Test

Standards-related Product Specification										
<b>Tx/Rx Channel Frequency Range</b>	5745 MHz ~ 5825 MHz									
<b>Maximum Output Power &lt;CDD Modes&gt;</b>	<p><b>&lt;5745 MHz ~ 5825 MHz&gt;</b>  <b>&lt;Ant. 1&gt;</b>            802.11a : 15.93 dBm / 0.0392 W            802.11n HT20 : 15.90 dBm / 0.0389 W            802.11n HT40 : 15.30 dBm / 0.0339 W            802.11ac VHT20: 15.93 dBm / 0.0392 W            802.11ac VHT40: 15.37 dBm / 0.0344 W            802.11ac VHT80: 14.35 dBm / 0.0272 W  <b>&lt;Ant. 2&gt;</b>            802.11a : 17.60 dBm / 0.0575 W            802.11n HT20 : 17.64 dBm / 0.0581 W            802.11n HT40 : 17.05 dBm / 0.0507 W            802.11ac VHT20: 17.68 dBm / 0.0586 W            802.11ac VHT40: 17.07 dBm / 0.0509 W            802.11ac VHT80: 16.10 dBm / 0.0407 W  <b>MIMO &lt;Ant. 1 + 2&gt;</b>            802.11a : 19.95 dBm / 0.0989 W            802.11n HT20 : 19.88 dBm / 0.0973 W            802.11n HT40 : 19.39 dBm / 0.0869 W            802.11ac VHT20: 19.90 dBm / 0.0977 W            802.11ac VHT40: 19.45 dBm / 0.0881 W            802.11ac VHT80: 18.37 dBm / 0.0687 W</p>									
<b>Maximum Output Power &lt;TXBF Modes&gt;</b>	<p><b>&lt;5745 MHz ~ 5825 MHz&gt;</b>  <b>MIMO &lt;Ant. 1 + 2&gt;</b>            802.11n HT20 : 19.59 dBm / 0.0910 W            802.11n HT40 : 19.04 dBm / 0.0802 W            802.11ac VHT20: 19.75 dBm / 0.0944 W            802.11ac VHT40: 19.19 dBm / 0.0830 W            802.11ac VHT80: 17.85 dBm / 0.0610 W</p>									
<b>99% Occupied Bandwidth &lt;CDD Modes&gt;</b>	802.11a : 20.85 MHz 802.11ac VHT20 : 20.30 MHz 802.11ac VHT40 : 38.80 MHz 802.11ac VHT80 : 76.08 MHz									
<b>99% Occupied Bandwidth &lt;TXBF Modes&gt;</b>	802.11ac VHT20 : 19.40 MHz 802.11ac VHT40 : 37.00 MHz 802.11ac VHT80 : 75.84 MHz									
<b>Type of Modulation</b>	802.11a/n : OFDM (BPSK / QPSK / 16QAM / 64QAM) 802.11ac : OFDM (BPSK / QPSK / 16QAM / 64QAM / 256QAM)									
<b>Antenna Type / Gain</b>	<Ant. 1> : IFA Antenna with gain 3.90 dBi <Ant. 2> : IFA Antenna with gain 3.80 dBi									
<b>Antenna Function Description</b>	<table border="1"> <thead> <tr> <th></th> <th>Ant. 1</th> <th>Ant. 2</th> </tr> </thead> <tbody> <tr> <td>802.11 a/n/ac</td> <td>V</td> <td>V</td> </tr> <tr> <td>802.11 a/n/ac MIMO</td> <td>V</td> <td>V</td> </tr> </tbody> </table>		Ant. 1	Ant. 2	802.11 a/n/ac	V	V	802.11 a/n/ac MIMO	V	V
	Ant. 1	Ant. 2								
802.11 a/n/ac	V	V								
802.11 a/n/ac MIMO	V	V								

**Note:** MIMO Ant. 1+2 is a calculated result from sum of the power MIMO Ant. 1 and MIMO Ant. 2.



### 1.5 Modification of EUT

No modifications are made to the EUT during all test items.

### 1.6 Testing Location

Sporton Lab is accredited to ISO 17025 by Taiwan Accreditation Foundation (TAF code : 1190) and the FCC designation No. TW1022 under the FCC 2.948(e) by Mutual Recognition Agreement (MRA) in FCC Test.

<b>Test Site</b>	SPORTON INTERNATIONAL INC.	
<b>Test Site Location</b>	No. 52, Hwa Ya 1 <sup>st</sup> Rd., Hwa Ya Technology Park, Kwei-Shan District, Tao Yuan City, Taiwan, R.O.C. TEL: +886-3-327-3456 FAX: +886-3-328-4978	
<b>Test Site No.</b>	<b>Sporton Site No.</b>	
	TH05-HY	CO05-HY

**Note:** The test site complies with ANSI C63.4 2014 requirement.

<b>Test Site</b>	SPORTON INTERNATIONAL INC.	
<b>Test Site Location</b>	No.58, Aly. 75, Ln. 564, Wenhua 3rd Rd. Guishan Dist, Taoyuan City, Taiwan (R.O.C.) TEL: +886-3-327-0868 FAX: +886-3-327-0855	
<b>Test Site No.</b>	<b>Sporton Site No.</b>	
	03CH12-HY	

**Note:** The test site complies with ANSI C63.4 2014 requirement.



## 1.7 Applicable Standards

According to the specifications of the manufacturer, the EUT must comply with the requirements of the following standards:

- ♦ FCC Part 15 Subpart E
- ♦ FCC KDB 789033 D02 General UNII Test Procedures New Rules v01r03
- ♦ FCC KDB 662911 D01 Multiple Transmitter Output v02r01.
- ♦ FCC KDB 644545 D03 Guidance for IEEE 802 11ac New Rules v01
- ♦ ANSI C63.10-2013

**Remark:**

1. All test items were verified and recorded according to the standards and without any deviation during the test.
2. This EUT has also been tested and complied with the requirements of FCC Part 15, Subpart B, recorded in a separate test report.





## 2 Test Configuration of Equipment Under Test

The EUT has been associated with peripherals and configuration operated in a manner tended to maximize its emission characteristics in a typical application. Frequency range investigated: conducted emission (150 kHz to 30 MHz) and radiated emission (9 kHz to the 10th harmonic of the highest fundamental frequency or to 40 GHz, whichever is lower). For radiated measurement, pre-scanned in three orthogonal panels, X, Y, Z. The worst position for each mode was recorded in the appendix of this test report.

### 2.1 Carrier Frequency and Channel

Frequency Band	Channel	Freq. (MHz)	Channel	Freq. (MHz)
5725-5850 MHz Band 4 (U-NII-3)	149	5745	157	5785
	151*	5755	159*	5795
	153	5765	161	5805
	155#	5775	165	5825

**Note:**

1. The above Frequency and Channel in "\*" were 802.11n HT40 and 802.11ac VHT40.
2. The above Frequency and Channel in "#" were 802.11ac VHT80.



## 2.2 Pre-Scanned RF Power

Preliminary tests were performed in different data rate and data rate associated with the highest power were chosen for full test in the following tables. Final Output Power equals to Measured Output Power adds the duty factor.

<Ant. 1>

<CDD Modes>

WLAN 802.11a RF Average Output Power (dBm)										
Power vs. Channel			Power vs. Data Rate							
Channel	Frequency (MHz)	Data Rate (bps)	Channel	Data Rate (bps)						
		6M		9M	12M	18M	24M	36M	48M	54M
Duty Cycle (%)		92.86		89.72	86.75	81.67	78.48	71.11	64.87	63.57
CH 149	5745 MHz	15.84	CH 157	15.85	15.82	15.90	15.78	15.90	15.88	15.73
CH 157	5785 MHz	15.93								
CH 165	5825 MHz	15.88								

WLAN 802.11n HT20 RF Average Output Power (dBm)										
Power vs. Channel			Power vs. Data Rate							
Channel	Frequency (MHz)	MCS Index	Channel	MCS Index						
		MCS0		MCS1	MCS2	MCS3	MCS4	MCS5	MCS6	MCS7
Duty Cycle (%)		92.86		87.34	81.94	78.21	70.79	66.22	63.83	61.94
CH 149	5745 MHz	15.82	CH 157	15.83	15.76	15.81	15.86	15.84	15.79	15.79
CH 157	5785 MHz	15.90								
CH 165	5825 MHz	15.78								

WLAN 802.11n HT40 RF Average Output Power (dBm)										
Power vs. Channel			Power vs. Data Rate							
Channel	Frequency (MHz)	MCS Index	Channel	MCS Index						
		MCS0		MCS1	MCS2	MCS3	MCS4	MCS5	MCS6	MCS7
Duty Cycle (%)		98.01		95.31	94.44	92.06	90.39	88.37	86.25	85.14
CH 151	5755 MHz	15.30	CH 151	15.21	15.20	15.14	15.20	15.22	15.19	15.18
CH 159	5795 MHz	15.24								



WLAN 802.11ac VHT20 RF Average Output Power (dBm)											
Power vs. Channel			Power vs. Data Rate								
Channel	Frequency (MHz)	MCS Index	Channel	MCS Index							
		MCS0		MCS1	MCS2	MCS3	MCS4	MCS5	MCS6	MCS7	MCS8
Duty Cycle (%)		92.86		86.87	81.25	78.21	71.91	66.23	63.89	61.77	59.59
CH 149	5745 MHz	15.84	CH 157	15.86	15.82	15.83	15.80	15.91	15.76	15.84	15.83
CH 157	5785 MHz	15.93									
CH 165	5825 MHz	15.80									

WLAN 802.11ac VHT40 RF Average Output Power (dBm)												
Power vs. Channel			Average Power vs. Data Rate									
Channel	Frequency (MHz)	MCS Index	Channel	MCS Index								
		MCS0		MCS1	MCS2	MCS3	MCS4	MCS5	MCS6	MCS7	MCS8	MCS9
Duty Cycle (%)		98.02		96.47	93.41	93.06	90.48	87.50	86.59	85.53	85.29	83.97
CH 151	5755 MHz	15.37	CH 151	15.31	15.30	15.31	15.23	15.22	15.18	15.18	15.11	15.10
CH 159	5795 MHz	15.34										

WLAN 802.11ac VHT80 RF Average Output Power (dBm)												
Power vs. Channel			Power vs. Data Rate									
Channel	Frequency (MHz)	MCS Index	Channel	MCS Index								
		MCS0		MCS1	MCS2	MCS3	MCS4	MCS5	MCS6	MCS7	MCS8	MCS9
Duty Cycle (%)		95.95		92.65	89.90	86.91	84.85	82.76	81.48	78.85	77.08	75.56
CH 155	5775MHz	14.35	CH 155	14.23	14.21	14.20	14.20	14.14	14.17	14.18	14.27	14.32



<Ant. 2>

WLAN 802.11a RF Average Output Power (dBm)										
Power vs. Channel			Power vs. Data Rate							
Channel	Frequency (MHz)	Data Rate (bps)	Channel	Data Rate (bps)						
		6M		9M	12M	18M	24M	36M	48M	54M
<b>Duty Cycle (%)</b>		92.86		89.72	87.95	81.82	78.39	71.11	66.22	64.29
CH 149	5745 MHz	17.53	CH 157	17.58	17.51	17.57	17.56	17.58	17.59	17.57
CH 157	5785 MHz	17.60								
CH 165	5825 MHz	17.57								

WLAN 802.11n HT20 RF Average Output Power (dBm)										
Power vs. Channel			Power vs. Data Rate							
Channel	Frequency (MHz)	MCS Index	Channel	MCS Index						
		MCS0		MCS1	MCS2	MCS3	MCS4	MCS5	MCS6	MCS7
<b>Duty Cycle (%)</b>		92.86		86.08	81.25	77.92	70.79	66.67	63.83	62.69
CH 149	5745 MHz	17.53	CH 165	17.55	17.56	17.54	17.55	17.56	17.53	17.55
CH 157	5785 MHz	17.48								
CH 165	5825 MHz	17.64								

WLAN 802.11n HT40 RF Average Output Power (dBm)										
Power vs. Channel			Power vs. Data Rate							
Channel	Frequency (MHz)	MCS Index	Channel	MCS Index						
		MCS0		MCS1	MCS2	MCS3	MCS4	MCS5	MCS6	MCS7
<b>Duty Cycle (%)</b>		98.01		96.47	94.38	93.62	90.29	87.21	86.25	85.14
CH 151	5755 MHz	17.05	CH 151	17.00	17.01	17.02	16.99	16.97	16.89	16.98
CH 159	5795 MHz	16.95								

WLAN 802.11ac VHT20 RF Average Output Power (dBm)											
Power vs. Channel			Power vs. Data Rate								
Channel	Frequency (MHz)	MCS Index	Channel	MCS Index							
		MCS0		MCS1	MCS2	MCS3	MCS4	MCS5	MCS6	MCS7	MCS8
<b>Duty Cycle (%)</b>		92.28		86.87	82.29	78.07	71.11	65.79	65.28	62.50	59.52
CH 149	5745 MHz	17.63	CH 165	17.63	17.62	17.60	17.63	17.62	17.66	17.54	17.67
CH 157	5785 MHz	17.51									
CH 165	5825 MHz	17.68									



WLAN 802.11ac VHT40 RF Average Output Power (dBm)												
Power vs. Channel			Power vs. Data Rate									
Channel	Frequency (MHz)	MCS Index	Channel	MCS Index								
		MCS0		MCS1	MCS2	MCS3	MCS4	MCS5	MCS6	MCS7	MCS8	MCS9
Duty Cycle (%)		98.21		95.35	94.44	92.36	90.48	88.64	86.59	85.53	85.29	84.85
CH 151	5755 MHz	17.07	CH 151	17.05	17.02	17.05	17.01	17.00	16.98	17.00	17.01	17.03
CH 159	5795 MHz	17.03										

WLAN 802.11ac VHT80 RF Average Output Power (dBm)												
Power vs. Channel			Power vs. Data Rate									
Channel	Frequency (MHz)	MCS Index	Channel	MCS Index								
		MCS0		MCS1	MCS2	MCS3	MCS4	MCS5	MCS6	MCS7	MCS8	MCS9
Duty Cycle (%)		95.05		92.65	90.00	88.10	83.33	82.76	81.48	80.77	77.08	76.34
CH 155	5775MHz	16.10	CH 155	16.06	16.04	16.05	16.07	15.99	15.94	15.88	16.03	16.06



MIMO <Ant. 1+2>

WLAN 802.11a RF Average Output Power (dBm)										
Power vs. Channel			Power vs. Data Rate							
Channel	Frequency (MHz)	Data Rate (bps)	Channel	Data Rate (bps)						
		6M		9M	12M	18M	24M	36M	48M	54M
CH 149	5745 MHz	19.93	CH 157	19.89	19.86	19.90	19.83	19.92	19.93	19.94
CH 157	5785 MHz	19.95								
CH 165	5825 MHz	19.87								

WLAN 802.11n HT20 RF Average Output Power (dBm)										
Power vs. Channel			Power vs. Data Rate							
Channel	Frequency (MHz)	MCS Index	Channel	MCS Index						
		MCS0		MCS1	MCS2	MCS3	MCS4	MCS5	MCS6	MCS7
CH 149	5745 MHz	19.85	CH 157	19.79	19.76	19.79	19.79	19.78	19.73	19.81
CH 157	5785 MHz	19.88								
CH 165	5825 MHz	19.85								

WLAN 802.11n HT40 RF Average Output Power (dBm)										
Power vs. Channel			Power vs. Data Rate							
Channel	Frequency (MHz)	MCS Index	Channel	MCS Index						
		MCS0		MCS1	MCS2	MCS3	MCS4	MCS5	MCS6	MCS7
CH 151	5755 MHz	19.36	CH 159	19.36	19.37	19.34	19.34	19.34	19.31	19.35
CH 159	5795 MHz	19.39								

WLAN 802.11ac VHT20 RF Average Output Power (dBm)											
Power vs. Channel			Power vs. Data Rate								
Channel	Frequency (MHz)	MCS Index	Channel	MCS Index							
		MCS0		MCS1	MCS2	MCS3	MCS4	MCS5	MCS6	MCS7	MCS8
CH 149	5745 MHz	19.87	CH 157	19.89	19.86	19.86	19.88	19.89	19.88	19.86	19.88
CH 157	5785 MHz	19.90									
CH 165	5825 MHz	19.89									



WLAN 802.11ac VHT40 RF Average Output Power (dBm)												
Power vs. Channel			Power vs. Data Rate									
Channel	Frequency (MHz)	MCS Index	Channel	MCS Index								
		MCS0		MCS1	MCS2	MCS3	MCS4	MCS5	MCS6	MCS7	MCS8	MCS9
CH 151	5755 MHz	19.45	CH 151	19.44	19.45	19.38	19.42	19.44	19.43	19.45	19.39	19.37
CH 159	5795 MHz	19.41										

WLAN 802.11ac VHT80 RF Average Output Power (dBm)												
Power vs. Channel			Power vs. Data Rate									
Channel	Frequency (MHz)	MCS Index	Channel	MCS Index								
		MCS0		MCS1	MCS2	MCS3	MCS4	MCS5	MCS6	MCS7	MCS8	MCS9
CH 155	5775MHz	18.37	CH 155	18.35	18.28	18.26	18.34	18.32	18.27	18.24	18.31	18.34

Note: MIMO Ant. 1+2 is a calculated result from sum of the power MIMO Ant. 1 and MIMO Ant. 2.



<TXBF Modes>

MIMO <Ant. 1+2>

WLAN 802.11n HT20 RF Average Output Power (dBm)										
Power vs. Channel			Power vs. Data Rate							
Channel	Frequency (MHz)	MCS Index	Channel	MCS Index						
		MCS0		MCS1	MCS2	MCS3	MCS4	MCS5	MCS6	MCS7
CH 149	5745 MHz	19.52	CH 165	19.55	19.52	19.52	19.46	19.55	19.49	19.46
CH 157	5785 MHz	19.52								
CH 165	5825 MHz	19.59								

WLAN 802.11n HT40 RF Average Output Power (dBm)										
Power vs. Channel			Power vs. Data Rate							
Channel	Frequency (MHz)	MCS Index	Channel	MCS Index						
		MCS0		MCS1	MCS2	MCS3	MCS4	MCS5	MCS6	MCS7
CH 151	5755 MHz	19.04	CH 151	19.00	18.97	18.97	18.91	18.94	18.94	18.97
CH 159	5795 MHz	19.02								





WLAN 802.11ac VHT20 RF Average Output Power (dBm)											
Power vs. Channel			Power vs. Data Rate								
Channel	Frequency (MHz)	MCS Index	Channel	MCS Index							
		MCS0		MCS1	MCS2	MCS3	MCS4	MCS5	MCS6	MCS7	MCS8
CH 149	5745 MHz	19.62	CH 165	19.71	19.69	19.69	19.71	19.69	19.71	19.65	19.71
CH 157	5785 MHz	19.69									
CH 165	5825 MHz	19.75									

WLAN 802.11ac VHT40 RF Average Output Power (dBm)												
Power vs. Channel			Power vs. Data Rate									
Channel	Frequency (MHz)	MCS Index	Channel	MCS Index								
		MCS0		MCS1	MCS2	MCS3	MCS4	MCS5	MCS6	MCS7	MCS8	MCS9
CH 151	5755 MHz	19.14	CH 159	19.15	19.15	19.12	19.06	19.06	19.15	19.12	19.06	19.12
CH 159	5795 MHz	19.19										

WLAN 802.11ac VHT80 RF Average Output Power (dBm)												
Power vs. Channel			Power vs. Data Rate									
Channel	Frequency (MHz)	MCS Index	Channel	MCS Index								
		MCS0		MCS1	MCS2	MCS3	MCS4	MCS5	MCS6	MCS7	MCS8	MCS9
CH 155	5775MHz	17.85	CH 155	17.81	17.79	17.79	17.82	17.79	17.81	17.82	17.79	17.81

Note: MIMO Ant. 1+2 is a calculated result from sum of the power MIMO Ant. 1 and MIMO Ant. 2.



### 2.3 Test Mode

Final test mode of conducted test items and radiated spurious emissions are considering the modulation and worse data rates from the power table described in section 2.2.

Modulation	Data Rate
802.11a	6 Mbps
802.11n HT20	MCS0
802.11n HT40	MCS0
802.11ac VHT20	MCS0
802.11ac VHT40	MCS0
802.11ac VHT80	MCS0

<b>AC Conducted Emission</b>	<p>Mode 1 : NFC Link + AC Adapter + Charging only Cable + Bluetooth Link + WLAN (5GHz) Link + Earphone 1 with Audio Adaptor connect to EUT</p> <p>Mode 2 : NFC Link + AC Adapter + Snap on USB Cable Data Link with Notebook + WLAN (5GHz) Link + Bluetooth Link with Earphone 3 + Copy data from Notebook to EDA (SD Card)</p> <p>Mode 3 : NFC Link + AC Adapter + Charging only Cable + Bluetooth Link + WLAN (5GHz) Link + Earphone 2 with Audio Adaptor connect to EUT</p>
<b>Remark:</b> The worst case of conducted emission is mode 2; only the test data of it was reported.	

Ch. #		Band IV : 5725-5850 MHz		
		802.11a	802.11n HT20	802.11n HT40
L	Low	149	149	151
M	Middle	157	157	-
H	High	165	165	159

Ch. #		Band IV : 5725-5850 MHz		
		802.11ac VHT20	802.11ac VHT40	802.11ac VHT80
L	Low	149	151	-
M	Middle	157	-	155
H	High	165	159	-

## 2.4 Connection Diagram of Test System

<WLAN Tx CDD Mode>

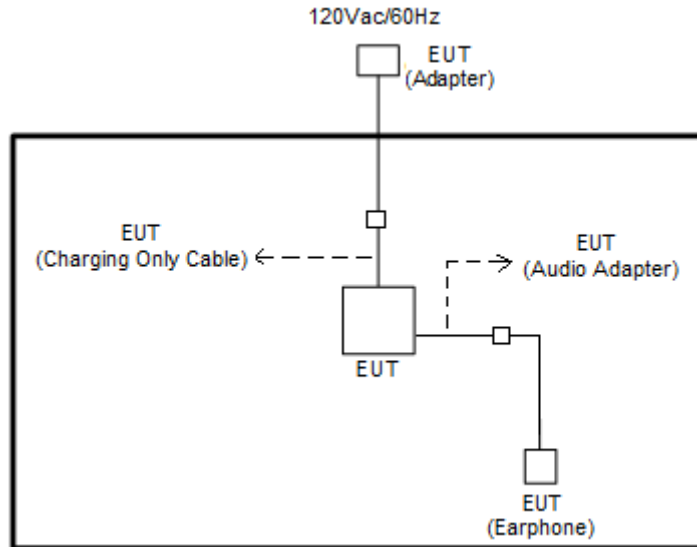

<WLAN Tx TXBF Mode>

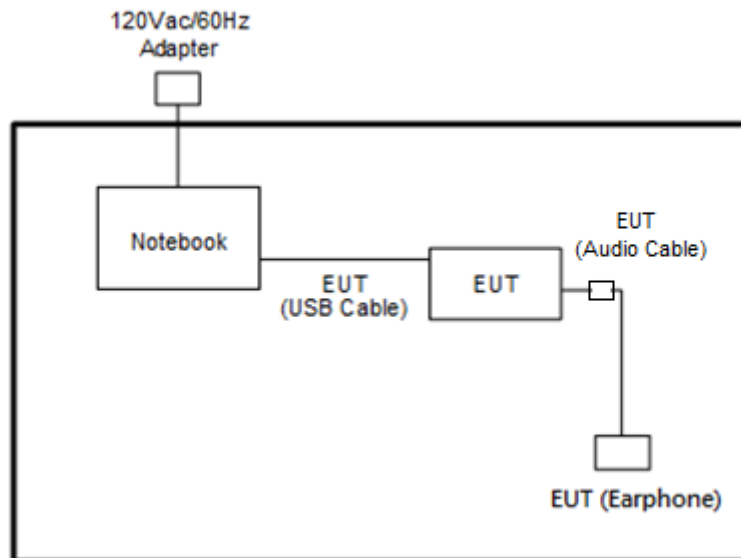

<AC Conducted Emission Mode>

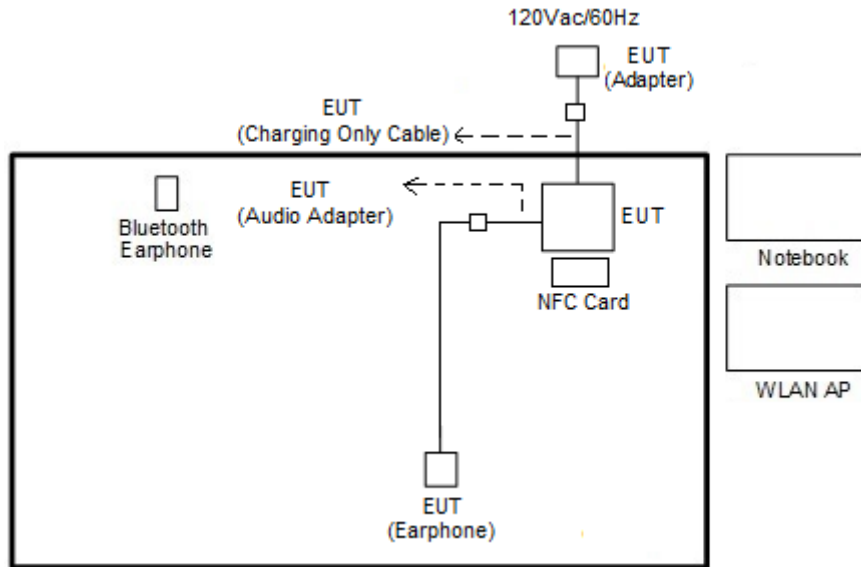

2.5 Support Unit used in test configuration and system

Item	Equipment	Trade Name	Model Name	FCC ID	Data Cable	Power Cord
1.	Bluetooth Earphone	Sony Ericsson	MW600	PY7DDA-2029	N/A	N/A
2.	WLAN AP	D-Link	DIR-628	KA2DIR628A2	N/A	Unshielded, 1.8 m
3.	Notebook	DELL	Latitude E6320	FCC DoC/ Contains FCC ID: QDS-BRCM1054	N/A	AC I/P: Unshielded, 1.2 m DC O/P: Shielded, 1.8 m
4.	Notebook	DELL	P20G	FCC DoC/ Contains FCC ID: QDS-BRCM1051	N/A	AC I/P: Unshielded, 1.2 m DC O/P: Shielded, 1.8 m
5.	iPod Earphone	Apple	N/A	Verification	Unshielded, 1.0 m	N/A
6.	SD Card	SanDisk	MicroSD HC	FCC DoC	N/A	N/A
7.	NFC Card	Metro Taipei	Easy Card	N/A	N/A	N/A



## 2.6 EUT Operation Test Setup

For WLAN CDD modes, programmed RF utility, "CMD" installed in the notebook make the EUT provide functions like channel selection and power level for continuous transmitting and receiving signals.

For WLAN MIMO TXBF modes, the EUT was tested under normal operation and link to another device with power, modulation modes and data rates controlled by engineer mode command lines. The CMD software tool was used to make EUT continuous transmitting signals.

## 2.7 Measurement Results Explanation Example

### For all conducted test items:

The offset level is set in the spectrum analyzer to compensate the RF cable loss and attenuator factor between EUT conducted output port and spectrum analyzer. With the offset compensation, the spectrum analyzer reading level is exactly the EUT RF output level.

Example :

The spectrum analyzer offset is derived from RF cable loss and attenuator factor.

*Offset = RF cable loss + attenuator factor.*

Following shows an offset computation example with cable loss 4.2 dB and 10dB attenuator.

$$\begin{aligned} \text{Offset(dB)} &= \text{RF cable loss(dB)} + \text{attenuator factor(dB)}. \\ &= 4.2 + 10 = 14.2 \text{ (dB)} \end{aligned}$$

### 3 Test Result

#### 3.1 6dB and 26dB and 99% Occupied Bandwidth Measurement

##### 3.1.1 Description of 6dB and 26dB and 99% Occupied Bandwidth

The minimum 6 dB bandwidth shall be at least 500 kHz.

26dB and 99% Occupied bandwidth are reporting only.

##### 3.1.2 Measuring Instruments

The measuring equipment is listed in the section 4 of this test report.

##### 3.1.3 Test Procedures

1. The testing follows FCC KDB 789033 D02 General UNII Test Procedures New Rules v01r03.  
Section C) Emission bandwidth for the band 5.725-5.85GHz
2. Set RBW = 100kHz.
3. Set the VBW  $\geq 3 \times$  RBW.
4. Detector = Peak.
5. Trace mode = max hold
6. Measure the maximum width of the emission that is 6 dB down from the peak of the emission.
7. Measure and record the results in the test report.

##### 3.1.4 Test Setup

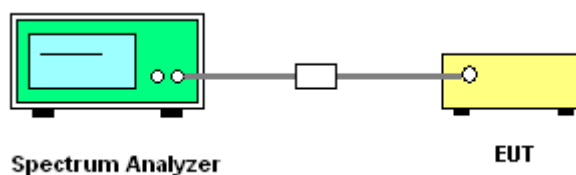



### 3.1.5 Test Result of 6dB Bandwidth

Please refer to Appendix A.

<CDD Modes>

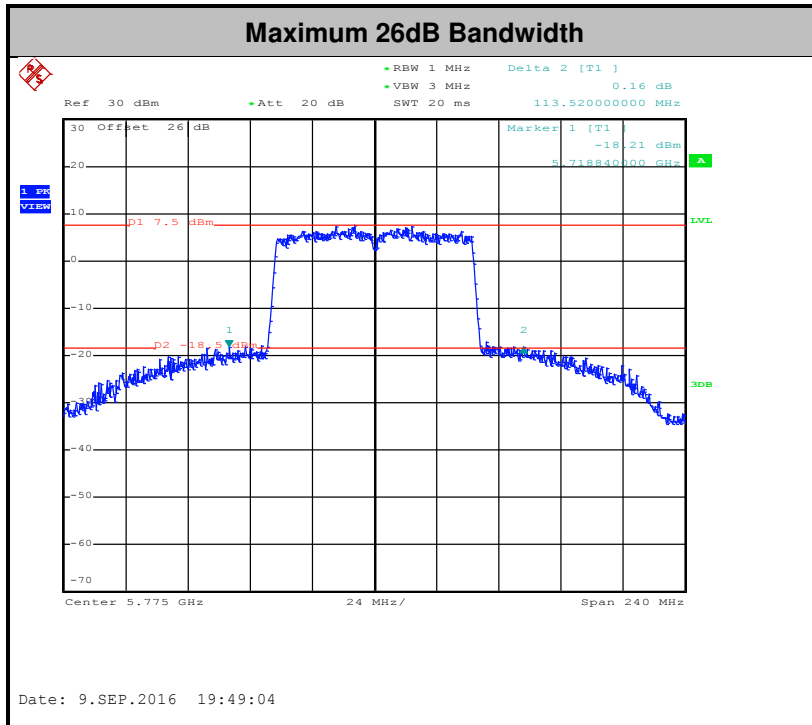
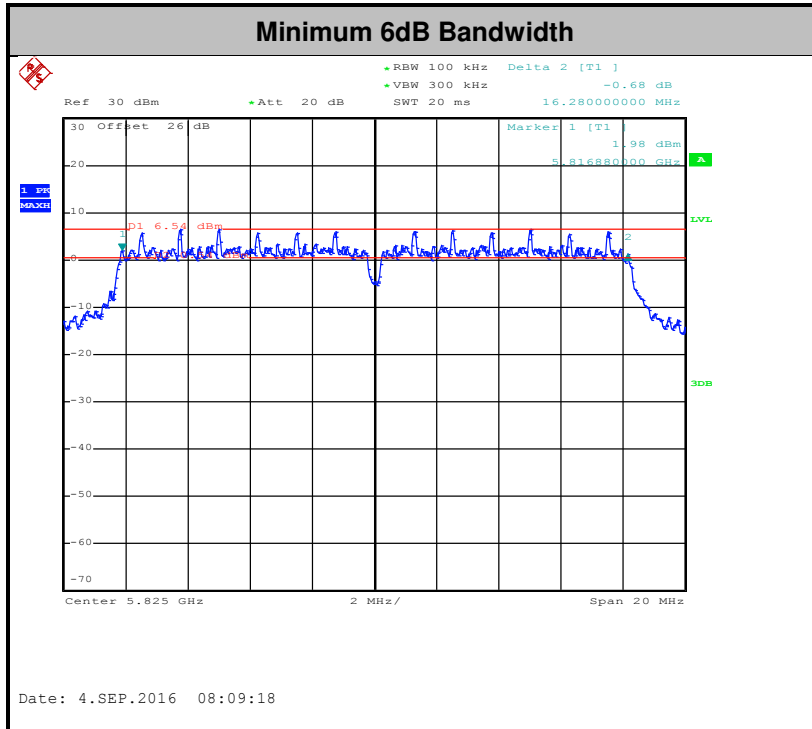

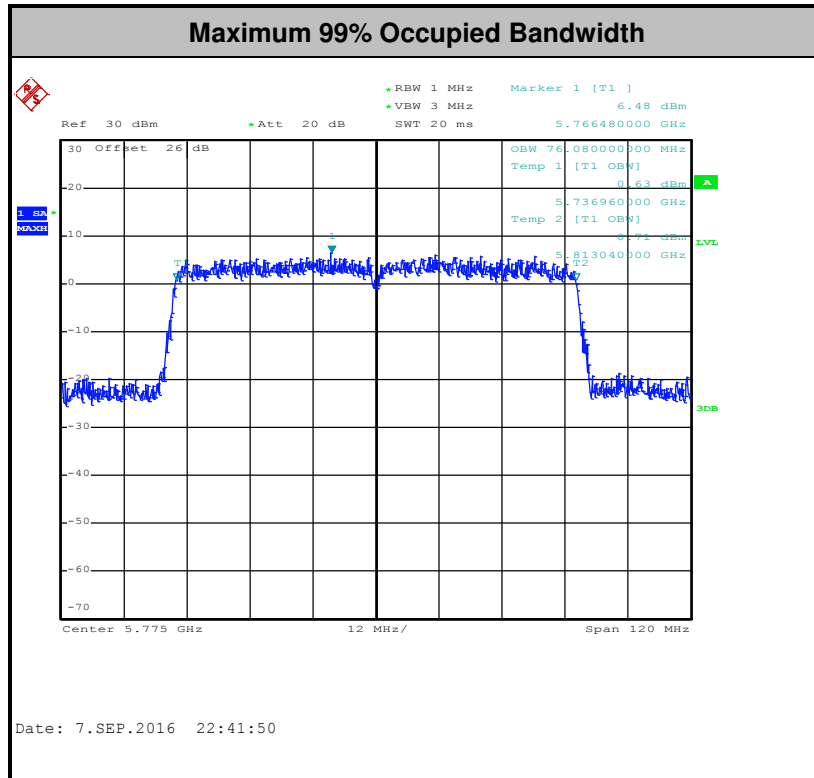

**Note:** The occupied channel bandwidth is maintained within the band of operation for all of the modulations.





<TXBF Modes>

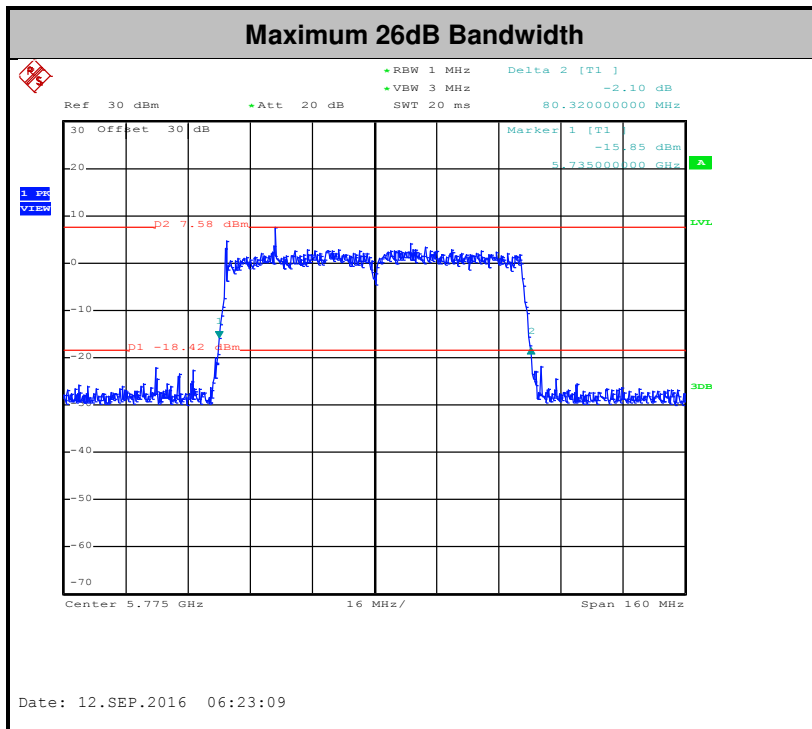
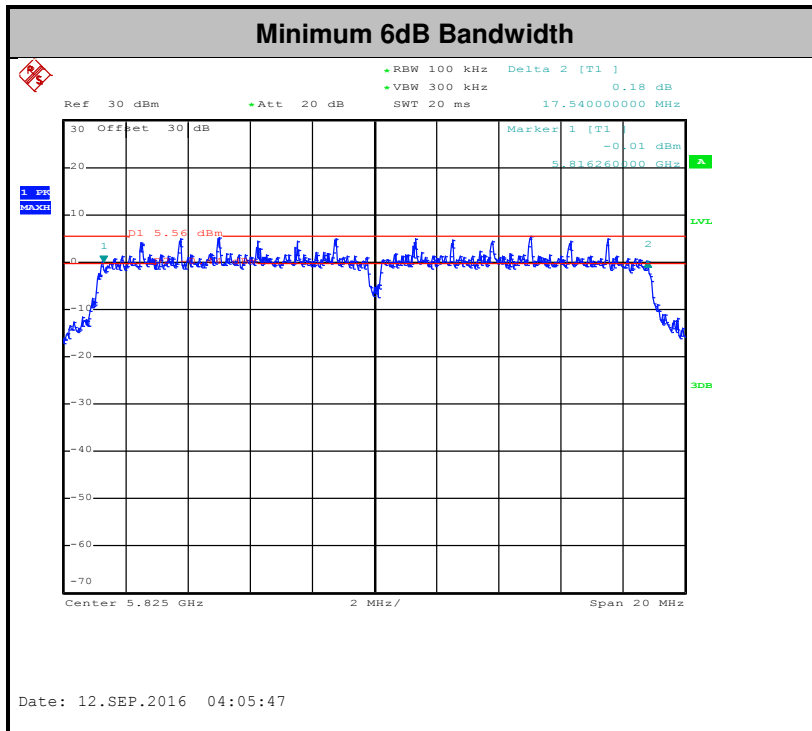

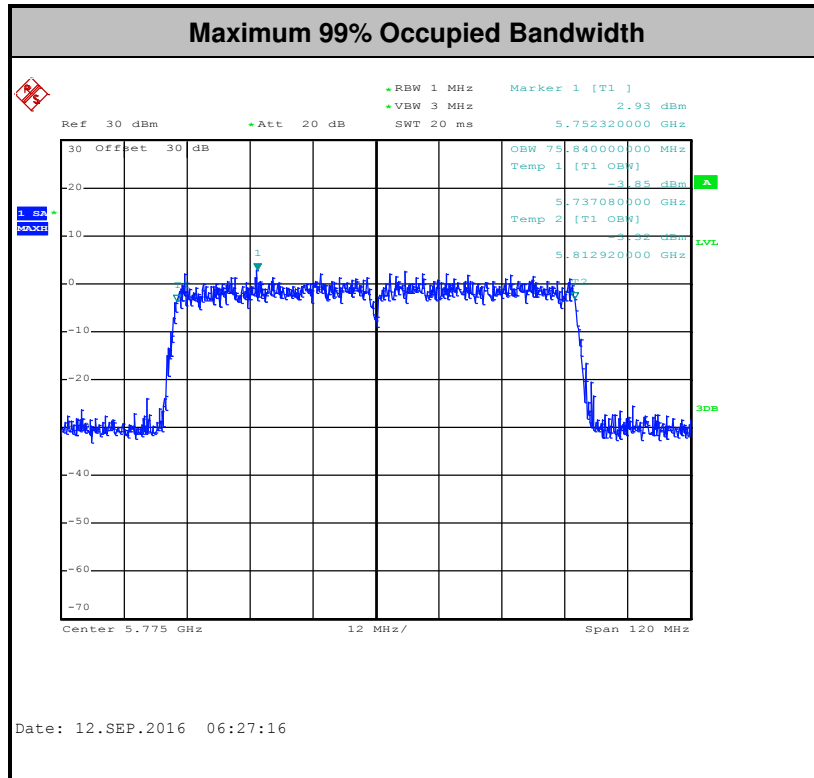

**Note:** The occupied channel bandwidth is maintained within the band of operation for all of the modulations.



## 3.2 Maximum Conducted Output Power Measurement

### 3.2.1 Limit of Maximum Conducted Output Power

For the band 5.725–5.85 GHz, the maximum conducted output power over the frequency band of operation shall not exceed 1 W.

If transmitting antennas of directional gain greater than 6 dBi are used, the peak output power shall be reduced by the amount in dB that the directional gain of the antenna exceeds 6 dBi.

### 3.2.2 Measuring Instruments

The measuring equipment is listed in the section 4 of this test report.

### 3.2.3 Test Procedures

#### CDD modes

The testing follows Method PM of FCC KDB 789033 D02 General UNII Test Procedures New Rules v01r03.

Method PM (Measurement using an RF average power meter):

1. Measurement is performed using a wideband RF power meter.
2. The EUT is configured to transmit continuously with a consistent duty cycle at its maximum power control level.
3. Measure the average power of the transmitter, and the average power is corrected with duty factor,  $10 \log(1/x)$ , where  $x$  is the duty cycle.

#### TXBF modes

The testing follows Method PM-G of FCC KDB 789033 D02 General UNII Test Procedures New Rules v01r03 for TXBF modes.

Method PM-G (Measurement using a gated RF average power meter):

1. Measurement is performed using a wideband RF power meter.
2. The EUT is configured to transmit at its maximum power control level.
3. Measure the average power of the transmitter
4. Since the measurement is made only during the ON time of the transmitter, no duty cycle correction factor is required.

### 3.2.4 Test Setup

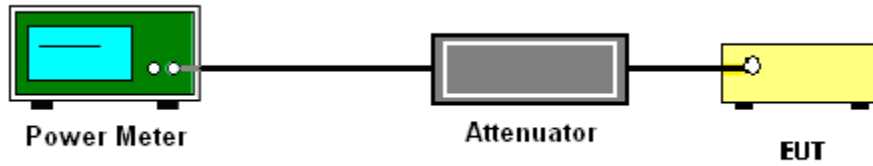

### 3.2.5 Test Result of Maximum Conducted Output Power

Please refer to Appendix A.



### 3.3 Power Spectral Density Measurement

#### 3.3.1 Limit of Power Spectral Density

For the band 5.725–5.85 GHz, the maximum power spectral density shall not exceed 30 dBm in any 500-kHz band.

If transmitting antennas of directional gain greater than 6 dBi are used, the peak output power shall be reduced by the amount in dB that the directional gain of the antenna exceeds 6 dBi.

#### 3.3.2 Measuring Instruments

The measuring equipment is listed in the section 4 of this test report.

#### 3.3.3 Test Procedures

The testing follows FCC KDB 789033 D02 General UNII Test Procedures New Rules v01r03. Section F) Maximum power spectral density.

##### CDD modes

##### **# Method SA-2 #**

(trace averaging across on and off times of the EUT transmissions, followed by duty cycle correction).

- Measure the duty cycle.
- Set span to encompass the entire emission bandwidth (EBW) of the signal.
- Set RBW = 300 kHz.
- Set VBW  $\geq$  1 MHz.
- Number of points in sweep  $\geq$  2 Span / RBW.
- Sweep time = auto.
- Detector = RMS
- Trace average at least 100 traces in power averaging mode.
- Add  $10 \log(500\text{kHz}/\text{RBW})$  to the test result.
- Add  $10 \log(1/x)$ , where  $x$  is the duty cycle, to the measured power in order to compute the average power during the actual transmission times. For example, add  $10 \log(1/0.25) = 6$  dB if the duty cycle is 25 percent.

**TXBF modes****# Method SA-3 #**

(power averaging (rms) detection with max hold):

- Set span to encompass the entire emission bandwidth (EBW) of the signal.
  - Set RBW = 300 kHz.
  - Set VBW  $\geq$  1 MHz.
  - Number of points in sweep  $\geq$  2 Span / RBW.
  - Sweep time  $\leq$  (number of points in sweep)  $\times$  T, when duty cycle is less than 98 percent where T is the minimum transmission duration over which the transmitter is on and is transmitting at its maximum power control level for the tested mode of operation.
  - Detector = power averaging (rms).
  - Trace mode = max hold.
  - Allow max hold to run for at least 60 seconds, or longer as needed to allow the trace to stabilize.
1. The RF output of EUT was connected to the spectrum analyzer by a low loss cable.
  2. Each plot has already offset with cable loss, and attenuator loss. Measure the PPSD and record it.
  3. For MIMO mode, calculation method follows FCC KDB 662911 D01 Multiple Transmitter Output v02r01.

Method (c): Measure and add  $10 \log(N_{ANT})$  dB.

With this technique, spectrum measurements are performed at each output of the device, but rather than summing the spectra or the spectral peaks across the outputs, the quantity  $10 \log(N_{ANT})$  dB is added to each spectrum value before comparing to the emission limit. The addition of  $10 \log(N_{ANT})$  dB serves to apportion the emission limit among the  $N_{ANT}$  outputs so that each output is permitted to contribute no more than  $1/N_{ANT}^{th}$  of the PSD limit.

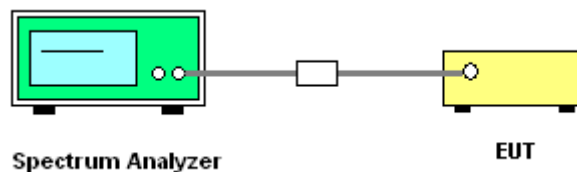
**3.3.4 Test Setup**



### 3.3.5 Test Result of Power Spectral Density

Please refer to Appendix A.

<CDD Modes>

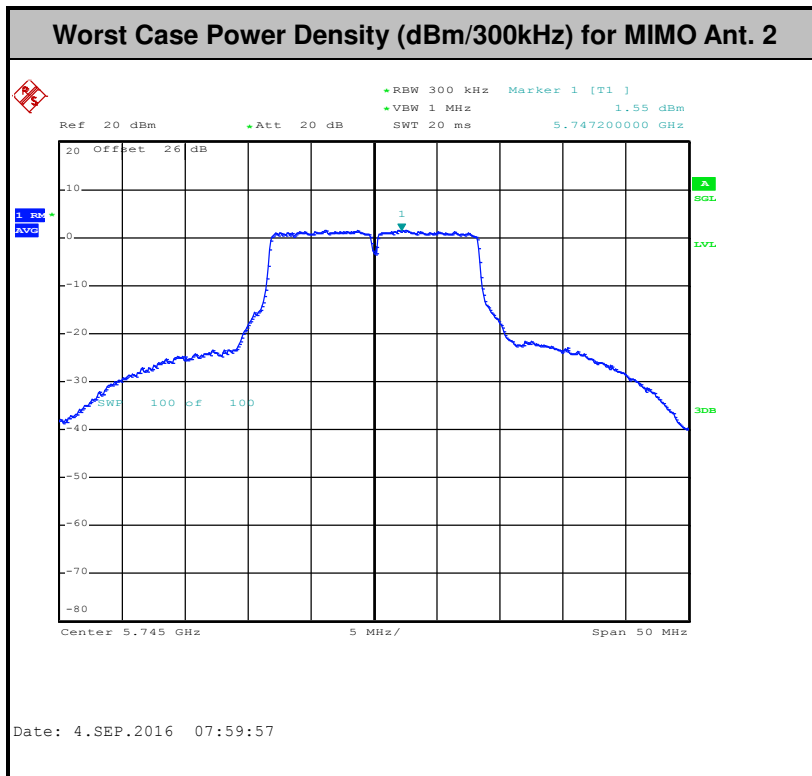
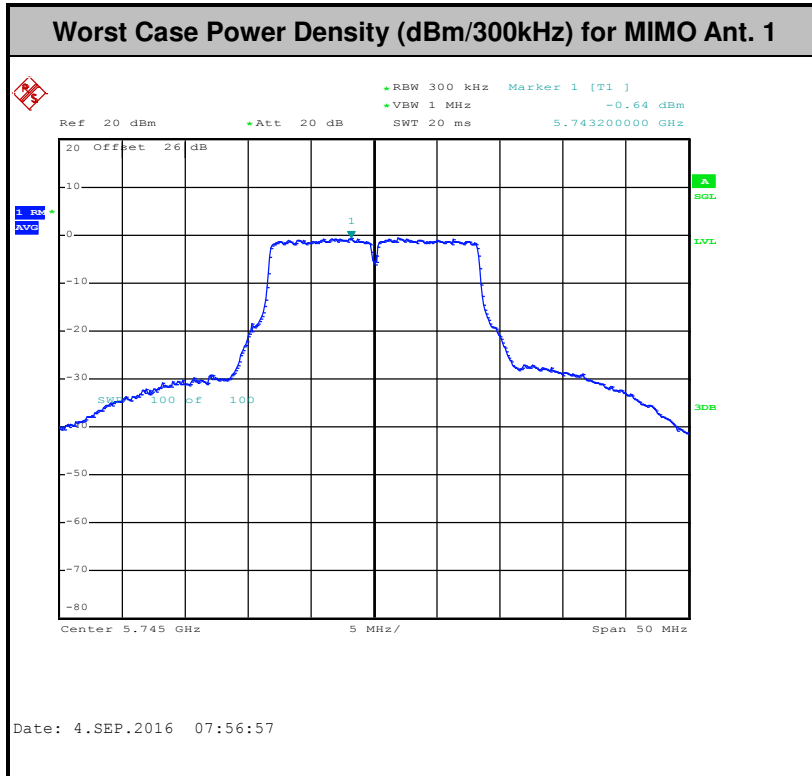



<TXBF Modes>

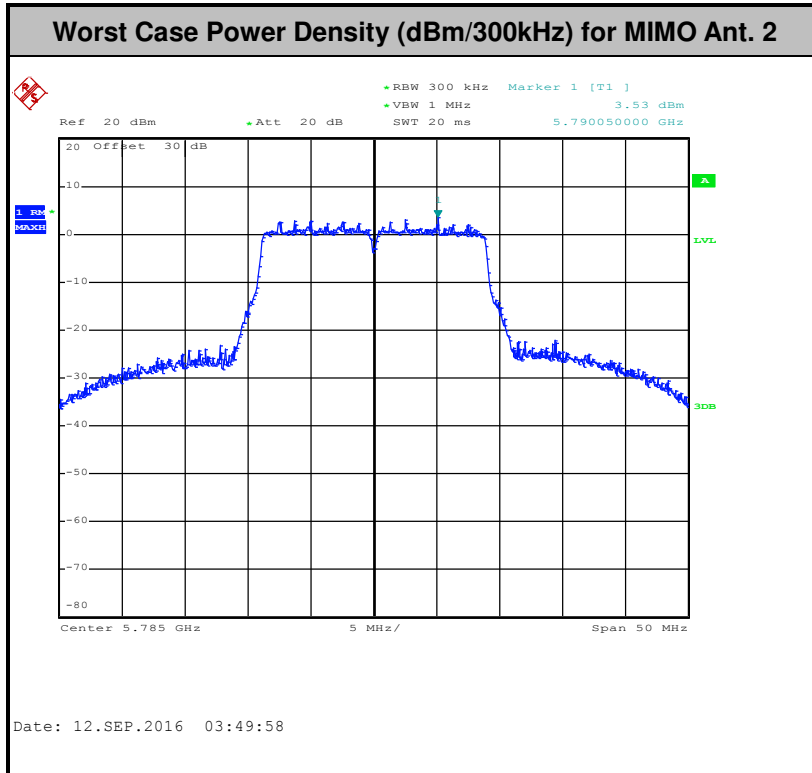
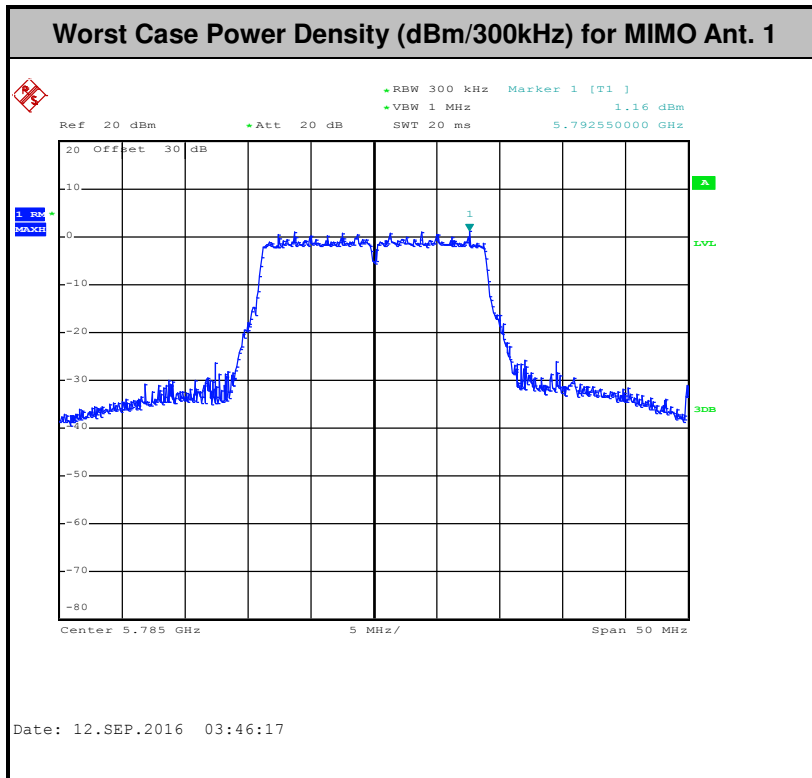





### 3.4 Unwanted Emissions Measurement

This section as specified in FCC Part 15.407(b) is to measure unwanted emissions through radiated measurement for band edge spurious emissions and out of band emissions measurement. The unwanted emissions shall comply with 15.407(b)(1) to (6), and restricted bands per FCC Part15.205.

#### 3.4.1 Limit of Unwanted Emissions

(1) For transmitters operating in the 5.725-5.85 GHz band:

15.407(b)(4)(i) All emissions shall be limited to a level of -27 dBm/MHz at 75 MHz or more above or below the band edge increasing linearly to 10 dBm/MHz at 25 MHz above or below the band edge, and from 25 MHz above or below the band edge increasing linearly to a level of 15.6 dBm/MHz at 5 MHz above or below the band edge, and from 5 MHz above or below the band edge increasing linearly to a level of 27 dBm/MHz at the band edge.

(2) Unwanted spurious emissions fallen in restricted bands per FCC Part15.205 shall comply with the general field strength limits set forth in § 15.209 as below table,

Frequency (MHz)	Field Strength (microvolts/meter)	Measurement Distance (meters)
0.009 – 0.490	2400/F(kHz)	300
0.490 – 1.705	24000/F(kHz)	30
1.705 – 30.0	30	30
30 – 88	100	3
88 – 216	150	3
216 - 960	200	3
Above 960	500	3

**Note:** The following formula is used to convert the EIRP to field strength.

$$E = \frac{1000000\sqrt{30P}}{3} \mu\text{V/m, where P is the eirp (Watts)}$$



EIRP (dBm)	Field Strength at 3m (dBµV/m)
-17	78.3
- 27	68.3

(3) KDB 789033 D02 General UNII Test Procedures New Rules v01r03 G)2)c) As specified in 15.407(b), emissions above 1000 MHz that are outside of the restricted bands are subject to a peak emission limit of -27 dBm/MHz (or -17 dBm/MHz as specified in 15.407(b)(4)). However, an out-of-band emission that complies with both the average and peak limits of 15.209 is not required to satisfy the -27 dBm/MHz or -17 dBm/MHz peak emission limit.

### 3.4.2 Measuring Instruments

The measuring equipment is listed in the section 4 of this test report.

### 3.4.3 Test Procedures

1. The testing follows FCC KDB 789033 D02 General UNII Test Procedures New Rules v01r03. Section G) Unwanted emissions measurement.

(1) Procedure for Unwanted Emissions Measurements Below 1000MHz

- RBW = 120 kHz
- VBW = 300 kHz
- Detector = Peak
- Trace mode = max hold

(2) Procedure for Peak Unwanted Emissions Measurements Above 1000 MHz

- RBW = 1 MHz
- VBW ≥ 3 MHz
- Detector = Peak
- Sweep time = auto
- Trace mode = max hold

(3) Procedures for Average Unwanted Emissions Measurements Above 1000MHz

- RBW = 1 MHz
- VBW = 10 Hz, when duty cycle is no less than 98 percent.
- VBW ≥ 1/T, when duty cycle is less than 98 percent where T is the minimum transmission duration over which the transmitter is on and is transmitting at its maximum power control level for the tested mode of operation.

2. The EUT was placed on a turntable with 0.8 meter for frequency below 1GHz and 1.5 meter for frequency above 1GHz respectively above ground.
3. The EUT was set 3 meters from the interference receiving antenna which was mounted on the top of a variable height antenna tower.
4. The antenna is a broadband antenna and its height is adjusted between one meter and four meters above ground to find the maximum value of the field strength for both horizontal polarization and vertical polarization of the antenna.
5. For each suspected emission, the EUT was arranged to its worst case and then adjust the antenna tower (from 1 m to 4 m) and turntable (from 0 degree to 360 degrees) to find the maximum reading.
6. For testing below 1GHz, if the emission level of the EUT in peak mode was 3 dB lower than the limit specified, then peak values of EUT will be reported, otherwise, the emissions will be repeated one by one using the CISPR quasi-peak method and reported.
7. For testing above 1GHz, the emission level of the EUT in peak mode was 20dB lower than average limit (that means the emission level in average mode also complies with the limit in average mode), then peak values of EUT will be reported, otherwise, the emissions will be measured in average mode again and reported.

### 3.4.4 Test Setup

For radiated emissions below 30MHz

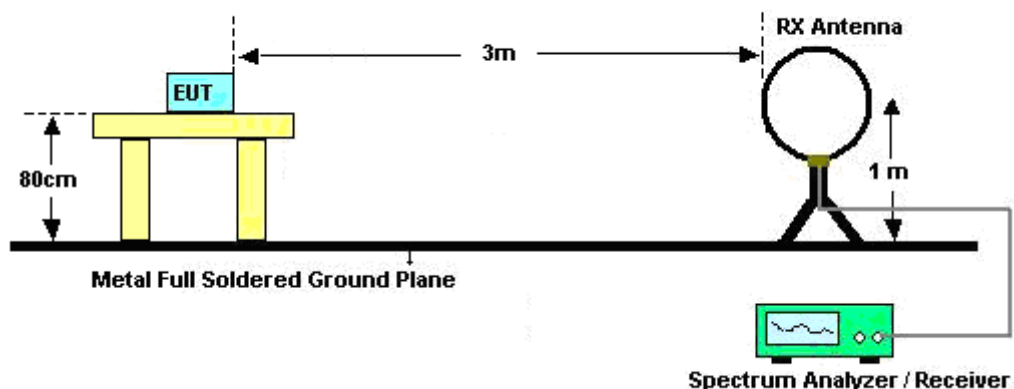

For radiated emissions from 30MHz to 1GHz

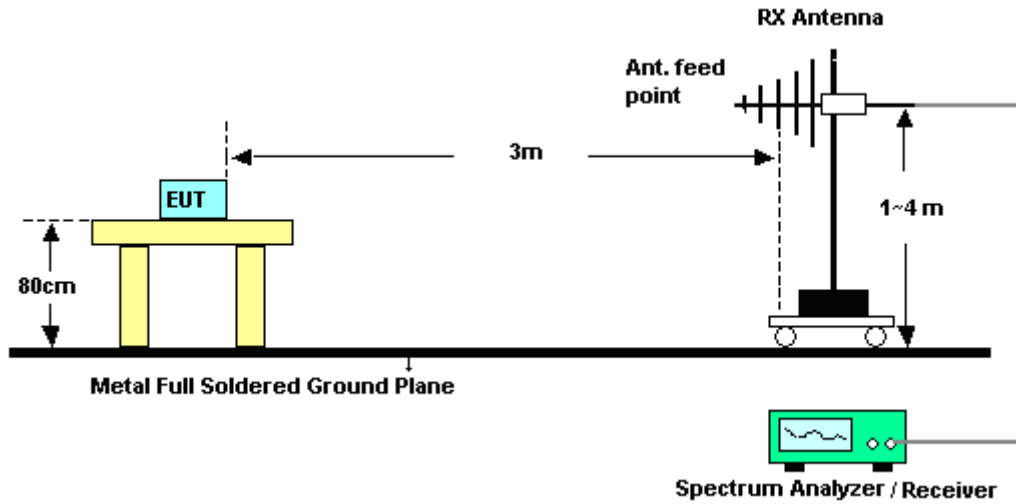

For radiated emissions above 1GHz

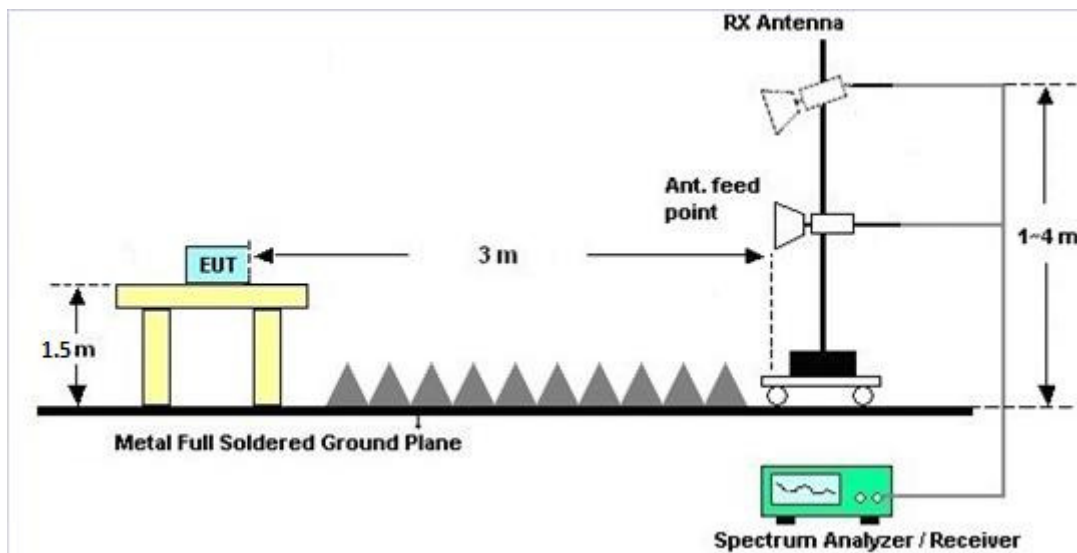



### **3.4.5 Test Results of Radiated Emissions (9 kHz ~ 30 MHz)**

The low frequency, which started from 9 kHz to 30MHz, was pre-scanned and the result which was 20dB lower than the limit line per 15.31(o) was not reported.

### **3.4.6 Test Result of Radiated Band Edges**

Please refer to Appendix B and C.

### **3.4.7 Duty Cycle**

Please refer to Appendix D.

### **3.4.8 Test Result of Unwanted Radiated Emission (30MHz ~ 10th Harmonic)**

Please refer to Appendix B and C.



### 3.5 AC Conducted Emission Measurement

#### 3.5.1 Limit of AC Conducted Emission

For equipment that is designed to be connected to the public utility (AC) power line, the radio frequency voltage that is conducted back onto the AC power line on any frequency or frequencies within the band 150 kHz to 30 MHz shall not exceed the limits in the following table.

Frequency of emission (MHz)	Conducted limit (dBµV)	
	Quasi-peak	Average
0.15-0.5	66 to 56*	56 to 46*
0.5-5	56	46
5-30	60	50

\*Decreases with the logarithm of the frequency.

For terminal test result, the testing follows FCC KDB 174176.

#### 3.5.2 Measuring Instruments

The measuring equipment is listed in the section 4 of this test report.

#### 3.5.3 Test Procedures

1. The EUT was placed 0.4 meter from the conducting wall of the shielding room was kept at least 80 centimeters from any other grounded conducting surface.
2. Connect EUT to the power mains through a line impedance stabilization network (LISN).
3. All the support units are connecting to the other LISN.
4. The LISN provides 50 ohm coupling impedance for the measuring instrument.
5. The FCC states that a 50 ohm, 50 microhenry LISN should be used.
6. Both sides of AC line were checked for maximum conducted interference.
7. The frequency range from 150 kHz to 30 MHz was searched.
8. Set the test-receiver system to Peak Detect Function and specified bandwidth with Maximum Hold Mode.

### 3.5.4 Test Setup

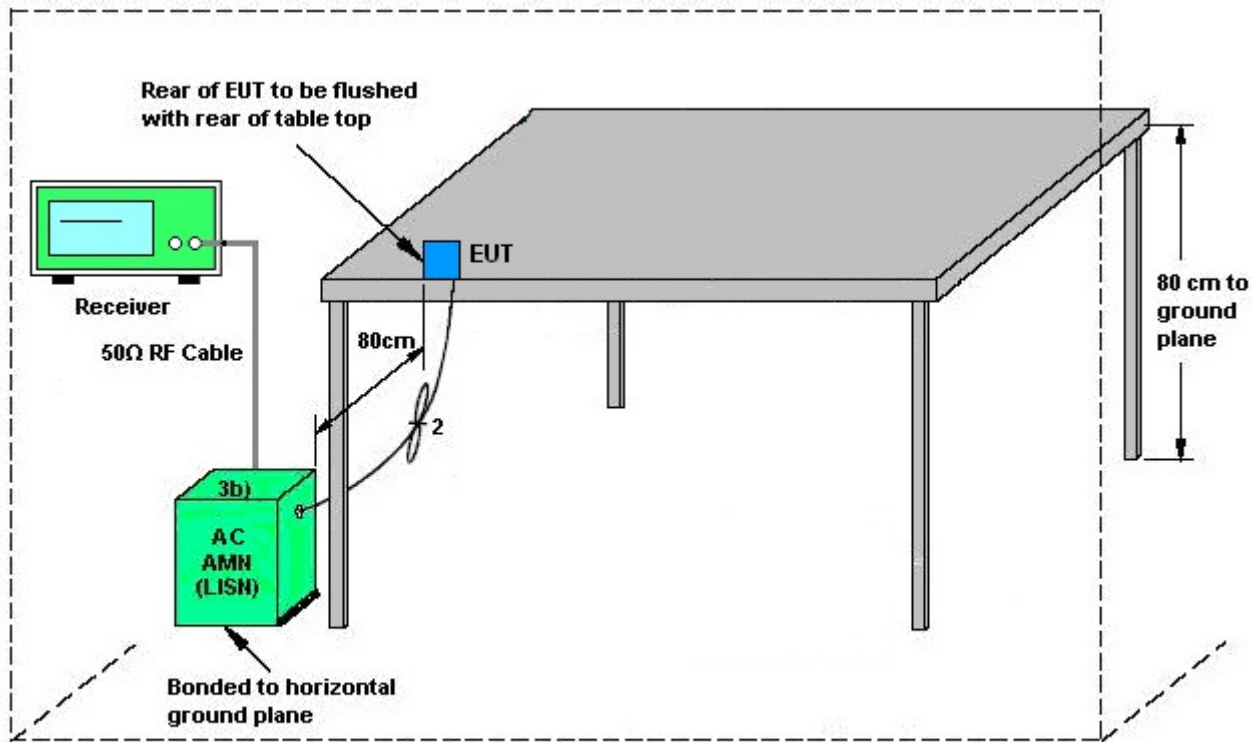

AMN = Artificial mains network (LISH)  
 AE = Associated equipment  
 EUT = Equipment under test  
 ISN = Impedance stabilization network



### 3.5.5 Test Result of AC Conducted Emission

<Original Test Result>

Test Mode :	Mode 1	Temperature :	22~24°C
Test Engineer :	Arthur Hsieh	Relative Humidity :	51~53%
Test Voltage :	120Vac / 60Hz	Phase :	Line
Function Type :	NFC Link + AC Adapter + Charging only Cable + Bluetooth Link + WLAN (5GHz) Link + Earphone 1 with Audio Adaptor connect to EUT		

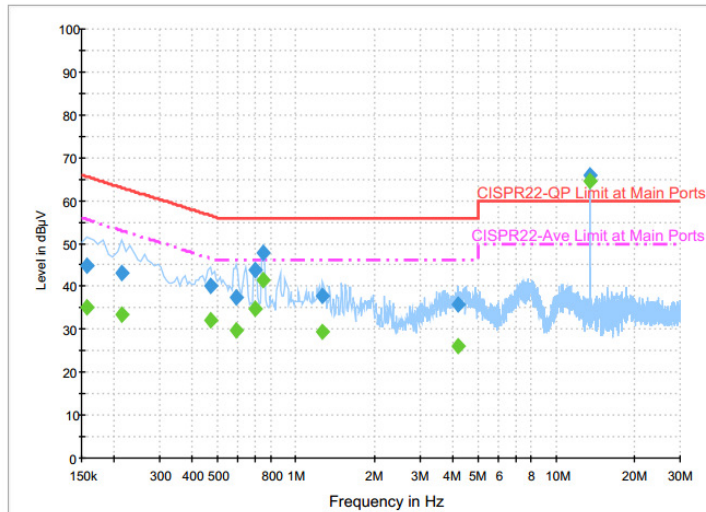

**Final Result : QuasiPeak**

Frequency (MHz)	QuasiPeak (dBµV)	Filter	Line	Corr. (dB)	Margin (dB)	Limit (dBµV)
0.158000	44.7	Off	L1	19.6	20.9	65.6
0.214000	43.3	Off	L1	19.6	19.7	63.0
0.470000	40.1	Off	L1	19.6	16.4	56.5
0.590000	37.5	Off	L1	19.6	18.5	56.0
0.694000	43.8	Off	L1	19.6	12.2	56.0
0.750000	47.9	Off	L1	19.6	8.1	56.0
1.270000	37.8	Off	L1	19.6	18.2	56.0
4.182000	35.7	Off	L1	19.7	20.3	56.0
13.558000	66.0	Off	L1	19.8	-6.0	60.0

**Final Result : Average**

Frequency (MHz)	Average (dBµV)	Filter	Line	Corr. (dB)	Margin (dB)	Limit (dBµV)
0.158000	35.1	Off	L1	19.6	20.5	55.6
0.214000	33.6	Off	L1	19.6	19.4	53.0
0.470000	32.2	Off	L1	19.6	14.3	46.5
0.590000	29.7	Off	L1	19.6	16.3	46.0
0.694000	34.8	Off	L1	19.6	11.2	46.0
0.750000	41.4	Off	L1	19.6	4.6	46.0
1.270000	29.4	Off	L1	19.6	16.6	46.0
4.182000	26.1	Off	L1	19.7	19.9	46.0
13.558000	64.7	Off	L1	19.8	-14.7	50.0





Test Mode :	Mode 1	Temperature :	22~24°C
Test Engineer :	Arthur Hsieh	Relative Humidity :	51~53%
Test Voltage :	120Vac / 60Hz	Phase :	Neutral
Function Type :	NFC Link + AC Adapter + Charging only Cable + Bluetooth Link + WLAN (5GHz) Link + Earphone 1 with Audio Adaptor connect to EUT		

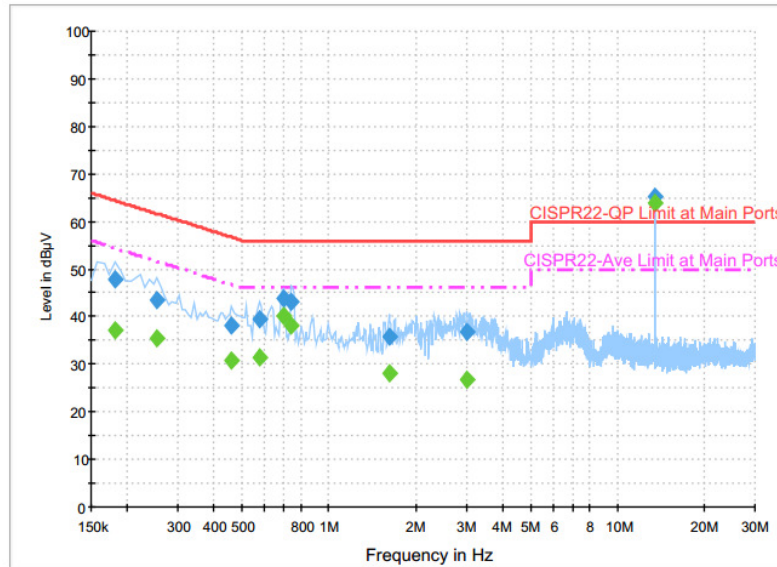

**Final Result : QuasiPeak**

Frequency (MHz)	QuasiPeak (dBµV)	Filter	Line	Corr. (dB)	Margin (dB)	Limit (dBµV)
0.182000	48.0	Off	N	19.6	16.4	64.4
0.254000	43.6	Off	N	19.6	18.0	61.6
0.462000	38.0	Off	N	19.6	18.7	56.7
0.574000	39.4	Off	N	19.6	16.6	56.0
0.694000	43.9	Off	N	19.6	12.1	56.0
0.742000	43.3	Off	N	19.6	12.7	56.0
1.614000	35.9	Off	N	19.6	20.1	56.0
2.998000	36.7	Off	N	19.5	19.3	56.0
13.558000	65.4	Off	N	19.8	-5.4	60.0

**Final Result : Average**

Frequency (MHz)	Average (dBµV)	Filter	Line	Corr. (dB)	Margin (dB)	Limit (dBµV)
0.182000	37.3	Off	N	19.6	17.1	54.4
0.254000	35.5	Off	N	19.6	16.1	51.6
0.462000	30.7	Off	N	19.6	16.0	46.7
0.574000	31.6	Off	N	19.6	14.4	46.0
0.694000	40.0	Off	N	19.6	6.0	46.0
0.742000	38.2	Off	N	19.6	7.8	46.0
1.614000	28.0	Off	N	19.6	18.0	46.0
2.998000	26.9	Off	N	19.5	19.1	46.0
13.558000	64.0	Off	N	19.8	-14.0	50.0



<Terminal Test Result>

Test Mode :	Mode 1	Temperature :	22~24°C
Test Engineer :	Arthur Hsieh	Relative Humidity :	51~53%
Test Voltage :	120Vac / 60Hz	Phase :	Line
Function Type :	NFC Link + AC Adapter + Charging only Cable + Bluetooth Link + WLAN (5GHz) Link + Earphone 1 with Audio Adaptor connect to EUT		

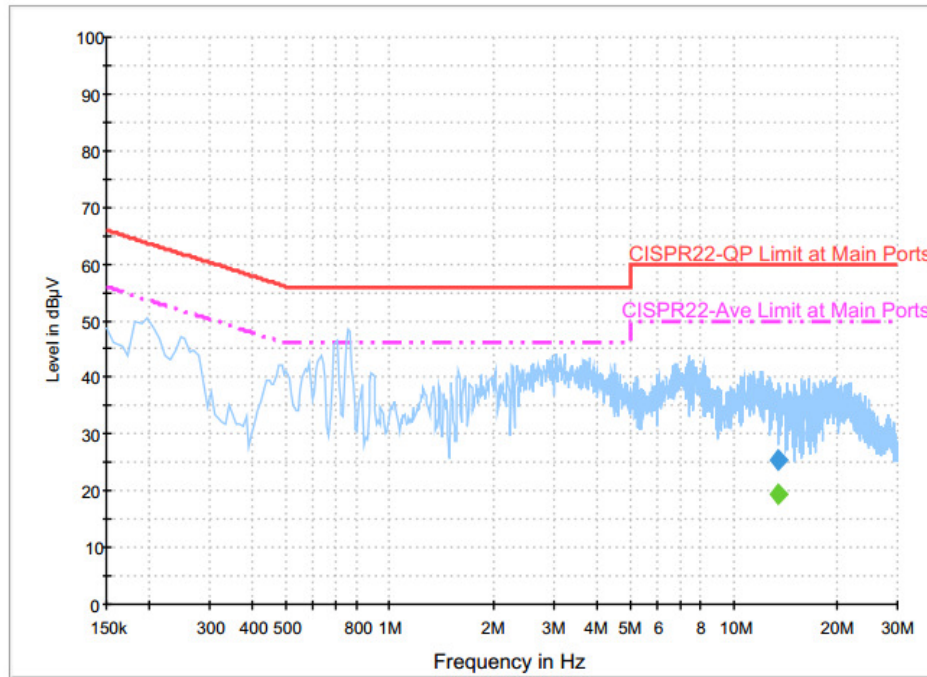

Final Result : QuasiPeak

Frequency (MHz)	QuasiPeak (dBµV)	Filter	Line	Corr. (dB)	Margin (dB)	Limit (dBµV)
13.558000	25.3	Off	L1	19.8	34.7	60.0

Final Result : Average

Frequency (MHz)	Average (dBµV)	Filter	Line	Corr. (dB)	Margin (dB)	Limit (dBµV)
13.558000	19.3	Off	L1	19.8	30.7	50.0



<b>Test Mode :</b>	Mode 1	<b>Temperature :</b>	22~24°C
<b>Test Engineer :</b>	Arthur Hsieh	<b>Relative Humidity :</b>	51~53%
<b>Test Voltage :</b>	120Vac / 60Hz	<b>Phase :</b>	Neutral
<b>Function Type :</b>	NFC Link + AC Adapter + Charging only Cable + Bluetooth Link + WLAN (5GHz) Link + Earphone 1 with Audio Adaptor connect to EUT		

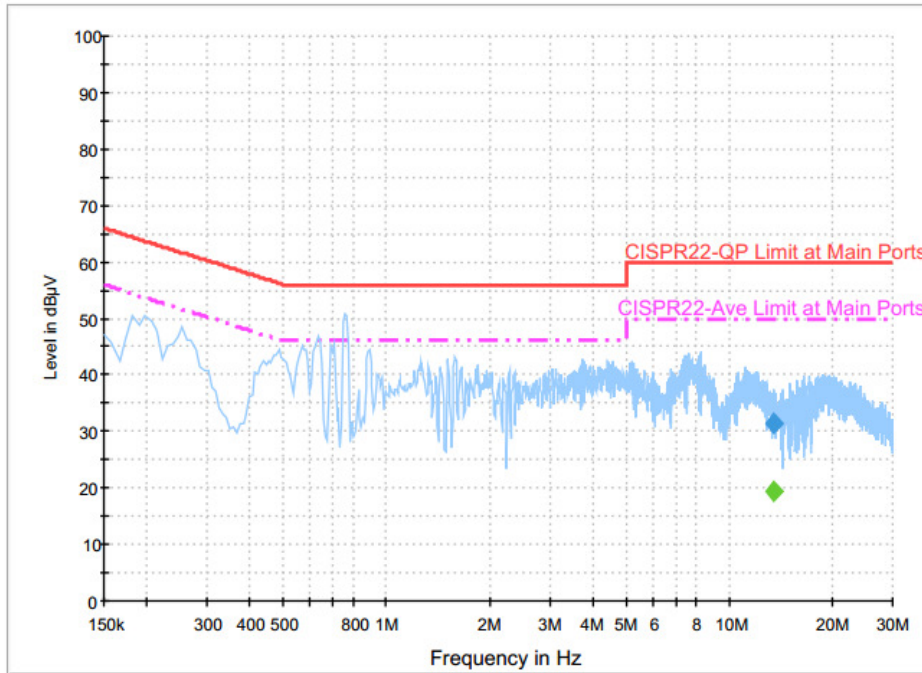

**Final Result : QuasiPeak**

Frequency (MHz)	QuasiPeak (dBµV)	Filter	Line	Corr. (dB)	Margin (dB)	Limit (dBµV)
13.558000	31.4	Off	N	19.8	28.6	60.0

**Final Result : Average**

Frequency (MHz)	Average (dBµV)	Filter	Line	Corr. (dB)	Margin (dB)	Limit (dBµV)
13.558000	19.5	Off	N	19.8	30.5	50.0



<Original Test Result>

Test Mode :	Mode 2	Temperature :	22~24°C
Test Engineer :	Arthur Hsieh	Relative Humidity :	51~53%
Test Voltage :	120Vac / 60Hz	Phase :	Line
Function Type :	NFC Link + AC Adapter + Snap on USB Cable Data Link with Notebook + WLAN (5GHz) Link + Bluetooth Link with Earphone 3 + Copy data from Notebook to EDA (SD Card)		

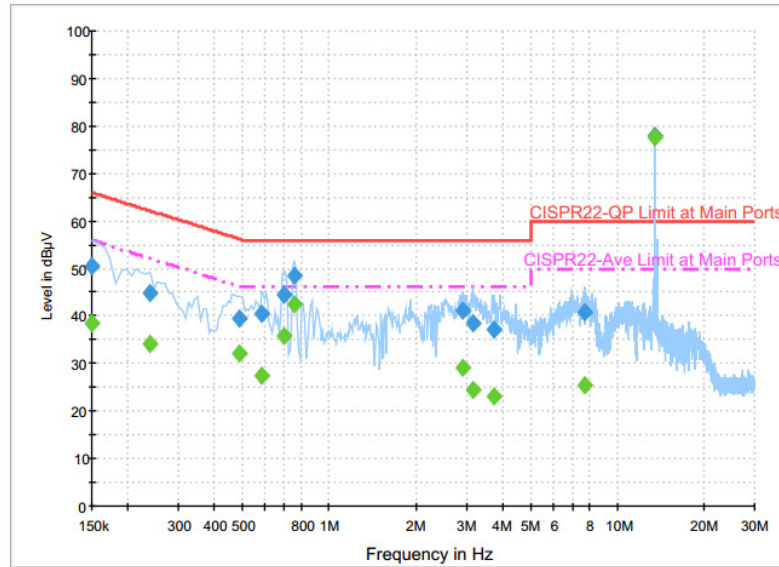

Final Result : QuasiPeak

Frequency (MHz)	QuasiPeak (dBµV)	Filter	Line	Corr. (dB)	Margin (dB)	Limit (dBµV)
0.150000	50.5	Off	L1	19.6	15.5	66.0
0.238000	44.8	Off	L1	19.6	17.4	62.2
0.486000	39.4	Off	L1	19.6	16.8	56.2
0.582000	40.6	Off	L1	19.6	15.4	56.0
0.694000	44.5	Off	L1	19.6	11.5	56.0
0.758000	48.6	Off	L1	19.6	7.4	56.0
2.902000	41.3	Off	L1	19.5	14.7	56.0
3.150000	38.3	Off	L1	19.6	17.7	56.0
3.750000	37.0	Off	L1	19.7	19.0	56.0
7.678000	40.9	Off	L1	19.7	19.1	60.0
13.558000	78.0	Off	L1	19.8	-18.0	60.0



Test Mode :	Mode 2	Temperature :	22~24°C
Test Engineer :	Arthur Hsieh	Relative Humidity :	51~53%
Test Voltage :	120Vac / 60Hz	Phase :	Line
Function Type :	NFC Link + AC Adapter + Snap on USB Cable Data Link with Notebook + WLAN (5GHz) Link + Bluetooth Link with Earphone 3 + Copy data from Notebook to EDA (SD Card)		

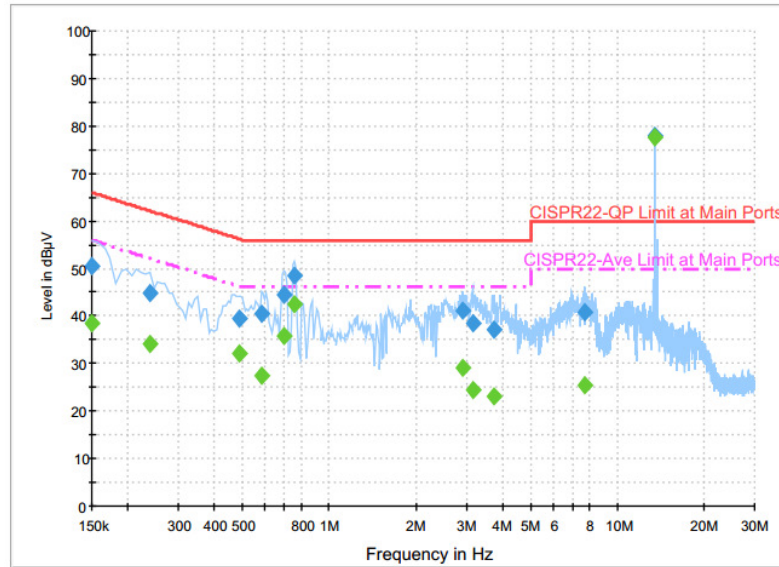

**Final Result : Average**

Frequency (MHz)	Average (dBµV)	Filter	Line	Corr. (dB)	Margin (dB)	Limit (dBµV)
0.150000	38.4	Off	L1	19.6	17.6	56.0
0.238000	34.1	Off	L1	19.6	18.1	52.2
0.486000	32.0	Off	L1	19.6	14.2	46.2
0.582000	27.5	Off	L1	19.6	18.5	46.0
0.694000	35.8	Off	L1	19.6	10.2	46.0
0.758000	42.6	Off	L1	19.6	3.4	46.0
2.902000	29.1	Off	L1	19.5	16.9	46.0
3.150000	24.4	Off	L1	19.6	21.6	46.0
3.750000	23.1	Off	L1	19.7	22.9	46.0
7.678000	25.4	Off	L1	19.7	24.6	50.0
13.558000	77.7	Off	L1	19.8	-27.7	50.0



Test Mode :	Mode 2	Temperature :	22~24°C
Test Engineer :	Arthur Hsieh	Relative Humidity :	51~53%
Test Voltage :	120Vac / 60Hz	Phase :	Neutral
Function Type :	NFC Link + AC Adapter + Snap on USB Cable Data Link with Notebook + WLAN (5GHz) Link + Bluetooth Link with Earphone 3 + Copy data from Notebook to EDA (SD Card)		

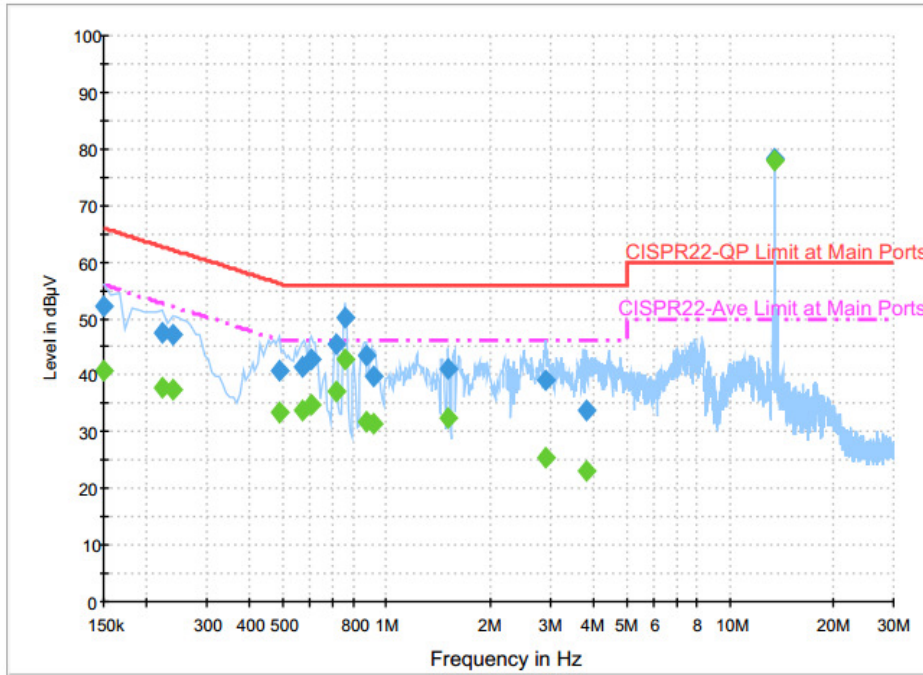

Final Result : QuasiPeak

Frequency (MHz)	QuasiPeak (dBµV)	Filter	Line	Corr. (dB)	Margin (dB)	Limit (dBµV)
0.150000	52.2	Off	N	19.6	13.8	66.0
0.222000	47.5	Off	N	19.6	15.2	62.7
0.238000	47.2	Off	N	19.6	15.0	62.2
0.486000	40.7	Off	N	19.6	15.5	56.2
0.566000	41.3	Off	N	19.6	14.7	56.0
0.606000	42.9	Off	N	19.6	13.1	56.0
0.710000	45.6	Off	N	19.6	10.4	56.0
0.758000	50.3	Off	N	19.6	5.7	56.0
0.870000	43.6	Off	N	19.6	12.4	56.0
0.918000	39.8	Off	N	19.6	16.2	56.0
1.510000	41.3	Off	N	19.6	14.7	56.0
2.910000	39.0	Off	N	19.5	17.0	56.0
3.838000	33.6	Off	N	19.6	22.4	56.0
13.558000	78.2	Off	N	19.8	-18.2	60.0



Test Mode :	Mode 2	Temperature :	22~24°C
Test Engineer :	Arthur Hsieh	Relative Humidity :	51~53%
Test Voltage :	120Vac / 60Hz	Phase :	Neutral
Function Type :	NFC Link + AC Adapter + Snap on USB Cable Data Link with Notebook + WLAN (5GHz) Link + Bluetooth Link with Earphone 3 + Copy data from Notebook to EDA (SD Card)		

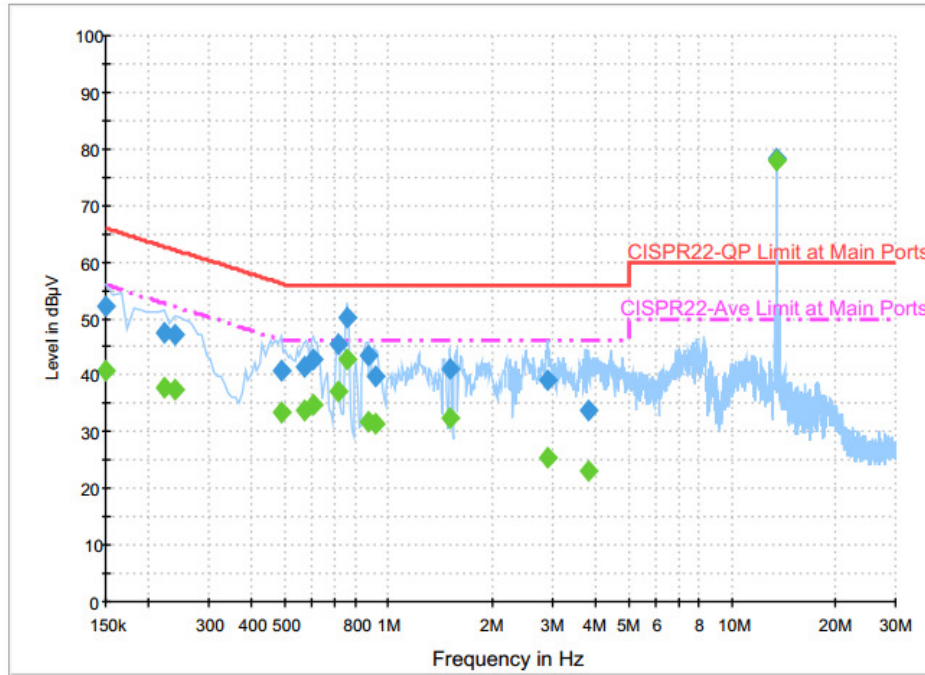

**Final Result : Average**

Frequency (MHz)	Average (dBµV)	Filter	Line	Corr. (dB)	Margin (dB)	Limit (dBµV)
0.150000	40.8	Off	N	19.6	15.2	56.0
0.222000	37.8	Off	N	19.6	14.9	52.7
0.238000	37.4	Off	N	19.6	14.8	52.2
0.486000	33.3	Off	N	19.6	12.9	46.2
0.566000	33.7	Off	N	19.6	12.3	46.0
0.606000	34.7	Off	N	19.6	11.3	46.0
0.710000	37.1	Off	N	19.6	8.9	46.0
0.758000	42.8	Off	N	19.6	3.2	46.0
0.870000	31.7	Off	N	19.6	14.3	46.0
0.918000	31.4	Off	N	19.6	14.6	46.0
1.510000	32.3	Off	N	19.6	13.7	46.0
2.910000	25.3	Off	N	19.5	20.7	46.0
3.838000	23.0	Off	N	19.6	23.0	46.0
13.558000	78.0	Off	N	19.8	-28.0	50.0



<Terminal Test Result>

Test Mode :	Mode 2	Temperature :	22~24°C
Test Engineer :	Arthur Hsieh	Relative Humidity :	51~53%
Test Voltage :	120Vac / 60Hz	Phase :	Line
Function Type :	NFC Link + AC Adapter + Snap on USB Cable Data Link with Notebook + WLAN (5GHz) Link + Bluetooth Link with Earphone 3 + Copy data from Notebook to EDA (SD Card)		

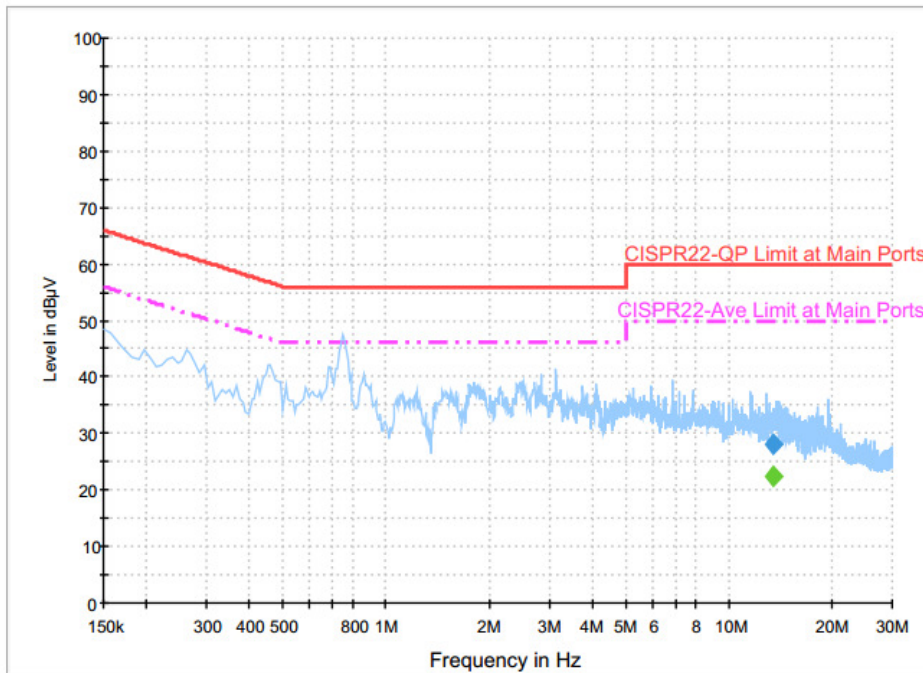

Final Result : QuasiPeak

Frequency (MHz)	QuasiPeak (dBµV)	Filter	Line	Corr. (dB)	Margin (dB)	Limit (dBµV)
13.558000	28.2	Off	L1	19.8	31.8	60.0

Final Result : Average

Frequency (MHz)	Average (dBµV)	Filter	Line	Corr. (dB)	Margin (dB)	Limit (dBµV)
13.558000	22.5	Off	L1	19.8	27.5	50.0





<b>Test Mode :</b>	Mode 2	<b>Temperature :</b>	22~24°C
<b>Test Engineer :</b>	Arthur Hsieh	<b>Relative Humidity :</b>	51~53%
<b>Test Voltage :</b>	120Vac / 60Hz	<b>Phase :</b>	Neutral
<b>Function Type :</b>	NFC Link + AC Adapter + Snap on USB Cable Data Link with Notebook + WLAN (5GHz) Link + Bluetooth Link with Earphone 3 + Copy data from Notebook to EDA (SD Card)		

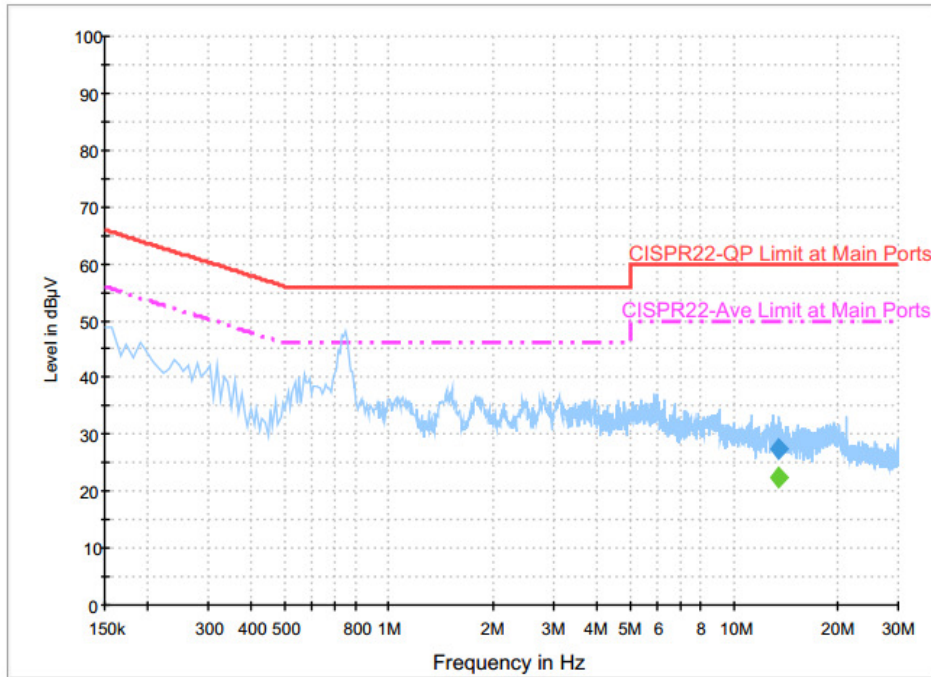

**Final Result : QuasiPeak**

Frequency (MHz)	QuasiPeak (dBµV)	Filter	Line	Corr. (dB)	Margin (dB)	Limit (dBµV)
13.558000	27.4	Off	N	19.8	32.6	60.0

**Final Result : Average**

Frequency (MHz)	Average (dBµV)	Filter	Line	Corr. (dB)	Margin (dB)	Limit (dBµV)
13.558000	22.4	Off	N	19.8	27.6	50.0



<Original Test Result>

Test Mode :	Mode 3	Temperature :	22~24°C
Test Engineer :	Arthur Hsieh	Relative Humidity :	51~53%
Test Voltage :	120Vac / 60Hz	Phase :	Line
Function Type :	NFC Link + AC Adapter + Charging only Cable + Bluetooth Link + WLAN (5GHz) Link + Earphone 2 with Audio Adapter connect to EUT		

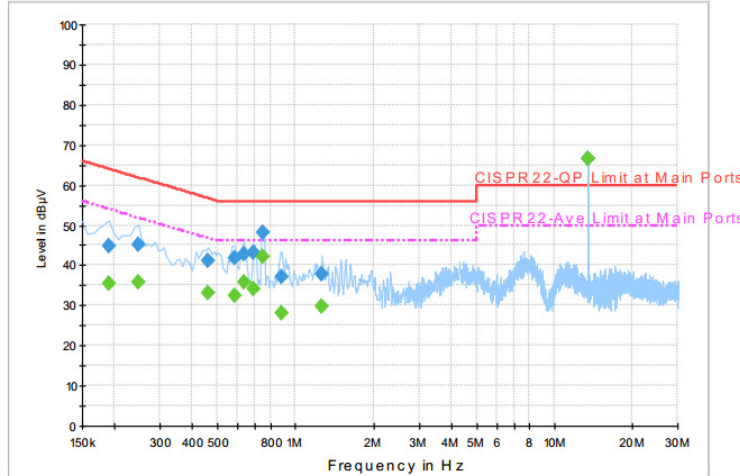

Final Result : QuasiPeak

Frequency (MHz)	QuasiPeak (dBµV)	Filter	Line	Corr. (dB)	Margin (dB)	Limit (dBµV)
0.190000	44.9	Off	L1	19.6	19.1	64.0
0.246000	45.1	Off	L1	19.6	16.8	61.9
0.462000	41.0	Off	L1	19.6	15.7	56.7
0.582000	42.0	Off	L1	19.6	14.0	56.0
0.630000	42.7	Off	L1	19.6	13.3	56.0
0.686000	43.2	Off	L1	19.6	12.8	56.0
0.750000	48.1	Off	L1	19.6	7.9	56.0
0.886000	37.3	Off	L1	19.6	18.7	56.0
1.270000	37.7	Off	L1	19.6	18.3	56.0
13.558000	66.7	Off	L1	19.8	-6.7	60.0

Final Result : Average

Frequency (MHz)	Average (dBµV)	Filter	Line	Corr. (dB)	Margin (dB)	Limit (dBµV)
0.190000	35.5	Off	L1	19.6	18.5	54.0
0.246000	35.8	Off	L1	19.6	16.1	51.9
0.462000	33.2	Off	L1	19.6	13.5	46.7
0.582000	32.4	Off	L1	19.6	13.6	46.0
0.630000	35.9	Off	L1	19.6	10.1	46.0
0.686000	34.3	Off	L1	19.6	11.7	46.0
0.750000	42.2	Off	L1	19.6	3.8	46.0
0.886000	28.1	Off	L1	19.6	17.9	46.0
1.270000	29.7	Off	L1	19.6	16.3	46.0
13.558000	66.7	Off	L1	19.8	-16.7	50.0



<b>Test Mode :</b>	Mode 3	<b>Temperature :</b>	22~24°C
<b>Test Engineer :</b>	Arthur Hsieh	<b>Relative Humidity :</b>	51~53%
<b>Test Voltage :</b>	120Vac / 60Hz	<b>Phase :</b>	Neutral
<b>Function Type :</b>	NFC Link + AC Adapter + Charging only Cable + Bluetooth Link + WLAN (5GHz) Link + Earphone 2 with Audio Adapter connect to EUT		

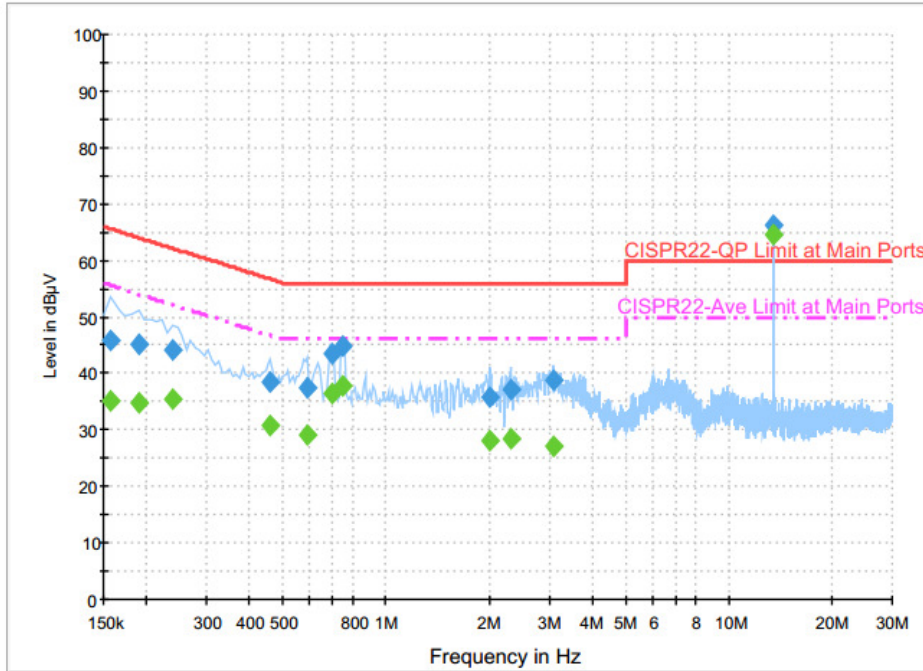

**Final Result : QuasiPeak**

Frequency (MHz)	QuasiPeak (dBµV)	Filter	Line	Corr. (dB)	Margin (dB)	Limit (dBµV)
0.158000	45.8	Off	N	19.6	19.8	65.6
0.190000	45.3	Off	N	19.6	18.7	64.0
0.238000	44.2	Off	N	19.6	18.0	62.2
0.462000	38.4	Off	N	19.6	18.3	56.7
0.590000	37.4	Off	N	19.6	18.6	56.0
0.694000	43.6	Off	N	19.6	12.4	56.0
0.750000	44.8	Off	N	19.6	11.2	56.0
2.014000	35.6	Off	N	19.6	20.4	56.0
2.318000	37.1	Off	N	18.6	18.9	56.0
3.078000	38.9	Off	N	19.5	17.1	56.0
13.558000	66.1	Off	N	19.8	-6.1	60.0



Test Mode :	Mode 3	Temperature :	22~24°C
Test Engineer :	Arthur Hsieh	Relative Humidity :	51~53%
Test Voltage :	120Vac / 60Hz	Phase :	Neutral
Function Type :	NFC Link + AC Adapter + Charging only Cable + Bluetooth Link + WLAN (5GHz) Link + Earphone 2 with Audio Adapter connect to EUT		

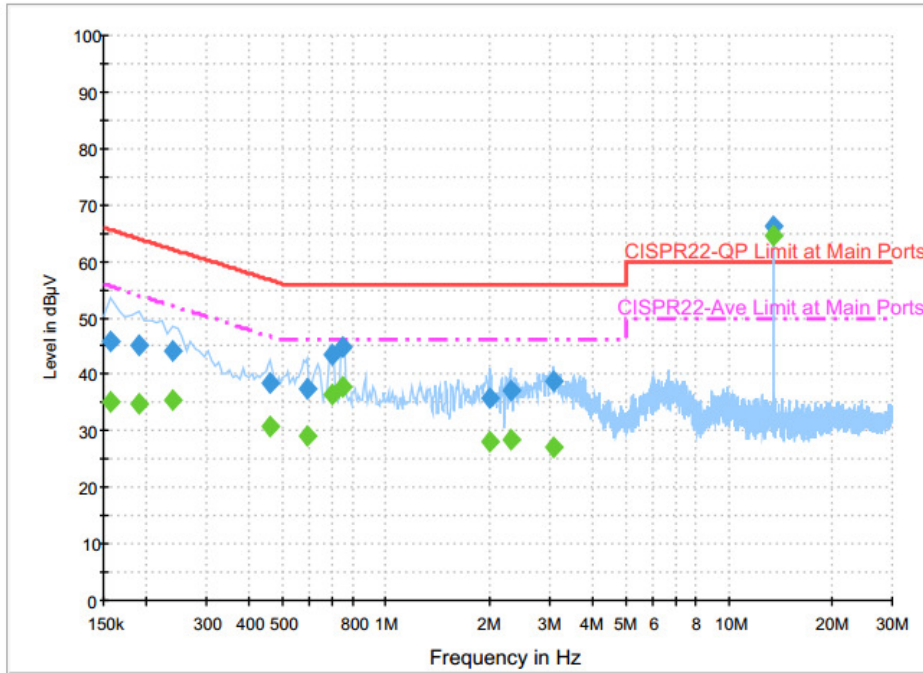

Final Result : Average

Frequency (MHz)	Average (dBµV)	Filter	Line	Corr. (dB)	Margin (dB)	Limit (dBµV)
0.158000	35.2	Off	N	19.6	20.4	55.6
0.190000	34.8	Off	N	19.6	19.2	54.0
0.238000	35.6	Off	N	19.6	16.6	52.2
0.462000	30.8	Off	N	19.6	15.9	46.7
0.590000	29.2	Off	N	19.6	16.8	46.0
0.694000	36.5	Off	N	19.6	9.5	46.0
0.750000	37.8	Off	N	19.6	8.2	46.0
2.014000	28.0	Off	N	19.6	18.0	46.0
2.318000	28.4	Off	N	18.6	17.6	46.0
3.078000	27.2	Off	N	19.5	18.8	46.0
13.558000	64.7	Off	N	19.8	-14.7	50.0



<Terminal Test Result>

Test Mode :	Mode 3	Temperature :	22~24°C
Test Engineer :	Arthur Hsieh	Relative Humidity :	51~53%
Test Voltage :	120Vac / 60Hz	Phase :	Line
Function Type :	NFC Link + AC Adapter + Charging only Cable + Bluetooth Link + WLAN (5GHz) Link + Earphone 2 with Audio Adapter connect to EUT		

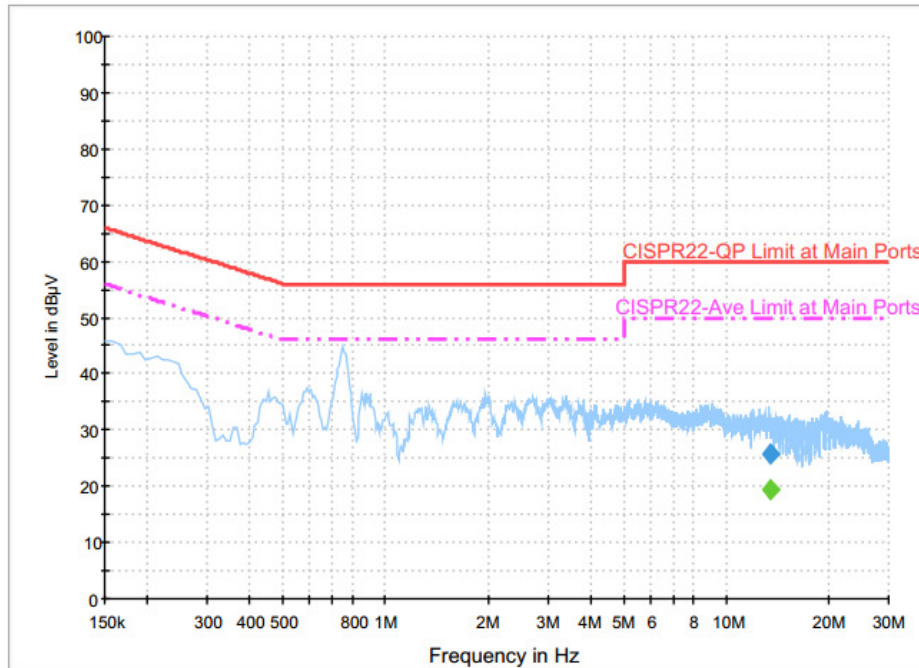

Final Result : QuasiPeak

Frequency (MHz)	QuasiPeak (dBµV)	Filter	Line	Corr. (dB)	Margin (dB)	Limit (dBµV)
13.558000	25.8	Off	L1	19.8	34.2	60.0

Final Result : Average

Frequency (MHz)	Average (dBµV)	Filter	Line	Corr. (dB)	Margin (dB)	Limit (dBµV)
13.558000	19.5	Off	L1	19.8	30.5	50.0



<b>Test Mode :</b>	Mode 3	<b>Temperature :</b>	22~24°C
<b>Test Engineer :</b>	Arthur Hsieh	<b>Relative Humidity :</b>	51~53%
<b>Test Voltage :</b>	120Vac / 60Hz	<b>Phase :</b>	Neutral
<b>Function Type :</b>	NFC Link + AC Adapter + Charging only Cable + Bluetooth Link + WLAN (5GHz) Link + Earphone 2 with Audio Adapter connect to EUT		

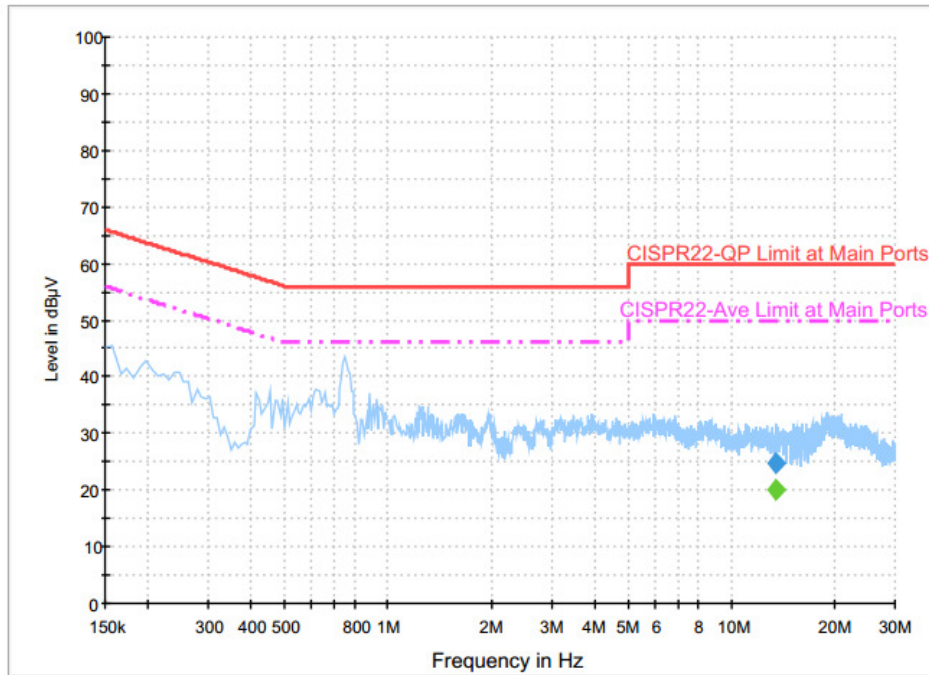

**Final Result : QuasiPeak**

Frequency (MHz)	QuasiPeak (dBµV)	Filter	Line	Corr. (dB)	Margin (dB)	Limit (dBµV)
13.558000	24.7	Off	N	19.8	35.3	60.0

**Final Result : Average**

Frequency (MHz)	Average (dBµV)	Filter	Line	Corr. (dB)	Margin (dB)	Limit (dBµV)
13.558000	19.9	Off	N	19.8	30.1	50.0

## 3.6 Frequency Stability Measurement

### 3.6.1 Limit of Frequency Stability

Manufacturers of U-NII devices are responsible for ensuring frequency stability such that an emission is maintained within the band of operation under all conditions of normal operation as specified in the user's manual.

### 3.6.2 Measuring Instruments

The measuring equipment is listed in the section 4 of this test report.

### 3.6.3 Test Procedures

1. To ensure emission at the band edge is maintained within the authorized band, those values shall be measured by radiation emissions at upper and lower frequency points, and finally compensated by frequency deviation as procedures below.
2. The EUT was operated at the maximum output power, and connected to the spectrum analyzer, which is set to maximum hold function and peak detector. The peak value of the power envelope was measured and noted. The upper and lower frequency points were respectively measured relatively 10dB lower than the measured peak value.
3. The frequency deviation was calculated by adding the upper frequency point and the lower frequency point divided by two. Those detailed values of frequency deviation are provided in table below.

### 3.6.4 Test Setup

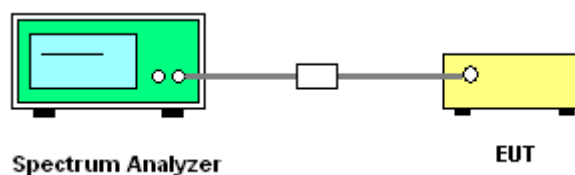

### 3.6.5 Test Result of Frequency Stability

Please refer to Appendix A.



## **3.7 Automatically Discontinue Transmission**

### **3.7.1 Limit of Automatically Discontinue Transmission**

The device shall automatically discontinue transmission in case of either absence of information to transmit or operational failure. These provisions are not intended to preclude the transmission of control or signaling information or the use of repetitive codes used by certain digital technologies to complete frame or burst intervals. Applicants shall include in their application for equipment authorization to describe how this requirement is met.

### **3.7.2 Measuring Instruments**

The measuring equipment is listed in the section 4 of this test report.

### **3.7.3 Test Result of Automatically Discontinue Transmission**

While the EUT is not transmitting any information, the EUT can automatically discontinue transmission and become standby mode for power saving. The EUT can detect the controlling signal of ACK message transmitting from remote device and verify whether it shall resend or discontinue transmission.





### 3.8 Antenna Requirements

#### 3.8.1 Standard Applicable

According to FCC 47 CFR Section 15.407(a)(1)(2) ,if transmitting antenna directional gain is greater than 6 dBi, both the peak transmit power and the peak power spectral density shall be reduced by the amount in dB that the directional gain of the antenna exceeds 6 dBi.

#### 3.8.2 Antenna Anti-Replacement Construction

An embedded-in antenna design is used.

#### 3.8.3 Antenna Gain

##### CDD modes

FCC KDB 662911 D01 Multiple Transmitter Output v02r01

For CDD transmissions, directional gain is calculated as

Directional gain =  $G_{ANT} + \text{Array Gain}$ , where Array Gain is as follows.

For power spectral density (PSD) measurements on all devices,

Array Gain =  $10 \log(N_{ANT}/N_{SS}=1)$  dB.

For power measurements on IEEE 802.11 devices,

Array Gain = 0 dB (i.e., no array gain) for  $N_{ANT} \leq 4$ .

Directional gain may be calculated by using the formulas applicable to equal gain antennas with  $G_{ANT}$  set equal to the gain of the antenna having the highest gain;

The EUT supports CDD mode.

For power, the directional gain  $G_{ANT}$  is set equal to the antenna having the highest gain, i.e., F)2)f)i).

For PSD, the directional gain calculation is following F)2)f)ii) of KDB 662911 D01 v02r01.

The power and PSD limit should be modified if the directional gain of EUT is over 6 dBi,

The directional gain "DG" is calculated as following table.

			DG for Power (dBi)	DG for PSD (dBi)	Power Limit Reduction (dB)	PSD Limit Reduction (dB)
	Ant 1 (dBi)	Ant 2 (dBi)				
Band IV	3.90	3.80	3.90	6.86	0.00	0.86

*Power limit reduction = Composite gain – 6dBi, ( min = 0 )*

*PSD limit reduction = Composite gain + PSD Array gain – 6dBi, ( min = 0 )*



**TXBF modes**

FCC KDB 662911 D01 Multiple Transmitter Output v02r01

For CDD transmissions, directional gain is calculated as

$$DirectionalGain = 10 \cdot \log \left[ \frac{\sum_{j=1}^{N_{SS}} \left\{ \sum_{k=1}^{N_{ANT}} g_{j,k} \right\}^2}{N_{ANT}} \right]$$

where

Each antenna is driven by no more than one spatial stream;

$N_{SS}$  = the number of independent spatial streams of data;

$N_{ANT}$  = the total number of antennas

$g_{j,k} = 10^{G_k / 20}$  if the  $k$ th antenna is being fed by spatial stream  $j$ , or zero if it is not;  
 $G_k$  is the gain in dBi of the  $k$ th antenna.

The EUT supports beamforming for 802.11ac modes.

The directional gain calculation is following F)2)e)ii) of KDB 662911 D01 v02r01.

The power and PSD limit should be modified if the directional gain of EUT is over 6 dBi,

The directional gain “DG” is calculated as following table.

			DG	DG	Power	PSD
			for	for	Limit	Limit
	Ant 1	Ant 2	Power	PSD	Reduction	Reduction
	(dBi)	(dBi)	(dBi)	(dBi)	(dB)	(dB)
Band IV	3.90	3.80	6.86	6.86	0.86	0.86

Power Limit Reduction = DG(Power) – 6dBi, ( min = 0 )

PSD Limit Reduction = DG(PSD) – 6dBi, ( min = 0 )



## 4 List of Measuring Equipment

Instrument	Manufacturer	Model No.	Serial No.	Characteristics	Calibration Date	Test Date	Due Date	Remark
Power Meter	Anritsu	ML2495A	1132003	300MHz~40GHz	Aug. 04, 2016	Aug. 18, 2016 ~ Sep. 16, 2016	Aug. 03, 2017	Conducted (TH05-HY)
Power Sensor	Anritsu	MA2411B	1126017	300MHz~40GHz	Aug. 04, 2016	Aug. 18, 2016 ~ Sep. 16, 2016	Aug. 03, 2017	Conducted (TH05-HY)
Spectrum Analyzer	Rohde & Schwarz	FSP40	100057	9kHz-40GHz	Nov. 23, 2015	Aug. 18, 2016 ~ Sep. 16, 2016	Nov. 22, 2016	Conducted (TH05-HY)
Temperature Chamber	ESPEC	SU-241	92003713	-30℃ ~95℃	Jun. 06, 2016	Aug. 18, 2016 ~ Sep. 16, 2016	Jun. 05, 2017	Conducted (TH05-HY)
Power Sensor	DARE	RadiPower	15I00041SN O09	10MHz~6GHz	May. 03, 2016	Sep. 10, 2016 ~ Sep. 16, 2016	May. 02, 2017	Conducted (TH05-HY)
Power Sensor	DARE	RadiPower	15I00041SN O10	10MHz~6GHz	May. 03, 2016	Sep. 10, 2016 ~ Sep. 16, 2016	May. 02, 2017	Conducted (TH05-HY)
Temperature Chamber	ESPEC	SH-641	92013720	-40℃ ~90℃	Sep. 01, 2016	Sep. 10, 2016 ~ Sep. 16, 2016	Aug. 31, 2017	Conducted (TH05-HY)
Programmable Power Supply	GW Instek	PSS-2005	EL890094	1V~20V 0.5A~5A	Oct. 12, 2015	Sep. 10, 2016 ~ Sep. 16, 2016	Oct. 11, 2016	Conducted (TH05-HY)
AC Power Source	ChainTek	APC-1000W	N/A	N/A	N/A	Sep. 06, 2016 ~ Sep. 20, 2016	N/A	Conduction (CO05-HY)
EMI Test Receiver	Rohde & Schwarz	ESCI 7	100724	9kHz~7GHz	Aug. 30, 2016	Sep. 06, 2016 ~ Sep. 20, 2016	Aug. 29, 2017	Conduction (CO05-HY)
Pulse Limiter	Rohde & Schwarz	ESH3-Z2	100851	N/A	Jan. 08, 2016	Sep. 06, 2016 ~ Sep. 20, 2016	Jan. 07, 2017	Conduction (CO05-HY)
Bilog Antenna	TESEQ	CBL 6111D	35419	30MHz to 1GHz	Jan. 13, 2016	Aug. 23, 2016 ~ Sep. 09, 2016	Jan. 12, 2017	Radiation (03CH07-HY)
Double Ridge Horn Antenna	ESCO	3117	00075962	1GHz ~ 18GHz	Aug. 19, 2016	Aug. 23, 2016 ~ Sep. 09, 2016	Aug. 18, 2017	Radiation (03CH07-HY)
EMI Test Receiver	Keysight	N9038A(MXE)	MY54130085	20Hz ~ 8.4GHz	Nov. 04, 2015	Aug. 23, 2016 ~ Sep. 09, 2016	Nov. 03, 2016	Radiation (03CH07-HY)
Loop Antenna	Rohde & Schwarz	HFH2-Z2	100315	9 kHz~30 MHz	Sep. 02, 2015	Aug. 23, 2016 ~ Sep. 09, 2016	Sep. 01, 2017	Radiation (03CH07-HY)
Preamplifier	MITEQ	AMF-7D-0010 1800-30-10P	1590075	1GHz ~ 18GHz	Apr. 15, 2016	Aug. 23, 2016 ~ Sep. 09, 2016	Apr. 14, 2017	Radiation (03CH07-HY)
Preamplifier	COM-POWER	PA-103A	161241	10MHz-1GHz	Mar. 18, 2016	Aug. 23, 2016 ~ Sep. 09, 2016	Mar. 17, 2017	Radiation (03CH07-HY)
Preamplifier	Agilent	8449B	3008A02362	1GHz~ 26.5GHz	Oct. 19, 2015	Aug. 23, 2016 ~ Sep. 09, 2016	Oct. 18, 2016	Radiation (03CH07-HY)
Spectrum Analyzer	Agilent	N9010A	MY53470118	10Hz~44GHz	Feb. 27, 2016	Aug. 23, 2016 ~ Sep. 09, 2016	Feb. 26, 2017	Radiation (03CH07-HY)



Instrument	Manufacturer	Model No.	Serial No.	Characteristics	Calibration Date	Test Date	Due Date	Remark
Antenna Mast	Max-Full	MFA520BS	N/A	1m~4m	N/A	Aug. 23, 2016 ~ Sep. 09, 2016	N/A	Radiation (03CH07-HY)
Turn Table	ChainTek	Chaintek 3000	N/A	0~360 Degree	N/A	Aug. 23, 2016 ~ Sep. 09, 2016	N/A	Radiation (03CH07-HY)
Loop Cable	Rohde & Schwarz	N/A	N/A	9KHz~30MHz	Dec. 03, 2015	Aug. 23, 2016 ~ Sep. 09, 2016	Dec. 02, 2016	Radiation (03CH07-HY)
Preamplifier	MITEQ	JS44-1800400 0-33-8P	1840917	18GHz ~ 40GHz	Jun. 14, 2016	Aug. 23, 2016 ~ Sep. 09, 2016	Jun. 13, 2017	Radiation (03CH07-HY)
SHF-EHF Horn Antenna	SCHWARZBE CK	BBHA 9170	BBHA917058 4	18GHz- 40GHz	Nov. 02, 2015	Aug. 23, 2016 ~ Sep. 09, 2016	Nov. 01, 2016	Radiation (03CH07-HY)



## 5 Uncertainty of Evaluation

### Uncertainty of Conducted Emission Measurement (150kHz ~ 30MHz)

Measuring Uncertainty for a Level of Confidence of 95% ( $U = 2Uc(y)$ )	2.70
---	------

### Uncertainty of Radiated Emission Measurement (30 MHz ~ 1000 MHz)

Measuring Uncertainty for a Level of Confidence of 95% ( $U = 2Uc(y)$ )	5.70
---	------

### Uncertainty of Radiated Emission Measurement (1000 MHz ~ 18 GHz)

Measuring Uncertainty for a Level of Confidence of 95% ( $U = 2Uc(y)$ )	5.50
---	------

### Uncertainty of Radiated Emission Measurement (18 GHz ~ 40 GHz)

Measuring Uncertainty for a Level of Confidence of 95% ( $U = 2Uc(y)$ )	5.20
---	------



## **Appendix A. Conducted Test Results**

**<CDD Modes>**

Test Engineer:	Tommy Lee / Luffy Lin / Kai Liao	Temperature:	21~25	°C
Test Date:	2016/8/18 ~ 2016/09/18	Relative Humidity:	51~54	%

**TEST RESULTS DATA**  
**6dB and 26dB EBW and 99% OBW**

Band IV													
Mod.	Data Rate	NTX	CH.	Freq. (MHz)	99% Bandwidth (MHz)		26dB Bandwidth (MHz)		6 dB Bandwidth (MHz)		6 dB Bandwidth Min. Limit (MHz)		Pass/Fail
					Ant 1	Ant 2	Ant 1	Ant 2	Ant 1	Ant 2	Ant 1	Ant 2	
11a	6Mbps	1	149	5745	18.60	18.90	27.52	37.93	16.32	16.32	0.5	0.5	Pass
11a	6Mbps	1	157	5785	18.75	19.05	36.38	39.60	16.32	16.32	0.5	0.5	Pass
11a	6Mbps	1	165	5825	18.80	19.55	35.44	38.80	16.32	16.28	0.5	0.5	Pass
11a	6Mbps	2	149	5745	18.90	19.35	35.40	39.60	16.32	16.32	0.5	0.5	Pass
11a	6Mbps	2	157	5785	19.10	20.85	39.12	42.00	16.32	16.32	0.5	0.5	Pass
11a	6Mbps	2	165	5825	19.05	19.65	37.36	41.16	16.30	16.32	0.5	0.5	Pass
VHT20	MCS0	2	149	5745	19.50	19.75	34.72	42.77	17.56	17.56	0.5	0.5	Pass
VHT20	MCS0	2	157	5785	19.10	19.75	38.24	43.36	17.56	17.60	0.5	0.5	Pass
VHT20	MCS0	2	165	5825	19.50	20.30	37.92	46.69	17.56	17.60	0.5	0.5	Pass
VHT40	MCS0	2	151	5755	36.80	37.40	66.40	94.78	36.32	36.32	0.5	0.5	Pass
VHT40	MCS0	2	159	5795	37.00	38.80	73.60	91.20	36.32	36.32	0.5	0.5	Pass
VHT80	MCS0	2	155	5775	76.08	76.08	82.32	#####	75.44	75.20	0.5	0.5	Pass



**TEST RESULTS DATA**  
**Average Power Table**

Band IV														
Mod.	Data Rate	NTX	CH.	Freq. (MHz)	Duty Factor (dB)		Average Conducted Power (dBm)			FCC Conducted Power Limit (dBm)		DG (dBi)		Pass/Fail
					Ant 1	Ant 2	Ant 1	Ant 2	SUM	Ant 1	Ant 2	Ant 1	Ant 2	
11a	6Mbps	1	149	5745	0.32	0.32	15.84	17.53		30.00	30.00	3.90	3.80	Pass
11a	6Mbps	1	157	5785	0.32	0.32	15.93	17.60		30.00	30.00	3.90	3.80	Pass
11a	6Mbps	1	165	5825	0.32	0.32	15.88	17.57		30.00	30.00	3.90	3.80	Pass
HT20	MCS0	1	149	5745	0.32	0.32	15.82	17.53		30.00	30.00	3.90	3.80	Pass
HT20	MCS0	1	157	5785	0.32	0.32	15.90	17.48		30.00	30.00	3.90	3.80	Pass
HT20	MCS0	1	165	5825	0.32	0.32	15.78	17.64		30.00	30.00	3.90	3.80	Pass
HT40	MCS0	1	151	5755	0.09	0.09	15.30	17.05		30.00	30.00	3.90	3.80	Pass
HT40	MCS0	1	159	5795	0.09	0.09	15.24	16.95		30.00	30.00	3.90	3.80	Pass
VHT20	MCS0	1	149	5745	0.32	0.35	15.84	17.63		30.00	30.00	3.90	3.80	Pass
VHT20	MCS0	1	157	5785	0.32	0.35	15.93	17.51		30.00	30.00	3.90	3.80	Pass
VHT20	MCS0	1	165	5825	0.32	0.35	15.80	17.68		30.00	30.00	3.90	3.80	Pass
VHT40	MCS0	1	151	5755	0.09	0.08	15.37	17.07		30.00	30.00	3.90	3.80	Pass
VHT40	MCS0	1	159	5795	0.09	0.08	15.34	17.03		30.00	30.00	3.90	3.80	Pass
VHT80	MCS0	1	155	5775	0.18	0.22	14.35	16.10		30.00	30.00	3.90	3.80	Pass
11a	6Mbps	2	149	5745	0.32	0.32	15.85	17.77	19.93	30.00		3.90		Pass
11a	6Mbps	2	157	5785	0.32	0.32	15.98	17.73	19.95	30.00		3.90		Pass
11a	6Mbps	2	165	5825	0.32	0.32	15.90	17.65	19.87	30.00		3.90		Pass
HT20	MCS0	2	149	5745	0.32	0.32	15.84	17.65	19.85	30.00		3.90		Pass
HT20	MCS0	2	157	5785	0.32	0.32	15.94	17.63	19.88	30.00		3.90		Pass
HT20	MCS0	2	165	5825	0.32	0.32	15.80	17.67	19.85	30.00		3.90		Pass
HT40	MCS0	2	151	5755	0.09	0.09	15.32	17.19	19.36	30.00		3.90		Pass
HT40	MCS0	2	159	5795	0.09	0.09	15.28	17.26	19.39	30.00		3.90		Pass
VHT20	MCS0	2	149	5745	0.32	0.32	15.86	17.67	19.87	30.00		3.90		Pass
VHT20	MCS0	2	157	5785	0.32	0.32	15.97	17.64	19.90	30.00		3.90		Pass
VHT20	MCS0	2	165	5825	0.32	0.32	15.85	17.70	19.89	30.00		3.90		Pass
VHT40	MCS0	2	151	5755	0.09	0.09	15.39	17.29	19.45	30.00		3.90		Pass
VHT40	MCS0	2	159	5795	0.09	0.09	15.31	17.27	19.41	30.00		3.90		Pass
VHT80	MCS0	2	155	5775	0.18	0.18	14.38	16.16	18.37	30.00		3.90		Pass

***TEST RESULTS DATA***  
***Power Spectral Density***

Band IV																
Mod.	Data Rate	NTX	CH.	Freq. (MHz)	Duty Factor (dB)		10log (500kHz /RBW) Factor (dB)		Average Power Density (dBm/500kHz)			Average PSD Limit (dBm/500kHz)		DG (dBi)		Pass /Fail
					Ant 1	Ant 2	Ant 1	Ant 2	Ant 1	Ant 2	SUM	Ant 1	Ant 2	Ant 1	Ant 2	
11a	6Mbps	1	149	5745	0.32	0.32	2.22	2.22	1.70	3.93		30.00	30.00	3.90	3.80	Pass
11a	6Mbps	1	157	5785	0.32	0.32	2.22	2.22	1.48	2.78		30.00	30.00	3.90	3.80	Pass
11a	6Mbps	1	165	5825	0.32	0.32	2.22	2.22	1.48	3.18		30.00	30.00	3.90	3.80	Pass
11a	6Mbps	2	149	5745	0.32	0.32	2.22					7.10	29.14	6.86		Pass
11a	6Mbps	2	157	5785	0.32	0.32	2.22					5.56	29.14	6.86		Pass
11a	6Mbps	2	165	5825	0.32	0.32	2.22					6.31	29.14	6.86		Pass
VHT20	MCS0	2	149	5745	0.32	0.32	2.22					6.78	29.14	6.86		Pass
VHT20	MCS0	2	157	5785	0.32	0.32	2.22					5.40	29.14	6.86		Pass
VHT20	MCS0	2	165	5825	0.32	0.32	2.22					6.12	29.14	6.86		Pass
VHT40	MCS0	2	151	5755	0.09	0.09	2.22					2.45	29.14	6.86		Pass
VHT40	MCS0	2	159	5795	0.09	0.09	2.22		3.13	29.14	6.86		Pass			
VHT80	MCS0	2	155	5775	0.18	0.18	2.22		-0.89	29.14	6.86		Pass			

**TEST RESULTS DATA**  
**Frequency Stability**

Band IV										
Mod.	Data Rate	NTX	CH.	Freq. (MHz)	Center Frequency (MHz)	Frequency Deviation (MHz)	Frequency Stability (ppm)	Temperature (°C)	Voltage (V)	Note
11a	6Mbps	1	149	5745	5745.000	0.000	0.00	60	3.9	
11a	6Mbps	1	149	5745	5745.000	0.000	0.00	-30	3.9	
11a	6Mbps	1	149	5745	5745.000	0.000	0.00	20	4.2	
11a	6Mbps	1	149	5745	5745.000	0.000	0.00	20	3.7	
11a	6Mbps	1	149	5745	5745.025	0.025	4.35	20	3.9	



**<TXBF Modes>**

Test Engineer:	Kai Liao / Tommy Lee	Temperature:	21~25	°C
Test Date:	2016/09/03 ~ 2016/09/16	Relative Humidity:	51~54	%

**TEST RESULTS DATA**  
**6dB and 26dB EBW and 99% OBW**

Band IV													
Mod.	Data Rate	NTX	CH.	Freq. (MHz)	99% Bandwidth (MHz)		26dB Bandwidth (MHz)		6 dB Bandwidth (MHz)		6 dB Bandwidth Min. Limit (MHz)		Pass/Fail
					Ant 1	Ant 2	Ant 1	Ant 2	Ant 1	Ant 2	Ant 1	Ant 2	
VHT20	MCS0	2	149	5745	19.00	19.25	31.70	37.80	17.56	17.56	0.5	0.5	Pass
VHT20	MCS0	2	157	5785	19.15	19.25	33.60	37.00	17.56	17.56	0.5	0.5	Pass
VHT20	MCS0	2	165	5825	19.05	19.40	30.70	38.00	17.56	17.54	0.5	0.5	Pass
VHT40	MCS0	2	151	5755	36.70	36.90	40.86	49.32	36.24	35.40	0.5	0.5	Pass
VHT40	MCS0	2	159	5795	36.80	37.00	57.06	64.26	36.32	35.96	0.5	0.5	Pass
VHT80	MCS0	2	155	5775	75.84	75.84	80.32	80.00	70.72	76.32	0.5	0.5	Pass

**TEST RESULTS DATA**  
**Average Power Table**

Band IV												
Mod.	Data Rate	NTX	CH.	Freq. (MHz)	Average Conducted Power (dBm)			FCC Conducted Power Limit (dBm)		DG (dBi)		Pass/Fail
					Ant 1	Ant 2	SUM	Ant 1	Ant 2	Ant 1	Ant 2	
HT20	MCS0	2	149	5745	15.40	17.40	19.52	29.14	29.14	6.86	6.86	Pass
HT20	MCS0	2	157	5785	15.40	17.40	19.52	29.14	29.14	6.86	6.86	Pass
HT20	MCS0	2	165	5825	15.40	17.50	19.59	29.14	29.14	6.86	6.86	Pass
HT40	MCS0	2	151	5755	14.60	17.10	19.04	29.14	29.14	6.86	6.86	Pass
HT40	MCS0	2	159	5795	14.90	16.90	19.02	29.14	29.14	6.86	6.86	Pass
VHT20	MCS0	2	149	5745	15.50	17.50	19.62	29.14	29.14	6.86	6.86	Pass
VHT20	MCS0	2	157	5785	15.50	17.60	19.69	29.14	29.14	6.86	6.86	Pass
VHT20	MCS0	2	165	5825	15.50	17.70	19.75	29.14	29.14	6.86	6.86	Pass
VHT40	MCS0	2	151	5755	14.70	17.20	19.14	29.14	29.14	6.86	6.86	Pass
VHT40	MCS0	2	159	5795	15.00	17.10	19.19	29.14	29.14	6.86	6.86	Pass
VHT80	MCS0	2	155	5775	13.60	15.80	17.85	29.14	29.14	6.86	6.86	Pass

**TEST RESULTS DATA**  
**Power Spectral Density**

Band IV														
Mod.	Data Rate	NTX	CH.	Freq. (MHz)	10log (500kHz /RBW) Factor (dB)		Average Power Density (dBm/500kHz)			Average PSD Limit (dBm/500kHz)		DG (dBi)		Pass /Fail
					Ant 1	Ant 2	Ant 1	Ant 2	SUM	Ant 1	Ant 2	Ant 1	Ant 2	
VHT20	MCS0	2	149	5745	2.22					8.57	29.14	6.86		Pass
VHT20	MCS0	2	157	5785	2.22					8.76	29.14	6.86		Pass
VHT20	MCS0	2	165	5825	2.22					8.19	29.14	6.86		Pass
VHT40	MCS0	2	151	5755	2.22					5.20	29.14	6.86		Pass
VHT40	MCS0	2	159	5795	2.22					5.65	29.14	6.86		Pass
VHT80	MCS0	2	155	5775	2.22					1.33	29.14	6.86		Pass





## Appendix B. Radiated Spurious Emission

Test Engineer :	Luke Chang, Ken Wu, Derreck Chen, Jesse Wang, and James Chiu	Temperature :	21~24°C
		Relative Humidity :	50~55%

<CDD Modes>

Band 4 - 5725~5850MHz

WIFI 802.11a (Band Edge @ 3m)

WIFI Ant. 1	Note	Frequency ( MHz )	Level ( dBμV/m )	Over Limit ( dB )	Limit Line ( dBμV/m )	Read Level ( dBμV )	Antenna Factor ( dB/m )	Cable Loss ( dB )	Preamp Factor ( dB )	Ant Pos ( cm )	Table Pos ( deg )	Peak Avg. ( P/A )	Pol. ( H/V )	
802.11a CH 149 5745MHz		5616.2	49.56	-18.64	68.2	38.33	34.6	11.89	35.26	244	299	P	H	
		5699	56.24	-48.22	104.46	44.92	34.6	12	35.28	244	299	P	H	
		5719	61.93	-48.59	110.52	50.55	34.6	12.06	35.28	244	299	P	H	
		5722.6	69.02	-47.71	116.73	57.64	34.6	12.06	35.28	244	299	P	H	
	*	5745	106.66	-	-	95.24	34.6	12.11	35.29	244	299	P	H	
	*	5745	99.11	-	-	87.69	34.6	12.11	35.29	244	299	A	H	
														H
														H
			5602	49.31	-18.89	68.2	38.08	34.6	11.89	35.26	218	26	P	V
			5698.4	52.42	-51.6	104.02	41.1	34.6	12	35.28	218	26	P	V
			5719.4	57.54	-53.09	110.63	46.16	34.6	12.06	35.28	218	26	P	V
			5722.6	66.34	-50.39	116.73	54.96	34.6	12.06	35.28	218	26	P	V
	*		5745	103.95	-	-	92.53	34.6	12.11	35.29	218	26	P	V
	*		5745	96.35	-	-	84.93	34.6	12.11	35.29	218	26	A	V
														V
													V	



WIFI Ant. 1	Note	Frequency ( MHz )	Level ( dBμV/m )	Over Limit ( dB )	Limit Line ( dBμV/m )	Read Level ( dBμV )	Antenna Factor ( dB/m )	Cable Loss ( dB )	Preamp Factor ( dB )	Ant Pos ( cm )	Table Pos ( deg )	Peak Avg. ( P/A )	Pol. ( H/V )
		5603.6	49.67	-18.53	68.2	38.44	34.6	11.89	35.26	252	301	P	H
		5690.4	49.51	-48.61	98.12	38.19	34.6	12	35.28	252	301	P	H
		5712.8	50.66	-58.13	108.79	39.28	34.6	12.06	35.28	252	301	P	H
		5725	51.97	-70.23	122.2	40.59	34.6	12.06	35.28	252	301	P	H
	*	5785	104.72	-	-	93.25	34.6	12.17	35.3	252	301	P	H
	*	5785	97.14	-	-	85.67	34.6	12.17	35.3	252	301	A	H
		5850.2	49.96	-71.78	121.74	38.39	34.6	12.28	35.31	252	301	P	H
		5865	49.6	-58.4	108	37.92	34.6	12.39	35.31	252	301	P	H
		5920.8	51.63	-19.67	71.3	39.84	34.6	12.51	35.32	252	301	P	H
		5937.8	49.52	-18.68	68.2	37.74	34.6	12.51	35.33	252	301	P	H
													H
													H
802.11a													
CH 157													
5785MHz		5601	50.24	-17.96	68.2	39.01	34.6	11.89	35.26	226	26	P	V
		5669.6	49.25	-33.49	82.74	37.92	34.6	12	35.27	226	26	P	V
		5717.6	49.43	-60.7	110.13	38.05	34.6	12.06	35.28	226	26	P	V
		5723.2	50.49	-67.61	118.1	39.11	34.6	12.06	35.28	226	26	P	V
	*	5785	101.85	-	-	90.38	34.6	12.17	35.3	226	26	P	V
	*	5785	94.26	-	-	82.79	34.6	12.17	35.3	226	26	A	V
		5852.8	49.29	-66.53	115.82	37.72	34.6	12.28	35.31	226	26	P	V
		5858.4	50.99	-58.86	109.85	39.42	34.6	12.28	35.31	226	26	P	V
		5886.2	50.47	-46.41	96.88	38.8	34.6	12.39	35.32	226	26	P	V
		5938.6	50.66	-17.54	68.2	38.88	34.6	12.51	35.33	226	26	P	V
													V
													V



WiFi Ant. 1	Note	Frequency ( MHz )	Level ( dBµV/m )	Over Limit ( dB )	Limit Line ( dBµV/m )	Read Level ( dBµV )	Antenna Factor ( dB/m )	Cable Loss ( dB )	Preamp Factor ( dB )	Ant Pos ( cm )	Table Pos ( deg )	Peak Avg. ( P/A )	Pol. ( H/V )	
802.11a CH 165 5825MHz	*	5825	105.93	-	-	94.36	34.6	12.28	35.31	248	299	P	H	
	*	5825	98.35	-	-	86.78	34.6	12.28	35.31	248	299	A	H	
		5851.6	61.92	-56.63	118.55	50.35	34.6	12.28	35.31	248	299	P	H	
		5855.4	59.17	-51.52	110.69	47.6	34.6	12.28	35.31	248	299	P	H	
		5878	52.32	-50.65	102.97	40.65	34.6	12.39	35.32	248	299	P	H	
		5927.8	49.58	-18.62	68.2	37.8	34.6	12.51	35.33	248	299	P	H	
														H
														H
	*	5825	103.75	-	-	92.18	34.6	12.28	35.31	198	22	P	V	
	*	5825	96.14	-	-	84.57	34.6	12.28	35.31	198	22	A	V	
		5851.8	59.15	-58.95	118.1	47.58	34.6	12.28	35.31	198	22	P	V	
		5855	56.38	-54.42	110.8	44.81	34.6	12.28	35.31	198	22	P	V	
		5882	50.78	-49.22	100	39.11	34.6	12.39	35.32	198	22	P	V	
		5937.6	50.16	-18.04	68.2	38.38	34.6	12.51	35.33	198	22	P	V	
														V
														V
													V	
<b>Remark</b>	1. No other spurious found. 2. All results are PASS against Peak and Average limit line.													



Band 4 5725~5850MHz

WIFI 802.11a (Harmonic @ 3m)

WIFI Ant. 1	Note	Frequency ( MHz )	Level ( dBμV/m )	Over Limit ( dB )	Limit Line ( dBμV/m )	Read Level ( dBμV )	Antenna Factor ( dB/m )	Cable Loss ( dB )	Preamp Factor ( dB )	Ant Pos ( cm )	Table Pos ( deg )	Peak Avg. ( P/A )	Pol. ( H/V )
802.11a CH 149 5745MHz		11490	43.33	-30.67	74	44.24	39.27	17.16	57.34	100	0	P	H
		17232	46.56	-21.64	68.2	39.26	42.43	20.76	55.89	100	0	P	H
													H
													H
		11490	42.11	-31.89	74	43.02	39.27	17.16	57.34	100	0	P	V
		17232	46.46	-21.74	68.2	39.16	42.43	20.76	55.89	100	0	P	V
													V
													V
802.11a CH 157 5785MHz		11570	43.64	-30.36	74	44.47	39.2	17.16	57.19	100	0	P	H
		17352	45.4	-22.8	68.2	38.26	42.24	20.84	55.94	100	0	P	H
													H
													H
		11570	42.02	-31.98	74	42.85	39.2	17.16	57.19	100	0	P	V
		17352	46.49	-21.71	68.2	39.35	42.24	20.84	55.94	100	0	P	V
													V
													V
802.11a CH 165 5825MHz		11650	41.54	-32.46	74	42.35	39.11	17.16	57.08	100	0	P	H
		17472	45.91	-22.29	68.2	38.92	42.05	20.93	55.99	100	0	P	H
													H
													H
		11650	42.31	-31.69	74	43.12	39.11	17.16	57.08	100	0	P	V
		17472	46.99	-21.21	68.2	40	42.05	20.93	55.99	100	0	P	V
													V
													V
Remark	1. No other spurious found. 2. All results are PASS against Peak and Average limit line.												



Emission below 1GHz

5GHz WIFI 802.11a (LF @ 3m)

WIFI	Note	Frequency	Level	Over	Limit	Read	Antenna	Cable	Preamp	Ant	Table	Peak	Pol.	
Ant.				Limit	Line	Level	Factor	Loss	Factor	Pos	Pos	Avg.		
1		( MHz )	( dBμV/m )	( dB )	( dBμV/m )	( dBμV )	( dB/m )	( dB )	( dB )	( cm )	( deg )	( P/A )	( H/V )	
5GHz 802.11a LF		144.75	38.7	-4.8	43.5	50.16	17.86	1.78	31.1	100	268	P	H	
		225.48	30.95	-15.05	46	43	16.88	2.07	31	-	-	P	H	
		298.11	35.55	-10.45	46	44.47	19.78	2.32	31.02	-	-	P	H	
		579.3	28.14	-17.86	46	30.52	25.06	3.24	30.68	-	-	P	H	
		794.2	32.41	-13.59	46	31.18	27.64	3.9	30.31	-	-	P	H	
		986	34.52	-19.48	54	30.52	30.27	3.98	30.25	-	-	P	H	
														H
														H
														H
														H
														H
														H
			77.25	34.3	-5.7	40	50.65	13.57	1.28	31.2	100	45	P	V
			99.66	33	-10.5	43.5	46.42	16.4	1.28	31.1	-	-	P	V
			220.62	30.24	-15.76	46	42.69	16.48	2.07	31	-	-	P	V
			329.4	28.8	-17.2	46	36.76	20.63	2.41	31	-	-	P	V
			651.4	29.33	-16.67	46	30.34	25.92	3.57	30.5	-	-	P	V
			963.6	34.45	-19.55	54	30.5	30.23	4.07	30.35	-	-	P	V
														V
														V
													V	
													V	
													V	
													V	
Remark	1. No other spurious found. 2. All results are PASS against limit line.													



**Note symbol**

*	<b>Fundamental Frequency</b> which can be ignored. However, the level of any unwanted emissions shall not exceed the level of the fundamental frequency.
!	Test result is <b>over limit</b> line.
P/A	<b>Peak</b> or <b>Average</b>
H/V	<b>Horizontal</b> or <b>Vertical</b>



A calculation example for radiated spurious emission is shown as below:

WIFI	Note	Frequency	Level	Over	Limit	Read	Antenna	Cable	Preamp	Ant	Table	Peak	Pol.
Ant.				Limit	Line	Level	Factor	Loss	Factor	Pos	Pos	Avg.	
1		( MHz )	( dBμV/m )	( dB )	( dBμV/m )	( dBμV )	( dB/m )	( dB )	( dB )	( cm )	( deg )	( P/A )	( H/V )
802.11b		2390	55.45	-18.55	74	54.51	32.22	4.58	35.86	103	308	P	H
CH 01													
2412MHz		2390	43.54	-10.46	54	42.6	32.22	4.58	35.86	103	308	A	H

- Level(dBμV/m) =  
Antenna Factor(dB/m) + Cable Loss(dB) + Read Level(dBμV) - Preamp Factor(dB)
- Over Limit(dB) = Level(dBμV/m) – Limit Line(dBμV/m)

**For Peak Limit @ 2390MHz:**

- Level(dBμV/m)  
= Antenna Factor(dB/m) + Cable Loss(dB) + Read Level(dBμV) - Preamp Factor(dB)  
= 32.22(dB/m) + 4.58(dB) + 54.51(dBμV) – 35.86 (dB)  
= 55.45 (dBμV/m)
- Over Limit(dB)  
= Level(dBμV/m) – Limit Line(dBμV/m)  
= 55.45(dBμV/m) – 74(dBμV/m)  
= -18.55(dB)

**For Average Limit @ 2390MHz:**

- Level(dBμV/m)  
= Antenna Factor(dB/m) + Cable Loss(dB) + Read Level(dBμV) - Preamp Factor(dB)  
= 32.22(dB/m) + 4.58(dB) + 42.6(dBμV) – 35.86 (dB)  
= 43.54 (dBμV/m)
- Over Limit(dB)  
= Level(dBμV/m) – Limit Line(dBμV/m)  
= 43.54(dBμV/m) – 54(dBμV/m)  
= -10.46(dB)

Both peak and average measured complies with the limit line, so test result is “PASS”.



Band 4 - 5725~5850MHz

WIFI 802.11a (Band Edge @ 3m)

WIFI	Note	Frequency	Level	Over	Limit	Read	Antenna	Cable	Preamp	Ant	Table	Peak	Pol.	
Ant.				Limit	Line	Level	Factor	Loss	Factor	Pos	Pos	Avg.		
2		( MHz )	( dBμV/m )	( dB )	( dBμV/m )	( dBμV )	( dB/m )	( dB )	( dB )	( cm )	( deg )	(P/A)	(H/V)	
802.11a CH 149 5745MHz		5603.6	49.26	-18.94	68.2	38.03	34.6	11.89	35.26	198	58	P	H	
		5698.2	58.26	-45.61	103.87	46.94	34.6	12	35.28	198	58	P	H	
		5718.4	68.85	-41.5	110.35	57.47	34.6	12.06	35.28	198	58	P	H	
		5724.6	78.2	-43.09	121.29	66.82	34.6	12.06	35.28	198	58	P	H	
	*	5745	109.67	-	-	98.25	34.6	12.11	35.29	198	58	P	H	
	*	5745	101.28	-	-	89.86	34.6	12.11	35.29	198	58	A	H	
														H
														H
			5648.2	51.05	-17.15	68.2	39.77	34.6	11.95	35.27	200	58	P	V
			5698	56.42	-47.31	103.73	45.1	34.6	12	35.28	200	58	P	V
			5718.4	67.38	-42.97	110.35	56	34.6	12.06	35.28	200	58	P	V
			5724.8	76.13	-45.61	121.74	64.75	34.6	12.06	35.28	200	58	P	V
	*		5745	106.96	-	-	95.54	34.6	12.11	35.29	200	58	P	V
	*		5745	98.79	-	-	87.37	34.6	12.11	35.29	200	58	A	V
														V
													V	





WIFI Ant. 2	Note	Frequency ( MHz )	Level ( dBμV/m )	Over Limit ( dB )	Limit Line ( dBμV/m )	Read Level ( dBμV )	Antenna Factor ( dB/m )	Cable Loss ( dB )	Preamp Factor ( dB )	Ant Pos ( cm )	Table Pos ( deg )	Peak Avg. ( P/A )	Pol. ( H/V )
		5619.4	50.64	-17.56	68.2	39.41	34.6	11.89	35.26	193	57	P	H
		5673.2	51.25	-34.16	85.41	39.92	34.6	12	35.27	193	57	P	H
		5719.8	54.18	-56.56	110.74	42.8	34.6	12.06	35.28	193	57	P	H
		5725	53.88	-68.32	122.2	42.5	34.6	12.06	35.28	193	57	P	H
	*	5785	109.81	-	-	98.34	34.6	12.17	35.3	193	57	P	H
	*	5785	101.57	-	-	90.1	34.6	12.17	35.3	193	57	A	H
		5850.8	51.96	-68.42	120.38	40.39	34.6	12.28	35.31	193	57	P	H
		5861.2	51.28	-57.78	109.06	39.6	34.6	12.39	35.31	193	57	P	H
		5877.2	50.75	-52.82	103.57	39.08	34.6	12.39	35.32	193	57	P	H
		5949.8	51.33	-16.87	68.2	39.44	34.6	12.62	35.33	193	57	P	H
													H
													H
802.11a													
CH 157													
5785MHz		5645.8	51.06	-17.14	68.2	39.78	34.6	11.95	35.27	204	57	P	V
		5692.6	50.37	-49.37	99.74	39.05	34.6	12	35.28	204	57	P	V
		5705.2	52	-54.66	106.66	40.62	34.6	12.06	35.28	204	57	P	V
		5722.2	52.44	-63.38	115.82	41.06	34.6	12.06	35.28	204	57	P	V
	*	5785	107.2	-	-	95.73	34.6	12.17	35.3	204	57	P	V
	*	5785	98.89	-	-	87.42	34.6	12.17	35.3	204	57	A	V
		5850.2	51.01	-70.73	121.74	39.44	34.6	12.28	35.31	204	57	P	V
		5874.6	49.93	-55.38	105.31	38.25	34.6	12.39	35.31	204	57	P	V
		5879.8	50.84	-50.79	101.63	39.17	34.6	12.39	35.32	204	57	P	V
		5938	50.28	-17.92	68.2	38.5	34.6	12.51	35.33	204	57	P	V
													V
													V



WiFi Ant. 2	Note	Frequency ( MHz )	Level ( dBμV/m )	Over Limit ( dB )	Limit Line ( dBμV/m )	Read Level ( dBμV )	Antenna Factor ( dB/m )	Cable Loss ( dB )	Preamp Factor ( dB )	Ant Pos ( cm )	Table Pos ( deg )	Peak Avg. ( P/A )	Pol. ( H/V )	
802.11a CH 165 5825MHz	*	5825	109.93	-	-	98.36	34.6	12.28	35.31	200	58	P	H	
	*	5825	101.72	-	-	90.15	34.6	12.28	35.31	200	58	A	H	
		5851.8	71.05	-47.05	118.1	59.48	34.6	12.28	35.31	200	58	P	H	
		5856.2	64.71	-45.75	110.46	53.14	34.6	12.28	35.31	200	58	P	H	
		5878.4	55.39	-47.28	102.67	43.72	34.6	12.39	35.32	200	58	P	H	
		5945.8	51.61	-16.59	68.2	39.72	34.6	12.62	35.33	200	58	P	H	
														H
														H
	*	5825	106.28	-	-	94.71	34.6	12.28	35.31	204	58	P	V	
	*	5825	98.08	-	-	86.51	34.6	12.28	35.31	204	58	A	V	
		5851.2	64.25	-55.21	119.46	52.68	34.6	12.28	35.31	204	58	P	V	
		5858.2	61.01	-48.89	109.9	49.44	34.6	12.28	35.31	204	58	P	V	
		5878.8	51.5	-50.88	102.38	39.83	34.6	12.39	35.32	204	58	P	V	
		5928.8	51.36	-16.84	68.2	39.58	34.6	12.51	35.33	204	58	P	V	
														V
														V
														V
<b>Remark</b>	1. No other spurious found. 2. All results are PASS against Peak and Average limit line.													



Band 4 5725~5850MHz

WIFI 802.11a (Harmonic @ 3m)

WIFI Ant. 2	Note	Frequency ( MHz )	Level ( dBμV/m )	Over Limit ( dB )	Limit Line ( dBμV/m )	Read Level ( dBμV )	Antenna Factor ( dB/m )	Cable Loss ( dB )	Preamp Factor ( dB )	Ant Pos ( cm )	Table Pos ( deg )	Peak Avg. ( P/A )	Pol. ( H/V )	
802.11a CH 149 5745MHz		11490	43.22	-30.78	74	44.13	39.27	17.16	57.34	100	0	P	H	
		17235	53.84	-14.36	68.2	46.54	42.43	20.76	55.89	100	0	P	H	
													H	
													H	
			11490	43.37	-30.63	74	44.28	39.27	17.16	57.34	100	0	P	V
			17235	57.68	-10.52	68.2	50.38	42.43	20.76	55.89	100	321	P	V
														V
802.11a CH 157 5785MHz		11570	42.98	-31.02	74	43.81	39.2	17.16	57.19	100	0	P	H	
		17352	50.87	-17.33	68.2	43.73	42.24	20.84	55.94	100	0	P	H	
													H	
													H	
			11570	43.93	-30.07	74	44.76	39.2	17.16	57.19	100	0	P	V
			17364	52.35	-15.85	68.2	45.25	42.21	20.84	55.95	100	0	P	V
														V
802.11a CH 165 5825MHz		11650	43.55	-30.45	74	44.36	39.11	17.16	57.08	100	0	P	H	
		17475	51.22	-16.98	68.2	44.23	42.05	20.93	55.99	100	0	P	H	
													H	
													H	
			11650	45.01	-28.99	74	45.82	39.11	17.16	57.08	100	0	P	V
			17475	52.55	-15.65	68.2	45.56	42.05	20.93	55.99	-	-	P	V
														V
Remark	1. No other spurious found.													
	2. All results are PASS against Peak and Average limit line.													



Emission below 1GHz

5GHz WIFI 802.11a (LF @ 3m)

WIFI	Note	Frequency	Level	Over	Limit	Read	Antenna	Cable	Preamp	Ant	Table	Peak	Pol.	
Ant.				Limit	Line	Level	Factor	Loss	Factor	Pos	Pos	Avg.		
2		( MHz )	( dBμV/m )	( dB )	( dBμV/m )	( dBμV )	( dB/m )	( dB )	( dB )	( cm )	( deg )	( P/A )	( H/V )	
5GHz 802.11a LF		149.07	38.5	-5	43.5	50.09	17.73	1.78	31.1	100	305	P	H	
		225.48	30.75	-15.25	46	42.8	16.88	2.07	31	-	-	P	H	
		297.3	35.83	-10.17	46	44.76	19.78	2.32	31.03	-	-	P	H	
		491.1	27.1	-18.9	46	30.76	23.99	3.04	30.69	-	-	P	H	
		826.4	32.68	-13.32	46	30.7	28.23	4.1	30.35	-	-	P	H	
		947.5	34.91	-11.09	46	31.08	30.15	4.07	30.39	-	-	P	H	
														H
														H
														H
														H
														H
														H
			77.52	35.04	-4.96	40	51.39	13.57	1.28	31.2	100	55	P	V
			100.2	33.25	-10.25	43.5	46.4	16.4	1.55	31.1	-	-	P	V
			221.7	29.97	-16.03	46	42.34	16.56	2.07	31	-	-	P	V
			335	28.53	-17.47	46	36.35	20.77	2.41	31	-	-	P	V
			612.9	29.33	-16.67	46	31.01	25.53	3.36	30.57	-	-	P	V
			976.9	34.23	-19.77	54	30.2	30.25	4.07	30.29	-	-	P	V
														V
														V
													V	
													V	
													V	
													V	
Remark	1. No other spurious found. 2. All results are PASS against limit line.													



**Note symbol**

*	<b>Fundamental Frequency</b> which can be ignored. However, the level of any unwanted emissions shall not exceed the level of the fundamental frequency.
!	Test result is <b>over limit</b> line.
P/A	<b>Peak</b> or <b>Average</b>
H/V	<b>Horizontal</b> or <b>Vertical</b>



A calculation example for radiated spurious emission is shown as below:

WIFI	Note	Frequency	Level	Over	Limit	Read	Antenna	Cable	Preamp	Ant	Table	Peak	Pol.
Ant.				Limit	Line	Level	Factor	Loss	Factor	Pos	Pos	Avg.	
2		( MHz )	( dBμV/m )	( dB )	( dBμV/m )	( dBμV )	( dB/m )	( dB )	( dB )	( cm )	( deg )	( P/A )	( H/V )
802.11b		2390	55.45	-18.55	74	54.51	32.22	4.58	35.86	103	308	P	H
CH 01													
2412MHz		2390	43.54	-10.46	54	42.6	32.22	4.58	35.86	103	308	A	H

- Level(dBμV/m) =  
Antenna Factor(dB/m) + Cable Loss(dB) + Read Level(dBμV) - Preamp Factor(dB)
- Over Limit(dB) = Level(dBμV/m) – Limit Line(dBμV/m)

**For Peak Limit @ 2390MHz:**

- Level(dBμV/m)  
= Antenna Factor(dB/m) + Cable Loss(dB) + Read Level(dBμV) - Preamp Factor(dB)  
= 32.22(dB/m) + 4.58(dB) + 54.51(dBμV) – 35.86 (dB)  
= 55.45 (dBμV/m)
- Over Limit(dB)  
= Level(dBμV/m) – Limit Line(dBμV/m)  
= 55.45(dBμV/m) – 74(dBμV/m)  
= -18.55(dB)

**For Average Limit @ 2390MHz:**

- Level(dBμV/m)  
= Antenna Factor(dB/m) + Cable Loss(dB) + Read Level(dBμV) - Preamp Factor(dB)  
= 32.22(dB/m) + 4.58(dB) + 42.6(dBμV) – 35.86 (dB)  
= 43.54 (dBμV/m)
- Over Limit(dB)  
= Level(dBμV/m) – Limit Line(dBμV/m)  
= 43.54(dBμV/m) – 54(dBμV/m)  
= -10.46(dB)

Both peak and average measured complies with the limit line, so test result is “PASS”.



Band 4 - 5725~5850MHz

WIFI 802.11a (Band Edge @ 3m)

WIFI	Note	Frequency	Level	Over	Limit	Read	Antenna	Cable	Preamp	Ant	Table	Peak	Pol.	
Ant.				Limit	Line	Level	Factor	Loss	Factor	Pos	Pos	Avg.		
1+2		( MHz )	( dBμV/m )	( dB )	( dBμV/m )	( dBμV )	( dB/m )	( dB )	( dB )	( cm )	( deg )	(P/A)	(H/V)	
802.11a CH 149 5745MHz		5648.6	50.29	-17.91	68.2	39.01	34.6	11.95	35.27	378	51	P	H	
		5697.6	57.9	-45.53	103.43	46.58	34.6	12	35.28	378	51	P	H	
		5719	70.96	-39.56	110.52	59.58	34.6	12.06	35.28	378	51	P	H	
		5724	77.69	-42.23	119.92	66.31	34.6	12.06	35.28	378	51	P	H	
	*	5745	110.37	-	-	98.95	34.6	12.11	35.29	378	51	P	H	
	*	5745	102.23	-	-	90.81	34.6	12.11	35.29	378	51	A	H	
														H
														H
			5623	50.22	-17.98	68.2	38.93	34.6	11.95	35.26	239	32	P	V
			5697.4	58.6	-44.68	103.28	47.28	34.6	12	35.28	239	32	P	V
			5716.6	70.58	-39.27	109.85	59.2	34.6	12.06	35.28	239	32	P	V
			5725	75.3	-46.9	122.2	63.92	34.6	12.06	35.28	239	32	P	V
	*		5745	110.78	-	-	99.36	34.6	12.11	35.29	239	32	P	V
	*		5745	102.38	-	-	90.96	34.6	12.11	35.29	239	32	A	V
														V
													V	



WIFI Ant. 1+2	Note	Frequency ( MHz )	Level ( dBμV/m )	Over Limit ( dB )	Limit Line ( dBμV/m )	Read Level ( dBμV )	Antenna Factor ( dB/m )	Cable Loss ( dB )	Preamp Factor ( dB )	Ant Pos ( cm )	Table Pos ( deg )	Peak Avg. (P/A)	Pol. (H/V)
		5617	49.32	-18.88	68.2	38.09	34.6	11.89	35.26	351	40	P	H
		5682	50.64	-41.28	91.92	39.32	34.6	12	35.28	351	40	P	H
		5714.8	49.68	-59.67	109.35	38.3	34.6	12.06	35.28	351	40	P	H
		5724.8	50.99	-70.75	121.74	39.61	34.6	12.06	35.28	351	40	P	H
	*	5785	110.32	-	-	98.85	34.6	12.17	35.3	351	40	P	H
	*	5785	102.67	-	-	91.2	34.6	12.17	35.3	351	40	A	H
		5850.8	49.81	-70.57	120.38	38.24	34.6	12.28	35.31	351	40	P	H
		5863.6	50.5	-57.89	108.39	38.82	34.6	12.39	35.31	351	40	P	H
		5911.4	51.16	-27.07	78.23	39.37	34.6	12.51	35.32	351	40	P	H
		5936.6	50.98	-17.22	68.2	39.2	34.6	12.51	35.33	351	40	P	H
													H
													H
802.11a													
CH 157													
5785MHz		5647.6	50.37	-17.83	68.2	39.09	34.6	11.95	35.27	219	27	P	V
		5661.8	50.43	-26.53	76.96	39.1	34.6	12	35.27	219	27	P	V
		5717	52.7	-57.26	109.96	41.32	34.6	12.06	35.28	219	27	P	V
		5724.2	53.19	-67.19	120.38	41.81	34.6	12.06	35.28	219	27	P	V
	*	5785	110.39	-	-	98.92	34.6	12.17	35.3	219	27	P	V
	*	5785	101.97	-	-	90.5	34.6	12.17	35.3	219	27	A	V
		5854.4	49.94	-62.23	112.17	38.37	34.6	12.28	35.31	219	27	P	V
		5856.4	50.33	-60.08	110.41	38.76	34.6	12.28	35.31	219	27	P	V
		5883.2	50.71	-48.4	99.11	39.04	34.6	12.39	35.32	219	27	P	V
		5939	49.84	-18.36	68.2	38.06	34.6	12.51	35.33	219	27	P	V
													V
													V





WiFi Ant. 1+2	Note	Frequency ( MHz )	Level ( dBμV/m )	Over Limit ( dB )	Limit Line ( dBμV/m )	Read Level ( dBμV )	Antenna Factor ( dB/m )	Cable Loss ( dB )	Preamp Factor ( dB )	Ant Pos ( cm )	Table Pos ( deg )	Peak Avg. ( P/A )	Pol. ( H/V )	
802.11a CH 165 5825MHz	*	5825	110.65	-	-	99.08	34.6	12.28	35.31	380	42	P	H	
	*	5825	102.81	-	-	91.24	34.6	12.28	35.31	380	42	A	H	
		5853	67.25	-48.11	115.36	55.68	34.6	12.28	35.31	380	42	P	H	
		5855.8	64.49	-46.09	110.58	52.92	34.6	12.28	35.31	380	42	P	H	
		5877.2	53.44	-50.13	103.57	41.77	34.6	12.39	35.32	380	42	P	H	
		5938.6	51.2	-17	68.2	39.42	34.6	12.51	35.33	380	42	P	H	
														H
														H
	*	5825	108.88	-	-	97.31	34.6	12.28	35.31	223	28	P	V	
	*	5825	101.35	-	-	89.78	34.6	12.28	35.31	223	28	A	V	
		5852.6	65.66	-50.61	116.27	54.09	34.6	12.28	35.31	223	28	P	V	
		5856.2	64.08	-46.38	110.46	52.51	34.6	12.28	35.31	223	28	P	V	
		5877	51.99	-51.72	103.71	40.32	34.6	12.39	35.32	223	28	P	V	
		5946.6	50.13	-18.07	68.2	38.24	34.6	12.62	35.33	223	28	P	V	
														V
														V
														V
	<b>Remark</b>	1. No other spurious found. 2. All results are PASS against Peak and Average limit line.												



Band 4 5725~5850MHz

WIFI 802.11a (Harmonic @ 3m)

WIFI Ant. 1+2	Note	Frequency ( MHz )	Level ( dBμV/m )	Over Limit ( dB )	Limit Line ( dBμV/m )	Read Level ( dBμV )	Antenna Factor ( dB/m )	Cable Loss ( dB )	Preamp Factor ( dB )	Ant Pos ( cm )	Table Pos ( deg )	Peak Avg. ( P/A )	Pol. ( H/V )
802.11a CH 149 5745MHz		11490	43.13	-30.87	74	44.04	39.27	17.16	57.34	380	0	P	H
		17235	56.72	-11.48	68.2	49.42	42.43	20.76	55.89	100	0	P	H
													H
													H
		11490	43.83	-30.17	74	44.74	39.27	17.16	57.34	380	0	P	V
		17235	55.44	-12.76	68.2	48.14	42.43	20.76	55.89	100	0	P	V
													V
													V
802.11a CH 157 5785MHz		11570	44.59	-29.41	74	45.42	39.2	17.16	57.19	100	0	P	H
		17355	52.94	-15.26	68.2	45.8	42.24	20.84	55.94	100	0	P	H
													H
													H
		11570	42.71	-31.29	74	43.54	39.2	17.16	57.19	100	0	P	V
		17355	52.35	-15.85	68.2	45.21	42.24	20.84	55.94	100	0	P	V
													V
													V
802.11a CH 165 5825MHz		11650	44.27	-29.73	74	45.08	39.11	17.16	57.08	100	0	P	H
		17472	54.81	-13.39	68.2	47.82	42.05	20.93	55.99	100	0	P	H
													H
													H
		11650	43.35	-30.65	74	44.16	39.11	17.16	57.08	100	0	P	V
		17472	52.29	-15.91	68.2	45.3	42.05	20.93	55.99	100	0	P	V
													V
													V
Remark	1. No other spurious found. 2. All results are PASS against Peak and Average limit line.												



Band 4 5725~5850MHz

WIFI 802.11ac VHT20 (Band Edge @ 3m)

WIFI Ant. 1+2	Note	Frequency ( MHz )	Level ( dBμV/m )	Over Limit ( dB )	Limit Line ( dBμV/m )	Read Level ( dBμV )	Antenna Factor ( dB/m )	Cable Loss ( dB )	Preamp Factor ( dB )	Ant Pos ( cm )	Table Pos ( deg )	Peak Avg. ( P/A )	Pol. ( H/V )	
802.11ac VHT20 CH 149 5745MHz		5623.2	50.01	-18.19	68.2	38.72	34.6	11.95	35.26	376	53	P	H	
		5699.8	58.75	-46.3	105.05	47.43	34.6	12	35.28	376	53	P	H	
		5720	72.47	-38.33	110.8	61.09	34.6	12.06	35.28	376	53	P	H	
		5724.6	80.14	-41.15	121.29	68.76	34.6	12.06	35.28	376	53	P	H	
	*	5745	108.39	-	-	96.97	34.6	12.11	35.29	376	53	P	H	
	*	5745	101.07	-	-	89.65	34.6	12.11	35.29	376	53	A	H	
														H
														H
			5613.8	49.58	-18.62	68.2	38.35	34.6	11.89	35.26	220	31	P	V
			5697.4	57.88	-45.4	103.28	46.56	34.6	12	35.28	220	31	P	V
			5719.8	69.09	-41.65	110.74	57.71	34.6	12.06	35.28	220	31	P	V
			5724.6	79.7	-41.59	121.29	68.32	34.6	12.06	35.28	220	31	P	V
	*		5745	108.78	-	-	97.36	34.6	12.11	35.29	220	31	P	V
	*		5745	101.29	-	-	89.87	34.6	12.11	35.29	220	31	A	V
														V
														V



WIFI Ant. 1+2	Note	Frequency ( MHz )	Level ( dBμV/m )	Over Limit ( dB )	Limit Line ( dBμV/m )	Read Level ( dBμV )	Antenna Factor ( dB/m )	Cable Loss ( dB )	Preamp Factor ( dB )	Ant Pos ( cm )	Table Pos ( deg )	Peak Avg. (P/A)	Pol. (H/V)
		5628.4	50.33	-17.87	68.2	39.05	34.6	11.95	35.27	333	40	P	H
		5699.6	51.07	-53.84	104.91	39.75	34.6	12	35.28	333	40	P	H
		5702.4	51.31	-54.56	105.87	39.93	34.6	12.06	35.28	333	40	P	H
		5724.2	55.91	-64.47	120.38	44.53	34.6	12.06	35.28	333	40	P	H
	*	5785	109.32	-	-	97.85	34.6	12.17	35.3	333	40	P	H
	*	5785	101.44	-	-	89.97	34.6	12.17	35.3	333	40	A	H
		5850.8	50.86	-69.52	120.38	39.29	34.6	12.28	35.31	333	40	P	H
		5869	51.51	-55.37	106.88	39.83	34.6	12.39	35.31	333	40	P	H
		5891.4	50.37	-42.66	93.03	38.7	34.6	12.39	35.32	333	40	P	H
		5945.6	49.89	-18.31	68.2	38	34.6	12.62	35.33	333	40	P	H
802.11ac													H
VHT20													H
CH 157		5636.4	49.31	-18.89	68.2	38.03	34.6	11.95	35.27	202	28	P	V
5785MHz		5670	51.03	-32.01	83.04	39.7	34.6	12	35.27	202	28	P	V
		5715	51.66	-57.74	109.4	40.28	34.6	12.06	35.28	202	28	P	V
		5721.4	54.86	-59.13	113.99	43.48	34.6	12.06	35.28	202	28	P	V
	*	5785	108.97	-	-	97.5	34.6	12.17	35.3	202	28	P	V
	*	5785	100.53	-	-	89.06	34.6	12.17	35.3	202	28	A	V
		5852.4	49.73	-67	116.73	38.16	34.6	12.28	35.31	202	28	P	V
		5855.4	50.72	-59.97	110.69	39.15	34.6	12.28	35.31	202	28	P	V
		5892	50.04	-42.54	92.58	38.37	34.6	12.39	35.32	202	28	P	V
		5947.4	51.37	-16.83	68.2	39.48	34.6	12.62	35.33	202	28	P	V
													V
													V



WiFi Ant. 1+2	Note	Frequency ( MHz )	Level ( dBµV/m )	Over Limit ( dB )	Limit Line ( dBµV/m )	Read Level ( dBµV )	Antenna Factor ( dB/m )	Cable Loss ( dB )	Preamp Factor ( dB )	Ant Pos ( cm )	Table Pos ( deg )	Peak Avg. ( P/A )	Pol. ( H/V )	
802.11ac VHT20 CH 165 5825MHz	*	5825	109.79	-	-	98.22	34.6	12.28	35.31	380	42	P	H	
	*	5825	101.39	-	-	89.82	34.6	12.28	35.31	380	42	A	H	
		5850.2	67.81	-53.93	121.74	56.24	34.6	12.28	35.31	380	42	P	H	
		5857.6	63.87	-46.2	110.07	52.3	34.6	12.28	35.31	380	42	P	H	
		5876.4	54.84	-49.32	104.16	43.17	34.6	12.39	35.32	380	42	P	H	
		5931.8	50.85	-17.35	68.2	39.07	34.6	12.51	35.33	380	42	P	H	
														H
														H
	*	5825	108.81	-	-	97.24	34.6	12.28	35.31	219	28	P	V	
	*	5825	100.53	-	-	88.96	34.6	12.28	35.31	219	28	A	V	
		5850	67.06	-55.14	122.2	55.49	34.6	12.28	35.31	219	28	P	V	
		5855.2	63.23	-47.51	110.74	51.66	34.6	12.28	35.31	219	28	P	V	
		5881.8	55.78	-44.37	100.15	44.11	34.6	12.39	35.32	219	28	P	V	
		5941	49.65	-18.55	68.2	37.76	34.6	12.62	35.33	219	28	P	V	
														V
														V
<b>Remark</b>	1. No other spurious found. 2. All results are PASS against Peak and Average limit line.													



Band 4 5725~5850MHz

WIFI 802.11ac VHT20 (Harmonic @ 3m)

WIFI Ant. 1+2	Note	Frequency ( MHz )	Level ( dBμV/m )	Over Limit ( dB )	Limit Line ( dBμV/m )	Read Level ( dBμV )	Antenna Factor ( dB/m )	Cable Loss ( dB )	Preamp Factor ( dB )	Ant Pos ( cm )	Table Pos ( deg )	Peak Avg. ( P/A )	Pol. ( H/V )	
802.11ac VHT20 CH 149 5745MHz		11490	43.3	-30.7	74	44.21	39.27	17.16	57.34	100	0	P	H	
		17235	54.62	-13.58	68.2	47.32	42.43	20.76	55.89	100	0	P	H	
													H	
													H	
			11490	43.37	-30.63	74	44.28	39.27	17.16	57.34	100	0	P	V
			17235	55.77	-12.43	68.2	48.47	42.43	20.76	55.89	100	0	P	V
														V
802.11ac VHT20 CH 157 5785MHz		11570	43.73	-30.27	74	44.56	39.2	17.16	57.19	100	0	P	H	
		17355	52.81	-15.39	68.2	45.67	42.24	20.84	55.94	100	0	P	H	
													H	
													H	
			11570	43.37	-30.63	74	44.2	39.2	17.16	57.19	100	0	P	V
			17355	52.55	-15.65	68.2	45.41	42.24	20.84	55.94	100	0	P	V
														V
802.11ac VHT20 CH 165 5825MHz		11650	44.87	-29.13	74	45.68	39.11	17.16	57.08	100	0	P	H	
		17475	53.46	-14.74	68.2	46.47	42.05	20.93	55.99	100	0	P	H	
													H	
													H	
			11650	42.68	-31.32	74	43.49	39.11	17.16	57.08	100	0	P	V
			17475	52.1	-16.1	68.2	45.11	42.05	20.93	55.99	100	0	P	V
														V
Remark	1. No other spurious found.													
	2. All results are PASS against Peak and Average limit line.													



Band 4 5725~5850MHz

WIFI 802.11ac VHT40 (Band Edge @ 3m)

WIFI Ant. 1+2	Note	Frequency ( MHz )	Level ( dBμV/m )	Over Limit ( dB )	Limit Line ( dBμV/m )	Read Level ( dBμV )	Antenna Factor ( dB/m )	Cable Loss ( dB )	Preamp Factor ( dB )	Ant Pos ( cm )	Table Pos ( deg )	Peak Avg. ( P/A )	Pol. ( H/V )	
		5647.6	53.82	-14.38	68.2	42.54	34.6	11.95	35.27	373	52	P	H	
		5697.2	60.57	-42.57	103.14	49.25	34.6	12	35.28	373	52	P	H	
		5719.6	79.51	-31.18	110.69	68.13	34.6	12.06	35.28	373	52	P	H	
		5720.2	78.31	-32.95	111.26	66.93	34.6	12.06	35.28	373	52	P	H	
	*	5755	105.92	-	-	94.5	34.6	12.11	35.29	373	52	P	H	
	*	5755	97.49	-	-	86.07	34.6	12.11	35.29	373	52	A	H	
		5851.4	51.12	-67.89	119.01	39.55	34.6	12.28	35.31	373	52	P	H	
		5870.6	51.39	-55.04	106.43	39.71	34.6	12.39	35.31	373	52	P	H	
		5913.6	51.78	-24.83	76.61	39.99	34.6	12.51	35.32	373	52	P	H	
		5936.4	49.96	-18.24	68.2	38.18	34.6	12.51	35.33	373	52	P	H	
802.11ac VHT40 CH 151 5755MHz													H	
													H	
			5648.6	53.57	-14.63	68.2	42.29	34.6	11.95	35.27	212	31	P	V
			5697.2	62.32	-40.82	103.14	51	34.6	12	35.28	212	31	P	V
			5717.4	77.97	-32.1	110.07	66.59	34.6	12.06	35.28	212	31	P	V
			5723.2	81.24	-36.86	118.1	69.86	34.6	12.06	35.28	212	31	P	V
		*	5755	105.74	-	-	94.32	34.6	12.11	35.29	212	31	P	V
		*	5755	97.61	-	-	86.19	34.6	12.11	35.29	212	31	A	V
			5852.2	51.69	-65.49	117.18	40.12	34.6	12.28	35.31	212	31	P	V
			5868.8	51.74	-55.19	106.93	40.06	34.6	12.39	35.31	212	31	P	V
			5882.4	51.58	-48.12	99.7	39.91	34.6	12.39	35.32	212	31	P	V
			5935	49.83	-18.37	68.2	38.05	34.6	12.51	35.33	212	31	P	V
														V
														V



WIFI Ant. 1+2	Note	Frequency ( MHz )	Level ( dBμV/m )	Over Limit ( dB )	Limit Line ( dBμV/m )	Read Level ( dBμV )	Antenna Factor ( dB/m )	Cable Loss ( dB )	Preamp Factor ( dB )	Ant Pos ( cm )	Table Pos ( deg )	Peak Avg. ( P/A )	Pol. ( H/V )
		5634.4	50.44	-17.76	68.2	39.16	34.6	11.95	35.27	348	36	P	H
		5695.4	55.71	-46.1	101.81	44.39	34.6	12	35.28	348	36	P	H
		5717.4	57.66	-52.41	110.07	46.28	34.6	12.06	35.28	348	36	P	H
		5724	58.86	-61.06	119.92	47.48	34.6	12.06	35.28	348	36	P	H
	*	5795	106.66	-	-	95.19	34.6	12.17	35.3	348	36	P	H
	*	5795	98.13	-	-	86.66	34.6	12.17	35.3	348	36	A	H
		5853.8	60.28	-53.26	113.54	48.71	34.6	12.28	35.31	348	36	P	H
		5860	59.03	-50.37	109.4	47.46	34.6	12.28	35.31	348	36	P	H
		5877	54.25	-49.46	103.71	42.58	34.6	12.39	35.32	348	36	P	H
		5933	52.84	-15.36	68.2	41.06	34.6	12.51	35.33	348	36	P	H
802.11ac													H
VHT40													H
CH 159		5606	49.77	-18.43	68.2	38.54	34.6	11.89	35.26	220	30	P	V
5795MHz		5698	57.1	-46.63	103.73	45.78	34.6	12	35.28	220	30	P	V
		5718	58.34	-51.9	110.24	46.96	34.6	12.06	35.28	220	30	P	V
		5723	60.32	-57.32	117.64	48.94	34.6	12.06	35.28	220	30	P	V
	*	5795	105.72	-	-	94.25	34.6	12.17	35.3	220	30	P	V
	*	5795	97.07	-	-	85.6	34.6	12.17	35.3	220	30	A	V
		5851.4	59.66	-59.35	119.01	48.09	34.6	12.28	35.31	220	30	P	V
		5856	58.52	-52	110.52	46.95	34.6	12.28	35.31	220	30	P	V
		5875.6	53.54	-51.21	104.75	41.87	34.6	12.39	35.32	220	30	P	V
		5949.8	50.47	-17.73	68.2	38.58	34.6	12.62	35.33	220	30	P	V
													V
													V
Remark	1. No other spurious found. 2. All results are PASS against Peak and Average limit line.												





Band 4 5725~5850MHz

WIFI 802.11ac VHT40 (Harmonic @ 3m)

WIFI Ant. 1+2	Note	Frequency ( MHz )	Level ( dBμV/m )	Over Limit ( dB )	Limit Line ( dBμV/m )	Read Level ( dBμV )	Antenna Factor ( dB/m )	Cable Loss ( dB )	Preamp Factor ( dB )	Ant Pos ( cm )	Table Pos ( deg )	Peak Avg. ( P/A )	Pol. ( H/V )	
802.11ac VHT40 CH 151 5755MHz		11510	43.67	-30.33	74	44.51	39.3	17.16	57.3	100	0	P	H	
		17268	50.59	-17.61	68.2	43.34	42.37	20.79	55.91	100	0	P	H	
													H	
													H	
			11510	43.59	-30.41	74	44.43	39.3	17.16	57.3	100	0	P	V
			17268	51.02	-17.18	68.2	43.77	42.37	20.79	55.91	100	0	P	V
														V
802.11ac VHT40 CH 159 5795MHz		11590	43.61	-30.39	74	44.43	39.18	17.16	57.16	100	0	P	H	
		17388	48.98	-19.22	68.2	41.87	42.19	20.87	55.95	100	0	P	H	
													H	
													H	
			11590	44.39	-29.61	74	45.21	39.18	17.16	57.16	100	0	P	V
			17388	48.94	-19.26	68.2	41.83	42.19	20.87	55.95	100	0	P	V
														V
Remark	1. No other spurious found.													
	2. All results are PASS against Peak and Average limit line.													



Band 4 5725~5850MHz

WIFI 802.11ac VHT80 (Band Edge @ 3m)

WIFI Ant. 1+2	Note	Frequency ( MHz )	Level ( dBμV/m )	Over Limit ( dB )	Limit Line ( dBμV/m )	Read Level ( dBμV )	Antenna Factor ( dB/m )	Cable Loss ( dB )	Preamp Factor ( dB )	Ant Pos ( cm )	Table Pos ( deg )	Peak Avg. ( P/A )	Pol. ( H/V )
		5643.8	59.77	-8.43	68.2	48.49	34.6	11.95	35.27	351	41	P	H
		5700	74.95	-30.25	105.2	63.63	34.6	12	35.28	351	41	P	H
		5718	79.32	-30.92	110.24	67.94	34.6	12.06	35.28	351	41	P	H
		5723.6	77.78	-41.23	119.01	66.4	34.6	12.06	35.28	351	41	P	H
	*	5775	104.01	-	-	92.6	34.6	12.11	35.3	351	41	P	H
	*	5775	95.53	-	-	84.12	34.6	12.11	35.3	351	41	A	H
		5852.8	73.45	-42.37	115.82	61.88	34.6	12.28	35.31	351	41	P	H
		5856.2	72.72	-37.74	110.46	61.15	34.6	12.28	35.31	351	41	P	H
		5875.2	68.16	-36.89	105.05	56.49	34.6	12.39	35.32	351	41	P	H
		5941.6	53.64	-14.56	68.2	41.75	34.6	12.62	35.33	351	41	P	H
802.11ac													H
VHT80													H
CH 155		5647.8	61.25	-6.95	68.2	49.97	34.6	11.95	35.27	224	30	P	V
5775MHz		5698	75.42	-28.31	103.73	64.1	34.6	12	35.28	224	30	P	V
		5715.8	78.92	-30.71	109.63	67.54	34.6	12.06	35.28	224	30	P	V
		5722.8	79.2	-37.98	117.18	67.82	34.6	12.06	35.28	224	30	P	V
	*	5775	102.82	-	-	91.41	34.6	12.11	35.3	224	30	P	V
	*	5775	94.6	-	-	83.19	34.6	12.11	35.3	224	30	A	V
		5853.2	73.03	-41.87	114.9	61.46	34.6	12.28	35.31	224	30	P	V
		5857.8	72.64	-37.37	110.01	61.07	34.6	12.28	35.31	224	30	P	V
		5875.4	65.14	-39.76	104.9	53.47	34.6	12.39	35.32	224	30	P	V
		5932.6	52.38	-15.82	68.2	40.6	34.6	12.51	35.33	224	30	P	V
													V
													V
Remark	1. No other spurious found. 2. All results are PASS against Peak and Average limit line.												



Band 4 5725~5850MHz

WIFI 802.11ac VHT80 (Harmonic @ 3m)

WIFI Ant. 1+2	Note	Frequency ( MHz )	Level ( dBμV/m )	Over Limit ( dB )	Limit Line ( dBμV/m )	Read Level ( dBμV )	Antenna Factor ( dB/m )	Cable Loss ( dB )	Preamp Factor ( dB )	Ant Pos ( cm )	Table Pos ( deg )	Peak Avg. ( P/A )	Pol. ( H/V )	
802.11ac VHT80 CH 155 5775MHz		11550	42.32	-31.68	74	43.15	39.23	17.16	57.22	100	0	P	H	
		17328	47.32	-20.88	68.2	40.15	42.29	20.81	55.93	100	0	P	H	
													H	
													H	
			11550	42.62	-31.38	74	43.45	39.23	17.16	57.22	100	0	P	V
			17328	47.22	-20.98	68.2	40.05	42.29	20.81	55.93	100	0	P	V
														V
Remark	1. No other spurious found. 2. All results are PASS against Peak and Average limit line.													



Emission below 1GHz

5GHz WIFI 802.11n VHT80 (LF @ 3m)

WIFI	Note	Frequency	Level	Over	Limit	Read	Antenna	Cable	Preamp	Ant	Table	Peak	Pol.	
Ant.				Limit	Line	Level	Factor	Loss	Factor	Pos	Pos	Avg.		
1+2		( MHz )	( dBµV/m )	( dB )	( dBµV/m )	( dBµV )	( dB/m )	( dB )	( dB )	( cm )	( deg )	( P/A )	( H/V )	
5GHz 802.11n VHT80 LF		148.8	38.62	-4.88	43.5	50.19	17.75	1.78	31.1	100	298	P	H	
		225.48	30.6	-15.4	46	42.65	16.88	2.07	31	-	-	P	H	
		297.57	35.29	-10.71	46	44.21	19.78	2.32	31.02	-	-	P	H	
		456.1	27.21	-18.79	46	31.87	23.23	2.89	30.78	-	-	P	H	
		764.8	31.53	-14.47	46	30.73	27.35	3.82	30.37	-	-	P	H	
		930.7	33.94	-12.06	46	30.43	29.75	4.12	30.36	-	-	P	H	
														H
														H
														H
														H
														H
														H
			76.98	34.33	-5.67	40	50.79	13.46	1.28	31.2	100	88	P	V
			115.59	33.17	-10.33	43.5	45.13	17.63	1.55	31.14	-	-	P	V
			268.68	29.29	-16.71	46	38.51	19.46	2.32	31	-	-	P	V
			319.6	29.16	-16.84	46	37.38	20.37	2.41	31	-	-	P	V
			632.5	29.59	-16.41	46	30.84	25.72	3.57	30.54	-	-	P	V
			931.4	33.68	-12.32	46	30.17	29.75	4.12	30.36	-	-	P	V
													V	
													V	
													V	
													V	
													V	
													V	
Remark	1. No other spurious found. 2. All results are PASS against limit line.													



**Note symbol**

*	<b>Fundamental Frequency</b> which can be ignored. However, the level of any unwanted emissions shall not exceed the level of the fundamental frequency.
!	Test result is <b>over limit</b> line.
P/A	<b>Peak</b> or <b>Average</b>
H/V	<b>Horizontal</b> or <b>Vertical</b>



A calculation example for radiated spurious emission is shown as below:

WIFI	Note	Frequency	Level	Over	Limit	Read	Antenna	Cable	Preamp	Ant	Table	Peak	Pol.
Ant.				Limit	Line	Level	Factor	Loss	Factor	Pos	Pos	Avg.	
1+2		( MHz )	( dBμV/m )	( dB )	( dBμV/m )	( dBμV )	( dB/m )	( dB )	( dB )	( cm )	( deg )	( P/A )	( H/V )
802.11b		2390	55.45	-18.55	74	54.51	32.22	4.58	35.86	103	308	P	H
CH 01													
2412MHz		2390	43.54	-10.46	54	42.6	32.22	4.58	35.86	103	308	A	H

- Level(dBμV/m) =  
Antenna Factor(dB/m) + Cable Loss(dB) + Read Level(dBμV) - Preamp Factor(dB)
- Over Limit(dB) = Level(dBμV/m) – Limit Line(dBμV/m)

**For Peak Limit @ 2390MHz:**

- Level(dBμV/m)  
= Antenna Factor(dB/m) + Cable Loss(dB) + Read Level(dBμV) - Preamp Factor(dB)  
= 32.22(dB/m) + 4.58(dB) + 54.51(dBμV) – 35.86 (dB)  
= 55.45 (dBμV/m)
- Over Limit(dB)  
= Level(dBμV/m) – Limit Line(dBμV/m)  
= 55.45(dBμV/m) – 74(dBμV/m)  
= -18.55(dB)

**For Average Limit @ 2390MHz:**

- Level(dBμV/m)  
= Antenna Factor(dB/m) + Cable Loss(dB) + Read Level(dBμV) - Preamp Factor(dB)  
= 32.22(dB/m) + 4.58(dB) + 42.6(dBμV) – 35.86 (dB)  
= 43.54 (dBμV/m)
- Over Limit(dB)  
= Level(dBμV/m) – Limit Line(dBμV/m)  
= 43.54(dBμV/m) – 54(dBμV/m)  
= -10.46(dB)

Both peak and average measured complies with the limit line, so test result is “PASS”.



<TXBF Modes>

Band 4 - 5725~5850MHz

WIFI 802.11ac VHT20 (Band Edge @ 3m)

WIFI Ant.	Note	Frequency	Level	Over Limit	Limit Line	Read Level	Antenna Factor	Cable Loss	Preamp Factor	Ant Pos	Table Pos	Peak Avg.	Pol.	
1+2		( MHz )	( dBμV/m )	( dB )	( dBμV/m )	( dBμV )	( dB/m )	( dB )	( dB )	( cm )	( deg )	( P/A )	( H/V )	
802.11ac VHT20 CH 149 5745MHz		5640.8	50.67	-17.53	68.2	39.39	34.6	11.95	35.27	335	0	P	H	
		5694.2	53.18	-47.74	100.92	41.86	34.6	12	35.28	335	0	P	H	
		5719.8	66.49	-44.25	110.74	55.11	34.6	12.06	35.28	335	0	P	H	
		5723.4	68.05	-50.5	118.55	56.67	34.6	12.06	35.28	335	0	P	H	
	*	5745	108.82	-	-	97.4	34.6	12.11	35.29	335	0	P	H	
	*	5745	101.06	-	-	89.64	34.6	12.11	35.29	335	0	A	H	
														H
														H
			5626.6	50.58	-17.62	68.2	39.3	34.6	11.95	35.27	118	298	P	V
			5699.4	56.72	-48.04	104.76	45.4	34.6	12	35.28	118	298	P	V
			5712.8	66.5	-42.29	108.79	55.12	34.6	12.06	35.28	118	298	P	V
			5721.8	72.95	-41.95	114.9	61.57	34.6	12.06	35.28	118	298	P	V
	*		5745	110.89	-	-	99.47	34.6	12.11	35.29	118	298	P	V
	*		5745	103.43	-	-	92.01	34.6	12.11	35.29	118	298	A	V
													V	
													V	



WIFI Ant. 1+2	Note	Frequency ( MHz )	Level ( dBμV/m )	Over Limit ( dB )	Limit Line ( dBμV/m )	Read Level ( dBμV )	Antenna Factor ( dB/m )	Cable Loss ( dB )	Preamp Factor ( dB )	Ant Pos ( cm )	Table Pos ( deg )	Peak Avg. ( P/A )	Pol. ( H/V )
		5629.2	51.09	-17.11	68.2	39.81	34.6	11.95	35.27	345	0	P	H
		5666.2	49.77	-30.45	80.22	38.44	34.6	12	35.27	345	0	P	H
		5717.6	50.25	-59.88	110.13	38.87	34.6	12.06	35.28	345	0	P	H
		5720.8	48.14	-64.48	112.62	36.76	34.6	12.06	35.28	345	0	P	H
	*	5785	108.94	-	-	97.47	34.6	12.17	35.3	345	0	P	H
	*	5785	101.13	-	-	89.66	34.6	12.17	35.3	345	0	A	H
		5854	48.74	-64.34	113.08	37.17	34.6	12.28	35.31	345	0	P	H
		5865.4	49.55	-58.34	107.89	37.87	34.6	12.39	35.31	345	0	P	H
		5890.2	50.09	-43.83	93.92	38.42	34.6	12.39	35.32	345	0	P	H
		5949.6	49.81	-18.39	68.2	37.92	34.6	12.62	35.33	345	0	P	H
802.11ac													H
VHT20													H
CH 157		5636.8	49.91	-18.29	68.2	38.63	34.6	11.95	35.27	118	338	P	V
5785MHz		5693.8	51.48	-49.15	100.63	40.16	34.6	12	35.28	118	338	P	V
		5718.4	50.48	-59.87	110.35	39.1	34.6	12.06	35.28	118	338	P	V
		5724.4	49.62	-71.21	120.83	38.24	34.6	12.06	35.28	118	338	P	V
	*	5785	110.2	-	-	98.73	34.6	12.17	35.3	118	338	P	V
	*	5785	102.05	-	-	90.58	34.6	12.17	35.3	118	338	A	V
		5850.2	49.65	-72.09	121.74	38.08	34.6	12.28	35.31	118	338	P	V
		5861.2	49.73	-59.33	109.06	38.05	34.6	12.39	35.31	118	338	P	V
		5885.6	49.67	-47.66	97.33	38	34.6	12.39	35.32	118	338	P	V
		5942.2	50.2	-18	68.2	38.31	34.6	12.62	35.33	118	338	P	V
													V
													V





WIFI Ant. 1+2	Note	Frequency ( MHz )	Level ( dBμV/m )	Over Limit ( dB )	Limit Line ( dBμV/m )	Read Level ( dBμV )	Antenna Factor ( dB/m )	Cable Loss ( dB )	Preamp Factor ( dB )	Ant Pos ( cm )	Table Pos ( deg )	Peak Avg. ( P/A )	Pol. ( H/V )	
802.11ac VHT20 CH 165 5825MHz	*	5825	107.13	-	-	95.56	34.6	12.28	35.31	246	360	P	H	
	*	5825	99.04	-	-	87.47	34.6	12.28	35.31	246	360	A	H	
		5850.8	61.94	-58.44	120.38	50.37	34.6	12.28	35.31	246	360	P	H	
		5857	57.5	-52.74	110.24	45.93	34.6	12.28	35.31	246	360	P	H	
		5877.4	52.46	-50.96	103.42	40.79	34.6	12.39	35.32	246	360	P	H	
		5931.2	49.48	-18.72	68.2	37.7	34.6	12.51	35.33	246	360	P	H	
														H
														H
	*	5825	110.66	-	-	99.09	34.6	12.28	35.31	102	341	P	V	
	*	5825	102.74	-	-	91.17	34.6	12.28	35.31	102	341	A	V	
		5851.2	62.14	-57.32	119.46	50.57	34.6	12.28	35.31	102	341	P	V	
		5857.2	56.2	-53.98	110.18	44.63	34.6	12.28	35.31	102	341	P	V	
		5876.6	53.37	-50.64	104.01	41.7	34.6	12.39	35.32	102	341	P	V	
		5940.8	50.24	-17.96	68.2	38.35	34.6	12.62	35.33	102	341	P	V	
														V
													V	
<b>Remark</b>	1. No other spurious found. 2. All results are PASS against Peak and Average limit line.													



Band 4 5725~5850MHz

WIFI 802.11ac VHT20 (Harmonic @ 3m)

WIFI Ant. 1+2	Note	Frequency ( MHz )	Level ( dBμV/m )	Over Limit ( dB )	Limit Line ( dBμV/m )	Read Level ( dBμV )	Antenna Factor ( dB/m )	Cable Loss ( dB )	Preamp Factor ( dB )	Ant Pos ( cm )	Table Pos ( deg )	Peak Avg. ( P/A )	Pol. ( H/V )	
802.11ac VHT20 CH 149 5745MHz		11490	41.73	-32.27	74	42.64	39.27	17.16	57.34	100	0	P	H	
		17235	51.59	-16.61	68.2	44.29	42.43	20.76	55.89	100	0	P	H	
													H	
													H	
			11490	43.39	-30.61	74	44.3	39.27	17.16	57.34	100	0	P	V
			17235	54.28	-13.92	68.2	46.98	42.43	20.76	55.89	100	0	P	V
														V
802.11ac VHT20 CH 157 5785MHz		11570	42.43	-31.57	74	43.26	39.2	17.16	57.19	100	0	P	H	
		17355	50.96	-17.24	68.2	43.82	42.24	20.84	55.94	100	0	P	H	
													H	
													H	
			11570	42.81	-31.19	74	43.64	39.2	17.16	57.19	100	0	P	V
			17355	50.53	-17.67	68.2	43.39	42.24	20.84	55.94	100	0	P	V
														V
802.11ac VHT20 CH 165 5825MHz		11650	42.12	-31.88	74	42.93	39.11	17.16	57.08	100	0	P	H	
		17475	53.05	-15.15	68.2	46.06	42.05	20.93	55.99	100	0	P	H	
													H	
													H	
			11650	41.76	-32.24	74	42.57	39.11	17.16	57.08	100	0	P	V
			17475	51.12	-17.08	68.2	44.13	42.05	20.93	55.99	100	0	P	V
														V
Remark	1. No other spurious found.													
	2. All results are PASS against Peak and Average limit line.													



Band 4 5725~5850MHz

WIFI 802.11ac VHT40 (Band Edge @ 3m)

WIFI Ant. 1+2	Note	Frequency ( MHz )	Level ( dBμV/m )	Over Limit ( dB )	Limit Line ( dBμV/m )	Read Level ( dBμV )	Antenna Factor ( dB/m )	Cable Loss ( dB )	Preamp Factor ( dB )	Ant Pos ( cm )	Table Pos ( deg )	Peak Avg. ( P/A )	Pol. ( H/V )
		5632.8	50.32	-17.88	68.2	39.04	34.6	11.95	35.27	380	0	P	H
		5697.2	54.89	-48.25	103.14	43.57	34.6	12	35.28	380	0	P	H
		5720	62.43	-48.37	110.8	51.05	34.6	12.06	35.28	380	0	P	H
		5723.2	62.6	-55.5	118.1	51.22	34.6	12.06	35.28	380	0	P	H
	*	5755	105.26	-	-	93.84	34.6	12.11	35.29	380	0	P	H
	*	5755	97.67	-	-	86.25	34.6	12.11	35.29	380	0	A	H
		5853.4	49.17	-65.28	114.45	37.6	34.6	12.28	35.31	380	0	P	H
		5859.4	49.66	-59.91	109.57	38.09	34.6	12.28	35.31	380	0	P	H
		5910.2	50.14	-28.98	79.12	38.35	34.6	12.51	35.32	380	0	P	H
		5946.2	49.99	-18.21	68.2	38.1	34.6	12.62	35.33	380	0	P	H
													H
													H
802.11ac VHT40 CH 151 5755MHz		5642.8	52.29	-15.91	68.2	41.01	34.6	11.95	35.27	106	299	P	V
		5694.6	61.27	-39.95	101.22	49.95	34.6	12	35.28	106	299	P	V
		5719.8	68.98	-41.76	110.74	57.6	34.6	12.06	35.28	106	299	P	V
		5724.6	70.58	-50.71	121.29	59.2	34.6	12.06	35.28	106	299	P	V
	*	5755	106.92	-	-	95.5	34.6	12.11	35.29	106	299	P	V
	*	5755	98.99	-	-	87.57	34.6	12.11	35.29	106	299	A	V
		5851	50.98	-68.94	119.92	39.41	34.6	12.28	35.31	106	299	P	V
		5862.8	50.47	-58.14	108.61	38.79	34.6	12.39	35.31	106	299	P	V
		5903.6	50.37	-33.63	84	38.58	34.6	12.51	35.32	106	299	P	V
		5931.2	50.4	-17.8	68.2	38.62	34.6	12.51	35.33	106	299	P	V
													V
													V



WIFI Ant. 1+2	Note	Frequency ( MHz )	Level ( dBμV/m )	Over Limit ( dB )	Limit Line ( dBμV/m )	Read Level ( dBμV )	Antenna Factor ( dB/m )	Cable Loss ( dB )	Preamp Factor ( dB )	Ant Pos ( cm )	Table Pos ( deg )	Peak Avg. ( P/A )	Pol. ( H/V )
		5616.2	49.45	-18.75	68.2	38.22	34.6	11.89	35.26	328	0	P	H
		5683	52.04	-40.62	92.66	40.72	34.6	12	35.28	328	0	P	H
		5715.8	52.93	-56.7	109.63	41.55	34.6	12.06	35.28	328	0	P	H
		5722	53.74	-61.62	115.36	42.36	34.6	12.06	35.28	328	0	P	H
	*	5795	106.14	-	-	94.67	34.6	12.17	35.3	328	0	P	H
	*	5795	97.42	-	-	85.95	34.6	12.17	35.3	328	0	A	H
		5850	52.52	-69.68	122.2	40.95	34.6	12.28	35.31	328	0	P	H
		5861	51.25	-57.87	109.12	39.57	34.6	12.39	35.31	328	0	P	H
		5878.2	50.53	-52.29	102.82	38.86	34.6	12.39	35.32	328	0	P	H
		5933.8	50.67	-17.53	68.2	38.89	34.6	12.51	35.33	328	0	P	H
802.11ac													H
VHT40													H
CH 159		5629	49.77	-18.43	68.2	38.49	34.6	11.95	35.27	119	301	P	V
5795MHz		5697	51.49	-51.5	102.99	40.17	34.6	12	35.28	119	301	P	V
		5711.4	55.14	-53.25	108.39	43.76	34.6	12.06	35.28	119	301	P	V
		5721.4	56.03	-57.96	113.99	44.65	34.6	12.06	35.28	119	301	P	V
	*	5795	108.43	-	-	96.96	34.6	12.17	35.3	119	301	P	V
	*	5795	98.73	-	-	87.26	34.6	12.17	35.3	119	301	A	V
		5851	56.11	-63.81	119.92	44.54	34.6	12.28	35.31	119	301	P	V
		5858.8	54.85	-54.88	109.73	43.28	34.6	12.28	35.31	119	301	P	V
		5877.4	51.88	-51.54	103.42	40.21	34.6	12.39	35.32	119	301	P	V
		5939.4	49.44	-18.76	68.2	37.66	34.6	12.51	35.33	119	301	P	V
													V
													V
Remark	1. No other spurious found. 2. All results are PASS against Peak and Average limit line.												



Band 4 5725~5850MHz

WIFI 802.11ac VHT40 (Harmonic @ 3m)

WIFI Ant. 1+2	Note	Frequency ( MHz )	Level ( dBμV/m )	Over Limit ( dB )	Limit Line ( dBμV/m )	Read Level ( dBμV )	Antenna Factor ( dB/m )	Cable Loss ( dB )	Preamp Factor ( dB )	Ant Pos ( cm )	Table Pos ( deg )	Peak Avg. ( P/A )	Pol. ( H/V )	
802.11ac VHT40 CH 151 5755MHz		11510	42.19	-31.81	74	43.03	39.3	17.16	57.3	100	0	P	H	
		17265	48.79	-19.41	68.2	41.54	42.37	20.79	55.91	100	0	P	H	
													H	
													H	
			11510	42.41	-31.59	74	43.25	39.3	17.16	57.3	100	0	P	V
			17265	50.75	-17.45	68.2	43.5	42.37	20.79	55.91	100	0	P	V
														V
802.11ac VHT40 CH 159 5795MHz		11590	43.21	-30.79	74	44.03	39.18	17.16	57.16	100	0	P	H	
		17385	45.96	-22.24	68.2	38.85	42.19	20.87	55.95	100	0	P	H	
													H	
													H	
			11590	43.51	-30.49	74	44.33	39.18	17.16	57.16	100	0	P	V
			17385	47.57	-20.63	68.2	40.46	42.19	20.87	55.95	100	0	P	V
														V
Remark	1. No other spurious found.													
	2. All results are PASS against Peak and Average limit line.													



Band 4 5725~5850MHz

WIFI 802.11ac VHT80 (Band Edge @ 3m)

WIFI Ant. 1+2	Note	Frequency ( MHz )	Level ( dBμV/m )	Over Limit ( dB )	Limit Line ( dBμV/m )	Read Level ( dBμV )	Antenna Factor ( dB/m )	Cable Loss ( dB )	Preamp Factor ( dB )	Ant Pos ( cm )	Table Pos ( deg )	Peak Avg. ( P/A )	Pol. ( H/V )
		5627	52.01	-16.19	68.2	40.73	34.6	11.95	35.27	320	0	P	H
		5687.8	60.22	-35.98	96.2	48.9	34.6	12	35.28	320	0	P	H
		5719.8	60.15	-50.59	110.74	48.77	34.6	12.06	35.28	320	0	P	H
		5723.2	59.93	-58.17	118.1	48.55	34.6	12.06	35.28	320	0	P	H
	*	5775	100.92	-	-	89.51	34.6	12.11	35.3	320	0	P	H
	*	5775	93.32	-	-	81.91	34.6	12.11	35.3	320	0	A	H
		5854	62.06	-51.02	113.08	50.49	34.6	12.28	35.31	320	0	P	H
		5859.4	57.96	-51.61	109.57	46.39	34.6	12.28	35.31	320	0	P	H
		5898.8	50.49	-37.06	87.55	38.82	34.6	12.39	35.32	320	0	P	H
		5945.6	49.88	-18.32	68.2	37.99	34.6	12.62	35.33	320	0	P	H
802.11ac													H
VHT80													H
CH 155		5630	53.5	-14.7	68.2	42.22	34.6	11.95	35.27	100	340	P	V
5775MHz		5697	64.77	-38.22	102.99	53.45	34.6	12	35.28	100	340	P	V
		5711	65.72	-42.56	108.28	54.34	34.6	12.06	35.28	100	340	P	V
		5723.4	67.43	-51.12	118.55	56.05	34.6	12.06	35.28	100	340	P	V
	*	5775	102.77	-	-	91.36	34.6	12.11	35.3	100	340	P	V
	*	5775	94.66	-	-	83.25	34.6	12.11	35.3	100	340	A	V
		5854.2	60.06	-52.56	112.62	48.49	34.6	12.28	35.31	100	340	P	V
		5865.8	57.77	-50	107.77	46.09	34.6	12.39	35.31	100	340	P	V
		5881	53.88	-46.86	100.74	42.21	34.6	12.39	35.32	100	340	P	V
		5948.2	51.02	-17.18	68.2	39.13	34.6	12.62	35.33	100	340	P	V
													V
													V
Remark	1. No other spurious found. 2. All results are PASS against Peak and Average limit line.												



Band 4 5725~5850MHz

WIFI 802.11ac VHT80 (Harmonic @ 3m)

WIFI Ant. 1+2	Note	Frequency ( MHz )	Level ( dBμV/m )	Over Limit ( dB )	Limit Line ( dBμV/m )	Read Level ( dBμV )	Antenna Factor ( dB/m )	Cable Loss ( dB )	Preamp Factor ( dB )	Ant Pos ( cm )	Table Pos ( deg )	Peak Avg. ( P/A )	Pol. ( H/V )	
802.11ac VHT80 CH 155 5775MHz		11550	43.86	-30.14	74	44.69	39.23	17.16	57.22	100	0	P	H	
		17325	46.39	-21.81	68.2	39.22	42.29	20.81	55.93	100	0	P	H	
													H	
													H	
			11550	43.77	-30.23	74	44.6	39.23	17.16	57.22	100	0	P	V
			17325	47.81	-20.39	68.2	40.64	42.29	20.81	55.93	100	0	P	V
														V
Remark	1. No other spurious found. 2. All results are PASS against Peak and Average limit line.													



Emission below 1GHz

5GHz WIFI 802.11n VHT80 (LF @ 3m)

WIFI	Note	Frequency	Level	Over	Limit	Read	Antenna	Cable	Preamp	Ant	Table	Peak	Pol.	
Ant.				Limit	Line	Level	Factor	Loss	Factor	Pos	Pos	Avg.		
1+2		( MHz )	( dBμV/m )	( dB )	( dBμV/m )	( dBμV )	( dB/m )	( dB )	( dB )	( cm )	( deg )	(P/A)	(H/V)	
5GHz 802.11n VHT80 LF		149.34	38.83	-4.67	43.5	50.42	17.73	1.78	31.1	100	312	P	H	
		225.48	34.44	-11.56	46	46.49	16.88	2.07	31	-	-	P	H	
		296.76	34.09	-11.91	46	43.03	19.77	2.32	31.03	-	-	P	H	
		565.3	26.91	-19.09	46	29.56	24.85	3.24	30.74	-	-	P	H	
		835.5	32.6	-13.4	46	30.46	28.41	4.1	30.37	-	-	P	H	
		996.5	33.92	-20.08	54	29.87	30.29	3.98	30.22	-	-	P	H	
														H
														H
														H
														H
														H
														H
														H
														H
			77.25	34	-6	40	50.35	13.57	1.28	31.2	100	75	P	V
			116.13	33.51	-9.99	43.5	45.42	17.68	1.55	31.14	-	-	P	V
			221.16	30.61	-15.39	46	43.06	16.48	2.07	31	-	-	P	V
			324.5	28.08	-17.92	46	36.17	20.5	2.41	31	-	-	P	V
			669.6	29.32	-16.68	46	30.04	26.09	3.65	30.46	-	-	P	V
			967.1	34.01	-19.99	54	30.04	30.23	4.07	30.33	-	-	P	V
													V	
													V	
													V	
													V	
													V	
													V	
<b>Remark</b>	1. No other spurious found. 2. All results are PASS against limit line.													





**Note symbol**

*	<b>Fundamental Frequency</b> which can be ignored. However, the level of any unwanted emissions shall not exceed the level of the fundamental frequency.
!	Test result is <b>over limit</b> line.
P/A	<b>Peak</b> or <b>Average</b>
H/V	<b>Horizontal</b> or <b>Vertical</b>



A calculation example for radiated spurious emission is shown as below:

WIFI	Note	Frequency	Level	Over	Limit	Read	Antenna	Cable	Preamp	Ant	Table	Peak	Pol.
Ant.				Limit	Line	Level	Factor	Loss	Factor	Pos	Pos	Avg.	
1+2		( MHz )	( dBμV/m )	( dB )	( dBμV/m )	( dBμV )	( dB/m )	( dB )	( dB )	( cm )	( deg )	( P/A )	( H/V )
802.11b		2390	55.45	-18.55	74	54.51	32.22	4.58	35.86	103	308	P	H
CH 01													
2412MHz		2390	43.54	-10.46	54	42.6	32.22	4.58	35.86	103	308	A	H

- Level(dBμV/m) =  
Antenna Factor(dB/m) + Cable Loss(dB) + Read Level(dBμV) - Preamp Factor(dB)
- Over Limit(dB) = Level(dBμV/m) – Limit Line(dBμV/m)

**For Peak Limit @ 2390MHz:**

- Level(dBμV/m)  
= Antenna Factor(dB/m) + Cable Loss(dB) + Read Level(dBμV) - Preamp Factor(dB)  
= 32.22(dB/m) + 4.58(dB) + 54.51(dBμV) – 35.86 (dB)  
= 55.45 (dBμV/m)
- Over Limit(dB)  
= Level(dBμV/m) – Limit Line(dBμV/m)  
= 55.45(dBμV/m) – 74(dBμV/m)  
= -18.55(dB)

**For Average Limit @ 2390MHz:**

- Level(dBμV/m)  
= Antenna Factor(dB/m) + Cable Loss(dB) + Read Level(dBμV) - Preamp Factor(dB)  
= 32.22(dB/m) + 4.58(dB) + 42.6(dBμV) – 35.86 (dB)  
= 43.54 (dBμV/m)
- Over Limit(dB)  
= Level(dBμV/m) – Limit Line(dBμV/m)  
= 43.54(dBμV/m) – 54(dBμV/m)  
= -10.46(dB)

Both peak and average measured complies with the limit line, so test result is “PASS”.



## Appendix C. Radiated Spurious Emission Plots

Test Engineer :	Luke Chang, Ken Wu, Derreck Chen, Jesse Wang, and James Chiu	Temperature :	21~24°C
		Relative Humidity :	50~55%

<CDD Modes>

Band 4 - 5725~5850MHz

WIFI 802.11a (Band Edge @ 3m)

WIFI	Band 4 5725~5850MHz Band Edge @ 3m	
ANT	802.11a CH149 5745MHz	
1	Horizontal	Fundamental
Peak	<p> <small>           Date: 2014.08.08            File: 80211a_149_H         </small> </p> <p> <small>           Site: 3008T-RF            Condition: PCAN 30204 15.24 3m HF ANT 13000 HORIZONTAL            Distance: 30m 100 859Hz 120A 200 000Hz SWT Full            Project: 47284            Mode: 11         </small> </p>	<p> <small>           Date: 2014.08.08            File: 80211a_149_F         </small> </p> <p> <small>           Site: 3008T-RF            Condition: PCAN30204 15.24 3m HF ANT 13000 HORIZONTAL            Distance: 30m 100 859Hz 120A 200 000Hz SWT Full            Project: 47284            Mode: 11         </small> </p>

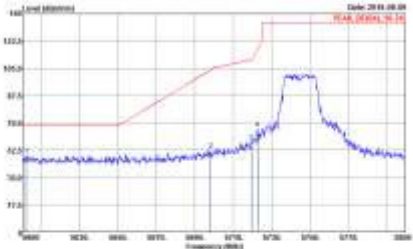
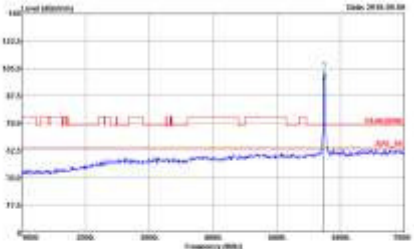

WIFI	Band 4 5725~5850MHz Band Edge @ 3m	
ANT	802.11a CH149 5745MHz	
1	Vertical	Fundamental
Peak	 <p data-bbox="347 719 603 786"> Date: 20081119  Condition: 200MHz BW, 10.04 Jm HP-Ant, 15000 VERTICAL  Duration: 1000.000Hz VSW 2000.000Hz SMT-Ant  Project: 672834  Multi: 11 </p>	 <p data-bbox="944 719 1200 786"> Date: 20081119  Condition: 200MHz BW, 10.04 Jm HP-Ant, 15000 VERTICAL  Duration: 1000.000Hz VSW 2000.000Hz SMT-Ant  Project: 672834  Multi: 11 </p>

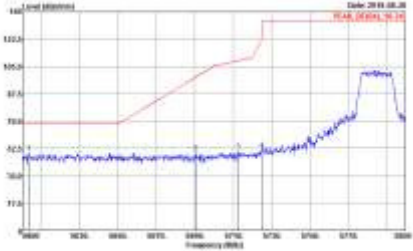
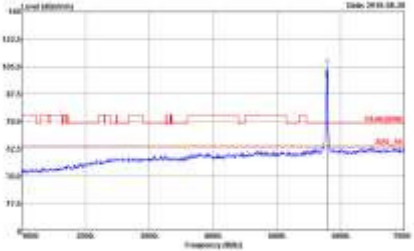
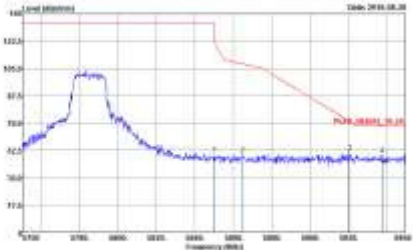

WIFI	Band 4 5725~5850MHz Band Edge @ 3m	
ANT	802.11a CH157 5785MHz	
1	Horizontal	Fundamental
Peak	 <p> <small>Date: 20081107            Condition: 2004W_05204_15.04_3m_HF_Ant_15000_HORIZONTAL            Detector: Peak            Preamp: 420dB            Mode: 12</small> </p>	 <p> <small>Date: 20081107            Condition: 2004W050_3m_HF_Ant_15000_HORIZONTAL            Detector: Peak            Preamp: 420dB            Mode: 12</small> </p>
Peak	 <p> <small>Date: 20081107            Condition: 2004W_05204_15.04_3m_HF_Ant_15000_HORIZONTAL            Detector: Peak            Preamp: 420dB            Mode: 12</small> </p>	Left blank



WIFI	Band 4 5725~5850MHz Band Edge @ 3m	
ANT	802.11a CH157 5785MHz	
1	Vertical	Fundamental
Peak	<p> <small>           Date: 2018.08.28            File: 80211_157_11            Size: 200MB WAV            Condition: FICAR_80211_157_04 15.04 3m RF ANT 15000 VERTICAL            Detector: Peak            Preamp: 67DB            Mode: 12         </small> </p>	<p> <small>           Date: 2018.08.28            File: 80211_157_11            Size: 200MB WAV            Condition: FICAR80211_157_04 15.04 3m RF ANT 15000 VERTICAL            Detector: Peak            Preamp: 67DB            Mode: 12         </small> </p>
Peak	<p> <small>           Date: 2018.08.28            File: 80211_157_11            Size: 200MB WAV            Condition: FICAR_80211_157_04 15.04 3m RF ANT 15000 VERTICAL            Detector: Peak            Preamp: 67DB            Mode: 12         </small> </p>	Left blank

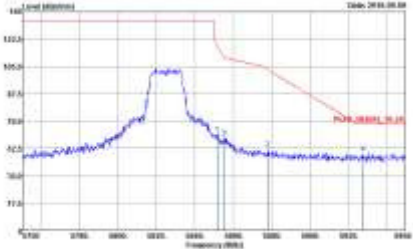
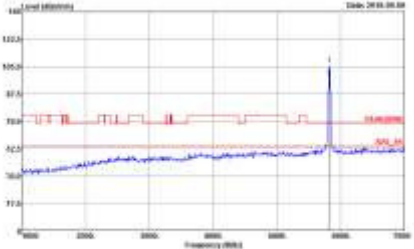

WIFI	Band 4 5725~5850MHz Band Edge @ 3m	
ANT	802.11a CH165 5825MHz	
1	Horizontal	Fundamental
Peak	 <p>File : 200817-01  Condition : PCAN_20204_15-24_3m HF-AMP_15000 HORIZONTAL  Detector : Peak  Project : 47284  Mode : FS</p>	 <p>File : 200817-01  Condition : PCAN20204_15-24_3m HF-AMP_15000 FUNDAMENTAL  Detector : Peak  Project : 47284  Mode : FS</p>

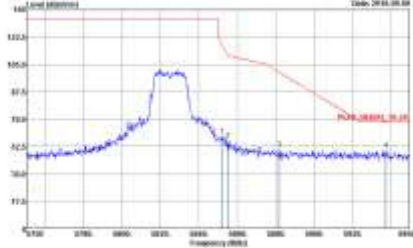
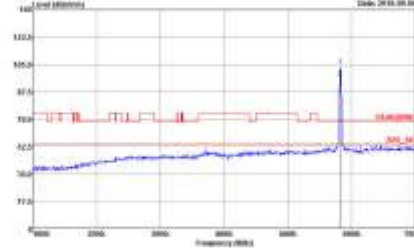

WIFI	Band 4 5725~5850MHz Band Edge @ 3m	
ANT	802.11a CH165 5825MHz	
1	Vertical	Fundamental
Peak	 <p>Site : 300MT-WY  Condition : PCAN_30204_19-04_3m HF ANT_19000 VERTICAL  Distance : 30m 100.00MHz VEA 200.000Hz SWT-Ant  Project : 47204  Make : 19</p>	 <p>Site : 300MT-WY  Condition : PCAN30204_19-04_3m HF ANT_19000 VERTICAL  Distance : 30m 100.00MHz VEA 200.000Hz SWT-Ant  Project : 47204  Make : 19</p>





**Band 4 - 5725~5850MHz**  
**WIFI 802.11a (Harmonic @ 3m)**

WIFI	Band 4 5725~5850MHz Harmonic @ 3m	
ANT	802.11a CH149 5745MHz	
1	Horizontal	Vertical
<p><b>Peak</b> <b>Avg.</b></p>		

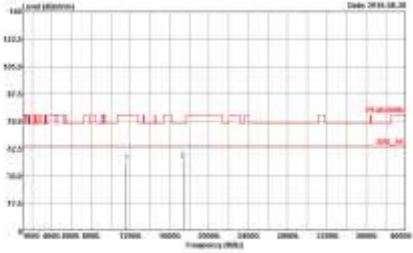
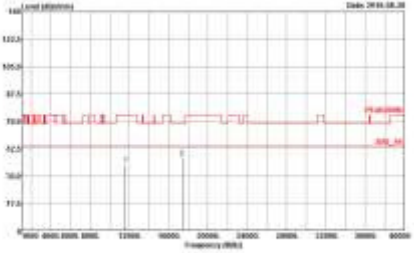

WIFI	Band 4 5725~5850MHz Harmonic @ 3m	
ANT	802.11a CH157 5785MHz	
1	Horizontal	Vertical
Peak Avg.	 <p>Site : SPORTON Condition : PCANUSW 3m 5M CH1, 1152H HORIZONTAL Detector : Peak Preamp : N20M Mode : 12</p>	 <p>Site : SPORTON Condition : PCANUSW 3m 5M CH1, 1152H VERTICAL Detector : Peak Preamp : N20M Mode : 12</p>



WIFI	Band 4 5725~5850MHz Harmonic @ 3m	
ANT	802.11a CH165 5825MHz	
1	Horizontal	Vertical
Peak Avg.		



Emission below 1GHz  
5GHz WIFI 802.11a (LF)

WIFI	5GHz 5725~5850MHz	
ANT	802.11a LF	
1	Horizontal	Vertical
QP / Peak		



**Band 4 - 5725~5850MHz**  
**WIFI 802.11a (Band Edge @ 3m)**

WIFI	Band 4 5725~5850MHz Band Edge @ 3m	
ANT	802.11a CH149 5745MHz	
2	Horizontal	Fundamental
Peak	<p> <small>           Date: 20081114            Condition: 30dBm, 20204, 10.24, 3m HF ANT, 15000 HORIZONTAL            Detector: Peak            Preamp: 40204            Mode: 20         </small> </p>	<p> <small>           Date: 20081114            Condition: 30dBm, 20204, 10.24, 3m HF ANT, 15000 HORIZONTAL            Detector: Peak            Preamp: 40204            Mode: 20         </small> </p>

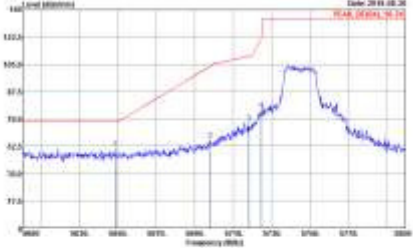
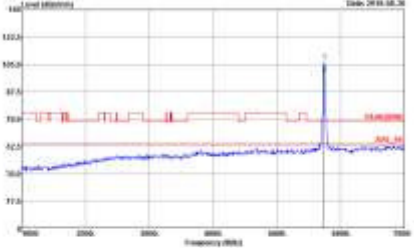

WIFI	Band 4 5725~5850MHz Band Edge @ 3m	
ANT	802.11a CH149 5745MHz	
2	Vertical	Fundamental
Peak	 <p>       Date: 2018.08.28        File: 0101_16.10     </p> <p>       Site: -300MHz        Condition: -70dBm 10.24 10.24 10.24 10.24 VERTICAL        Distance: 1000 1000Hz 1000 1000Hz 1000Hz 1000Hz        Project: 672834        Mode: -28     </p>	 <p>       Date: 2018.08.28        File: 0101_16.10     </p> <p>       Site: -300MHz        Condition: -70dBm 10.24 10.24 10.24 VERTICAL        Distance: 1000 1000Hz 1000 1000Hz 1000Hz 1000Hz        Project: 672834        Mode: -28     </p>

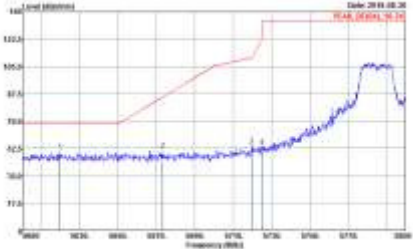
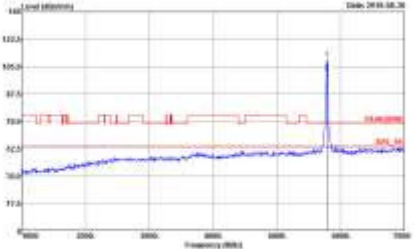
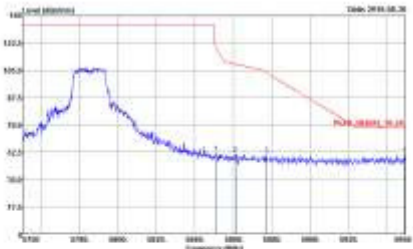

WIFI	Band 4 5725~5850MHz Band Edge @ 3m	
ANT	802.11a CH157 5785MHz	
2	Horizontal	Fundamental
Peak	 <p> <small>           Date: 2018.08.28            File: 80211_15.24         </small> </p> <p> <small>           Size: 300x141            Condition: FICAR_80211_15.24 15.24 15.24 15.24 HORIZONTAL            Detector: Peak            Project: 80211            Mode: -29         </small> </p>	 <p> <small>           Date: 2018.08.28            File: 80211_15.24         </small> </p> <p> <small>           Size: 300x141            Condition: FICAR_80211_15.24 15.24 15.24 15.24 HORIZONTAL            Detector: Peak            Project: 80211            Mode: -29         </small> </p>
Peak	 <p> <small>           Date: 2018.08.28            File: 80211_15.24         </small> </p> <p> <small>           Size: 300x141            Condition: FICAR_80211_15.24 15.24 15.24 15.24 HORIZONTAL            Detector: Peak            Project: 80211            Mode: -29         </small> </p>	Left blank

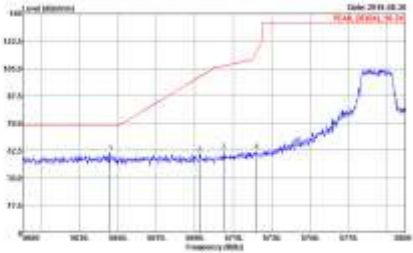
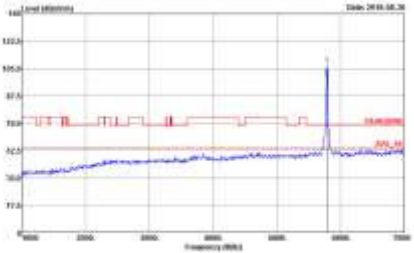
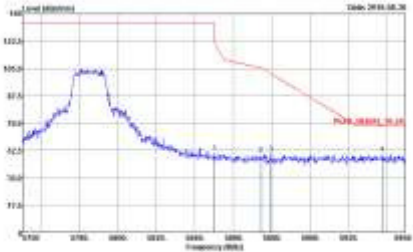

WIFI	Band 4 5725~5850MHz Band Edge @ 3m	
ANT	802.11a CH157 5785MHz	
2	Vertical	Fundamental
Peak	 <p> <small>           Date: 20081107            Condition: 200MHz, 20dB, 10.04 Jm HF ANT, 15000 VERTICAL            Detector: Peak            Preamp: 420dB            Mode: -29         </small> </p>	 <p> <small>           Date: 20081107            Condition: 200MHz, 20dB, 10.04 Jm HF ANT, 15000 VERTICAL            Detector: Peak            Preamp: 420dB            Mode: -29         </small> </p>
Peak	 <p> <small>           Date: 20081107            Condition: 200MHz, 20dB, 10.04 Jm HF ANT, 15000 VERTICAL            Detector: Peak            Preamp: 420dB            Mode: -29         </small> </p>	Left blank





WIFI	Band 4 5725~5850MHz Band Edge @ 3m	
ANT	802.11a CH165 5825MHz	
2	Horizontal	Fundamental
Peak	<p>File : 200817.rtf Condition : 70CAW 30.20A 15.24 km HF ANT 15000 HORIZONTAL Detector : Peak Preamp : 47DBH Mode : 28</p>	<p>File : 200817.rtf Condition : 70CAW 30.20A 15.24 km HF ANT 15000 HORIZONTAL Detector : Peak Preamp : 47DBH Mode : 28</p>

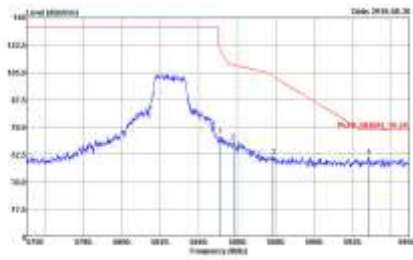
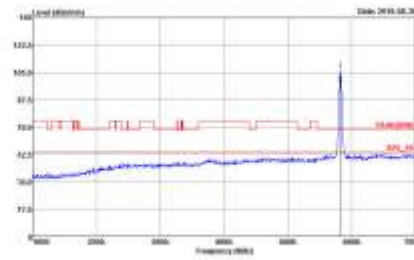

WIFI	Band 4 5725~5850MHz Band Edge @ 3m	
ANT	802.11a CH165 5825MHz	
2	Vertical	Fundamental
Peak	 <p>File: 200817.rtf  Condition: PCAN_80211a_15.04_3m RF-4M 10000 VERTICAL  Detector: Peak  Project: 872834  Mode: 28</p>	 <p>File: 200817.rtf  Condition: PCAN80211a_3m RF-4M 10000 VERTICAL  Detector: Peak  Project: 872834  Mode: 28</p>



Band 4 - 5725~5850MHz
WIFI 802.11a (Harmonic @ 3m)

Table with 3 columns: WIFI, ANT, and measurement results for Horizontal and Vertical orientations. Includes 'Peak Avg.' label and two spectral plots.

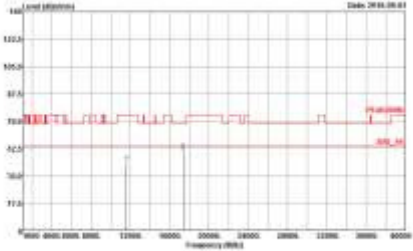
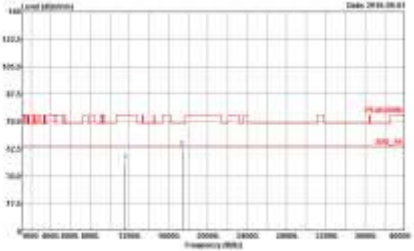

WIFI	Band 4 5725~5850MHz Harmonic @ 3m	
ANT	802.11a CH157 5785MHz	
2	Horizontal	Vertical
Peak Avg.	 <p>Site : 200817 BY          Condition : TCA0196 3m SFP CVF_0152 HORIZONTAL          Date : 7/24          Project : 57284          Mode : 75</p>	 <p>Site : 200817 BY          Condition : TCA0196 3m SFP CVF_0152 VERTICAL          Date : 7/24          Project : 57284          Mode : 75</p>

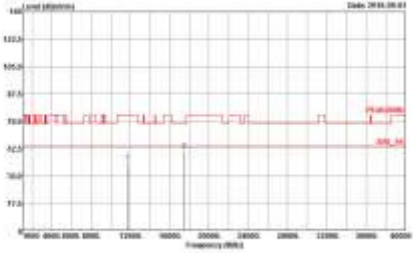
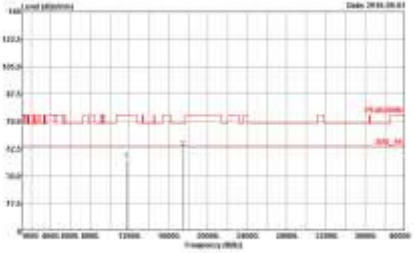

WIFI	Band 4 5725~5850MHz Harmonic @ 3m	
ANT	802.11a CH165 5825MHz	
2	Horizontal	Vertical
Peak Avg.	 <p>Site : SPORTON BY  Condition : PCANUSW 3m 5M CH165 1152H HORIZONTAL  Detector : Peak  Preamp : STD24  Mode : 2H</p>	 <p>Site : SPORTON BY  Condition : PCANUSW 3m 5M CH165 1152H VERTICAL  Detector : Peak  Preamp : STD24  Mode : 2H</p>



Emission below 1GHz  
5GHz WIFI 802.11a (LF)

WIFI	5GHz 5725~5850MHz	
ANT	802.11a LF	
2	Horizontal	Vertical
QP / Peak	<p>Site : 3008T-WY Condition : QP On LF-ANT(34-186) HORIZONTAL Detector : Peak Project : N2024 Mode : IS</p>	<p>Site : 3008T-WY Condition : QP On LF-ANT(34-186) VERTICAL Detector : Peak Project : N2024 Mode : IS</p>



Band 4 - 5725~5850MHz
WIFI 802.11a (Band Edge @ 3m)

Table with 3 columns: WIFI, ANT, and 1+2. The 1+2 column contains two sub-tables: 'Horizontal' and 'Fundamental', each with a spectral plot and technical details like Date, Condition, Reference, Detector, Project, and Mark.

Peak

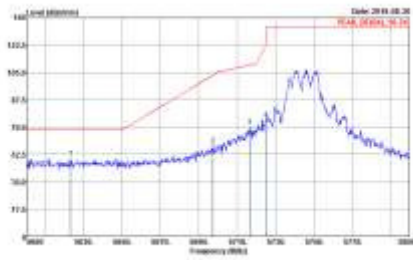
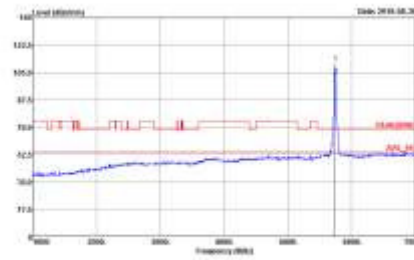

WIFI	Band 4 5725~5850MHz Band Edge @ 3m	
ANT	802.11a CH149 5745MHz	
1+2	Vertical	Fundamental
Peak	 <p> <small>           Date : 20081114            Condition : PCAR_80211a_15.04_3m RF-4M 10000 VERTICAL            Detector : Peak            Project : 8725H            Mode : IS         </small> </p>	 <p> <small>           Date : 20081114            Condition : PCAR80211a_3m RF-4M 10000 VERTICAL            Detector : Peak            Project : 8725H            Mode : IS         </small> </p>



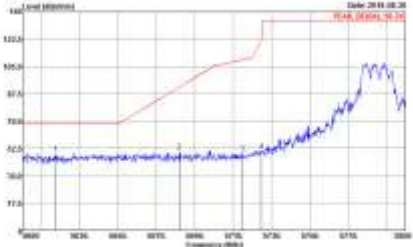
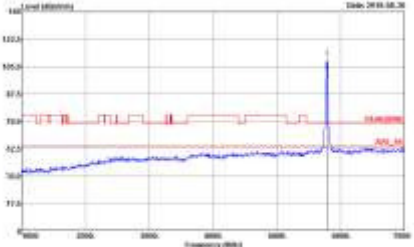
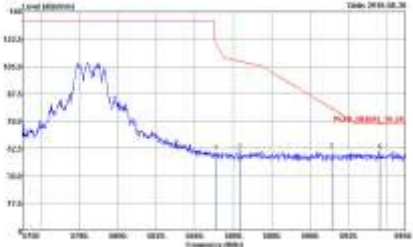

WIFI	Band 4 5725~5850MHz Band Edge @ 3m	
ANT	802.11a CH157 5785MHz	
1+2	Horizontal	Fundamental
Peak	 <p> <small>Site : 3008T-WF            Condition : PCAN_30204_15-04_3m HF-AMP_15000 HORIZONTAL            Detector : Peak            Project : 47024            Mode : 00</small> </p>	 <p> <small>Site : 3008T-WF            Condition : PCAN30204_3m HF-AMP_15000 FUNDAMENTAL            Detector : Peak            Project : 47024            Mode : 00</small> </p>
Peak	 <p> <small>Site : 3008T-WF            Condition : PCAN_30204_15-04_3m HF-AMP_15000 HORIZONTAL            Detector : Peak            Project : 47024            Mode : 00</small> </p>	Left blank

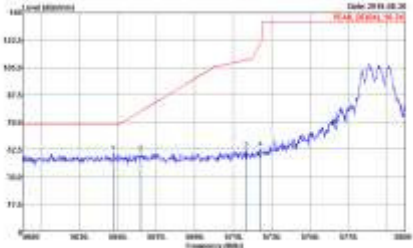
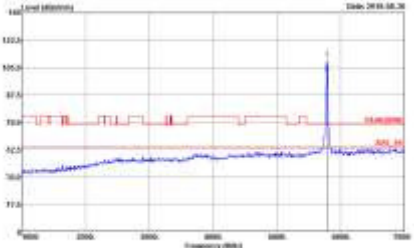
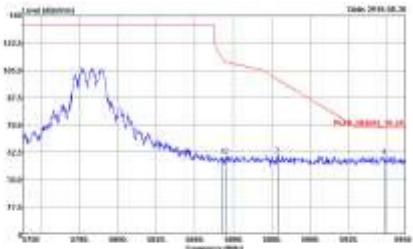

WIFI	Band 4 5725~5850MHz Band Edge @ 3m	
ANT	802.11a CH157 5785MHz	
1+2	Vertical	Fundamental
Peak	 <p> <small>Date: 2018.08.28        Condition: PCAN_80204_19.04_3m HF ANT 15000 VERTICAL        Detector: Peak        Project: 672834        Mode: 88</small> </p>	 <p> <small>Date: 2018.08.28        Condition: PCAN_80204_19.04_3m HF ANT 15000 VERTICAL        Detector: Peak        Project: 672834        Mode: 88</small> </p>
Peak	 <p> <small>Date: 2018.08.28        Condition: PCAN_80204_19.04_3m HF ANT 15000 VERTICAL        Detector: Peak        Project: 672834        Mode: 88</small> </p>	Left blank

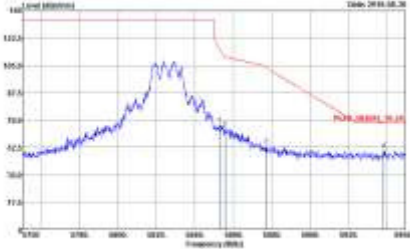
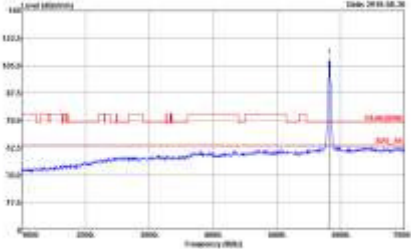

WIFI	Band 4 5725~5850MHz Band Edge @ 3m	
ANT	802.11a CH165 5825MHz	
1+2	Horizontal	Fundamental
Peak	 <p> <small>           Date: 20081107            Condition: 300M 30204 10.24 3m HP ANT 15000 HORIZONTAL            Detector: Peak            Preamp: 40DB            Mode: 01         </small> </p>	 <p> <small>           Date: 20081107            Condition: 300M 30204 10.24 3m HP ANT 15000 HORIZONTAL            Detector: Peak            Preamp: 40DB            Mode: 01         </small> </p>

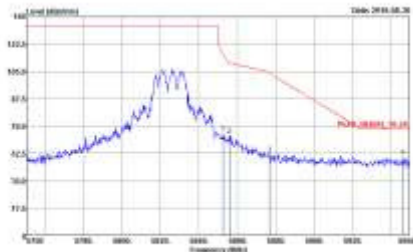
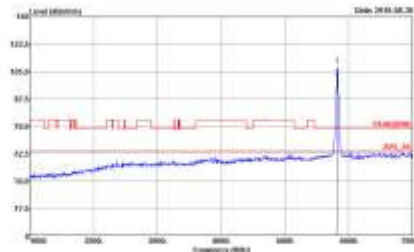

WIFI	Band 4 5725~5850MHz Band Edge @ 3m	
ANT	802.11a CH165 5825MHz	
1+2	Vertical	Fundamental
Peak	 <p>File: 300817.rtf  Condition: 70CA_2024_10-04_3u HF ANT_13000 VERTICAL  Detector: Peak  Project: 47284  Mark: 01</p>	 <p>File: 300817.rtf  Condition: 70CA_2024_10-04_3u HF ANT_13000 VERTICAL  Detector: Peak  Project: 47284  Mark: 01</p>



Band 4 5725~5850MHz  
WIFI 802.11ac VHT20 (Band Edge @ 3m)

WIFI	Band 4 5725~5850MHz Band Edge @ 3m	
ANT	802.11ac VHT20 CH149 5745MHz	
1+2	Horizontal	Fundamental
Peak	<p>Site : 30081-WF          Condition : PCAN_30084_16.04_3m HF ANT_15000 HORIZONTAL          Detector : Peak          Preamp : AT20H          Modu : CC</p>	<p>Site : 30081-WF          Condition : PCAN30084_16.04_3m HF ANT_15000 HORIZONTAL          Detector : Peak          Preamp : AT20H          Modu : CC</p>



WIFI	Band 4 5725~5850MHz Band Edge @ 3m	
ANT	802.11ac VHT20 CH149 5745MHz	
1+2	Vertical	Fundamental
Peak Avg.	<p>Site : 3008T BY          Condition : PCAN_30204_19_04_3m HF ANT 19000 VERTICAL          Distance : 19m 100.00Hz VEA 200.00Hz SWT Avg          Project : 67284          Mode : CC</p>	<p>Site : 3008T BY          Condition : PCAN30204_19_04_3m HF ANT 19000 VERTICAL          Distance : 19m 100.00Hz VEA 200.00Hz SWT Avg          Project : 67284          Mode : CC</p>

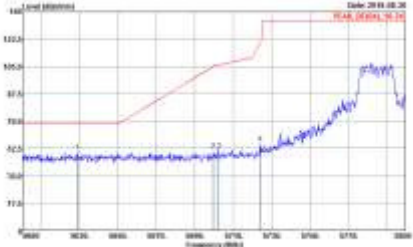
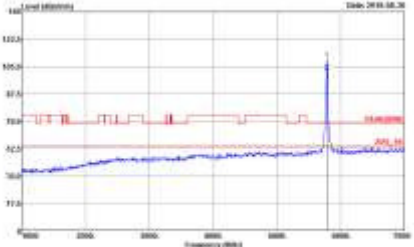
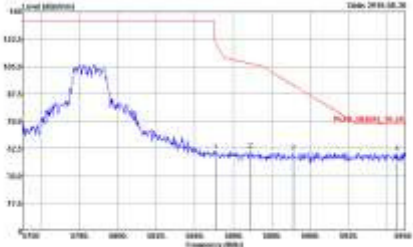

WIFI	Band 4 5725~5850MHz Band Edge @ 3m	
ANT	802.11ac VHT20 CH157 5785MHz	
1+2	Horizontal	Fundamental
Peak	 <p>       Date : 20081104        Condition : PCAN_80204_15-04_3m HF-AMP_15000 HORIZONTAL        Detector : Peak        Project : AT20H        Mode : 01     </p>	 <p>       Date : 20081104        Condition : PCAN_80204_15-04_3m HF-AMP_15000 HORIZONTAL        Detector : Peak        Project : AT20H        Mode : 01     </p>
Peak	 <p>       Date : 20081104        Condition : PCAN_80204_15-04_3m HF-AMP_15000 HORIZONTAL        Detector : Peak        Project : AT20H        Mode : 01     </p>	Left blank

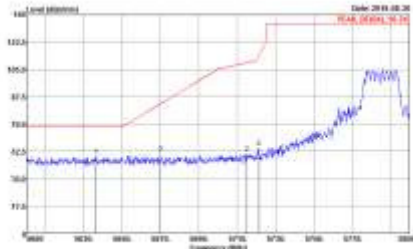
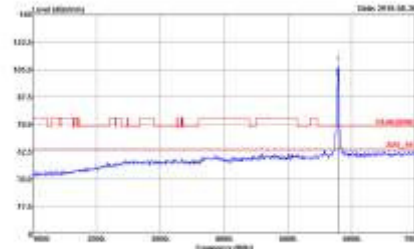
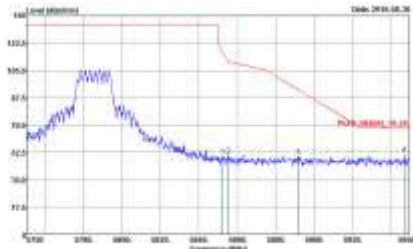

WIFI	Band 4 5725~5850MHz Band Edge @ 3m	
ANT	802.11ac VHT20 CH157 5785MHz	
1+2	Vertical	Fundamental
Peak	 <p> <small>Site: -30067-01            Condition: PCAR_3E204_15-04_3m HF-AMP_15000 VERTICAL            Detector: Peak            Project: 4725H            Mark: 01</small> </p>	 <p> <small>Site: -30067-01            Condition: PCAR3E204_3m HF-AMP_15000 VERTICAL            Detector: Peak            Project: 4725H            Mark: 01</small> </p>
Peak	 <p> <small>Site: -30067-01            Condition: PCAR_3E204_15-04_3m HF-AMP_15000 VERTICAL            Detector: Peak            Project: 4725H            Mark: 01</small> </p>	Left blank



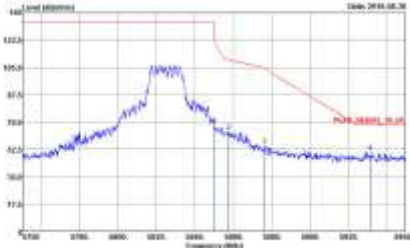
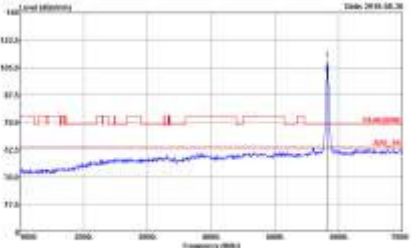

WIFI	Band 4 5725~5850MHz Band Edge @ 3m	
ANT	802.11ac VHT20 CH165 5825MHz	
1+2	Horizontal	Fundamental
Peak	 <p>Site : 30087-BY  Condition : PCAN_30204_16-04_3u HF-AMF_13020 HORIZONTAL  Detector : Peak  Project : AT20H  Mark : 01</p>	 <p>Site : 30087-BY  Condition : PCAN30204_16-04_3u HF-AMF_13020 HORIZONTAL  Detector : Peak  Project : AT20H  Mark : 01</p>



WIFI	Band 4 5725~5850MHz Band Edge @ 3m	
ANT	802.11ac VHT20 CH165 5825MHz	
1+2	Vertical	Fundamental
Peak Avg.	<p>File: 300817.rtf          Condition: 70CA_2024_10-04_3u HF AMF 13000 VERTICAL          Detector: Peak          Project: 47234          Mark: 00</p>	<p>File: 300817.rtf          Condition: 70CA_2024_10-04_3u HF AMF 13000 VERTICAL          Detector: Peak          Project: 47234          Mark: 00</p>



**Band 4 5725~5850MHz**  
**WIFI 802.11ac VHT40 (Band Edge @ 3m)**

WIFI	Band 4 5725~5850MHz Band Edge @ 3m	
ANT	802.11ac VHT40 CH151 5755MHz	
1+2	Horizontal	Fundamental
Peak		
Peak		Left blank



WIFI	Band 4 5725~5850MHz Band Edge @ 3m	
ANT	802.11ac VHT40 CH151 5755MHz	
1+2	Vertical	Fundamental
Peak	<p> <small>           Date: 2018-08-28            Condition: FCAN_2E204_15-24 3m HF ANT 15000 VERTICAL            Detector: Peak            Preamp: 47DB            Mode: 80         </small> </p>	<p> <small>           Date: 2018-08-28            Condition: FCAN204 3m HF ANT 15000 VERTICAL            Detector: Peak            Preamp: 47DB            Mode: 80         </small> </p>
Peak	<p> <small>           Date: 2018-08-28            Condition: FCAN_2E204_15-24 3m HF ANT 15000 VERTICAL            Detector: Peak            Preamp: 47DB            Mode: 80         </small> </p>	Left blank



WIFI	Band 4 5725~5850MHz Band Edge @ 3m	
ANT	802.11ac VHT40 CH159 5795MHz	
1+2	Horizontal	Fundamental
Peak	<p>File: 1300M14V          Condition: 2014_0824_19:24 3m RF AMP 13000 HORIZONTAL          Frequency: 5725~5850 MHz VSW 3000 6000Hz SWT Auto          Reference: Peak          Project: 672834          Mode: 36</p>	<p>File: 1300M14V          Condition: 2014_0824_19:24 3m RF AMP 13000 HORIZONTAL          Frequency: 5725~5850 MHz VSW 3000 6000Hz SWT Auto          Reference: Peak          Project: 672834          Mode: 36</p>
Peak	<p>File: 1300M14V          Condition: 2014_0824_19:24 3m RF AMP 13000 HORIZONTAL          Frequency: 5725~5850 MHz VSW 3000 6000Hz SWT Auto          Reference: Peak          Project: 672834          Mode: 36</p>	Left blank

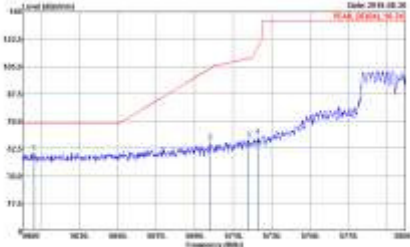
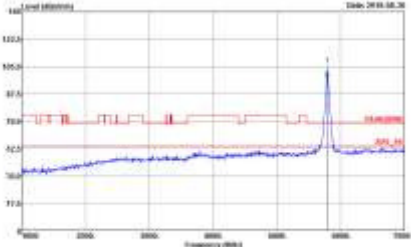
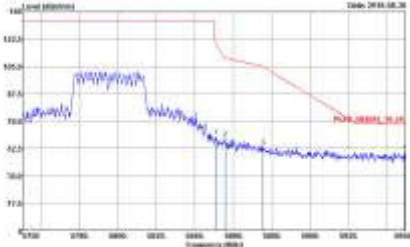

WIFI	Band 4 5725~5850MHz Band Edge @ 3m	
ANT	802.11ac VHT40 CH159 5795MHz	
1+2	Vertical	Fundamental
Peak	 <p>       Date: 20081104        Condition: PCAN_80211ac_15-04_3m HF-AMF_15000 VERTICAL        Detector: Peak        Project: 47024        Mark: 00     </p>	 <p>       Date: 20081104        Condition: PCAN_80211ac_15-04_3m HF-AMF_15000 VERTICAL        Detector: Peak        Project: 47024        Mark: 00     </p>
Peak	 <p>       Date: 20081104        Condition: PCAN_80211ac_15-04_3m HF-AMF_15000 VERTICAL        Detector: Peak        Project: 47024        Mark: 00     </p>	Left blank

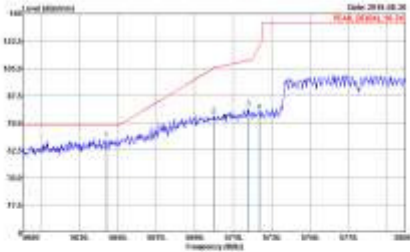
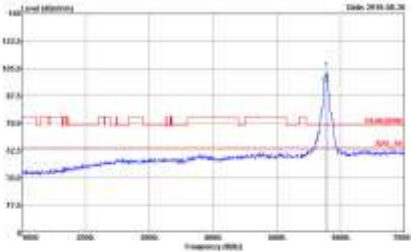
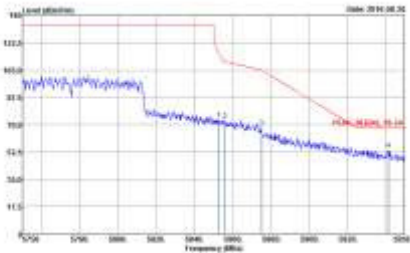

**Band 4 5725~5850MHz**  
**WIFI 802.11ac VHT80 (Band Edge @ 3m)**

WIFI	Band 4 5725~5850MHz Band Edge @ 3m	
ANT	802.11ac VHT80 CH155 5775MHz	
1+2	Horizontal	Fundamental
Peak	 <p>File: 20081114F            Condition: PCAN_20204_15-04_3m HF ANT_15000 HORIZONTAL            Reference: 1000 dBm/Hz VSW 2000 6000Hz SWT Auto            Detector: Peak            Project: 672834            Mode: 01</p>	 <p>File: 20081114F            Condition: PCAN_20204_15-04_3m HF ANT_15000 HORIZONTAL            Reference: 1000 dBm/Hz VSW 2000 6000Hz SWT Auto            Detector: Peak            Project: 672834            Mode: 01</p>
Peak	 <p>File: 20081114F            Condition: PCAN_20204_15-04_3m HF ANT_15000 HORIZONTAL            Reference: 1000 dBm/Hz VSW 2000 6000Hz SWT Auto            Detector: Peak            Project: 672834            Mode: 01</p>	Left blank

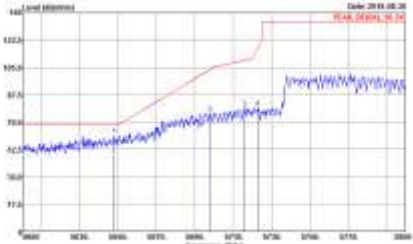
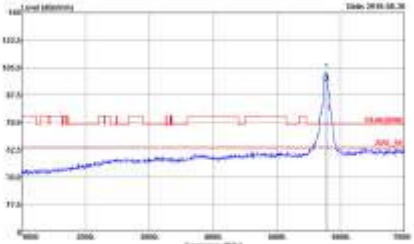
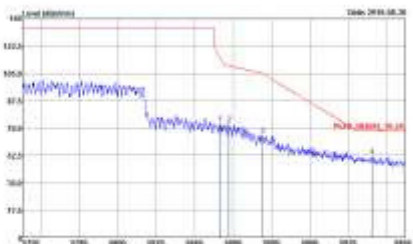

WIFI	Band 4 5725~5850MHz Band Edge @ 3m	
ANT	802.11ac VHT80 CH155 5775MHz	
1+2	Vertical	Fundamental
Peak	 <p> <small>           Date: 20081107            Condition: ZCWA_ZCWA_15-04_3m HF AMP_15000 VERTICAL            Detector: Peak            Project: 672834            Mark: off         </small> </p>	 <p> <small>           Date: 20081107            Condition: ZCWA_ZCWA_15-04_3m HF AMP_15000 VERTICAL            Detector: Peak            Project: 672834            Mark: off         </small> </p>
Peak	 <p> <small>           Date: 20081107            Condition: ZCWA_ZCWA_15-04_3m HF AMP_15000 VERTICAL            Detector: Peak            Project: 672834            Mark: off         </small> </p>	Left blank





Band 4 - 5725~5850MHz  
WIFI 802.11a (Harmonic @ 3m)

WIFI	Band 4 5725~5850MHz Harmonic @ 3m	
ANT	802.11a CH149 5745MHz	
1+2	Horizontal	Vertical
Peak Avg.	<p>Site : 2008174Y Condition : 20CA40996 5m SWF CH149 HORIZONTAL Detector : Peak Preamp : AT234 Modu : 00</p>	<p>Site : 2008174Y Condition : 20CA40996 5m SWF CH149 VERTICAL Detector : Peak Preamp : AT234 Modu : 00</p>

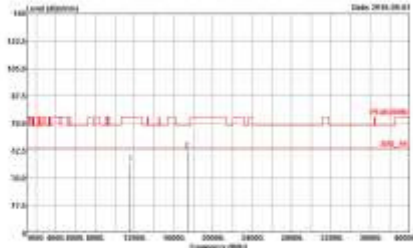
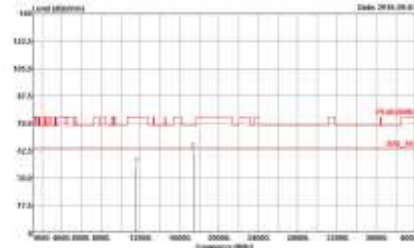

WIFI	Band 4 5725~5850MHz Harmonic @ 3m	
ANT	802.11a CH157 5785MHz	
1+2	Horizontal	Vertical
Peak Avg.	 <p>File : 20081117          Condition : ZCAGU996 On Site CH157, CH157 HORIZONTAL          Detector : Peak          Program : 472834          Mode : 99</p>	 <p>File : 20081117          Condition : ZCAGU996 On Site CH157, CH157 VERTICAL          Detector : Peak          Program : 472834          Mode : 99</p>

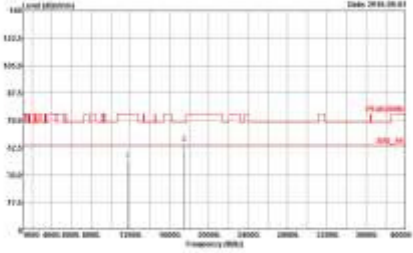
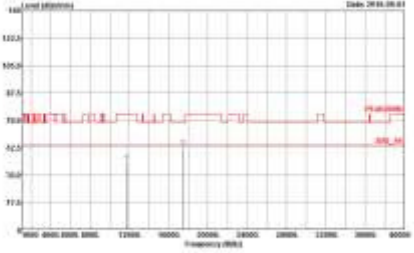

WIFI	Band 4 5725~5850MHz Harmonic @ 3m	
ANT	802.11a CH165 5825MHz	
1+2	Horizontal	Vertical
Peak Avg.	 <p>Site : SPORTON LAB. Condition : PCAU165 3m 5M CHF, 11A2H HORIZONTAL Detector : Peak Project : 42024 Mode : 802.11a</p>	 <p>Site : SPORTON LAB. Condition : PCAU165 3m 5M CHF, 11A2H VERTICAL Detector : Peak Project : 42024 Mode : 802.11a</p>



**Band 4 5725~5850MHz**  
**WIFI 802.11ac VHT20 (Harmonic @ 3m)**

WIFI	Band 4 5725~5850MHz Harmonic @ 3m	
ANT	802.11ac VHT20 CH149 5745MHz	
1+2	Horizontal	Vertical
<p><b>Peak</b> <b>Avg.</b></p>	<p>File : 20081717          Condition : 20081717_5m_SMP_CV_F_1492H_HORIZONTAL          Detector : Peak          Filter : AC20H          Mode : SC</p>	<p>File : 20081717          Condition : 20081717_5m_SMP_CV_F_1492V_VERTICAL          Detector : Peak          Filter : AC20H          Mode : SC</p>



WIFI	Band 4 5725~5850MHz Harmonic @ 3m	
ANT	802.11ac VHT20 CH157 5785MHz	
1+2	Horizontal	Vertical
Peak Avg.		



WIFI	Band 4 5725~5850MHz Harmonic @ 3m	
ANT	802.11ac VHT20 CH165 5825MHz	
1+2	Horizontal	Vertical
Peak Avg.		



Band 4 5725~5850MHz  
WIFI 802.11ac VHT40 (Harmonic @ 3m)

WIFI	Band 4 5725~5850MHz Harmonic @ 3m	
ANT	802.11ac VHT40 CH151 5755MHz	
1+2	Horizontal	Vertical
Peak Avg.		



WIFI	Band 4 5725~5850MHz Harmonic @ 3m	
ANT	802.11ac VHT40 CH159 5795MHz	
1+2	Horizontal	Vertical
Peak Avg.		





Band 4 5725~5850MHz  
WIFI 802.11ac VHT80 (Harmonic @ 3m)

WIFI	Band 4 5725~5850MHz Harmonic @ 3m	
ANT	802.11ac VHT80 CH155 5775MHz	
1+2	Horizontal	Vertical
Peak Avg.		



Emission below 1GHz  
5GHz WIFI 802.11ac VHT80 (LF)

WIFI	5GHz 5725~5850MHz	
ANT	802.11ac VHT80 LF	
1+2	Horizontal	Vertical
QP / Peak	<p>Site : 300817-WY Condition : QP On LP-ANT(304786)-HORIZONTAL Detector : Peak Product : 8720H Mode : 120</p>	<p>Site : 300817-WY Condition : QP On LP-ANT(304786)-VERTICAL Detector : Peak Product : 8720H Mode : 120</p>



<TXBF Modes>

Band 4 - 5725~5850MHz

WIFI 802.11ac VHT20 (Band Edge @ 3m)

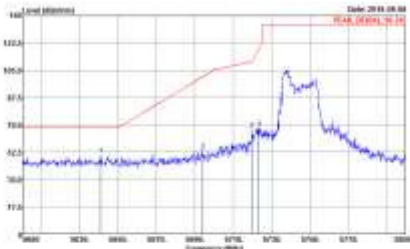
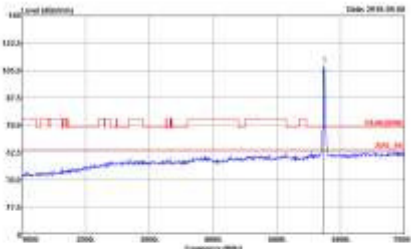
WIFI	Band 4 5725~5850MHz Band Edge @ 3m	
ANT	802.11ac VHT20 CH149 5745MHz	
1+2	Horizontal	Fundamental
Peak	 <p>Site : 300817-WY  Condition : PCAN_3E204_15-04_3m HP ANT_15000 HORIZONTAL  Detector : Peak  Preamp : SC20H  Modu : IS</p>	 <p>Site : 300817-WY  Condition : PCAN3088_3m HP ANT_15000 HORIZONTAL  Detector : Peak  Preamp : SC20H  Modu : IS</p>

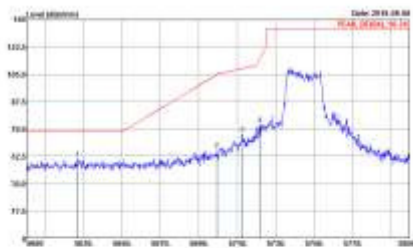
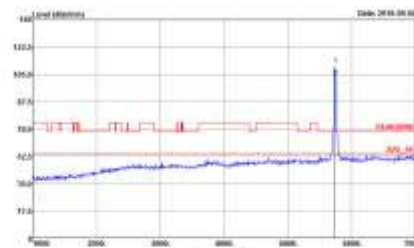

WIFI	Band 4 5725~5850MHz Band Edge @ 3m	
ANT	802.11ac VHT20 CH149 5745MHz	
1+2	Vertical	Fundamental
Peak Avg.	 <p> Date: 20081107  Condition: 2004W_0520A_15.04 3m HP-ANT 15000 VERTICAL  Extensor: REF: 1000 80MHz VSW 2000 6000Hz SHT-Ant  Preamp: K202H  Mod: 65 </p>	 <p> Date: 20081107  Condition: 2004W_0520A_15.04 3m HP-ANT 15000 VERTICAL  Extensor: REF: 1000 80MHz VSW 2000 6000Hz SHT-Ant  Preamp: K202H  Mod: 65 </p>

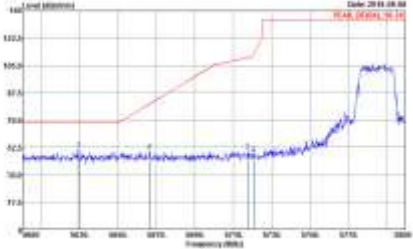
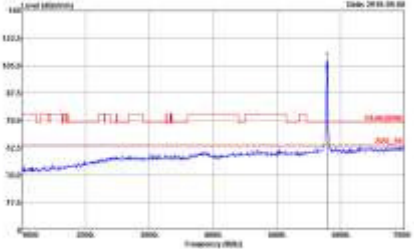
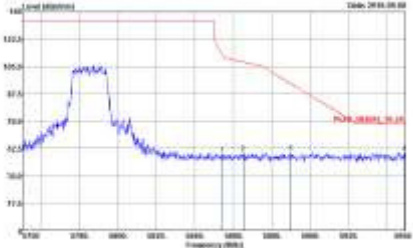

WIFI	Band 4 5725~5850MHz Band Edge @ 3m	
ANT	802.11ac VHT20 CH157 5785MHz	
1+2	Horizontal	Fundamental
Peak	 <p>File: :S00617.vi            Condition: :PCAR_3E204_15-04_3m RF-AMP_15000 HORIZONTAL            Detector: :Peak            Project: 472834            Mode: 40</p>	 <p>File: :S00617.vi            Condition: :PCAR304030_3m RF-AMP_15000 HORIZONTAL            Detector: :Peak            Project: 472834            Mode: 40</p>
Peak	 <p>File: :S00617.vi            Condition: :PCAR_3E204_15-04_3m RF-AMP_15000 HORIZONTAL            Detector: :Peak            Project: 472834            Mode: 40</p>	Left blank

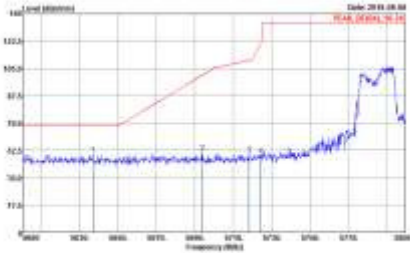
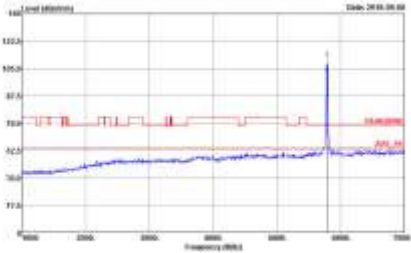
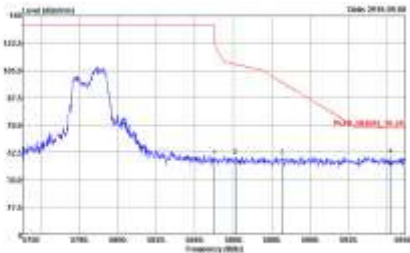

WIFI	Band 4 5725~5850MHz Band Edge @ 3m	
ANT	802.11ac VHT20 CH157 5785MHz	
1+2	Vertical	Fundamental
Peak	 <p> <small>           Date: 2018.08.08            PCAN_2018_10_10            Title: 2018.08.08            Condition: PCAN_2018_10_10 15.24 3m HF ANT 15000 VERTICAL            Detector: Peak            Preamp: STDEN            Modu: 01         </small> </p>	 <p> <small>           Date: 2018.08.08            PCAN_2018_10_10            Title: 2018.08.08            Condition: PCAN_2018_10_10 15.24 3m HF ANT 15000 VERTICAL            Detector: Peak            Preamp: STDEN            Modu: 01         </small> </p>
Peak	 <p> <small>           Date: 2018.08.08            PCAN_2018_10_10            Title: 2018.08.08            Condition: PCAN_2018_10_10 15.24 3m HF ANT 15000 VERTICAL            Detector: Peak            Preamp: STDEN            Modu: 01         </small> </p>	Left blank

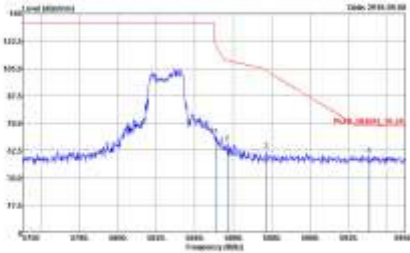
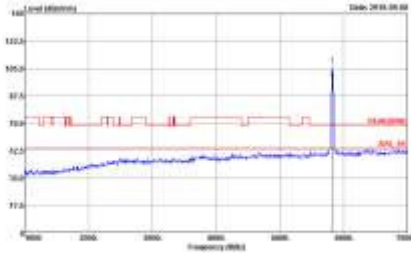

WIFI	Band 4 5725~5850MHz Band Edge @ 3m	
ANT	802.11ac VHT20 CH165 5825MHz	
1+2	Horizontal	Fundamental
Peak	 <p>Site : 30081 NY          Condition : PCAN_30204_16.04_3m HF ANT_15000 HORIZONTAL          Detector : Peak          Preamp : 42DB          Mask : G2</p>	 <p>Site : 30081 NY          Condition : PCAN30204_16.04_3m HF ANT_15000 HORIZONTAL          Detector : Peak          Preamp : 42DB          Mask : G2</p>

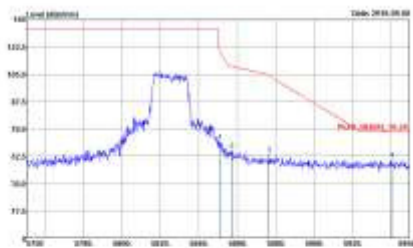
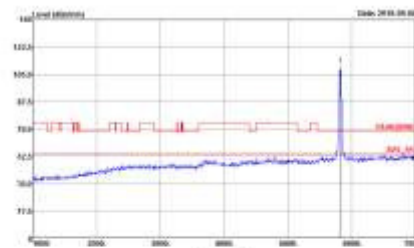

WIFI	Band 4 5725~5850MHz Band Edge @ 3m	
ANT	802.11ac VHT20 CH165 5825MHz	
1+2	Vertical	Fundamental
Peak Avg.	 <p> Date: 200817.WY  Condition: 2004A_0520A_15.04 3m HP-ANT 15000 VERTICAL  Extensor: REF: 1000 80MHz VSW 2000 6000Hz SHT-Ant  Project: 672834  Mark: 62 </p>	 <p> Date: 200817.WY  Condition: 2004A050_3m HP-ANT 15000 VERTICAL  Extensor: REF: 1000 80MHz VSW 2000 6000Hz SHT-Ant  Project: 672834  Mark: 62 </p>



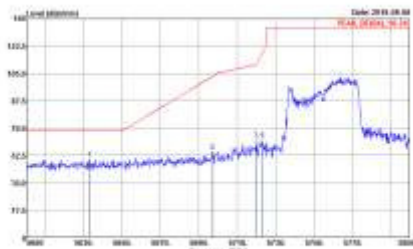
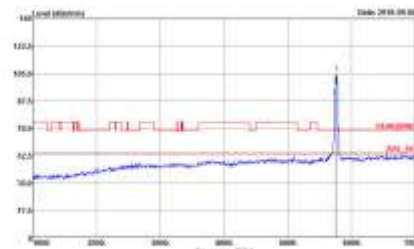
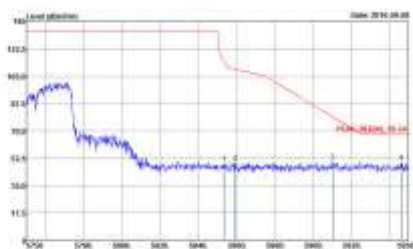

**Band 4 5725~5850MHz**  
**WIFI 802.11ac VHT40 (Band Edge @ 3m)**

WIFI	Band 4 5725~5850MHz Band Edge @ 3m	
ANT	802.11ac VHT40 CH151 5755MHz	
1+2	Horizontal	Fundamental
Peak	 <p data-bbox="343 851 758 918"> <small>Date: 2014.08.08            Title: 300M14V            Condition: PCAN_3E204_15.04_3m HF ANT_15000 HORIZONTAL            Detector: Peak            Project: 4702H            Mode: SI</small> </p>	 <p data-bbox="933 851 1348 918"> <small>Date: 2014.08.08            Title: 300M14V            Condition: PCAN308_15.04_3m HF ANT_15000 HORIZONTAL            Detector: Peak            Project: 4702H            Mode: SI</small> </p>
Peak	 <p data-bbox="343 1590 758 1657"> <small>Date: 2014.08.08            Title: 300M14V            Condition: PCAN_3E204_15.04_3m HF ANT_15000 HORIZONTAL            Detector: Peak            Project: 4702H            Mode: SI</small> </p>	Left blank

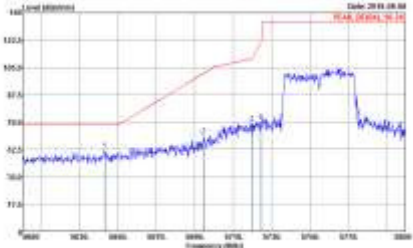
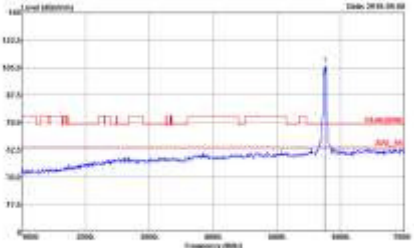
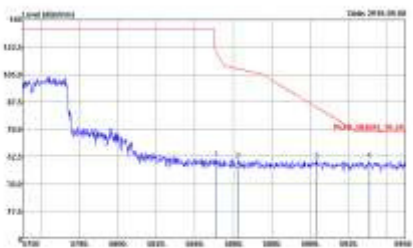

WIFI	Band 4 5725~5850MHz Band Edge @ 3m	
ANT	802.11ac VHT40 CH151 5755MHz	
1+2	Vertical	Fundamental
Peak	 <p> <small>           Date: 20081107            Condition: 200M10V, 200M, 20204, 10.04, 3m HF ANT, 15000 VERTICAL            Extensor: None, 1000, 800Hz, VSW, 2000, 6000Hz, SWT, Auto            Preamp: Peak            Mod: 6.5         </small> </p>	 <p> <small>           Date: 20081107            Condition: 200M10V, 200M, 20204, 10.04, 3m HF ANT, 15000 VERTICAL            Extensor: None, 1000, 800Hz, VSW, 2000, 6000Hz, SWT, Auto            Preamp: Peak            Mod: 6.5         </small> </p>
Peak	 <p> <small>           Date: 20081107            Condition: 200M10V, 200M, 20204, 10.04, 3m HF ANT, 15000 VERTICAL            Extensor: None, 1000, 800Hz, VSW, 2000, 6000Hz, SWT, Auto            Preamp: Peak            Mod: 6.5         </small> </p>	Left blank



WIFI	Band 4 5725~5850MHz Band Edge @ 3m	
ANT	802.11ac VHT40 CH159 5795MHz	
1+2	Horizontal	Fundamental
Peak	<p>           Date: 2018-08-08            Condition: 300M14V            File: 300M14V_18-08-08_19-24_3m_HF_Ant_15000_HORIZONTAL            Frequency: 5795.000000            Power: 100.000000            Mode: 34         </p>	<p>           Date: 2018-08-08            Condition: 300M14V            File: 300M14V_18-08-08_19-24_3m_HF_Ant_15000_HORIZONTAL            Frequency: 5795.000000            Power: 100.000000            Mode: 34         </p>
Peak	<p>           Date: 2018-08-08            Condition: 300M14V            File: 300M14V_18-08-08_19-24_3m_HF_Ant_15000_HORIZONTAL            Frequency: 5795.000000            Power: 100.000000            Mode: 34         </p>	Left blank



WIFI	<b>Band 4 5725~5850MHz Band Edge @ 3m</b>	
ANT	<b>802.11ac VHT40 CH159 5795MHz</b>	
1+2	<b>Vertical</b>	<b>Fundamental</b>
<b>Peak</b>	<p> <small>           Date: 2018/08/08            Condition: PCAN_2E204_19_24 3m HP ANT 12000 VERTICAL            Detector: Peak            Preamp: 47DB            Mode: SA         </small> </p>	<p> <small>           Date: 2018/08/08            Condition: PCAN2096 3m HP ANT 12000 VERTICAL            Detector: Peak            Preamp: 47DB            Mode: SA         </small> </p>
<b>Peak</b>	<p> <small>           Date: 2018/08/08            Condition: PCAN_2E204_19_24 3m HP ANT 12000 VERTICAL            Detector: Peak            Preamp: 47DB            Mode: SA         </small> </p>	<b>Left blank</b>



**Band 4 5725~5850MHz**  
**WIFI 802.11ac VHT80 (Band Edge @ 3m)**

WIFI	Band 4 5725~5850MHz Band Edge @ 3m	
ANT	802.11ac VHT80 CH155 5775MHz	
1+2	Horizontal	Fundamental
Peak	<p> <small>Date: 2016-08-08            Condition: PCAN_30204_16-04_3m_HF_4E1_10000_HORIZONTAL            Detector: Peak            Project: 472834            Mode: 40</small> </p>	<p> <small>Date: 2016-08-08            Condition: PCAN30204_3m_HF_4E1_10000_HORIZONTAL            Detector: Peak            Project: 472834            Mode: 40</small> </p>
Peak	<p> <small>Date: 2016-08-08            Condition: PCAN_30204_16-04_3m_HF_4E1_10000_HORIZONTAL            Detector: Peak            Project: 472834            Mode: 40</small> </p>	Left blank



WIFI	Band 4 5725~5850MHz Band Edge @ 3m	
ANT	802.11ac VHT80 CH155 5775MHz	
1+2	Vertical	Fundamental
Peak		
Peak		Left blank



Band 4 - 5725~5850MHz

WIFI 802.11ac VHT20 (Harmonic @ 3m)

WIFI	Band 4 5725~5850MHz Harmonic @ 3m	
ANT	802.11ac VHT20 CH149 5745MHz	
1+2	Horizontal	Vertical
Peak Avg.	<p>Site : 3008T BY  Condition : 7CA4976 3m SHF CVF_0149 HORIZONTAL  Device : P44  Project : 4725H  Mode : IS</p>	<p>Site : 3008T BY  Condition : 7CA4976 3m SHF CVF_0149 VERTICAL  Device : P44  Project : 4725H  Mode : IS</p>



WIFI	Band 4 5725~5850MHz Harmonic @ 3m	
ANT	802.11ac VHT20 CH157 5785MHz	
1+2	Horizontal	Vertical
Peak Avg.		





WIFI	Band 4 5725~5850MHz Harmonic @ 3m	
ANT	802.11ac VHT20 CH165 5825MHz	
1+2	Horizontal	Vertical
Peak Avg.	<p>Site : 300BT BY Condition : 3CA4096 3m SFP CVF_0152 HORIZONTAL Device : Pua Project : 47034 Mode : 12</p>	<p>Site : 300BT BY Condition : 3CA4096 3m SFP CVF_0152 VERTICAL Device : Pua Project : 47034 Mode : 12</p>



**Band 4 5725~5850MHz**  
**WIFI 802.11ac VHT40 (Harmonic @ 3m)**

WIFI	Band 4 5725~5850MHz Harmonic @ 3m	
ANT	802.11ac VHT40 CH151 5755MHz	
1+2	Horizontal	Vertical
<p><b>Peak</b> <b>Avg.</b></p>		



WIFI	Band 4 5725~5850MHz Harmonic @ 3m	
ANT	802.11ac VHT40 CH159 5795MHz	
1+2	Horizontal	Vertical
Peak Avg.	<p>Site : 300874Y  Condition : 3CA4956 3m SMP ENV_0152 HORIZONTAL  Device : Pua  Project : 4726H  Mode : SA</p>	<p>Site : 300874Y  Condition : 3CA4956 3m SMP ENV_0152 VERTICAL  Device : Pua  Project : 4726H  Mode : SA</p>



**Band 4 5725~5850MHz**  
**WIFI 802.11ac VHT80 (Harmonic @ 3m)**

WIFI	Band 4 5725~5850MHz Harmonic @ 3m	
ANT	802.11ac VHT80 CH155 5775MHz	
1+2	Horizontal	Vertical
<p><b>Peak</b> <b>Avg.</b></p>	<p>Site : 3008T.RY            Condition : PCA0596 3m 5HP CH155 HORIZONTAL            Detector : Peak            Product : 172EM            Mode : SA</p>	<p>Site : 3008T.RY            Condition : PCA0596 3m 5HP CH155 VERTICAL            Detector : Peak            Product : 172EM            Mode : SA</p>



Emission below 1GHz  
5GHz WIFI 802.11ac VHT20 (LF)

WIFI	5GHz 5725~5850MHz	
ANT	802.11ac VHT20 LF	
1+2	Horizontal	Vertical
QP / Peak	<p>Site: 80211ac VHT20 LF  Condition: 5GHz LF ANT (24) (H) HORIZONTAL  Detector: Peak  Preamp: -120dB  Modu: ISM</p>	<p>Site: 80211ac VHT20 LF  Condition: 5GHz LF ANT (24) (V) VERTICAL  Detector: Peak  Preamp: -120dB  Modu: ISM</p>



### Appendix D. Duty Cycle Plots

Antenna	Band	Duty Cycle(%)	T(us)	1/T(kHz)	VBW Setting
1	802.11a	92.86	1430	0.699300699	1kHz
2	802.11a	92.86	1430	0.699300699	1kHz
1+2	802.11a for Ant 1	92.86	1430	0.699300699	1kHz
1+2	802.11a for Ant 2	92.86	1430	0.699300699	1kHz
1	5GHz 802.11n HT20	92.86	1430	0.699300699	1kHz
2	5GHz 802.11n HT20	92.86	1430	0.699300699	1kHz
1+2	5GHz 802.11n HT20 for Ant 1	92.86	1430	0.699300699	1kHz
1+2	5GHz 802.11n HT20 for Ant 2	92.86	1430	0.699300699	1kHz
1	5GHz 802.11n HT40	98.01	-	-	10Hz
2	5GHz 802.11n HT40	98.01	-	-	10Hz
1+2	5GHz 802.11n HT40 for Ant 1	97.91	945	1.058201058	3kHz
1+2	5GHz 802.11n HT40 for Ant 2	98.00	-	-	10Hz
1	5GHz 802.11ac VHT20	92.86	1354.167	0.738461357	1kHz
2	5GHz 802.11ac VHT20	92.28	1341.34	0.745523134	1kHz
1+2	5GHz 802.11ac VHT20 for Ant 1	92.83	1347.756	0.741974067	1kHz
1+2	5GHz 802.11ac VHT20 for Ant 2	92.82	1346.154	0.742857058	1kHz
1	5GHz 802.11ac VHT40	98.02	-	-	10Hz
2	5GHz 802.11ac VHT40	98.21	-	-	10Hz
1+2	5GHz 802.11ac VHT40 for Ant 1	98.02	-	-	10Hz
1+2	5GHz 802.11ac VHT40 for Ant 2	98.03	-	-	10Hz
1	5GHz 802.11ac VHT80	95.95	455.769231	2.194092826	3kHz
2	5GHz 802.11ac VHT80	95.05	461.538462	2.166666665	3kHz
1+2	5GHz 802.11ac VHT80 for Ant 1	95.96	456.730768	2.18947369	3kHz
1+2	5GHz 802.11ac VHT80 for Ant 2	95.96	456.730769	2.189473685	3kHz



<Ant. 1>

802.11a

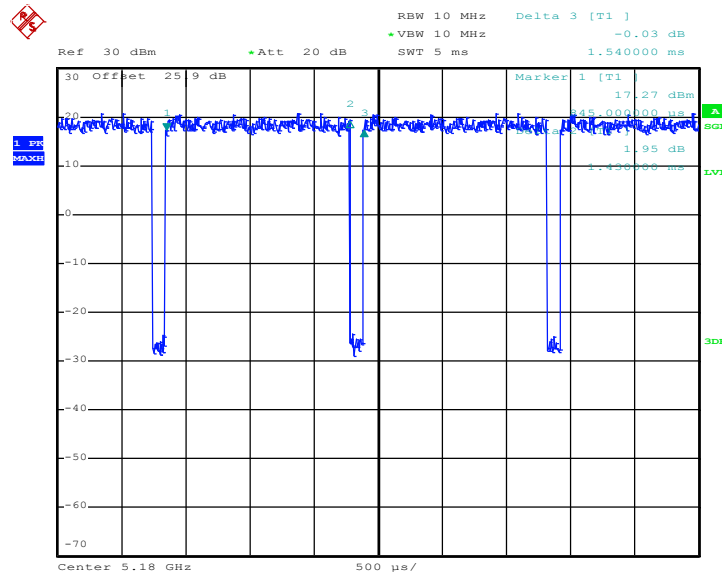

Date: 18.AUG.2016 20:03:34

802.11n HT20

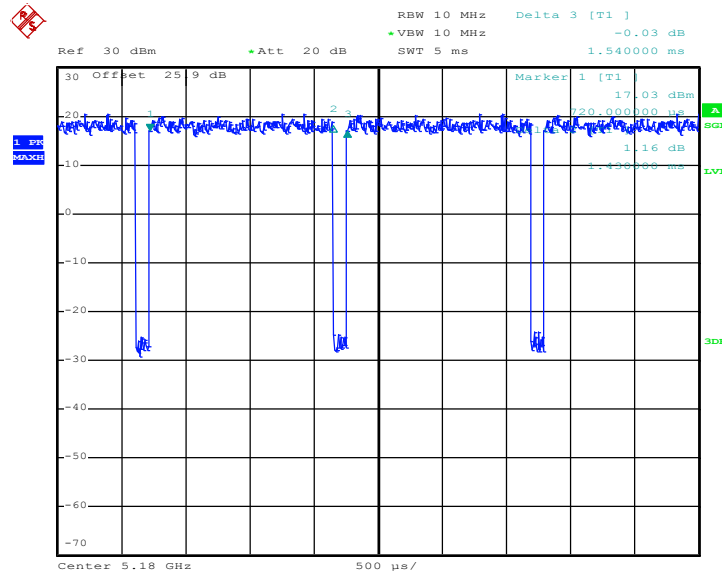

Date: 18.AUG.2016 21:16:39



802.11n HT40

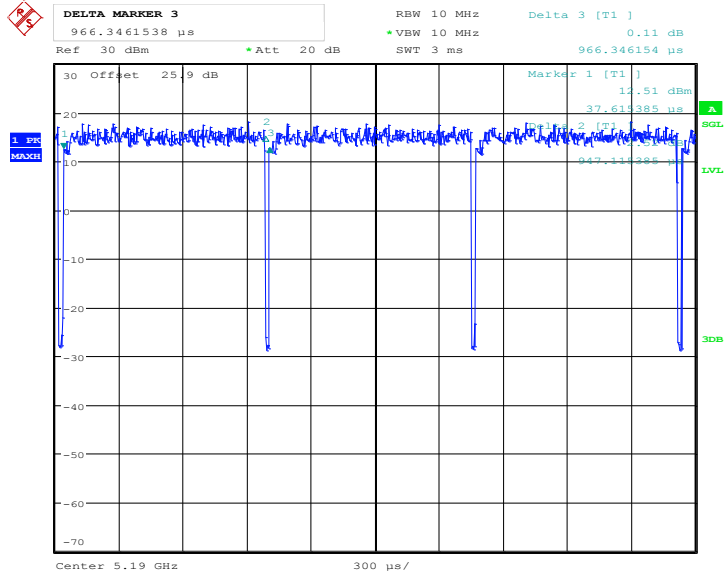

Date: 18.AUG.2016 22:32:42

802.11ac VHT20

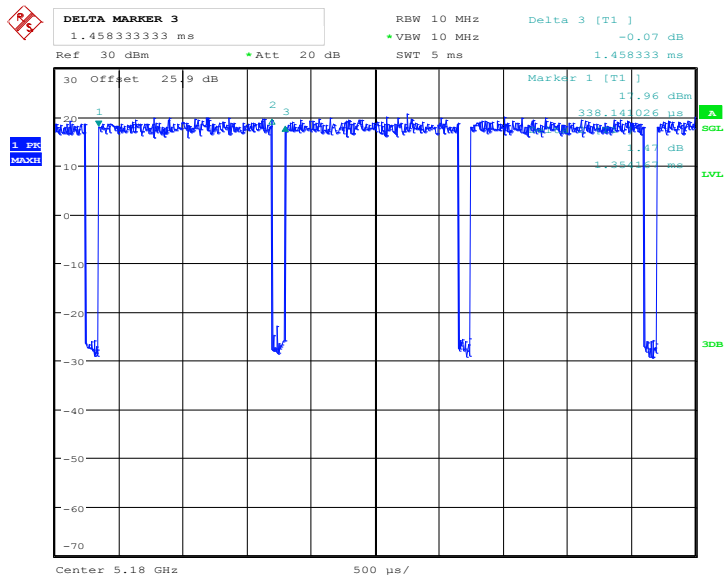

Date: 18.AUG.2016 23:33:33





802.11ac VHT40

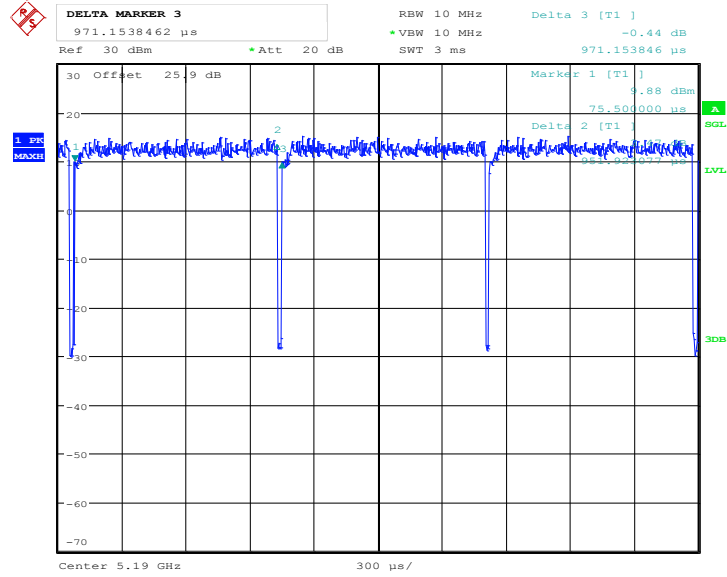

Date: 18.AUG.2016 23:41:03

802.11ac VHT80

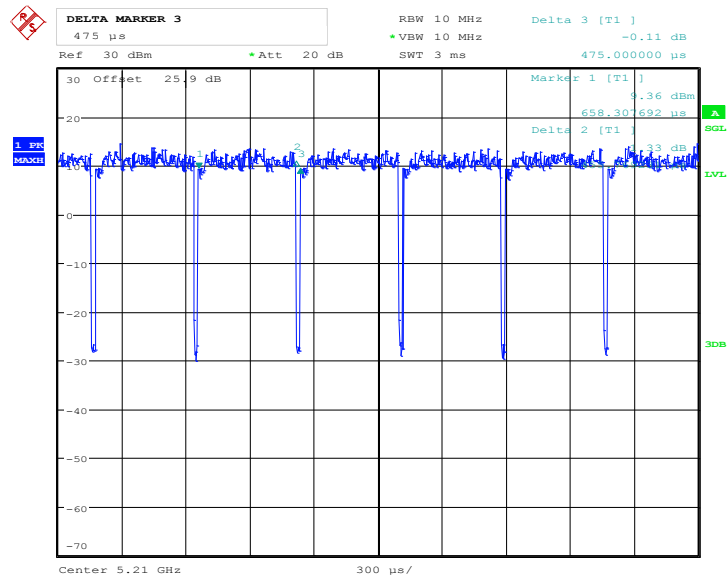

Date: 18.AUG.2016 23:49:55



<Ant. 2>

802.11a

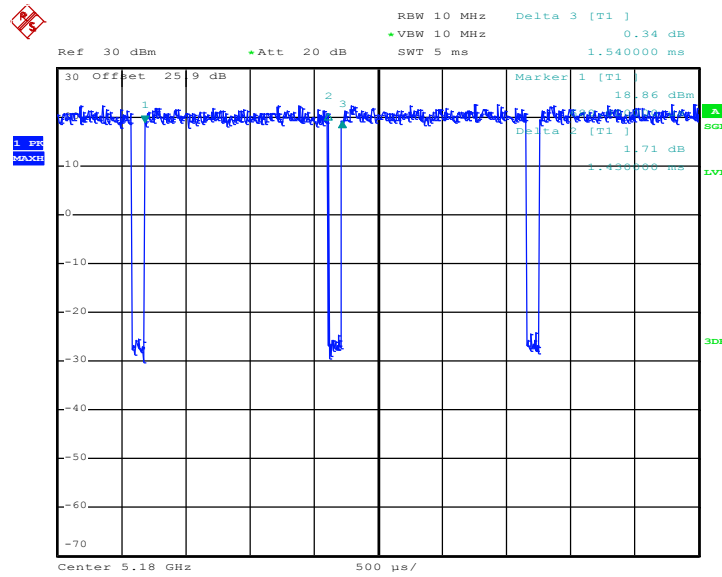

Date: 18.AUG.2016 20:04:56

802.11n HT20

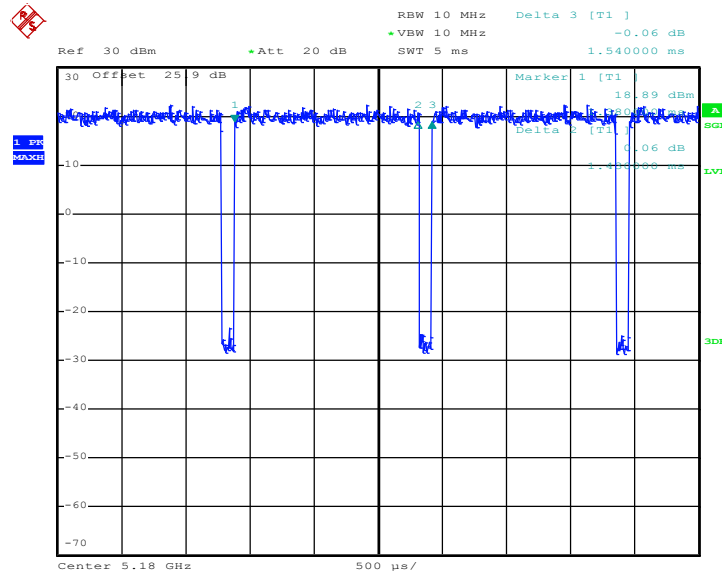

Date: 18.AUG.2016 21:18:23



802.11n HT40

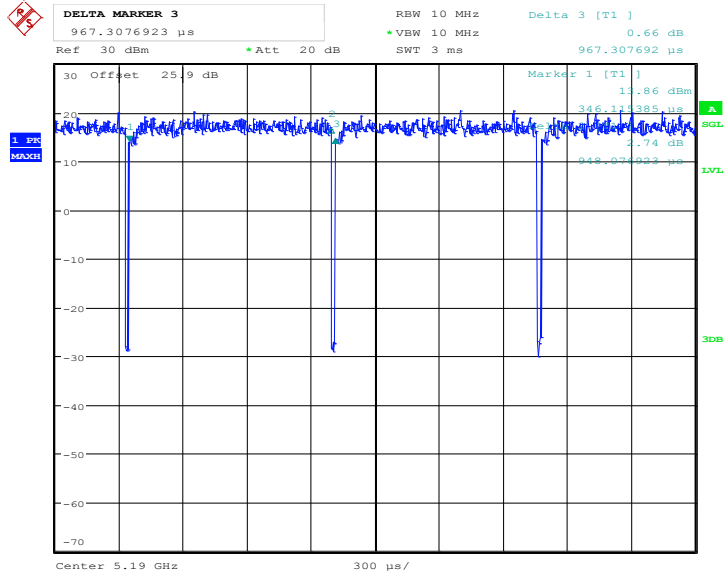

Date: 18.AUG.2016 22:34:54

802.11ac VHT20

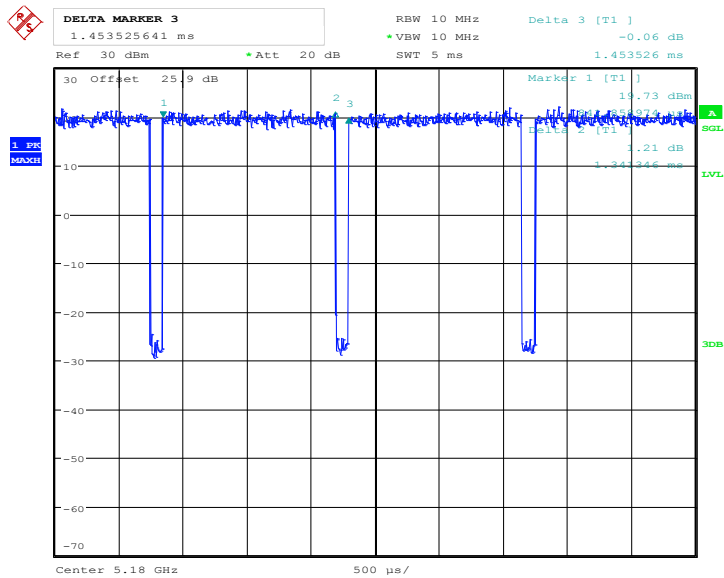

Date: 18.AUG.2016 23:35:37



802.11ac VHT40

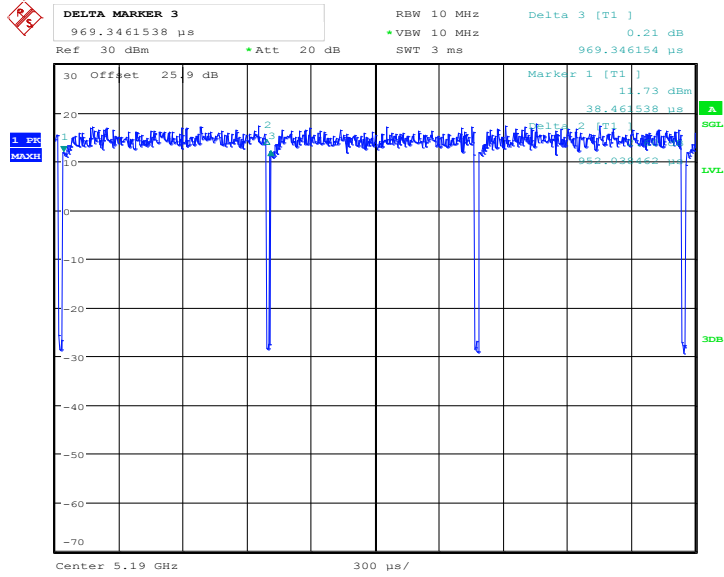

Date: 18.AUG.2016 23:42:22

802.11ac VHT80

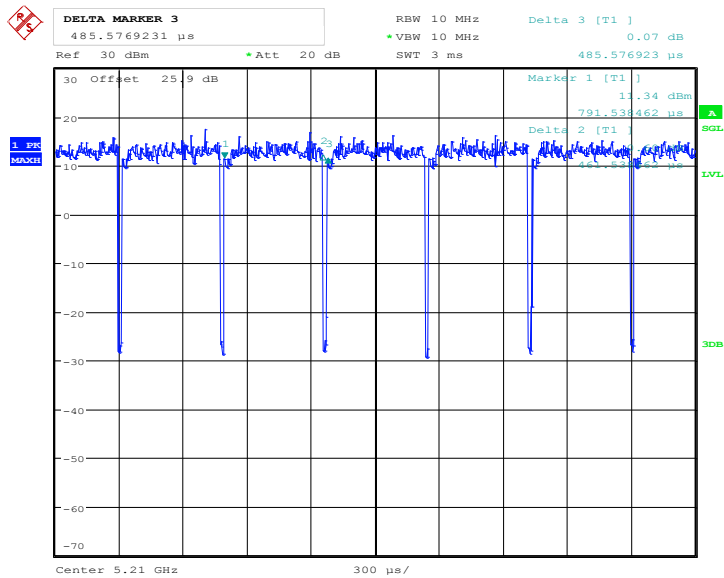

Date: 18.AUG.2016 23:51:32



MIMO <Ant. 1+2(1)>

802.11a

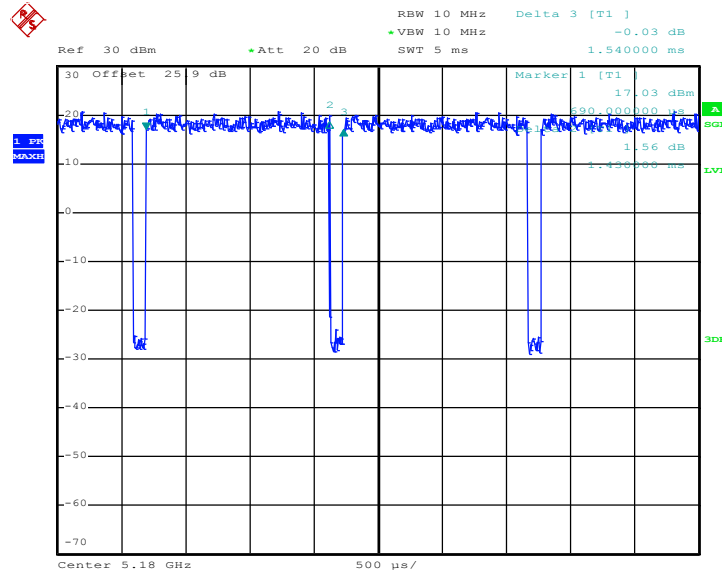

Date: 18.AUG.2016 20:19:15

802.11n HT20

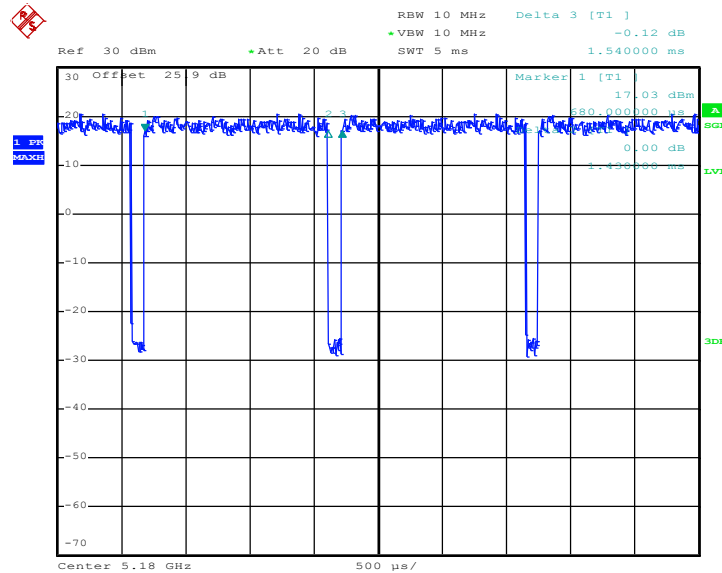

Date: 18.AUG.2016 21:33:22



802.11n HT40

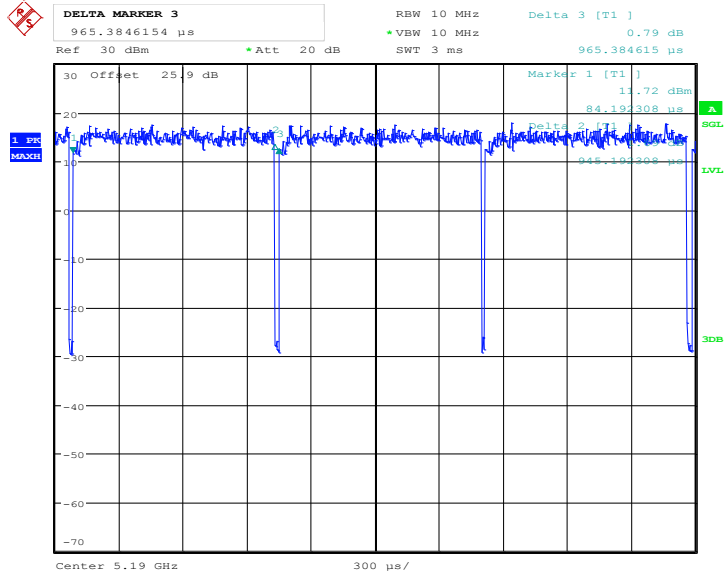

Date: 18.AUG.2016 22:39:15

802.11ac VHT20

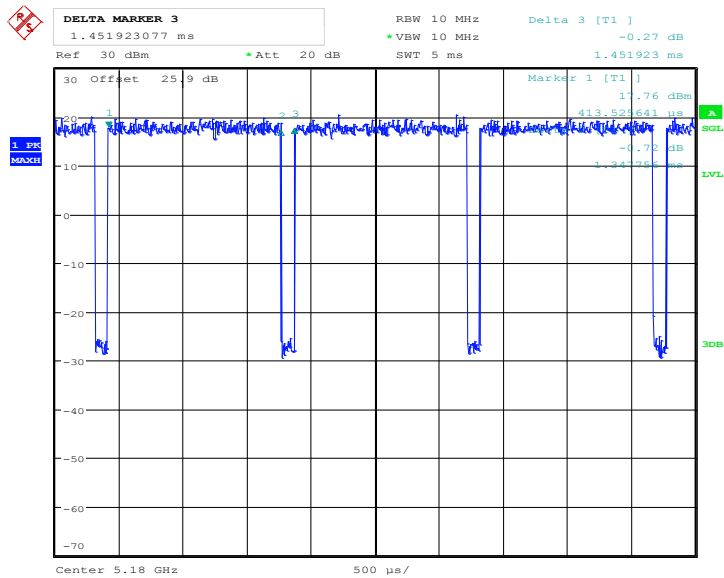

Date: 18.AUG.2016 23:37:50



802.11ac VHT40

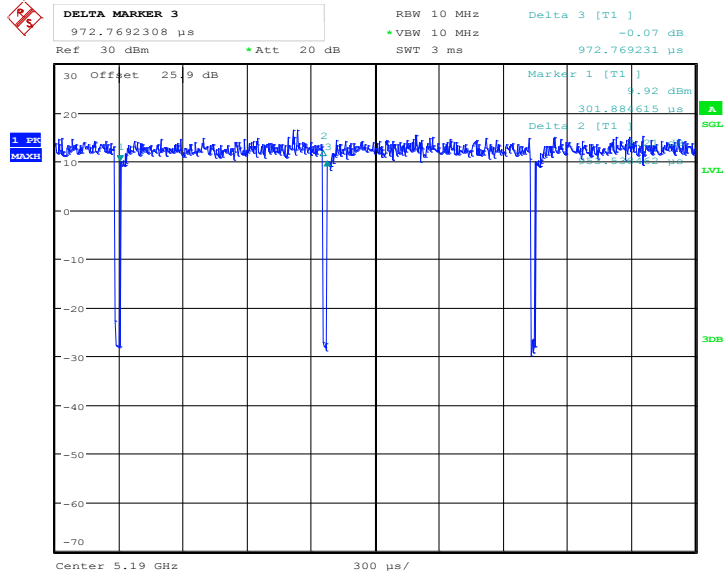

Date: 18.AUG.2016 23:44:03

802.11ac VHT80

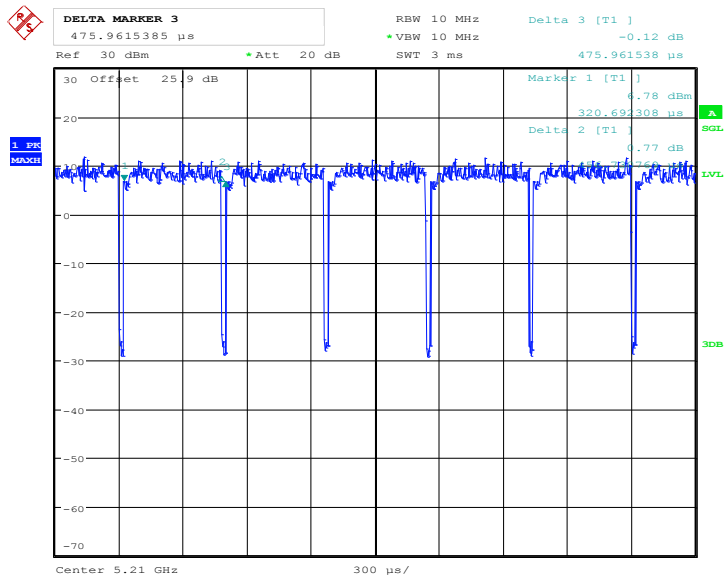

Date: 18.AUG.2016 23:53:54



MIMO <Ant. 1+2(2)>

802.11a

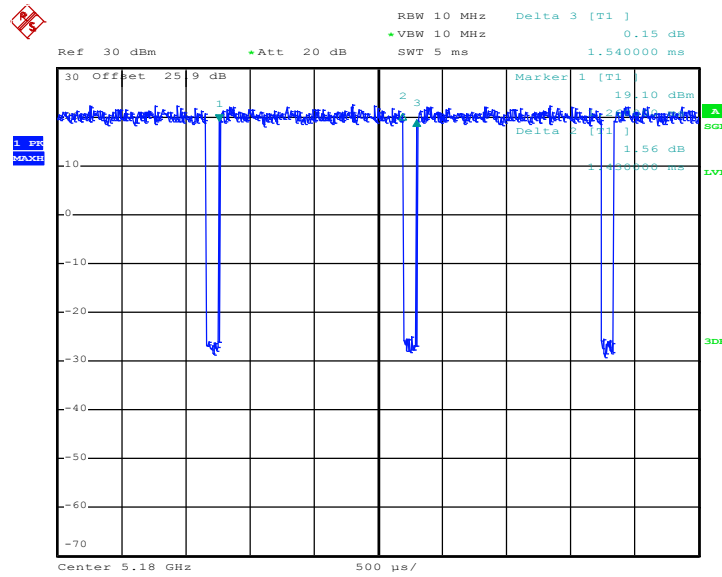

Date: 18.AUG.2016 20:20:08

802.11n HT20

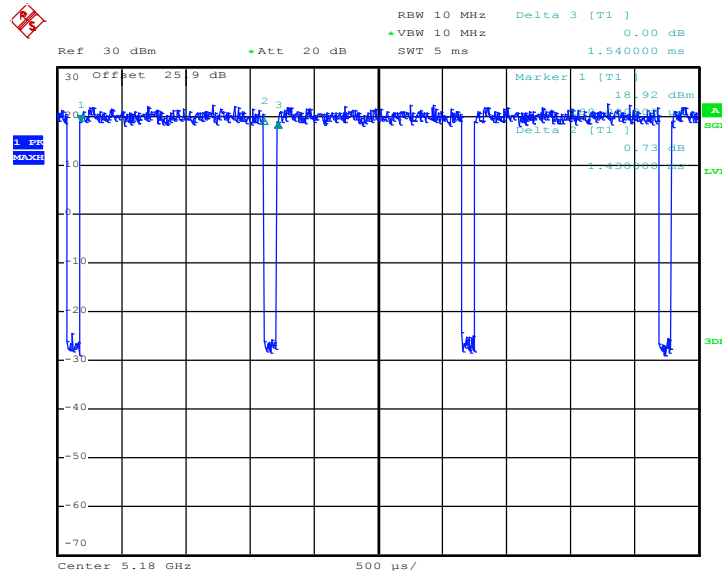

Date: 18.AUG.2016 21:35:22





802.11n HT40

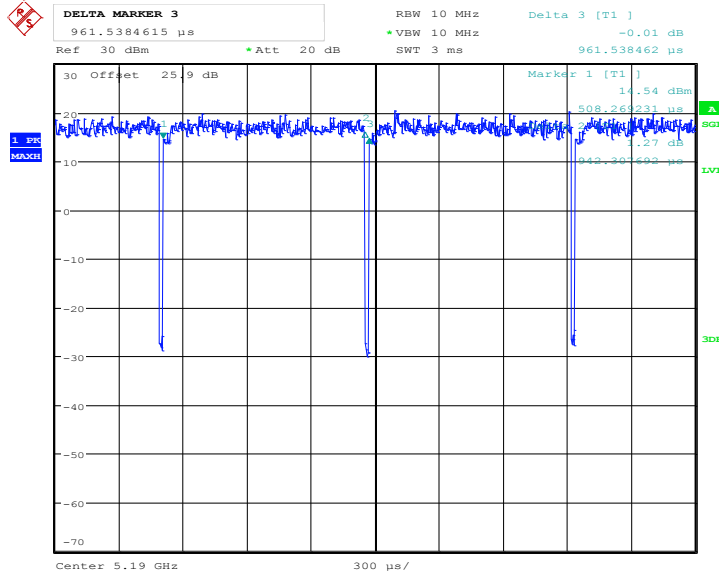

Date: 18.AUG.2016 22:38:16

802.11ac VHT20

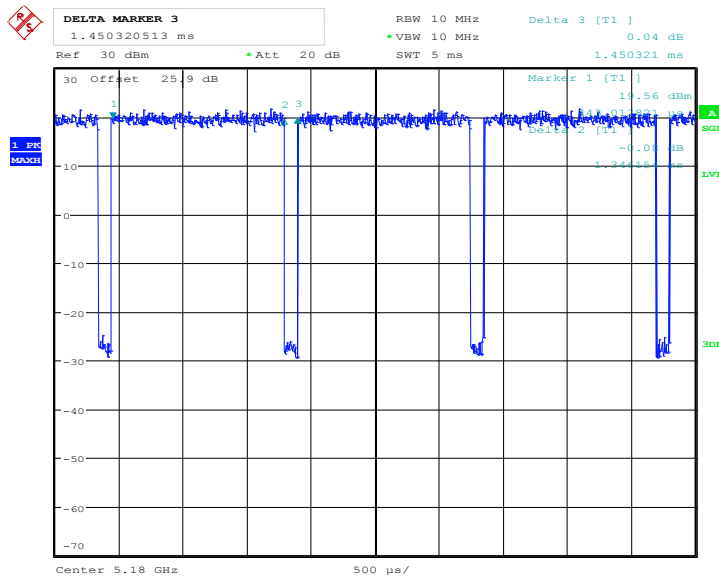

Date: 18.AUG.2016 23:39:03



802.11ac VHT40

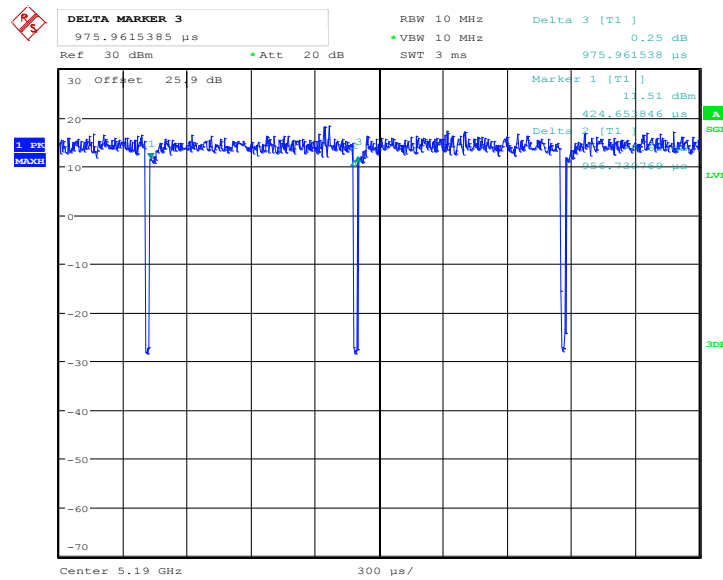

Date: 18.AUG.2016 23:45:26

802.11ac VHT80

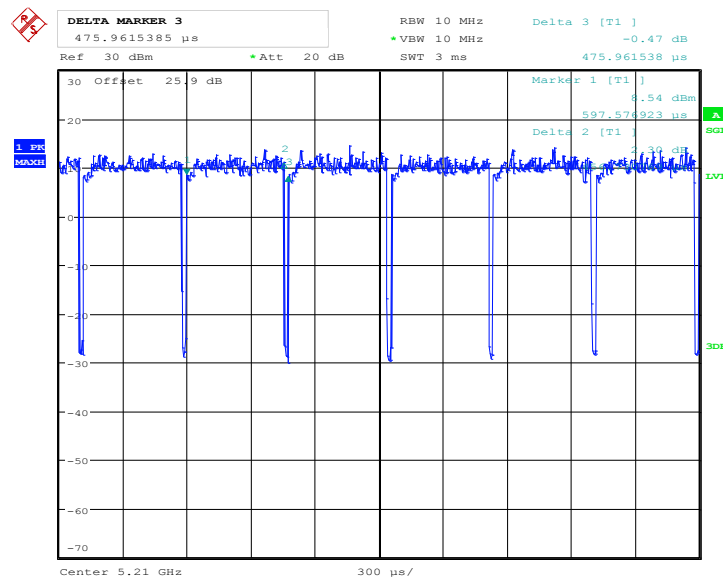

Date: 18.AUG.2016 23:54:39