



FCC RF Test Report

APPLICANT : Zebra Technologies Corporation
EQUIPMENT : Touch computer
BRAND NAME : Zebra
MODEL NAME : TC75EK
FCC ID : UZ7TC75EK
STANDARD : FCC Part 15 Subpart C §15.247
CLASSIFICATION : (DSS) Spread Spectrum Transmitter

The product was received on Jul. 28, 2016 and testing was completed on Sep. 20, 2016. We, SPORTON INTERNATIONAL INC., would like to declare that the tested sample has been evaluated in accordance with the test procedures and has been in compliance with the applicable technical standards.

The test results in this report apply exclusively to the tested model / sample. Without written approval of SPORTON INTERNATIONAL INC., the test report shall not be reproduced except in full.

Reviewed by: Joseph Lin / Supervisor

Approved by: Jones Tsai / Manager



SPORTON INTERNATIONAL INC.

No. 52, Hwa Ya 1st Rd., Hwa Ya Technology Park, Kwei-Shan District, Tao Yuan City, Taiwan, R.O.C.



TABLE OF CONTENTS

REVISION HISTORY..... 3

SUMMARY OF TEST RESULT 4

1 GENERAL DESCRIPTION..... 5

1.1 Applicant 5

1.2 Manufacturer..... 5

1.3 Product Feature of Equipment Under Test..... 5

1.4 Product Specification of Equipment Under Test..... 6

1.5 Modification of EUT 6

1.6 Testing Location 6

1.7 Applicable Standards..... 7

2 TEST CONFIGURATION OF EQUIPMENT UNDER TEST..... 8

2.1 Descriptions of Test Mode 8

2.2 Test Mode..... 10

2.3 Connection Diagram of Test System..... 11

2.4 Support Unit used in test configuration and system 12

2.5 EUT Operation Test Setup 12

2.6 Measurement Results Explanation Example..... 13

3 TEST RESULT 14

3.1 Number of Channel Measurement 14

3.2 Hopping Channel Separation Measurement 16

3.3 Dwell Time Measurement..... 23

3.4 20dB and 99% Bandwidth Measurement 25

3.5 Peak Output Power Measurement 38

3.6 Conducted Band Edges Measurement..... 40

3.7 Conducted Spurious Emission Measurement 47

3.8 Radiated Band Edges and Spurious Emission Measurement 57

3.9 AC Conducted Emission Measurement..... 63

3.10 Antenna Requirements..... 81

4 LIST OF MEASURING EQUIPMENT..... 82

5 UNCERTAINTY OF EVALUATION..... 83

APPENDIX A. RADIATED SPURIOUS EMISSION

APPENDIX B. RADIATED SPURIOUS EMISSION PLOTS

APPENDIX C. SETUP PHOTOGRAPHS



REVISION HISTORY

REPORT NO.	VERSION	DESCRIPTION	ISSUED DATE
FR672834A	Rev. 01	Initial issue of report	Sep. 29, 2016
FR672834A	Rev. 02	Revising the specification of accessories.	Oct. 04, 2016
FR672834A	Rev. 03	Revising the Adapter information in specification of accessories.	Oct. 07, 2016



SUMMARY OF TEST RESULT

Report Section	FCC Rule	Description	Limit	Result	Remark
3.1	15.247(a)(1)	Number of Channels	≥ 15Chs	Pass	-
3.2	15.247(a)(1)	Hopping Channel Separation	≥ 2/3 of 20dB BW	Pass	-
3.3	15.247(a)(1)	Dwell Time of Each Channel	≤ 0.4sec in 31.6sec period	Pass	-
3.4	15.247(a)(1)	20dB Bandwidth	NA	Pass	-
3.4	-	99% Bandwidth	-	Pass	-
3.5	15.247(b)(1)	Peak Output Power	≤ 125 mW	Pass	-
3.6	15.247(d)	Conducted Band Edges	≤ 20dBc	Pass	-
3.7	15.247(d)	Conducted Spurious Emission	≤ 20dBc	Pass	-
3.8	15.247(d)	Radiated Band Edges and Radiated Spurious Emission	15.209(a) & 15.247(d)	Pass	Under limit 5.33 dB at 84.000 MHz
3.9	15.207	AC Conducted Emission	15.207(a)	Pass	Under limit 3.10 dB at 0.758 MHz
3.10	15.203 & 15.247(b)	Antenna Requirement	N/A	Pass	-



1 General Description

1.1 Applicant

Zebra Technologies Corporation
1 Zebra Plaza Holtsville, NY 11742

1.2 Manufacturer

Wistron Corporation
21F, No. 88, Sec. 1, Hsin Tai Wu Rd., Hsichih Dist, New Taipei City 221, Taiwan R.O.C.

1.3 Product Feature of Equipment Under Test

Product Feature	
Equipment	Touch computer
Brand Name	Zebra
Model Name	TC75EK
FCC ID	UZ7TC75EK
EUT supports Radios application	CDMA/EV-DO/GSM/EGPRS/WCDMA/HSPA/LTE/NFC WLAN 11a/b/g/n HT20/HT40 WLAN 11ac VHT20/VHT40/VHT80 Bluetooth BR/EDR/LE
HW Version	DV
SW Version	Android version 6.0.1
FW Version	91-10-01-MG-00
MFD	14JUL16
EUT Stage	Engineering sample

Remark: The above EUT's information was declared by manufacturer. Please refer to the specifications or user's manual for more detailed description.

Specification of Accessories				
AC Adapter	Brand Name	Zebra	Part Number	PWR-BUA5V16W0WW
Snap-On USB/Charge Cable	Brand Name	Symbols	Part Number	CBL-TC7X-USB1-01
Snap-On Charging Cable Cup	Brand Name	Symbol	Part Number	CHG-TC7X-CBL1-01
Battery	Brand Name	Zebra	Part Number	BT-000318-01
Earphone 1	Brand Name	Zebra	Part Number	HDST-35MM-PTVP-01
Earphone 2	Brand Name	Zebra	Part Number	HS2100-OTH
Earphone 3	Brand Name	Zebra	Part Number	HS3100-OTH
Snap-on 3.5MM Audio Nugget	Brand Name	Symbol	Part Number	ADP-TC7X-AUD35-01
3.5mm Jack 43"(1.1m) Standard Cable	Brand Name	Zebra	Part Number	CBL-HS2100-3MS1-01
Soft Holster	Brand Name	Zebra	Part Number	SG-TC7X-HLSTR1-01
Rigid Holster	Brand Name	Zebra	Part Number	SG-TC7X-RHLSTR1-01
Power Cord	Brand Name	LOROM	Part Number	50-16000-182R
Cable line	Brand Name	Zebra	Part Number	CBL-DC-383A1-01



1.4 Product Specification of Equipment Under Test

Standards-related Product Specification	
Tx/Rx Frequency Range	2402 MHz ~ 2480 MHz
Number of Channels	79
Carrier Frequency of Each Channel	2402+n*1 MHz; n=0~78
Maximum Output Power to Antenna	Bluetooth BR(1Mbps) : 4.13 dBm (0.0026 W) Bluetooth EDR (2Mbps) : 2.76 dBm (0.0019 W) Bluetooth EDR (3Mbps) : 2.75 dBm (0.0019 W)
99% Occupied Bandwidth	Bluetooth BR(1Mbps) : 0.884MHz Bluetooth EDR (2Mbps) : 1.208MHz Bluetooth EDR (3Mbps) : 1.184MHz
Antenna Type / Gain	IFA Antenna type with gain 2.60 dBi
Type of Modulation	Bluetooth BR (1Mbps) : GFSK Bluetooth EDR (2Mbps) : $\pi/4$ -DQPSK Bluetooth EDR (3Mbps) : 8-DPSK

1.5 Modification of EUT

No modifications are made to the EUT during all test items.

1.6 Testing Location

Sporton Lab is accredited to ISO 17025 by Taiwan Accreditation Foundation (TAF code : 1190) and the FCC designation No. TW1022 under the FCC 2.948(e) by Mutual Recognition Agreement (MRA) in FCC Test.

Test Site	SPORTON INTERNATIONAL INC.		
Test Site Location	No. 52, Hwa Ya 1 st Rd., Hwa Ya Technology Park, Kwei-Shan District, Tao Yuan City, Taiwan, R.O.C. TEL: +886-3-327-3456 FAX: +886-3-328-4978		
Test Site No.	Sporton Site No.		
	TH02-HY	CO05-HY	03CH07-HY

Note: The test site complies with ANSI C63.4 2014 requirement.



1.7 Applicable Standards

According to the specifications of the manufacturer, the EUT must comply with the requirements of the following standards:

- ♦ FCC Part 15 Subpart C §15.247
- ♦ ANSI C63.10-2013

Remark:

1. All test items were verified and recorded according to the standards and without any deviation during the test.
2. This EUT has also been tested and complied with the requirements of FCC Part 15, Subpart B, recorded in a separate test report.



2 Test Configuration of Equipment Under Test

2.1 Descriptions of Test Mode

Preliminary tests were performed in different data rates and recorded the RF output power in the following table:

Channel	Frequency	Bluetooth RF Average Output Power (dBm)		
		GFSK / 1Mbps		
		DH1	DH3	DH5
Duty Cycle (%)		30.48	65.74	77.13
Ch00	2402MHz	1.02 dBm	1.00 dBm	1.01 dBm
Ch39	2441MHz	3.28 dBm	3.24 dBm	3.23 dBm
Ch78	2480MHz	3.21 dBm	3.15 dBm	3.14 dBm

Channel	Frequency	Bluetooth RF Average Output Power (dBm)		
		π /4-DQPSK / 2Mbps		
		2DH1	2DH3	2DH5
Duty Cycle (%)		30.79	65.74	77.13
Ch00	2402MHz	-2.65 dBm	-2.61 dBm	-2.62 dBm
Ch39	2441MHz	-0.40 dBm	-0.42 dBm	-0.42 dBm
Ch78	2480MHz	-0.55 dBm	-0.56 dBm	-0.56 dBm

Channel	Frequency	Bluetooth RF Average Output Power (dBm)		
		8-DPSK / 3Mbps		
		3DH1	3DH3	3DH5
Duty Cycle (%)		31.11	65.34	77.13
Ch00	2402MHz	-2.71 dBm	-2.57 dBm	-2.60 dBm
Ch39	2441MHz	-0.37 dBm	-0.38 dBm	-0.38 dBm
Ch78	2480MHz	-0.61 dBm	-0.65 dBm	-0.62 dBm



Channel	Frequency	Bluetooth RF Peak Output Power (dBm)		
		GFSK / 1Mbps		
		DH1	DH3	DH5
Ch00	2402MHz	2.38 dBm	2.34 dBm	2.36 dBm
Ch39	2441MHz	4.13 dBm	4.08 dBm	4.06 dBm
Ch78	2480MHz	4.05 dBm	4.03 dBm	3.99 dBm

Channel	Frequency	Bluetooth RF Peak Output Power (dBm)		
		$\pi/4$ -DQPSK / 2Mbps		
		2DH1	2DH3	2DH5
Ch00	2402MHz	1.22 dBm	1.38 dBm	1.16 dBm
Ch39	2441MHz	2.76 dBm	2.75 dBm	2.75 dBm
Ch78	2480MHz	2.59 dBm	2.47 dBm	2.46 dBm

Channel	Frequency	Bluetooth RF Peak Output Power (dBm)		
		8-DPSK / 3Mbps		
		3DH1	3DH3	3DH5
Ch00	2402MHz	1.24 dBm	1.22 dBm	1.20 dBm
Ch39	2441MHz	2.75 dBm	2.73 dBm	2.72 dBm
Ch78	2480MHz	2.56 dBm	2.53 dBm	2.55 dBm

Remark: The data rate was set in 1Mbps for all the test items due to the highest RF output power.

- a. The EUT has been associated with peripherals and configuration operated in a manner tended to maximize its emission characteristics in a typical application. Frequency range investigated: conduction (150 kHz to 30 MHz), radiation (9 kHz to the 10th harmonic of the highest fundamental frequency or to 40 GHz, whichever is lower). Pre-scanned tests, X, Y, Z in three orthogonal panels, and different data rates were conducted to determine the final configuration. The worst position for each mode was recorded in the appendix of this test report. From all possible combinations, and the worst mode of radiated spurious emissions is Bluetooth 1Mbps mode, and recorded in this report.
- b. AC power line Conducted Emission was tested under maximum output power.



2.2 Test Mode

The following summary table is showing all test modes to demonstrate in compliance with the standard.

Summary table of Test Cases			
Test Item	Data Rate / Modulation		
	Bluetooth BR 1Mbps GFSK	Bluetooth EDR 2Mbps π /4-DQPSK	Bluetooth EDR 3Mbps 8-DPSK
Conducted Test Cases	Mode 1: CH00_2402 MHz Mode 2: CH39_2441 MHz Mode 3: CH78_2480 MHz	Mode 4: CH00_2402 MHz Mode 5: CH39_2441 MHz Mode 6: CH78_2480 MHz	Mode 7: CH00_2402 MHz Mode 8: CH39_2441 MHz Mode 9: CH78_2480 MHz
Radiated Test Cases	Bluetooth BR 1Mbps GFSK Mode 1: CH00_2402 MHz Mode 2: CH39_2441 MHz Mode 3: CH78_2480 MHz		
AC Conducted Emission	Mode 1 :NFC Link + WLAN (2.4GHz) Link + Bluetooth Link + Earphone 1 with Audio Adapter connect to EUT + Charging Only Cable + AC Adapter Mode 2 :NFC Link + WLAN (5GHz) Link + Bluetooth Link with Earphone 3 + Snap on USB Cable Data Link with Notebook + Copy Data from Notebook to EDA (SD Card) + AC Adapter Mode 3 :NFC Link + WLAN (2.4GHz) Link + Bluetooth Link + Earphone 2 with Audio Adapter connect to EUT + Charging Only Cable + AC Adapter		
Remark:			
<ol style="list-style-type: none"> For radiated test cases, the worst mode data rate 1Mbps was reported only, because this data rate has the highest RF output power at preliminary tests, and the conducted spurious emissions and conducted band edge measurement for each data rate are no worse than 1Mbps, and no other significantly frequencies found in conducted spurious emission. All the radiated test cases were performance with Earphone 1, Adapter and USB Cable. 			

2.3 Connection Diagram of Test System

<AC Conducted Emission for charging mode>

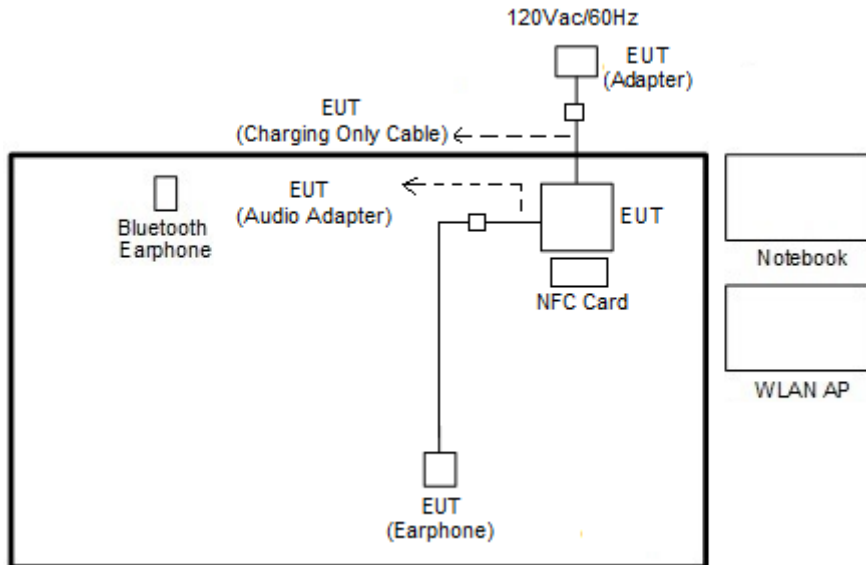

<AC Conducted Emission for data link mode>

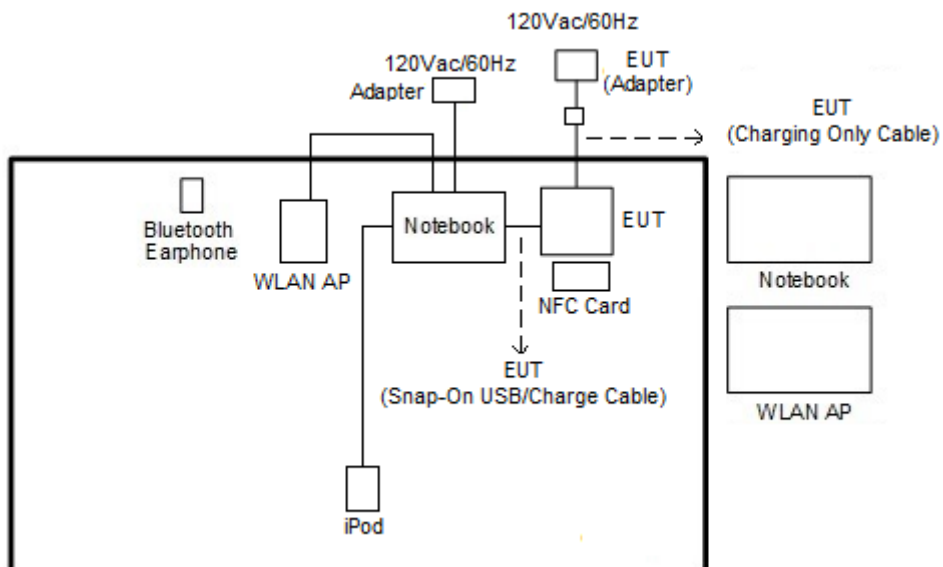

<For Fundamental Emissions and Mask and Radiated Emissions Measurement>

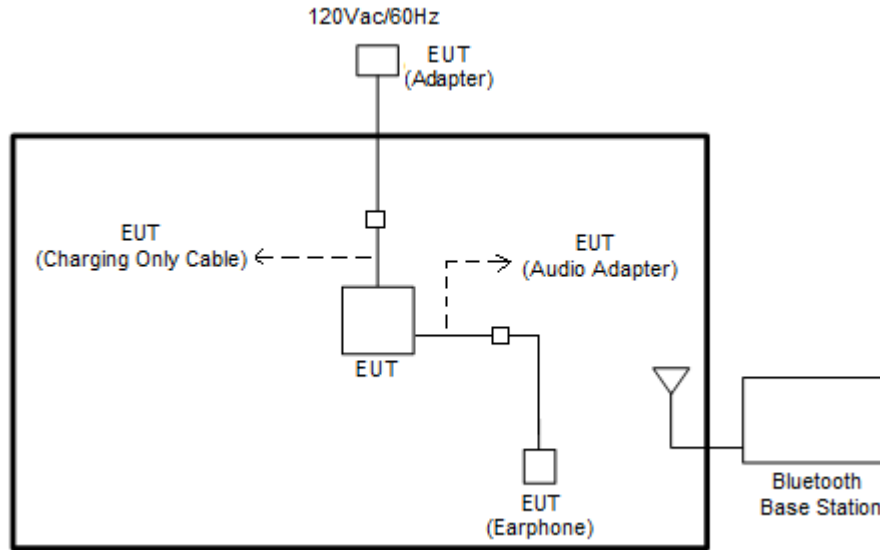

2.4 Support Unit used in test configuration and system

Item	Equipment	Trade Name	Model Name	FCC ID	Data Cable	Power Cord
1.	Bluetooth Base Station	R&S	CBT32	N/A	N/A	Unshielded, 1.8 m
2.	WLAN AP	D-Link	DIR-628	KA2DIR628A2	N/A	Unshielded, 1.8 m
3.	Bluetooth Earphone	Sony Ericsson	MW600	PY7DDA-2029	N/A	N/A
4.	Notebook	DELL	P20G	FCC DoC/ Contains FCC ID: QDS-BRCM1051	N/A	AC I/P: Unshielded, 1.2 m DC O/P: Shielded, 1.8 m
5.	Notebook	DELL	Latitude E6320	FCC DoC/ Contains FCC ID: QDS-BRCM1054	N/A	AC I/P: Unshielded, 1.2 m DC O/P: Shielded, 1.8 m
6.	Notebook	Lenovo	M490S(E330)	QDS-BRCM1063	N/A	Unshielded, 1.8 m
7.	SD Card	SanDisk	MicroSD HC	FCC DoC	N/A	N/A
8.	NFC Card	Metro Taipei	Easy Card	N/A	N/A	N/A
9.	iPod	Apple	A1285	FCC DoC	Shielded, 1.0 m	N/A

2.5 EUT Operation Test Setup

For Bluetooth function, the RF utility, "Command" was installed in EUT which was programmed in order to make the EUT get into the engineering modes to contact with Bluetooth base station for continuous transmitting and receiving signals.



2.6 Measurement Results Explanation Example

For all conducted test items:

The offset level is set in the spectrum analyzer to compensate the RF cable loss and attenuator factor between EUT conducted output port and spectrum analyzer. With the offset compensation, the spectrum analyzer reading level is exactly the EUT RF output level.

Example:

The spectrum analyzer offset is derived from RF cable loss and attenuator factor.

Offset = RF cable loss + attenuator factor.

Following shows an offset computation example with cable loss 4.2 dB and 10dB attenuator.

$$\begin{aligned} \text{Offset(dB)} &= \text{RF cable loss(dB)} + \text{attenuator factor(dB)}. \\ &= 4.2 + 10 = 14.2 \text{ (dB)} \end{aligned}$$

3 Test Result

3.1 Number of Channel Measurement

3.1.1 Limits of Number of Hopping Frequency

Frequency hopping systems in the 2400-2483.5 MHz band shall use at least 15 channels.

3.1.2 Measuring Instruments

The measuring equipment is listed in the section 4 of this test report.

3.1.3 Test Procedure

1. The testing follows ANSI C63.10-2013 clause 7.8.3.
2. The RF output of EUT was connected to the spectrum analyzer by RF cable and attenuator. The path loss was compensated to the results for each measurement.
3. Set to the maximum power setting and enable the EUT transmit continuously.
4. Enable the EUT hopping function.
5. Use the following spectrum analyzer settings: Span = the frequency band of operation; RBW = 300kHz; VBW \geq RBW; Sweep = auto; Detector function = peak; Trace = max hold.
6. The number of hopping frequency used is defined as the number of total channel.
7. Record the measurement data derived from spectrum analyzer.

3.1.4 Test Setup

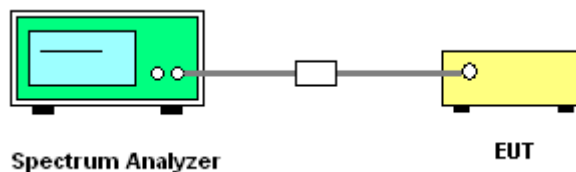

3.1.5 Test Result of Number of Hopping Frequency

Test Mode :	1Mbps	Temperature :	24~26°C
Test Engineer :	An Wu and Tommy Lee	Relative Humidity :	48~51%
Number of Hopping (Channel)	Adaptive Frequency Hopping (Channel)	Limits (Channel)	Pass/Fail
79	20	> 15	Pass



Number of Hopping Channel Plot on Channel 00 - 78

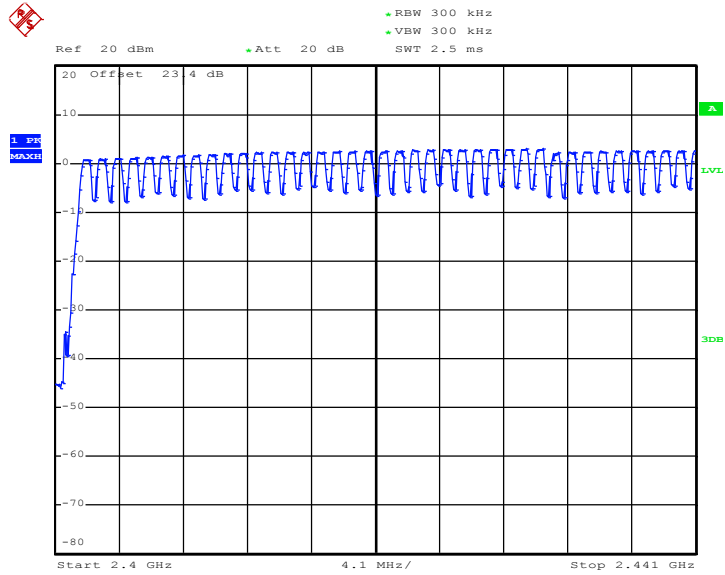

Date: 26.AUG.2016 23:43:59

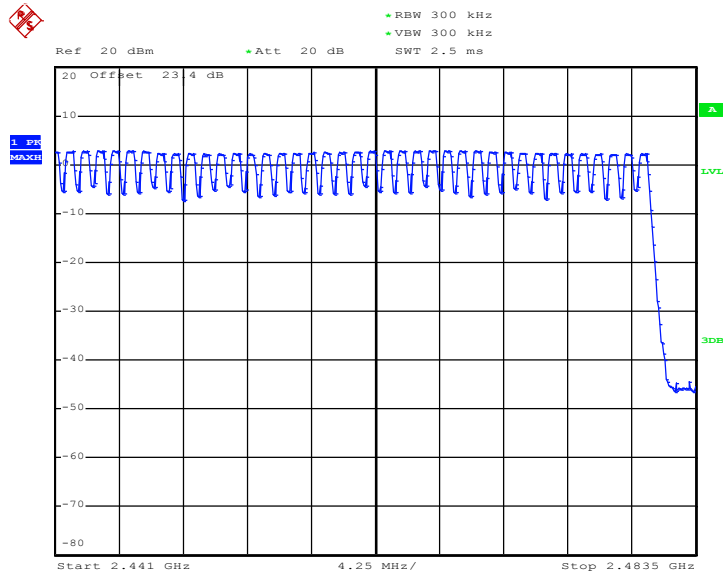

Date: 26.AUG.2016 23:46:09

3.2 Hopping Channel Separation Measurement

3.2.1 Limit of Hopping Channel Separation

Frequency hopping systems operating in the 2400-2483.5 MHz band may have hopping channel carrier frequencies that are separated by 25 kHz or two-thirds of the 20 dB bandwidth of the hopping channel, whichever is greater.

3.2.2 Measuring Instruments

The measuring equipment is listed in the section 4 of this test report.

3.2.3 Test Procedures

1. The testing follows ANSI C63.10-2013 clause 7.8.2.
2. The RF output of EUT was connected to the spectrum analyzer by RF cable and attenuator. The path loss was compensated to the results for each measurement.
3. Set to the maximum power setting and enable the EUT transmit continuously.
4. Enable the EUT hopping function.
5. Use the following spectrum analyzer settings:
Span = wide enough to capture the peaks of two adjacent channels;
RBW = 300kHz; VBW \geq RBW; Sweep = auto; Detector function = peak; Trace = max hold.
6. Measure and record the results in the test report.

3.2.4 Test Setup

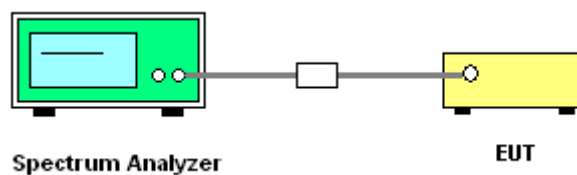



3.2.5 Test Result of Hopping Channel Separation

Test Mode :	1Mbps	Temperature :	24~26°C
Test Engineer :	An Wu and Tommy Lee	Relative Humidity :	48~51%

Channel	Frequency (MHz)	Frequency Separation (MHz)	(2/3 of 20dB BW) Limits (MHz)	Pass/Fail
00	2402	1.002	0.6427	Pass
39	2441	1.008	0.6320	Pass
78	2480	1.008	0.6320	Pass

Channel Separation Plot on Channel 00 - 01

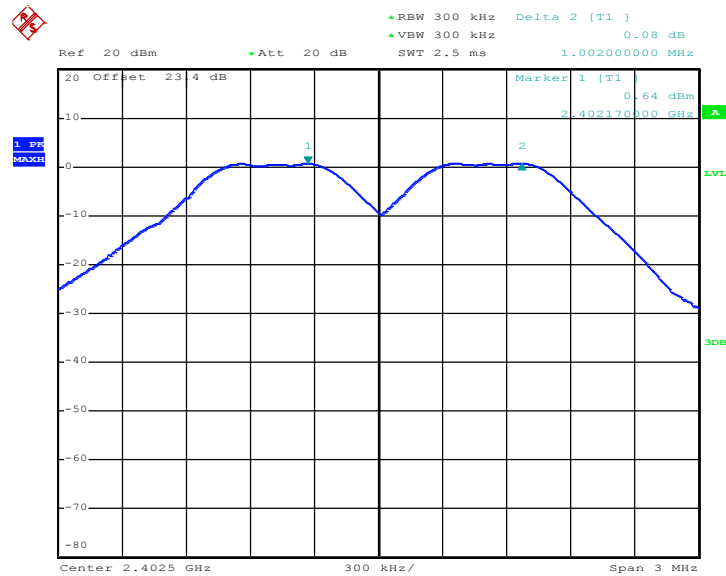

Date: 26.AUG.2016 22:22:48



Channel Separation Plot on Channel 39 - 40

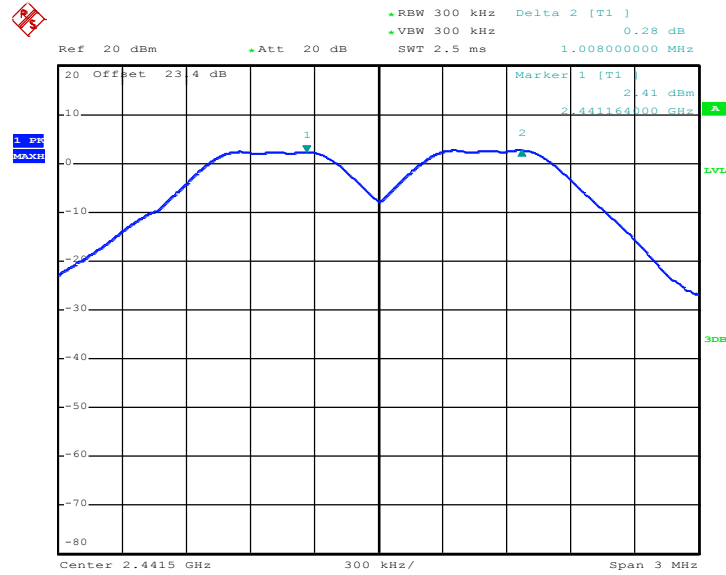

Date: 26.AUG.2016 22:37:51

Channel Separation Plot on Channel 77 - 78

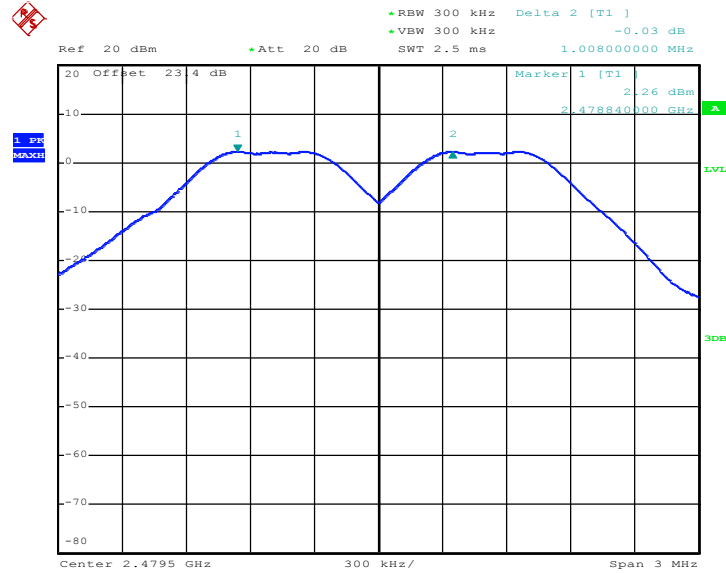

Date: 26.AUG.2016 22:39:22



Test Mode :	2Mbps	Temperature :	24~26°C
Test Engineer :	An Wu and Tommy Lee	Relative Humidity :	48~51%

Channel	Frequency (MHz)	Frequency Separation (MHz)	(2/3 of 20dB BW) Limits (MHz)	Pass/Fail
00	2402	1.002	0.9000	Pass
39	2441	1.002	0.9000	Pass
78	2480	1.002	0.9000	Pass

Channel Separation Plot on Channel 00 - 01

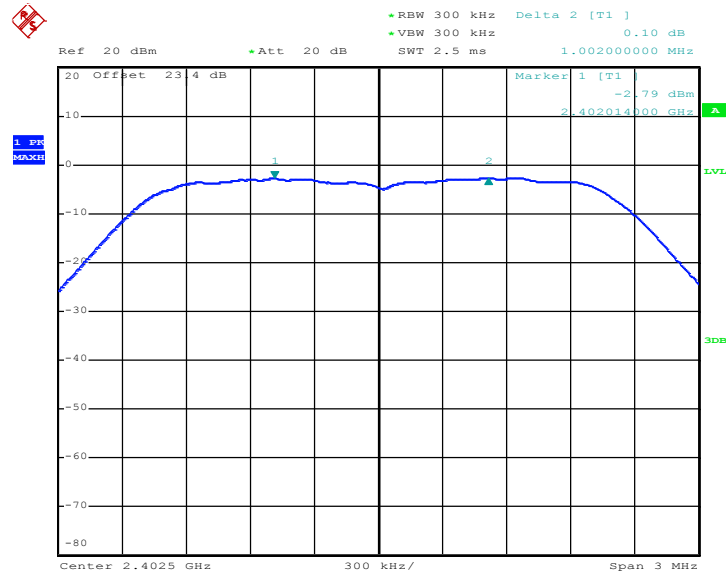

Date: 26.AUG.2016 22:42:20



Channel Separation Plot on Channel 39 - 40

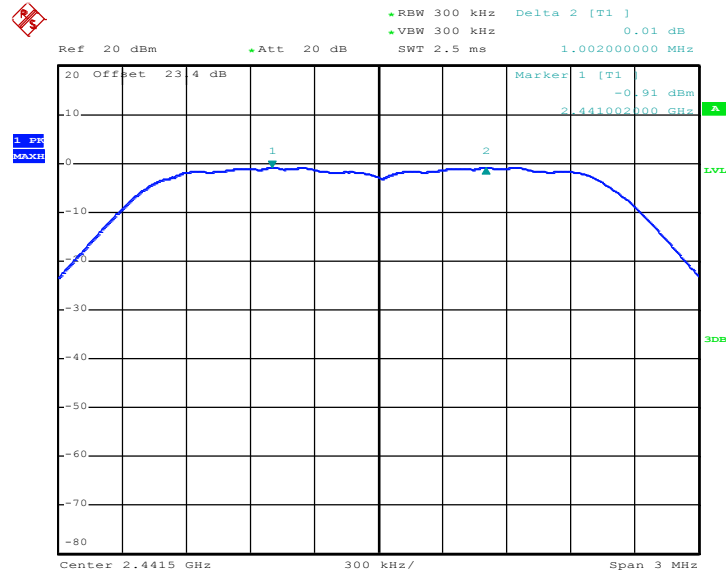

Date: 26.AUG.2016 22:44:20

Channel Separation Plot on Channel 77 - 78

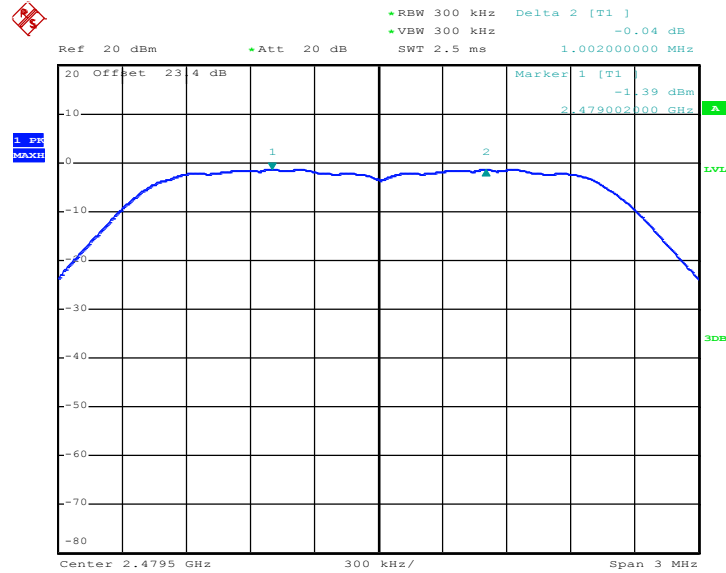

Date: 26.AUG.2016 22:45:46



Test Mode :	3Mbps	Temperature :	24~26°C
Test Engineer :	An Wu and Tommy Lee	Relative Humidity :	48~51%

Channel	Frequency (MHz)	Frequency Separation (MHz)	(2/3 of 20dB BW) Limits (MHz)	Pass/Fail
00	2402	1.002	0.8680	Pass
39	2441	1.008	0.8680	Pass
78	2480	1.002	0.8760	Pass

Channel Separation Plot on Channel 00 - 01

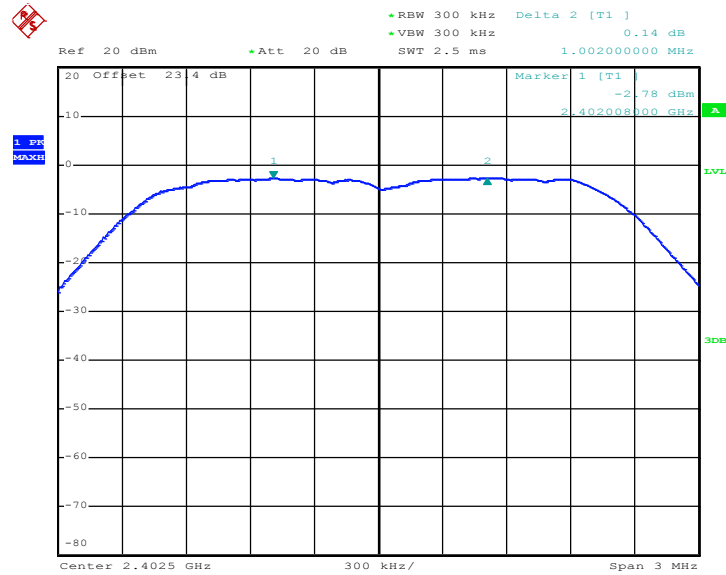

Date: 26.AUG.2016 22:47:24



Channel Separation Plot on Channel 39 - 40

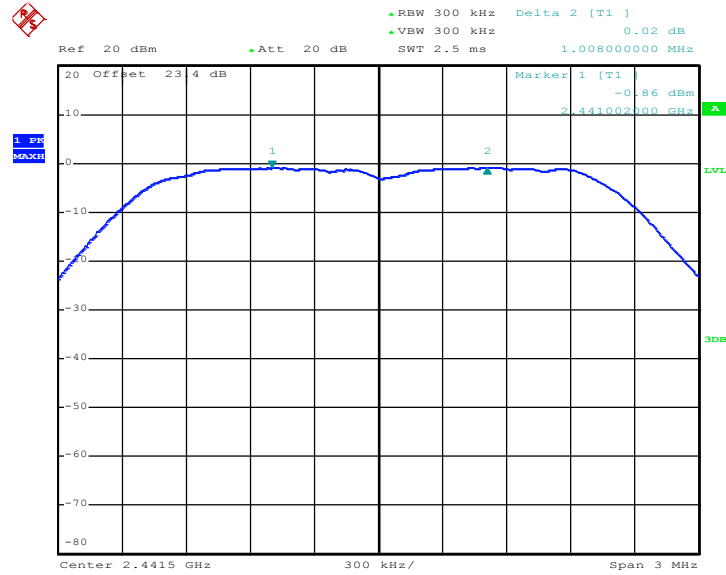

Date: 26.AUG.2016 22:50:14

Channel Separation Plot on Channel 77 - 78

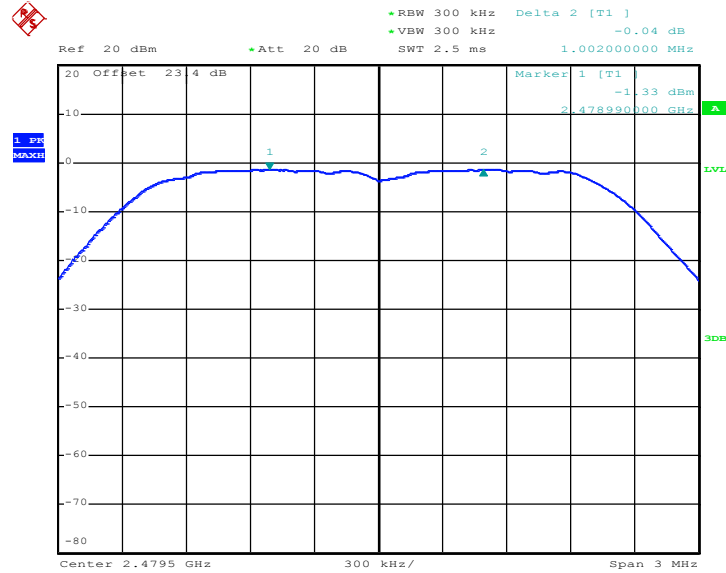

Date: 26.AUG.2016 22:51:34

3.3 Dwell Time Measurement

3.3.1 Limit of Dwell Time

The average time of occupancy on any channel shall not be greater than 0.4 seconds within a period of 0.4 seconds multiplied by the number of hopping channels employed.

3.3.2 Measuring Instruments

The measuring equipment is listed in the section 4 of this test report.

3.3.3 Test Procedures

1. The testing follows ANSI C63.10-2013 clause 7.8.4.
2. The RF output of EUT was connected to the spectrum analyzer by RF cable and attenuator. The path loss was compensated to the results for each measurement.
3. Set to the maximum power setting and enable the EUT transmit continuously.
4. Enable the EUT hopping function.
5. Use the following spectrum analyzer settings: Span = zero span, centered on a hopping channel; RBW = 1 MHz; VBW \geq RBW; Sweep = as necessary to capture the entire dwell time per hopping channel; Detector function = peak; Trace = max hold.
6. Measure and record the results in the test report.

3.3.4 Test Setup





3.3.5 Test Result of Dwell Time

Test Mode :	DH5	Temperature :	24~26°C
Test Engineer :	An Wu and Tommy Lee	Relative Humidity :	48~51%

Mode	Hopping Channel Number	Hops Over Occupancy Time(hops)	Package Transfer Time (msec)	Dwell Time (sec)	Limits (sec)	Pass/Fail
Normal	79	106.67	2.90	0.31	0.4	Pass
AFH	20	53.33	2.90	0.15	0.4	Pass

Remark:

- In normal mode, hopping rate is 1600 hops/s with 6 slots in 79 hopping channels.
With channel hopping rate (1600 / 6 / 79) in Occupancy Time Limit (0.4 x 79) (s),
Hops Over Occupancy Time comes to (1600 / 6 / 79) x (0.4 x 79) = 106.67 hops.
- In AFH mode, hopping rate is 800 hops/s with 6 slots in 20 hopping channels.
With channel hopping rate (800 / 6 / 20) in Occupancy Time Limit (0.4 x 20) (s),
Hops Over Occupancy Time comes to (800 / 6 / 20) x (0.4 x 20) = 53.33 hops.
- Dwell Time(s) = Hops Over Occupancy Time (hops) x Package Transfer Time

Package Transfer Time Plot

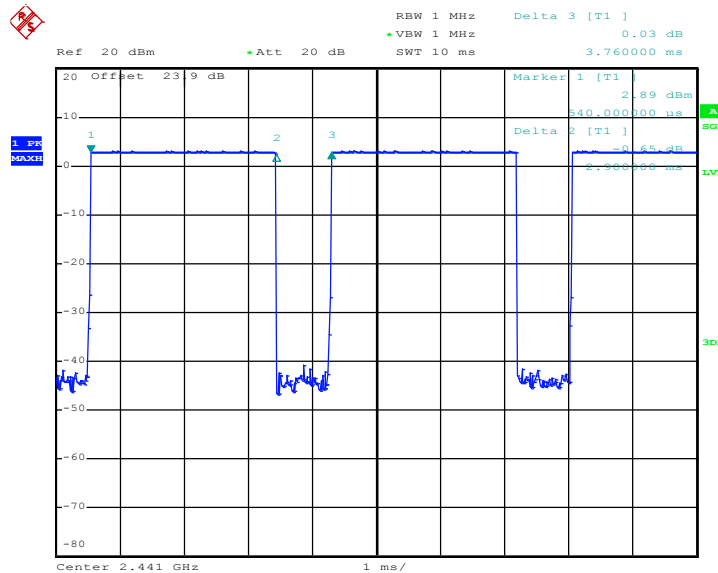

Date: 19.AUG.2016 14:36:18

3.4 20dB and 99% Bandwidth Measurement

3.4.1 Limit of 20dB and 99% Bandwidth

Reporting only

3.4.2 Measuring Instruments

The measuring equipment is listed in the section 4 of this test report.

3.4.3 Test Procedures

1. The testing follows ANSI C63.10-2013 clause 6.9.2 and 6.9.3.
2. The RF output of EUT was connected to the spectrum analyzer by RF cable and attenuator. The path loss was compensated to the results for each measurement.
3. Set to the maximum power setting and enable the EUT transmit continuously.
4. Use the following spectrum analyzer settings for 20dB Bandwidth measurement.
Span = approximately 2 to 5 times the 20 dB bandwidth, centered on a hopping channel;
RBW \geq 1% of the 20 dB bandwidth; VBW \geq RBW; Sweep = auto; Detector function = peak;
Trace = max hold.
5. Use the following spectrum analyzer settings for 99 % Bandwidth measurement.
Span = approximately 1.5 to 5 times the 99% bandwidth, centered on a hopping channel;
RBW \geq 1% of the 99% bandwidth; VBW \geq RBW; Sweep = auto; Detector function = peak;
Trace = max hold.
6. Measure and record the results in the test report.

3.4.4 Test Setup

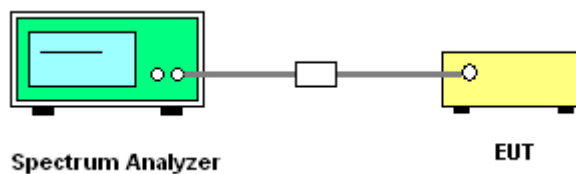



3.4.5 Test Result of 20dB Bandwidth

Test Mode :	1Mbps	Temperature :	24~26°C
Test Engineer :	An Wu and Tommy Lee	Relative Humidity :	48~51%

Channel	Frequency (MHz)	20dB Bandwidth (MHz)
00	2402	0.964
39	2441	0.948
78	2480	0.948

20 dB Bandwidth Plot on Channel 00

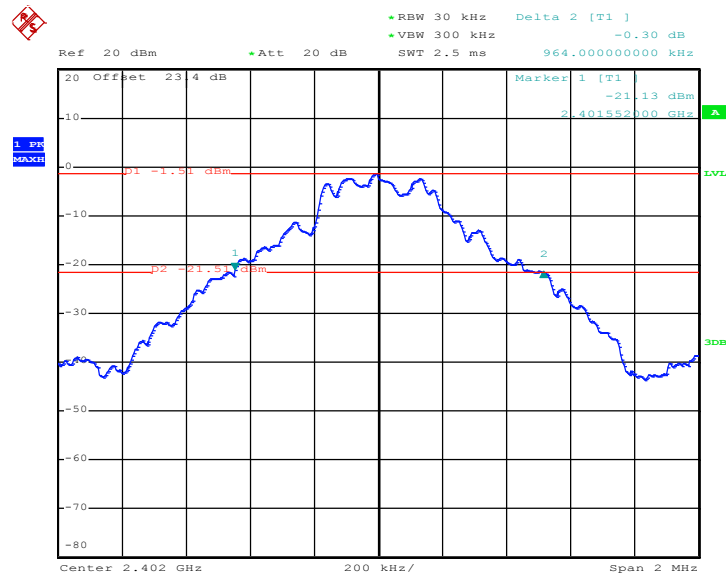

Date: 26.AUG.2016 22:56:00



20 dB Bandwidth Plot on Channel 39

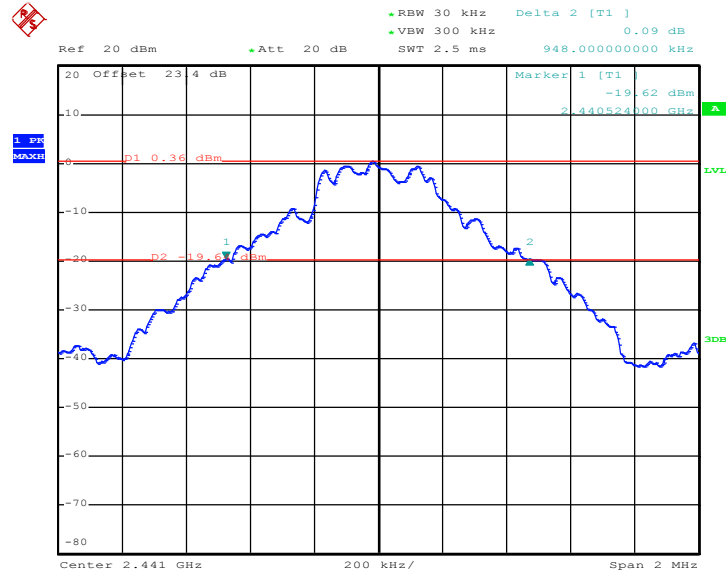

Date: 26.AUG.2016 22:58:06

20 dB Bandwidth Plot on Channel 78

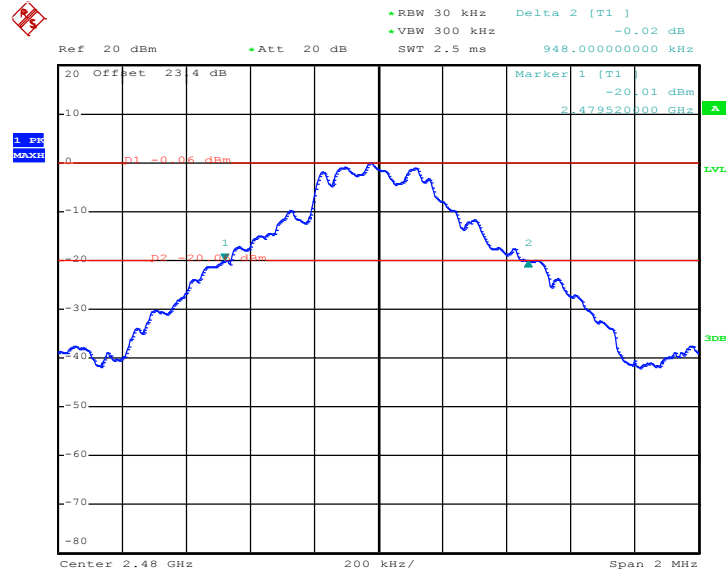

Date: 26.AUG.2016 23:00:32



Test Mode :	2Mbps	Temperature :	24~26°C
Test Engineer :	An Wu and Tommy Lee	Relative Humidity :	48~51%

Channel	Frequency (MHz)	20dB Bandwidth (MHz)
00	2402	1.350
39	2441	1.350
78	2480	1.350

20 dB Bandwidth Plot on Channel 00

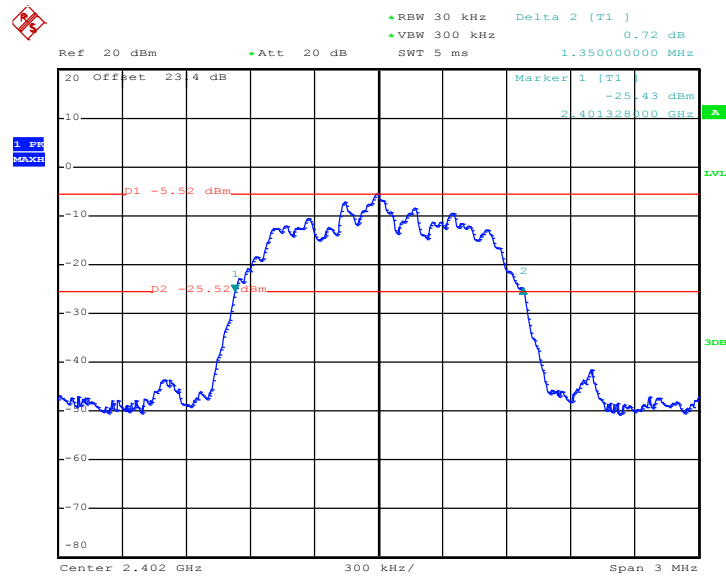

Date: 26.AUG.2016 23:02:43



20 dB Bandwidth Plot on Channel 39

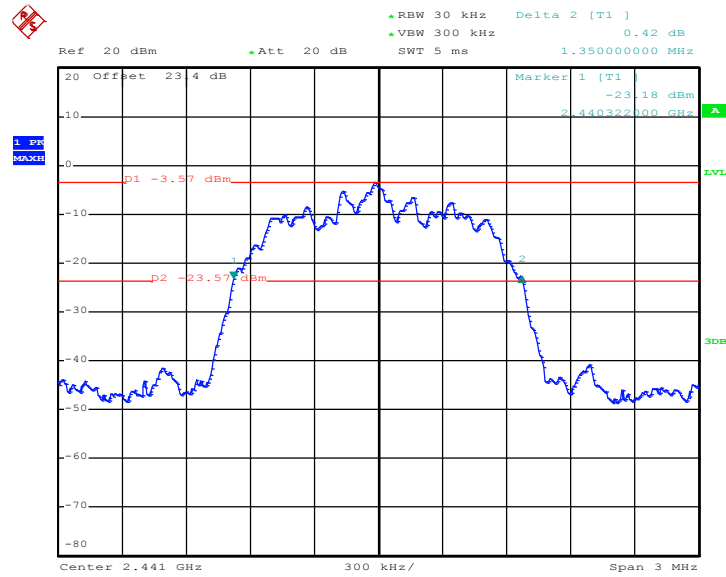

Date: 26.AUG.2016 23:04:46

20 dB Bandwidth Plot on Channel 78

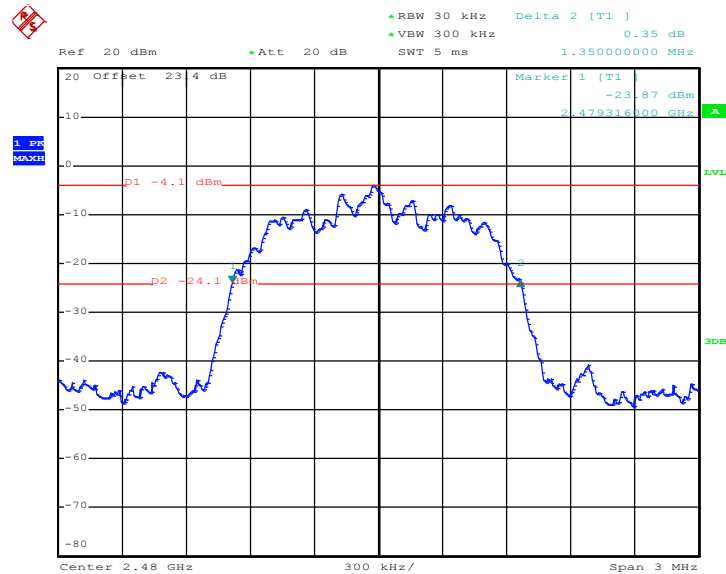

Date: 26.AUG.2016 23:07:11



Test Mode :	3Mbps	Temperature :	24~26°C
Test Engineer :	An Wu and Tommy Lee	Relative Humidity :	48~51%

Channel	Frequency (MHz)	20dB Bandwidth (MHz)
00	2402	1.302
39	2441	1.302
78	2480	1.314

20 dB Bandwidth Plot on Channel 00

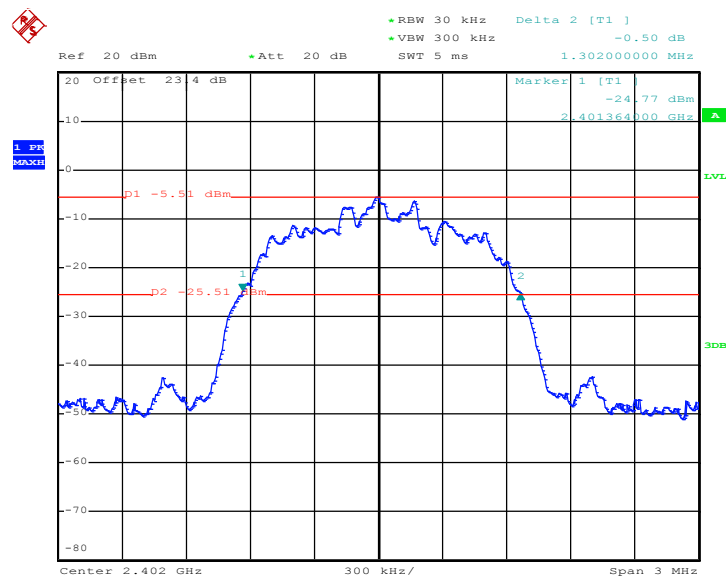

Date: 26.AUG.2016 23:09:43



20 dB Bandwidth Plot on Channel 39

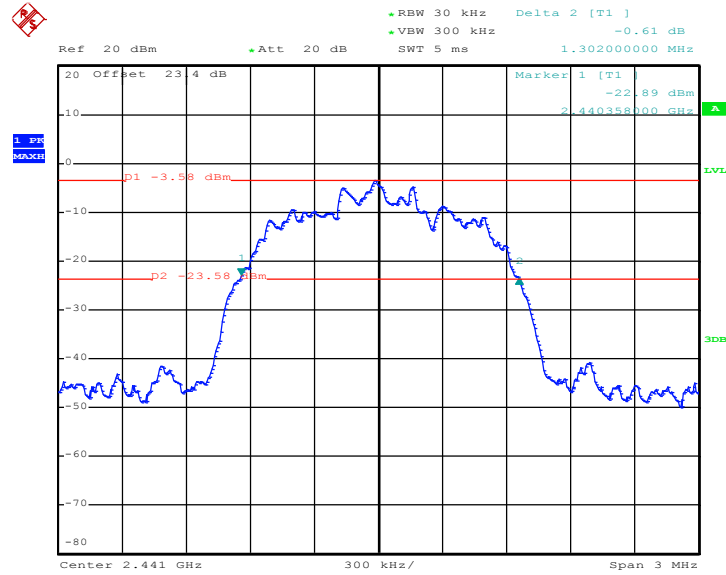

Date: 26.AUG.2016 23:11:27

20 dB Bandwidth Plot on Channel 78

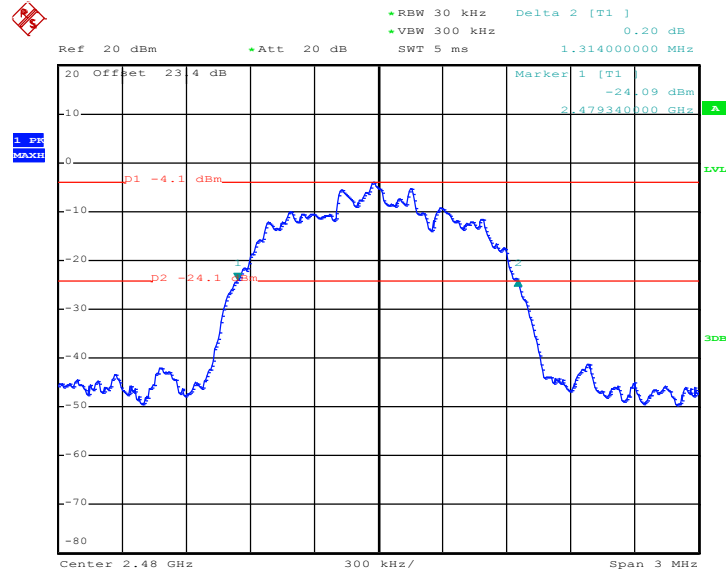

Date: 26.AUG.2016 23:13:36



3.4.6 Test Result of 99% Occupied Bandwidth

Test Mode :	1Mbps	Temperature :	24~26°C
Test Engineer :	An Wu and Tommy Lee	Relative Humidity :	48~51%

Channel	Frequency (MHz)	99% Occupied Bandwidth (MHz)
00	2402	0.884
39	2441	0.884
78	2480	0.884

99% Occupied Bandwidth Plot on Channel 00

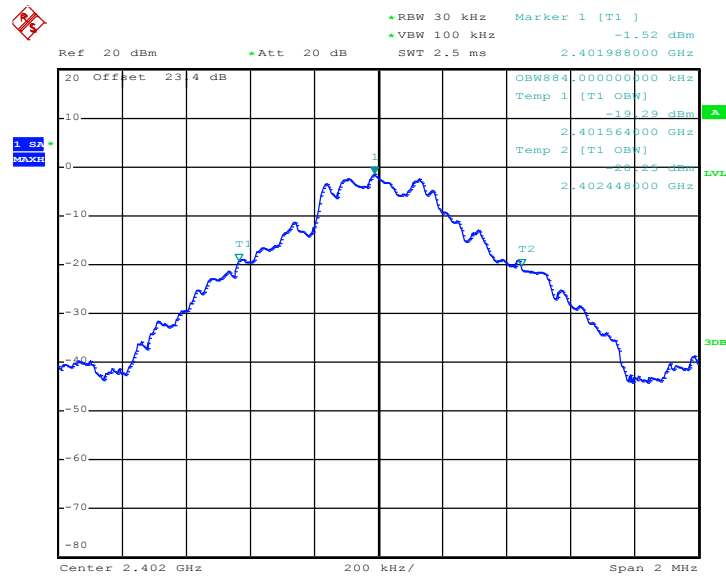

Date: 26.AUG.2016 23:16:30



99% Occupied Bandwidth Plot on Channel 39

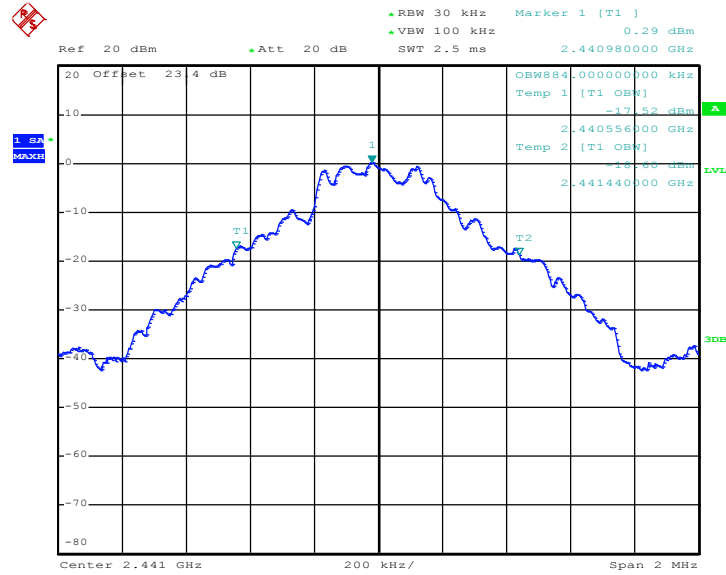

Date: 26.AUG.2016 23:17:16

99% Occupied Bandwidth Plot on Channel 78

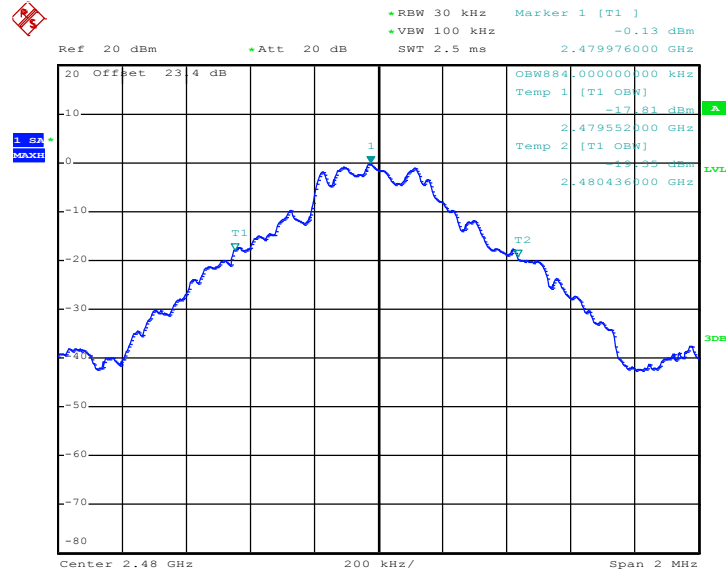

Date: 26.AUG.2016 23:18:05



Test Mode :	2Mbps	Temperature :	24~26°C
Test Engineer :	An Wu and Tommy Lee	Relative Humidity :	48~51%

Channel	Frequency (MHz)	99% Occupied Bandwidth (MHz)
00	2402	1.204
39	2441	1.208
78	2480	1.208

99% Occupied Bandwidth Plot on Channel 00

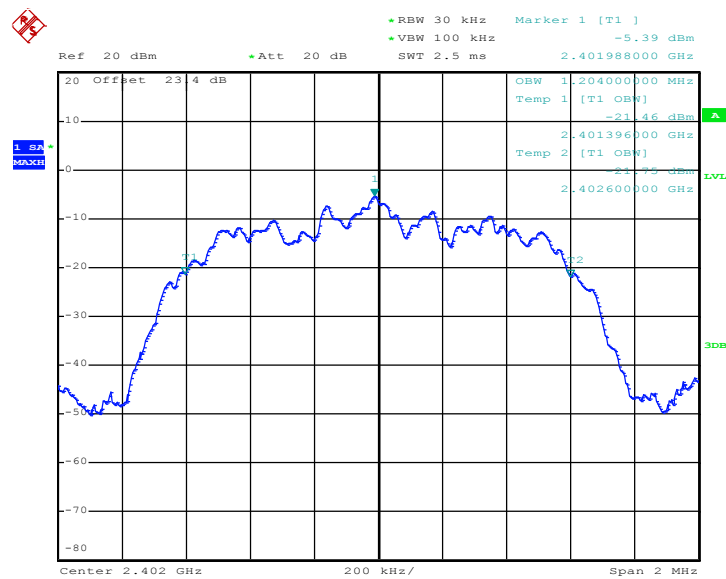

Date: 26.AUG.2016 23:19:29



99% Occupied Bandwidth Plot on Channel 39

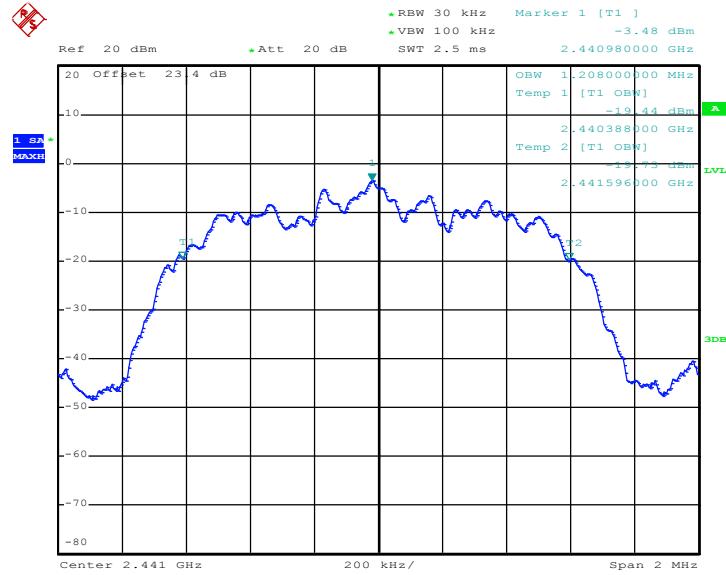

Date: 26.AUG.2016 23:20:11

99% Occupied Bandwidth Plot on Channel 78

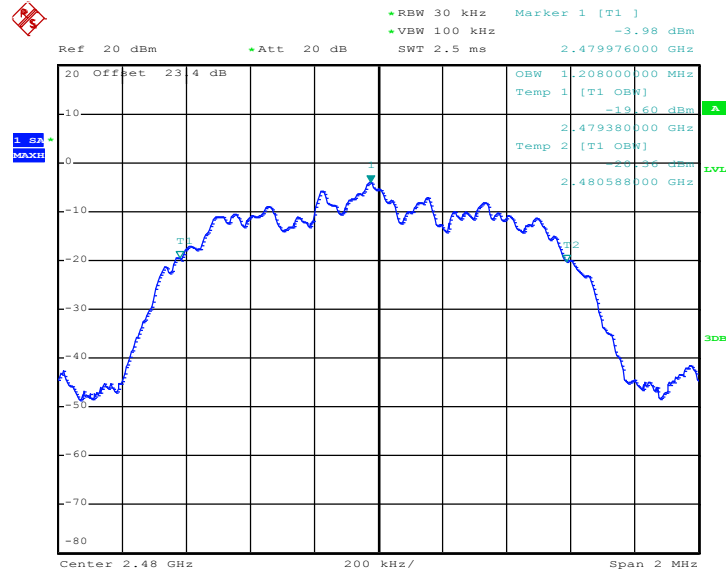

Date: 26.AUG.2016 23:34:53



Test Mode :	3Mbps	Temperature :	24~26°C
Test Engineer :	An Wu and Tommy Lee	Relative Humidity :	48~51%

Channel	Frequency (MHz)	99% Occupied Bandwidth (MHz)
00	2402	1.184
39	2441	1.180
78	2480	1.184

99% Occupied Bandwidth Plot on Channel 00

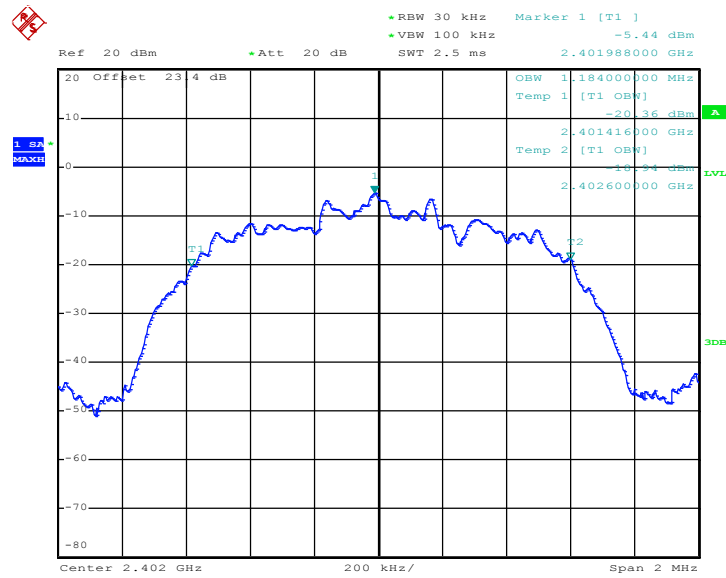

Date: 26.AUG.2016 23:22:25



99% Occupied Bandwidth Plot on Channel 39

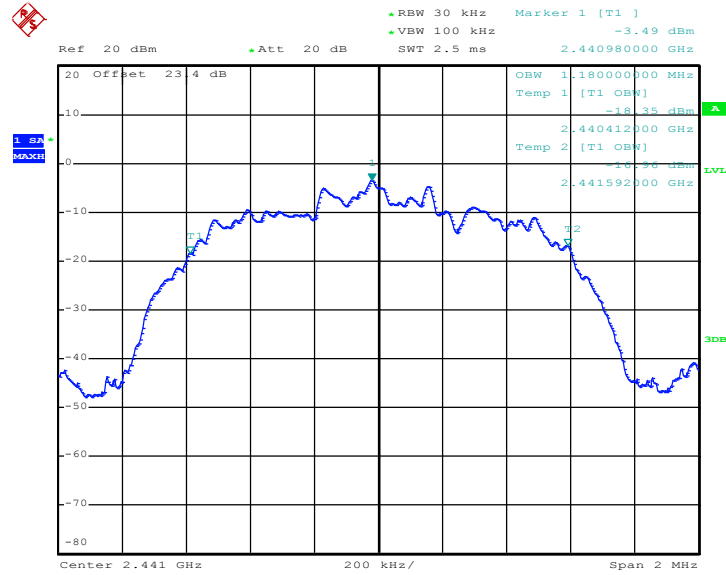

Date: 26.AUG.2016 23:23:07

99% Occupied Bandwidth Plot on Channel 78

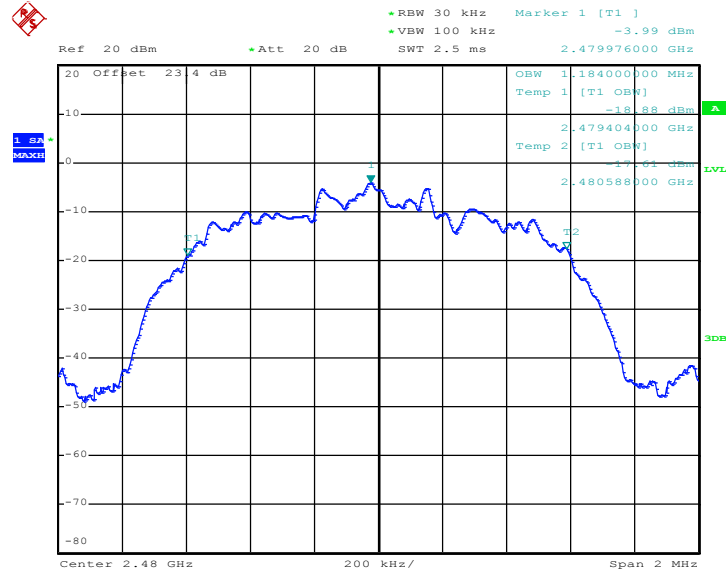

Date: 26.AUG.2016 23:24:08

Note : The occupied channel bandwidth is maintained within the band of operation for all of the modulations.

3.5 Peak Output Power Measurement

3.5.1 Limit of Peak Output Power

Section 15.247 (b) The maximum peak conducted output power of the intentional radiator shall not exceed the following: (1) For frequency hopping systems operating in the 2400-2483.5 MHz band employing at least 75 non-overlapping hopping channels, and all frequency hopping systems in the 5725-5850 MHz band: 1 watt. For all other frequency hopping systems in the 2400-2483.5 MHz band 0.125 watts. The power limit for 1Mbps, 2Mbps, 3Mbps and AFH modes are 0.125 watts.

3.5.2 Measuring Instruments

The measuring equipment is listed in the section 4 of this test report.

3.5.3 Test Procedures

1. The testing follows ANSI C63.10-2013 clause 7.8.5.
2. The RF output of EUT was connected to the spectrum analyzer by RF cable and attenuator. The path loss was compensated to the results for each measurement.
3. The RF output of EUT was connected to the power meter by RF cable and attenuator. The path loss was compensated to the results for each measurement.
4. Set to the maximum power setting and enable the EUT transmit continuously.
5. Measure the conducted output power with cable loss and record the results in the test report.
6. Measure and record the results in the test report.

3.5.4 Test Setup

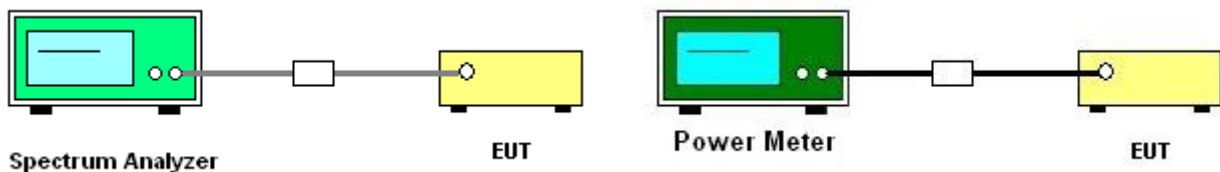



3.5.5 Test Result of Peak Output Power

Test Mode :	1Mbps	Temperature :	24~26°C
Test Engineer :	An Wu and Tommy Lee	Relative Humidity :	48~51%

Channel	Frequency (MHz)	RF Power (dBm)		
		GFSK	Max. Limits (dBm)	Pass/Fail
		1 Mbps		
00	2402	2.38	20.97	Pass
39	2441	4.13	20.97	Pass
78	2480	4.05	20.97	Pass

Note: For AFH mode using 20 hopping channels, the maximum output power limit is 20.97dBm.

Test Mode :	2Mbps	Temperature :	24~26°C
Test Engineer :	An Wu and Tommy Lee	Relative Humidity :	48~51%

Channel	Frequency (MHz)	RF Power (dBm)		
		$\pi/4$ -DQPSK	Max. Limits (dBm)	Pass/Fail
		2 Mbps		
00	2402	1.22	20.97	Pass
39	2441	2.76	20.97	Pass
78	2480	2.59	20.97	Pass

Test Mode :	3Mbps	Temperature :	24~26°C
Test Engineer :	An Wu and Tommy Lee	Relative Humidity :	48~51%

Channel	Frequency (MHz)	RF Power (dBm)		
		8-DPSK	Max. Limits (dBm)	Pass/Fail
		3 Mbps		
00	2402	1.24	20.97	Pass
39	2441	2.75	20.97	Pass
78	2480	2.56	20.97	Pass

3.6 Conducted Band Edges Measurement

3.6.1 Limit of Band Edges

In any 100 kHz bandwidth outside the intentional radiation frequency band, the radio frequency power shall be at least 20 dB below the highest level of the radiated power. In addition, radiated emissions which fall in the restricted bands must also comply with the radiated emission limits.

3.6.2 Measuring Instruments

The measuring equipment is listed in the section 4 of this test report.

3.6.3 Test Procedures

1. The testing follows ANSI C63.10-2013 clause 7.8.6.
2. Set to the maximum power setting and enable the EUT transmit continuously.
3. Set RBW = 100kHz, VBW = 300kHz. Band edge emissions must be at least 20 dB down from the highest emission level within the authorized band as measured with a 100kHz RBW. The attenuation shall be 30 dB instead of 20 dB when RMS conducted output power procedure is used.
4. Enable hopping function of the EUT and then repeat step 2. and 3.
5. Measure and record the results in the test report.

3.6.4 Test Setup





3.6.5 Test Result of Conducted Band Edges

Test Mode :	1Mbps	Temperature :	24~26°C
Test Channel :	00 and 78	Relative Humidity :	48~51%
		Test Engineer :	An Wu and Tommy Lee

Low Band Edge Plot on Channel 00

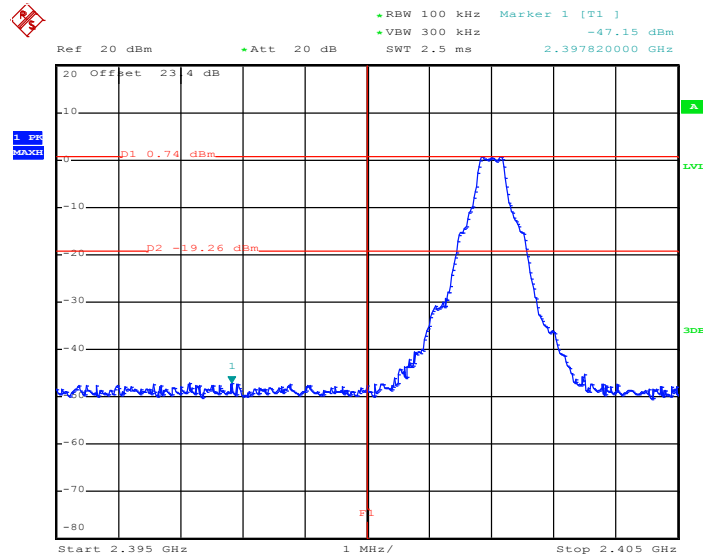

Date: 26.AUG.2016 23:59:42

High Band Edge Plot on Channel 78

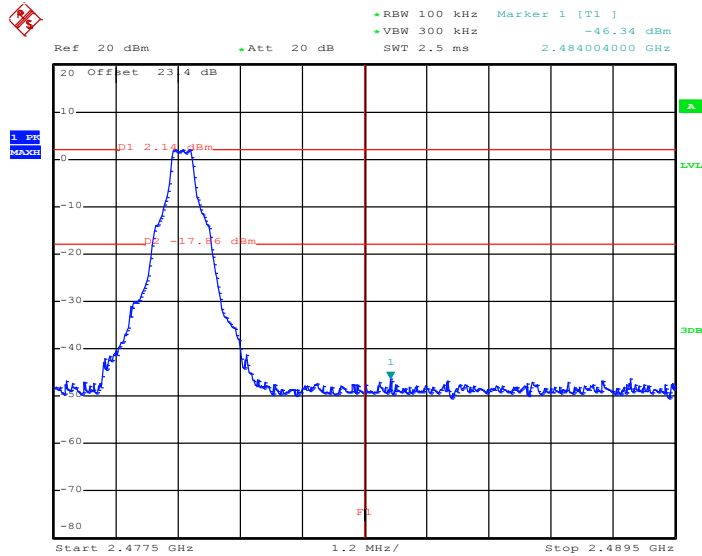

Date: 27.AUG.2016 00:00:19



Test Mode :	2Mbps	Temperature :	24~26°C
Test Channel :	00 and 78	Relative Humidity :	48~51%
		Test Engineer :	An Wu and Tommy Lee

Low Band Edge Plot on Channel 00

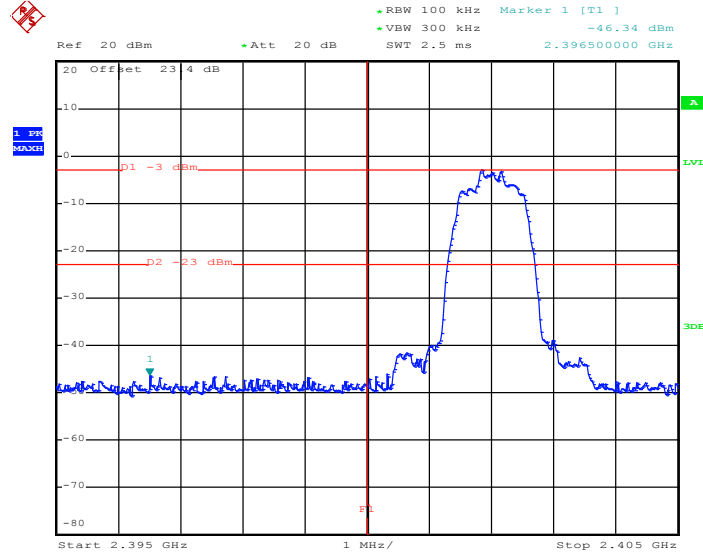

Date: 27.AUG.2016 00:01:06

High Band Edge Plot on Channel 78

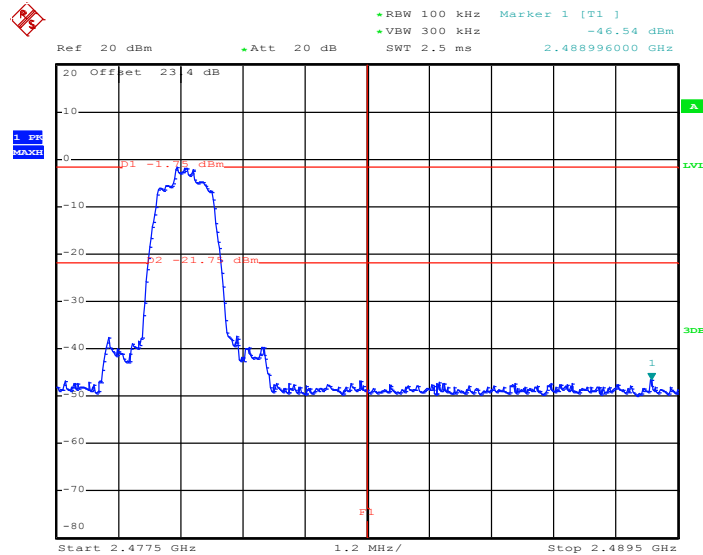

Date: 27.AUG.2016 00:01:31



Test Mode :	3Mbps	Temperature :	24~26°C
Test Channel :	00 and 78	Relative Humidity :	48~51%
		Test Engineer :	An Wu and Tommy Lee

Low Band Edge Plot on Channel 00

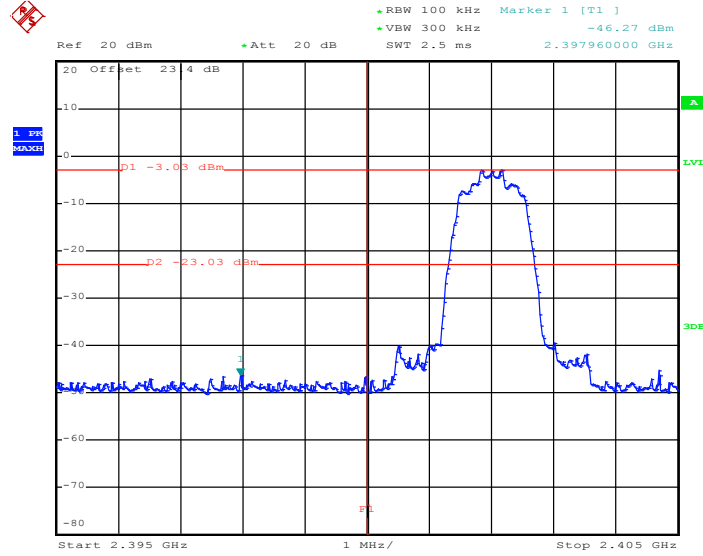

Date: 27.AUG.2016 00:02:14

High Band Edge Plot on Channel 78

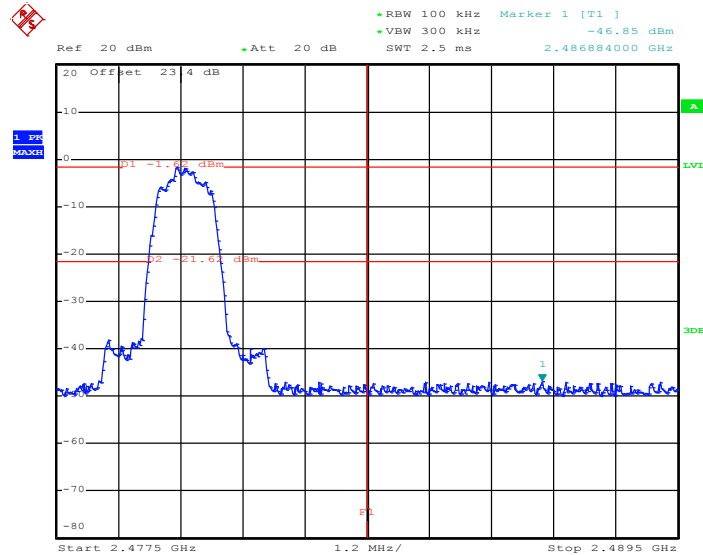

Date: 27.AUG.2016 00:02:57



3.6.6 Test Result of Conducted Hopping Mode Band Edges

Test Mode :	1Mbps	Temperature :	24~26°C
Test Engineer :	An Wu and Tommy Lee	Relative Humidity :	48~51%

1Mbps Hopping Mode Low Band Edge Plot

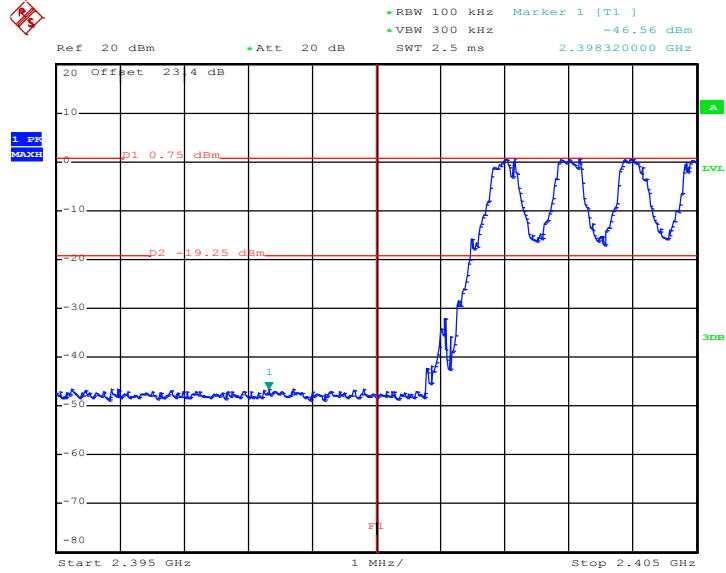

Date: 26.AUG.2016 23:48:44

1Mbps Hopping Mode High Band Edge Plot

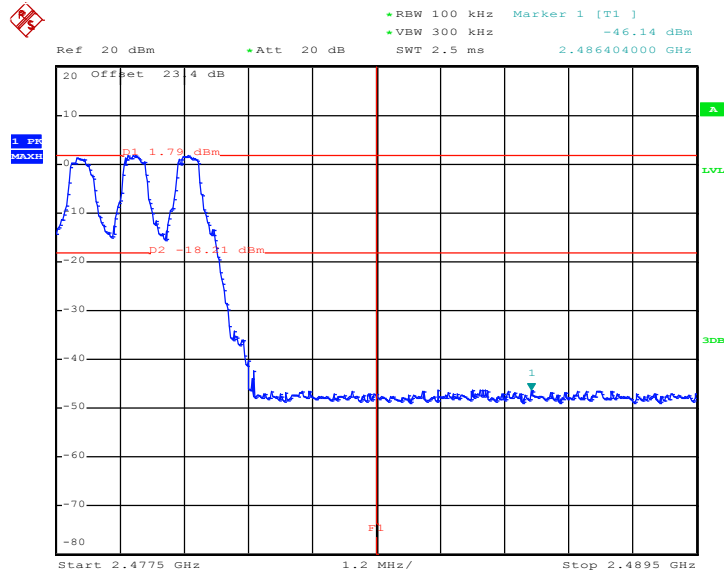

Date: 26.AUG.2016 23:50:25



Test Mode :	2Mbps	Temperature :	24~26°C
Test Engineer :	An Wu and Tommy Lee	Relative Humidity :	48~51%

2Mbps Hopping Mode Low Band Edge Plot

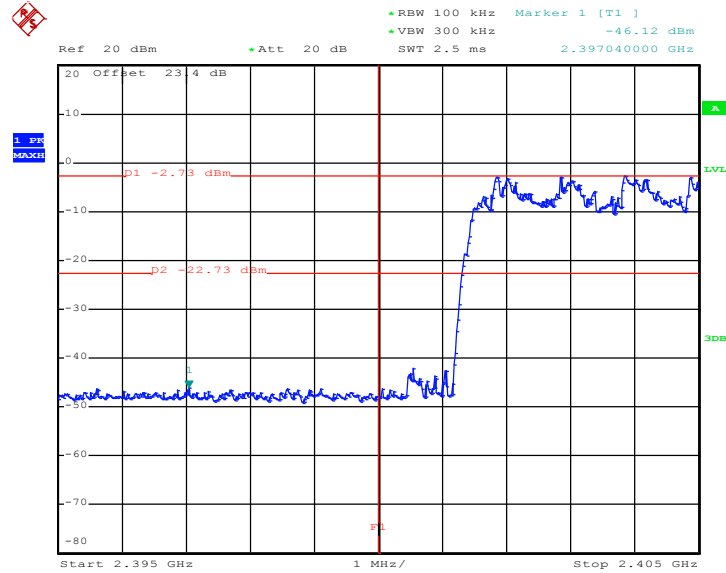

Date: 26.AUG.2016 23:52:42

2Mbps Hopping Mode High Band Edge Plot

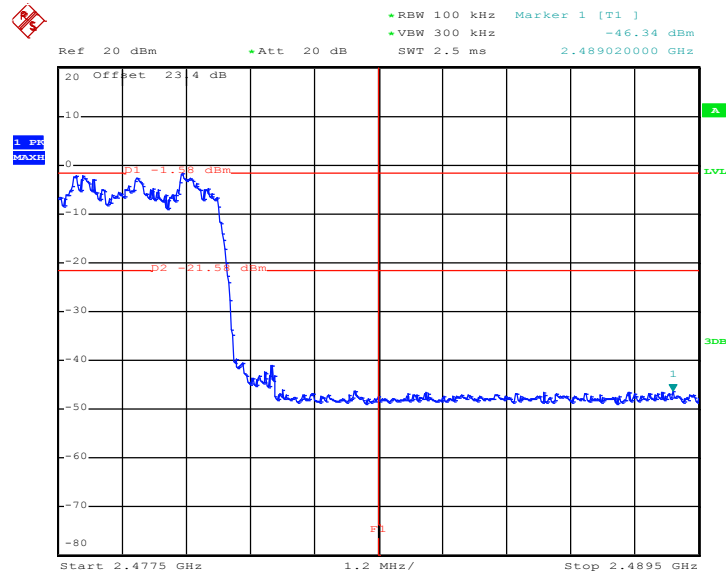

Date: 26.AUG.2016 23:54:30



Test Mode :	3Mbps	Temperature :	24~26°C
Test Engineer :	An Wu and Tommy Lee	Relative Humidity :	48~51%

3Mbps Hopping Mode Low Band Edge Plot

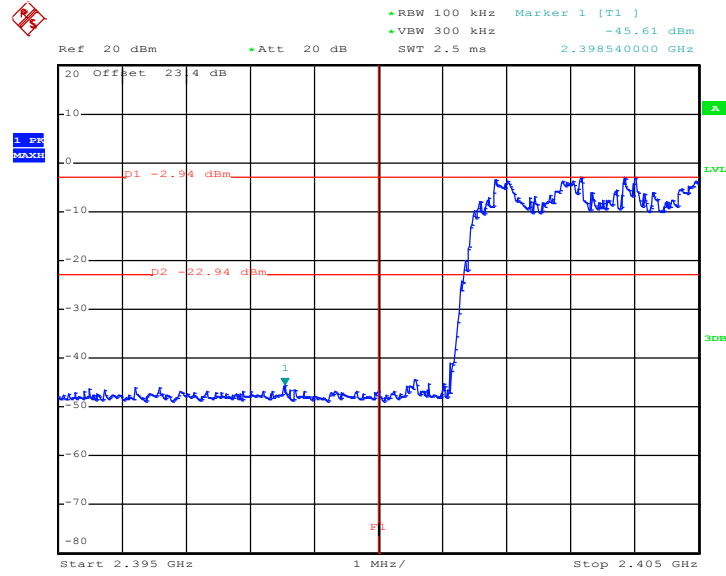

Date: 26.AUG.2016 23:56:32

3Mbps Hopping Mode High Band Edge Plot

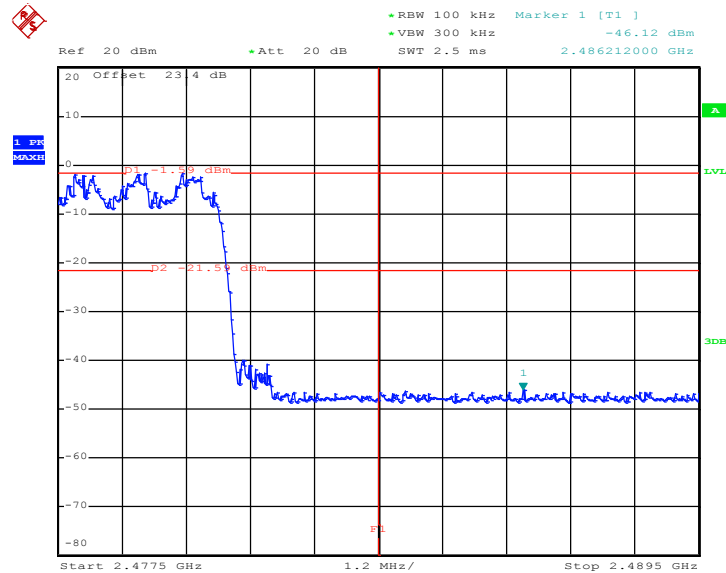

Date: 26.AUG.2016 23:58:25

3.7 Conducted Spurious Emission Measurement

3.7.1 Limit of Spurious Emission Measurement

In any 100 kHz bandwidth outside the intentional radiation frequency band, the radio frequency power shall be at least 20 dB below the highest level of the radiated power. In addition, radiated emissions which fall in the restricted bands must also comply with the radiated emission limits.

3.7.2 Measuring Instruments

The measuring equipment is listed in the section 4 of this test report.

3.7.3 Test Procedure

1. The testing follows ANSI C63.10-2013 clause 7.8.8.
2. The RF output of EUT was connected to the spectrum analyzer by RF cable and attenuator. The path loss was compensated to the results for each measurement.
3. Set to the maximum power setting and enable the EUT transmit continuously.
4. Set RBW = 100 kHz, VBW = 300kHz, scan up through 10th harmonic. All harmonics / spurs must be at least 20 dB down from the highest emission level within the authorized band as measured with a 100 kHz RBW.
5. Measure and record the results in the test report.
6. The RF fundamental frequency should be excluded against the limit line in the operating frequency band.

3.7.4 Test Setup

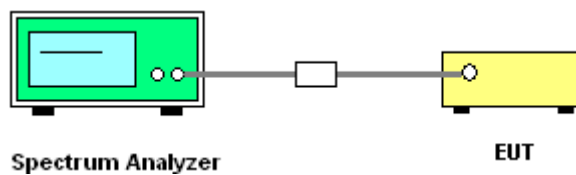



3.7.5 Test Result of Conducted Spurious Emission

Test Mode :	1Mbps	Temperature :	24~26°C
Test Channel :	00	Relative Humidity :	48~51%
		Test Engineer :	An Wu and Tommy Lee

1Mbps CSE Plot on Ch 00 between 30MHz ~ 3 GHz

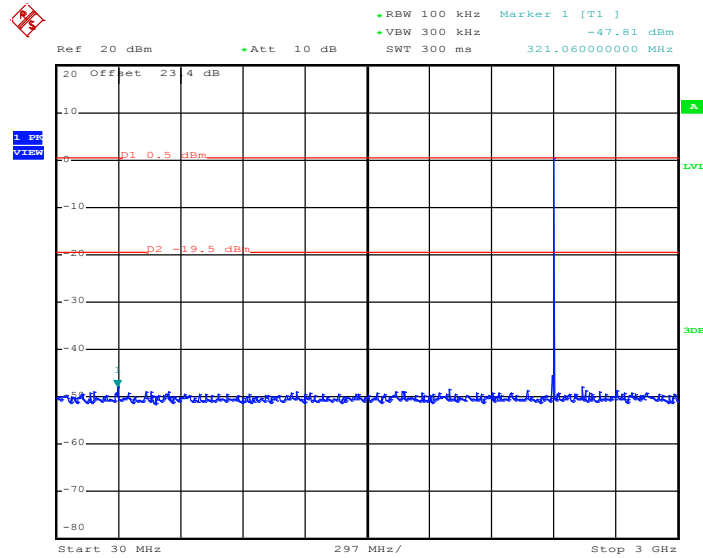

Date: 26.AUG.2016 23:26:22

1Mbps CSE Plot on Ch 00 between 2 GHz ~ 25 GHz

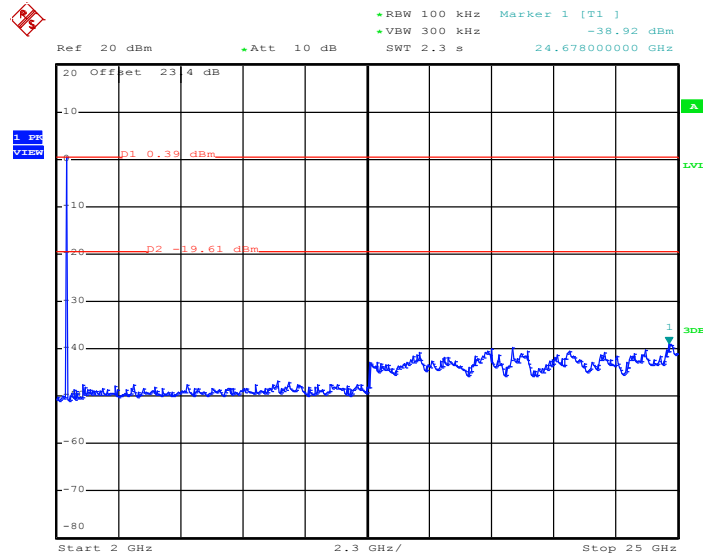

Date: 26.AUG.2016 23:26:44



Test Mode :	1Mbps	Temperature :	24~26°C
Test Channel :	39	Relative Humidity :	48~51%
		Test Engineer :	An Wu and Tommy Lee

1Mbps CSE Plot on Ch 39 between 30MHz ~ 3 GHz

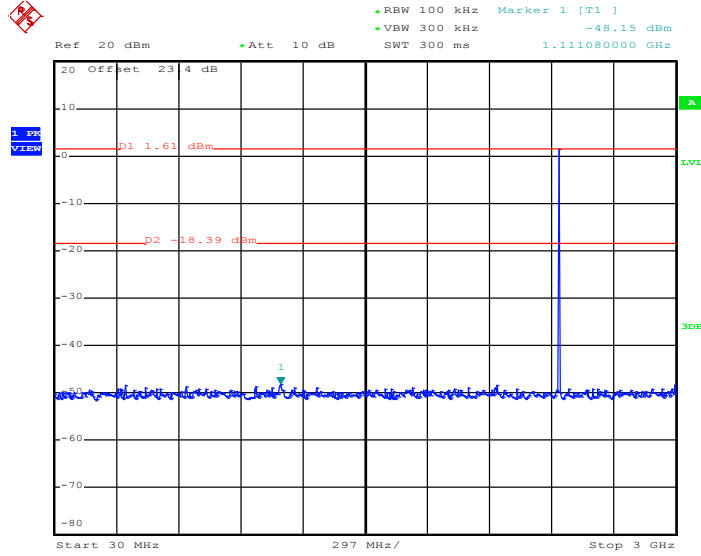

Date: 26.AUG.2016 23:27:45

1Mbps CSE Plot on Ch 39 between 2 GHz ~ 25 GHz

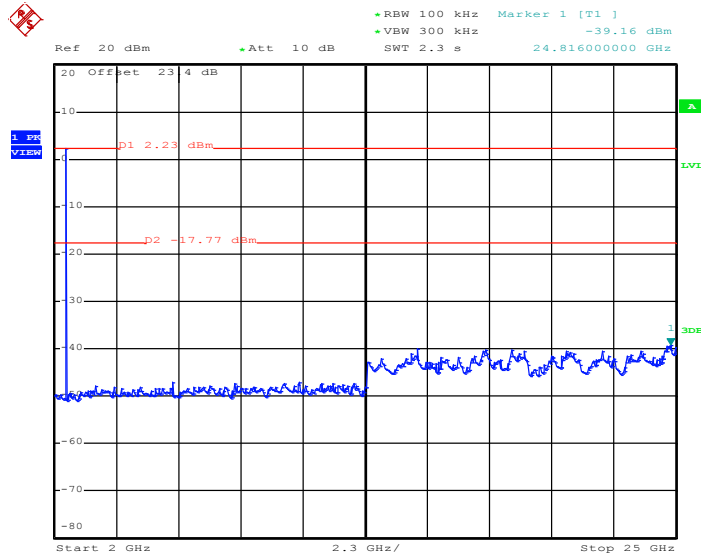

Date: 26.AUG.2016 23:28:06



Test Mode :	1Mbps	Temperature :	24~26°C
Test Channel :	78	Relative Humidity :	48~51%
		Test Engineer :	An Wu and Tommy Lee

1Mbps CSE Plot on Ch 78 between 30MHz ~ 3 GHz

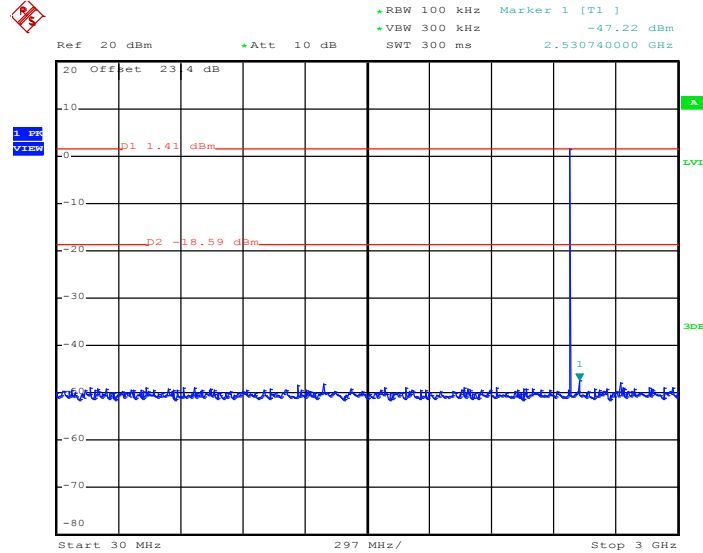

Date: 26.AUG.2016 23:29:47

1Mbps CSE Plot on Ch 78 between 2 GHz ~ 25 GHz

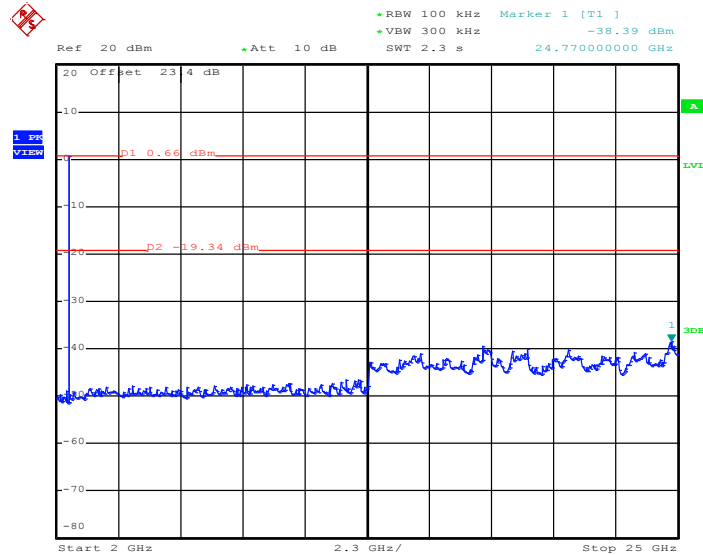

Date: 26.AUG.2016 23:30:09



Test Mode :	2Mbps	Temperature :	24~26°C
Test Channel :	00	Relative Humidity :	48~51%
		Test Engineer :	An Wu and Tommy Lee

2Mbps CSE Plot on Ch 00 between 30MHz ~ 3 GHz

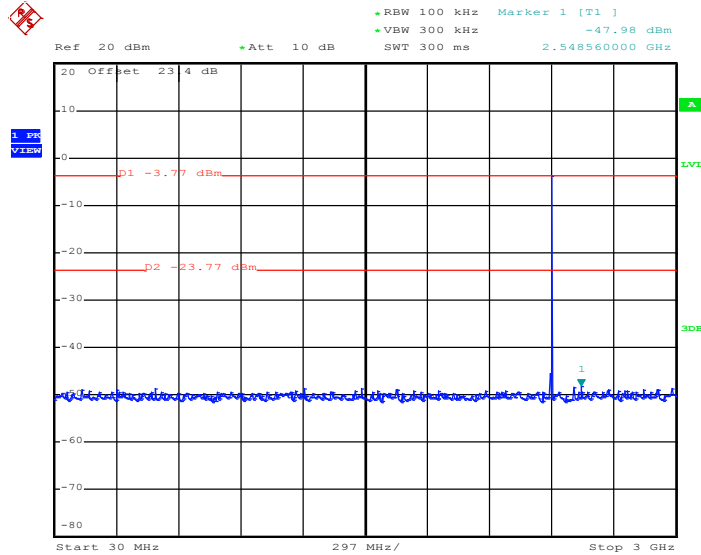

Date: 26.AUG.2016 23:32:38

2Mbps CSE Plot on Ch 00 between 2 GHz ~ 25 GHz

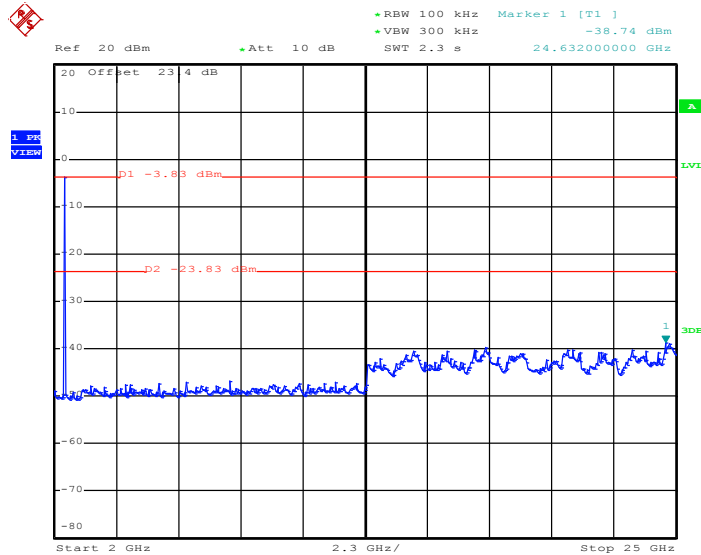

Date: 26.AUG.2016 23:33:00



Test Mode :	2Mbps	Temperature :	24~26°C
Test Channel :	39	Relative Humidity :	48~51%
		Test Engineer :	An Wu and Tommy Lee

2Mbps CSE Plot on Ch 39 between 30MHz ~ 3 GHz

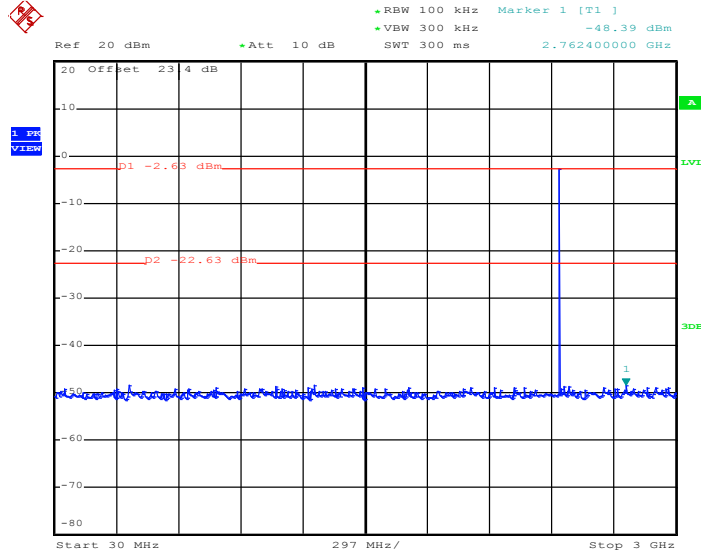

Date: 26.AUG.2016 23:33:41

2Mbps CSE Plot on Ch 39 between 2 GHz ~ 25 GHz

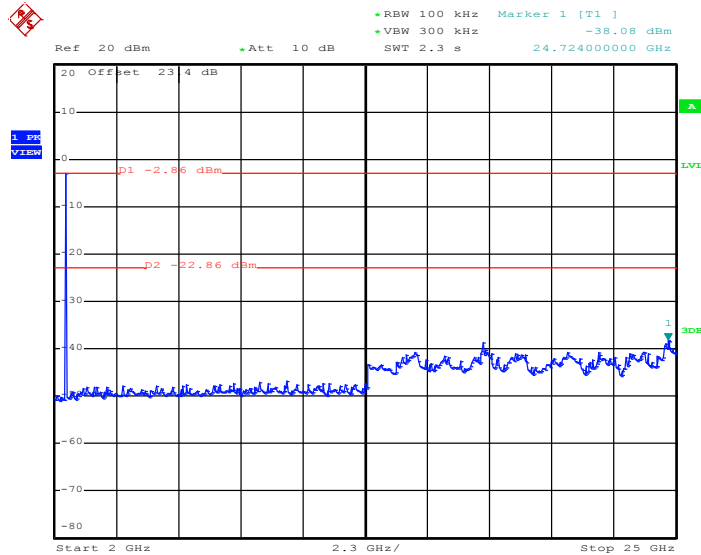

Date: 26.AUG.2016 23:34:03



Test Mode :	2Mbps	Temperature :	24~26°C
Test Channel :	78	Relative Humidity :	48~51%
		Test Engineer :	An Wu and Tommy Lee

2Mbps CSE Plot on Ch 78 between 30MHz ~ 3 GHz

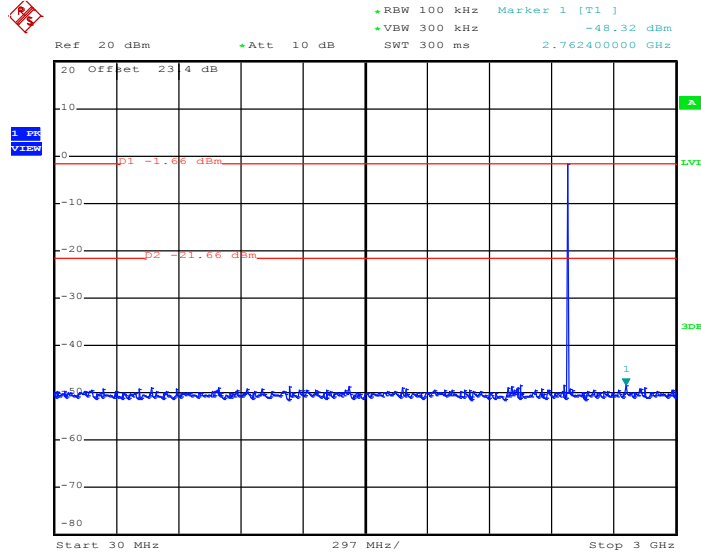

Date: 26.AUG.2016 23:35:19

2Mbps CSE Plot on Ch 78 between 2 GHz ~ 25 GHz

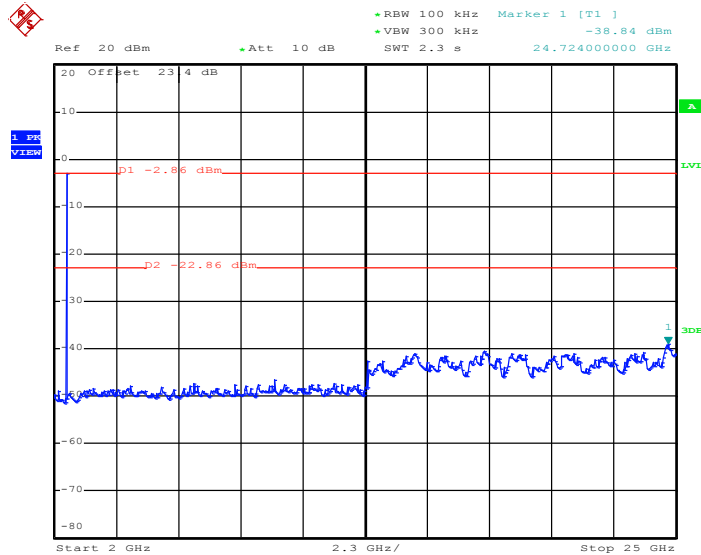

Date: 26.AUG.2016 23:35:42



Test Mode :	3Mbps	Temperature :	24~26°C
Test Channel :	00	Relative Humidity :	48~51%
		Test Engineer :	An Wu and Tommy Lee

3Mbps CSE Plot on Ch 00 between 30MHz ~ 3 GHz

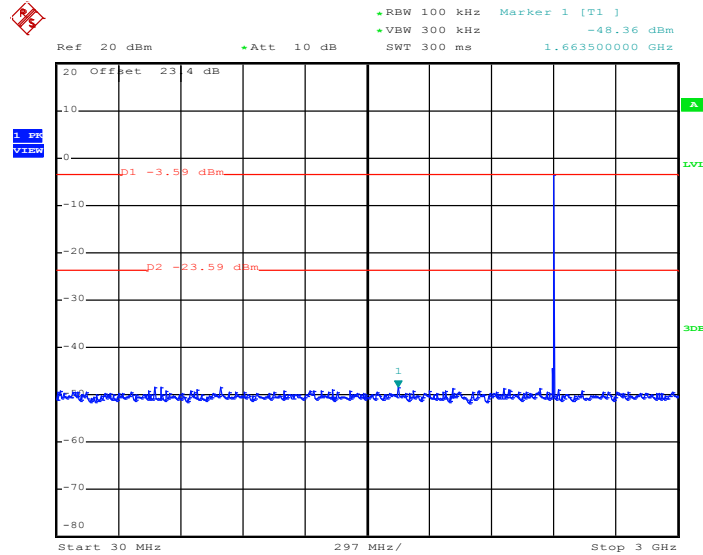

Date: 26.AUG.2016 23:37:48

3Mbps CSE Plot on Ch 00 between 2 GHz ~ 25 GHz

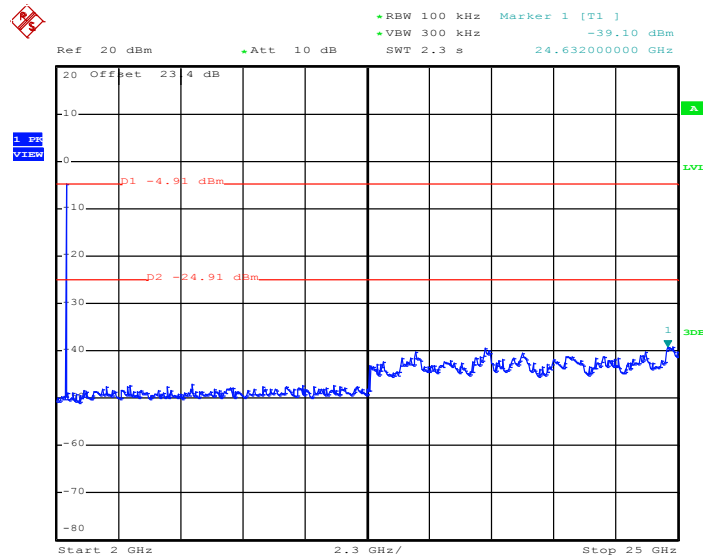

Date: 26.AUG.2016 23:38:10



Test Mode :	3Mbps	Temperature :	24~26°C
Test Channel :	39	Relative Humidity :	48~51%
		Test Engineer :	An Wu and Tommy Lee

3Mbps CSE Plot on Ch 39 between 30MHz ~ 3 GHz

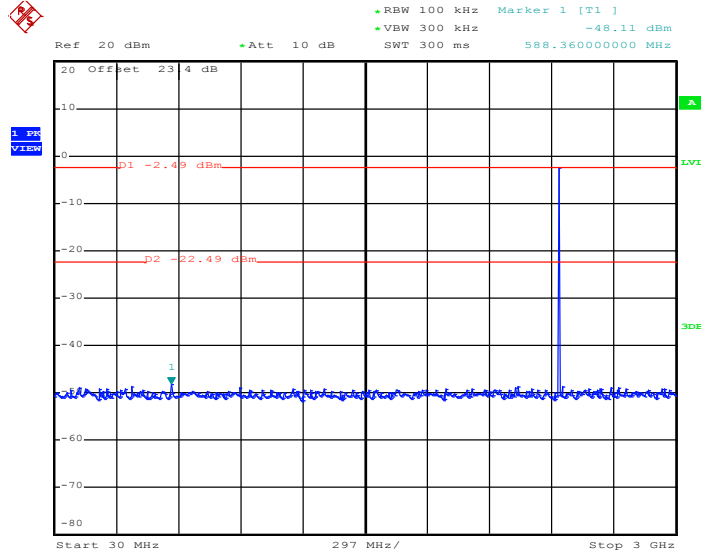

Date: 26.AUG.2016 23:38:55

3Mbps CSE Plot on Ch 39 between 2 GHz ~ 25 GHz

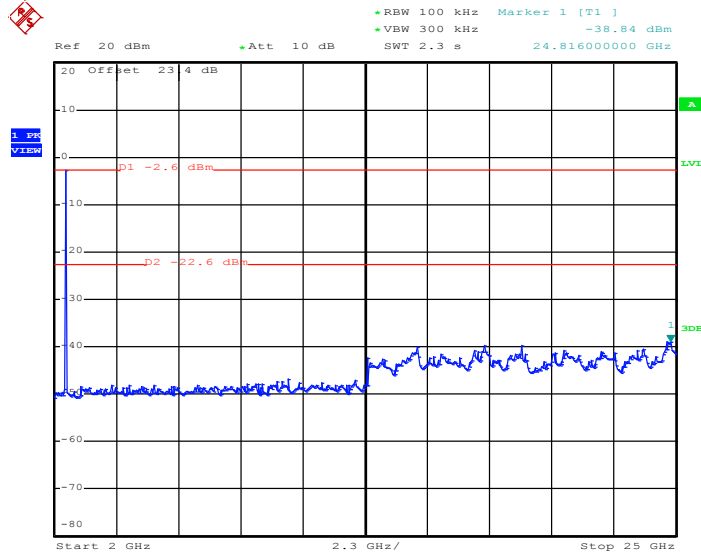

Date: 26.AUG.2016 23:39:17



Test Mode :	3Mbps	Temperature :	24~26°C
Test Channel :	78	Relative Humidity :	48~51%
		Test Engineer :	An Wu and Tommy Lee

3Mbps CSE Plot on Ch 78 between 30MHz ~ 3 GHz

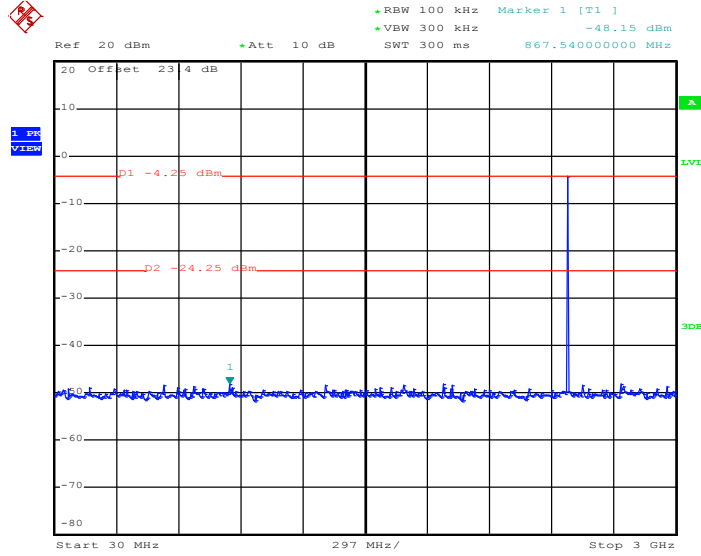

Date: 26.AUG.2016 23:41:11

3Mbps CSE Plot on Ch 78 between 2 GHz ~ 25 GHz

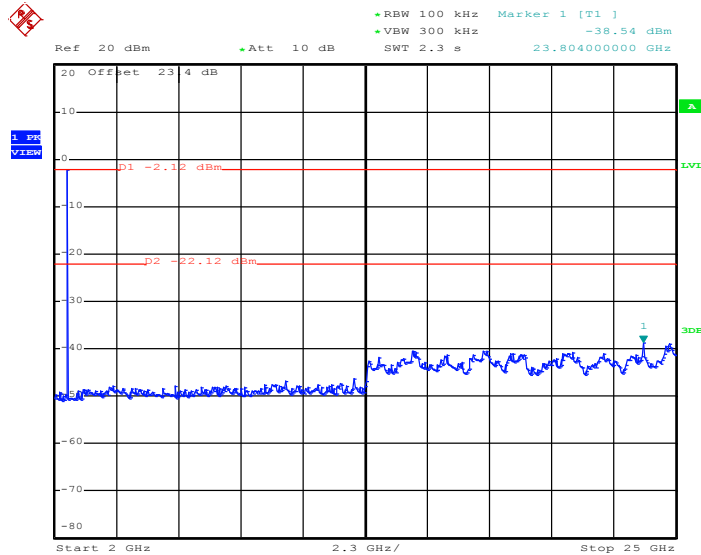

Date: 26.AUG.2016 23:41:33



3.8 Radiated Band Edges and Spurious Emission Measurement

3.8.1 Limit of Radiated Band Edges and Spurious Emission

In any 100 kHz bandwidth outside the intentional radiator frequency band, all harmonics/spurious must be at least 20 dB below the highest emission level within the authorized band. In addition, radiated emissions which fall in the restricted bands must also comply with the FCC section 15.209 limits as below.

Frequency (MHz)	Field Strength (microvolts/meter)	Measurement Distance (meters)
0.009 – 0.490	2400/F(kHz)	300
0.490 – 1.705	24000/F(kHz)	30
1.705 – 30.0	30	30
30 – 88	100	3
88 – 216	150	3
216 - 960	200	3
Above 960	500	3

3.8.2 Measuring Instruments

The measuring equipment is listed in the section 4 of this test report.



3.8.3 Test Procedures

1. The EUT was placed on a turntable with 0.8 meter for frequency below 1GHz and 1.5 meter for frequency above 1GHz respectively above ground.
2. The EUT was set 3 meters from the interference receiving antenna, which was mounted on the top of a variable height antenna tower.
3. For each suspected emission, the EUT was arranged to its worst case and then tune the Antenna tower (from 1 m to 4 m) and turntable (from 0 degree to 360 degrees) to find the maximum reading. A pre-amp and a high pass filter are used for the test in order to get better signal level to comply with the guidelines.
4. Set to the maximum power setting and enable the EUT transmit continuously.
5. Use the following spectrum analyzer settings:
 - (1) Span shall wide enough to fully capture the emission being measured;
 - (2) Set RBW=100 kHz for $f < 1 \text{ GHz}$, RBW=1MHz for $f > 1\text{GHz}$; VBW \geq RBW; Sweep = auto; Detector function = peak; Trace = max hold for peak
 - (3) For average measurement: use duty cycle correction factor method per 15.35(c).
Duty cycle = On time/100 milliseconds
On time = $N_1 * L_1 + N_2 * L_2 + \dots + N_{n-1} * L_{n-1} + N_n * L_n$
Where N_1 is number of type 1 pulses, L_1 is length of type 1 pulses, etc.
Average Emission Level = Peak Emission Level + $20 * \log(\text{Duty cycle})$
6. Corrected Reading: Antenna Factor + Cable Loss + Read Level - Preamp Factor = Level

Note: The average levels were calculated from the peak level corrected with duty cycle correction factor (24.76dB) derived from $20 \log (\text{dwell time}/100\text{ms})$. This correction is only for signals that hop with the fundamental signal, such as band-edge and harmonic. Other spurious signals that are independent of the hopping signal would not use this correction.

3.8.4 Test Setup

For radiated emissions below 30MHz

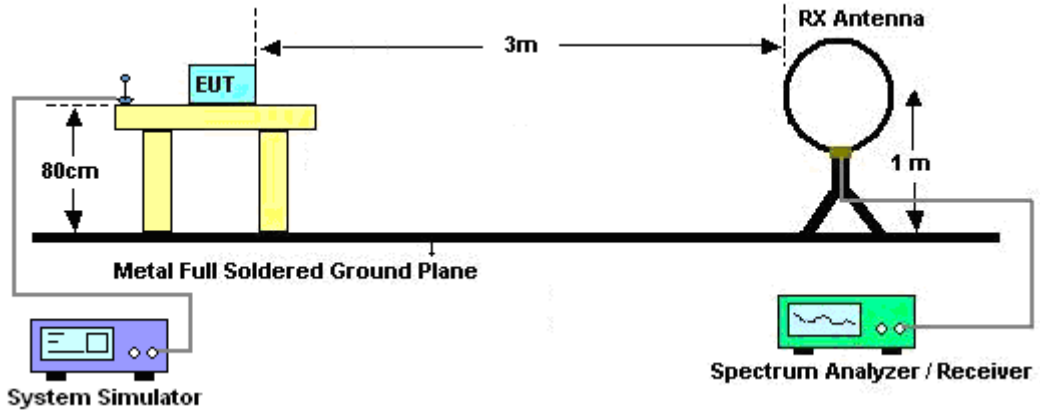

For radiated emissions from 30MHz to 1GHz

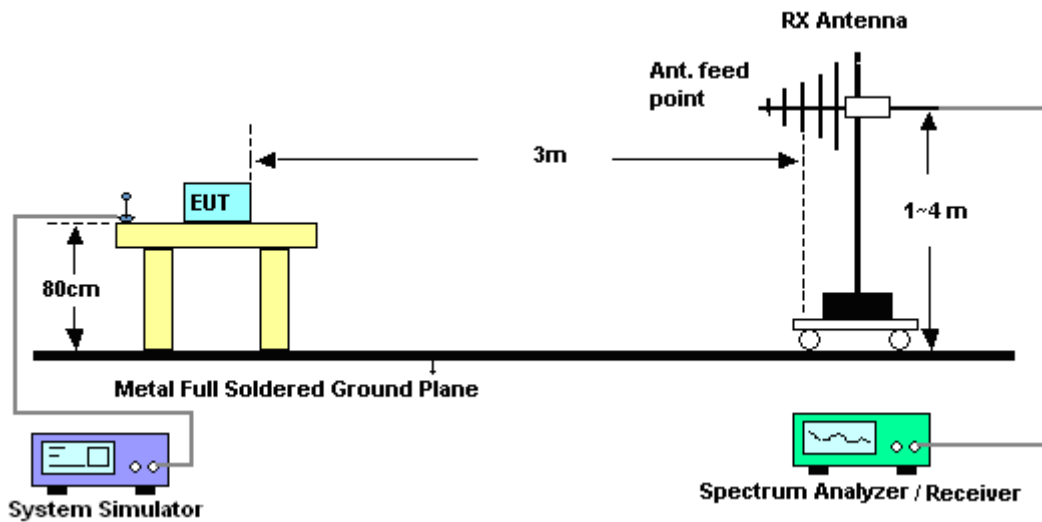

For radiated emissions above 1GHz

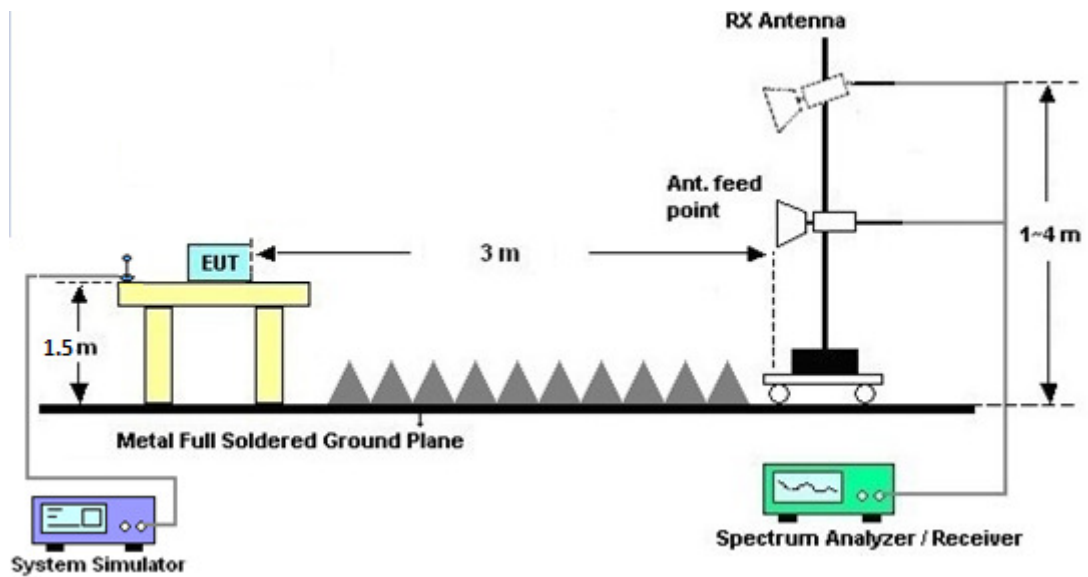

3.8.5 Test Results of Radiated Spurious Emissions (9 kHz ~ 30 MHz)

The low frequency, which started from 9 kHz to 30MHz, was pre-scanned and the result which was 20dB lower than the limit line per 15.31(o) was not reported.

3.8.6 Duty cycle correction factor for average measurement

DH5 on time (One Pulse) Plot on Channel 39

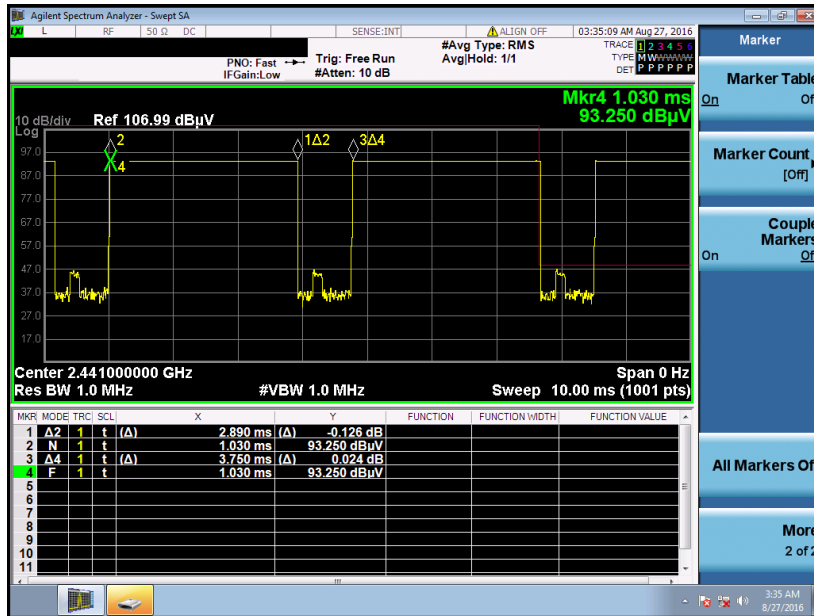

DH5 on time (Count Pulses) Plot on Channel 39

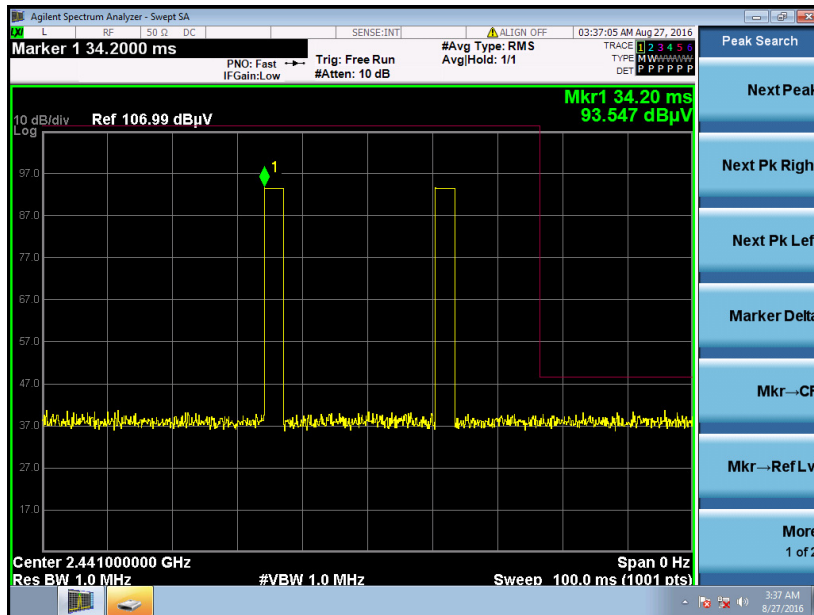

Note:

1. Worst case Duty cycle = on time/100 milliseconds = $2 * 2.89 / 100 = 5.78 \%$
2. Worst case Duty cycle correction factor = $20 * \log(\text{Duty cycle}) = -24.76 \text{ dB}$
3. DH5 has the highest duty cycle worst case and is reported.



Duty Cycle Correction Factor Consideration for AFH mode:

Bluetooth normal hopping rate is 1600Hz and reduced to 800Hz in AFH mode; due to the reduced number of hopping frequencies, with the same packet configuration the dwell time in each channel frequency within 100msec period is longer in AFH mode than normal mode.

In AFH mode, the minimum hopping frequencies are 20, to get the longest dwell time DH5 packet is observed; the period to have DH5 packet completing one hopping sequence is

$$2.76 \text{ ms} \times 20 \text{ channels} = 57.8 \text{ ms}$$

There cannot be 2 complete hopping sequences within 100ms period, considering the random hopping behavior, maximum 2 hops can be possibly observed within the period. $[100\text{ms} / 57.6\text{ms}] = 2 \text{ hops}$

Thus, the maximum possible ON time:

$$2.76 \text{ ms} \times 2 = 5.78 \text{ ms}$$

Worst case Duty Cycle Correction factor, which is derived from the maximum possible ON time,

$$20 \times \log(5.78 \text{ ms}/100\text{ms}) = -24.76 \text{ dB}$$

3.8.7 Test Result of Radiated Spurious at Band Edges

Please refer to Appendix A and B.

3.8.8 Test Result of Radiated Spurious Emission (30MHz ~ 10th Harmonic)

Please refer to Appendix A and B.



3.9 AC Conducted Emission Measurement

3.9.1 Limit of AC Conducted Emission

For equipment that is designed to be connected to the public utility (AC) power line, the radio frequency voltage that is conducted back onto the AC power line on any frequency or frequencies within the band 150 kHz to 30 MHz shall not exceed the limits in the following table.

Frequency of emission (MHz)	Conducted limit (dBµV)	
	Quasi-peak	Average
0.15-0.5	66 to 56*	56 to 46*
0.5-5	56	46
5-30	60	50

*Decreases with the logarithm of the frequency.

For terminal test result, the testing follows FCC KDB 174176.

3.9.2 Measuring Instruments

The measuring equipment is listed in the section 4 of this test report.

3.9.3 Test Procedures

1. The EUT was placed 0.4 meter from the conducting wall of the shielding room was kept at least 80 centimeters from any other grounded conducting surface.
2. Connect EUT to the power mains through a line impedance stabilization network (LISN).
3. All the support units are connecting to the other LISN.
4. The LISN provides 50 ohm coupling impedance for the measuring instrument.
5. The FCC states that a 50 ohm, 50 microhenry LISN should be used.
6. Both sides of AC line were checked for maximum conducted interference.
7. The frequency range from 150 kHz to 30 MHz was searched.
8. Set the test-receiver system to Peak Detect Function and specified bandwidth (IF Bandwidth = 9kHz) with Maximum Hold Mode. Then measurement is also conducted by Average Detector and Quasi-Peak Detector Function respectively.

3.9.4 Test Setup

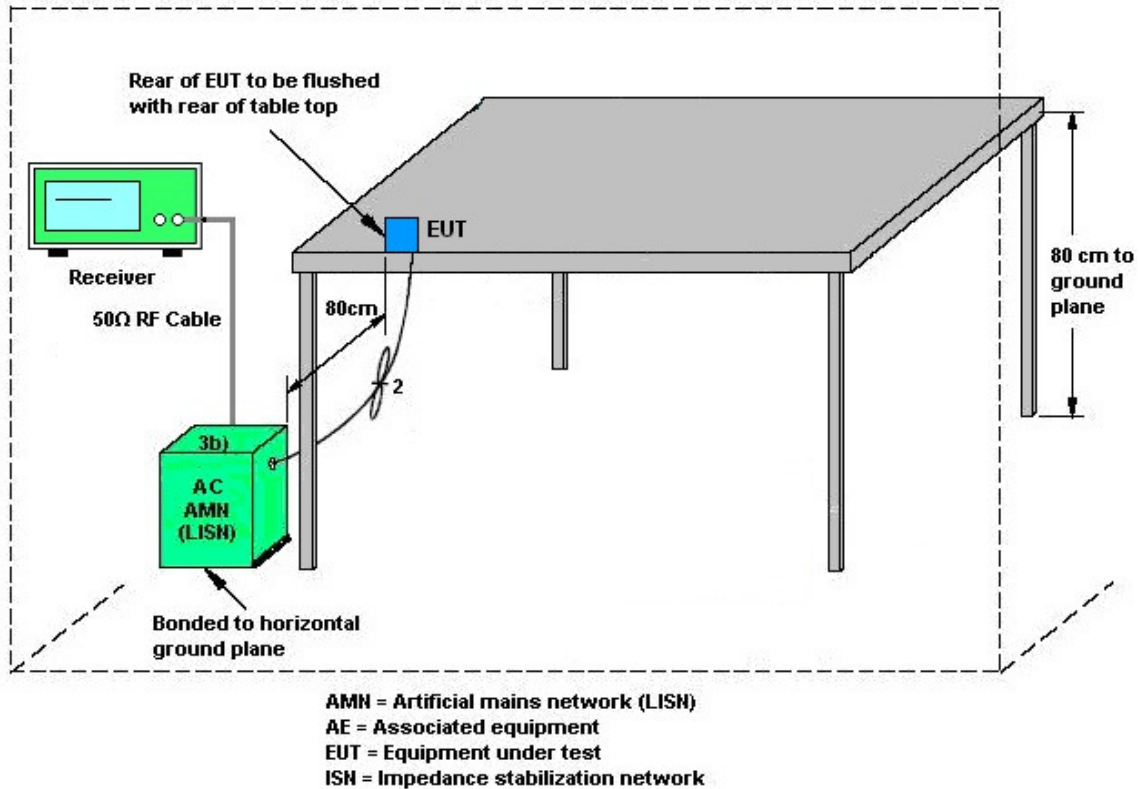

3.9.5 Test Result of AC Conducted Emission

<Original test result with NFC antenna>

Test Mode :	Mode 1	Temperature :	22~24°C
Test Engineer :	Arthur Hsieh	Relative Humidity :	51~53%
Test Voltage :	120Vac / 60Hz	Phase :	Line
Function Type :	NFC Link + WLAN (2.4GHz) Link + Bluetooth Link + Earphone 1 with Audio Adapter connect to EUT + Charging Only Cable + AC Adapter		

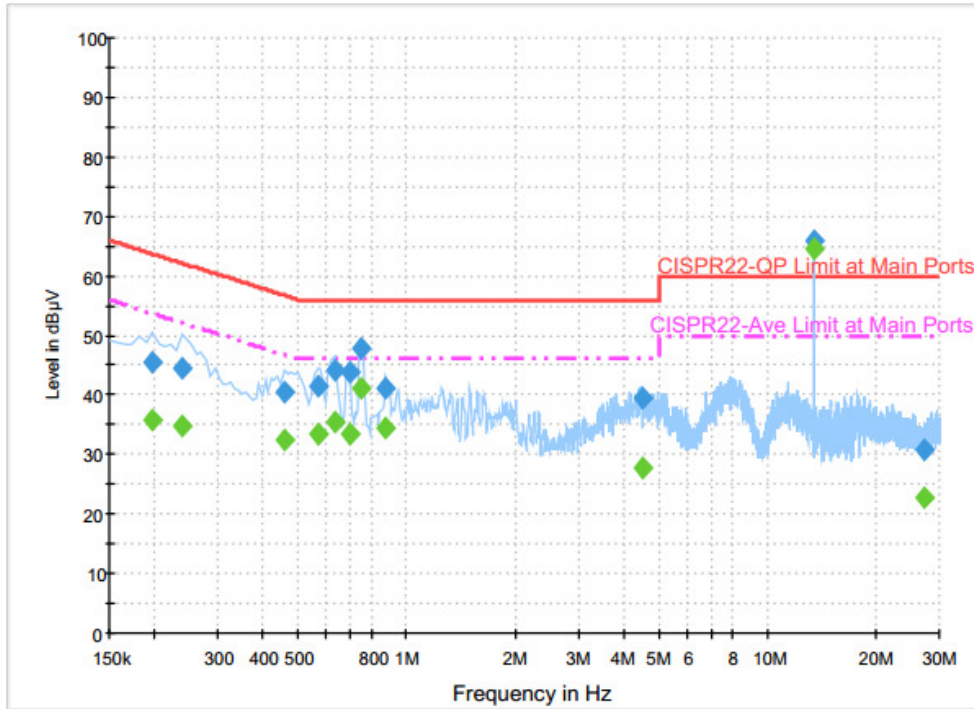

Final Result : Quasi-Peak

Frequency (MHz)	Quasi-Peak (dBμV)	Filter	Line	Corr. (dB)	Margin (dB)	Limit (dBμV)
0.198000	45.5	Off	L1	19.6	18.2	63.7
0.238000	44.4	Off	L1	19.6	17.8	62.2
0.462000	40.5	Off	L1	19.6	16.2	56.7
0.566000	41.4	Off	L1	19.6	14.6	56.0
0.630000	44.1	Off	L1	19.6	11.9	56.0
0.694000	43.8	Off	L1	19.6	12.2	56.0
0.750000	48.0	Off	L1	19.6	8.0	56.0
0.878000	41.2	Off	L1	19.6	14.8	56.0
4.534000	39.3	Off	L1	19.7	16.7	56.0
13.558000	65.9	Off	L1	19.8	-5.9	60.0
27.118000	30.9	Off	L1	19.9	29.1	60.0



Test Mode :	Mode 1	Temperature :	22~24°C
Test Engineer :	Arthur Hsieh	Relative Humidity :	51~53%
Test Voltage :	120Vac / 60Hz	Phase :	Line
Function Type :	NFC Link + WLAN (2.4GHz) Link + Bluetooth Link + Earphone 1 with Audio Adapter connect to EUT + Charging Only Cable + AC Adapter		

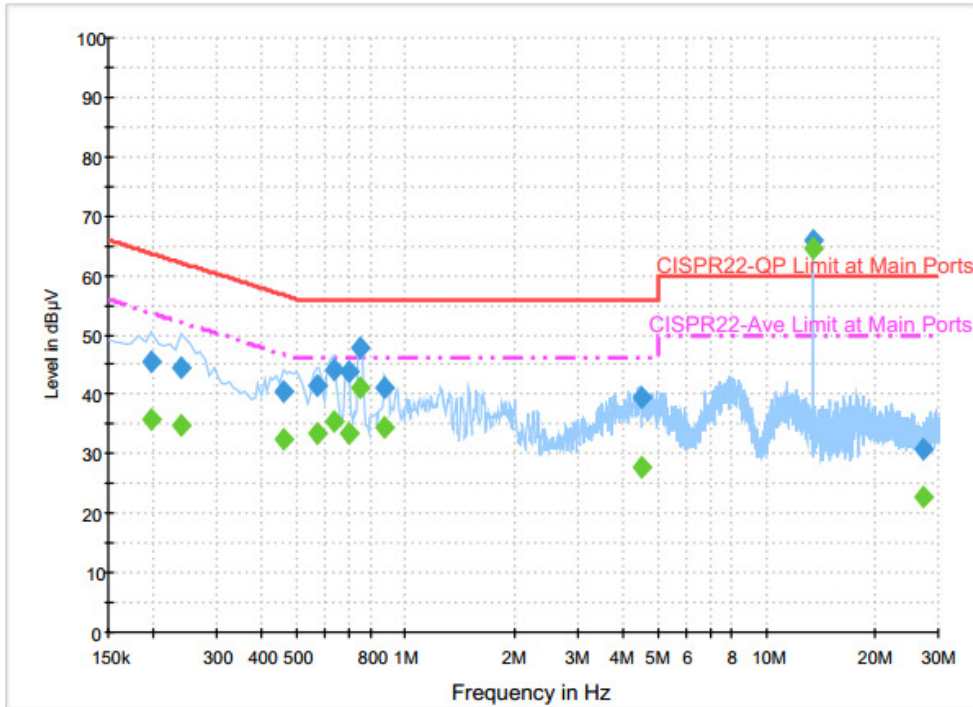

Final Result : Average

Frequency (MHz)	Average (dBµV)	Filter	Line	Corr. (dB)	Margin (dB)	Limit (dBµV)
0.198000	35.7	Off	L1	19.6	18.0	53.7
0.238000	34.7	Off	L1	19.6	17.5	52.2
0.462000	32.3	Off	L1	19.6	14.4	46.7
0.566000	33.4	Off	L1	19.6	12.6	46.0
0.630000	35.3	Off	L1	19.6	10.7	46.0
0.694000	33.6	Off	L1	19.6	12.4	46.0
0.750000	41.1	Off	L1	19.6	4.9	46.0
0.878000	34.4	Off	L1	19.6	11.6	46.0
4.534000	27.8	Off	L1	19.7	18.2	46.0
13.558000	64.6	Off	L1	19.8	-14.6	50.0
27.118000	22.6	Off	L1	19.9	27.4	50.0



Test Mode :	Mode 1	Temperature :	22~24°C
Test Engineer :	Arthur Hsieh	Relative Humidity :	51~53%
Test Voltage :	120Vac / 60Hz	Phase :	Neutral
Function Type :	NFC Link + WLAN (2.4GHz) Link + Bluetooth Link + Earphone 1 with Audio Adapter connect to EUT + Charging Only Cable + AC Adapter		

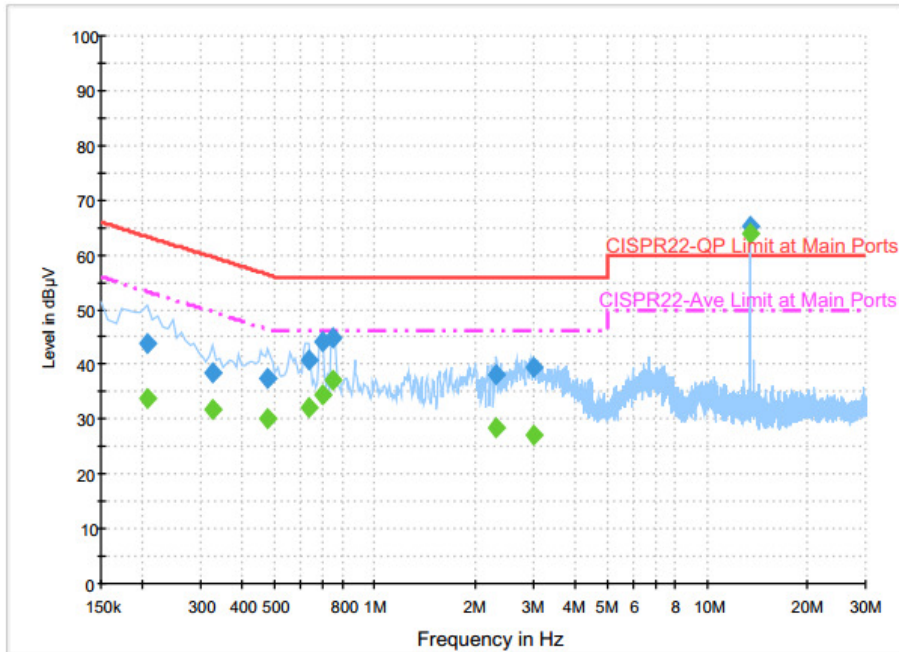

Final Result : Quasi-Peak

Frequency (MHz)	Quasi-Peak (dBµV)	Filter	Line	Corr. (dB)	Margin (dB)	Limit (dBµV)
0.206000	44.0	Off	N	19.6	19.4	63.4
0.326000	38.6	Off	N	19.6	21.0	59.6
0.478000	37.6	Off	N	19.6	18.8	56.4
0.630000	40.9	Off	N	19.6	15.1	56.0
0.694000	44.2	Off	N	19.6	11.8	56.0
0.750000	44.7	Off	N	19.6	11.3	56.0
2.326000	38.1	Off	N	18.6	17.9	56.0
3.022000	39.3	Off	N	19.5	16.7	56.0
13.558000	65.3	Off	N	19.8	-5.3	60.0

Final Result : Average

Frequency (MHz)	Average (dBµV)	Filter	Line	Corr. (dB)	Margin (dB)	Limit (dBµV)
0.206000	33.9	Off	N	19.6	19.5	53.4
0.326000	31.8	Off	N	19.6	17.8	49.6
0.478000	30.1	Off	N	19.6	16.3	46.4
0.630000	31.9	Off	N	19.6	14.1	46.0
0.694000	34.5	Off	N	19.6	11.5	46.0
0.750000	37.1	Off	N	19.6	8.9	46.0
2.326000	28.4	Off	N	18.6	17.6	46.0
3.022000	27.2	Off	N	19.5	18.8	46.0
13.558000	63.8	Off	N	19.8	-13.8	50.0

<Terminal test result with dummy load>

Test Mode :	Mode 1	Temperature :	22~24°C
Test Engineer :	Arthur Hsieh	Relative Humidity :	51~53%
Test Voltage :	120Vac / 60Hz	Phase :	Line
Function Type :	NFC Link + WLAN (2.4GHz) Link + Bluetooth Link + Earphone 1 with Audio Adapter connect to EUT + Charging Only Cable + AC Adapter		

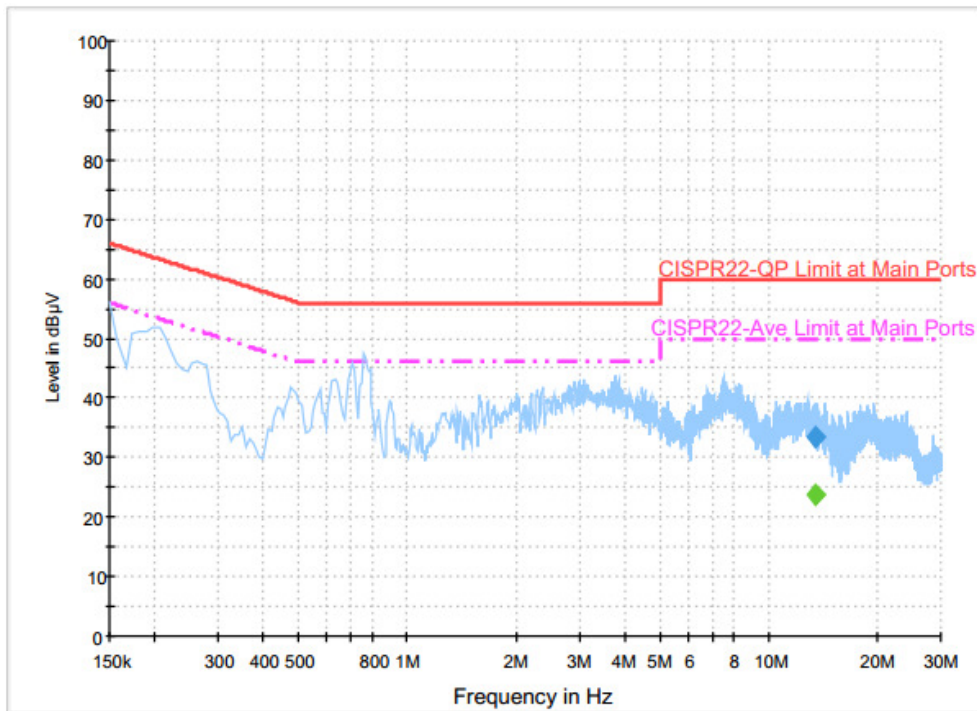

Final Result : Quasi-Peak

Frequency (MHz)	Quasi-Peak (dBµV)	Filter	Line	Corr. (dB)	Margin (dB)	Limit (dBµV)
13.558000	33.5	Off	L1	19.8	26.5	60.0

Final Result : Average

Frequency (MHz)	Average (dBµV)	Filter	Line	Corr. (dB)	Margin (dB)	Limit (dBµV)
13.558000	23.6	Off	L1	19.8	26.4	50.0



Test Mode :	Mode 1	Temperature :	22~24°C
Test Engineer :	Arthur Hsieh	Relative Humidity :	51~53%
Test Voltage :	120Vac / 60Hz	Phase :	Neutral
Function Type :	NFC Link + WLAN (2.4GHz) Link + Bluetooth Link + Earphone 1 with Audio Adapter connect to EUT + Charging Only Cable + AC Adapter		

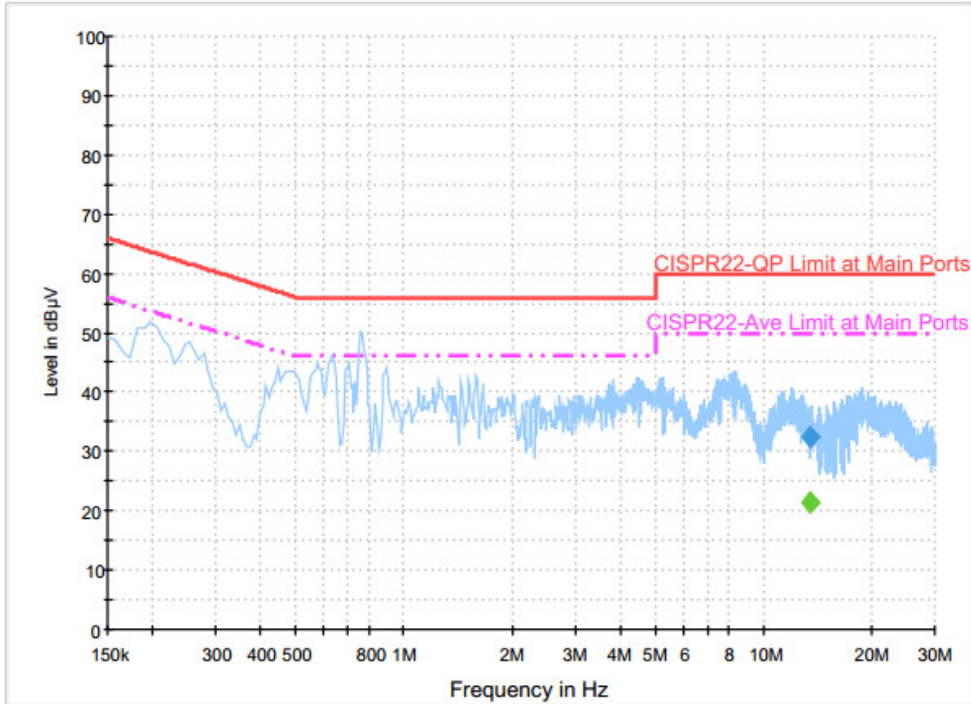

Final Result : Quasi-Peak

Frequency (MHz)	Quasi-Peak (dBµV)	Filter	Line	Corr. (dB)	Margin (dB)	Limit (dBµV)
13.558000	32.3	Off	N	19.8	27.7	60.0

Final Result : Average

Frequency (MHz)	Average (dBµV)	Filter	Line	Corr. (dB)	Margin (dB)	Limit (dBµV)
13.558000	21.5	Off	N	19.8	28.5	50.0



<Original test result with NFC antenna>

Test Mode :	Mode 2	Temperature :	22~24°C
Test Engineer :	Arthur Hsieh	Relative Humidity :	51~53%
Test Voltage :	120Vac / 60Hz	Phase :	Line
Function Type :	NFC Link + WLAN (5GHz) Link + Bluetooth Link with Earphone 3 + Snap on USB Cable Data Link with Notebook + Copy Data from Notebook to EDA (SD Card) + AC Adapter		

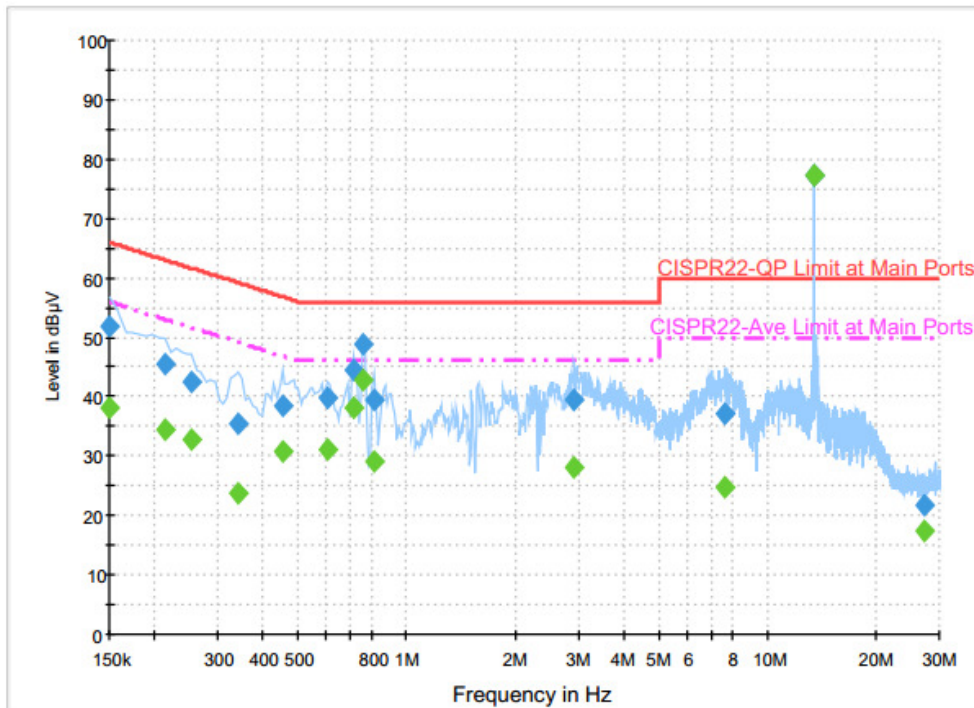

Final Result : Quasi-Peak

Frequency (MHz)	Quasi-Peak (dBµV)	Filter	Line	Corr. (dB)	Margin (dB)	Limit (dBµV)
0.150000	51.9	Off	L1	19.6	14.1	66.0
0.214000	45.6	Off	L1	19.6	17.4	63.0
0.254000	42.6	Off	L1	19.6	19.0	61.6
0.342000	35.4	Off	L1	19.6	23.8	59.2
0.454000	38.5	Off	L1	19.6	18.3	56.8
0.606000	39.8	Off	L1	19.6	16.2	56.0
0.710000	44.4	Off	L1	19.6	11.6	56.0
0.758000	48.8	Off	L1	19.6	7.2	56.0
0.814000	39.6	Off	L1	19.6	16.4	56.0
2.918000	39.6	Off	L1	19.5	16.4	56.0
7.654000	37.2	Off	L1	19.7	22.8	60.0
13.558000	77.4	Off	L1	19.8	-17.4	60.0
27.118000	21.9	Off	L1	19.9	38.1	60.0



Test Mode :	Mode 2	Temperature :	22~24°C
Test Engineer :	Arthur Hsieh	Relative Humidity :	51~53%
Test Voltage :	120Vac / 60Hz	Phase :	Line
Function Type :	NFC Link + WLAN (5GHz) Link + Bluetooth Link with Earphone 3 + Snap on USB Cable Data Link with Notebook + Copy Data from Notebook to EDA (SD Card) + AC Adapter		

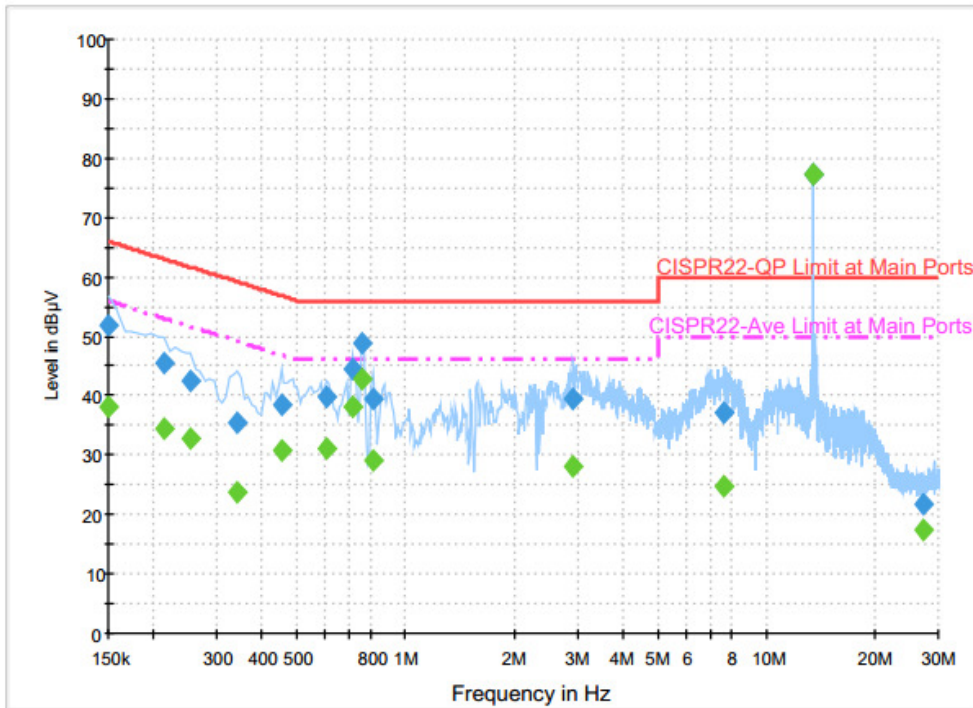

Final Result : Average

Frequency (MHz)	Average (dBµV)	Filter	Line	Corr. (dB)	Margin (dB)	Limit (dBµV)
0.150000	38.3	Off	L1	19.6	17.7	56.0
0.214000	34.5	Off	L1	19.6	18.5	53.0
0.254000	32.9	Off	L1	19.6	18.7	51.6
0.342000	23.8	Off	L1	19.6	25.4	49.2
0.454000	30.8	Off	L1	19.6	16.0	46.8
0.606000	31.1	Off	L1	19.6	14.9	46.0
0.710000	38.2	Off	L1	19.6	7.8	46.0
0.758000	42.9	Off	L1	19.6	3.1	46.0
0.814000	29.1	Off	L1	19.6	16.9	46.0
2.918000	28.1	Off	L1	19.5	17.9	46.0
7.654000	24.6	Off	L1	19.7	25.4	50.0
13.558000	77.1	Off	L1	19.8	-27.1	50.0
27.118000	17.3	Off	L1	19.9	32.7	50.0



Test Mode :	Mode 2	Temperature :	22~24°C
Test Engineer :	Arthur Hsieh	Relative Humidity :	51~53%
Test Voltage :	120Vac / 60Hz	Phase :	Neutral
Function Type :	NFC Link + WLAN (5GHz) Link + Bluetooth Link with Earphone 3 + Snap on USB Cable Data Link with Notebook + Copy Data from Notebook to EDA (SD Card) + AC Adapter		

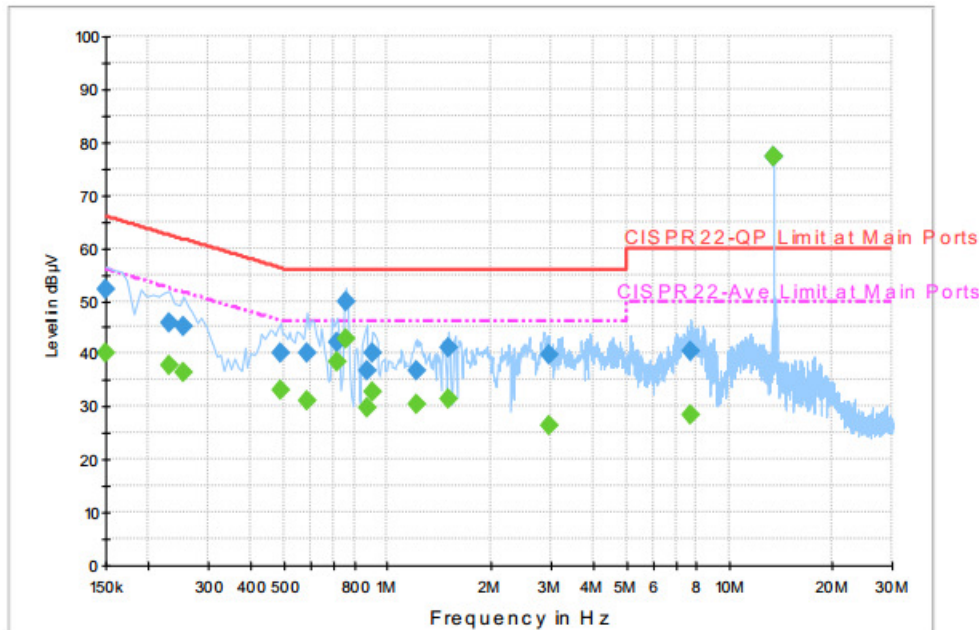

Final Result : Quasi-Peak

Frequency (MHz)	Quasi-Peak (dBµV)	Filter	Line	Corr. (dB)	Margin (dB)	Limit (dBµV)
0.150000	52.0	Off	N	19.6	14.0	66.0
0.230000	45.9	Off	N	19.6	16.5	62.4
0.254000	45.3	Off	N	19.6	16.3	61.6
0.486000	40.2	Off	N	19.6	16.0	56.2
0.582000	40.1	Off	N	19.6	15.9	56.0
0.710000	42.1	Off	N	19.6	13.9	56.0
0.758000	49.8	Off	N	19.6	6.2	56.0
0.870000	36.7	Off	N	19.6	19.3	56.0
0.910000	40.1	Off	N	19.6	15.9	56.0
1.214000	36.9	Off	N	19.6	19.1	56.0
1.510000	41.0	Off	N	19.6	15.0	56.0
2.974000	39.7	Off	N	19.5	16.3	56.0
7.734000	40.3	Off	N	19.7	19.7	60.0
13.558000	77.4	Off	N	19.8	-17.4	60.0



Test Mode :	Mode 2	Temperature :	22~24°C
Test Engineer :	Arthur Hsieh	Relative Humidity :	51~53%
Test Voltage :	120Vac / 60Hz	Phase :	Neutral
Function Type :	NFC Link + WLAN (5GHz) Link + Bluetooth Link with Earphone 3 + Snap on USB Cable Data Link with Notebook + Copy Data from Notebook to EDA (SD Card) + AC Adapter		

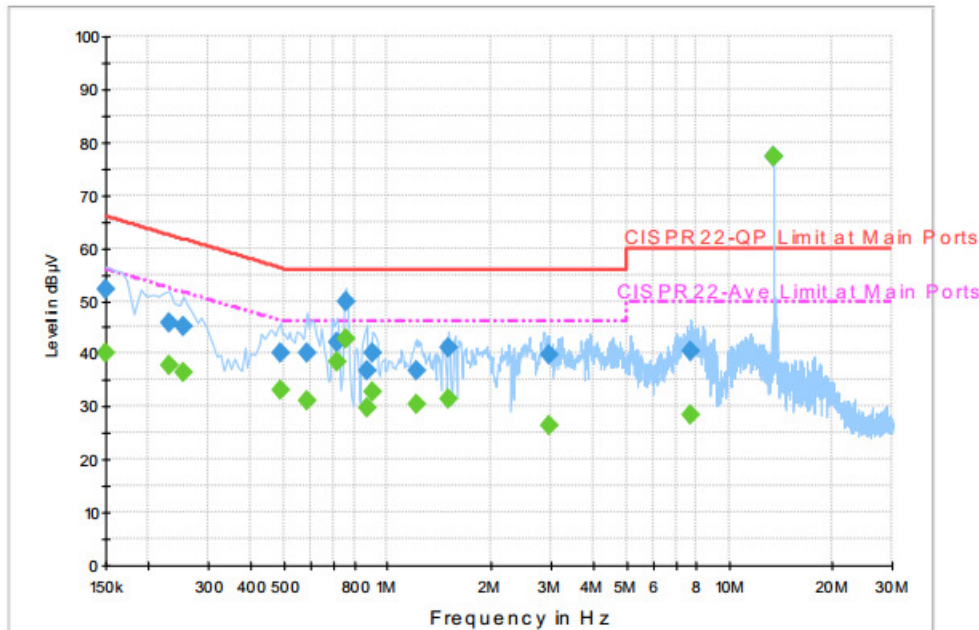

Final Result : Average

Frequency (MHz)	Average (dBµV)	Filter	Line	Corr. (dB)	Margin (dB)	Limit (dBµV)
0.150000	40.1	Off	N	19.6	15.9	56.0
0.230000	37.7	Off	N	19.6	14.7	52.4
0.254000	36.3	Off	N	19.6	15.3	51.6
0.486000	33.1	Off	N	19.6	13.1	46.2
0.582000	31.0	Off	N	19.6	15.0	46.0
0.710000	38.3	Off	N	19.6	7.7	46.0
0.758000	42.8	Off	N	19.6	3.2	46.0
0.870000	29.8	Off	N	19.6	16.2	46.0
0.910000	32.7	Off	N	19.6	13.3	46.0
1.214000	30.3	Off	N	19.6	15.7	46.0
1.510000	31.4	Off	N	19.6	14.6	46.0
2.974000	26.4	Off	N	19.5	19.6	46.0
7.734000	28.3	Off	N	19.7	21.7	50.0
13.558000	77.2	Off	N	19.8	-27.2	50.0



<Terminal test result with dummy load>

Test Mode :	Mode 2	Temperature :	22~24°C
Test Engineer :	Arthur Hsieh	Relative Humidity :	51~53%
Test Voltage :	120Vac / 60Hz	Phase :	Line
Function Type :	NFC Link + WLAN (5GHz) Link + Bluetooth Link with Earphone 3 + Snap on USB Cable Data Link with Notebook + Copy Data from Notebook to EDA (SD Card) + AC Adapter		

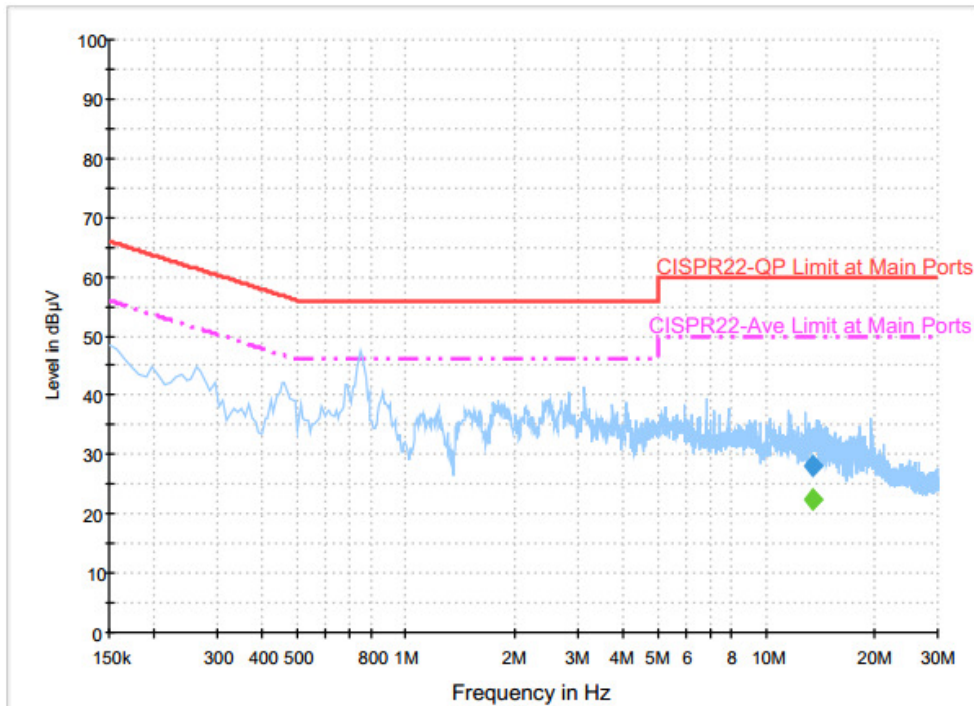

Final Result : Quasi-Peak

Frequency (MHz)	Quasi-Peak (dBµV)	Filter	Line	Corr. (dB)	Margin (dB)	Limit (dBµV)
13.558000	28.2	Off	L1	19.8	31.8	60.0

Final Result : Average

Frequency (MHz)	Average (dBµV)	Filter	Line	Corr. (dB)	Margin (dB)	Limit (dBµV)
13.558000	22.5	Off	L1	19.8	27.5	50.0



Test Mode :	Mode 2	Temperature :	22~24°C
Test Engineer :	Arthur Hsieh	Relative Humidity :	51~53%
Test Voltage :	120Vac / 60Hz	Phase :	Neutral
Function Type :	NFC Link + WLAN (5GHz) Link + Bluetooth Link with Earphone 3 + Snap on USB Cable Data Link with Notebook + Copy Data from Notebook to EDA (SD Card) + AC Adapter		

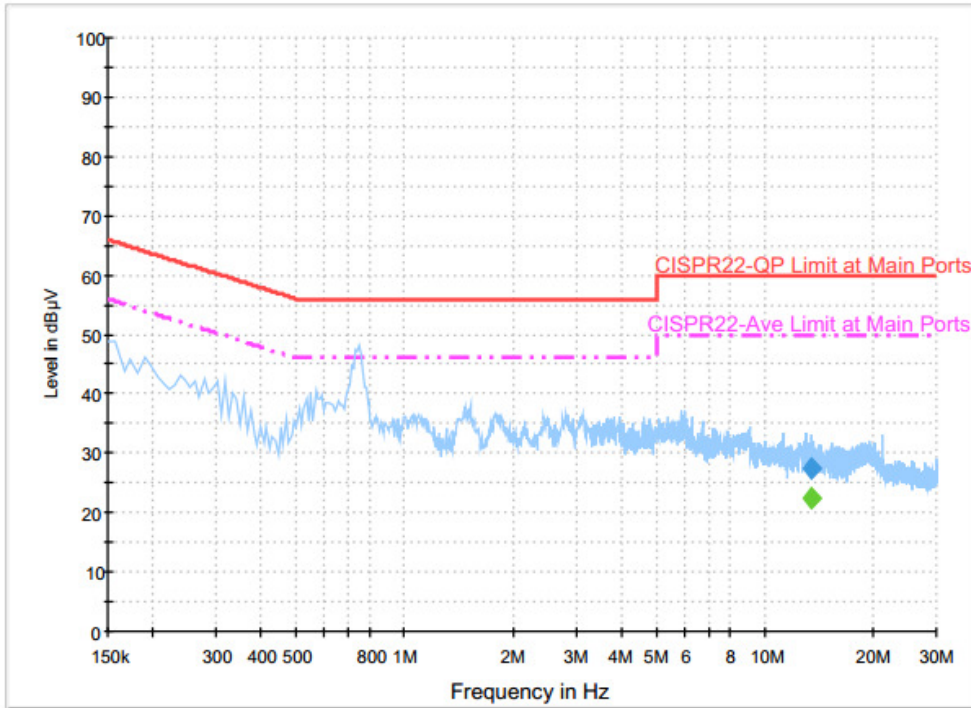

Final Result : Quasi-Peak

Frequency (MHz)	Quasi-Peak (dBµV)	Filter	Line	Corr. (dB)	Margin (dB)	Limit (dBµV)
13.558000	27.4	Off	N	19.8	32.6	60.0

Final Result : Average

Frequency (MHz)	Average (dBµV)	Filter	Line	Corr. (dB)	Margin (dB)	Limit (dBµV)
13.558000	22.4	Off	N	19.8	27.6	50.0



<Original test result with NFC antenna>

Test Mode :	Mode 3	Temperature :	22~24°C
Test Engineer :	Arthur Hsieh	Relative Humidity :	51~53%
Test Voltage :	120Vac / 60Hz	Phase :	Line
Function Type :	NFC Link + WLAN (2.4GHz) Link + Bluetooth Link + Earphone 2 with Audio Adapter connect to EUT + Charging Only Cable + AC Adapter		

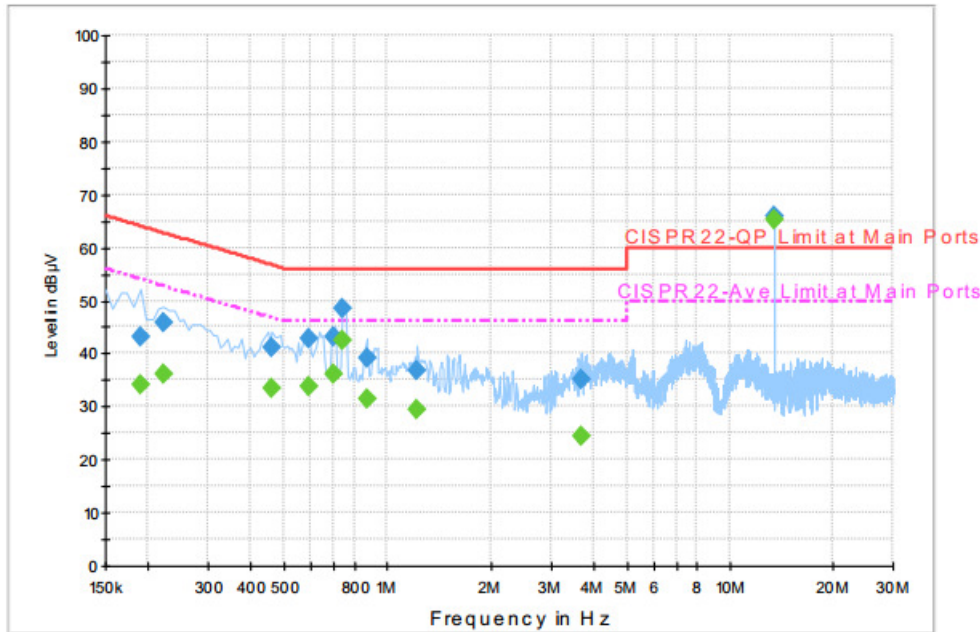

Final Result : Quasi-Peak

Frequency (MHz)	Quasi-Peak (dBµV)	Filter	Line	Corr. (dB)	Margin (dB)	Limit (dBµV)
0.190000	43.2	Off	L1	19.6	20.8	64.0
0.222000	45.8	Off	L1	19.6	16.9	62.7
0.462000	41.2	Off	L1	19.6	15.5	56.7
0.590000	42.7	Off	L1	19.6	13.3	56.0
0.694000	43.2	Off	L1	19.6	12.8	56.0
0.742000	48.5	Off	L1	19.6	7.5	56.0
0.870000	39.2	Off	L1	19.6	16.8	56.0
1.222000	36.6	Off	L1	19.6	19.4	56.0
3.702000	35.1	Off	L1	19.7	20.9	56.0
13.558000	65.8	Off	L1	19.8	-5.8	60.0



Test Mode :	Mode 3	Temperature :	22~24°C
Test Engineer :	Arthur Hsieh	Relative Humidity :	51~53%
Test Voltage :	120Vac / 60Hz	Phase :	Line
Function Type :	NFC Link + WLAN (2.4GHz) Link + Bluetooth Link + Earphone 2 with Audio Adapter connect to EUT + Charging Only Cable + AC Adapter		

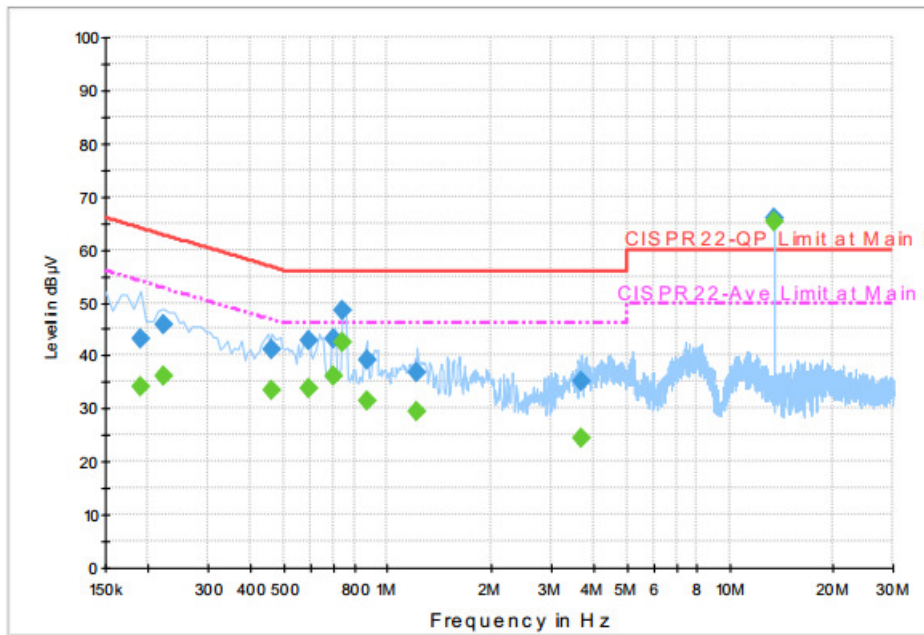

Final Result : Average

Frequency (MHz)	Average (dBµV)	Filter	Line	Corr. (dB)	Margin (dB)	Limit (dBµV)
0.190000	34.0	Off	L1	19.6	20.0	54.0
0.222000	36.3	Off	L1	19.6	16.4	52.7
0.462000	33.3	Off	L1	19.6	13.4	46.7
0.590000	33.9	Off	L1	19.6	12.1	46.0
0.694000	36.2	Off	L1	19.6	9.8	46.0
0.742000	42.6	Off	L1	19.6	3.4	46.0
0.870000	31.4	Off	L1	19.6	14.6	46.0
1.222000	29.4	Off	L1	19.6	16.6	46.0
3.702000	24.3	Off	L1	19.7	21.7	46.0
13.558000	65.4	Off	L1	19.8	-15.4	50.0



Test Mode :	Mode 3	Temperature :	22~24°C
Test Engineer :	Arthur Hsieh	Relative Humidity :	51~53%
Test Voltage :	120Vac / 60Hz	Phase :	Neutral
Function Type :	NFC Link + WLAN (2.4GHz) Link + Bluetooth Link + Earphone 2 with Audio Adapter connect to EUT + Charging Only Cable + AC Adapter		

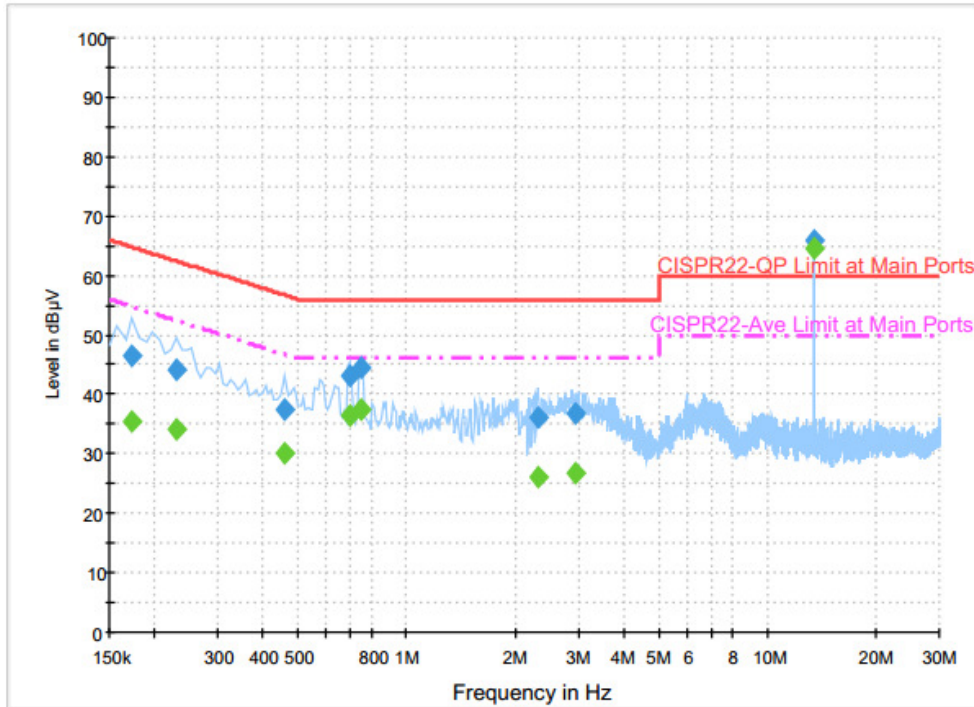

Final Result : Quasi-Peak

Frequency (MHz)	Quasi-Peak (dBµV)	Filter	Line	Corr. (dB)	Margin (dB)	Limit (dBµV)
0.174000	46.5	Off	N	19.6	18.3	64.8
0.230000	44.2	Off	N	19.6	18.2	62.4
0.462000	37.5	Off	N	19.6	19.2	56.7
0.694000	43.2	Off	N	19.6	12.8	56.0
0.750000	44.4	Off	N	19.6	11.6	56.0
2.318000	36.2	Off	N	18.6	19.8	56.0
2.942000	36.9	Off	N	19.5	19.1	56.0
13.558000	66.0	Off	N	19.8	-6.0	60.0

Final Result : Average

Frequency (MHz)	Average (dBµV)	Filter	Line	Corr. (dB)	Margin (dB)	Limit (dBµV)
0.174000	35.4	Off	N	19.6	19.4	54.8
0.230000	34.0	Off	N	19.6	18.4	52.4
0.462000	30.2	Off	N	19.6	16.5	46.7
0.694000	36.5	Off	N	19.6	9.5	46.0
0.750000	37.5	Off	N	19.6	8.5	46.0
2.318000	25.9	Off	N	18.6	20.1	46.0
2.942000	26.9	Off	N	19.5	19.1	46.0
13.558000	64.7	Off	N	19.8	-14.7	50.0

<Terminal test result with dummy load>

Test Mode :	Mode 3	Temperature :	22~24°C
Test Engineer :	Arthur Hsieh	Relative Humidity :	51~53%
Test Voltage :	120Vac / 60Hz	Phase :	Line
Function Type :	NFC Link + WLAN (2.4GHz) Link + Bluetooth Link + Earphone 2 with Audio Adapter connect to EUT + Charging Only Cable + AC Adapter		

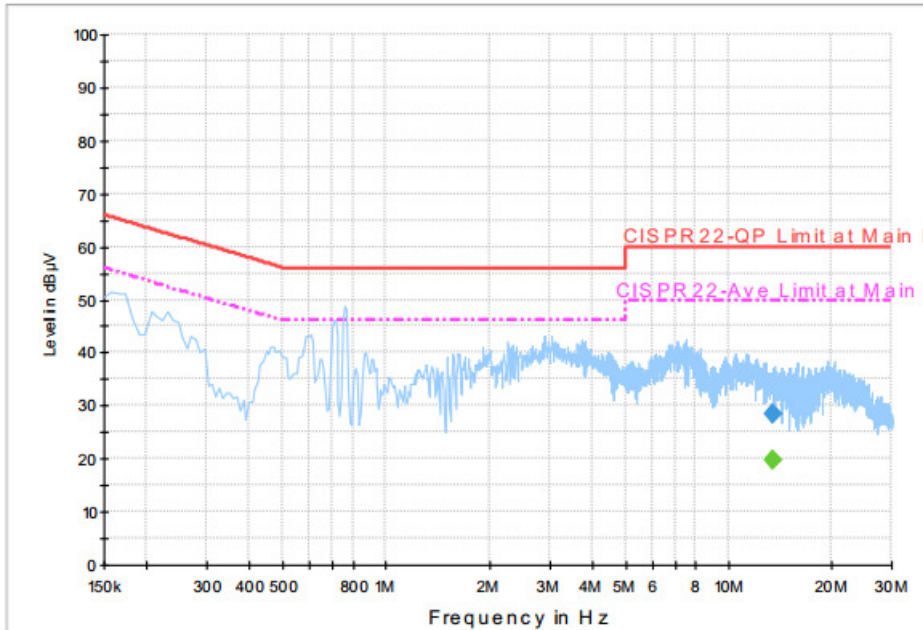

Final Result : Quasi-Peak

Frequency (MHz)	Quasi-Peak (dBµV)	Filter	Line	Corr. (dB)	Margin (dB)	Limit (dBµV)
13.558000	28.4	Off	L1	19.8	31.6	60.0

Final Result : Average

Frequency (MHz)	Average (dBµV)	Filter	Line	Corr. (dB)	Margin (dB)	Limit (dBµV)
13.558000	19.8	Off	L1	19.8	30.2	50.0



Test Mode :	Mode 3	Temperature :	22~24°C
Test Engineer :	Arthur Hsieh	Relative Humidity :	51~53%
Test Voltage :	120Vac / 60Hz	Phase :	Neutral
Function Type :	NFC Link + WLAN (2.4GHz) Link + Bluetooth Link + Earphone 2 with Audio Adapter connect to EUT + Charging Only Cable + AC Adapter		

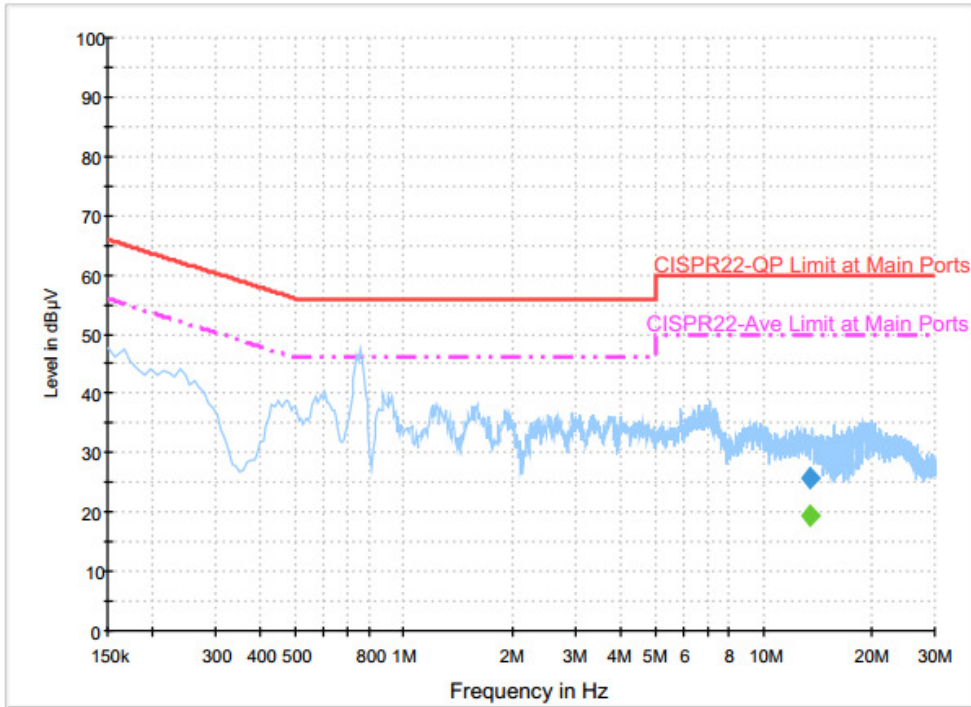

Final Result : Quasi-Peak

Frequency (MHz)	Quasi-Peak (dBµV)	Filter	Line	Corr. (dB)	Margin (dB)	Limit (dBµV)
13.558000	25.8	Off	N	19.8	34.2	60.0

Final Result : Average

Frequency (MHz)	Average (dBµV)	Filter	Line	Corr. (dB)	Margin (dB)	Limit (dBµV)
13.558000	19.5	Off	N	19.8	30.5	50.0



3.10 Antenna Requirements

3.10.1 Standard Applicable

If directional gain of transmitting antennas is greater than 6dBi, the power shall be reduced by the same level in dB comparing to gain minus 6dBi. The use of a permanently attached antenna or of an antenna that uses a unique coupling to the intentional radiator shall be considered sufficient to comply with the FCC rule.

3.10.2 Antenna Anti-Replacement Construction

An embedded-in antenna design is used.

3.10.3 Antenna Gain

The antenna peak gain of EUT is less than 6 dBi. Therefore, it is not necessary to reduce maximum peak output power limit.



4 List of Measuring Equipment

Instrument	Manufacturer	Model No.	Serial No.	Characteristics	Calibration Date	Test Date	Due Date	Remark
Power Meter	Agilent	E4416A	GB412923 44	300MHz~40GHz	Jan. 08, 2016	Aug. 22, 2016 ~ Aug. 26, 2016	Jan. 07, 2017	Conducted (TH05-HY)
Power Sensor	Agilent	E9327A	US404415 48	300MHz~40GHz	Jan. 07, 2016	Aug. 22, 2016 ~ Aug. 26, 2016	Jan. 06, 2017	Conducted (TH05-HY)
Spectrum Analyzer	Rohde & Schwarz	FSP40	100057	9kHz-40GHz	Nov. 23, 2015	Aug. 22, 2016 ~ Aug. 26, 2016	Nov. 22, 2016	Conducted (TH05-HY)
BT Base Station(Measure)	Rohde & Schwarz	CBT	101136	BT 3.0	Sep. 17, 2015	Aug. 22, 2016 ~ Aug. 26, 2016	Sep. 16, 2016	Conducted (TH05-HY)
AC Power Source	ChainTek	APC-1000W	N/A	N/A	N/A	Sep. 06, 2016 ~ Sep. 20, 2016	N/A	Conduction (CO05-HY)
EMI Test Receiver	Rohde & Schwarz	ESCI 7	100724	9kHz~7GHz	Aug. 30, 2016	Sep. 06, 2016 ~ Sep. 20, 2016	Aug. 29, 2017	Conduction (CO05-HY)
LISN	Rohde & Schwarz	ENV216	100080	9kHz~30MHz	Dec. 02, 2015	Sep. 06, 2016 ~ Sep. 20, 2016	Dec. 01, 2016	Conduction (CO05-HY)
LISN	Rohde & Schwarz	ENV216	100081	9kHz~30MHz	Dec. 14, 2015	Sep. 06, 2016 ~ Sep. 20, 2016	Dec. 13, 2016	Conduction (CO05-HY)
Bilog Antenna	TESEQ	CBL 6111D	35419	30MHz to 1GHz	Jan. 13, 2016	Aug. 23, 2016 ~ Sep. 09, 2016	Jan. 12, 2017	Radiation (03CH07-HY)
Double Ridge Horn Antenna	ESCO	3117	00075962	1GHz ~ 18GHz	Aug. 19, 2016	Aug. 23, 2016 ~ Sep. 09, 2016	Aug. 18, 2017	Radiation (03CH07-HY)
EMI Test Receiver	Keysight	N9038A (MXE)	MY541300 85	20Hz ~ 8.4GHz	Nov. 04, 2015	Aug. 23, 2016 ~ Sep. 09, 2016	Nov. 03, 2016	Radiation (03CH07-HY)
Loop Antenna	Rohde & Schwarz	HFH2-Z2	100315	9 kHz~30 MHz	Sep. 02, 2015	Aug. 23, 2016 ~ Sep. 09, 2016	Sep. 01, 2017	Radiation (03CH07-HY)
Preamplifier	MITEQ	AMF-7D-0010 1800-30-10P	1590075	1GHz ~ 18GHz	Apr. 15, 2016	Aug. 23, 2016 ~ Sep. 09, 2016	Apr. 14, 2017	Radiation (03CH07-HY)
Preamplifier	COM-POWER	PA-103A	161241	10MHz-1GHz	Mar. 18, 2016	Aug. 23, 2016 ~ Sep. 09, 2016	Mar. 17, 2017	Radiation (03CH07-HY)
Preamplifier	Agilent	8449B	3008A023 62	1GHz~ 26.5GHz	Oct. 19, 2015	Aug. 23, 2016 ~ Sep. 09, 2016	Oct. 18, 2016	Radiation (03CH07-HY)
Spectrum Analyzer	Agilent	N9010A	MY534701 18	10Hz~44GHz	Feb. 27, 2016	Aug. 23, 2016 ~ Sep. 09, 2016	Feb. 26, 2017	Radiation (03CH07-HY)
Antenna Mast	Max-Full	MFA520BS	N/A	1m~4m	N/A	Aug. 23, 2016 ~ Sep. 09, 2016	N/A	Radiation (03CH07-HY)
Turn Table	ChainTek	Chaintek 3000	N/A	0~360 Degree	N/A	Aug. 23, 2016 ~ Sep. 09, 2016	N/A	Radiation (03CH07-HY)
Preamplifier	MITEQ	JS44-180040 00-33-8P	1840917	18GHz ~ 40GHz	Jun. 14, 2016	Aug. 23, 2016 ~ Sep. 09, 2016	Jun. 13, 2017	Radiation (03CH07-HY)
SHF-EHF Horn Antenna	SCHWARZBE CK	BBHA 9170	BBHA9170 584	18GHz- 40GHz	Nov. 02, 2015	Aug. 23, 2016 ~ Sep. 09, 2016	Nov. 01, 2016	Radiation (03CH07-HY)



5 Uncertainty of Evaluation

Uncertainty of Conducted Emission Measurement (150 kHz ~ 30 MHz)

Measuring Uncertainty for a Level of Confidence of 95% ($U = 2Uc(y)$)	2.26
---	------

Uncertainty of Radiated Emission Measurement (30 MHz ~ 1000 MHz)

Measuring Uncertainty for a Level of Confidence of 95% ($U = 2Uc(y)$)	5.70
---	------

Uncertainty of Radiated Emission Measurement (1000 MHz ~ 18000 MHz)

Measuring Uncertainty for a Level of Confidence of 95% ($U = 2Uc(y)$)	5.50
---	------

Uncertainty of Radiated Emission Measurement (18000 MHz ~ 40000 MHz)

Measuring Uncertainty for a Level of Confidence of 95% ($U = 2Uc(y)$)	5.20
---	------



Appendix A. Radiated Spurious Emission

Test Engineer :	Luke Chang, Jesse Wang, Derreck Chen and James Chiu	Temperature :	21~24°C
		Relative Humidity :	50~55%

2.4GHz 2400~2483.5MHz

BT (Band Edge @ 3m)

BT	Note	Frequency (MHz)	Level (dBμV/m)	Over Limit (dB)	Limit Line (dBμV/m)	Read Level (dBμV)	Antenna Factor (dB/m)	Cable Loss (dB)	Preamp Factor (dB)	Ant Pos (cm)	Table Pos (deg)	Peak Avg. (P/A)	Pol. (H/V)	
BT CH00 2402MHz		2368.695	46.27	-27.73	74	41.34	32.06	7.24	34.37	314	280	P	H	
		2368.695	21.51	-32.49	54	-	-	-	-	-	-	A	H	
	*	2402	97.23	-	-	92.15	32.08	7.31	34.31	314	280	P	H	
		2402	72.47	-	-	-	-	-	-	-	-	A	H	
													H	
														H
			2344.44	45.42	-28.58	74	40.58	32.01	7.24	34.41	100	83	P	V
			2344.44	20.66	-33.34	54	-	-	-	-	-	-	A	V
	*		2402	98.58	-	-	93.5	32.08	7.31	34.31	100	83	P	V
			2402	73.82	-	-	-	-	-	-	-	-	A	V
														V
														V
BT CH 39 2441MHz		2385.6	45.26	-28.74	74	40.21	32.08	7.31	34.34	308	36	P	H	
		2385.6	20.5	-33.5	54	-	-	-	-	-	-	A	H	
	*	2442	98.81	-	-	93.56	32.14	7.36	34.25	308	36	P	H	
		2442	74.05	-	-	-	-	-	-	-	-	A	H	
		2494.12	46.55	-27.45	74	41.11	32.2	7.4	34.16	308	36	P	H	
		2494.12	21.79	-32.21	54	-	-	-	-	-	-	A	H	
		2366.42	45.08	-28.92	74	40.18	32.03	7.24	34.37	109	81	P	V	
		2366.42	20.32	-33.68	54	-	-	-	-	-	-	A	V	
	*		2442	100.27	-	-	95.02	32.14	7.36	34.25	109	81	P	V
			2442	75.51	-	-	-	-	-	-	-	-	A	V
			2484.95	45.45	-28.55	74	40.04	32.18	7.4	34.17	109	81	P	V
			2484.95	20.69	-33.31	54	-	-	-	-	-	-	A	V



BT CH 78 2480MHz	*	2480	97.76	-	-	92.36	32.18	7.4	34.18	298	32	P	H
		2480	73	-	-	-	-	-	-	-	-	A	H
		2483.6	45.4	-28.6	74	40	32.18	7.4	34.18	298	32	P	H
		2483.6	20.64	-33.36	54	-	-	-	-	-	-	A	H
													H
													H
	*	2480	97.61	-	-	92.21	32.18	7.4	34.18	128	82	P	V
		2480	72.85	-	-	-	-	-	-	-	-	A	V
		2484.48	46.02	-27.98	74	40.62	32.18	7.4	34.18	128	82	P	V
		2484.48	21.26	-32.74	54	-	-	-	-	-	-	A	V
													V
													V
Remark	1. No other spurious found. 2. All results are PASS against Peak and Average limit line.												



2.4GHz 2400~2483.5MHz

BT (Harmonic @ 3m)

BT	Note	Frequency (MHz)	Level (dBμV/m)	Over Limit (dB)	Limit Line (dBμV/m)	Read Level (dBμV)	Antenna Factor (dB/m)	Cable Loss (dB)	Preamp Factor (dB)	Ant Pos (cm)	Table Pos (deg)	Peak Avg. (P/A)	Pol. (H/V)
BT CH 00 2402MHz		4804	41.18	-32.82	74	54.33	34.1	11.83	59.08	100	0	P	H
		4804	16.42	-37.58	54	-	-	-	-	-	-	A	H
													H
													H
		4804	41	-33	74	54.15	34.1	11.83	59.08	100	0	P	V
		4804	16.24	-37.76	54	-	-	-	-	-	-	A	V
													V
													V
BT CH 39 2441MHz		4882	40.17	-33.83	74	53.48	34.1	11.53	58.94	100	0	P	H
		4882	15.41	-38.59	54	-	-	-	-	-	-	A	H
		7323	40.47	-33.53	74	48.52	36.1	13.81	57.96	100	0	P	H
		7323	15.71	-38.29	54	-	-	-	-	-	-	A	H
		4882	38.75	-35.25	74	52.06	34.1	11.53	58.94	100	0	P	V
		4882	13.99	-40.01	54	-	-	-	-	-	-	A	V
		7323	41.18	-32.82	74	49.23	36.1	13.81	57.96	100	0	P	V
		7323	16.42	-37.58	54	-	-	-	-	-	-	A	V
BT CH 78 2480MHz		4960	40.53	-33.47	74	53.98	34.1	11.22	58.77	100	0	P	H
		4960	15.77	-38.23	54	-	-	-	-	-	-	A	H
		7440	41.56	-32.44	74	49.47	36.17	14.05	58.13	100	0	P	H
		7440	16.8	-37.2	54	-	-	-	-	-	-	A	H
		4960	39.3	-34.7	74	52.75	34.1	11.22	58.77	100	0	P	V
		4960	14.54	-39.46	54	-	-	-	-	-	-	A	V
		7440	40.11	-33.89	74	48.02	36.17	14.05	58.13	100	0	P	V
		7440	15.35	-38.65	54	-	-	-	-	-	-	A	V
Remark	1. No other spurious found. 2. All results are PASS against Peak and Average limit line.												



Emission below 1GHz

2.4GHz BT (LF)

BT	Note	Frequency	Level	Over	Limit	Read	Antenna	Cable	Preamp	Ant	Table	Peak	Pol.	
		(MHz)	(dBμV/m)	(dB)	(dBμV/m)	(dBμV)	(dB/m)	(dB)	(dB)	(cm)	(deg)	(P/A)	(H/V)	
2.4GHz BT LF		83.46	28.38	-11.62	40	44.39	14.26	1.28	31.55	-	-	P	H	
		154.2	36.66	-6.84	43.5	48.96	17.42	1.78	31.5	100	305	P	H	
		226.29	30.46	-15.54	46	42.94	16.88	2.07	31.43	-	-	P	H	
		319.6	31.15	-14.85	46	39.62	20.37	2.41	31.25	-	-	P	H	
		729.8	29.99	-16.01	46	30.06	26.87	3.74	30.68	-	-	P	H	
		995.8	34.09	-19.91	54	30.34	30.29	3.98	30.52	-	-	P	H	
														H
														H
														H
														H
														H
														H
			84	34.67	-5.33	40	50.56	14.38	1.28	31.55	100	71	P	V
			116.13	34.77	-8.73	43.5	47.05	17.68	1.55	31.51	-	-	P	V
			225.21	29.56	-16.44	46	42.12	16.8	2.07	31.43	-	-	P	V
			320.3	29.4	-16.6	46	37.87	20.37	2.41	31.25	-	-	P	V
			751.5	30.77	-15.23	46	30.38	27.22	3.82	30.65	-	-	P	V
			979.7	33.53	-20.47	54	29.72	30.26	4.07	30.52	-	-	P	V
														V
														V
													V	
													V	
													V	
													V	
Remark	1. No other spurious found. 2. All results are PASS against limit line.													



Note symbol

*	Fundamental Frequency which can be ignored. However, the level of any unwanted emissions shall not exceed the level of the fundamental frequency.
!	Test result is over limit line.
P/A	Peak or Average
H/V	Horizontal or Vertical



A calculation example for radiated spurious emission is shown as below:

WIFI	Note	Frequency	Level	Over	Limit	Read	Antenna	Cable	Preamp	Ant	Table	Peak	Pol.
Ant.				Limit	Line	Level	Factor	Loss	Factor	Pos	Pos	Avg.	
1+2		(MHz)	(dBμV/m)	(dB)	(dBμV/m)	(dBμV)	(dB/m)	(dB)	(dB)	(cm)	(deg)	(P/A)	(H/V)
802.11b		2390	55.45	-18.55	74	54.51	32.22	4.58	35.86	103	308	P	H
CH 01													
2412MHz		2390	43.54	-10.46	54	42.6	32.22	4.58	35.86	103	308	A	H

- Level(dBμV/m) =
Antenna Factor(dB/m) + Cable Loss(dB) + Read Level(dBμV) - Preamp Factor(dB)
- Over Limit(dB) = Level(dBμV/m) – Limit Line(dBμV/m)

For Peak Limit @ 2390MHz:

- Level(dBμV/m)
= Antenna Factor(dB/m) + Cable Loss(dB) + Read Level(dBμV) - Preamp Factor(dB)
= 32.22(dB/m) + 4.58(dB) + 54.51(dBμV) – 35.86 (dB)
= 55.45 (dBμV/m)
- Over Limit(dB)
= Level(dBμV/m) – Limit Line(dBμV/m)
= 55.45(dBμV/m) – 74(dBμV/m)
= -18.55(dB)

For Average Limit @ 2390MHz:

- Level(dBμV/m)
= Antenna Factor(dB/m) + Cable Loss(dB) + Read Level(dBμV) - Preamp Factor(dB)
= 32.22(dB/m) + 4.58(dB) + 42.6(dBμV) – 35.86 (dB)
= 43.54 (dBμV/m)
- Over Limit(dB)
= Level(dBμV/m) – Limit Line(dBμV/m)
= 43.54(dBμV/m) – 54(dBμV/m)
= -10.46(dB)

Both peak and average measured complies with the limit line, so test result is “PASS”.



Appendix B. Radiated Spurious Emission Plots

Test Engineer :	Luke Chang, Jesse Wang, Derreck Chen and James Chiu	Temperature :	21~24°C
		Relative Humidity :	50~55%

2.4GHz 2400~2483.5MHz

BT (Band Edge @ 3m)

BT	2.4GHz 2400~2483.5MHz Band Edge @ 3m	
ANT	BT CH00 2402MHz	
1	Horizontal	Fundamental
Peak	<p> Date: 2016-08-27 PEAK_BE_74 </p> <p> Site : 03CH07.HY Condition : PEAK_BE_74 3m HF-ANT_130829 HORIZONTAL RBW: 1000.000kHz VBW: 3000.000kHz SWT: Auto Detector : Peak Project : 672834 Mode : 1 </p>	<p> Date: 2016-08-27 PEAK_74 </p> <p> Site : 03CH07.HY Condition : PEAK_74 3m HF-ANT_130829 HORIZONTAL RBW: 1000.000kHz VBW: 3000.000kHz SWT: Auto Detector : Peak Project : 672834 Mode : 1 </p>

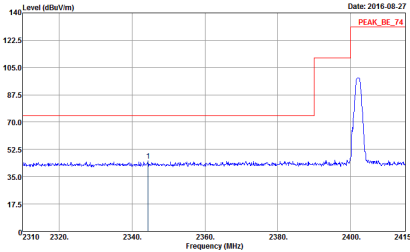
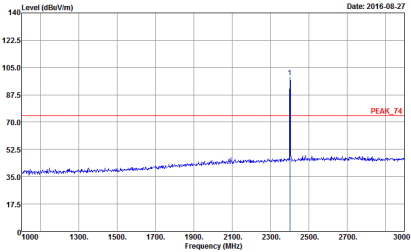

BT	2.4GHz 2400~2483.5MHz Band Edge @ 3m	
ANT	BT CH00 2402MHz	
1	Vertical	Fundamental
Peak	 <p data-bbox="347 748 592 808">Date: 2016-08-27 PEAK_BE_74</p> <p data-bbox="347 748 592 808">Site : 03CH07.HY Condition : PEAK_BE_74 3m HF-ANT_130829 VERTICAL Detector : Peak Project : 672834 Mode : 1</p>	 <p data-bbox="944 748 1189 808">Date: 2016-08-27 PEAK_74</p> <p data-bbox="944 748 1189 808">Site : 03CH07.HY Condition : PEAK_74 3m HF-ANT_130829 VERTICAL Detector : Peak Project : 672834 Mode : 1</p>



BT	2.4GHz 2400~2483.5MHz Band Edge @ 3m	
ANT	BT CH39 2441MHz	
1	Horizontal	Fundamental
Peak	<p>Date: 2016-08-27 PEAK_BE_T4</p> <p>Site : 03CH07HY Condition : PEAK_BE_T4 3m HF-ANT_130829 HORIZONTAL Detector : Peak Project : 672834 Mode : 2</p>	<p>Date: 2016-08-27 PEAK_T4</p> <p>Site : 03CH07HY Condition : PEAK_T4 3m HF-ANT_130829 HORIZONTAL Detector : Peak Project : 672834 Mode : 2</p>
Peak	<p>Date: 2016-08-27 PEAK_BE_T4</p> <p>Site : 03CH07HY Condition : PEAK_BE_T4 3m HF-ANT_130829 HORIZONTAL Detector : Peak Project : 672834 Mode : 2</p>	Left blank



BT	2.4GHz 2400~2483.5MHz Band Edge @ 3m	
ANT	BT CH39 2441MHz	
1	Vertical	Fundamental
Peak	<p>Date: 2016-08-27</p> <p>Site : 03CH07HY Condition : PEAK_BE_T4 3m HF-ANT_130829 VERTICAL Detector : Peak Project : 672834 Mode : 2</p>	<p>Date: 2016-08-27</p> <p>Site : 03CH07HY Condition : PEAK_T4 3m HF-ANT_130829 VERTICAL Detector : Peak Project : 672834 Mode : 2</p>
Peak	<p>Date: 2016-08-27</p> <p>Site : 03CH07HY Condition : PEAK_BE_T4 3m HF-ANT_130829 VERTICAL Detector : Peak Project : 672834 Mode : 2</p>	Left blank

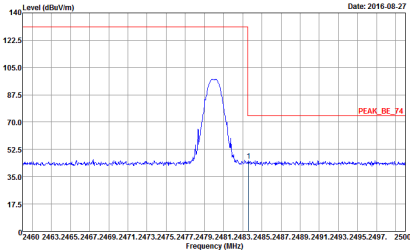
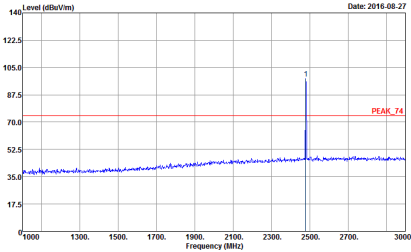

BT	2.4GHz 2400~2483.5MHz Band Edge @ 3m	
ANT	BT CH78 2480MHz	
1	Horizontal	Fundamental
Peak	 <p>Site : 03CH07.HY Condition : PEAK_BE_T4 3m HF-ANT_130829 HORIZONTAL Detector : Peak Project : 672834 Mode : 3</p>	 <p>Site : 03CH07.HY Condition : PEAK_T4 3m HF-ANT_130829 HORIZONTAL Detector : Peak Project : 672834 Mode : 3</p>

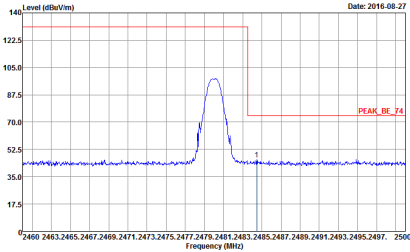
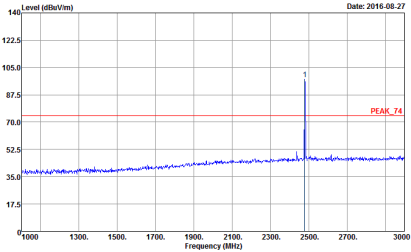

BT	2.4GHz 2400~2483.5MHz Band Edge @ 3m	
ANT	BT CH78 2480MHz	
1	Vertical	Fundamental
Peak	 <p data-bbox="347 748 592 808">Site : 03CH07.HY Condition : PEAK_BE_74 3m HF-ANT_130829 VERTICAL Detector : Peak Project : 672834 Mode : 3</p>	 <p data-bbox="944 748 1189 808">Site : 03CH07.HY Condition : PEAK_74 3m HF-ANT_130829 VERTICAL Detector : Peak Project : 672834 Mode : 3</p>



2.4GHz 2400~2483.5MHz

BT (Harmonic @ 3m)

BT	2.4GHz 2400~2483.5MHz Harmonic @ 3m	
ANT	BT CH00 2402MHz	
1	Horizontal	Vertical
Peak Avg.	<p>Site : 03CH07.HY Condition : PEAK_74 3m SHF-EHF_131029 HORIZONTAL Detector : Peak Project : 672834 Mode : 1</p>	<p>Site : 03CH07.HY Condition : PEAK_74 3m SHF-EHF_131029 VERTICAL Detector : Peak Project : 672834 Mode : 1</p>

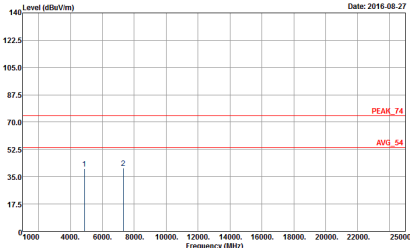
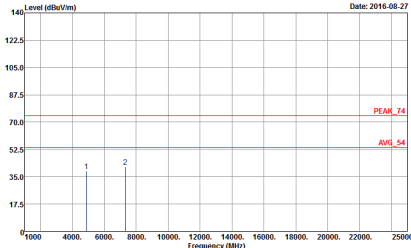

BT	2.4GHz 2400~2483.5MHz Harmonic @ 3m	
ANT	BT CH39 2441MHz	
1	Horizontal	Vertical
Peak Avg.	 <p>Site : 03CH07.HY Condition : PEAK_T4 3m SHF-EHF_131029 HORIZONTAL Detector : Peak Project : 672834 Mode : 2</p>	 <p>Site : 03CH07.HY Condition : PEAK_T4 3m SHF-EHF_131029 VERTICAL Detector : Peak Project : 672834 Mode : 2</p>

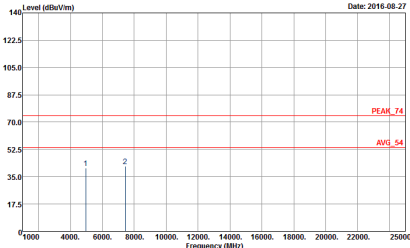
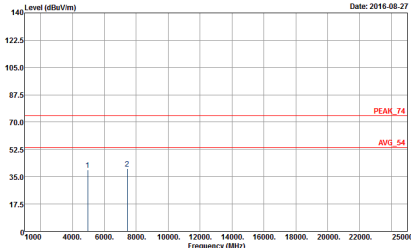

BT	2.4GHz 2400~2483.5MHz Harmonic @ 3m	
ANT	BT CH78 2480MHz	
1	Horizontal	Vertical
Peak Avg.	 <p>Site : 03CH07.HY Condition : PEAK_T4 3m SHF-EHF_131029 HORIZONTAL Detector : Peak Project : 672834 Mode : 3</p>	 <p>Site : 03CH07.HY Condition : PEAK_T4 3m SHF-EHF_131029 VERTICAL Detector : Peak Project : 672834 Mode : 1</p>



Emission below 1GHz

2.4GHz BT (LF)

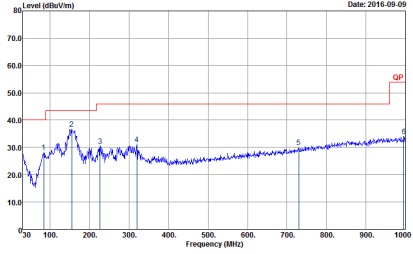
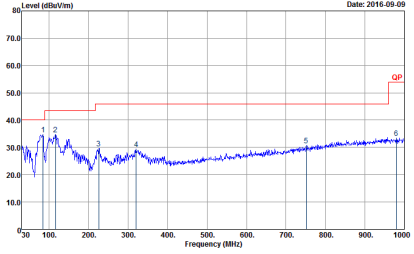
BT	2.4GHz 2400~2483.5MHz	
ANT	BT LF	
1	Horizontal	Vertical
QP / Peak	 <p>Site : 03CH07HY Condition : QP 3m LF-ANT-35419(6) HORIZONTAL Detector : Peak Project : 672834 Mode : 59</p>	 <p>Site : 03CH07HY Condition : QP 3m LF-ANT-35419(6) VERTICAL Detector : Peak Project : 672834 Mode : 59</p>