



FCC RF Test Report

APPLICANT : Zebra Technologies Corporation
EQUIPMENT : Touch computer
BRAND NAME : Zebra
MODEL NAME : TC75EK
FCC ID : UZ7TC75EK
STANDARD : FCC Part 15 Subpart C §15.247
CLASSIFICATION : (DTS) Digital Transmission System

The product was received on Jul. 28, 2016 and testing was completed on Sep. 22, 2016. We, SPORTON INTERNATIONAL INC., would like to declare that the tested sample has been evaluated in accordance with the test procedures and has been in compliance with the applicable technical standards.

The test results in this report apply exclusively to the tested model / sample. Without written approval of SPORTON INTERNATIONAL INC., the test report shall not be reproduced except in full.

Reviewed by: Joseph Lin / Supervisor

Approved by: Jones Tsai / Manager



SPORTON INTERNATIONAL INC.

No. 52, Hwa Ya 1st Rd., Hwa Ya Technology Park, Kwei-Shan District, Tao Yuan City, Taiwan, R.O.C.



TABLE OF CONTENTS

REVISION HISTORY 3

SUMMARY OF TEST RESULT 4

1 GENERAL DESCRIPTION 5

 1.1 Applicant 5

 1.2 Manufacturer 5

 1.3 Product Feature of Equipment Under Test 5

 1.4 Product Specification of Equipment Under Test 6

 1.5 Modification of EUT 7

 1.6 Testing Location 8

 1.7 Applicable Standards 8

2 TEST CONFIGURATION OF EQUIPMENT UNDER TEST 9

 2.1 Carrier Frequency and Channel 9

 2.2 Pre-Scanned RF Power 10

 2.3 Test Mode 19

 2.4 Connection Diagram of Test System 20

 2.5 Support Unit used in test configuration and system 21

 2.6 EUT Operation Test Setup 22

 2.7 Measurement Results Explanation Example 22

3 TEST RESULT 23

 3.1 6dB and 99% Bandwidth Measurement 23

 3.2 Output Power Measurement 25

 3.3 Power Spectral Density Measurement 27

 3.4 Conducted Band Edges and Spurious Emission Measurement 32

 3.5 Radiated Band Edges and Spurious Emission Measurement 81

 3.6 AC Conducted Emission Measurement 86

 3.7 Antenna Requirements 104

4 LIST OF MEASURING EQUIPMENT 106

5 UNCERTAINTY OF EVALUATION 107

APPENDIX A. CONDUCTED TEST RESULTS

APPENDIX B. RADIATED SPURIOUS EMISSION

APPENDIX C. RADIATED SPURIOUS EMISSION PLOTS

APPENDIX D. DUTY CYCLE PLOTS

APPENDIX E. SETUP PHOTOGRAPHS



SUMMARY OF TEST RESULT

Report Section	FCC Rule	Description	Limit	Result	Remark
3.1	15.247(a)(2)	6dB Bandwidth	$\geq 0.5\text{MHz}$	Pass	-
3.1	-	99% Bandwidth	-	Pass	-
3.2	15.247(b)	Power Output Measurement	$\leq 30\text{dBm}$	Pass	-
3.3	15.247(e)	Power Spectral Density	$\leq 8\text{dBm}/3\text{kHz}$	Pass	-
3.4	15.247(d)	Conducted Band Edges	$\leq 30\text{dBc}$	Pass	-
		Conducted Spurious Emission		Pass	-
3.5	15.247(d)	Radiated Band Edges and Radiated Spurious Emission	15.209(a) & 15.247(d)	Pass	Under limit 1.03 dB at 2483.520 MHz
3.6	15.207	AC Conducted Emission	15.207(a)	Pass	Under limit 3.10 dB at 0.758 MHz
3.7	15.203 & 15.247(b)	Antenna Requirement	N/A	Pass	-



1 General Description

1.1 Applicant

Zebra Technologies Corporation
1 Zebra Plaza Holtsville, NY 11742

1.2 Manufacturer

Wistron Corporation
21F, No. 88, Sec. 1, Hsin Tai Wu Rd., Hsichih Dist, New Taipei City 221, Taiwan R.O.C.

1.3 Product Feature of Equipment Under Test

Product Feature	
Equipment	Touch computer
Brand Name	Zebra
Model Name	TC75EK
FCC ID	UZ7TC75EK
EUT supports Radios application	CDMA/EV-DO/GSM/EGPRS/WCDMA/HSPA/LTE/NFC WLAN 11a/b/g/n HT20/HT40 WLAN 11ac VHT20/VHT40/VHT80 Bluetooth BR/EDR/LE
HW Version	DV
SW Version	Android version 6.0.1
FW Version	91-10-01-MG-00
MFD	14JUL16
EUT Stage	Engineering sample

Remark: The above EUT's information was declared by manufacturer. Please refer to the specifications or user's manual for more detailed description.



Specification of Accessories				
AC Adapter	Brand Name	Zebra	Part Number	PWR-BUA5V16W0WW
Snap-On USB/Charge Cable	Brand Name	Symbol	Part Number	CBL-TC7X-USB1-01
Snap-On Charging Cable Cup	Brand Name	Symbol	Part Number	CHG-TC7X-CBL1-01
Battery	Brand Name	Zebra	Part Number	BT-000318-01
Earphone 1	Brand Name	Zebra	Part Number	HDST-35MM-PTVP-01
Earphone 2	Brand Name	Zebra	Part Number	HS2100-OTH
Earphone 3	Brand Name	Zebra	Part Number	HS3100-OTH
Snap-on 3.5MM Audio Nugget	Brand Name	Symbol	Part Number	ADP-TC7X-AUD35-01
3.5mm Jack 43"(1.1m) Standard Cable	Brand Name	Zebra	Part Number	CBL-HS2100-3MS1-01
Soft Holster	Brand Name	Zebra	Part Number	SG-TC7X-HLSTR1-01
Rigid Holster	Brand Name	Zebra	Part Number	SG-TC7X-RHLSTR1-01
Power Cord	Brand Name	LOROM	Part Number	50-16000-182R
Cable line	Brand Name	Zebra	Part Number	CBL-DC-383A1-01

1.4 Product Specification of Equipment Under Test

Standards-related Product Specification	
Tx/Rx Channel Frequency Range	2412 MHz ~ 2462 MHz
Maximum (Average) Output Power to antenna <CDD Modes>	<p><Ant. 1> 802.11b : 18.13 dBm (0.0650 W) 802.11g : 17.10 dBm (0.0513 W) 802.11n HT20 : 16.99 dBm (0.0500 W) 802.11n HT40 : 14.52 dBm (0.0283 W) 802.11ac VHT20 : 17.19 dBm (0.0524 W) 802.11ac VHT40 : 14.57 dBm (0.0286 W)</p> <p><Ant. 2> 802.11b : 18.72 dBm (0.0745 W) 802.11g : 17.90 dBm (0.0617 W) 802.11n HT20 : 17.66 dBm (0.0583 W) 802.11n HT40 : 14.86 dBm (0.0306 W) 802.11ac VHT20 : 17.67 dBm (0.0585 W) 802.11ac VHT40 : 14.88 dBm (0.0308 W)</p> <p>MIMO <Ant. 1 + 2> 802.11b : 21.46 dBm (0.1400 W) 802.11g : 20.64 dBm (0.1159 W) 802.11n HT20 : 20.63 dBm (0.1156 W) 802.11n HT40 : 17.90 dBm (0.0617 W) 802.11ac VHT20 : 20.68 dBm (0.1169 W) 802.11ac VHT40 : 17.93 dBm (0.0621 W)</p>
Maximum (Average) Output Power to antenna <TXBF Modes>	<p>MIMO <Ant. 1 + 2> 802.11n HT20 : 20.61 dBm (0.1151 W) 802.11n HT40 : 17.80 dBm (0.0603 W) 802.11ac VHT20 : 20.66 dBm (0.1164 W) 802.11ac VHT40 : 17.90 dBm (0.0617 W)</p>



Standards-related Product Specification			
99% Occupied Bandwidth <CDD Modes>	802.11b : 11.95MHz		
	802.11g : 18.60MHz		
	802.11ac VHT20 : 18.45MHz		
	802.11ac VHT40 : 36.70MHz		
99% Occupied Bandwidth <TXBF Modes>	802.11ac VHT20 : 19.55MHz		
	802.11ac VHT40 : 36.70MHz		
Antenna Type / Gain	<Ant 1> IFA Antenna type with gain 2.60 dBi		
	<Ant 2> IFA Antenna type with gain 1.80 dBi		
Type of Modulation	802.11b : DSSS (DBPSK / DQPSK / CCK)		
	802.11g/n : OFDM (BPSK / QPSK / 16QAM / 64QAM)		
	802.11ac : OFDM (BPSK / QPSK / 16QAM / 64QAM / 256QAM)		
Antenna Function for Transmitter		Ant. 1	Ant. 2
	802.11 b/g/n/ac	V	V
	802.11 b/g/n/ac MIMO	V	V

Note: MIMO Ant. 1+2 is a calculated result from sum of the power MIMO Ant. 1 and MIMO Ant. 2.

1.5 Modification of EUT

No modifications are made to the EUT during all test items.



1.6 Testing Location

Sporton Lab is accredited to ISO 17025 by Taiwan Accreditation Foundation (TAF code : 1190) and the FCC designation No. TW1022 under the FCC 2.948(e) by Mutual Recognition Agreement (MRA) in FCC Test.

Test Site	SPORTON INTERNATIONAL INC.		
Test Site Location	No. 52, Hwa Ya 1 st Rd., Hwa Ya Technology Park, Kwei-Shan District, Tao Yuan City, Taiwan, R.O.C. TEL: +886-3-327-3456 FAX: +886-3-328-4978		
Test Site No.	Sporton Site No.		
	TH02-HY	CO05-HY	03CH07-HY

Note: The test site complies with ANSI C63.4 2014 requirement.

1.7 Applicable Standards

According to the specifications of the manufacturer, the EUT must comply with the requirements of the following standards:

- ♦ FCC Part 15 Subpart C §15.247
- ♦ FCC KDB Publication No. 558074 D01 DTS Meas. Guidance v03r05
- ♦ FCC KDB 662911 D01 Multiple Transmitter Output v02r01.
- ♦ FCC KDB 644545 D03 Guidance for IEEE 802 11ac New Rules v01
- ♦ ANSI C63.10-2013

Remark:

1. All test items were verified and recorded according to the standards and without any deviation during the test.
2. This EUT has also been tested and complied with the requirements of FCC Part 15, Subpart B, recorded in a separate test report.



2 Test Configuration of Equipment Under Test

The EUT has been associated with peripherals and configuration operated in a manner tended to maximize its emission characteristics in a typical application. Frequency range investigated: conducted emission (150 kHz to 30 MHz) and radiated emission (9 kHz to the 10th harmonic of the highest fundamental frequency or to 40 GHz, whichever is lower). For radiated measurement, pre-scanned in three orthogonal panels, X, Y, Z. The worst position for each mode was recorded in the appendix of this test report.

2.1 Carrier Frequency and Channel

Frequency Band	Channel	Freq. (MHz)	Channel	Freq. (MHz)
2400-2483.5 MHz	1	2412	7	2442
	2	2417	8	2447
	3	2422	9	2452
	4	2427	10	2457
	5	2432	11	2462
	6	2437		



2.2 Pre-Scanned RF Power

Preliminary tests were performed in different data rate and data rate associated with the highest power were chosen for full test shown in the following tables.

<CDD Modes>

<Ant. 1>

802.11b RF Average Output Power (dBm)						
Power vs. Channel			Power vs. Data Rate			
Channel	Frequency (MHz)	Data Rate (bps)	Channel	Data Rate (bps)		
		1M		2M	5.5M	11M
Duty Cycle (%)		98.62		97.73	94.44	89.58
CH 01	2412	17.60	CH 06	18.06	18.05	18.10
CH 02	2417	17.65				
CH 06	2437	18.04				
CH 10	2457	18.09				
CH 11	2462	18.13				

802.11g RF Average Output Power (dBm)										
Power vs. Channel			Power vs. Data Rate							
Channel	Frequency (MHz)	Data Rate (bps)	Channel	Data Rate (bps)						
		6M		9M	12M	18M	24M	36M	48M	54M
Duty Cycle (%)		92.21		89.72	86.75	82.83	77.97	71.11	64.65	63.12
CH 01	2412	16.17	CH 06	17.09	17.07	17.05	17.04	17.06	17.09	17.08
CH 02	2417	16.90								
CH 06	2437	17.10								
CH 10	2457	16.89								
CH 11	2462	15.83								



802.11n HT20 RF Average Output Power (dBm)										
Power vs. Channel			Power vs. Data Rate							
Channel	Frequency (MHz)	MCS Index	Channel	MCS Index						
		MCS0		MCS1	MCS2	MCS3	MCS4	MCS5	MCS6	MCS7
Duty Cycle (%)		93.06		91.67	82.58	77.66	70.79	65.01	64.56	62.22
CH 01	2412	14.10	CH 06	16.65	16.79	16.87	16.94	16.98	16.91	16.98
CH 02	2417	17.01								
CH 06	2437	16.99								
CH 10	2457	16.47								
CH 11	2462	14.65								

802.11n HT40 RF Average Output Power (dBm)										
Power vs. Channel			Power vs. Data Rate							
Channel	Frequency (MHz)	MCS Index	Channel	MCS Index						
		MCS0		MCS1	MCS2	MCS3	MCS4	MCS5	MCS6	MCS7
Duty Cycle (%)		97.52		95.31	93.41	92.96	89.86	87.21	86.25	85.14
CH 03	2422	12.59	CH 06	14.41	14.34	14.43	14.46	14.49	14.45	14.50
CH 04	2427	12.55								
CH 06	2437	14.52								
CH 08	2447	13.01								
CH 09	2452	12.86								

802.11ac VHT20 RF Average Output Power (dBm)											
Power vs. Channel			Power vs. Data Rate								
Channel	Frequency (MHz)	MCS Index	Channel	MCS Index							
		MCS0		MCS1	MCS2	MCS3	MCS4	MCS5	MCS6	MCS7	MCS8
Duty Cycle (%)		92.21		86.25	82.29	77.97	70.33	66.23	64.71	61.77	59.52
CH 01	2412	14.15	CH 06	17.04	16.96	17.04	17.14	17.15	17.11	17.15	17.16
CH 02	2417	17.22									
CH 06	2437	17.19									
CH 10	2457	17.15									
CH 11	2462	14.72									



802.11ac VHT40 RF Average Output Power (dBm)												
Power vs. Channel			Power vs. Data Rate									
Channel	Frequency (MHz)	MCS Index	Channel	MCS Index								
		MCS0		MCS1	MCS2	MCS3	MCS4	MCS5	MCS6	MCS7	MCS8	MCS9
Duty Cycle (%)		96.69		95.35	93.41	97.71	90.00	87.64	86.75	85.53	83.82	82.09
CH 03	2422	12.68	CH 06	14.40	14.36	14.22	14.50	14.52	14.54	14.55	14.49	14.54
CH 04	2427	12.66										
CH 06	2437	14.57										
CH 08	2447	13.25										
CH 09	2452	12.99										

<Ant. 2>

802.11b RF Average Output Power (dBm)						
Power vs. Channel			Power vs. Data Rate			
Channel	Frequency (MHz)	Data Rate (bps)	Channel	Data Rate (bps)		
		1M		2M	5.5M	11M
Duty Cycle (%)		98.62		97.73	94.22	89.58
CH 01	2412	17.94	CH 06	18.65	18.64	18.60
CH 02	2417	18.33				
CH 06	2437	18.72				
CH 10	2457	18.44				
CH 11	2462	18.23				



802.11g RF Average Output Power (dBm)										
Power vs. Channel			Power vs. Data Rate							
Channel	Frequency (MHz)	Data Rate (bps)	Channel	Data Rate (bps)						
		6M		9M	12M	18M	24M	36M	48M	54M
Duty Cycle (%)		92.21		89.72	86.75	81.82	77.22	71.91	65.66	63.83
CH 01	2412	16.71	CH 06	17.80	17.79	17.76	17.89	17.89	17.80	17.79
CH 02	2417	17.89								
CH 06	2437	17.90								
CH 10	2457	17.88								
CH 11	2462	16.50								

802.11n HT20 RF Average Output Power (dBm)										
Power vs. Channel			Power vs. Data Rate							
Channel	Frequency (MHz)	MCS Index	Channel	MCS Index						
		MCS0		MCS1	MCS2	MCS3	MCS4	MCS5	MCS6	MCS7
Duty Cycle (%)		93.06		91.78	82.29	77.78	71.43	66.00	64.56	62.22
CH 01	2412	14.61	CH 06	17.35	17.52	17.64	17.56	17.61	17.54	17.60
CH 02	2417	17.89								
CH 06	2437	17.66								
CH 10	2457	17.84								
CH 11	2462	14.93								

802.11n HT40 RF Average Output Power (dBm)										
Power vs. Channel			Power vs. Data Rate							
Channel	Frequency (MHz)	MCS Index	Channel	MCS Index						
		MCS0		MCS1	MCS2	MCS3	MCS4	MCS5	MCS6	MCS7
Duty Cycle (%)		97.52		96.09	92.98	91.58	89.42	88.37	86.42	85.14
CH 03	2422	12.89	CH 06	14.67	14.81	14.79	14.78	14.72	14.77	14.84
CH 04	2427	14.79								
CH 06	2437	14.86								
CH 08	2447	14.98								
CH 09	2452	13.11								



802.11ac VHT20 RF Average Output Power (dBm)											
Power vs. Channel			Power vs. Data Rate								
Channel	Frequency (MHz)	MCS Index	Channel	MCS Index							
		MCS0		MCS1	MCS2	MCS3	MCS4	MCS5	MCS6	MCS7	MCS8
Duty Cycle (%)		93.42		86.25	82.29	78.63	71.07	66.34	64.58	62.50	59.06
CH 01	2412	14.65	CH 06	17.66	17.57	17.65	17.66	17.65	17.65	17.65	17.62
CH 02	2417	17.88									
CH 06	2437	17.67									
CH 10	2457	17.95									
CH 11	2462	14.94									

802.11ac VHT40 RF Average Output Power (dBm)											
Power vs. Channel			Power vs. Data Rate								
Channel	Frequency (MHz)	MCS Index	Channel	MCS Index							
		MCS0		MCS1	MCS2	MCS3	MCS4	MCS5	MCS6	MCS7	MCS8
Duty Cycle (%)		97.52		95.35	93.41	91.75	89.62	87.50	86.59	85.62	82.09
CH 03	2422	12.96	CH 06	14.75	14.82	14.78	14.80	14.80	14.82	14.84	14.86
CH 04	2427	14.79									
CH 06	2437	14.88									
CH 08	2447	14.83									
CH 09	2452	13.13									

MIMO <Ant. 1+2>

802.11b RF Average Output Power (dBm)						
Power vs. Channel			Power vs. Data Rate			
Channel	Frequency (MHz)	Data Rate (bps)	Channel	Data Rate (bps)		
		1M		2M	5.5M	11M
CH 01	2412	20.88	CH 06	21.39	21.43	21.42
CH 02	2417	20.89				
CH 06	2437	21.46				
CH 10	2457	21.27				
CH 11	2462	21.26				



802.11g RF Average Output Power (dBm)										
Power vs. Channel			Power vs. Data Rate							
Channel	Frequency (MHz)	Data Rate (bps)	Channel	Data Rate (bps)						
		6M		9M	12M	18M	24M	36M	48M	54M
CH 01	2412	18.97	CH 06	20.55	20.54	20.50	20.55	20.63	20.63	20.55
CH 02	2417	20.60								
CH 06	2437	20.64								
CH 10	2457	20.68								
CH 11	2462	18.46								

802.11n HT20 RF Average Output Power (dBm)										
Power vs. Channel			Power vs. Data Rate							
Channel	Frequency (MHz)	MCS Index	Channel	MCS Index						
		MCS0		MCS1	MCS2	MCS3	MCS4	MCS5	MCS6	MCS7
CH 01	2412	17.54	CH 06	20.40	20.23	19.98	19.90	19.87	19.98	19.93
CH 02	2417	20.63								
CH 06	2437	20.63								
CH 10	2457	20.17								
CH 11	2462	17.90								

802.11n HT40 RF Average Output Power (dBm)										
Power vs. Channel			Power vs. Data Rate							
Channel	Frequency (MHz)	MCS Index	Channel	MCS Index						
		MCS0		MCS1	MCS2	MCS3	MCS4	MCS5	MCS6	MCS7
CH 03	2422	15.97	CH 06	17.69	17.64	17.63	17.65	17.70	17.69	17.80
CH 04	2427	15.96								
CH 06	2437	17.90								
CH 08	2447	16.38								
CH 09	2452	16.15								



802.11ac VHT20 RF Average Output Power (dBm)											
Power vs. Channel			Power vs. Data Rate								
Channel	Frequency (MHz)	MCS Index	Channel	MCS Index							
		MCS0		MCS1	MCS2	MCS3	MCS4	MCS5	MCS6	MCS7	MCS8
CH 01	2412	17.71	CH 06	20.46	20.23	20.02	20.00	19.90	19.98	19.98	19.89
CH 02	2417	20.54									
CH 06	2437	20.68									
CH 10	2457	20.20									
CH 11	2462	17.97									

802.11ac VHT40 RF Average Output Power (dBm)												
Power vs. Channel			Power vs. Data Rate									
Channel	Frequency (MHz)	MCS Index	Channel	MCS Index								
		MCS0		MCS1	MCS2	MCS3	MCS4	MCS5	MCS6	MCS7	MCS8	MCS9
CH 03	2422	16.00	CH 06	17.70	17.55	17.62	17.59	17.66	17.64	17.71	17.61	17.59
CH 04	2427	16.01										
CH 06	2437	17.93										
CH 08	2447	16.46										
CH 09	2452	16.17										

Note: MIMO Ant. 1+2 is a calculated result from sum of the power MIMO Ant. 1 and MIMO Ant. 2.



<TXBF Modes>

MIMO <Ant. 1+2>

802.11n HT20 RF Average Output Power (dBm)										
Power vs. Channel			Power vs. Data Rate							
Channel	Frequency (MHz)	MCS Index	Channel	MCS Index						
		MCS0		MCS1	MCS2	MCS3	MCS4	MCS5	MCS6	MCS7
CH 01	2412	17.57	CH 06	20.56	20.56	20.46	20.56	20.46	20.51	20.51
CH 02	2417	20.63								
CH 06	2437	20.61								
CH 10	2457	20.17								
CH 11	2462	17.91								

802.11n HT40 RF Average Output Power (dBm)										
Power vs. Channel			Power vs. Data Rate							
Channel	Frequency (MHz)	MCS Index	Channel	MCS Index						
		MCS0		MCS1	MCS2	MCS3	MCS4	MCS5	MCS6	MCS7
CH 03	2422	15.97	CH 06	17.74	17.78	17.74	17.68	17.74	17.70	17.74
CH 04	2427	15.96								
CH 06	2437	17.80								
CH 08	2447	16.38								
CH 09	2452	16.11								

802.11ac VHT20 RF Average Output Power (dBm)										
Power vs. Channel			Power vs. Data Rate							
Channel	Frequency (MHz)	MCS Index	Channel	MCS Index						
		MCS0		MCS1	MCS2	MCS3	MCS4	MCS5	MCS6	MCS7
CH 01	2412	17.67	CH 06	20.61	20.61	20.56	20.61	20.51	20.56	20.56
CH 02	2417	20.54								
CH 06	2437	20.66								
CH 10	2457	20.20								
CH 11	2462	17.96								



802.11ac VHT40 RF Average Output Power (dBm)												
Power vs. Channel			Power vs. Data Rate									
Channel	Frequency (MHz)	MCS Index	Channel	MCS Index								
		MCS0		MCS1	MCS2	MCS3	MCS4	MCS5	MCS6	MCS7	MCS8	MCS9
CH 03	2422	16.03	CH 06	17.84	17.85	17.85	17.84	17.78	17.78	17.80	17.84	17.80
CH 04	2427	16.01										
CH 06	2437	17.90										
CH 08	2447	16.46										
CH 09	2452	16.16										

Note: MIMO Ant. 1+2 is a calculated result from sum of the power MIMO Ant. 1 and MIMO Ant. 2.



2.3 Test Mode

Final test mode of conducted test items and radiated spurious emissions are considering the modulation and worse data rates from the power table described in section 2.2.

Single Antenna

Modulation	Data Rate
802.11b	1 Mbps
802.11g	6 Mbps
802.11n HT20	MCS0
802.11n HT40	MCS0
802.11ac VHT20	MCS0
802.11ac VHT40	MCS0
802.11ac VHT80	MCS0

MIMO Antenna

Modulation	Data Rate
802.11b	1 Mbps
802.11g	6 Mbps
802.11n HT20	MCS0
802.11n HT40	MCS0
802.11ac VHT20	MCS0
802.11ac VHT40	MCS0
802.11ac VHT80	MCS0

Test Cases	
AC Conducted Emission	<p>Mode 1 :NFC Link + WLAN (2.4GHz) Link + Bluetooth Link + Earphone 1 with Audio Adapter connect to EUT + Charging Only Cable + AC Adapter</p> <p>Mode 2 :NFC Link + WLAN (5GHz) Link + Bluetooth Link with Earphone 3 + Snap on USB Cable Data Link with Notebook + Copy Data from Notebook to EDA (SD Card) + AC Adapter</p> <p>Mode 3 :NFC Link + WLAN (2.4GHz) Link + Bluetooth Link + Earphone 2 with Audio Adapter connect to EUT + Charging Only Cable + AC Adapter</p>

2.4 Connection Diagram of Test System

<WLAN Tx Mode>

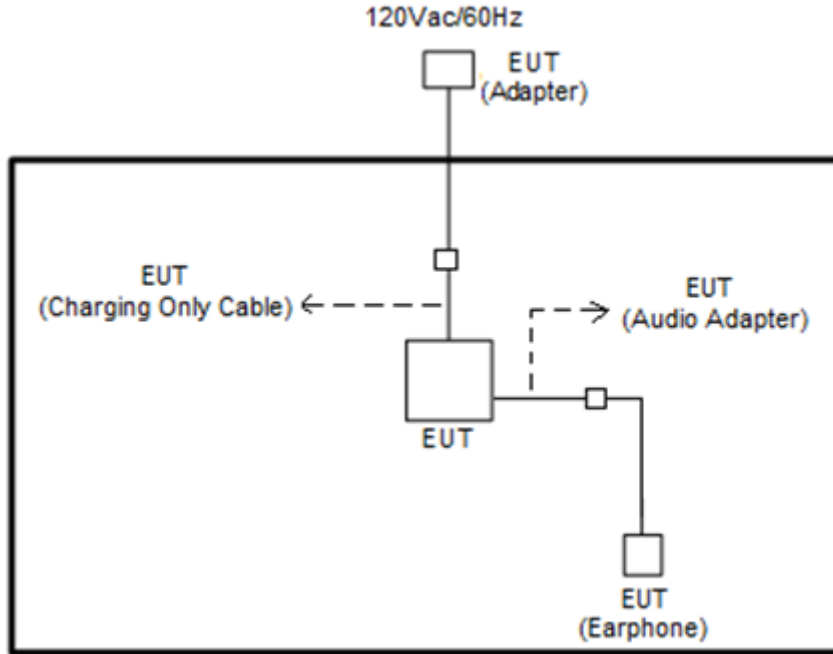

<AC Conducted Emission for charging mode>

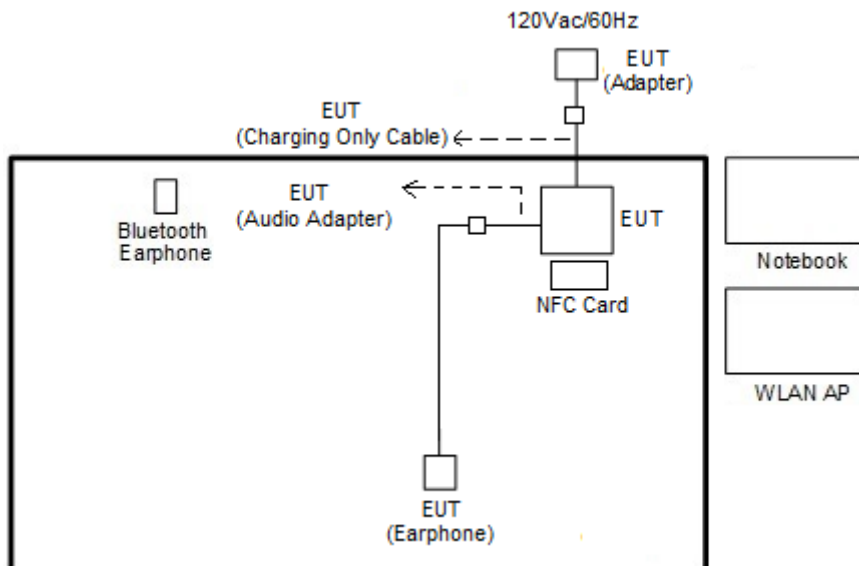

<AC Conducted Emission for data link mode>

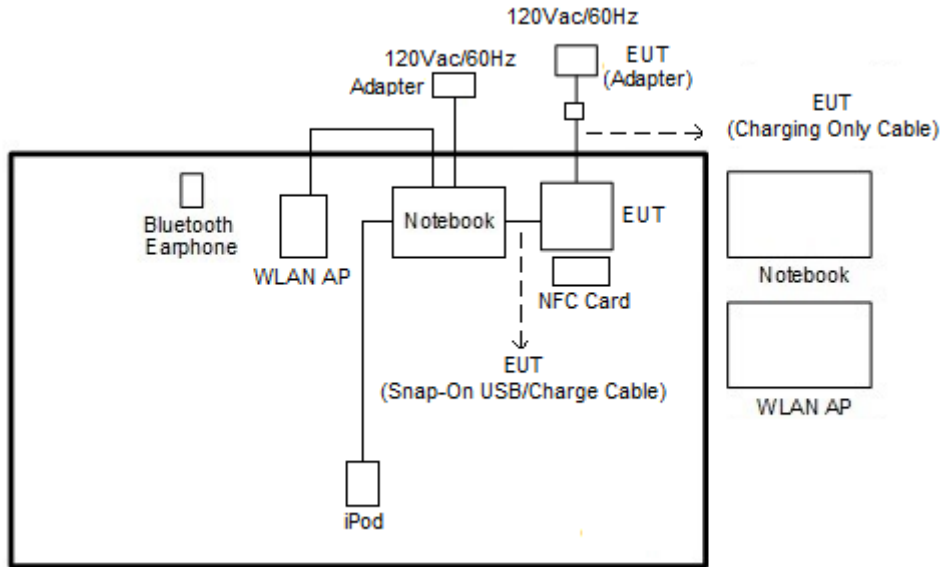

2.5 Support Unit used in test configuration and system

Item	Equipment	Trade Name	Model Name	FCC ID	Data Cable	Power Cord
1.	WLAN AP	D-Link	DIR-628	KA2DIR628A2	N/A	Unshielded, 1.8 m
2.	Bluetooth Earphone	Sony Ericsson	MW600	PY7DDA-2029	N/A	N/A
3.	Notebook	DELL	P20G	FCC DoC/ Contains FCC ID: QDS-BRCM1051	N/A	AC I/P: Unshielded, 1.2 m DC O/P: Shielded, 1.8 m
4.	Notebook	DELL	Latitude E6320	FCC DoC/ Contains FCC ID: QDS-BRCM1054	N/A	AC I/P: Unshielded, 1.2 m DC O/P: Shielded, 1.8 m
5.	Notebook	Lenovo	M490S(E330)	QDS-BRCM1063	N/A	Unshielded, 1.8 m
6.	SD Card	SanDisk	MicroSD HC	FCC DoC	N/A	N/A
7.	NFC Card	Metro Taipei	Easy Card	N/A	N/A	N/A
8.	iPod	Apple	A1285	FCC DoC	Shielded, 1.0 m	N/A



2.6 EUT Operation Test Setup

For WLAN function, programmed RF utility, “AT Command” installed in the notebook make the EUT provide functions like channel selection and power level for continuous transmitting and receiving signals.

For WLAN MIMO TXBF modes, the EUT was tested under normal operation and link to another device with power, modulation modes and data rates controlled by engineer mode command lines. The “CMD” software tool was used to make EUT continuous transmitting signals.

2.7 Measurement Results Explanation Example

For all conducted test items:

The offset level is set in the spectrum analyzer to compensate the RF cable loss and attenuator factor between EUT conducted output port and spectrum analyzer. With the offset compensation, the spectrum analyzer reading level is exactly the EUT RF output level.

Example:

The spectrum analyzer offset is derived from RF cable loss and attenuator factor.

Offset = RF cable loss + attenuator factor.

Following shows an offset computation example with cable loss 4.2 dB and 10dB attenuator.

Offset(dB) = RF cable loss(dB) + attenuator factor(dB).

= 4.2 + 10 = 14.2 (dB)

3 Test Result

3.1 6dB and 99% Bandwidth Measurement

3.1.1 Limit of 6dB and 99% Bandwidth

The minimum 6 dB bandwidth shall be at least 500 kHz.

3.1.2 Measuring Instruments

The measuring equipment is listed in the section 4 of this test report.

3.1.3 Test Procedures

1. The testing follows FCC KDB Publication No. 558074 DTS D01 Meas. Guidance v03r05.
2. The RF output of EUT was connected to the spectrum analyzer by RF cable and attenuator. The path loss was compensated to the results for each measurement.
3. Set to the maximum power setting and enable the EUT transmit continuously.
4. Make the measurement with the spectrum analyzer's resolution bandwidth (RBW) = 100 kHz. Set the Video bandwidth (VBW) = 300 kHz. In order to make an accurate measurement. The 6 dB bandwidth must be greater than 500 kHz.
5. For 99% Bandwidth Measurement, the spectrum analyzer's resolution bandwidth (RBW) = 1MHz and set the Video bandwidth (VBW) = 3MHz.
6. Measure and record the results in the test report.

3.1.4 Test Setup

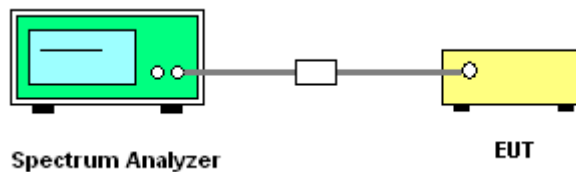



3.1.5 Test Result of 6dB and 99% Occupied Bandwidth

Please refer to Appendix A.

<CDD Modes>

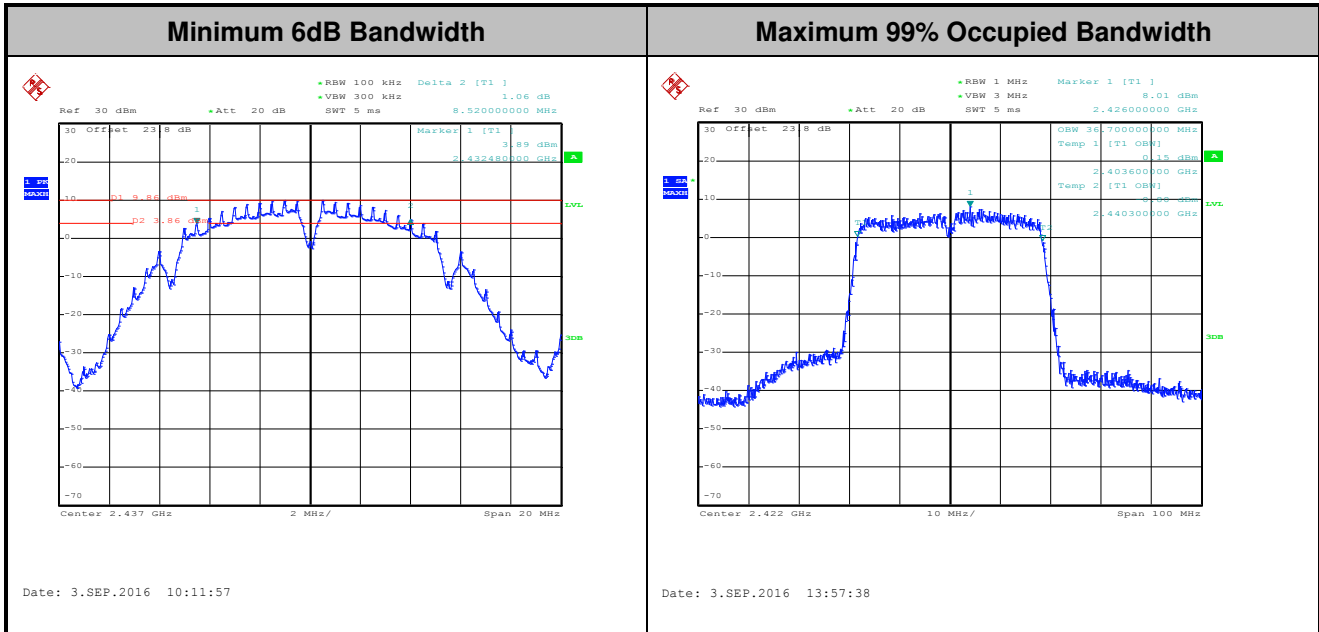

Note : The occupied channel bandwidth is maintained within the band of operation for all of the modulations.

<TXBF Modes>

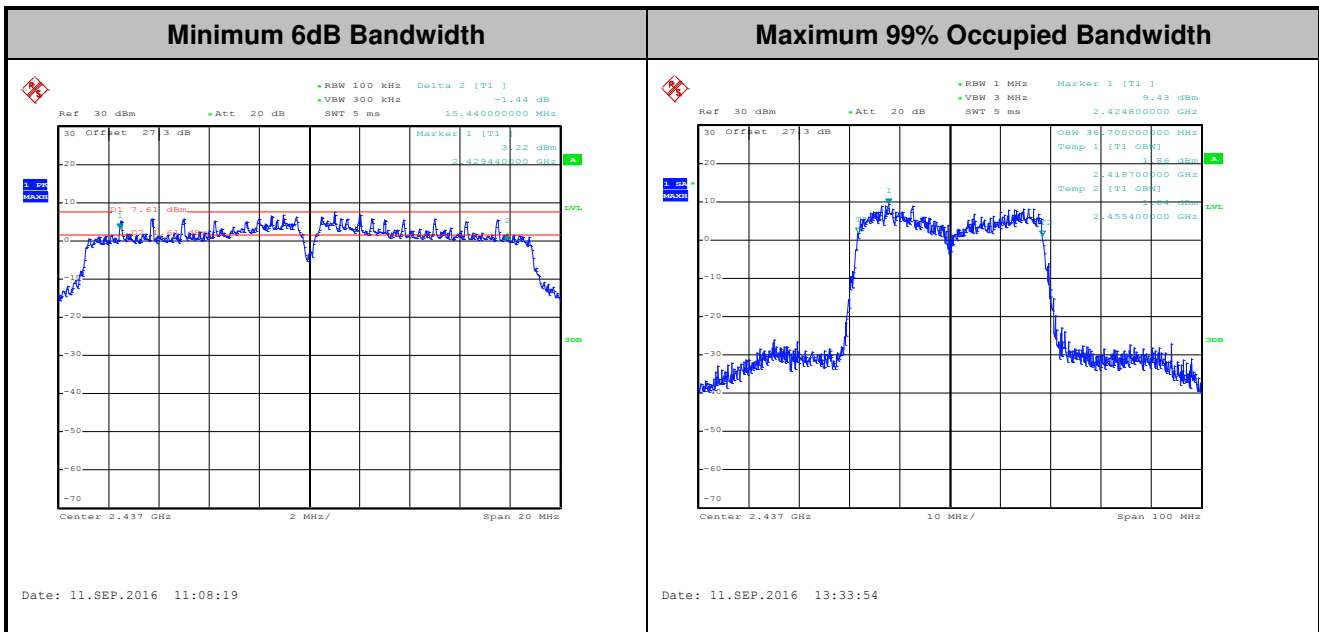

Note : The occupied channel bandwidth is maintained within the band of operation for all of the modulations.



3.2 Output Power Measurement

3.2.1 Limit of Output Power

For systems using digital modulation in the 2400-2483.5MHz, the limit for output power is 30dBm. If transmitting antenna with directional gain greater than 6dBi is used, the output power from the intentional radiator shall be reduced below the above stated value by the amount in dB that the directional gain of the antenna exceeds 6 dBi. In case of point-to-point operation, the limit has to be reduced by 1dB for every 3dB that the directional gain of the antenna exceeds 6dBi.

3.2.2 Measuring Instruments

The measuring equipment is listed in the section 4 of this test report.

3.2.3 Test Procedures

CDD Modes

1. The testing follows the Measurement Procedure of FCC KDB No. 558074 DTS D01 Meas. Guidance v03r05 section 9.2.3.1 Method AVGPM.
2. The RF output of EUT was connected to the power meter by RF cable and attenuator. The path loss was compensated to the results for each measurement.
3. Set to the maximum power setting and enable the EUT transmit continuously.
4. Measure the conducted output power and record the results in the test report.
5. For MIMO mode, calculation method follows FCC KDB 662911 D01 Multiple Transmitter Output v02r01.

TXBF Modes

1. The testing follows the Measurement Procedure of FCC KDB No. 558074 DTS D01 Meas. Guidance v03r05 section 9.2.3.2 Method AVGPM-G.
2. The RF output of EUT was connected to the power meter by RF cable and attenuator. The path loss was compensated to the results for each measurement.
3. Set to the maximum power setting and enable the EUT transmit continuously.
4. Measure the conducted output power and record the results in the test report.
5. For MIMO mode, calculation method follows FCC KDB 662911 D01 Multiple Transmitter Output v02r01.

3.2.4 Test Setup

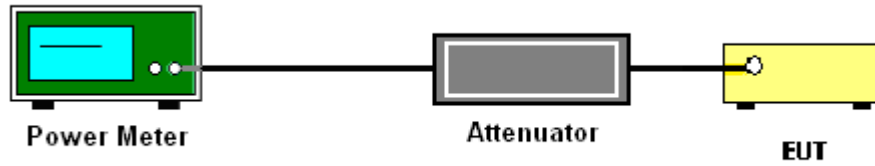

3.2.5 Test Result of Peak Output Power (Reporting Only)

Please refer to Appendix A.

3.2.6 Test Result of Average output Power

Please refer to Appendix A.



3.3 Power Spectral Density Measurement

3.3.1 Limit of Power Spectral Density

The peak power spectral density shall not be greater than 8dBm in any 3kHz band at any time interval of continuous transmission.

3.3.2 Measuring Instruments

The measuring equipment is listed in the section 4 of this test report.



3.3.3 Test Procedures

CDD Modes

Method AVGPSD-2

1. The testing follows Measurement Procedure 10.5 Method AVGPSD-2 of FCC KDB Publication No. 558074 D01 DTS Meas. Guidance v03r05.
2. The RF output of EUT was connected to the spectrum analyzer by RF cable and attenuator. The path loss was compensated to the results for each measurement.
3. Set to the maximum power setting and enable the EUT transmit continuously.
4. Make the measurement with the spectrum analyzer's resolution bandwidth (RBW) = 10 kHz. Video bandwidth VBW = 30 kHz In order to make an accurate measurement, set the span to 1.5 times DTS Channel Bandwidth. (6dB BW).
5. Number of points in sweep ≥ 2 Span / RBW. (This ensures that bin-to-bin spacing is \leq RBW/2, so that narrowband signals are not lost between frequency bins).
6. Detector = RMS, Sweep time = auto couple.
7. Trace average at least 100 traces in power averaging mode.
8. Add $10 \log(1/x)$, where x is the duty cycle, to the measured power in order to compute the average power during the actual transmission times. For example, add $10 \log(1/0.25) = 6$ dB if the duty cycle is 25 percent.
9. Measure and record the results in the test report. For MIMO mode, calculation method follows FCC KDB 662911 D01 Multiple Transmitter Output v02r01.
Method (c): Measure and add $10 \log(N_{ANT})$ dB.

With this technique, spectrum measurements are performed at each output of the device, but rather than summing the spectra or the spectral peaks across the outputs, the quantity $10 \log(N_{ANT})$ dB is added to each spectrum value before comparing to the emission limit. The addition of $10 \log(N_{ANT})$ dB serves to apportion the emission limit among the N_{ANT} outputs so that each output is permitted to contribute no more than $1/N_{ANT}^{\text{th}}$ of the PSD limit .

TXBF Modes**Method AVGPSD-3**

1. The testing follows Measurement Procedure 10.7 Method AVGPSD-3 of FCC KDB Publication No. 558074 D01 DTS Meas. Guidance v03r05.
2. The RF output of EUT was connected to the spectrum analyzer by RF cable and attenuator. The path loss was compensated to the results for each measurement.
3. Set to the maximum power setting and enable the EUT transmit continuously.
4. Make the measurement with the spectrum analyzer's resolution bandwidth (RBW) = 10 kHz. Video bandwidth VBW = 30 kHz In order to make an accurate measurement, set the span to 1.5 times DTS Channel Bandwidth. (6dB BW).
5. Number of points in sweep ≥ 2 Span / RBW. (This ensures that bin-to-bin spacing is \leq RBW/2, so that narrowband signals are not lost between frequency bins).
6. Detector = RMS, Sweep time = auto couple.
7. Trace mode = max hold.
8. Allow max hold to run for at least 60 seconds, or longer as needed to allow the trace to stabilize.
9. Measure and record the results in the test report. For MIMO mode, calculation method follows FCC KDB 662911 D01 Multiple Transmitter Output v02r01.

Method (c): Measure and add $10 \log(N_{\text{ANT}})$ dB.

With this technique, spectrum measurements are performed at each output of the device, but rather than summing the spectra or the spectral peaks across the outputs, the quantity $10 \log(N_{\text{ANT}})$ dB is added to each spectrum value before comparing to the emission limit. The addition of $10 \log(N_{\text{ANT}})$ dB serves to apportion the emission limit among the N_{ANT} outputs so that each output is permitted to contribute no more than $1/N_{\text{ANT}}^{\text{th}}$ of the PSD limit .

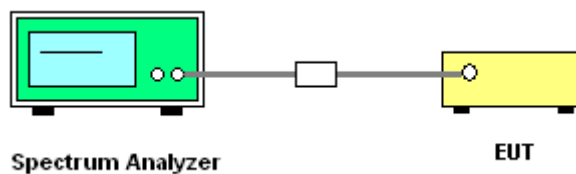
3.3.4 Test Setup



3.3.5 Test Result of Power Spectral Density

Please refer to Appendix A.

<CDD Modes>

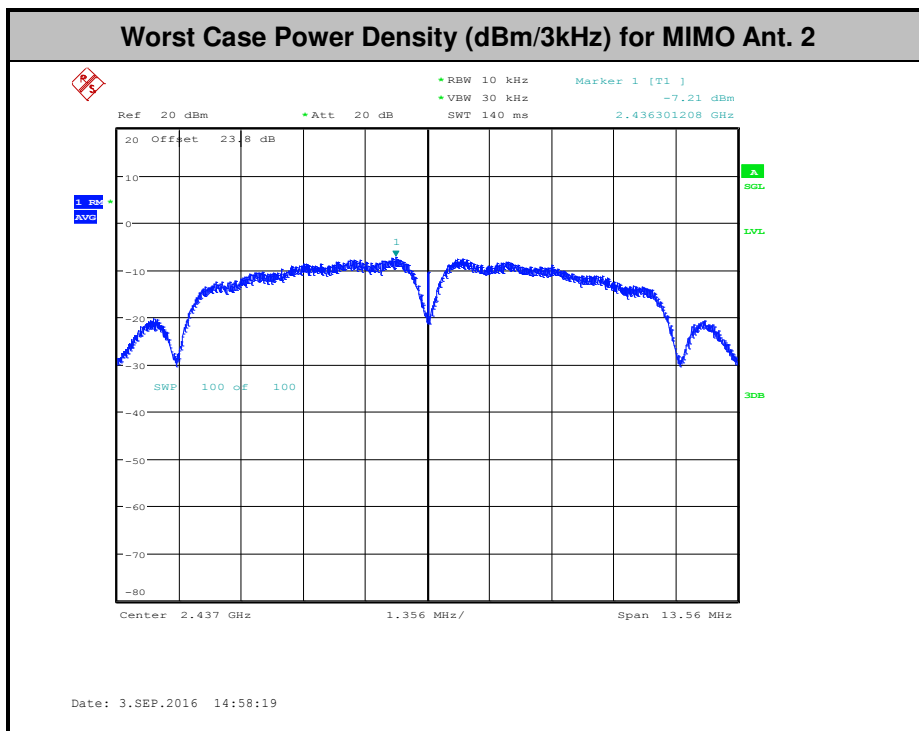
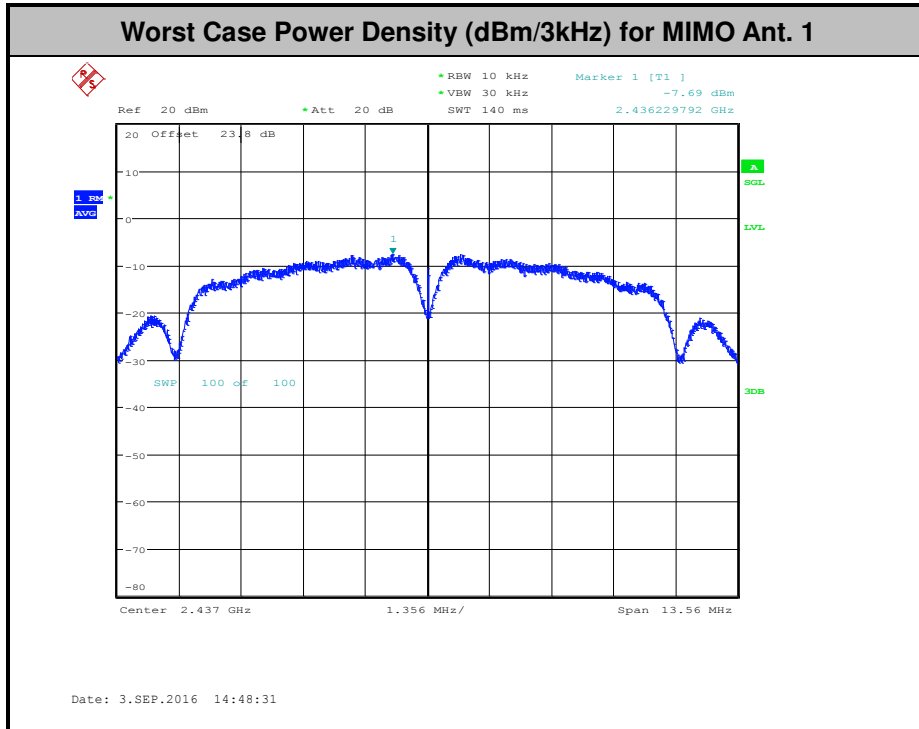



<TXBF Modes>

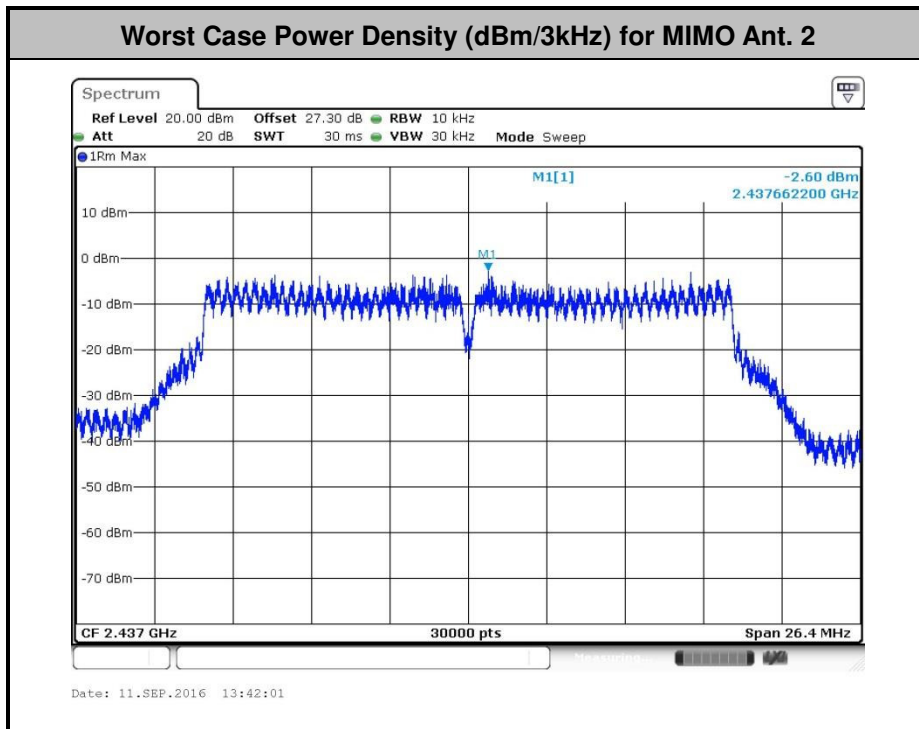
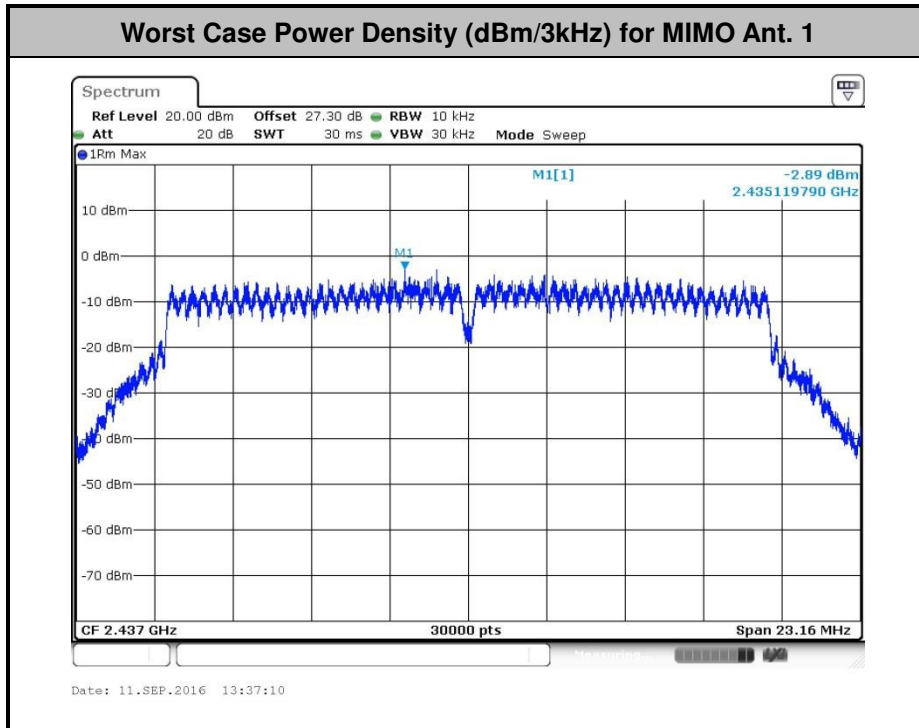

3.4 Conducted Band Edges and Spurious Emission Measurement

3.4.1 Limit of Conducted Band Edges and Spurious Emission Measurement

In any 100 kHz bandwidth outside of the authorized frequency band, the emissions which fall in the non-restricted bands shall be attenuated at least 20 dB / 30dB relative to the maximum PSD level in 100 kHz by RF conducted measurement and radiated emissions which fall in the restricted bands, as defined in Section 15.205(a), must also comply with the radiated emission limits specified in Section 15.209(a).

3.4.2 Measuring Instruments

The measuring equipment is listed in the section 4 of this test report.

3.4.3 Test Procedures

1. The testing follows FCC KDB Publication No. 558074 D01 DTS Meas. Guidance v03r05.
2. The RF output of EUT was connected to the spectrum analyzer by RF cable and attenuator. The path loss was compensated to the results for each measurement.
3. Set to the maximum power setting and enable the EUT transmit continuously.
4. Set RBW = 100 kHz, VBW=300 kHz, Peak Detector. Unwanted Emissions measured in any 100 kHz bandwidth outside of the authorized frequency band shall be attenuated by at least 20 dB relative to the maximum in-band peak PSD level in 100 kHz when maximum peak conducted output power procedure is used. If the transmitter complies with the conducted power limits based on the use of RMS averaging over a time interval, the attenuation required under this paragraph shall be 30 dB instead of 20 dB per 15.247(d).
5. Measure and record the results in the test report.
6. The RF fundamental frequency should be excluded against the limit line in the operating frequency band.

3.4.4 Test Setup

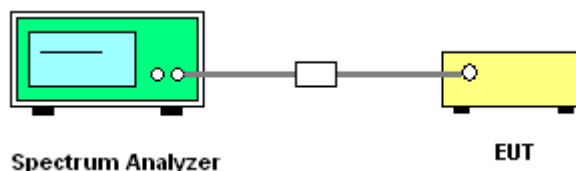



3.4.5 Test Result of Conducted Band Edges and Spurious Emission

<CDD Modes>

Number of TX = 1, Ant. 1 (Measured)

Number of TX	1	Ant. :	1
Test Mode :	802.11b	Temperature :	21~25°C
Test Band :	2.4GHz Low	Relative Humidity :	51~54%
Test Channel :	01	Test Engineer :	AnAn Wu

WLAN 802.11b Channel 01

100kHz PSD reference Level

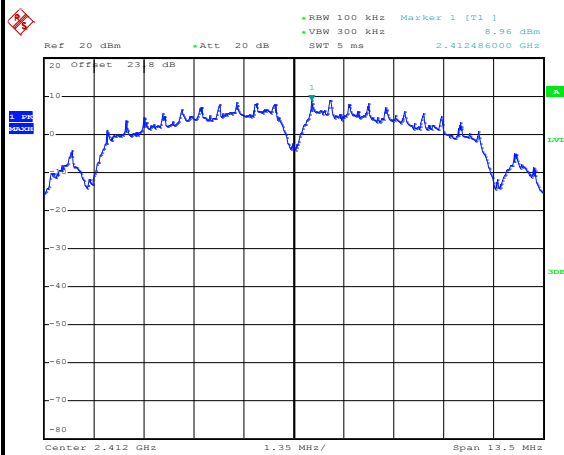

Date: 3.SEP.2016 10:21:26

Low Channel Plot

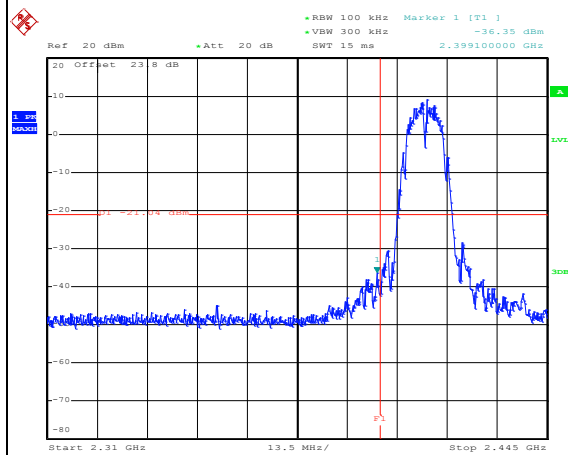

Date: 3.SEP.2016 10:22:28

Spurious Emission 30MHz~3GHz

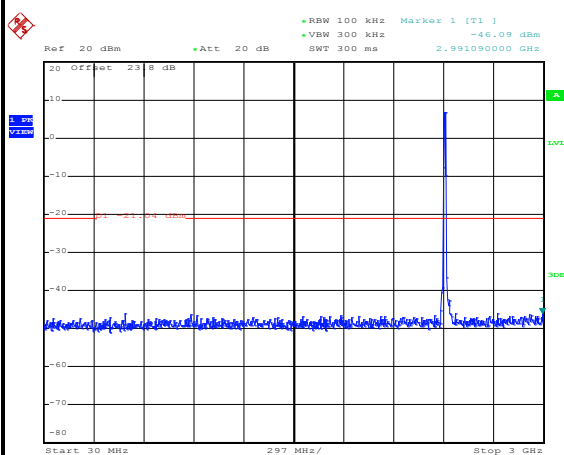

Date: 3.SEP.2016 10:22:40

Spurious Emission 2GHz~25GHz

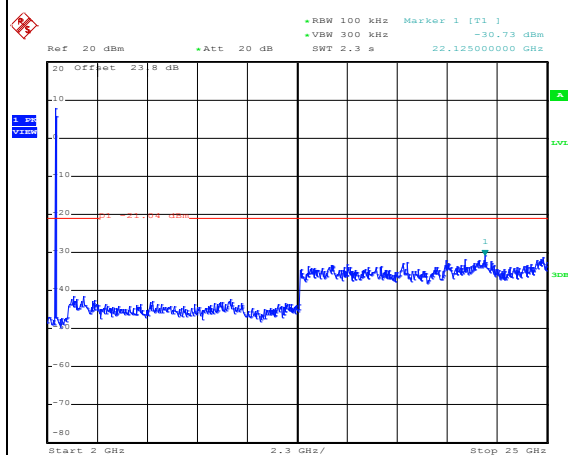

Date: 3.SEP.2016 10:22:49



Number of TX :	1	Ant. :	1
Test Mode :	802.11b	Temperature :	21~25°C
Test Band :	2.4GHz Mid	Relative Humidity :	51~54%
Test Channel :	06	Test Engineer :	AnAn Wu

WLAN 802.11b Channel 06

100kHz PSD reference Level

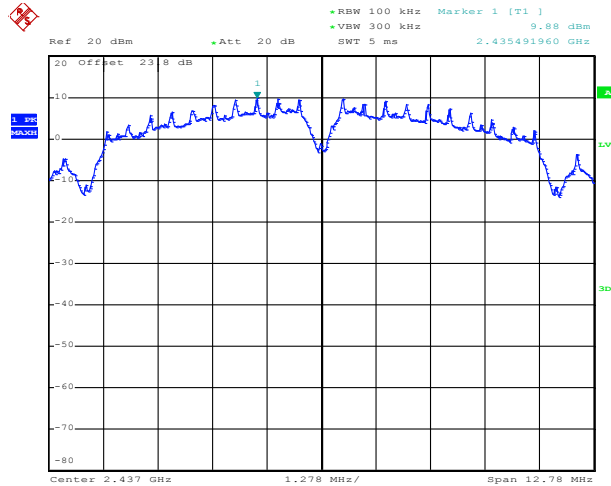

Date: 3.SEP.2016 10:12:23

Spurious Emission 30MHz~3GHz

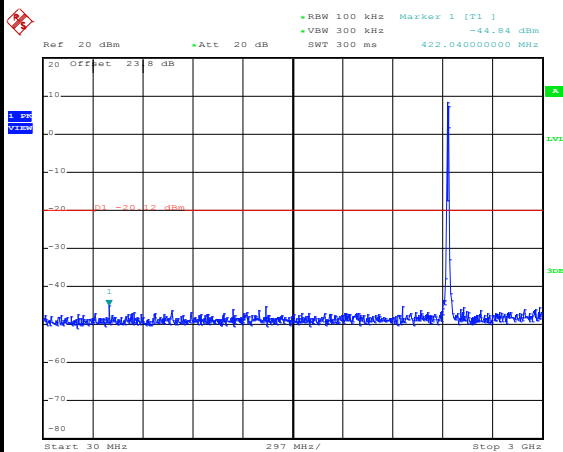

Date: 3.SEP.2016 10:13:38

Spurious Emission 2GHz~25GHz

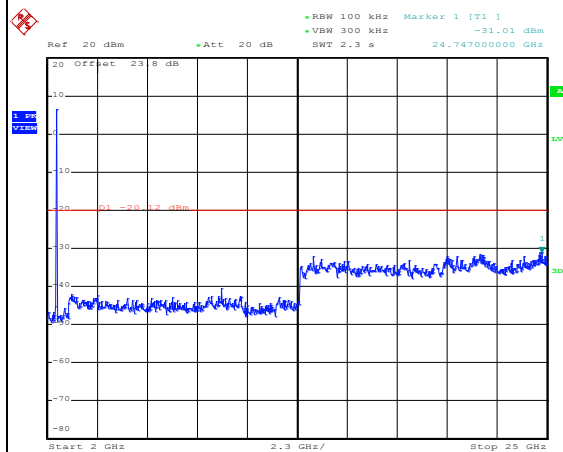

Date: 3.SEP.2016 10:13:47



Number of TX :	1	Ant. :	1
Test Mode :	802.11b	Temperature :	21~25°C
Test Band :	2.4GHz High	Relative Humidity :	51~54%
Test Channel :	11	Test Engineer :	AnAn Wu

WLAN 802.11b Channel 11

100kHz PSD reference Level

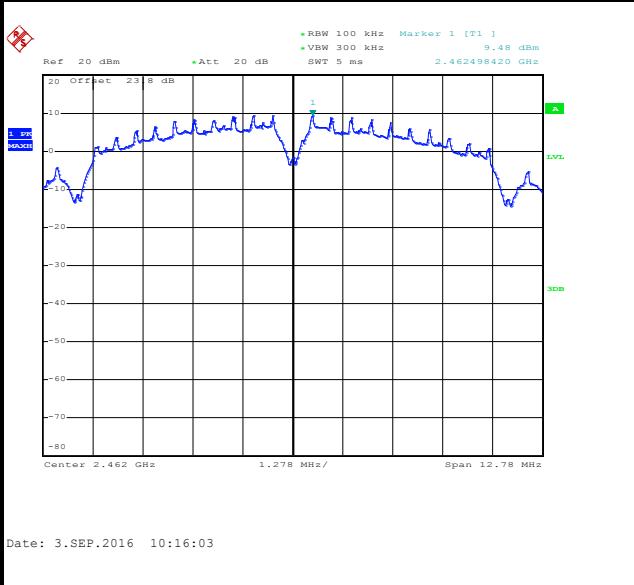

High Channel Plot

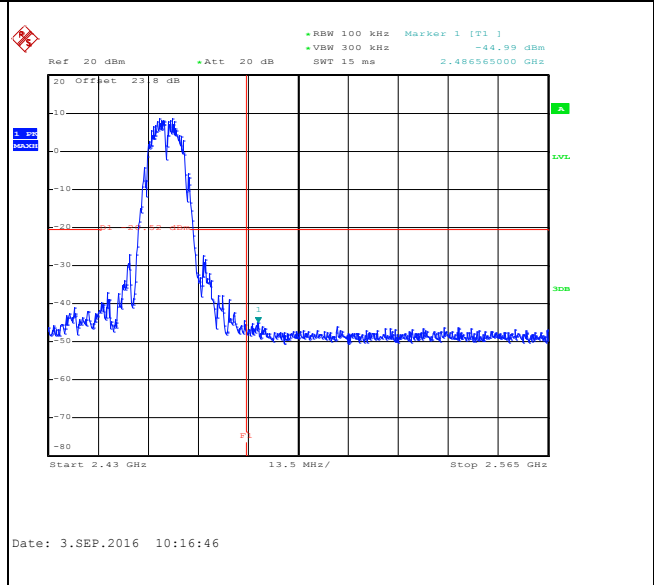

Spurious Emission 30MHz~3GHz

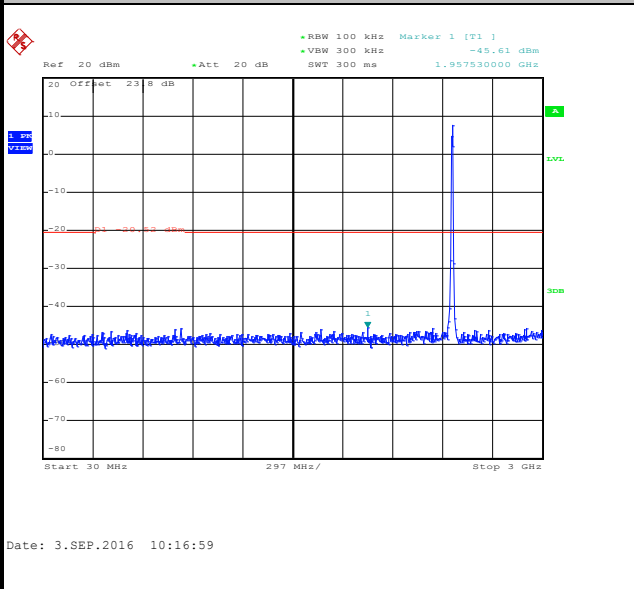

Spurious Emission 2GHz~25GHz

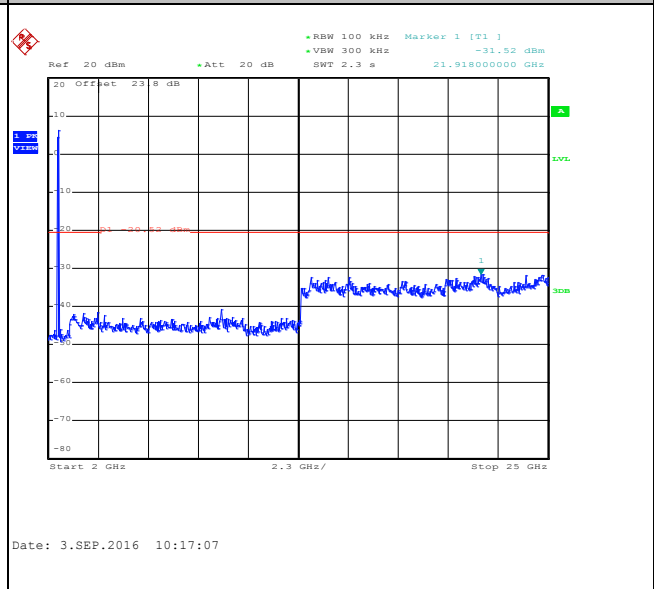



Number of TX :	1	Ant. :	1
Test Mode :	802.11g	Temperature :	21~25°C
Test Band :	2.4GHz Low	Relative Humidity :	51~54%
Test Channel :	01	Test Engineer :	AnAn Wu

WLAN 802.11g Channel 01

100kHz PSD reference Level

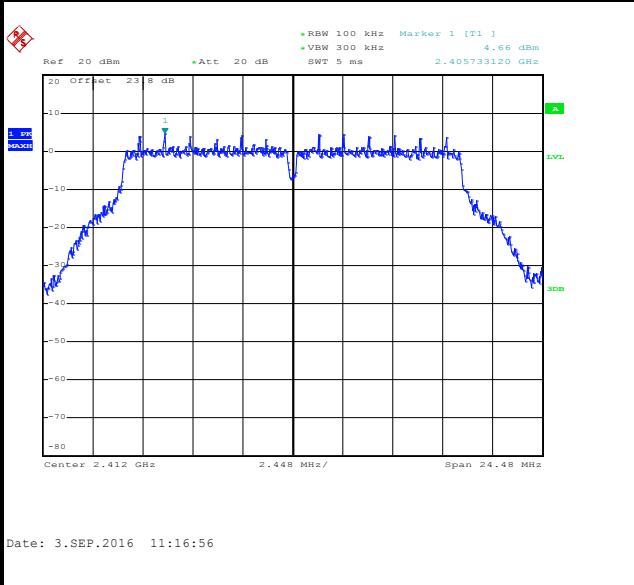

Low Channel Plot

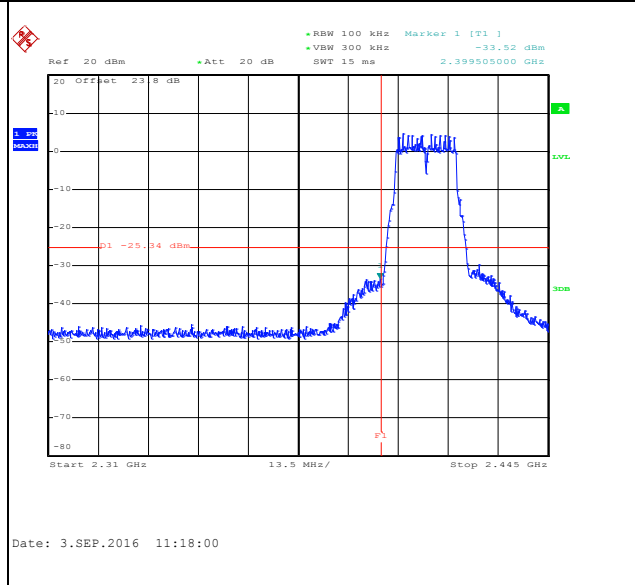

Spurious Emission 30MHz~3GHz

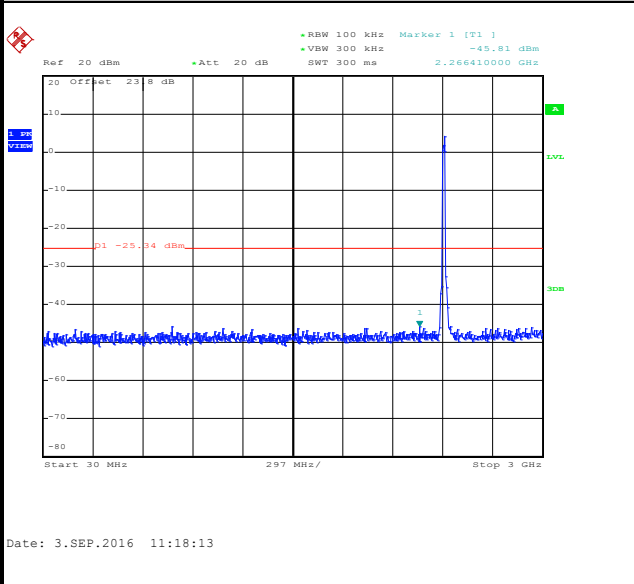

Spurious Emission 2GHz~25GHz

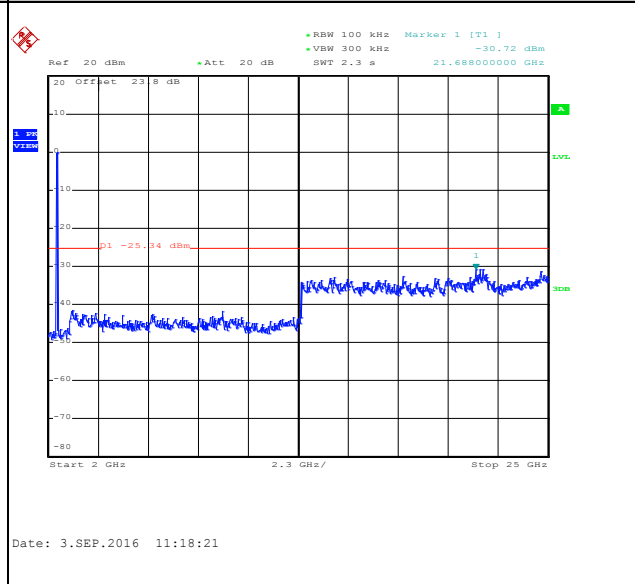



Number of TX :	1	Ant. :	1
Test Mode :	802.11g	Temperature :	21~25°C
Test Band :	2.4GHz Mid	Relative Humidity :	51~54%
Test Channel :	06	Test Engineer :	AnAn Wu

WLAN 802.11g Channel 06

100kHz PSD reference Level

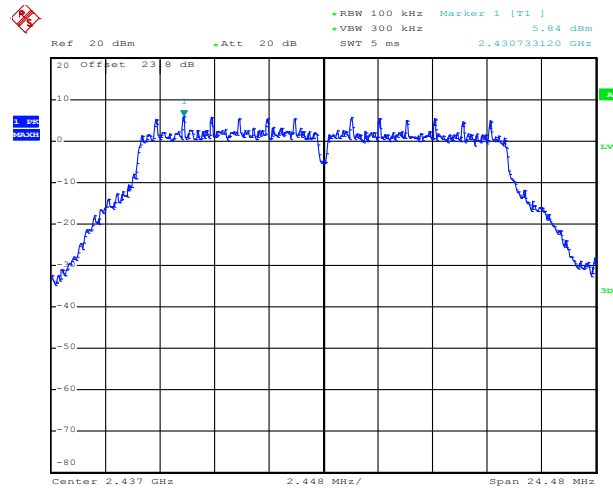

Date: 3.SEP.2016 11:34:00

Spurious Emission 30MHz~3GHz

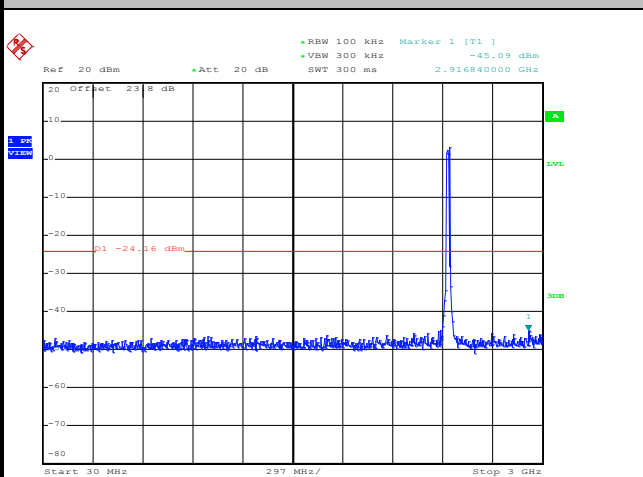

Date: 3.SEP.2016 11:34:49

Spurious Emission 2GHz~25GHz

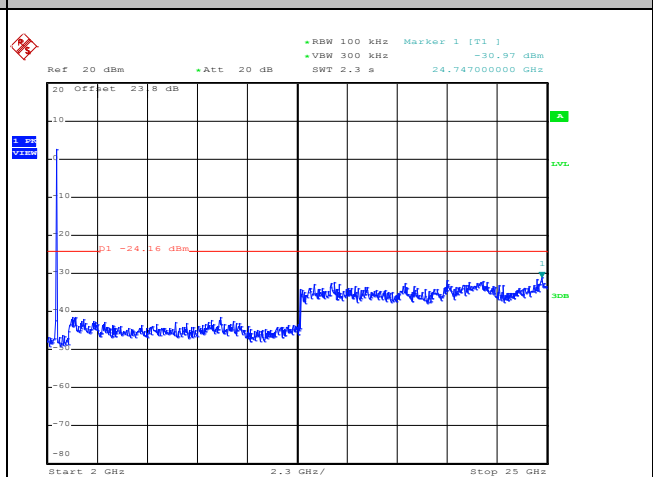

Date: 3.SEP.2016 11:34:58



Number of TX :	1	Ant. :	1
Test Mode :	802.11g	Temperature :	21~25°C
Test Band :	2.4GHz High	Relative Humidity :	51~54%
Test Channel :	11	Test Engineer :	AnAn Wu

WLAN 802.11g Channel 11

100kHz PSD reference Level

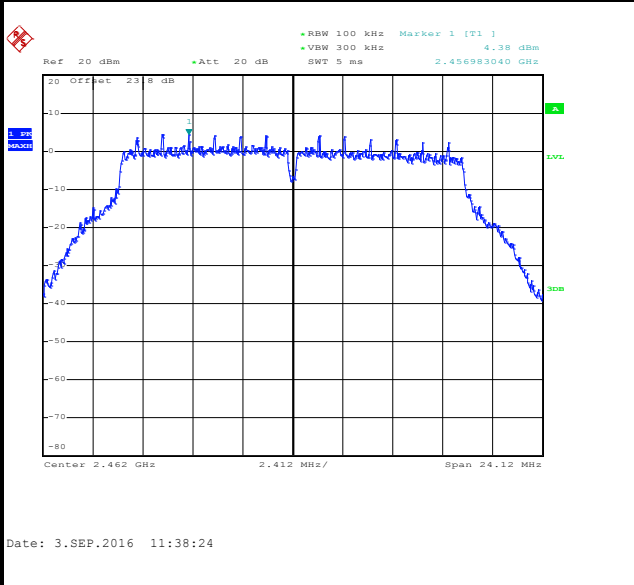

High Channel Plot

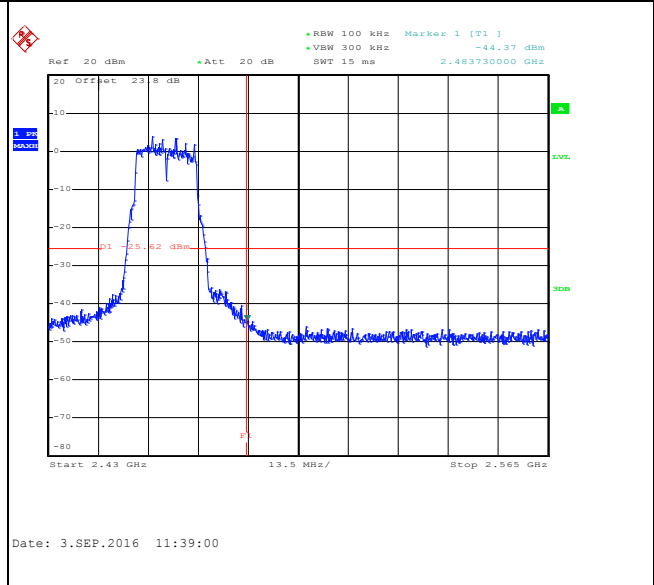

Spurious Emission 30MHz~3GHz

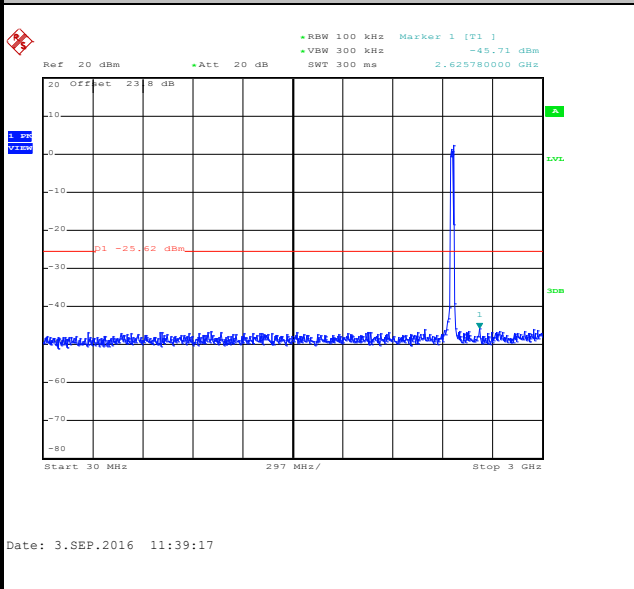

Spurious Emission 2GHz~25GHz

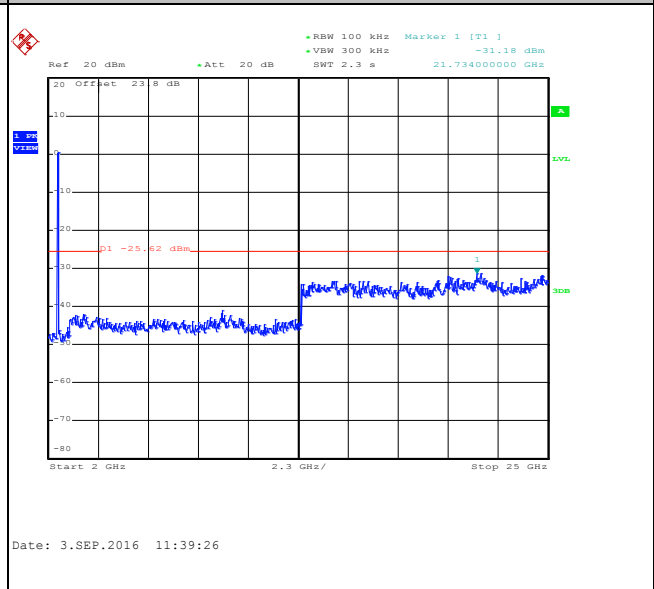



Number of TX = 1, Ant. 2 (Measured)

Number of TX	1	Ant. :	2
Test Mode :	802.11b	Temperature :	21~25°C
Test Band :	2.4GHz Low	Relative Humidity :	51~54%
Test Channel :	01	Test Engineer :	AnAn Wu

WLAN 802.11b Channel 01

100kHz PSD reference Level

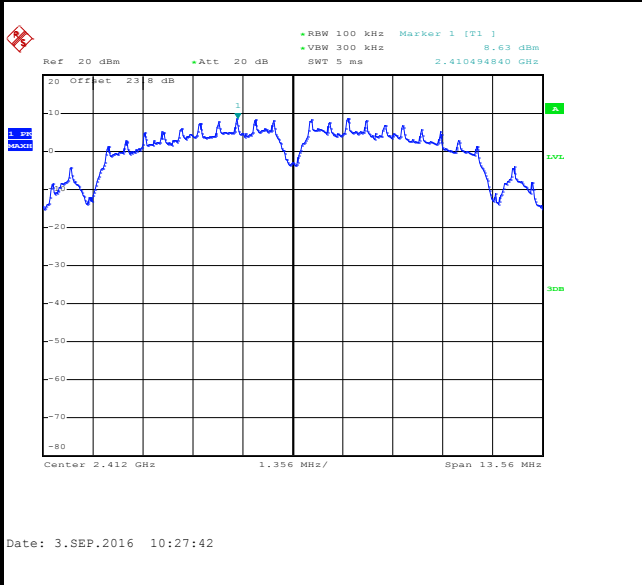

Low Channel Plot

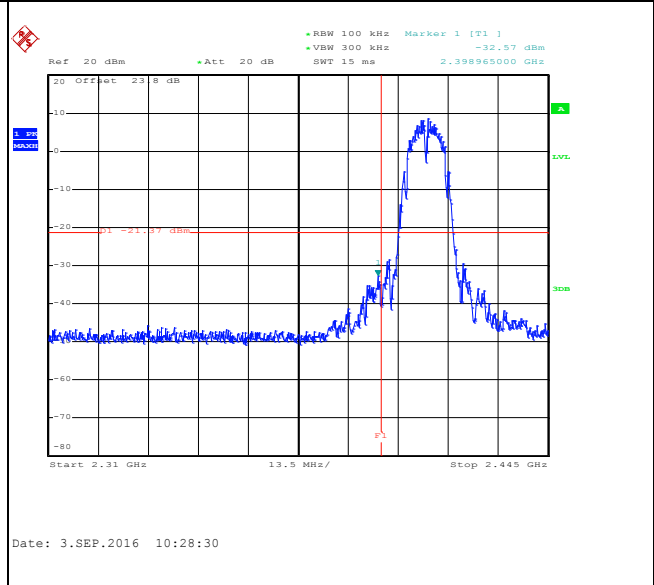

Spurious Emission 30MHz~3GHz

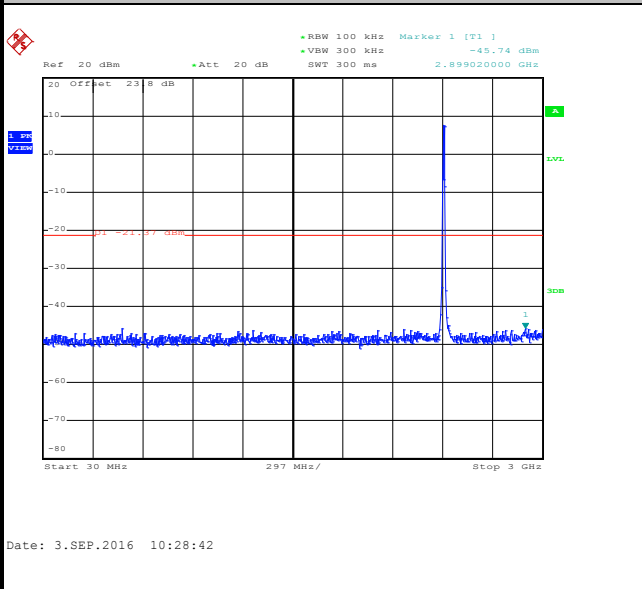

Spurious Emission 2GHz~25GHz

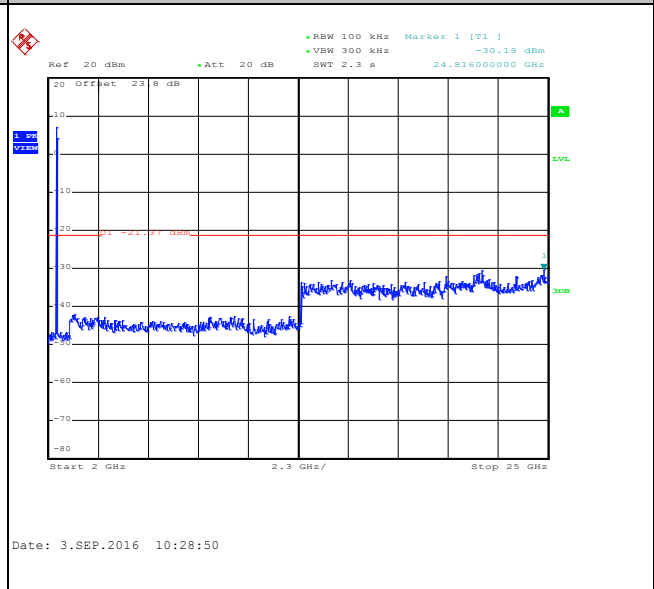



Number of TX :	1	Ant. :	2
Test Mode :	802.11b	Temperature :	21~25°C
Test Band :	2.4GHz Mid	Relative Humidity :	51~54%
Test Channel :	06	Test Engineer :	AnAn Wu

WLAN 802.11b Channel 06

100kHz PSD reference Level

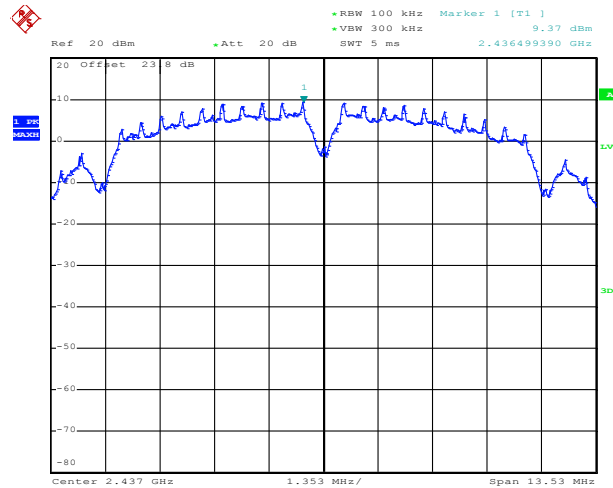

Date: 3.SEP.2016 10:32:45

Spurious Emission 30MHz~3GHz

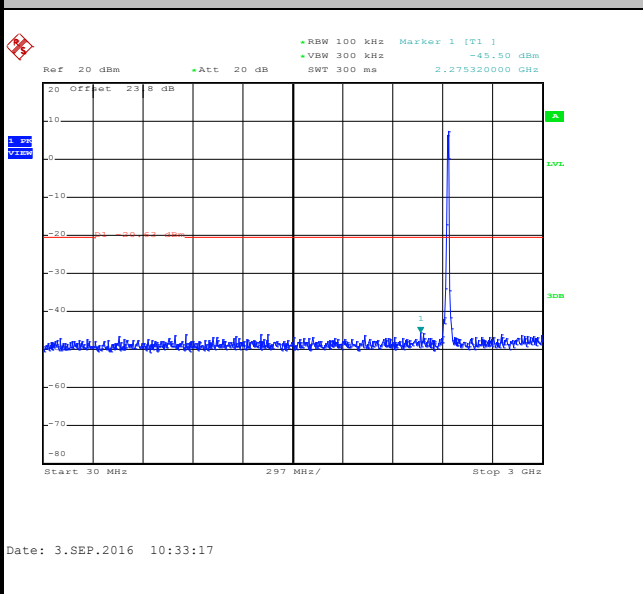

Date: 3.SEP.2016 10:33:17

Spurious Emission 2GHz~25GHz

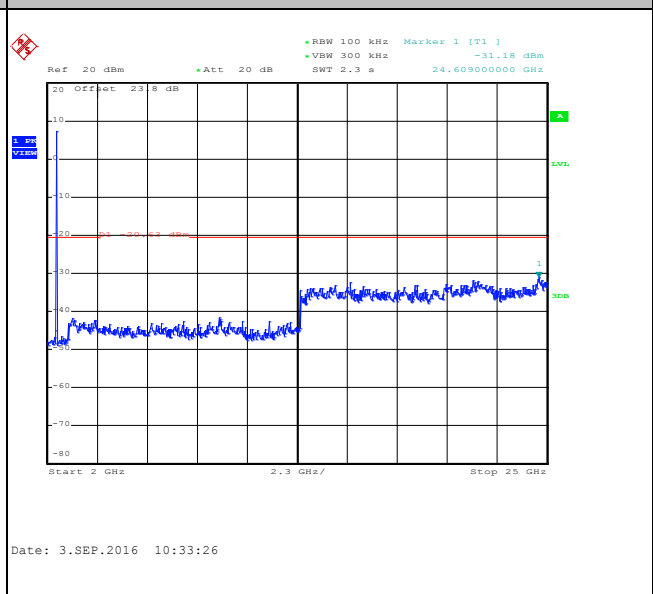

Date: 3.SEP.2016 10:33:26



Number of TX :	1	Ant. :	2
Test Mode :	802.11b	Temperature :	21~25°C
Test Band :	2.4GHz High	Relative Humidity :	51~54%
Test Channel :	11	Test Engineer :	AnAn Wu

WLAN 802.11b Channel 11

100kHz PSD reference Level

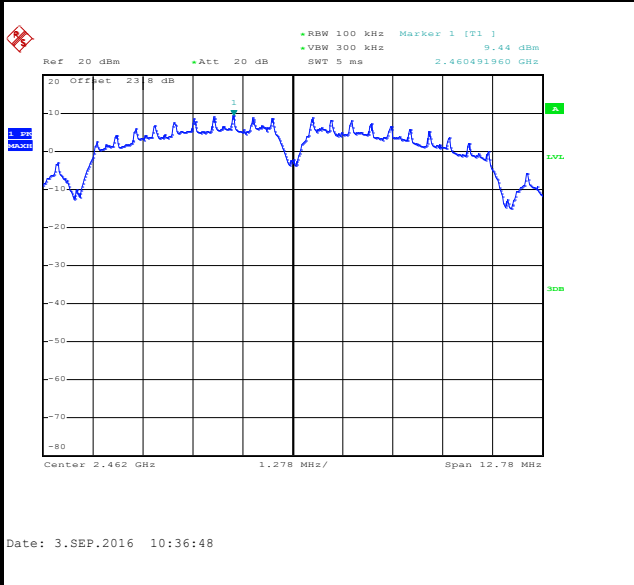

High Channel Plot

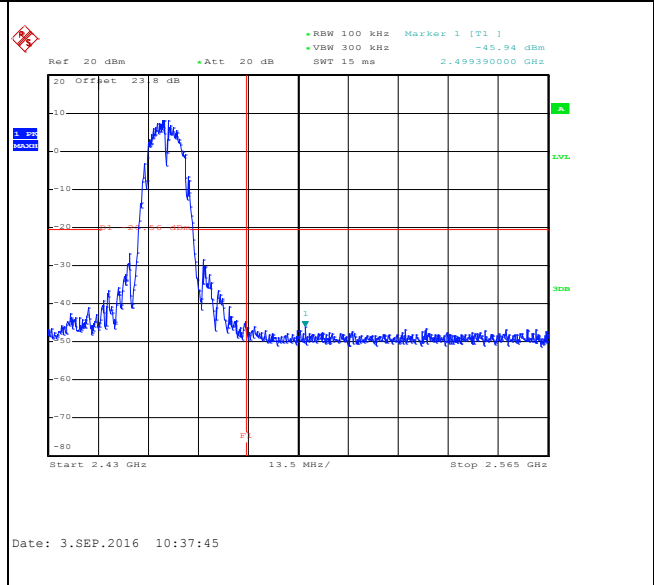

Spurious Emission 30MHz~3GHz

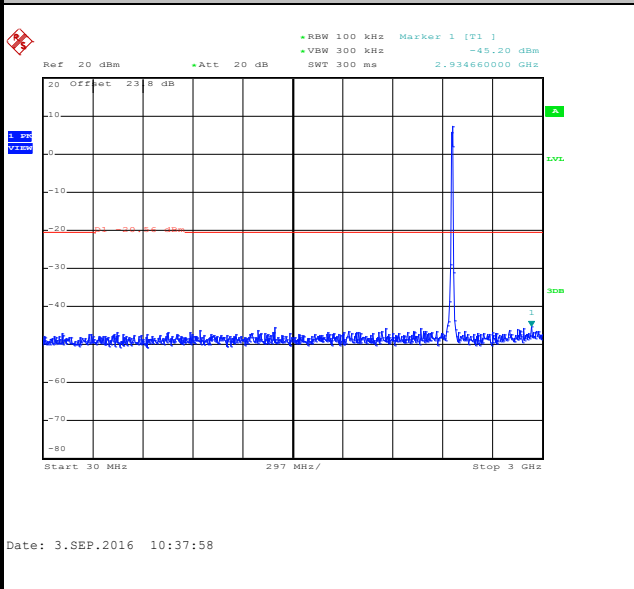

Spurious Emission 2GHz~25GHz

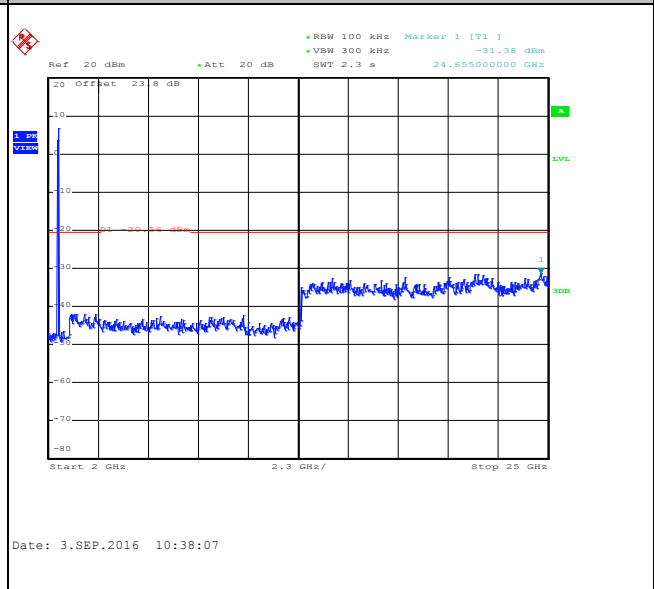



Number of TX :	1	Ant. :	2
Test Mode :	802.11g	Temperature :	21~25°C
Test Band :	2.4GHz Low	Relative Humidity :	51~54%
Test Channel :	01	Test Engineer :	AnAn Wu

WLAN 802.11g Channel 01

100kHz PSD reference Level

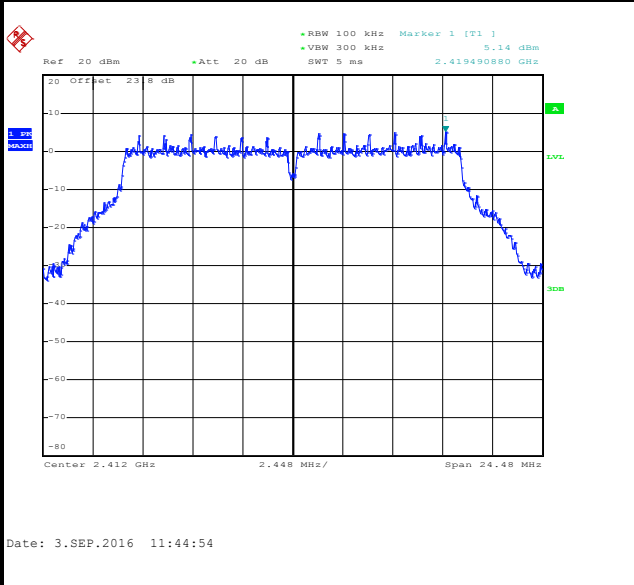

Low Channel Plot

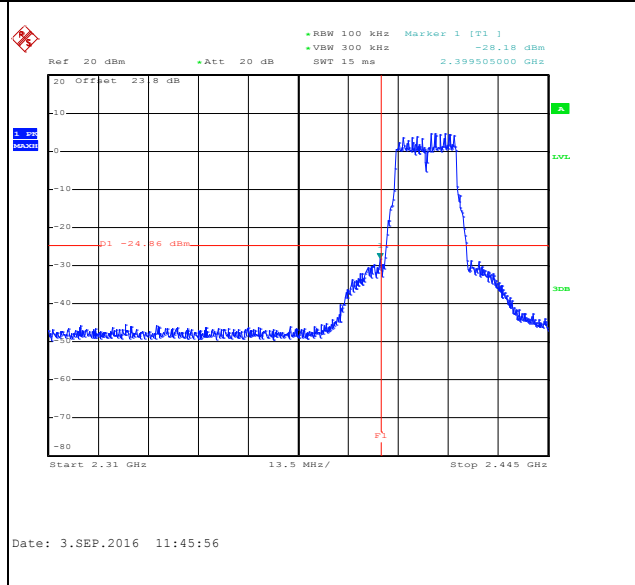

Spurious Emission 30MHz~3GHz

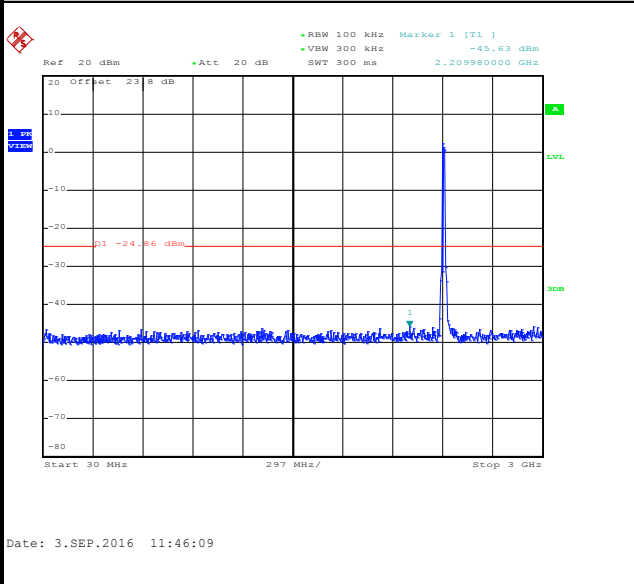

Spurious Emission 2GHz~25GHz

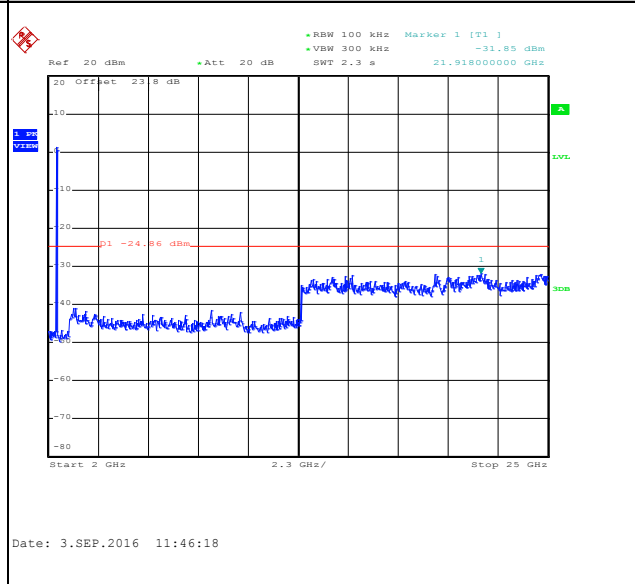



Number of TX :	1	Ant. :	2
Test Mode :	802.11g	Temperature :	21~25°C
Test Band :	2.4GHz Mid	Relative Humidity :	51~54%
Test Channel :	06	Test Engineer :	AnAn Wu

WLAN 802.11g Channel 06

100kHz PSD reference Level

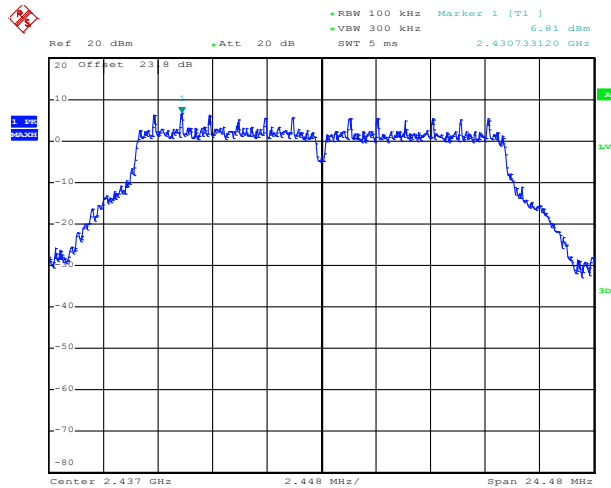

Date: 3.SEP.2016 11:56:58

Spurious Emission 30MHz~3GHz

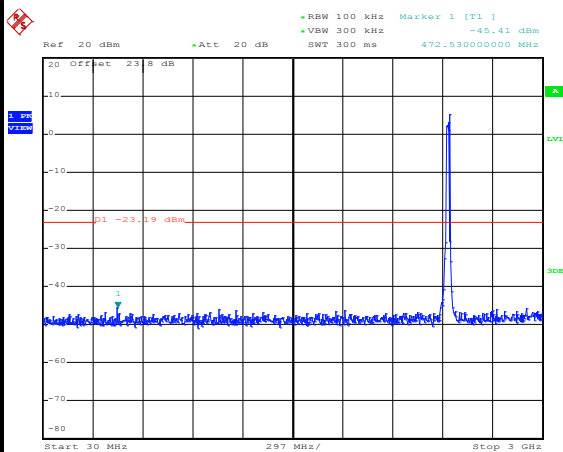

Date: 3.SEP.2016 11:58:34

Spurious Emission 2GHz~25GHz

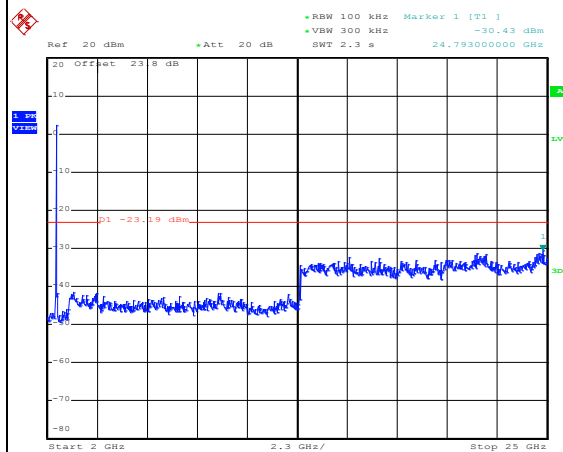

Date: 3.SEP.2016 11:58:42



Number of TX :	1	Ant. :	2
Test Mode :	802.11g	Temperature :	21~25°C
Test Band :	2.4GHz High	Relative Humidity :	51~54%
Test Channel :	11	Test Engineer :	AnAn Wu

WLAN 802.11g Channel 11

100kHz PSD reference Level

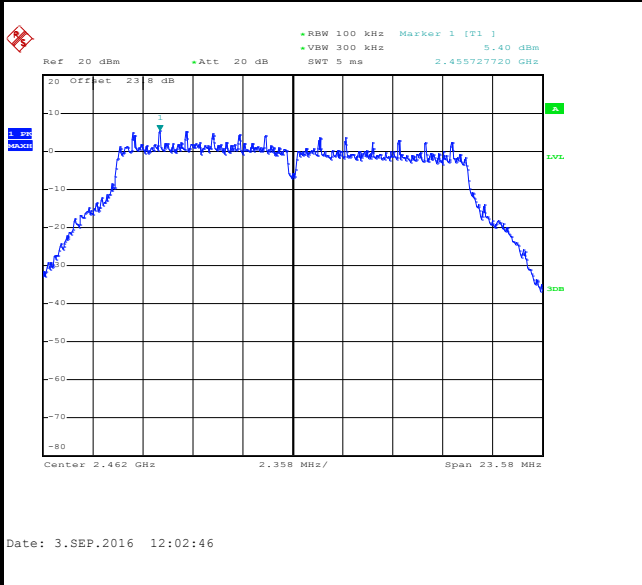

High Channel Plot

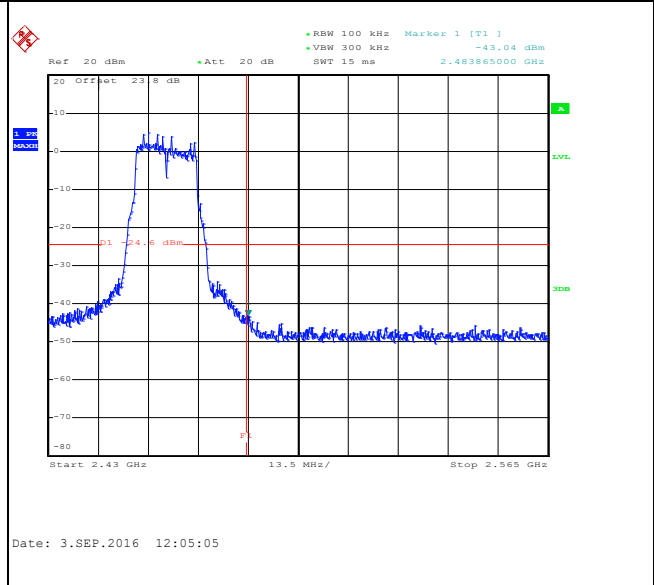

Spurious Emission 30MHz~3GHz

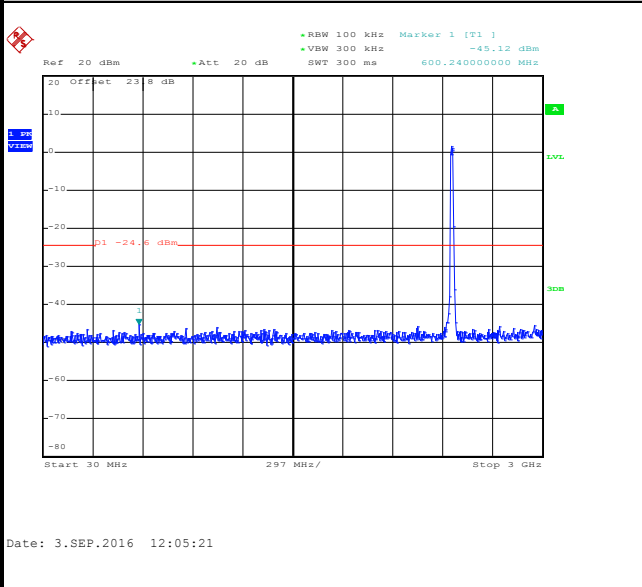

Spurious Emission 2GHz~25GHz

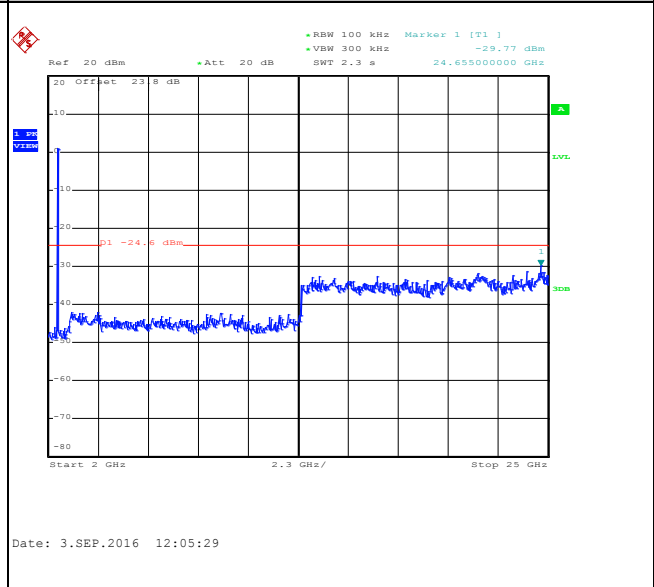



Number of TX = 2, Ant. 1 (Measured)

Number of TX	2	Ant. :	1
Test Mode :	802.11b	Temperature :	21~25°C
Test Band :	2.4GHz Low	Relative Humidity :	51~54%
Test Channel :	01	Test Engineer :	AnAn Wu

WLAN 802.11b Channel 01

100kHz PSD reference Level

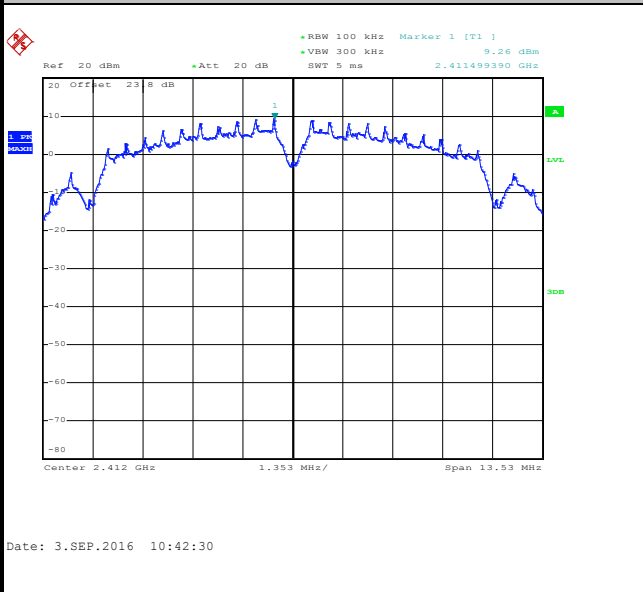

Low Channel Plot

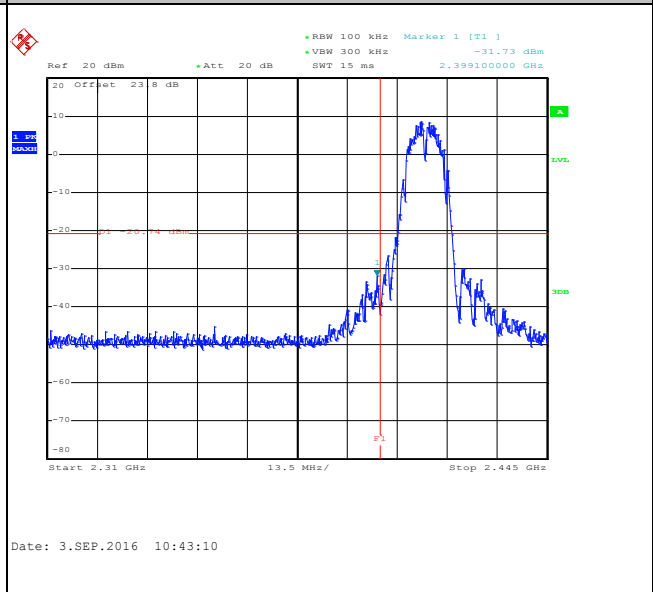

Spurious Emission 30MHz~3GHz

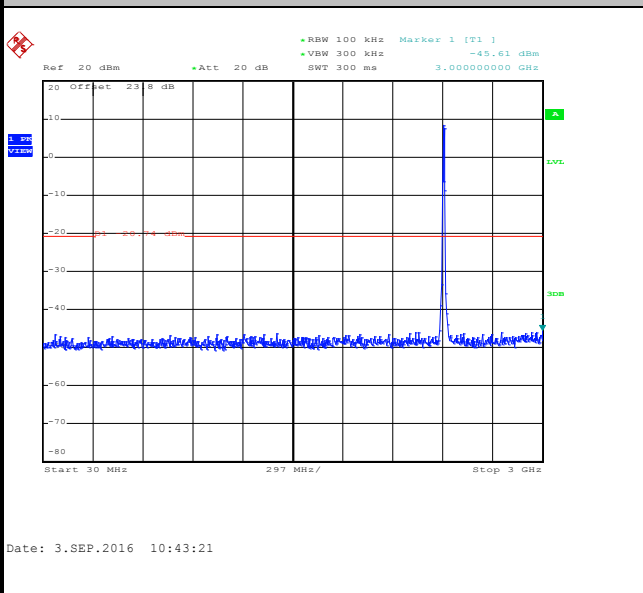

Spurious Emission 2GHz~25GHz

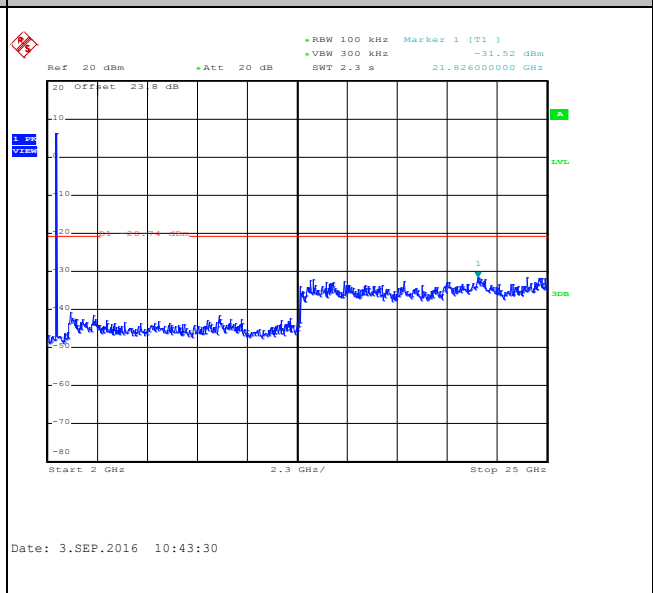



Number of TX :	2	Ant. :	1
Test Mode :	802.11b	Temperature :	21~25°C
Test Band :	2.4GHz Mid	Relative Humidity :	51~54%
Test Channel :	06	Test Engineer :	AnAn Wu

WLAN 802.11b Channel 06

100kHz PSD reference Level

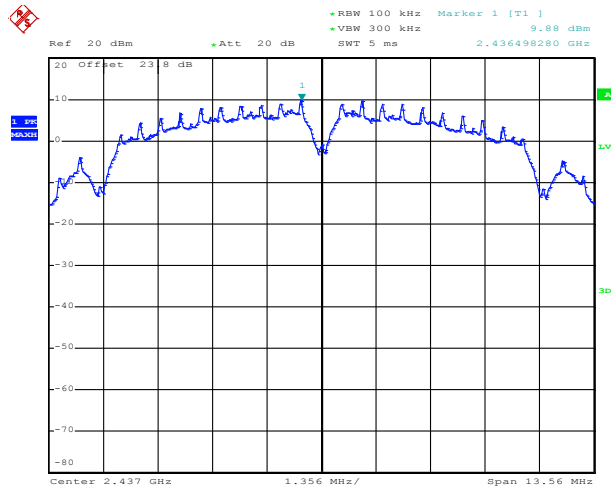

Date: 3.SEP.2016 10:47:48

Spurious Emission 30MHz~3GHz

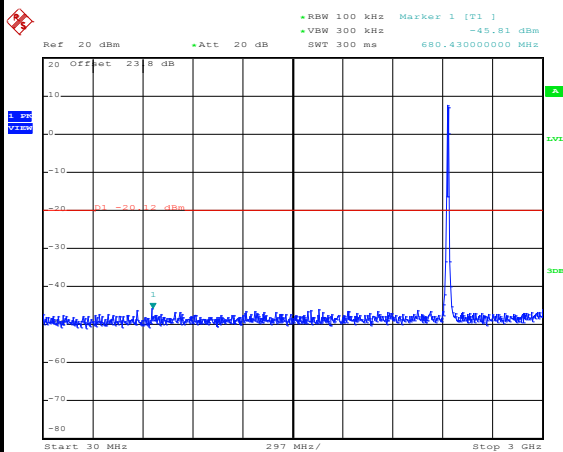

Date: 3.SEP.2016 10:48:29

Spurious Emission 2GHz~25GHz

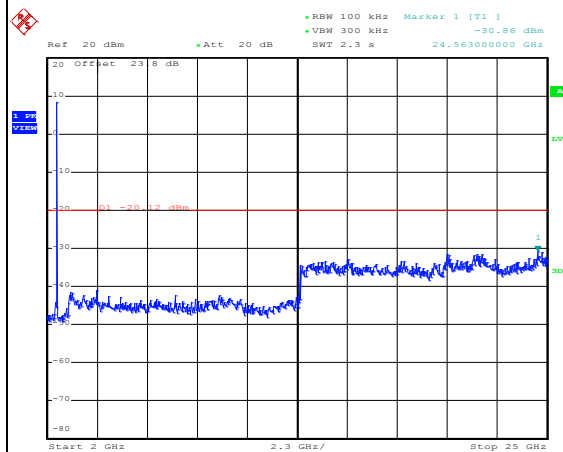

Date: 3.SEP.2016 10:48:37



Number of TX :	2	Ant. :	1
Test Mode :	802.11b	Temperature :	21~25°C
Test Band :	2.4GHz High	Relative Humidity :	51~54%
Test Channel :	11	Test Engineer :	AnAn Wu

WLAN 802.11b Channel 11

100kHz PSD reference Level

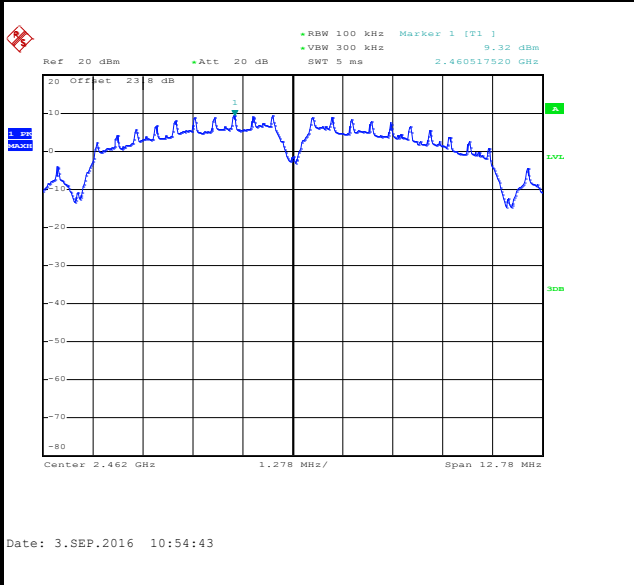

High Channel Plot

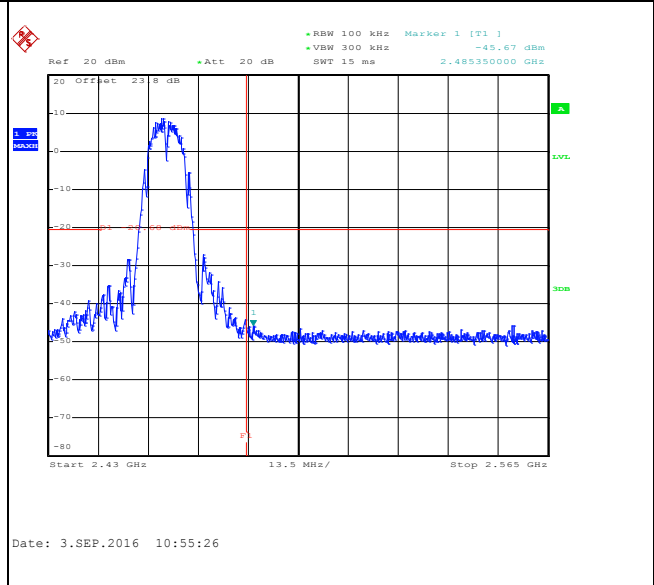

Spurious Emission 30MHz~3GHz

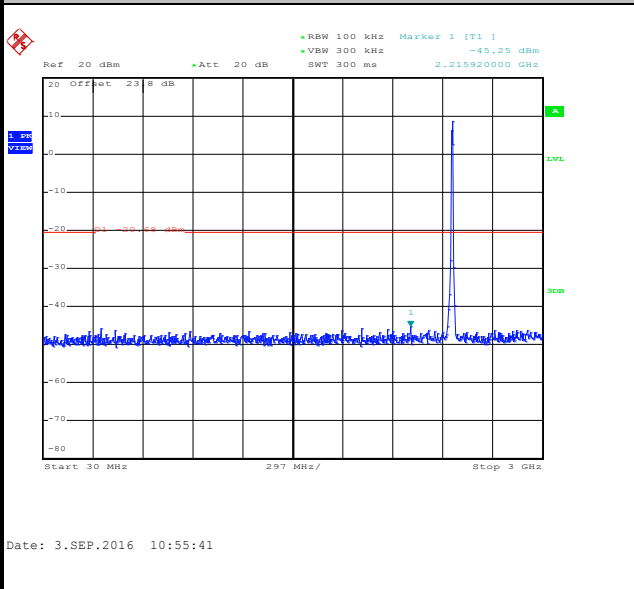

Spurious Emission 2GHz~25GHz

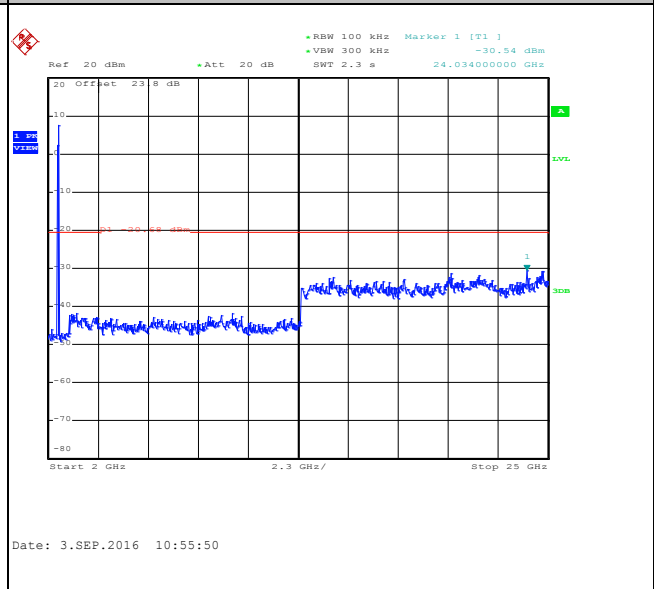



Number of TX :	2	Ant. :	1
Test Mode :	802.11g	Temperature :	21~25°C
Test Band :	2.4GHz Low	Relative Humidity :	51~54%
Test Channel :	01	Test Engineer :	AnAn Wu

WLAN 802.11g Channel 01

100kHz PSD reference Level

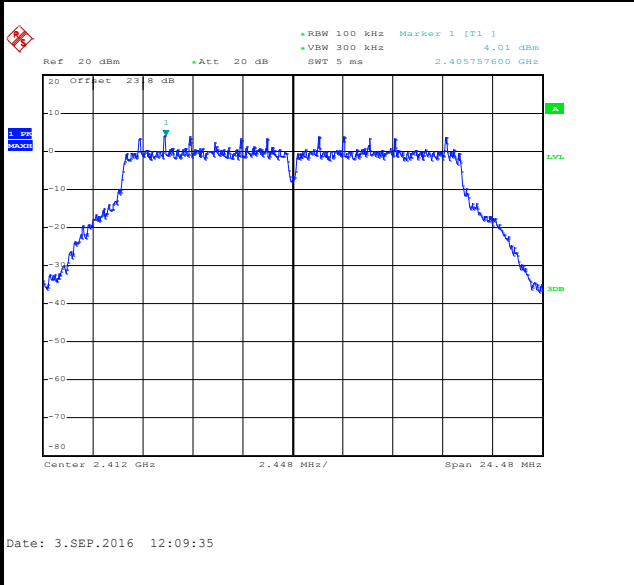

Low Channel Plot

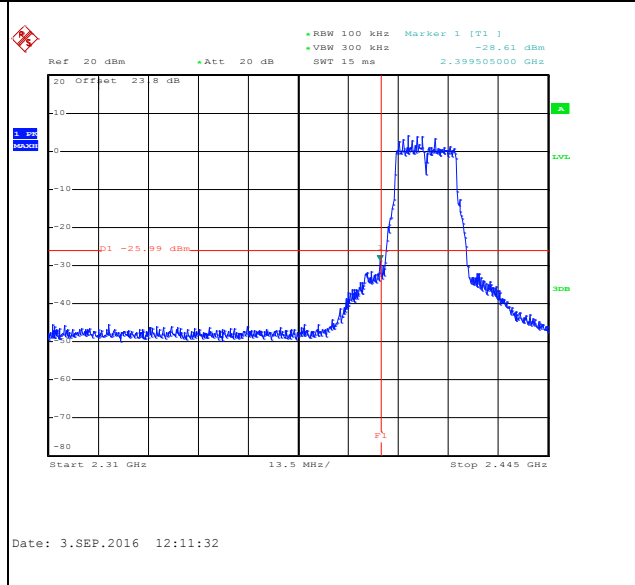

Spurious Emission 30MHz~3GHz

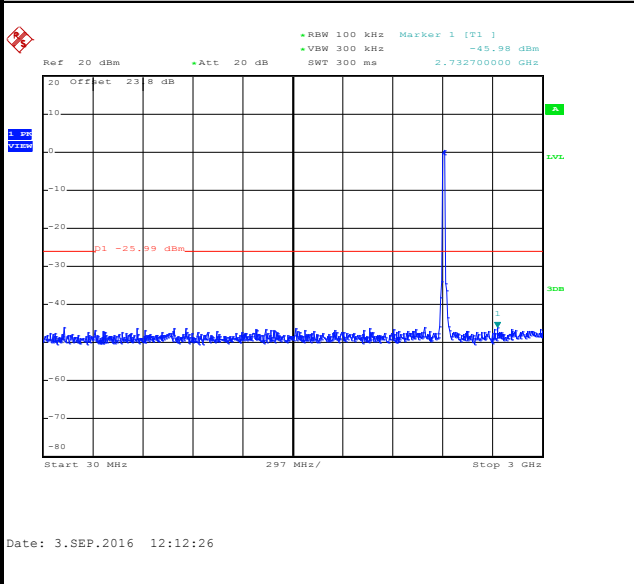

Spurious Emission 2GHz~25GHz

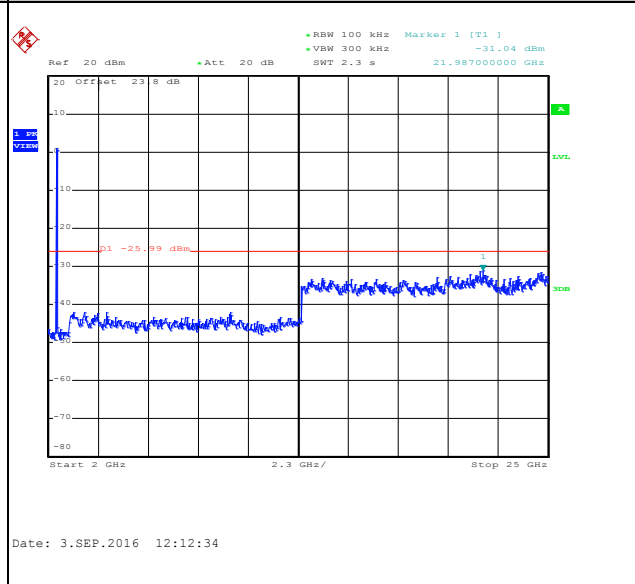



Number of TX :	2	Ant. :	1
Test Mode :	802.11g	Temperature :	21~25°C
Test Band :	2.4GHz Mid	Relative Humidity :	51~54%
Test Channel :	06	Test Engineer :	AnAn Wu

WLAN 802.11g Channel 06

100kHz PSD reference Level

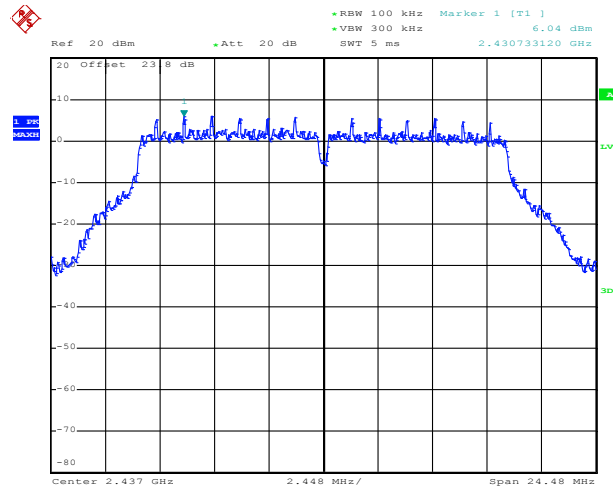

Date: 3.SEP.2016 12:15:48

Spurious Emission 30MHz~3GHz

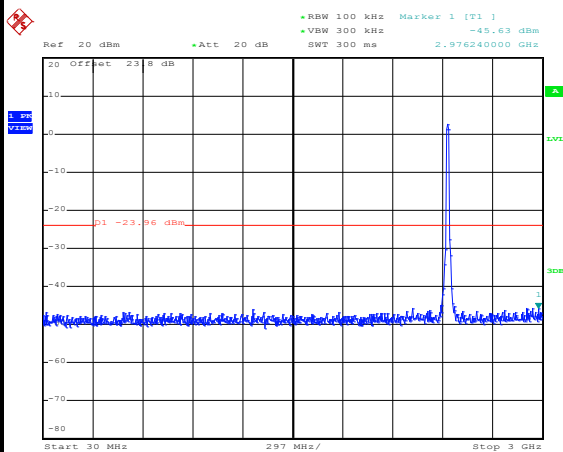

Date: 3.SEP.2016 12:16:29

Spurious Emission 2GHz~25GHz

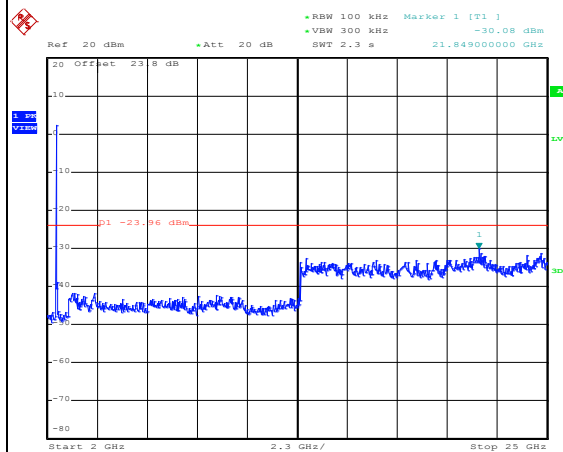

Date: 3.SEP.2016 12:16:38



Number of TX :	2	Ant. :	1
Test Mode :	802.11g	Temperature :	21~25°C
Test Band :	2.4GHz High	Relative Humidity :	51~54%
Test Channel :	11	Test Engineer :	AnAn Wu

WLAN 802.11g Channel 11

100kHz PSD reference Level

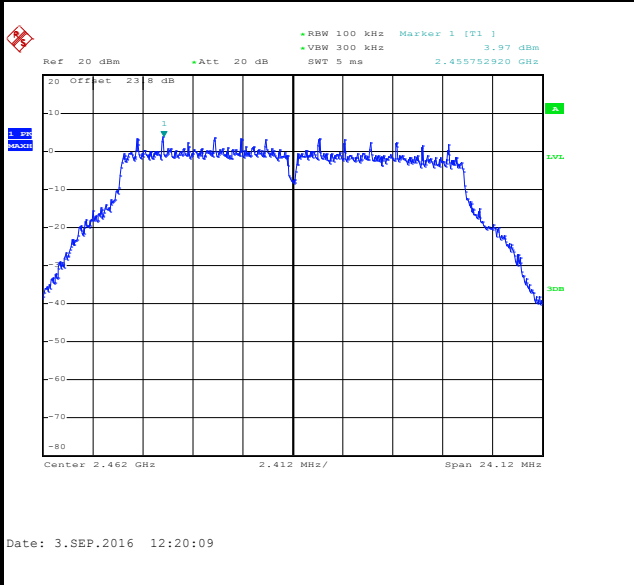

High Channel Plot

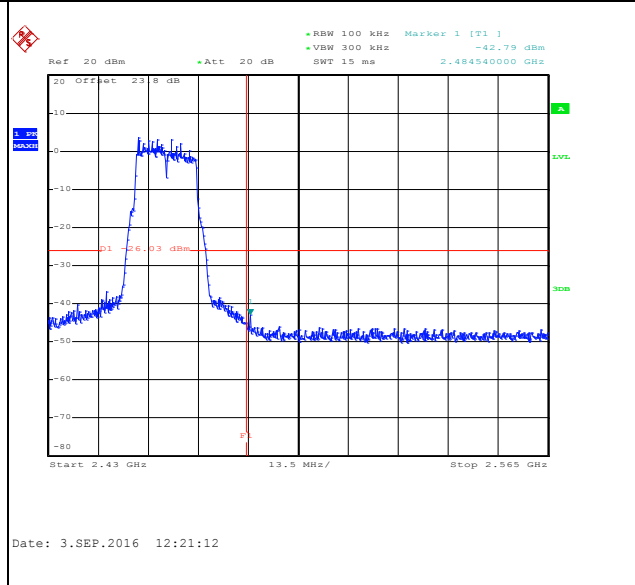

Spurious Emission 30MHz~3GHz

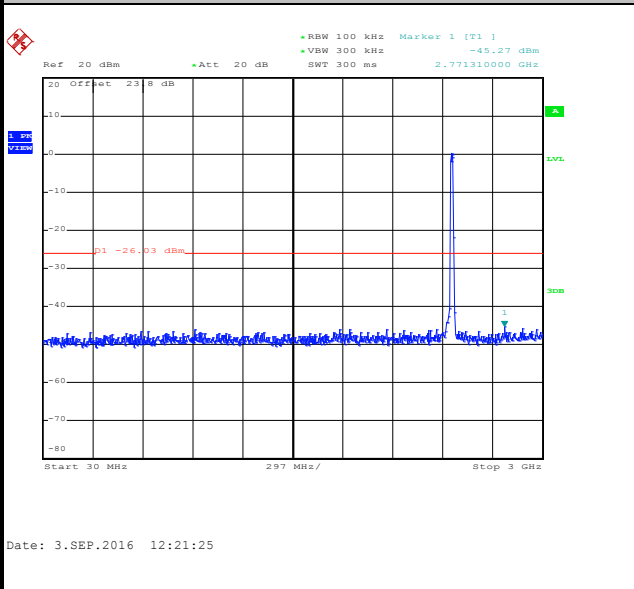

Spurious Emission 2GHz~25GHz

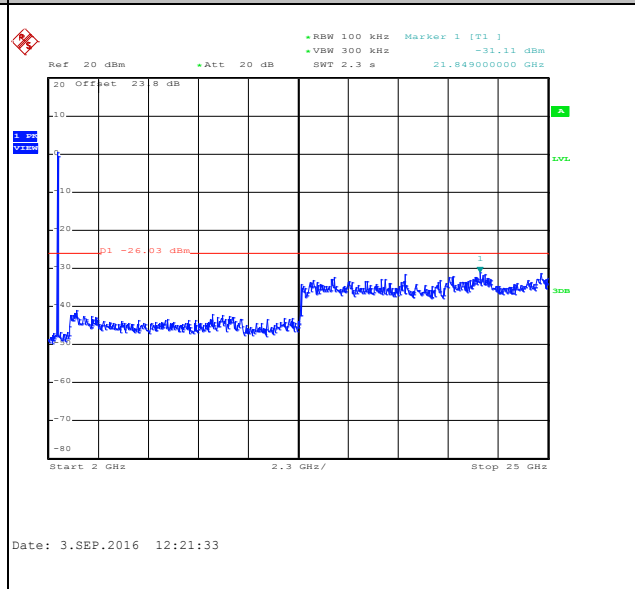



Number of TX :	2	Ant. :	1
Test Mode :	802.11ac VHT20	Temperature :	21~25°C
Test Band :	2.4GHz Low	Relative Humidity :	51~54%
Test Channel :	01	Test Engineer :	AnAn Wu

WLAN 802.11ac VHT20 Channel 01

100kHz PSD reference Level

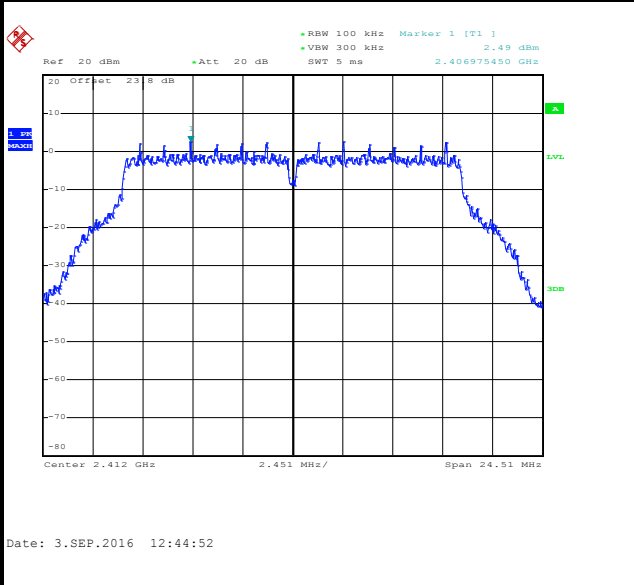

Low Channel Plot

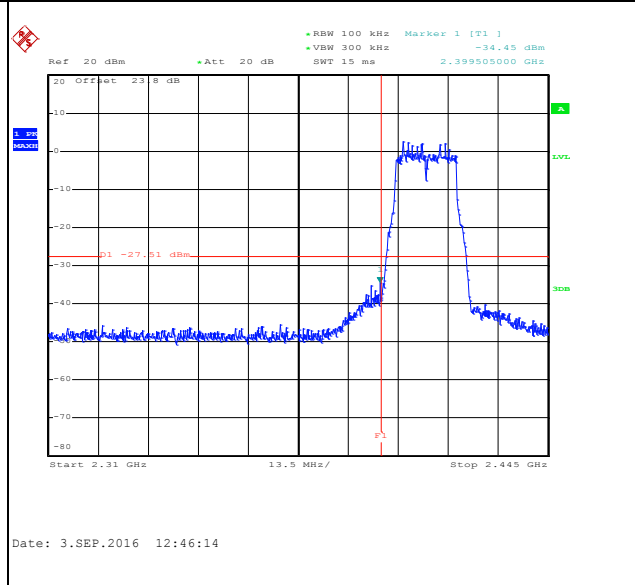

Spurious Emission 30MHz~3GHz

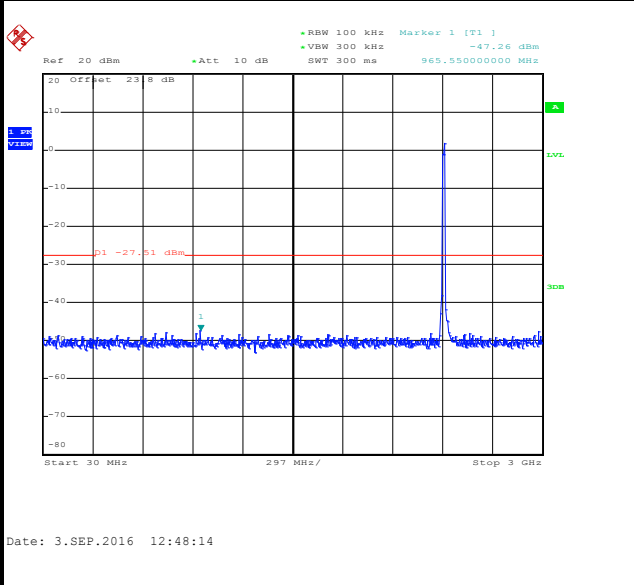

Spurious Emission 2GHz~25GHz

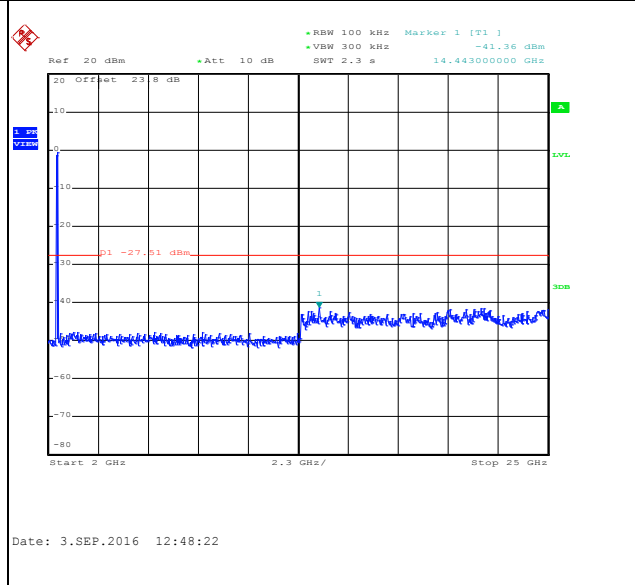



Number of TX :	2	Ant. :	1
Test Mode :	802.11ac VHT20	Temperature :	21~25°C
Test Band :	2.4GHz Mid	Relative Humidity :	51~54%
Test Channel :	06	Test Engineer :	AnAn Wu

WLAN 802.11ac VHT20 Channel 06

100kHz PSD reference Level

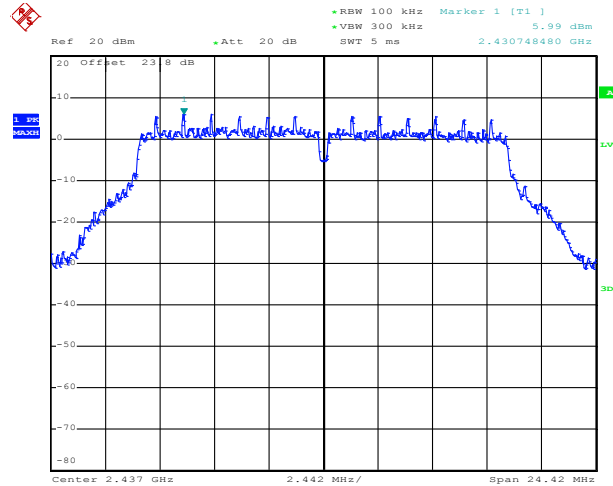

Date: 3.SEP.2016 12:55:12

Spurious Emission 30MHz~3GHz

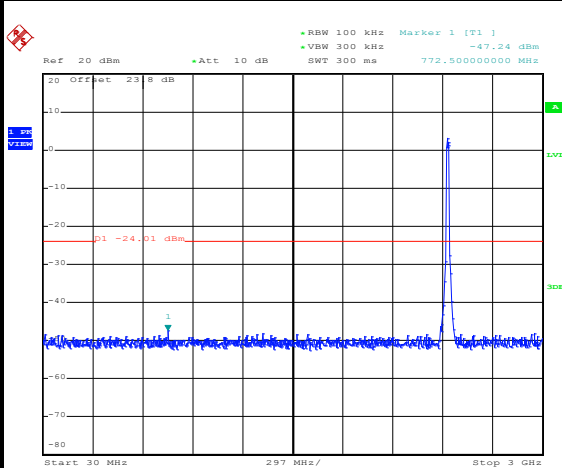

Date: 3.SEP.2016 12:56:30

Spurious Emission 2GHz~25GHz

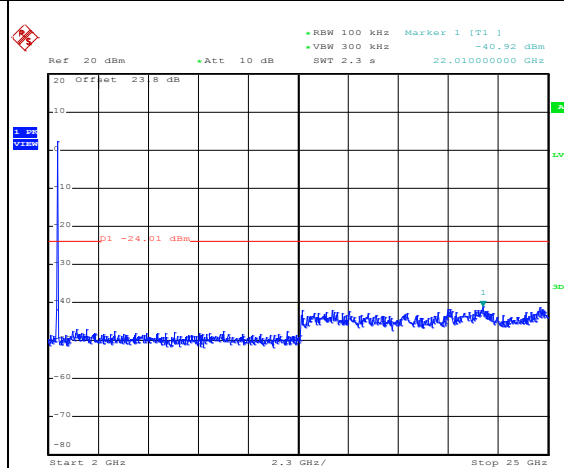

Date: 3.SEP.2016 12:56:38



Number of TX :	2	Ant. :	1
Test Mode :	802.11ac VHT20	Temperature :	21~25°C
Test Band :	2.4GHz High	Relative Humidity :	51~54%
Test Channel :	11	Test Engineer :	AnAn Wu

WLAN 802.11ac VHT20 Channel 11

100kHz PSD reference Level

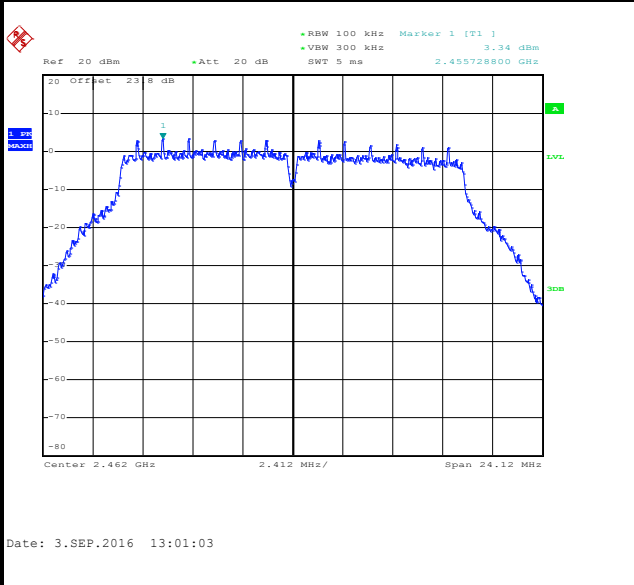

High Channel Plot

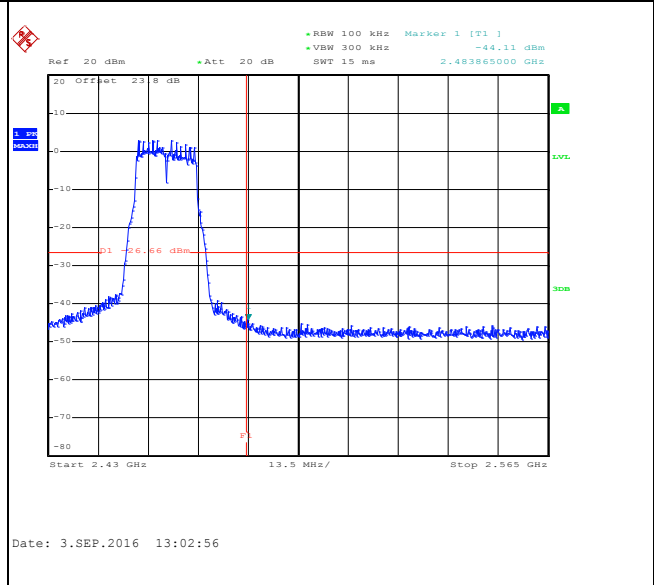

Spurious Emission 30MHz~3GHz

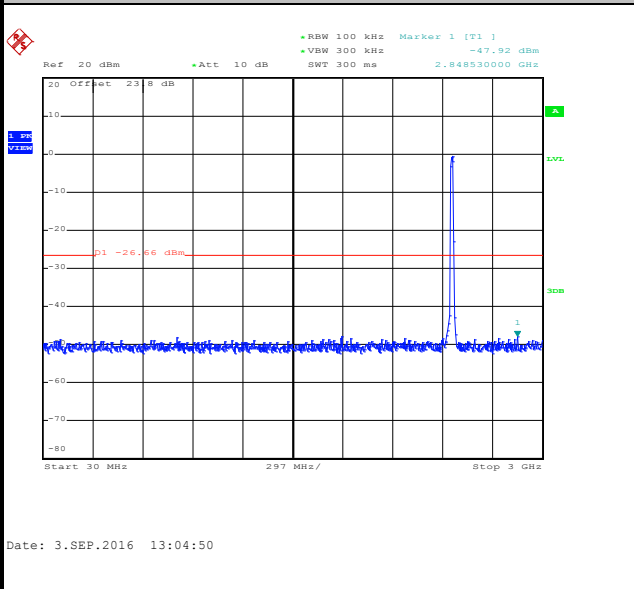

Spurious Emission 2GHz~25GHz

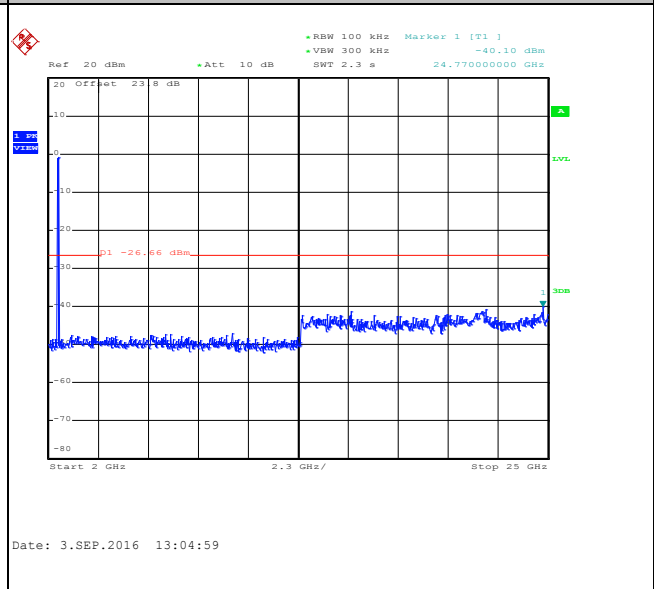



Number of TX :	2	Ant. :	1
Test Mode :	802.11ac VHT40	Temperature :	21~25°C
Test Band :	2.4GHz Low	Relative Humidity :	51~54%
Test Channel :	03	Test Engineer :	AnAn Wu

WLAN 802.11ac VHT40 Channel 03

100kHz PSD reference Level

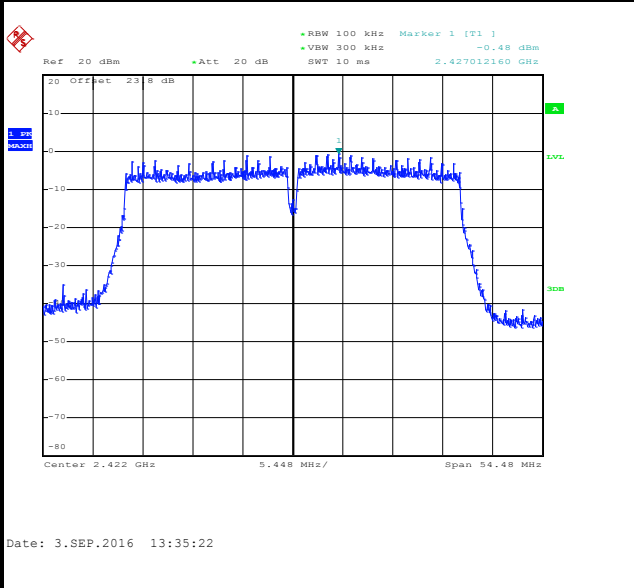

Low Channel Plot

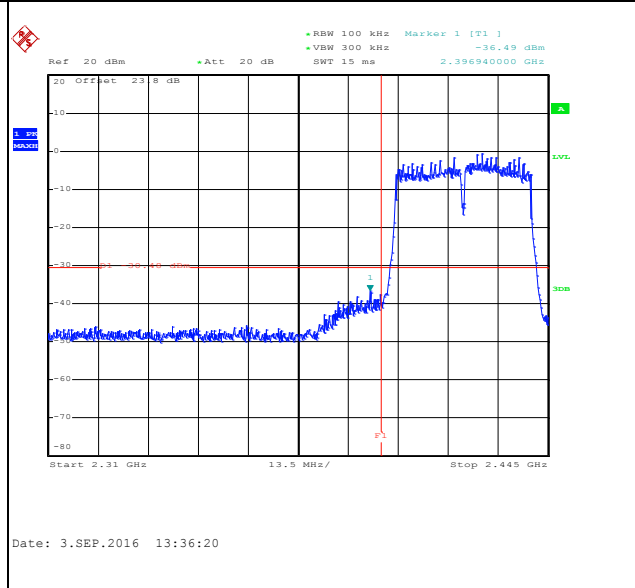

Spurious Emission 30MHz~3GHz

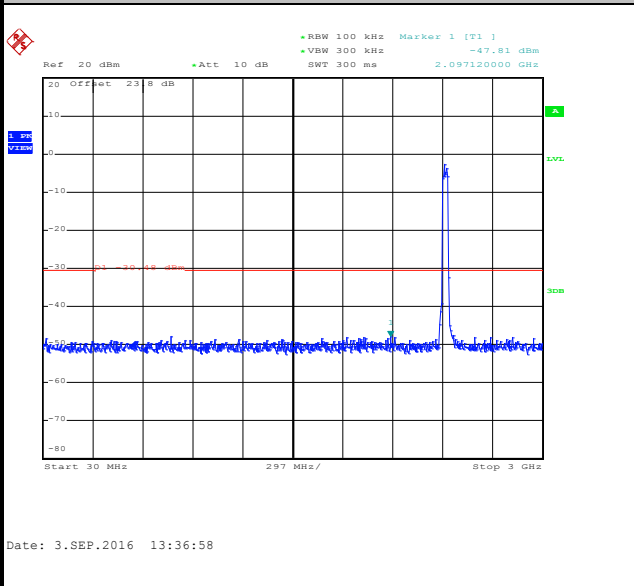

Spurious Emission 2GHz~25GHz

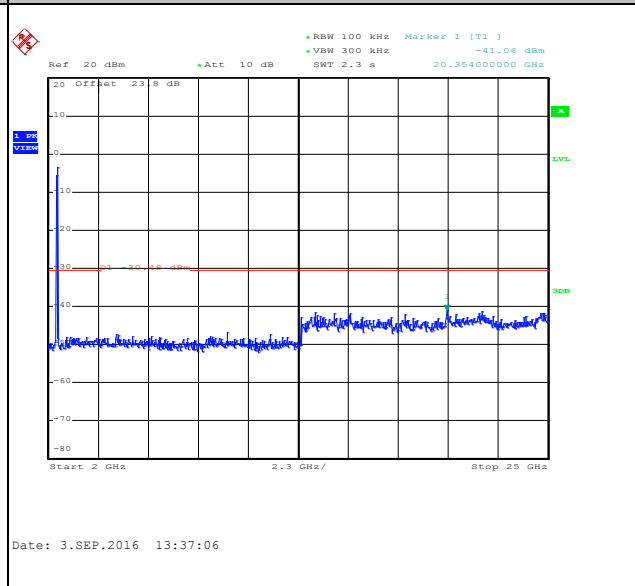



Number of TX :	2	Ant. :	1
Test Mode :	802.11ac VHT40	Temperature :	21~25°C
Test Band :	2.4GHz Mid	Relative Humidity :	51~54%
Test Channel :	06	Test Engineer :	AnAn Wu

WLAN 802.11ac VHT40 Channel 06

100kHz PSD reference Level

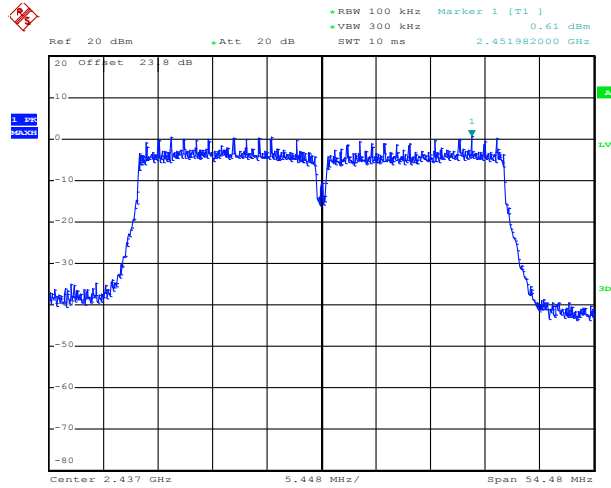

Date: 3.SEP.2016 13:40:56

Spurious Emission 30MHz~3GHz

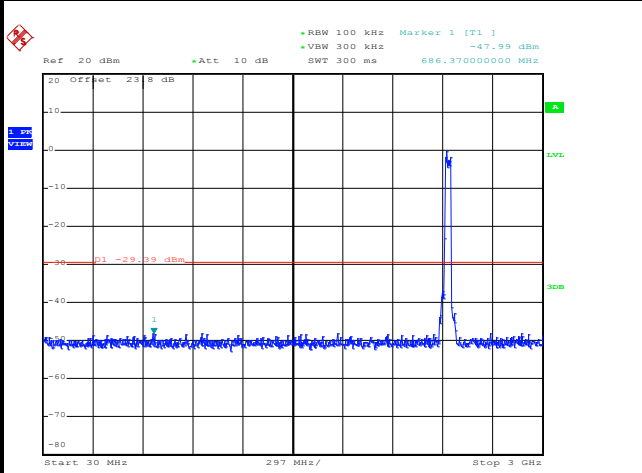

Date: 3.SEP.2016 13:42:29

Spurious Emission 2GHz~25GHz

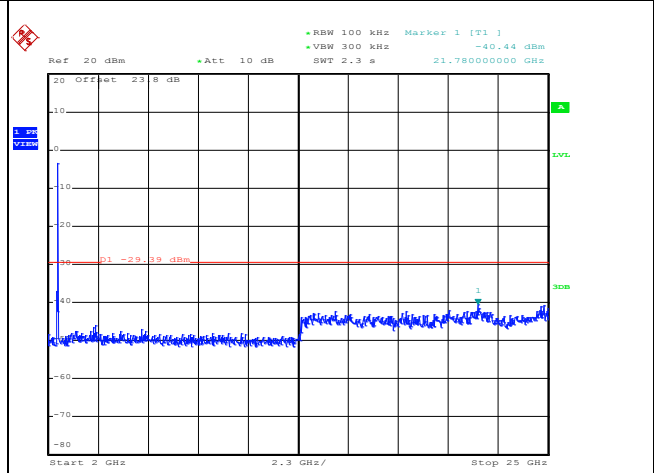

Date: 3.SEP.2016 13:42:37



Number of TX :	2	Ant. :	1
Test Mode :	802.11ac VHT40	Temperature :	21~25°C
Test Band :	2.4GHz High	Relative Humidity :	51~54%
Test Channel :	09	Test Engineer :	AnAn Wu

WLAN 802.11ac VHT40 Channel 09

100kHz PSD reference Level

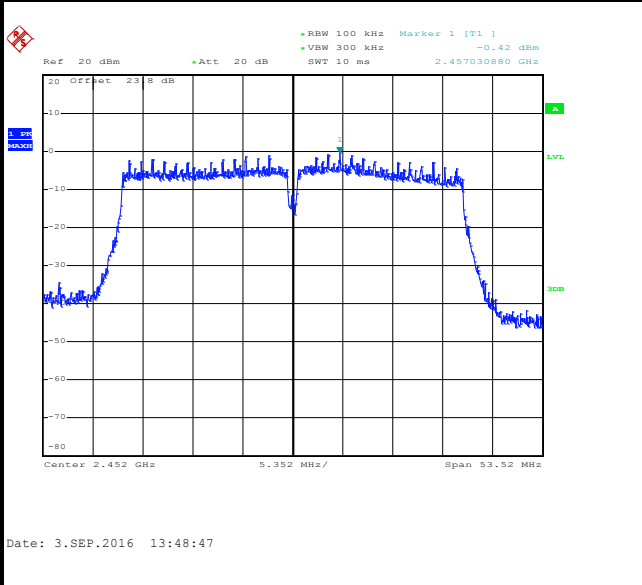

High Channel Plot

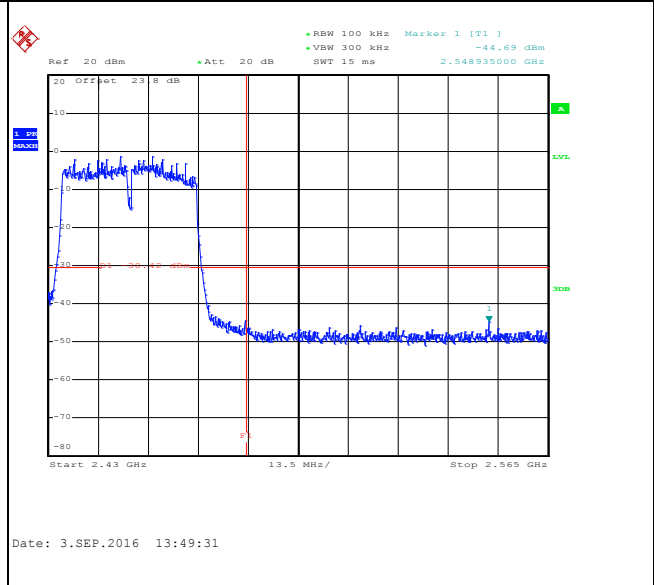

Spurious Emission 30MHz~3GHz

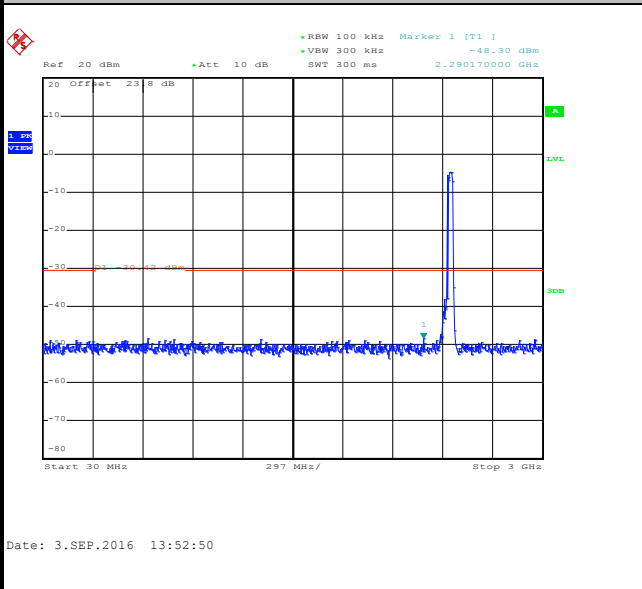

Spurious Emission 2GHz~25GHz

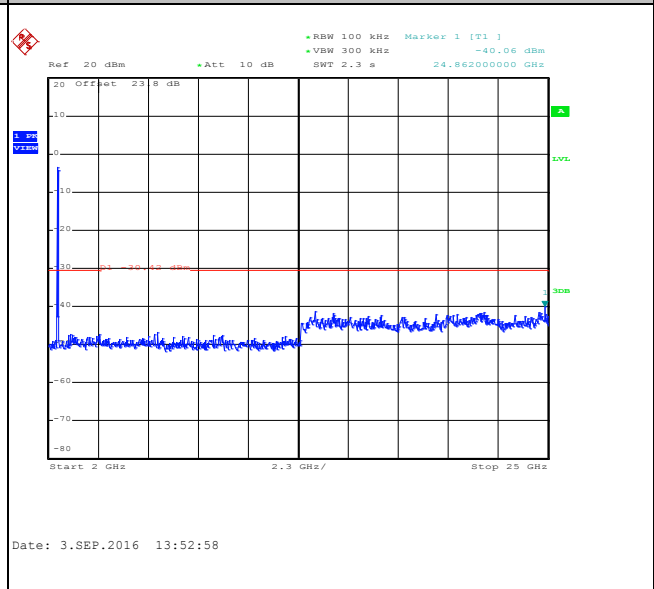



Number of TX = 2, Ant. 2 (Measured)

Number of TX :	2	Ant. :	2
Test Mode :	802.11b	Temperature :	21~25°C
Test Band :	2.4GHz Low	Relative Humidity :	51~54%
Test Channel :	01	Test Engineer :	AnAn Wu

WLAN 802.11b Channel 01

100kHz PSD reference Level

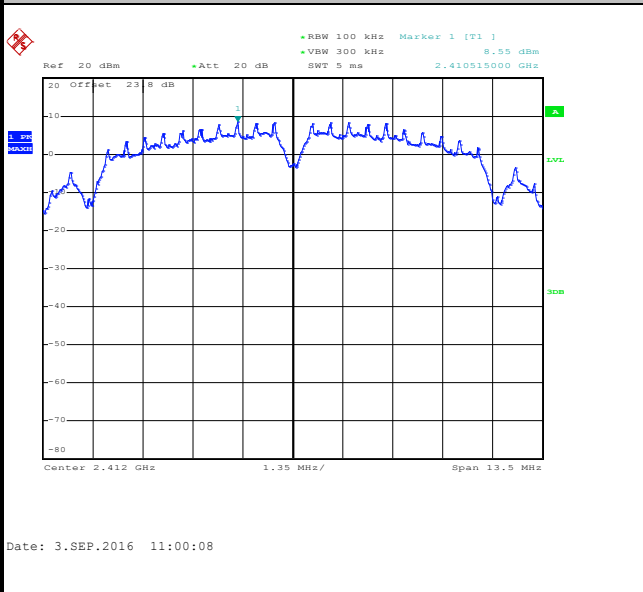

Low Channel Plot

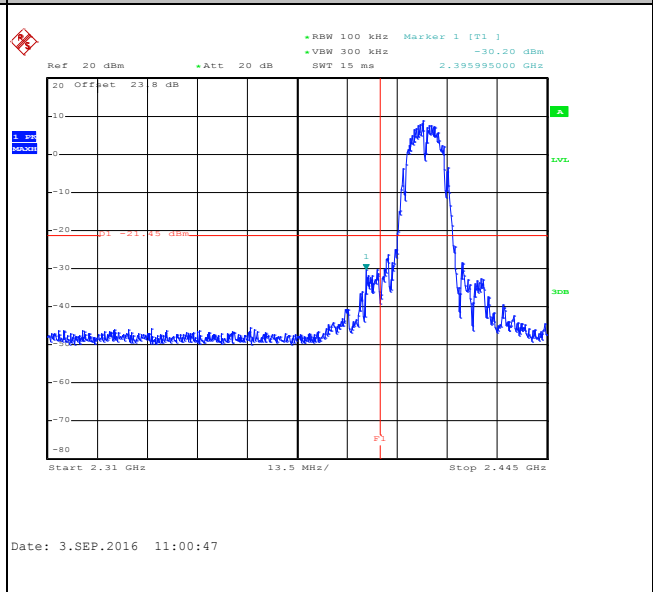

Spurious Emission 30MHz~3GHz

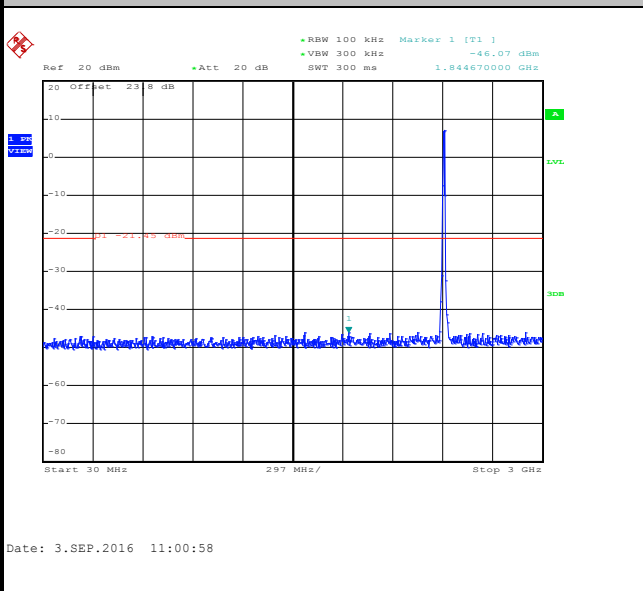

Spurious Emission 2GHz~25GHz

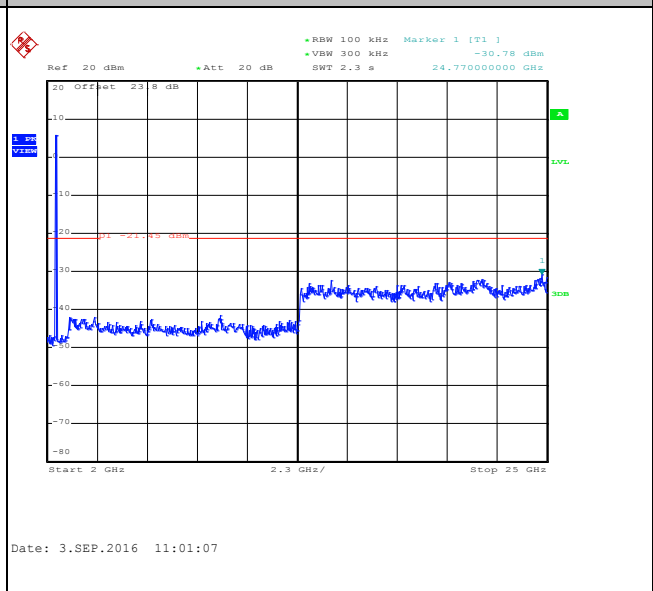



Number of TX :	2	Ant. :	2
Test Mode :	802.11b	Temperature :	21~25°C
Test Band :	2.4GHz Mid	Relative Humidity :	51~54%
Test Channel :	06	Test Engineer :	AnAn Wu

WLAN 802.11b Channel 06

100kHz PSD reference Level

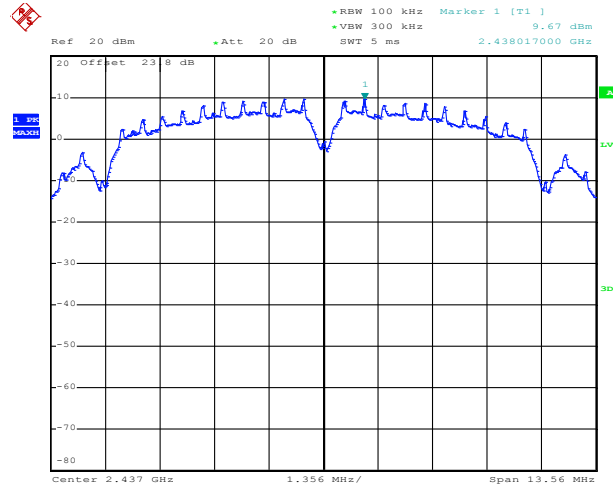

Date: 3.SEP.2016 11:03:33

Spurious Emission 30MHz~3GHz

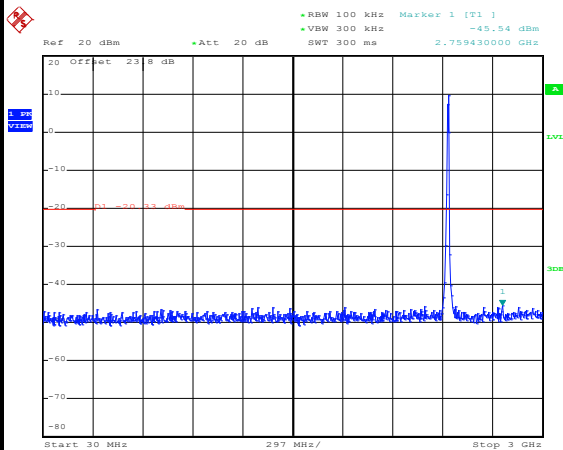

Date: 3.SEP.2016 11:04:15

Spurious Emission 2GHz~25GHz

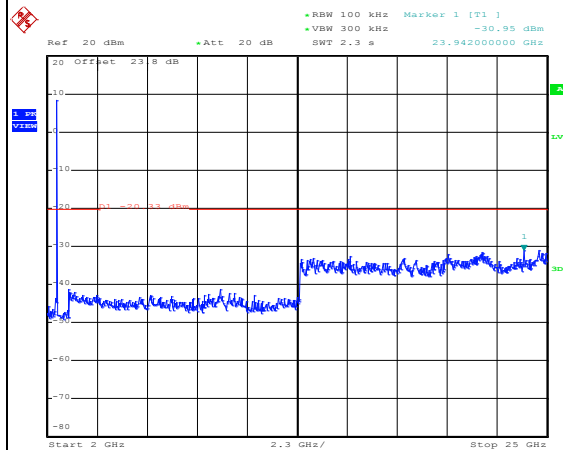

Date: 3.SEP.2016 11:04:24



Number of TX :	2	Ant. :	2
Test Mode :	802.11b	Temperature :	21~25°C
Test Band :	2.4GHz High	Relative Humidity :	51~54%
Test Channel :	11	Test Engineer :	AnAn Wu

WLAN 802.11b Channel 11

100kHz PSD reference Level

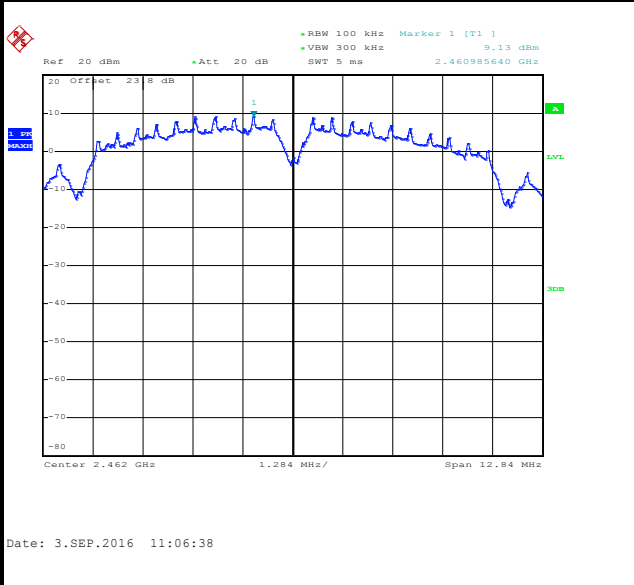

High Channel Plot

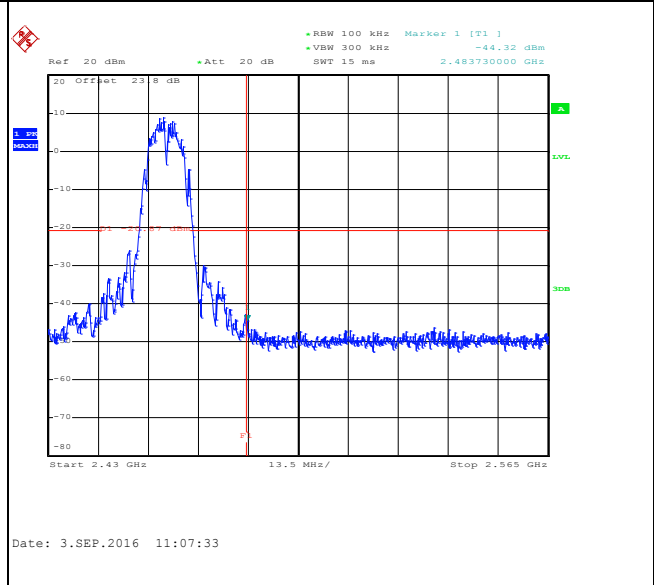

Spurious Emission 30MHz~3GHz

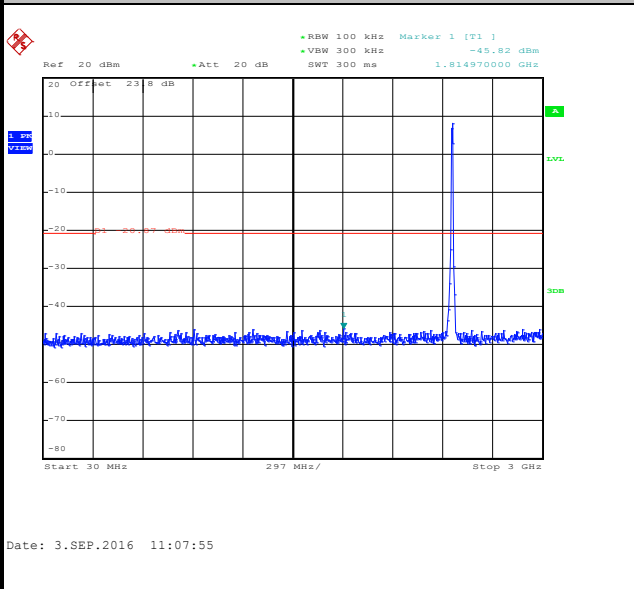

Spurious Emission 2GHz~25GHz

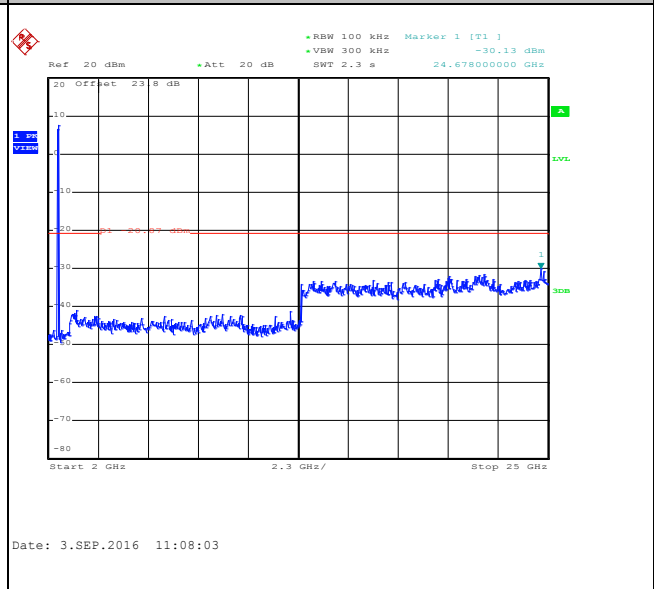



Number of TX :	2	Ant. :	2
Test Mode :	802.11g	Temperature :	21~25°C
Test Band :	2.4GHz Low	Relative Humidity :	51~54%
Test Channel :	01	Test Engineer :	AnAn Wu

WLAN 802.11g Channel 01

100kHz PSD reference Level

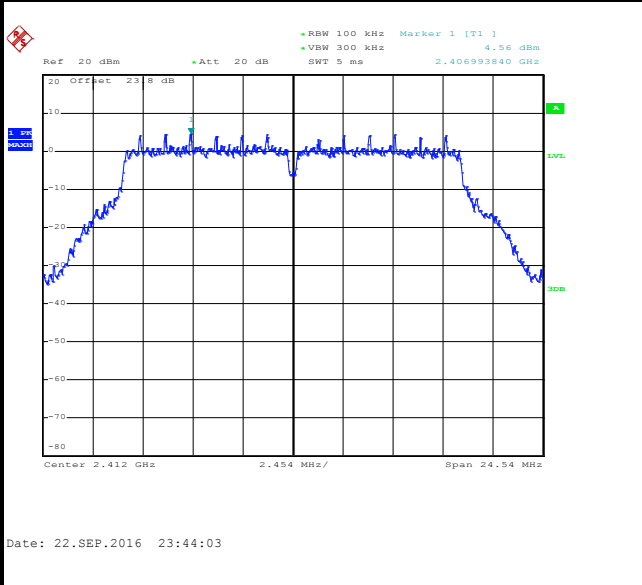

Low Channel Plot

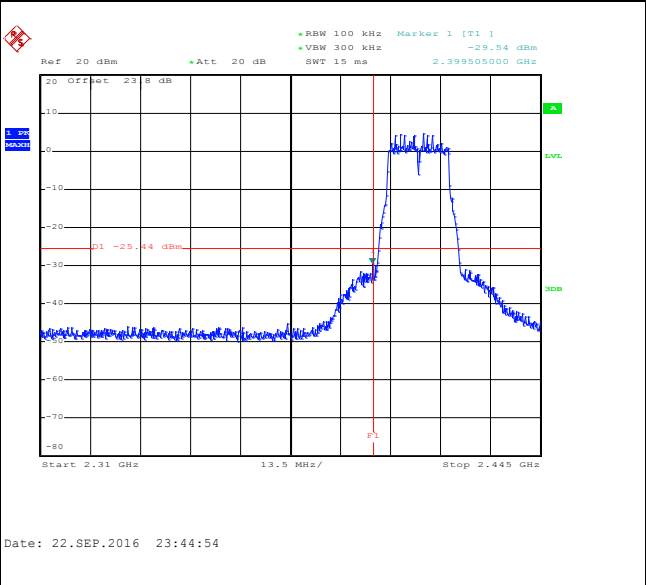

Spurious Emission 30MHz~3GHz

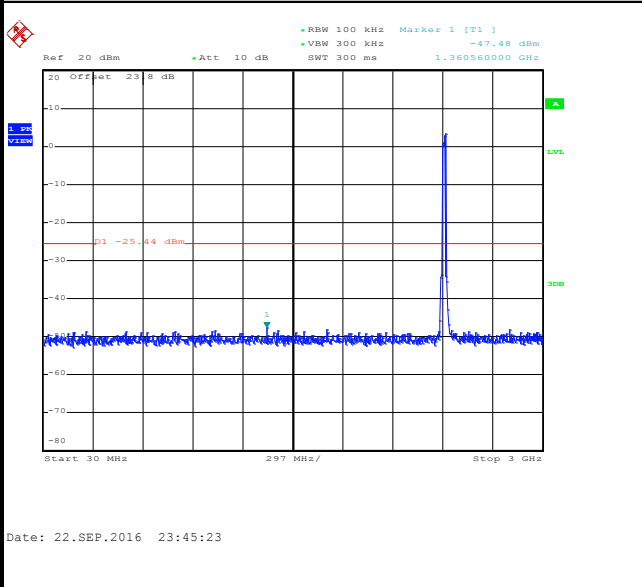

Spurious Emission 2GHz~25GHz

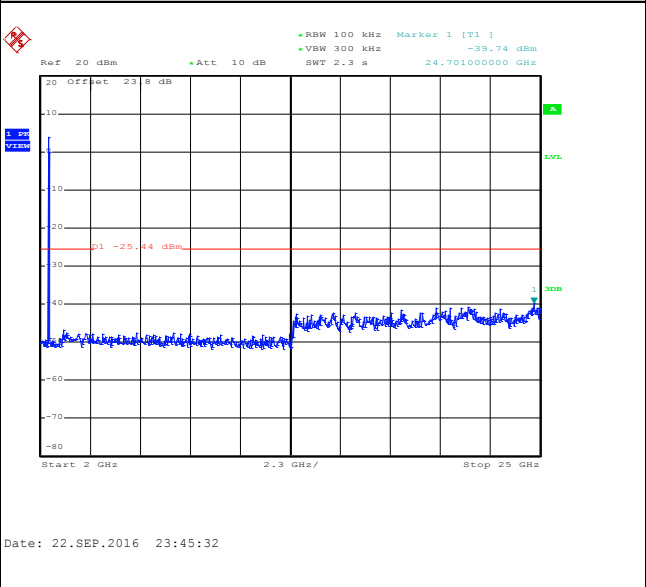



Number of TX :	2	Ant. :	2
Test Mode :	802.11g	Temperature :	21~25°C
Test Band :	2.4GHz Mid	Relative Humidity :	51~54%
Test Channel :	06	Test Engineer :	AnAn Wu

WLAN 802.11g Channel 06

100kHz PSD reference Level

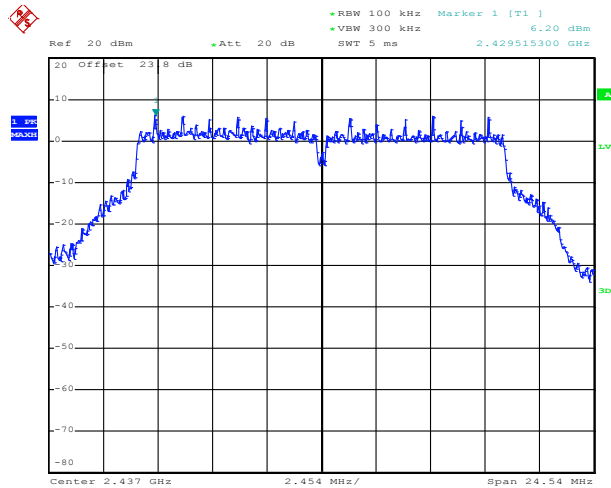

Date: 3.SEP.2016 12:34:51

Spurious Emission 30MHz~3GHz

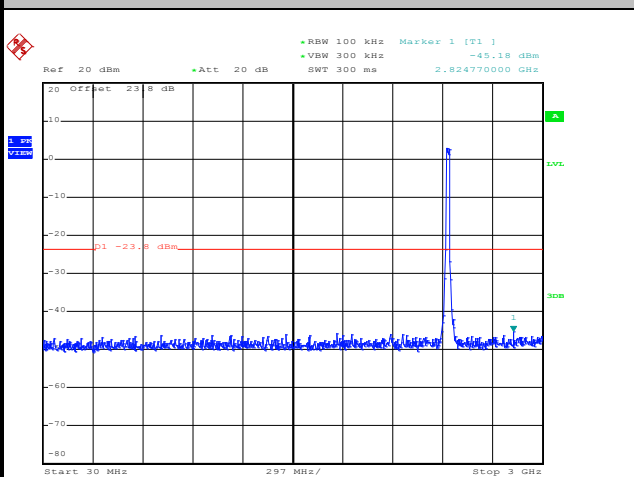

Date: 3.SEP.2016 12:35:24

Spurious Emission 2GHz~25GHz

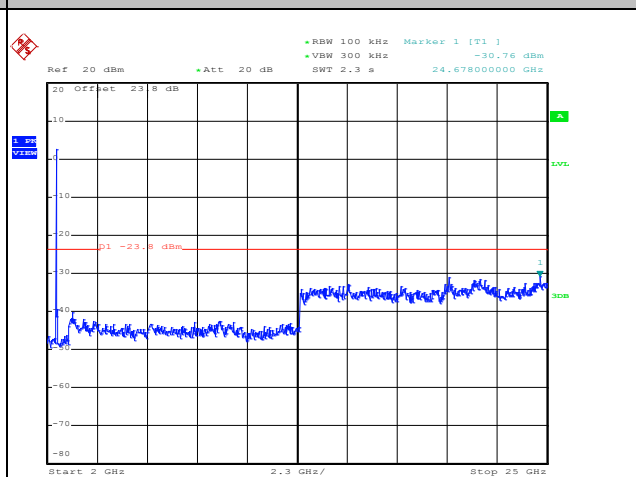

Date: 3.SEP.2016 12:35:33



Number of TX :	2	Ant. :	2
Test Mode :	802.11g	Temperature :	21~25°C
Test Band :	2.4GHz High	Relative Humidity :	51~54%
Test Channel :	11	Test Engineer :	AnAn Wu

WLAN 802.11g Channel 11

100kHz PSD reference Level

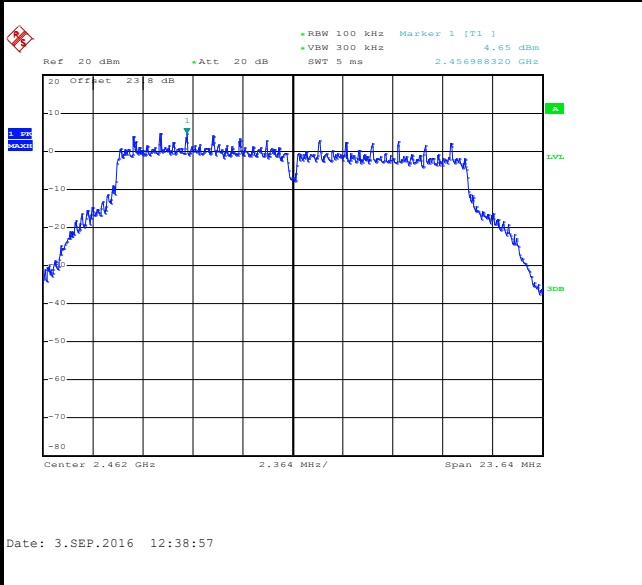

High Channel Plot

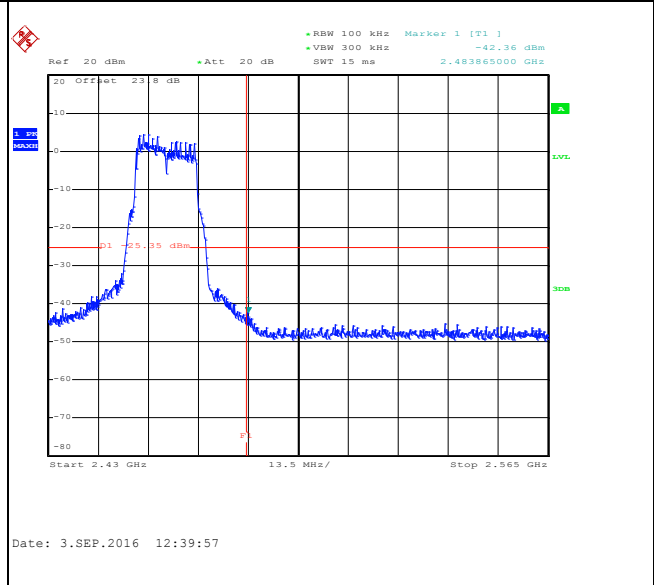

Spurious Emission 30MHz~3GHz

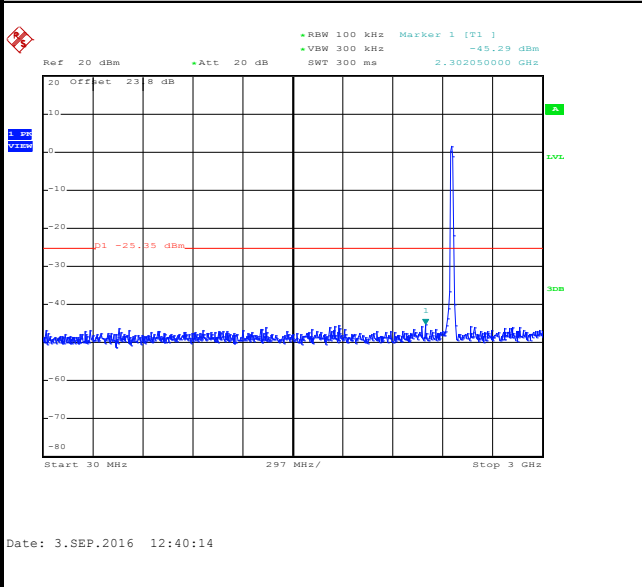

Spurious Emission 2GHz~25GHz

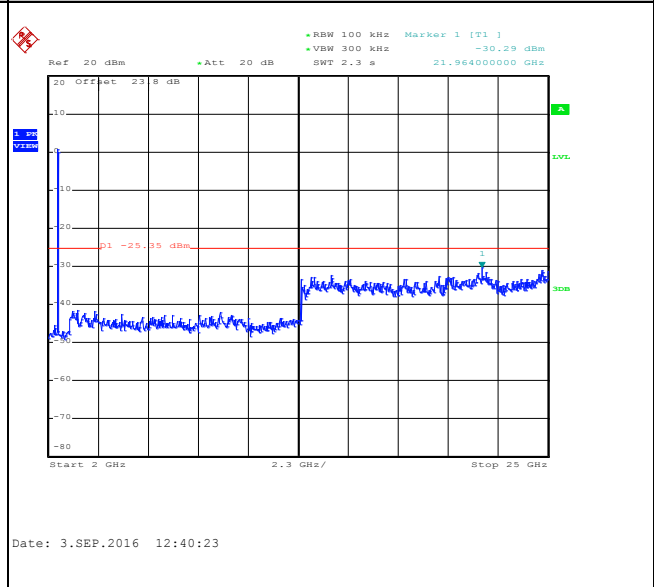



Number of TX :	2	Ant. :	2
Test Mode :	802.11ac VHT20	Temperature :	21~25°C
Test Band :	2.4GHz Low	Relative Humidity :	51~54%
Test Channel :	01	Test Engineer :	AnAn Wu

WLAN 802.11ac VHT20 Channel 01

100kHz PSD reference Level

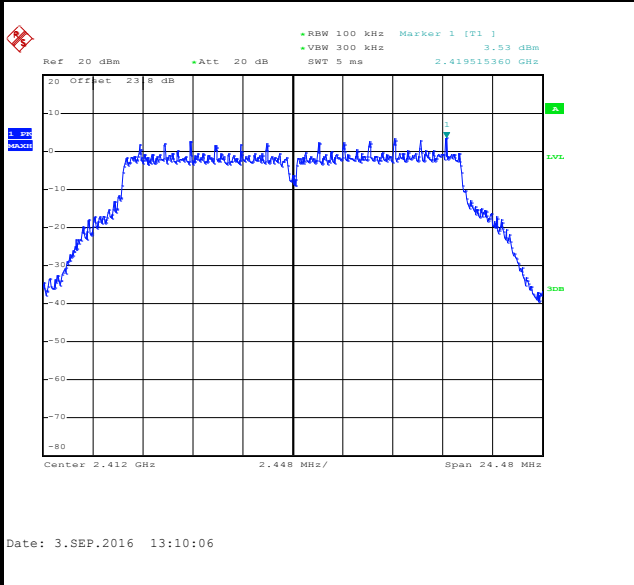

Low Channel Plot

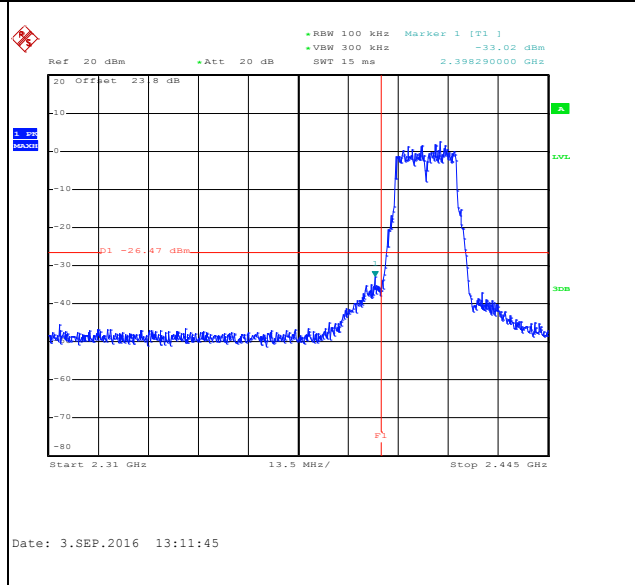

Spurious Emission 30MHz~3GHz

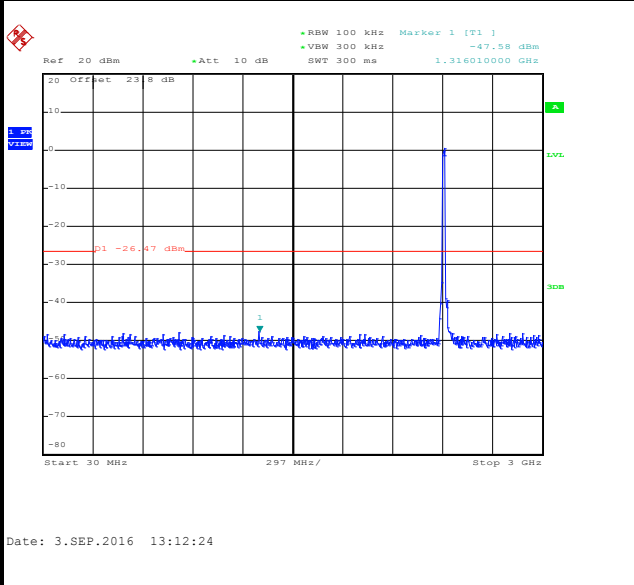

Spurious Emission 2GHz~25GHz

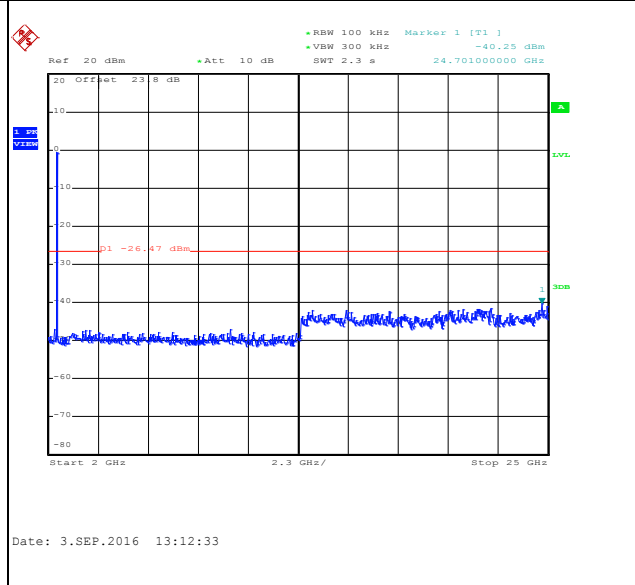



Number of TX :	2	Ant. :	2
Test Mode :	802.11ac VHT20	Temperature :	21~25°C
Test Band :	2.4GHz Mid	Relative Humidity :	51~54%
Test Channel :	06	Test Engineer :	AnAn Wu

WLAN 802.11ac VHT20 Channel 06

100kHz PSD reference Level

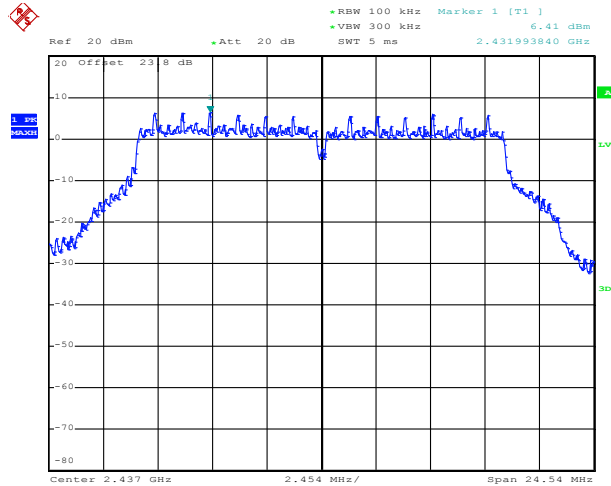

Date: 3.SEP.2016 13:19:31

Spurious Emission 30MHz~3GHz

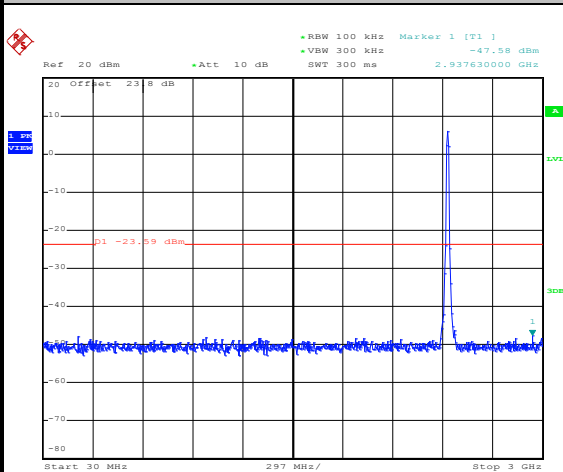

Date: 3.SEP.2016 13:20:36

Spurious Emission 2GHz~25GHz

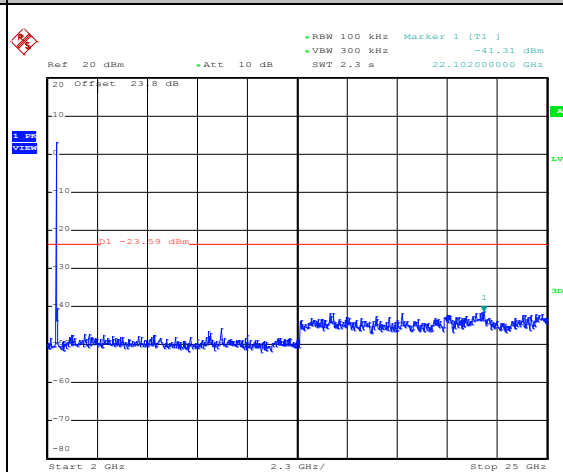

Date: 3.SEP.2016 13:20:44



Number of TX :	2	Ant. :	2
Test Mode :	802.11ac VHT20	Temperature :	21~25°C
Test Band :	2.4GHz High	Relative Humidity :	51~54%
Test Channel :	11	Test Engineer :	AnAn Wu

WLAN 802.11ac VHT20 Channel 11

100kHz PSD reference Level

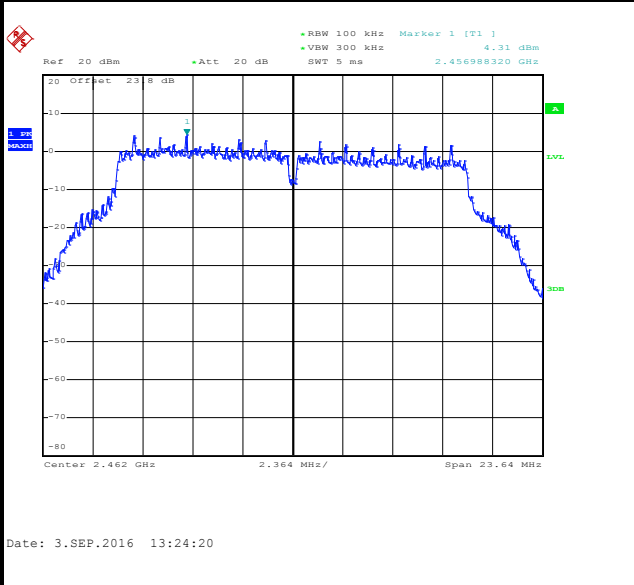

High Channel Plot

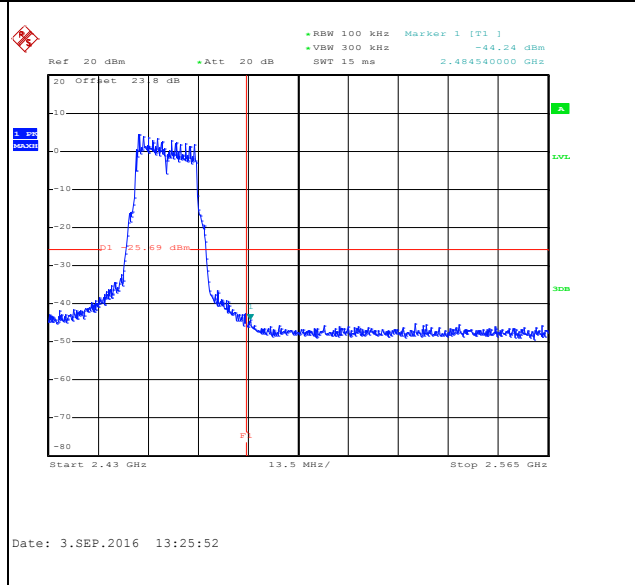

Spurious Emission 30MHz~3GHz

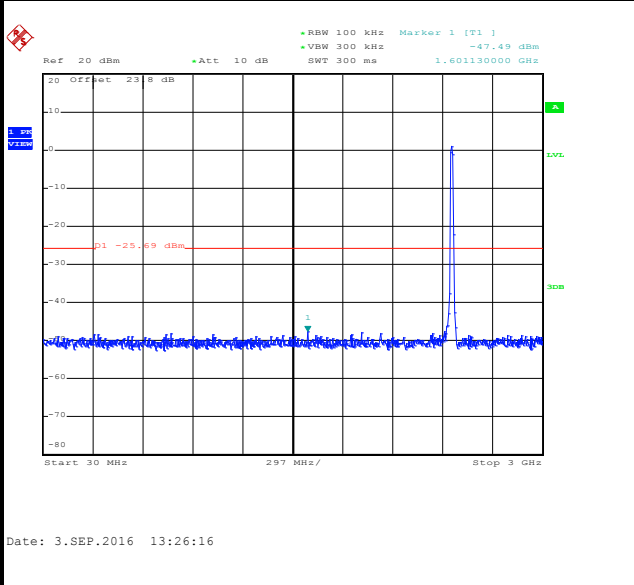

Spurious Emission 2GHz~25GHz

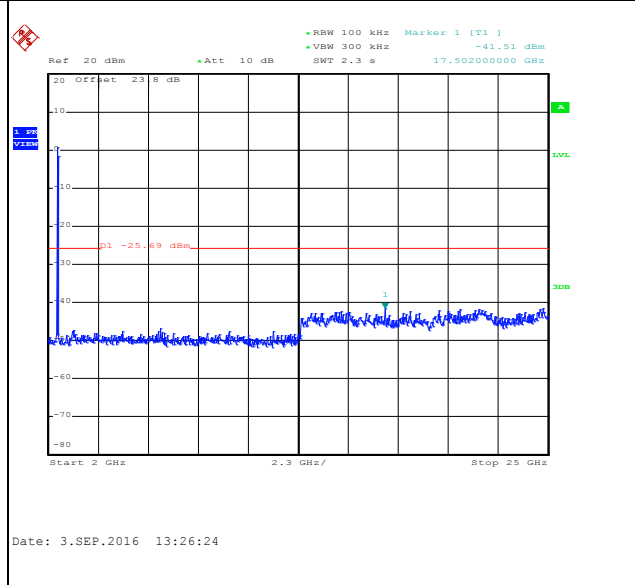



Number of TX :	2	Ant. :	2
Test Mode :	802.11ac VHT40	Temperature :	21~25°C
Test Band :	2.4GHz Low	Relative Humidity :	51~54%
Test Channel :	03	Test Engineer :	AnAn Wu

WLAN 802.11ac VHT40 Channel 03

100kHz PSD reference Level

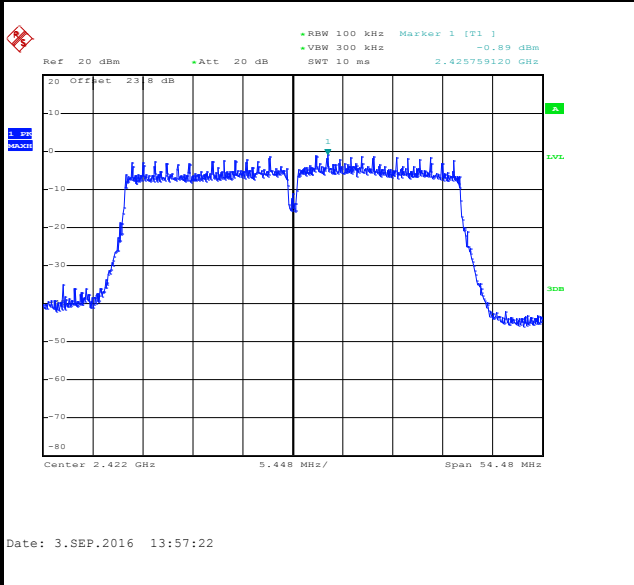

Low Channel Plot

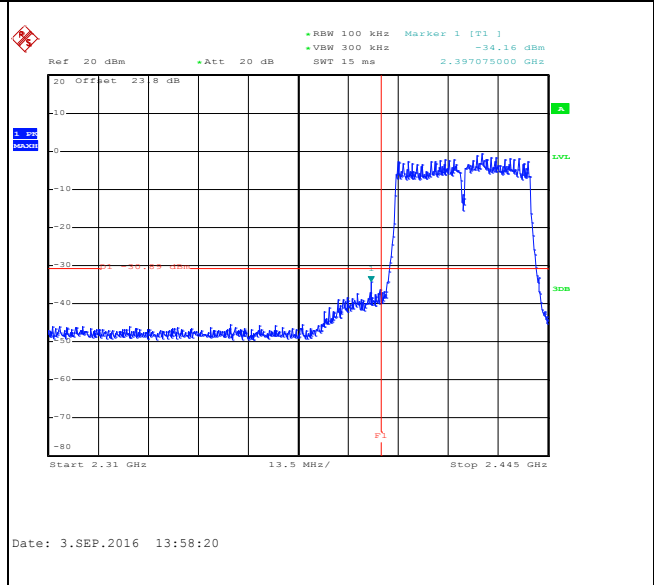

Spurious Emission 30MHz~3GHz

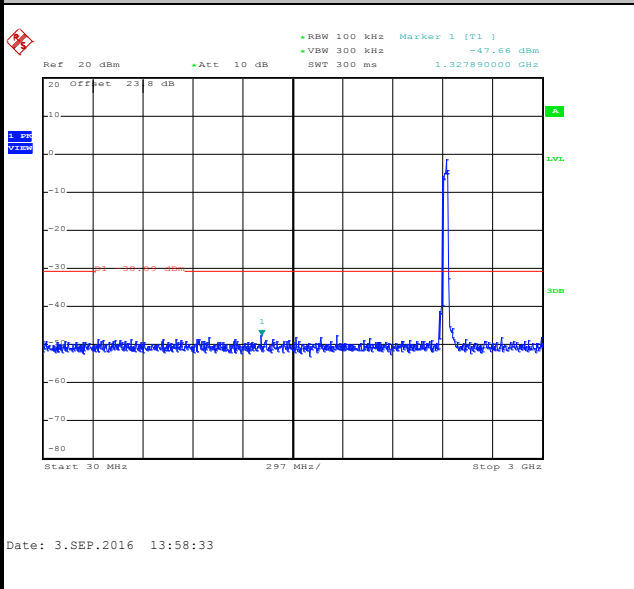

Spurious Emission 2GHz~25GHz

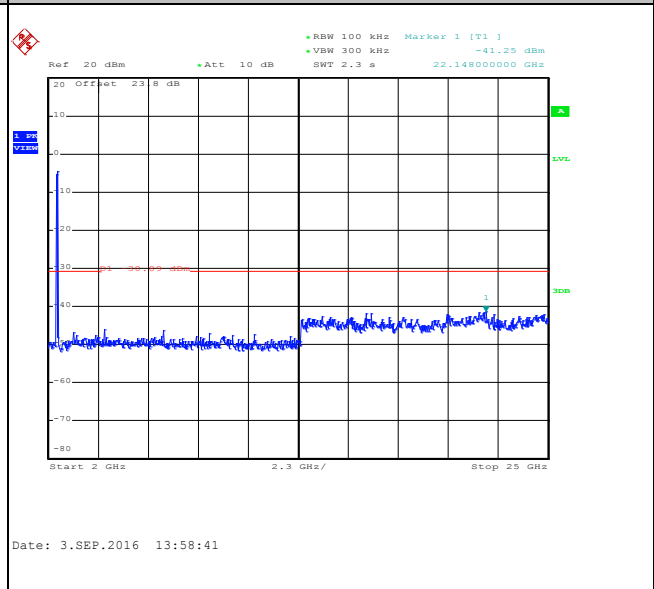



Number of TX :	2	Ant. :	2
Test Mode :	802.11ac VHT40	Temperature :	21~25°C
Test Band :	2.4GHz Mid	Relative Humidity :	51~54%
Test Channel :	06	Test Engineer :	AnAn Wu

WLAN 802.11ac VHT40 Channel 06

100kHz PSD reference Level

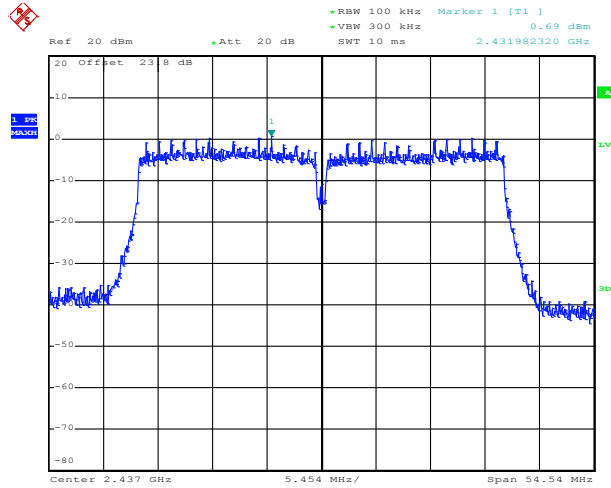

Date: 3.SEP.2016 14:03:45

Spurious Emission 30MHz~3GHz

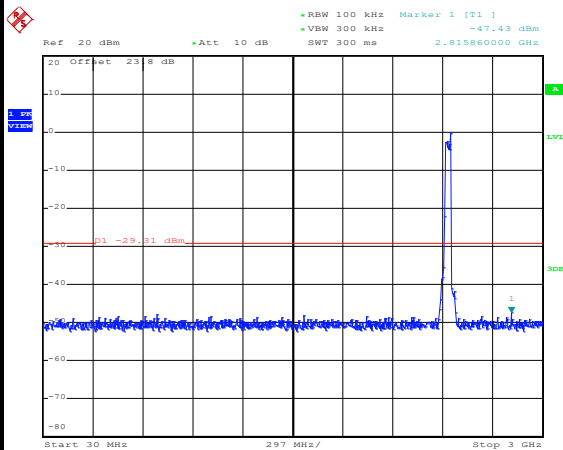

Date: 3.SEP.2016 14:04:48

Spurious Emission 2GHz~25GHz

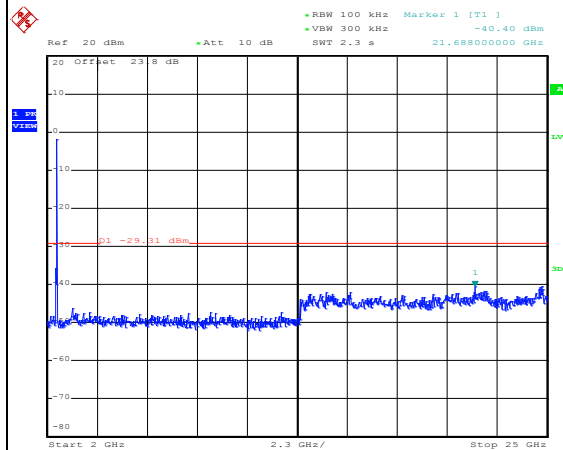

Date: 3.SEP.2016 14:04:57



Number of TX :	2	Ant. :	2
Test Mode :	802.11ac VHT40	Temperature :	21~25°C
Test Band :	2.4GHz High	Relative Humidity :	51~54%
Test Channel :	09	Test Engineer :	AnAn Wu

WLAN 802.11ac VHT40 Channel 09

100kHz PSD reference Level

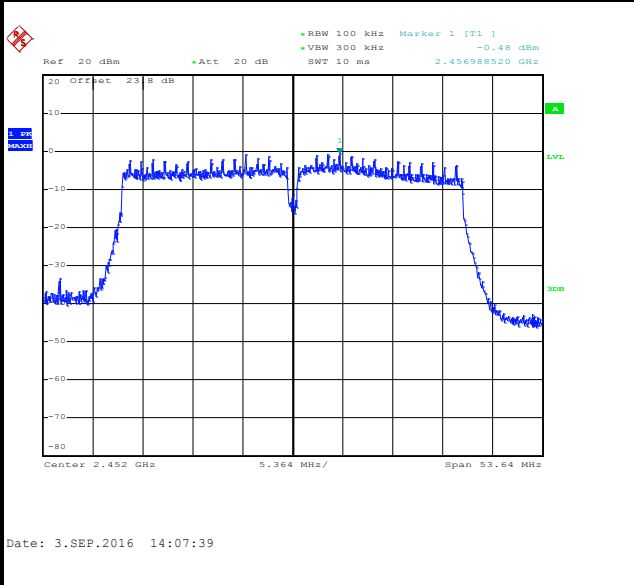

High Channel Plot

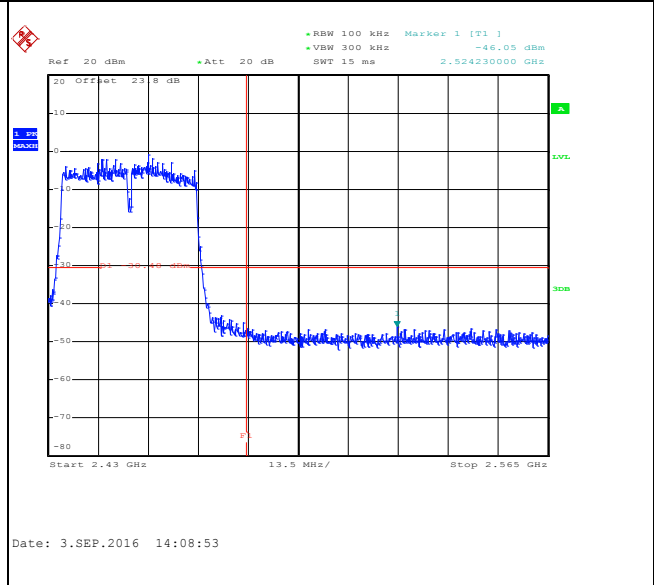

Spurious Emission 30MHz~3GHz

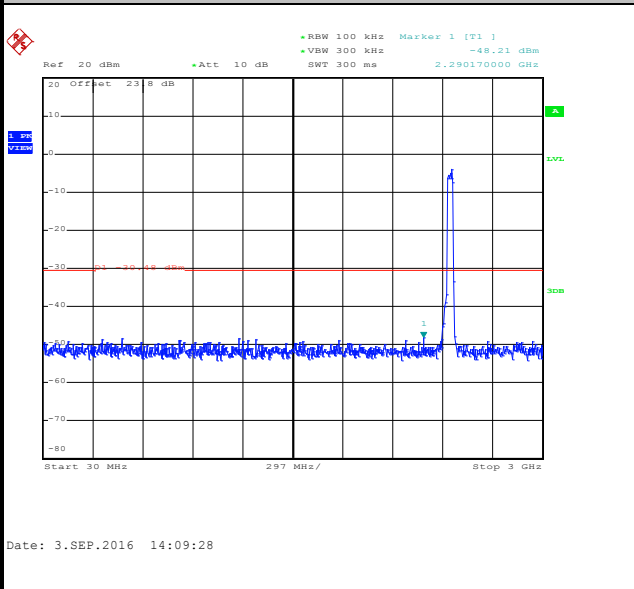

Spurious Emission 2GHz~25GHz

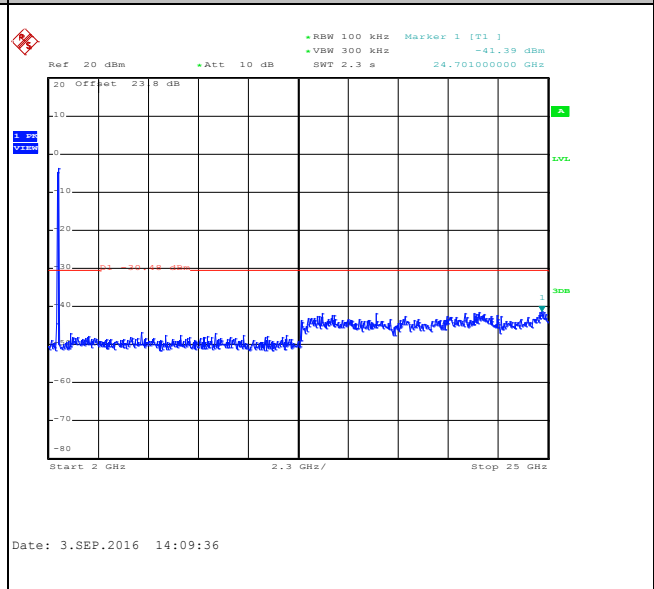



<TXBF Modes>

Number of TX = 2, Ant. 1 (Measured)

Number of TX :	2	Ant. :	1
Test Mode :	802.11ac VHT20	Temperature :	21~25°C
Test Band :	2.4GHz Low	Relative Humidity :	51~54%
Test Channel :	01	Test Engineer :	AnAn Wu

WLAN 802.11ac VHT20 Channel 01

100kHz PSD reference Level

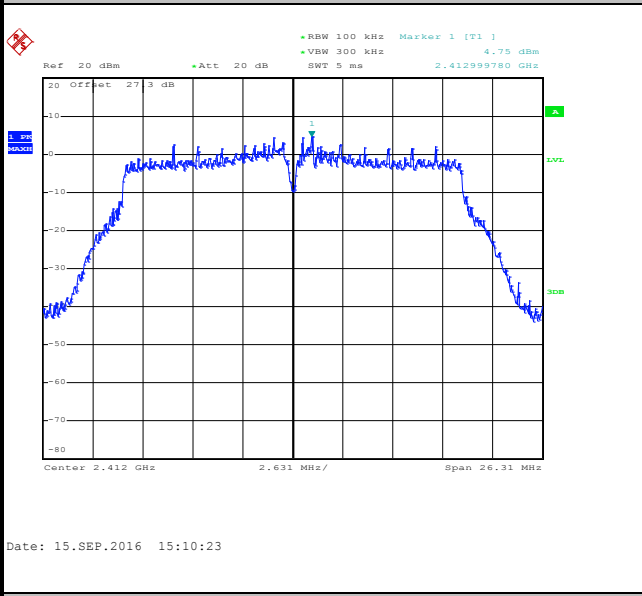

Low Channel Plot

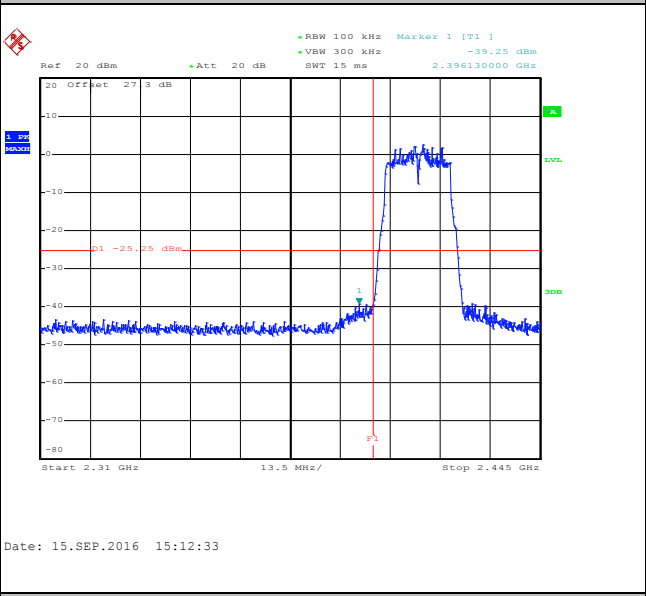

Spurious Emission 30MHz~3GHz

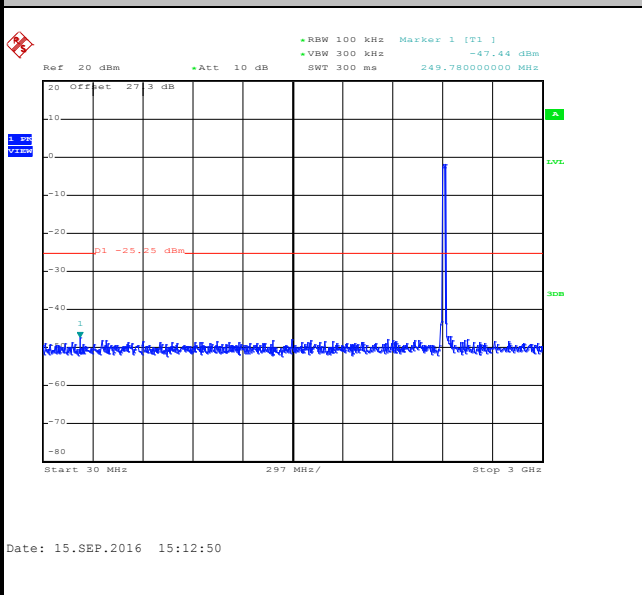

Spurious Emission 2GHz~25GHz

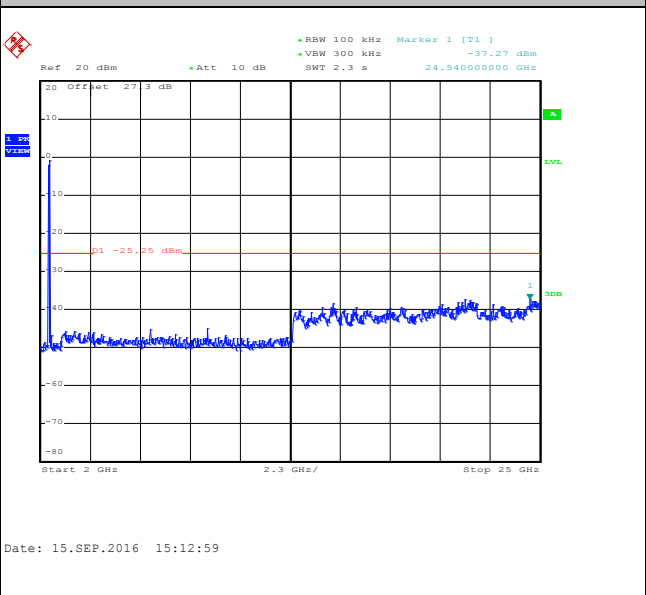



Number of TX :	2	Ant. :	1
Test Mode :	802.11ac VHT20	Temperature :	21~25°C
Test Band :	2.4GHz Mid	Relative Humidity :	51~54%
Test Channel :	06	Test Engineer :	AnAn Wu

WLAN 802.11ac VHT20 Channel 06

100kHz PSD reference Level

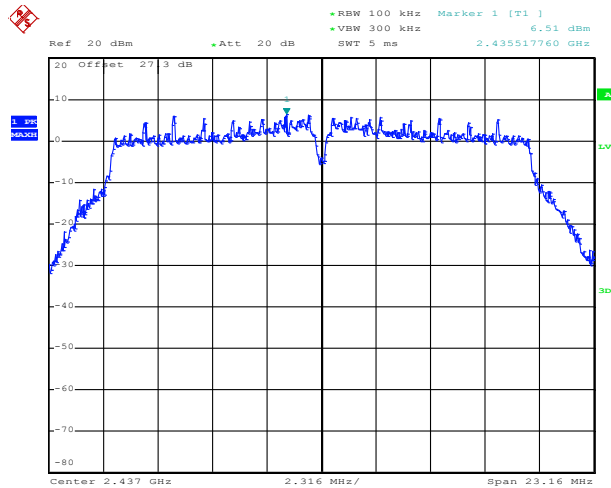

Date: 11.SEP.2016 11:09:25

Spurious Emission 30MHz~3GHz

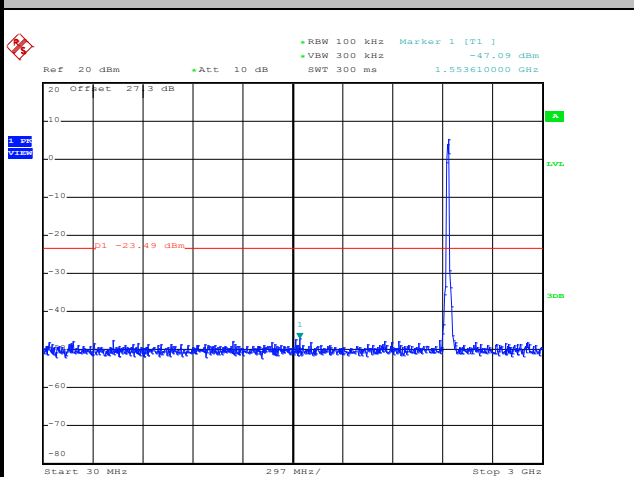

Date: 11.SEP.2016 12:18:49

Spurious Emission 2GHz~25GHz

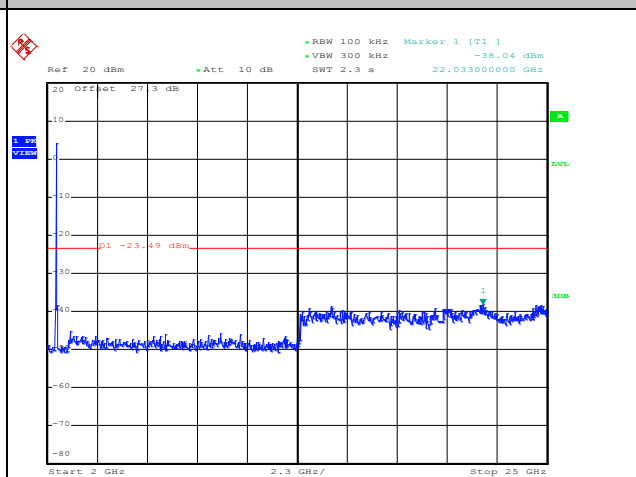

Date: 11.SEP.2016 12:18:57



Number of TX :	2	Ant. :	1
Test Mode :	802.11ac VHT20	Temperature :	21~25°C
Test Band :	2.4GHz High	Relative Humidity :	51~54%
Test Channel :	11	Test Engineer :	AnAn Wu

WLAN 802.11ac VHT20 Channel 11

100kHz PSD reference Level

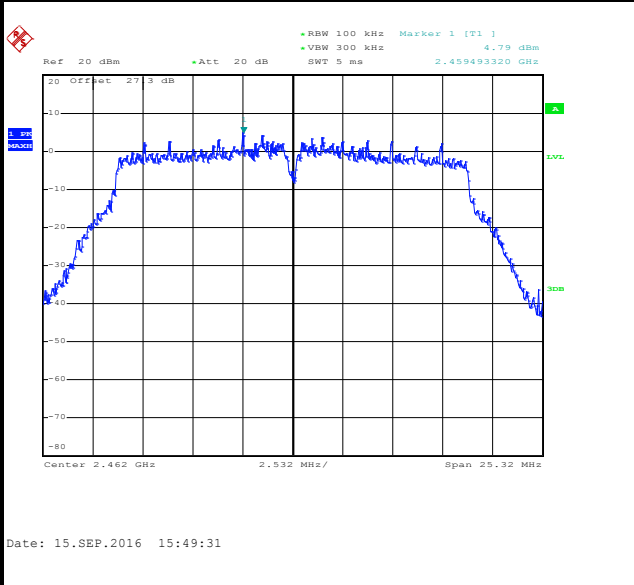

High Channel Plot

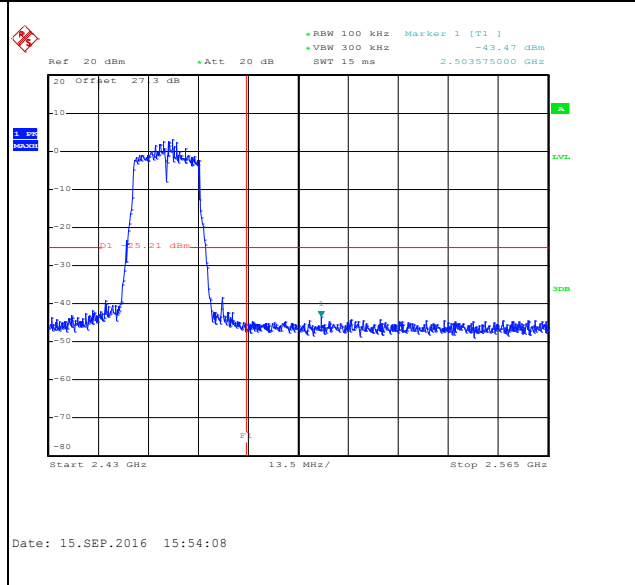

Spurious Emission 30MHz~3GHz

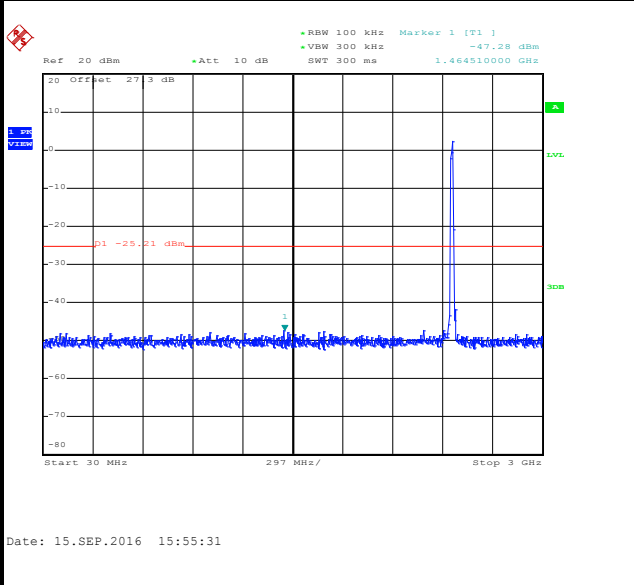

Spurious Emission 2GHz~25GHz

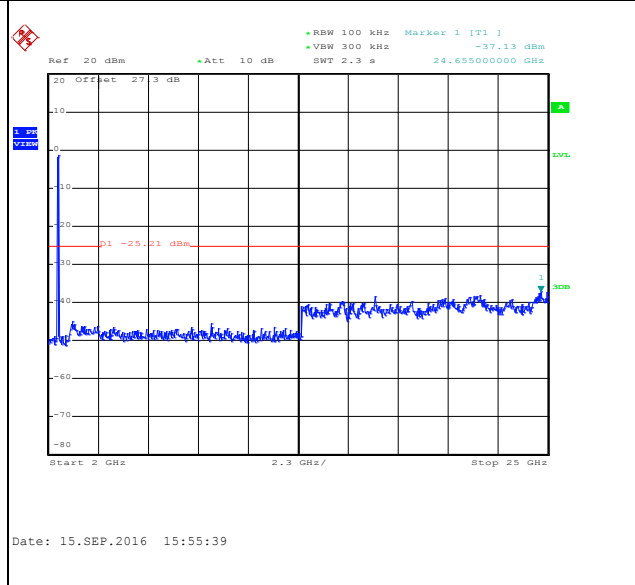



Number of TX :	2	Ant. :	1
Test Mode :	802.11ac VHT40	Temperature :	21~25°C
Test Band :	2.4GHz Low	Relative Humidity :	51~54%
Test Channel :	03	Test Engineer :	AnAn Wu

WLAN 802.11ac VHT40 Channel 03

100kHz PSD reference Level

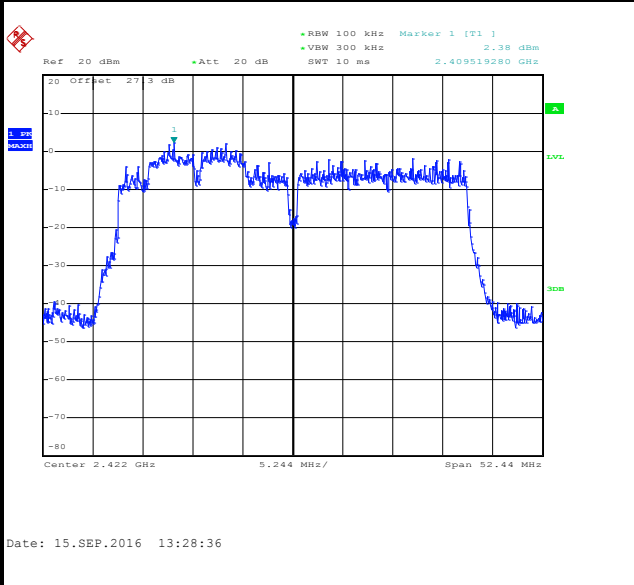

Low Channel Plot

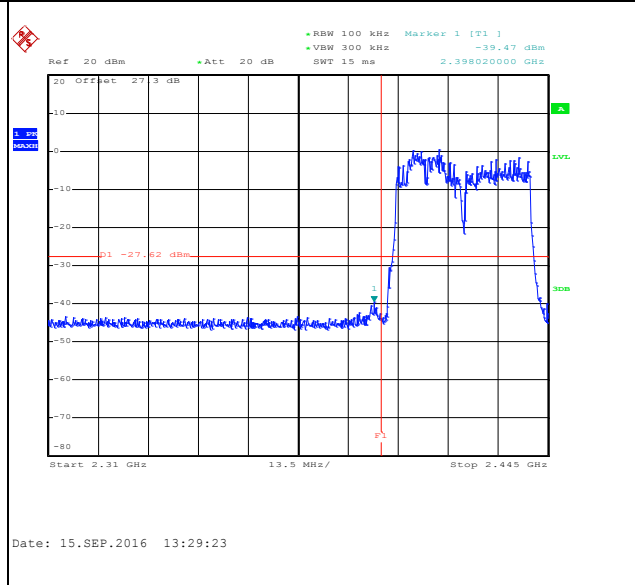

Spurious Emission 30MHz~3GHz

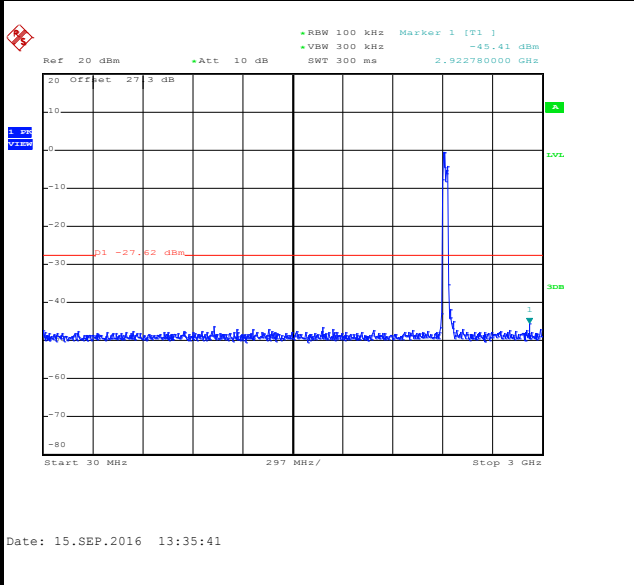

Spurious Emission 2GHz~25GHz

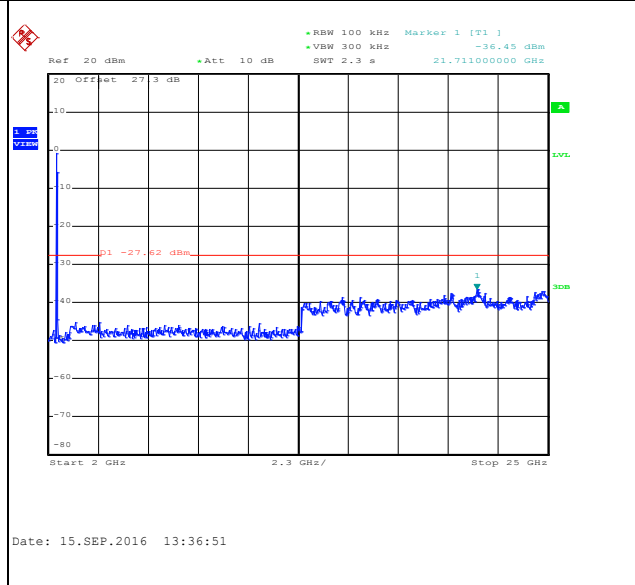



Number of TX :	2	Ant. :	1
Test Mode :	802.11ac VHT40	Temperature :	21~25°C
Test Band :	2.4GHz Mid	Relative Humidity :	51~54%
Test Channel :	06	Test Engineer :	AnAn Wu

WLAN 802.11ac VHT40 Channel 06

100kHz PSD reference Level

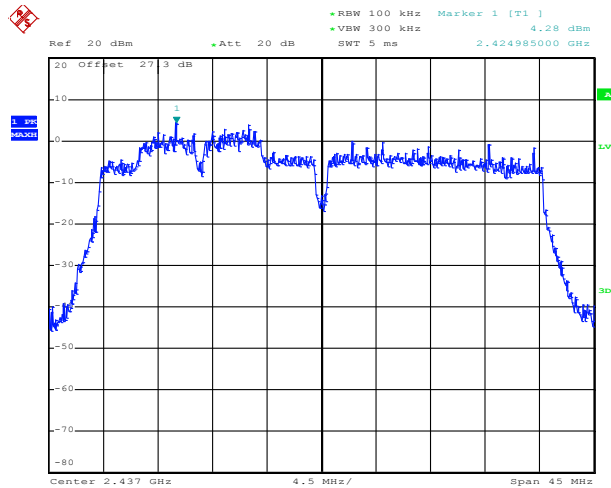

Date: 11.SEP.2016 12:48:55

Spurious Emission 30MHz~3GHz

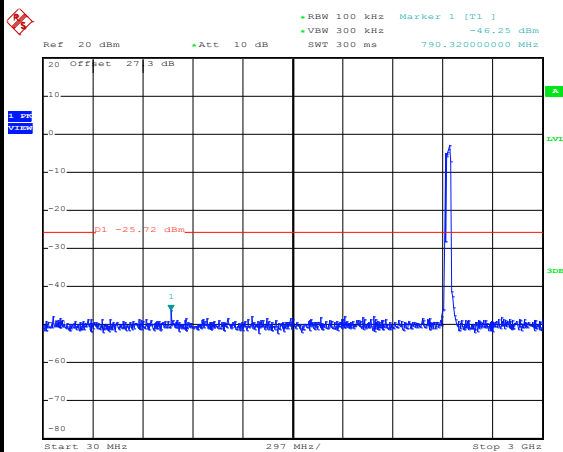

Date: 11.SEP.2016 12:51:45

Spurious Emission 2GHz~25GHz

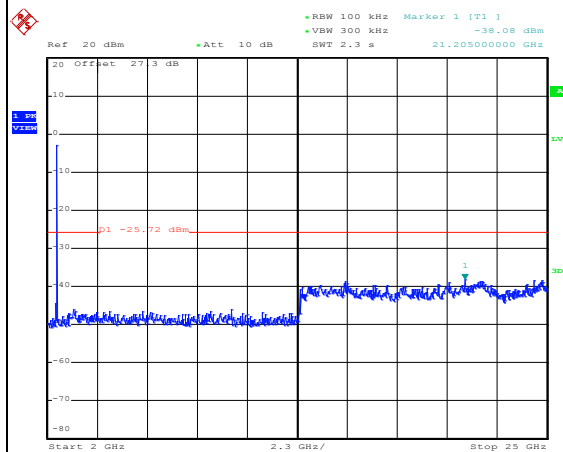

Date: 11.SEP.2016 12:51:53



Number of TX :	2	Ant. :	1
Test Mode :	802.11ac VHT40	Temperature :	21~25°C
Test Band :	2.4GHz High	Relative Humidity :	51~54%
Test Channel :	09	Test Engineer :	AnAn Wu

WLAN 802.11ac VHT40 Channel 09

100kHz PSD reference Level

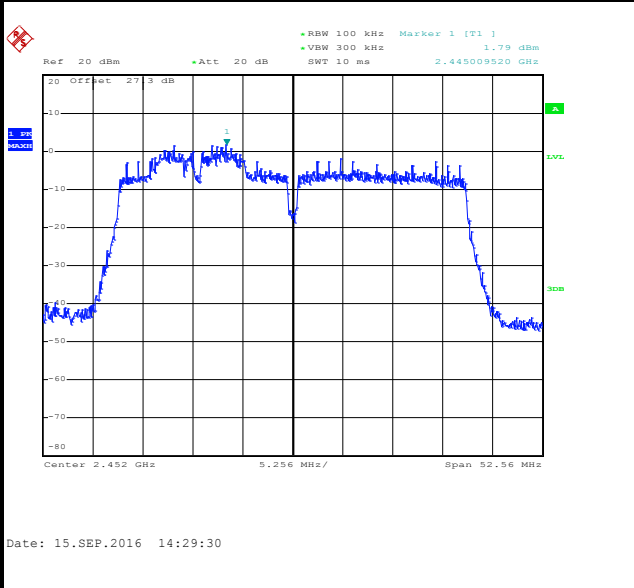

High Channel Plot

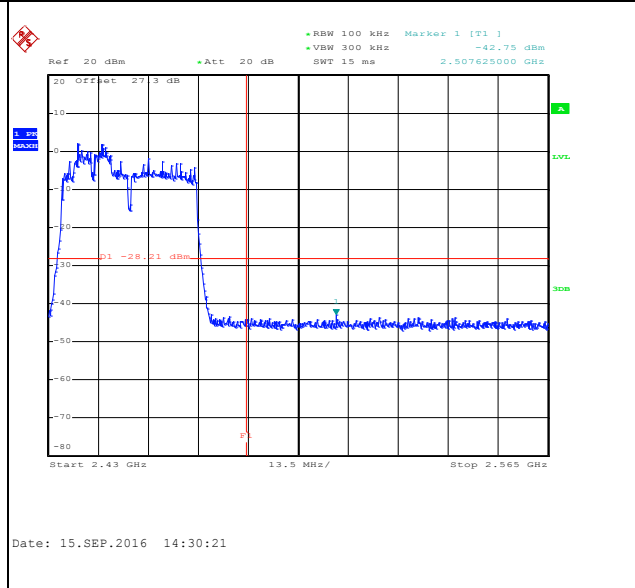

Spurious Emission 30MHz~3GHz

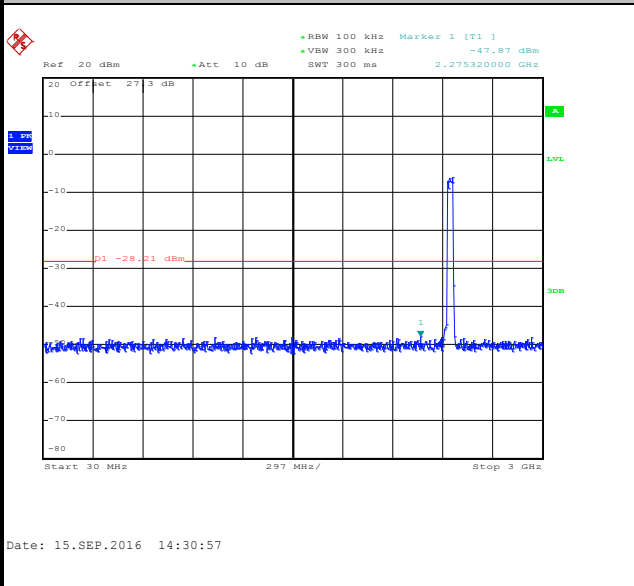

Spurious Emission 2GHz~25GHz

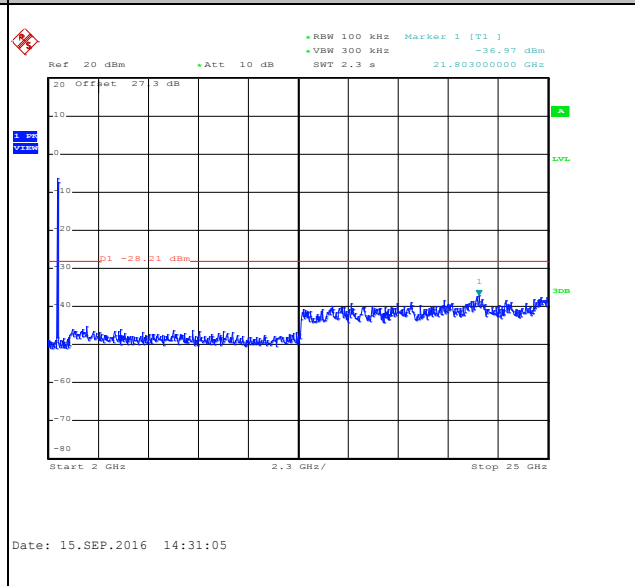



Number of TX = 2, Ant. 2 (Measured)

Number of TX :	2	Ant. :	2
Test Mode :	802.11ac VHT20	Temperature :	21~25°C
Test Band :	2.4GHz Low	Relative Humidity :	51~54%
Test Channel :	01	Test Engineer :	AnAn Wu

WLAN 802.11ac VHT20 Channel 01

100kHz PSD reference Level

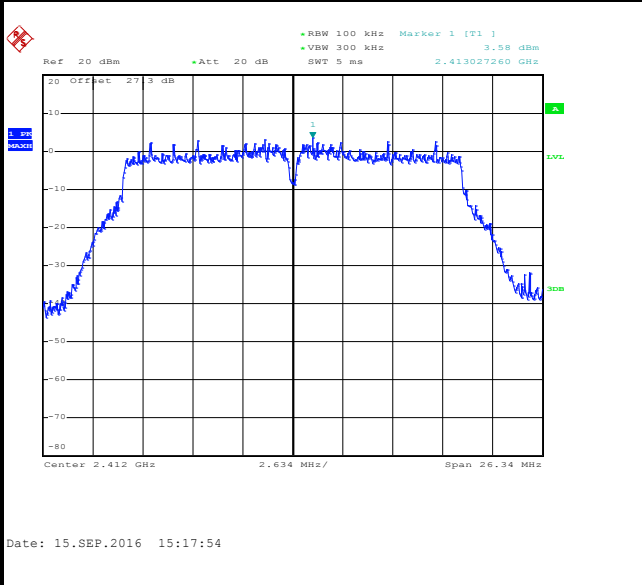

Low Channel Plot

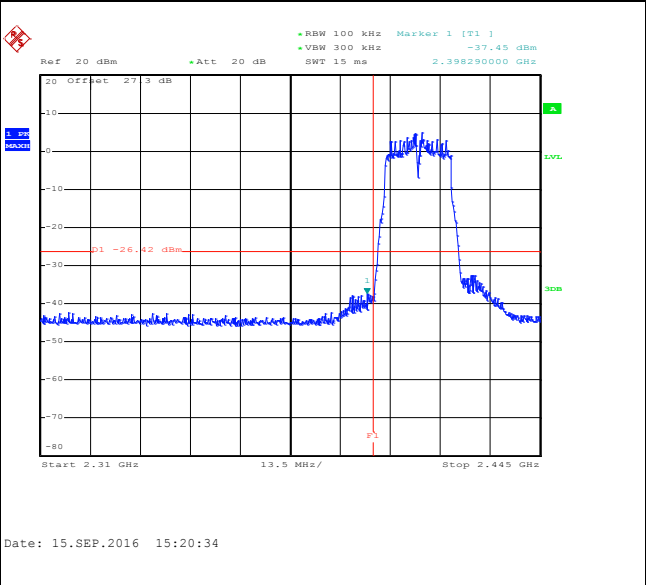

Spurious Emission 30MHz~3GHz

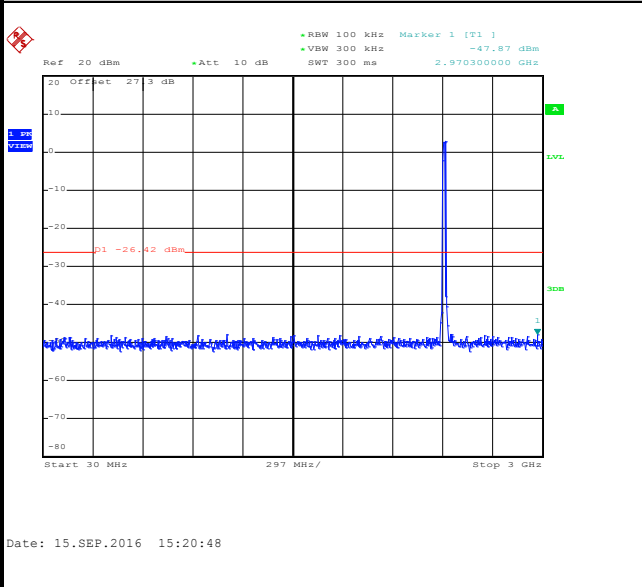

Spurious Emission 2GHz~25GHz

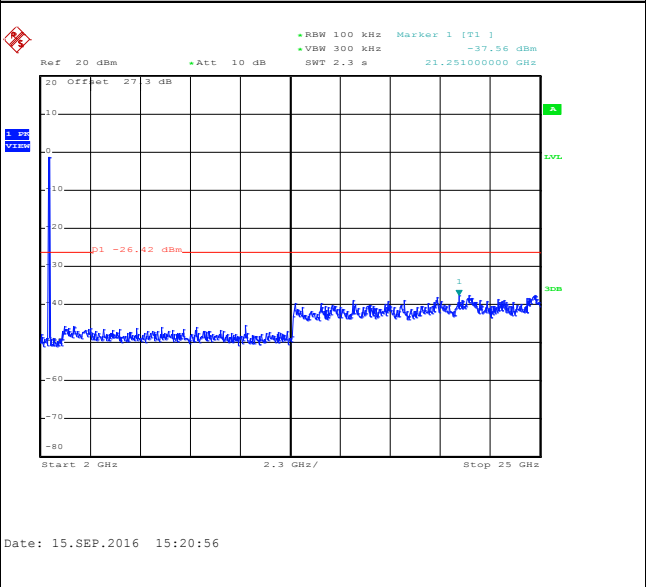



Number of TX :	2	Ant. :	2
Test Mode :	802.11ac VHT20	Temperature :	21~25°C
Test Band :	2.4GHz Mid	Relative Humidity :	51~54%
Test Channel :	06	Test Engineer :	AnAn Wu

WLAN 802.11ac VHT20 Channel 06

100kHz PSD reference Level

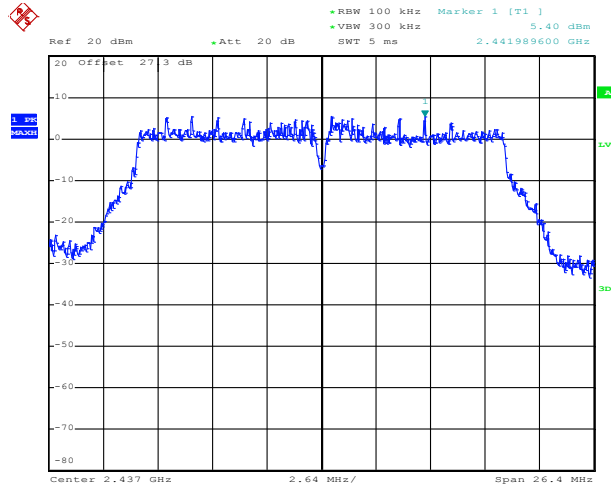

Date: 11.SEP.2016 11:32:08

Spurious Emission 30MHz~3GHz

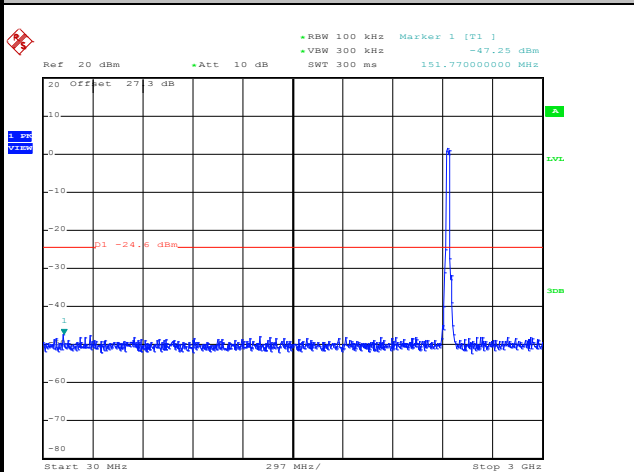

Date: 11.SEP.2016 11:33:01

Spurious Emission 2GHz~25GHz

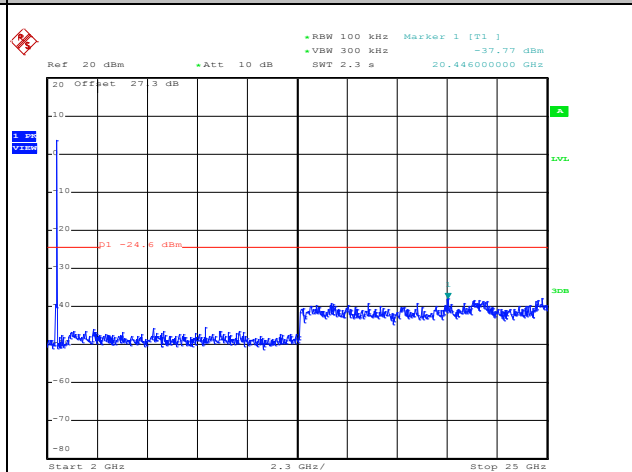

Date: 11.SEP.2016 11:33:09



Number of TX :	2	Ant. :	2
Test Mode :	802.11ac VHT20	Temperature :	21~25°C
Test Band :	2.4GHz High	Relative Humidity :	51~54%
Test Channel :	11	Test Engineer :	AnAn Wu

WLAN 802.11ac VHT20 Channel 11

100kHz PSD reference Level

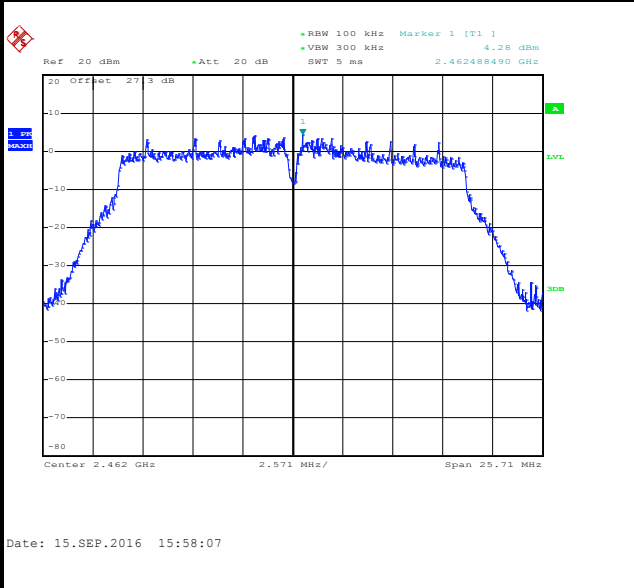

High Channel Plot

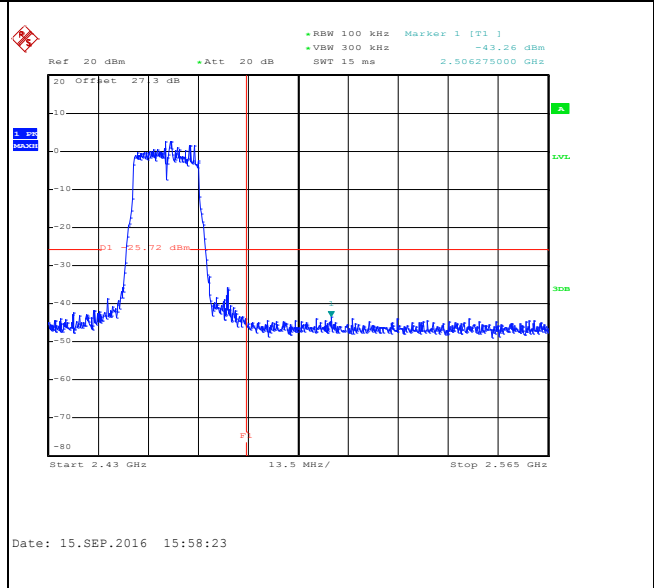

Spurious Emission 30MHz~3GHz

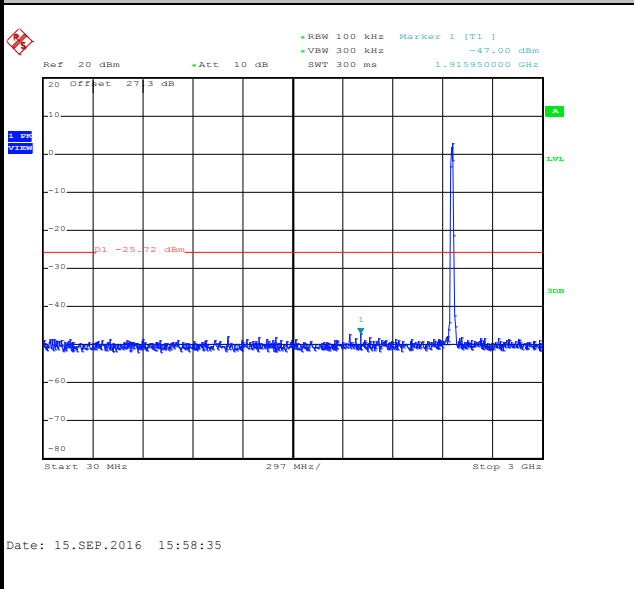

Spurious Emission 2GHz~25GHz

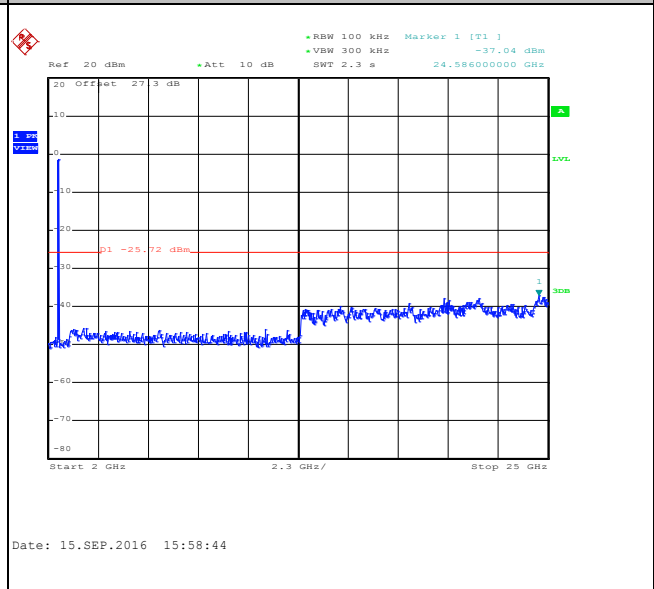



Number of TX :	2	Ant. :	2
Test Mode :	802.11ac VHT40	Temperature :	21~25°C
Test Band :	2.4GHz Low	Relative Humidity :	51~54%
Test Channel :	03	Test Engineer :	AnAn Wu

WLAN 802.11ac VHT40 Channel 03

100kHz PSD reference Level

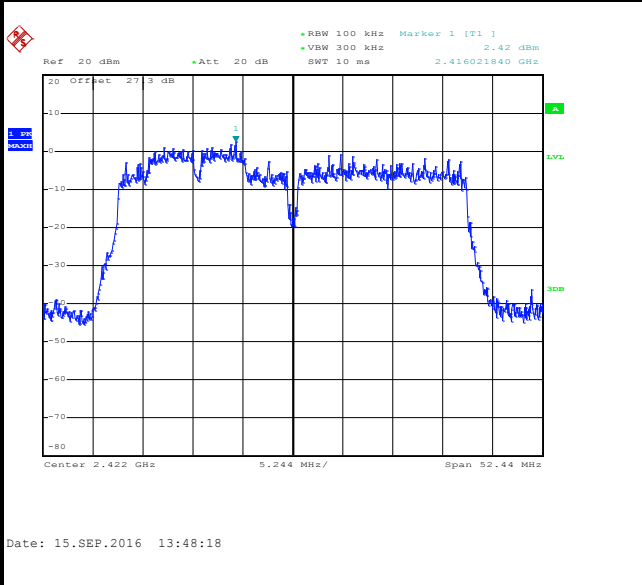

Low Channel Plot

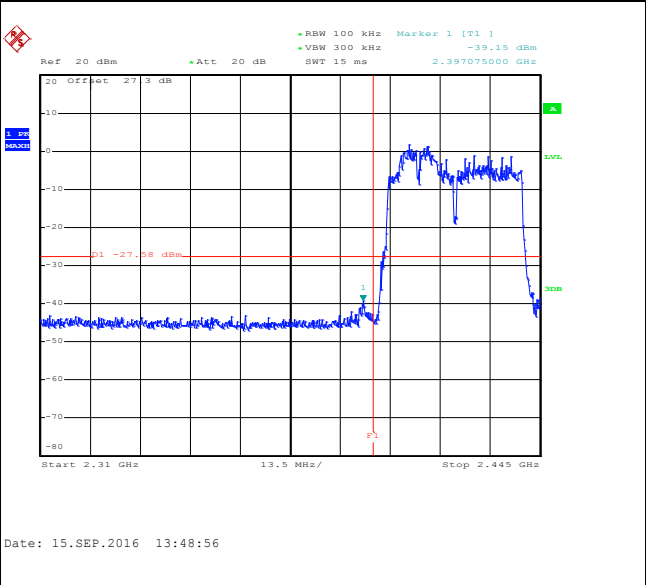

Spurious Emission 30MHz~3GHz

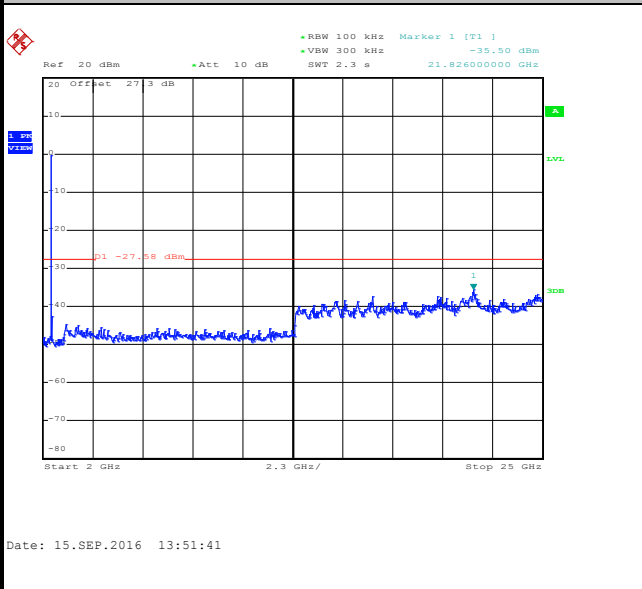

Spurious Emission 2GHz~25GHz

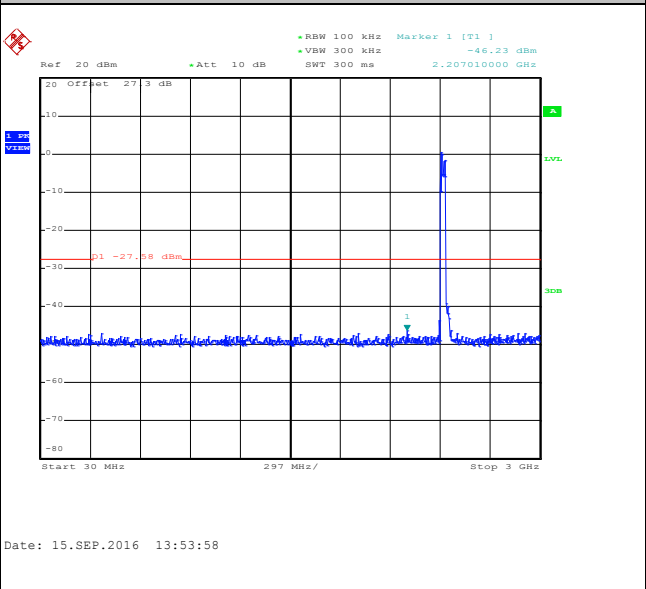



Number of TX :	2	Ant. :	2
Test Mode :	802.11ac VHT40	Temperature :	21~25°C
Test Band :	2.4GHz Mid	Relative Humidity :	51~54%
Test Channel :	06	Test Engineer :	AnAn Wu

WLAN 802.11ac VHT40 Channel 06

100kHz PSD reference Level

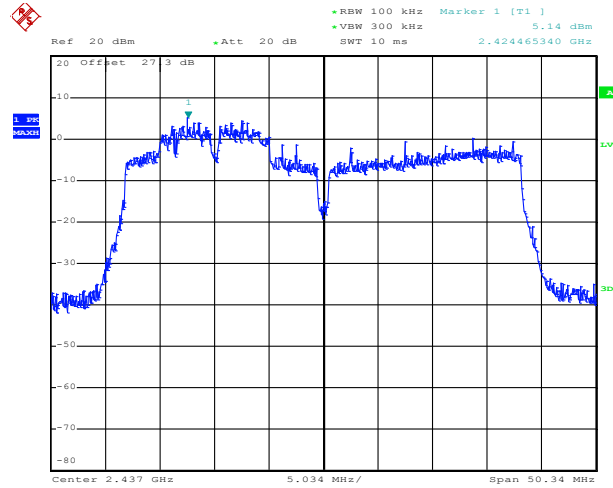

Date: 11.SEP.2016 13:24:41

Spurious Emission 30MHz~3GHz

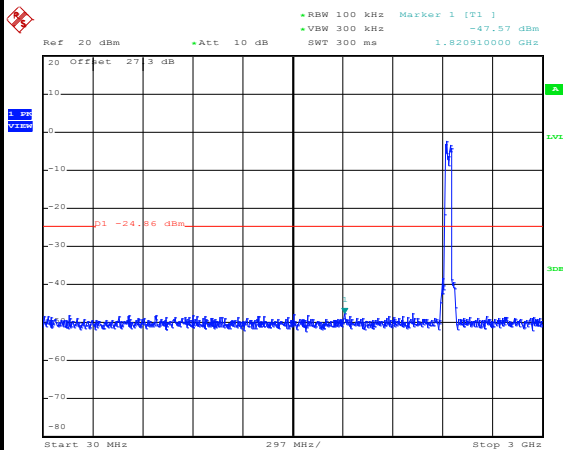

Date: 11.SEP.2016 13:30:46

Spurious Emission 2GHz~25GHz

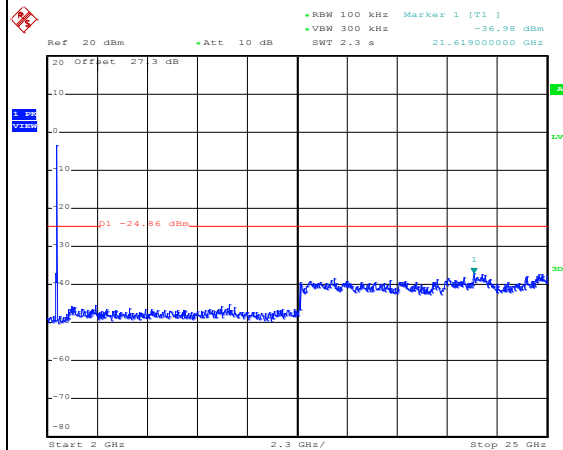

Date: 11.SEP.2016 13:33:00



Number of TX :	2	Ant. :	2
Test Mode :	802.11ac VHT40	Temperature :	21~25°C
Test Band :	2.4GHz High	Relative Humidity :	51~54%
Test Channel :	09	Test Engineer :	AnAn Wu

WLAN 802.11ac VHT40 Channel 09

100kHz PSD reference Level

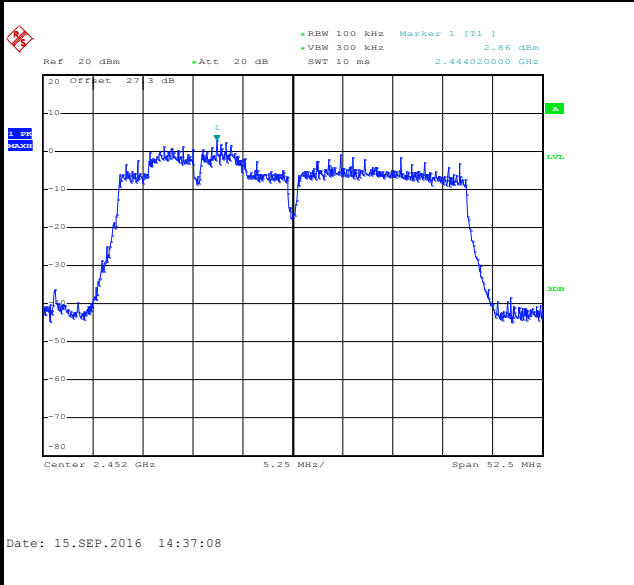

High Channel Plot

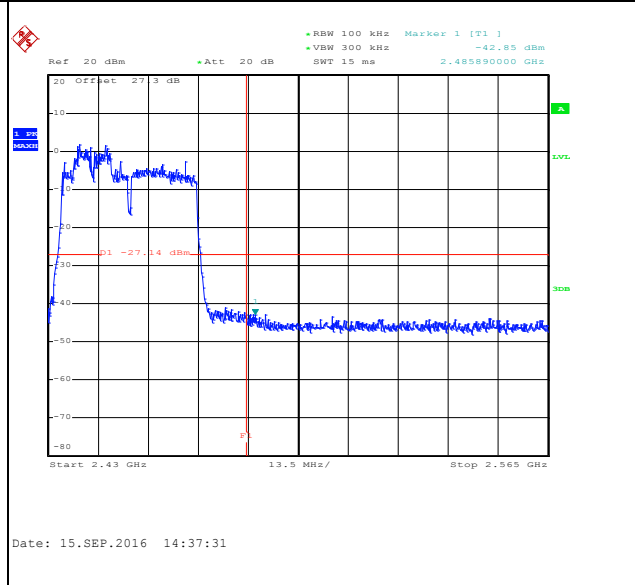

Spurious Emission 30MHz~3GHz

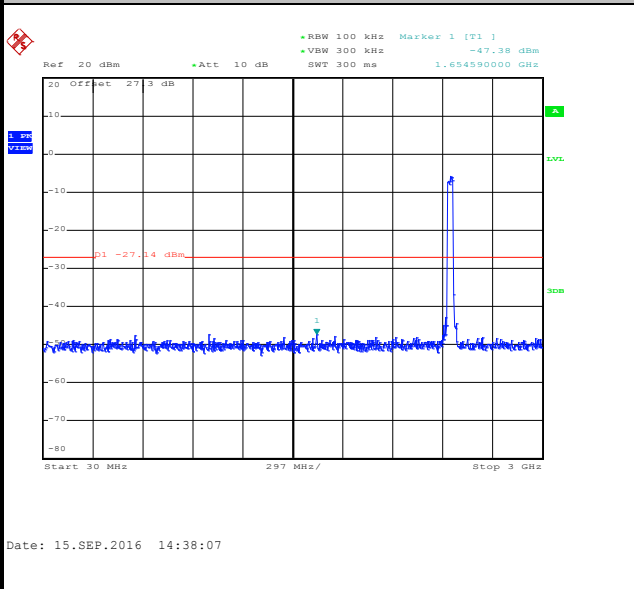

Spurious Emission 2GHz~25GHz

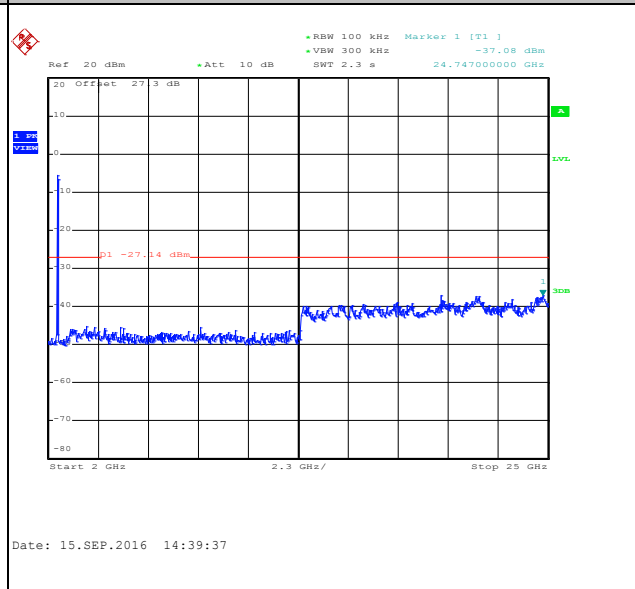



3.5 Radiated Band Edges and Spurious Emission Measurement

3.5.1 Limit of Radiated band edge and Spurious Emission Measurement

In any 100 kHz bandwidth outside the intentional radiator frequency band, all harmonics/spurious must be at least 20 dB below the highest emission level within the authorized band. If the output power of this device was measured by spectrum analyzer, the attenuation under this paragraph shall be 30 dB instead of 20 dB. In addition, radiated emissions which fall in the restricted bands must also comply with the FCC section 15.209 limits as below.

Frequency (MHz)	Field Strength (microvolts/meter)	Measurement Distance (meters)
0.009 – 0.490	2400/F(kHz)	300
0.490 – 1.705	24000/F(kHz)	30
1.705 – 30.0	30	30
30 – 88	100	3
88 – 216	150	3
216 - 960	200	3
Above 960	500	3

3.5.2 Measuring Instruments

The measuring equipment is listed in the section 4 of this test report.



3.5.3 Test Procedures

1. The testing follows FCC KDB Publication No. 558074 D01 DTS Meas. Guidance v03r05.
2. The EUT was arranged to its worst case and then tune the antenna tower (from 1 m to 4 m) and turntable (from 0 degree to 360 degrees) to find the maximum reading. A pre-amp and a high pass filter are used for the test in order to get better signal level.
3. The EUT was placed on a turntable with 0.8 meter for frequency below 1GHz and 1.5 meter for frequency above 1GHz respectively above ground.
4. The EUT was set 3 meters from the interference receiving antenna, which was mounted on the top of a variable height antenna tower.
5. Corrected Reading: Antenna Factor + Cable Loss + Read Level - Preamp Factor = Level
6. For measurement below 1GHz, If the emission level of the EUT measured by the peak detector is 3 dB lower than the applicable limit, the peak emission level will be reported. Otherwise, the emission measurement will be repeated using the quasi-peak detector and reported.
7. Use the following spectrum analyzer settings:
 - (1) Span shall wide enough to fully capture the emission being measured;
 - (2) Set RBW=100 kHz for $f < 1$ GHz; VBW \geq RBW; Sweep = auto; Detector function = peak; Trace = max hold;
 - (3) Set RBW = 1 MHz, VBW= 3MHz for $f \geq 1$ GHz for peak measurement.
For average measurement:
 - VBW = 10 Hz, when duty cycle is no less than 98 percent.
 - VBW $\geq 1/T$, when duty cycle is less than 98 percent where T is the minimum transmission duration over which the transmitter is on and is transmitting at its maximum power control level for the tested mode of operation.

3.5.4 Test Setup

For radiated emissions below 30MHz

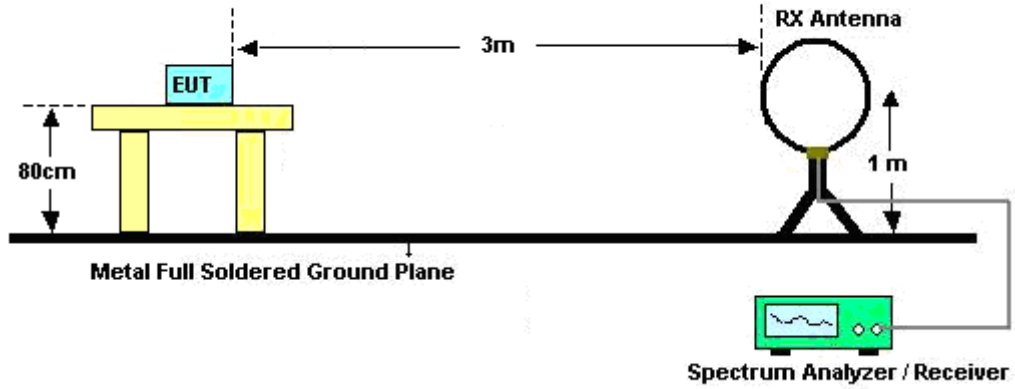

For radiated emissions from 30MHz to 1GHz

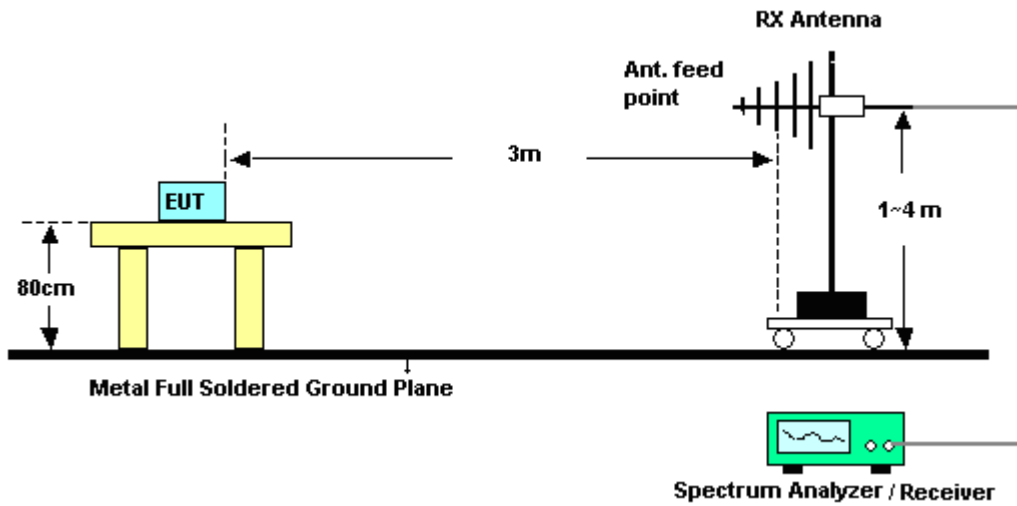

For radiated emissions above 1GHz

<CDD Modes>

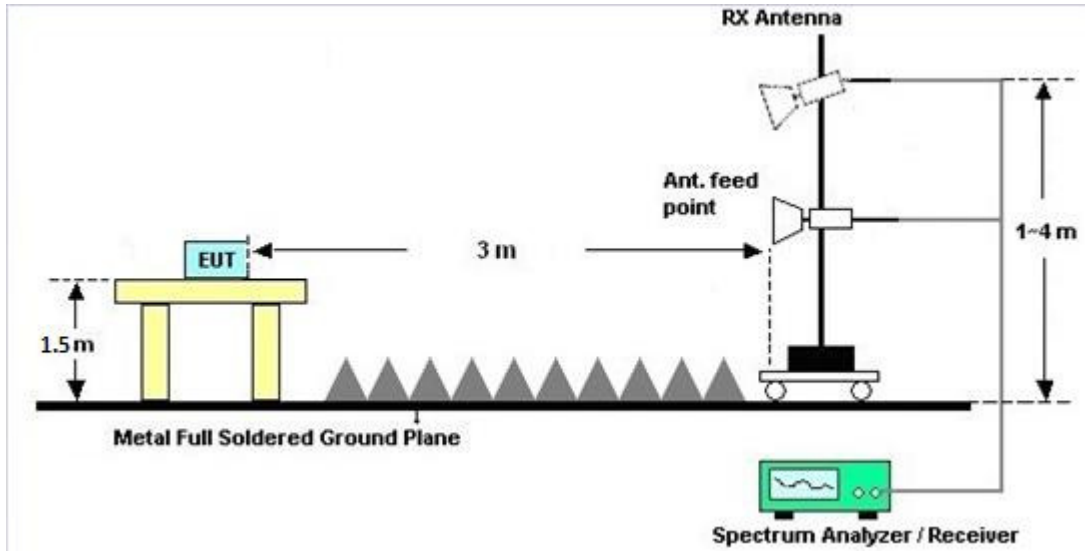

<TXBF Modes>

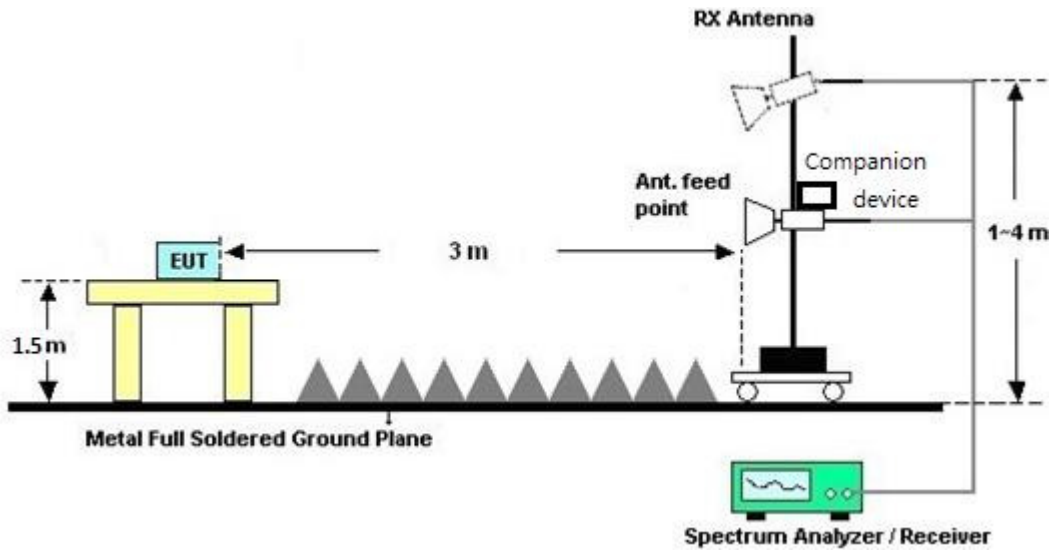



3.5.5 Test Results of Radiated Spurious Emissions (9kHz ~ 30MHz)

The low frequency, which started from 9 kHz to 30MHz, was pre-scanned and the result which was 20dB lower than the limit line per 15.31(o) was not reported.

3.5.6 Test Result of Radiated Spurious at Band Edges

Please refer to Appendix B and C.

3.5.7 Duty Cycle

Please refer to Appendix D.

3.5.8 Test Result of Radiated Spurious Emission (30MHz ~ 10th Harmonic)

Please refer to Appendix B and C.



3.6 AC Conducted Emission Measurement

3.6.1 Limit of AC Conducted Emission

For equipment that is designed to be connected to the public utility (AC) power line, the radio frequency voltage that is conducted back onto the AC power line on any frequency or frequencies within the band 150 kHz to 30 MHz shall not exceed the limits in the following table.

Frequency of Emission (MHz)	Conducted Limit (dBµV)	
	Quasi-Peak	Average
0.15-0.5	66 to 56*	56 to 46*
0.5-5	56	46
5-30	60	50

*Decreases with the logarithm of the frequency.

For terminal test result, the testing follows FCC KDB 174176.

3.6.2 Measuring Instruments

The measuring equipment is listed in the section 4 of this test report.

3.6.3 Test Procedures

1. The EUT was placed 0.4 meter from the conducting wall of the shielding room, and it was kept at least 80 centimeters from any other grounded conducting surface.
2. Connect EUT to the power mains through a line impedance stabilization network (LISN).
3. All the support units are connecting to the other LISN.
4. The LISN provides 50 ohm coupling impedance for the measuring instrument.
5. The FCC states that a 50 ohm, 50 microhenry LISN should be used.
6. Both sides of AC line were checked for maximum conducted interference.
7. The frequency range from 150 kHz to 30 MHz was searched.
8. Set the test-receiver system to Peak Detect Function and specified bandwidth (IF bandwidth = 9kHz) with Maximum Hold Mode.

3.6.4 Test Setup

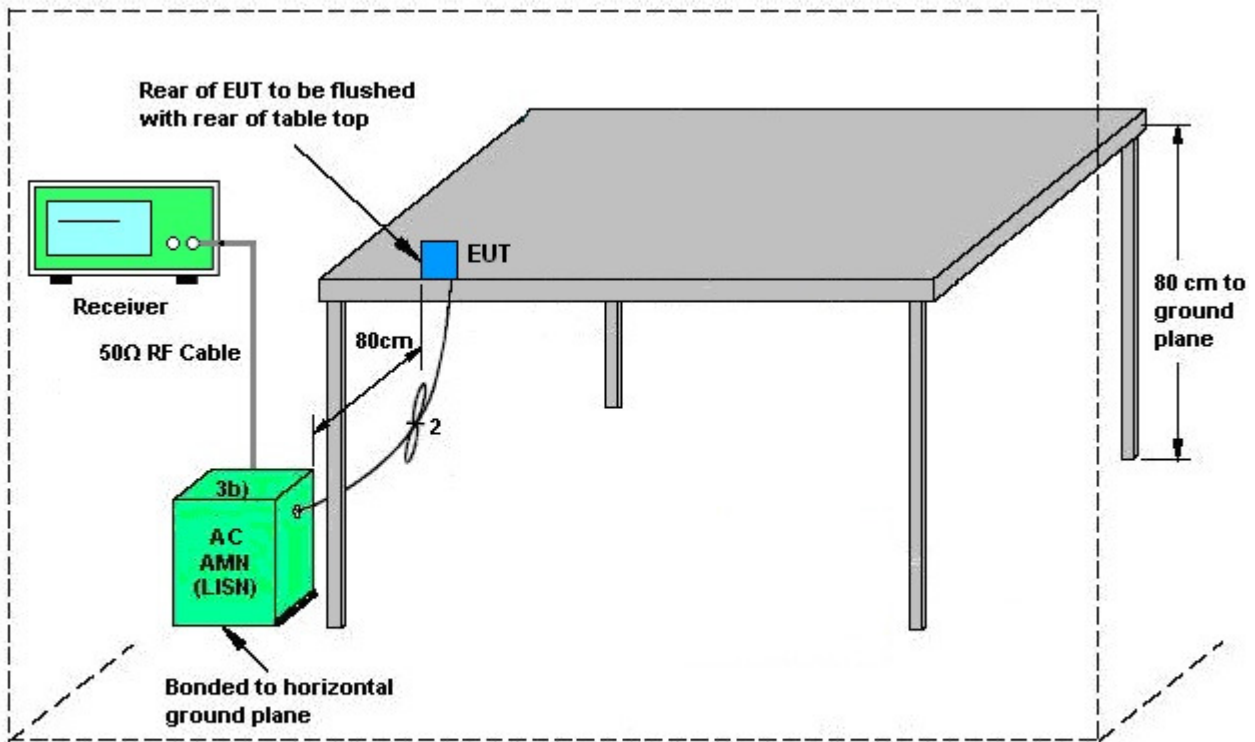

AMN = Artificial mains network (LISN)
AE = Associated equipment
EUT = Equipment under test
ISN = Impedance stabilization network



3.6.5 Test Result of AC Conducted Emission

<Original test result with NFC antenna>

Test Mode :	Mode 1	Temperature :	22~24°C
Test Engineer :	Arthur Hsieh	Relative Humidity :	51~53%
Test Voltage :	120Vac / 60Hz	Phase :	Line
Function Type :	NFC Link + WLAN (2.4GHz) Link + Bluetooth Link + Earphone 1 with Audio Adapter connect to EUT + Charging Only Cable + AC Adapter		

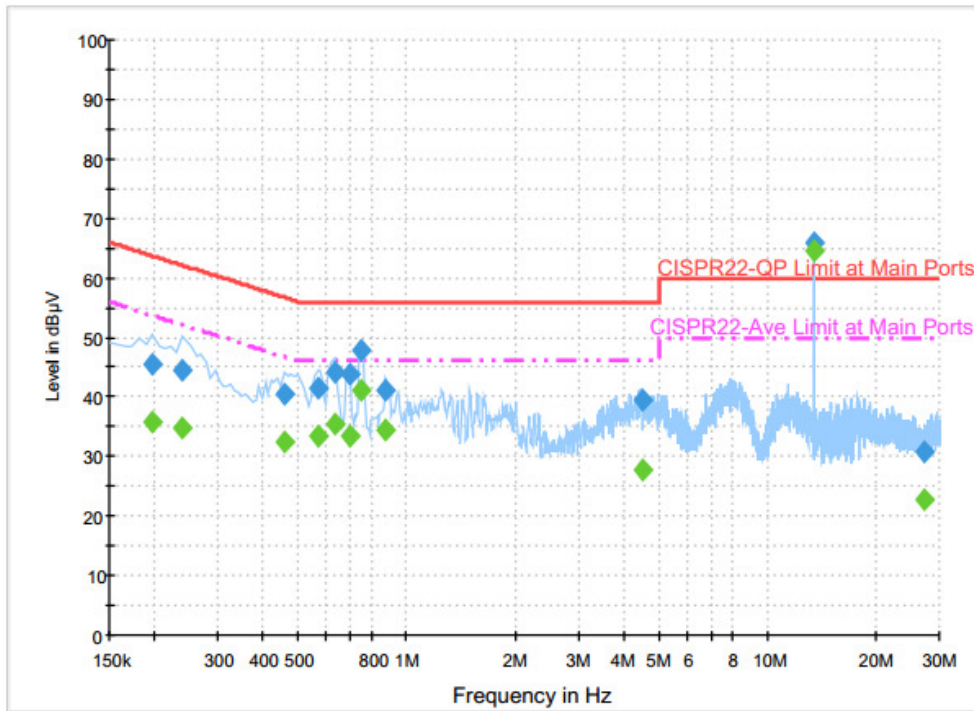

Final Result : Quasi-Peak

Frequency (MHz)	Quasi-Peak (dBµV)	Filter	Line	Corr. (dB)	Margin (dB)	Limit (dBµV)
0.198000	45.5	Off	L1	19.6	18.2	63.7
0.238000	44.4	Off	L1	19.6	17.8	62.2
0.462000	40.5	Off	L1	19.6	16.2	56.7
0.566000	41.4	Off	L1	19.6	14.6	56.0
0.630000	44.1	Off	L1	19.6	11.9	56.0
0.694000	43.8	Off	L1	19.6	12.2	56.0
0.750000	48.0	Off	L1	19.6	8.0	56.0
0.878000	41.2	Off	L1	19.6	14.8	56.0
4.534000	39.3	Off	L1	19.7	16.7	56.0
13.558000	65.9	Off	L1	19.8	-5.9	60.0
27.118000	30.9	Off	L1	19.9	29.1	60.0



Test Mode :	Mode 1	Temperature :	22~24°C
Test Engineer :	Arthur Hsieh	Relative Humidity :	51~53%
Test Voltage :	120Vac / 60Hz	Phase :	Line
Function Type :	NFC Link + WLAN (2.4GHz) Link + Bluetooth Link + Earphone 1 with Audio Adapter connect to EUT + Charging Only Cable + AC Adapter		

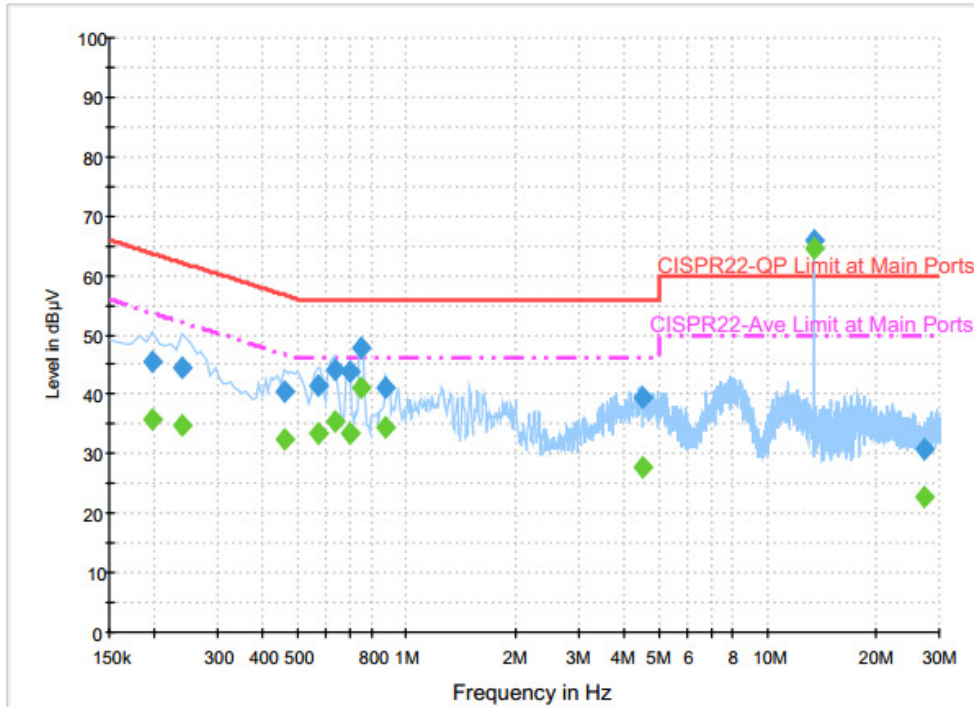

Final Result : Average

Frequency (MHz)	Average (dBµV)	Filter	Line	Corr. (dB)	Margin (dB)	Limit (dBµV)
0.198000	35.7	Off	L1	19.6	18.0	53.7
0.238000	34.7	Off	L1	19.6	17.5	52.2
0.462000	32.3	Off	L1	19.6	14.4	46.7
0.566000	33.4	Off	L1	19.6	12.6	46.0
0.630000	35.3	Off	L1	19.6	10.7	46.0
0.694000	33.6	Off	L1	19.6	12.4	46.0
0.750000	41.1	Off	L1	19.6	4.9	46.0
0.878000	34.4	Off	L1	19.6	11.6	46.0
4.534000	27.8	Off	L1	19.7	18.2	46.0
13.558000	64.6	Off	L1	19.8	-14.6	50.0
27.118000	22.6	Off	L1	19.9	27.4	50.0



Test Mode :	Mode 1	Temperature :	22~24°C
Test Engineer :	Arthur Hsieh	Relative Humidity :	51~53%
Test Voltage :	120Vac / 60Hz	Phase :	Neutral
Function Type :	NFC Link + WLAN (2.4GHz) Link + Bluetooth Link + Earphone 1 with Audio Adapter connect to EUT + Charging Only Cable + AC Adapter		

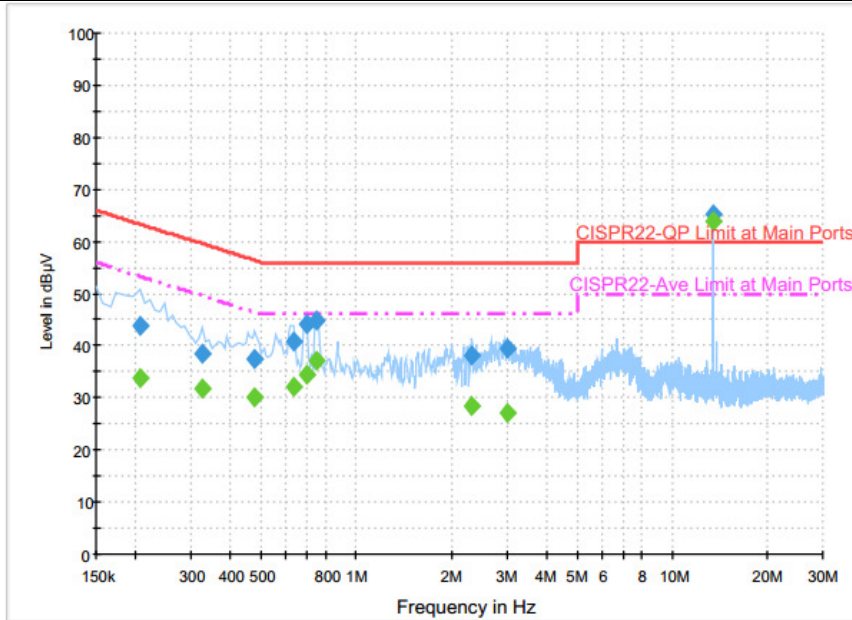

Final Result : Quasi-Peak

Frequency (MHz)	Quasi-Peak (dBµV)	Filter	Line	Corr. (dB)	Margin (dB)	Limit (dBµV)
0.206000	44.0	Off	N	19.6	19.4	63.4
0.326000	38.6	Off	N	19.6	21.0	59.6
0.478000	37.6	Off	N	19.6	18.8	56.4
0.630000	40.9	Off	N	19.6	15.1	56.0
0.694000	44.2	Off	N	19.6	11.8	56.0
0.750000	44.7	Off	N	19.6	11.3	56.0
2.326000	38.1	Off	N	18.6	17.9	56.0
3.022000	39.3	Off	N	19.5	16.7	56.0
13.558000	65.3	Off	N	19.8	-5.3	60.0

Final Result : Average

Frequency (MHz)	Average (dBµV)	Filter	Line	Corr. (dB)	Margin (dB)	Limit (dBµV)
0.206000	33.9	Off	N	19.6	19.5	53.4
0.326000	31.8	Off	N	19.6	17.8	49.6
0.478000	30.1	Off	N	19.6	16.3	46.4
0.630000	31.9	Off	N	19.6	14.1	46.0
0.694000	34.5	Off	N	19.6	11.5	46.0
0.750000	37.1	Off	N	19.6	8.9	46.0
2.326000	28.4	Off	N	18.6	17.6	46.0
3.022000	27.2	Off	N	19.5	18.8	46.0
13.558000	63.8	Off	N	19.8	-13.8	50.0



<Terminal test result with dummy load>

Test Mode :	Mode 1	Temperature :	22~24°C
Test Engineer :	Arthur Hsieh	Relative Humidity :	51~53%
Test Voltage :	120Vac / 60Hz	Phase :	Line
Function Type :	NFC Link + WLAN (2.4GHz) Link + Bluetooth Link + Earphone 1 with Audio Adapter connect to EUT + Charging Only Cable + AC Adapter		

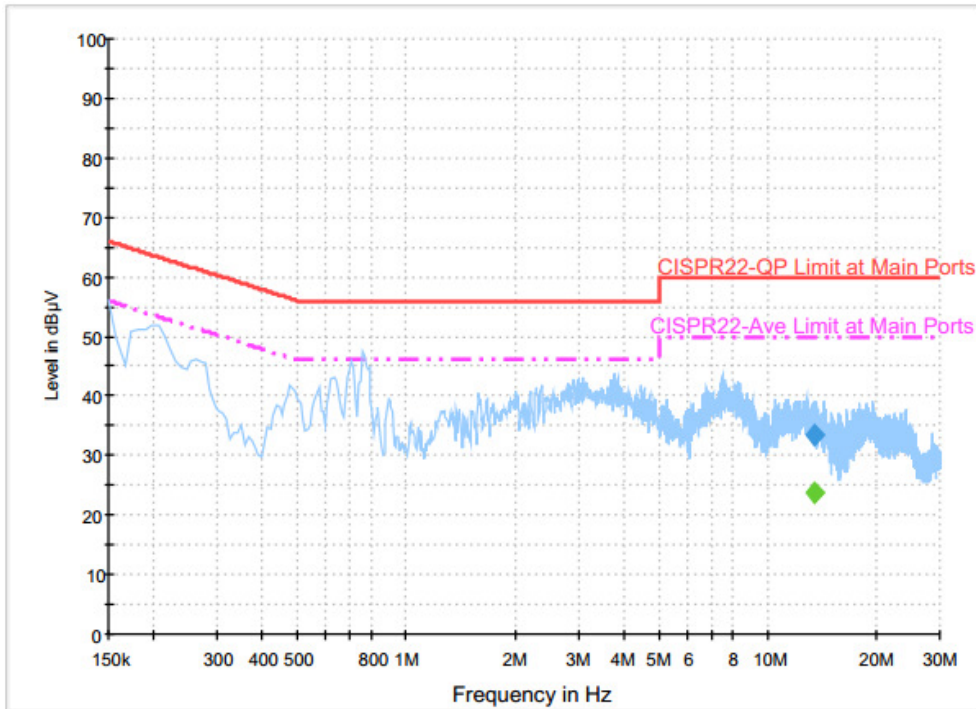

Final Result : Quasi-Peak

Frequency (MHz)	Quasi-Peak (dBµV)	Filter	Line	Corr. (dB)	Margin (dB)	Limit (dBµV)
13.558000	33.5	Off	L1	19.8	26.5	60.0

Final Result : Average

Frequency (MHz)	Average (dBµV)	Filter	Line	Corr. (dB)	Margin (dB)	Limit (dBµV)
13.558000	23.6	Off	L1	19.8	26.4	50.0



Test Mode :	Mode 1	Temperature :	22~24°C
Test Engineer :	Arthur Hsieh	Relative Humidity :	51~53%
Test Voltage :	120Vac / 60Hz	Phase :	Neutral
Function Type :	NFC Link + WLAN (2.4GHz) Link + Bluetooth Link + Earphone 1 with Audio Adapter connect to EUT + Charging Only Cable + AC Adapter		

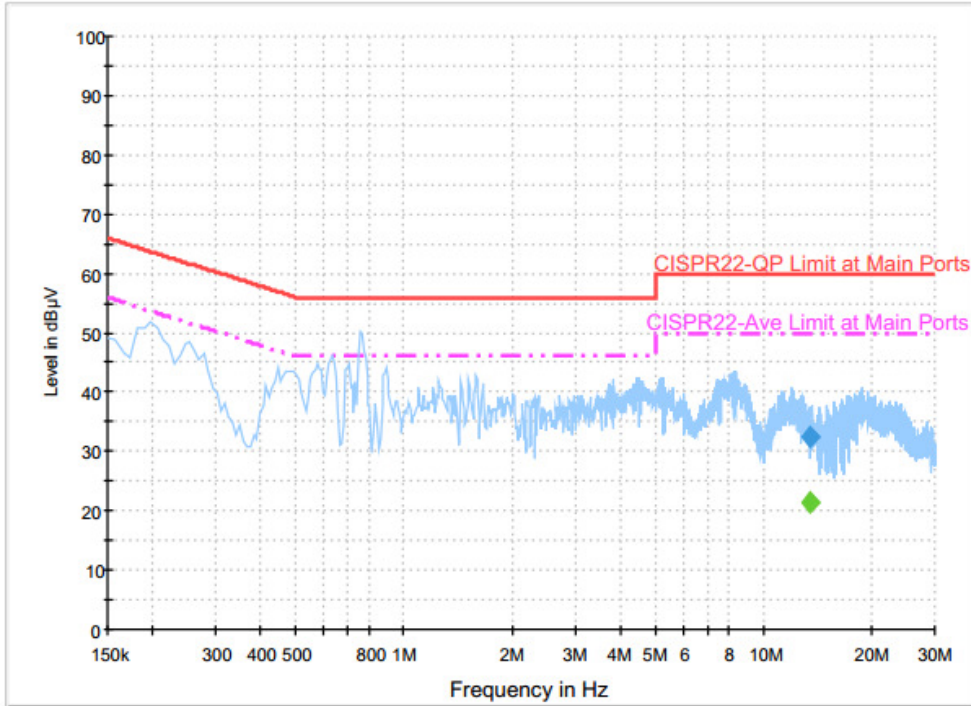

Final Result : Quasi-Peak

Frequency (MHz)	Quasi-Peak (dBµV)	Filter	Line	Corr. (dB)	Margin (dB)	Limit (dBµV)
13.558000	32.3	Off	N	19.8	27.7	60.0

Final Result : Average

Frequency (MHz)	Average (dBµV)	Filter	Line	Corr. (dB)	Margin (dB)	Limit (dBµV)
13.558000	21.5	Off	N	19.8	28.5	50.0



<Original test result with NFC antenna>

Test Mode :	Mode 2	Temperature :	22~24°C
Test Engineer :	Arthur Hsieh	Relative Humidity :	51~53%
Test Voltage :	120Vac / 60Hz	Phase :	Line
Function Type :	NFC Link + WLAN (5GHz) Link + Bluetooth Link with Earphone 3 + Snap on USB Cable Data Link with Notebook + Copy Data from Notebook to EDA (SD Card) + AC Adapter		

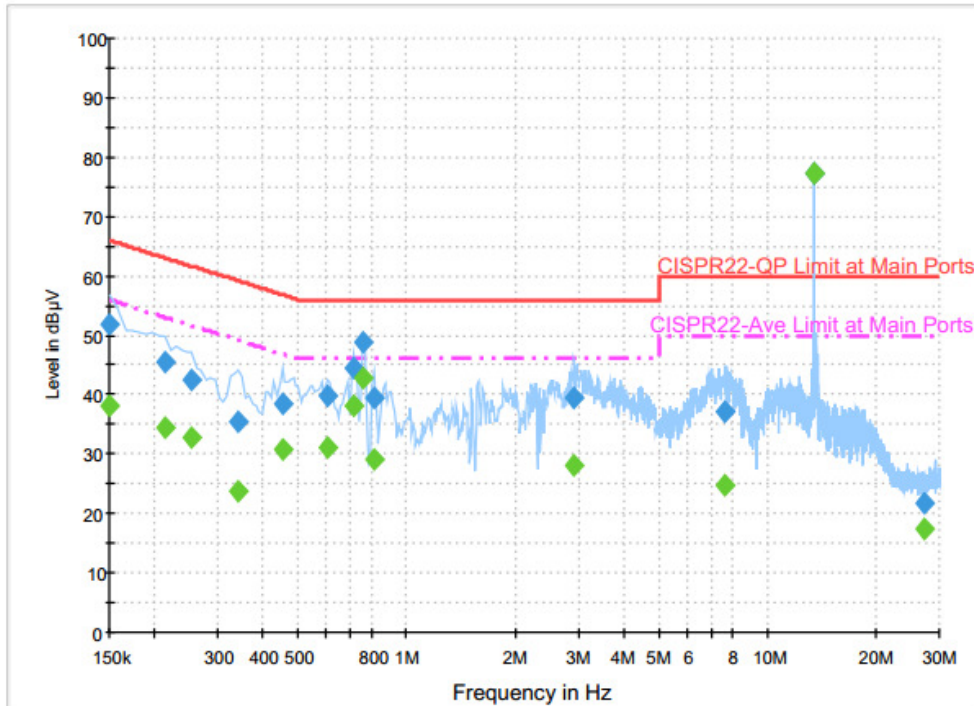

Final Result : Quasi-Peak

Frequency (MHz)	Quasi-Peak (dBµV)	Filter	Line	Corr. (dB)	Margin (dB)	Limit (dBµV)
0.150000	51.9	Off	L1	19.6	14.1	66.0
0.214000	45.6	Off	L1	19.6	17.4	63.0
0.254000	42.6	Off	L1	19.6	19.0	61.6
0.342000	35.4	Off	L1	19.6	23.8	59.2
0.454000	38.5	Off	L1	19.6	18.3	56.8
0.606000	39.8	Off	L1	19.6	16.2	56.0
0.710000	44.4	Off	L1	19.6	11.6	56.0
0.758000	48.8	Off	L1	19.6	7.2	56.0
0.814000	39.6	Off	L1	19.6	16.4	56.0
2.918000	39.6	Off	L1	19.5	16.4	56.0
7.654000	37.2	Off	L1	19.7	22.8	60.0
13.558000	77.4	Off	L1	19.8	-17.4	60.0
27.118000	21.9	Off	L1	19.9	38.1	60.0



Test Mode :	Mode 2	Temperature :	22~24°C
Test Engineer :	Arthur Hsieh	Relative Humidity :	51~53%
Test Voltage :	120Vac / 60Hz	Phase :	Line
Function Type :	NFC Link + WLAN (5GHz) Link + Bluetooth Link with Earphone 3 + Snap on USB Cable Data Link with Notebook + Copy Data from Notebook to EDA (SD Card) + AC Adapter		

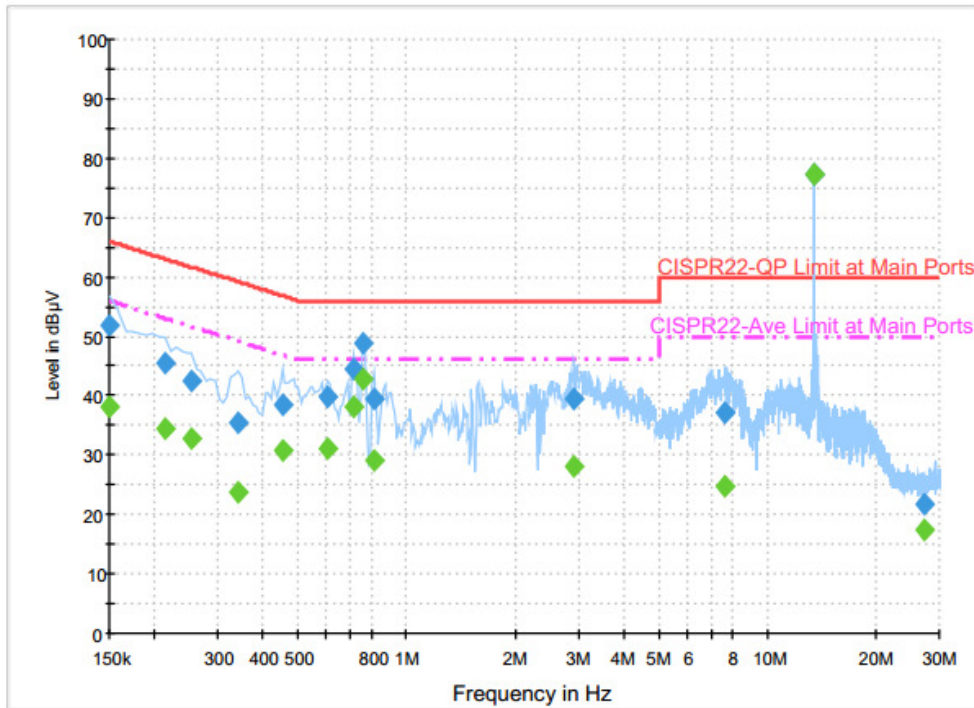

Final Result : Average

Frequency (MHz)	Average (dBµV)	Filter	Line	Corr. (dB)	Margin (dB)	Limit (dBµV)
0.150000	38.3	Off	L1	19.6	17.7	56.0
0.214000	34.5	Off	L1	19.6	18.5	53.0
0.254000	32.9	Off	L1	19.6	18.7	51.6
0.342000	23.8	Off	L1	19.6	25.4	49.2
0.454000	30.8	Off	L1	19.6	16.0	46.8
0.606000	31.1	Off	L1	19.6	14.9	46.0
0.710000	38.2	Off	L1	19.6	7.8	46.0
0.758000	42.9	Off	L1	19.6	3.1	46.0
0.814000	29.1	Off	L1	19.6	16.9	46.0
2.918000	28.1	Off	L1	19.5	17.9	46.0
7.654000	24.6	Off	L1	19.7	25.4	50.0
13.558000	77.1	Off	L1	19.8	-27.1	50.0
27.118000	17.3	Off	L1	19.9	32.7	50.0



Test Mode :	Mode 2	Temperature :	22~24°C
Test Engineer :	Arthur Hsieh	Relative Humidity :	51~53%
Test Voltage :	120Vac / 60Hz	Phase :	Neutral
Function Type :	NFC Link + WLAN (5GHz) Link + Bluetooth Link with Earphone 3 + Snap on USB Cable Data Link with Notebook + Copy Data from Notebook to EDA (SD Card) + AC Adapter		

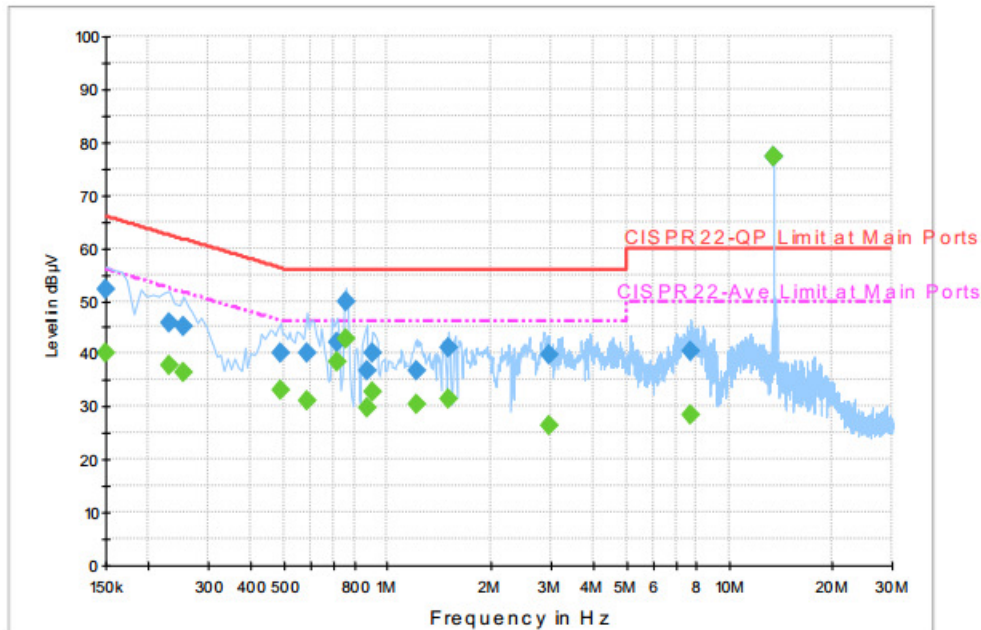

Final Result : Quasi-Peak

Frequency (MHz)	Quasi-Peak (dBµV)	Filter	Line	Corr. (dB)	Margin (dB)	Limit (dBµV)
0.150000	52.0	Off	N	19.6	14.0	66.0
0.230000	45.9	Off	N	19.6	16.5	62.4
0.254000	45.3	Off	N	19.6	16.3	61.6
0.486000	40.2	Off	N	19.6	16.0	56.2
0.582000	40.1	Off	N	19.6	15.9	56.0
0.710000	42.1	Off	N	19.6	13.9	56.0
0.758000	49.8	Off	N	19.6	6.2	56.0
0.870000	36.7	Off	N	19.6	19.3	56.0
0.910000	40.1	Off	N	19.6	15.9	56.0
1.214000	36.9	Off	N	19.6	19.1	56.0
1.510000	41.0	Off	N	19.6	15.0	56.0
2.974000	39.7	Off	N	19.5	16.3	56.0
7.734000	40.3	Off	N	19.7	19.7	60.0
13.558000	77.4	Off	N	19.8	-17.4	60.0



Test Mode :	Mode 2	Temperature :	22~24°C
Test Engineer :	Arthur Hsieh	Relative Humidity :	51~53%
Test Voltage :	120Vac / 60Hz	Phase :	Neutral
Function Type :	NFC Link + WLAN (5GHz) Link + Bluetooth Link with Earphone 3 + Snap on USB Cable Data Link with Notebook + Copy Data from Notebook to EDA (SD Card) + AC Adapter		

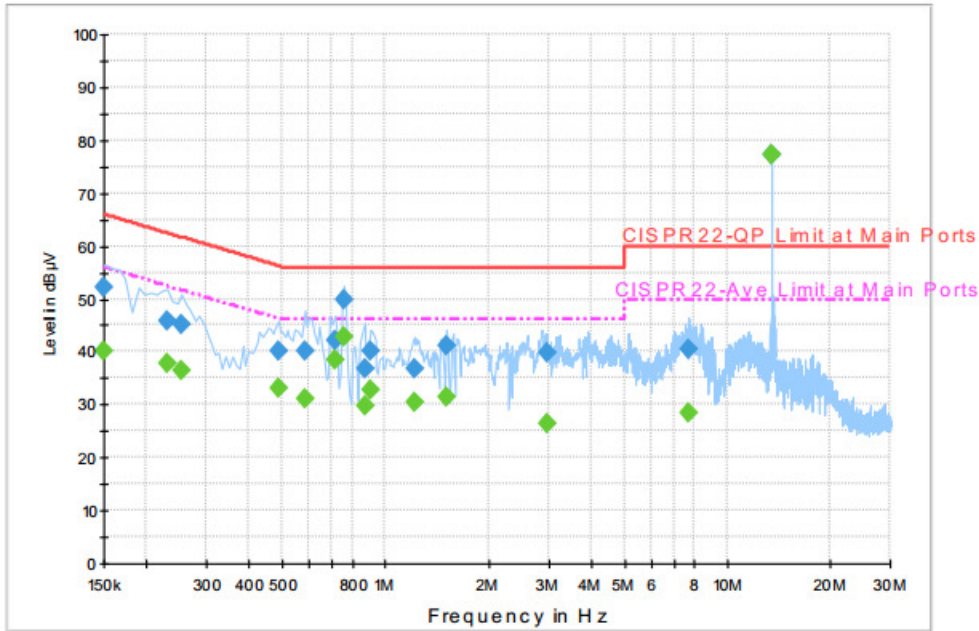

Final Result : Average

Frequency (MHz)	Average (dBµV)	Filter	Line	Corr. (dB)	Margin (dB)	Limit (dBµV)
0.150000	40.1	Off	N	19.6	15.9	56.0
0.230000	37.7	Off	N	19.6	14.7	52.4
0.254000	36.3	Off	N	19.6	15.3	51.6
0.486000	33.1	Off	N	19.6	13.1	46.2
0.582000	31.0	Off	N	19.6	15.0	46.0
0.710000	38.3	Off	N	19.6	7.7	46.0
0.758000	42.8	Off	N	19.6	3.2	46.0
0.870000	29.8	Off	N	19.6	16.2	46.0
0.910000	32.7	Off	N	19.6	13.3	46.0
1.214000	30.3	Off	N	19.6	15.7	46.0
1.510000	31.4	Off	N	19.6	14.6	46.0
2.974000	26.4	Off	N	19.5	19.6	46.0
7.734000	28.3	Off	N	19.7	21.7	50.0
13.558000	77.2	Off	N	19.8	-27.2	50.0



<Terminal test result with dummy load>

Test Mode :	Mode 2	Temperature :	22~24°C
Test Engineer :	Arthur Hsieh	Relative Humidity :	51~53%
Test Voltage :	120Vac / 60Hz	Phase :	Line
Function Type :	NFC Link + WLAN (5GHz) Link + Bluetooth Link with Earphone 3 + Snap on USB Cable Data Link with Notebook + Copy Data from Notebook to EDA (SD Card) + AC Adapter		

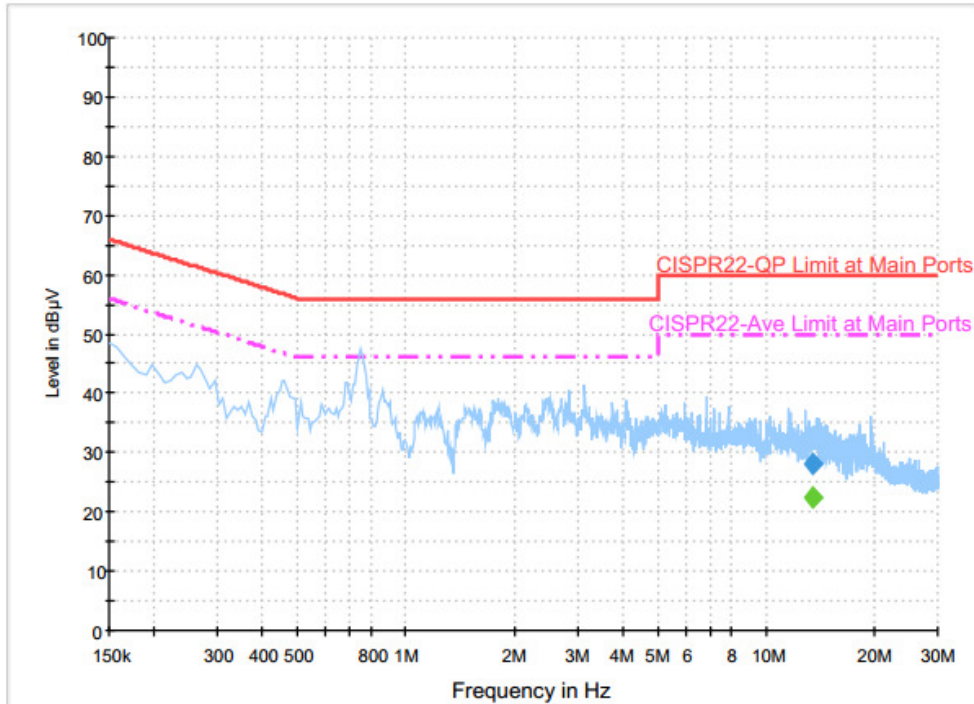

Final Result : Quasi-Peak

Frequency (MHz)	Quasi-Peak (dBµV)	Filter	Line	Corr. (dB)	Margin (dB)	Limit (dBµV)
13.558000	28.2	Off	L1	19.8	31.8	60.0

Final Result : Average

Frequency (MHz)	Average (dBµV)	Filter	Line	Corr. (dB)	Margin (dB)	Limit (dBµV)
13.558000	22.5	Off	L1	19.8	27.5	50.0



Test Mode :	Mode 2	Temperature :	22~24°C
Test Engineer :	Arthur Hsieh	Relative Humidity :	51~53%
Test Voltage :	120Vac / 60Hz	Phase :	Neutral
Function Type :	NFC Link + WLAN (5GHz) Link + Bluetooth Link with Earphone 3 + Snap on USB Cable Data Link with Notebook + Copy Data from Notebook to EDA (SD Card) + AC Adapter		

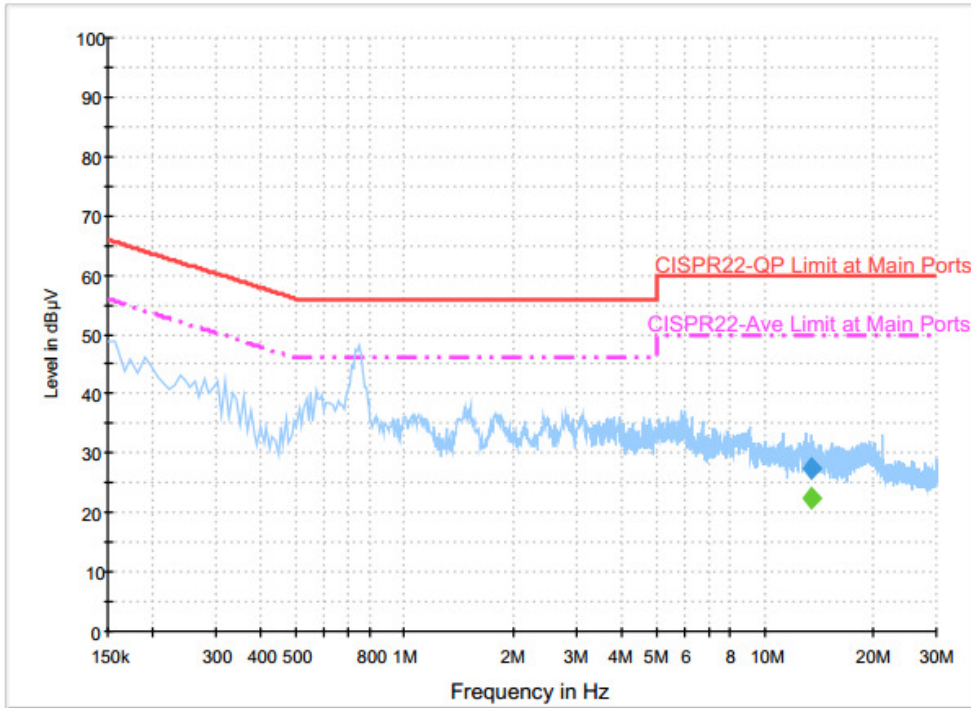

Final Result : Quasi-Peak

Frequency (MHz)	Quasi-Peak (dBµV)	Filter	Line	Corr. (dB)	Margin (dB)	Limit (dBµV)
13.558000	27.4	Off	N	19.8	32.6	60.0

Final Result : Average

Frequency (MHz)	Average (dBµV)	Filter	Line	Corr. (dB)	Margin (dB)	Limit (dBµV)
13.558000	22.4	Off	N	19.8	27.6	50.0



<Original test result with NFC antenna>

Test Mode :	Mode 3	Temperature :	22~24°C
Test Engineer :	Arthur Hsieh	Relative Humidity :	51~53%
Test Voltage :	120Vac / 60Hz	Phase :	Line
Function Type :	NFC Link + WLAN (2.4GHz) Link + Bluetooth Link + Earphone 2 with Audio Adapter connect to EUT + Charging Only Cable + AC Adapter		

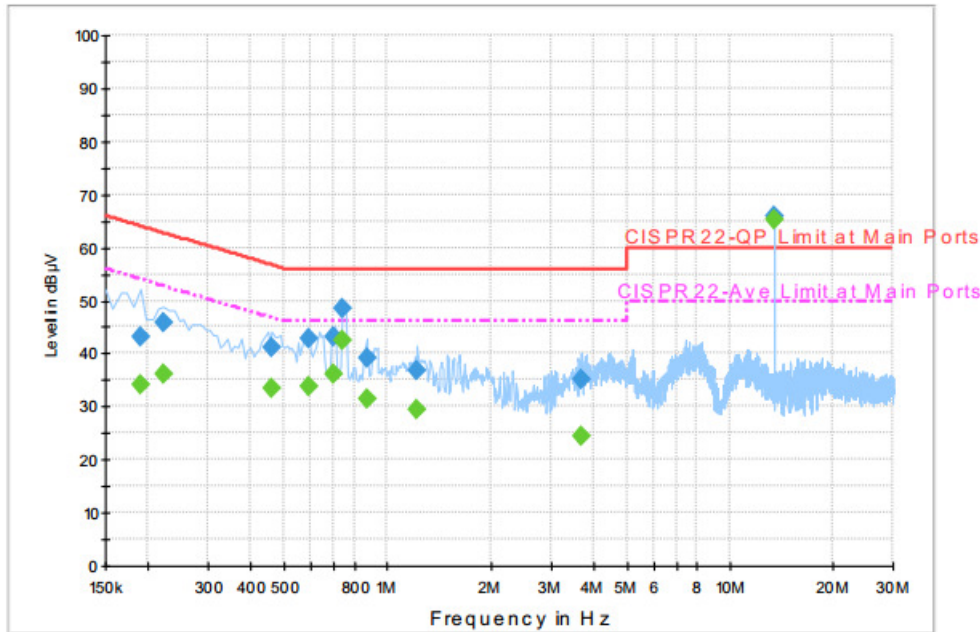

Final Result : Quasi-Peak

Frequency (MHz)	Quasi-Peak (dBµV)	Filter	Line	Corr. (dB)	Margin (dB)	Limit (dBµV)
0.190000	43.2	Off	L1	19.6	20.8	64.0
0.222000	45.8	Off	L1	19.6	16.9	62.7
0.462000	41.2	Off	L1	19.6	15.5	56.7
0.590000	42.7	Off	L1	19.6	13.3	56.0
0.694000	43.2	Off	L1	19.6	12.8	56.0
0.742000	48.5	Off	L1	19.6	7.5	56.0
0.870000	39.2	Off	L1	19.6	16.8	56.0
1.222000	36.6	Off	L1	19.6	19.4	56.0
3.702000	35.1	Off	L1	19.7	20.9	56.0
13.558000	65.8	Off	L1	19.8	-5.8	60.0



Test Mode :	Mode 3	Temperature :	22~24°C
Test Engineer :	Arthur Hsieh	Relative Humidity :	51~53%
Test Voltage :	120Vac / 60Hz	Phase :	Line
Function Type :	NFC Link + WLAN (2.4GHz) Link + Bluetooth Link + Earphone 2 with Audio Adapter connect to EUT + Charging Only Cable + AC Adapter		

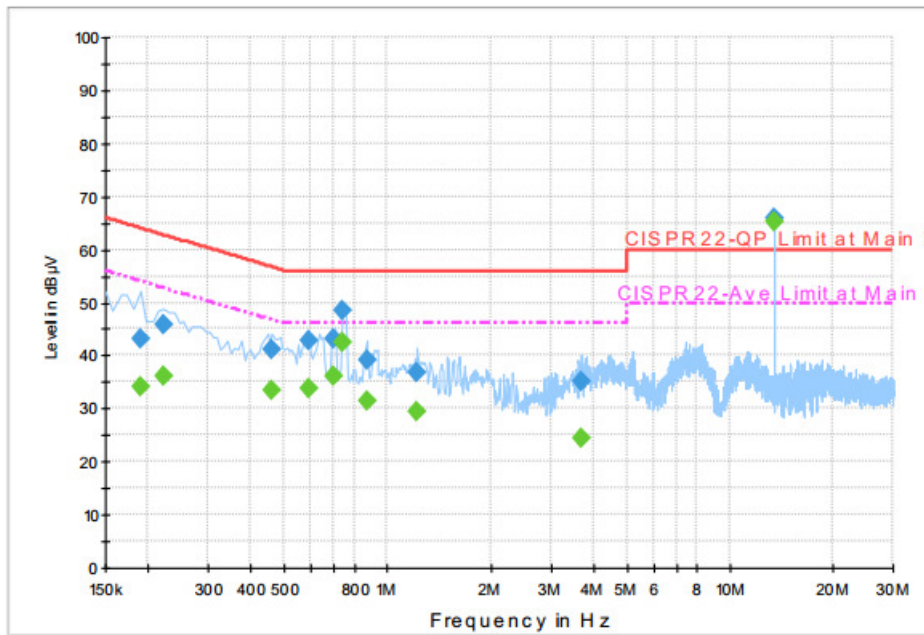

Final Result : Average

Frequency (MHz)	Average (dBµV)	Filter	Line	Corr. (dB)	Margin (dB)	Limit (dBµV)
0.190000	34.0	Off	L1	19.6	20.0	54.0
0.222000	36.3	Off	L1	19.6	16.4	52.7
0.462000	33.3	Off	L1	19.6	13.4	46.7
0.590000	33.9	Off	L1	19.6	12.1	46.0
0.694000	36.2	Off	L1	19.6	9.8	46.0
0.742000	42.6	Off	L1	19.6	3.4	46.0
0.870000	31.4	Off	L1	19.6	14.6	46.0
1.222000	29.4	Off	L1	19.6	16.6	46.0
3.702000	24.3	Off	L1	19.7	21.7	46.0
13.558000	65.4	Off	L1	19.8	-15.4	50.0



Test Mode :	Mode 3	Temperature :	22~24°C
Test Engineer :	Arthur Hsieh	Relative Humidity :	51~53%
Test Voltage :	120Vac / 60Hz	Phase :	Neutral
Function Type :	NFC Link + WLAN (2.4GHz) Link + Bluetooth Link + Earphone 2 with Audio Adapter connect to EUT + Charging Only Cable + AC Adapter		

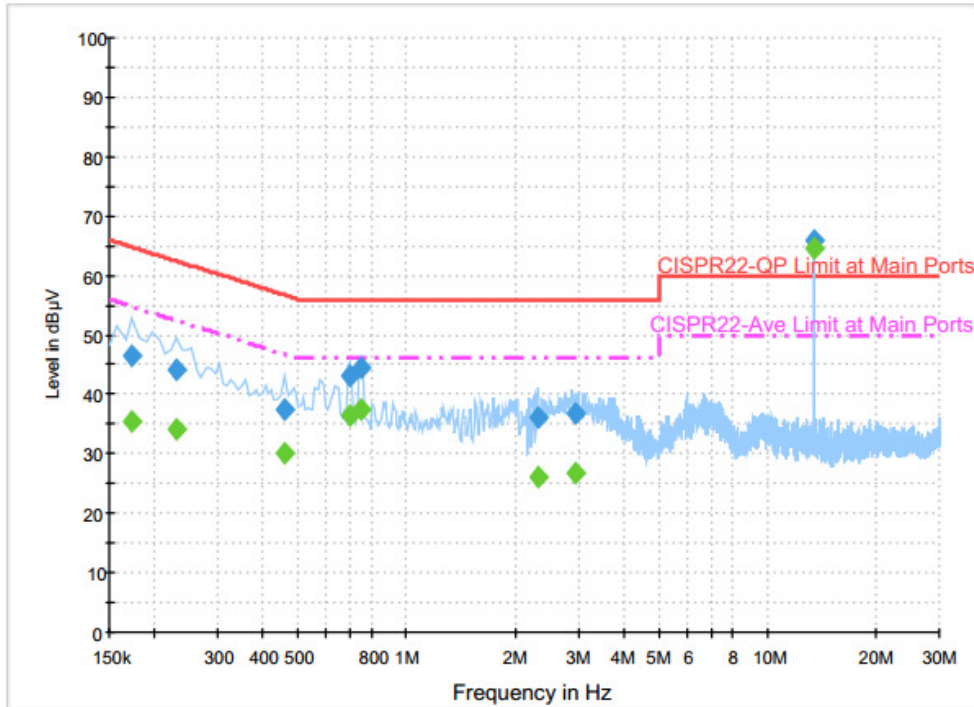

Final Result : Quasi-Peak

Frequency (MHz)	Quasi-Peak (dBµV)	Filter	Line	Corr. (dB)	Margin (dB)	Limit (dBµV)
0.174000	46.5	Off	N	19.6	18.3	64.8
0.230000	44.2	Off	N	19.6	18.2	62.4
0.462000	37.5	Off	N	19.6	19.2	56.7
0.694000	43.2	Off	N	19.6	12.8	56.0
0.750000	44.4	Off	N	19.6	11.6	56.0
2.318000	36.2	Off	N	18.6	19.8	56.0
2.942000	36.9	Off	N	19.5	19.1	56.0
13.558000	66.0	Off	N	19.8	-6.0	60.0

Final Result : Average

Frequency (MHz)	Average (dBµV)	Filter	Line	Corr. (dB)	Margin (dB)	Limit (dBµV)
0.174000	35.4	Off	N	19.6	19.4	54.8
0.230000	34.0	Off	N	19.6	18.4	52.4
0.462000	30.2	Off	N	19.6	16.5	46.7
0.694000	36.5	Off	N	19.6	9.5	46.0
0.750000	37.5	Off	N	19.6	8.5	46.0
2.318000	25.9	Off	N	18.6	20.1	46.0
2.942000	26.9	Off	N	19.5	19.1	46.0
13.558000	64.7	Off	N	19.8	-14.7	50.0



<Terminal test result with dummy load>

Test Mode :	Mode 3	Temperature :	22~24°C
Test Engineer :	Arthur Hsieh	Relative Humidity :	51~53%
Test Voltage :	120Vac / 60Hz	Phase :	Line
Function Type :	NFC Link + WLAN (2.4GHz) Link + Bluetooth Link + Earphone 2 with Audio Adapter connect to EUT + Charging Only Cable + AC Adapter		

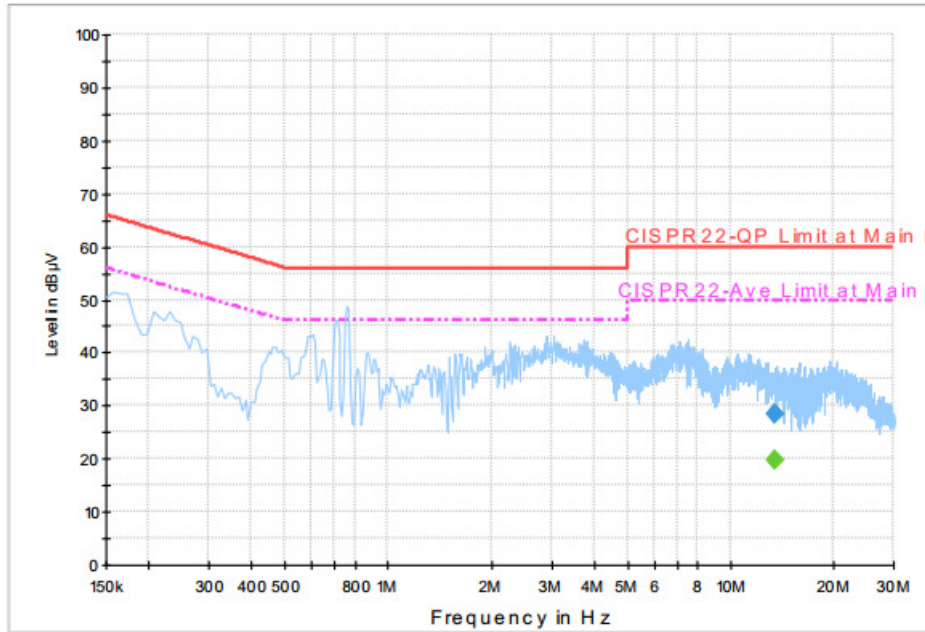

Final Result : Quasi-Peak

Frequency (MHz)	Quasi-Peak (dBµV)	Filter	Line	Corr. (dB)	Margin (dB)	Limit (dBµV)
13.558000	28.4	Off	L1	19.8	31.6	60.0

Final Result : Average

Frequency (MHz)	Average (dBµV)	Filter	Line	Corr. (dB)	Margin (dB)	Limit (dBµV)
13.558000	19.8	Off	L1	19.8	30.2	50.0



Test Mode :	Mode 3	Temperature :	22~24°C
Test Engineer :	Arthur Hsieh	Relative Humidity :	51~53%
Test Voltage :	120Vac / 60Hz	Phase :	Neutral
Function Type :	NFC Link + WLAN (2.4GHz) Link + Bluetooth Link + Earphone 2 with Audio Adapter connect to EUT + Charging Only Cable + AC Adapter		

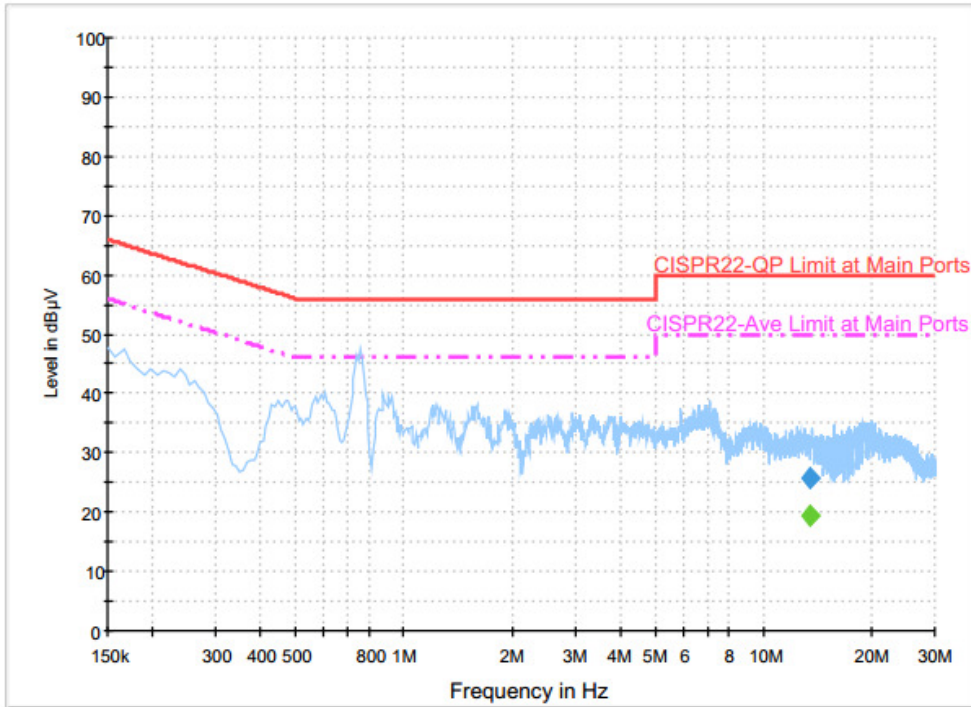

Final Result : Quasi-Peak

Frequency (MHz)	Quasi-Peak (dBµV)	Filter	Line	Corr. (dB)	Margin (dB)	Limit (dBµV)
13.558000	25.8	Off	N	19.8	34.2	60.0

Final Result : Average

Frequency (MHz)	Average (dBµV)	Filter	Line	Corr. (dB)	Margin (dB)	Limit (dBµV)
13.558000	19.5	Off	N	19.8	30.5	50.0



3.7 Antenna Requirements

3.7.1 Standard Applicable

If directional gain of transmitting Antennas is greater than 6dBi, the power shall be reduced by the same level in dB comparing to gain minus 6dBi. For the fixed point-to-point operation, the power shall be reduced by one dB for every 3 dB that the directional gain of the Antenna exceeds 6 dBi. The use of a permanently attached Antenna or of an Antenna that uses a unique coupling to the intentional radiator shall be considered sufficient to comply with the FCC rule.

3.7.2 Antenna Anti-Replacement Construction

An embedded-in antenna design is used.

3.7.3 Antenna Gain

CDD modes

FCC KDB 662911 D01 Multiple Transmitter Output v02r01

For CDD transmissions, directional gain is calculated as

Directional gain = $G_{ANT} + \text{Array Gain}$, where Array Gain is as follows.

For power spectral density (PSD) measurements on all devices,

Array Gain = $10 \log(N_{ANT}/N_{SS}=1)$ dB.

For power measurements on IEEE 802.11 devices,

Array Gain = 0 dB (i.e., no array gain) for $N_{ANT} \leq 4$.

Directional gain may be calculated by using the formulas applicable to equal gain antennas with G_{ANT} set equal to the gain of the antenna having the highest gain;

The EUT supports CDD mode.

For power, the directional gain G_{ANT} is set equal to the antenna having the highest gain, i.e., F)2)f)i).

For PSD, the directional gain calculation is following F)2)f)ii) of KDB 662911 D01 v02r01.

The power and PSD limit should be modified if the directional gain of EUT is over 6 dBi,

The directional gain "DG" is calculated as following table.

			DG for Power (dBi)	DG for PSD (dBi)	Power Limit Reduction (dB)	PSD Limit Reduction (dB)
	Ant. 1 (dBi)	Ant. 2 (dBi)				
2.4 GHz	2.60	1.80	2.60	5.22	0.00	0.00

$Power\ Limit\ Reduction = DG(Power) - 6dBi, (min = 0)$

$PSD\ Limit\ Reduction = DG(PSD) - 6dBi, (min = 0)$

TXBF modes

FCC KDB 662911 D01 Multiple Transmitter Output v02r01

For CDD transmissions, directional gain is calculated as

$$DirectionalGain = 10 \cdot \log \left[\frac{\sum_{j=1}^{N_{SS}} \left\{ \sum_{k=1}^{N_{ANT}} g_{j,k} \right\}^2}{N_{ANT}} \right]$$

where

Each antenna is driven by no more than one spatial stream;

N_{SS} = the number of independent spatial streams of data;

N_{ANT} = the total number of antennas

$g_{j,k} = 10^{G_k / 20}$ if the k th antenna is being fed by spatial stream j , or zero if it is not;
 G_k is the gain in dBi of the k th antenna.

The EUT supports beamforming for 802.11ac modes.

The directional gain calculation is following F)2)e)ii) of KDB 662911 D01 v02r01.

The power and PSD limit should be modified if the directional gain of EUT is over 6 dBi,

The directional gain “DG” is calculated as following table.

			DG	DG	Power	PSD
			for	for	Limit	Limit
	Ant. 1	Ant. 2	Power	PSD	Reduction	Reduction
	(dBi)	(dBi)	(dBi)	(dBi)	(dB)	(dB)
2.4 GHz	2.60	1.80	5.22	5.22	0.00	0.00

$Power\ Limit\ Reduction = DG(Power) - 6dBi, (min = 0)$

$PSD\ Limit\ Reduction = DG(PSD) - 6dBi, (min = 0)$



4 List of Measuring Equipment

Instrument	Manufacturer	Model No.	Serial No.	Characteristics	Calibration Date	Test Date	Due Date	Remark
Power Meter	Anritsu	ML2495A	1132003	300MHz~40GHz	Aug. 04, 2016	Aug. 18, 2016 ~ Sep. 22, 2016	Aug. 03, 2017	Conducted (TH05-HY)
Power Sensor	Anritsu	MA2411B	1126017	300MHz~40GHz	Aug. 04, 2016	Aug. 18, 2016 ~ Sep. 22, 2016	Aug. 03, 2017	Conducted (TH05-HY)
Power Sensor	DARE	RPR3006W	13100030S NO31	9kHz~6GHz	Sep. 17, 2015	Aug. 18, 2016 ~ Sep. 15, 2016	Sep. 16, 2016	Conducted (TH05-HY)
Power Sensor	DARE	RPR3006W	13100030S NO31	9kHz~6GHz	Sep. 21, 2016	Sep. 22, 2016	Sep. 20, 2017	Conducted (TH05-HY)
Spectrum Analyzer	Rohde & Schwarz	FSP40	100057	9kHz~40GHz	Nov. 23, 2015	Aug. 18, 2016 ~ Sep. 22, 2016	Nov. 22, 2016	Conducted (TH05-HY)
AC Power Source	ChainTek	APC-1000W	N/A	N/A	N/A	Sep. 06, 2016	N/A	Conduction (CO05-HY)
EMI Test Receiver	Rohde & Schwarz	ESCI 7	100724	9kHz~7GHz	Aug. 30, 2016	Sep. 06, 2016	Aug. 29, 2017	Conduction (CO05-HY)
LISN	Rohde & Schwarz	ENV216	100080	9kHz~30MHz	Dec. 02, 2015	Sep. 06, 2016	Dec. 01, 2016	Conduction (CO05-HY)
LISN	Rohde & Schwarz	ENV216	100081	9kHz~30MHz	Dec. 14, 2015	Sep. 06, 2016	Dec. 13, 2016	Conduction (CO05-HY)
Bilog Antenna	TESEQ	CBL 6111D	35419	30MHz to 1GHz	Jan. 13, 2016	Aug. 23, 2016 ~ Sep. 09, 2016	Jan. 12, 2017	Radiation (03CH07-HY)
Double Ridge Horn Antenna	ESCO	3117	00075962	1GHz ~ 18GHz	Aug. 19, 2016	Aug. 23, 2016 ~ Sep. 09, 2016	Aug. 18, 2017	Radiation (03CH07-HY)
EMI Test Receiver	Keysight	N9038A(MXE)	MY541300 85	20Hz ~ 8.4GHz	Nov. 04, 2015	Aug. 23, 2016 ~ Sep. 09, 2016	Nov. 03, 2016	Radiation (03CH07-HY)
Loop Antenna	Rohde & Schwarz	HFH2-Z2	100315	9 kHz~30 MHz	Sep. 02, 2015	Aug. 23, 2016 ~ Sep. 09, 2016	Sep. 01, 2017	Radiation (03CH07-HY)
Preamplifier	MITEQ	AMF-7D-0010 1800-30-10P	1590075	1GHz ~ 18GHz	Apr. 15, 2016	Aug. 23, 2016 ~ Sep. 09, 2016	Apr. 14, 2017	Radiation (03CH07-HY)
Preamplifier	COM-POWER	PA-103A	161241	10MHz-1GHz	Mar. 18, 2016	Aug. 23, 2016 ~ Sep. 09, 2016	Mar. 17, 2017	Radiation (03CH07-HY)
Preamplifier	Agilent	8449B	3008A023 62	1GHz~ 26.5GHz	Oct. 19, 2015	Aug. 23, 2016 ~ Sep. 09, 2016	Oct. 18, 2016	Radiation (03CH07-HY)
Spectrum Analyzer	Agilent	N9010A	MY534701 18	10Hz~44GHz	Feb. 27, 2016	Aug. 23, 2016 ~ Sep. 09, 2016	Feb. 26, 2017	Radiation (03CH07-HY)
Antenna Mast	Max-Full	MFA520BS	N/A	1m~4m	N/A	Aug. 23, 2016 ~ Sep. 09, 2016	N/A	Radiation (03CH07-HY)
Turn Table	ChainTek	Chaintek 3000	N/A	0~360 Degree	N/A	Aug. 23, 2016 ~ Sep. 09, 2016	N/A	Radiation (03CH07-HY)
Preamplifier	MITEQ	JS44-180040 00-33-8P	1840917	18GHz ~ 40GHz	Jun. 14, 2016	Aug. 23, 2016 ~ Sep. 09, 2016	Jun. 13, 2017	Radiation (03CH07-HY)
SHF-EHF Horn Antenna	SCHWARZBECK	BBHA 9170	BBHA9170 584	18GHz- 40GHz	Nov. 02, 2015	Aug. 23, 2016 ~ Sep. 09, 2016	Nov. 01, 2016	Radiation (03CH07-HY)



5 Uncertainty of Evaluation

Uncertainty of Conducted Emission Measurement (150kHz ~ 30MHz)

Measuring Uncertainty for a Level of Confidence of 95% ($U = 2Uc(y)$)	2.26
---	------

Uncertainty of Radiated Emission Measurement (30 MHz ~ 1000 MHz)

Measuring Uncertainty for a Level of Confidence of 95% ($U = 2Uc(y)$)	5.70
---	------

Uncertainty of Radiated Emission Measurement (1000 MHz ~ 18000 MHz)

Measuring Uncertainty for a Level of Confidence of 95% ($U = 2Uc(y)$)	5.50
---	------

Uncertainty of Radiated Emission Measurement (18000 MHz ~ 40000 MHz)

Measuring Uncertainty for a Level of Confidence of 95% ($U = 2Uc(y)$)	5.20
---	------



Appendix A. Conducted Test Results

<CDD Modes>

Test Engineer:	AnAn Wu	Temperature:	21~25	°C
Test Date:	2016/08/18~2016/09/22	Relative Humidity:	51~54	%

TEST RESULTS DATA
6dB and 99% Occupied Bandwidth

2.4GHz Band										
Mod.	Data Rate	NTX	CH.	Freq. (MHz)	99% Occupied BW (MHz)		6dB BW (MHz)		6dB BW Limit (MHz)	Pass/Fail
					Ant 1	Ant 2	Ant 1	Ant 2		
11b	1Mbps	1	1	2412	11.80	11.95	9.00	9.04	0.50	Pass
11b	1Mbps	1	6	2437	11.80	11.90	8.52	9.02	0.50	Pass
11b	1Mbps	1	11	2462	11.80	11.85	8.52	8.52	0.50	Pass
11g	6Mbps	1	1	2412	18.35	18.50	16.32	16.32	0.50	Pass
11g	6Mbps	1	6	2437	18.40	18.60	16.32	16.32	0.50	Pass
11g	6Mbps	1	11	2462	17.95	18.15	16.08	15.72	0.50	Pass
11b	1Mbps	2	1	2412	11.80	11.95	9.02	9.00	0.50	Pass
11b	1Mbps	2	6	2437	11.80	11.90	9.04	9.04	0.50	Pass
11b	1Mbps	2	11	2462	11.75	11.85	8.52	8.56	0.50	Pass
11g	6Mbps	2	1	2412	18.30	18.55	16.32	16.36	0.50	Pass
11g	6Mbps	2	6	2437	18.35	18.20	16.32	16.36	0.50	Pass
11g	6Mbps	2	11	2462	18.10	18.10	16.08	15.76	0.50	Pass
VHT20	MCS0	2	1	2412	18.30	18.25	16.34	16.32	0.50	Pass
VHT20	MCS0	2	6	2437	18.35	18.45	16.28	16.36	0.50	Pass
VHT20	MCS0	2	11	2462	18.10	18.15	16.08	15.76	0.50	Pass
VHT40	MCS0	2	3	2422	36.60	36.70	36.32	36.32	0.50	Pass
VHT40	MCS0	2	6	2437	36.70	36.60	36.32	36.36	0.50	Pass
VHT40	MCS0	2	9	2452	36.60	36.60	35.68	35.76	0.50	Pass

TEST RESULTS DATA
Peak Output Power

2.4GHz Band											
Mod.	Data Rate	NTX	CH.	Freq. (MHz)	Peak Conducted Power (dBm)			DG (dBi)		EIRP Power (dBm)	
					Ant 1	Ant 2	SUM	Ant 1	Ant 2	Ant 1	Ant 2
11b	1Mbps	1	1	2412	20.63	21.05		2.60	1.80	23.23	22.85
11b	1Mbps	1	2	2417	20.66	21.54		2.60	1.80	23.26	23.34
11b	1Mbps	1	6	2437	21.08	21.76		2.60	1.80	23.68	23.56
11b	1Mbps	1	10	2457	21.10	21.60		2.60	1.80	23.70	23.40
11b	1Mbps	1	11	2462	21.27	21.32		2.60	1.80	23.87	23.12
11g	6Mbps	1	1	2412	22.11	22.11		2.60	1.80	24.71	23.91
11g	6Mbps	1	2	2417	23.12	23.12		2.60	1.80	25.72	24.92
11g	6Mbps	1	6	2437	23.20	23.20		2.60	1.80	25.80	25.00
11g	6Mbps	1	10	2457	23.20	23.20		2.60	1.80	25.80	25.00
11g	6Mbps	1	11	2462	22.10	22.69		2.60	1.80	24.70	24.49
HT20	MCS0	1	1	2412	20.85	21.52		2.60	1.80	23.45	23.32
HT20	MCS0	1	2	2417	23.30	24.12		2.60	1.80	25.90	25.92
HT20	MCS0	1	6	2437	23.25	23.90		2.60	1.80	25.85	25.70
HT20	MCS0	1	10	2457	22.73	24.08		2.60	1.80	25.33	25.88
HT20	MCS0	1	11	2462	21.80	21.91		2.60	1.80	24.40	23.71
HT40	MCS0	1	3	2422	19.92	20.28		2.60	1.80	22.52	22.08
HT40	MCS0	1	4	2427	19.89	21.62		2.60	1.80	22.49	23.42
HT40	MCS0	1	6	2437	21.67	21.71		2.60	1.80	24.27	23.51
HT40	MCS0	1	8	2447	20.46	21.80		2.60	1.80	23.06	23.60
HT40	MCS0	1	9	2452	20.39	20.43		2.60	1.80	22.99	22.23
VHT20	MCS0	1	1	2412	20.87	21.54		2.60	1.80	23.47	23.34
VHT20	MCS0	1	2	2417	23.39	23.68		2.60	1.80	25.99	25.48
VHT20	MCS0	1	6	2437	23.32	23.95		2.60	1.80	25.92	25.75
VHT20	MCS0	1	10	2457	23.25	23.96		2.60	1.80	25.85	25.76
VHT20	MCS0	1	11	2462	21.82	21.92		2.60	1.80	24.42	23.72
VHT40	MCS0	1	3	2422	19.96	20.30		2.60	1.80	22.56	22.10
VHT40	MCS0	1	4	2427	19.90	21.62		2.60	1.80	22.50	23.42
VHT40	MCS0	1	6	2437	21.70	21.73		2.60	1.80	24.30	23.53
VHT40	MCS0	1	8	2447	20.75	21.70		2.60	1.80	23.35	23.50
VHT40	MCS0	1	9	2452	20.45	20.45		2.60	1.80	23.05	22.25

11b	1Mbps	2	1	2412	20.85	21.25	24.06	2.60	26.66
11b	1Mbps	2	2	2417	20.80	21.22	24.03	2.60	26.63
11b	1Mbps	2	6	2437	21.32	21.95	24.66	2.60	27.26
11b	1Mbps	2	10	2457	21.33	21.48	24.42	2.60	27.02
11b	1Mbps	2	11	2462	21.38	21.52	24.46	2.60	27.06
11g	6Mbps	2	1	2412	22.11	22.64	25.39	2.60	27.99
11g	6Mbps	2	2	2417	23.08	23.70	26.41	2.60	29.01
11g	6Mbps	2	6	2437	23.15	24.42	26.47	2.60	29.07
11g	6Mbps	2	10	2457	23.16	23.79	26.50	2.60	29.10
11g	6Mbps	2	11	2462	21.99	22.45	25.24	2.60	27.84
HT20	MCS0	2	1	2412	20.82	21.41	24.14	2.60	26.74
HT20	MCS0	2	2	2417	23.18	23.36	26.28	2.60	28.88
HT20	MCS0	2	6	2437	23.20	24.68	26.54	2.60	29.14
HT20	MCS0	2	10	2457	22.78	22.98	25.89	2.60	28.49
HT20	MCS0	2	11	2462	21.49	21.96	24.74	2.60	27.34
HT40	MCS0	2	3	2422	19.92	20.54	23.25	2.60	25.85
HT40	MCS0	2	4	2427	19.88	20.51	23.22	2.60	25.82
HT40	MCS0	2	6	2437	21.65	23.28	24.97	2.60	27.57
HT40	MCS0	2	8	2447	20.32	20.63	23.49	2.60	26.09
HT40	MCS0	2	9	2452	20.26	20.59	23.44	2.60	26.04
VHT20	MCS0	2	1	2412	20.83	21.42	24.15	2.60	26.75
VHT20	MCS0	2	2	2417	23.11	23.87	26.52	2.60	29.12
VHT20	MCS0	2	6	2437	23.21	23.88	26.57	2.60	29.17
VHT20	MCS0	2	10	2457	23.01	23.64	26.35	2.60	28.95
VHT20	MCS0	2	11	2462	21.51	21.97	24.76	2.60	27.36
VHT40	MCS0	2	3	2422	20.12	20.60	23.38	2.60	25.98
VHT40	MCS0	2	4	2427	20.14	20.63	23.40	2.60	26.00
VHT40	MCS0	2	6	2437	21.67	22.29	25.00	2.60	27.60
VHT40	MCS0	2	8	2447	20.40	20.70	23.56	2.60	26.16
VHT40	MCS0	2	9	2452	20.28	20.62	23.46	2.60	26.06

Note: Measured power (dBm) has offset with cable loss.

TEST RESULTS DATA
Average Output Power

2.4GHz Band																		
Mod.	Data Rate	NTX	CH.	Freq. (MHz)	Duty Factor (dB)		Average Conducted Power (dBm)			Conducted Power Limit (dBm)		DG (dBi)		EIRP Power (dBm)		EIRP Power Limit (dBm)		Pass /Fail
					Ant 1	Ant 2	Ant 1	Ant 2	SUM	Ant 1	Ant 2	Ant 1	Ant 2	Ant 1	Ant 2	Ant 1	Ant 2	
11b	1Mbps	1	1	2412	0.06	0.06	17.60	17.94		30.00	30.00	2.60	1.80	20.20	19.74	36.00	36.00	Pass
11b	1Mbps	1	2	2417	0.06	0.06	17.65	18.33		30.00	30.00	2.60	1.80	20.25	20.13	36.00	36.00	Pass
11b	1Mbps	1	6	2437	0.06	0.06	18.04	18.72		30.00	30.00	2.60	1.80	20.64	20.52	36.00	36.00	Pass
11b	1Mbps	1	10	2457	0.06	0.06	18.09	18.44		30.00	30.00	2.60	1.80	20.69	20.24	36.00	36.00	Pass
11b	1Mbps	1	11	2462	0.06	0.06	18.13	18.23		30.00	30.00	2.60	1.80	20.73	20.03	36.00	36.00	Pass
11g	6Mbps	1	1	2412	0.35	0.35	16.17	16.71		30.00	30.00	2.60	1.80	18.77	18.51	36.00	36.00	Pass
11g	6Mbps	1	2	2417	0.35	0.35	16.90	17.89		30.00	30.00	2.60	1.80	19.50	19.69	36.00	36.00	Pass
11g	6Mbps	1	6	2437	0.35	0.35	17.10	17.90		30.00	30.00	2.60	1.80	19.70	19.70	36.00	36.00	Pass
11g	6Mbps	1	10	2457	0.35	0.35	16.89	17.88		30.00	30.00	2.60	1.80	19.49	19.68	36.00	36.00	Pass
11g	6Mbps	1	11	2462	0.35	0.35	15.83	16.50		30.00	30.00	2.60	1.80	18.43	18.30	36.00	36.00	Pass
HT20	MCS0	1	1	2412	0.31	0.31	14.10	14.61		30.00	30.00	2.60	1.80	16.70	16.41	36.00	36.00	Pass
HT20	MCS0	1	2	2417	0.31	0.31	17.01	17.89		30.00	30.00	2.60	1.80	16.70	16.41	36.00	36.00	Pass
HT20	MCS0	1	6	2437	0.38	0.31	16.99	17.66		30.00	30.00	2.60	1.80	16.70	16.41	36.00	36.00	Pass
HT20	MCS0	1	10	2457	0.38	0.31	16.47	17.84		30.00	30.00	2.60	1.80	16.70	16.41	36.00	36.00	Pass
HT20	MCS0	1	11	2462	0.00	0.31	14.65	14.93		30.00	30.00	2.60	1.80	16.70	16.41	36.00	36.00	Pass
HT40	MCS0	1	3	2422	0.11	0.11	12.59	12.89		30.00	30.00	2.60	1.80	15.19	14.69	36.00	36.00	Pass
HT40	MCS0	1	4	2427	0.11	0.11	12.55	14.79		30.00	30.00	2.60	1.80	15.15	16.59	36.00	36.00	Pass
HT40	MCS0	1	6	2437	0.11	0.11	14.52	14.86		30.00	30.00	2.60	1.80	17.12	16.66	36.00	36.00	Pass
HT40	MCS0	1	8	2447	0.11	0.11	13.01	14.98		30.00	30.00	2.60	1.80	15.61	16.78	36.00	36.00	Pass
HT40	MCS0	1	9	2452	0.11	0.11	12.86	13.11		30.00	30.00	2.60	1.80	15.46	14.91	36.00	36.00	Pass
VHT20	MCS0	1	1	2412	0.35	0.30	14.15	14.65		30.00	30.00	2.60	1.80	16.75	16.45	36.00	36.00	Pass
VHT20	MCS0	1	2	2417	0.35	0.30	17.22	17.88		30.00	30.00	2.60	1.80	19.82	19.68	36.00	36.00	Pass
VHT20	MCS0	1	6	2437	0.35	0.30	17.19	17.67		30.00	30.00	2.60	1.80	19.79	19.47	36.00	36.00	Pass
VHT20	MCS0	1	10	2457	0.35	0.30	17.15	17.95		30.00	30.00	2.60	1.80	19.75	19.75	36.00	36.00	Pass
VHT20	MCS0	1	11	2462	0.35	0.30	14.72	14.94		30.00	30.00	2.60	1.80	17.32	16.74	36.00	36.00	Pass
VHT40	MCS0	1	3	2422	0.15	0.11	12.68	12.96		30.00	30.00	2.60	1.80	15.28	14.76	36.00	36.00	Pass
VHT40	MCS0	1	4	2427	0.15	0.11	12.66	14.79		30.00	30.00	2.60	1.80	15.26	16.59	36.00	36.00	Pass
VHT40	MCS0	1	6	2437	0.15	0.11	14.57	14.88		30.00	30.00	2.60	1.80	17.17	16.68	36.00	36.00	Pass
VHT40	MCS0	1	8	2447	0.15	0.11	13.25	14.83		30.00	30.00	2.60	1.80	15.85	16.63	36.00	36.00	Pass
VHT40	MCS0	1	9	2452	0.15	0.11	12.99	13.13		30.00	30.00	2.60	1.80	15.59	14.93	36.00	36.00	Pass

11b	1Mbps	2	1	2412	0.04	0.06	17.71	18.03	20.88	30.00		2.60		23.48		36.00		Pass
11b	1Mbps	2	2	2417	0.04	0.06	17.70	18.06	20.89	30.00		2.60		23.49		36.00		Pass
11b	1Mbps	2	6	2437	0.04	0.06	18.12	18.76	21.46	30.00		2.60		24.06		36.00		Pass
11b	1Mbps	2	10	2457	0.04	0.06	18.12	18.39	21.27	30.00		2.60		23.87		36.00		Pass
11b	1Mbps	2	11	2462	0.04	0.06	18.21	18.28	21.26	30.00		2.60		23.86		36.00		Pass
11g	6Mbps	2	1	2412	0.30	0.30	15.73	16.18	18.97	30.00		2.60		21.57		36.00		Pass
11b	6Mbps	2	2	2417	0.30	0.30	17.15	18.00	20.60	30.00		2.60		23.20		36.00		Pass
11g	6Mbps	2	6	2437	0.30	0.30	17.20	18.02	20.64	30.00		2.60		23.24		36.00		Pass
11b	6Mbps	2	10	2457	0.30	0.30	17.21	18.10	20.68	30.00		2.60		23.28		36.00		Pass
11g	6Mbps	2	11	2462	0.30	0.30	15.20	15.70	18.46	30.00		2.60		21.06		36.00		Pass
HT20	MCS0	2	1	2412	0.38	0.38	14.31	14.75	17.54	30.00		2.60		20.14		36.00		Pass
HT20	MCS0	2	2	2417	0.38	0.38	17.16	18.04	20.63	30.00		2.60		23.23		36.00		Pass
HT20	MCS0	2	6	2437	0.38	0.38	17.18	18.03	20.63	30.00		2.60		23.23		36.00		Pass
HT20	MCS0	2	10	2457	0.38	0.38	16.71	17.58	20.17	30.00		2.60		22.77		36.00		Pass
HT20	MCS0	2	11	2462	0.38	0.38	14.68	15.10	17.90	30.00		2.60		20.50		36.00		Pass
HT40	MCS0	2	3	2422	0.11	0.11	12.51	13.37	15.97	30.00		2.60		18.57		36.00		Pass
HT40	MCS0	2	4	2427	0.11	0.11	12.50	13.36	15.96	30.00		2.60		18.56		36.00		Pass
HT40	MCS0	2	6	2437	0.11	0.11	14.49	15.26	17.90	30.00		2.60		20.50		36.00		Pass
HT40	MCS0	2	8	2447	0.11	0.11	13.06	13.66	16.38	30.00		2.60		18.98		36.00		Pass
HT40	MCS0	2	9	2452	0.11	0.11	12.81	13.45	16.15	30.00		2.60		18.75		36.00		Pass
VHT20	MCS0	2	1	2412	0.35	0.41	14.31	15.05	17.71	30.00		2.60		20.31		36.00		Pass
VHT20	MCS0	2	2	2417	0.35	0.41	17.03	17.97	20.54	30.00		2.60		23.14		36.00		Pass
VHT20	MCS0	2	6	2437	0.35	0.41	17.23	18.07	20.68	30.00		2.60		23.28		36.00		Pass
VHT20	MCS0	2	10	2457	0.35	0.41	16.67	17.66	20.20	30.00		2.60		22.80		36.00		Pass
VHT20	MCS0	2	11	2462	0.35	0.41	14.68	15.23	17.97	30.00		2.60		20.57		36.00		Pass
VHT40	MCS0	2	3	2422	0.11	0.11	12.56	13.38	16.00	30.00		2.60		18.60		36.00		Pass
VHT40	MCS0	2	4	2427	0.11	0.11	12.54	13.41	16.01	30.00		2.60		18.61		36.00		Pass
VHT40	MCS0	2	6	2437	0.11	0.11	14.51	15.29	17.93	30.00		2.60		20.53		36.00		Pass
VHT40	MCS0	2	8	2447	0.11	0.11	13.12	13.76	16.46	30.00		2.60		19.06		36.00		Pass
VHT40	MCS0	2	9	2452	0.11	0.11	12.83	13.46	16.17	30.00		2.60		18.77		36.00		Pass

Note: Measured power (dBm) has offset with cable loss.

TEST RESULTS DATA
Average Power Spectral Density

2.4GHz Band												
Mod.	Data Rate	NTX	CH.	Freq. (MHz)	Average PSD (dBm/3kHz)			DG (dBi)		Average PSD Limit (dBm/3kHz)		Pass/Fail
					Ant 1	Ant 2	Worse + 3.01	Ant 1	Ant 2	Ant 1	Ant 2	
11b	1Mbps	1	1	2412	-8.15	-8.40	-	2.60	1.80	8.00	8.00	Pass
11b	1Mbps	1	6	2437	-7.10	-7.01		2.60	1.80	8.00	8.00	Pass
11b	1Mbps	1	11	2462	-7.70	-7.77		2.60	1.80	8.00	8.00	Pass
11g	6Mbps	1	1	2412	-10.67	-10.84		2.60	1.80	8.00	8.00	Pass
11g	6Mbps	1	6	2437	-9.66	-9.16		2.60	1.80	8.00	8.00	Pass
11g	6Mbps	1	11	2462	-10.31	-9.21		2.60	1.80	8.00	8.00	Pass
11b	1Mbps	2	1	2412	-8.18	-8.14	-5.13	5.22		8.00		Pass
11b	1Mbps	2	6	2437	-7.65	-7.15	-4.14	5.22		8.00		Pass
11b	1Mbps	2	11	2462	-8.03	-8.12	-5.02	5.22		8.00		Pass
11g	6Mbps	2	1	2412	-11.04	-11.13	-8.03	5.22		8.00		Pass
11g	6Mbps	2	6	2437	-9.28	-8.74	-5.73	5.22		8.00		Pass
11g	6Mbps	2	11	2462	-11.30	-10.93	-7.92	5.22		8.00		Pass
VHT20	MCS0	2	1	2412	-12.75	-12.65	-9.64	5.22		8.00		Pass
VHT20	MCS0	2	6	2437	-9.15	-8.98	-5.97	5.22		8.00		Pass
VHT20	MCS0	2	11	2462	-11.86	-11.29	-8.28	5.22		8.00		Pass
VHT40	MCS0	2	3	2422	-18.18	-16.98	-13.97	5.22		8.00		Pass
VHT40	MCS0	2	6	2437	-15.76	-16.07	-12.75	5.22		8.00		Pass
VHT40	MCS0	2	9	2452	-18.23	-16.74	-13.73	5.22		8.00		Pass

Measured power density (dBm) has offset with cable loss.



<TXBF Modes>

Test Engineer:	AnAn Wu	Temperature:	21~25	°C
Test Date:	2016/08/18~2016/09/22	Relative Humidity:	51~54	%

TEST RESULTS DATA
6dB and 99% Occupied Bandwidth

2.4GHz Band										
Mod.	Data Rate	NTX	CH.	Freq. (MHz)	99% Occupied BW (MHz)		6dB BW (MHz)		6dB BW Limit (MHz)	Pass/Fail
					Ant 1	Ant 2	Ant 1	Ant 2		
VHT20	MCS0	2	1	2412	18.90	19.00	17.54	17.56	0.50	Pass
VHT20	MCS0	2	6	2437	19.10	19.55	15.44	17.60	0.50	Pass
VHT20	MCS0	2	11	2462	18.95	18.85	16.88	17.14	0.50	Pass
VHT40	MCS0	2	3	2422	36.50	36.30	34.96	34.96	0.50	Pass
VHT40	MCS0	2	6	2437	36.30	36.70	30.00	33.56	0.50	Pass
VHT40	MCS0	2	9	2452	36.30	36.40	35.04	35.00	0.50	Pass

TEST RESULTS DATA
Average Output Power

2.4GHz Band																
Mod.	Data Rate	NTX	CH.	Freq. (MHz)	Average Conducted Power (dBm)			Conducted Power Limit (dBm)		DG (dBi)		EIRP Power (dBm)		EIRP Power Limit (dBm)		Pass /Fail
					Ant 1	Ant 2	SUM	Ant 1	Ant 2	Ant 1	Ant 2	Ant 1	Ant 2	Ant 1	Ant 2	
HT20	MCS0	2	1	2412	14.30	14.80	17.57	30.00		5.22		22.79	36.00		Pass	
HT20	MCS0	2	2	2417	17.53	17.70	20.63	30.00		5.22		25.85	36.00		Pass	
HT20	MCS0	2	6	2437	17.50	17.70	20.61	30.00		5.22		25.83	36.00		Pass	
HT20	MCS0	2	10	2457	17.11	17.20	20.17	30.00		5.22		25.39	36.00		Pass	
HT20	MCS0	2	11	2462	14.80	15.00	17.91	30.00		5.22		23.13	36.00		Pass	
HT40	MCS0	2	3	2422	12.60	13.30	15.97	30.00		5.22		21.19	36.00		Pass	
HT40	MCS0	2	4	2427	12.60	13.30	15.97	30.00		5.22		21.19	36.00		Pass	
HT40	MCS0	2	6	2437	14.30	15.20	17.78	30.00		5.22		23.00	36.00		Pass	
HT40	MCS0	2	8	2447	12.60	13.30	15.97	30.00		5.22		21.19	36.00		Pass	
HT40	MCS0	2	9	2452	13.00	13.20	16.11	30.00		5.22		21.33	36.00		Pass	
VHT20	MCS0	2	1	2412	14.40	14.90	17.67	30.00		5.22		22.89	36.00		Pass	
VHT20	MCS0	2	2	2417	17.36	17.70	20.54	30.00		5.22		25.76	36.00		Pass	
VHT20	MCS0	2	6	2437	17.50	17.80	20.66	30.00		5.22		25.88	36.00		Pass	
VHT20	MCS0	2	10	2457	17.17	17.20	20.20	30.00		5.22		25.41	36.00		Pass	
VHT20	MCS0	2	11	2462	14.80	15.10	17.96	30.00		5.22		23.18	36.00		Pass	
VHT40	MCS0	2	3	2422	12.60	13.40	16.03	30.00		5.22		21.25	36.00		Pass	
VHT40	MCS0	2	4	2427	12.60	13.40	16.03	30.00		5.22		21.25	36.00		Pass	
VHT40	MCS0	2	6	2437	14.20	15.40	17.85	30.00		5.22		23.07	36.00		Pass	
VHT40	MCS0	2	8	2447	12.60	13.40	16.03	30.00		5.22		21.25	36.00		Pass	
VHT40	MCS0	2	9	2452	12.60	13.30	15.97	30.00		5.22		21.19	36.00		Pass	

Note: Measured power (dBm) has offset with cable loss.

TEST RESULTS DATA
Average Power Spectral Density

2.4GHz Band												
Mod.	Data Rate	NTX	CH.	Freq. (MHz)	Average PSD (dBm/3kHz)			DG (dBi)		Average PSD Limit (dBm/3kHz)		Pass/Fail
					Ant 1	Ant 2	Worse + 3.01	Ant 1	Ant 2	Ant 1	Ant 2	
VHT20	MCS0	2	1	2412	-5.10	-5.53	-2.09	5.22		8.00		Pass
VHT20	MCS0	2	6	2437	-2.89	-2.60	0.41	5.22		8.00		Pass
VHT20	MCS0	2	11	2462	-4.64	-3.73	-0.72	5.22		8.00		Pass
VHT40	MCS0	2	3	2422	-6.38	-5.64	-2.63	5.22		8.00		Pass
VHT40	MCS0	2	6	2437	-6.00	-5.56	-2.55	5.22		8.00		Pass
VHT40	MCS0	2	9	2452	-6.69	-5.99	-2.98	5.22		8.00		Pass

Measured power density (dBm) has offset with cable loss.



Appendix B. Radiated Spurious Emission

Test Engineer :	Luke Chang, Jesse Wang, Derreck Chen and James Chiu	Temperature :	21~24°C
		Relative Humidity :	50~55%

<CDD Modes>

2.4GHz 2400~2483.5MHz

WIFI 802.11b (Band Edge @ 3m)

WIFI	Note	Frequency	Level	Over	Limit	Read	Antenna	Cable	Preamp	Ant	Table	Peak	Pol.		
Ant. 1		(MHz)	(dBμV/m)	Limit (dB)	Line (dBμV/m)	Level (dBμV)	Factor (dB/m)	Loss (dB)	Factor (dB)	Pos (cm)	Pos (deg)	Avg. (P/A)	(H/V)		
802.11b CH 01 2412MHz		2387.28	55.75	-18.25	74	50.7	32.08	7.31	34.34	258	360	P	H		
		2390	46.01	-7.99	54	40.95	32.08	7.31	34.33	258	360	A	H		
	*	2412	103.7	-	-	98.59	32.1	7.31	34.3	258	360	P	H		
	*	2412	100.59	-	-	95.48	32.1	7.31	34.3	258	360	A	H		
													H		
														H	
			2348.01	56.22	-17.78	74	51.37	32.01	7.24	34.4	351	354	P	V	
			2390	46.16	-7.84	54	41.1	32.08	7.31	34.33	351	354	A	V	
	*		2412	107.12	-	-	102.01	32.1	7.31	34.3	351	354	P	V	
	*		2412	104.09	-	-	98.98	32.1	7.31	34.3	351	354	A	V	
													V		
802.11b CH 02 2417MHz		2373	55.28	-18.72	74	50.34	32.06	7.24	34.36	249	360	P	H		
		2389.94	45.23	-8.77	54	40.17	32.08	7.31	34.33	249	360	A	H		
	*	2417	102.83	-	-	97.71	32.1	7.31	34.29	249	360	P	H		
	*	2417	99.52	-	-	94.4	32.1	7.31	34.29	249	360	A	H		
													P	H	
														A	H
			2386.3	55.12	-18.88	74	50.07	32.08	7.31	34.34	350	355	P	V	
			2389.94	45.77	-8.23	54	40.71	32.08	7.31	34.33	350	355	A	V	
	*		2417	107.92	-	-	102.8	32.1	7.31	34.29	350	355	P	V	
	*		2417	104.7	-	-	99.58	32.1	7.31	34.29	350	355	A	V	
													P	V	
													A	V	



802.11b CH 06 2437MHz		2334.08	54.84	-19.16	74	50.1	31.99	7.18	34.43	380	307	P	H
		2387.56	44.38	-9.62	54	39.33	32.08	7.31	34.34	380	307	A	H
	*	2437	105.17	-	-	99.92	32.14	7.36	34.25	380	307	P	H
	*	2437	102.19	-	-	96.94	32.14	7.36	34.25	380	307	A	H
		2484.04	55.41	-18.59	74	50.01	32.18	7.4	34.18	380	307	P	H
		2485.86	44.82	-9.18	54	39.41	32.18	7.4	34.17	380	307	A	H
		2379.3	55.47	-18.53	74	50.52	32.06	7.24	34.35	244	358	P	V
		2389.94	44.52	-9.48	54	39.46	32.08	7.31	34.33	244	358	A	V
	*	2437	107.46	-	-	102.21	32.14	7.36	34.25	244	358	P	V
	*	2437	104.36	-	-	99.11	32.14	7.36	34.25	244	358	A	V
		2499.93	55.3	-18.7	74	49.85	32.2	7.4	34.15	244	358	P	V
		2484.53	44.87	-9.13	54	39.47	32.18	7.4	34.18	244	358	A	V
	802.11b CH 10 2457MHz	*	2457	105.32	-	-	100.02	32.16	7.36	34.22	380	292	P
*		2457	102.19	-	-	96.89	32.16	7.36	34.22	380	292	A	H
		2483.92	56.05	-17.95	74	50.65	32.18	7.4	34.18	380	292	P	H
		2483.56	45.95	-8.05	54	40.55	32.18	7.4	34.18	380	292	A	H
												P	H
												A	H
*		2457	106.49	-	-	101.19	32.16	7.36	34.22	271	359	P	V
*		2457	103.53	-	-	98.23	32.16	7.36	34.22	271	359	A	V
		2484.28	56.29	-17.71	74	50.89	32.18	7.4	34.18	271	359	P	V
		2483.56	46.37	-7.63	54	40.97	32.18	7.4	34.18	271	359	A	V
												P	V
											A	V	



802.11b CH 11 2462MHz	*	2462	105.54	-	-	100.19	32.16	7.4	34.21	380	284	P	H
	*	2462	102.46	-	-	97.11	32.16	7.4	34.21	380	284	A	H
		2488.72	56.47	-17.53	74	51.04	32.2	7.4	34.17	380	284	P	H
		2483.52	45.88	-8.12	54	40.48	32.18	7.4	34.18	380	284	A	H
													H
													H
	*	2462	106.92	-	-	101.57	32.16	7.4	34.21	270	357	P	V
	*	2462	103.91	-	-	98.56	32.16	7.4	34.21	270	357	A	V
		2485.92	56	-18	74	50.59	32.18	7.4	34.17	270	357	P	V
		2483.52	46.24	-7.76	54	40.84	32.18	7.4	34.18	270	357	A	V
													V
													V
Remark	1. No other spurious found. 2. All results are PASS against Peak and Average limit line.												



**2.4GHz 2400~2483.5MHz
WIFI 802.11b (Harmonic @ 3m)**

WIFI Ant. 1	Note	Frequency (MHz)	Level (dBµV/m)	Over Limit (dB)	Limit Line (dBµV/m)	Read Level (dBµV)	Antenna Factor (dB/m)	Cable Loss (dB)	Preamp Factor (dB)	Ant Pos (cm)	Table Pos (deg)	Peak Avg. (P/A)	Pol. (H/V)	
802.11b CH 01 2412MHz		4824	44.91	-29.09	74	58.17	34.1	11.68	59.04	100	0	P	H	
													H	
													H	
													H	
			4824	43.69	-30.31	74	56.95	34.1	11.68	59.04	100	0	P	V
														V
														V
802.11b CH 02 2417MHz		4834	44.41	-29.59	74	57.64	34.1	11.68	59.01	100	0	P	H	
		7251	41.56	-32.44	74	49.68	36.06	13.68	57.86	100	0	P	H	
													H	
													H	
			4836	43.8	-30.2	74	57.03	34.1	11.68	59.01	100	0	P	V
			7251	41.04	-32.96	74	49.16	36.06	13.68	57.86	100	0	P	V
														V
802.11b CH 06 2437MHz		4874	43.54	-30.46	74	56.85	34.1	11.53	58.94	100	0	P	H	
		7311	41.23	-32.77	74	49.26	36.09	13.81	57.93	100	0	P	H	
													H	
													H	
			4874	43.17	-30.83	74	56.48	34.1	11.53	58.94	100	0	P	V
			7311	41.62	-32.38	74	49.65	36.09	13.81	57.93	100	0	P	V
														V
Remark	1. No other spurious found.													
	2. All results are PASS against Peak and Average limit line.													



802.11b CH 10 2457MHz	4914	44.42	-29.58	74	57.82	34.1	11.37	58.87	100	0	P	H
	7371	41.31	-32.69	74	49.33	36.13	13.88	58.03	100	0	P	H
												H
												H
	4914	44.15	-29.85	74	57.55	34.1	11.37	58.87	100	0	P	V
	7371	41.58	-32.42	74	49.6	36.13	13.88	58.03	100	0	P	V
												V
												V
802.11b CH 11 2462MHz	4924	44.56	-29.44	74	57.93	34.1	11.37	58.84	100	0	P	H
	7386	41.47	-32.53	74	49.44	36.14	13.95	58.06	100	0	P	H
												H
												H
	4924	43.34	-30.66	74	56.71	34.1	11.37	58.84	100	0	P	V
	7386	41.45	-32.55	74	49.42	36.14	13.95	58.06	100	0	P	V
												V
												V
Remark	1. No other spurious found. 2. All results are PASS against Peak and Average limit line.											



2.4GHz 2400~2483.5MHz
WIFI 802.11g (Band Edge @ 3m)

WIFI Ant. 1	Note	Frequency (MHz)	Level (dBμV/m)	Over Limit (dB)	Limit Line (dBμV/m)	Read Level (dBμV)	Antenna Factor (dB/m)	Cable Loss (dB)	Preamp Factor (dB)	Ant Pos (cm)	Table Pos (deg)	Peak Avg. (P/A)	Pol. (H/V)	
802.11g CH 01 2412MHz		2389.8	59.49	-14.51	74	54.43	32.08	7.31	34.33	226	360	P	H	
		2389.905	49.75	-4.25	54	44.69	32.08	7.31	34.33	226	360	A	H	
	*	2412	104.35	-	-	99.24	32.1	7.31	34.3	226	360	P	H	
	*	2412	96.94	-	-	91.83	32.1	7.31	34.3	226	360	A	H	
													H	
													H	
			2389.905	61.39	-12.61	74	56.33	32.08	7.31	34.33	228	360	P	V
			2390	51.54	-2.46	54	46.48	32.08	7.31	34.33	228	360	A	V
	*		2412	108	-	-	102.89	32.1	7.31	34.3	228	360	P	V
	*		2412	100.08	-	-	94.97	32.1	7.31	34.3	228	360	A	V
													V	
													V	
802.11g CH 02 2417MHz		2389.24	56.02	-17.98	74	50.96	32.08	7.31	34.33	224	360	P	H	
		2389.52	47.19	-6.81	54	42.13	32.08	7.31	34.33	224	360	A	H	
	*	2417	105.13	-	-	100.01	32.1	7.31	34.29	224	360	P	H	
	*	2417	97.5	-	-	92.38	32.1	7.31	34.29	224	360	A	H	
													H	
													H	
			2389.24	57.54	-16.46	74	52.48	32.08	7.31	34.33	224	0	P	V
			2389.94	48.01	-5.99	54	42.95	32.08	7.31	34.33	224	0	A	V
	*		2417	108.22	-	-	103.1	32.1	7.31	34.29	224	0	P	V
	*		2417	100.52	-	-	95.4	32.1	7.31	34.29	224	0	A	V
													V	
													V	



WIFI Ant. 1	Note	Frequency (MHz)	Level (dBμV/m)	Over Limit (dB)	Limit Line (dBμV/m)	Read Level (dBμV)	Antenna Factor (dB/m)	Cable Loss (dB)	Preamp Factor (dB)	Ant Pos (cm)	Table Pos (deg)	Peak Avg. (P/A)	Pol. (H/V)
802.11g CH 06 2437MHz		2376.5	56.59	-17.41	74	51.65	32.06	7.24	34.36	380	290	P	H
		2388.4	45.58	-8.42	54	40.53	32.08	7.31	34.34	380	290	A	H
	*	2437	105.91	-	-	100.66	32.14	7.36	34.25	380	290	P	H
	*	2437	98.05	-	-	92.8	32.14	7.36	34.25	380	290	A	H
		2489.15	55.95	-18.05	74	50.52	32.2	7.4	34.17	380	290	P	H
		2485.16	46.05	-7.95	54	40.64	32.18	7.4	34.17	380	290	A	H
		2354.66	55.66	-18.34	74	50.78	32.03	7.24	34.39	345	356	P	V
		2389.8	45.64	-8.36	54	40.58	32.08	7.31	34.33	345	356	A	V
	*	2437	108.08	-	-	102.83	32.14	7.36	34.25	345	356	P	V
	*	2437	100.11	-	-	94.86	32.14	7.36	34.25	345	356	A	V
		2495.24	55.59	-18.41	74	50.15	32.2	7.4	34.16	345	356	P	V
		2483.55	45.59	-8.41	54	40.19	32.18	7.4	34.18	345	356	A	V
802.11g CH 10 2457MHz	*	2457	106.28	-	-	100.98	32.16	7.36	34.22	380	285	P	H
	*	2457	98.38	-	-	93.08	32.16	7.36	34.22	380	285	A	H
		2483.86	59.61	-14.39	74	54.21	32.18	7.4	34.18	380	285	P	H
		2483.5	48.89	-5.11	54	43.49	32.18	7.4	34.18	380	285	A	H
													H
													H
	*	2457	107.64	-	-	102.34	32.16	7.36	34.22	273	356	P	V
	*	2457	99.78	-	-	94.48	32.16	7.36	34.22	273	356	A	V
		2483.62	59.19	-14.81	74	53.79	32.18	7.4	34.18	273	356	P	V
		2483.56	48.94	-5.06	54	43.54	32.18	7.4	34.18	273	356	A	V
												V	
												V	



802.11g CH 11 2462MHz	*	2462	106.47	-	-	101.12	32.16	7.4	34.21	380	286	P	H
	*	2462	98.6	-	-	93.25	32.16	7.4	34.21	380	286	A	H
		2483.88	63.32	-10.68	74	57.92	32.18	7.4	34.18	380	286	P	H
		2483.56	51.78	-2.22	54	46.38	32.18	7.4	34.18	380	286	A	H
													H
													H
	*	2462	109.72	-	-	104.37	32.16	7.4	34.21	273	360	P	V
	*	2462	102.01	-	-	96.66	32.16	7.4	34.21	273	360	P	V
		2483.52	63.5	-10.5	74	58.1	32.18	7.4	34.18	273	360	P	V
		2483.56	51.9	-2.1	54	46.5	32.18	7.4	34.18	273	360	A	V
													V
													V
Remark	1. No other spurious found. 2. All results are PASS against Peak and Average limit line.												



**2.4GHz 2400~2483.5MHz
WIFI 802.11g (Harmonic @ 3m)**

WIFI Ant. 1	Note	Frequency (MHz)	Level (dBμV/m)	Over Limit (dB)	Limit Line (dBμV/m)	Read Level (dBμV)	Antenna Factor (dB/m)	Cable Loss (dB)	Preamp Factor (dB)	Ant Pos (cm)	Table Pos (deg)	Peak Avg. (P/A)	Pol. (H/V)	
802.11g CH 01 2412MHz		4824	41.19	-32.81	74	54.45	34.1	11.68	59.04	100	0	P	H	
													H	
													H	
													H	
			4824	43.4	-30.6	74	56.66	34.1	11.68	59.04	100	0	P	V
														V
														V
802.11g CH 02 2417MHz		4834	41.1	-32.9	74	54.33	34.1	11.68	59.01	100	0	P	H	
		7251	40.54	-33.46	74	48.66	36.06	13.68	57.86	100	0	P	H	
													H	
													H	
			4834	44.9	-29.1	74	58.13	34.1	11.68	59.01	100	0	P	V
			7251	41.3	-32.7	74	49.42	36.06	13.68	57.86	100	0	P	V
														V
802.11g CH 06 2437MHz		4974	39.21	-34.79	74	52.62	34.1	11.22	58.73	100	0	P	H	
		7308	40.86	-33.14	74	48.89	36.09	13.81	57.93	100	0	P	H	
													H	
													H	
			4974	39.99	-34.01	74	53.4	34.1	11.22	58.73	100	0	P	V
			7308	40.73	-33.27	74	48.76	36.09	13.81	57.93	100	0	P	V
														V
Remark	1. No other spurious found.													
	2. All results are PASS against Peak and Average limit line.													



802.11g CH 10 2457MHz	4914	40.3	-33.7	74	53.7	34.1	11.37	58.87	100	0	P	H
	7368	40.39	-33.61	74	48.41	36.13	13.88	58.03	100	0	P	H
												H
												H
	4914	40.37	-33.63	74	53.77	34.1	11.37	58.87	100	0	P	V
	7368	40.56	-33.44	74	48.58	36.13	13.88	58.03	100	0	P	V
												V
												V
802.11g CH 11 2462MHz	4926	40.58	-33.42	74	53.95	34.1	11.37	58.84	100	0	P	H
	7386	40.8	-33.2	74	48.77	36.14	13.95	58.06	100	0	P	H
												H
												H
	4926	41.46	-32.54	74	54.83	34.1	11.37	58.84	100	0	P	V
	7386	41.25	-32.75	74	49.22	36.14	13.95	58.06	100	0	P	V
												V
												V
Remark	1. No other spurious found. 2. All results are PASS against Peak and Average limit line.											



2.4GHz 2400~2483.5MHz

Emission below 1GHz

2.4GHz WIFI 802.11g (LF)

WIFI Ant.	Note	Frequency	Level	Over Limit	Limit Line	Read Level	Antenna Factor	Cable Loss	Preamp Factor	Ant Pos	Table Pos	Peak Avg.	Pol.	
1		(MHz)	(dBμV/m)	(dB)	(dBμV/m)	(dBμV)	(dB/m)	(dB)	(dB)	(cm)	(deg)	(P/A)	(H/V)	
2.4GHz 802.11g LF		82.11	28.77	-11.23	40	44.9	14.14	1.28	31.55			P	H	
		148.53	38.79	-4.71	43.5	50.76	17.75	1.78	31.5	100	295	P	H	
		297.03	33	-13	46	42.19	19.77	2.32	31.28			P	H	
		306.3	34.55	-11.45	46	43.41	19.99	2.41	31.26			P	H	
		703.9	29.8	-16.2	46	30.31	26.46	3.74	30.71			P	H	
		953.1	33.81	-12.19	46	30.06	30.21	4.07	30.53			P	H	
														H
														H
														H
														H
														H
			71.31	33.62	-6.38	40	50.99	12.92	1.28	31.57	100	99	P	V
			116.67	32.95	-10.55	43.5	45.23	17.68	1.55	31.51			P	V
			225.21	29	-17	46	41.56	16.8	2.07	31.43			P	V
			322.4	27.44	-18.56	46	35.86	20.42	2.41	31.25			P	V
			607.3	28.74	-17.26	46	30.72	25.47	3.36	30.81			P	V
			946.8	34.08	-11.92	46	30.41	30.13	4.07	30.53			P	V
														V
													V	
													V	
													V	
													V	
													V	
Remark	1. No other spurious found. 2. All results are PASS against limit line.													



Note symbol

*	Fundamental Frequency which can be ignored. However, the level of any unwanted emissions shall not exceed the level of the fundamental frequency.
!	Test result is over limit line.
P/A	Peak or Average
H/V	Horizontal or Vertical