



FCC RF Test Report

APPLICANT : Zebra Technologies Corporation
EQUIPMENT : Touch computer
BRAND NAME : Zebra
MODEL NAME : TC75EK
FCC ID : UZ7TC75EK
STANDARD : FCC Part 15 Subpart C §15.247
CLASSIFICATION : (DTS) Digital Transmission System

The product was received on Jul. 28, 2016 and testing was completed on Sep. 20, 2016. We, SPORTON INTERNATIONAL INC., would like to declare that the tested sample has been evaluated in accordance with the test procedures and has been in compliance with the applicable technical standards.

The test results in this report apply exclusively to the tested model / sample. Without written approval of SPORTON INTERNATIONAL INC., the test report shall not be reproduced except in full.

Reviewed by: Joseph Lin / Supervisor

Approved by: Jones Tsai / Manager



SPORTON INTERNATIONAL INC.

No. 52, Hwa Ya 1st Rd., Hwa Ya Technology Park, Kwei-Shan District, Tao Yuan City, Taiwan, R.O.C.



TABLE OF CONTENTS

SUMMARY OF TEST RESULT 4

1 GENERAL DESCRIPTION..... 5

1.1 Applicant 5

1.2 Manufacturer 5

1.3 Product Feature of Equipment Under Test..... 5

1.4 Product Specification of Equipment Under Test..... 6

1.5 Modification of EUT 6

1.6 Testing Location 6

1.7 Applicable Standards..... 6

2 TEST CONFIGURATION OF EQUIPMENT UNDER TEST..... 7

2.1 Descriptions of Test Mode 7

2.2 Test Mode 8

2.3 Connection Diagram of Test System 9

2.4 Support Unit used in test configuration and system 10

2.5 EUT Operation Test Setup 10

2.6 Measurement Results Explanation Example..... 11

3 TEST RESULT 12

3.1 6dB and 99% Bandwidth Measurement 12

3.2 Peak Output Power Measurement 17

3.3 Power Spectral Density Measurement 18

3.4 Conducted Band Edges and Spurious Emission Measurement 23

3.5 Radiated Band Edges and Spurious Emission Measurement 28

3.6 AC Conducted Emission Measurement..... 32

3.7 Antenna Requirements 50

4 LIST OF MEASURING EQUIPMENT..... 51

5 UNCERTAINTY OF EVALUATION..... 52

APPENDIX A. CONDUCTED TEST RESULTS

APPENDIX B. RADIATED SPURIOUS EMISSION

APPENDIX C. RADIATED SPURIOUS EMISSION PLOTS

APPENDIX D. DUTY CYCLE PLOTS

APPENDIX E. SETUP PHOTOGRAPHS



SUMMARY OF TEST RESULT

| Report Section | FCC Rule | Description | Limit | Result | Remark |
|----------------|--------------------|--|--------------------------------|--------|---|
| 3.1 | 15.247(a)(2) | 6dB Bandwidth | $\geq 0.5\text{MHz}$ | Pass | - |
| 3.1 | - | 99% Bandwidth | - | Pass | - |
| 3.2 | 15.247(b)(3) | Peak Output Power | $\leq 30\text{dBm}$ | Pass | - |
| 3.3 | 15.247(e) | Power Spectral Density | $\leq 8\text{dBm}/3\text{kHz}$ | Pass | - |
| 3.4 | 15.247(d) | Conducted Band Edges and Spurious Emission | $\leq 20\text{dBc}$ | Pass | - |
| 3.5 | 15.247(d) | Radiated Band Edges and Spurious Emission | 15.209(a) & 15.247(d) | Pass | Under limit 5.42 dB at 79.140 MHz |
| 3.6 | 15.207 | AC Conducted Emission | 15.207(a) | Pass | Under limit 3.10 dB at 0.758 MHz |
| 3.7 | 15.203 & 15.247(b) | Antenna Requirement | N/A | Pass | - |



1 General Description

1.1 Applicant

Zebra Technologies Corporation
1 Zebra Plaza Holtsville, NY 11742

1.2 Manufacturer

Wistron Corporation
21F, No. 88, Sec. 1, Hsin Tai Wu Rd., Hsichih Dist, New Taipei City 221, Taiwan R.O.C.

1.3 Product Feature of Equipment Under Test

| Product Feature | |
|--|---|
| Equipment | Touch computer |
| Brand Name | Zebra |
| Model Name | TC75EK |
| FCC ID | UZ7TC75EK |
| EUT supports Radios application | CDMA/EV-DO/GSM/EGPRS/WCDMA/HSPA/LTE/NFC WLAN 11a/b/g/n HT20/HT40 WLAN 11ac VHT20/VHT40/VHT80 Bluetooth BR/EDR/LE |
| HW Version | DV |
| SW Version | Android version 6.0.1 |
| FW Version | 91-10-01-MG-00 |
| MFD | 14JUL16 |
| EUT Stage | Engineering sample |

Remark: The above EUT's information was declared by manufacturer. Please refer to the specifications or user's manual for more detailed description.

| Specification of Accessories | | | | |
|--|-------------------|--------|--------------------|--------------------|
| AC Adapter | Brand Name | Zebra | Part Number | PWR-BUA5V16W0WW |
| Snap-On USB/Charge Cable | Brand Name | Symbol | Part Number | CBL-TC7X-USB1-01 |
| Snap-On Charging Cable Cup | Brand Name | Symbol | Part Number | CHG-TC7X-CBL1-01 |
| Battery | Brand Name | Zebra | Part Number | BT-000318-01 |
| Earphone 1 | Brand Name | Zebra | Part Number | HDST-35MM-PTVP-01 |
| Earphone 2 | Brand Name | Zebra | Part Number | HS2100-OTH |
| Earphone 3 | Brand Name | Zebra | Part Number | HS3100-OTH |
| Snap-on 3.5MM Audio Nugget | Brand Name | Symbol | Part Number | ADP-TC7X-AUD35-01 |
| 3.5mm Jack 43"(1.1m) Standard Cable | Brand Name | Zebra | Part Number | CBL-HS2100-3MS1-01 |
| Soft Holster | Brand Name | Zebra | Part Number | SG-TC7X-HLSTR1-01 |
| Rigid Holster | Brand Name | Zebra | Part Number | SG-TC7X-RHLSTR1-01 |
| Power Cord | Brand Name | LOROM | Part Number | 50-16000-182R |
| Cable line | Brand Name | Zebra | Part Number | CBL-DC-383A1-01 |



1.4 Product Specification of Equipment Under Test

| Standards-related Product Specification | |
|---|--|
| Tx/Rx Frequency Range | 2402 MHz ~ 2480 MHz |
| Number of Channels | 40 |
| Carrier Frequency of Each Channel | 40 Channel(37 hopping + 3 advertising channel) |
| Maximum Output Power to Antenna | 4.51 dBm (0.0028 W) |
| 99% Occupied Bandwidth | 1.06 MHz |
| Antenna Type / Gain | IFA Antenna type with gain 2.60 dBi |
| Type of Modulation | Bluetooth LE : GFSK |

1.5 Modification of EUT

No modifications are made to the EUT during all test items.

1.6 Testing Location

Sporton Lab is accredited to ISO 17025 by Taiwan Accreditation Foundation (TAF code : 1190) and the FCC designation No. TW1022 under the FCC 2.948(e) by Mutual Recognition Agreement (MRA) in FCC Test.

| | | | |
|--------------------|--|---------|-----------|
| Test Site | SPORTON INTERNATIONAL INC. | | |
| Test Site Location | No. 52, Hwa Ya 1 st Rd., Hwa Ya Technology Park, Kwei-Shan District, Tao Yuan City, Taiwan, R.O.C. TEL: +886-3-327-3456 FAX: +886-3-328-4978 | | |
| Test Site No. | Sporton Site No. | | |
| | TH02-HY | CO05-HY | 03CH07-HY |

Note: The test site complies with ANSI C63.4 2014 requirement.

1.7 Applicable Standards

According to the specifications of the manufacturer, the EUT must comply with the requirements of the following standards:

- ♦ FCC Part 15 Subpart C §15.247
- ♦ FCC KDB Publication No. 558074 D01 DTS Meas. Guidance v03r05
- ♦ ANSI C63.10-2013

Remark:

1. All test items were verified and recorded according to the standards and without any deviation during the test.
2. This EUT has also been tested and complied with the requirements of FCC Part 15, Subpart B, recorded in a separate test report.



2 Test Configuration of Equipment Under Test

2.1 Descriptions of Test Mode

The RF output power was recorded in the following table:

| Channel | Frequency | Bluetooth – LE RF Average Output Power (dBm) | |
|----------------|-----------|--|--|
| | | Data Rate / Modulation | |
| | | GFSK | |
| | | 1Mbps | |
| Duty Cycle (%) | | 62.18 | |
| Ch00 | 2402MHz | 1.60 dBm | |
| Ch19 | 2440MHz | 3.20 dBm | |
| Ch39 | 2480MHz | 3.48 dBm | |

| Channel | Frequency | Bluetooth – LE RF Peak Output Power (dBm) | |
|---------|-----------|---|--|
| | | Data Rate / Modulation | |
| | | GFSK | |
| | | 1Mbps | |
| Ch00 | 2402MHz | 3.02 dBm | |
| Ch19 | 2440MHz | 4.27 dBm | |
| Ch39 | 2480MHz | 4.51 dBm | |

a. The EUT has been associated with peripherals and configuration operated in a manner tended to maximize its emission characteristics in a typical application. Frequency range investigated: conduction (150 kHz to 30 MHz), radiation (9 kHz to the 10th harmonic of the highest fundamental frequency or to 40 GHz, whichever is lower). Pre-scanned tests, X, Y, Z in three orthogonal panels to determine the final configuration. The worst position for each mode was recorded in the appendix of this test report. From all possible combinations.

b. AC power line Conducted Emission was tested under maximum output power.



2.2 Test Mode

The following summary table is showing all test modes to demonstrate in compliance with the standard.

| Summary table of Test Cases | |
|---|--|
| Test Item | Data Rate / Modulation |
| | Bluetooth – LE / GFSK |
| Conducted TCs | Mode 1: Bluetooth Tx CH00_2402 MHz_1Mbps Mode 2: Bluetooth Tx CH19_2440 MHz_1Mbps Mode 3: Bluetooth Tx CH39_2480 MHz_1Mbps |
| Radiated TCs | Mode 1: Bluetooth Tx CH00_2402 MHz_1Mbps Mode 2: Bluetooth Tx CH19_2440 MHz_1Mbps Mode 3: Bluetooth Tx CH39_2480 MHz_1Mbps |
| AC Conducted Emission | Mode 1 :NFC Link + WLAN (2.4GHz) Link + Bluetooth Link + Earphone 1 with Audio Adapter connect to EUT + Charging Only Cable + AC Adapter Mode 2 :NFC Link + WLAN (5GHz) Link + Bluetooth Link with Earphone 3 + Snap on USB Cable Data Link with Notebook + Copy Data from Notebook to EDA (SD Card) + AC Adapter Mode 3 :NFC Link + WLAN (2.4GHz) Link + Bluetooth Link + Earphone 2 with Audio Adapter connect to EUT + Charging Only Cable + AC Adapter |
| Remark: All the radiated test cases were performance with Earphone 1, Adapter and USB Cable. | |

2.3 Connection Diagram of Test System

<AC Conducted Emission for charging mode>

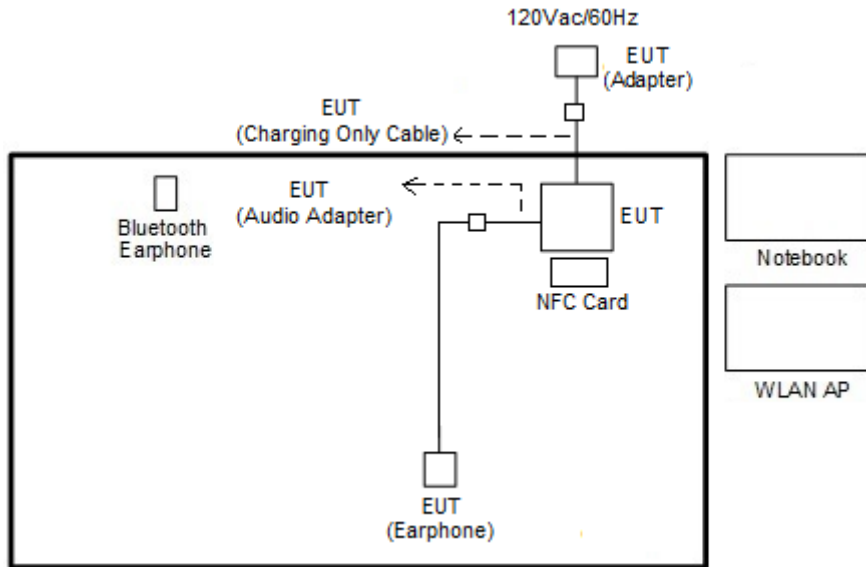

<AC Conducted Emission for data link mode>

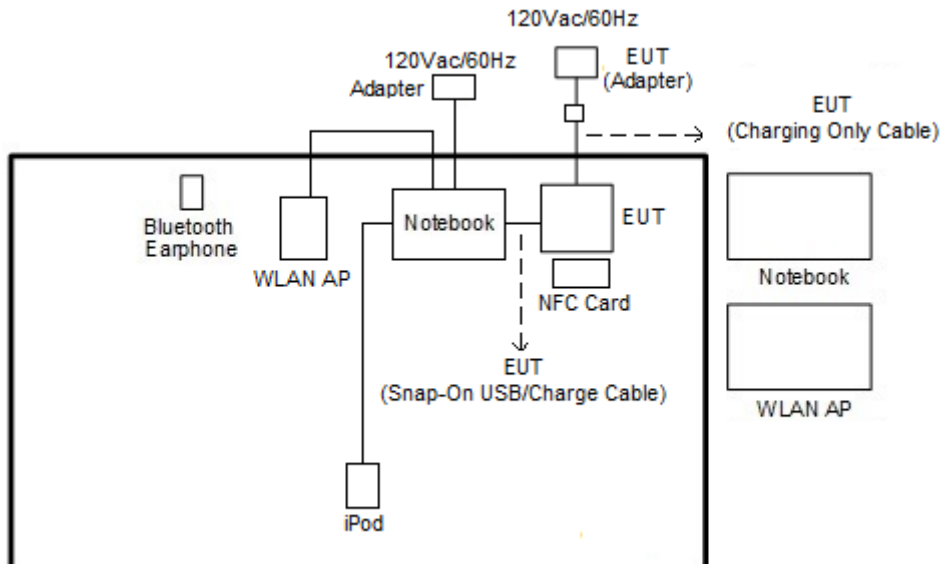

<For Fundamental Emissions and Mask and Radiated Emissions Measurement>

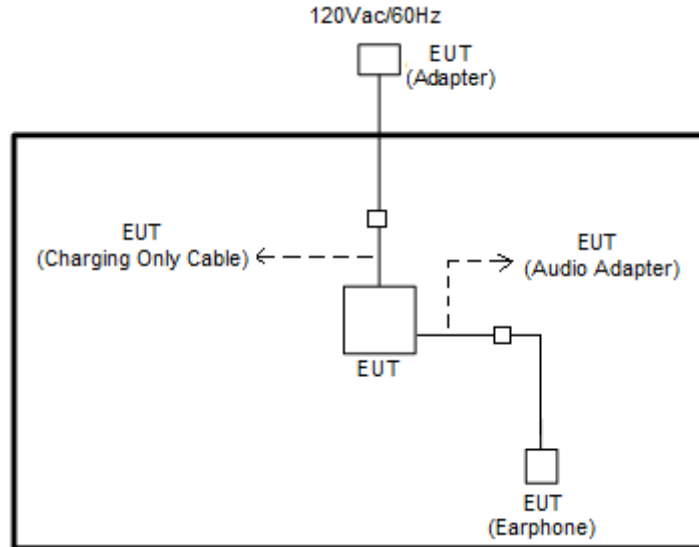

2.4 Support Unit used in test configuration and system

| Item | Equipment | Trade Name | Model Name | FCC ID | Data Cable | Power Cord |
|------|--------------------|---------------|----------------|--|-----------------|--|
| 1. | WLAN AP | D-Link | DIR-628 | KA2DIR628A2 | N/A | Unshielded, 1.8 m |
| 2. | Bluetooth Earphone | Sony Ericsson | MW600 | PY7DDA-2029 | N/A | N/A |
| 3. | Notebook | DELL | P20G | FCC DoC/ Contains FCC ID: QDS-BRCM1051 | N/A | AC I/P: Unshielded, 1.2 m DC O/P: Shielded, 1.8 m |
| 4. | Notebook | DELL | Latitude E6320 | FCC DoC/ Contains FCC ID: QDS-BRCM1054 | N/A | AC I/P: Unshielded, 1.2 m DC O/P: Shielded, 1.8 m |
| 5. | Notebook | Lenovo | M490S(E330) | QDS-BRCM1063 | N/A | Unshielded, 1.8 m |
| 6. | SD Card | SanDisk | MicroSD HC | FCC DoC | N/A | N/A |
| 7. | NFC Card | Metro Taipei | Easy Card | N/A | N/A | N/A |
| 8. | iPod | Apple | A1285 | FCC DoC | Shielded, 1.0 m | N/A |

2.5 EUT Operation Test Setup

For Bluetooth function, the RF utility, "Command" was installed in EUT which was programmed in order to make the EUT get into the engineering modes to contact with Bluetooth base station for continuous transmitting and receiving signals.



2.6 Measurement Results Explanation Example

For all conducted test items:

The offset level is set in the spectrum analyzer to compensate the RF cable loss and attenuator factor between EUT conducted output port and spectrum analyzer. With the offset compensation, the spectrum analyzer reading level is exactly the EUT RF output level.

Example :

The spectrum analyzer offset is derived from RF cable loss and attenuator factor.

Offset = RF cable loss + attenuator factor.

Following shows an offset computation example with cable loss 4.2 dB and 10dB attenuator.

$$\begin{aligned} \text{Offset(dB)} &= \text{RF cable loss(dB)} + \text{attenuator factor(dB)}. \\ &= 4.2 + 10 = 14.2 \text{ (dB)} \end{aligned}$$

3 Test Result

3.1 6dB and 99% Bandwidth Measurement

3.1.1 Limit of 6dB and 99% Bandwidth

The minimum 6 dB bandwidth shall be at least 500 kHz.

3.1.2 Measuring Instruments

The section 4.0 of List of Measuring Equipment of this test report is used for test.

3.1.3 Test Procedures

1. The testing follows FCC KDB Publication No. 558074 D01 DTS Meas. Guidance v03r05.
2. The RF output of EUT was connected to the spectrum analyzer by RF cable and attenuator. The path loss was compensated to the results for each measurement.
3. Set to the maximum power setting and enable the EUT transmit continuously.
4. Make the measurement with the spectrum analyzer's resolution bandwidth (RBW) = 100 kHz. Set the Video bandwidth (VBW) = 300 kHz. In order to make an accurate measurement. The 6 dB bandwidth must be greater than 500 kHz.
5. For 99% Bandwidth Measurement, the spectrum analyzer's resolution bandwidth (RBW) is set 30kHz and set the Video bandwidth (VBW) = 100kHz.
6. Measure and record the results in the test report.

3.1.4 Test Setup

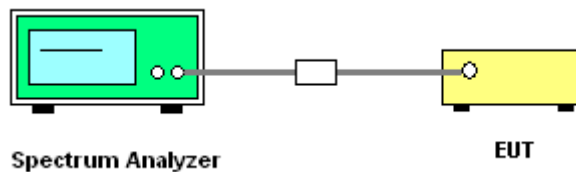



3.1.5 Test Result of 6dB Bandwidth

Test data refer to Appendix A.

6 dB Bandwidth Plot on Channel 00

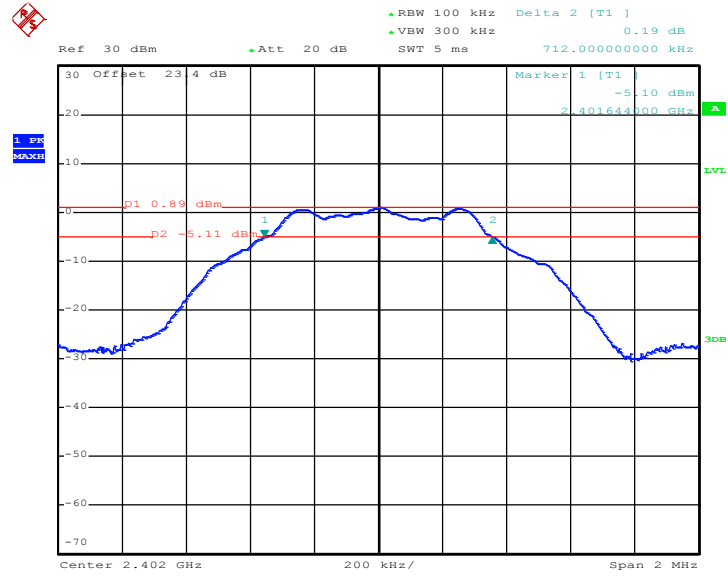

Date: 26.AUG.2016 22:04:24



6 dB Bandwidth Plot on Channel 19

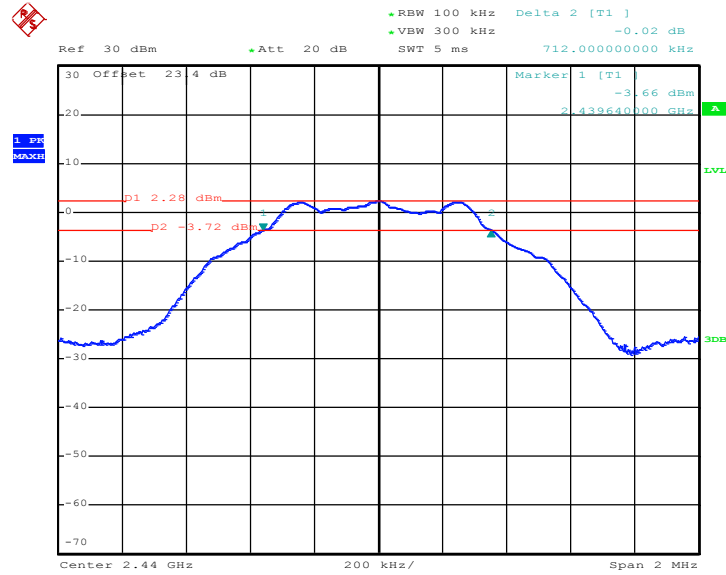

Date: 26.AUG.2016 21:59:22

6 dB Bandwidth Plot on Channel 39

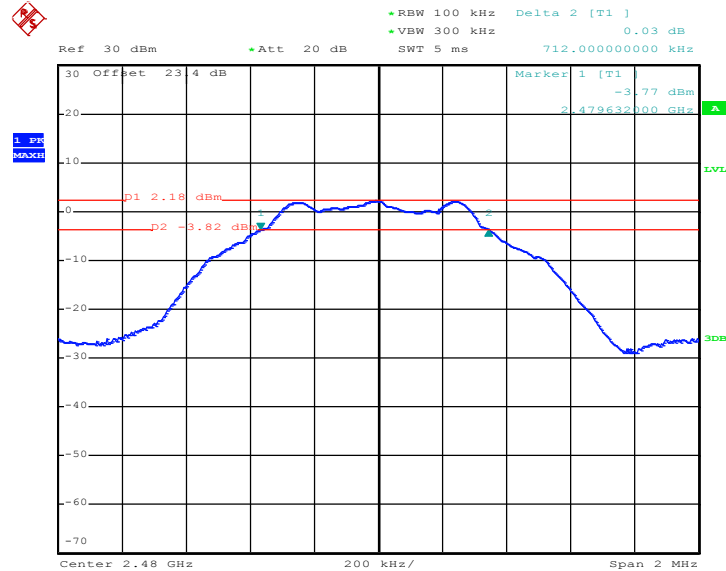

Date: 26.AUG.2016 21:53:05



3.1.6 Test Result of 99% Occupied Bandwidth

Test data refer to Appendix A.

99% Bandwidth Plot on Channel 00

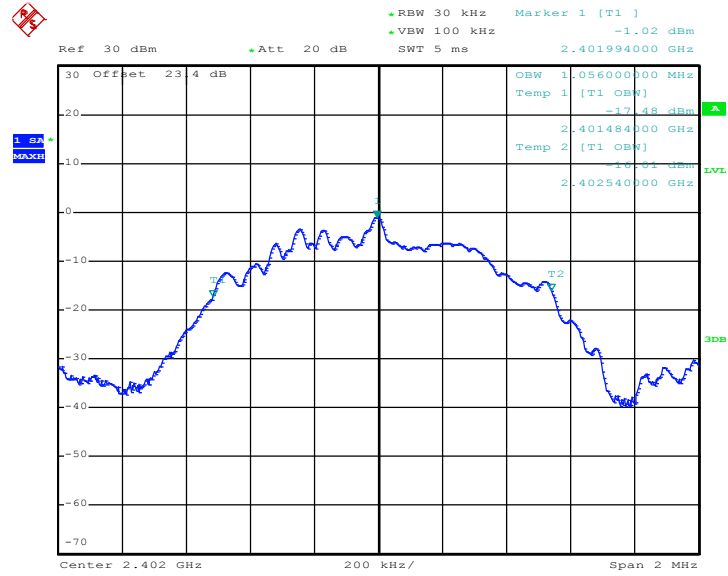

Date: 26.AUG.2016 22:06:50



99% Occupied Bandwidth Plot on Channel 19

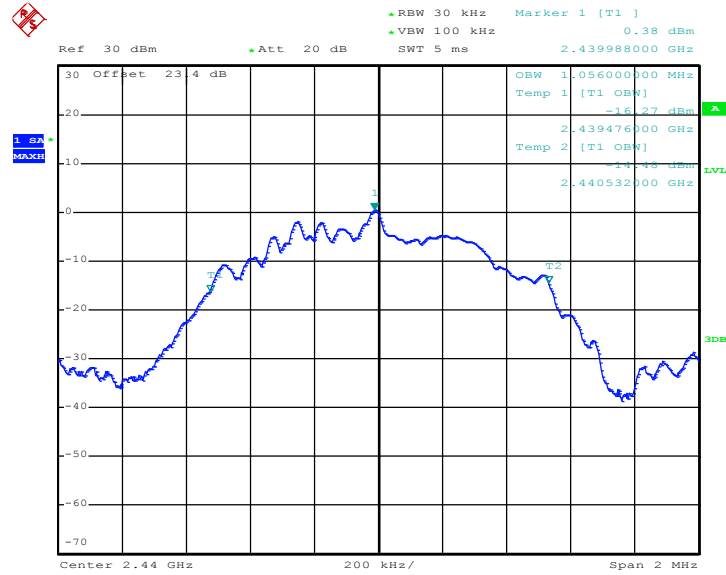

Date: 26.AUG.2016 22:02:15

99% Occupied Bandwidth Plot on Channel 39

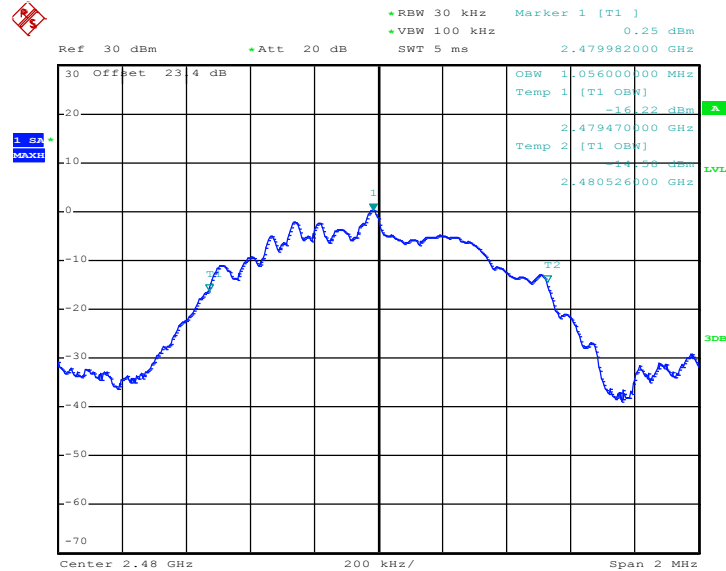

Date: 26.AUG.2016 21:55:54

Note : The occupied channel bandwidth is maintained within the band of operation for all of the modulations.

3.2 Peak Output Power Measurement

3.2.1 Limit of Peak Output Power

For systems using digital modulation in the 2400-2483.5MHz, the limit for peak output power is 30dBm. If transmitting antenna of directional gain greater than 6dBi is used, the peak output power from the intentional radiator shall be reduced below the above stated value by the amount in dB that the directional gain of the antenna exceeds 6 dBi. In case of point-to-point operation, the limit has to be reduced by 1dB for every 3dB that the directional gain of the antenna exceeds 6dBi.

3.2.2 Measuring Instruments

The section 4.0 of List of Measuring Equipment of this test report is used for test.

3.2.3 Test Procedures

1. The testing follows the Measurement Procedure of FCC KDB No. 558074 DTS D01 Meas. Guidance v03r05 section 9.1.2 PKPM1 Peak power meter method.
2. The RF output of EUT was connected to the power meter by RF cable and attenuator. The path loss was compensated to the results for each measurement.
3. Set to the maximum power setting and enable the EUT transmit continuously.
4. Measure the conducted output power and record the results in the test report.

3.2.4 Test Setup

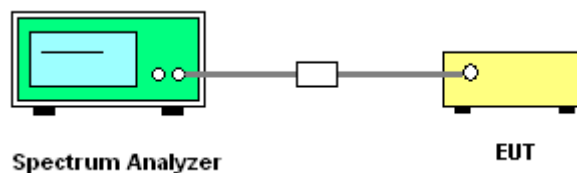

3.2.5 Test Result of Peak Output Power

Test data refers to Appendix A.

3.3 Power Spectral Density Measurement

3.3.1 Limit of Power Spectral Density

The peak power spectral density shall not be greater than 8dBm in any 3kHz band at any time interval of continuous transmission.

3.3.2 Measuring Instruments

The section 4.0 of List of Measuring Equipment of this test report is used for test.

3.3.3 Test Procedures

1. The testing follows Measurement Procedure 10.2 Method PKPSD of FCC KDB Publication No. 558074 D01 DTS Meas. Guidance v03r05
2. The RF output of EUT was connected to the spectrum analyzer by RF cable and attenuator. The path loss was compensated to the results for each measurement.
3. Set to the maximum power setting and enable the EUT transmit continuously.
4. Make the measurement with the spectrum analyzer's resolution bandwidth (RBW) = 3 kHz. Video bandwidth VBW = 10 kHz In order to make an accurate measurement, set the span to 1.5 times DTS Channel Bandwidth. (6dB BW)
5. Detector = peak, Sweep time = auto couple, Trace mode = max hold, Allow trace to fully stabilize. Use the peak marker function to determine the maximum power level.
6. Measure and record the results in the test report.
7. The Measured power density (dBm)/ 100kHz is a reference level and used as 20dBc down limit line for Conducted Band Edges and Conducted Spurious Emission.

3.3.4 Test Setup

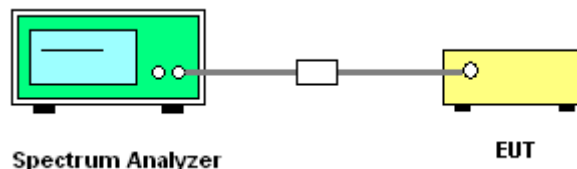



3.3.5 Test Result of Power Spectral Density

Test data refers to Appendix A.

3.3.6 Test Result of Power Spectral Density Plots (100kHz)

PSD 100kHz Plot on Channel 00

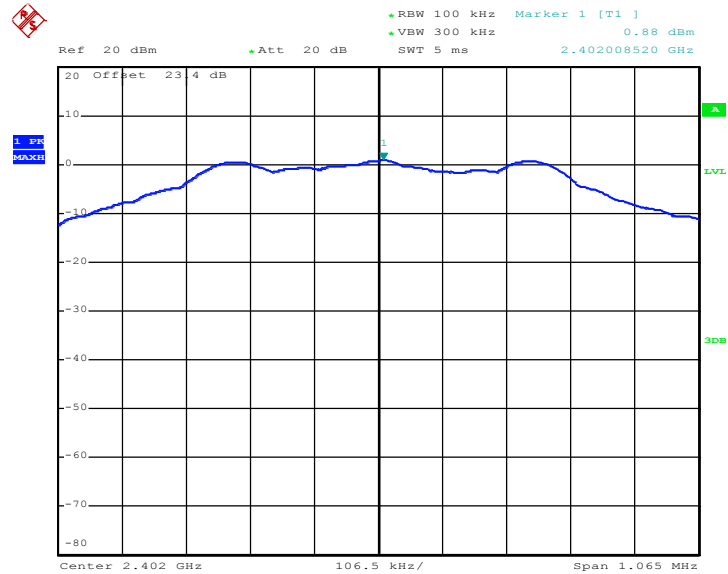

Date: 26.AUG.2016 22:05:18



PSD 100kHz Plot on Channel 19

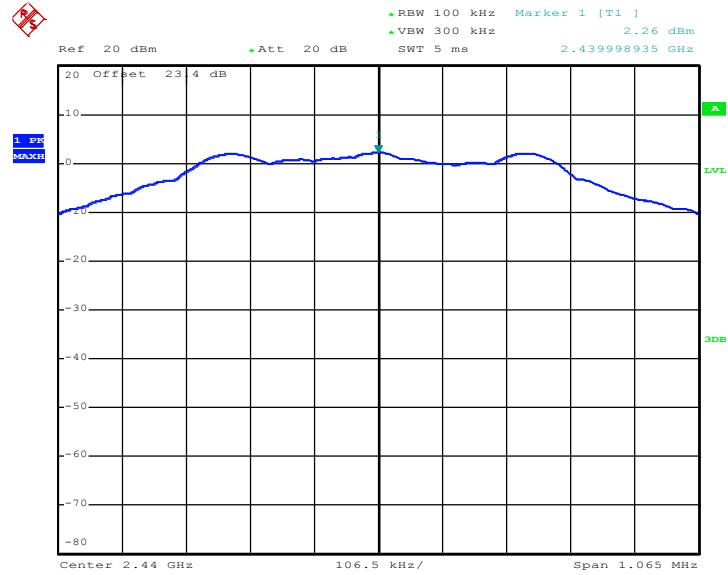

Date: 26.AUG.2016 22:00:30

PSD 100kHz Plot on Channel 39

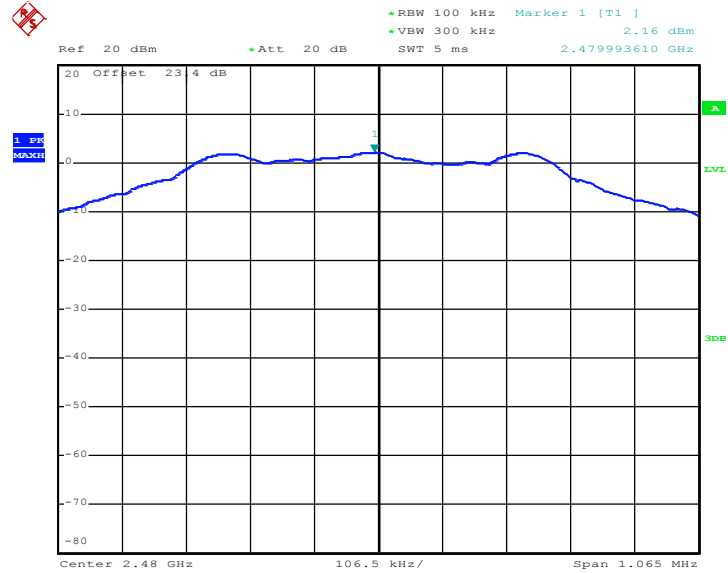

Date: 26.AUG.2016 21:54:05



3.3.7 Test Result of Power Spectral Density Plots (3kHz)

PSD 3kHz Plot on Channel 00

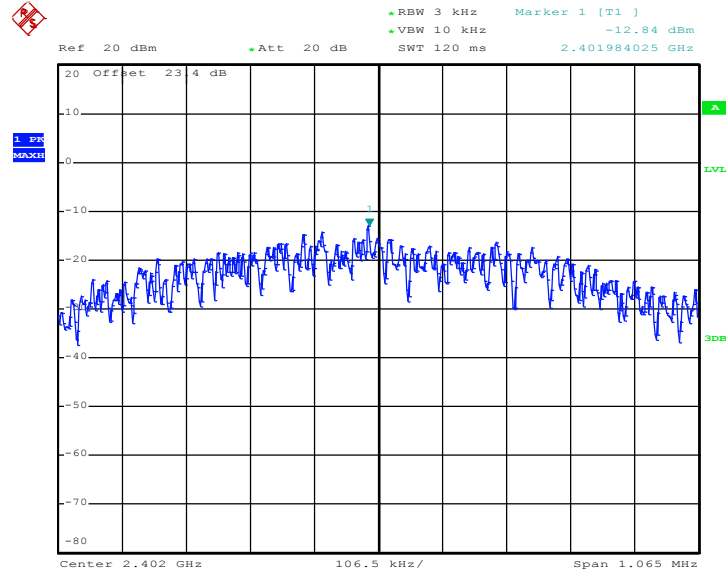

Date: 26.AUG.2016 22:04:58



PSD 3kHz Plot on Channel 19

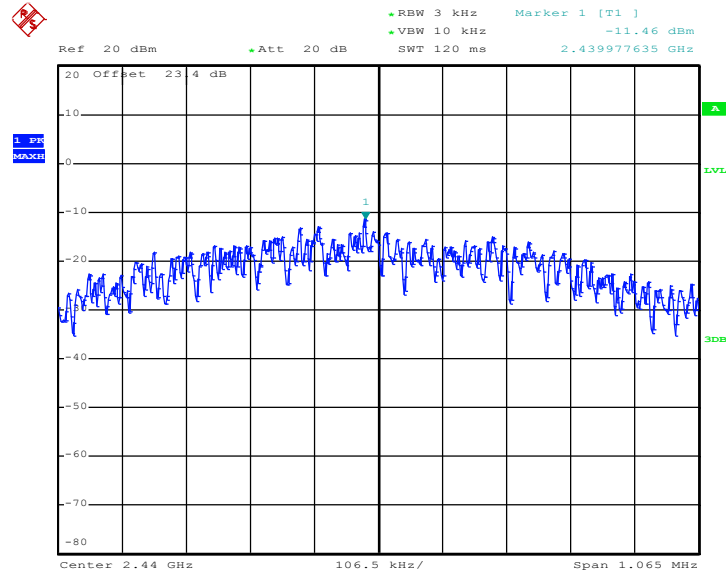

Date: 26.AUG.2016 22:00:08

PSD 3kHz Plot on Channel 39

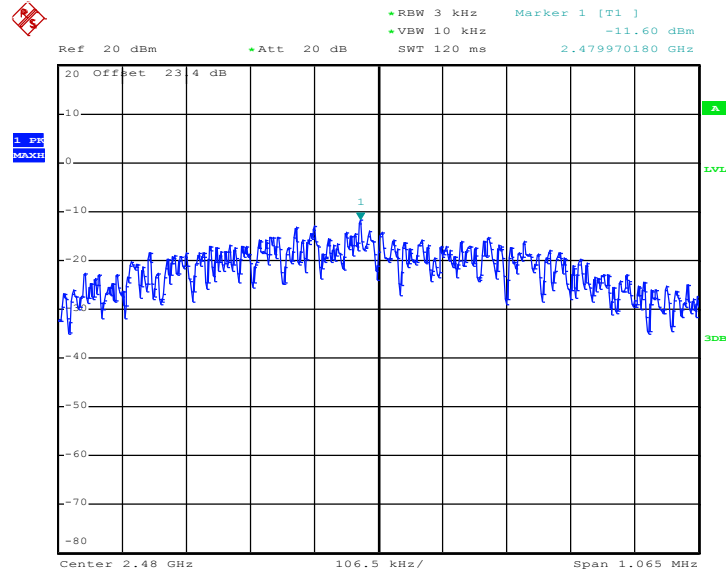

Date: 26.AUG.2016 21:53:45

3.4 Conducted Band Edges and Spurious Emission Measurement

3.4.1 Limit of Conducted Band Edges and Spurious Emission

All harmonics/spurious must be at least 20 dB down from the highest emission level within the authorized band.

3.4.2 Measuring Instruments

The section 4.0 of List of Measuring Equipment of this test report is used for test.

3.4.3 Test Procedure

1. The testing follows FCC KDB Publication No. 558074 D01 DTS Meas. Guidance v03r05.
2. The RF output of EUT was connected to the spectrum analyzer by RF cable and attenuator. The path loss was compensated to the results for each measurement.
3. Set to the maximum power setting and enable the EUT transmit continuously.
4. Set RBW = 100 kHz, VBW=300 kHz, Peak Detector. Unwanted Emissions measured in any 100 kHz bandwidth outside of the authorized frequency band shall be attenuated by at least 20 dB relative to the maximum in-band peak PSD level in 100 kHz when maximum peak conducted output power procedure is used. If the transmitter complies with the conducted power limits based on the use of RMS averaging over a time interval, the attenuation required under this paragraph shall be 30 dB instead of 20 dB per 15.247(d).
5. Measure and record the results in the test report.
6. The RF fundamental frequency should be excluded against the limit line in the operating frequency band.

3.4.4 Test Setup

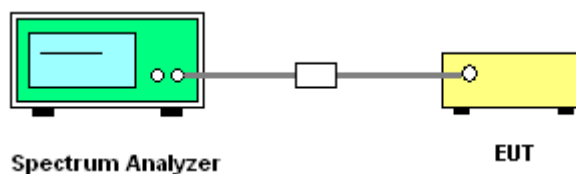



3.4.5 Test Result of Conducted Band Edges Plots

Low Band Edge Plot on Channel 00

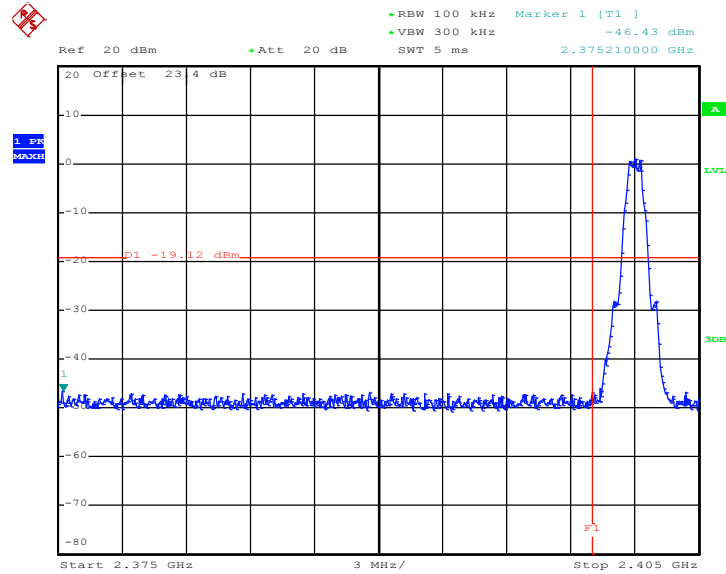

Date: 26.AUG.2016 22:05:34

High Band Edge Plot on Channel 39

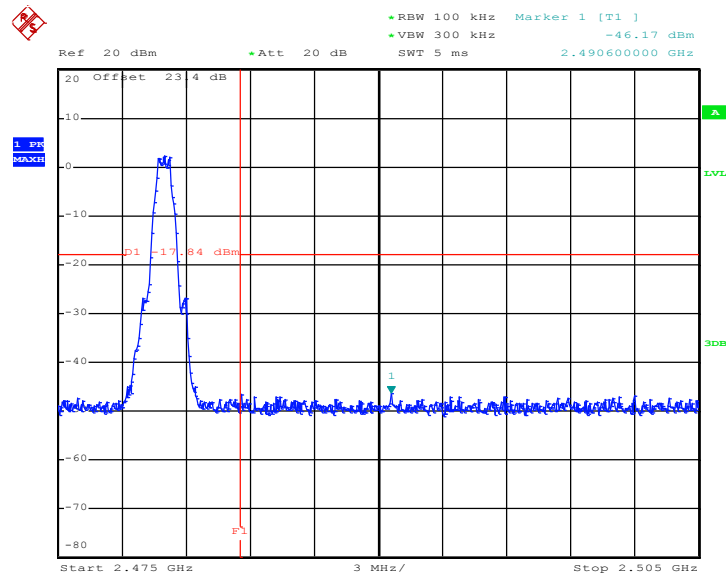

Date: 26.AUG.2016 21:54:26



Conducted Spurious Emission Plot on Bluetooth LE 1Mbps GFSK Channel 19

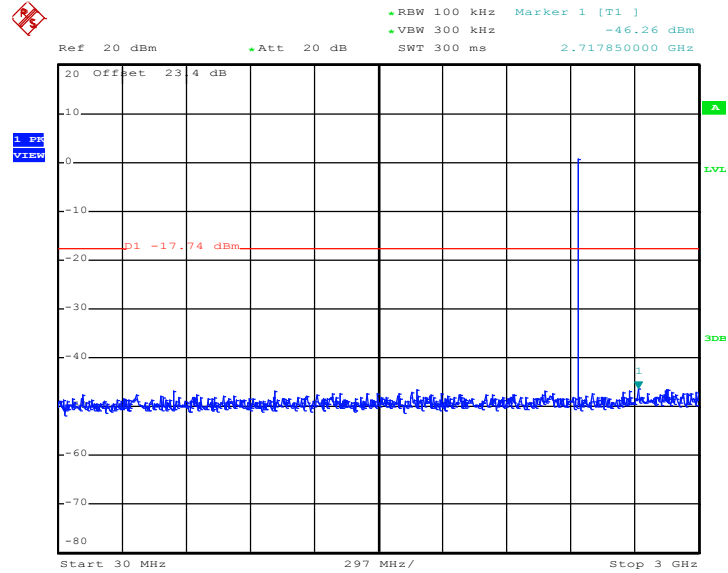

Date: 26.AUG.2016 22:01:24

Conducted Spurious Emission Plot on Bluetooth LE 1Mbps GFSK Channel 19

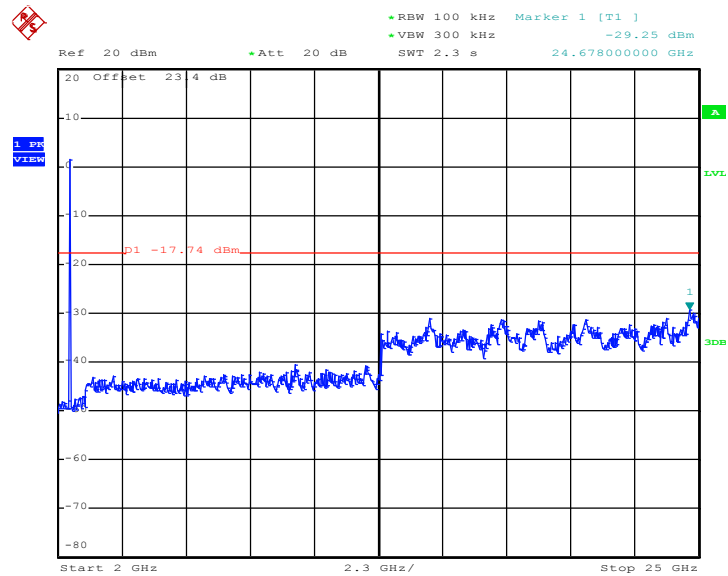

Date: 26.AUG.2016 22:01:32



Conducted Spurious Emission Plot on Bluetooth LE 1Mbps GFSK Channel 39

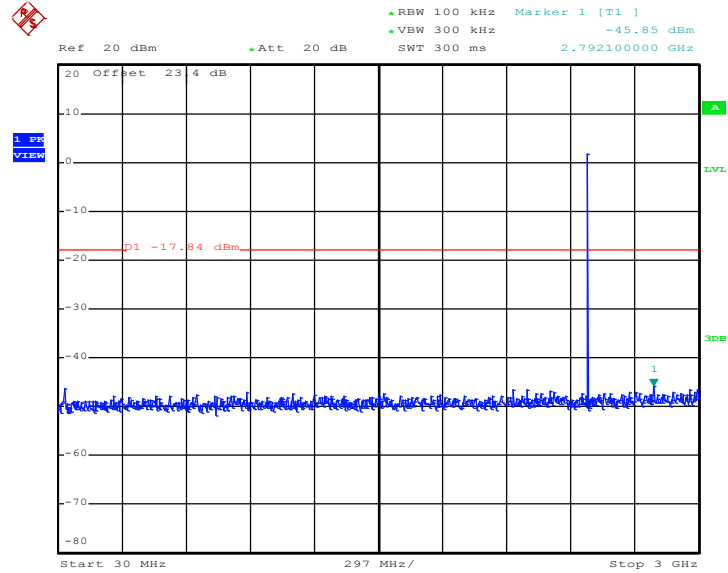

Date: 26.AUG.2016 21:55:15

Conducted Spurious Emission Plot on Bluetooth LE 1Mbps GFSK Channel 39

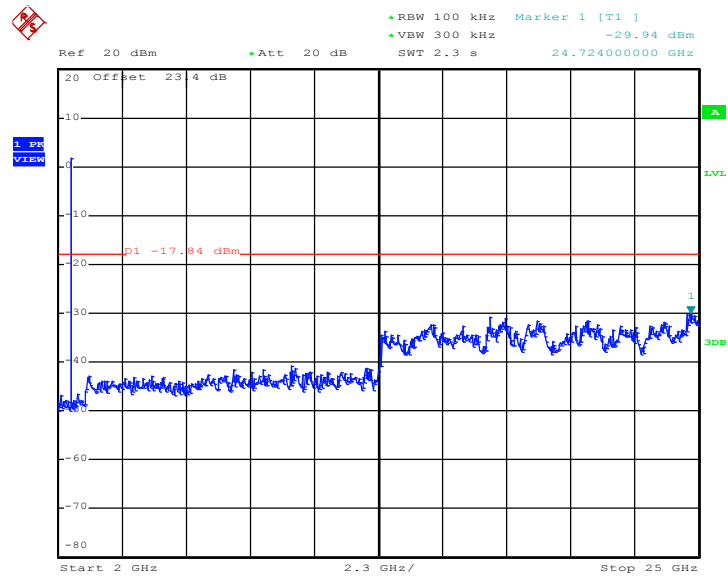

Date: 26.AUG.2016 21:55:24



3.5 Radiated Band Edges and Spurious Emission Measurement

3.5.1 Limit of Radiated Band Edges and Spurious Emission

In any 100 kHz bandwidth outside the intentional radiator frequency band, all harmonics/spurious must be at least 20 dB below the highest emission level within the authorized band. If the output power of this device was measured by spectrum analyzer, the attenuation under this paragraph shall be 30 dB instead of 20 dB. In addition, radiated emissions which fall in the restricted bands must also comply with the FCC section 15.209 limits as below.

| Frequency (MHz) | Field Strength (microvolts/meter) | Measurement Distance (meters) |
|-----------------|-----------------------------------|-------------------------------|
| 0.009 – 0.490 | 2400/F(kHz) | 300 |
| 0.490 – 1.705 | 24000/F(kHz) | 30 |
| 1.705 – 30.0 | 30 | 30 |
| 30 – 88 | 100 | 3 |
| 88 – 216 | 150 | 3 |
| 216 - 960 | 200 | 3 |
| Above 960 | 500 | 3 |

3.5.2 Measuring Instruments

The section 4.0 of List of Measuring Equipment of this test report is used for test.



3.5.3 Test Procedures

1. The testing follows FCC KDB Publication No. 558074 D01 DTS Meas. Guidance v03r05.
2. The EUT was arranged to its worst case and then tune the antenna tower (from 1 m to 4 m) and turntable (from 0 degree to 360 degrees) to find the maximum reading. A pre-amp and a high pass filter are used for the test in order to get better signal level.
3. The EUT was placed on a turntable with 0.8 meter for frequency below 1GHz and 1.5 meter for frequency above 1GHz respectively above ground.
4. The EUT was set 3 meters from the interference receiving antenna, which was mounted on the top of a variable height antenna tower.
5. Corrected Reading: Antenna Factor + Cable Loss + Read Level - Preamp Factor = Level
6. For measurement below 1GHz, If the emission level of the EUT measured by the peak detector is 3 dB lower than the applicable limit, the peak emission level will be reported. Otherwise, the emission measurement will be repeated using the quasi-peak detector and reported.
7. Use the following spectrum analyzer settings:
 - (1) Span shall wide enough to fully capture the emission being measured;
 - (2) Set RBW=100 kHz for $f < 1$ GHz; VBW \geq RBW; Sweep = auto; Detector function = peak; Trace = max hold;
 - (3) Set RBW = 1 MHz, VBW= 3MHz for $f \geq 1$ GHz for peak measurement.
For average measurement:
 - VBW = 10 Hz, when duty cycle is no less than 98 percent.
 - VBW $\geq 1/T$, when duty cycle is less than 98 percent where T is the minimum transmission duration over which the transmitter is on and is transmitting at its maximum power control level for the tested mode of operation.

3.5.4 Test Setup

For radiated emissions below 30MHz

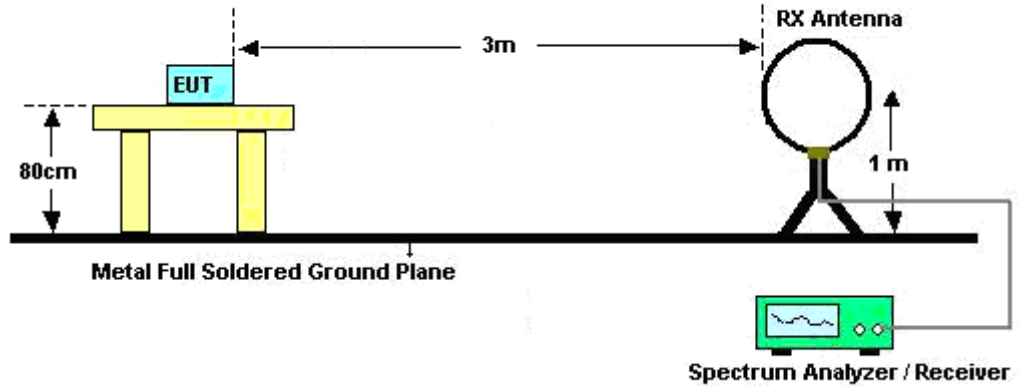

For radiated emissions from 30MHz to 1GHz

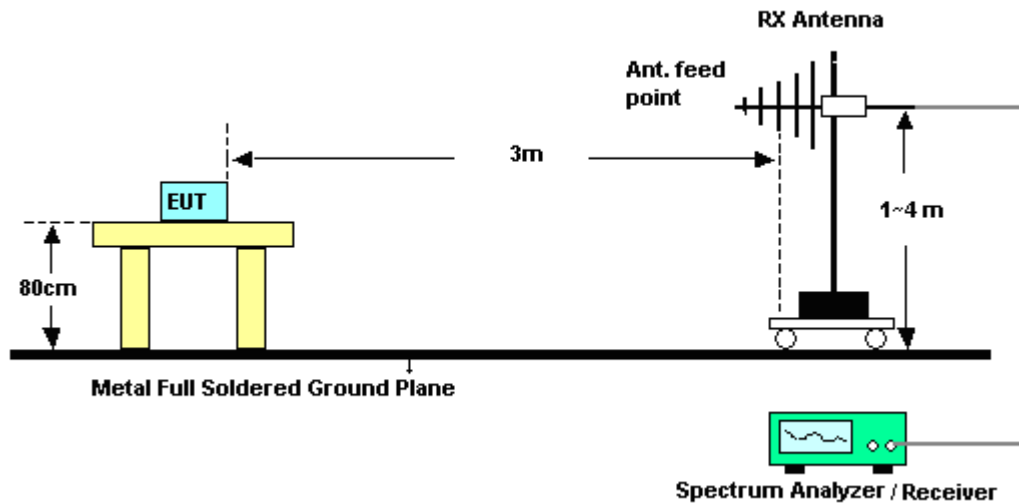

For radiated emissions above 1GHz

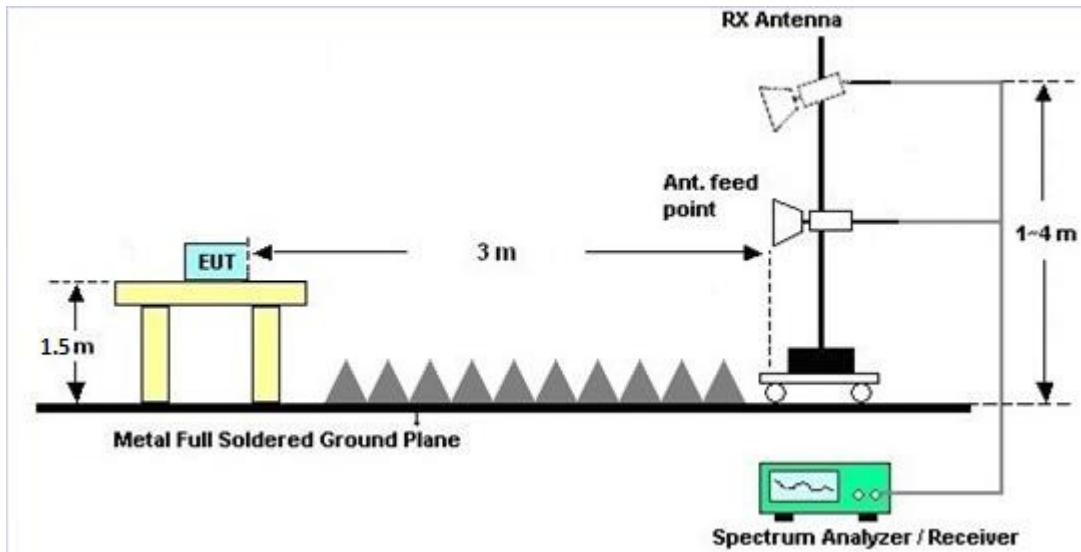

3.5.5 Test Results of Radiated Spurious Emissions (9 kHz ~ 30 MHz)

The low frequency, which started from 9 kHz to 30MHz, was pre-scanned and the result which was 20dB lower than the limit line per 15.31(o) was not reported.

3.5.6 Test Result of Radiated Spurious at Band Edges

Please refer to Appendix B and C.

3.5.7 Duty Cycle

Please refer to Appendix D.

3.5.8 Test Result of Radiated Spurious Emission (30MHz ~ 10th Harmonic)

Please refer to Appendix B and C.



3.6 AC Conducted Emission Measurement

3.6.1 Limit of AC Conducted Emission

For equipment that is designed to be connected to the public utility (AC) power line, the radio frequency voltage that is conducted back onto the AC power line on any frequency or frequencies within the band 150 kHz to 30 MHz shall not exceed the limits in the following table.

| Frequency of emission (MHz) | Conducted limit (dBµV) | |
|-----------------------------|------------------------|-----------|
| | Quasi-peak | Average |
| 0.15-0.5 | 66 to 56* | 56 to 46* |
| 0.5-5 | 56 | 46 |
| 5-30 | 60 | 50 |

*Decreases with the logarithm of the frequency.

For terminal test result, the testing follows FCC KDB 174176.

3.6.2 Measuring Instruments

The section 4.0 of List of Measuring Equipment of this test report is used for test.

3.6.3 Test Procedures

1. The EUT was placed 0.4 meter from the conducting wall of the shielding room was kept at least 80 centimeters from any other grounded conducting surface.
2. Connect EUT to the power mains through a line impedance stabilization network (LISN).
3. All the support units are connecting to the other LISN.
4. The LISN provides 50 ohm coupling impedance for the measuring instrument.
5. The FCC states that a 50 ohm, 50 microhenry LISN should be used.
6. Both sides of AC line were checked for maximum conducted interference.
7. The frequency range from 150 kHz to 30 MHz was searched.
8. Set the test-receiver system to Peak Detect Function and specified bandwidth (IF Bandwidth = 9kHz) with Maximum Hold Mode. Then measurement is also conducted by Average Detector and Quasi-Peak Detector Function respectively.

3.6.4 Test Setup

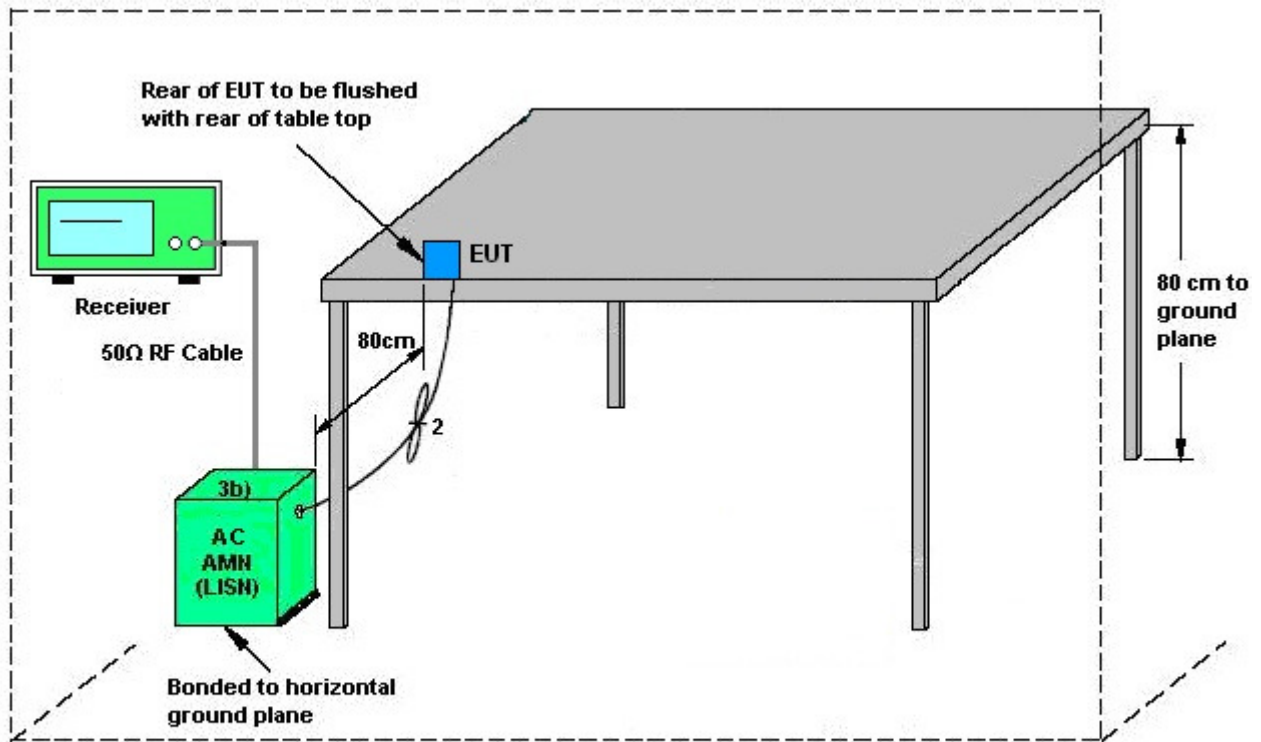

AMN = Artificial mains network (LISH)
AE = Associated equipment
EUT = Equipment under test
ISN = Impedance stabilization network



3.6.5 Test Result of AC Conducted Emission

<Original test result with NFC antenna>

| | | | |
|-----------------|--|---------------------|---------|
| Test Mode : | Mode 1 | Temperature : | 22~24°C |
| Test Engineer : | Arthur Hsieh | Relative Humidity : | 51~53% |
| Test Voltage : | 120Vac / 60Hz | Phase : | Line |
| Function Type : | NFC Link + WLAN (2.4GHz) Link + Bluetooth Link + Earphone 1 with Audio Adapter connect to EUT + Charging Only Cable + AC Adapter | | |

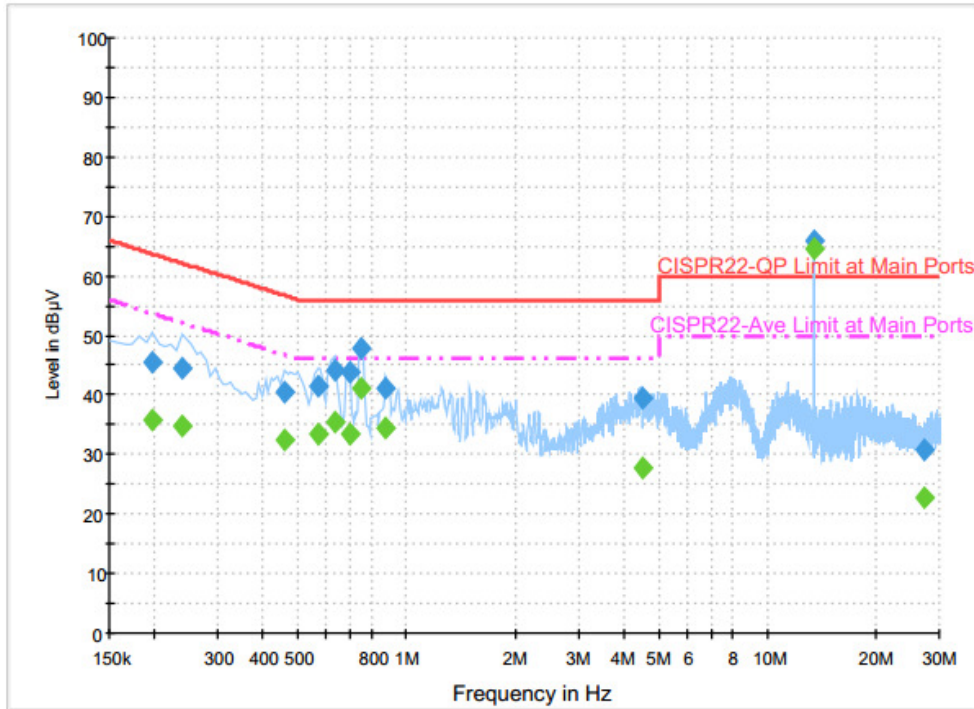

Final Result : Quasi-Peak

| Frequency (MHz) | Quasi-Peak (dBµV) | Filter | Line | Corr. (dB) | Margin (dB) | Limit (dBµV) |
|-----------------|-------------------|--------|------|------------|-------------|--------------|
| 0.198000 | 45.5 | Off | L1 | 19.6 | 18.2 | 63.7 |
| 0.238000 | 44.4 | Off | L1 | 19.6 | 17.8 | 62.2 |
| 0.462000 | 40.5 | Off | L1 | 19.6 | 16.2 | 56.7 |
| 0.566000 | 41.4 | Off | L1 | 19.6 | 14.6 | 56.0 |
| 0.630000 | 44.1 | Off | L1 | 19.6 | 11.9 | 56.0 |
| 0.694000 | 43.8 | Off | L1 | 19.6 | 12.2 | 56.0 |
| 0.750000 | 48.0 | Off | L1 | 19.6 | 8.0 | 56.0 |
| 0.878000 | 41.2 | Off | L1 | 19.6 | 14.8 | 56.0 |
| 4.534000 | 39.3 | Off | L1 | 19.7 | 16.7 | 56.0 |
| 13.558000 | 65.9 | Off | L1 | 19.8 | -5.9 | 60.0 |
| 27.118000 | 30.9 | Off | L1 | 19.9 | 29.1 | 60.0 |



| | | | |
|-----------------|--|---------------------|---------|
| Test Mode : | Mode 1 | Temperature : | 22~24°C |
| Test Engineer : | Arthur Hsieh | Relative Humidity : | 51~53% |
| Test Voltage : | 120Vac / 60Hz | Phase : | Line |
| Function Type : | NFC Link + WLAN (2.4GHz) Link + Bluetooth Link + Earphone 1 with Audio Adapter connect to EUT + Charging Only Cable + AC Adapter | | |

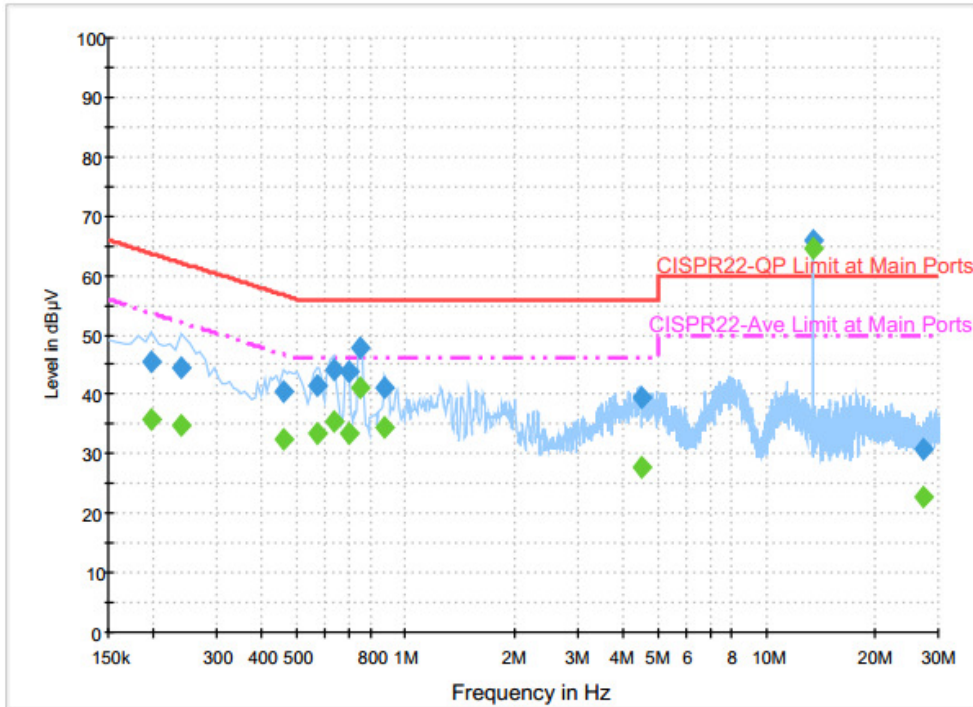

Final Result : Average

| Frequency (MHz) | Average (dBµV) | Filter | Line | Corr. (dB) | Margin (dB) | Limit (dBµV) |
|-----------------|----------------|--------|------|------------|-------------|--------------|
| 0.198000 | 35.7 | Off | L1 | 19.6 | 18.0 | 53.7 |
| 0.238000 | 34.7 | Off | L1 | 19.6 | 17.5 | 52.2 |
| 0.462000 | 32.3 | Off | L1 | 19.6 | 14.4 | 46.7 |
| 0.566000 | 33.4 | Off | L1 | 19.6 | 12.6 | 46.0 |
| 0.630000 | 35.3 | Off | L1 | 19.6 | 10.7 | 46.0 |
| 0.694000 | 33.6 | Off | L1 | 19.6 | 12.4 | 46.0 |
| 0.750000 | 41.1 | Off | L1 | 19.6 | 4.9 | 46.0 |
| 0.878000 | 34.4 | Off | L1 | 19.6 | 11.6 | 46.0 |
| 4.534000 | 27.8 | Off | L1 | 19.7 | 18.2 | 46.0 |
| 13.558000 | 64.6 | Off | L1 | 19.8 | -14.6 | 50.0 |
| 27.118000 | 22.6 | Off | L1 | 19.9 | 27.4 | 50.0 |



| | | | |
|-----------------|--|---------------------|---------|
| Test Mode : | Mode 1 | Temperature : | 22~24°C |
| Test Engineer : | Arthur Hsieh | Relative Humidity : | 51~53% |
| Test Voltage : | 120Vac / 60Hz | Phase : | Neutral |
| Function Type : | NFC Link + WLAN (2.4GHz) Link + Bluetooth Link + Earphone 1 with Audio Adapter connect to EUT + Charging Only Cable + AC Adapter | | |

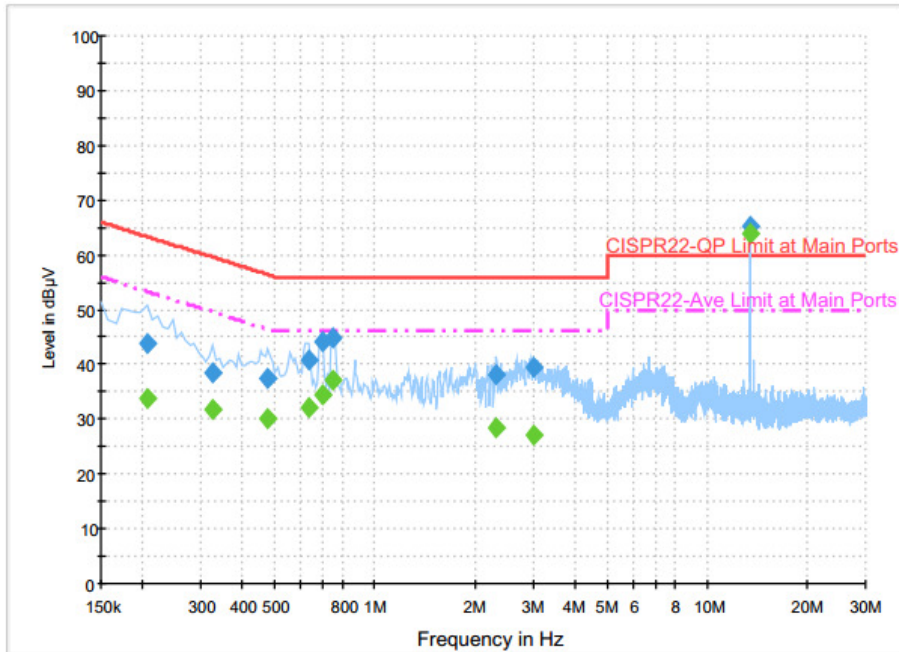

Final Result : Quasi-Peak

| Frequency (MHz) | Quasi-Peak (dBµV) | Filter | Line | Corr. (dB) | Margin (dB) | Limit (dBµV) |
|-----------------|-------------------|--------|------|------------|-------------|--------------|
| 0.206000 | 44.0 | Off | N | 19.6 | 19.4 | 63.4 |
| 0.326000 | 38.6 | Off | N | 19.6 | 21.0 | 59.6 |
| 0.478000 | 37.6 | Off | N | 19.6 | 18.8 | 56.4 |
| 0.630000 | 40.9 | Off | N | 19.6 | 15.1 | 56.0 |
| 0.694000 | 44.2 | Off | N | 19.6 | 11.8 | 56.0 |
| 0.750000 | 44.7 | Off | N | 19.6 | 11.3 | 56.0 |
| 2.326000 | 38.1 | Off | N | 18.6 | 17.9 | 56.0 |
| 3.022000 | 39.3 | Off | N | 19.5 | 16.7 | 56.0 |
| 13.558000 | 65.3 | Off | N | 19.8 | -5.3 | 60.0 |

Final Result : Average

| Frequency (MHz) | Average (dBµV) | Filter | Line | Corr. (dB) | Margin (dB) | Limit (dBµV) |
|-----------------|----------------|--------|------|------------|-------------|--------------|
| 0.206000 | 33.9 | Off | N | 19.6 | 19.5 | 53.4 |
| 0.326000 | 31.8 | Off | N | 19.6 | 17.8 | 49.6 |
| 0.478000 | 30.1 | Off | N | 19.6 | 16.3 | 46.4 |
| 0.630000 | 31.9 | Off | N | 19.6 | 14.1 | 46.0 |
| 0.694000 | 34.5 | Off | N | 19.6 | 11.5 | 46.0 |
| 0.750000 | 37.1 | Off | N | 19.6 | 8.9 | 46.0 |
| 2.326000 | 28.4 | Off | N | 18.6 | 17.6 | 46.0 |
| 3.022000 | 27.2 | Off | N | 19.5 | 18.8 | 46.0 |
| 13.558000 | 63.8 | Off | N | 19.8 | -13.8 | 50.0 |



<Terminal test result with dummy load>

| | | | |
|-----------------|--|---------------------|---------|
| Test Mode : | Mode 1 | Temperature : | 22~24°C |
| Test Engineer : | Arthur Hsieh | Relative Humidity : | 51~53% |
| Test Voltage : | 120Vac / 60Hz | Phase : | Line |
| Function Type : | NFC Link + WLAN (2.4GHz) Link + Bluetooth Link + Earphone 1 with Audio Adapter connect to EUT + Charging Only Cable + AC Adapter | | |

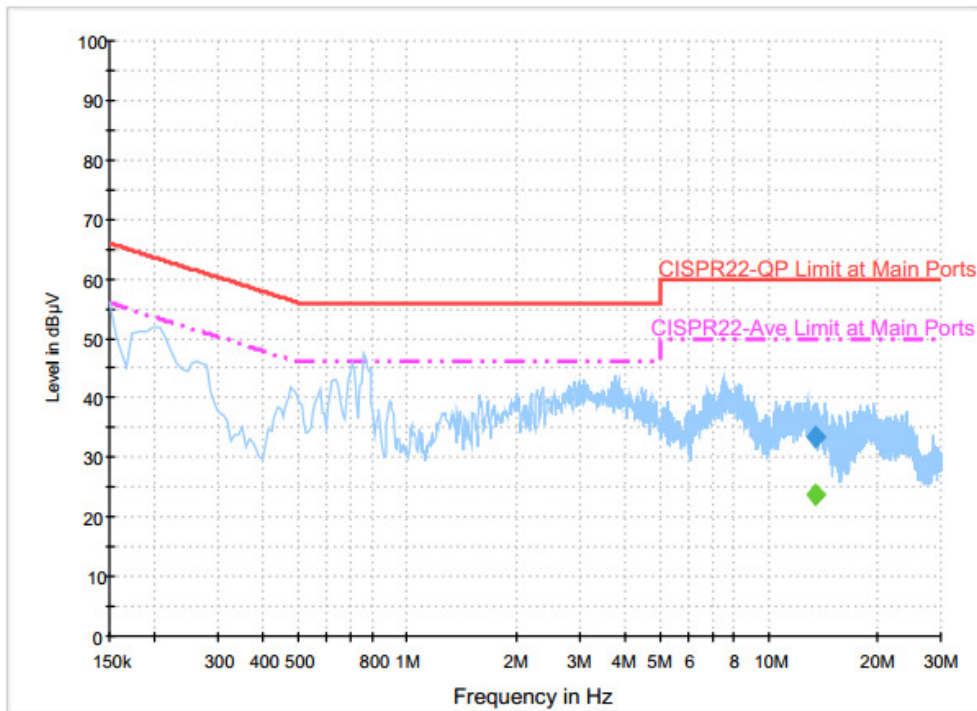

Final Result : Quasi-Peak

| Frequency (MHz) | Quasi-Peak (dBµV) | Filter | Line | Corr. (dB) | Margin (dB) | Limit (dBµV) |
|-----------------|-------------------|--------|------|------------|-------------|--------------|
| 13.558000 | 33.5 | Off | L1 | 19.8 | 26.5 | 60.0 |

Final Result : Average

| Frequency (MHz) | Average (dBµV) | Filter | Line | Corr. (dB) | Margin (dB) | Limit (dBµV) |
|-----------------|----------------|--------|------|------------|-------------|--------------|
| 13.558000 | 23.6 | Off | L1 | 19.8 | 26.4 | 50.0 |



| | | | |
|-----------------|--|---------------------|---------|
| Test Mode : | Mode 1 | Temperature : | 22~24°C |
| Test Engineer : | Arthur Hsieh | Relative Humidity : | 51~53% |
| Test Voltage : | 120Vac / 60Hz | Phase : | Neutral |
| Function Type : | NFC Link + WLAN (2.4GHz) Link + Bluetooth Link + Earphone 1 with Audio Adapter connect to EUT + Charging Only Cable + AC Adapter | | |

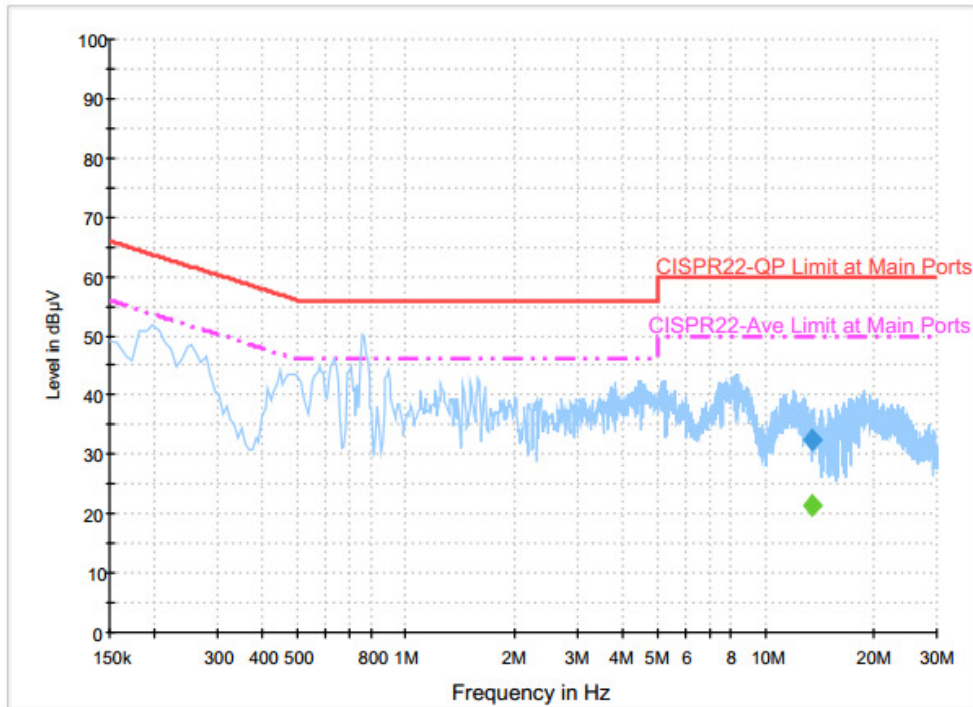

Final Result : Quasi-Peak

| Frequency (MHz) | Quasi-Peak (dBµV) | Filter | Line | Corr. (dB) | Margin (dB) | Limit (dBµV) |
|-----------------|-------------------|--------|------|------------|-------------|--------------|
| 13.558000 | 32.3 | Off | N | 19.8 | 27.7 | 60.0 |

Final Result : Average

| Frequency (MHz) | Average (dBµV) | Filter | Line | Corr. (dB) | Margin (dB) | Limit (dBµV) |
|-----------------|----------------|--------|------|------------|-------------|--------------|
| 13.558000 | 21.5 | Off | N | 19.8 | 28.5 | 50.0 |



<Original test result with NFC antenna>

| | | | |
|-----------------|--|---------------------|---------|
| Test Mode : | Mode 2 | Temperature : | 22~24°C |
| Test Engineer : | Arthur Hsieh | Relative Humidity : | 51~53% |
| Test Voltage : | 120Vac / 60Hz | Phase : | Line |
| Function Type : | NFC Link + WLAN (5GHz) Link + Bluetooth Link with Earphone 3 + Snap on USB Cable Data Link with Notebook + Copy Data from Notebook to EDA (SD Card) + AC Adapter | | |

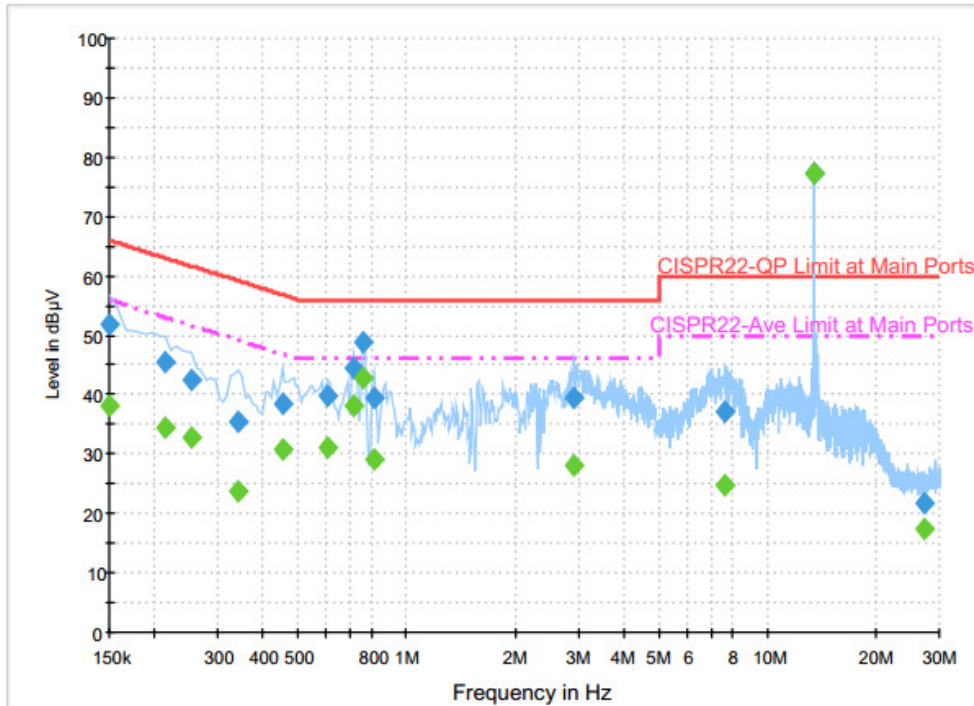

Final Result : Quasi-Peak

| Frequency (MHz) | Quasi-Peak (dBµV) | Filter | Line | Corr. (dB) | Margin (dB) | Limit (dBµV) |
|-----------------|-------------------|--------|------|------------|-------------|--------------|
| 0.150000 | 51.9 | Off | L1 | 19.6 | 14.1 | 66.0 |
| 0.214000 | 45.6 | Off | L1 | 19.6 | 17.4 | 63.0 |
| 0.254000 | 42.6 | Off | L1 | 19.6 | 19.0 | 61.6 |
| 0.342000 | 35.4 | Off | L1 | 19.6 | 23.8 | 59.2 |
| 0.454000 | 38.5 | Off | L1 | 19.6 | 18.3 | 56.8 |
| 0.606000 | 39.8 | Off | L1 | 19.6 | 16.2 | 56.0 |
| 0.710000 | 44.4 | Off | L1 | 19.6 | 11.6 | 56.0 |
| 0.758000 | 48.8 | Off | L1 | 19.6 | 7.2 | 56.0 |
| 0.814000 | 39.6 | Off | L1 | 19.6 | 16.4 | 56.0 |
| 2.918000 | 39.6 | Off | L1 | 19.5 | 16.4 | 56.0 |
| 7.654000 | 37.2 | Off | L1 | 19.7 | 22.8 | 60.0 |
| 13.558000 | 77.4 | Off | L1 | 19.8 | -17.4 | 60.0 |
| 27.118000 | 21.9 | Off | L1 | 19.9 | 38.1 | 60.0 |



| | | | |
|-----------------|--|---------------------|---------|
| Test Mode : | Mode 2 | Temperature : | 22~24°C |
| Test Engineer : | Arthur Hsieh | Relative Humidity : | 51~53% |
| Test Voltage : | 120Vac / 60Hz | Phase : | Line |
| Function Type : | NFC Link + WLAN (5GHz) Link + Bluetooth Link with Earphone 3 + Snap on USB Cable Data Link with Notebook + Copy Data from Notebook to EDA (SD Card) + AC Adapter | | |

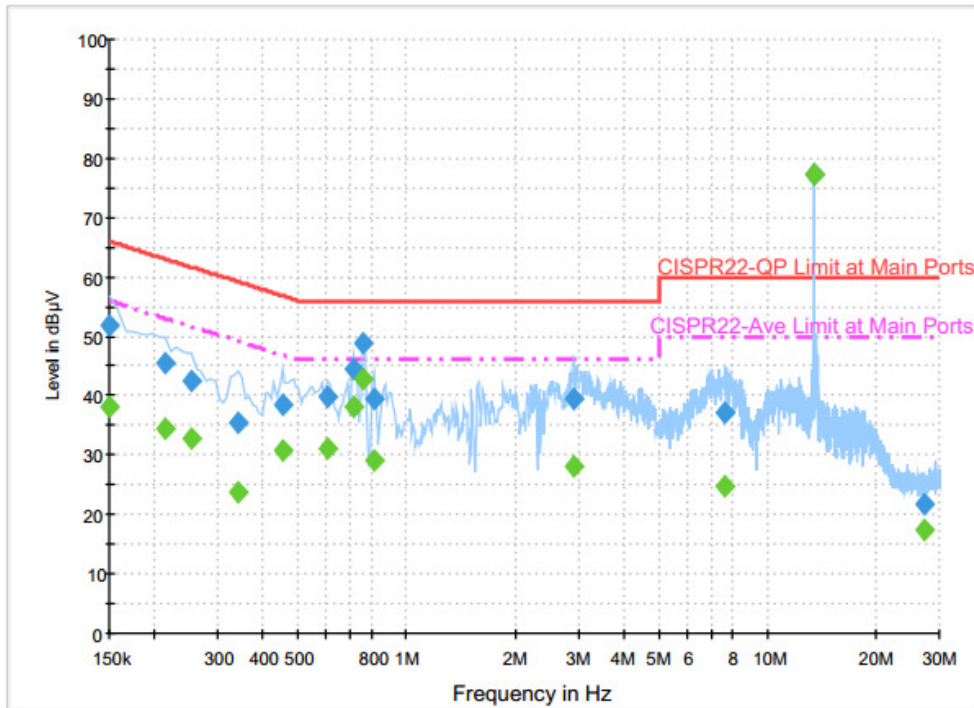

Final Result : Average

| Frequency (MHz) | Average (dBµV) | Filter | Line | Corr. (dB) | Margin (dB) | Limit (dBµV) |
|-----------------|----------------|--------|------|------------|-------------|--------------|
| 0.150000 | 38.3 | Off | L1 | 19.6 | 17.7 | 56.0 |
| 0.214000 | 34.5 | Off | L1 | 19.6 | 18.5 | 53.0 |
| 0.254000 | 32.9 | Off | L1 | 19.6 | 18.7 | 51.6 |
| 0.342000 | 23.8 | Off | L1 | 19.6 | 25.4 | 49.2 |
| 0.454000 | 30.8 | Off | L1 | 19.6 | 16.0 | 46.8 |
| 0.606000 | 31.1 | Off | L1 | 19.6 | 14.9 | 46.0 |
| 0.710000 | 38.2 | Off | L1 | 19.6 | 7.8 | 46.0 |
| 0.758000 | 42.9 | Off | L1 | 19.6 | 3.1 | 46.0 |
| 0.814000 | 29.1 | Off | L1 | 19.6 | 16.9 | 46.0 |
| 2.918000 | 28.1 | Off | L1 | 19.5 | 17.9 | 46.0 |
| 7.654000 | 24.6 | Off | L1 | 19.7 | 25.4 | 50.0 |
| 13.558000 | 77.1 | Off | L1 | 19.8 | -27.1 | 50.0 |
| 27.118000 | 17.3 | Off | L1 | 19.9 | 32.7 | 50.0 |



| | | | |
|-----------------|--|---------------------|---------|
| Test Mode : | Mode 2 | Temperature : | 22~24°C |
| Test Engineer : | Arthur Hsieh | Relative Humidity : | 51~53% |
| Test Voltage : | 120Vac / 60Hz | Phase : | Neutral |
| Function Type : | NFC Link + WLAN (5GHz) Link + Bluetooth Link with Earphone 3 + Snap on USB Cable Data Link with Notebook + Copy Data from Notebook to EDA (SD Card) + AC Adapter | | |

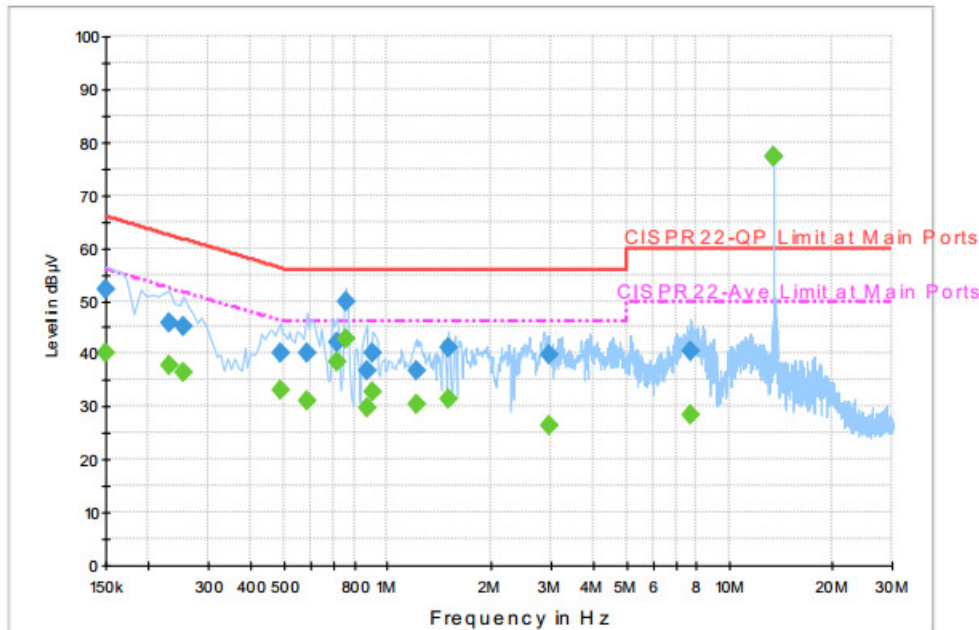

Final Result : Quasi-Peak

| Frequency (MHz) | Quasi-Peak (dBµV) | Filter | Line | Corr. (dB) | Margin (dB) | Limit (dBµV) |
|-----------------|-------------------|--------|------|------------|-------------|--------------|
| 0.150000 | 52.0 | Off | N | 19.6 | 14.0 | 66.0 |
| 0.230000 | 45.9 | Off | N | 19.6 | 16.5 | 62.4 |
| 0.254000 | 45.3 | Off | N | 19.6 | 16.3 | 61.6 |
| 0.486000 | 40.2 | Off | N | 19.6 | 16.0 | 56.2 |
| 0.582000 | 40.1 | Off | N | 19.6 | 15.9 | 56.0 |
| 0.710000 | 42.1 | Off | N | 19.6 | 13.9 | 56.0 |
| 0.758000 | 49.8 | Off | N | 19.6 | 6.2 | 56.0 |
| 0.870000 | 36.7 | Off | N | 19.6 | 19.3 | 56.0 |
| 0.910000 | 40.1 | Off | N | 19.6 | 15.9 | 56.0 |
| 1.214000 | 36.9 | Off | N | 19.6 | 19.1 | 56.0 |
| 1.510000 | 41.0 | Off | N | 19.6 | 15.0 | 56.0 |
| 2.974000 | 39.7 | Off | N | 19.5 | 16.3 | 56.0 |
| 7.734000 | 40.3 | Off | N | 19.7 | 19.7 | 60.0 |
| 13.558000 | 77.4 | Off | N | 19.8 | -17.4 | 60.0 |



| | | | |
|-----------------|--|---------------------|---------|
| Test Mode : | Mode 2 | Temperature : | 22~24°C |
| Test Engineer : | Arthur Hsieh | Relative Humidity : | 51~53% |
| Test Voltage : | 120Vac / 60Hz | Phase : | Neutral |
| Function Type : | NFC Link + WLAN (5GHz) Link + Bluetooth Link with Earphone 3 + Snap on USB Cable Data Link with Notebook + Copy Data from Notebook to EDA (SD Card) + AC Adapter | | |

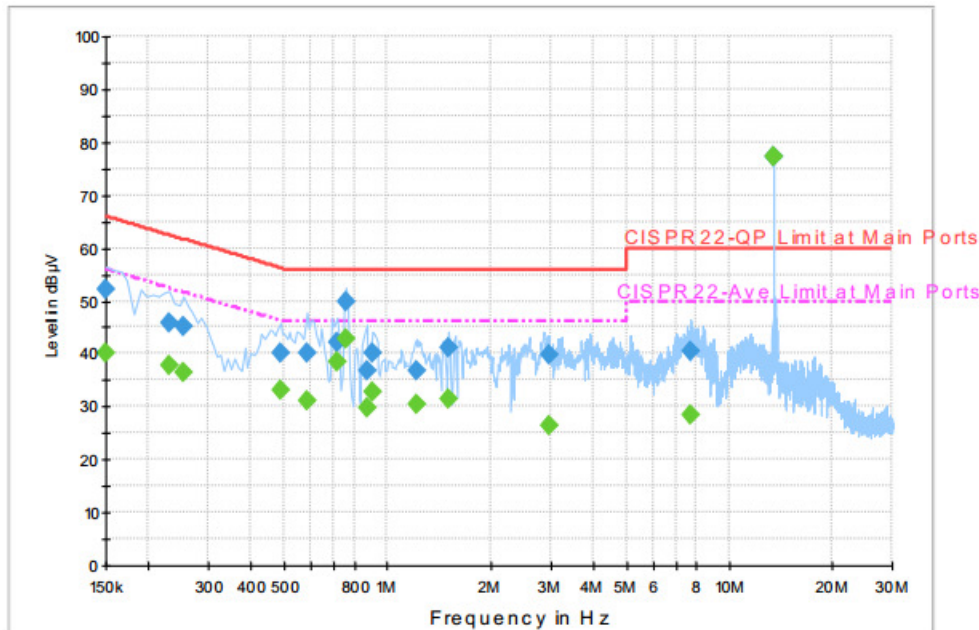

Final Result : Average

| Frequency (MHz) | Average (dBµV) | Filter | Line | Corr. (dB) | Margin (dB) | Limit (dBµV) |
|-----------------|----------------|--------|------|------------|-------------|--------------|
| 0.150000 | 40.1 | Off | N | 19.6 | 15.9 | 56.0 |
| 0.230000 | 37.7 | Off | N | 19.6 | 14.7 | 52.4 |
| 0.254000 | 36.3 | Off | N | 19.6 | 15.3 | 51.6 |
| 0.486000 | 33.1 | Off | N | 19.6 | 13.1 | 46.2 |
| 0.582000 | 31.0 | Off | N | 19.6 | 15.0 | 46.0 |
| 0.710000 | 38.3 | Off | N | 19.6 | 7.7 | 46.0 |
| 0.758000 | 42.8 | Off | N | 19.6 | 3.2 | 46.0 |
| 0.870000 | 29.8 | Off | N | 19.6 | 16.2 | 46.0 |
| 0.910000 | 32.7 | Off | N | 19.6 | 13.3 | 46.0 |
| 1.214000 | 30.3 | Off | N | 19.6 | 15.7 | 46.0 |
| 1.510000 | 31.4 | Off | N | 19.6 | 14.6 | 46.0 |
| 2.974000 | 26.4 | Off | N | 19.5 | 19.6 | 46.0 |
| 7.734000 | 28.3 | Off | N | 19.7 | 21.7 | 50.0 |
| 13.558000 | 77.2 | Off | N | 19.8 | -27.2 | 50.0 |



<Terminal test result with dummy load>

| | | | |
|-----------------|--|---------------------|---------|
| Test Mode : | Mode 2 | Temperature : | 22~24°C |
| Test Engineer : | Arthur Hsieh | Relative Humidity : | 51~53% |
| Test Voltage : | 120Vac / 60Hz | Phase : | Line |
| Function Type : | NFC Link + WLAN (5GHz) Link + Bluetooth Link with Earphone 3 + Snap on USB Cable Data Link with Notebook + Copy Data from Notebook to EDA (SD Card) + AC Adapter | | |

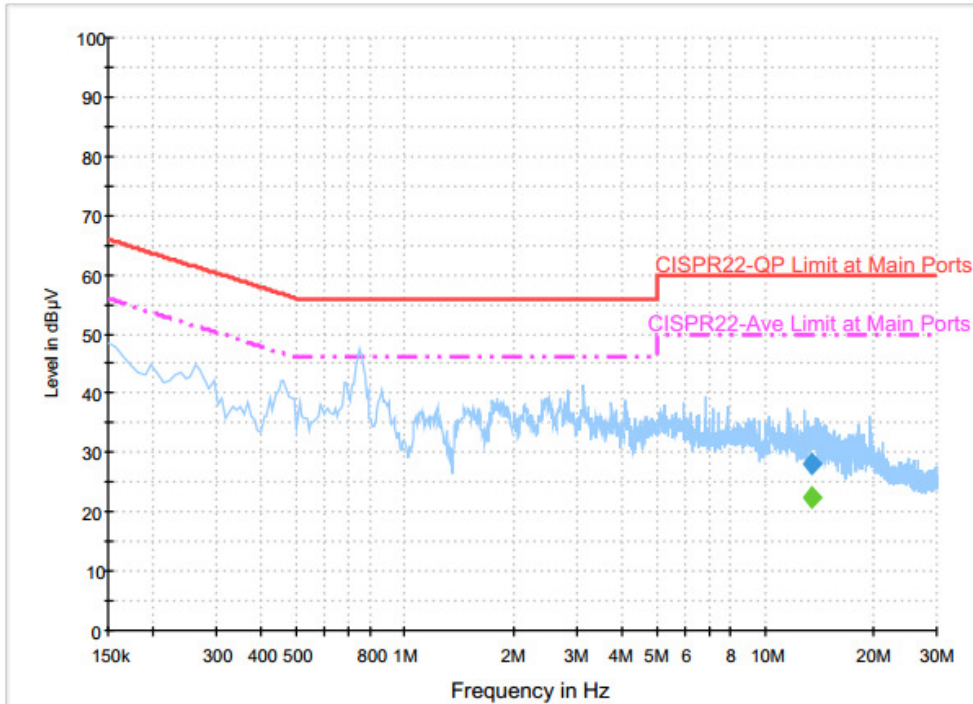

Final Result : Quasi-Peak

| Frequency (MHz) | Quasi-Peak (dBµV) | Filter | Line | Corr. (dB) | Margin (dB) | Limit (dBµV) |
|-----------------|-------------------|--------|------|------------|-------------|--------------|
| 13.558000 | 28.2 | Off | L1 | 19.8 | 31.8 | 60.0 |

Final Result : Average

| Frequency (MHz) | Average (dBµV) | Filter | Line | Corr. (dB) | Margin (dB) | Limit (dBµV) |
|-----------------|----------------|--------|------|------------|-------------|--------------|
| 13.558000 | 22.5 | Off | L1 | 19.8 | 27.5 | 50.0 |



| | | | |
|-----------------|--|---------------------|---------|
| Test Mode : | Mode 2 | Temperature : | 22~24°C |
| Test Engineer : | Arthur Hsieh | Relative Humidity : | 51~53% |
| Test Voltage : | 120Vac / 60Hz | Phase : | Neutral |
| Function Type : | NFC Link + WLAN (5GHz) Link + Bluetooth Link with Earphone 3 + Snap on USB Cable Data Link with Notebook + Copy Data from Notebook to EDA (SD Card) + AC Adapter | | |

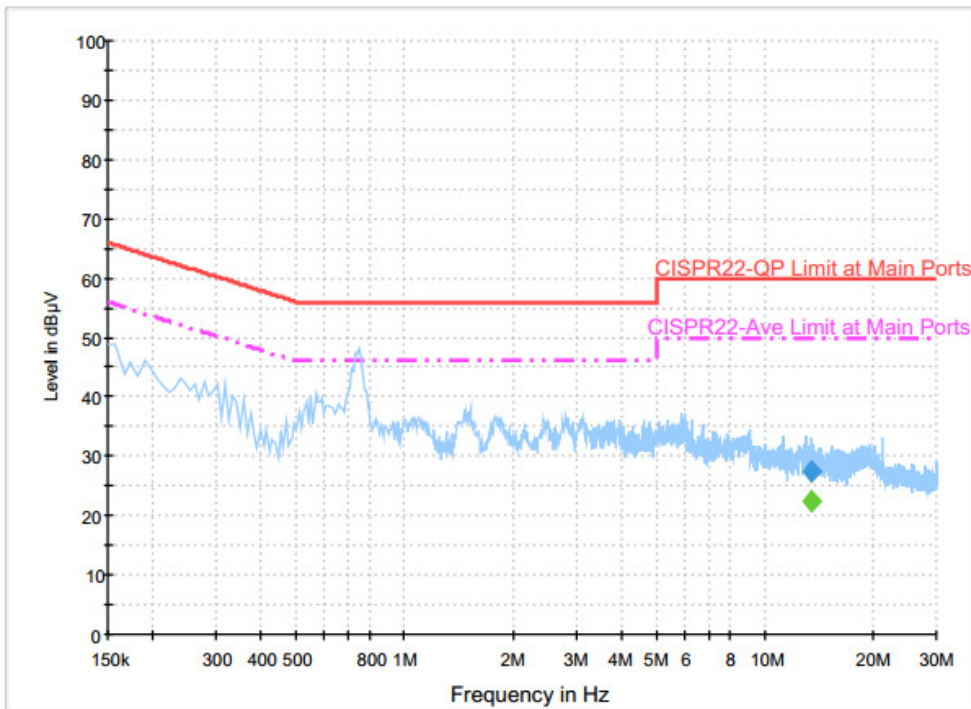

Final Result : Quasi-Peak

| Frequency (MHz) | Quasi-Peak (dBµV) | Filter | Line | Corr. (dB) | Margin (dB) | Limit (dBµV) |
|-----------------|-------------------|--------|------|------------|-------------|--------------|
| 13.558000 | 27.4 | Off | N | 19.8 | 32.6 | 60.0 |

Final Result : Average

| Frequency (MHz) | Average (dBµV) | Filter | Line | Corr. (dB) | Margin (dB) | Limit (dBµV) |
|-----------------|----------------|--------|------|------------|-------------|--------------|
| 13.558000 | 22.4 | Off | N | 19.8 | 27.6 | 50.0 |



<Original test result with NFC antenna>

| | | | |
|-----------------|--|---------------------|---------|
| Test Mode : | Mode 3 | Temperature : | 22~24°C |
| Test Engineer : | Arthur Hsieh | Relative Humidity : | 51~53% |
| Test Voltage : | 120Vac / 60Hz | Phase : | Line |
| Function Type : | NFC Link + WLAN (2.4GHz) Link + Bluetooth Link + Earphone 2 with Audio Adapter connect to EUT + Charging Only Cable + AC Adapter | | |

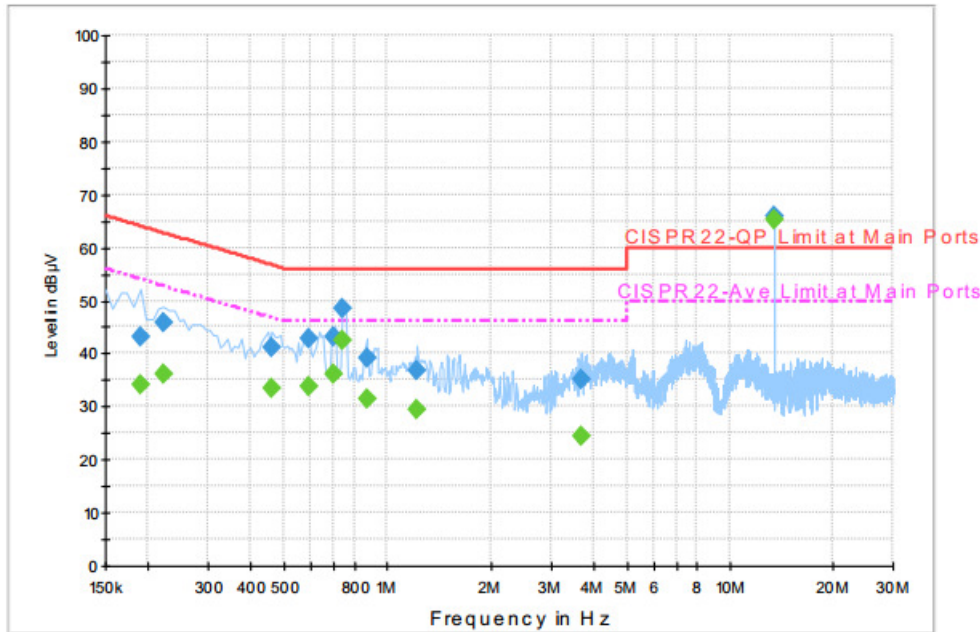

Final Result : Quasi-Peak

| Frequency (MHz) | Quasi-Peak (dBµV) | Filter | Line | Corr. (dB) | Margin (dB) | Limit (dBµV) |
|-----------------|-------------------|--------|------|------------|-------------|--------------|
| 0.190000 | 43.2 | Off | L1 | 19.6 | 20.8 | 64.0 |
| 0.222000 | 45.8 | Off | L1 | 19.6 | 16.9 | 62.7 |
| 0.462000 | 41.2 | Off | L1 | 19.6 | 15.5 | 56.7 |
| 0.590000 | 42.7 | Off | L1 | 19.6 | 13.3 | 56.0 |
| 0.694000 | 43.2 | Off | L1 | 19.6 | 12.8 | 56.0 |
| 0.742000 | 48.5 | Off | L1 | 19.6 | 7.5 | 56.0 |
| 0.870000 | 39.2 | Off | L1 | 19.6 | 16.8 | 56.0 |
| 1.222000 | 36.6 | Off | L1 | 19.6 | 19.4 | 56.0 |
| 3.702000 | 35.1 | Off | L1 | 19.7 | 20.9 | 56.0 |
| 13.558000 | 65.8 | Off | L1 | 19.8 | -5.8 | 60.0 |



| | | | |
|-----------------|--|---------------------|---------|
| Test Mode : | Mode 3 | Temperature : | 22~24°C |
| Test Engineer : | Arthur Hsieh | Relative Humidity : | 51~53% |
| Test Voltage : | 120Vac / 60Hz | Phase : | Line |
| Function Type : | NFC Link + WLAN (2.4GHz) Link + Bluetooth Link + Earphone 2 with Audio Adapter connect to EUT + Charging Only Cable + AC Adapter | | |

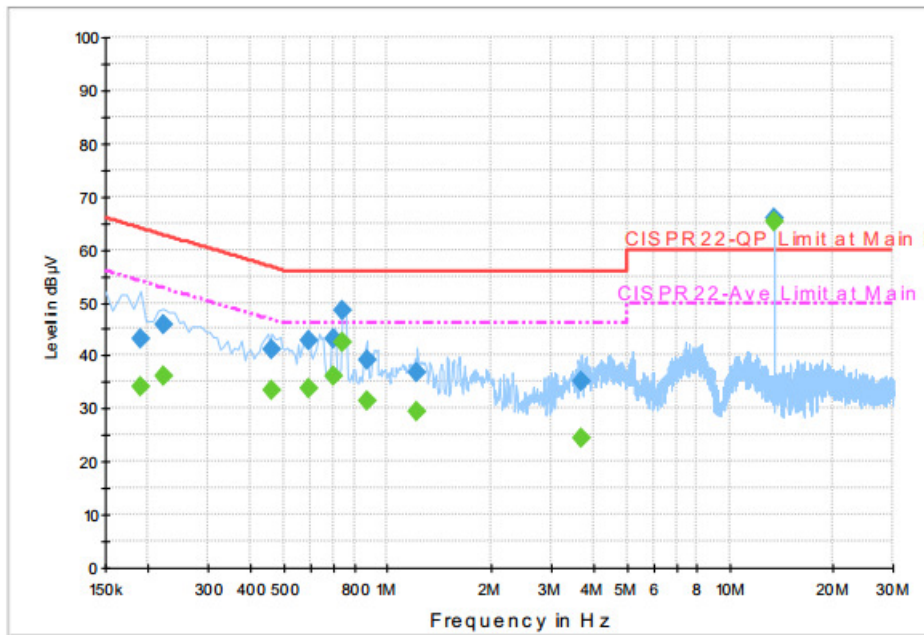

Final Result : Average

| Frequency (MHz) | Average (dBµV) | Filter | Line | Corr. (dB) | Margin (dB) | Limit (dBµV) |
|-----------------|----------------|--------|------|------------|-------------|--------------|
| 0.190000 | 34.0 | Off | L1 | 19.6 | 20.0 | 54.0 |
| 0.222000 | 36.3 | Off | L1 | 19.6 | 16.4 | 52.7 |
| 0.462000 | 33.3 | Off | L1 | 19.6 | 13.4 | 46.7 |
| 0.590000 | 33.9 | Off | L1 | 19.6 | 12.1 | 46.0 |
| 0.694000 | 36.2 | Off | L1 | 19.6 | 9.8 | 46.0 |
| 0.742000 | 42.6 | Off | L1 | 19.6 | 3.4 | 46.0 |
| 0.870000 | 31.4 | Off | L1 | 19.6 | 14.6 | 46.0 |
| 1.222000 | 29.4 | Off | L1 | 19.6 | 16.6 | 46.0 |
| 3.702000 | 24.3 | Off | L1 | 19.7 | 21.7 | 46.0 |
| 13.558000 | 65.4 | Off | L1 | 19.8 | -15.4 | 50.0 |



| | | | |
|-----------------|--|---------------------|---------|
| Test Mode : | Mode 3 | Temperature : | 22~24°C |
| Test Engineer : | Arthur Hsieh | Relative Humidity : | 51~53% |
| Test Voltage : | 120Vac / 60Hz | Phase : | Neutral |
| Function Type : | NFC Link + WLAN (2.4GHz) Link + Bluetooth Link + Earphone 2 with Audio Adapter connect to EUT + Charging Only Cable + AC Adapter | | |

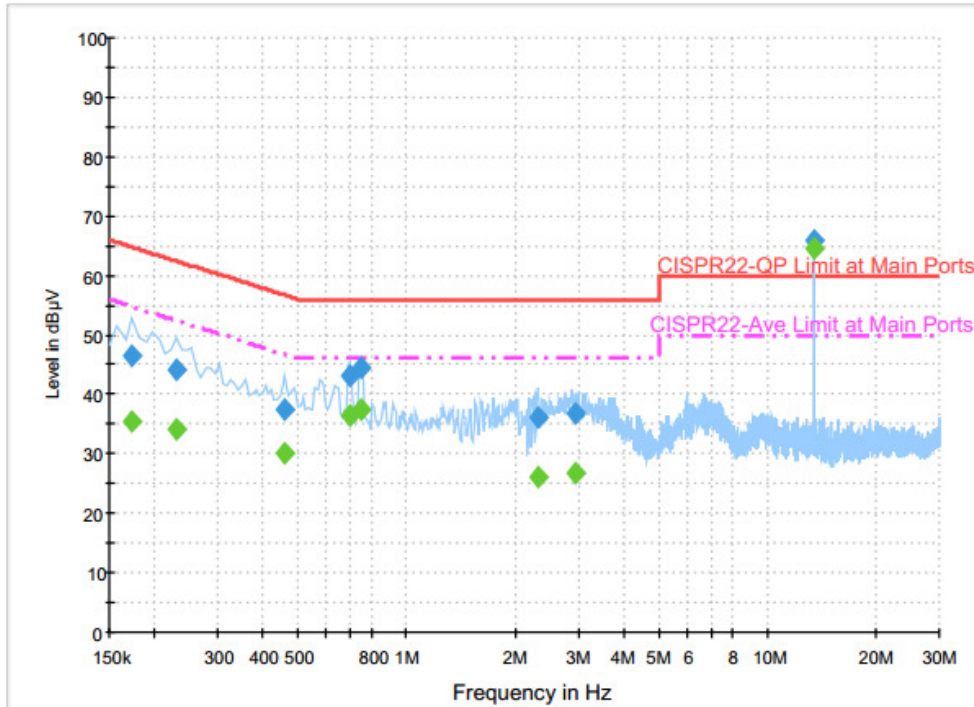

Final Result : Quasi-Peak

| Frequency (MHz) | Quasi-Peak (dBµV) | Filter | Line | Corr. (dB) | Margin (dB) | Limit (dBµV) |
|-----------------|-------------------|--------|------|------------|-------------|--------------|
| 0.174000 | 46.5 | Off | N | 19.6 | 18.3 | 64.8 |
| 0.230000 | 44.2 | Off | N | 19.6 | 18.2 | 62.4 |
| 0.462000 | 37.5 | Off | N | 19.6 | 19.2 | 56.7 |
| 0.694000 | 43.2 | Off | N | 19.6 | 12.8 | 56.0 |
| 0.750000 | 44.4 | Off | N | 19.6 | 11.6 | 56.0 |
| 2.318000 | 36.2 | Off | N | 18.6 | 19.8 | 56.0 |
| 2.942000 | 36.9 | Off | N | 19.5 | 19.1 | 56.0 |
| 13.558000 | 66.0 | Off | N | 19.8 | -6.0 | 60.0 |

Final Result : Average

| Frequency (MHz) | Average (dBµV) | Filter | Line | Corr. (dB) | Margin (dB) | Limit (dBµV) |
|-----------------|----------------|--------|------|------------|-------------|--------------|
| 0.174000 | 35.4 | Off | N | 19.6 | 19.4 | 54.8 |
| 0.230000 | 34.0 | Off | N | 19.6 | 18.4 | 52.4 |
| 0.462000 | 30.2 | Off | N | 19.6 | 16.5 | 46.7 |
| 0.694000 | 36.5 | Off | N | 19.6 | 9.5 | 46.0 |
| 0.750000 | 37.5 | Off | N | 19.6 | 8.5 | 46.0 |
| 2.318000 | 25.9 | Off | N | 18.6 | 20.1 | 46.0 |
| 2.942000 | 26.9 | Off | N | 19.5 | 19.1 | 46.0 |
| 13.558000 | 64.7 | Off | N | 19.8 | -14.7 | 50.0 |

<Terminal test result with dummy load>

| | | | |
|-----------------|--|---------------------|---------|
| Test Mode : | Mode 3 | Temperature : | 22~24°C |
| Test Engineer : | Arthur Hsieh | Relative Humidity : | 51~53% |
| Test Voltage : | 120Vac / 60Hz | Phase : | Line |
| Function Type : | NFC Link + WLAN (2.4GHz) Link + Bluetooth Link + Earphone 2 with Audio Adapter connect to EUT + Charging Only Cable + AC Adapter | | |

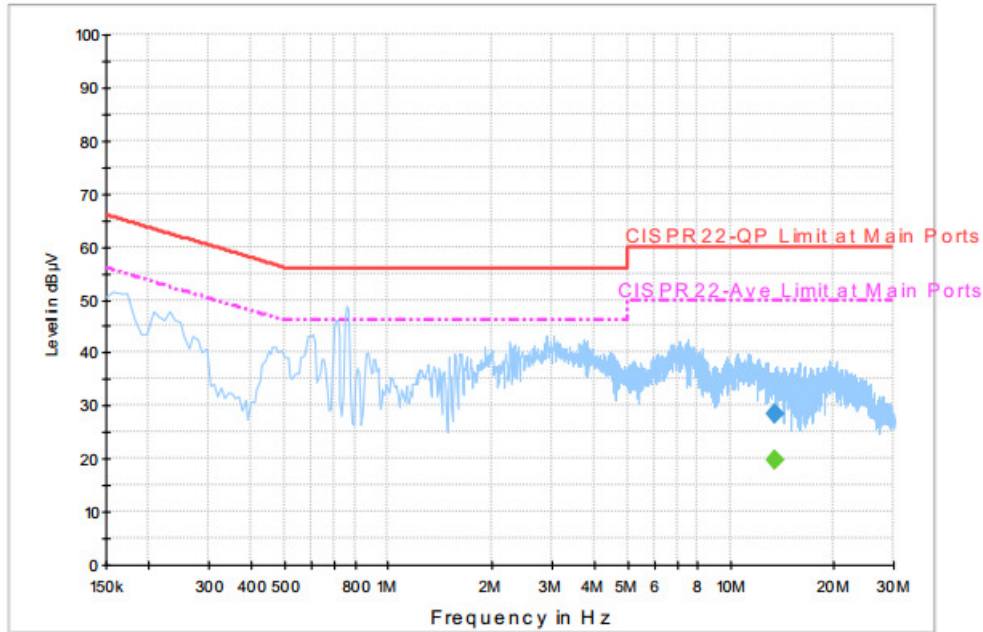

Final Result : Quasi-Peak

| Frequency (MHz) | Quasi-Peak (dBµV) | Filter | Line | Corr. (dB) | Margin (dB) | Limit (dBµV) |
|-----------------|-------------------|--------|------|------------|-------------|--------------|
| 13.558000 | 28.4 | Off | L1 | 19.8 | 31.6 | 60.0 |

Final Result : Average

| Frequency (MHz) | Average (dBµV) | Filter | Line | Corr. (dB) | Margin (dB) | Limit (dBµV) |
|-----------------|----------------|--------|------|------------|-------------|--------------|
| 13.558000 | 19.8 | Off | L1 | 19.8 | 30.2 | 50.0 |



| | | | |
|-----------------|--|---------------------|---------|
| Test Mode : | Mode 3 | Temperature : | 22~24°C |
| Test Engineer : | Arthur Hsieh | Relative Humidity : | 51~53% |
| Test Voltage : | 120Vac / 60Hz | Phase : | Neutral |
| Function Type : | NFC Link + WLAN (2.4GHz) Link + Bluetooth Link + Earphone 2 with Audio Adapter connect to EUT + Charging Only Cable + AC Adapter | | |

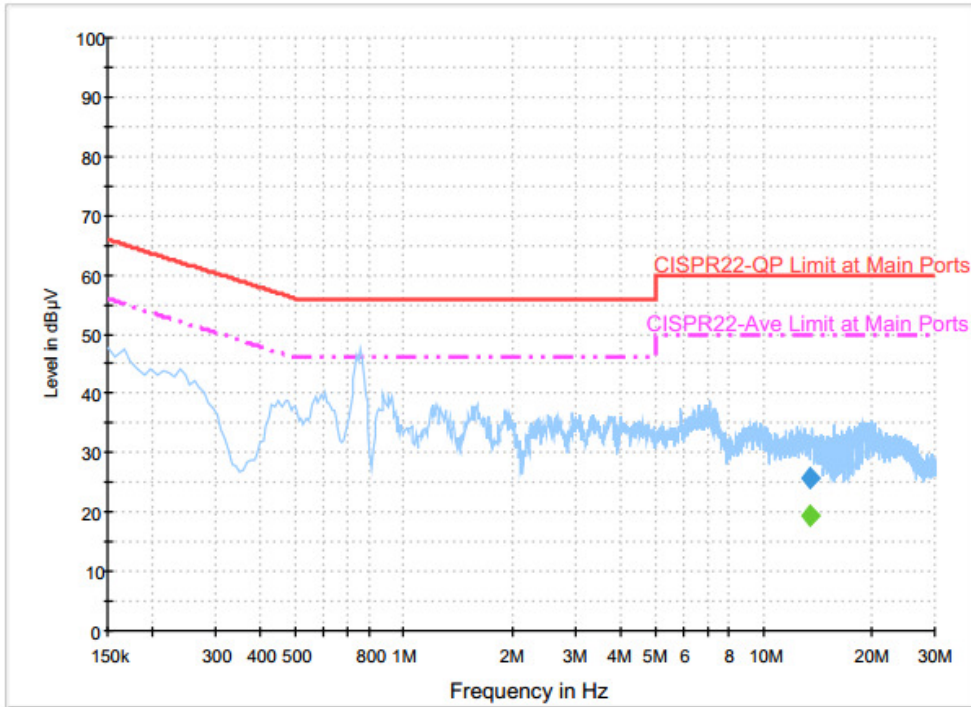

Final Result : Quasi-Peak

| Frequency (MHz) | Quasi-Peak (dBµV) | Filter | Line | Corr. (dB) | Margin (dB) | Limit (dBµV) |
|-----------------|-------------------|--------|------|------------|-------------|--------------|
| 13.558000 | 25.8 | Off | N | 19.8 | 34.2 | 60.0 |

Final Result : Average

| Frequency (MHz) | Average (dBµV) | Filter | Line | Corr. (dB) | Margin (dB) | Limit (dBµV) |
|-----------------|----------------|--------|------|------------|-------------|--------------|
| 13.558000 | 19.5 | Off | N | 19.8 | 30.5 | 50.0 |



3.7 Antenna Requirements

3.7.1 Standard Applicable

If directional gain of transmitting antennas is greater than 6dBi, the power shall be reduced by the same level in dB comparing to gain minus 6dBi. The use of a permanently attached antenna or of an antenna that uses a unique coupling to the intentional radiator shall be considered sufficient to comply with the FCC rule.

3.7.2 Antenna Anti-Replacement Construction

An embedded-in antenna design is used.

3.7.3 Antenna Gain

The antenna peak gain of EUT is less than 6 dBi. Therefore, it is not necessary to reduce maximum peak output power limit.



4 List of Measuring Equipment

| Instrument | Manufacturer | Model No. | Serial No. | Characteristics | Calibration Date | Test Date | Due Date | Remark |
|---------------------------|-----------------|----------------------------|-----------------|-----------------|------------------|----------------------------------|---------------|--------------------------|
| Power Meter | Agilent | E4416A | GB412923 44 | 300MHz~40GHz | Jan. 08, 2016 | Aug. 22, 2016 ~ Aug. 26, 2016 | Jan. 07, 2017 | Conducted (TH05-HY) |
| Power Sensor | Agilent | E9327A | US404415 48 | 300MHz~40GHz | Jan. 07, 2016 | Aug. 22, 2016 ~ Aug. 26, 2016 | Jan. 06, 2017 | Conducted (TH05-HY) |
| Spectrum Analyzer | Rohde & Schwarz | FSP40 | 100057 | 9kHz-40GHz | Nov. 23, 2015 | Aug. 22, 2016 ~ Aug. 26, 2016 | Nov. 22, 2016 | Conducted (TH05-HY) |
| AC Power Source | ChainTek | APC-1000W | N/A | N/A | N/A | Sep. 06, 2016 ~ Sep. 20, 2016 | N/A | Conduction (CO05-HY) |
| EMI Test Receiver | Rohde & Schwarz | ESCI 7 | 100724 | 9kHz~7GHz | Aug. 30, 2016 | Sep. 06, 2016 ~ Sep. 20, 2016 | Aug. 29, 2017 | Conduction (CO05-HY) |
| LISN | Rohde & Schwarz | ENV216 | 100080 | 9kHz~30MHz | Dec. 02, 2015 | Sep. 06, 2016 ~ Sep. 20, 2016 | Dec. 01, 2016 | Conduction (CO05-HY) |
| LISN | Rohde & Schwarz | ENV216 | 100081 | 9kHz~30MHz | Dec. 14, 2015 | Sep. 06, 2016 ~ Sep. 20, 2016 | Dec. 13, 2016 | Conduction (CO05-HY) |
| Bilog Antenna | TESEQ | CBL 6111D | 35419 | 30MHz to 1GHz | Jan. 13, 2016 | Aug. 23, 2016 ~ Sep. 09, 2016 | Jan. 12, 2017 | Radiation (03CH07-HY) |
| Double Ridge Horn Antenna | ESCO | 3117 | 00075962 | 1GHz ~ 18GHz | Aug. 19, 2016 | Aug. 23, 2016 ~ Sep. 09, 2016 | Aug. 18, 2017 | Radiation (03CH07-HY) |
| EMI Test Receiver | Keysight | N9038A (MXE) | MY541300 85 | 20Hz ~ 8.4GHz | Nov. 04, 2015 | Aug. 23, 2016 ~ Sep. 09, 2016 | Nov. 03, 2016 | Radiation (03CH07-HY) |
| Loop Antenna | Rohde & Schwarz | HFH2-Z2 | 100315 | 9 kHz~30 MHz | Sep. 02, 2015 | Aug. 23, 2016 ~ Sep. 09, 2016 | Sep. 01, 2017 | Radiation (03CH07-HY) |
| Preamplifier | MITEQ | AMF-7D-0010 1800-30-10P | 1590075 | 1GHz ~ 18GHz | Apr. 15, 2016 | Aug. 23, 2016 ~ Sep. 09, 2016 | Apr. 14, 2017 | Radiation (03CH07-HY) |
| Preamplifier | COM-POWER | PA-103A | 161241 | 10MHz-1GHz | Mar. 18, 2016 | Aug. 23, 2016 ~ Sep. 09, 2016 | Mar. 17, 2017 | Radiation (03CH07-HY) |
| Preamplifier | Agilent | 8449B | 3008A023 62 | 1GHz~ 26.5GHz | Oct. 19, 2015 | Aug. 23, 2016 ~ Sep. 09, 2016 | Oct. 18, 2016 | Radiation (03CH07-HY) |
| Spectrum Analyzer | Agilent | N9010A | MY534701 18 | 10Hz~44GHz | Feb. 27, 2016 | Aug. 23, 2016 ~ Sep. 09, 2016 | Feb. 26, 2017 | Radiation (03CH07-HY) |
| Antenna Mast | Max-Full | MFA520BS | N/A | 1m~4m | N/A | Aug. 23, 2016 ~ Sep. 09, 2016 | N/A | Radiation (03CH07-HY) |
| Turn Table | ChainTek | Chaintek 3000 | N/A | 0~360 Degree | N/A | Aug. 23, 2016 ~ Sep. 09, 2016 | N/A | Radiation (03CH07-HY) |
| Preamplifier | MITEQ | JS44-180040 00-33-8P | 1840917 | 18GHz ~ 40GHz | Jun. 14, 2016 | Aug. 23, 2016 ~ Sep. 09, 2016 | Jun. 13, 2017 | Radiation (03CH07-HY) |
| SHF-EHF Horn Antenna | SCHWARZBE CK | BBHA 9170 | BBHA9170 584 | 18GHz- 40GHz | Nov. 02, 2015 | Aug. 23, 2016 ~ Sep. 09, 2016 | Nov. 01, 2016 | Radiation (03CH07-HY) |



5 Uncertainty of Evaluation

Uncertainty of Conducted Emission Measurement (150 kHz ~ 30 MHz)

| | |
|---|------|
| Measuring Uncertainty for a Level of Confidence of 95% ($U = 2Uc(y)$) | 2.26 |
|---|------|

Uncertainty of Radiated Emission Measurement (30 MHz ~ 1000 MHz)

| | |
|---|------|
| Measuring Uncertainty for a Level of Confidence of 95% ($U = 2Uc(y)$) | 5.70 |
|---|------|

Uncertainty of Radiated Emission Measurement (1000 MHz ~ 18000 MHz)

| | |
|---|------|
| Measuring Uncertainty for a Level of Confidence of 95% ($U = 2Uc(y)$) | 5.50 |
|---|------|

Uncertainty of Radiated Emission Measurement (18000 MHz ~ 40000 MHz)

| | |
|---|------|
| Measuring Uncertainty for a Level of Confidence of 95% ($U = 2Uc(y)$) | 5.20 |
|---|------|



Appendix A. Conducted Test Results

Bluetooth Low Energy

| | | | | |
|----------------|-----------------------|--------------------|-------|----|
| Test Engineer: | An Wu and Tommy Lee | Temperature: | 21~25 | °C |
| Test Date: | 2016/08/22~2016/08/26 | Relative Humidity: | 51~54 | % |

TEST RESULTS DATA
6dB and 99% Occupied Bandwidth

| Mod. | Data Rate | NTX | CH. | Freq. (MHz) | 99% Occupied BW (MHz) | 6dB BW (MHz) | 6dB BW Limit (MHz) | Pass/Fail |
|------|-----------|-----|-----|-------------|-----------------------|--------------|--------------------|-----------|
| BLE | 1Mbps | 1 | 0 | 2402 | 1.06 | 0.71 | 0.50 | Pass |
| BLE | 1Mbps | 1 | 19 | 2440 | 1.06 | 0.71 | 0.50 | Pass |
| BLE | 1Mbps | 1 | 39 | 2480 | 1.06 | 0.71 | 0.50 | Pass |

TEST RESULTS DATA
Peak Power Table

| Mod. | Data Rate | NTX | CH. | Freq. (MHz) | Peak Conducted Power (dBm) | Conducted Power Limit (dBm) | DG (dBi) | EIRP Power (dBm) | EIRP Power Limit (dBm) | Pass /Fail |
|------|-----------|-----|-----|-------------|----------------------------|-----------------------------|----------|------------------|------------------------|------------|
| BLE | 1Mbps | 1 | 0 | 2402 | 3.02 | 30.00 | 2.60 | 5.62 | 36.00 | Pass |
| BLE | 1Mbps | 1 | 19 | 2440 | 4.27 | 30.00 | 2.60 | 6.87 | 36.00 | Pass |
| BLE | 1Mbps | 1 | 39 | 2480 | 4.51 | 30.00 | 2.60 | 7.11 | 36.00 | Pass |

TEST RESULTS DATA
Average Power Table
(Reporting Only)

| Mod. | Data Rate | NTX | CH. | Freq. (MHz) | Duty Factor (dB) | Average Conducted Power (dBm) |
|------|-----------|-----|-----|-------------|------------------|-------------------------------|
| BLE | 1Mbps | 1 | 0 | 2402 | 2.06 | 1.60 |
| BLE | 1Mbps | 1 | 19 | 2440 | 2.06 | 3.20 |
| BLE | 1Mbps | 1 | 39 | 2480 | 2.06 | 3.48 |

TEST RESULTS DATA
Peak Power Density

| Mod. | Data Rate | NTX | CH. | Freq. (MHz) | Peak PSD (dBm /100kHz) | Peak PSD (dBm /3kHz) | DG (dBi) | Peak PSD Limit (dBm /3kHz) | Pass/Fail |
|------|-----------|-----|-----|-------------|------------------------|----------------------|----------|----------------------------|-----------|
| BLE | 1Mbps | 1 | 0 | 2402 | 0.88 | -12.84 | 2.60 | 8.00 | Pass |
| BLE | 1Mbps | 1 | 19 | 2440 | 2.26 | -11.46 | 2.60 | 8.00 | Pass |
| BLE | 1Mbps | 1 | 39 | 2480 | 2.16 | -11.60 | 2.60 | 8.00 | Pass |

Note: PSD (dBm/ 100kHz) is a reference level used for Conducted Band Edges and Conducted Spurious Emission 20dBc limit.



Appendix B. Radiated Spurious Emission

| | | | |
|-----------------|---|---------------------|---------|
| Test Engineer : | Luke Chang, Jesse Wang, Derreck Chen and James Chiu | Temperature : | 21~24°C |
| | | Relative Humidity : | 50~55% |

2.4GHz 2400~2483.5MHz

BLE (Band Edge @ 3m)

| BLE | Note | Frequency (MHz) | Level (dBμV/m) | Over Limit (dB) | Limit Line (dBμV/m) | Read Level (dBμV) | Antenna Factor (dB/m) | Cable Loss (dB) | Preamp Factor (dB) | Ant Pos (cm) | Table Pos (deg) | Peak Avg. (P/A) | Pol. (H/V) | |
|-------------------------|------|----------------------|---------------------|-------------------------|-----------------------------|---------------------------|-------------------------------|-------------------------|----------------------------|----------------------|-------------------------|-------------------------|-----------------|---|
| BLE CH 00 2402MHz | | 2355.15 | 55.13 | -18.87 | 74 | 50.25 | 32.03 | 7.24 | 34.39 | 100 | 37 | P | H | |
| | | 2389.59 | 46.05 | -7.95 | 54 | 40.99 | 32.08 | 7.31 | 34.33 | 100 | 37 | A | H | |
| | * | 2402 | 98.03 | - | - | 92.95 | 32.08 | 7.31 | 34.31 | 100 | 37 | P | H | |
| | * | 2402 | 97.5 | - | - | 92.42 | 32.08 | 7.31 | 34.31 | 100 | 37 | A | H | |
| | | | | | | | | | | | | | H | |
| | | | | | | | | | | | | | | H |
| | | | 2370.27 | 55.43 | -18.57 | 74 | 50.5 | 32.06 | 7.24 | 34.37 | 198 | 303 | P | V |
| | | | 2374.365 | 46.19 | -7.81 | 54 | 41.25 | 32.06 | 7.24 | 34.36 | 198 | 303 | A | V |
| | * | | 2402 | 98.43 | - | - | 93.35 | 32.08 | 7.31 | 34.31 | 198 | 303 | P | V |
| | * | | 2402 | 97.82 | - | - | 92.74 | 32.08 | 7.31 | 34.31 | 198 | 303 | A | V |
| | | | | | | | | | | | | | | V |
| | | | | | | | | | | | | | | V |
| BLE CH 19 2440MHz | | 2363.34 | 55.42 | -18.58 | 74 | 50.53 | 32.03 | 7.24 | 34.38 | 100 | 53 | P | H | |
| | | 2386.16 | 46.09 | -7.91 | 54 | 41.04 | 32.08 | 7.31 | 34.34 | 100 | 53 | A | H | |
| | * | 2440 | 97.92 | - | - | 92.67 | 32.14 | 7.36 | 34.25 | 100 | 53 | P | H | |
| | * | 2440 | 97.37 | - | - | 92.12 | 32.14 | 7.36 | 34.25 | 100 | 53 | A | H | |
| | | | 2497.76 | 55.59 | -18.41 | 74 | 50.14 | 32.2 | 7.4 | 34.15 | 100 | 53 | P | H |
| | | | 2488.66 | 46.57 | -27.43 | 74 | 41.14 | 32.2 | 7.4 | 34.17 | 100 | 53 | P | H |
| | | | 2381.26 | 54.97 | -19.03 | 74 | 49.95 | 32.06 | 7.31 | 34.35 | 198 | 304 | P | V |
| | | | 2370.06 | 46.09 | -7.91 | 54 | 41.16 | 32.06 | 7.24 | 34.37 | 198 | 304 | A | V |
| | * | | 2440 | 98.86 | - | - | 93.61 | 32.14 | 7.36 | 34.25 | 198 | 304 | P | V |
| | * | | 2440 | 98.39 | - | - | 93.14 | 32.14 | 7.36 | 34.25 | 198 | 304 | A | V |
| | | | 2494.61 | 55.61 | -18.39 | 74 | 50.17 | 32.2 | 7.4 | 34.16 | 198 | 304 | P | V |
| | | | 2497.69 | 46.69 | -7.31 | 54 | 41.24 | 32.2 | 7.4 | 34.15 | 198 | 304 | A | V |



| | | | | | | | | | | | | | |
|----------------------------------|---|---------|-------|--------|----|-------|-------|-----|-------|-----|-----|---|---|
| BLE CH 39 2480MHz | * | 2480 | 97.24 | - | - | 91.84 | 32.18 | 7.4 | 34.18 | 100 | 55 | P | H |
| | * | 2480 | 96.64 | - | - | 91.24 | 32.18 | 7.4 | 34.18 | 100 | 55 | A | H |
| | | 2486.16 | 56.33 | -17.67 | 74 | 50.92 | 32.18 | 7.4 | 34.17 | 100 | 55 | P | H |
| | | 2491.6 | 46.64 | -7.36 | 54 | 41.2 | 32.2 | 7.4 | 34.16 | 100 | 55 | A | H |
| | | | | | | | | | | | | | H |
| | | | | | | | | | | | | | H |
| | * | 2480 | 98 | - | - | 92.6 | 32.18 | 7.4 | 34.18 | 208 | 312 | P | V |
| | * | 2480 | 97.26 | - | - | 91.86 | 32.18 | 7.4 | 34.18 | 208 | 312 | A | V |
| | | 2491.92 | 55.41 | -18.59 | 74 | 49.97 | 32.2 | 7.4 | 34.16 | 208 | 312 | P | V |
| | | 2488.04 | 46.62 | -7.38 | 54 | 41.19 | 32.2 | 7.4 | 34.17 | 208 | 312 | A | V |
| | | | | | | | | | | | | | V |
| | | | | | | | | | | | | | V |
| Remark | 1. No other spurious found. 2. All results are PASS against Peak and Average limit line. | | | | | | | | | | | | |



2.4GHz 2400~2483.5MHz

BLE (Harmonic @ 3m)

| BLE | Note | Frequency (MHz) | Level (dBµV/m) | Over Limit (dB) | Limit Line (dBµV/m) | Read Level (dBµV) | Antenna Factor (dB/m) | Cable Loss (dB) | Preamp Factor (dB) | Ant Pos (cm) | Table Pos (deg) | Peak Avg. (P/A) | Pol. (H/V) | |
|-------------------------|--|----------------------|---------------------|-------------------------|-----------------------------|---------------------------|-------------------------------|-------------------------|----------------------------|----------------------|-------------------------|-------------------------|-----------------|---|
| BLE CH 00 2402MHz | | 4804 | 40.31 | -33.69 | 74 | 53.46 | 34.1 | 11.83 | 59.08 | 100 | 0 | P | H | |
| | | | | | | | | | | | | | H | |
| | | | | | | | | | | | | | H | |
| | | | | | | | | | | | | | H | |
| | | | 4804 | 40.2 | -33.8 | 74 | 53.35 | 34.1 | 11.83 | 59.08 | 100 | 0 | P | V |
| | | | | | | | | | | | | | | V |
| | | | | | | | | | | | | | | V |
| BLE CH 19 2440MHz | | 4880 | 39.83 | -34.17 | 74 | 53.14 | 34.1 | 11.53 | 58.94 | 100 | 0 | P | H | |
| | | 7320 | 40.71 | -33.29 | 74 | 48.76 | 36.1 | 13.81 | 57.96 | 100 | 0 | P | H | |
| | | | | | | | | | | | | | H | |
| | | | | | | | | | | | | | H | |
| | | | 4880 | 40.03 | -33.97 | 74 | 53.34 | 34.1 | 11.53 | 58.94 | 100 | 0 | P | V |
| | | | 7320 | 39.87 | -34.13 | 74 | 47.92 | 36.1 | 13.81 | 57.96 | 100 | 0 | P | V |
| | | | | | | | | | | | | | | V |
| BLE CH 39 2480MHz | | 4960 | 40.95 | -33.05 | 74 | 54.4 | 34.1 | 11.22 | 58.77 | 100 | 0 | P | H | |
| | | 7440 | 40.74 | -33.26 | 74 | 48.65 | 36.17 | 14.05 | 58.13 | 100 | 0 | P | H | |
| | | | | | | | | | | | | | H | |
| | | | | | | | | | | | | | H | |
| | | | 4960 | 40.54 | -33.46 | 74 | 53.99 | 34.1 | 11.22 | 58.77 | 100 | 0 | P | V |
| | | | 7440 | 41.45 | -32.55 | 74 | 49.36 | 36.17 | 14.05 | 58.13 | 100 | 0 | P | V |
| | | | | | | | | | | | | | | V |
| Remark | 1. No other spurious found. | | | | | | | | | | | | | |
| | 2. All results are PASS against Peak and Average limit line. | | | | | | | | | | | | | |



Emission below 1GHz

2.4GHz BLE (LF)

| BLE | Note | Frequency | Level | Over | Limit | Read | Antenna | Cable | Preamp | Ant | Table | Peak | Pol. | |
|---------------------|--|-----------|------------|--------|------------|----------|----------|--------|--------|--------|---------|---------|---------|---|
| | | (MHz) | (dBμV/m) | (dB) | (dBμV/m) | (dBμV) | (dB/m) | (dB) | (dB) | (cm) | (deg) | (P/A) | (H/V) | |
| 2.4GHz BLE LF | | 84 | 28.55 | -11.45 | 40 | 44.44 | 14.38 | 1.28 | 31.55 | - | - | P | H | |
| | | 157.98 | 37.36 | -6.14 | 43.5 | 49.94 | 17.14 | 1.78 | 31.5 | 100 | 280 | P | H | |
| | | 259.5 | 30.49 | -15.51 | 46 | 39.78 | 20 | 2.07 | 31.36 | - | - | P | H | |
| | | 305.6 | 30.75 | -15.25 | 46 | 39.64 | 19.96 | 2.41 | 31.26 | - | - | P | H | |
| | | 735.4 | 30.2 | -15.8 | 46 | 30.17 | 26.96 | 3.74 | 30.67 | - | - | P | H | |
| | | 966.4 | 34.42 | -19.58 | 54 | 30.65 | 30.23 | 4.07 | 30.53 | - | - | P | H | |
| | | | | | | | | | | | | | | H |
| | | | | | | | | | | | | | | H |
| | | | | | | | | | | | | | | H |
| | | | | | | | | | | | | | | H |
| | | | | | | | | | | | | | | H |
| | | | | | | | | | | | | | | H |
| | | | 79.14 | 34.58 | -5.42 | 40 | 51.06 | 13.79 | 1.28 | 31.55 | 100 | 84 | P | V |
| | | | 116.4 | 34.86 | -8.64 | 43.5 | 47.14 | 17.68 | 1.55 | 31.51 | - | - | P | V |
| | | | 224.94 | 29.66 | -16.34 | 46 | 42.22 | 16.8 | 2.07 | 31.43 | - | - | P | V |
| | | | 323.8 | 29.63 | -16.37 | 46 | 38 | 20.47 | 2.41 | 31.25 | - | - | P | V |
| | | | 673.8 | 29.36 | -16.64 | 46 | 30.32 | 26.14 | 3.65 | 30.75 | - | - | P | V |
| | | | 990.9 | 33.6 | -20.4 | 54 | 29.86 | 30.28 | 3.98 | 30.52 | - | - | P | V |
| | | | | | | | | | | | | | | V |
| | | | | | | | | | | | | | | V |
| | | | | | | | | | | | | | V | |
| | | | | | | | | | | | | | V | |
| | | | | | | | | | | | | | V | |
| | | | | | | | | | | | | | V | |
| Remark | 1. No other spurious found. 2. All results are PASS against limit line. | | | | | | | | | | | | | |



Note symbol

| | |
|-----|--|
| * | Fundamental Frequency which can be ignored. However, the level of any unwanted emissions shall not exceed the level of the fundamental frequency. |
| ! | Test result is over limit line. |
| P/A | Peak or Average |
| H/V | Horizontal or Vertical |



A calculation example for radiated spurious emission is shown as below:

| WIFI | Note | Frequency | Level | Over | Limit | Read | Antenna | Cable | Preamp | Ant | Table | Peak | Pol. |
|---------|------|-----------|------------|--------|------------|----------|----------|--------|--------|--------|---------|---------|---------|
| Ant. | | | | Limit | Line | Level | Factor | Loss | Factor | Pos | Pos | Avg. | |
| 1+2 | | (MHz) | (dBμV/m) | (dB) | (dBμV/m) | (dBμV) | (dB/m) | (dB) | (dB) | (cm) | (deg) | (P/A) | (H/V) |
| 802.11b | | 2390 | 55.45 | -18.55 | 74 | 54.51 | 32.22 | 4.58 | 35.86 | 103 | 308 | P | H |
| CH 01 | | | | | | | | | | | | | |
| 2412MHz | | 2390 | 43.54 | -10.46 | 54 | 42.6 | 32.22 | 4.58 | 35.86 | 103 | 308 | A | H |

- Level(dBμV/m) =
Antenna Factor(dB/m) + Cable Loss(dB) + Read Level(dBμV) - Preamp Factor(dB)
- Over Limit(dB) = Level(dBμV/m) – Limit Line(dBμV/m)

For Peak Limit @ 2390MHz:

- Level(dBμV/m)
= Antenna Factor(dB/m) + Cable Loss(dB) + Read Level(dBμV) - Preamp Factor(dB)
= 32.22(dB/m) + 4.58(dB) + 54.51(dBμV) – 35.86 (dB)
= 55.45 (dBμV/m)
- Over Limit(dB)
= Level(dBμV/m) – Limit Line(dBμV/m)
= 55.45(dBμV/m) – 74(dBμV/m)
= -18.55(dB)

For Average Limit @ 2390MHz:

- Level(dBμV/m)
= Antenna Factor(dB/m) + Cable Loss(dB) + Read Level(dBμV) - Preamp Factor(dB)
= 32.22(dB/m) + 4.58(dB) + 42.6(dBμV) – 35.86 (dB)
= 43.54 (dBμV/m)
- Over Limit(dB)
= Level(dBμV/m) – Limit Line(dBμV/m)
= 43.54(dBμV/m) – 54(dBμV/m)
= -10.46(dB)

Both peak and average measured complies with the limit line, so test result is “PASS”.



Appendix C. Radiated Spurious Emission Plots

| | | | |
|------------------------|---|----------------------------|---------|
| Test Engineer : | Luke Chang, Jesse Wang, Derreck Chen and James Chiu | Temperature : | 21~24°C |
| | | Relative Humidity : | 50~55% |

Note symbol

| | |
|----|-----------------------|
| -L | Low channel location |
| -R | High channel location |



2.4GHz 2400~2483.5MHz

BLE (Band Edge @ 3m)

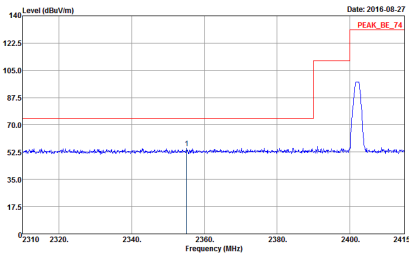
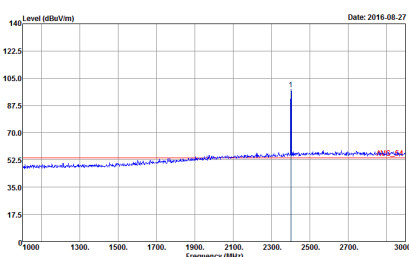
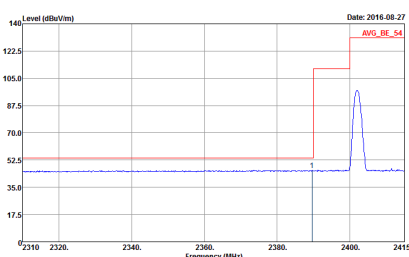
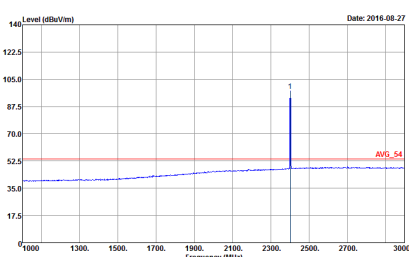
| BLE | 2.4GHz 2400~2483.5MHz Band Edge @ 3m | |
|--------------------|--|---|
| ANT | BLE CH00 2402MHz | |
| 1 | Horizontal | Fundamental |
| <p>Peak</p> |  <p>Level (dBuV/m) vs Frequency (MHz) plot for Peak Horizontal. The plot shows a sharp peak at approximately 2402 MHz. A red line indicates the peak level at 122.5 dBuV/m, labeled 'PEAK_BE_74'. The baseline noise floor is around 52.5 dBuV/m. The x-axis ranges from 2310 to 2415 MHz, and the y-axis ranges from 17.5 to 140 dBuV/m.</p> <p>Site : 03CH07-HY Condition : PEAK_BE_74 3m HF-ANT_130829 HORIZONTAL RBW: 1000.000kHz VBW: 3000.000kHz SWT: Auto Detector : Peak Project : 672834 Mode : 5</p> |  <p>Level (dBuV/m) vs Frequency (MHz) plot for Peak Fundamental. The plot shows a sharp peak at approximately 2402 MHz. A red line indicates the peak level at 105.0 dBuV/m, labeled 'PEAK_BE_54'. The baseline noise floor is around 52.5 dBuV/m. The x-axis ranges from 1900 to 3000 MHz, and the y-axis ranges from 17.5 to 140 dBuV/m.</p> <p>Site : 03CH07-HY Condition : AVG_BE_54 3m HF-ANT_130829 HORIZONTAL RBW: 1000.000kHz VBW: 3.000kHz SWT: Auto Detector : Peak Project : 672834 Mode : 5</p> |
| <p>Avg.</p> |  <p>Level (dBuV/m) vs Frequency (MHz) plot for Avg Horizontal. The plot shows a sharp peak at approximately 2402 MHz. A red line indicates the average level at 122.5 dBuV/m, labeled 'AVG_BE_54'. The baseline noise floor is around 52.5 dBuV/m. The x-axis ranges from 2310 to 2415 MHz, and the y-axis ranges from 17.5 to 140 dBuV/m.</p> <p>Site : 03CH07-HY Condition : AVG_BE_54 3m HF-ANT_130829 HORIZONTAL RBW: 1000.000kHz VBW: 3.000kHz SWT: Auto Detector : Peak Project : 672834 Mode : 5</p> |  <p>Level (dBuV/m) vs Frequency (MHz) plot for Avg Fundamental. The plot shows a sharp peak at approximately 2402 MHz. A red line indicates the average level at 105.0 dBuV/m, labeled 'AVG_BE_54'. The baseline noise floor is around 52.5 dBuV/m. The x-axis ranges from 1900 to 3000 MHz, and the y-axis ranges from 17.5 to 140 dBuV/m.</p> <p>Site : 03CH07-HY Condition : AVG_BE_54 3m HF-ANT_130829 HORIZONTAL RBW: 1000.000kHz VBW: 3.000kHz SWT: Auto Detector : Peak Project : 672834 Mode : 5</p> |

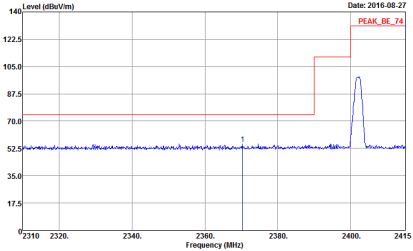
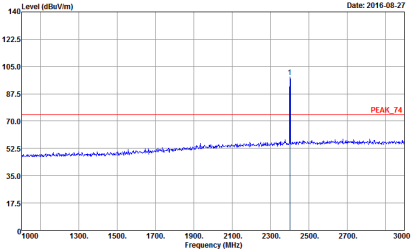
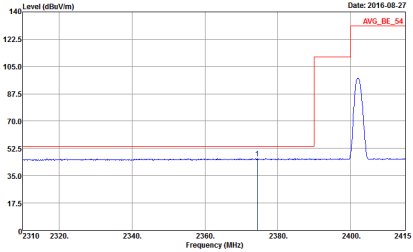
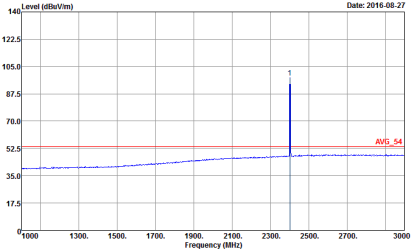

| BLE | 2.4GHz 2400~2483.5MHz Band Edge @ 3m | |
|------|---|--|
| ANT | BLE CH00 2402MHz | |
| 1 | Vertical | Fundamental |
| Peak |  <p>Date: 2016-08-27 PEAK_BE_74</p> <p>Site : 03CH07.HY Condition : PEAK_BE_74 3m HF-ANT_130829 VERTICAL Detector : Peak Project : 672834 Mode : 5</p> |  <p>Date: 2016-08-27 PEAK_74</p> <p>Site : 03CH07.HY Condition : PEAK_74 3m HF-ANT_130829 VERTICAL Detector : Peak Project : 672834 Mode : 5</p> |
| Avg |  <p>Date: 2016-08-27 AVG_BE_54</p> <p>Site : 03CH07.HY Condition : AVG_BE_54 3m HF-ANT_130829 VERTICAL Detector : Peak Project : 672834 Mode : 5</p> |  <p>Date: 2016-08-27 AVG_54</p> <p>Site : 03CH07.HY Condition : AVG_54 3m HF-ANT_130829 VERTICAL Detector : Peak Project : 672834 Mode : 5</p> |

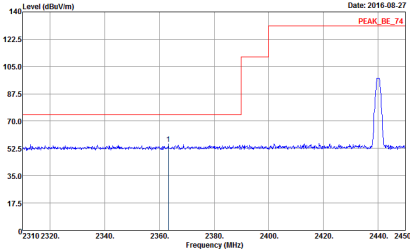
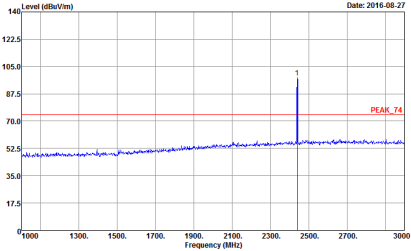
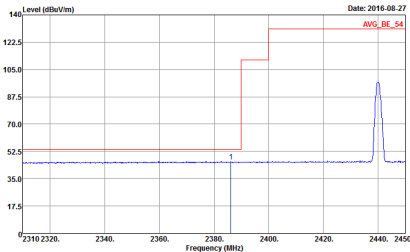
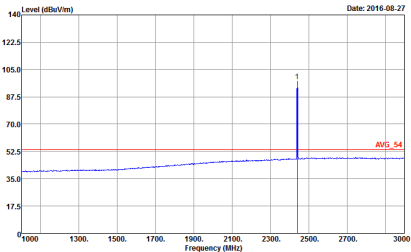

| BLE | 2.4GHz 2400~2483.5MHz Band Edge @ 3m | |
|------|---|--|
| ANT | BLE CH19 2440MHz - L | |
| 1 | Horizontal | Fundamental |
| Peak |  <p>Date: 2016-08-27 PEAK_BE_74</p> <p>Site : 03CH07.HY Condition : PEAK_BE_74 3m HF-ANT_130829 HORIZONTAL Detector : Peak Project : 672834 Mode : 5</p> |  <p>Date: 2016-08-27 PEAK_74</p> <p>Site : 03CH07.HY Condition : PEAK_74 3m HF-ANT_130829 HORIZONTAL Detector : Peak Project : 672834 Mode : 5</p> |
| Avg. |  <p>Date: 2016-08-27 AVG_BE_54</p> <p>Site : 03CH07.HY Condition : AVG_BE_54 3m HF-ANT_130829 HORIZONTAL Detector : Peak Project : 672834 Mode : 5</p> |  <p>Date: 2016-08-27 AVG_54</p> <p>Site : 03CH07.HY Condition : AVG_54 3m HF-ANT_130829 HORIZONTAL Detector : Peak Project : 672834 Mode : 5</p> |



| BLE | 2.4GHz 2400~2483.5MHz Band Edge @ 3m | |
|------|---|-------------|
| ANT | BLE CH19 2440MHz - R | |
| 1 | Horizontal | Fundamental |
| Peak | <p>Site : 03CH071Y Condition : PEAK_BE_74 3m HF-ANT_130829 HORIZONTAL Detector : Peak Project : 672834 Mode : S</p> | Left blank |
| Avg. | <p>Site : 03CH071Y Condition : PEAK_BE_74 3m HF-ANT_130829 HORIZONTAL Detector : Peak Project : 672834 Mode : S</p> | Left blank |

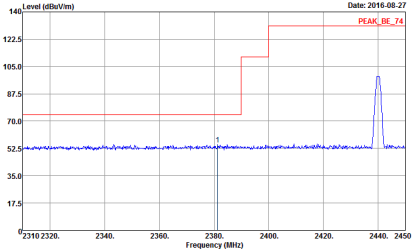
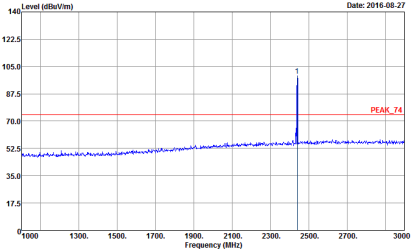
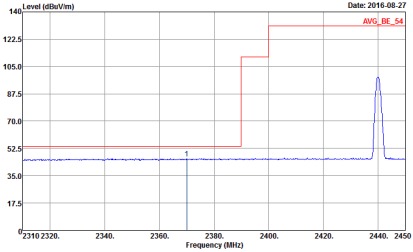
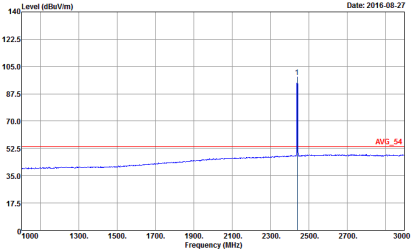

| BLE | 2.4GHz 2400~2483.5MHz Band Edge @ 3m | |
|------|---|--|
| ANT | BLE CH19 2440MHz - L | |
| 1 | Vertical | Fundamental |
| Peak |  <p>Date: 2016-08-27 PEAK_BE_74</p> <p>Site : 03CH07.HY Condition : PEAK_BE_74 3m HF-ANT_130829 VERTICAL Detector : Peak Project : 672834 Mode : 5</p> |  <p>Date: 2016-08-27 PEAK_74</p> <p>Site : 03CH07.HY Condition : PEAK_74 3m HF-ANT_130829 VERTICAL Detector : Peak Project : 672834 Mode : 5</p> |
| Avg. |  <p>Date: 2016-08-27 AVG_BE_54</p> <p>Site : 03CH07.HY Condition : AVG_BE_54 3m HF-ANT_130829 VERTICAL Detector : Peak Project : 672834 Mode : 5</p> |  <p>Date: 2016-08-27 AVG_54</p> <p>Site : 03CH07.HY Condition : AVG_54 3m HF-ANT_130829 VERTICAL Detector : Peak Project : 672834 Mode : 5</p> |

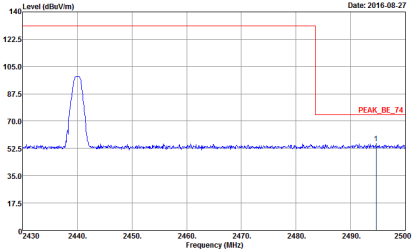
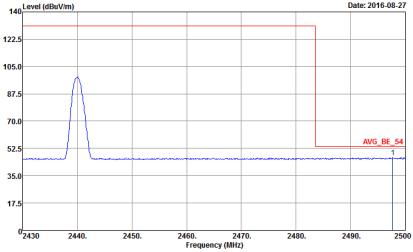

| BLE | 2.4GHz 2400~2483.5MHz Band Edge @ 3m | |
|------|--|-------------|
| ANT | BLE CH19 2440MHz - R | |
| 1 | Vertical | Fundamental |
| Peak |  <p> Date: 2016-08-27 Site : 03CH07HY Condition : PEAK_BE_74 3m HF-ANT_130829 VERTICAL Detector : Peak Project : 672834 Mode : 5 </p> | Left blank |
| Avg. |  <p> Date: 2016-08-27 Site : 03CH07HY Condition : AVG_BE_54 3m HF-ANT_130829 VERTICAL Detector : Peak Project : 672834 Mode : 5 </p> | Left blank |

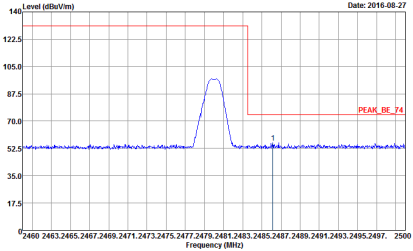
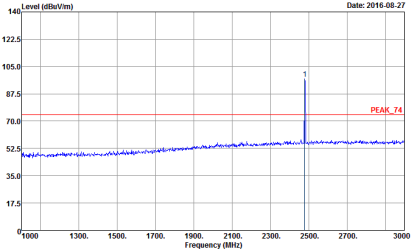
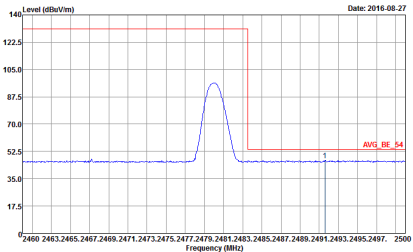
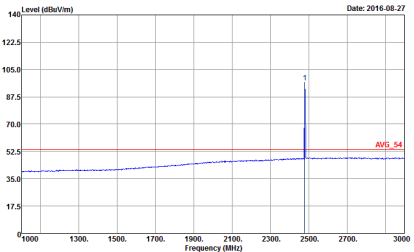

| BLE | 2.4GHz 2400~2483.5MHz Band Edge @ 3m | |
|------|---|--|
| ANT | BLE CH39 2480MHz | |
| 1 | Horizontal | Fundamental |
| Peak |  <p>Date: 2016-08-27</p> <p>Level (dBuV/m)</p> <p>Frequency (MHz)</p> <p>PEAK_BE_T4</p> <p>Site : 03CH07.HY Condition : PEAK_BE_T4 3m HF-ANT_130829 HORIZONTAL Detector : Peak Project : 672834 Mode : 6</p> |  <p>Date: 2016-08-27</p> <p>Level (dBuV/m)</p> <p>Frequency (MHz)</p> <p>PEAK_T4</p> <p>Site : 03CH07.HY Condition : PEAK_T4 3m HF-ANT_130829 HORIZONTAL Detector : Peak Project : 672834 Mode : 6</p> |
| Avg. |  <p>Date: 2016-08-27</p> <p>Level (dBuV/m)</p> <p>Frequency (MHz)</p> <p>AVG_BE_S4</p> <p>Site : 03CH07.HY Condition : AVG_BE_S4 3m HF-ANT_130829 HORIZONTAL Detector : Peak Project : 672834 Mode : 6</p> |  <p>Date: 2016-08-27</p> <p>Level (dBuV/m)</p> <p>Frequency (MHz)</p> <p>AVG_S4</p> <p>Site : 03CH07.HY Condition : AVG_S4 3m HF-ANT_130829 HORIZONTAL Detector : Peak Project : 672834 Mode : 6</p> |

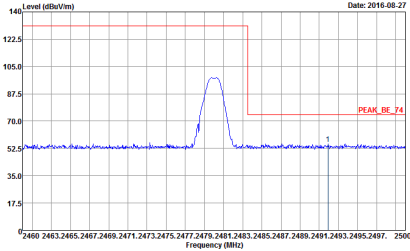
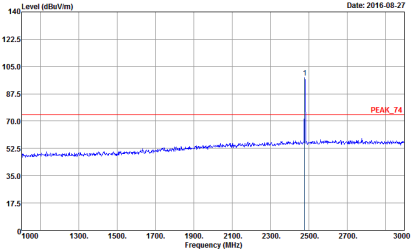
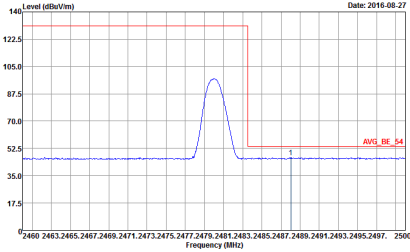
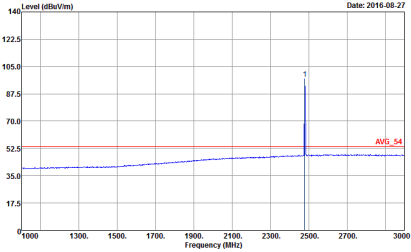

| BLE | 2.4GHz 2400~2483.5MHz Band Edge @ 3m | |
|------|---|--|
| ANT | BLE CH39 2480MHz | |
| 1 | Vertical | Fundamental |
| Peak |  <p>Level (dBuV/m) vs Frequency (MHz) plot showing a peak at 2480 MHz. The peak level is approximately 105 dBuV/m. The plot includes a red box highlighting the peak and a red line labeled 'PEAK_BE_T4'.</p> <p>Site : 03CH07.HY Condition : PEAK_BE_T4 3m HF-ANT_130829 VERTICAL Detector : Peak Project : 672834 Mode : 6</p> |  <p>Level (dBuV/m) vs Frequency (MHz) plot showing a peak at 2480 MHz. The peak level is approximately 105 dBuV/m. The plot includes a red box highlighting the peak and a red line labeled 'PEAK_T4'.</p> <p>Site : 03CH07.HY Condition : PEAK_T4 3m HF-ANT_130829 VERTICAL Detector : Peak Project : 672834 Mode : 6</p> |
| Avg. |  <p>Level (dBuV/m) vs Frequency (MHz) plot showing the average level. The average level is approximately 52.5 dBuV/m. The plot includes a red box highlighting the average level and a red line labeled 'AVG_BE_S4'.</p> <p>Site : 03CH07.HY Condition : AVG_BE_S4 3m HF-ANT_130829 VERTICAL Detector : Peak Project : 672834 Mode : 6</p> |  <p>Level (dBuV/m) vs Frequency (MHz) plot showing the average level. The average level is approximately 52.5 dBuV/m. The plot includes a red box highlighting the average level and a red line labeled 'AVG_S4'.</p> <p>Site : 03CH07.HY Condition : AVG_S4 3m HF-ANT_130829 VERTICAL Detector : Peak Project : 672834 Mode : 6</p> |



2.4GHz 2400~2483.5MHz

BLE (Harmonic @ 3m)

| BLE | 2.4GHz 2400~2483.5MHz Harmonic @ 3m | |
|----------------------|--|--|
| ANT | BLE CH00 2402MHz | |
| 1 | Horizontal | Vertical |
| <p>Peak Avg.</p> | <p>Site : 03CH07HY Condition : PEAK_74 3m SHF-EHF_131029 HORIZONTAL RBW: 1000.000kHz VBW: 3000.000kHz SWT: Auto Detector : Peak Project : 672834 Mode : 5</p> | <p>Site : 03CH07HY Condition : PEAK_74 3m SHF-EHF_131029 VERTICAL RBW: 1000.000kHz VBW: 3000.000kHz SWT: Auto Detector : Peak Project : 672834 Mode : 5</p> |

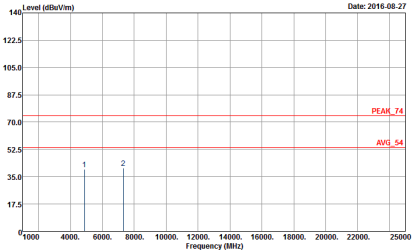
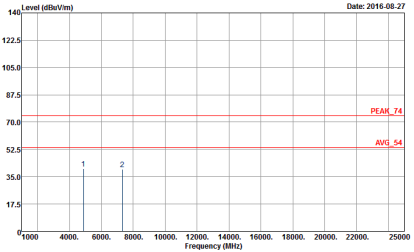

| BLE | 2.4GHz 2400~2483.5MHz Harmonic @ 3m | |
|---------------------------------------|--|---|
| ANT | BLE CH19 2440MHz | |
| 1 | Horizontal | Vertical |
| <p>Peak</p> <p>Avg.</p> |  <p>Site : 03CH07.HY Condition : PEAK_T4 3m SHF-EHF_131029 HORIZONTAL Detector : Peak Project : 672834 Mode : 5</p> |  <p>Site : 03CH07.HY Condition : PEAK_T4 3m SHF-EHF_131029 VERTICAL Detector : Peak Project : 672834 Mode : 5</p> |

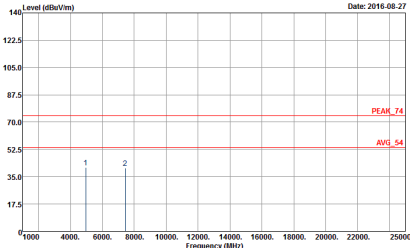
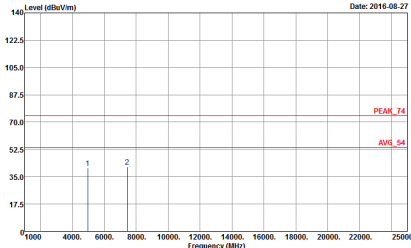

| BLE | 2.4GHz 2400~2483.5MHz Harmonic @ 3m | |
|------|--|---|
| ANT | BLE CH39 2480MHz | |
| 1 | Horizontal | Vertical |
| Peak |  <p>Date: 2016-08-27</p> <p>Site : 03CH07.HY Condition : PEAK_T4 3m SHF-EHF_131029 HORIZONTAL Detector : Peak Project : 672834 Mode : 6</p> |  <p>Date: 2016-08-27</p> <p>Site : 03CH07.HY Condition : PEAK_T4 3m SHF-EHF_131029 VERTICAL Detector : Peak Project : 672834 Mode : 6</p> |



Emission below 1GHz

2.4GHz BLE (LF)

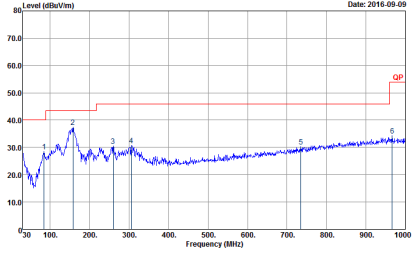
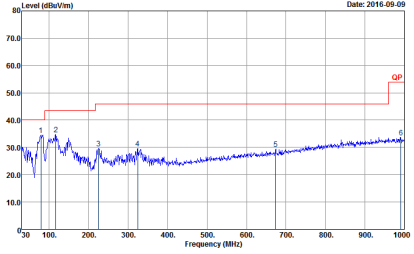
| | | |
|------------------|--|---|
| BLE | 2.4GHz 2400~2483.5MHz | |
| ANT | BLE LF | |
| 1 | Horizontal | Vertical |
| QP / Peak |  <p>Site : 03CH07HY Condition : QP 3m LF-ANT:35419(6) HORIZONTAL Detector : Peak Project : 672834 Mode : 60</p> |  <p>Site : 03CH07HY Condition : QP 3m LF-ANT:35419(6) VERTICAL Detector : Peak Project : 672834 Mode : 60</p> |

Appendix D. Duty Cycle Plots

| Band | Duty Cycle(%) | T(us) | 1/T(kHz) | VBW Setting |
|--------------------|---------------|-------|----------|-------------|
| Bluetooth 4.1 – LE | 62.179 | 388 | 2.58 | 3kHz |

Bluetooth 4.1 – LE

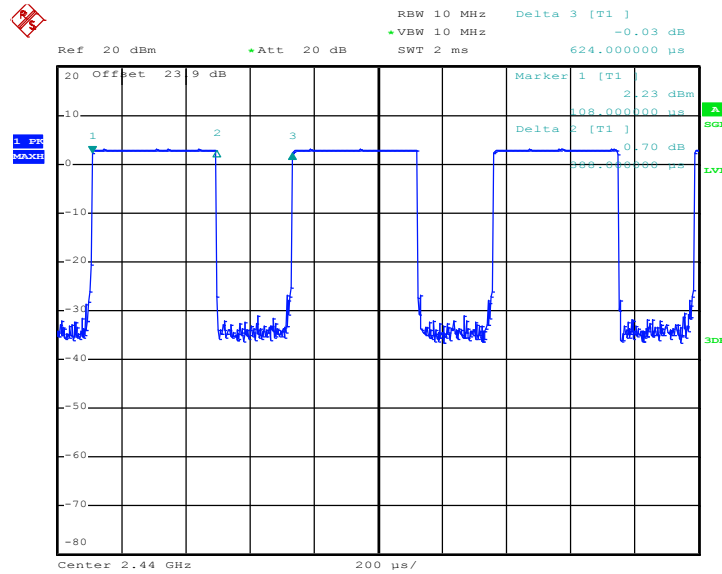

Date: 19.AUG.2016 14:10:24