



FCC RF Test Report

APPLICANT : Zebra Technologies Corporation
EQUIPMENT : Touch computer
BRAND NAME : Zebra
MODEL NAME : TC75EK
FCC ID : UZ7TC75EK
STANDARD : FCC Part 15 Subpart E §15.407
CLASSIFICATION : (NII) Unlicensed National Information Infrastructure

The product was received on Jul. 28, 2016 and testing was completed on Sep. 16, 2016. We, SPORTON INTERNATIONAL INC., would like to declare that the tested sample has been evaluated in accordance with the test procedures and has been in compliance with the applicable technical standards.

The test results in this report apply exclusively to the tested model / sample. Without written approval of SPORTON INTERNATIONAL INC., the test report shall not be reproduced except in full.

Reviewed by: Joseph Lin / Supervisor

Approved by: Jones Tsai / Manager



SPORTON INTERNATIONAL INC.

No. 52, Hwa Ya 1st Rd., Hwa Ya Technology Park, Kwei-Shan District, Tao Yuan City, Taiwan, R.O.C.



TABLE OF CONTENTS

REVISION HISTORY 3

SUMMARY OF TEST RESULT 4

1 GENERAL DESCRIPTION 5

 1.1 Applicant 5

 1.2 Manufacturer 5

 1.3 Feature of Equipment Under Test 5

 1.4 Product Specification of Equipment Under Test 6

 1.5 Modification of EUT 9

 1.6 Testing Location 10

 1.7 Applicable Standards 11

2 TEST CONFIGURATION OF EQUIPMENT UNDER TEST 12

 2.1 Carrier Frequency and Channel 12

 2.2 Pre-Scanned RF Power 14

 2.3 Test Mode 27

 2.4 Connection Diagram of Test System 30

 2.5 Support Unit used in test configuration and system 31

 2.6 EUT Operation Test Setup 32

 2.7 Measurement Results Explanation Example 33

3 TEST RESULT 34

 3.1 26dB & 99% Occupied Bandwidth Measurement 34

 3.2 Maximum Conducted Output Power Measurement 37

 3.3 Power Spectral Density Measurement 42

 3.4 Unwanted Emissions Measurement 46

 3.5 AC Conducted Emission Measurement 52

 3.6 Frequency Stability Measurement 69

 3.7 Automatically Discontinue Transmission 70

 3.8 Antenna Requirements 71

4 LIST OF MEASURING EQUIPMENT 73

5 UNCERTAINTY OF EVALUATION 74

APPENDIX A. CONDUCTED TEST RESULTS

APPENDIX B. RADIATED SPURIOUS EMISSION

APPENDIX C. RADIATED SPURIOUS EMISSION PLOTS

APPENDIX D. DUTY CYCLE PLOTS

APPENDIX E. SETUP PHOTOGRAPHS



REVISION HISTORY

REPORT NO.	VERSION	DESCRIPTION	ISSUED DATE
FR672834E	Rev. 01	Initial issue of report	Sep. 29, 2016
FR672834E	Rev. 02	Detail changes list as below : 1. Adding the applied standard in the section 1.7 and the specification of accessories 2. Updating average power in appendix A and section 1.4 3. Revising 99% occupied bandwidth in section 1.4 4. Adding straddle channel power in section 2.2 5. Revising maximum straddle channel power for CDD mode in section 3.2.5 6. Revising Band III antenna gain for CDD mode in section 3.8.3	Oct. 05, 2016
FR672834E	Rev. 03	Revising the Adapter information in specification of accessories.	Oct. 07, 2016



SUMMARY OF TEST RESULT

Report Section	FCC Rule	Description	Limit	Result	Remark
3.1	2.1049 15.403(i)	26dB & 99% Bandwidth	-	Pass	-
3.2	15.407(a)	Maximum Conducted Output Power	FCC ≤ 24 dBm (depend on band)	Pass	-
3.3	15.407(a)	Power Spectral Density	FCC ≤ 11 dBm (depend on band)	Pass	-
3.4	15.407(b)	Unwanted Emissions	≤ -17, -27 dBm (depend on band)&15.209(a)	Pass	Under limit 1.01 dB at 5458.960 MHz
3.5	15.207	AC Conducted Emission	15.207(a)	Pass	Under limit 3.20 dB at 0.758 MHz
3.6	15.407(g)	Frequency Stability	Within Operation Band	Pass	-
3.7	15.407(c)	Automatically Discontinue Transmission	Discontinue Transmission	Pass	-
3.8	15.203 & 15.407(a)	Antenna Requirement	N/A	Pass	-



1 General Description

1.1 Applicant

Zebra Technologies Corporation
1 Zebra Plaza Holtsville, NY 11742

1.2 Manufacturer

Wistron Corporation
21F, No. 88, Sec. 1, Hsin Tai Wu Rd., Hsichih Dist, New Taipei City 221, Taiwan R.O.C.

1.3 Feature of Equipment Under Test

Product Feature	
Equipment	Touch computer
Brand Name	Zebra
Model Name	TC75EK
FCC ID	UZ7TC75EK
EUT supports Radios application	CDMA/EV-DO/GSM/EGPRS/WCDMA/HSPA/LTE/NFC WLAN 11a/b/g/n HT20/HT40 WLAN 11ac VHT20/VHT40/VHT80 Bluetooth BR/EDR/LE
HW Version	DV
SW Version	Android version 6.0.1
FW Version	91-10-01-MG-00
MFD	14JUL16
EUT Stage	Engineering sample

Remark: The above EUT's information was declared by manufacturer. Please refer to the specifications or user's manual for more detailed description.

Specification of Accessories				
AC Adapter	Brand Name	Zebra	Part Number	PWR-BUA5V16W0WW
Snap-On USB/Charge Cable	Brand Name	Symbol	Part Number	CBL-TC7X-USB1-01
Snap-On Charging Cable Cup	Brand Name	Symbol	Part Number	CHG-TC7X-CBL1-01
Battery	Brand Name	Zebra	Part Number	BT-000318-01
Earphone 1	Brand Name	Zebra	Part Number	HDST-35MM-PTVP-01
Earphone 2	Brand Name	Zebra	Part Number	HS2100-OTH
Earphone 3	Brand Name	Zebra	Part Number	HS3100-OTH
Snap-on 3.5MM Audio Nugget	Brand Name	Symbol	Part Number	ADP-TC7X-AUD35-01
3.5mm Jack 43"(1.1m) Standard Cable	Brand Name	Zebra	Part Number	CBL-HS2100-3MS1-01
Soft Holster	Brand Name	Zebra	Part Number	SG-TC7X-HLSTR1-01
Rigid Holster	Brand Name	Zebra	Part Number	SG-TC7X-RHLSTR1-01
Power Cord	Brand Name	LOROM	Part Number	50-16000-182R
Cable line	Brand Name	Zebra	Part Number	CBL-DC-383A1-01



1.4 Product Specification of Equipment Under Test

Standards-related Product Specification	
Tx/Rx Frequency Range	5180 MHz ~ 5240 MHz 5260 MHz ~ 5320 MHz 5500 MHz ~ 5720 MHz
Maximum Output Power <CDD Modes>	<p><5180 MHz ~ 5240 MHz></p> <p><Ant. 1> 802.11a : 15.98 dBm / 0.0396 W 802.11n HT20 : 15.82 dBm / 0.0382 W 802.11n HT40 : 15.15 dBm / 0.0327 W 802.11ac VHT20: 15.90 dBm / 0.0389 W 802.11ac VHT40: 15.33 dBm / 0.0341 W 802.11ac VHT80: 12.08 dBm / 0.0161 W</p> <p><Ant. 2> 802.11a : 17.61 dBm / 0.0577 W 802.11n HT20 : 17.54 dBm / 0.0568 W 802.11n HT40 : 16.86 dBm / 0.0485 W 802.11ac VHT20: 17.67 dBm / 0.0585 W 802.11ac VHT40: 16.93 dBm / 0.0493 W 802.11ac VHT80: 14.03 dBm / 0.0253 W</p> <p>MIMO <Ant. 1 + 2> 802.11a : 19.89 dBm / 0.0975 W 802.11n HT20 : 19.89 dBm / 0.0975 W 802.11n HT40 : 19.18 dBm / 0.0828 W 802.11ac VHT20: 19.91 dBm / 0.0979 W 802.11ac VHT40: 19.33 dBm / 0.0857 W 802.11ac VHT80: 16.26 dBm / 0.0423 W</p> <p><5260 MHz ~ 5320 MHz></p> <p><Ant. 1> 802.11a : 16.09 dBm / 0.0406 W 802.11n HT20 : 15.80 dBm / 0.0380 W 802.11n HT40 : 15.44 dBm / 0.0350 W 802.11ac VHT20: 15.83 dBm / 0.0383 W 802.11ac VHT40: 15.47 dBm / 0.0352 W 802.11ac VHT80: 11.69 dBm / 0.0148 W</p> <p><Ant. 2> 802.11a : 17.56 dBm / 0.0570 W 802.11n HT20 : 17.58 dBm / 0.0573 W 802.11n HT40 : 17.06 dBm / 0.0508 W 802.11ac VHT20: 17.63 dBm / 0.0579 W 802.11ac VHT40: 17.08 dBm / 0.0511 W 802.11ac VHT80: 13.14 dBm / 0.0206 W</p> <p>MIMO <Ant. 1 + 2> 802.11a : 19.91 dBm / 0.0979 W 802.11n HT20 : 19.86 dBm / 0.0968 W 802.11n HT40 : 19.41 dBm / 0.0873 W 802.11ac VHT20: 19.90 dBm / 0.0977 W 802.11ac VHT40: 19.50 dBm / 0.0891 W 802.11ac VHT80: 15.58 dBm / 0.0361 W</p>



Standards-related Product Specification	
<p>Maximum Output Power <CDD Modes></p>	<p><5500 MHz ~ 5720 MHz> <Ant. 1> 802.11a : 15.88 dBm / 0.0387 W 802.11n HT20 : 15.81 dBm / 0.0381 W 802.11n HT40 : 15.30 dBm / 0.0339 W 802.11ac VHT20: 15.83 dBm / 0.0383 W 802.11ac VHT40: 15.53 dBm / 0.0357 W 802.11ac VHT80: 14.16 dBm / 0.0261 W <Ant. 2> 802.11a : 17.77 dBm / 0.0598 W 802.11n HT20 : 17.54 dBm / 0.0568 W 802.11n HT40 : 17.11 dBm / 0.0514 W 802.11ac VHT20: 17.57 dBm / 0.0571 W 802.11ac VHT40: 17.16 dBm / 0.0520 W 802.11ac VHT80: 16.11 dBm / 0.0408 W MIMO <Ant. 1 + 2> 802.11a : 19.97 dBm / 0.0993 W 802.11n HT20 : 19.83 dBm / 0.0962 W 802.11n HT40 : 19.36 dBm / 0.0863 W 802.11ac VHT20: 19.85 dBm / 0.0966 W 802.11ac VHT40: 19.50 dBm / 0.0891 W 802.11ac VHT80: 18.34 dBm / 0.0682 W</p>
<p>Maximum Output Power <TXBF Modes></p>	<p>MIMO <Ant. 1 + 2> <5180 MHz ~ 5240 MHz> 802.11n HT20 : 19.66 dBm / 0.0925 W 802.11n HT40 : 19.30 dBm / 0.0851 W 802.11ac VHT20: 19.82 dBm / 0.0959 W 802.11ac VHT40: 19.30 dBm / 0.0851 W 802.11ac VHT80: 16.25 dBm / 0.0422 W <5260 MHz ~ 5320 MHz> 802.11n HT20 : 19.60 dBm / 0.0912 W 802.11n HT40 : 19.20 dBm / 0.0832 W 802.11ac VHT20: 19.70 dBm / 0.0933 W 802.11ac VHT40: 19.30 dBm / 0.0851 W 802.11ac VHT80: 15.32 dBm / 0.0340 W <5500 MHz ~ 5720 MHz> 802.11n HT20 : 19.55 dBm / 0.0902 W 802.11n HT40 : 19.32 dBm / 0.0855 W 802.11ac VHT20: 19.72 dBm / 0.0938 W 802.11ac VHT40: 19.46 dBm / 0.0883 W 802.11ac VHT80: 18.30 dBm / 0.0676 W</p>



Standards-related Product Specification	
<p>Maximum Output Power to Antenna for Straddle Channel <CDD Modes></p>	<p><Ant. 1> 802.11a : 15.81 dBm / 0.0381 W 802.11n HT20 : 15.77 dBm / 0.0378 W 802.11n HT40 : 15.18 dBm / 0.0330 W 802.11ac VHT20: 15.86 dBm / 0.0385 W 802.11ac VHT40: 15.27 dBm / 0.0337 W 802.11ac VHT80: 14.04 dBm / 0.0254 W</p> <p><Ant. 2> 802.11a : 17.59 dBm / 0.0574 W 802.11n HT20 : 17.48 dBm / 0.0560 W 802.11n HT40 : 17.05 dBm / 0.0507 W 802.11ac VHT20: 17.61 dBm / 0.0577 W 802.11ac VHT40: 17.15 dBm / 0.0519 W 802.11ac VHT80: 16.18 dBm / 0.0415 W</p> <p>MIMO <Ant. 1 + 2> 802.11a : 19.92 dBm / 0.0982 W 802.11n HT20 : 19.79 dBm / 0.0953 W 802.11n HT40 : 19.28 dBm / 0.0847 W 802.11ac VHT20: 19.92 dBm / 0.0982 W 802.11ac VHT40: 19.42 dBm / 0.0875 W 802.11ac VHT80: 18.31 dBm / 0.0678 W</p>
<p>Maximum Output Power to Antenna for Straddle Channel <TXBF Modes></p>	<p>MIMO <Ant. 1 + 2> 802.11n HT20 : 19.66 dBm / 0.0925 W 802.11n HT40 : 19.33 dBm / 0.0857 W 802.11ac VHT20: 19.76 dBm / 0.0946 W 802.11ac VHT40: 19.46 dBm / 0.0883 W 802.11ac VHT80: 18.23 dBm / 0.0665 W</p>
<p>99% Occupied Bandwidth <CDD Modes></p>	<p>802.11a : 18.70 MHz 802.11ac VHT20 : 19.35 MHz 802.11ac VHT40 : 37.20 MHz 802.11ac VHT80 : 76.08 MHz</p>
<p>99% Occupied Bandwidth <TXBF Modes></p>	<p>802.11ac VHT20 : 19.40 MHz 802.11ac VHT40 : 37.00 MHz 802.11ac VHT80 : 76.08 MHz</p>



Standards-related Product Specification										
99% Occupied Bandwidth for Straddle Channel <CDD Modes>	802.11a : 18.75 MHz 802.11ac VHT20 : 19.20 MHz 802.11ac VHT40 : 36.90 MHz 802.11ac VHT80 : 75.84 MHz									
99% Occupied Bandwidth for Straddle Channel <TXBF Modes>	802.11ac VHT20 : 19.20 MHz 802.11ac VHT40 : 37.20 MHz 802.11ac VHT80 : 75.96 MHz									
Antenna Type / Gain	<5180 MHz ~ 5240 MHz> Ant. 1 : IFA Antenna with gain 4.90 dBi Ant. 2 : IFA Antenna with gain 1.60 dBi <5260 MHz ~ 5320 MHz> Ant. 1 : IFA Antenna with gain 4.90 dBi Ant. 2 : IFA Antenna with gain 2.20 dBi <5500 MHz ~ 5720 MHz> Ant. 1 : IFA Antenna with gain 4.90 dBi Ant. 2 : IFA Antenna with gain 3.30 dBi									
Type of Modulation	802.11a/n : OFDM (BPSK / QPSK / 16QAM / 64QAM) 802.11ac : OFDM (BPSK / QPSK / 16QAM / 64QAM / 256QAM)									
Antenna Function Description	<table border="1"> <thead> <tr> <th></th> <th>Ant. 1</th> <th>Ant. 2</th> </tr> </thead> <tbody> <tr> <td>802.11 a/n/ac</td> <td>V</td> <td>V</td> </tr> <tr> <td>802.11 a/n/ac MIMO</td> <td>V</td> <td>V</td> </tr> </tbody> </table>		Ant. 1	Ant. 2	802.11 a/n/ac	V	V	802.11 a/n/ac MIMO	V	V
	Ant. 1	Ant. 2								
802.11 a/n/ac	V	V								
802.11 a/n/ac MIMO	V	V								

Note: MIMO Ant. 1+2 is a calculated result from sum of the power MIMO Ant. 1 and MIMO Ant. 2.

1.5 Modification of EUT

No modifications are made to the EUT during all test items.



1.6 Testing Location

Sporton Lab is accredited to ISO 17025 by Taiwan Accreditation Foundation (TAF code : 1190) and the FCC designation No. TW1022 under the FCC 2.948(e) by Mutual Recognition Agreement (MRA) in FCC Test.

Test Site	SPORTON INTERNATIONAL INC.	
Test Site Location	No. 52, Hwa Ya 1 st Rd., Hwa Ya Technology Park, Kwei-Shan District, Tao Yuan City, Taiwan, R.O.C. TEL: +886-3-327-3456 FAX: +886-3-328-4978	
Test Site No.	Sporton Site No.	
	TH05-HY	CO05-HY

Note: The test site complies with ANSI C63.4 2014 requirement.

Test Site	SPORTON INTERNATIONAL INC.	
Test Site Location	No.58, Aly. 75, Ln. 564, Wenhua 3rd Rd. Guishan Dist, Taoyuan City, Taiwan (R.O.C.) TEL: +886-3-327-0868 FAX: +886-3-327-0855	
Test Site No.	Sporton Site No.	
	03CH12-HY	

Note: The test site complies with ANSI C63.4 2014 requirement.



1.7 Applicable Standards

According to the specifications of the manufacturer, the EUT must comply with the requirements of the following standards:

- ♦ FCC Part 15 Subpart E
- ♦ FCC KDB 789033 D02 General UNII Test Procedures New Rules v01r03
- ♦ FCC KDB 662911 D01 Multiple Transmitter Output v02r01.
- ♦ FCC KDB 644545 D03 Guidance for IEEE 802 11ac New Rules v01
- ♦ ANSI C63.10-2013

Remark:

1. All test items were verified and recorded according to the standards and without any deviation during the test.
2. This EUT has also been tested and complied with the requirements of FCC Part 15, Subpart B, recorded in a separate test report.



2 Test Configuration of Equipment Under Test

The EUT has been associated with peripherals and configuration operated in a manner tended to maximize its emission characteristics in a typical application. Frequency range investigated: conducted emission (150 kHz to 30 MHz) and radiated emission (9 kHz to the 10th harmonic of the highest fundamental frequency or to 40 GHz, whichever is lower). For radiated measurement, pre-scanned in three orthogonal panels, X, Y, Z. The worst position for each mode was recorded in the appendix of this test report.

2.1 Carrier Frequency and Channel

Frequency Band	Channel	Freq. (MHz)	Channel	Freq. (MHz)
5150-5250 MHz Band 1 (U-NII-1)	36	5180	44	5220
	38*	5190	46*	5230
	40	5200	48	5240
	42#	5210		

Frequency Band	Channel	Freq. (MHz)	Channel	Freq. (MHz)
5250-5350 MHz Band 2 (U-NII-2A)	52	5260	60	5300
	54*	5270	62*	5310
	56	5280	64	5320
	58#	5290		

Frequency Band	Channel	Freq. (MHz)	Channel	Freq. (MHz)
5470-5725 MHz Band 3 (U-NII-2C)	100	5500	112	5560
	102*	5510	116	5580
	104	5520	132	5660
	106#	5530	134*	5670
	108	5540	136	5680
	110*	5550	140	5700



Frequency Band	Channel	Freq. (MHz)	Channel	Freq. (MHz)
TDWR Channel	118*	5590	124	5620
	120	5600	126*	5630
	122 [#]	5610	128	5640

Frequency Band	Channel	Freq. (MHz)	Channel	Freq. (MHz)
Straddle Channel	138 [#]	5690	144	5720
	142*	5710		

Note:

- 1. The above Frequency and Channel in "*" were 802.11n HT40 and 802.11ac VHT40.
- 2. The above Frequency and Channel in "[#]" were 802.11ac VHT80.



2.2 Pre-Scanned RF Power

Preliminary tests were performed in different data rate and data rate associated with the highest power were chosen for full test in the following tables. Final Output Power equals to Measured Output Power adds the duty factor.

<CDD Modes>

<Ant. 1>

802.11a RF Average Output Power (dBm)										
Power vs. Channel			Average Power vs. Data Rate							
Channel	Frequency (MHz)	Data Rate (bps)	Channel	Data Rate (bps)						
		6M		9M	12M	18M	24M	36M	48M	54M
Duty Cycle (%)		92.86		89.72	86.75	81.67	78.48	71.11	64.87	63.57
CH 36	5180	15.81	CH 48	15.91	15.88	15.86	15.85	15.82	15.81	15.79
CH 44	5220	15.91								
CH 48	5240	15.98								
CH 52	5260	15.93	CH 60	16.01	15.98	15.95	15.94	15.92	15.90	15.89
CH 60	5300	16.09								
CH 64	5320	15.98								
CH 100	5500	15.77	CH 140	15.83	15.82	15.79	15.77	15.75	15.73	15.71
CH 116	5580	15.84								
CH 140	5700	15.88								
CH 144*	5720	15.81								

Note: The above Frequency and Channel in "*" were straddle channel.



802.11n HT20 RF Average Output Power (dBm)										
Power vs. Channel			Average Power vs. Data Rate							
Channel	Frequency (MHz)	MCS Index	Channel	MCS Index						
		MCS0		MCS1	MCS2	MCS3	MCS4	MCS5	MCS6	MCS7
Duty Cycle (%)		92.86		87.34	81.94	78.21	70.79	66.22	63.83	61.94
CH 36	5180	14.62	CH 44	15.61	15.67	15.78	15.78	15.80	15.82	15.76
CH 44	5220	15.82								
CH 48	5240	15.67								
CH 52	5260	15.65	CH 60	15.67	15.70	15.75	15.78	15.72	15.79	15.55
CH 60	5300	15.80								
CH 64	5320	14.70								
CH 100	5500	15.34	CH 116	15.73	15.53	15.62	15.61	15.63	15.62	15.56
CH 116	5580	15.81								
CH 140	5700	14.94								
CH 144*	5720	15.77								

Note: The above Frequency and Channel in "*" were straddle channel.



802.11n HT40 RF Average Output Power (dBm)										
Power vs. Channel			Average Power vs. Data Rate							
Channel	Frequency (MHz)	MCS Index	Channel	MCS Index						
		MCS0		MCS1	MCS2	MCS3	MCS4	MCS5	MCS6	MCS7
Duty Cycle (%)		98.01		95.31	94.44	92.06	90.39	88.37	86.25	85.14
CH 38	5190	11.99	CH 46	15.12	15.10	15.04	15.01	14.98	15.01	14.92
CH 46	5230	15.15								
CH 54	5270	15.44	CH 54	15.40	15.36	15.35	15.31	15.21	15.20	15.13
CH 62	5310	11.94								
CH 102	5510	12.76	CH 110	15.28	15.22	15.20	15.10	15.07	15.10	15.01
CH 110	5550	15.30								
CH 134	5670	14.89								
CH 142*	5710	15.18								

Note: The above Frequency and Channel in "*" were straddle channel.

802.11ac VHT20 RF Average Output Power (dBm)											
Power vs. Channel			Average Power vs. Data Rate								
Channel	Frequency (MHz)	MCS Index	Channel	MCS Index							
		MCS0		MCS1	MCS2	MCS3	MCS4	MCS5	MCS6	MCS7	MCS8
Duty Cycle (%)		92.86		86.87	81.25	78.21	71.91	66.23	63.89	61.77	59.59
CH 36	5180	14.64	CH 44	15.65	15.71	15.80	15.86	15.89	15.85	15.80	15.86
CH 44	5220	15.90									
CH 48	5240	15.69									
CH 52	5260	15.70	CH 60	15.70	15.74	15.82	15.80	15.83	15.82	15.77	15.80
CH 60	5300	15.83									
CH 64	5320	14.73									
CH 100	5500	15.53	CH 116	15.78	15.76	15.82	15.82	15.81	15.78	15.73	15.78
CH 116	5580	15.83									
CH 140	5700	14.95									
CH 144*	5720	15.86									

Note: The above Frequency and Channel in "*" were straddle channel.



802.11ac VHT40 RF Average Output Power (dBm)												
Power vs. Channel			Average Power vs. Data Rate									
Channel	Frequency (MHz)	MCS Index	Channel	MCS Index								
		MCS0		MCS1	MCS2	MCS3	MCS4	MCS5	MCS6	MCS7	MCS8	MCS9
Duty Cycle (%)		98.02		96.47	93.41	93.06	90.48	87.50	86.59	85.53	85.29	83.97
CH 38	5190	12.10	CH 46	15.29	15.27	15.26	15.28	15.32	15.30	15.30	15.30	15.27
CH 46	5230	15.33										
CH 54	5270	15.47	CH 54	15.43	15.41	15.40	15.42	15.46	15.44	15.44	15.44	15.41
CH 62	5310	12.00										
CH 102	5510	12.84	CH 110	15.50	15.48	15.47	15.49	15.51	15.49	15.49	15.49	15.46
CH 110	5550	15.53										
CH 134	5670	15.21										
CH 142*	5710	15.27										

Note: The above Frequency and Channel in "*" were straddle channel.

802.11ac VHT80 RF Average Output Power (dBm)												
Power vs. Channel			Average Power vs. Data Rate									
Channel	Frequency (MHz)	MCS Index	Channel	MCS Index								
		MCS0		MCS1	MCS2	MCS3	MCS4	MCS5	MCS6	MCS7	MCS8	MCS9
Duty Cycle (%)		95.95		92.65	89.90	86.91	84.85	82.76	81.48	78.85	77.08	75.56
CH 042	5210	12.08	CH 42	11.95	11.94	12.00	11.92	12.02	11.98	11.99	12.06	12.07
CH 058	5290	11.69	CH 58	11.56	11.55	11.61	11.53	11.63	11.59	11.60	11.67	11.68
CH 106	5530	11.73	CH 122	14.03	14.02	14.08	14.00	14.10	14.06	14.07	14.14	14.15
CH 122	5610	14.16										
CH 138*	5690	14.04										

Note: The above Frequency and Channel in "*" were straddle channel.



<Ant. 2>

802.11a RF Average Output Power (dBm)										
Power vs. Channel			Average Power vs. Data Rate							
Channel	Frequency (MHz)	Data Rate (bps)	Channel	Data Rate (bps)						
		6M		9M	12M	18M	24M	36M	48M	54M
Duty Cycle (%)		92.86		89.72	87.95	81.82	78.39	71.11	66.22	64.29
CH 36	5180	16.22	CH 44	17.58	17.52	17.59	17.54	17.50	17.49	17.48
CH 44	5220	17.61								
CH 48	5240	17.60								
CH 52	5260	17.55	CH 60	17.54	17.49	17.55	17.49	17.43	17.41	17.40
CH 60	5300	17.56								
CH 64	5320	16.43								
CH 100	5500	17.77	CH 100	17.72	17.69	17.67	17.65	17.62	17.60	17.58
CH 116	5580	17.54								
CH 140	5700	17.73								
CH 144*	5720	17.59								

Note: The above Frequency and Channel in "*" were straddle channel.

802.11n HT20 RF Average Output Power (dBm)										
Power vs. Channel			Average Power vs. Data Rate							
Channel	Frequency (MHz)	MCS Index	Channel	MCS Index						
		MCS0		MCS1	MCS2	MCS3	MCS4	MCS5	MCS6	MCS7
Duty Cycle (%)		92.86		86.08	81.25	77.92	70.79	66.67	63.83	62.69
CH 36	5180	16.51	CH 44	17.52	17.30	17.39	17.47	17.38	17.35	17.39
CH 44	5220	17.54								
CH 48	5240	17.38								
CH 52	5260	17.33	CH 60	17.50	17.40	17.45	17.45	17.53	17.43	17.46
CH 60	5300	17.58								
CH 64	5320	16.40								
CH 100	5500	17.32	CH 116	17.32	17.18	17.14	17.12	17.23	17.04	16.94
CH 116	5580	17.54								
CH 140	5700	16.66								
CH 144*	5720	17.48								

Note: The above Frequency and Channel in "*" were straddle channel.



802.11n HT40 RF Average Output Power (dBm)										
Power vs. Channel			Average Power vs. Data Rate							
Channel	Frequency (MHz)	MCS Index	Channel	MCS Index						
		MCS0		MCS1	MCS2	MCS3	MCS4	MCS5	MCS6	MCS7
Duty Cycle (%)		98.01		96.47	94.38	93.62	90.29	87.21	86.25	85.14
CH 38	5190	13.70	CH 46	16.85	16.81	16.76	16.81	16.83	16.80	16.81
CH 46	5230	16.86								
CH 54	5270	17.06	CH 54	17.02	17.03	17.03	17.04	17.03	16.95	16.94
CH 62	5310	13.45								
CH 102	5510	14.96	CH 110	17.10	17.06	17.02	17.02	16.98	16.87	16.83
CH 110	5550	17.11								
CH 134	5670	16.74								
CH 142*	5710	17.05								

Note: The above Frequency and Channel in "*" were straddle channel.

802.11ac VHT20 RF Average Output Power (dBm)											
Power vs. Channel			Average Power vs. Data Rate								
Channel	Frequency (MHz)	MCS Index	Channel	MCS Index							
		MCS0		MCS1	MCS2	MCS3	MCS4	MCS5	MCS6	MCS7	MCS8
Duty Cycle (%)		92.28		86.87	82.29	78.07	71.11	65.79	65.28	62.50	59.52
CH 36	5180	16.57	CH 44	17.64	17.61	17.57	17.60	17.66	17.53	17.65	17.65
CH 44	5220	17.67									
CH 48	5240	17.62									
CH 52	5260	17.46	CH 60	17.60	17.58	17.56	17.57	17.61	17.46	17.52	17.53
CH 60	5300	17.63									
CH 64	5320	16.50									
CH 100	5500	17.37	CH 116	17.52	17.52	17.54	17.50	17.49	17.42	17.45	17.55
CH 116	5580	17.57									
CH 140	5700	16.70									
CH 144*	5720	17.61									

Note: The above Frequency and Channel in "*" were straddle channel.



802.11ac VHT40 RF Average Output Power (dBm)												
Power vs. Channel			Average Power vs. Data Rate									
Channel	Frequency (MHz)	MCS Index	Channel	MCS Index								
		MCS0		MCS1	MCS2	MCS3	MCS4	MCS5	MCS6	MCS7	MCS8	MCS9
Duty Cycle (%)		98.21		95.35	94.44	92.36	90.48	88.64	86.59	85.53	85.29	84.85
CH 38	5190	13.76	CH 46	16.92	16.91	16.92	16.90	16.91	16.89	16.87	16.85	16.82
CH 46	5230	16.93										
CH 54	5270	17.08	CH 54	17.07	17.06	17.04	17.05	17.06	17.04	17.02	17.00	16.95
CH 62	5310	13.61										
CH 102	5510	15.04	CH 110	17.15	17.14	17.15	17.13	17.14	17.13	17.10	17.07	17.05
CH 110	5550	17.16										
CH 134	5670	16.75										
CH 142*	5710	17.15										

Note: The above Frequency and Channel in "*" were straddle channel.

802.11ac VHT80 RF Average Output Power (dBm)												
Power vs. Channel			Average Power vs. Data Rate									
Channel	Frequency (MHz)	MCS Index	Channel	MCS Index								
		MCS0		MCS1	MCS2	MCS3	MCS4	MCS5	MCS6	MCS7	MCS8	MCS9
Duty Cycle (%)		95.05		92.65	90.00	88.10	83.33	82.76	81.48	80.77	77.08	76.34
CH 042	5210	14.03	CH 42	13.94	13.93	13.95	14.00	13.97	13.95	13.90	14.01	13.97
CH 058	5290z	13.14	CH 58	13.05	13.04	13.06	13.11	13.08	13.06	13.01	13.12	13.08
CH 106	5530	13.64	CH 122	16.02	16.01	16.03	16.08	16.05	16.03	15.98	16.09	16.05
CH 122	5610	16.11										
CH 138*	5690	16.18										

Note: The above Frequency and Channel in "*" were straddle channel.



MIMO <Ant. 1+2>

802.11a RF Average Output Power (dBm)										
Power vs. Channel			Average Power vs. Data Rate							
Channel	Frequency (MHz)	Data Rate (bps)	Channel	Data Rate (bps)						
		6M		9M	12M	18M	24M	36M	48M	54M
CH 36	5180	18.46	CH 44	19.84	19.80	19.79	19.78	19.77	19.77	19.78
CH 44	5220	19.89								
CH 48	5240	19.86								
CH 52	5260	19.90	CH 60	19.88	19.86	19.85	19.85	19.84	19.84	19.82
CH 60	5300	19.91								
CH 64	5320	19.21								
CH 100	5500	19.58	CH 116	19.95	19.93	19.92	19.90	19.88	19.86	19.84
CH 116	5580	19.97								
CH 140	5700	19.42								
CH 144*	5720	19.92								

Note: The above Frequency and Channel in "*" were straddle channel.

802.11n HT20 RF Average Output Power (dBm)										
Power vs. Channel			Average Power vs. Data Rate							
Channel	Frequency (MHz)	MCS Index	Channel	MCS Index						
		MCS0		MCS1	MCS2	MCS3	MCS4	MCS5	MCS6	MCS7
CH 36	5180	18.77	CH 44	19.79	19.71	19.78	19.75	19.76	19.72	19.76
CH 44	5220	19.89								
CH 48	5240	19.77								
CH 52	5260	19.71	CH 60	19.60	19.51	19.57	19.59	19.67	19.62	19.68
CH 60	5300	19.86								
CH 64	5320	18.73								
CH 100	5500	19.57	CH 116	19.64	19.50	19.52	19.54	19.60	19.46	19.50
CH 116	5580	19.83								
CH 140	5700	19.02								
CH 144*	5720	19.79								

Note: The above Frequency and Channel in "*" were straddle channel.



802.11n HT40 RF Average Output Power (dBm)										
Power vs. Channel			Average Power vs. Data Rate							
Channel	Frequency (MHz)	MCS Index	Channel	MCS Index						
		MCS0		MCS1	MCS2	MCS3	MCS4	MCS5	MCS6	MCS7
CH 38	5190	16.02	CH 46	19.17	19.14	19.14	19.14	19.13	19.12	19.15
CH 46	5230	19.18								
CH 54	5270	19.41	CH 54	19.40	19.39	19.39	19.32	19.30	19.27	19.31
CH 62	5310	15.90								
CH 102	5510	17.06	CH 110	19.35	19.33	19.26	19.22	19.20	19.12	19.15
CH 110	5550	19.36								
CH 134	5670	19.14								
CH 142*	5710	19.28								

Note: The above Frequency and Channel in "*" were straddle channel.

802.11ac VHT20 RF Average Output Power (dBm)											
Power vs. Channel			Average Power vs. Data Rate								
Channel	Frequency (MHz)	MCS Index	Channel	MCS Index							
		MCS0		MCS1	MCS2	MCS3	MCS4	MCS5	MCS6	MCS7	MCS8
CH 36	5180	18.79	CH 44	19.84	19.80	19.87	19.81	19.80	19.75	19.80	19.80
CH 44	5220	19.91									
CH 48	5240	19.80									
CH 52	5260	19.73	CH 60	19.64	19.59	19.65	19.64	19.71	19.64	19.73	19.73
CH 60	5300	19.90									
CH 64	5320	18.80									
CH 100	5500	19.63	CH 116	19.66	19.57	19.58	19.59	19.64	19.50	19.56	19.65
CH 116	5580	19.85									
CH 140	5700	19.07									
CH 144*	5720	19.92									

Note: The above Frequency and Channel in "*" were straddle channel.



802.11ac VHT40 RF Average Output Power (dBm)												
Power vs. Channel			Average Power vs. Data Rate									
Channel	Frequency (MHz)	MCS Index	Channel	MCS Index								
		MCS0		MCS1	MCS2	MCS3	MCS4	MCS5	MCS6	MCS7	MCS8	MCS9
CH 38	5190	16.10	CH 46	19.32	19.32	19.28	19.25	19.28	19.29	19.31	19.29	19.30
CH 46	5230	19.33										
CH 54	5270	19.50	CH 54	19.49	19.49	19.47	19.42	19.37	19.40	19.43	19.39	19.37
CH 62	5310	15.96										
CH 102	5510	17.14										
CH 110	5550	19.50	CH 110	19.46	19.42	19.35	19.31	19.32	19.28	19.29	19.19	19.20
CH 134	5670	19.17										
CH 142*	5710	19.42										

Note: The above Frequency and Channel in "*" were straddle channel.

802.11ac VHT80 RF Average Output Power (dBm)												
Power vs. Channel			Average Power vs. Data Rate									
Channel	Frequency (MHz)	MCS Index	Channel	MCS Index								
		MCS0		MCS1	MCS2	MCS3	MCS4	MCS5	MCS6	MCS7	MCS8	MCS9
CH 42	5210	16.26	CH 42	16.24	16.21	16.23	16.21	16.25	16.23	16.24	16.20	16.19
CH 58	5290	15.58	CH 58	15.56	15.53	15.54	15.55	15.56	15.55	15.57	15.54	15.51
CH 106	5530	15.91	CH 122	18.32	18.29	18.29	18.29	18.34	18.31	18.31	18.30	18.25
CH 122	5610	18.34										
CH 138*	5690	18.31										

Note:

1. The above Frequency and Channel in "*" were straddle channel.
2. MIMO Ant. 1+2 is a calculated result from sum of the power MIMO Ant. 1 and MIMO Ant. 2.



<TXBF Modes>

MIMO <Ant. 1+2>

802.11n HT20 RF Average Output Power (dBm)										
Power vs. Channel			Average Power vs. Data Rate							
Channel	Frequency (MHz)	MCS Index	Channel	MCS Index						
		MCS0		MCS1	MCS2	MCS3	MCS4	MCS5	MCS6	MCS7
CH 36	5180	18.42	CH 44	19.60	19.56	19.50	19.52	19.59	19.62	19.60
CH 44	5220	19.66								
CH 48	5240	19.58								
CH 52	5260	19.60	CH 52	19.56	19.50	19.54	19.44	19.46	19.56	19.52
CH 60	5300	19.56								
CH 64	5320	18.66								
CH 100	5500	19.48	CH 116	19.52	19.51	19.52	19.46	19.49	19.45	19.51
CH 116	5580	19.55								
CH 140	5700	18.96								
CH 144*	5720	19.66								

Note: The above Frequency and Channel in "*" were straddle channel.

802.11n HT40 RF Average Output Power (dBm)										
Power vs. Channel			Power vs. Data Rate							
Channel	Frequency (MHz)	MCS Index	Channel	MCS Index						
		MCS0		MCS1	MCS2	MCS3	MCS4	MCS5	MCS6	MCS7
CH 38	5190	15.92	CH 46	19.14	19.10	19.16	19.12	19.10	19.06	19.04
CH 46	5230	19.30								
CH 54	5270	19.20	CH 54	19.20	19.20	19.18	19.10	19.12	19.10	19.00
CH 62	5310	15.82								
CH 102	5510	17.00	CH 110	19.29	19.25	19.22	19.22	19.20	19.26	19.22
CH 110	5550	19.32								
CH 134	5670	18.99								
CH 142*	5710	19.33								

Note: The above Frequency and Channel in "*" were straddle channel.



802.11ac VHT20 RF Average Output Power (dBm)											
Power vs. Channel			Average Power vs. Data Rate								
Channel	Frequency (MHz)	MCS Index	Channel	MCS Index							
		MCS0		MCS1	MCS2	MCS3	MCS4	MCS5	MCS6	MCS7	MCS8
CH 36	5180	18.68	CH 44	19.76	19.72	19.66	19.69	19.75	19.79	19.76	19.79
CH 44	5220	19.82									
CH 48	5240	19.74									
CH 52	5260	19.70	CH 52	19.66	19.60	19.64	19.54	19.56	19.66	19.62	19.52
CH 60	5300	19.66									
CH 64	5320	18.76									
CH 100	5500	19.62	CH 116	19.66	19.69	19.66	19.64	19.66	19.62	19.69	19.66
CH 116	5580	19.72									
CH 140	5700	19.06									
CH 144*	5720	19.76									

Note: The above Frequency and Channel in "*" were straddle channel.

802.11ac VHT40 RF Average Output Power (dBm)												
Power vs. Channel			Average Power vs. Data Rate									
Channel	Frequency (MHz)	MCS Index	Channel	MCS Index								
		MCS0		MCS1	MCS2	MCS3	MCS4	MCS5	MCS6	MCS7	MCS8	MCS9
CH 38	5190	16.07	CH 46	19.24	19.20	19.26	19.22	19.20	19.16	19.14	19.24	19.26
CH 46	5230	19.30										
CH 54	5270	19.30	CH 54	19.26	19.26	19.24	19.20	19.22	19.20	19.10	19.20	19.24
CH 62	5310	15.92										
CH 102	5510	17.10	CH 110	19.42	19.39	19.36	19.36	19.34	19.40	19.36	19.39	19.32
CH 110	5550	19.46										
CH 134	5670	19.09										
CH 142*	5710	19.46										

Note: The above Frequency and Channel in "*" were straddle channel.



802.11ac VHT80 RF Average Output Power (dBm)												
Power vs. Channel			Average Power vs. Data Rate									
Channel	Frequency (MHz)	MCS Index	Channel	MCS Index								
		MCS0		MCS1	MCS2	MCS3	MCS4	MCS5	MCS6	MCS7	MCS8	MCS9
CH 42	5210	16.25	CH 42	16.19	16.21	16.21	16.11	16.09	16.19	16.15	16.17	16.09
CH 58	5290	15.32	CH 58	15.26	15.22	15.29	15.26	15.12	15.29	15.22	15.20	15.16
CH 106	5530	15.79	CH 122									
CH 122	5610	18.30										
CH 138*	5690	18.23										

Note:

1. The above Frequency and Channel in "*" were straddle channel.
2. MIMO Ant. 1+2 is a calculated result from sum of the power MIMO Ant. 1 and MIMO Ant. 2.



2.3 Test Mode

Final test mode of conducted test items and radiated spurious emissions are considering the modulation and worse data rates from the power table described in section 2.2.

Single Antenna

Modulation	Data Rate
802.11a	6 Mbps
802.11n HT20	MCS0
802.11n HT40	MCS0
802.11ac VHT20	MCS0
802.11ac VHT40	MCS0
802.11ac VHT80	MCS0

MIMO Antenna

Modulation	Data Rate
802.11a	6 Mbps
802.11n HT20	MCS0
802.11n HT40	MCS0
802.11ac VHT20	MCS0
802.11ac VHT40	MCS0
802.11ac VHT80	MCS0

Test Cases	
AC Conducted Emission	<p>Mode 1 : WLAN (5GHz) Link + Bluetooth Link + NFC Link + AC Adapter + Charging Only Cable + Earphone 1 with Audio Adapter connect to EUT</p> <p>Mode 2 : WLAN (5GHz) Link + Bluetooth Link with Earphone 3 + NFC Link + AC Adapter + Snap on USB Cable (Data Link with Notebook) + Copy Data from Notebook to EDA (SD Card)</p> <p>Mode 3 : WLAN (5GHz) Link + Bluetooth Link + NFC Link + AC Adapter + Charging Only Cable + Earphone 2 with Audio Adapter connect to EUT</p>



Ch. #		Band I : 5150-5250 MHz	Band II : 5250-5350 MHz	Band III : 5470-5725MHz
		802.11a	802.11a	802.11a
L	Low	36	52	100
M	Middle	44	60	116
H	High	48	64	140
Straddle				144

Ch. #		Band I : 5150-5250 MHz	Band II : 5250-5350 MHz	Band III : 5470-5725MHz
		802.11n HT20	802.11n HT20	802.11n HT20
L	Low	36	52	100
M	Middle	44	60	116
H	High	48	64	140
Straddle				144

Ch. #		Band I : 5150-5250 MHz	Band II : 5250-5350 MHz	Band III : 5470-5725MHz
		802.11n HT40	802.11n HT40	802.11n HT40
L	Low	38	54	102
M	Middle	-	-	110
H	High	46	62	134
Straddle				142



Ch. #		Band I : 5150-5250 MHz	Band II : 5250-5350 MHz	Band III : 5470-5725MHz
		802.11ac VHT20	802.11ac VHT20	802.11ac VHT20
L	Low	36	52	100
M	Middle	44	60	116
H	High	48	64	140
Straddle				144

Ch. #		Band I : 5150-5250 MHz	Band II : 5250-5350 MHz	Band III : 5470-5725MHz
		802.11ac VHT40	802.11ac VHT40	802.11ac VHT40
L	Low	38	54	102
M	Middle	-	-	110
H	High	46	62	134
Straddle				142

Ch. #		Band I : 5150-5250 MHz	Band II : 5250-5350 MHz	Band III : 5470-5725MHz
		802.11ac VHT80	802.11ac VHT80	802.11ac VHT80
L	Low	-	-	-
M	Middle	42	58	106
H	High	-	-	-
Straddle				138

2.4 Connection Diagram of Test System

<WLAN Tx CDD Mode>

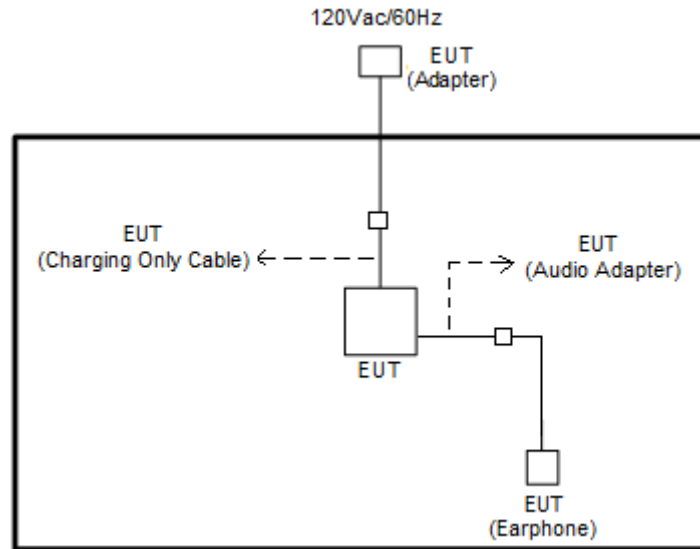

<WLAN Tx TXBF Mode>

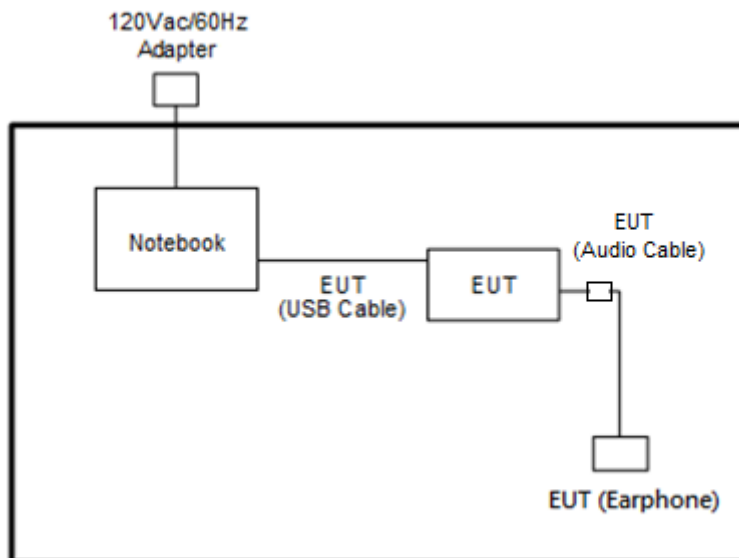

<AC Conducted Emission Mode>

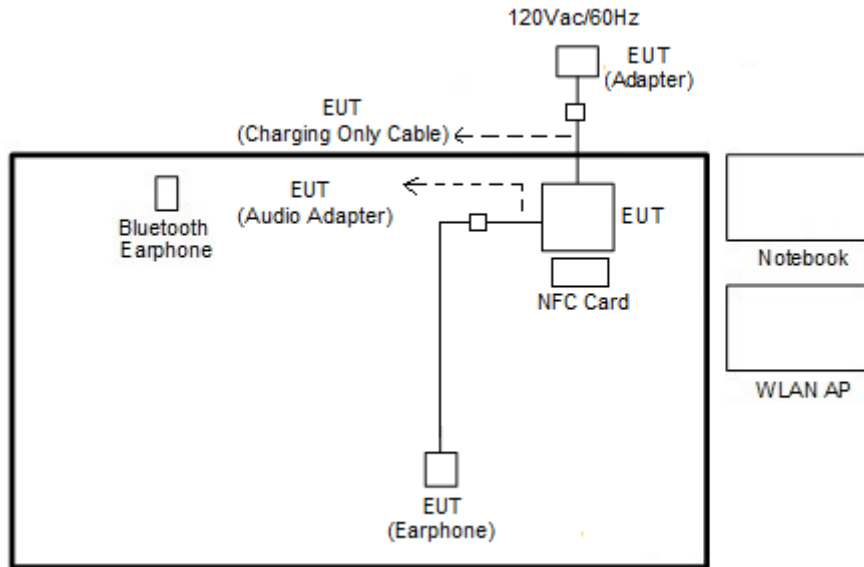

2.5 Support Unit used in test configuration and system

Item	Equipment	Trade Name	Model Name	FCC ID	Data Cable	Power Cord
1.	Bluetooth Earphone	Sony Ericsson	MW600	PY7DDA-2029	N/A	N/A
2.	WLAN AP	D-Link	DIR-628	KA2DIR628A2	N/A	Unshielded, 1.8 m
3.	Notebook	DELL	Latitude E6320	FCC DoC/ Contains FCC ID: QDS-BRCM1054	N/A	AC I/P: Unshielded, 1.2 m DC O/P: Shielded, 1.8 m
4.	Notebook	DELL	P20G	FCC DoC/ Contains FCC ID: QDS-BRCM1051	N/A	AC I/P: Unshielded, 1.2 m DC O/P: Shielded, 1.8 m
5.	iPod Earphone	Apple	N/A	Verification	Unshielded, 1.0 m	N/A
6.	SD Card	SanDisk	MicroSD HC	FCC DoC	N/A	N/A
7.	NFC Card	Metro Taipei	Easy Card	N/A	N/A	N/A



2.6 EUT Operation Test Setup

For WLAN CDD modes, programmed RF utility, "CMD" installed in the notebook make the EUT provide functions like channel selection and power level for continuous transmitting and receiving signals.

For WLAN MIMO TXBF modes, the EUT was tested under normal operation and link to another device with power, modulation modes and data rates controlled by engineer mode command lines. The CMD software tool was used to make EUT continuous transmitting signals.



2.7 Measurement Results Explanation Example

For all conducted test items:

The offset level is set in the spectrum analyzer to compensate the RF cable loss and attenuator factor between EUT conducted output port and spectrum analyzer. With the offset compensation, the spectrum analyzer reading level is exactly the EUT RF output level.

Example :

The spectrum analyzer offset is derived from RF cable loss and attenuator factor.

Offset = RF cable loss + attenuator factor.

Following shows an offset computation example with cable loss 4.2 dB and 10dB attenuator.

$$\begin{aligned} \text{Offset(dB)} &= \text{RF cable loss(dB)} + \text{attenuator factor(dB)}. \\ &= 4.2 + 10 = 14.2 \text{ (dB)} \end{aligned}$$

3 Test Result

3.1 26dB & 99% Occupied Bandwidth Measurement

3.1.1 Description of 26dB & 99% Occupied Bandwidth

This section is for reporting purpose only.

There is no restriction limits for bandwidth.

For Straddle Channel, U-NII procedures and limits were applied for operations in the frequency band in accordance with FCC KDB 644545 D03.

3.1.2 Measuring Instruments

The measuring equipment is listed in the section 4 of this test report.

3.1.3 Test Procedures

1. The testing follows FCC KDB 789033 D02 General UNII Test Procedures New Rules v01r03. Section C) Emission bandwidth
2. Set RBW = approximately 1% of the emission bandwidth.
3. Set the VBW > RBW.
4. Detector = Peak.
5. Trace mode = max hold
6. Measure the maximum width of the emission that is 26 dB down from the peak of the emission. Compare this with the RBW setting of the analyzer. Readjust RBW and repeat measurement as needed until the RBW/EBW ratio is approximately 1%.
7. For 99% Bandwidth Measurement, the spectrum analyzer's resolution bandwidth (RBW) is set 1MHz and set the Video bandwidth (VBW) $\geq 3 * RBW$.
8. Measure and record the results in the test report.

3.1.4 Test Setup

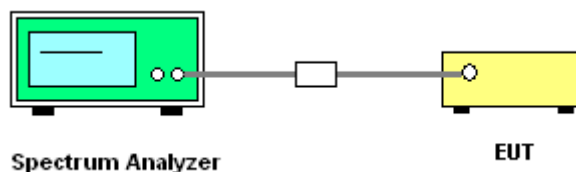

3.1.5 Test Result of 26dB & 99% Occupied Bandwidth

Please refer to Appendix A.



<CDD Modes>

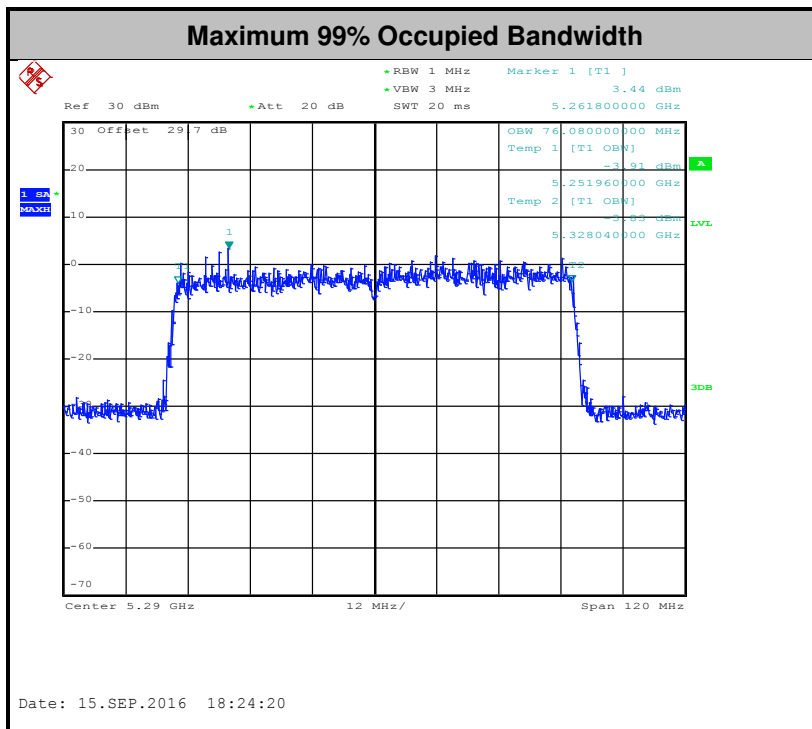
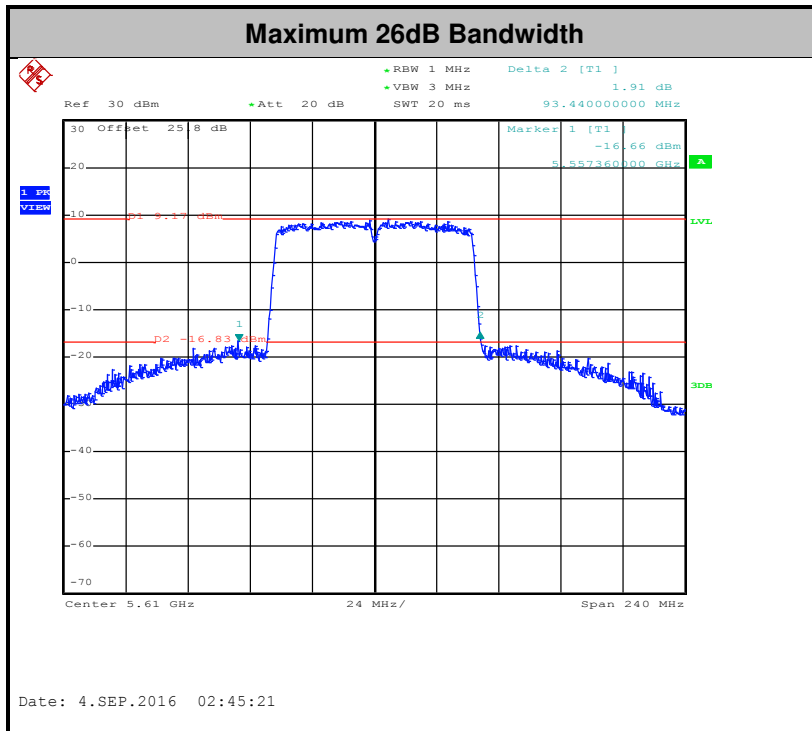

Note: The occupied channel bandwidth is maintained within the band of operation for all of the modulations.



<TXBF Modes>

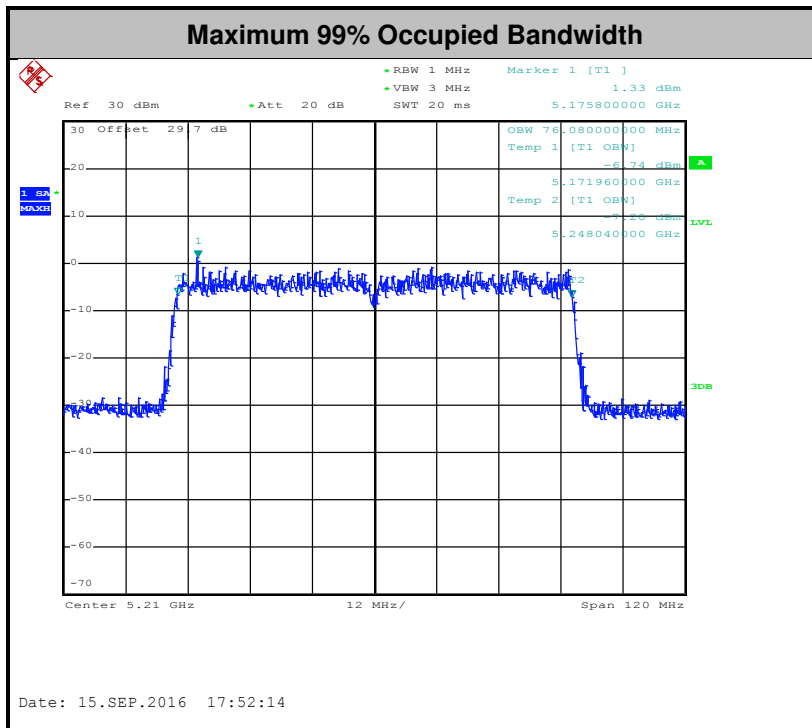
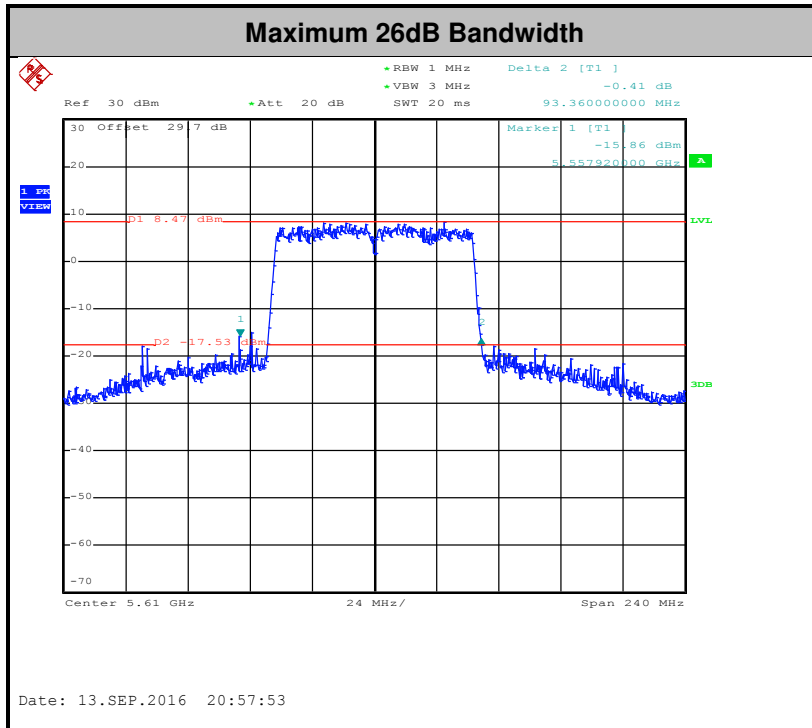

Note: The occupied channel bandwidth is maintained within the band of operation for all of the modulations.



3.2 Maximum Conducted Output Power Measurement

3.2.1 Limit of Maximum Conducted Output Power

<FCC 14-30 CFR 15.407>

For mobile and portable client devices in the 5.15–5.25 GHz band, the maximum conducted output power over the frequency band of operation shall not exceed 250 mW.

For the 5.25–5.725 GHz bands, the maximum conducted output power over the frequency bands of operation shall not exceed the lesser of 250 mW or $11 \text{ dBm} + 10 \log B$, where B is the 26 dB emission bandwidth in megahertz.

For Straddle Channel, U-NII procedures and limits were applied for operations in the frequency band in accordance with FCC KDB 644545 D03.

If transmitting antennas of directional gain greater than 6 dBi are used, the peak output power shall be reduced by the amount in dB that the directional gain of the antenna exceeds 6 dBi.

Note that U-NII-2 band, devices with a maximum e.i.r.p. greater than 500 mW shall implement TPC in order to have the capability to operate at least 6 dB below the maximum permitted e.i.r.p. of 1 W.

3.2.2 Measuring Instruments

The measuring equipment is listed in the section 4 of this test report.



3.2.3 Test Procedures

CDD modes

The testing follows Method PM of FCC KDB 789033 D02 General UNII Test Procedures New Rules v01r03 for CDD modes.

Method PM (Measurement using an RF average power meter):

1. Measurement is performed using a wideband RF power meter.
2. The EUT is configured to transmit continuously with a consistent duty cycle at its maximum power control level.
3. Measure the average power of the transmitter, and the average power is corrected with duty factor, $10 \log(1/x)$, where x is the duty cycle.

TXBF modes

The testing follows Method PM-G of FCC KDB 789033 D02 General UNII Test Procedures New Rules v01r03 for TXBF modes.

Method PM-G (Measurement using a gated RF average power meter):

1. Measurement is performed using a wideband RF power meter.
2. The EUT is configured to transmit at its maximum power control level.
3. Measure the average power of the transmitter
4. Since the measurement is made only during the ON time of the transmitter, no duty cycle correction factor is required.

For straddle channel, the testing follows Method SA-3 (RMS detection with max hold) of FCC KDB 789033 D02 General UNII Test Procedures New Rules v01r03.

Compute power by integrating the spectrum across the 99% occupied bandwidth of the signal using the instrument's band power measurement function.

3.2.4 Test Setup

For normal channel:

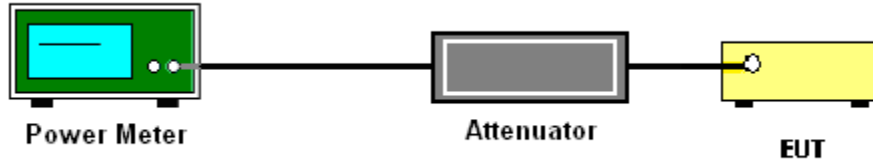

For straddle channel:

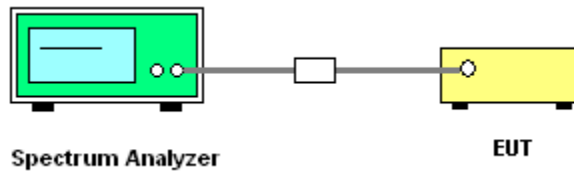



3.2.5 Test Result of Maximum Conducted Output Power

Please refer to Appendix A.

<CDD Modes>

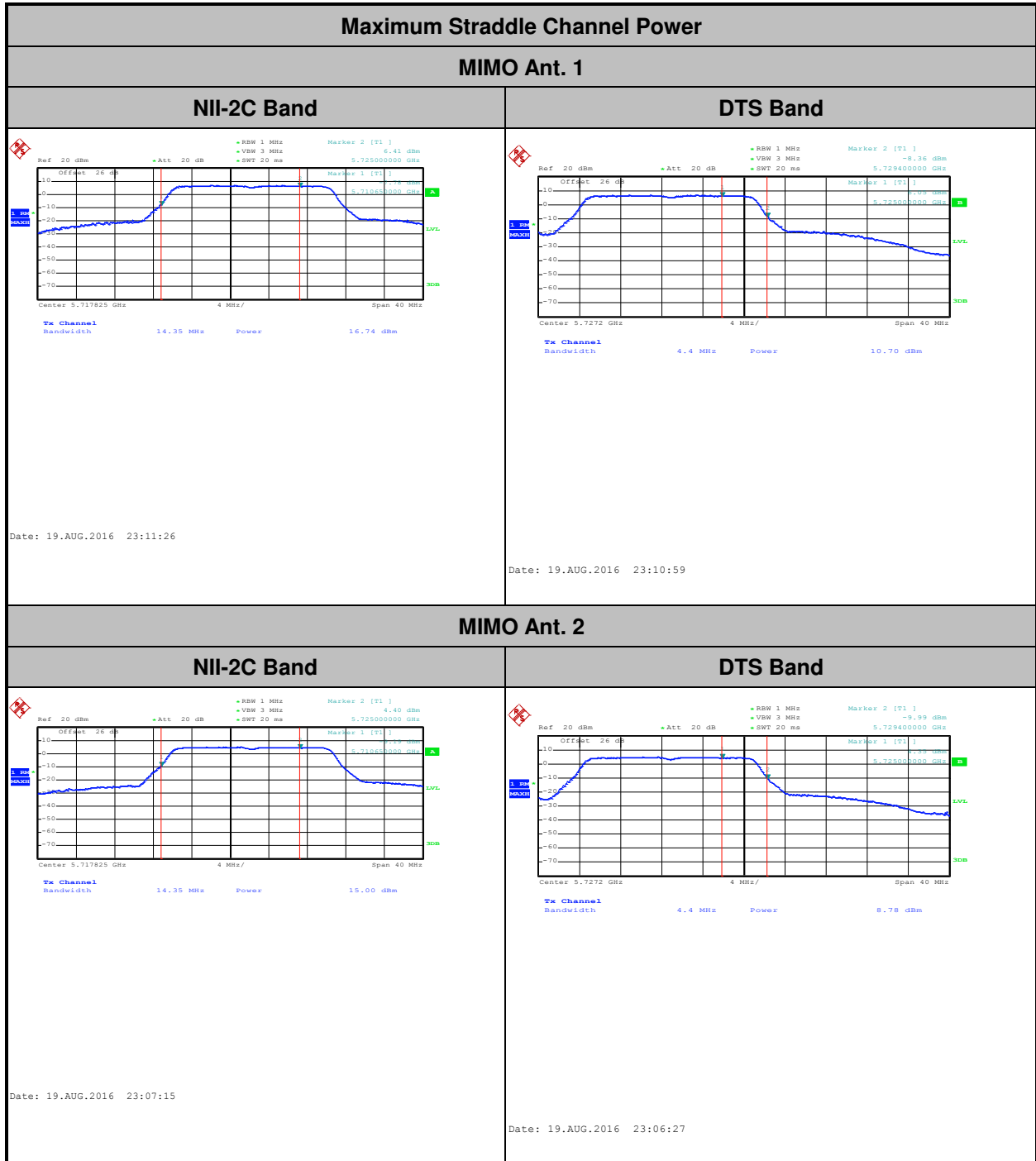



<TXBF Modes>

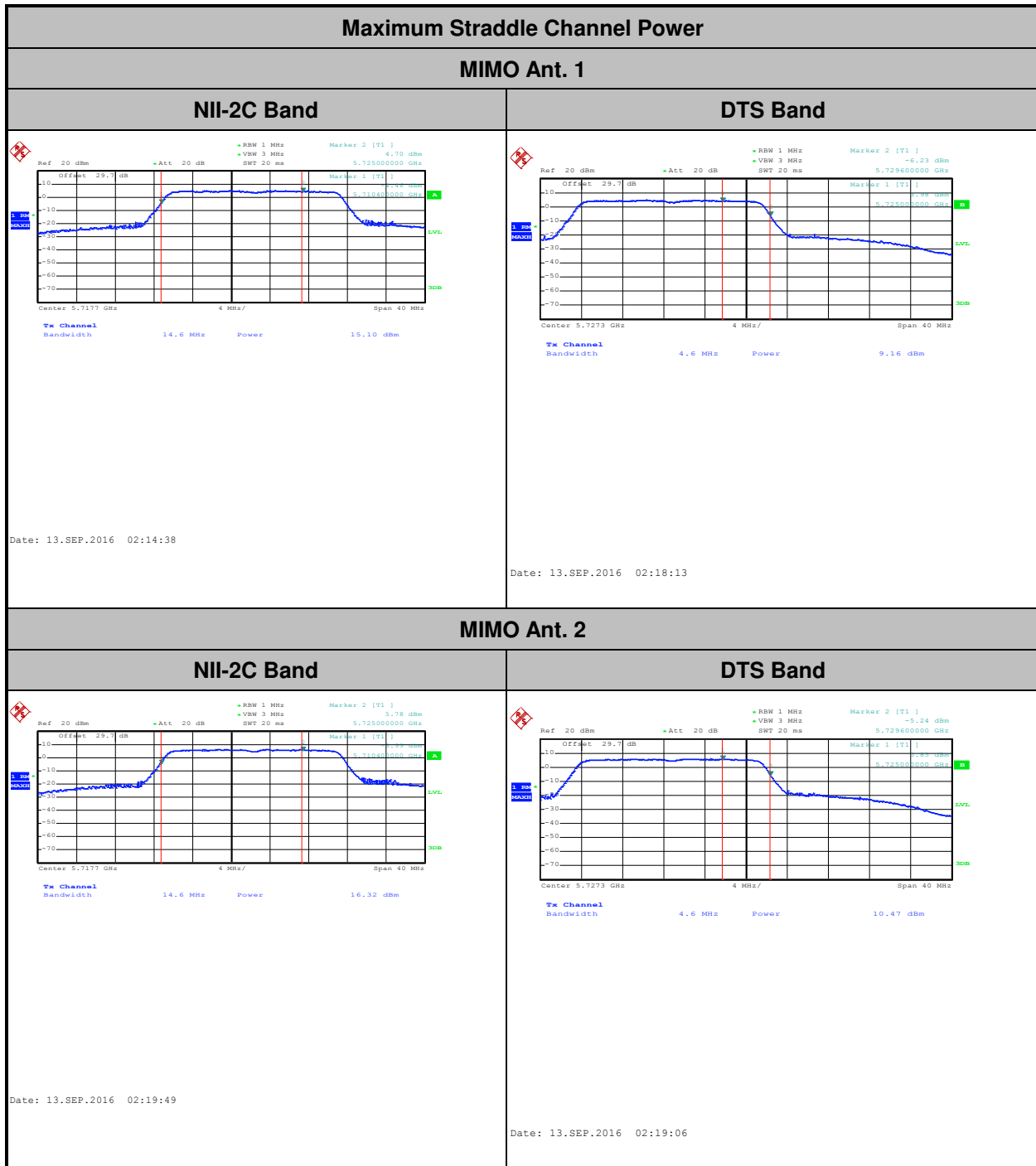



3.3 Power Spectral Density Measurement

3.3.1 Limit of Power Spectral Density

<FCC 14-30 CFR 15.407>

For mobile and portable client devices in the 5.15–5.25 GHz band, the maximum power spectral density shall not exceed 11dBm in any 1 megahertz band.

For the 5.25–5.725 GHz bands, the maximum power spectral density shall not exceed 11 dBm in any 1 megahertz band.

For Straddle Channel, U-NII procedures and limits were applied for operations in the frequency band in accordance with FCC KDB 644545 D03.

If transmitting antennas of directional gain greater than 6 dBi are used, the peak output power shall be reduced by the amount in dB that the directional gain of the antenna exceeds 6 dBi.

3.3.2 Measuring Instruments

The measuring equipment is listed in the section 4 of this test report.



3.3.3 Test Procedures

The testing follows FCC KDB 789033 D02 General UNII Test Procedures New Rules v01r03.
Section F) Maximum power spectral density.

CDD modes

Method SA-2

(trace averaging across on and off times of the EUT transmissions, followed by duty cycle correction).

- Measure the duty cycle.
- Set span to encompass the entire emission bandwidth (EBW) of the signal.
- Set RBW = 1 MHz.
- Set VBW \geq 3 MHz.
- Number of points in sweep \geq 2 Span / RBW.
- Sweep time = auto.
- Detector = RMS
- Trace average at least 100 traces in power averaging mode.
- Add $10 \log(1/x)$, where x is the duty cycle, to the measured power in order to compute the average power during the actual transmission times. For example, add $10 \log(1/0.25) = 6$ dB if the duty cycle is 25 percent.

TXBF modes

Method SA-3

(power averaging (rms) detection with max hold):

- Set span to encompass the entire emission bandwidth (EBW) of the signal.
- Set RBW = 1 MHz.
- Set VBW \geq 3 MHz
- Number of points in sweep \geq 2 Span / RBW.
- Sweep time \leq (number of points in sweep) \times T, when duty cycle is less than 98 percent where T is the minimum transmission duration over which the transmitter is on and is transmitting at its maximum power control level for the tested mode of operation.
- Detector = power averaging (rms).
- Trace mode = max hold.
- Allow max hold to run for at least 60 seconds, or longer as needed to allow the trace to stabilize.

1. The RF output of EUT was connected to the spectrum analyzer by a low loss cable.
2. Each plot has already offset with cable loss, and attenuator loss. Measure the PPSD and record it.
3. For MIMO mode, calculation method follows FCC KDB 662911 D01 Multiple Transmitter Output v02r01.

Method (a): Measure and sum the spectra across the outputs.

The total final Power Spectral Density is from a device with 2 transmitter outputs. The spectrum measurements of the individual outputs are all performed with the same span and number of points, the spectrum value in the first spectral bin of output 1 is summed with that in the first spectral bin of output 2 to obtain the value for the first frequency bin of the summed spectrum.

3.3.4 Test Setup

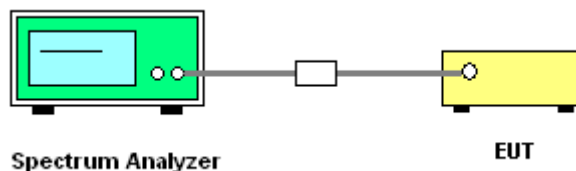

3.3.5 Test Result of Power Spectral Density

Please refer to Appendix A.



<CDD Modes>

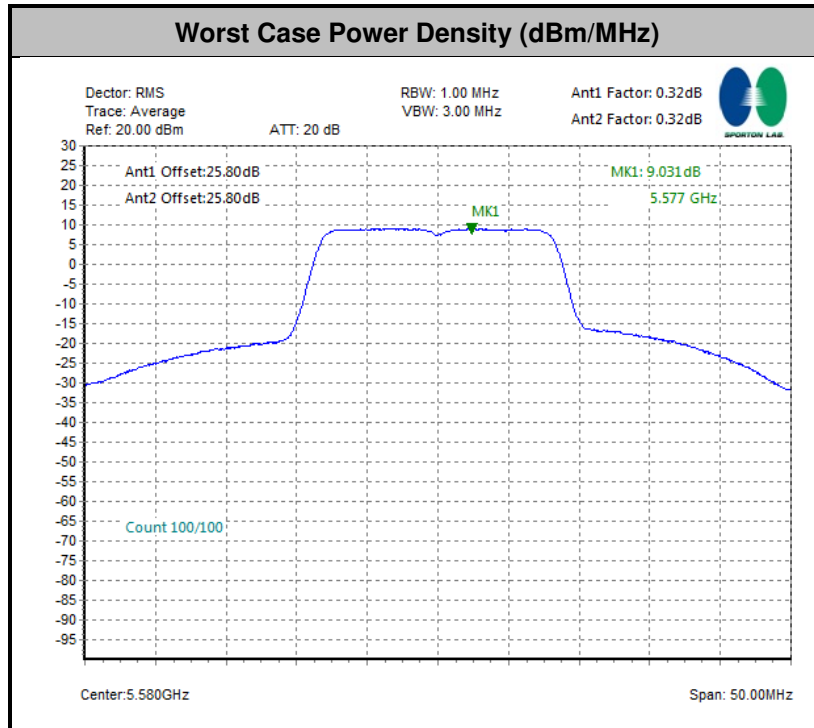

Note: Average Power Density (dB) = Measured value+ Duty Factor

<TXBF Modes>

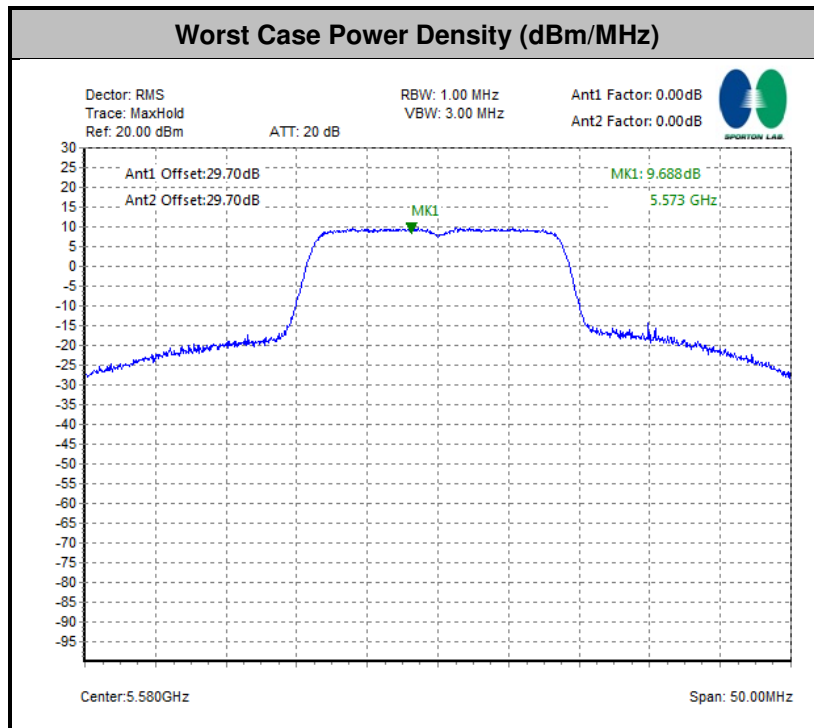



3.4 Unwanted Emissions Measurement

This section as specified in FCC Part 15.407(b) is to measure unwanted emissions through radiated measurement for band edge spurious emissions and out of band emissions measurement. The unwanted emissions shall comply with 15.407(b)(1) to (6), and restricted bands per FCC Part15.205.

3.4.1 Limit of Unwanted Emissions

- (1) For transmitters operating in the 5150-5250 MHz band: all emissions outside of the 5150-5350 MHz band shall not exceed an EIRP of -27dBm/MHz.

For transmitters operating in the 5250-5350 MHz band: all emissions outside of the 5150-5350 MHz band shall not exceed an EIRP of -27 dBm/MHz. Devices operating in the 5250-5350 MHz band that generate emissions in the 5150-5250 MHz band must meet all applicable technical requirements for operation in the 5150-5250 MHz band (including indoor use) or alternatively meet an out-of-band emission EIRP limit of -27 dBm/MHz in the 5150-5250 MHz band.

For transmitters operating in the 5470-5600 MHz and 5650-5725MHz band: all emissions outside of the 5470-5600 MHz and 5650-5725MHz band shall not exceed an EIRP of -27 dBm/MHz.

- (2) Unwanted spurious emissions fallen in restricted bands per FCC Part15.205 shall comply with the general field strength limits set forth in § 15.209 as below table,

Frequency (MHz)	Field Strength (microvolts/meter)	Measurement Distance (meters)
0.009 – 0.490	2400/F(kHz)	300
0.490 – 1.705	24000/F(kHz)	30
1.705 – 30.0	30	30
30 – 88	100	3
88 – 216	150	3
216 - 960	200	3
Above 960	500	3

Note: The following formula is used to convert the EIRP to field strength.

$$E = \frac{1000000\sqrt{30P}}{3} \mu\text{V/m, where P is the eirp (Watts)}$$



EIRP (dBm)	Field Strength at 3m (dBµV/m)
-17	78.3
- 27	68.3

(3) KDB789033 D02 v01r03 G)2)c) As specified in 15.407(b), emissions above 1000 MHz that are outside of the restricted bands are subject to a peak emission limit of -27 dBm/MHz (or -17 dBm/MHz as specified in 15.407(b)(4)). However, an out-of-band emission that complies with both the average and peak limits of 15.209 is not required to satisfy the -27 dBm/MHz or -17 dBm/MHz peak emission limit.

3.4.2 Measuring Instruments

The measuring equipment is listed in the section 4 of this test report.

3.4.3 Test Procedures

1. The testing follows FCC KDB 789033 D02 General UNII Test Procedures New Rules v01r03. Section G) Unwanted emissions measurement.

(1) Procedure for Unwanted Emissions Measurements Below 1000MHz

- RBW = 120 kHz
- VBW = 300 kHz
- Detector = Peak
- Trace mode = max hold

(2) Procedure for Peak Unwanted Emissions Measurements Above 1000 MHz

- RBW = 1 MHz
- VBW ≥ 3 MHz
- Detector = Peak
- Sweep time = auto
- Trace mode = max hold

(3) Procedures for Average Unwanted Emissions Measurements Above 1000MHz

- RBW = 1 MHz
- VBW = 10 Hz, when duty cycle is no less than 98 percent.
- VBW ≥ 1/T, when duty cycle is less than 98 percent where T is the minimum transmission duration over which the transmitter is on and is transmitting at its maximum power control level for the tested mode of operation.



2. The EUT was placed on a turntable with 0.8 meter for frequency below 1GHz and 1.5 meter for frequency above 1GHz respectively above ground.
3. The EUT was set 3 meters from the interference receiving antenna which was mounted on the top of a variable height antenna tower.
4. The antenna is a broadband antenna and its height is adjusted between one meter and four meters above ground to find the maximum value of the field strength for both horizontal polarization and vertical polarization of the antenna.
5. For each suspected emission, the EUT was arranged to its worst case and then adjust the antenna tower (from 1 m to 4 m) and turntable (from 0 degree to 360 degrees) to find the maximum reading.
6. For testing below 1GHz, if the emission level of the EUT in peak mode was 3 dB lower than the limit specified, then peak values of EUT will be reported, otherwise, the emissions will be repeated one by one using the CISPR quasi-peak method and reported.
7. For testing above 1GHz, the emission level of the EUT in peak mode was 20dB lower than average limit (that means the emission level in average mode also complies with the limit in average mode), then peak values of EUT will be reported, otherwise, the emissions will be measured in average mode again and reported.

3.4.4 Test Setup

For radiated emissions below 30MHz

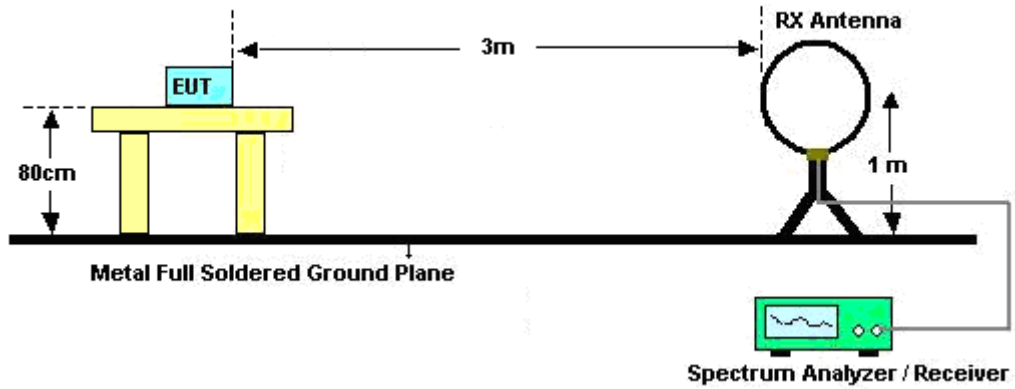

For radiated emissions from 30MHz to 1GHz

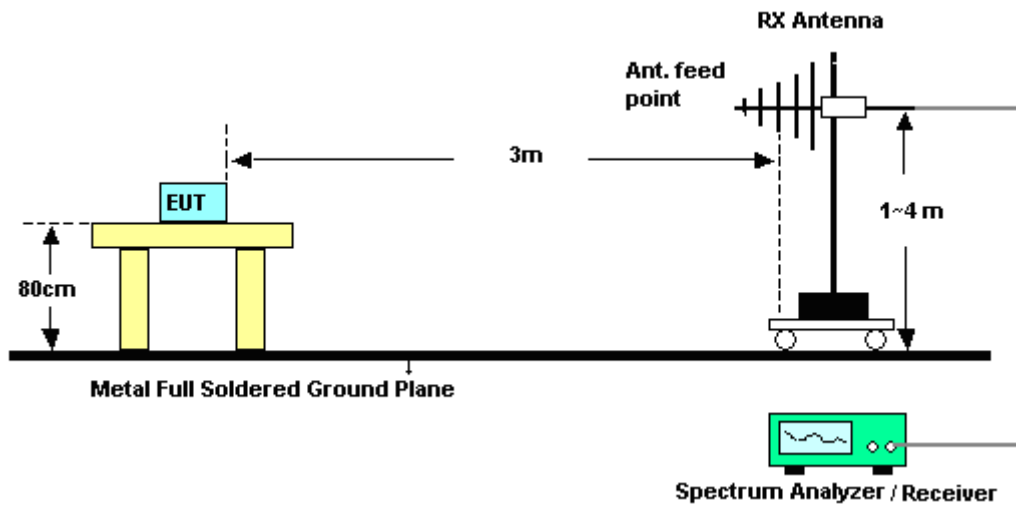

For radiated emissions above 1GHz

CDD modes

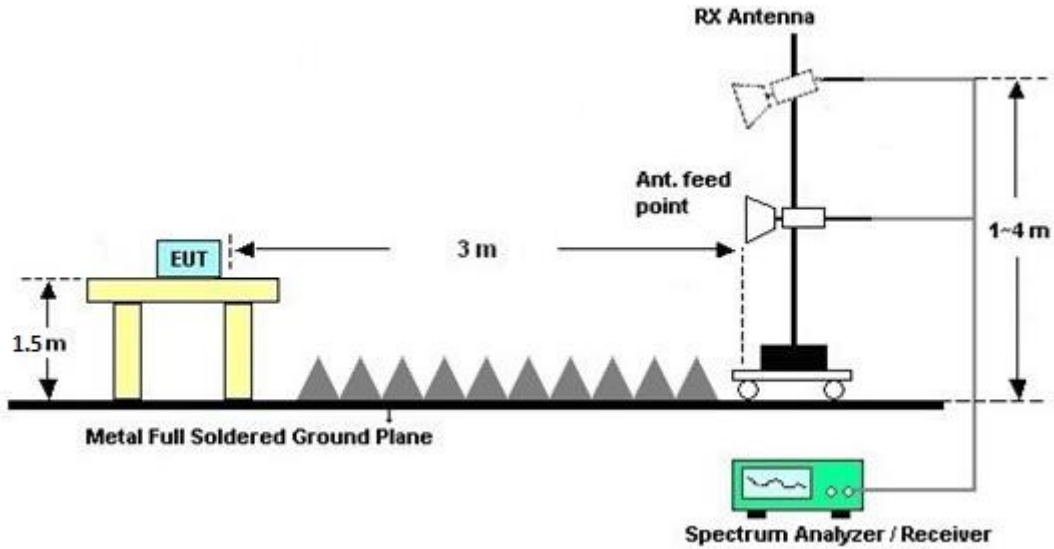

TXBF mode

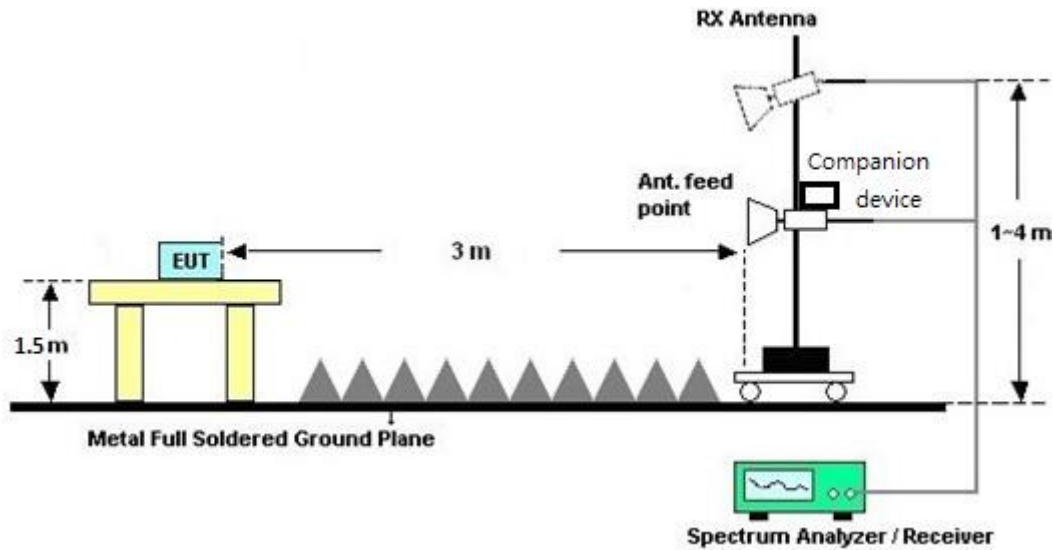



3.4.5 Test Results of Radiated Spurious Emissions (9 kHz ~ 30 MHz)

The low frequency, which started from 9 kHz to 30MHz, was pre-scanned and the result which was 20dB lower than the limit line per 15.31(o) was not reported.

3.4.6 Test Result of Radiated Spurious at Band Edges

Please refer to Appendix B and C.

3.4.7 Duty Cycle

Please refer to Appendix D.

3.4.8 Test Result of Radiated Spurious Emissions (30MHz ~ 10th Harmonic)

Please refer to Appendix B and C.



3.5 AC Conducted Emission Measurement

3.5.1 Limit of AC Conducted Emission

For equipment that is designed to be connected to the public utility (AC) power line, the radio frequency voltage that is conducted back onto the AC power line on any frequency or frequencies within the band 150 kHz to 30 MHz shall not exceed the limits in the following table.

Frequency of emission (MHz)	Conducted limit (dBµV)	
	Quasi-peak	Average
0.15-0.5	66 to 56*	56 to 46*
0.5-5	56	46
5-30	60	50

*Decreases with the logarithm of the frequency.

For terminal test result, the testing follows FCC KDB 174176.

3.5.2 Measuring Instruments

The measuring equipment is listed in the section 4 of this test report.

3.5.3 Test Procedures

1. The EUT was placed 0.4 meter from the conducting wall of the shielding room was kept at least 80 centimeters from any other grounded conducting surface.
2. Connect EUT to the power mains through a line impedance stabilization network (LISN).
3. All the support units are connecting to the other LISN.
4. The LISN provides 50 ohm coupling impedance for the measuring instrument.
5. The FCC states that a 50 ohm, 50 microhenry LISN should be used.
6. Both sides of AC line were checked for maximum conducted interference.
7. The frequency range from 150 kHz to 30 MHz was searched.
8. Set the test-receiver system to Peak Detect Function and specified bandwidth with Maximum Hold Mode.

3.5.4 Test Setup

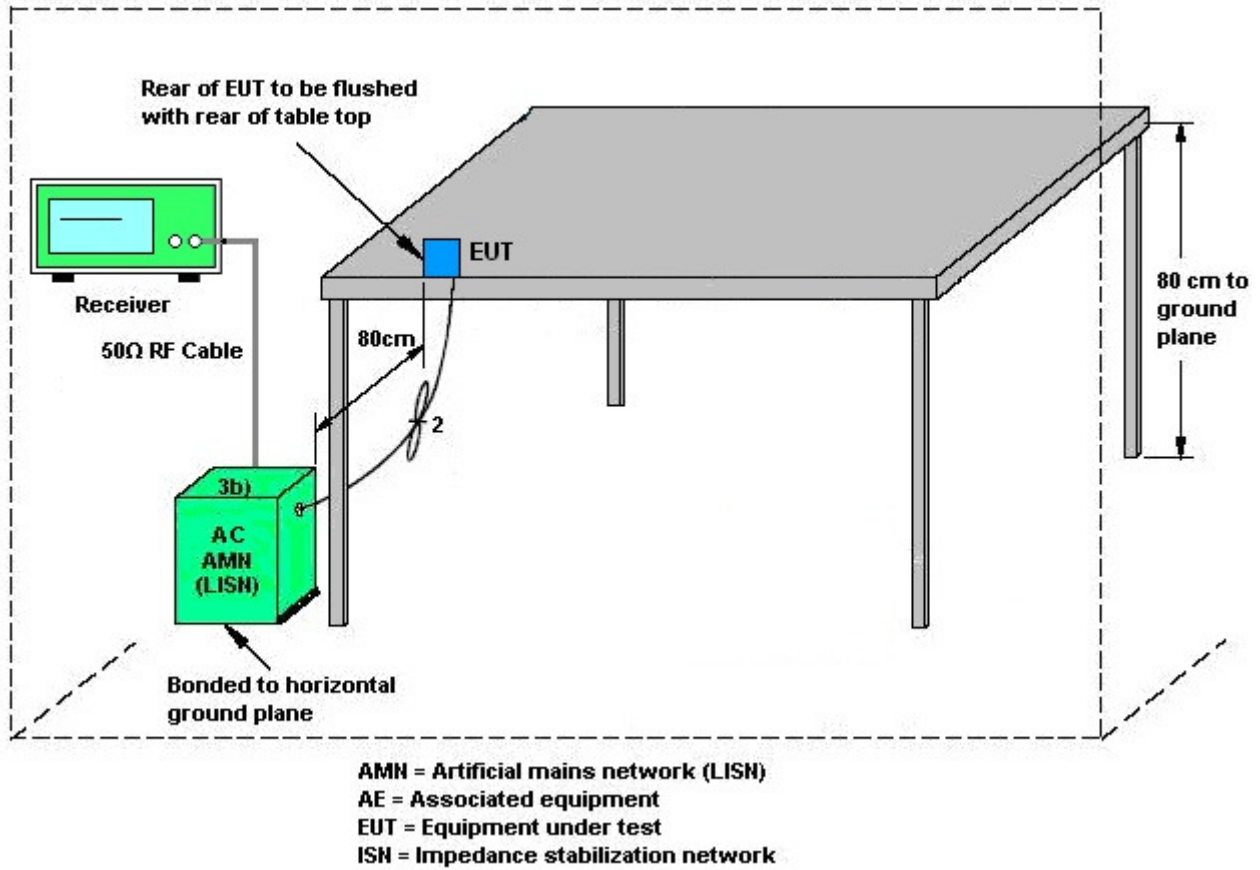



3.5.5 Test Result of AC Conducted Emission

<Original Test Result>

Test Mode :	Mode 1	Temperature :	22~24°C
Test Engineer :	Arthur Hsieh	Relative Humidity :	51~53%
Test Voltage :	120Vac / 60Hz	Phase :	Line
Function Type :	WLAN (5GHz) Link + Bluetooth Link + NFC Link + AC Adapter + Charging Only Cable + Earphone 1 with Audio Adapter connect to EUT		

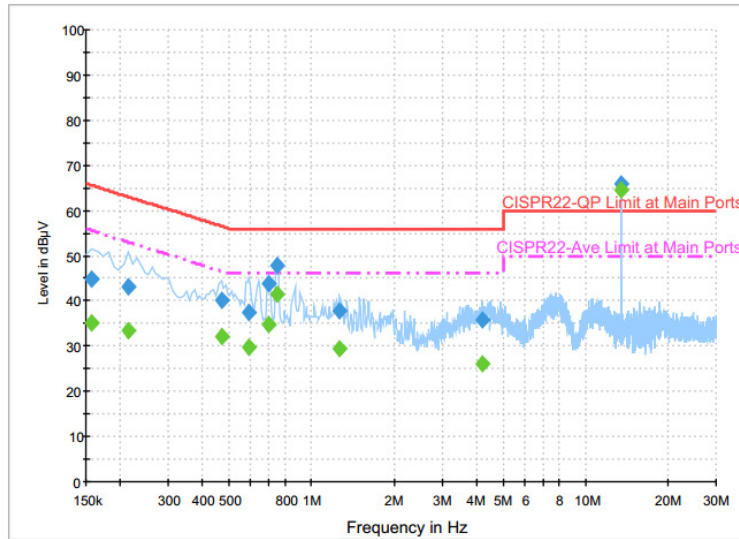

Final Result : QuasiPeak

Frequency (MHz)	QuasiPeak (dBµV)	Filter	Line	Corr. (dB)	Margin (dB)	Limit (dBµV)
0.158000	44.7	Off	L1	19.6	20.9	65.6
0.214000	43.3	Off	L1	19.6	19.7	63.0
0.470000	40.1	Off	L1	19.6	16.4	56.5
0.590000	37.5	Off	L1	19.6	18.5	56.0
0.694000	43.8	Off	L1	19.6	12.2	56.0
0.750000	47.9	Off	L1	19.6	8.1	56.0
1.270000	37.8	Off	L1	19.6	18.2	56.0
4.182000	35.7	Off	L1	19.7	20.3	56.0
13.558000	66.0	Off	L1	19.8	-6.0	60.0

Final Result : Average

Frequency (MHz)	Average (dBµV)	Filter	Line	Corr. (dB)	Margin (dB)	Limit (dBµV)
0.158000	35.1	Off	L1	19.6	20.5	55.6
0.214000	33.6	Off	L1	19.6	19.4	53.0
0.470000	32.2	Off	L1	19.6	14.3	46.5
0.590000	29.7	Off	L1	19.6	16.3	46.0
0.694000	34.8	Off	L1	19.6	11.2	46.0
0.750000	41.4	Off	L1	19.6	4.6	46.0
1.270000	29.4	Off	L1	19.6	16.6	46.0
4.182000	26.1	Off	L1	19.7	19.9	46.0
13.558000	64.7	Off	L1	19.8	-14.7	50.0



Test Mode :	Mode 1	Temperature :	22~24°C
Test Engineer :	Arthur Hsieh	Relative Humidity :	51~53%
Test Voltage :	120Vac / 60Hz	Phase :	Neutral
Function Type :	WLAN (5GHz) Link + Bluetooth Link + NFC Link + AC Adapter + Charging Only Cable + Earphone 1 with Audio Adapter connect to EUT		

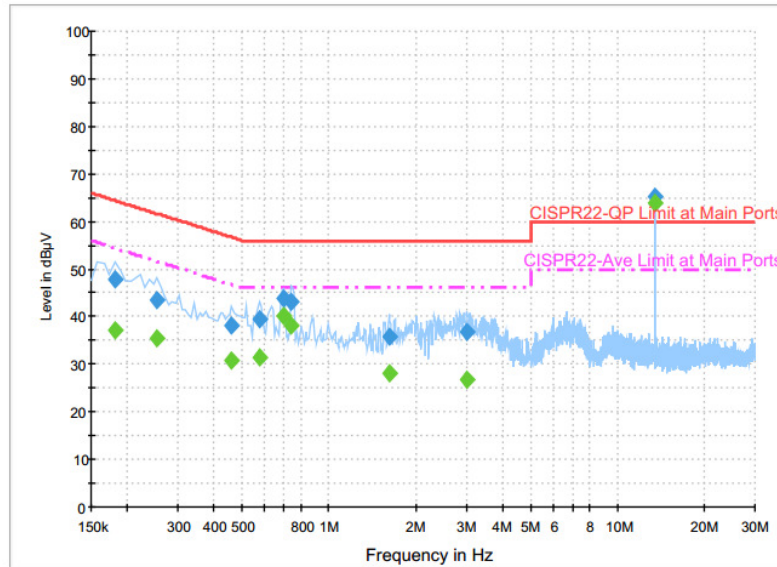

Final Result : QuasiPeak

Frequency (MHz)	QuasiPeak (dBµV)	Filter	Line	Corr. (dB)	Margin (dB)	Limit (dBµV)
0.182000	48.0	Off	N	19.6	16.4	64.4
0.254000	43.6	Off	N	19.6	18.0	61.6
0.462000	38.0	Off	N	19.6	18.7	56.7
0.574000	39.4	Off	N	19.6	16.6	56.0
0.694000	43.9	Off	N	19.6	12.1	56.0
0.742000	43.3	Off	N	19.6	12.7	56.0
1.614000	35.9	Off	N	19.6	20.1	56.0
2.998000	36.7	Off	N	19.5	19.3	56.0
13.558000	65.4	Off	N	19.8	-5.4	60.0

Final Result : Average

Frequency (MHz)	Average (dBµV)	Filter	Line	Corr. (dB)	Margin (dB)	Limit (dBµV)
0.182000	37.3	Off	N	19.6	17.1	54.4
0.254000	35.5	Off	N	19.6	16.1	51.6
0.462000	30.7	Off	N	19.6	16.0	46.7
0.574000	31.6	Off	N	19.6	14.4	46.0
0.694000	40.0	Off	N	19.6	6.0	46.0
0.742000	38.2	Off	N	19.6	7.8	46.0
1.614000	28.0	Off	N	19.6	18.0	46.0
2.998000	26.9	Off	N	19.5	19.1	46.0
13.558000	64.0	Off	N	19.8	-14.0	50.0



<Terminal Test Result>

Test Mode :	Mode 1	Temperature :	22~24°C
Test Engineer :	Arthur Hsieh	Relative Humidity :	51~53%
Test Voltage :	120Vac / 60Hz	Phase :	Line
Function Type :	WLAN (5GHz) Link + Bluetooth Link + NFC Link + AC Adapter + Charging Only Cable + Earphone 1 with Audio Adapter connect to EUT		

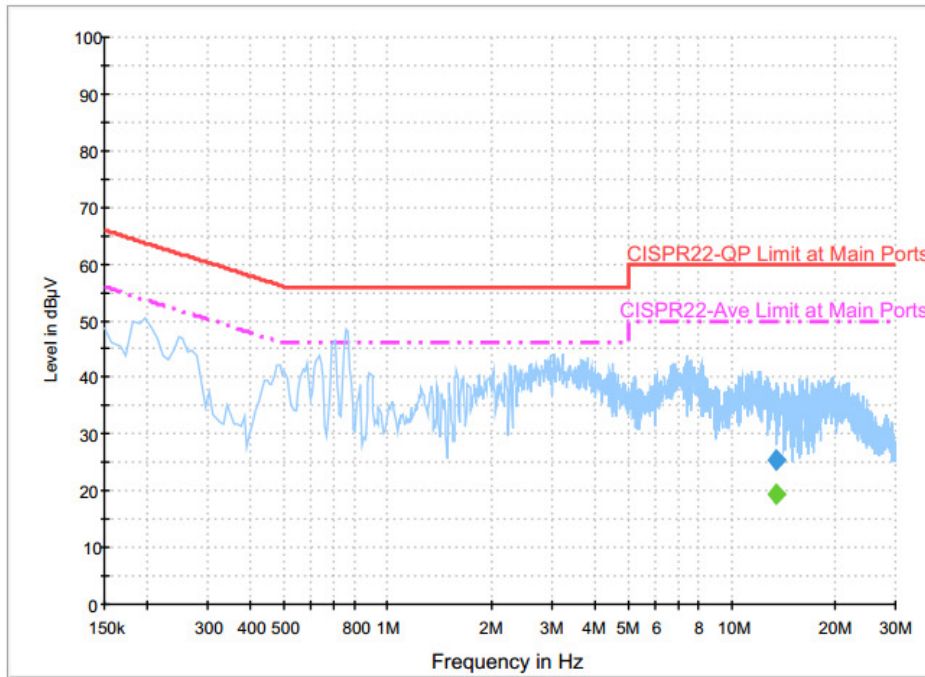

Final Result : QuasiPeak

Frequency (MHz)	QuasiPeak (dBµV)	Filter	Line	Corr. (dB)	Margin (dB)	Limit (dBµV)
13.558000	25.3	Off	L1	19.8	34.7	60.0

Final Result : Average

Frequency (MHz)	Average (dBµV)	Filter	Line	Corr. (dB)	Margin (dB)	Limit (dBµV)
13.558000	19.3	Off	L1	19.8	30.7	50.0



Test Mode :	Mode 1	Temperature :	22~24°C
Test Engineer :	Arthur Hsieh	Relative Humidity :	51~53%
Test Voltage :	120Vac / 60Hz	Phase :	Neutral
Function Type :	WLAN (5GHz) Link + Bluetooth Link + NFC Link + AC Adapter + Charging Only Cable + Earphone 1 with Audio Adapter connect to EUT		

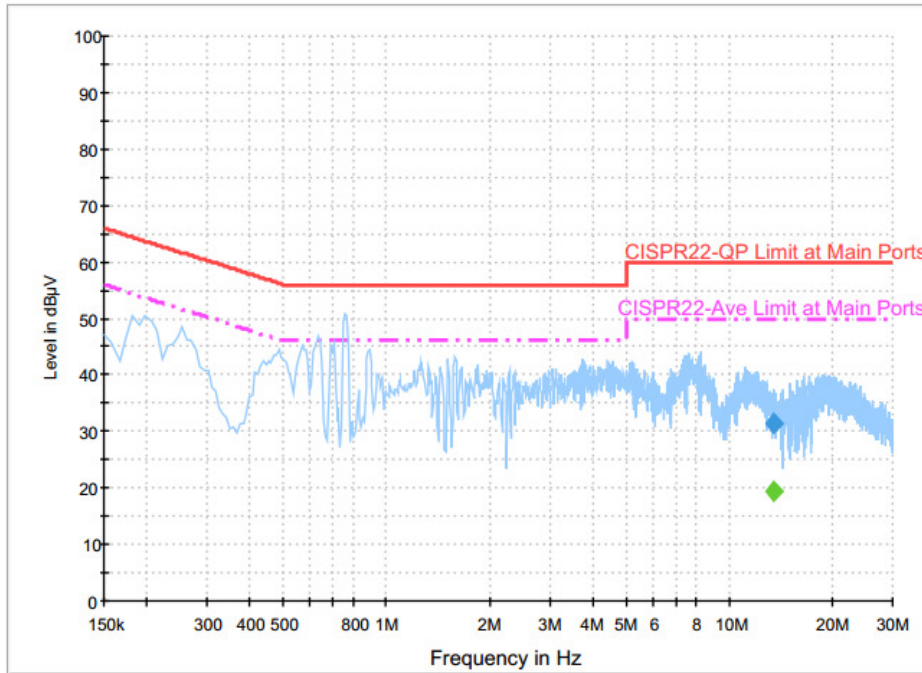

Final Result : QuasiPeak

Frequency (MHz)	QuasiPeak (dBµV)	Filter	Line	Corr. (dB)	Margin (dB)	Limit (dBµV)
13.558000	31.4	Off	N	19.8	28.6	60.0

Final Result : Average

Frequency (MHz)	Average (dBµV)	Filter	Line	Corr. (dB)	Margin (dB)	Limit (dBµV)
13.558000	19.5	Off	N	19.8	30.5	50.0



<Original Test Result>

Test Mode :	Mode 2	Temperature :	22~24°C
Test Engineer :	Arthur Hsieh	Relative Humidity :	51~53%
Test Voltage :	120Vac / 60Hz	Phase :	Line
Function Type :	WLAN (5GHz) Link + Bluetooth Link with Earphone 3 + NFC Link + AC Adapter + Snap on USB Cable (Data Link with Notebook) + Copy Data from Notebook to EDA (SD Card)		

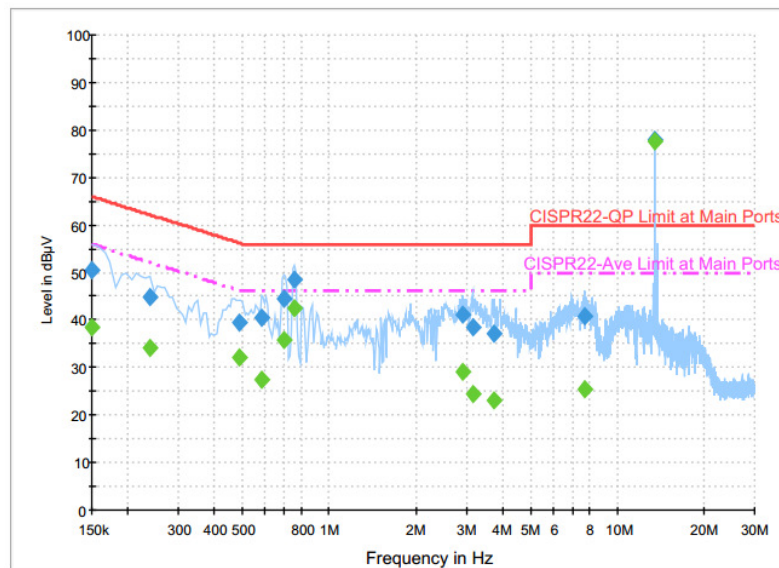

Final Result : QuasiPeak

Frequency (MHz)	QuasiPeak (dBµV)	Filter	Line	Corr. (dB)	Margin (dB)	Limit (dBµV)
0.150000	50.5	Off	L1	19.6	15.5	66.0
0.238000	44.8	Off	L1	19.6	17.4	62.2
0.486000	39.4	Off	L1	19.6	16.8	56.2
0.582000	40.6	Off	L1	19.6	15.4	56.0
0.694000	44.5	Off	L1	19.6	11.5	56.0
0.758000	48.6	Off	L1	19.6	7.4	56.0
2.902000	41.3	Off	L1	19.5	14.7	56.0
3.150000	38.3	Off	L1	19.6	17.7	56.0
3.750000	37.0	Off	L1	19.7	19.0	56.0
7.678000	40.9	Off	L1	19.7	19.1	60.0
13.558000	78.0	Off	L1	19.8	-18.0	60.0



Test Mode :	Mode 2	Temperature :	22~24°C
Test Engineer :	Arthur Hsieh	Relative Humidity :	51~53%
Test Voltage :	120Vac / 60Hz	Phase :	Line
Function Type :	WLAN (5GHz) Link + Bluetooth Link with Earphone 3 + NFC Link + AC Adapter + Snap on USB Cable (Data Link with Notebook) + Copy Data from Notebook to EDA (SD Card)		

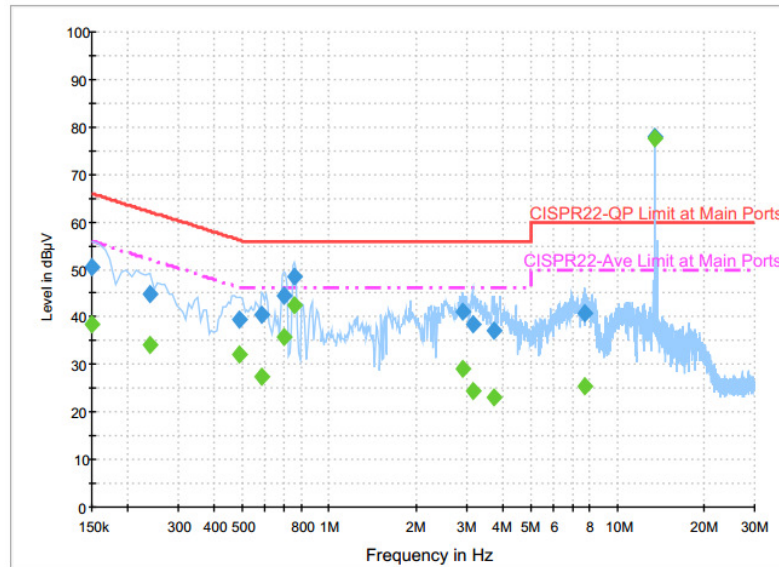

Final Result : Average

Frequency (MHz)	Average (dBµV)	Filter	Line	Corr. (dB)	Margin (dB)	Limit (dBµV)
0.150000	38.4	Off	L1	19.6	17.6	56.0
0.238000	34.1	Off	L1	19.6	18.1	52.2
0.486000	32.0	Off	L1	19.6	14.2	46.2
0.582000	27.5	Off	L1	19.6	18.5	46.0
0.694000	35.8	Off	L1	19.6	10.2	46.0
0.758000	42.6	Off	L1	19.6	3.4	46.0
2.902000	29.1	Off	L1	19.5	16.9	46.0
3.150000	24.4	Off	L1	19.6	21.6	46.0
3.750000	23.1	Off	L1	19.7	22.9	46.0
7.678000	25.4	Off	L1	19.7	24.6	50.0
13.558000	77.7	Off	L1	19.8	-27.7	50.0



Test Mode :	Mode 2	Temperature :	22~24°C
Test Engineer :	Arthur Hsieh	Relative Humidity :	51~53%
Test Voltage :	120Vac / 60Hz	Phase :	Neutral
Function Type :	WLAN (5GHz) Link + Bluetooth Link with Earphone 3 + NFC Link + AC Adapter + Snap on USB Cable (Data Link with Notebook) + Copy Data from Notebook to EDA (SD Card)		

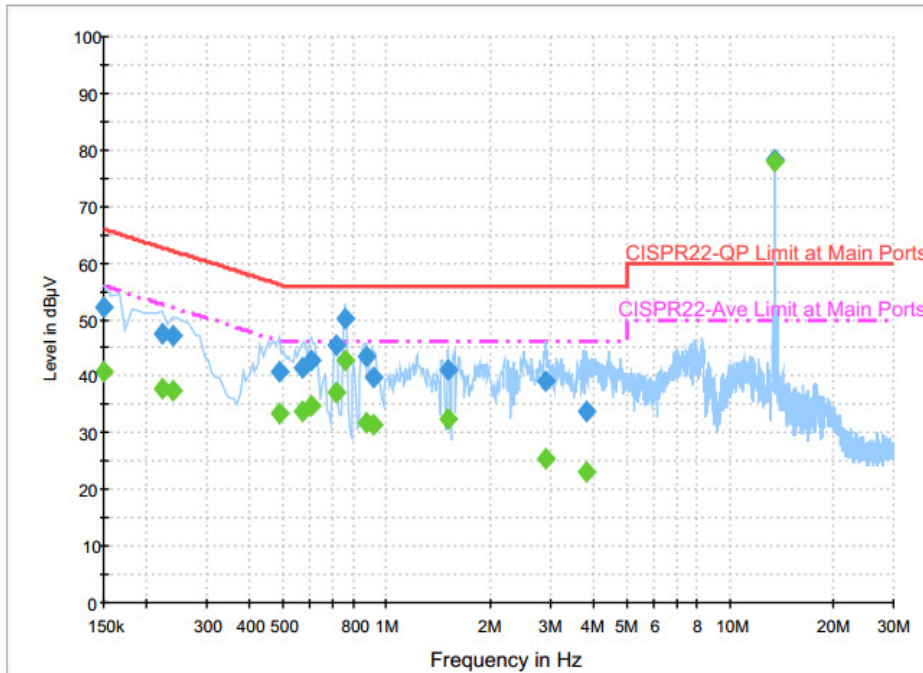

Final Result : QuasiPeak

Frequency (MHz)	QuasiPeak (dBµV)	Filter	Line	Corr. (dB)	Margin (dB)	Limit (dBµV)
0.150000	52.2	Off	N	19.6	13.8	66.0
0.222000	47.5	Off	N	19.6	15.2	62.7
0.238000	47.2	Off	N	19.6	15.0	62.2
0.486000	40.7	Off	N	19.6	15.5	56.2
0.566000	41.3	Off	N	19.6	14.7	56.0
0.606000	42.9	Off	N	19.6	13.1	56.0
0.710000	45.6	Off	N	19.6	10.4	56.0
0.758000	50.3	Off	N	19.6	5.7	56.0
0.870000	43.6	Off	N	19.6	12.4	56.0
0.918000	39.8	Off	N	19.6	16.2	56.0
1.510000	41.3	Off	N	19.6	14.7	56.0
2.910000	39.0	Off	N	19.5	17.0	56.0
3.838000	33.6	Off	N	19.6	22.4	56.0
13.558000	78.2	Off	N	19.8	-18.2	60.0



Test Mode :	Mode 2	Temperature :	22~24°C
Test Engineer :	Arthur Hsieh	Relative Humidity :	51~53%
Test Voltage :	120Vac / 60Hz	Phase :	Neutral
Function Type :	WLAN (5GHz) Link + Bluetooth Link with Earphone 3 + NFC Link + AC Adapter + Snap on USB Cable (Data Link with Notebook) + Copy Data from Notebook to EDA (SD Card)		

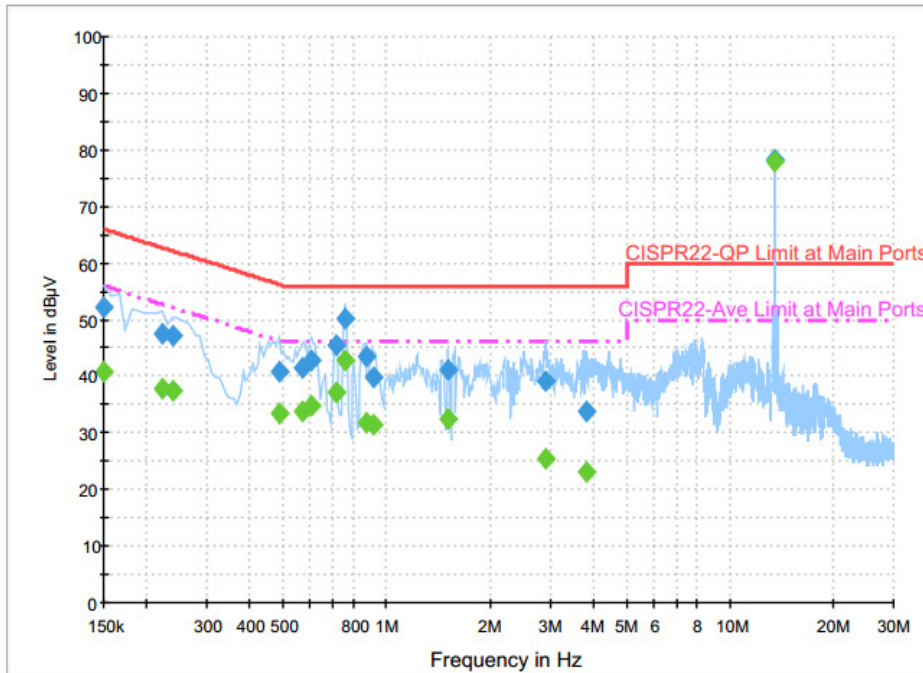

Final Result : Average

Frequency (MHz)	Average (dBµV)	Filter	Line	Corr. (dB)	Margin (dB)	Limit (dBµV)
0.150000	40.8	Off	N	19.6	15.2	56.0
0.222000	37.8	Off	N	19.6	14.9	52.7
0.238000	37.4	Off	N	19.6	14.8	52.2
0.486000	33.3	Off	N	19.6	12.9	46.2
0.566000	33.7	Off	N	19.6	12.3	46.0
0.606000	34.7	Off	N	19.6	11.3	46.0
0.710000	37.1	Off	N	19.6	8.9	46.0
0.758000	42.8	Off	N	19.6	3.2	46.0
0.870000	31.7	Off	N	19.6	14.3	46.0
0.918000	31.4	Off	N	19.6	14.6	46.0
1.510000	32.3	Off	N	19.6	13.7	46.0
2.910000	25.3	Off	N	19.5	20.7	46.0
3.838000	23.0	Off	N	19.6	23.0	46.0
13.558000	78.0	Off	N	19.8	-28.0	50.0

<Terminal Test Result>

Test Mode :	Mode 2	Temperature :	22~24°C
Test Engineer :	Arthur Hsieh	Relative Humidity :	51~53%
Test Voltage :	120Vac / 60Hz	Phase :	Line
Function Type :	WLAN (5GHz) Link + Bluetooth Link with Earphone 3 + NFC Link + AC Adapter + Snap on USB Cable (Data Link with Notebook) + Copy Data from Notebook to EDA (SD Card)		

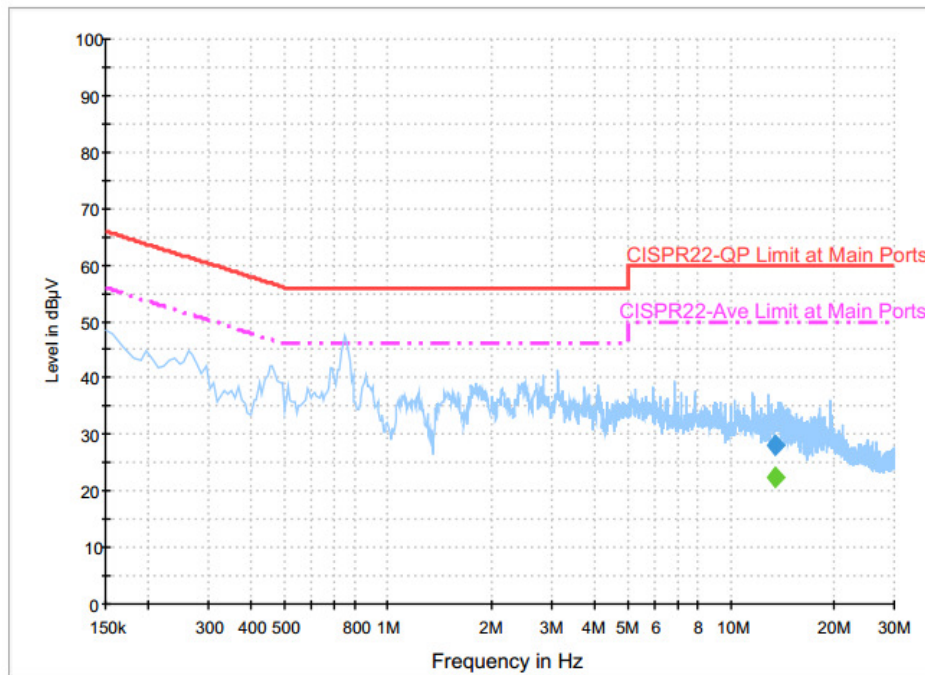

Final Result : QuasiPeak

Frequency (MHz)	QuasiPeak (dBµV)	Filter	Line	Corr. (dB)	Margin (dB)	Limit (dBµV)
13.558000	28.2	Off	L1	19.8	31.8	60.0

Final Result : Average

Frequency (MHz)	Average (dBµV)	Filter	Line	Corr. (dB)	Margin (dB)	Limit (dBµV)
13.558000	22.5	Off	L1	19.8	27.5	50.0



Test Mode :	Mode 2	Temperature :	22~24°C
Test Engineer :	Arthur Hsieh	Relative Humidity :	51~53%
Test Voltage :	120Vac / 60Hz	Phase :	Neutral
Function Type :	WLAN (5GHz) Link + Bluetooth Link with Earphone 3 + NFC Link + AC Adapter + Snap on USB Cable (Data Link with Notebook) + Copy Data from Notebook to EDA (SD Card)		

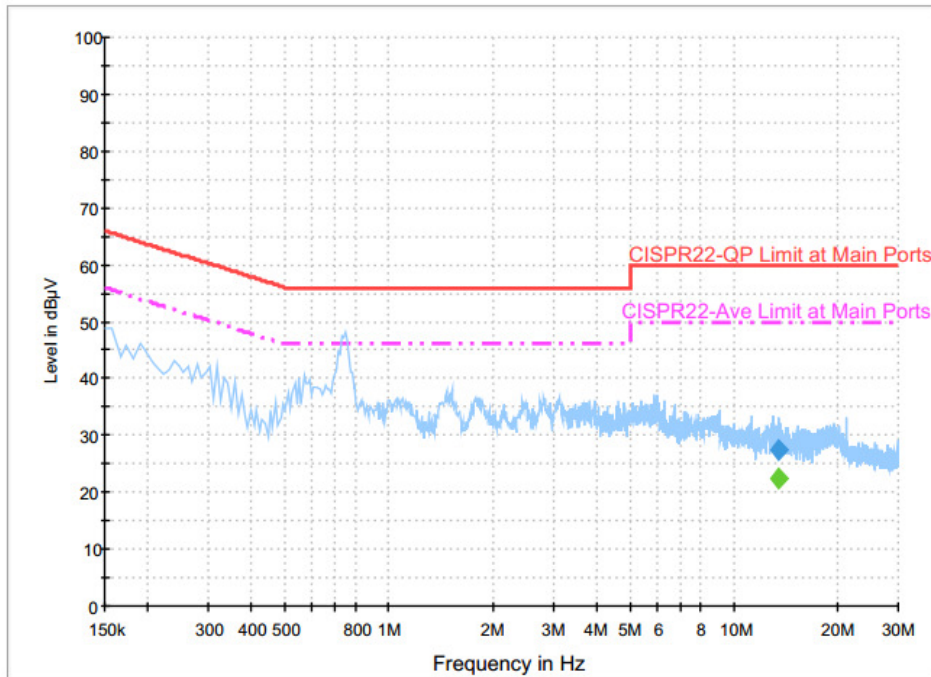

Final Result : QuasiPeak

Frequency (MHz)	QuasiPeak (dBµV)	Filter	Line	Corr. (dB)	Margin (dB)	Limit (dBµV)
13.558000	27.4	Off	N	19.8	32.6	60.0

Final Result : Average

Frequency (MHz)	Average (dBµV)	Filter	Line	Corr. (dB)	Margin (dB)	Limit (dBµV)
13.558000	22.4	Off	N	19.8	27.6	50.0



<Original Test Result>

Test Mode :	Mode 3	Temperature :	22~24°C
Test Engineer :	Arthur Hsieh	Relative Humidity :	51~53%
Test Voltage :	120Vac / 60Hz	Phase :	Line
Function Type :	WLAN (5GHz) Link + Bluetooth Link + NFC Link + AC Adapter + Charging Only Cable + Earphone 1 with Audio Adapter connect to EUT		

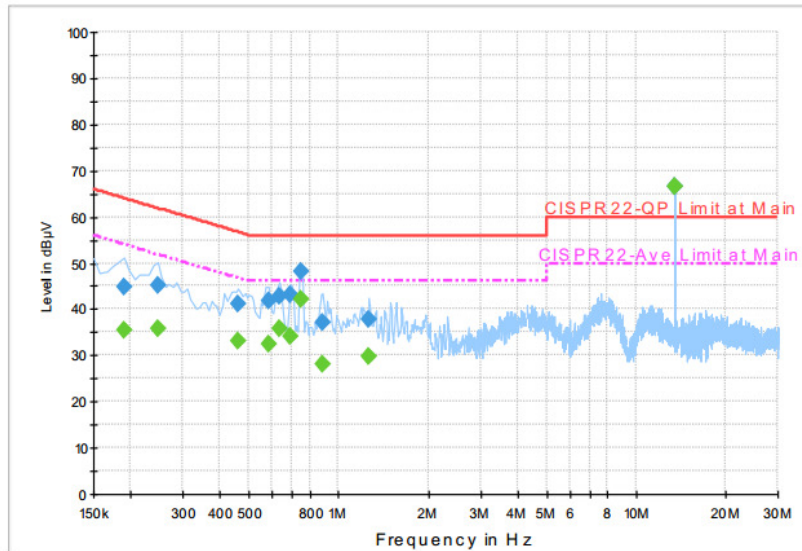

Final Result : QuasiPeak

Frequency (MHz)	QuasiPeak (dBµV)	Filter	Line	Corr. (dB)	Margin (dB)	Limit (dBµV)
0.190000	44.9	Off	L1	19.6	19.1	64.0
0.246000	45.1	Off	L1	19.6	16.8	61.9
0.462000	41.0	Off	L1	19.6	15.7	56.7
0.582000	42.0	Off	L1	19.6	14.0	56.0
0.630000	42.7	Off	L1	19.6	13.3	56.0
0.686000	43.2	Off	L1	19.6	12.8	56.0
0.750000	48.1	Off	L1	19.6	7.9	56.0
0.886000	37.3	Off	L1	19.6	18.7	56.0
1.270000	37.7	Off	L1	19.6	18.3	56.0
13.558000	66.7	Off	L1	19.8	-6.7	60.0

Final Result : Average

Frequency (MHz)	Average (dBµV)	Filter	Line	Corr. (dB)	Margin (dB)	Limit (dBµV)
0.190000	35.5	Off	L1	19.6	18.5	54.0
0.246000	35.8	Off	L1	19.6	16.1	51.9
0.462000	33.2	Off	L1	19.6	13.5	46.7
0.582000	32.4	Off	L1	19.6	13.6	46.0
0.630000	35.9	Off	L1	19.6	10.1	46.0
0.686000	34.3	Off	L1	19.6	11.7	46.0
0.750000	42.2	Off	L1	19.6	3.8	46.0
0.886000	28.1	Off	L1	19.6	17.9	46.0
1.270000	29.7	Off	L1	19.6	16.3	46.0
13.558000	66.7	Off	L1	19.8	-16.7	50.0



Test Mode :	Mode 3	Temperature :	22~24°C
Test Engineer :	Arthur Hsieh	Relative Humidity :	51~53%
Test Voltage :	120Vac / 60Hz	Phase :	Neutral
Function Type :	WLAN (5GHz) Link + Bluetooth Link + NFC Link + AC Adapter + Charging Only Cable + Earphone 1 with Audio Adapter connect to EUT		

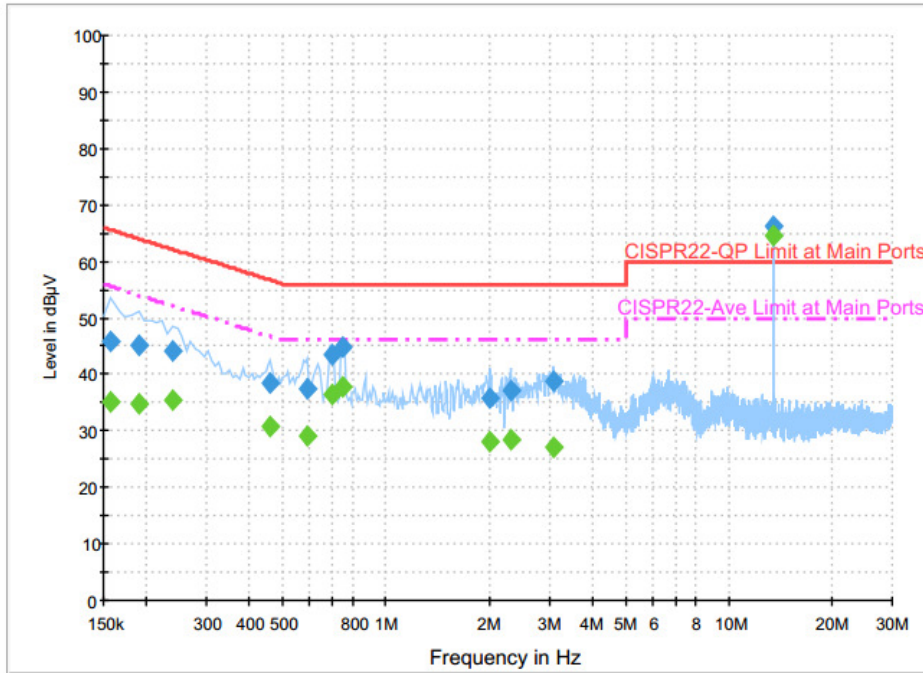

Final Result : QuasiPeak

Frequency (MHz)	QuasiPeak (dBµV)	Filter	Line	Corr. (dB)	Margin (dB)	Limit (dBµV)
0.158000	45.8	Off	N	19.6	19.8	65.6
0.190000	45.3	Off	N	19.6	18.7	64.0
0.238000	44.2	Off	N	19.6	18.0	62.2
0.462000	38.4	Off	N	19.6	18.3	56.7
0.590000	37.4	Off	N	19.6	18.6	56.0
0.694000	43.6	Off	N	19.6	12.4	56.0
0.750000	44.8	Off	N	19.6	11.2	56.0
2.014000	35.6	Off	N	19.6	20.4	56.0
2.318000	37.1	Off	N	18.6	18.9	56.0
3.078000	38.9	Off	N	19.5	17.1	56.0
13.558000	66.1	Off	N	19.8	-6.1	60.0



Test Mode :	Mode 3	Temperature :	22~24°C
Test Engineer :	Arthur Hsieh	Relative Humidity :	51~53%
Test Voltage :	120Vac / 60Hz	Phase :	Neutral
Function Type :	WLAN (5GHz) Link + Bluetooth Link + NFC Link + AC Adapter + Charging Only Cable + Earphone 1 with Audio Adapter connect to EUT		

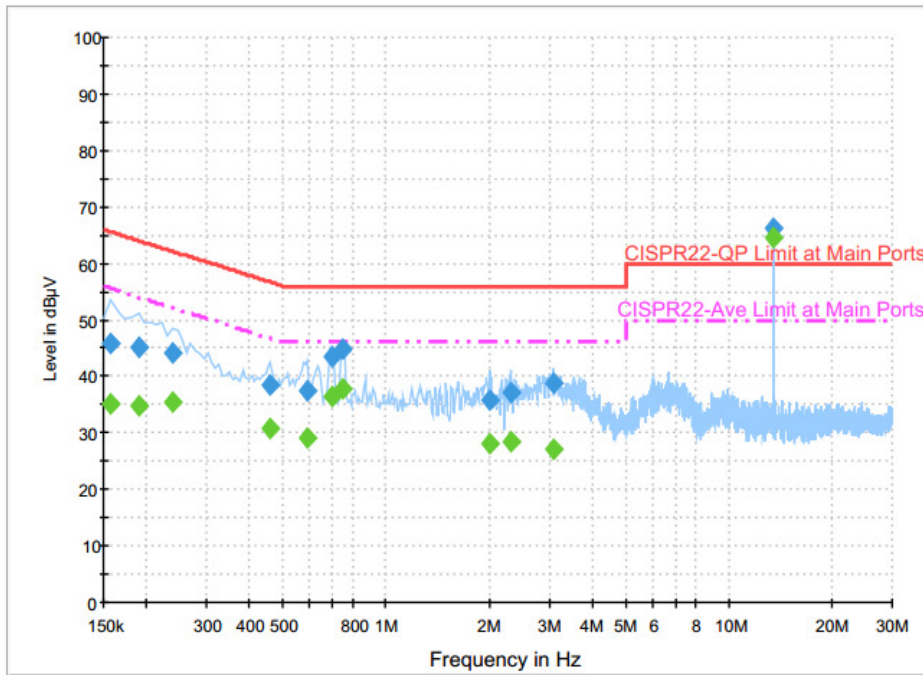

Final Result : Average

Frequency (MHz)	Average (dBµV)	Filter	Line	Corr. (dB)	Margin (dB)	Limit (dBµV)
0.158000	35.2	Off	N	19.6	20.4	55.6
0.190000	34.8	Off	N	19.6	19.2	54.0
0.238000	35.6	Off	N	19.6	16.6	52.2
0.462000	30.8	Off	N	19.6	15.9	46.7
0.590000	29.2	Off	N	19.6	16.8	46.0
0.694000	36.5	Off	N	19.6	9.5	46.0
0.750000	37.8	Off	N	19.6	8.2	46.0
2.014000	28.0	Off	N	19.6	18.0	46.0
2.318000	28.4	Off	N	18.6	17.6	46.0
3.078000	27.2	Off	N	19.5	18.8	46.0
13.558000	64.7	Off	N	19.8	-14.7	50.0

<Terminal Test Result>

Test Mode :	Mode 3	Temperature :	22~24°C
Test Engineer :	Arthur Hsieh	Relative Humidity :	51~53%
Test Voltage :	120Vac / 60Hz	Phase :	Line
Function Type :	WLAN (5GHz) Link + Bluetooth Link + NFC Link + AC Adapter + Charging Only Cable + Earphone 1 with Audio Adapter connect to EUT		

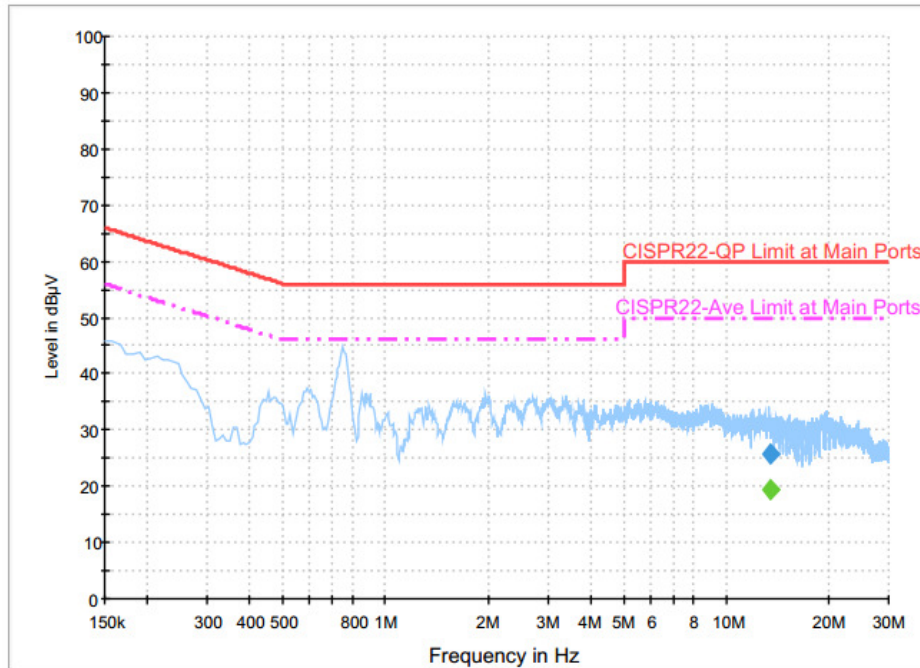

Final Result : QuasiPeak

Frequency (MHz)	QuasiPeak (dBµV)	Filter	Line	Corr. (dB)	Margin (dB)	Limit (dBµV)
13.558000	25.8	Off	L1	19.8	34.2	60.0

Final Result : Average

Frequency (MHz)	Average (dBµV)	Filter	Line	Corr. (dB)	Margin (dB)	Limit (dBµV)
13.558000	19.5	Off	L1	19.8	30.5	50.0



Test Mode :	Mode 3	Temperature :	22~24°C
Test Engineer :	Arthur Hsieh	Relative Humidity :	51~53%
Test Voltage :	120Vac / 60Hz	Phase :	Neutral
Function Type :	WLAN (5GHz) Link + Bluetooth Link + NFC Link + AC Adapter + Charging Only Cable + Earphone 1 with Audio Adapter connect to EUT		

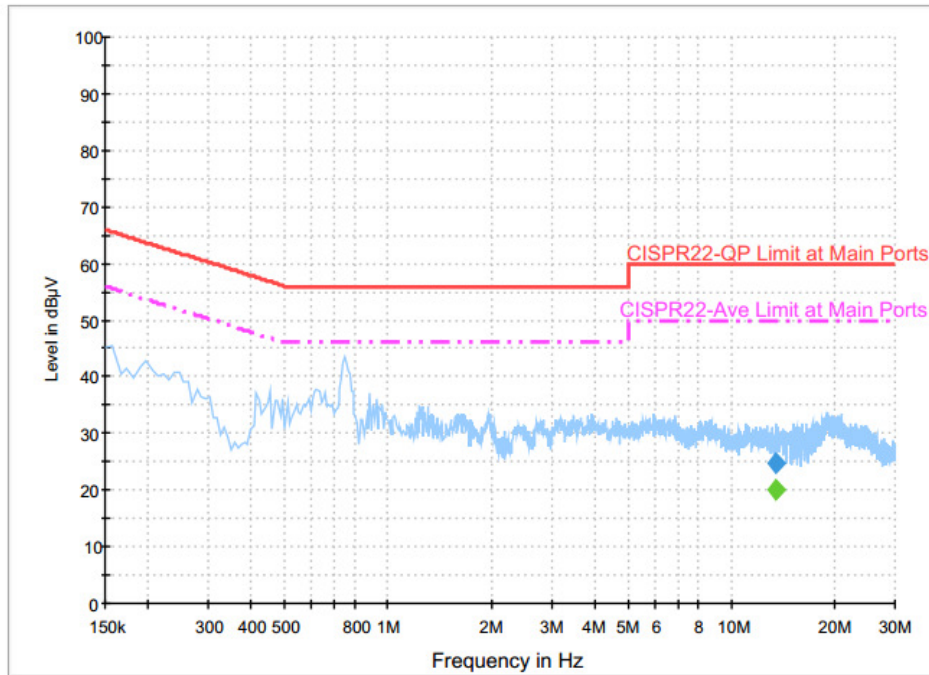

Final Result : QuasiPeak

Frequency (MHz)	QuasiPeak (dBµV)	Filter	Line	Corr. (dB)	Margin (dB)	Limit (dBµV)
13.558000	24.7	Off	N	19.8	35.3	60.0

Final Result : Average

Frequency (MHz)	Average (dBµV)	Filter	Line	Corr. (dB)	Margin (dB)	Limit (dBµV)
13.558000	19.9	Off	N	19.8	30.1	50.0

3.6 Frequency Stability Measurement

3.6.1 Limit of Frequency Stability

Manufacturers of U-NII devices are responsible for ensuring frequency stability such that an emission is maintained within the band of operation under all conditions of normal operation as specified in the user's manual.

3.6.2 Measuring Instruments

The measuring equipment is listed in the section 4 of this test report.

3.6.3 Test Procedures

1. To ensure emission at the band edge is maintained within the authorized band, those values shall be measured by radiation emissions at upper and lower frequency points, and finally compensated by frequency deviation as procedures below.
2. The EUT was operated at the maximum output power, and connected to the spectrum analyzer, which is set to maximum hold function and peak detector. The peak value of the power envelope was measured and noted. The upper and lower frequency points were respectively measured relatively 10dB lower than the measured peak value.
3. The frequency deviation was calculated by adding the upper frequency point and the lower frequency point divided by two. Those detailed values of frequency deviation are provided in table below.

3.6.4 Test Setup

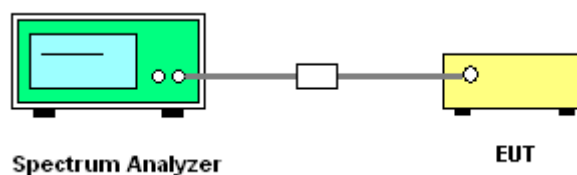

3.6.5 Test Result of Frequency Stability

Please refer to Appendix A.

The frequency band 5180-5240MHz which was verified by testing against other standard is less than 20 ppm which is sufficient to maintain the signal within the 5150-5250MHz band.



3.7 Automatically Discontinue Transmission

3.7.1 Limit of Automatically Discontinue Transmission

The device shall automatically discontinue transmission in case of either absence of information to transmit or operational failure. These provisions are not intended to preclude the transmission of control or signaling information or the use of repetitive codes used by certain digital technologies to complete frame or burst intervals. Applicants shall include in their application for equipment authorization to describe how this requirement is met.

3.7.2 Measuring Instruments

The measuring equipment is listed in the section 4 of this test report.

3.7.3 Test Result of Automatically Discontinue Transmission

While the EUT is not transmitting any information, the EUT can automatically discontinue transmission and become standby mode for power saving. The EUT can detect the controlling signal of ACK message transmitting from remote device and verify whether it shall resend or discontinue transmission.



3.8 Antenna Requirements

3.8.1 Standard Applicable

According to FCC 47 CFR Section 15.407(a)(1)(2) ,if transmitting antenna directional gain is greater than 6 dBi, both the peak transmit power and the peak power spectral density shall be reduced by the amount in dB that the directional gain of the antenna exceeds 6 dBi.

3.8.2 Antenna Anti-Replacement Construction

An embedded-in antenna design is used.

3.8.3 Antenna Gain

CDD modes

FCC KDB 662911 D01 Multiple Transmitter Output v02r01

For CDD transmissions, directional gain is calculated as

Directional gain = $G_{ANT} + \text{Array Gain}$, where Array Gain is as follows.

For power spectral density (PSD) measurements on all devices,

Array Gain = $10 \log(N_{ANT}/N_{SS}=1)$ dB.

For power measurements on IEEE 802.11 devices,

Array Gain = 0 dB (i.e., no array gain) for $N_{ANT} \leq 4$.

Directional gain may be calculated by using the formulas applicable to equal gain antennas with G_{ANT} set equal to the gain of the antenna having the highest gain;

The EUT supports CDD mode.

For power, the directional gain G_{ANT} is set equal to the antenna having the highest gain, i.e., F)2)f)i).

For PSD, the directional gain calculation is following F)2)f)ii) of KDB 662911 D01 v02r01.

The power and PSD limit should be modified if the directional gain of EUT is over 6 dBi,

The directional gain "DG" is calculated as following table.

	Ant 1	Ant 2	for	for	Limit	Limit
	(dBi)	(dBi)	Power	PSD	Reduction	Reduction
			(dBi)	(dBi)	(dB)	(dB)
Band I	4.90	1.60	4.90	6.42	0.00	0.42
Band II	4.90	2.20	4.90	6.66	0.00	0.66
Band III	4.90	3.30	4.90	7.15	0.00	1.15

Power limit reduction = Composite gain – 6dBi, (min = 0)

PSD limit reduction = Composite gain + PSD Array gain – 6dBi, (min = 0)

TXBF modes

FCC KDB 662911 D01 Multiple Transmitter Output v02r01

For CDD transmissions, directional gain is calculated as

$$DirectionalGain = 10 \cdot \log \left[\frac{\sum_{j=1}^{N_{SS}} \left\{ \sum_{k=1}^{N_{ANT}} g_{j,k} \right\}^2}{N_{ANT}} \right]$$

where

Each antenna is driven by no more than one spatial stream;

N_{SS} = the number of independent spatial streams of data;

N_{ANT} = the total number of antennas

$g_{j,k} = 10^{G_k / 20}$ if the k th antenna is being fed by spatial stream j , or zero if it is not;
 G_k is the gain in dBi of the k th antenna.

The EUT supports beamforming for 802.11ac modes.

The directional gain calculation is following F)2)e)ii) of KDB 662911 D01 v02r01.

The power and PSD limit should be modified if the directional gain of EUT is over 6 dBi,

The directional gain “DG” is calculated as following table.

			DG for Power (dBi)	DG for PSD (dBi)	Power Limit Reduction (dB)	PSD Limit Reduction (dB)
	Ant 1 (dBi)	Ant 2 (dBi)				
Band I	4.90	1.60	6.42	6.42	0.42	0.42
Band II	4.90	2.20	6.66	6.66	0.66	0.66
Band III	4.90	3.30	7.15	7.15	1.15	1.15

Power Limit Reduction = $DG(Power) - 6dBi$, (min = 0)

PSD Limit Reduction = $DG(PSD) - 6dBi$, (min = 0)



4 List of Measuring Equipment

Instrument	Manufacturer	Model No.	Serial No.	Characteristics	Calibration Date	Test Date	Due Date	Remark
Power Meter	Anritsu	ML2495A	1132003	300MHz~40GHz	Aug. 04, 2016	Aug. 18, 2016 ~ Sep. 16, 2016	Aug. 03, 2017	Conducted (TH05-HY)
Power Sensor	Anritsu	MA2411B	1126017	300MHz~40GHz	Aug. 04, 2016	Aug. 18, 2016 ~ Sep. 16, 2016	Aug. 03, 2017	Conducted (TH05-HY)
Spectrum Analyzer	Rohde & Schwarz	FSP40	100057	9kHz-40GHz	Nov. 23, 2015	Aug. 18, 2016 ~ Sep. 16, 2016	Nov. 22, 2016	Conducted (TH05-HY)
Temperature Chamber	ESPEC	SU-241	92003713	-30℃ ~95℃	Jun. 06, 2016	Aug. 18, 2016 ~ Sep. 16, 2016	Jun. 05, 2017	Conducted (TH05-HY)
Power Sensor	DARE	RadiPower	15I00041SN O09	10MHz~6GHz	May. 03, 2016	Sep. 10, 2016 ~ Sep. 16, 2016	May. 02, 2017	Conducted (TH05-HY)
Power Sensor	DARE	RadiPower	15I00041SN O10	10MHz~6GHz	May. 03, 2016	Sep. 10, 2016 ~ Sep. 16, 2016	May. 02, 2017	Conducted (TH05-HY)
Temperature Chamber	ESPEC	SH-641	92013720	-40℃ ~90℃	Sep. 01, 2016	Sep. 10, 2016 ~ Sep. 16, 2016	Aug. 31, 2017	Conducted (TH05-HY)
Programmable Power Supply	GW Instek	PSS-2005	EL890094	1V~20V 0.5A~5A	Oct. 12, 2015	Sep. 10, 2016 ~ Sep. 16, 2016	Oct. 11, 2016	Conducted (TH05-HY)
AC Power Source	ChainTek	APC-1000W	N/A	N/A	N/A	Sep. 06, 2016 ~ Sep. 20, 2016	N/A	Conduction (CO05-HY)
EMI Test Receiver	Rohde & Schwarz	ESCI 7	100724	9kHz~7GHz	Aug. 30, 2016	Sep. 06, 2016 ~ Sep. 20, 2016	Aug. 29, 2017	Conduction (CO05-HY)
Pulse Limiter	Rohde & Schwarz	ESH3-Z2	100851	N/A	Jan. 08, 2016	Sep. 06, 2016 ~ Sep. 20, 2016	Jan. 07, 2017	Conduction (CO05-HY)
Bilog Antenna	TESEQ	CBL 6111D	35419	30MHz to 1GHz	Jan. 13, 2016	Aug. 23, 2016 ~ Sep. 09, 2016	Jan. 12, 2017	Radiation (03CH07-HY)
Double Ridge Horn Antenna	ESCO	3117	00075962	1GHz ~ 18GHz	Aug. 19, 2016	Aug. 23, 2016 ~ Sep. 09, 2016	Aug. 18, 2017	Radiation (03CH07-HY)
EMI Test Receiver	Keysight	N9038A(MXE)	MY54130085	20Hz ~ 8.4GHz	Nov. 04, 2015	Aug. 23, 2016 ~ Sep. 09, 2016	Nov. 03, 2016	Radiation (03CH07-HY)
Loop Antenna	Rohde & Schwarz	HFH2-Z2	100315	9 kHz~30 MHz	Sep. 02, 2015	Aug. 23, 2016 ~ Sep. 09, 2016	Sep. 01, 2017	Radiation (03CH07-HY)
Preamplifier	MITEQ	AMF-7D-0010 1800-30-10P	1590075	1GHz ~ 18GHz	Apr. 15, 2016	Aug. 23, 2016 ~ Sep. 09, 2016	Apr. 14, 2017	Radiation (03CH07-HY)
Preamplifier	COM-POWER	PA-103A	161241	10MHz-1GHz	Mar. 18, 2016	Aug. 23, 2016 ~ Sep. 09, 2016	Mar. 17, 2017	Radiation (03CH07-HY)
Preamplifier	Agilent	8449B	3008A02362	1GHz~ 26.5GHz	Oct. 19, 2015	Aug. 23, 2016 ~ Sep. 09, 2016	Oct. 18, 2016	Radiation (03CH07-HY)
Spectrum Analyzer	Agilent	N9010A	MY53470118	10Hz~44GHz	Feb. 27, 2016	Aug. 23, 2016 ~ Sep. 09, 2016	Feb. 26, 2017	Radiation (03CH07-HY)
Antenna Mast	Max-Full	MFA520BS	N/A	1m~4m	N/A	Aug. 23, 2016 ~ Sep. 09, 2016	N/A	Radiation (03CH07-HY)
Turn Table	ChainTek	Chaintek 3000	N/A	0~360 Degree	N/A	Aug. 23, 2016 ~ Sep. 09, 2016	N/A	Radiation (03CH07-HY)
Loop Cable	Rohde & Schwarz	N/A	N/A	9KHz~30MHz	Dec. 03, 2015	Aug. 23, 2016 ~ Sep. 09, 2016	Dec. 02, 2016	Radiation (03CH07-HY)
Preamplifier	MITEQ	JS44-1800400 0-33-8P	1840917	18GHz ~ 40GHz	Jun. 14, 2016	Aug. 23, 2016 ~ Sep. 09, 2016	Jun. 13, 2017	Radiation (03CH07-HY)
SHF-EHF Horn Antenna	SCHWARZBE CK	BBHA 9170	BBHA917058 4	18GHz- 40GHz	Nov. 02, 2015	Aug. 23, 2016 ~ Sep. 09, 2016	Nov. 01, 2016	Radiation (03CH07-HY)



5 Uncertainty of Evaluation

Uncertainty of Conducted Emission Measurement (150kHz ~ 30MHz)

Measuring Uncertainty for a Level of Confidence of 95% ($U = 2Uc(y)$)	2.70
---	------

Uncertainty of Radiated Emission Measurement (30 MHz ~ 1000 MHz)

Measuring Uncertainty for a Level of Confidence of 95% ($U = 2Uc(y)$)	5.70
---	------

Uncertainty of Radiated Emission Measurement (1000 MHz ~ 18 GHz)

Measuring Uncertainty for a Level of Confidence of 95% ($U = 2Uc(y)$)	5.50
---	------

Uncertainty of Radiated Emission Measurement (18 GHz ~ 40 GHz)

Measuring Uncertainty for a Level of Confidence of 95% ($U = 2Uc(y)$)	5.20
---	------



Appendix A. Conducted Test Results

<CDD Modes>

Test Engineer:	Luffy Lin / Kai Liao	Temperature:	21~25	°C
Test Date:	2016/08/18~2016/09/16	Relative Humidity:	51~54	%

TEST RESULTS DATA
26dB and 99% OBW

Band I													
Mod.	Data Rate	NTX	CH.	Freq. (MHz)	99% Bandwidth (MHz)		26 dB Bandwidth (MHz)		IC 99% Bandwidth Power Limit (dBm)		IC 99% Bandwidth EIRP Limit (dBm)		Note
					Ant 1	Ant 2	Ant 1	Ant 2	Ant 1	Ant 2	Ant 1	Ant 2	
11a	6Mbps	1	36	5180	18.40	18.40	22.74	22.85	-	-	22.65	22.65	
11a	6Mbps	1	44	5220	18.20	18.20	23.06	26.87	-	-	22.60	22.60	
11a	6Mbps	1	48	5240	17.45	17.60	25.92	27.17	-	-	22.42	22.46	
11a	6Mbps	2	36	5180	18.30	18.30	22.74	22.77	-	-	22.62		
11a	6Mbps	2	44	5220	18.50	18.45	26.82	27.02	-	-	22.66		
11a	6Mbps	2	48	5240	17.50	17.50	27.11	27.69	-	-	22.43		
VHT20	MCS0	2	36	5180	18.95	19.10	23.28	23.04	-	-	22.78		
VHT20	MCS0	2	44	5220	19.10	18.95	28.53	28.90	-	-	22.78		
VHT20	MCS0	2	48	5240	18.25	18.35	29.98	32.88	-	-	22.61		
VHT40	MCS0	2	38	5190	36.80	36.70	41.44	40.91	-	-	23.01		
VHT40	MCS0	2	46	5230	36.80	37.10	41.76	64.64	-	-	23.01		
VHT80	MCS0	2	42	5210	75.96	75.84	82.08	81.84	-	-	23.01		

TEST RESULTS DATA
Average Power Table

FCC Band I														
Mod.	Data Rate	NTX	CH.	Freq. (MHz)	Duty Factor (dB)		Average Conducted Power (dBm)			FCC Conducted Power Limit (dBm)		DG (dBi)		Pass/Fail
					Ant 1	Ant 2	Ant 1	Ant 2	SUM	Ant 1	Ant 2	Ant 1	Ant 2	
11a	6Mbps	1	36	5180	0.32	0.32	15.81	16.22		24.00	24.00	4.90	1.60	Pass
11a	6Mbps	1	44	5220	0.32	0.32	15.91	17.61		24.00	24.00	4.90	1.60	Pass
11a	6Mbps	1	48	5240	0.32	0.32	15.98	17.60		24.00	24.00	4.90	1.60	Pass
HT20	MCS0	1	36	5180	0.32	0.32	14.62	16.51		24.00	24.00	4.90	1.60	Pass
HT20	MCS0	1	44	5220	0.32	0.32	15.82	17.54		24.00	24.00	4.90	1.60	Pass
HT20	MCS0	1	48	5240	0.32	0.32	15.67	17.38		24.00	24.00	4.90	1.60	Pass
HT40	MCS0	1	38	5190	0.09	0.09	11.99	13.70		24.00	24.00	4.90	1.60	Pass
HT40	MCS0	1	46	5230	0.09	0.09	15.15	16.86		24.00	24.00	4.90	1.60	Pass
VHT20	MCS0	1	36	5180	0.32	0.35	14.64	16.57		24.00	24.00	4.90	1.60	Pass
VHT20	MCS0	1	44	5220	0.32	0.35	15.90	17.67		24.00	24.00	4.90	1.60	Pass
VHT20	MCS0	1	48	5240	0.32	0.35	15.69	17.62		24.00	24.00	4.90	1.60	Pass
VHT40	MCS0	1	38	5190	0.09	0.08	12.10	13.76		24.00	24.00	4.90	1.60	Pass
VHT40	MCS0	1	46	5230	0.09	0.08	15.33	16.93		24.00	24.00	4.90	1.60	Pass
VHT80	MCS0	1	42	5210	0.18	0.22	12.08	14.03		24.00	24.00	4.90	1.60	Pass
11a	6Mbps	2	36	5180	0.32	0.32	14.47	16.24	18.46	24.00		4.90		Pass
11a	6Mbps	2	44	5220	0.32	0.32	15.95	17.64	19.89	24.00		4.90		Pass
11a	6Mbps	2	48	5240	0.32	0.32	15.81	17.68	19.86	24.00		4.90		Pass
HT20	MCS0	2	36	5180	0.32	0.32	14.70	16.60	18.77	24.00		4.90		Pass
HT20	MCS0	2	44	5220	0.32	0.32	15.90	17.67	19.89	24.00		4.90		Pass
HT20	MCS0	2	48	5240	0.32	0.32	15.70	17.61	19.77	24.00		4.90		Pass
HT40	MCS0	2	38	5190	0.09	0.09	12.00	13.83	16.02	24.00		4.90		Pass
HT40	MCS0	2	46	5230	0.09	0.09	15.18	16.97	19.18	24.00		4.90		Pass
VHT20	MCS0	2	36	5180	0.32	0.32	14.73	16.62	18.79	24.00		4.90		Pass
VHT20	MCS0	2	44	5220	0.32	0.32	15.92	17.70	19.91	24.00		4.90		Pass
VHT20	MCS0	2	48	5240	0.32	0.32	15.75	17.63	19.80	24.00		4.90		Pass
VHT40	MCS0	2	38	5190	0.09	0.09	12.13	13.88	16.10	24.00		4.90		Pass
VHT40	MCS0	2	46	5230	0.09	0.09	15.35	17.12	19.33	24.00		4.90		Pass
VHT80	MCS0	2	42	5210	0.18	0.18	12.12	14.15	16.26	24.00		4.90		Pass

TEST RESULTS DATA
Power Spectral Density

FCC Band I														
Mod.	Data Rate	NTX	CH.	Freq. (MHz)	Duty Factor (dB)		Average Power Density (dBm/MHz)			Average PSD Limit (dBm/MHz)		DG (dBi)		Pass /Fail
					Ant 1	Ant 2	Ant 1	Ant 2	SUM	Ant 1	Ant 2	Ant 1	Ant 2	
11a	6Mbps	1	36	5180	0.32	0.32	3.10	5.73		11.00	11.00	4.90	1.60	Pass
11a	6Mbps	1	44	5220	0.32	0.32	4.04	5.62		11.00	11.00	4.90	1.60	Pass
11a	6Mbps	1	48	5240	0.32	0.32	4.44	6.55		11.00	11.00	4.90	1.60	Pass
11a	6Mbps	2	36	5180	0.32	0.32			6.89	10.58		6.42		Pass
11a	6Mbps	2	44	5220	0.32	0.32			7.98	10.58		6.42		Pass
11a	6Mbps	2	48	5240	0.32	0.32			7.88	10.58		6.42		Pass
VHT20	MCS0	2	36	5180	0.32	0.32			6.66	10.58		6.42		Pass
VHT20	MCS0	2	44	5220	0.32	0.32			7.70	10.58		6.42		Pass
VHT20	MCS0	2	48	5240	0.32	0.32			7.62	10.58		6.42		Pass
VHT40	MCS0	2	38	5190	0.09	0.09			1.22	10.58		6.42		Pass
VHT40	MCS0	2	46	5230	0.09	0.09			4.05	10.58		6.42		Pass
VHT80	MCS0	2	42	5210	0.18	0.18			-2.14	10.58		6.42		Pass

TEST RESULTS DATA
26dB and 99% OBW

Band II															
Mod.	Data Rate	NTX	CH.	Freq. (MHz)	99% Bandwidth (MHz)		26 dB Bandwidth (MHz)		IC 99% Bandwidth Power Limit (dBm)		IC 99% Bandwidth EIRP Limit (dBm)		FCC 26dB Bandwidth Power Limit (dBm)		Note
					Ant 1	Ant 2	Ant 1	Ant 2	Ant 1	Ant 2	Ant 1	Ant 2	Ant 1	Ant 2	
11a	6Mbps	1	52	5260	17.40	17.40	25.68	26.23	23.41	23.41	29.41	29.41	23.98	23.98	
11a	6Mbps	1	60	5300	18.45	18.45	27.16	27.04	23.66	23.66	29.66	29.66	23.98	23.98	
11a	6Mbps	1	64	5320	18.45	18.35	22.82	23.07	23.66	23.64	29.66	29.64	23.98	23.98	
11a	6Mbps	2	52	5260	17.55	17.55	27.06	30.49	23.44		29.44		23.98		
11a	6Mbps	2	60	5300	18.25	18.30	27.31	27.35	23.61		29.61		23.98		
11a	6Mbps	2	64	5320	18.50	18.35	23.01	22.85	23.64		29.64		23.98		
VHT20	MCS0	2	52	5260	18.15	18.40	28.40	38.80	23.59		29.59		23.98		
VHT20	MCS0	2	60	5300	19.20	19.20	23.28	29.44	23.83		29.83		23.98		
VHT20	MCS0	2	64	5320	19.20	19.20	23.03	23.00	23.83		29.83		23.98		
VHT40	MCS0	2	54	5270	36.80	36.80	43.87	42.88	23.98		30.00		23.98		
VHT40	MCS0	2	62	5310	36.60	36.80	41.12	40.96	23.98		30.00		23.98		
VHT80	MCS0	2	58	5290	75.96	76.08	82.40	81.84	23.98		30.00		23.98		

TEST RESULTS DATA
Average Power Table

FCC Band II																
Mod.	Data Rate	NTX	CH.	Freq. (MHz)	Duty Factor (dB)		Average Conducted Power (dBm)			FCC Conducted Power Limit (dBm)		DG (dBi)		EIRP Power Limit (dBm)	Pass/Fail	
					Ant 1	Ant 2	Ant 1	Ant 2	SUM	Ant 1	Ant 2	Ant 1	Ant 2			
11a	6Mbps	1	52	5260	0.32	0.32	15.93	17.55		23.98	23.98	4.90	2.20	30	Pass	
11a	6Mbps	1	60	5300	0.32	0.32	16.09	17.56		23.98	23.98	4.90	2.20	30	Pass	
11a	6Mbps	1	64	5320	0.32	0.32	15.98	16.43		23.98	23.98	4.90	2.20	30	Pass	
HT20	MCS0	1	52	5260	0.32	0.32	15.65	17.33		23.98	23.98	4.90	2.20	30	Pass	
HT20	MCS0	1	60	5300	0.32	0.32	15.80	17.58		23.98	23.98	4.90	2.20	30	Pass	
HT20	MCS0	1	64	5320	0.32	0.32	14.70	16.40		23.98	23.98	4.90	2.20	30	Pass	
HT40	MCS0	1	54	5270	0.09	0.09	15.44	17.06		23.98	23.98	4.90	2.20	30	Pass	
HT40	MCS0	1	62	5310	0.09	0.09	11.94	13.45		23.98	23.98	4.90	2.20	30	Pass	
VHT20	MCS0	1	52	5260	0.32	0.35	15.70	17.46		23.98	23.98	4.90	2.20	30	Pass	
VHT20	MCS0	1	60	5300	0.32	0.35	15.83	17.63		23.98	23.98	4.90	2.20	30	Pass	
VHT20	MCS0	1	64	5320	0.32	0.35	14.73	16.50		23.98	23.98	4.90	2.20	30	Pass	
VHT40	MCS0	1	54	5270	0.09	0.08	15.47	17.08		23.98	23.98	4.90	2.20	30	Pass	
VHT40	MCS0	1	62	5310	0.09	0.08	12.00	13.61		23.98	23.98	4.90	2.20	30	Pass	
VHT80	MCS0	1	58	5290	0.18	0.22	11.69	13.14		23.98	23.98	4.90	2.20	30	Pass	
11a	6Mbps	2	52	5260	0.32	0.32	15.83	17.74	19.90	23.98		4.90		30	Pass	
11a	6Mbps	2	60	5300	0.32	0.32	15.88	17.73	19.91	23.98		4.90		30	Pass	
11a	6Mbps	2	64	5320	0.32	0.32	15.35	16.90	19.21	23.98		4.90		30	Pass	
HT20	MCS0	2	52	5260	0.32	0.32	15.69	17.52	19.71	23.98		4.90		30	Pass	
HT20	MCS0	2	60	5300	0.32	0.32	15.82	17.68	19.86	23.98		4.90		30	Pass	
HT20	MCS0	2	64	5320	0.32	0.32	14.73	16.52	18.73	23.98		4.90		30	Pass	
HT40	MCS0	2	54	5270	0.09	0.09	15.47	17.16	19.41	23.98		4.90		30	Pass	
HT40	MCS0	2	62	5310	0.09	0.09	11.98	13.64	15.90	23.98		4.90		30	Pass	
VHT20	MCS0	2	52	5260	0.32	0.32	15.70	17.54	19.73	23.98		4.90		30	Pass	
VHT20	MCS0	2	60	5300	0.32	0.32	15.84	17.73	19.90	23.98		4.90		30	Pass	
VHT20	MCS0	2	64	5320	0.32	0.32	14.78	16.60	18.80	23.98		4.90		30	Pass	
VHT40	MCS0	2	54	5270	0.09	0.09	15.51	17.29	19.50	23.98		4.90		30	Pass	
VHT40	MCS0	2	62	5310	0.09	0.09	12.04	13.70	15.96	23.98		4.90		30	Pass	
VHT80	MCS0	2	58	5290	0.18	0.18	11.71	13.29	15.58	23.98		4.90		30	Pass	

TEST RESULTS DATA
Power Spectral Density

Band II														
Mod.	Data Rate	NTX	CH.	Freq. (MHz)	Duty Factor (dB)		Average Power Density (dBm/MHz)			Average PSD Limit (dBm/MHz)		DG (dBi)		Pass /Fail
					Ant 1	Ant 2	Ant 1	Ant 2	SUM	Ant 1	Ant 2	Ant 1	Ant 2	
11a	6Mbps	1	52	5260	0.32	0.32	4.36	6.21		11.00	11.00	4.90	2.20	Pass
11a	6Mbps	1	60	5300	0.32	0.32	4.54	5.90		11.00	11.00	4.90	2.20	Pass
11a	6Mbps	1	64	5320	0.32	0.32	3.56	4.98		11.00	11.00	4.90	2.20	Pass
11a	6Mbps	2	52	5260	0.32	0.32			7.87	10.34		6.66		Pass
11a	6Mbps	2	60	5300	0.32	0.32			7.52	10.34		6.66		Pass
11a	6Mbps	2	64	5320	0.32	0.32			6.71	10.34		6.66		Pass
VHT20	MCS0	2	52	5260	0.32	0.32			7.54	10.34		6.66		Pass
VHT20	MCS0	2	60	5300	0.32	0.32			7.34	10.34		6.66		Pass
VHT20	MCS0	2	64	5320	0.32	0.32			6.00	10.34		6.66		Pass
VHT40	MCS0	2	54	5270	0.09	0.09			3.71	10.34		6.66		Pass
VHT40	MCS0	2	62	5310	0.09	0.09			0.21	10.34		6.66		Pass
VHT80	MCS0	2	58	5290	0.18	0.18			-3.36	10.34		6.66		Pass

TEST RESULTS DATA
26dB and 99% OBW

Band III															
Mod.	Data Rate	NTX	CH.	Freq. (MHz)	99% Bandwidth (MHz)		26 dB Bandwidth (MHz)		IC 99% Bandwidth Power Limit (dBm)		IC 99% Bandwidth EIRP Limit (dBm)		FCC 26dB Bandwidth Power Limit (dBm)		Note
					Ant 1	Ant 2	Ant 1	Ant 2	Ant 1	Ant 2	Ant 1	Ant 2	Ant 1	Ant 2	
11a	6Mbps	1	100	5500	18.55	18.55	23.15	27.39	23.68	23.68	29.68	29.68	23.98	23.98	
11a	6Mbps	1	116	5580	17.45	17.60	27.49	27.14	23.42	23.46	29.42	29.46	23.98	23.98	
11a	6Mbps	1	140	5700	18.55	18.70	26.58	30.66	23.68	23.72	29.68	29.72	23.98	23.98	
11a	6Mbps	2	100	5500	18.70	18.70	27.41	27.12	23.72		29.72		23.98		
11a	6Mbps	2	116	5580	17.45	17.80	27.49	35.18	23.42		29.42		23.98		
11a	6Mbps	2	140	5700	18.50	18.70	27.76	35.61	23.67		29.67		23.98		
VHT20	MCS0	2	100	5500	19.30	19.30	28.40	28.98	23.86		29.86		23.98		
VHT20	MCS0	2	116	5580	18.20	18.45	26.24	34.88	23.60		29.60		23.98		
VHT20	MCS0	2	140	5700	19.35	19.30	23.04	23.04	23.86		29.86		23.98		
VHT40	MCS0	2	102	5510	36.80	36.70	41.60	41.21	23.98		30.00		23.98		
VHT40	MCS0	2	110	5550	36.90	37.10	66.56	66.48	23.98		30.00		23.98		
VHT40	MCS0	2	134	5670	37.20	37.20	54.99	85.12	23.98		30.00		23.98		
VHT80	MCS0	2	106	5530	75.84	75.96	82.08	81.60	23.98		30.00		23.98		
VHT80	MCS0	2	122	5610	75.84	75.84	82.24	93.44	23.98		30.00		23.98		

TEST RESULTS DATA
Average Power Table

FCC Band III															
Mod.	Data Rate	Nrx	CH.	Freq. (MHz)	Duty Factor (dB)		Average Conducted Power (dBm)			FCC Conducted Power Limit (dBm)		DG (dBi)		EIRP Power Limit (dBm)	Pass/Fail
					Ant 1	Ant 2	Ant 1	Ant 2	SUM	Ant 1	Ant 2	Ant 1	Ant 2		
11a	6Mbps	1	100	5500	0.32	0.32	15.77	17.77		23.98	23.98	4.90	3.30	30	Pass
11a	6Mbps	1	116	5580	0.32	0.32	15.84	17.54		23.98	23.98	4.90	3.30	30	Pass
11a	6Mbps	1	140	5700	0.32	0.32	15.88	17.73		23.98	23.98	4.90	3.30	30	Pass
HT20	MCS0	1	100	5500	0.32	0.32	15.34	17.32		23.98	23.98	4.90	3.30	30	Pass
HT20	MCS0	1	116	5580	0.32	0.32	15.81	17.54		23.98	23.98	4.90	3.30	30	Pass
HT20	MCS0	1	140	5700	0.32	0.32	14.94	16.66		23.98	23.98	4.90	3.30	30	Pass
HT40	MCS0	1	102	5510	0.09	0.09	12.76	14.96		23.98	23.98	4.90	3.30	30	Pass
HT40	MCS0	1	110	5550	0.09	0.09	15.30	17.11		23.98	23.98	4.90	3.30	30	Pass
HT40	MCS0	1	134	5670	0.09	0.09	14.89	16.74		23.98	23.98	4.90	3.30	30	Pass
VHT20	MCS0	1	100	5500	0.32	0.35	15.53	17.37		23.98	23.98	4.90	3.30	30	Pass
VHT20	MCS0	1	116	5580	0.32	0.35	15.83	17.57		23.98	23.98	4.90	3.30	30	Pass
VHT20	MCS0	1	140	5700	0.32	0.35	14.95	16.70		23.98	23.98	4.90	3.30	30	Pass
VHT40	MCS0	1	102	5510	0.09	0.08	12.84	15.04		23.98	23.98	4.90	3.30	30	Pass
VHT40	MCS0	1	110	5550	0.09	0.08	15.53	17.16		23.98	23.98	4.90	3.30	30	Pass
VHT40	MCS0	1	134	5670	0.09	0.08	15.21	16.75		23.98	23.98	4.90	3.30	30	Pass
VHT80	MCS0	1	106	5530	0.18	0.22	11.73	13.64		23.98	23.98	4.90	3.30	30	Pass
VHT80	MCS0	1	122	5610	0.18	0.22	14.16	16.11		23.98	23.98	4.90	3.30	30	Pass
11a	6Mbps	2	100	5500	0.32	0.32	15.50	17.42	19.58	23.98		4.90		30	Pass
11a	6Mbps	2	116	5580	0.32	0.32	15.93	17.79	19.97	23.98		4.90		30	Pass
11a	6Mbps	2	140	5700	0.32	0.32	15.42	17.22	19.42	23.98		4.90		30	Pass
HT20	MCS0	2	100	5500	0.32	0.32	15.47	17.43	19.57	23.98		4.90		30	Pass
HT20	MCS0	2	116	5580	0.32	0.32	15.89	17.58	19.83	23.98		4.90		30	Pass
HT20	MCS0	2	140	5700	0.32	0.32	15.00	16.83	19.02	23.98		4.90		30	Pass
HT40	MCS0	2	102	5510	0.09	0.09	12.79	15.03	17.06	23.98		4.90		30	Pass
HT40	MCS0	2	110	5550	0.09	0.09	15.32	17.19	19.36	23.98		4.90		30	Pass
HT40	MCS0	2	134	5670	0.09	0.09	15.17	16.91	19.14	23.98		4.90		30	Pass
VHT20	MCS0	2	100	5500	0.32	0.32	15.60	17.44	19.63	23.98		4.90		30	Pass
VHT20	MCS0	2	116	5580	0.32	0.32	15.91	17.60	19.85	23.98		4.90		30	Pass
VHT20	MCS0	2	140	5700	0.32	0.32	15.03	16.88	19.07	23.98		4.90		30	Pass
VHT40	MCS0	2	102	5510	0.09	0.09	12.86	15.11	17.14	23.98		4.90		30	Pass
VHT40	MCS0	2	110	5550	0.09	0.09	15.54	17.27	19.50	23.98		4.90		30	Pass
VHT40	MCS0	2	134	5670	0.09	0.09	15.06	17.05	19.17	23.98		4.90		30	Pass
VHT80	MCS0	2	106	5530	0.18	0.18	11.79	13.79	15.91	23.98		4.90		30	Pass
VHT80	MCS0	2	122	5610	0.18	0.18	14.28	16.18	18.34	23.98		4.90		30	Pass

TEST RESULTS DATA
Power Spectral Density

Band III														
Mod.	Data Rate	NTX	CH.	Freq. (MHz)	Duty Factor (dB)		Average Power Density (dBm/MHz)			Average PSD Limit (dBm/MHz)		DG (dBi)		Pass /Fail
					Ant 1	Ant 2	Ant 1	Ant 2	SUM	Ant 1	Ant 2	Ant 1	Ant 2	
11a	6Mbps	1	100	5500	0.32	0.32	4.73	6.96		11.00	11.00	4.90	3.30	Pass
11a	6Mbps	1	116	5580	0.32	0.32	5.16	7.07		11.00	11.00	4.90	3.30	Pass
11a	6Mbps	1	140	5700	0.32	0.32	4.24	6.05		11.00	11.00	4.90	3.30	Pass
11a	6Mbps	2	100	5500	0.32	0.32			8.52	9.85		7.15		Pass
11a	6Mbps	2	116	5580	0.32	0.32			9.03	9.85		7.15		Pass
11a	6Mbps	2	140	5700	0.32	0.32			7.94	9.85		7.15		Pass
VHT20	MCS0	2	100	5500	0.32	0.32			8.03	9.85		7.15		Pass
VHT20	MCS0	2	116	5580	0.32	0.32			8.67	9.85		7.15		Pass
VHT20	MCS0	2	140	5700	0.32	0.32			7.01	9.85		7.15		Pass
VHT40	MCS0	2	102	5510	0.09	0.09			2.73	9.85		7.15		Pass
VHT40	MCS0	2	110	5550	0.09	0.09			5.23	9.85		7.15		Pass
VHT40	MCS0	2	134	5670	0.09	0.09			4.06	9.85		7.15		Pass
VHT80	MCS0	2	106	5530	0.18	0.18			-1.13	9.85		7.15		Pass
VHT80	MCS0	2	122	5610	0.18	0.18			0.98	9.85		7.15		Pass

TEST RESULTS DATA
26dB and 99% OBW

Straddle Channel																
Mod.	Data Rate	NTX	CH.	Freq. (MHz)	99% Bandwidth (MHz)		26dB Emission Bandwidth (MHz)		6 dB Emission Bandwidth (MHz)		IC 99% Bandwidth Power Limit (dBm)		IC 99% Bandwidth EIRP Limit (dBm)		FCC 26dB Bandwidth Power Limit (dBm)	
					Ant 1	Ant 2	Ant 1	Ant 2	Ant 1	Ant 2	Ant 1	Ant 2	Ant 1	Ant 2	Ant 1	Ant 2
11a	6Mbps	1	144	5720	18.75	18.75	23.00	26.90	16.32	16.36	-	-	-	-	-	-
				NII-2C	14.35	14.35	16.45	16.75	13.18	13.18	22.57	22.57	28.57	28.57	23.16	23.24
				NII-3	4.40	4.40	6.55	10.15	3.14	3.18	30.00	30.00	36.02	36.02	-	-
11a	6Mbps	2	144	5720	18.75	18.75	23.40	27.00	16.32	16.32	-	-	-	-	-	-
				NII-2C	14.35	14.35	16.75	16.7	13.16	13.16	22.57	22.57	28.57	28.57	23.23	23.23
				NII-3	4.4	4.4	6.65	10.3	3.16	3.16	30.00	30.00	36.02	36.02	-	-
VHT20	MCS0	2	144	5720	19.20	19.20	23.10	23.30	17.56	17.60	-	-	-	-	-	-
				NII-2C	14.6	14.6	16.5	16.75	13.78	13.8	22.64	22.64	28.64	28.64	23.17	23.17
				NII-3	4.6	4.6	6.6	6.55	3.78	3.8	30.00	30.00	36.02	36.02	-	-
VHT40	MCS0	2	142	5710	36.90	36.90	41.40	41.94	36.32	36.32	-	-	-	-	-	-
				NII-2C	33.5	33.5	35.61	35.7	33.12	33.12	23.98	23.98	30.00	30.00	23.98	23.98
				NII-3	3.4	3.4	5.79	6.24	3.2	3.2	30.00	30.00	36.02	36.02	-	-
VHT80	MCS0	2	138	5690	75.84	75.84	82.24	81.92	75.68	75.84	-	-	-	-	-	-
				NII-2C	72.92	72.92	76.12	75.8	72.52	72.92	23.98	23.98	30.00	30.00	23.98	23.98
				NII-3	2.92	2.92	6.12	6.12	3.16	2.92	30.00	30.00	36.02	36.02	-	-

TEST RESULTS DATA
Average Power Table

FCC Straddle Channel														
Mod.	Data Rate	NTX	CH.	Freq. (MHz)	Duty Factor (dB)		Average Conducted Power (dBm)			FCC Conducted Power Limit (dBm)		DG (dBi)		Pass/Fail
					Ant 1	Ant 2	Ant 1	Ant 2	SUM	Ant 1	Ant 2	Ant 1	Ant 2	
11a	6Mbps	1	144	5720	0.32	0.32	15.81	17.59		-	-	4.90	3.30	-
				NII-2C	0.32	0.32	14.83	16.59		23.16	23.24	4.90	3.30	Pass
				NII-3	0.32	0.32	8.86	10.74		-	-	4.90	3.30	Pass
HT20	MCS0	1	144	5720	0.32	0.32	15.77	17.48		-	-	4.90	3.30	-
				NII-2C	0.32	0.32	14.80	16.41		23.98	23.98	4.90	3.30	Pass
				NII-3	0.32	0.32	8.80	10.89		-	-	4.90	3.30	Pass
HT40	MCS0	1	142	5710	0.09	0.09	15.18	17.05		-	-	4.90	3.30	-
				NII-2C	0.09	0.09	14.79	16.68		23.98	23.98	4.90	3.30	Pass
				NII-3	0.09	0.09	4.48	6.12		-	-	4.90	3.30	Pass
VHT20	MCS0	1	144	5720	0.32	0.35	15.86	17.61		-	-	4.90	3.30	-
				NII-2C	0.32	0.35	14.82	16.56		23.98	23.98	4.90	3.30	Pass
				NII-3	0.32	0.35	9.15	10.93		-	-	4.90	3.30	Pass
VHT40	MCS0	1	142	5710	0.09	0.08	15.27	17.15		-	-	4.90	3.30	-
				NII-2C	0.09	0.08	14.88	16.78		23.98	23.98	4.90	3.30	Pass
				NII-3	0.09	0.08	4.56	6.30		-	-	4.90	3.30	Pass
VHT80	MCS0	1	138	5690	0.18	0.22	14.04	16.18		-	-	4.90	3.30	-
				NII-2C	0.18	0.22	13.88	16.02		23.98	23.98	4.90	3.30	Pass
				NII-3	0.18	0.22	-0.33	1.63		-	-	4.90	3.30	Pass
11a	6Mbps	2	144	5720	0.32	0.32	17.71	15.93	19.92	-	-	4.90	-	-
				NII-2C	0.32	0.32	16.74	15.00	18.97	-	23.23	4.90	-	Pass
				NII-3	0.32	0.32	10.70	8.78	12.86	-	-	4.90	-	Pass
HT20	MCS0	2	144	5720	0.32	0.32	15.82	17.57	19.79	-	-	4.90	-	-
				NII-2C	0.32	0.32	14.81	16.50	18.75	23.17	-	4.90	-	Pass
				NII-3	0.32	0.32	8.99	10.94	13.08	-	-	4.90	-	Pass
HT40	MCS0	2	142	5710	0.09	0.09	15.22	17.11	19.28	-	-	4.90	-	-
				NII-2C	0.09	0.09	14.84	16.74	18.90	23.98	-	4.90	-	Pass
				NII-3	0.09	0.09	4.51	6.22	8.46	-	-	4.90	-	Pass
VHT20	MCS0	2	144	5720	0.32	0.32	15.89	17.74	19.92	-	-	4.90	-	-
				NII-2C	0.32	0.32	14.84	16.69	18.87	23.17	-	4.90	-	Pass
				NII-3	0.32	0.32	9.21	11.05	13.24	-	-	4.90	-	Pass
VHT40	MCS0	2	142	5710	0.09	0.09	15.29	17.29	19.42	-	-	4.90	-	-
				NII-2C	0.09	0.09	14.90	16.92	19.04	23.98	-	4.90	-	Pass
				NII-3	0.09	0.09	4.60	6.45	8.63	-	-	4.90	-	Pass
VHT80	MCS0	2	138	5690	0.18	0.18	14.06	16.27	18.31	-	-	4.90	-	-
				NII-2C	0.18	0.18	13.91	16.11	18.16	23.98	-	4.90	-	Pass
				NII-3	0.18	0.18	-0.59	1.73	3.73	-	-	4.90	-	Pass

TEST RESULTS DATA
Power Spectral Density

Straddle Channel														
Mod.	Data Rate	NTX	CH.	Freq. (MHz)	Duty Factor (dB)		Average Power Density (dBm/MHz)			Average PSD Limit (dBm/MHz)		DG (dBi)		Pass /Fail
					Ant 1	Ant 2	Ant 1	Ant 2	SUM	Ant 1	Ant 2	Ant 1	Ant 2	
11a	6Mbps	1	144	NII-2C	0.32	0.32	3.09	4.89		11.00	11.00	4.90	3.30	Pass
				NII-3	0.32	0.32	3.09	4.89		30.00	30.00	4.90	3.30	Pass
11a	6Mbps	2	144	NII-2C	0.32	0.32			7.08	9.85	7.15		Pass	
				NII-3	0.32	0.32			7.08	28.85	7.15		Pass	
VHT20	MCS0	2	144	NII-2C	0.32	0.32			6.38	9.85	7.15		Pass	
				NII-3	0.32	0.32			6.38	28.85	7.15		Pass	
VHT40	MCS0	2	142	NII-2C	0.09	0.09			2.94	9.85	7.15		Pass	
				NII-3	0.09	0.09			2.94	28.85	7.15		Pass	
VHT80	MCS0	2	138	NII-2C	0.18	0.18			-0.54	9.85	7.15		Pass	
				NII-3	0.18	0.18			-0.54	28.85	7.15		Pass	

TEST RESULTS DATA
Frequency Stability

Band I										
Mod.	Data Rate	NTX	CH.	Freq. (MHz)	Center Frequency (MHz)	Frequency Deviation (MHz)	Frequency Stability (ppm)	Temperature (°C)	Voltage (V)	Note
11a	6Mbps	1	36	5180	5180.000	0.000	0.00	60	3.9	
11a	6Mbps	1	36	5180	5180.000	0.000	0.00	-30	3.9	
11a	6Mbps	1	36	5180	5180.000	0.000	0.00	20	4.2	
11a	6Mbps	1	36	5180	5180.000	0.000	0.00	20	3.7	
11a	6Mbps	1	36	5180	5180.000	0.000	0.00	20	3.9	

Band II										
Mod.	Data Rate	NTX	CH.	Freq. (MHz)	Center Frequency (MHz)	Frequency Deviation (MHz)	Frequency Stability (ppm)	Temperature (°C)	Voltage (V)	Note
11a	6Mbps	1	64	5320	5320.000	0.000	0.00	60	3.9	
11a	6Mbps	1	64	5320	5320.000	0.000	0.00	-30	3.9	
11a	6Mbps	1	64	5320	5320.000	0.000	0.00	20	4.2	
11a	6Mbps	1	64	5320	5320.000	0.000	0.00	20	3.7	
11a	6Mbps	1	64	5320	5320.000	0.000	0.00	20	3.9	

Band III										
Mod.	Data Rate	NTX	CH.	Freq. (MHz)	Center Frequency (MHz)	Frequency Deviation (MHz)	Frequency Stability (ppm)	Temperature (°C)	Voltage (V)	Note
11a	6Mbps	1	100	5500	5500.000	0.000	0.00	60	3.9	
11a	6Mbps	1	100	5500	5500.025	0.025	4.55	-30	3.9	
11a	6Mbps	1	100	5500	5500.000	0.000	0.00	20	4.2	
11a	6Mbps	1	100	5500	5500.000	0.000	0.00	20	3.7	
11a	6Mbps	1	100	5500	5500.000	0.000	0.00	20	3.9	



<TXBF Modes>

Test Engineer:	Kai Liao	Temperature:	21~25	°C
Test Date:	2016/09/03 ~ 2016/09/16	Relative Humidity:	51~54	%

TEST RESULTS DATA
26dB and 99% OBW

Band I													
Mod.	Data Rate	NTX	CH.	Freq. (MHz)	99% Bandwidth (MHz)		26 dB Bandwidth (MHz)		IC 99% Bandwidth Power Limit (dBm)		IC 99% Bandwidth EIRP Limit (dBm)		Note
					Ant 1	Ant 2	Ant 1	Ant 2	Ant 1	Ant 2	Ant 1	Ant 2	
VHT20	MCS0	2	36	5180	18.95	18.95	29.36	29.75	-	-	22.78	-	
VHT20	MCS0	2	44	5220	19.00	19.00	32.01	38.68	-	-	22.79	-	
VHT20	MCS0	2	48	5240	18.10	18.25	29.81	31.78	-	-	22.58	-	
VHT40	MCS0	2	38	5190	36.70	36.70	40.96	41.28	-	-	23.01	-	
VHT40	MCS0	2	46	5230	36.80	36.90	50.56	67.52	-	-	23.01	-	
VHT80	MCS0	2	42	5210	76.08	75.72	81.60	81.60	-	-	23.01	-	

TEST RESULTS DATA
Average Power Table

FCC Band I												
Mod.	Data Rate	NTX	CH.	Freq. (MHz)	Average Conducted Power (dBm)			FCC Conducted Power Limit (dBm)		DG (dBi)		Pass/Fail
					Ant 1	Ant 2	SUM	Ant 1	Ant 2	Ant 1	Ant 2	
HT20	MCS0	2	36	5180	14.60	16.10	18.42	23.58		6.42	Pass	
HT20	MCS0	2	44	5220	15.60	17.50	19.66	23.58		6.42	Pass	
HT20	MCS0	2	48	5240	15.70	17.30	19.58	23.58		6.42	Pass	
HT40	MCS0	2	38	5190	12.10	13.60	15.92	23.58		6.42	Pass	
HT40	MCS0	2	46	5230	15.30	17.10	19.30	23.58		6.42	Pass	
VHT20	MCS0	2	36	5180	14.80	16.40	18.68	23.58		6.42	Pass	
VHT20	MCS0	2	44	5220	15.70	17.70	19.82	23.58		6.42	Pass	
VHT20	MCS0	2	48	5240	15.80	17.50	19.74	23.58		6.42	Pass	
VHT40	MCS0	2	38	5190	12.30	13.70	16.07	23.58		6.42	Pass	
VHT40	MCS0	2	46	5230	15.30	17.10	19.30	23.58		6.42	Pass	
VHT80	MCS0	2	42	5210	12.00	14.20	16.25	23.58		6.42	Pass	

TEST RESULTS DATA
Power Spectral Density

FCC Band I												
Mod.	Data Rate	NTX	CH.	Freq. (MHz)	Average Power Density (dBm/MHz)			Average PSD Limit (dBm/MHz)		DG (dBi)		Pass /Fail
					Ant 1	Ant 2	SUM	Ant 1	Ant 2	Ant 1	Ant 2	
VHT20	MCS0	2	36	5180			7.25	10.58	6.42		Pass	
VHT20	MCS0	2	44	5220			8.73	10.58	6.42		Pass	
VHT20	MCS0	2	48	5240			8.86	10.58	6.42		Pass	
VHT40	MCS0	2	38	5190			3.27	10.58	6.42		Pass	
VHT40	MCS0	2	46	5230			5.96	10.58	6.42		Pass	
VHT80	MCS0	2	42	5210			-1.94	10.58	6.42		Pass	

TEST RESULTS DATA
26dB and 99% OBW

Band II															
Mod.	Data Rate	NTX	CH.	Freq. (MHz)	99% Bandwidth (MHz)		26 dB Bandwidth (MHz)		IC 99% Bandwidth Power Limit (dBm)		IC 99% Bandwidth EIRP Limit (dBm)		FCC 26dB Bandwidth Power Limit (dBm)		Note
					Ant 1	Ant 2	Ant 1	Ant 2	Ant 1	Ant 2	Ant 1	Ant 2	Ant 1	Ant 2	
VHT20	MCS0	2	52	5260	18.10	18.25	33.02	31.48	23.58		29.58		23.98		
VHT20	MCS0	2	60	5300	18.90	19.00	31.59	32.69	23.76		29.76		23.98		
VHT20	MCS0	2	64	5320	19.10	19.00	29.92	34.24	23.79		29.79		23.98		
VHT40	MCS0	2	54	5270	36.90	36.80	55.68	55.68	23.98		30.00		23.98		
VHT40	MCS0	2	62	5310	36.80	36.70	41.06	40.93	23.98		30.00		23.98		
VHT80	MCS0	2	58	5290	76.08	76.08	82.56	81.12	23.98		30.00		23.98		

TEST RESULTS DATA
Average Power Table

FCC Band II													
Mod.	Data Rate	NTX	CH.	Freq. (MHz)	Average Conducted Power (dBm)			FCC Conducted Power Limit (dBm)		DG (dBi)		EIRP Power Limit (dBm)	Pass/Fail
					Ant 1	Ant 2	SUM	Ant 1	Ant 2	Ant 1	Ant 2		
HT20	MCS0	2	52	5260	15.60	17.40	19.60	23.31		6.66		30	Pass
HT20	MCS0	2	60	5300	15.50	17.40	19.56	23.31		6.66		30	Pass
HT20	MCS0	2	64	5320	14.60	16.50	18.66	23.31		6.66		30	Pass
HT40	MCS0	2	54	5270	15.20	17.00	19.20	23.31		6.66		30	Pass
HT40	MCS0	2	62	5310	12.00	13.50	15.82	23.31		6.66		30	Pass
VHT20	MCS0	2	52	5260	15.70	17.50	19.70	23.31		6.66		30	Pass
VHT20	MCS0	2	60	5300	15.60	17.50	19.66	23.31		6.66		30	Pass
VHT20	MCS0	2	64	5320	14.70	16.60	18.76	23.31		6.66		30	Pass
VHT40	MCS0	2	54	5270	15.30	17.10	19.30	23.31		6.66		30	Pass
VHT40	MCS0	2	62	5310	12.10	13.60	15.92	23.31		6.66		30	Pass
VHT80	MCS0	2	58	5290	11.20	13.20	15.32	23.31		6.66		30	Pass

TEST RESULTS DATA
Power Spectral Density

Band II												
Mod.	Data Rate	NTX	CH.	Freq. (MHz)	Average Power Density (dBm/MHz)			Average PSD Limit (dBm/MHz)		DG (dBi)		Pass /Fail
					Ant 1	Ant 2	SUM	Ant 1	Ant 2	Ant 1	Ant 2	
VHT20	MCS0	2	52	5260			8.95	10.34		6.66	Pass	
VHT20	MCS0	2	60	5300			8.51	10.34		6.66	Pass	
VHT20	MCS0	2	64	5320			3.35	10.34		6.66	Pass	
VHT40	MCS0	2	54	5270			7.12	10.34		6.66	Pass	
VHT40	MCS0	2	62	5310			-0.26	10.34		6.66	Pass	
VHT80	MCS0	2	58	5290			-3.36	10.34		6.66	Pass	

TEST RESULTS DATA
26dB and 99% OBW

Band III															
Mod.	Data Rate	NTX	CH.	Freq. (MHz)	99% Bandwidth (MHz)		26 dB Bandwidth (MHz)		IC 99% Bandwidth Power Limit (dBm)		IC 99% Bandwidth EIRP Limit (dBm)		FCC 26dB Bandwidth Power Limit (dBm)		Note
					Ant 1	Ant 2	Ant 1	Ant 2	Ant 1	Ant 2	Ant 1	Ant 2	Ant 1	Ant 2	
VHT20	MCS0	2	100	5500	19.15	19.25	31.21	35.36	23.82		29.82		23.98		
VHT20	MCS0	2	116	5580	18.45	18.45	40.51	41.75	23.66		29.66		23.98		
VHT20	MCS0	2	140	5700	19.30	19.40	42.07	40.76	23.86		29.86		23.98		
VHT40	MCS0	2	102	5510	36.70	36.60	40.83	40.96	23.98		30.00		23.98		
VHT40	MCS0	2	110	5550	36.90	37.00	48.48	54.40	23.98		30.00		23.98		
VHT40	MCS0	2	134	5670	36.80	36.90	51.68	61.84	23.98		30.00		23.98		
VHT80	MCS0	2	106	5530	76.08	75.96	81.12	82.32	23.98		30.00		23.98		
VHT80	MCS0	2	122	5610	75.84	75.84	82.08	93.36	23.98		30.00		23.98		

TEST RESULTS DATA
Average Power Table

FCC Band III													
Mod.	Data Rate	Ntx	CH.	Freq. (MHz)	Average Conducted Power (dBm)			FCC Conducted Power Limit (dBm)		DG (dBi)		EIRP Power Limit (dBm)	Pass/Fail
					Ant 1	Ant 2	SUM	Ant 1	Ant 2	Ant 1	Ant 2		
HT20	MCS0	2	100	5500	15.60	17.20	19.48	22.83		7.15	30	Pass	
HT20	MCS0	2	116	5580	15.30	17.50	19.55	22.83		7.15	30	Pass	
HT20	MCS0	2	140	5700	14.90	16.80	18.96	22.83		7.15	30	Pass	
HT40	MCS0	2	102	5510	13.00	14.80	17.00	22.83		7.15	30	Pass	
HT40	MCS0	2	110	5550	15.20	17.20	19.32	22.83		7.15	30	Pass	
HT40	MCS0	2	134	5670	14.80	16.90	18.99	22.83		7.15	30	Pass	
VHT20	MCS0	2	100	5500	15.80	17.30	19.62	22.83		7.15	30	Pass	
VHT20	MCS0	2	116	5580	15.60	17.60	19.72	22.83		7.15	30	Pass	
VHT20	MCS0	2	140	5700	15.00	16.90	19.06	22.83		7.15	30	Pass	
VHT40	MCS0	2	102	5510	13.10	14.90	17.10	22.83		7.15	30	Pass	
VHT40	MCS0	2	110	5550	15.40	17.30	19.46	22.83		7.15	30	Pass	
VHT40	MCS0	2	134	5670	14.90	17.00	19.09	22.83		7.15	30	Pass	
VHT80	MCS0	2	106	5530	11.60	13.70	15.79	22.83		7.15	30	Pass	
VHT80	MCS0	2	122	5610	14.30	16.10	18.30	22.83		7.15	30	Pass	

TEST RESULTS DATA
Power Spectral Density

Band III												
Mod.	Data Rate	NTX	CH.	Freq. (MHz)	Average Power Density (dBm/MHz)			Average PSD Limit (dBm/MHz)		DG (dBi)		Pass /Fail
					Ant 1	Ant 2	SUM	Ant 1	Ant 2	Ant 1	Ant 2	
VHT20	MCS0	2	100	5500			9.48	9.85	7.15		Pass	
VHT20	MCS0	2	116	5580			9.69	9.85	7.15		Pass	
VHT20	MCS0	2	140	5700			8.54	9.85	7.15		Pass	
VHT40	MCS0	2	102	5510			5.16	9.85	7.15		Pass	
VHT40	MCS0	2	110	5550			8.95	9.85	7.15		Pass	
VHT40	MCS0	2	134	5670			5.81	9.85	7.15		Pass	
VHT80	MCS0	2	106	5530			-1.07	9.85	7.15		Pass	
VHT80	MCS0	2	122	5610			2.34	9.85	7.15		Pass	

TEST RESULTS DATA
26dB and 99% OBW

Straddle Channel																	
Mod.	Data Rate	NTX	CH.	Freq. (MHz)	99% Bandwidth (MHz)		26dB Emission Bandwidth (MHz)		6 dB Emission Bandwidth (MHz)		IC 99% Bandwidth Power Limit (dBm)		IC 99% Bandwidth EIRP Limit (dBm)		FCC 26dB Bandwidth Power Limit (dBm)		Note
					Ant 1	Ant 2	Ant 1	Ant 2	Ant 1	Ant 2	Ant 1	Ant 2	Ant 1	Ant 2	Ant 1	Ant 2	
VHT20	MCS0	2	144	5720	19.20	19.20	33.52	39.60	17.60	17.52	-	-	-	-	-	-	
				NII-2C	14.6	14.6	21.32	24.52	13.78	13.74	22.64	28.64	23.98				
				NII-3	4.6	4.6	12.2	15.08	3.82	3.78	23.63	29.63	21.86				
VHT40	MCS0	2	142	5710	37.20	37.20	69.76	87.06	36.32	36.32	-	-	-	-	-	-	
				NII-2C	33.6	33.6	50.2	59.66	33.16	33.16	23.98	30.00	23.98				
				NII-3	3.6	3.6	19.56	27.4	3.16	3.16	22.56	28.56	23.91				
VHT80	MCS0	2	138	5690	75.96	75.96	84.24	#####	75.76	75.28	-	-	-	-	-	-	
				NII-2C	73.04	73.04	75.56	100.6	73.24	72.76	23.98	30.00	23.98				
				NII-3	2.92	2.92	8.68	27.16	2.52	2.52	21.65	27.65	20.39				

TEST RESULTS DATA
Average Power Table

FCC Straddle Channel												
Mod.	Data Rate	NTX	CH.	Freq. (MHz)	Average Conducted Power (dBm)			FCC Conducted Power Limit (dBm)		DG (dBi)		Pass/Fail
					Ant 1	Ant 2	SUM	Ant 1	Ant 2	Ant 1	Ant 2	
HT20	MCS0	2	144	5720	15.90	17.29	19.66	-	-	7.15	7.15	-
				NII-2C	14.90	16.25	18.64	22.83	22.83	7.15	7.15	Pass
				NII-3	9.01	10.58	12.88	20.72	20.72	7.15	7.15	Pass
HT40	MCS0	2	142	5710	15.48	17.02	19.33	-	-	7.15	7.15	-
				NII-2C	15.12	16.61	18.94	22.83	22.83	7.15	7.15	Pass
				NII-3	4.51	6.52	8.64	14.85	14.85	7.15	7.15	Pass
VHT20	MCS0	2	144	5720	16.09	17.32	19.76	-	-	7.15	7.15	-
				NII-2C	15.10	16.32	18.76	22.83	22.83	7.15	7.15	Pass
				NII-3	9.16	10.47	12.87	20.72	20.72	7.15	7.15	Pass
VHT40	MCS0	2	142	5710	15.56	17.19	19.46	-	-	7.15	7.15	-
				NII-2C	15.24	16.80	19.10	22.83	22.83	7.15	7.15	Pass
				NII-3	4.09	6.53	8.49	22.77	22.77	7.15	7.15	Pass
VHT80	MCS0	2	138	5690	14.48	15.85	18.23	-	-	7.15	7.15	-
				NII-2C	14.33	15.71	18.08	22.83	22.83	7.15	7.15	Pass
				NII-3	-0.19	0.92	3.41	19.24	19.24	7.15	7.15	Pass

TEST RESULTS DATA
Power Spectral Density

Straddle Channel												
Mod.	Data Rate	NTX	CH.	Freq. (MHz)	Average Power Density (dBm/MHz)			Average PSD Limit (dBm/MHz)		DG (dBi)		Pass /Fail
					Ant 1	Ant 2	SUM	Ant 1	Ant 2	Ant 1	Ant 2	
VHT20	MCS0	2	144	NII-2C			9.39	9.85	7.15		Pass	
				NII-3			9.39	28.85	7.15		Pass	
VHT40	MCS0	2	142	NII-2C			6.78	9.85	7.15		Pass	
				NII-3			6.78	28.85	7.15		Pass	
VHT80	MCS0	2	138	NII-2C			2.78	9.85	7.15		Pass	
				NII-3			2.78	28.85	7.15		Pass	



Appendix B. Radiated Spurious Emission

Test Engineer :	Luke Chang, Ken Wu, Derreck Chen, Jesse Wang, and James Chiu	Temperature :	21~24°C
		Relative Humidity :	50~55%

Band 1 - 5150~5250MHz

WIFI 802.11a (Band Edge @ 3m)

WIFI Ant. 1	Note	Frequency (MHz)	Level (dBμV/m)	Over Limit (dB)	Limit Line (dBμV/m)	Read Level (dBμV)	Antenna Factor (dB/m)	Cable Loss (dB)	Preamp Factor (dB)	Ant Pos (cm)	Table Pos (deg)	Peak Avg. (P/A)	Pol. (H/V)	
802.11a CH 36 5180MHz		5148.2	55.84	-18.16	74	46.16	33.69	11.21	35.22	296	298	P	H	
		5150	48.92	-5.08	54	39.24	33.69	11.21	35.22	296	298	A	H	
	*	5180	106.35	-	-	96.58	33.78	11.21	35.22	296	298	P	H	
	*	5180	98.71	-	-	88.94	33.78	11.21	35.22	296	298	A	H	
													H	
														H
			5144.82	58.06	-15.94	74	48.38	33.69	11.21	35.22	103	4	P	V
			5150	50.98	-3.02	54	41.3	33.69	11.21	35.22	103	4	A	V
	*		5180	105.48	-	-	95.71	33.78	11.21	35.22	103	4	P	V
	*		5180	97.96	-	-	88.19	33.78	11.21	35.22	103	4	A	V
														V
														V
802.11a CH 44 5220MHz		5140.66	49.37	-24.63	74	39.69	33.69	11.21	35.22	279	301	P	H	
		5149.76	41.13	-12.87	54	31.45	33.69	11.21	35.22	279	301	A	H	
	*	5220	107.58	-	-	97.69	33.86	11.25	35.22	279	301	P	H	
	*	5220	99.59	-	-	89.7	33.86	11.25	35.22	279	301	A	H	
			5413.92	50.41	-23.59	74	39.37	34.38	11.89	35.23	279	301	P	H
			5430.24	42.99	-11.01	54	31.91	34.43	11.89	35.24	279	301	A	H
			5070.46	49.72	-24.28	74	40.32	33.47	11.14	35.21	103	2	P	V
			5148.46	41.64	-12.36	54	31.96	33.69	11.21	35.22	103	2	A	V
	*		5220	105.97	-	-	96.08	33.86	11.25	35.22	103	2	P	V
	*		5220	98.39	-	-	88.5	33.86	11.25	35.22	103	2	A	V
			5369.52	48.42	-25.58	74	37.64	34.25	11.76	35.23	103	2	P	V
			5429.76	41.59	-12.41	54	30.51	34.43	11.89	35.24	103	2	A	V



802.11a CH 48 5240MHz		5032.5	50.02	-23.98	74	40.73	33.39	11.11	35.21	292	300	P	H
		5088.92	40.85	-13.15	54	31.37	33.56	11.14	35.22	292	300	A	H
	*	5240	108	-	-	97.93	33.91	11.38	35.22	292	300	P	H
	*	5240	100.32	-	-	90.25	33.91	11.38	35.22	292	300	A	H
		5453.52	50.14	-23.86	74	39.02	34.47	11.89	35.24	292	300	P	H
		5451.12	43.15	-10.85	54	32.03	34.47	11.89	35.24	292	300	A	H
		5145.6	49.18	-24.82	74	39.5	33.69	11.21	35.22	103	2	P	V
		5146.12	40.92	-13.08	54	31.24	33.69	11.21	35.22	103	2	A	V
	*	5240	106.3	-	-	96.23	33.91	11.38	35.22	103	2	P	V
	*	5240	98.78	-	-	88.71	33.91	11.38	35.22	103	2	A	V
		5444.4	48.9	-25.1	74	37.82	34.43	11.89	35.24	103	2	P	V
		5452.08	41.9	-12.1	54	30.78	34.47	11.89	35.24	103	2	A	V
Remark	1. No other spurious found. 2. All results are PASS against Peak and Average limit line.												



Band 1 5150~5250MHz

WIFI 802.11a (Harmonic @ 3m)

WIFI Ant. 1	Note	Frequency (MHz)	Level (dBμV/m)	Over Limit (dB)	Limit Line (dBμV/m)	Read Level (dBμV)	Antenna Factor (dB/m)	Cable Loss (dB)	Preamp Factor (dB)	Ant Pos (cm)	Table Pos (deg)	Peak Avg. (P/A)	Pol. (H/V)
802.11a CH 36 5180MHz		10360	44.29	-29.71	74	47.24	39.09	17.17	59.21	100	0	P	H
		15540	43.75	-30.25	74	40.25	41.07	19.61	57.18	100	0	P	H
													H
													H
		10360	44.27	-29.73	74	47.22	39.09	17.17	59.21	100	0	P	V
		15540	44.27	-29.73	74	40.77	41.07	19.61	57.18	100	0	P	V
													V
													V
802.11a CH 44 5220MHz		10440	44.75	-29.25	74	47.58	39.15	17.17	59.15	100	0	P	H
		15660	43.08	-30.92	74	39.2	41.31	19.68	57.11	100	0	P	H
													H
													H
		10440	45.1	-28.9	74	47.93	39.15	17.17	59.15	100	0	P	V
		15660	44.6	-29.4	74	40.72	41.31	19.68	57.11	100	0	P	V
													V
													V
802.11a CH 48 5240MHz		10480	45.17	-28.83	74	47.92	39.19	17.17	59.11	100	0	P	H
		15720	45.39	-28.61	74	41.28	41.45	19.73	57.07	100	0	P	H
													H
													H
		10480	44.84	-29.16	74	47.59	39.19	17.17	59.11	100	0	P	V
		15720	44.52	-29.48	74	40.41	41.45	19.73	57.07	100	0	P	V
													V
													V
Remark	1. No other spurious found. 2. All results are PASS against Peak and Average limit line.												



Band 1 5150~5250MHz

Band 2 - 5250~5350MHz

WIFI 802.11a (Band Edge @ 3m)

WIFI Ant.	Note	Frequency	Level	Over Limit	Limit Line	Read Level	Antenna Factor	Cable Loss	Preamp Factor	Ant Pos	Table Pos	Peak Avg.	Pol.
1		(MHz)	(dBμV/m)	(dB)	(dBμV/m)	(dBμV)	(dB/m)	(dB)	(dB)	(cm)	(deg)	(P/A)	(H/V)
802.11a CH 52 5260MHz		5015.08	49.04	-24.96	74	39.84	33.34	11.07	35.21	275	302	P	H
		5141.96	40.74	-13.26	54	31.06	33.69	11.21	35.22	275	302	A	H
	*	5260	108.21	-	-	98.07	33.99	11.38	35.23	275	302	P	H
	*	5260	100.48	-	-	90.34	33.99	11.38	35.23	275	302	A	H
		5364.96	49.42	-24.58	74	38.64	34.25	11.76	35.23	275	302	P	H
		5447.28	41.56	-12.44	54	30.44	34.47	11.89	35.24	275	302	A	H
		5124.28	49.68	-24.32	74	40.07	33.65	11.18	35.22	101	3	P	V
		5111.02	40.88	-13.12	54	31.32	33.6	11.18	35.22	101	3	A	V
	*	5260	106.31	-	-	96.17	33.99	11.38	35.23	101	3	P	V
	*	5260	98.8	-	-	88.66	33.99	11.38	35.23	101	3	A	V
		5436	49.36	-24.64	74	38.28	34.43	11.89	35.24	101	3	P	V
		5456.88	40.76	-13.24	54	29.64	34.47	11.89	35.24	101	3	A	V
802.11a CH 60 5300MHz		5040.04	50.25	-23.75	74	40.92	33.43	11.11	35.21	300	302	P	H
		5144.04	40.62	-13.38	54	30.94	33.69	11.21	35.22	300	302	A	H
	*	5300	108.1	-	-	97.74	34.08	11.51	35.23	300	302	P	H
	*	5300	100.43	-	-	90.07	34.08	11.51	35.23	300	302	A	H
		5350.56	54.45	-19.55	74	43.71	34.21	11.76	35.23	300	302	P	H
		5350.56	46.72	-7.28	54	35.98	34.21	11.76	35.23	300	302	A	H
		5073.32	49.38	-24.62	74	39.93	33.52	11.14	35.21	101	3	P	V
		5127.14	40.56	-13.44	54	30.95	33.65	11.18	35.22	101	3	A	V
	*	5300	105.86	-	-	95.5	34.08	11.51	35.23	101	3	P	V
	*	5300	98.42	-	-	88.06	34.08	11.51	35.23	101	3	A	V
		5350.32	52.12	-21.88	74	41.38	34.21	11.76	35.23	101	3	P	V
		5350.08	44.43	-9.57	54	33.69	34.21	11.76	35.23	101	3	A	V



802.11a CH 64 5320MHz	*	5320	107.92	-	-	97.4	34.12	11.63	35.23	300	300	P	H
	*	5320	100.4	-	-	89.88	34.12	11.63	35.23	300	300	A	H
		5351.84	60.16	-13.84	74	49.42	34.21	11.76	35.23	300	300	P	H
		5350.08	53.6	-1.4	54	41.86	34.21	11.76	35.23	300	300	A	H
													H
													H
	*	5320	106.7	-	-	96.18	34.12	11.63	35.23	103	3	P	V
	*	5320	98.1	-	-	87.58	34.12	11.63	35.23	103	3	A	V
		5353.12	58.74	-15.26	74	48	34.21	11.76	35.23	103	3	P	V
		5350.08	50.21	-3.79	54	39.47	34.21	11.76	35.23	103	3	A	V
													V
													V
Remark	1. No other spurious found. 2. All results are PASS against Peak and Average limit line.												



Band 2 5250~5350MHz

WIFI 802.11a (Harmonic @ 3m)

WIFI Ant. 1	Note	Frequency (MHz)	Level (dBμV/m)	Over Limit (dB)	Limit Line (dBμV/m)	Read Level (dBμV)	Antenna Factor (dB/m)	Cable Loss (dB)	Preamp Factor (dB)	Ant Pos (cm)	Table Pos (deg)	Peak Avg. (P/A)	Pol. (H/V)
802.11a CH 52 5260MHz		10520	44.62	-29.38	74	47.35	39.18	17.17	59.08	100	0	P	H
		15780	45.6	-28.4	74	41.33	41.55	19.75	57.03	100	0	P	H
													H
													H
		10520	44.63	-29.37	74	47.36	39.18	17.17	59.08	100	0	P	V
		15780	45.35	-28.65	74	41.08	41.55	19.75	57.03	100	0	P	V
													V
													V
802.11a CH 60 5300MHz		10600	44.07	-29.93	74	46.8	39.06	17.17	58.96	100	0	P	H
		15900	46.15	-27.85	74	41.5	41.79	19.82	56.96	100	0	P	H
													H
													H
		10600	43.81	-30.19	74	46.54	39.06	17.17	58.96	100	0	P	V
		15900	45.2	-28.8	74	40.55	41.79	19.82	56.96	100	0	P	V
													V
													V
802.11a CH 64 5320MHz		10640	43.77	-30.23	74	46.5	39.01	17.17	58.91	100	0	P	H
		15960	44.52	-29.48	74	39.64	41.93	19.87	56.92	100	0	P	H
													H
													H
		10640	43.11	-30.89	74	45.84	39.01	17.17	58.91	100	0	P	V
		15960	43.94	-30.06	74	39.06	41.93	19.87	56.92	100	0	P	V
													V
													V
Remark	1. No other spurious found. 2. All results are PASS against Peak and Average limit line.												



Band 2 5250~5350MHz

Band 3 - 5470~5725MHz

WIFI 802.11a (Band Edge @ 3m)

WIFI Ant.	Note	Frequency	Level	Over Limit	Limit Line	Read Level	Antenna Factor	Cable Loss	Preamp Factor	Ant Pos	Table Pos	Peak Avg.	Pol.	
1		(MHz)	(dBµV/m)	(dB)	(dBµV/m)	(dBµV)	(dB/m)	(dB)	(dB)	(cm)	(deg)	(P/A)	(H/V)	
802.11a CH 100 5500MHz		5459.44	58.55	-15.45	74	47.35	34.55	11.89	35.24	287	300	P	H	
		5468.88	65.55	-2.65	68.2	54.33	34.57	11.89	35.24	287	300	P	H	
		5460	51.82	-2.18	54	40.62	34.55	11.89	35.24	287	300	A	H	
	*	5500	110.12	-	-	98.87	34.6	11.89	35.24	287	300	P	H	
	*	5500	102.06	-	-	90.81	34.6	11.89	35.24	287	300	A	H	
														H
			5458.8	57.27	-16.73	74	46.07	34.55	11.89	35.24	218	306	P	V
			5468.88	60.42	-7.78	68.2	49.2	34.57	11.89	35.24	218	306	P	V
			5459.76	48.96	-5.04	54	37.76	34.55	11.89	35.24	218	306	A	V
	*		5500	106.92	-	-	95.67	34.6	11.89	35.24	218	306	P	V
	*		5500	98.73	-	-	87.48	34.6	11.89	35.24	218	306	A	V
													V	
802.11a CH 116 5580MHz		5448.4	48.63	-25.37	74	37.51	34.47	11.89	35.24	292	303	P	H	
		5461.6	49.29	-18.91	68.2	38.17	34.47	11.89	35.24	292	303	P	H	
		5457.28	41.44	-12.56	54	30.32	34.47	11.89	35.24	292	303	A	H	
	*	5580	110.3	-	-	99.07	34.6	11.89	35.26	292	303	P	H	
	*	5580	102.63	-	-	91.4	34.6	11.89	35.26	292	303	A	H	
			5764.825	49.69	-18.51	68.2	38.27	34.6	12.11	35.29	292	303	P	H
			5455.6	49.49	-24.51	74	38.37	34.47	11.89	35.24	102	354	P	V
			5463.76	49.82	-18.38	68.2	38.66	34.51	11.89	35.24	102	354	P	V
			5457.04	40.89	-13.11	54	29.77	34.47	11.89	35.24	102	354	A	V
	*		5580	106.93	-	-	95.7	34.6	11.89	35.26	102	354	P	V
	*		5580	99.18	-	-	87.95	34.6	11.89	35.26	102	354	A	V
		5743.825	50.93	-17.27	68.2	39.51	34.6	12.11	35.29	102	354	P	V	



802.11a CH 140 5700MHz	*	5700	108.45	-	-	97.13	34.6	12	35.28	282	303	P	H
	*	5700	100.69	-	-	89.37	34.6	12	35.28	282	303	A	H
		5726.04	63.14	-5.06	68.2	51.77	34.6	12.06	35.29	282	303	P	H
													H
													H
													H
	*	5700	104.84	-	-	93.52	34.6	12	35.28	112	298	P	V
	*	5700	97.09	-	-	85.77	34.6	12	35.28	112	298	A	V
		5726.04	59.71	-8.49	68.2	48.34	34.6	12.06	35.29	112	298	P	V
													V
													V
													V
	Remark	1. No other spurious found. 2. All results are PASS against Peak and Average limit line.											



Band 3 - 5470~5725MHz

WIFI 802.11a (Harmonic @ 3m)

WIFI Ant. 1	Note	Frequency (MHz)	Level (dBμV/m)	Over Limit (dB)	Limit Line (dBμV/m)	Read Level (dBμV)	Antenna Factor (dB/m)	Cable Loss (dB)	Preamp Factor (dB)	Ant Pos (cm)	Table Pos (deg)	Peak Avg. (P/A)	Pol. (H/V)
802.11a CH 100 5500MHz		11000	43.75	-30.25	74	46.48	38.5	17.17	58.4	100	0	P	H
		16500	47.45	-20.75	68.2	40.32	43	20.23	56.1	100	0	P	H
													H
													H
		11000	44.14	-29.86	74	46.87	38.5	17.17	58.4	100	0	P	V
		16500	45.97	-22.23	68.2	38.84	43	20.23	56.1	100	0	P	V
													V
													V
802.11a CH 116 5580MHz		11160	42.26	-31.74	74	44.36	38.77	17.16	58.03	100	0	P	H
		16740	46.43	-21.77	68.2	39.1	42.9	20.39	55.96	100	0	P	H
													H
													H
		11160	43.8	-30.2	74	45.9	38.77	17.16	58.03	100	0	P	V
		16740	45.92	-22.28	68.2	38.59	42.9	20.39	55.96	100	0	P	V
													V
													V
802.11a CH 140 5700MHz		11400	43.6	-30.4	74	44.82	39.14	17.16	57.52	100	0	P	H
		17100	46.26	-27.74	74	38.81	42.64	20.65	55.84	100	0	P	H
													H
													H
		11400	43.56	-30.44	74	44.78	39.14	17.16	57.52	100	0	P	V
		17100	46.75	-27.25	74	39.3	42.64	20.65	55.84	100	0	P	V
													V
													V
Remark	1. No other spurious found. 2. All results are PASS against Peak and Average limit line.												



Band 3 - 5470~5725MHz

Emission below 1GHz

WIFI 802.11a (LF @ 3m)

WIFI Ant.	Note	Frequency	Level	Over Limit	Limit Line	Read Level	Antenna Factor	Cable Loss	Preamp Factor	Ant Pos	Table Pos	Peak Avg.	Pol.	
1		(MHz)	(dBμV/m)	(dB)	(dBμV/m)	(dBμV)	(dB/m)	(dB)	(dB)	(cm)	(deg)	(P/A)	(H/V)	
802.11a LF		144.75	38.75	-4.75	43.5	50.61	17.86	1.78	31.5	100	350	P	H	
		224.4	30.29	-15.71	46	42.93	16.72	2.07	31.43			P	H	
		290.82	34.68	-11.32	46	43.94	19.71	2.32	31.29			P	H	
		454	26.58	-19.42	46	31.6	23.18	2.89	31.09			P	H	
		752.2	30.41	-15.59	46	30.01	27.23	3.82	30.65			P	H	
		981.1	34.43	-19.57	54	30.71	30.26	3.98	30.52			P	H	
														H
														H
														H
														H
														H
														H
			77.52	34.47	-5.53	40	51.18	13.57	1.28	31.56	100	75	P	V
			99.93	32.71	-10.79	43.5	46.55	16.4	1.28	31.52			P	V
			219.54	29.4	-16.6	46	42.58	16.39	1.87	31.44			P	V
			330.8	28.36	-17.64	46	36.53	20.66	2.41	31.24			P	V
			646.5	28.73	-17.27	46	30.06	25.87	3.57	30.77			P	V
			986.7	33.46	-20.54	54	29.73	30.27	3.98	30.52			P	V
													V	
													V	
													V	
													V	
													V	
													V	
Remark	1. No other spurious found. 2. All results are PASS against limit line.													



Note symbol

*	Fundamental Frequency which can be ignored. However, the level of any unwanted emissions shall not exceed the level of the fundamental frequency.
!	Test result is over limit line.
P/A	Peak or Average
H/V	Horizontal or Vertical



A calculation example for radiated spurious emission is shown as below:

WIFI	Note	Frequency	Level	Over	Limit	Read	Antenna	Cable	Preamp	Ant	Table	Peak	Pol.
Ant.				Limit	Line	Level	Factor	Loss	Factor	Pos	Pos	Avg.	
1		(MHz)	(dBμV/m)	(dB)	(dBμV/m)	(dBμV)	(dB/m)	(dB)	(dB)	(cm)	(deg)	(P/A)	(H/V)
802.11b		2390	55.45	-18.55	74	54.51	32.22	4.58	35.86	103	308	P	H
CH 01													
2412MHz		2390	43.54	-10.46	54	42.6	32.22	4.58	35.86	103	308	A	H

- Level(dBμV/m) =
Antenna Factor(dB/m) + Cable Loss(dB) + Read Level(dBμV) - Preamp Factor(dB)
- Over Limit(dB) = Level(dBμV/m) – Limit Line(dBμV/m)

For Peak Limit @ 2390MHz:

- Level(dBμV/m)
= Antenna Factor(dB/m) + Cable Loss(dB) + Read Level(dBμV) - Preamp Factor(dB)
= 32.22(dB/m) + 4.58(dB) + 54.51(dBμV) – 35.86 (dB)
= 55.45 (dBμV/m)
- Over Limit(dB)
= Level(dBμV/m) – Limit Line(dBμV/m)
= 55.45(dBμV/m) – 74(dBμV/m)
= -18.55(dB)

For Average Limit @ 2390MHz:

- Level(dBμV/m)
= Antenna Factor(dB/m) + Cable Loss(dB) + Read Level(dBμV) - Preamp Factor(dB)
= 32.22(dB/m) + 4.58(dB) + 42.6(dBμV) – 35.86 (dB)
= 43.54 (dBμV/m)
- Over Limit(dB)
= Level(dBμV/m) – Limit Line(dBμV/m)
= 43.54(dBμV/m) – 54(dBμV/m)
= -10.46(dB)

Both peak and average measured complies with the limit line, so test result is “PASS”.



Appendix B. Radiated Spurious Emission

Test Engineer :	Luke Chang, Ken Wu, Derreck Chen, Jesse Wang, and James Chiu	Temperature :	21~24°C
		Relative Humidity :	50~55%

Band 1 - 5150~5250MHz

WIFI 802.11a (Band Edge @ 3m)

WIFI Ant. 2	Note	Frequency (MHz)	Level (dBμV/m)	Over Limit (dB)	Limit Line (dBμV/m)	Read Level (dBμV)	Antenna Factor (dB/m)	Cable Loss (dB)	Preamp Factor (dB)	Ant Pos (cm)	Table Pos (deg)	Peak Avg. (P/A)	Pol. (H/V)	
802.11a CH 36 5180MHz		5148.72	60.96	-13.04	74	51.28	33.69	11.21	35.22	100	347	P	H	
		5150	51.89	-2.11	54	42.21	33.69	11.21	35.22	100	347	A	H	
	*	5180	107.52	-	-	97.75	33.78	11.21	35.22	100	347	P	H	
	*	5180	99.42	-	-	89.65	33.78	11.21	35.22	100	347	A	H	
													H	
														H
			5145.6	58.24	-15.76	74	48.56	33.69	11.21	35.22	100	62	P	V
			5150	50.86	-3.14	54	41.18	33.69	11.21	35.22	100	62	A	V
	*		5180	106.44	-	-	96.67	33.78	11.21	35.22	100	62	P	V
	*		5180	98.27	-	-	88.5	33.78	11.21	35.22	100	62	A	V
														V
														V
802.11a CH 44 5220MHz		5137.28	50.53	-23.47	74	40.92	33.65	11.18	35.22	100	348	P	H	
		5150	42.6	-11.4	54	32.92	33.69	11.21	35.22	100	348	A	H	
	*	5220	107.69	-	-	97.8	33.86	11.25	35.22	100	348	P	H	
	*	5220	99.59	-	-	89.7	33.86	11.25	35.22	100	348	A	H	
			5437.44	48.8	-25.2	74	37.72	34.43	11.89	35.24	100	348	P	H
			5440.8	41.48	-12.52	54	30.4	34.43	11.89	35.24	100	348	A	H
			5147.68	50.41	-23.59	74	40.73	33.69	11.21	35.22	100	63	P	V
			5146.9	42.17	-11.83	54	32.49	33.69	11.21	35.22	100	63	A	V
	*		5220	107.65	-	-	97.76	33.86	11.25	35.22	100	63	P	V
	*		5220	99.59	-	-	89.7	33.86	11.25	35.22	100	63	A	V
			5419.92	49.34	-24.66	74	38.31	34.38	11.89	35.24	100	63	P	V
			5440.32	40.96	-13.04	54	29.88	34.43	11.89	35.24	100	63	A	V



802.11a CH 48 5240MHz		5099.32	50.08	-23.92	74	40.6	33.56	11.14	35.22	105	5	P	H
		5148.2	41.3	-12.7	54	31.62	33.69	11.21	35.22	105	5	A	H
	*	5240	109.08	-	-	99.01	33.91	11.38	35.22	105	5	P	H
	*	5240	100.84	-	-	90.77	33.91	11.38	35.22	105	5	A	H
		5351.04	49.7	-24.3	74	38.96	34.21	11.76	35.23	105	5	P	H
		5456.64	41.57	-12.43	54	30.45	34.47	11.89	35.24	105	5	A	H
		5144.04	50.39	-23.61	74	40.71	33.69	11.21	35.22	100	64	P	V
		5130.26	41.11	-12.89	54	31.5	33.65	11.18	35.22	100	64	A	V
	*	5240	108.35	-	-	98.28	33.91	11.38	35.22	100	64	P	V
	*	5240	100.11	-	-	90.04	33.91	11.38	35.22	100	64	A	V
		5399.28	49.37	-24.63	74	38.37	34.34	11.89	35.23	100	64	P	V
		5451.6	41.32	-12.68	54	30.2	34.47	11.89	35.24	100	64	A	V
Remark	1. No other spurious found. 2. All results are PASS against Peak and Average limit line.												



Band 1 5150~5250MHz

WIFI 802.11a (Harmonic @ 3m)

WIFI Ant. 2	Note	Frequency (MHz)	Level (dBμV/m)	Over Limit (dB)	Limit Line (dBμV/m)	Read Level (dBμV)	Antenna Factor (dB/m)	Cable Loss (dB)	Preamp Factor (dB)	Ant Pos (cm)	Table Pos (deg)	Peak Avg. (P/A)	Pol. (H/V)
802.11a CH 36 5180MHz		10360	44.48	-29.52	74	47.43	39.09	17.17	59.21	100	0	P	H
		15540	45.04	-28.96	74	41.54	41.07	19.61	57.18	100	0	P	H
													H
													H
		10360	44.59	-29.41	74	47.54	39.09	17.17	59.21	100	0	P	V
		15540	45.43	-28.57	74	41.93	41.07	19.61	57.18	100	0	P	V
													V
													V
802.11a CH 44 5220MHz		10440	44.98	-29.02	74	47.81	39.15	17.17	59.15	100	0	P	H
		15660	46.51	-27.49	74	42.63	41.31	19.68	57.11	100	0	P	H
													H
													H
		10440	45.11	-28.89	74	47.94	39.15	17.17	59.15	100	0	P	V
		15660	46.78	-27.22	74	42.9	41.31	19.68	57.11	100	0	P	V
													V
													V
802.11a CH 48 5240MHz		10480	45.11	-28.89	74	47.86	39.19	17.17	59.11	100	0	P	H
		15720	46.32	-27.68	74	42.21	41.45	19.73	57.07	100	0	P	H
													H
													H
		10480	44.76	-29.24	74	47.51	39.19	17.17	59.11	100	0	P	V
		15720	47.25	-26.75	74	43.14	41.45	19.73	57.07	100	0	P	V
													V
													V
Remark	1. No other spurious found. 2. All results are PASS against Peak and Average limit line.												



Band 1 5150~5250MHz

Band 2 - 5250~5350MHz

WIFI 802.11a (Band Edge @ 3m)

WIFI Ant.	Note	Frequency	Level	Over Limit	Limit Line	Read Level	Antenna Factor	Cable Loss	Preamp Factor	Ant Pos	Table Pos	Peak Avg.	Pol.
2		(MHz)	(dBμV/m)	(dB)	(dBμV/m)	(dBμV)	(dB/m)	(dB)	(dB)	(cm)	(deg)	(P/A)	(H/V)
802.11a CH 52 5260MHz		5047.84	49.47	-24.53	74	40.14	33.43	11.11	35.21	105	4	P	H
		5128.44	41.05	-12.95	54	31.44	33.65	11.18	35.22	105	4	A	H
	*	5260	109.33	-	-	99.19	33.99	11.38	35.23	105	4	P	H
	*	5260	101.11	-	-	90.97	33.99	11.38	35.23	105	4	A	H
		5415.6	49.44	-24.56	74	38.4	34.38	11.89	35.23	105	4	P	H
		5414.16	41.16	-12.84	54	30.12	34.38	11.89	35.23	105	4	A	H
		5135.72	50.13	-23.87	74	40.52	33.65	11.18	35.22	100	64	P	V
		5132.6	40.98	-13.02	54	31.37	33.65	11.18	35.22	100	64	A	V
	*	5260	108.5	-	-	98.36	33.99	11.38	35.23	100	64	P	V
	*	5260	100.13	-	-	89.99	33.99	11.38	35.23	100	64	A	V
		5449.68	50.55	-23.45	74	39.43	34.47	11.89	35.24	100	64	P	V
		5444.16	40.82	-13.18	54	29.74	34.43	11.89	35.24	100	64	A	V
802.11a CH 60 5300MHz		5111.8	49.86	-24.14	74	40.3	33.6	11.18	35.22	100	356	P	H
		5121.68	41.03	-12.97	54	31.47	33.6	11.18	35.22	100	356	A	H
	*	5300	108.59	-	-	98.23	34.08	11.51	35.23	100	356	P	H
	*	5300	100.24	-	-	89.88	34.08	11.51	35.23	100	356	A	H
		5351.52	53.8	-20.2	74	43.06	34.21	11.76	35.23	100	356	P	H
		5350.08	46.52	-7.48	54	35.78	34.21	11.76	35.23	100	356	A	H
		5105.3	49.43	-24.57	74	39.91	33.56	11.18	35.22	130	23	P	V
		5130.78	40.87	-13.13	54	31.26	33.65	11.18	35.22	130	23	A	V
	*	5300	108.79	-	-	98.43	34.08	11.51	35.23	130	23	P	V
	*	5300	100.47	-	-	90.11	34.08	11.51	35.23	130	23	A	V
		5351.04	53.58	-20.42	74	42.84	34.21	11.76	35.23	130	23	P	V
		5350.8	46.21	-7.79	54	35.47	34.21	11.76	35.23	130	23	A	V



802.11a CH 64 5320MHz	*	5320	108.23	-	-	97.71	34.12	11.63	35.23	105	356	P	H
	*	5320	100.7	-	-	90.18	34.12	11.63	35.23	105	356	A	H
		5350.56	61.23	-12.77	74	50.49	34.21	11.76	35.23	105	356	P	H
		5350.08	52.13	-1.87	54	41.39	34.21	11.76	35.23	105	356	A	H
													H
													H
	*	5320	108.39	-	-	97.87	34.12	11.63	35.23	105	34	P	V
	*	5320	100.88	-	-	90.36	34.12	11.63	35.23	105	34	A	V
		5352	59.36	-14.64	74	48.62	34.21	11.76	35.23	105	34	P	V
		5350.4	52.61	-1.39	54	41.87	34.21	11.76	35.23	105	34	A	V
													V
													V
Remark	1. No other spurious found. 2. All results are PASS against Peak and Average limit line.												



Band 2 5250~5350MHz

WIFI 802.11a (Harmonic @ 3m)

WIFI Ant. 2	Note	Frequency (MHz)	Level (dBμV/m)	Over Limit (dB)	Limit Line (dBμV/m)	Read Level (dBμV)	Antenna Factor (dB/m)	Cable Loss (dB)	Preamp Factor (dB)	Ant Pos (cm)	Table Pos (deg)	Peak Avg. (P/A)	Pol. (H/V)
802.11a CH 52 5260MHz		10520	45.64	-28.36	74	48.37	39.18	17.17	59.08	100	0	P	H
		15780	47.22	-26.78	74	42.95	41.55	19.75	57.03	100	0	P	H
													H
													H
		10520	45.11	-28.89	74	47.84	39.18	17.17	59.08	100	0	P	V
		15780	48.22	-25.78	74	43.95	41.55	19.75	57.03	100	0	P	V
													V
													V
802.11a CH 60 5300MHz		10600	44.66	-29.34	74	47.39	39.06	17.17	58.96	100	0	P	H
		15900	47.93	-26.07	74	43.28	41.79	19.82	56.96	100	0	P	H
													H
													H
		10600	44.4	-29.6	74	47.13	39.06	17.17	58.96	100	0	P	V
		15900	47.63	-26.37	74	42.98	41.79	19.82	56.96	100	0	P	V
													V
													V
802.11a CH 64 5320MHz		10640	44.18	-29.82	74	46.91	39.01	17.17	58.91	100	0	P	H
		15960	46.4	-27.6	74	41.52	41.93	19.87	56.92	100	0	P	H
													H
													H
		10640	43.93	-30.07	74	46.66	39.01	17.17	58.91	100	0	P	V
		15960	46.39	-27.61	74	41.51	41.93	19.87	56.92	100	0	P	V
													V
													V
Remark	1. No other spurious found. 2. All results are PASS against Peak and Average limit line.												



Band 2 5250~5350MHz

Band 3 - 5470~5725MHz

WIFI 802.11a (Band Edge @ 3m)

WIFI Ant.	Note	Frequency (MHz)	Level (dBμV/m)	Over Limit (dB)	Limit Line (dBμV/m)	Read Level (dBμV)	Antenna Factor (dB/m)	Cable Loss (dB)	Preamp Factor (dB)	Ant Pos (cm)	Table Pos (deg)	Peak Avg. (P/A)	Pol. (H/V)	
802.11a CH 100 5500MHz		5459.44	59.64	-14.36	74	48.52	34.47	11.89	35.24	100	353	P	H	
		5469.68	67.14	-1.06	68.2	55.98	34.51	11.89	35.24	100	353	P	H	
		5460	53.36	-1.04	54	41.84	34.47	11.89	35.24	100	353	A	H	
	*	5500	109.43	-	-	98.18	34.6	11.89	35.24	100	353	P	H	
	*	5500	101.73	-	-	90.48	34.6	11.89	35.24	100	353	A	H	
														H
			5460	59.55	-8.65	68.2	48.43	34.47	11.89	35.24	100	29	P	V
			5469.52	67.41	-1.19	68.2	55.85	34.51	11.89	35.24	100	29	P	V
			5460	52.72	-1.28	54	41.6	34.47	11.89	35.24	100	29	A	V
	*		5500	109.74	-	-	98.49	34.6	11.89	35.24	100	29	P	V
	*		5500	101.94	-	-	90.69	34.6	11.89	35.24	100	29	A	V
														V
802.11a CH 116 5580MHz		5391.52	49.17	-24.83	74	38.21	34.3	11.89	35.23	100	354	P	H	
		5465.44	49.5	-18.7	68.2	38.34	34.51	11.89	35.24	100	354	P	H	
		5455.36	41.1	-12.9	54	29.98	34.47	11.89	35.24	100	354	A	H	
	*	5580	109.02	-	-	97.79	34.6	11.89	35.26	100	354	P	H	
	*	5580	101.34	-	-	90.11	34.6	11.89	35.26	100	354	A	H	
			5749.95	50.38	-17.82	68.2	38.96	34.6	12.11	35.29	100	354	P	H
			5386.48	49.48	-24.52	74	38.52	34.3	11.89	35.23	108	61	P	V
			5462.56	49.17	-19.03	68.2	38.01	34.51	11.89	35.24	108	61	P	V
			5458.24	40.98	-13.02	54	29.86	34.47	11.89	35.24	108	61	A	V
	*		5580	109.13	-	-	97.9	34.6	11.89	35.26	108	61	P	V
	*		5580	101.57	-	-	90.34	34.6	11.89	35.26	108	61	A	V
			5760.8	49.33	-18.87	68.2	37.91	34.6	12.11	35.29	108	61	P	V



802.11a CH 140 5700MHz	*	5700	108.7	-	-	97.38	34.6	12	35.28	104	356	P	H
	*	5700	101.43	-	-	90.11	34.6	12	35.28	104	356	A	H
		5725.8	63.33	-4.87	68.2	51.96	34.6	12.06	35.29	104	356	P	H
													H
													H
													H
	*	5700	109.23	-	-	97.91	34.6	12	35.28	100	58	P	V
	*	5700	101.51	-	-	90.19	34.6	12	35.28	100	58	A	V
		5726.2	67.56	-1.14	68.2	55.69	34.6	12.06	35.29	100	58	P	V
													V
													V
													V
Remark	1. No other spurious found. 2. All results are PASS against Peak and Average limit line.												



Band 3 - 5470~5725MHz

WIFI 802.11a (Harmonic @ 3m)

WIFI Ant. 2	Note	Frequency (MHz)	Level (dBμV/m)	Over Limit (dB)	Limit Line (dBμV/m)	Read Level (dBμV)	Antenna Factor (dB/m)	Cable Loss (dB)	Preamp Factor (dB)	Ant Pos (cm)	Table Pos (deg)	Peak Avg. (P/A)	Pol. (H/V)
802.11a CH 100 5500MHz		11000	43.64	-30.36	74	46.37	38.5	17.17	58.4	100	0	P	H
		16500	46.91	-21.29	68.2	39.78	43	20.23	56.1	100	0	P	H
													H
													H
		11000	44.75	-29.25	74	47.48	38.5	17.17	58.4	100	0	P	V
		16500	46.51	-21.69	68.2	39.38	43	20.23	56.1	100	0	P	V
													V
													V
802.11a CH 116 5580MHz		11160	43.97	-30.03	74	46.07	38.77	17.16	58.03	100	0	P	H
		16740	47.01	-21.19	68.2	39.68	42.9	20.39	55.96	100	0	P	H
													H
													H
		11160	43.57	-30.43	74	45.67	38.77	17.16	58.03	100	0	P	V
		16740	47.48	-20.72	68.2	40.15	42.9	20.39	55.96	100	0	P	V
													V
													V
802.11a CH 140 5700MHz		11400	44.7	-29.3	74	45.92	39.14	17.16	57.52	100	0	P	H
		17100	50.24	-17.96	68.2	42.79	42.64	20.65	55.84	100	0	P	H
													H
													H
		11400	44.24	-29.76	74	45.46	39.14	17.16	57.52	100	0	P	V
		17100	52.75	-15.45	68.2	45.3	42.64	20.65	55.84	100	2	P	V
		17100	42.86	-11.14	54	35.41	42.64	20.65	55.84	100	2	A	V
													V
Remark	1. No other spurious found. 2. All results are PASS against Peak and Average limit line.												



Band 3 - Straddle Channel

WIFI 802.11a (Band Edge @ 3m)

WIFI	Note	Frequency	Level	Over	Limit	Read	Antenna	Cable	Preamp	Ant	Table	Peak	Pol.
Ant.				Limit	Line	Level	Factor	Loss	Factor	Pos	Pos	Avg.	
2		(MHz)	(dBμV/m)	(dB)	(dBμV/m)	(dBμV)	(dB/m)	(dB)	(dB)	(cm)	(deg)	(P/A)	(H/V)
802.11a CH 144 5720MHz	*	5720	108.05	-	-	96.67	34.6	12.06	35.28	100	356	P	H
	*	5720	100.32	-	-	88.94	34.6	12.06	35.28	100	356	A	H
													H
													H
													H
	*	5720	109.54	-	-	98.16	34.6	12.06	35.28	102	58	P	V
	*	5720	101.92	-	-	90.54	34.6	12.06	35.28	102	58	A	V
													V
													V
													V
													V
	Remark	1. No other spurious found. 2. All results are PASS against Peak and Average limit line.											



Band 3 - Straddle Channel
WIFI 802.11a (Harmonic @ 3m)

WIFI Ant. 2	Note	Frequency (MHz)	Level (dBµV/m)	Over Limit (dB)	Limit Line (dBµV/m)	Read Level (dBµV)	Antenna Factor (dB/m)	Cable Loss (dB)	Preamp Factor (dB)	Ant Pos (cm)	Table Pos (deg)	Peak Avg. (P/A)	Pol. (H/V)	
802.11a CH 144 5720MHz		11440	44.93	-29.07	74	46.03	39.19	17.16	57.45	100	0	P	H	
		17160	50.01	-23.99	74	42.65	42.53	20.7	55.87	100	0	P	H	
													H	
													H	
			11440	44.78	-29.22	74	45.88	39.19	17.16	57.45	100	0	P	V
			17160	50.53	-23.47	74	43.17	42.53	20.7	55.87	100	0	P	V
														V
														V
Remark	1. No other spurious found. 2. All results are PASS against Peak and Average limit line.													



Band 3 - Straddle Channel

Emission below 1GHz

WIFI 802.11a (LF @ 3m)

WIFI Ant.	Note	Frequency	Level	Over Limit	Limit Line	Read Level	Antenna Factor	Cable Loss	Preamp Factor	Ant Pos	Table Pos	Peak Avg.	Pol.	
2		(MHz)	(dBµV/m)	(dB)	(dBµV/m)	(dBµV)	(dB/m)	(dB)	(dB)	(cm)	(deg)	(P/A)	(H/V)	
802.11a LF		143.94	38.35	-5.15	43.5	49.78	17.89	1.78	31.1	100	265	P	H	
		225.48	33.31	-12.69	46	45.36	16.88	2.07	31			P	H	
		292.71	35.6	-10.4	46	44.62	19.73	2.32	31.07			P	H	
		557.6	28.13	-17.87	46	30.94	24.72	3.24	30.77			P	H	
		769.7	32.3	-13.7	46	31.44	27.4	3.82	30.36			P	H	
		971.3	34.16	-19.84	54	30.16	30.24	4.07	30.31			P	H	
														H
														H
														H
														H
														H
														H
			77.25	34.43	-5.57	40	50.78	13.57	1.28	31.2	100	66	P	V
			99.12	33.29	-10.21	43.5	46.84	16.27	1.28	31.1			P	V
			269.49	29.1	-16.9	46	38.38	19.4	2.32	31			P	V
			324.5	28.47	-17.53	46	36.56	20.5	2.41	31			P	V
			692	31.45	-14.55	46	31.91	26.31	3.65	30.42			P	V
			981.8	33.81	-20.19	54	29.84	30.26	3.98	30.27			P	V
													V	
													V	
													V	
													V	
													V	
													V	
Remark	1. No other spurious found. 2. All results are PASS against limit line.													



Note symbol

*	Fundamental Frequency which can be ignored. However, the level of any unwanted emissions shall not exceed the level of the fundamental frequency.
!	Test result is over limit line.
P/A	Peak or Average
H/V	Horizontal or Vertical



A calculation example for radiated spurious emission is shown as below:

WIFI	Note	Frequency	Level	Over	Limit	Read	Antenna	Cable	Preamp	Ant	Table	Peak	Pol.
Ant.				Limit	Line	Level	Factor	Loss	Factor	Pos	Pos	Avg.	
2		(MHz)	(dBμV/m)	(dB)	(dBμV/m)	(dBμV)	(dB/m)	(dB)	(dB)	(cm)	(deg)	(P/A)	(H/V)
802.11b		2390	55.45	-18.55	74	54.51	32.22	4.58	35.86	103	308	P	H
CH 01													
2412MHz		2390	43.54	-10.46	54	42.6	32.22	4.58	35.86	103	308	A	H

- Level(dBμV/m) =
Antenna Factor(dB/m) + Cable Loss(dB) + Read Level(dBμV) - Preamp Factor(dB)
- Over Limit(dB) = Level(dBμV/m) – Limit Line(dBμV/m)

For Peak Limit @ 2390MHz:

- Level(dBμV/m)
= Antenna Factor(dB/m) + Cable Loss(dB) + Read Level(dBμV) - Preamp Factor(dB)
= 32.22(dB/m) + 4.58(dB) + 54.51(dBμV) – 35.86 (dB)
= 55.45 (dBμV/m)
- Over Limit(dB)
= Level(dBμV/m) – Limit Line(dBμV/m)
= 55.45(dBμV/m) – 74(dBμV/m)
= -18.55(dB)

For Average Limit @ 2390MHz:

- Level(dBμV/m)
= Antenna Factor(dB/m) + Cable Loss(dB) + Read Level(dBμV) - Preamp Factor(dB)
= 32.22(dB/m) + 4.58(dB) + 42.6(dBμV) – 35.86 (dB)
= 43.54 (dBμV/m)
- Over Limit(dB)
= Level(dBμV/m) – Limit Line(dBμV/m)
= 43.54(dBμV/m) – 54(dBμV/m)
= -10.46(dB)

Both peak and average measured complies with the limit line, so test result is “PASS”.



Appendix B. Radiated Spurious Emission

Test Engineer :	Luke Chang, Ken Wu, Derreck Chen, Jesse Wang, and James Chiu	Temperature :	21~24°C
		Relative Humidity :	50~55%

Band 1 - 5150~5250MHz

WIFI 802.11a (Band Edge @ 3m)

WIFI Ant. 1+2	Note	Frequency (MHz)	Level (dBμV/m)	Over Limit (dB)	Limit Line (dBμV/m)	Read Level (dBμV)	Antenna Factor (dB/m)	Cable Loss (dB)	Preamp Factor (dB)	Ant Pos (cm)	Table Pos (deg)	Peak Avg. (P/A)	Pol. (H/V)	
802.11a CH 36 5180MHz		5145.6	61.33	-12.67	74	51.65	33.69	11.21	35.22	172	96	P	H	
		5150	52.71	-1.29	54	43.03	33.69	11.21	35.22	172	96	A	H	
	*	5180	110.77	-	-	101	33.78	11.21	35.22	172	96	P	H	
	*	5180	103.27	-	-	93.5	33.78	11.21	35.22	172	96	A	H	
													H	
														H
			5150	62.74	-11.26	74	53.06	33.69	11.21	35.22	273	360	P	V
			5150	51.71	-2.29	54	42.03	33.69	11.21	35.22	273	360	A	V
	*		5180	110.94	-	-	101.17	33.78	11.21	35.22	273	360	P	V
	*		5180	103.5	-	-	93.73	33.78	11.21	35.22	273	360	A	V
														V
														V
802.11a CH 44 5220MHz		5146.9	52.81	-21.19	74	43.13	33.69	11.21	35.22	172	78	P	H	
		5150	43.96	-10.04	54	34.28	33.69	11.21	35.22	172	78	A	H	
	*	5220	110.89	-	-	101	33.86	11.25	35.22	172	78	P	H	
	*	5220	103.57	-	-	93.68	33.86	11.25	35.22	172	78	A	H	
			5432.64	48.87	-25.13	74	37.79	34.43	11.89	35.24	172	78	P	H
			5432.88	41.81	-12.19	54	30.73	34.43	11.89	35.24	172	78	A	H
			5069.16	49.98	-24.02	74	40.58	33.47	11.14	35.21	297	350	P	V
			5148.98	42.89	-11.11	54	33.21	33.69	11.21	35.22	297	350	A	V
	*		5220	111.19	-	-	101.3	33.86	11.25	35.22	297	350	P	V
	*		5220	103.79	-	-	93.9	33.86	11.25	35.22	297	350	A	V
			5376.24	50.46	-23.54	74	39.68	34.25	11.76	35.23	297	350	P	V
			5430.48	42.84	-11.16	54	31.76	34.43	11.89	35.24	297	350	A	V



802.11a CH 48 5240MHz		5063.96	51.16	-22.84	74	41.76	33.47	11.14	35.21	174	77	P	H
		5146.12	42.01	-11.99	54	32.33	33.69	11.21	35.22	174	77	A	H
	*	5240	110.6	-	-	100.53	33.91	11.38	35.22	174	77	P	H
	*	5240	103.06	-	-	92.99	33.91	11.38	35.22	174	77	A	H
		5366.64	49.13	-24.87	74	38.35	34.25	11.76	35.23	174	77	P	H
		5454.24	42.08	-11.92	54	30.96	34.47	11.89	35.24	174	77	A	H
		5148.2	49.17	-24.83	74	39.49	33.69	11.21	35.22	307	346	P	V
		5145.08	41.56	-12.44	54	31.88	33.69	11.21	35.22	307	346	A	V
	*	5240	112.13	-	-	102.06	33.91	11.38	35.22	307	346	P	V
	*	5240	104.58	-	-	94.51	33.91	11.38	35.22	307	346	A	V
		5436.96	50.23	-23.77	74	39.15	34.43	11.89	35.24	307	346	P	V
		5451.12	42.51	-11.49	54	31.39	34.47	11.89	35.24	307	346	A	V
Remark	1. No other spurious found. 2. All results are PASS against Peak and Average limit line.												



Band 1 5150~5250MHz

WIFI 802.11a (Harmonic @ 3m)

WIFI Ant. 1+2	Note	Frequency (MHz)	Level (dBμV/m)	Over Limit (dB)	Limit Line (dBμV/m)	Read Level (dBμV)	Antenna Factor (dB/m)	Cable Loss (dB)	Preamp Factor (dB)	Ant Pos (cm)	Table Pos (deg)	Peak Avg. (P/A)	Pol. (H/V)
802.11a CH 36 5180MHz		10360	44.74	-29.26	74	47.69	39.09	17.17	59.21	100	0	P	H
		15540	45.61	-28.39	74	42.11	41.07	19.61	57.18	100	0	P	H
													H
													H
		10360	45.96	-28.04	74	48.91	39.09	17.17	59.21	100	0	P	V
		15540	47.08	-26.92	74	43.58	41.07	19.61	57.18	100	0	P	V
													V
													V
802.11a CH 44 5220MHz		10440	46.15	-27.85	74	48.98	39.15	17.17	59.15	100	0	P	H
		15660	46.26	-27.74	74	42.38	41.31	19.68	57.11	100	0	P	H
													H
													H
		10440	44.59	-29.41	74	47.42	39.15	17.17	59.15	100	0	P	V
		15660	46.35	-27.65	74	42.47	41.31	19.68	57.11	100	0	P	V
													V
													V
802.11a CH 48 5240MHz		10480	45.75	-28.25	74	48.5	39.19	17.17	59.11	100	0	P	H
		15720	47.15	-26.85	74	43.04	41.45	19.73	57.07	100	0	P	H
													H
													H
		10480	45.69	-28.31	74	48.44	39.19	17.17	59.11	100	0	P	V
		15720	47.34	-26.66	74	43.23	41.45	19.73	57.07	100	0	P	V
													V
													V
Remark	1. No other spurious found. 2. All results are PASS against Peak and Average limit line.												



Band 1 5150~5250MHz

WIFI 802.11ac VHT20 (Band Edge @ 3m)

WIFI Ant. 1+2	Note	Frequency (MHz)	Level (dBμV/m)	Over Limit (dB)	Limit Line (dBμV/m)	Read Level (dBμV)	Antenna Factor (dB/m)	Cable Loss (dB)	Preamp Factor (dB)	Ant Pos (cm)	Table Pos (deg)	Peak Avg. (P/A)	Pol. (H/V)	
802.11ac VHT20 CH 36 5180MHz		5150	60.69	-13.31	74	51.01	33.69	11.21	35.22	100	29	P	H	
		5148.98	52.27	-1.73	54	42.59	33.69	11.21	35.22	100	29	A	H	
	*	5180	108.07	-	-	98.3	33.78	11.21	35.22	100	29	P	H	
	*	5180	101.14	-	-	91.37	33.78	11.21	35.22	100	29	A	H	
													H	
														H
			5149.76	60.56	-13.44	74	50.88	33.69	11.21	35.22	174	298	P	V
			5150	53.35	-1.65	54	42.67	33.69	11.21	35.22	174	298	A	V
		*	5180	107.96	-	-	98.19	33.78	11.21	35.22	174	298	P	V
		*	5180	99.99	-	-	90.22	33.78	11.21	35.22	174	298	A	V
													V	
													V	
802.11ac VHT20 CH 44 5220MHz		5136.76	50.95	-23.05	74	41.34	33.65	11.18	35.22	100	31	P	H	
		5150	43.96	-10.04	54	34.28	33.69	11.21	35.22	100	31	A	H	
		*	5220	109.44	-	-	99.55	33.86	11.25	35.22	100	31	P	H
		*	5220	102	-	-	92.11	33.86	11.25	35.22	100	31	A	H
			5351.76	49.73	-24.27	74	38.99	34.21	11.76	35.23	100	31	P	H
			5433.36	41.2	-12.8	54	30.12	34.43	11.89	35.24	100	31	A	H
			5147.94	51.44	-22.56	74	41.76	33.69	11.21	35.22	180	310	P	V
			5149.76	42.89	-11.11	54	33.21	33.69	11.21	35.22	180	310	A	V
		*	5220	109.44	-	-	99.55	33.86	11.25	35.22	180	310	P	V
		*	5220	102.1	-	-	92.21	33.86	11.25	35.22	180	310	A	V
		5433.36	50.87	-23.13	74	39.79	34.43	11.89	35.24	180	310	P	V	
		5430.24	41.97	-12.03	54	30.89	34.43	11.89	35.24	180	310	A	V	



802.11ac VHT20 CH 48 5240MHz		5086.84	50.25	-23.75	74	40.81	33.52	11.14	35.22	100	30	P	H
		5149.76	41.88	-12.12	54	32.2	33.69	11.21	35.22	100	30	A	H
	*	5240	109.3	-	-	99.23	33.91	11.38	35.22	100	30	P	H
	*	5240	101.96	-	-	91.89	33.91	11.38	35.22	100	30	A	H
		5452.8	48.7	-25.3	74	37.58	34.47	11.89	35.24	100	30	P	H
		5454.24	41.43	-12.57	54	30.31	34.47	11.89	35.24	100	30	A	H
		5093.6	50.1	-23.9	74	40.62	33.56	11.14	35.22	168	309	P	V
		5148.2	41.36	-12.64	54	31.68	33.69	11.21	35.22	168	309	A	V
	*	5240	110.18	-	-	100.11	33.91	11.38	35.22	168	309	P	V
	*	5240	102.29	-	-	92.22	33.91	11.38	35.22	168	309	A	V
		5450.88	50.08	-23.92	74	38.96	34.47	11.89	35.24	168	309	P	V
		5451.6	42.22	-11.78	54	31.1	34.47	11.89	35.24	168	309	A	V
Remark	1. No other spurious found. 2. All results are PASS against Peak and Average limit line.												



Band 1 5150~5250MHz

WIFI 802.11ac VHT20 (Harmonic @ 3m)

WIFI Ant. 1+2	Note	Frequency (MHz)	Level (dBμV/m)	Over Limit (dB)	Limit Line (dBμV/m)	Read Level (dBμV)	Antenna Factor (dB/m)	Cable Loss (dB)	Preamp Factor (dB)	Ant Pos (cm)	Table Pos (deg)	Peak Avg. (P/A)	Pol. (H/V)	
802.11ac VHT20 CH 36 5180MHz		10360	45.24	-28.76	74	48.19	39.09	17.17	59.21	100	0	P	H	
		15540	46.22	-27.78	74	42.72	41.07	19.61	57.18	100	0	P	H	
													H	
													H	
			10360	45.77	-28.23	74	48.72	39.09	17.17	59.21	100	0	P	V
			15540	45.72	-28.28	74	42.22	41.07	19.61	57.18	100	0	P	V
														V
802.11ac VHT20 CH 44 5220MHz		10440	45.84	-28.16	74	48.67	39.15	17.17	59.15	100	0	P	H	
		15660	46.37	-27.63	74	42.49	41.31	19.68	57.11	100	0	P	H	
													H	
													H	
			10440	45.88	-28.12	74	48.71	39.15	17.17	59.15	100	0	P	V
			15660	46.06	-27.94	74	42.18	41.31	19.68	57.11	100	0	P	V
														V
802.11ac VHT20 CH 48 5240MHz		10480	44.92	-29.08	74	47.67	39.19	17.17	59.11	100	0	P	H	
		15720	46.67	-27.33	74	42.56	41.45	19.73	57.07	100	0	P	H	
													H	
													H	
			10480	45.14	-28.86	74	47.89	39.19	17.17	59.11	100	0	P	V
			15720	46.93	-27.07	74	42.82	41.45	19.73	57.07	100	0	P	V
														V
Remark	1. No other spurious found.													
	2. All results are PASS against Peak and Average limit line.													



Band 1 5150~5250MHz

WIFI 802.11ac VHT40 (Band Edge @ 3m)

WIFI Ant. 1+2	Note	Frequency (MHz)	Level (dBμV/m)	Over Limit (dB)	Limit Line (dBμV/m)	Read Level (dBμV)	Antenna Factor (dB/m)	Cable Loss (dB)	Preamp Factor (dB)	Ant Pos (cm)	Table Pos (deg)	Peak Avg. (P/A)	Pol. (H/V)
802.11ac VHT40 CH 38 5190MHz		5148.46	63.63	-10.37	74	53.95	33.69	11.21	35.22	100	33	P	H
		5148.46	53.54	-1.46	54	42.86	33.69	11.21	35.22	100	33	P	H
	*	5190	103.09	-	-	93.28	33.78	11.25	35.22	100	33	P	H
	*	5190	96.07	-	-	86.26	33.78	11.25	35.22	100	33	A	H
		5384.64	49.59	-24.41	74	38.63	34.3	11.89	35.23	100	33	P	H
		5452.32	40.92	-13.08	54	29.8	34.47	11.89	35.24	100	33	A	H
		5147.94	60.85	-13.15	74	51.17	33.69	11.21	35.22	178	304	P	V
		5148.46	53.15	-1.85	54	42.47	33.69	11.21	35.22	178	304	A	V
	*	5190	103.83	-	-	94.02	33.78	11.25	35.22	178	304	P	V
	*	5190	96.28	-	-	86.47	33.78	11.25	35.22	178	304	A	V
		5437.44	48.74	-25.26	74	37.66	34.43	11.89	35.24	178	304	P	V
		5427.12	41.15	-12.85	54	30.12	34.38	11.89	35.24	178	304	A	V
802.11ac VHT40 CH 46 5230MHz		5142.22	58.79	-15.21	74	49.11	33.69	11.21	35.22	100	30	P	H
		5148.72	51.12	-2.88	54	41.44	33.69	11.21	35.22	100	30	A	H
	*	5230	106.12	-	-	96.05	33.91	11.38	35.22	100	30	P	H
	*	5230	99.1	-	-	89.03	33.91	11.38	35.22	100	30	A	H
		5401.2	49.28	-24.72	74	38.28	34.34	11.89	35.23	100	30	P	H
		5351.04	42.47	-11.53	54	31.73	34.21	11.76	35.23	100	30	A	H
		5143.52	57.81	-16.19	74	48.13	33.69	11.21	35.22	161	298	P	V
		5148.2	50.83	-3.17	54	41.15	33.69	11.21	35.22	161	298	A	V
	*	5230	108.18	-	-	98.11	33.91	11.38	35.22	161	298	P	V
	*	5230	100.16	-	-	90.09	33.91	11.38	35.22	161	298	A	V
	5358	50.72	-23.28	74	39.98	34.21	11.76	35.23	161	298	P	V	
	5350.32	43.1	-10.9	54	32.36	34.21	11.76	35.23	161	298	A	V	
Remark	1. No other spurious found. 2. All results are PASS against Peak and Average limit line.												



Band 1 5150~5250MHz

WIFI 802.11ac VHT40 (Harmonic @ 3m)

WIFI Ant. 1+2	Note	Frequency (MHz)	Level (dBμV/m)	Over Limit (dB)	Limit Line (dBμV/m)	Read Level (dBμV)	Antenna Factor (dB/m)	Cable Loss (dB)	Preamp Factor (dB)	Ant Pos (cm)	Table Pos (deg)	Peak Avg. (P/A)	Pol. (H/V)	
802.11ac VHT40 CH 38 5190MHz		10380	45.02	-28.98	74	47.93	39.11	17.17	59.19	100	0	P	H	
		15570	47.04	-26.96	74	43.43	41.14	19.63	57.16	100	0	P	H	
													H	
													H	
			10380	46.69	-27.31	74	49.6	39.11	17.17	59.19	100	0	P	V
			15570	47.05	-26.95	74	43.44	41.14	19.63	57.16	100	0	P	V
														V
802.11ac VHT40 CH 46 5230MHz		10460	44.95	-29.05	74	47.76	39.16	17.17	59.14	100	0	P	H	
		15690	46.99	-27.01	74	43	41.38	19.7	57.09	100	0	P	H	
													H	
													H	
			10460	45.43	-28.57	74	48.24	39.16	17.17	59.14	100	0	P	V
			15690	45.9	-28.1	74	41.91	41.38	19.7	57.09	100	0	P	V
														V
Remark	1. No other spurious found.													
	2. All results are PASS against Peak and Average limit line.													



Band 1 5150~5250MHz

WIFI 802.11ac VHT80 (Band Edge @ 3m)

WIFI Ant. 1+2	Note	Frequency (MHz)	Level (dBμV/m)	Over Limit (dB)	Limit Line (dBμV/m)	Read Level (dBμV)	Antenna Factor (dB/m)	Cable Loss (dB)	Preamp Factor (dB)	Ant Pos (cm)	Table Pos (deg)	Peak Avg. (P/A)	Pol. (H/V)
802.11ac VHT80 CH 42 5210MHz		5121.94	61.36	-12.64	74	51.8	33.6	11.18	35.22	100	29	P	H
		5121.16	53.75	-1.25	54	43.19	33.6	11.18	35.22	100	29	A	H
	*	5210	100.29	-	-	90.4	33.86	11.25	35.22	100	29	P	H
	*	5210	92.85	-	-	82.96	33.86	11.25	35.22	100	29	A	H
		5357.28	48.8	-25.2	74	38.06	34.21	11.76	35.23	100	29	P	H
		5355.84	41.8	-12.2	54	31.06	34.21	11.76	35.23	100	29	A	H
		5121.16	59.84	-14.16	74	50.28	33.6	11.18	35.22	162	298	P	V
		5121.16	52.06	-1.94	54	42.5	33.6	11.18	35.22	162	298	A	V
	*	5210	100.92	-	-	91.03	33.86	11.25	35.22	162	298	P	V
	*	5210	93.76	-	-	83.87	33.86	11.25	35.22	162	298	A	V
		5358.24	50.89	-23.11	74	40.15	34.21	11.76	35.23	162	298	P	V
		5350.8	42.87	-11.13	54	32.13	34.21	11.76	35.23	162	298	A	V
Remark	1. No other spurious found. 2. All results are PASS against Peak and Average limit line.												



Band 1 5150~5250MHz

WIFI 802.11ac VHT80 (Harmonic @ 3m)

WIFI Ant. 1+2	Note	Frequency (MHz)	Level (dBμV/m)	Over Limit (dB)	Limit Line (dBμV/m)	Read Level (dBμV)	Antenna Factor (dB/m)	Cable Loss (dB)	Preamp Factor (dB)	Ant Pos (cm)	Table Pos (deg)	Peak Avg. (P/A)	Pol. (H/V)	
802.11ac VHT80 CH 42 5210MHz		10420	45.44	-28.56	74	48.31	39.13	17.17	59.17	100	0	P	H	
		15630	46.84	-27.16	74	43	41.28	19.68	57.12	100	0	P	H	
													H	
													H	
			10420	44.79	-29.21	74	47.66	39.13	17.17	59.17	100	0	P	V
			15630	47.14	-26.86	74	43.3	41.28	19.68	57.12	100	0	P	V
														V
														V
Remark	1. No other spurious found. 2. All results are PASS against Peak and Average limit line.													



Band 2 - 5250~5350MHz

WIFI 802.11a (Band Edge @ 3m)

WIFI	Note	Frequency	Level	Over	Limit	Read	Antenna	Cable	Preamp	Ant	Table	Peak	Pol.
Ant.				Limit	Line	Level	Factor	Loss	Factor	Pos	Pos	Avg.	
1+2		(MHz)	(dBμV/m)	(dB)	(dBμV/m)	(dBμV)	(dB/m)	(dB)	(dB)	(cm)	(deg)	(P/A)	(H/V)
802.11a CH 52 5260MHz		5092.82	52.29	-21.71	74	42.81	33.56	11.14	35.22	174	77	P	H
		5134.94	41.7	-12.3	54	32.09	33.65	11.18	35.22	174	77	A	H
	*	5260	110.85	-	-	100.71	33.99	11.38	35.23	174	77	P	H
	*	5260	103.1	-	-	92.96	33.99	11.38	35.23	174	77	A	H
		5456.64	50.07	-23.93	74	38.95	34.47	11.89	35.24	174	77	P	H
		5350.32	41.27	-12.73	54	30.53	34.21	11.76	35.23	174	77	A	H
		5140.4	49.3	-24.7	74	39.62	33.69	11.21	35.22	303	346	P	V
		5149.24	41.47	-12.53	54	31.79	33.69	11.21	35.22	303	346	A	V
	*	5260	112.25	-	-	102.11	33.99	11.38	35.23	303	346	P	V
	*	5260	104.79	-	-	94.65	33.99	11.38	35.23	303	346	A	V
		5403.6	51.81	-22.19	74	40.81	34.34	11.89	35.23	303	346	P	V
		5412.48	41.71	-12.29	54	30.67	34.38	11.89	35.23	303	346	A	V
802.11a CH 60 5300MHz		5105.56	49.59	-24.41	74	40.03	33.6	11.18	35.22	176	4	P	H
		5134.68	41.16	-12.84	54	31.55	33.65	11.18	35.22	176	4	A	H
	*	5300	110	-	-	99.64	34.08	11.51	35.23	176	4	P	H
	*	5300	102.04	-	-	91.68	34.08	11.51	35.23	176	4	A	H
		5353.68	53.67	-20.33	74	42.93	34.21	11.76	35.23	176	4	P	H
		5351.52	46.35	-7.65	54	35.61	34.21	11.76	35.23	176	4	A	H
		5024.7	49.28	-24.72	74	39.99	33.39	11.11	35.21	301	346	P	V
		5141.7	41.31	-12.69	54	31.63	33.69	11.21	35.22	301	346	A	V
	*	5300	112.25	-	-	101.89	34.08	11.51	35.23	301	346	P	V
	*	5300	104.75	-	-	94.39	34.08	11.51	35.23	301	346	A	V
		5350.32	52.3	-21.7	74	41.56	34.21	11.76	35.23	301	346	P	V
		5351.04	46.5	-7.5	54	35.76	34.21	11.76	35.23	301	346	A	V



802.11a CH 64 5320MHz	*	5320	108.47	-	-	97.95	34.12	11.63	35.23	180	308	P	H
	*	5320	100.94	-	-	90.42	34.12	11.63	35.23	180	308	A	H
		5350.56	58.92	-15.08	74	48.18	34.21	11.76	35.23	180	308	P	H
		5350.08	50.37	-3.63	54	39.63	34.21	11.76	35.23	180	308	A	H
													H
													H
	*	5320	110.88	-	-	100.36	34.12	11.63	35.23	301	346	P	V
	*	5320	103.35	-	-	92.83	34.12	11.63	35.23	301	346	A	V
		5351.68	59.28	-14.72	74	48.54	34.21	11.76	35.23	301	346	P	V
		5351.52	52.92	-1.08	54	42.18	34.21	11.76	35.23	301	346	A	V
													V
													V
Remark	1. No other spurious found. 2. All results are PASS against Peak and Average limit line.												



Band 2 5250~5350MHz

WIFI 802.11a (Harmonic @ 3m)

WIFI Ant. 1+2	Note	Frequency (MHz)	Level (dBμV/m)	Over Limit (dB)	Limit Line (dBμV/m)	Read Level (dBμV)	Antenna Factor (dB/m)	Cable Loss (dB)	Preamp Factor (dB)	Ant Pos (cm)	Table Pos (deg)	Peak Avg. (P/A)	Pol. (H/V)
802.11a CH 52 5260MHz		10520	44.08	-29.92	74	46.81	39.18	17.17	59.08	100	0	P	H
		15780	47.07	-26.93	74	42.8	41.55	19.75	57.03	100	0	P	H
													H
													H
		10520	45.58	-28.42	74	48.31	39.18	17.17	59.08	100	0	P	V
		15780	47.25	-26.75	74	42.98	41.55	19.75	57.03	100	0	P	V
													V
													V
802.11a CH 60 5300MHz		10600	46.12	-27.88	74	48.85	39.06	17.17	58.96	100	0	P	H
		15900	46.68	-27.32	74	42.03	41.79	19.82	56.96	100	0	P	H
													H
													H
		10600	45.38	-28.62	74	48.11	39.06	17.17	58.96	100	0	P	V
		15900	46.79	-27.21	74	42.14	41.79	19.82	56.96	100	0	P	V
													V
													V
802.11a CH 64 5320MHz		10640	45.28	-28.72	74	48.01	39.01	17.17	58.91	100	0	P	H
		15960	46.7	-27.3	74	41.82	41.93	19.87	56.92	100	0	P	H
													H
													H
		10640	44.88	-29.12	74	47.61	39.01	17.17	58.91	100	0	P	V
		15960	47.73	-26.27	74	42.85	41.93	19.87	56.92	100	0	P	V
													V
													V
Remark	1. No other spurious found. 2. All results are PASS against Peak and Average limit line.												



Band 2 5250~5350MHz

WIFI 802.11ac VHT20 (Band Edge @ 3m)

WIFI Ant. 1+2	Note	Frequency (MHz)	Level (dBμV/m)	Over Limit (dB)	Limit Line (dBμV/m)	Read Level (dBμV)	Antenna Factor (dB/m)	Cable Loss (dB)	Preamp Factor (dB)	Ant Pos (cm)	Table Pos (deg)	Peak Avg. (P/A)	Pol. (H/V)
802.11ac VHT20 CH 52 5260MHz		5094.64	50.53	-23.47	74	41.05	33.56	11.14	35.22	100	29	P	H
		5148.46	41.73	-12.27	54	32.05	33.69	11.21	35.22	100	29	A	H
	*	5260	111.1	-	-	100.96	33.99	11.38	35.23	100	29	P	H
	*	5260	103.02	-	-	92.88	33.99	11.38	35.23	100	29	A	H
		5426.88	49.51	-24.49	74	38.48	34.38	11.89	35.24	100	29	P	H
		5353.68	41.24	-12.76	54	30.5	34.21	11.76	35.23	100	29	A	H
		5109.46	49.39	-24.61	74	39.83	33.6	11.18	35.22	170	306	P	V
		5145.08	41.5	-12.5	54	31.82	33.69	11.21	35.22	170	306	A	V
	*	5260	112.16	-	-	102.02	33.99	11.38	35.23	170	306	P	V
	*	5260	103.75	-	-	93.61	33.99	11.38	35.23	170	306	A	V
		5436.72	49.47	-24.53	74	38.39	34.43	11.89	35.24	170	306	P	V
		5362.56	41.91	-12.09	54	31.13	34.25	11.76	35.23	170	306	A	V
802.11ac VHT20 CH 60 5300MHz		5072.02	50.26	-23.74	74	40.81	33.52	11.14	35.21	100	33	P	H
		5110.5	41.47	-12.53	54	31.91	33.6	11.18	35.22	100	33	A	H
	*	5300	109.89	-	-	99.53	34.08	11.51	35.23	100	33	P	H
	*	5300	102.16	-	-	91.8	34.08	11.51	35.23	100	33	A	H
		5351.04	52.61	-21.39	74	41.87	34.21	11.76	35.23	100	33	P	H
		5350.56	46.04	-7.96	54	35.3	34.21	11.76	35.23	100	33	A	H
		5143	50.4	-23.6	74	40.72	33.69	11.21	35.22	171	304	P	V
		5079.04	41.55	-12.45	54	32.1	33.52	11.14	35.21	171	304	A	V
	*	5300	112.16	-	-	101.8	34.08	11.51	35.23	171	304	P	V
	*	5300	103.26	-	-	92.9	34.08	11.51	35.23	171	304	A	V
	5352.24	55.94	-18.06	74	45.2	34.21	11.76	35.23	171	304	P	V	
	5350.08	49.17	-4.83	54	38.43	34.21	11.76	35.23	171	304	A	V	



802.11ac VHT20 CH 64 5320MHz	*	5320	108.48	-	-	97.96	34.12	11.63	35.23	100	33	P	H
	*	5320	100.61	-	-	90.09	34.12	11.63	35.23	100	33	A	H
		5351.04	56.28	-17.72	74	45.54	34.21	11.76	35.23	100	33	P	H
		5350.24	51.19	-2.81	54	40.45	34.21	11.76	35.23	100	33	A	H
													H
													H
	*	5320	110.63	-	-	100.11	34.12	11.63	35.23	163	305	P	V
	*	5320	102.44	-	-	91.92	34.12	11.63	35.23	163	305	A	V
		5351.84	60.03	-13.97	74	49.29	34.21	11.76	35.23	163	305	P	V
		5350.24	53.59	-1.41	54	41.85	34.21	11.76	35.23	163	305	A	V
													V
													V
Remark	1. No other spurious found. 2. All results are PASS against Peak and Average limit line.												



Band 2 5250~5350MHz

WIFI 802.11ac VHT20 (Harmonic @ 3m)

WIFI Ant. 1+2	Note	Frequency (MHz)	Level (dBμV/m)	Over Limit (dB)	Limit Line (dBμV/m)	Read Level (dBμV)	Antenna Factor (dB/m)	Cable Loss (dB)	Preamp Factor (dB)	Ant Pos (cm)	Table Pos (deg)	Peak Avg. (P/A)	Pol. (H/V)	
802.11ac VHT20 CH 52 5260MHz		10520	44.34	-29.66	74	47.07	39.18	17.17	59.08	100	0	P	H	
		15780	48.35	-25.65	74	44.08	41.55	19.75	57.03	100	0	P	H	
													H	
													H	
			10520	45.88	-28.12	74	48.61	39.18	17.17	59.08	100	0	P	V
			15780	47.58	-26.42	74	43.31	41.55	19.75	57.03	100	0	P	V
														V
802.11ac VHT20 CH 60 5300MHz		10600	44.85	-29.15	74	47.58	39.06	17.17	58.96	100	0	P	H	
		15900	47.18	-26.82	74	42.53	41.79	19.82	56.96	100	0	P	H	
													H	
													H	
			10600	44.43	-29.57	74	47.16	39.06	17.17	58.96	100	0	P	V
			15900	46.2	-27.8	74	41.55	41.79	19.82	56.96	100	0	P	V
														V
802.11ac VHT20 CH 64 5320MHz		10640	43.85	-30.15	74	46.58	39.01	17.17	58.91	100	0	P	H	
		15960	46.54	-27.46	74	41.66	41.93	19.87	56.92	100	0	P	H	
													H	
													H	
			10640	44.51	-29.49	74	47.24	39.01	17.17	58.91	100	0	P	V
			15960	47.32	-26.68	74	42.44	41.93	19.87	56.92	100	0	P	V
														V
Remark	1. No other spurious found.													
	2. All results are PASS against Peak and Average limit line.													



Band 2 5250~5350MHz

WIFI 802.11ac VHT40 (Band Edge @ 3m)

WIFI Ant. 1+2	Note	Frequency (MHz)	Level (dBμV/m)	Over Limit (dB)	Limit Line (dBμV/m)	Read Level (dBμV)	Antenna Factor (dB/m)	Cable Loss (dB)	Preamp Factor (dB)	Ant Pos (cm)	Table Pos (deg)	Peak Avg. (P/A)	Pol. (H/V)	
802.11ac VHT40 CH 54 5270MHz		5148.46	52.6	-21.4	74	42.92	33.69	11.21	35.22	100	32	P	H	
		5149.24	46.29	-7.71	54	36.61	33.69	11.21	35.22	100	32	A	H	
	*	5270	107.57	-	-	97.3	33.99	11.51	35.23	100	32	P	H	
	*	5270	99.87	-	-	89.6	33.99	11.51	35.23	100	32	A	H	
		5350.8	55.76	-18.24	74	45.02	34.21	11.76	35.23	100	32	P	H	
		5350.56	49.32	-4.68	54	38.58	34.21	11.76	35.23	100	32	A	H	
		5144.56	54.65	-19.35	74	44.97	33.69	11.21	35.22	181	308	P	V	
		5149.24	45.85	-8.15	54	36.17	33.69	11.21	35.22	181	308	A	V	
	*	5270	109.37	-	-	99.1	33.99	11.51	35.23	181	308	P	V	
	*	5270	100.97	-	-	90.7	33.99	11.51	35.23	181	308	A	V	
		5350.08	57.32	-16.68	74	46.58	34.21	11.76	35.23	181	308	P	V	
		5350.08	51.39	-2.61	54	40.65	34.21	11.76	35.23	181	308	A	V	
	802.11ac VHT40 CH 62 5310MHz		5039.26	49.78	-24.22	74	40.45	33.43	11.11	35.21	100	33	P	H
			5113.36	41.36	-12.64	54	31.8	33.6	11.18	35.22	100	33	A	H
*		5310	103.43	-	-	92.91	34.12	11.63	35.23	100	33	P	H	
*		5310	95.7	-	-	85.18	34.12	11.63	35.23	100	33	A	H	
		5350.32	58.67	-15.33	74	47.93	34.21	11.76	35.23	100	33	P	H	
		5351.04	52.44	-1.56	54	41.7	34.21	11.76	35.23	100	33	A	H	
		5131.82	49.85	-24.15	74	40.24	33.65	11.18	35.22	177	302	P	V	
		5113.36	42.57	-11.43	54	33.01	33.6	11.18	35.22	177	302	A	V	
*		5310	105.73	-	-	95.21	34.12	11.63	35.23	177	302	P	V	
*		5310	97.46	-	-	86.94	34.12	11.63	35.23	177	302	A	V	
	5352.96	60.92	-13.08	74	50.18	34.21	11.76	35.23	177	302	P	V		
	5350.56	53.16	-1.24	54	42.02	34.21	11.76	35.23	177	302	A	V		
Remark	1. No other spurious found. 2. All results are PASS against Peak and Average limit line.													



Band 2 5250~5350MHz

WIFI 802.11ac VHT40 (Harmonic @ 3m)

WIFI Ant. 1+2	Note	Frequency (MHz)	Level (dBμV/m)	Over Limit (dB)	Limit Line (dBμV/m)	Read Level (dBμV)	Antenna Factor (dB/m)	Cable Loss (dB)	Preamp Factor (dB)	Ant Pos (cm)	Table Pos (deg)	Peak Avg. (P/A)	Pol. (H/V)	
802.11ac VHT40 CH 54 5270MHz		10540	44.74	-29.26	74	47.47	39.15	17.17	59.05	100	0	P	H	
		15810	45.65	-28.35	74	41.27	41.62	19.77	57.01	100	0	P	H	
													H	
													H	
			10540	44.69	-29.31	74	47.42	39.15	17.17	59.05	100	0	P	V
			15810	46.31	-27.69	74	41.93	41.62	19.77	57.01	100	0	P	V
														V
802.11ac VHT40 CH 62 5310MHz		10620	43.6	-30.4	74	46.33	39.03	17.17	58.93	100	0	P	H	
		15930	47.17	-26.83	74	42.41	41.86	19.84	56.94	100	0	P	H	
													H	
													H	
			10620	43.97	-30.03	74	46.7	39.03	17.17	58.93	100	0	P	V
			15930	46.74	-27.26	74	41.98	41.86	19.84	56.94	100	0	P	V
														V
Remark	1. No other spurious found.													
	2. All results are PASS against Peak and Average limit line.													



Band 2 5250~5350MHz

WIFI 802.11ac VHT80 (Band Edge @ 3m)

WIFI Ant. 1+2	Note	Frequency (MHz)	Level (dBμV/m)	Over Limit (dB)	Limit Line (dBμV/m)	Read Level (dBμV)	Antenna Factor (dB/m)	Cable Loss (dB)	Preamp Factor (dB)	Ant Pos (cm)	Table Pos (deg)	Peak Avg. (P/A)	Pol. (H/V)
802.11ac VHT80 CH 58 5290MHz		5149.5	54.34	-19.66	74	44.66	33.69	11.21	35.22	100	33	P	H
		5149.24	47.97	-6.03	54	38.29	33.69	11.21	35.22	100	33	A	H
	*	5290	100.22	-	-	89.9	34.04	11.51	35.23	100	33	P	H
	*	5290	92.51	-	-	82.19	34.04	11.51	35.23	100	33	A	H
		5360.88	56.81	-17.19	74	46.03	34.25	11.76	35.23	100	33	P	H
		5351.04	51.44	-2.56	54	40.7	34.21	11.76	35.23	100	33	A	H
		5141.7	55.01	-18.99	74	45.33	33.69	11.21	35.22	174	302	P	V
		5147.94	48.39	-5.61	54	38.71	33.69	11.21	35.22	174	302	A	V
	*	5290	102.72	-	-	92.4	34.04	11.51	35.23	174	302	P	V
	*	5290	93.89	-	-	83.57	34.04	11.51	35.23	174	302	A	V
		5351.28	57.79	-16.21	74	47.05	34.21	11.76	35.23	174	302	P	V
		5350.56	52.08	-1.92	54	41.34	34.21	11.76	35.23	174	302	A	V
Remark	1. No other spurious found. 2. All results are PASS against Peak and Average limit line.												



Band 2 5250~5350MHz

WIFI 802.11ac VHT80 (Harmonic @ 3m)

WIFI Ant. 1+2	Note	Frequency (MHz)	Level (dBμV/m)	Over Limit (dB)	Limit Line (dBμV/m)	Read Level (dBμV)	Antenna Factor (dB/m)	Cable Loss (dB)	Preamp Factor (dB)	Ant Pos (cm)	Table Pos (deg)	Peak Avg. (P/A)	Pol. (H/V)	
802.11ac VHT80 CH 58 5290MHz		10580	44.57	-29.43	74	47.3	39.08	17.17	58.98	100	0	P	H	
		15870	46.29	-27.71	74	41.68	41.76	19.82	56.97	100	0	P	H	
													H	
													H	
			10580	44.34	-29.66	74	47.07	39.08	17.17	58.98	100	0	P	V
			15870	46.72	-27.28	74	42.11	41.76	19.82	56.97	100	0	P	V
														V
														V
Remark	1. No other spurious found. 2. All results are PASS against Peak and Average limit line.													



Band 3 - 5470~5725MHz

WIFI 802.11a (Band Edge @ 3m)

WIFI	Note	Frequency	Level	Over	Limit	Read	Antenna	Cable	Preamp	Ant	Table	Peak	Pol.	
Ant.				Limit	Line	Level	Factor	Loss	Factor	Pos	Pos	Avg.		
1+2		(MHz)	(dBμV/m)	(dB)	(dBμV/m)	(dBμV)	(dB/m)	(dB)	(dB)	(cm)	(deg)	(P/A)	(H/V)	
802.11a CH 100 5500MHz		5457.2	59.24	-14.76	74	48.12	34.47	11.89	35.24	194	3	P	H	
		5469.04	65.25	-2.95	68.2	54.09	34.51	11.89	35.24	194	3	P	H	
		5459.6	52.1	-1.9	54	40.98	34.47	11.89	35.24	194	3	A	H	
	*	5500	109.72	-	-	98.47	34.6	11.89	35.24	194	3	P	H	
	*	5500	102.03	-	-	90.78	34.6	11.89	35.24	194	3	A	H	
														H
			5459.8	58.73	-15.27	74	47.61	34.47	11.89	35.24	102	345	P	V
			5469.36	66.27	-1.93	68.2	55.11	34.51	11.89	35.24	102	345	P	V
			5460	52.32	-1.68	54	41.2	34.47	11.89	35.24	102	345	A	V
	*		5500	111.54	-	-	100.29	34.6	11.89	35.24	102	345	P	V
	*		5500	103.54	-	-	92.29	34.6	11.89	35.24	102	345	A	V
														V
802.11a CH 116 5580MHz		5440.72	50.45	-23.55	74	39.37	34.43	11.89	35.24	179	9	P	H	
		5464.24	48.11	-20.09	68.2	36.95	34.51	11.89	35.24	179	9	P	H	
		5458.48	41.34	-12.66	54	30.22	34.47	11.89	35.24	179	9	A	H	
	*	5580	110.41	-	-	99.18	34.6	11.89	35.26	179	9	P	H	
	*	5580	102.35	-	-	91.12	34.6	11.89	35.26	179	9	A	H	
			5731.925	50.06	-18.14	68.2	38.69	34.6	12.06	35.29	179	9	P	H
			5432.8	49.11	-24.89	74	38.03	34.43	11.89	35.24	100	344	P	V
			5468.8	49.16	-19.04	68.2	38	34.51	11.89	35.24	100	344	P	V
			5459.44	41.49	-12.51	54	30.37	34.47	11.89	35.24	100	344	A	V
	*		5580	111.68	-	-	100.45	34.6	11.89	35.26	100	344	P	V
	*		5580	103.91	-	-	92.68	34.6	11.89	35.26	100	344	A	V
			5725	49.96	-18.24	68.2	38.58	34.6	12.06	35.28	100	344	P	V



802.11a CH 140 5700MHz	*	5700	107.71	-	-	96.39	34.6	12	35.28	186	316	P	H
	*	5700	99.86	-	-	88.54	34.6	12	35.28	186	316	A	H
		5725.24	64.47	-3.73	68.2	53.1	34.6	12.06	35.29	186	316	P	H
													H
													H
													H
	*	5700	110.12	-	-	98.8	34.6	12	35.28	100	308	P	V
	*	5700	102.05	-	-	90.73	34.6	12	35.28	100	308	A	V
		5727	65.15	-3.05	68.2	53.78	34.6	12.06	35.29	100	308	P	V
													V
													V
													V
Remark	1. No other spurious found. 2. All results are PASS against Peak and Average limit line.												



Band 3 - 5470~5725MHz

WIFI 802.11a (Harmonic @ 3m)

WIFI Ant. 1+2	Note	Frequency (MHz)	Level (dBμV/m)	Over Limit (dB)	Limit Line (dBμV/m)	Read Level (dBμV)	Antenna Factor (dB/m)	Cable Loss (dB)	Preamp Factor (dB)	Ant Pos (cm)	Table Pos (deg)	Peak Avg. (P/A)	Pol. (H/V)
802.11a CH 100 5500MHz		11000	44.17	-29.83	74	46.9	38.5	17.17	58.4	100	0	P	H
		16500	48.46	-19.74	68.2	41.33	43	20.23	56.1	100	0	P	H
													H
													H
		11000	43.53	-30.47	74	46.26	38.5	17.17	58.4	100	0	P	V
		16500	48.55	-19.65	68.2	41.42	43	20.23	56.1	100	0	P	V
													V
													V
802.11a CH 116 5580MHz		11160	44.12	-29.88	74	46.22	38.77	17.16	58.03	100	0	P	H
		16740	46.95	-21.25	68.2	39.62	42.9	20.39	55.96	100	0	P	H
													H
													H
		11160	43.22	-30.78	74	45.32	38.77	17.16	58.03	100	0	P	V
		16740	47.07	-21.13	68.2	39.74	42.9	20.39	55.96	100	0	P	V
													V
													V
802.11a CH 140 5700MHz		11400	43.45	-30.55	74	44.67	39.14	17.16	57.52	100	0	P	H
		17100	47.39	-20.81	68.2	39.94	42.64	20.65	55.84	100	0	P	H
													H
													H
		11400	43.75	-30.25	74	44.97	39.14	17.16	57.52	100	0	P	V
		17100	48.29	-19.91	68.2	40.84	42.64	20.65	55.84	100	0	P	V
													V
													V
Remark	1. No other spurious found. 2. All results are PASS against Peak and Average limit line.												



Band 3 - 5470~5725MHz

WIFI 802.11ac VHT20 (Band Edge @ 3m)

WIFI Ant. 1+2	Note	Frequency (MHz)	Level (dBμV/m)	Over Limit (dB)	Limit Line (dBμV/m)	Read Level (dBμV)	Antenna Factor (dB/m)	Cable Loss (dB)	Preamp Factor (dB)	Ant Pos (cm)	Table Pos (deg)	Peak Avg. (P/A)	Pol. (H/V)	
802.11ac VHT20 CH 100 5500MHz		5459.28	58.41	-15.59	74	47.29	34.47	11.89	35.24	173	310	P	H	
		5467.92	63.82	-4.38	68.2	52.66	34.51	11.89	35.24	173	310	P	H	
		5459.12	51.21	-2.79	54	40.09	34.47	11.89	35.24	173	310	A	H	
	*	5500	110.74	-	-	99.49	34.6	11.89	35.24	173	310	P	H	
	*	5500	101.95	-	-	90.7	34.6	11.89	35.24	173	310	A	H	
														H
			5459.6	59.89	-14.11	74	48.77	34.47	11.89	35.24	234	308	P	V
			5469.2	65.96	-2.24	68.2	54.8	34.51	11.89	35.24	234	308	P	V
			5459.28	52.44	-1.56	54	41.32	34.47	11.89	35.24	234	308	A	V
	*		5500	111.34	-	-	100.09	34.6	11.89	35.24	234	308	P	V
	*		5500	103.11	-	-	91.86	34.6	11.89	35.24	234	308	P	V
														V
802.11ac VHT20 CH 116 5580MHz		5418.16	49.12	-24.88	74	38.09	34.38	11.89	35.24	173	310	P	H	
		5468.32	48.09	-20.11	68.2	36.93	34.51	11.89	35.24	173	310	P	H	
		5458.48	41.3	-12.7	54	30.18	34.47	11.89	35.24	173	310	A	H	
	*	5580	110.3	-	-	99.07	34.6	11.89	35.26	173	310	P	H	
	*	5580	101.83	-	-	90.6	34.6	11.89	35.26	173	310	A	H	
			5727.725	49.42	-18.78	68.2	38.05	34.6	12.06	35.29	173	310	P	H
			5438.56	49.81	-24.19	74	38.73	34.43	11.89	35.24	234	308	P	V
			5469.52	50.45	-17.75	68.2	39.29	34.51	11.89	35.24	234	308	P	V
			5459.92	41.5	-12.5	54	30.38	34.47	11.89	35.24	234	308	A	V
	*		5580	111.33	-	-	100.1	34.6	11.89	35.26	234	308	P	V
	*		5580	102.51	-	-	91.28	34.6	11.89	35.26	234	308	A	V
			5737.875	50.57	-17.63	68.2	39.2	34.6	12.06	35.29	234	308	P	V



802.11ac VHT20 CH 140 5700MHz	*	5700	107.42	-	-	96.1	34.6	12	35.28	162	308	P	H
	*	5700	99.5	-	-	88.18	34.6	12	35.28	162	308	A	H
		5725.16	65.49	-2.71	68.2	54.12	34.6	12.06	35.29	162	308	P	H
													H
													H
													H
	*	5700	111.1	-	-	99.78	34.6	12	35.28	262	296	P	V
	*	5700	101.8	-	-	90.48	34.6	12	35.28	262	296	A	V
		5725.64	67.35	-1.85	68.2	54.98	34.6	12.06	35.29	262	296	P	V
													V
													V
													V
Remark	1. No other spurious found. 2. All results are PASS against Peak and Average limit line.												



Band 3 - 5470~5725MHz

WIFI 802.11ac VHT20 (Harmonic @ 3m)

WIFI Ant. 1+2	Note	Frequency (MHz)	Level (dBμV/m)	Over Limit (dB)	Limit Line (dBμV/m)	Read Level (dBμV)	Antenna Factor (dB/m)	Cable Loss (dB)	Preamp Factor (dB)	Ant Pos (cm)	Table Pos (deg)	Peak Avg. (P/A)	Pol. (H/V)	
802.11ac VHT20 CH 100 5500MHz		11000	44.9	-29.1	74	47.63	38.5	17.17	58.4	100	0	P	H	
		16500	46.7	-21.5	68.2	39.57	43	20.23	56.1	100	0	P	H	
													H	
													H	
			11000	44.61	-29.39	74	47.34	38.5	17.17	58.4	100	0	P	V
			16500	46.43	-21.77	68.2	39.3	43	20.23	56.1	100	0	P	V
														V
802.11ac VHT20 CH 116 5580MHz		11160	43.75	-30.25	74	45.85	38.77	17.16	58.03	100	0	P	H	
		16740	48.05	-20.15	68.2	40.72	42.9	20.39	55.96	100	0	P	H	
													H	
													H	
			11160	43.64	-30.36	74	45.74	38.77	17.16	58.03	100	0	P	V
			16740	48.15	-20.05	68.2	40.82	42.9	20.39	55.96	100	0	P	V
														V
802.11ac VHT20 CH 140 5700MHz		11400	44.22	-29.78	74	45.44	39.14	17.16	57.52	100	0	P	H	
		17100	53.2	-15	68.2	45.75	42.64	20.65	55.84	100	0	P	H	
													H	
													H	
			11400	46.01	-27.99	74	47.23	39.14	17.16	57.52	100	0	P	V
			17100	54.21	-13.99	68.2	46.76	42.64	20.65	55.84	100	0	P	V
														V
Remark	1. No other spurious found.													
	2. All results are PASS against Peak and Average limit line.													



Band 3 - 5470~5725MHz

WIFI 802.11ac VHT40 (Band Edge @ 3m)

WIFI Ant. 1+2	Note	Frequency (MHz)	Level (dBμV/m)	Over Limit (dB)	Limit Line (dBμV/m)	Read Level (dBμV)	Antenna Factor (dB/m)	Cable Loss (dB)	Preamp Factor (dB)	Ant Pos (cm)	Table Pos (deg)	Peak Avg. (P/A)	Pol. (H/V)
802.11ac VHT40 CH 102 5510MHz		5459.44	60.38	-13.62	74	49.26	34.47	11.89	35.24	176	305	P	H
		5462.8	65.02	-3.18	68.2	53.86	34.51	11.89	35.24	176	305	P	H
		5458.48	51.29	-2.71	54	40.17	34.47	11.89	35.24	176	305	A	H
	*	5510	104.9	-	-	93.65	34.6	11.89	35.24	176	305	P	H
	*	5510	96.75	-	-	85.5	34.6	11.89	35.24	176	305	A	H
		5762.9	49.25	-18.95	68.2	37.83	34.6	12.11	35.29	176	305	P	H
		5458.24	59.56	-14.44	74	48.44	34.47	11.89	35.24	224	300	P	V
		5466.4	65.83	-2.37	68.2	54.67	34.51	11.89	35.24	224	300	P	V
		5458.96	53.89	-1.01	54	41.87	34.47	11.89	35.24	224	300	A	V
	*	5510	106.15	-	-	94.9	34.6	11.89	35.24	224	300	P	V
	*	5510	97.94	-	-	86.69	34.6	11.89	35.24	224	300	A	V
		5754.325	49.78	-18.42	68.2	38.36	34.6	12.11	35.29	224	300	P	V
802.11ac VHT40 CH 110 5550MHz		5457.04	54.6	-19.4	74	43.48	34.47	11.89	35.24	176	309	P	H
		5469.04	57.52	-10.68	68.2	46.36	34.51	11.89	35.24	176	309	P	H
		5458.72	48.61	-5.39	54	37.49	34.47	11.89	35.24	176	309	A	H
	*	5550	107.37	-	-	96.13	34.6	11.89	35.25	176	309	P	H
	*	5550	98.81	-	-	87.57	34.6	11.89	35.25	176	309	A	H
		5752.4	49.82	-18.38	68.2	38.4	34.6	12.11	35.29	176	309	P	H
		5457.52	56.74	-17.26	74	45.62	34.47	11.89	35.24	214	298	P	V
		5469.04	58.9	-9.3	68.2	47.74	34.51	11.89	35.24	214	298	P	V
		5452.48	49.96	-4.04	54	38.84	34.47	11.89	35.24	214	298	A	V
	*	5550	108.04	-	-	96.8	34.6	11.89	35.25	214	298	P	V
	*	5550	99.54	-	-	88.3	34.6	11.89	35.25	214	298	A	V
		5765	50.6	-17.6	68.2	39.18	34.6	12.11	35.29	214	298	P	V



802.11ac VHT40 CH 134 5670MHz		5437.6	49.02	-24.98	74	37.94	34.43	11.89	35.24	162	308	P	H
		5469.76	49.12	-19.08	68.2	37.96	34.51	11.89	35.24	162	308	P	H
		5444.32	41.2	-12.8	54	30.12	34.43	11.89	35.24	162	308	A	H
	*	5670	105.23	-	-	93.9	34.6	12	35.27	162	308	P	H
	*	5670	97.08	-	-	85.75	34.6	12	35.27	162	308	A	H
		5725.975	57.44	-10.76	68.2	46.07	34.6	12.06	35.29	162	308	P	H
		5362.72	48.87	-25.13	74	38.09	34.25	11.76	35.23	269	296	P	V
		5466.88	48.56	-19.64	68.2	37.4	34.51	11.89	35.24	269	296	P	V
		5456.8	41.31	-12.69	54	30.19	34.47	11.89	35.24	269	296	A	V
	*	5670	107.53	-	-	96.2	34.6	12	35.27	269	296	P	V
	*	5670	99.08	-	-	87.75	34.6	12	35.27	269	296	A	V
		5726.325	62.19	-6.01	68.2	50.82	34.6	12.06	35.29	269	296	P	V
Remark	1. No other spurious found. 2. All results are PASS against Peak and Average limit line.												



Band 3 - 5470~5725MHz

WIFI 802.11ac VHT40 (Harmonic @ 3m)

WIFI Ant. 1+2	Note	Frequency (MHz)	Level (dBμV/m)	Over Limit (dB)	Limit Line (dBμV/m)	Read Level (dBμV)	Antenna Factor (dB/m)	Cable Loss (dB)	Preamp Factor (dB)	Ant Pos (cm)	Table Pos (deg)	Peak Avg. (P/A)	Pol. (H/V)	
802.11ac VHT40 CH 102 5510MHz		11020	44.32	-29.68	74	46.98	38.53	17.17	58.36	100	0	P	H	
		16530	46.83	-21.37	68.2	39.67	42.99	20.25	56.08	100	0	P	H	
													H	
													H	
			11020	44.57	-29.43	74	47.23	38.53	17.17	58.36	100	0	P	V
			16530	47.23	-20.97	68.2	40.07	42.99	20.25	56.08	100	0	P	V
														V
802.11ac VHT40 CH 110 5550MHz		11100	44.03	-29.97	74	46.39	38.66	17.16	58.18	100	0	P	H	
		16650	47.37	-20.83	68.2	40.1	42.94	20.34	56.01	100	0	P	H	
													H	
													H	
			11100	43.79	-30.21	74	46.15	38.66	17.16	58.18	100	0	P	V
			16650	46.68	-21.52	68.2	39.41	42.94	20.34	56.01	100	0	P	V
														V
802.11ac VHT40 CH 134 5670MHz		11340	43.71	-30.29	74	45.19	39.03	17.16	57.67	100	0	P	H	
		17010	48.34	-19.86	68.2	40.79	42.77	20.59	55.81	100	0	P	H	
													H	
													H	
			11340	43.51	-30.49	74	44.99	39.03	17.16	57.67	100	0	P	V
			17010	48.85	-19.35	68.2	41.3	42.77	20.59	55.81	100	0	P	V
														V
Remark	1. No other spurious found.													
	2. All results are PASS against Peak and Average limit line.													



Band 3 5470~5725MHz

WIFI 802.11ac VHT80 (Band Edge @ 3m)

WIFI Ant. 1+2	Note	Frequency (MHz)	Level (dBμV/m)	Over Limit (dB)	Limit Line (dBμV/m)	Read Level (dBμV)	Antenna Factor (dB/m)	Cable Loss (dB)	Preamp Factor (dB)	Ant Pos (cm)	Table Pos (deg)	Peak Avg. (P/A)	Pol. (H/V)
802.11ac VHT80 CH 106 5530MHz		5458.48	56.35	-17.65	74	45.23	34.47	11.89	35.24	176	300	P	H
		5465.44	57.17	-11.03	68.2	46.01	34.51	11.89	35.24	176	300	P	H
		5437.6	50.62	-3.38	54	39.54	34.43	11.89	35.24	176	300	A	H
	*	5530	99.4	-	-	88.16	34.6	11.89	35.25	176	300	P	H
	*	5530	91.58	-	-	80.34	34.6	11.89	35.25	176	300	A	H
		5739.975	50.03	-18.17	68.2	38.66	34.6	12.06	35.29	176	300	P	H
		5433.76	61.97	-12.03	74	50.89	34.43	11.89	35.24	224	300	P	V
		5460.88	59.02	-9.18	68.2	47.9	34.47	11.89	35.24	224	300	P	V
		5438.56	53.31	-1.69	54	41.23	34.43	11.89	35.24	224	300	A	V
	*	5530	101.64	-	-	90.4	34.6	11.89	35.25	224	300	P	V
	*	5530	93.87	-	-	82.63	34.6	11.89	35.25	224	300	A	V
		5726.325	50.34	-17.86	68.2	38.97	34.6	12.06	35.29	224	300	P	V
802.11ac VHT80 CH 122 5610MHz		5430.64	54.82	-19.18	74	43.74	34.43	11.89	35.24	200	300	P	H
		5463.52	55.48	-12.72	68.2	44.32	34.51	11.89	35.24	200	300	P	H
		5459.68	48.05	-5.95	54	36.93	34.47	11.89	35.24	200	300	A	H
	*	5610	102.36	-	-	91.13	34.6	11.89	35.26	200	300	P	H
	*	5610	94.13	-	-	82.9	34.6	11.89	35.26	200	300	A	H
		5741.2	52.06	-16.14	68.2	40.64	34.6	12.11	35.29	200	300	P	H
		5443.36	54.92	-19.08	74	43.84	34.43	11.89	35.24	225	296	P	V
		5465.92	56.34	-11.86	68.2	45.18	34.51	11.89	35.24	225	296	P	V
		5458.96	48.96	-5.04	54	37.84	34.47	11.89	35.24	225	296	A	V
	*	5610	103.87	-	-	92.64	34.6	11.89	35.26	225	296	P	V
	*	5610	95.97	-	-	84.74	34.6	11.89	35.26	225	296	A	V
	5725.1	55.12	-13.08	68.2	43.75	34.6	12.06	35.29	225	296	P	V	
Remark	1. No other spurious found. 2. All results are PASS against Peak and Average limit line.												



Band 3 5470~5725MHz

WIFI 802.11ac VHT80 (Harmonic @ 3m)

WIFI Ant. 1+2	Note	Frequency (MHz)	Level (dBμV/m)	Over Limit (dB)	Limit Line (dBμV/m)	Read Level (dBμV)	Antenna Factor (dB/m)	Cable Loss (dB)	Preamp Factor (dB)	Ant Pos (cm)	Table Pos (deg)	Peak Avg. (P/A)	Pol. (H/V)	
802.11ac VHT80 CH 106 5530MHz		11060	44.88	-29.12	74	47.36	38.61	17.16	58.25	100	0	P	H	
		16590	47.93	-20.27	68.2	40.7	42.97	20.31	56.05	100	0	P	H	
													H	
													H	
			11060	44.75	-29.25	74	47.23	38.61	17.16	58.25	100	0	P	V
			16590	47.9	-20.3	68.2	40.67	42.97	20.31	56.05	100	0	P	V
														V
802.11ac VHT80 CH 122 5610MHz		11220	44.51	-29.49	74	46.42	38.85	17.16	57.92	100	0	P	H	
		16830	47.67	-20.53	68.2	40.22	42.87	20.48	55.9	100	0	P	H	
													H	
													H	
			11220	44.06	-29.94	74	45.97	38.85	17.16	57.92	100	0	P	V
			16830	46.64	-21.56	68.2	39.19	42.87	20.48	55.9	100	0	P	V
														V
Remark	1. No other spurious found.													
	2. All results are PASS against Peak and Average limit line.													



Band 3 - Straddle Channel

WIFI 802.11a (Band Edge @ 3m)

WIFI	Note	Frequency	Level	Over	Limit	Read	Antenna	Cable	Preamp	Ant	Table	Peak	Pol.
Ant.				Limit	Line	Level	Factor	Loss	Factor	Pos	Pos	Avg.	
1+2		(MHz)	(dBμV/m)	(dB)	(dBμV/m)	(dBμV)	(dB/m)	(dB)	(dB)	(cm)	(deg)	(P/A)	(H/V)
802.11a CH 144 5720MHz	*	5720	109.09	-	-	97.71	34.6	12.06	35.28	179	316	P	H
	*	5720	101.64	-	-	90.26	34.6	12.06	35.28	179	316	A	H
													H
													H
													H
	*	5720	111.25	-	-	99.87	34.6	12.06	35.28	100	352	P	V
	*	5720	103.84	-	-	92.46	34.6	12.06	35.28	100	352	A	V
													V
													V
													V
													V
	Remark	1. No other spurious found. 2. All results are PASS against Peak and Average limit line.											



Band 3 - Straddle Channel
WIFI 802.11a (Harmonic @ 3m)

WIFI Ant. 1+2	Note	Frequency (MHz)	Level (dBµV/m)	Over Limit (dB)	Limit Line (dBµV/m)	Read Level (dBµV)	Antenna Factor (dB/m)	Cable Loss (dB)	Preamp Factor (dB)	Ant Pos (cm)	Table Pos (deg)	Peak Avg. (P/A)	Pol. (H/V)	
802.11a CH 144 5720MHz		11440	44.84	-29.16	74	45.94	39.19	17.16	57.45	100	0	P	H	
		17160	56.2	-12	68.2	48.84	42.53	20.7	55.87	100	0	P	H	
													H	
													H	
			11440	44.81	-29.19	74	45.91	39.19	17.16	57.45	100	0	P	V
			17160	54.78	-13.42	68.2	47.42	42.53	20.7	55.87	100	0	P	V
														V
														V
Remark	1. No other spurious found. 2. All results are PASS against Peak and Average limit line.													



Band 3 - Straddle Channel
WIFI 802.11ac VHT20 (Band Edge @ 3m)

WIFI Ant. 1+2	Note	Frequency (MHz)	Level (dBμV/m)	Over Limit (dB)	Limit Line (dBμV/m)	Read Level (dBμV)	Antenna Factor (dB/m)	Cable Loss (dB)	Preamp Factor (dB)	Ant Pos (cm)	Table Pos (deg)	Peak Avg. (P/A)	Pol. (H/V)
802.11ac VHT20 CH 144 5720MHz	*	5720	108.69	-	-	97.31	34.6	12.06	35.28	162	309	P	H
	*	5720	100.08	-	-	88.7	34.6	12.06	35.28	162	309	A	H
													H
													H
													H
													H
	*	5720	110.97	-	-	99.59	34.6	12.06	35.28	267	297	P	V
	*	5720	102.17	-	-	90.79	34.6	12.06	35.28	267	297	A	V
													V
													V
												V	
												V	
Remark	1. No other spurious found. 2. All results are PASS against Peak and Average limit line.												



Band 3 - Straddle Channel
WIFI 802.11ac VHT20 (Harmonic @ 3m)

WIFI Ant. 1+2	Note	Frequency (MHz)	Level (dBμV/m)	Over Limit (dB)	Limit Line (dBμV/m)	Read Level (dBμV)	Antenna Factor (dB/m)	Cable Loss (dB)	Preamp Factor (dB)	Ant Pos (cm)	Table Pos (deg)	Peak Avg. (P/A)	Pol. (H/V)	
802.11ac VHT20 CH 144 5720MHz		11440	46.06	-27.94	74	47.16	39.19	17.16	57.45	100	0	P	H	
		17160	52.17	-16.03	68.2	44.81	42.53	20.7	55.87	100	0	P	H	
													H	
													H	
			11440	44.85	-29.15	74	45.95	39.19	17.16	57.45	100	0	P	V
			17160	52.69	-15.51	68.2	45.33	42.53	20.7	55.87	100	0	P	V
														V
														V
Remark	1. No other spurious found. 2. All results are PASS against Peak and Average limit line.													



Band 3 - Straddle Channel
WIFI 802.11ac VHT40 (Band Edge @ 3m)

WIFI Ant. 1+2	Note	Frequency (MHz)	Level (dBμV/m)	Over Limit (dB)	Limit Line (dBμV/m)	Read Level (dBμV)	Antenna Factor (dB/m)	Cable Loss (dB)	Preamp Factor (dB)	Ant Pos (cm)	Table Pos (deg)	Peak Avg. (P/A)	Pol. (H/V)
802.11ac VHT40 CH 142 5710MHz	*	5710	105.58	-	-	94.2	34.6	12.06	35.28	162	308	P	H
	*	5710	96.84	-	-	85.46	34.6	12.06	35.28	162	308	A	H
													H
													H
													H
													H
	*	5710	107.18	-	-	95.8	34.6	12.06	35.28	269	296	P	V
	*	5710	98.72	-	-	87.34	34.6	12.06	35.28	269	296	A	V
													V
													V
												V	
												V	
Remark	1. No other spurious found. 2. All results are PASS against Peak and Average limit line.												



Band 3 - Straddle Channel
WIFI 802.11ac VHT40 (Harmonic @ 3m)

WIFI Ant. 1+2	Note	Frequency (MHz)	Level (dBμV/m)	Over Limit (dB)	Limit Line (dBμV/m)	Read Level (dBμV)	Antenna Factor (dB/m)	Cable Loss (dB)	Preamp Factor (dB)	Ant Pos (cm)	Table Pos (deg)	Peak Avg. (P/A)	Pol. (H/V)	
802.11ac VHT40 CH 142 5710MHz		11420	45.09	-28.91	74	46.24	39.17	17.16	57.48	100	0	P	H	
		17130	49.76	-18.44	68.2	42.35	42.59	20.67	55.85	100	0	P	H	
													H	
													H	
			11420	45.55	-28.45	74	46.7	39.17	17.16	57.48	100	0	P	V
			17130	49.89	-18.31	68.2	42.48	42.59	20.67	55.85	100	0	P	V
														V
														V
Remark	1. No other spurious found. 2. All results are PASS against Peak and Average limit line.													



Band 3 - Straddle Channel
WIFI 802.11ac VHT80 (Band Edge @ 3m)

WIFI Ant. 1+2	Note	Frequency (MHz)	Level (dBμV/m)	Over Limit (dB)	Limit Line (dBμV/m)	Read Level (dBμV)	Antenna Factor (dB/m)	Cable Loss (dB)	Preamp Factor (dB)	Ant Pos (cm)	Table Pos (deg)	Peak Avg. (P/A)	Pol. (H/V)
802.11ac VHT80 CH 138 5690MHz	*	5690	101.12	-	-	89.8	34.6	12	35.28	176	308	P	H
	*	5690	93.3	-	-	81.98	34.6	12	35.28	176	308	A	H
													H
													H
													H
													H
	*	5690	103.91	-	-	92.59	34.6	12	35.28	269	296	P	V
	*	5690	95.5	-	-	84.18	34.6	12	35.28	269	296	A	V
													V
													V
Remark	1. No other spurious found. 2. All results are PASS against Peak and Average limit line.												



Band 3 - Straddle Channel
WIFI 802.11ac VHT80 (Harmonic @ 3m)

WIFI Ant. 1+2	Note	Frequency (MHz)	Level (dBμV/m)	Over Limit (dB)	Limit Line (dBμV/m)	Read Level (dBμV)	Antenna Factor (dB/m)	Cable Loss (dB)	Preamp Factor (dB)	Ant Pos (cm)	Table Pos (deg)	Peak Avg. (P/A)	Pol. (H/V)	
802.11ac VHT80 CH 138 5690MHz		11380	44.3	-29.7	74	45.59	39.11	17.16	57.56	100	0	P	H	
		17070	48.54	-19.66	68.2	41.03	42.69	20.65	55.83	100	0	P	H	
													H	
													H	
			11380	44.42	-29.58	74	45.71	39.11	17.16	57.56	100	0	P	V
			17070	48.84	-19.36	68.2	41.33	42.69	20.65	55.83	100	0	P	V
														V
														V
Remark	1. No other spurious found. 2. All results are PASS against Peak and Average limit line.													



Band 3 - 5470~5725MHz

WIFI 802.11ac VHT40 (Band Edge @ 3m) (With NB)

WIFI	Note	Frequency	Level	Over	Limit	Read	Antenna	Cable	Preamp	Ant	Table	Peak	Pol.
Ant.				Limit	Line	Level	Factor	Loss	Factor	Pos	Pos	Avg.	
1+2		(MHz)	(dBμV/m)	(dB)	(dBμV/m)	(dBμV)	(dB/m)	(dB)	(dB)	(cm)	(deg)	(P/A)	(H/V)
802.11ac VHT40 CH 102 5510MHz		5456.56	55.38	-18.62	74	44.26	34.47	11.89	35.24	138	4	P	H
		5469.28	61.28	-6.92	68.2	50.12	34.51	11.89	35.24	138	4	P	H
		5459.68	49.87	-4.13	54	38.75	34.47	11.89	35.24	138	4	P	H
	*	5510	104.01	30.01	74	92.76	34.6	11.89	35.24	138	4	P	H
	*	5510	95.91	41.91	54	84.66	34.6	11.89	35.24	138	4	A	H
		5755.9	49.24	-18.96	68.2	37.82	34.6	12.11	35.29	138	4	P	H
		5441.92	56.26	-17.74	74	45.18	34.43	11.89	35.24	102	335	P	V
		5464.72	63.67	-4.53	68.2	52.51	34.51	11.89	35.24	102	335	P	V
		5459.44	53.35	-1.65	54	41.23	34.47	11.89	35.24	102	335	P	V
	*	5510	106.05	32.05	74	94.8	34.6	11.89	35.24	102	335	P	V
	*	5510	97.44	43.44	54	86.19	34.6	11.89	35.24	102	335	A	V
			5752.925	49.31	-18.89	68.2	37.89	34.6	12.11	35.29	102	335	P



Band 3 - 5470~5725MHz

WIFI 802.11ac VHT40 (Harmonic @ 3m) (With NB)

WIFI Ant. 1+2	Note	Frequency (MHz)	Level (dBμV/m)	Over Limit (dB)	Limit Line (dBμV/m)	Read Level (dBμV)	Antenna Factor (dB/m)	Cable Loss (dB)	Preamp Factor (dB)	Ant Pos (cm)	Table Pos (deg)	Peak Avg. (P/A)	Pol. (H/V)	
802.11ac VHT40 CH 102 5510MHz		11020	44.27	-29.73	74	46.93	38.53	17.17	58.36	100	0	P	H	
		16530	47.41	-20.79	68.2	40.25	42.99	20.25	56.08	100	0	P	H	
													H	
													H	
			11020	44.05	-29.95	74	46.71	38.53	17.17	58.36	100	0	P	V
			16530	47.81	-20.39	68.2	40.65	42.99	20.25	56.08	100	0	P	V
														V



Band 3 - 5470~5725MHz

WIFI 802.11ac VHT40 (Band Edge @ 3m) (Earphone2)

WIFI	Note	Frequency	Level	Over	Limit	Read	Antenna	Cable	Preamp	Ant	Table	Peak	Pol.
Ant.				Limit	Line	Level	Factor	Loss	Factor	Pos	Pos	Avg.	
1+2		(MHz)	(dBμV/m)	(dB)	(dBμV/m)	(dBμV)	(dB/m)	(dB)	(dB)	(cm)	(deg)	(P/A)	(H/V)
802.11ac VHT40 CH 102 5510MHz		5453.92	57.27	-16.73	74	46.15	34.47	11.89	35.24	137	5	P	H
		5466.64	61.89	-6.31	68.2	50.73	34.51	11.89	35.24	137	5	P	H
		5457.52	49.66	-4.34	54	38.54	34.47	11.89	35.24	137	5	A	H
	*	5510	103.77	-	-	92.52	34.6	11.89	35.24	137	5	P	H
	*	5510	95.68	-	-	84.43	34.6	11.89	35.24	137	5	A	H
		5747.325	50.03	-18.17	68.2	38.61	34.6	12.11	35.29	137	5	P	H
		5452	56.62	-17.38	74	45.5	34.47	11.89	35.24	102	337	P	V
		5469.28	64.17	-4.03	68.2	53.01	34.51	11.89	35.24	102	337	P	V
		5458.72	53.17	-1.83	54	41.05	34.47	11.89	35.24	102	337	A	V
	*	5510	105.92	-	-	94.67	34.6	11.89	35.24	102	337	P	V
	*	5510	97.26	-	-	86.01	34.6	11.89	35.24	102	337	A	V
		5744.525	48.85	-19.35	68.2	37.43	34.6	12.11	35.29	102	337	P	V



Band 3 - 5470~5725MHz

WIFI 802.11ac VHT40 (Harmonic @ 3m) (Earphone2)

WIFI Ant. 1+2	Note	Frequency (MHz)	Level (dBμV/m)	Over Limit (dB)	Limit Line (dBμV/m)	Read Level (dBμV)	Antenna Factor (dB/m)	Cable Loss (dB)	Preamp Factor (dB)	Ant Pos (cm)	Table Pos (deg)	Peak Avg. (P/A)	Pol. (H/V)	
802.11ac VHT40 CH 102 5510MHz		11020	44.14	-29.86	74	46.8	38.53	17.17	58.36	100	0	P	H	
		16530	47.27	-20.93	68.2	40.11	42.99	20.25	56.08	100	0	P	H	
													H	
													H	
			11020	43.99	-30.01	74	46.65	38.53	17.17	58.36	100	0	P	V
			16530	47.68	-20.52	68.2	40.52	42.99	20.25	56.08	100	0	P	V
														V
														V



Emission below 1GHz

WIFI 802.11n VHT40 (LF @ 3m)

WIFI	Note	Frequency	Level	Over	Limit	Read	Antenna	Cable	Preamp	Ant	Table	Peak	Pol.	
Ant.				Limit	Line	Level	Factor	Loss	Factor	Pos	Pos	Avg.		
1+2		(MHz)	(dBμV/m)	(dB)	(dBμV/m)	(dBμV)	(dB/m)	(dB)	(dB)	(cm)	(deg)	(P/A)	(H/V)	
802.11n VHT40 LF		148.53	39.64	-3.86	43.5	51.21	17.75	1.78	31.1	100	277	P	H	
		227.37	29.28	-16.72	46	41.25	16.96	2.07	31			P	H	
		298.65	35.17	-10.83	46	44.07	19.79	2.32	31.01			P	H	
		436.5	27.29	-18.71	46	32.21	22.91	2.89	30.72			P	H	
		765.5	30.68	-15.32	46	29.88	27.35	3.82	30.37			P	H	
		986	34.33	-19.67	54	30.33	30.27	3.98	30.25			P	H	
														H
														H
														H
														H
														H
														H
			71.31	33.77	-6.23	40	50.85	12.92	1.28	31.28	100	58	P	V
			116.4	32.91	-10.59	43.5	44.81	17.68	1.55	31.13			P	V
			220.62	29.63	-16.37	46	42.08	16.48	2.07	31			P	V
			326.6	27.88	-18.12	46	35.92	20.55	2.41	31			P	V
			585.6	29.24	-16.76	46	31.37	25.17	3.36	30.66			P	V
			928.6	33.25	-12.75	46	29.81	29.68	4.12	30.36			P	V
														V
														V
													V	
													V	
													V	
													V	
Remark	1. No other spurious found. 2. All results are PASS against limit line.													



Note symbol

*	Fundamental Frequency which can be ignored. However, the level of any unwanted emissions shall not exceed the level of the fundamental frequency.
!	Test result is over limit line.
P/A	Peak or Average
H/V	Horizontal or Vertical



A calculation example for radiated spurious emission is shown as below:

WIFI	Note	Frequency	Level	Over	Limit	Read	Antenna	Cable	Preamp	Ant	Table	Peak	Pol.
Ant.				Limit	Line	Level	Factor	Loss	Factor	Pos	Pos	Avg.	
1+2		(MHz)	(dBμV/m)	(dB)	(dBμV/m)	(dBμV)	(dB/m)	(dB)	(dB)	(cm)	(deg)	(P/A)	(H/V)
802.11b		2390	55.45	-18.55	74	54.51	32.22	4.58	35.86	103	308	P	H
CH 01													
2412MHz		2390	43.54	-10.46	54	42.6	32.22	4.58	35.86	103	308	A	H

- Level(dBμV/m) =
Antenna Factor(dB/m) + Cable Loss(dB) + Read Level(dBμV) - Preamp Factor(dB)
- Over Limit(dB) = Level(dBμV/m) – Limit Line(dBμV/m)

For Peak Limit @ 2390MHz:

- Level(dBμV/m)
= Antenna Factor(dB/m) + Cable Loss(dB) + Read Level(dBμV) - Preamp Factor(dB)
= 32.22(dB/m) + 4.58(dB) + 54.51(dBμV) – 35.86 (dB)
= 55.45 (dBμV/m)
- Over Limit(dB)
= Level(dBμV/m) – Limit Line(dBμV/m)
= 55.45(dBμV/m) – 74(dBμV/m)
= -18.55(dB)

For Average Limit @ 2390MHz:

- Level(dBμV/m)
= Antenna Factor(dB/m) + Cable Loss(dB) + Read Level(dBμV) - Preamp Factor(dB)
= 32.22(dB/m) + 4.58(dB) + 42.6(dBμV) – 35.86 (dB)
= 43.54 (dBμV/m)
- Over Limit(dB)
= Level(dBμV/m) – Limit Line(dBμV/m)
= 43.54(dBμV/m) – 54(dBμV/m)
= -10.46(dB)

Both peak and average measured complies with the limit line, so test result is “PASS”.



Appendix B. Radiated Spurious Emission

Test Engineer :	Luke Chang, Ken Wu, Derreck Chen, Jesse Wang, and James Chiu	Temperature :	21~24°C
		Relative Humidity :	50~55%

Band 1 - 5150~5250MHz

WIFI 802.11ac VHT20 (Band Edge @ 3m)

WIFI Ant. 1+2	Note	Frequency (MHz)	Level (dBμV/m)	Over Limit (dB)	Limit Line (dBμV/m)	Read Level (dBμV)	Antenna Factor (dB/m)	Cable Loss (dB)	Preamp Factor (dB)	Ant Pos (cm)	Table Pos (deg)	Peak Avg. (P/A)	Pol. (H/V)	
802.11ac VHT20 CH 36 5180MHz		5148.72	60.29	-13.71	74	50.61	33.69	11.21	35.22	100	32	P	H	
		5149.24	52.72	-1.28	54	43.04	33.69	11.21	35.22	100	32	A	H	
	*	5180	110.6	-	-	100.83	33.78	11.21	35.22	100	32	P	H	
	*	5180	103.09	-	-	93.32	33.78	11.21	35.22	100	32	A	H	
													H	
														H
			5148.2	61.4	-12.6	74	51.72	33.69	11.21	35.22	163	317	P	V
			5147.42	52.22	-1.78	54	42.54	33.69	11.21	35.22	163	317	A	V
	*		5180	110.66	-	-	100.89	33.78	11.21	35.22	163	317	P	V
	*		5180	104.33	-	-	94.56	33.78	11.21	35.22	163	317	A	V
														V
														V
802.11ac VHT20 CH 44 5220MHz		5147.16	53.84	-20.16	74	44.16	33.69	11.21	35.22	100	32	P	H	
		5149.24	45.03	-8.97	54	35.35	33.69	11.21	35.22	100	32	A	H	
	*	5220	113.27	-	-	103.38	33.86	11.25	35.22	100	32	P	H	
	*	5220	106.59	-	-	96.7	33.86	11.25	35.22	100	32	A	H	
			5441.76	49.73	-24.27	74	38.65	34.43	11.89	35.24	100	32	P	H
			5445.84	41.55	-12.45	54	30.43	34.47	11.89	35.24	100	32	A	H
			5150	52.48	-21.52	74	42.8	33.69	11.21	35.22	182	310	P	V
			5150	44.15	-9.85	54	34.47	33.69	11.21	35.22	182	310	A	V
	*		5220	112.31	-	-	102.42	33.86	11.25	35.22	182	310	P	V
	*		5220	104.89	-	-	95	33.86	11.25	35.22	182	310	A	V
			5361.36	49.56	-24.44	74	38.78	34.25	11.76	35.23	182	310	P	V
			5429.52	43.05	-10.95	54	31.97	34.43	11.89	35.24	182	310	A	V



802.11ac VHT20 CH 48 5240MHz		5141.18	51.66	-22.34	74	41.98	33.69	11.21	35.22	102	32	P	H
		5150	42.62	-11.38	54	32.94	33.69	11.21	35.22	102	32	A	H
	*	5240	111.78	-	-	101.71	33.91	11.38	35.22	102	32	P	H
	*	5240	104.8	-	-	94.73	33.91	11.38	35.22	102	32	A	H
		5355.12	49.77	-24.23	74	39.03	34.21	11.76	35.23	102	32	P	H
		5450.16	41.85	-12.15	54	30.73	34.47	11.89	35.24	102	32	A	H
		5102.18	50.24	-23.76	74	40.72	33.56	11.18	35.22	144	297	P	V
		5140.14	41.52	-12.48	54	31.84	33.69	11.21	35.22	144	297	A	V
	*	5240	112.88	-	-	102.81	33.91	11.38	35.22	144	297	P	V
	*	5240	105.99	-	-	95.92	33.91	11.38	35.22	144	297	A	V
		5451.36	51.39	-22.61	74	40.27	34.47	11.89	35.24	144	297	P	V
		5450.64	44.06	-9.94	54	32.94	34.47	11.89	35.24	144	297	A	V
Remark	1. No other spurious found. 2. All results are PASS against Peak and Average limit line.												



Band 1 5150~5250MHz

WIFI 802.11ac VHT20 (Harmonic @ 3m)

WIFI Ant. 1+2	Note	Frequency (MHz)	Level (dBμV/m)	Over Limit (dB)	Limit Line (dBμV/m)	Read Level (dBμV)	Antenna Factor (dB/m)	Cable Loss (dB)	Preamp Factor (dB)	Ant Pos (cm)	Table Pos (deg)	Peak Avg. (P/A)	Pol. (H/V)	
802.11ac VHT20 CH 36 5180MHz		10360	45.13	-28.87	74	48.08	39.09	17.17	59.21	100	0	P	H	
		15540	45.98	-28.02	74	42.48	41.07	19.61	57.18	100	0	P	H	
													H	
													H	
			10360	46.45	-27.55	74	49.4	39.09	17.17	59.21	100	0	P	V
			15540	45.71	-28.29	74	42.21	41.07	19.61	57.18	100	0	P	V
														V
802.11ac VHT20 CH 44 5220MHz		10440	44.93	-29.07	74	47.76	39.15	17.17	59.15	100	0	P	H	
		15660	45.21	-28.79	74	41.33	41.31	19.68	57.11	100	0	P	H	
													H	
													H	
			10440	45.29	-28.71	74	48.12	39.15	17.17	59.15	100	0	P	V
			15660	46.1	-27.9	74	42.22	41.31	19.68	57.11	100	0	P	V
														V
802.11ac VHT20 CH 48 5240MHz		10480	44.78	-29.22	74	47.53	39.19	17.17	59.11	100	0	P	H	
		15720	46.12	-27.88	74	42.01	41.45	19.73	57.07	100	0	P	H	
													H	
													H	
			10480	46.72	-27.28	74	49.47	39.19	17.17	59.11	100	0	P	V
			15720	46.17	-27.83	74	42.06	41.45	19.73	57.07	100	0	P	V
														V
Remark	1. No other spurious found.													
	2. All results are PASS against Peak and Average limit line.													



Band 1 5150~5250MHz

WIFI 802.11ac VHT40 (Band Edge @ 3m)

WIFI Ant. 1+2	Note	Frequency (MHz)	Level (dBμV/m)	Over Limit (dB)	Limit Line (dBμV/m)	Read Level (dBμV)	Antenna Factor (dB/m)	Cable Loss (dB)	Preamp Factor (dB)	Ant Pos (cm)	Table Pos (deg)	Peak Avg. (P/A)	Pol. (H/V)
802.11ac VHT40 CH 38 5190MHz		5145.86	61.38	-12.62	74	51.7	33.69	11.21	35.22	100	27	P	H
		5149.5	53.53	-1.47	54	42.85	33.69	11.21	35.22	100	27	P	H
	*	5190	105.32	-	-	95.51	33.78	11.25	35.22	100	27	P	H
	*	5190	97.32	-	-	87.51	33.78	11.25	35.22	100	27	A	H
		5363.52	48.75	-25.25	74	37.97	34.25	11.76	35.23	100	27	P	H
		5456.64	40.19	-13.81	54	29.07	34.47	11.89	35.24	100	27	A	H
		5148.46	57.77	-16.23	74	48.09	33.69	11.21	35.22	172	303	P	V
		5147.94	53.04	-1.96	54	42.36	33.69	11.21	35.22	172	303	A	V
	*	5190	105.03	-	-	95.22	33.78	11.25	35.22	172	303	P	V
	*	5190	97.86	-	-	88.05	33.78	11.25	35.22	172	303	A	V
		5445.12	48.09	-25.91	74	37.01	34.43	11.89	35.24	172	303	P	V
		5350.32	40.6	-13.4	54	29.86	34.21	11.76	35.23	172	303	A	V
802.11ac VHT40 CH 46 5230MHz		5132.6	59.79	-14.21	74	50.18	33.65	11.18	35.22	100	27	P	H
		5146.12	47.67	-6.33	54	37.99	33.69	11.21	35.22	100	27	A	H
	*	5230	109.3	-	-	99.23	33.91	11.38	35.22	100	27	P	H
	*	5230	101.71	-	-	91.64	33.91	11.38	35.22	100	27	A	H
		5426.88	50.12	-23.88	74	39.09	34.38	11.89	35.24	100	27	P	H
		5351.28	41.4	-12.6	54	30.66	34.21	11.76	35.23	100	27	A	H
		5136.76	57.09	-16.91	74	47.48	33.65	11.18	35.22	172	313	P	V
		5150	49.21	-4.79	54	39.53	33.69	11.21	35.22	172	313	A	V
	*	5230	109.45	-	-	99.38	33.91	11.38	35.22	172	313	P	V
	*	5230	102.07	-	-	92	33.91	11.38	35.22	172	313	A	V
	5360.88	51.25	-22.75	74	40.47	34.25	11.76	35.23	172	313	P	V	
	5350.32	43.04	-10.96	54	32.3	34.21	11.76	35.23	172	313	A	V	
Remark	1. No other spurious found. 2. All results are PASS against Peak and Average limit line.												



Band 1 5150~5250MHz

WIFI 802.11ac VHT40 (Harmonic @ 3m)

WIFI Ant. 1+2	Note	Frequency (MHz)	Level (dBμV/m)	Over Limit (dB)	Limit Line (dBμV/m)	Read Level (dBμV)	Antenna Factor (dB/m)	Cable Loss (dB)	Preamp Factor (dB)	Ant Pos (cm)	Table Pos (deg)	Peak Avg. (P/A)	Pol. (H/V)	
802.11ac VHT40 CH 38 5190MHz		10380	44.63	-29.37	74	47.54	39.11	17.17	59.19	100	0	P	H	
		15570	46.89	-27.11	74	43.28	41.14	19.63	57.16	100	0	P	H	
													H	
													H	
			10380	44.94	-29.06	74	47.85	39.11	17.17	59.19	100	0	P	V
			15570	45.74	-28.26	74	42.13	41.14	19.63	57.16	100	0	P	V
														V
802.11ac VHT40 CH 46 5230MHz		10460	44.18	-29.82	74	46.99	39.16	17.17	59.14	100	0	P	H	
		15690	45.62	-28.38	74	41.63	41.38	19.7	57.09	100	0	P	H	
													H	
													H	
			10460	45.62	-28.38	74	48.43	39.16	17.17	59.14	100	0	P	V
			15690	46	-28	74	42.01	41.38	19.7	57.09	100	0	P	V
														V
Remark	1. No other spurious found.													
	2. All results are PASS against Peak and Average limit line.													



Band 1 5150~5250MHz

WIFI 802.11ac VHT80 (Band Edge @ 3m)

WIFI Ant. 1+2	Note	Frequency (MHz)	Level (dBμV/m)	Over Limit (dB)	Limit Line (dBμV/m)	Read Level (dBμV)	Antenna Factor (dB/m)	Cable Loss (dB)	Preamp Factor (dB)	Ant Pos (cm)	Table Pos (deg)	Peak Avg. (P/A)	Pol. (H/V)	
802.11ac VHT80 CH 42 5210MHz		5145.08	58.2	-15.8	74	48.52	33.69	11.21	35.22	217	0	P	H	
		5144.04	50.67	-3.33	54	40.99	33.69	11.21	35.22	217	0	A	H	
	*	5210	106.07	-	-	96.18	33.86	11.25	35.22	217	0	P	H	
		5432.16	49.2	-24.8	74	38.12	34.43	11.89	35.24	217	0	P	H	
		5350.56	40.3	-13.7	54	29.56	34.21	11.76	35.23	217	0	A	H	
														H
			5119.6	64.34	-9.66	74	54.78	33.6	11.18	35.22	287	0	P	V
			5149.5	52.92	-1.08	54	43.24	33.69	11.21	35.22	287	0	A	V
		*	5210	107.34	-	-	97.45	33.86	11.25	35.22	287	0	P	V
		*	5210	97.59	-	-	87.7	33.86	11.25	35.22	287	0	A	V
			5407.2	49.88	-24.12	74	38.88	34.34	11.89	35.23	287	0	P	V
			5350.56	41.94	-12.06	54	31.2	34.21	11.76	35.23	287	0	A	V
Remark	1. No other spurious found. 2. All results are PASS against Peak and Average limit line.													



Band 1 5150~5250MHz

WIFI 802.11ac VHT80 (Harmonic @ 3m)

WIFI Ant. 1+2	Note	Frequency (MHz)	Level (dBμV/m)	Over Limit (dB)	Limit Line (dBμV/m)	Read Level (dBμV)	Antenna Factor (dB/m)	Cable Loss (dB)	Preamp Factor (dB)	Ant Pos (cm)	Table Pos (deg)	Peak Avg. (P/A)	Pol. (H/V)	
802.11ac VHT80 CH 42 5210MHz		10420	43.98	-30.02	74	46.85	39.13	17.17	59.17	100	0	P	H	
		15630	45.51	-28.49	74	41.67	41.28	19.68	57.12	100	0	P	H	
													H	
													H	
			10420	43.72	-30.28	74	46.59	39.13	17.17	59.17	100	0	P	V
			15630	46.9	-27.1	74	43.06	41.28	19.68	57.12	100	0	P	V
														V
														V
Remark	1. No other spurious found. 2. All results are PASS against Peak and Average limit line.													



Band 2 - 5250~5350MHz

WIFI 802.11ac VHT20 (Band Edge @ 3m)

WIFI	Note	Frequency	Level	Over	Limit	Read	Antenna	Cable	Preamp	Ant	Table	Peak	Pol.
Ant.				Limit	Line	Level	Factor	Loss	Factor	Pos	Pos	Avg.	
1+2		(MHz)	(dBμV/m)	(dB)	(dBμV/m)	(dBμV)	(dB/m)	(dB)	(dB)	(cm)	(deg)	(P/A)	(H/V)
802.11ac VHT20 CH 52 5260MHz		5129.22	50.64	-23.36	74	41.03	33.65	11.18	35.22	100	25	P	H
		5147.68	41.06	-12.94	54	31.38	33.69	11.21	35.22	100	25	A	H
	*	5260	111.91	-	-	101.77	33.99	11.38	35.23	100	25	P	H
	*	5260	105.23	-	-	95.09	33.99	11.38	35.23	100	25	A	H
		5410.8	49.74	-24.26	74	38.74	34.34	11.89	35.23	100	25	P	H
		5355.36	41.17	-12.83	54	30.43	34.21	11.76	35.23	100	25	P	H
		5085.02	50.18	-23.82	74	40.74	33.52	11.14	35.22	277	315	P	V
		5144.82	40.64	-13.36	54	30.96	33.69	11.21	35.22	277	315	A	V
	*	5260	111.51	-	-	101.37	33.99	11.38	35.23	277	315	P	V
	*	5260	103.82	-	-	93.68	33.99	11.38	35.23	277	315	A	V
		5442	49.95	-24.05	74	38.87	34.43	11.89	35.24	277	315	P	V
		5404.56	40.87	-13.13	54	29.87	34.34	11.89	35.23	277	315	A	V
802.11ac VHT20 CH 60 5300MHz		5048.88	50.52	-23.48	74	41.19	33.43	11.11	35.21	100	294	P	H
		5076.44	40.18	-13.82	54	30.73	33.52	11.14	35.21	100	294	A	H
	*	5300	107.66	-	-	97.3	34.08	11.51	35.23	100	294	P	H
	*	5300	100.62	-	-	90.26	34.08	11.51	35.23	100	294	A	H
		5355.12	52.89	-21.11	74	42.15	34.21	11.76	35.23	100	294	P	H
		5350.08	44.01	-9.99	54	33.27	34.21	11.76	35.23	100	294	A	H
		5081.64	48.95	-25.05	74	39.5	33.52	11.14	35.21	274	0	P	V
		5079.04	40.69	-13.31	54	31.24	33.52	11.14	35.21	274	0	A	V
	*	5300	111.18	-	-	100.82	34.08	11.51	35.23	274	0	P	V
	*	5300	103.5	-	-	93.14	34.08	11.51	35.23	274	0	A	V
		5370.48	53.28	-20.72	74	42.5	34.25	11.76	35.23	274	0	P	V
		5350.56	46.83	-7.17	54	36.09	34.21	11.76	35.23	274	0	A	V



802.11ac VHT20 CH 64 5320MHz	*	5320	110.15	-	-	99.63	34.12	11.63	35.23	100	19	P	H
	*	5320	103.58	-	-	93.06	34.12	11.63	35.23	100	19	A	H
		5350.72	57.19	-16.81	74	46.45	34.21	11.76	35.23	100	19	P	H
		5350.24	51.97	-2.03	54	41.23	34.21	11.76	35.23	100	19	A	H
													H
													H
	*	5320	110.75	-	-	100.23	34.12	11.63	35.23	284	0	P	V
	*	5320	103.06	-	-	92.54	34.12	11.63	35.23	284	0	A	V
		5351.52	58.03	-15.97	74	47.29	34.21	11.76	35.23	284	0	P	V
		5350.56	53.57	-1.43	54	41.83	34.21	11.76	35.23	284	0	A	V
													V
													V
Remark	1. No other spurious found. 2. All results are PASS against Peak and Average limit line.												



Band 2 5250~5350MHz

WIFI 802.11ac VHT20 (Harmonic @ 3m)

WIFI Ant. 1+2	Note	Frequency (MHz)	Level (dBμV/m)	Over Limit (dB)	Limit Line (dBμV/m)	Read Level (dBμV)	Antenna Factor (dB/m)	Cable Loss (dB)	Preamp Factor (dB)	Ant Pos (cm)	Table Pos (deg)	Peak Avg. (P/A)	Pol. (H/V)	
802.11ac VHT20 CH 52 5260MHz		10520	46.12	-27.88	74	48.85	39.18	17.17	59.08	100	0	P	H	
		15780	46.93	-27.07	74	42.66	41.55	19.75	57.03	100	0	P	H	
													H	
													H	
			10520	44.81	-29.19	74	47.54	39.18	17.17	59.08	100	0	P	V
			15780	46.23	-27.77	74	41.96	41.55	19.75	57.03	100	0	P	V
														V
802.11ac VHT20 CH 60 5300MHz		10600	43.56	-30.44	74	46.29	39.06	17.17	58.96	100	0	P	H	
		15900	47.56	-26.44	74	42.91	41.79	19.82	56.96	100	0	P	H	
													H	
													H	
			10600	44.31	-29.69	74	47.04	39.06	17.17	58.96	100	0	P	V
			15900	47.38	-26.62	74	42.73	41.79	19.82	56.96	100	0	P	V
														V
802.11ac VHT20 CH 64 5320MHz		10640	43.57	-30.43	74	46.3	39.01	17.17	58.91	100	0	P	H	
		15960	47.83	-26.17	74	42.95	41.93	19.87	56.92	100	0	P	H	
													H	
													H	
			10640	45.02	-28.98	74	47.75	39.01	17.17	58.91	100	0	P	V
			15960	46.15	-27.85	74	41.27	41.93	19.87	56.92	100	0	P	V
														V
Remark	1. No other spurious found.													
	2. All results are PASS against Peak and Average limit line.													



Band 2 5250~5350MHz

WIFI 802.11ac VHT40 (Band Edge @ 3m)

WIFI Ant. 1+2	Note	Frequency (MHz)	Level (dBμV/m)	Over Limit (dB)	Limit Line (dBμV/m)	Read Level (dBμV)	Antenna Factor (dB/m)	Cable Loss (dB)	Preamp Factor (dB)	Ant Pos (cm)	Table Pos (deg)	Peak Avg. (P/A)	Pol. (H/V)
802.11ac VHT40 CH 54 5270MHz		5148.72	52.09	-21.91	74	42.41	33.69	11.21	35.22	100	35	P	H
		5148.98	43.65	-10.35	54	33.97	33.69	11.21	35.22	100	35	A	H
	*	5270	106.14	-	-	95.87	33.99	11.51	35.23	100	35	P	H
	*	5270	98.92	-	-	88.65	33.99	11.51	35.23	100	35	A	H
		5361.6	52.35	-21.65	74	41.57	34.25	11.76	35.23	100	35	P	H
		5352.24	44.9	-9.1	54	34.16	34.21	11.76	35.23	100	35	A	H
		5149.5	53.38	-20.62	74	43.7	33.69	11.21	35.22	370	0	P	V
		5149.5	43.78	-10.22	54	34.1	33.69	11.21	35.22	370	0	A	V
	*	5270	107.06	-	-	96.79	33.99	11.51	35.23	370	0	P	V
	*	5270	100.38	-	-	90.11	33.99	11.51	35.23	370	0	A	V
		5350.56	53.6	-20.4	74	42.86	34.21	11.76	35.23	370	0	P	V
		5350.8	45.23	-8.77	54	34.49	34.21	11.76	35.23	370	0	A	V
802.11ac VHT40 CH 62 5310MHz		5034.58	49.66	-24.34	74	40.37	33.39	11.11	35.21	200	37	P	H
		5113.36	40.13	-13.87	54	30.57	33.6	11.18	35.22	200	37	A	H
	*	5310	102.19	-	-	91.67	34.12	11.63	35.23	200	37	P	H
	*	5310	95.22	-	-	84.7	34.12	11.63	35.23	200	37	A	H
		5354.16	60.25	-13.75	74	49.51	34.21	11.76	35.23	200	37	P	H
		5354.16	52.74	-1.26	54	42	34.21	11.76	35.23	200	37	P	H
		5088.14	49.65	-24.35	74	40.21	33.52	11.14	35.22	368	0	P	V
		5113.1	40.57	-13.43	54	31.01	33.6	11.18	35.22	368	0	A	V
	*	5310	105.04	-	-	94.52	34.12	11.63	35.23	368	0	P	V
	*	5310	97.7	-	-	87.18	34.12	11.63	35.23	368	0	A	V
	5351.28	57.99	-16.01	74	47.25	34.21	11.76	35.23	368	0	P	V	
	5350.8	51.8	-2.2	54	41.06	34.21	11.76	35.23	368	0	A	V	
Remark	1. No other spurious found. 2. All results are PASS against Peak and Average limit line.												



Band 2 5250~5350MHz

WIFI 802.11ac VHT40 (Harmonic @ 3m)

WIFI Ant. 1+2	Note	Frequency (MHz)	Level (dBμV/m)	Over Limit (dB)	Limit Line (dBμV/m)	Read Level (dBμV)	Antenna Factor (dB/m)	Cable Loss (dB)	Preamp Factor (dB)	Ant Pos (cm)	Table Pos (deg)	Peak Avg. (P/A)	Pol. (H/V)	
802.11ac VHT40 CH 54 5270MHz		10540	44.75	-29.25	74	47.48	39.15	17.17	59.05	100	0	P	H	
		15810	45.93	-28.07	74	41.55	41.62	19.77	57.01	100	0	P	H	
													H	
													H	
			10540	44.09	-29.91	74	46.82	39.15	17.17	59.05	100	0	P	V
			15810	46.5	-27.5	74	42.12	41.62	19.77	57.01	100	0	P	V
														V
802.11ac VHT40 CH 62 5310MHz		10620	45.04	-28.96	74	47.77	39.03	17.17	58.93	100	0	P	H	
		15930	46.24	-27.76	74	41.48	41.86	19.84	56.94	100	0	P	H	
													H	
													H	
			10620	43.34	-30.66	74	46.07	39.03	17.17	58.93	100	0	P	V
			15930	47.04	-26.96	74	42.28	41.86	19.84	56.94	100	0	P	V
														V
Remark	1. No other spurious found.													
	2. All results are PASS against Peak and Average limit line.													



Band 2 5250~5350MHz

WIFI 802.11ac VHT80 (Band Edge @ 3m)

WIFI Ant. 1+2	Note	Frequency (MHz)	Level (dBμV/m)	Over Limit (dB)	Limit Line (dBμV/m)	Read Level (dBμV)	Antenna Factor (dB/m)	Cable Loss (dB)	Preamp Factor (dB)	Ant Pos (cm)	Table Pos (deg)	Peak Avg. (P/A)	Pol. (H/V)
802.11ac VHT80 CH 58 5290MHz		5148.72	52.84	-21.16	74	43.16	33.69	11.21	35.22	100	18	P	H
		5148.46	44.18	-9.82	54	34.5	33.69	11.21	35.22	100	18	A	H
	*	5290	102.36	-	-	92.04	34.04	11.51	35.23	100	18	P	H
	*	5290	92.44	-	-	82.12	34.04	11.51	35.23	100	18	A	H
		5351.28	59.07	-14.93	74	48.33	34.21	11.76	35.23	100	18	P	H
		5354.88	52.18	-1.82	54	41.44	34.21	11.76	35.23	100	18	A	H
		5134.94	54.15	-19.85	74	44.54	33.65	11.18	35.22	369	0	P	V
		5148.72	46.07	-7.93	54	36.39	33.69	11.21	35.22	369	0	A	V
	*	5290	102.6	-	-	92.28	34.04	11.51	35.23	369	0	P	V
	*	5290	94.56	-	-	84.24	34.04	11.51	35.23	369	0	A	V
		5358	61.1	-12.9	74	50.36	34.21	11.76	35.23	369	0	P	V
	5350.32	51.97	-2.03	54	41.23	34.21	11.76	35.23	369	0	A	V	
Remark	1. No other spurious found. 2. All results are PASS against Peak and Average limit line.												



Band 2 5250~5350MHz

WIFI 802.11ac VHT80 (Harmonic @ 3m)

WIFI Ant. 1+2	Note	Frequency (MHz)	Level (dBμV/m)	Over Limit (dB)	Limit Line (dBμV/m)	Read Level (dBμV)	Antenna Factor (dB/m)	Cable Loss (dB)	Preamp Factor (dB)	Ant Pos (cm)	Table Pos (deg)	Peak Avg. (P/A)	Pol. (H/V)	
802.11ac VHT80 CH 58 5290MHz		10580	44.28	-29.72	74	47.01	39.08	17.17	58.98	100	0	P	H	
		15870	45.64	-28.36	74	41.03	41.76	19.82	56.97	100	0	P	H	
													H	
													H	
			10580	44.28	-29.72	74	47.01	39.08	17.17	58.98	100	0	P	V
			15870	46.47	-27.53	74	41.86	41.76	19.82	56.97	100	0	P	V
														V
														V
Remark	1. No other spurious found. 2. All results are PASS against Peak and Average limit line.													



Band 3 - 5470~5725MHz

WIFI 802.11ac VHT20 (Band Edge @ 3m)

WIFI	Note	Frequency	Level	Over	Limit	Read	Antenna	Cable	Preamp	Ant	Table	Peak	Pol.	
Ant.				Limit	Line	Level	Factor	Loss	Factor	Pos	Pos	Avg.		
1+2		(MHz)	(dBμV/m)	(dB)	(dBμV/m)	(dBμV)	(dB/m)	(dB)	(dB)	(cm)	(deg)	(P/A)	(H/V)	
802.11ac VHT20 CH 100 5500MHz		5447.76	56.96	-17.04	74	45.84	34.47	11.89	35.24	203	315	P	H	
		5469.36	61.06	-7.14	68.2	49.9	34.51	11.89	35.24	203	315	P	H	
		5459.76	50.37	-3.63	54	39.25	34.47	11.89	35.24	203	315	A	H	
	*	5500	109.7	-	-	98.45	34.6	11.89	35.24	203	315	P	H	
	*	5500	102.31	-	-	91.06	34.6	11.89	35.24	203	315	A	H	
														H
			5452.56	57.73	-16.27	74	46.61	34.47	11.89	35.24	100	338	P	V
			5470	61.94	-6.26	68.2	50.78	34.51	11.89	35.24	100	338	P	V
			5459.92	50.89	-3.11	54	39.77	34.47	11.89	35.24	100	338	A	V
	*		5500	112.04	-	-	100.79	34.6	11.89	35.24	100	338	P	V
	*		5500	104.62	-	-	93.37	34.6	11.89	35.24	100	338	A	V
													V	
802.11ac VHT20 CH 116 5580MHz		5440.48	48.63	-25.37	74	37.55	34.43	11.89	35.24	200	316	P	H	
		5469.04	47.52	-20.68	68.2	36.36	34.51	11.89	35.24	200	316	P	H	
		5457.52	40.57	-13.43	54	29.45	34.47	11.89	35.24	200	316	A	H	
	*	5580	110.48	-	-	99.25	34.6	11.89	35.26	200	316	P	H	
	*	5580	102.7	-	-	91.47	34.6	11.89	35.26	200	316	A	H	
			5747.675	50.52	-17.68	68.2	39.1	34.6	12.11	35.29	200	316	P	H
			5455.12	49.34	-24.66	74	38.22	34.47	11.89	35.24	110	337	P	V
			5461.12	49.05	-19.15	68.2	37.93	34.47	11.89	35.24	110	337	P	V
			5459.44	41.27	-12.73	54	30.15	34.47	11.89	35.24	110	337	A	V
	*		5580	113.13	-	-	101.9	34.6	11.89	35.26	110	337	P	V
	*		5580	105.24	-	-	94.01	34.6	11.89	35.26	110	337	A	V
		5746.45	51.38	-16.82	68.2	39.96	34.6	12.11	35.29	110	337	P	V	



802.11ac VHT20 CH 140 5700MHz	*	5700	108.28	-	-	96.96	34.6	12	35.28	172	315	P	H
	*	5700	100.3	-	-	88.98	34.6	12	35.28	172	315	A	H
		5725.4	64.42	-3.78	68.2	53.05	34.6	12.06	35.29	172	315	P	H
													H
													H
													H
	*	5700	110.13	-	-	98.81	34.6	12	35.28	104	355	P	V
	*	5700	101.92	-	-	90.6	34.6	12	35.28	104	355	A	V
		5725.16	67.76	-1.04	68.2	55.79	34.6	12.06	35.29	104	355	P	V
													V
													V
													V
Remark	1. No other spurious found. 2. All results are PASS against Peak and Average limit line.												



Band 3 - 5470~5725MHz

WIFI 802.11ac VHT20 (Harmonic @ 3m)

WIFI Ant. 1+2	Note	Frequency (MHz)	Level (dBμV/m)	Over Limit (dB)	Limit Line (dBμV/m)	Read Level (dBμV)	Antenna Factor (dB/m)	Cable Loss (dB)	Preamp Factor (dB)	Ant Pos (cm)	Table Pos (deg)	Peak Avg. (P/A)	Pol. (H/V)	
802.11ac VHT20 CH 100 5500MHz		11000	43.35	-30.65	74	46.08	38.5	17.17	58.4	100	0	P	H	
		16500	48.56	-25.44	74	41.43	43	20.23	56.1	100	0	P	H	
													H	
													H	
			11000	42.85	-31.15	74	45.58	38.5	17.17	58.4	100	0	P	V
			16500	48.28	-25.72	74	41.15	43	20.23	56.1	100	0	P	V
														V
802.11ac VHT20 CH 116 5580MHz		11160	44.27	-29.73	74	46.37	38.77	17.16	58.03	100	0	P	H	
		16740	49.61	-24.39	74	42.28	42.9	20.39	55.96	100	0	P	H	
													H	
													H	
			11160	43.25	-30.75	74	45.35	38.77	17.16	58.03	100	0	P	V
			16740	48.8	-25.2	74	41.47	42.9	20.39	55.96	100	0	P	V
														V
802.11ac VHT20 CH 140 5700MHz		11400	44.09	-29.91	74	45.31	39.14	17.16	57.52	100	0	P	H	
		17100	50.73	-23.27	74	43.28	42.64	20.65	55.84	100	0	P	H	
													H	
													H	
			11400	44.69	-29.31	74	45.91	39.14	17.16	57.52	100	0	P	V
			17100	50.09	-23.91	74	42.64	42.64	20.65	55.84	100	0	P	V
														V
Remark	1. No other spurious found.													
	2. All results are PASS against Peak and Average limit line.													



Band 3 - 5470~5725MHz

WIFI 802.11ac VHT40 (Band Edge @ 3m)

WIFI Ant. 1+2	Note	Frequency (MHz)	Level (dBμV/m)	Over Limit (dB)	Limit Line (dBμV/m)	Read Level (dBμV)	Antenna Factor (dB/m)	Cable Loss (dB)	Preamp Factor (dB)	Ant Pos (cm)	Table Pos (deg)	Peak Avg. (P/A)	Pol. (H/V)
802.11ac VHT40 CH 102 5510MHz		5449.36	54.49	-19.51	74	43.37	34.47	11.89	35.24	191	300	P	H
		5468.8	61.03	-7.17	68.2	49.87	34.51	11.89	35.24	191	300	P	H
		5459.44	49.41	-4.59	54	38.29	34.47	11.89	35.24	191	300	A	H
	*	5510	104.88	-	-	93.63	34.6	11.89	35.24	191	300	P	H
	*	5510	97.94	-	-	86.69	34.6	11.89	35.24	191	300	A	H
		5738.225	48.82	-19.38	68.2	37.45	34.6	12.06	35.29	191	300	P	H
		5458.96	59.45	-14.55	74	48.33	34.47	11.89	35.24	100	339	P	V
		5468.32	64.64	-3.56	68.2	53.48	34.51	11.89	35.24	100	339	P	V
		5459.68	52.05	-1.95	54	40.93	34.47	11.89	35.24	100	339	A	V
	*	5520	105.79	-	-	94.54	34.6	11.89	35.24	100	339	P	V
	*	5520	98.59	-	-	87.34	34.6	11.89	35.24	100	339	A	V
	5735.95	49.73	-18.47	68.2	38.36	34.6	12.06	35.29	100	339	P	V	
802.11ac VHT40 CH 110 5550MHz		5455.36	53.05	-20.95	74	41.93	34.47	11.89	35.24	191	300	P	H
		5464.72	52.72	-15.48	68.2	41.56	34.51	11.89	35.24	191	300	P	H
		5458	46.48	-7.52	54	35.36	34.47	11.89	35.24	191	300	A	H
	*	5550	106.16	-	-	94.92	34.6	11.89	35.25	191	300	P	H
	*	5550	99.25	-	-	88.01	34.6	11.89	35.25	191	300	A	H
		5736.3	50.96	-17.24	68.2	39.59	34.6	12.06	35.29	191	300	P	H
		5457.28	51.49	-22.51	74	40.37	34.47	11.89	35.24	121	337	P	V
		5468.32	56.18	-12.02	68.2	45.02	34.51	11.89	35.24	121	337	P	V
		5459.92	46.81	-7.19	54	35.69	34.47	11.89	35.24	121	337	A	V
	*	5550	109.21	-	-	97.97	34.6	11.89	35.25	121	337	P	V
	*	5550	102.14	-	-	90.9	34.6	11.89	35.25	121	337	A	V
	5726.5	49.93	-18.27	68.2	38.56	34.6	12.06	35.29	121	337	P	V	



802.11ac VHT40 CH 134 5670MHz		5425.84	48.86	-25.14	74	37.83	34.38	11.89	35.24	200	300	P	H
		5462.08	47.11	-21.09	68.2	35.99	34.47	11.89	35.24	200	300	P	H
		5458.48	40.23	-13.77	54	29.11	34.47	11.89	35.24	200	300	A	H
	*	5670	105.97	-	-	94.64	34.6	12	35.27	200	300	P	H
	*	5670	100.15	-	-	88.82	34.6	12	35.27	200	300	A	H
		5730.525	54.44	-13.76	68.2	43.07	34.6	12.06	35.29	200	300	P	H
		5456.32	48.61	-25.39	74	37.49	34.47	11.89	35.24	105	337	P	V
		5469.04	47.83	-20.37	68.2	36.67	34.51	11.89	35.24	105	337	P	V
		5458	40.33	-13.67	54	29.21	34.47	11.89	35.24	105	337	A	V
	*	5670	109.19	-	-	97.86	34.6	12	35.27	105	337	P	V
	*	5670	101.41	-	-	90.08	34.6	12	35.27	105	337	A	V
		5736.475	55.56	-12.64	68.2	44.19	34.6	12.06	35.29	105	337	P	V
Remark	1. No other spurious found. 2. All results are PASS against Peak and Average limit line.												



Band 3 - 5470~5725MHz

WIFI 802.11ac VHT40 (Harmonic @ 3m)

WIFI Ant. 1+2	Note	Frequency (MHz)	Level (dBμV/m)	Over Limit (dB)	Limit Line (dBμV/m)	Read Level (dBμV)	Antenna Factor (dB/m)	Cable Loss (dB)	Preamp Factor (dB)	Ant Pos (cm)	Table Pos (deg)	Peak Avg. (P/A)	Pol. (H/V)	
802.11ac VHT40 CH 102 5510MHz		11020	43.46	-30.54	74	46.12	38.53	17.17	58.36	100	0	P	H	
		16530	49.21	-24.79	74	42.05	42.99	20.25	56.08	100	0	P	H	
													H	
													H	
			11020	44	-30	74	46.66	38.53	17.17	58.36	100	0	P	V
			16530	48.35	-25.65	74	41.19	42.99	20.25	56.08	100	0	P	V
														V
802.11ac VHT40 CH 110 5550MHz		11100	42.95	-31.05	74	45.31	38.66	17.16	58.18	100	0	P	H	
		16650	48.9	-25.1	74	41.63	42.94	20.34	56.01	100	0	P	H	
													H	
													H	
			11100	44.22	-29.78	74	46.58	38.66	17.16	58.18	100	0	P	V
			16650	48.81	-25.19	74	41.54	42.94	20.34	56.01	100	0	P	V
														V
802.11ac VHT40 CH 134 5670MHz		11340	43.64	-30.36	74	45.12	39.03	17.16	57.67	100	0	P	H	
		17010	48.55	-25.45	74	41	42.77	20.59	55.81	100	0	P	H	
													H	
													H	
			11340	43.92	-30.08	74	45.4	39.03	17.16	57.67	100	0	P	V
			17010	48.28	-25.72	74	40.73	42.77	20.59	55.81	100	0	P	V
														V
Remark	1. No other spurious found.													
	2. All results are PASS against Peak and Average limit line.													



Band 3 5470~5725MHz

WIFI 802.11ac VHT80 (Band Edge @ 3m)

WIFI Ant. 1+2	Note	Frequency (MHz)	Level (dBμV/m)	Over Limit (dB)	Limit Line (dBμV/m)	Read Level (dBμV)	Antenna Factor (dB/m)	Cable Loss (dB)	Preamp Factor (dB)	Ant Pos (cm)	Table Pos (deg)	Peak Avg. (P/A)	Pol. (H/V)
802.11ac VHT80 CH 106 5530MHz		5450.08	65.78	-8.22	74	54.66	34.47	11.89	35.24	200	290	P	H
		5469.76	60.22	-7.98	68.2	49.06	34.51	11.89	35.24	200	290	P	H
		5459.92	51.67	-2.33	54	40.55	34.47	11.89	35.24	200	290	A	H
	*	5530	102.24	-	-	91	34.6	11.89	35.25	200	290	P	H
	*	5530	95.57	-	-	84.33	34.6	11.89	35.25	200	290	A	H
		5746.45	50.69	-17.51	68.2	39.27	34.6	12.11	35.29	200	290	P	H
		5457.76	59.63	-14.37	74	48.51	34.47	11.89	35.24	119	335	P	V
		5468.56	60.59	-7.61	68.2	49.43	34.51	11.89	35.24	119	335	P	V
		5459.92	53.51	-1.49	54	41.39	34.47	11.89	35.24	119	335	P	V
	*	5530	103.42	-	-	92.18	34.6	11.89	35.25	119	335	P	V
	*	5530	96.08	-	-	84.84	34.6	11.89	35.25	119	335	A	V
		5757.3	49.88	-18.32	68.2	38.46	34.6	12.11	35.29	119	335	P	V
802.11ac VHT80 CH 122 5610MHz		5446.24	53.33	-20.67	74	42.21	34.47	11.89	35.24	200	302	P	H
		5464.72	54.14	-14.06	68.2	42.98	34.51	11.89	35.24	200	302	P	H
		5459.92	45.02	-8.98	54	33.9	34.47	11.89	35.24	200	302	A	H
	*	5620	103.06	-	-	91.83	34.6	11.89	35.26	200	302	P	H
	*	5620	95.73	-	-	84.5	34.6	11.89	35.26	200	302	A	H
		5735.425	51.44	-16.76	68.2	40.07	34.6	12.06	35.29	200	302	P	H
		5449.36	57.71	-16.29	74	46.59	34.47	11.89	35.24	117	335	P	V
		5465.68	53.52	-14.68	68.2	42.36	34.51	11.89	35.24	117	335	P	V
		5458.96	46.35	-7.65	54	35.23	34.47	11.89	35.24	117	335	A	V
	*	5610	104.59	-	-	93.36	34.6	11.89	35.26	117	335	P	V
	*	5610	97.3	-	-	86.07	34.6	11.89	35.26	117	335	A	V
	5746.975	54.37	-13.83	68.2	42.95	34.6	12.11	35.29	117	335	P	V	
Remark	1. No other spurious found. 2. All results are PASS against Peak and Average limit line.												



Band 3 5470~5725MHz

WIFI 802.11ac VHT80 (Harmonic @ 3m)

WIFI Ant. 1+2	Note	Frequency (MHz)	Level (dBμV/m)	Over Limit (dB)	Limit Line (dBμV/m)	Read Level (dBμV)	Antenna Factor (dB/m)	Cable Loss (dB)	Preamp Factor (dB)	Ant Pos (cm)	Table Pos (deg)	Peak Avg. (P/A)	Pol. (H/V)	
802.11ac VHT80 CH 106 5530MHz		11060	44.74	-29.26	74	47.22	38.61	17.16	58.25	100	0	P	H	
		16590	49.12	-24.88	74	41.89	42.97	20.31	56.05	100	0	P	H	
													H	
													H	
			11060	44.17	-29.83	74	46.65	38.61	17.16	58.25	100	0	P	V
			16590	48.23	-25.77	74	41	42.97	20.31	56.05	100	0	P	V
														V
802.11ac VHT80 CH 122 5610MHz		11220	45	-29	74	46.91	38.85	17.16	57.92	100	0	P	H	
		16830	49.91	-24.09	74	42.46	42.87	20.48	55.9	100	0	P	H	
													H	
													H	
			11220	44.69	-29.31	74	46.6	38.85	17.16	57.92	100	0	P	V
			16830	49.51	-24.49	74	42.06	42.87	20.48	55.9	100	0	P	V
														V
Remark	1. No other spurious found.													
	2. All results are PASS against Peak and Average limit line.													



Band 3 - Straddle Channel

WIFI 802.11ac VHT20 (Band Edge @ 3m)

WIFI	Note	Frequency	Level	Over	Limit	Read	Antenna	Cable	Preamp	Ant	Table	Peak	Pol.
Ant.				Limit	Line	Level	Factor	Loss	Factor	Pos	Pos	Avg.	
1+2		(MHz)	(dBμV/m)	(dB)	(dBμV/m)	(dBμV)	(dB/m)	(dB)	(dB)	(cm)	(deg)	(P/A)	(H/V)
802.11ac VHT20 CH 144 5720MHz	*	5720	107.57	-	-	96.19	34.6	12.06	35.28	172	315	P	H
	*	5720	99.9	-	-	88.52	34.6	12.06	35.28	172	315	A	H
													H
													H
													H
													H
	*	5720	110.96	-	-	99.58	34.6	12.06	35.28	102	337	P	V
	*	5720	102.96	-	-	91.58	34.6	12.06	35.28	102	337	A	V
													V
													V
												V	
												V	
Remark	1. No other spurious found. 2. All results are PASS against Peak and Average limit line.												



Band 3 - Straddle Channel
WIFI 802.11ac VHT20 (Harmonic @ 3m)

WIFI Ant. 1+2	Note	Frequency (MHz)	Level (dBµV/m)	Over Limit (dB)	Limit Line (dBµV/m)	Read Level (dBµV)	Antenna Factor (dB/m)	Cable Loss (dB)	Preamp Factor (dB)	Ant Pos (cm)	Table Pos (deg)	Peak Avg. (P/A)	Pol. (H/V)	
802.11ac VHT20 CH 144 5720MHz		11440	45.02	-28.98	74	46.12	39.19	17.16	57.45	100	0	P	H	
		17160	50.56	-23.44	74	43.2	42.53	20.7	55.87	100	0	P	H	
													H	
													H	
			11440	44.69	-29.31	74	45.79	39.19	17.16	57.45	100	0	P	V
			17160	50.43	-23.57	74	43.07	42.53	20.7	55.87	100	0	P	V
														V
														V
Remark	1. No other spurious found. 2. All results are PASS against Peak and Average limit line.													



Band 3 - Straddle Channel
WIFI 802.11ac VHT40 (Band Edge @ 3m)

WIFI Ant. 1+2	Note	Frequency (MHz)	Level (dBμV/m)	Over Limit (dB)	Limit Line (dBμV/m)	Read Level (dBμV)	Antenna Factor (dB/m)	Cable Loss (dB)	Preamp Factor (dB)	Ant Pos (cm)	Table Pos (deg)	Peak Avg. (P/A)	Pol. (H/V)
802.11ac VHT40 CH 142 5710MHz	*	5710	104.49	-	-	93.11	34.6	12.06	35.28	200	300	P	H
	*	5710	96.63	-	-	85.25	34.6	12.06	35.28	200	300	A	H
													H
													H
													H
													H
	*	5710	106.34	-	-	94.96	34.6	12.06	35.28	100	335	P	V
	*	5710	98.58	-	-	87.2	34.6	12.06	35.28	100	335	A	V
													V
													V
Remark	1. No other spurious found. 2. All results are PASS against Peak and Average limit line.												



Band 3 - Straddle Channel
WIFI 802.11ac VHT40 (Harmonic @ 3m)

WIFI Ant. 1+2	Note	Frequency (MHz)	Level (dBµV/m)	Over Limit (dB)	Limit Line (dBµV/m)	Read Level (dBµV)	Antenna Factor (dB/m)	Cable Loss (dB)	Preamp Factor (dB)	Ant Pos (cm)	Table Pos (deg)	Peak Avg. (P/A)	Pol. (H/V)	
802.11ac VHT40 CH 142 5710MHz		11420	44.66	-29.34	74	45.81	39.17	17.16	57.48	100	0	P	H	
		17130	50.5	-23.5	74	43.09	42.59	20.67	55.85	100	0	P	H	
													H	
													H	
			11420	45.31	-28.69	74	46.46	39.17	17.16	57.48	100	0	P	V
			17130	49.44	-24.56	74	42.03	42.59	20.67	55.85	100	0	P	V
														V
														V
Remark	1. No other spurious found. 2. All results are PASS against Peak and Average limit line.													



Band 3 - Straddle Channel
WIFI 802.11ac VHT80 (Band Edge @ 3m)

WIFI Ant. 1+2	Note	Frequency (MHz)	Level (dBμV/m)	Over Limit (dB)	Limit Line (dBμV/m)	Read Level (dBμV)	Antenna Factor (dB/m)	Cable Loss (dB)	Preamp Factor (dB)	Ant Pos (cm)	Table Pos (deg)	Peak Avg. (P/A)	Pol. (H/V)	
802.11ac VHT80 CH 138 5690MHz	*	5690	104.81	-	-	93.49	34.6	12	35.28	187	293	P	H	
	*	5690	95.23	-	-	83.91	34.6	12	35.28	187	293	A	H	
													H	
													H	
													H	
													H	
	*	5690	106.06	-	-	94.74	34.6	12	35.28	119	318	P	V	
	*	5690	96.15	-	-	84.83	34.6	12	35.28	119	318	A	V	
														V
														V
Remark	1. No other spurious found. 2. All results are PASS against Peak and Average limit line.													



Band 3 - Straddle Channel
WIFI 802.11ac VHT80 (Harmonic @ 3m)

WIFI Ant. 1+2	Note	Frequency (MHz)	Level (dBμV/m)	Over Limit (dB)	Limit Line (dBμV/m)	Read Level (dBμV)	Antenna Factor (dB/m)	Cable Loss (dB)	Preamp Factor (dB)	Ant Pos (cm)	Table Pos (deg)	Peak Avg. (P/A)	Pol. (H/V)	
802.11ac VHT80 CH 138 5690MHz		11380	44.35	-29.65	74	45.64	39.11	17.16	57.56	100	0	P	H	
		17070	49.77	-24.23	74	42.26	42.69	20.65	55.83	100	0	P	H	
													H	
													H	
			11380	43.79	-30.21	74	45.08	39.11	17.16	57.56	100	0	P	V
			17070	49.76	-24.24	74	42.25	42.69	20.65	55.83	100	0	P	V
														V
														V
Remark	1. No other spurious found. 2. All results are PASS against Peak and Average limit line.													



Emission below 1GHz

WIFI 802.11n VHT20 (LF @ 3m)

WIFI	Note	Frequency	Level	Over	Limit	Read	Antenna	Cable	Preamp	Ant	Table	Peak	Pol.	
Ant.				Limit	Line	Level	Factor	Loss	Factor	Pos	Pos	Avg.		
1+2		(MHz)	(dBμV/m)	(dB)	(dBμV/m)	(dBμV)	(dB/m)	(dB)	(dB)	(cm)	(deg)	(P/A)	(H/V)	
802.11n VHT20 LF		149.34	39.01	-4.49	43.5	50.6	17.73	1.78	31.1	100	340	P	H	
		225.48	35.34	-10.66	46	47.39	16.88	2.07	31			P	H	
		297.84	34.34	-11.66	46	43.26	19.78	2.32	31.02			P	H	
		522.6	27.93	-18.07	46	31.1	24.38	3.14	30.69			P	H	
		723.5	31.27	-14.73	46	31.15	26.78	3.74	30.4			P	H	
		996.5	34.1	-19.9	54	30.05	30.29	3.98	30.22			P	H	
														H
														H
														H
														H
														H
														H
			76.44	33.74	-6.26	40	50.2	13.46	1.28	31.2	100	81	P	V
			116.13	33.22	-10.28	43.5	45.13	17.68	1.55	31.14			P	V
			222.24	30.56	-15.44	46	42.93	16.56	2.07	31			P	V
			302.8	28.48	-17.52	46	37.19	19.88	2.41	31			P	V
			656.3	29.66	-16.34	46	30.61	25.97	3.57	30.49			P	V
			982.5	34.75	-19.25	54	30.77	30.27	3.98	30.27			P	V
														V
														V
													V	
													V	
													V	
													V	
Remark	1. No other spurious found. 2. All results are PASS against limit line.													



Note symbol

*	Fundamental Frequency which can be ignored. However, the level of any unwanted emissions shall not exceed the level of the fundamental frequency.
!	Test result is over limit line.
P/A	Peak or Average
H/V	Horizontal or Vertical



A calculation example for radiated spurious emission is shown as below:

WIFI	Note	Frequency	Level	Over	Limit	Read	Antenna	Cable	Preamp	Ant	Table	Peak	Pol.
Ant.				Limit	Line	Level	Factor	Loss	Factor	Pos	Pos	Avg.	
1+2		(MHz)	(dBμV/m)	(dB)	(dBμV/m)	(dBμV)	(dB/m)	(dB)	(dB)	(cm)	(deg)	(P/A)	(H/V)
802.11b		2390	55.45	-18.55	74	54.51	32.22	4.58	35.86	103	308	P	H
CH 01													
2412MHz		2390	43.54	-10.46	54	42.6	32.22	4.58	35.86	103	308	A	H

- Level(dBμV/m) =
Antenna Factor(dB/m) + Cable Loss(dB) + Read Level(dBμV) - Preamp Factor(dB)
- Over Limit(dB) = Level(dBμV/m) – Limit Line(dBμV/m)

For Peak Limit @ 2390MHz:

- Level(dBμV/m)
= Antenna Factor(dB/m) + Cable Loss(dB) + Read Level(dBμV) - Preamp Factor(dB)
= 32.22(dB/m) + 4.58(dB) + 54.51(dBμV) – 35.86 (dB)
= 55.45 (dBμV/m)
- Over Limit(dB)
= Level(dBμV/m) – Limit Line(dBμV/m)
= 55.45(dBμV/m) – 74(dBμV/m)
= -18.55(dB)

For Average Limit @ 2390MHz:

- Level(dBμV/m)
= Antenna Factor(dB/m) + Cable Loss(dB) + Read Level(dBμV) - Preamp Factor(dB)
= 32.22(dB/m) + 4.58(dB) + 42.6(dBμV) – 35.86 (dB)
= 43.54 (dBμV/m)
- Over Limit(dB)
= Level(dBμV/m) – Limit Line(dBμV/m)
= 43.54(dBμV/m) – 54(dBμV/m)
= -10.46(dB)

Both peak and average measured complies with the limit line, so test result is “PASS”.



Appendix C. Radiated Spurious Emission

Test Engineer :	Luke Chang, Ken Wu, Derreck Chen, Jesse Wang, and James Chiu	Temperature :	21~24°C
		Relative Humidity :	50~55%

Note symbol

-L	Low channel location
-R	High channel location



Band 1 - 5150~5250MHz
WIFI 802.11a (Band Edge @ 3m)

WIFI	Band 1 5150~5250MHz Band Edge @ 3m	
ANT	802.11a CH36 5180MHz	
1	Horizontal	Fundamental
Peak	<p>Site : 03CH07-HY Condition : PEAK_BE_74 3m HF-ANT_130829 HORIZONTAL Detector : Peak Project : 672834 Mode : 1</p>	<p>Site : 03CH07-HY Condition : PEAK_74 3m HF-ANT_130829 HORIZONTAL Detector : Peak Project : 672834 Mode : 1</p>
Avg.	<p>Site : 03CH07-HY Condition : AVG_BE_54 3m HF-ANT_130829 HORIZONTAL Detector : Peak Project : 672834 Mode : 1</p>	Left blank

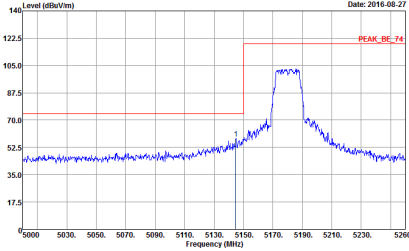
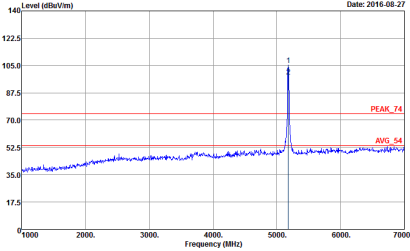
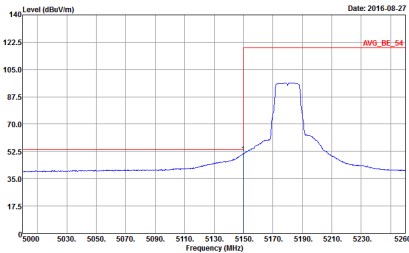

WIFI	Band 1 5150~5250MHz Band Edge @ 3m	
ANT	802.11a CH36 5180MHz	
1	<p style="text-align: center;">Vertical</p>  <p style="text-align: right;">Date: 2016-08-27</p> <p>Site : 03CH07-HY Condition : PEAK_BE_74 3m HF-ANT_130829 VERTICAL RBW: 1000.000kHz VBW: 3000.000kHz SWT: Auto Detector : Peak Project : 672834 Mode : 1</p>	<p style="text-align: center;">Fundamental</p>  <p style="text-align: right;">Date: 2016-08-27</p> <p>Site : 03CH07-HY Condition : PEAK_74 3m HF-ANT_130829 VERTICAL RBW: 1000.000kHz VBW: 3000.000kHz SWT: Auto Detector : Peak Project : 672834 Mode : 1</p>
Peak	<p style="text-align: center;">Avg.</p>  <p style="text-align: right;">Date: 2016-08-27</p> <p>Site : 03CH07-HY Condition : AVG_BE_54 3m HF-ANT_130829 VERTICAL RBW: 1000.000kHz VBW: 1.000kHz SWT: Auto Detector : Peak Project : 672834 Mode : 1</p>	<p style="text-align: center;">Left blank</p>

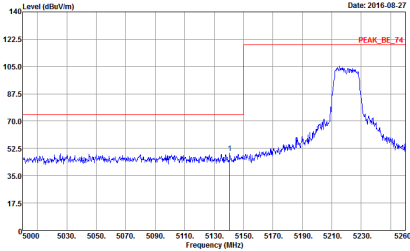
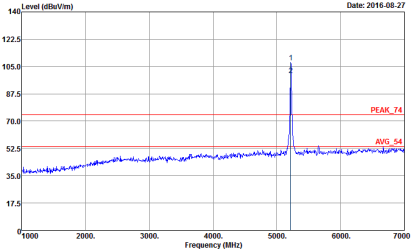
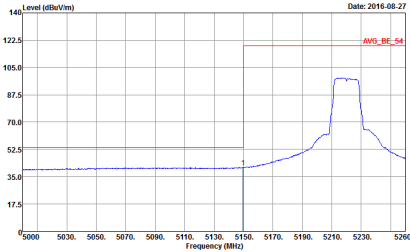

WIFI	Band 1 5150~5250MHz Band Edge @ 3m	
ANT	802.11a CH44 5220MHz - L	
1	Horizontal	Fundamental
Peak	 <p>Date: 2016-08-27</p> <p>Site : 03CH07-HY Condition : PEAK_BE_74 3m HF-ANT_130829 HORIZONTAL Detector : Peak Project : 672834 Mode : 2</p>	 <p>Date: 2016-08-27</p> <p>Site : 03CH07-HY Condition : PEAK_74 3m HF-ANT_130829 HORIZONTAL Detector : Peak Project : 672834 Mode : 2</p>
Avg.	 <p>Date: 2016-08-27</p> <p>Site : 03CH07-HY Condition : AVG_BE_54 3m HF-ANT_130829 HORIZONTAL Detector : Peak Project : 672834 Mode : 2</p>	Left blank



WIFI	Band 1 5150~5250MHz Band Edge @ 3m	
ANT	802.11a CH44 5220MHz - R	
1	Horizontal	Fundamental
Peak	<p>Site : 03CH07-HY Condition : PEAK_BE_74 3m HF-ANT_130829 HORIZONTAL Detector : Peak Project : 672834 Mode : 2</p>	Left blank
Avg.	<p>Site : 03CH07-HY Condition : AVG_BE_54 3m HF-ANT_130829 HORIZONTAL Detector : Peak Project : 672834 Mode : 2</p>	Left blank

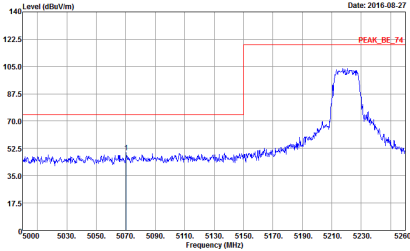
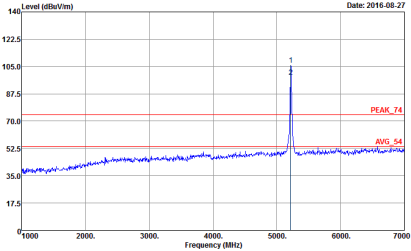
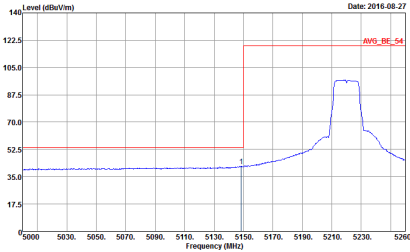

WIFI	Band 1 5150~5250MHz Band Edge @ 3m	
ANT	802.11a CH44 5220MHz - L	
1	Vertical	Fundamental
Peak	 <p>Date: 2016-08-27</p> <p>Site : 03CH07-HY Condition : PEAK_BE_74 3m HF-ANT_130829 VERTICAL Detector : Peak Project : 672834 Mode : 2</p>	 <p>Date: 2016-08-27</p> <p>Site : 03CH07-HY Condition : PEAK_74 3m HF-ANT_130829 VERTICAL Detector : Peak Project : 672834 Mode : 2</p>
Avg.	 <p>Date: 2016-08-27</p> <p>Site : 03CH07-HY Condition : AVG_BE_54 3m HF-ANT_130829 VERTICAL Detector : Peak Project : 672834 Mode : 2</p>	Left blank

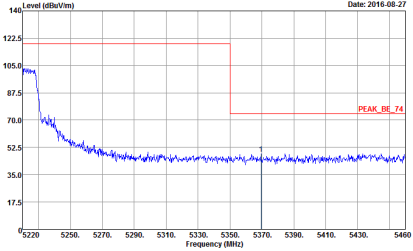
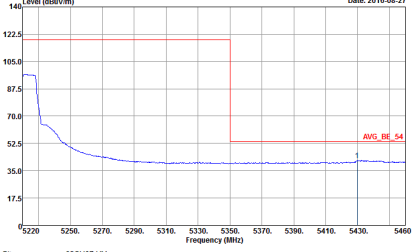

WIFI	Band 1 5150~5250MHz Band Edge @ 3m	
ANT	802.11a CH44 5220MHz - R	
1	Vertical	Fundamental
<p>Peak</p>	 <p> <small>Date: 2016-08-27</small> Site : 03CH07-HY Condition : PEAK_BE_74 3m HF-ANT_130829 VERTICAL Detector : Peak Project : 672834 Mode : 2 </p>	<p>Left blank</p>
<p>Avg.</p>	 <p> <small>Date: 2016-08-27</small> Site : 03CH07-HY Condition : AVG_BE_54 3m HF-ANT_130829 VERTICAL Detector : Peak Project : 672834 Mode : 2 </p>	<p>Left blank</p>

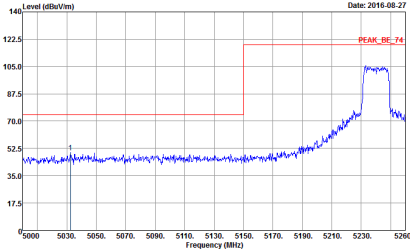
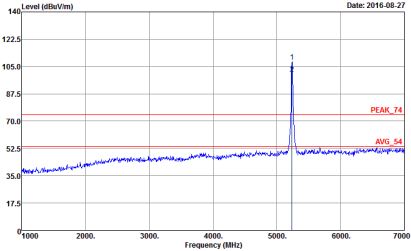
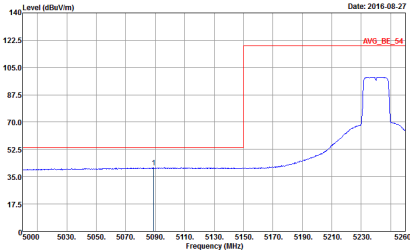

WIFI	Band 1 5150~5250MHz Band Edge @ 3m	
ANT	802.11a CH48 5240MHz - L	
1	Horizontal	Fundamental
Peak	 <p>Date: 2016-08-27</p> <p>Site : 03CH07-HY Condition : PEAK_BE_74 3m HF-ANT_130829 HORIZONTAL Detector : Peak Project : 672834 Mode : 3</p>	 <p>Date: 2016-08-27</p> <p>Site : 03CH07-HY Condition : PEAK_74 3m HF-ANT_130829 HORIZONTAL Detector : Peak Project : 672834 Mode : 3</p>
Avg.	 <p>Date: 2016-08-27</p> <p>Site : 03CH07-HY Condition : AVG_BE_54 3m HF-ANT_130829 HORIZONTAL Detector : Peak Project : 672834 Mode : 3</p>	Left blank



WIFI	Band 1 5150~5250MHz Band Edge @ 3m	
ANT	802.11a CH48 5240MHz - R	
1	Horizontal	Fundamental
Peak	<p>Site : 03CH07-FY Condition : PEAK_BE_74 3m HF-ANT_130829 HORIZONTAL Detector : Peak Project : 672834 Mode : 3</p>	Left blank
Avg.	<p>Site : 03CH07-FY Condition : AVG_BE_54 3m HF-ANT_130829 HORIZONTAL Detector : Peak Project : 672834 Mode : 3</p>	Left blank

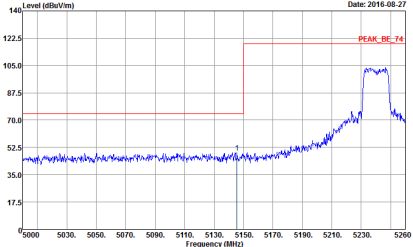
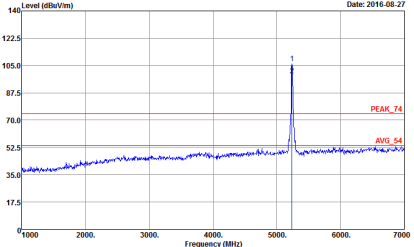
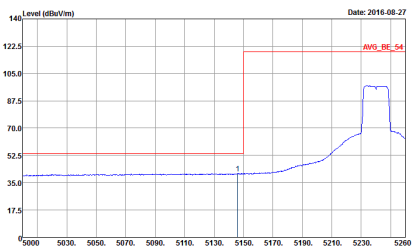

WIFI	Band 1 5150~5250MHz Band Edge @ 3m	
ANT	802.11a CH48 5240MHz - L	
<p style="text-align: center;">1</p>	<p style="text-align: center;">Vertical</p>  <p style="font-size: small;">Date: 2016-08-27</p> <p>Site : 03CH07-HY Condition : PEAK_BE_74 3m HF-ANT_130829 VERTICAL RBW:1000.000kHz VBW:3000.000kHz SWT:Auto Detector : Peak Project : 672834 Mode : 3</p>	<p style="text-align: center;">Fundamental</p>  <p style="font-size: small;">Date: 2016-08-27</p> <p>Site : 03CH07-HY Condition : PEAK_74 3m HF-ANT_130829 VERTICAL RBW:1000.000kHz VBW:3000.000kHz SWT:Auto Detector : Peak Project : 672834 Mode : 3</p>
<p style="text-align: center;">Peak</p>	 <p style="font-size: small;">Date: 2016-08-27</p> <p>Site : 03CH07-HY Condition : AVG_BE_54 3m HF-ANT_130829 VERTICAL RBW:1000.000kHz VBW:1.000kHz SWT:Auto Detector : Peak Project : 672834 Mode : 3</p>	<p style="text-align: center;">Left blank</p>

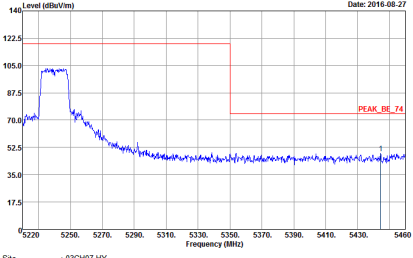
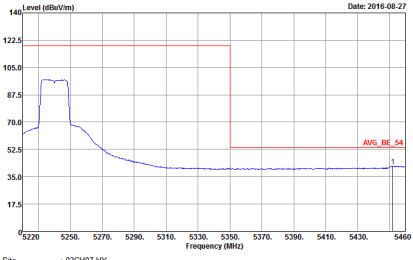

WIFI	Band 1 5150~5250MHz Band Edge @ 3m	
ANT	802.11a CH48 5240MHz - R	
1	Vertical	Fundamental
<p>Peak</p>	 <p>Date: 2016-08-27</p> <p>Site : 03CH07-HY Condition : PEAK_BE_74 3m HF-ANT_130829 VERTICAL RBW:1000.000kHz VBW:3000.000kHz SWT:Auto Detector : Peak Project : 672834 Mode : 3</p>	<p>Left blank</p>
<p>Avg.</p>	 <p>Date: 2016-08-27</p> <p>Site : 03CH07-HY Condition : AVG_BE_54 3m HF-ANT_130829 VERTICAL RBW:1000.000kHz VBW:1.000kHz SWT:Auto Detector : Peak Project : 672834 Mode : 3</p>	<p>Left blank</p>

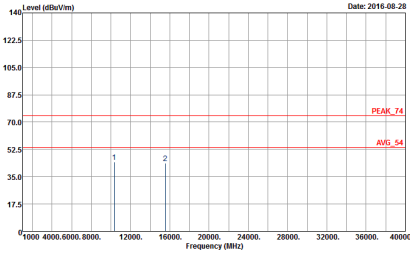
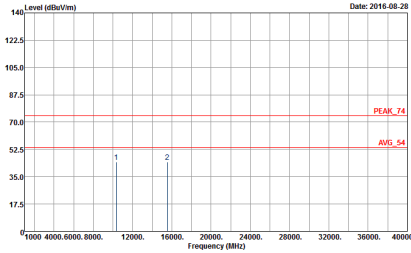

Band 1 - 5150~5250MHz
WIFI 802.11a (Harmonic @ 3m)

WIFI	Band 1 5150~5250MHz Harmonic @ 3m	
ANT	802.11a CH36 5180MHz	
1	Horizontal	Vertical
<p>Peak Avg.</p>	 <p>Site : 03CH07.HY Condition : PEAK_74 3m SHF-EHF_131029 HORIZONTAL Detector : Peak Project : 672834 Mode : 1</p>	 <p>Site : 03CH07.HY Condition : PEAK_74 3m SHF-EHF_131029 VERTICAL Detector : Peak Project : 672834 Mode : 1</p>



WIFI	Band 1 5150~5250MHz Harmonic @ 3m	
ANT	802.11a CH44 5220MHz	
1	Horizontal	Vertical
Peak Avg.	<p>Site : 03CH07.HY Condition : PEAK_74 3m SHF-EHF_131029 HORIZONTAL Detector : Peak Project : 672834 Mode : 2</p>	<p>Site : 03CH07.HY Condition : PEAK_74 3m SHF-EHF_131029 VERTICAL Detector : Peak Project : 672834 Mode : 2</p>

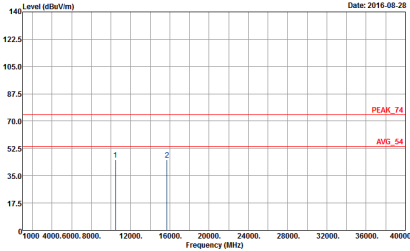
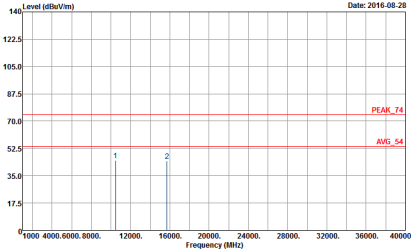

WIFI	Band 1 5150~5250MHz Harmonic @ 3m	
ANT	802.11a CH48 5240MHz	
1	Horizontal	Vertical
Peak Avg.	 <p data-bbox="347 748 579 801"> Site : 03CH07.HY Condition : PEAK_74 3m SHF-EHF_131029 HORIZONTAL Detector : Peak Project : 672834 Mode : 3 </p>	 <p data-bbox="943 748 1174 801"> Site : 03CH07.HY Condition : PEAK_74 3m SHF-EHF_131029 VERTICAL Detector : Peak Project : 672834 Mode : 3 </p>



Band 2 - 5250~5350MHz
WIFI 802.11a (Band Edge @ 3m)

WIFI	Band 2 5250~5350MHz Band Edge @ 3m	
ANT	802.11a CH52 5260MHz - L	
1	Horizontal	Fundamental
Peak	<p>Site : 03CH07-HY Condition : PEAK_BE_74 3m HF-ANT_130829 HORIZONTAL RBW: 1000.000kHz VSW: 3000.000kHz SWT: Auto Detector : Peak Project : 672834 Mode : 4</p>	<p>Site : 03CH07-HY Condition : PEAK_74 3m HF-ANT_130829 HORIZONTAL RBW: 1000.000kHz VSW: 3000.000kHz SWT: Auto Detector : Peak Project : 672834 Mode : 4</p>
Avg.	<p>Site : 03CH07-HY Condition : AVG_BE_54 3m HF-ANT_130829 HORIZONTAL RBW: 1000.000kHz VSW: 1.000kHz SWT: Auto Detector : Peak Project : 672834 Mode : 4</p>	Left blank

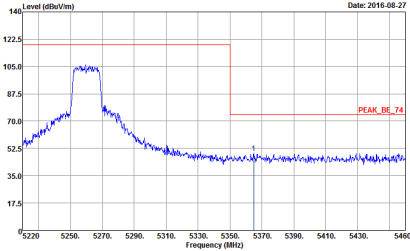
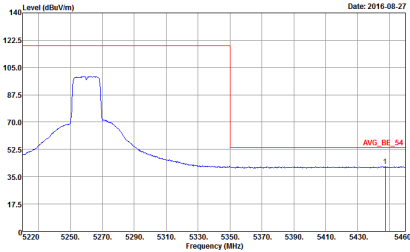

WIFI	Band 2 5250~5350MHz Band Edge @ 3m	
ANT	802.11a CH52 5260MHz - R	
1	Horizontal	Fundamental
<p>Peak</p>	 <p>Site : 03CH07-FY Condition : PEAK_BE_74 3m HF-ANT_130829 HORIZONTAL Detector : Peak Project : 672834 Mode : 4</p>	<p>Left blank</p>
<p>Avg.</p>	 <p>Site : 03CH07-FY Condition : AVG_BE_54 3m HF-ANT_130829 HORIZONTAL Detector : Peak Project : 672834 Mode : 4</p>	<p>Left blank</p>

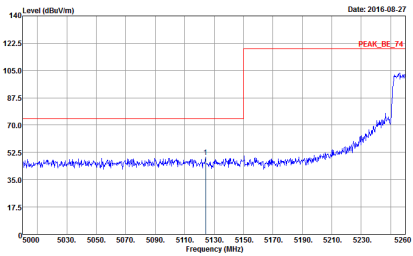
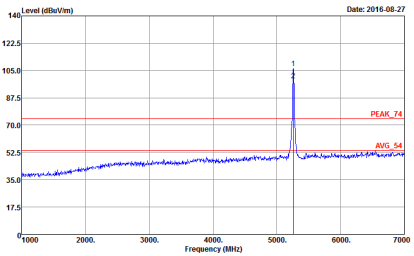
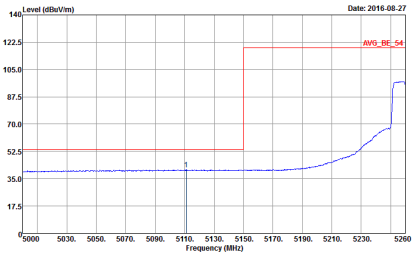

WIFI	Band 2 5250~5350MHz Band Edge @ 3m	
ANT	802.11a CH52 5260MHz - L	
<p style="text-align: center;">1</p>	<p style="text-align: center;">Vertical</p>  <p>Site : 03CH07-HY Condition : PEAK_BE_74 3m HF-ANT_130829 VERTICAL RBW:1000.000kHz VBW:3000.000kHz SWT:Auto Detector : Peak Project : 672834 Mode : 4</p>	<p style="text-align: center;">Fundamental</p>  <p>Site : 03CH07-HY Condition : PEAK_74 3m HF-ANT_130829 VERTICAL RBW:1000.000kHz VBW:3000.000kHz SWT:Auto Detector : Peak Project : 672834 Mode : 4</p>
<p style="text-align: center;">Peak</p>	 <p>Site : 03CH07-HY Condition : AVG_BE_54 3m HF-ANT_130829 VERTICAL RBW:1000.000kHz VBW:1.000kHz SWT:Auto Detector : Peak Project : 672834 Mode : 4</p>	<p style="text-align: center;">Left blank</p>



WIFI	Band 2 5250~5350MHz Band Edge @ 3m	
ANT	802.11a CH52 5260MHz - R	
1	Vertical	Fundamental
Peak	<p>Site : 03CH07-HY Condition : PEAK_BE_74 3m HF-ANT_130829 VERTICAL Detector : Peak Project : 672834 Mode : 4</p>	Left blank
Avg.	<p>Site : 03CH07-HY Condition : AVG_BE_54 3m HF-ANT_130829 VERTICAL Detector : Peak Project : 672834 Mode : 4</p>	Left blank

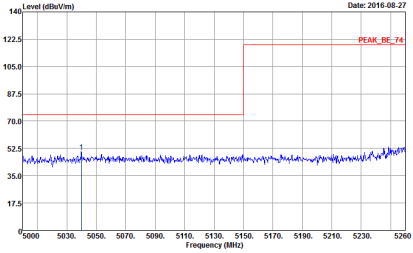
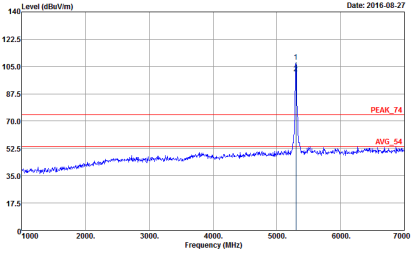
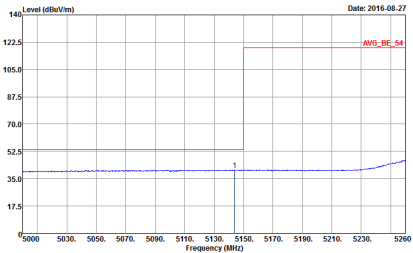

WIFI	Band 2 5250~5350MHz Band Edge @ 3m	
ANT	802.11a CH60 5300MHz - L	
1	Horizontal	Fundamental
Peak	 <p>Date: 2016-08-27</p> <p>Site : 03CH07-HY Condition : PEAK_BE_74 3m HF-ANT_130829 HORIZONTAL Detector : Peak Project : 672834 Mode : 5</p>	 <p>Date: 2016-08-27</p> <p>Site : 03CH07-HY Condition : PEAK_74 3m HF-ANT_130829 HORIZONTAL Detector : Peak Project : 672834 Mode : 5</p>
Avg.	 <p>Date: 2016-08-27</p> <p>Site : 03CH07-HY Condition : AVG_BE_54 3m HF-ANT_130829 HORIZONTAL Detector : Peak Project : 672834 Mode : 5</p>	Left blank



WIFI	Band 2 5250~5350MHz Band Edge @ 3m	
ANT	802.11a CH60 5300MHz - R	
1	Horizontal	Fundamental
Peak	<p>Site : 03CH07-HY Condition : PEAK_BE_74 3m HF-ANT_130829 HORIZONTAL Detector : Peak Project : 672834 Mode : S</p>	Left blank
Avg.	<p>Site : 03CH07-HY Condition : AVG_BE_54 3m HF-ANT_130829 HORIZONTAL Detector : Peak Project : 672834 Mode : S</p>	Left blank

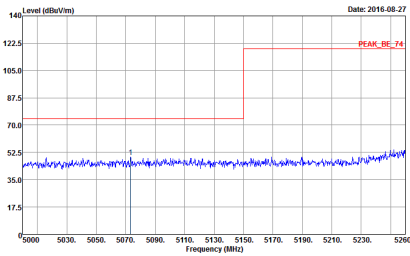
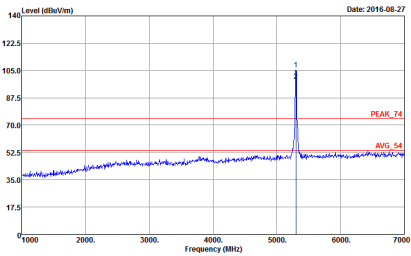
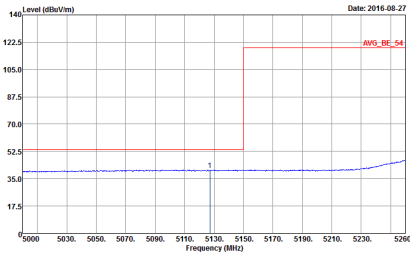

WIFI	Band 2 5250~5350MHz Band Edge @ 3m	
ANT	802.11a CH60 5300MHz - L	
<p style="text-align: center;">1</p>	<p style="text-align: center;">Vertical</p>  <p style="text-align: right;">Date: 2016-08-27</p> <p>PEAK_BE_74</p> <p>Site : 03CH07-HY Condition : PEAK_BE_74 3m HF-ANT_130829 VERTICAL RBW: 1000.000kHz VBW: 3000.000kHz SWT: Auto Detector : Peak Project : 672834 Mode : 5</p>	<p style="text-align: center;">Fundamental</p>  <p style="text-align: right;">Date: 2016-08-27</p> <p>PEAK_74</p> <p>AVG_54</p> <p>Site : 03CH07-HY Condition : PEAK_74 3m HF-ANT_130829 VERTICAL RBW: 1000.000kHz VBW: 3000.000kHz SWT: Auto Detector : Peak Project : 672834 Mode : 5</p>
<p style="text-align: center;">Peak</p>	 <p style="text-align: right;">Date: 2016-08-27</p> <p>AVG_BE_54</p> <p>Site : 03CH07-HY Condition : AVG_BE_54 3m HF-ANT_130829 VERTICAL RBW: 1000.000kHz VBW: 1.000kHz SWT: Auto Detector : Peak Project : 672834 Mode : 5</p>	<p style="text-align: center;">Left blank</p>
<p style="text-align: center;">Avg.</p>		

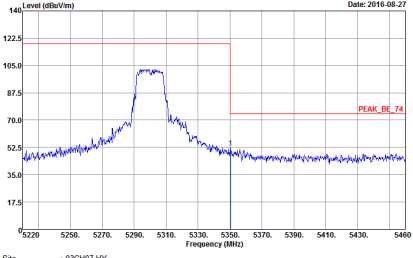
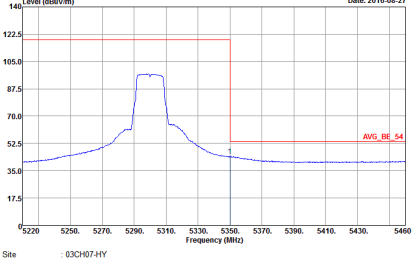

WIFI	Band 2 5250~5350MHz Band Edge @ 3m	
ANT	802.11a CH60 5300MHz - R	
1	Vertical	Fundamental
<p>Peak</p>	 <p>Date: 2016-08-27</p> <p>Site : 03CH07-HY Condition : PEAK_BE_74 3m HF-ANT_130829 VERTICAL RBW: 1000.000kHz VBW: 3000.000kHz SWT: Auto Detector : Peak Project : 672834 Mode : S</p>	<p>Left blank</p>
<p>Avg.</p>	 <p>Date: 2016-08-27</p> <p>Site : 03CH07-HY Condition : AVG_BE_54 3m HF-ANT_130829 VERTICAL RBW: 1000.000kHz VBW: 1.000kHz SWT: Auto Detector : Peak Project : 672834 Mode : S</p>	<p>Left blank</p>

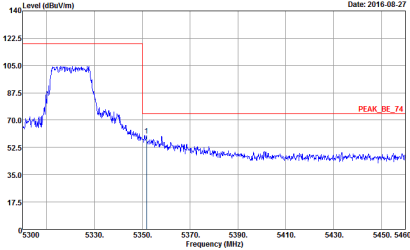
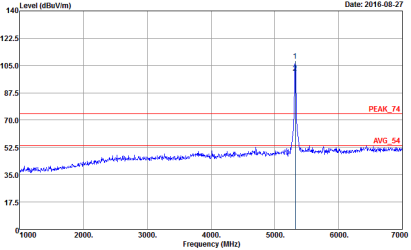
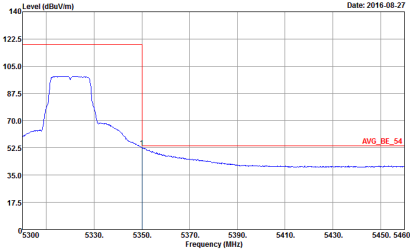

WIFI	Band 2 5250~5350MHz Band Edge @ 3m	
ANT	802.11a CH64 5320MHz	
1	<p style="text-align: center;">Horizontal</p>  <p style="text-align: right;">Date: 2016-08-27</p> <p>Site : 03CH07-HY Condition : PEAK_BE_74 3m HF-ANT_130829 HORIZONTAL RBW: 1000.000kHz VBW: 3000.000kHz SWT: Auto Detector : Peak Project : 672834 Mode : 6</p>	<p style="text-align: center;">Fundamental</p>  <p style="text-align: right;">Date: 2016-08-27</p> <p>Site : 03CH07-HY Condition : PEAK_74 3m HF-ANT_130829 HORIZONTAL RBW: 1000.000kHz VBW: 3000.000kHz SWT: Auto Detector : Peak Project : 672834 Mode : 6</p>
Peak	<p style="text-align: center;">Avg.</p>  <p style="text-align: right;">Date: 2016-08-27</p> <p>Site : 03CH07-HY Condition : AVG_BE_54 3m HF-ANT_130829 HORIZONTAL RBW: 1000.000kHz VBW: 1.000kHz SWT: Auto Detector : Peak Project : 672834 Mode : 6</p>	<p style="text-align: center;">Left blank</p>

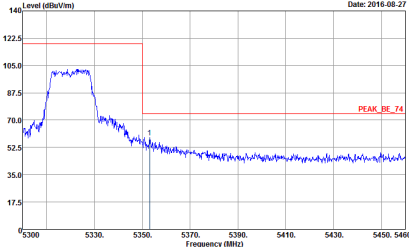
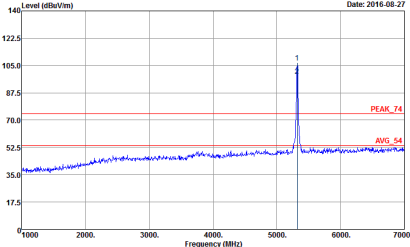
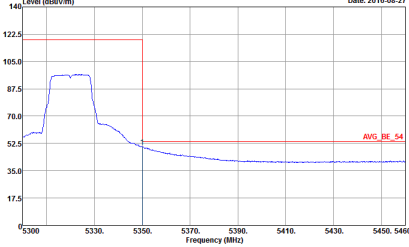

WIFI	Band 2 5250~5350MHz Band Edge @ 3m	
ANT	802.11a CH64 5320MHz	
1	<p style="text-align: center;">Vertical</p>  <p style="text-align: right;">Date: 2016-08-27</p> <p>Site : 03CH07-HY Condition : PEAK_BE_74 3m HF-ANT_130829 VERTICAL RBW: 1000.000kHz VBW: 3000.000kHz SWT: Auto Detector : Peak Project : 672834 Mode : 6</p>	<p style="text-align: center;">Fundamental</p>  <p style="text-align: right;">Date: 2016-08-27</p> <p>Site : 03CH07-HY Condition : PEAK_74 3m HF-ANT_130829 VERTICAL RBW: 1000.000kHz VBW: 3000.000kHz SWT: Auto Detector : Peak Project : 672834 Mode : 6</p>
Avg.	 <p style="text-align: right;">Date: 2016-08-27</p> <p>Site : 03CH07-HY Condition : AVG_BE_54 3m HF-ANT_130829 VERTICAL RBW: 1000.000kHz VBW: 1.000kHz SWT: Auto Detector : Peak Project : 672834 Mode : 6</p>	<p style="text-align: center;">Left blank</p>



Band 2 - 5250~5350MHz
WIFI 802.11a (Harmonic @ 3m)

WIFI	Band 2 5250~5350MHz Harmonic @ 3m	
ANT	802.11a CH52 5260MHz	
1	Horizontal	Vertical
<p>Peak</p> <p>Avg.</p>	<p>Site : 03CH07.HY Condition : PEAK_74 3m SHF-EHF_131029 HORIZONTAL Detector : Peak Project : 672834 Mode : 4</p>	<p>Site : 03CH07.HY Condition : PEAK_74 3m SHF-EHF_131029 VERTICAL Detector : Peak Project : 672834 Mode : 4</p>

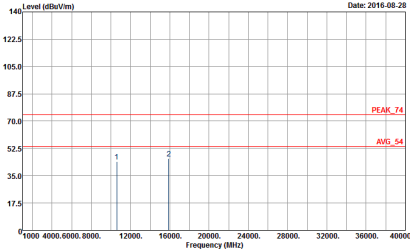
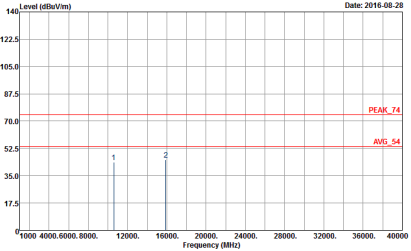

WIFI	Band 2 5250~5350MHz Harmonic @ 3m	
ANT	802.11a CH60 5300MHz	
1	Horizontal	Vertical
Peak Avg.	 <p>Site : 03CH07.HY Condition : PEAK_74 3m SHF-EHF_131029 HORIZONTAL Detector : Peak Project : 672834 Mode : 5</p>	 <p>Site : 03CH07.HY Condition : PEAK_74 3m SHF-EHF_131029 VERTICAL Detector : Peak Project : 672834 Mode : 5</p>

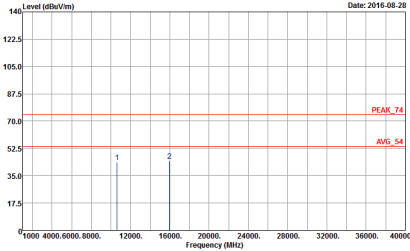
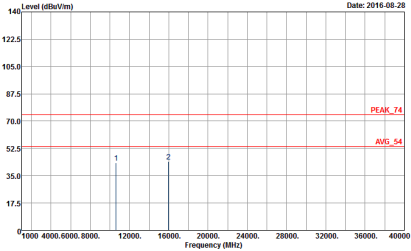

WIFI	Band 2 5250~5350MHz Harmonic @ 3m	
ANT	802.11a CH64 5320MHz	
1	Horizontal	Vertical
Peak Avg.	 <p>Site : 03CH07.HY Condition : PEAK_74 3m SHF-EHF_131029 HORIZONTAL Detector : Peak Project : 672834 Mode : 6</p>	 <p>Site : 03CH07.HY Condition : PEAK_74 3m SHF-EHF_131029 VERTICAL Detector : Peak Project : 672834 Mode : 6</p>



Band 3 - 5470~5725MHz
WIFI 802.11a (Band Edge @ 3m)

WIFI	Band 3 5470~5725MHz Band Edge @ 3m	
ANT	802.11a CH100 5500MHz	
1	Horizontal	Fundamental
Peak	<p>Site : 03CH07-HY Condition : PEAK_BE(UMI)_B3 3m HF-ANT_130829 HORIZONTAL RBW: 1000.000kHz VSW: 3000.000kHz SWT: Auto Detector : Peak Project : 672834 Mode : 7 : 68.3</p>	<p>Site : 03CH07-HY Condition : PEAK_T4 3m HF-ANT_130829 HORIZONTAL RBW: 1000.000kHz VSW: 3000.000kHz SWT: Auto Detector : Peak Project : 672834 Mode : 7 : 68.3</p>
Avg.	<p>Site : 03CH07-HY Condition : AVG_BE(UMI)_B3 3m HF-ANT_130829 HORIZONTAL RBW: 1000.000kHz VSW: 1.000kHz SWT: Auto Detector : Peak Project : 672834 Mode : 7 : 68.3</p>	Left blank

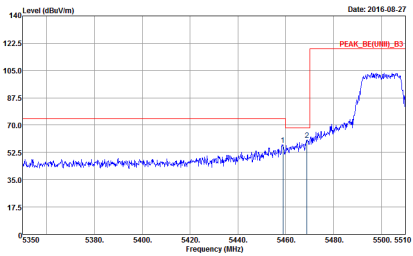
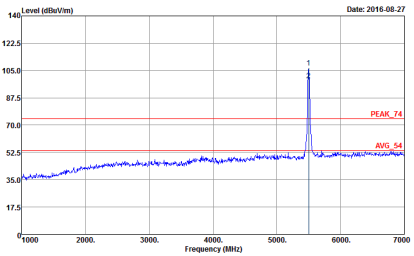
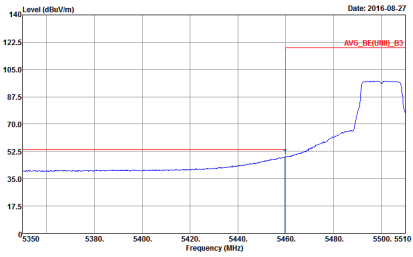

WIFI	Band 3 5470~5725MHz Band Edge @ 3m	
ANT	802.11a CH100 5500MHZ	
<p style="text-align: center;">1</p>	<p style="text-align: center;">Vertical</p>  <p style="font-size: small;">Date: 2016-08-27</p> <p style="font-size: x-small;">Site : 03CH07-HY Condition : PEAK_BE(UMI)_B3 3m HF-ANT_130829 VERTICAL RBW: 1000.000kHz VBW: 3000.000kHz SWT: Auto Detector : Peak Project : 672834 Mode : 68.3</p>	<p style="text-align: center;">Fundamental</p>  <p style="font-size: small;">Date: 2016-08-27</p> <p style="font-size: x-small;">Site : 03CH07-HY Condition : PEAK_T4 3m HF-ANT_130829 VERTICAL RBW: 1000.000kHz VBW: 3000.000kHz SWT: Auto Detector : Peak Project : 672834 Mode : 68.3</p>
<p style="text-align: center;">Peak</p>	<p style="text-align: center;">Avg.</p>  <p style="font-size: small;">Date: 2016-08-27</p> <p style="font-size: x-small;">Site : 03CH07-HY Condition : AVG_BE(UMI)_B3 3m HF-ANT_130829 VERTICAL RBW: 1000.000kHz VBW: 1.000kHz SWT: Auto Detector : Peak Project : 672834 Mode : 68.3</p>	<p style="text-align: center;">Left blank</p>

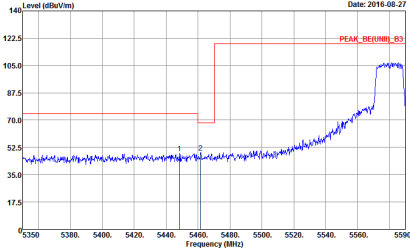
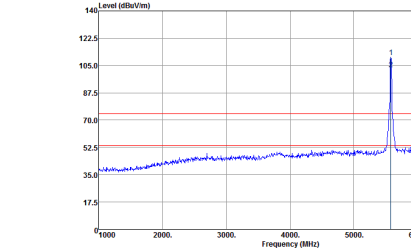
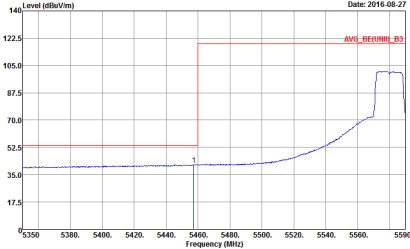

WIFI	Band 3 5470~5725MHz Band Edge @ 3m	
ANT	802.11a CH116 5580MHz - L	
1	Horizontal	Fundamental
Peak	 <p>Site : 03CH07.HY Condition : PEAK_BE(UNI)_B3 3m HF-ANT_130829 HORIZONTAL Detector : Peak Project : 672834 Mode : 8</p>	 <p>Site : 03CH07.HY Condition : PEAK_T4 3m HF-ANT_130829 HORIZONTAL Detector : Peak Project : 672834 Mode : 8</p>
Avg.	 <p>Site : 03CH07.HY Condition : AVG_BE(UNI)_B3 3m HF-ANT_130829 HORIZONTAL Detector : Peak Project : 672834 Mode : 8</p>	Left blank

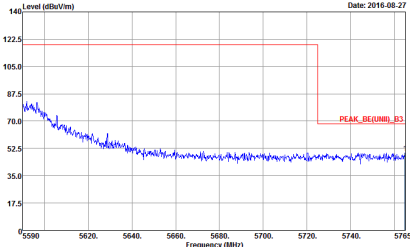

WIFI	Band 3 5470~5725MHz Band Edge @ 3m	
ANT	802.11a CH116 5580MHz - R	
1	Horizontal	Fundamental
Peak	 <p data-bbox="347 745 608 808">Site : 03CH0741Y Condition : PEAK_BE(UMI)_B3 3m HF ANT_130829 HORIZONTAL Detector : Peak Project : 672834 Mode : S</p>	Left blank

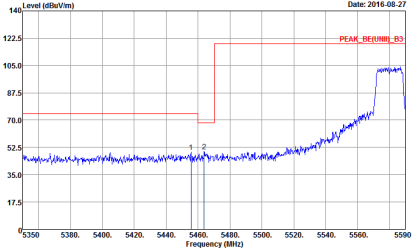
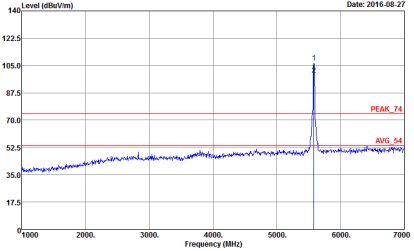
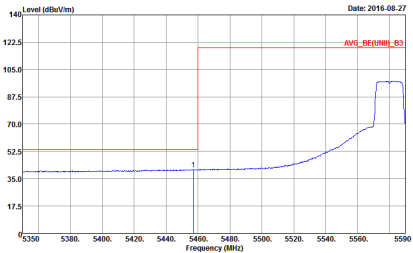

WIFI	Band 3 5470~5725MHz Band Edge @ 3m	
ANT	802.11a CH116 5580MHz - L	
<p style="text-align: center;">1</p>	<p style="text-align: center;">Vertical</p>  <p>Site : 03CH07-HY Condition : PEAK_BE(UNI)_B3 3m HF-ANT_130829 VERTICAL : RBW:1000.000kHz VBW:3000.000kHz SWT:Auto Detector : Peak Project : 672834 Mode : 8</p>	<p style="text-align: center;">Fundamental</p>  <p>Site : 03CH07-HY Condition : PEAK_T4 3m HF-ANT_130829 VERTICAL : RBW:1000.000kHz VBW:3000.000kHz SWT:Auto Detector : Peak Project : 672834 Mode : 8</p>
<p style="text-align: center;">Peak</p>	 <p>Site : 03CH07-HY Condition : AVG_BE(UNI)_B3 3m HF-ANT_130829 VERTICAL : RBW:1000.000kHz VBW:1.000kHz SWT:Auto Detector : Peak Project : 672834 Mode : 8</p>	<p style="text-align: center;">Left blank</p>



WIFI	Band 3 5470~5725MHz Band Edge @ 3m	
ANT	802.11a CH116 5580MHz - R	
1	Vertical	Fundamental
Peak	<p>Site : 03CH074NY Condition : PEAK_BE(UNI)_B3 3m HF ANT_130829 VERTICAL Detector : Peak Project : 672834 Mode : S</p>	Left blank

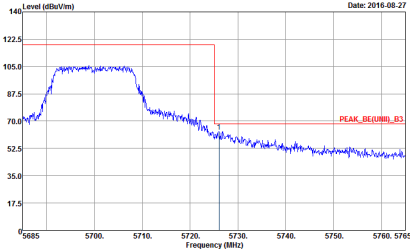
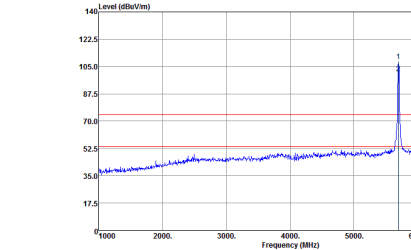

WIFI	Band 3 5470~5725MHz Band Edge @ 3m	
ANT	802.11a CH140 5700MHz	
1	Horizontal	Fundamental
Peak	 <p>Date: 2016-08-27</p> <p>Site : 03CH07.HY Condition : PEAK_BE(UMI)_B3 3m HF-ANT_130829 HORIZONTAL RBW: 1000.000kHz VBW: 3000.000kHz SWT: Auto Detector : Peak Project : 672834 Mode : 9</p>	 <p>Date: 2016-08-27</p> <p>Site : 03CH07.HY Condition : PEAK_T4 3m HF-ANT_130829 HORIZONTAL RBW: 1000.000kHz VBW: 3000.000kHz SWT: Auto Detector : Peak Project : 672834 Mode : 9</p>

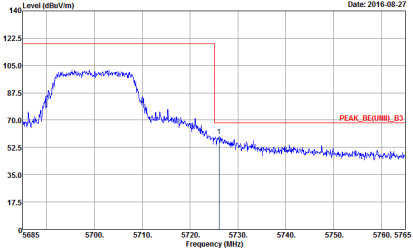
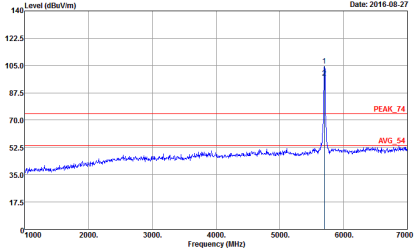

WIFI	Band 3 5470~5725MHz Band Edge @ 3m	
ANT	802.11a CH140 5700MHZ	
1	Vertical	Fundamental
Peak	 <p>Date: 2016-08-27</p> <p>Site : 03CH07.HY Condition : PEAK_BE(URB)_B3 3m HF ANT_130829 VERTICAL RBW: 1000.000kHz VBW: 3000.000kHz SWT: Auto Detector : Peak Project : 672834 Mode : 9</p>	 <p>Date: 2016-08-27</p> <p>Site : 03CH07.HY Condition : PEAK_T4 3m HF ANT_130829 VERTICAL RBW: 1000.000kHz VBW: 3000.000kHz SWT: Auto Detector : Peak Project : 672834 Mode : 9</p>



Band 3 - 5470~5725MHz
WIFI 802.11a (Harmonic @ 3m)

Table with 2 columns: WIFI (Band 3 5470~5725MHz Harmonic @ 3m), ANT (802.11a CH100 5500MHz). Row 1: 1, Horizontal, Vertical. Each plot shows Level (dBuV/m) vs Frequency (MHz) with Peak and Avg markers.

Peak
Avg.

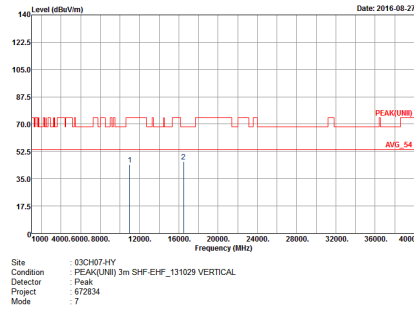
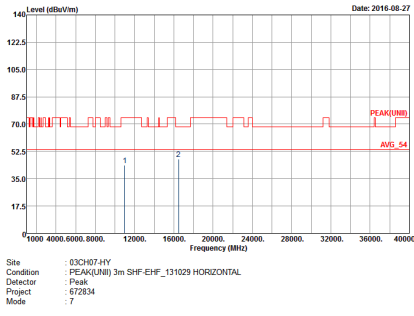



WIFI	Band 3 5470~5725MHz Harmonic @ 3m	
ANT	802.11a CH116 5580MHZ	
1	Horizontal	Vertical
Peak Avg.	<p>Site : 03CH07.HY Condition : PEAK(LIM) 3m SHF_EHF_131029 HORIZONTAL Detector : Peak Project : 672834 Mode : 8</p>	<p>Site : 03CH07.HY Condition : PEAK(LIM) 3m SHF_EHF_131029 VERTICAL Detector : Peak Project : 672834 Mode : 8</p>

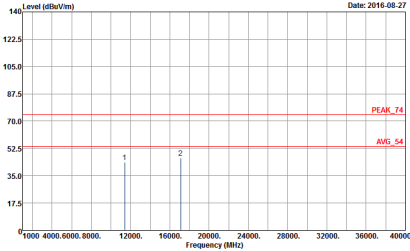
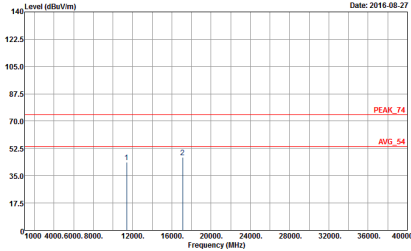

WIFI	Band 3 5470~5725MHz Harmonic @ 3m	
ANT	802.11a CH140 5700MHz	
1	Horizontal	Vertical
Peak Avg.	 <p data-bbox="347 745 579 801"> Site : 03CH07.HY Condition : PEAK_74 3m SHF-EHF_131029 HORIZONTAL Detector : Peak Project : 672834 Mode : 9 </p>	 <p data-bbox="941 745 1173 801"> Site : 03CH07.HY Condition : PEAK_74 3m SHF-EHF_131029 VERTICAL Detector : Peak Project : 672834 Mode : 9 </p>



Band 3 - Straddle Channel
WIFI 802.11a (Fundamental @ 3m)

Table with 2 main columns: Horizontal and Vertical. Each column contains a spectral plot showing Level (dBuV/m) vs Frequency (MHz) with a prominent peak at approximately 5720 MHz. The table also includes a 'Peak Avg.' label and detailed test parameters for both orientations.



Band 3 - Straddle Channel
WIFI 802.11a (Harmonic @ 3m)

Table with 2 columns: Horizontal and Vertical. Each column contains a graph of Level (dBuV/m) vs Frequency (MHz) with peak and average values indicated. Includes metadata like Site, Condition, Detector, Project, and Mode.



Emission below 1GHz
5GHz WIFI 802.11a (LF)

WIFI	5GHz WIFI	
ANT	802.11a LF	
1	Horizontal	Vertical
QP / Peak	<p>Site : 03CH07HY Condition : QP 3m LF-ANT-35419(6) HORIZONTAL Detector : Peak Project : 672834 Mode : 100</p>	<p>Site : 03CH07HY Condition : QP 3m LF-ANT-35419(6) VERTICAL Detector : Peak Project : 672834 Mode : 100</p>



Appendix C. Radiated Spurious Emission

Test Engineer :	Luke Chang, Ken Wu, Derreck Chen, Jesse Wang, and James Chiu	Temperature :	21~24°C
		Relative Humidity :	50~55%

Note symbol

-L	Low channel location
-R	High channel location



Band 1 - 5150~5250MHz
WIFI 802.11a (Band Edge @ 3m)

WIFI	Band 1 5150~5250MHz Band Edge @ 3m	
ANT	802.11a CH36 5180MHz	
2	Horizontal	Fundamental
Peak	<p>Site : 03CH07-HY Condition : PEAK_BE_74 3m HF-ANT_130829 HORIZONTAL RBW: 1000.000kHz VSW: 3000.000kHz SWT: Auto Detector : Peak Project : 672834 Mode : 14 Setting : 66</p>	<p>Site : 03CH07-HY Condition : PEAK_74 3m HF-ANT_130829 HORIZONTAL RBW: 1000.000kHz VSW: 3000.000kHz SWT: Auto Detector : Peak Project : 672834 Mode : 14 Setting : 66</p>
Avg.	<p>Site : 03CH07-HY Condition : AVG_BE_54 3m HF-ANT_130829 HORIZONTAL RBW: 1000.000kHz VSW: 1.000kHz SWT: Auto Detector : Peak Project : 672834 Mode : 14 Setting : 66</p>	Left blank

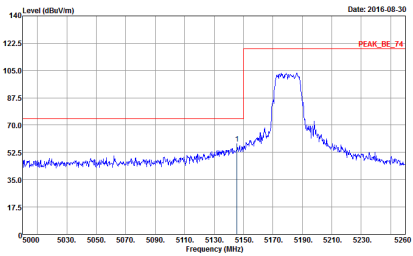
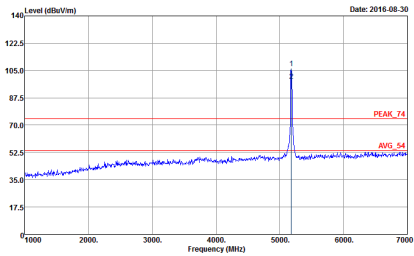
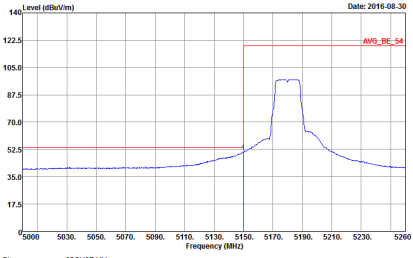

WIFI	Band 1 5150~5250MHz Band Edge @ 3m	
ANT	802.11a CH36 5180MHz	
2	Vertical	Fundamental
<p>Peak</p>	 <p>Site : 03CH07-HY Condition : PEAK_BE_74 3m HF-ANT_130829 VERTICAL Detector : Peak Project : 672834 Mode : 14 Setting : 66</p>	 <p>Site : 03CH07-HY Condition : PEAK_74 3m HF-ANT_130829 VERTICAL Detector : Peak Project : 672834 Mode : 14 Setting : 66</p>
<p>Avg.</p>	 <p>Site : 03CH07-HY Condition : AVG_BE_54 3m HF-ANT_130829 VERTICAL Detector : Peak Project : 672834 Mode : 14 Setting : 66</p>	<p>Left blank</p>

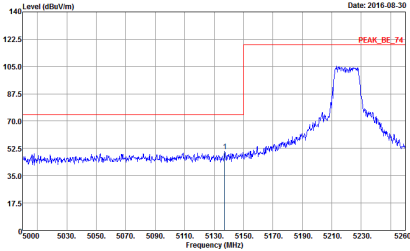
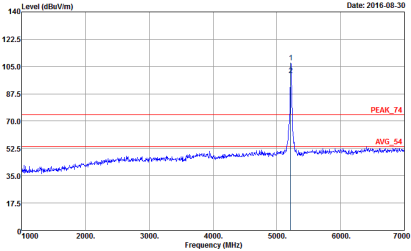
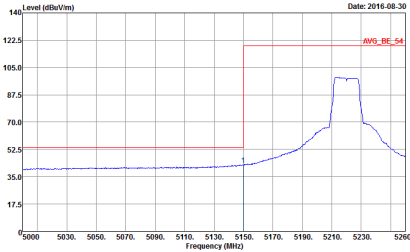

WIFI	Band 1 5150~5250MHz Band Edge @ 3m	
ANT	802.11a CH44 5220MHz - L	
2	Horizontal	Fundamental
Peak	 <p>Date: 2016-08-30</p> <p>Site : 03CH07-HY Condition : PEAK_BE_74 3m HF-ANT_130829 HORIZONTAL Detector : Peak Project : 672834 Mode : 15</p>	 <p>Date: 2016-08-30</p> <p>Site : 03CH07-HY Condition : PEAK_74 3m HF-ANT_130829 HORIZONTAL Detector : Peak Project : 672834 Mode : 15</p>
Avg.	 <p>Date: 2016-08-30</p> <p>Site : 03CH07-HY Condition : AVG_BE_54 3m HF-ANT_130829 HORIZONTAL Detector : Peak Project : 672834 Mode : 15</p>	Left blank



WIFI	Band 1 5150~5250MHz Band Edge @ 3m	
ANT	802.11a CH44 5220MHz - R	
2	Horizontal	Fundamental
Peak	<p>Site : 03CH07-HY Condition : PEAK_BE_74 3m HF-ANT_130829 HORIZONTAL Detector : Peak Project : 672834 Mode : 15</p>	Left blank
Avg.	<p>Site : 03CH07-HY Condition : AVG_BE_54 3m HF-ANT_130829 HORIZONTAL Detector : Peak Project : 672834 Mode : 15</p>	Left blank

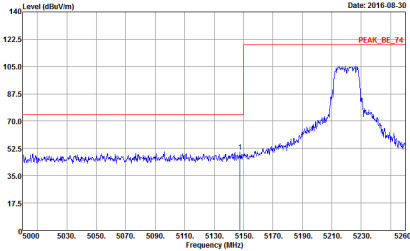
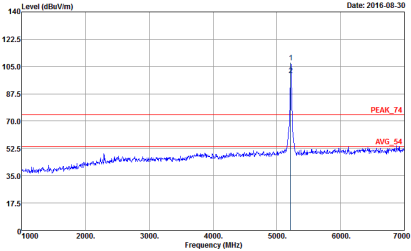
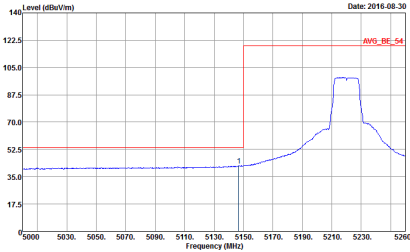

WIFI	Band 1 5150~5250MHz Band Edge @ 3m	
ANT	802.11a CH44 5220MHz - L	
2	Vertical	Fundamental
Peak	 <p>Date: 2016-08-30</p> <p>Site : 03CH07-HY Condition : PEAK_BE_74 3m HF-ANT_130829 VERTICAL Detector : Peak Project : 672834 Mode : 15</p>	 <p>Date: 2016-08-30</p> <p>Site : 03CH07-HY Condition : PEAK_74 3m HF-ANT_130829 VERTICAL Detector : Peak Project : 672834 Mode : 15</p>
Avg.	 <p>Date: 2016-08-30</p> <p>Site : 03CH07-HY Condition : AVG_BE_54 3m HF-ANT_130829 VERTICAL Detector : Peak Project : 672834 Mode : 15</p>	Left blank

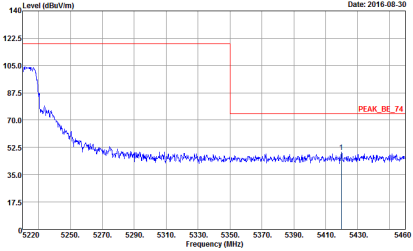
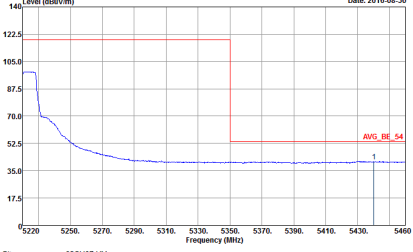

WIFI	Band 1 5150~5250MHz Band Edge @ 3m	
ANT	802.11a CH44 5220MHz - R	
2	Vertical	Fundamental
<p>Peak</p>	 <p> <small>Date: 2016-08-30</small> Site : 03CH07-HY Condition : PEAK_BE_74 3m HF-ANT_130829 VERTICAL Detector : Peak Project : 672834 Mode : 15 </p>	<p>Left blank</p>
<p>Avg.</p>	 <p> <small>Date: 2016-08-30</small> Site : 03CH07-HY Condition : AVG_BE_54 3m HF-ANT_130829 VERTICAL Detector : Peak Project : 672834 Mode : 15 </p>	<p>Left blank</p>

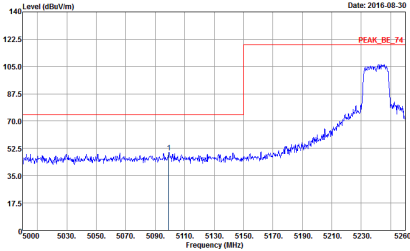
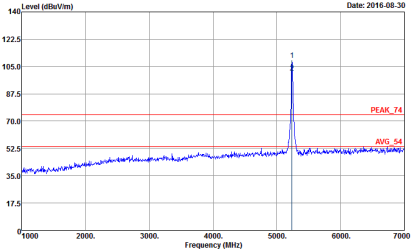
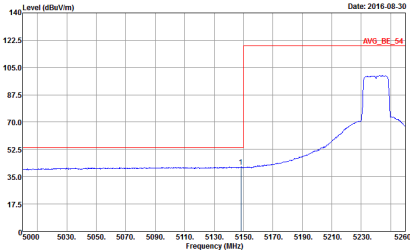

WIFI	Band 1 5150~5250MHz Band Edge @ 3m	
ANT	802.11a CH48 5240MHz - L	
2	Horizontal	Fundamental
Peak	 <p>Date: 2016-08-30</p> <p>Site : 03CH07-HY Condition : PEAK_BE_74 3m HF-ANT_130829 HORIZONTAL Detector : Peak Project : 672834 Mode : 16</p>	 <p>Date: 2016-08-30</p> <p>Site : 03CH07-HY Condition : PEAK_74 3m HF-ANT_130829 HORIZONTAL Detector : Peak Project : 672834 Mode : 16</p>
Avg.	 <p>Date: 2016-08-30</p> <p>Site : 03CH07-HY Condition : AVG_BE_54 3m HF-ANT_130829 HORIZONTAL Detector : Peak Project : 672834 Mode : 16</p>	Left blank

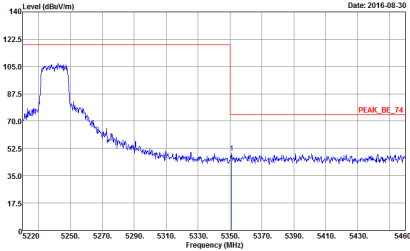
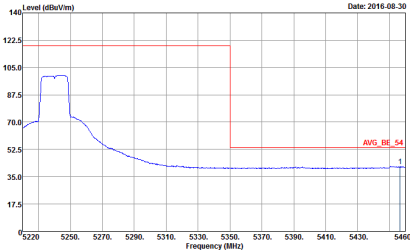

WIFI	Band 1 5150~5250MHz Band Edge @ 3m	
ANT	802.11a CH48 5240MHz - R	
2	Horizontal	Fundamental
Peak	 <p>Site : 03CH07-HY Condition : PEAK_BE_74 3m HF-ANT_130829 HORIZONTAL Detector : Peak Project : 672834 Mode : 16</p>	Left blank
Avg.	 <p>Site : 03CH07-HY Condition : AVG_BE_54 3m HF-ANT_130829 HORIZONTAL Detector : Peak Project : 672834 Mode : 16</p>	Left blank

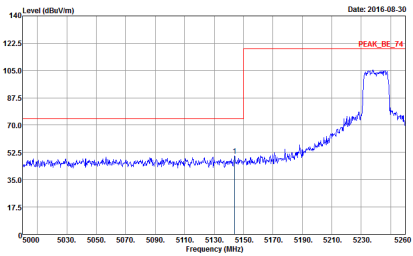
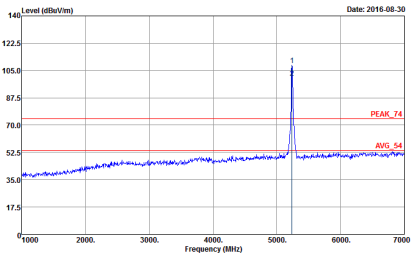
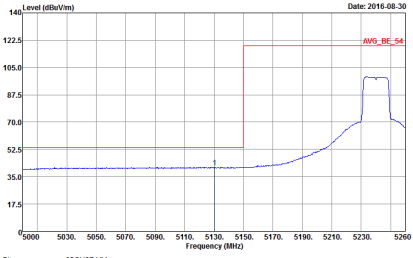

WIFI	Band 1 5150~5250MHz Band Edge @ 3m	
ANT	802.11a CH48 5240MHz - L	
2	Vertical	Fundamental
Peak	 <p>Site : 03CH07-HY Condition : PEAK_BE_74 3m HF-ANT_130829 VERTICAL RBW:1000.000kHz VBW:3000.000kHz SWT:Auto Detector : Peak Project : 672834 Mode : 16</p>	 <p>Site : 03CH07-HY Condition : PEAK_74 3m HF-ANT_130829 VERTICAL RBW:1000.000kHz VBW:3000.000kHz SWT:Auto Detector : Peak Project : 672834 Mode : 16</p>
Avg.	 <p>Site : 03CH07-HY Condition : AVG_BE_54 3m HF-ANT_130829 VERTICAL RBW:1000.000kHz VBW:1.000kHz SWT:Auto Detector : Peak Project : 672834 Mode : 16</p>	Left blank

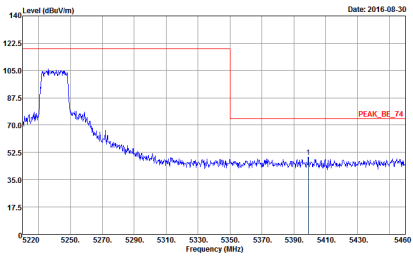
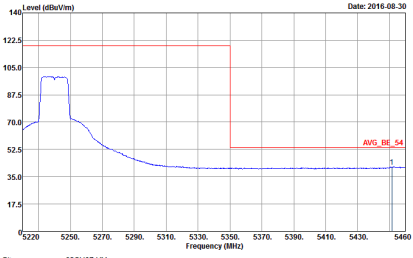

WIFI	Band 1 5150~5250MHz Band Edge @ 3m	
ANT	802.11a CH48 5240MHz - R	
2	Vertical	Fundamental
<p>Peak</p>	 <p>Site : 03CH07-HY Condition : PEAK_BE_74 3m HF-ANT_130829 VERTICAL Detector : Peak Project : 672834 Mode : 16</p>	<p>Left blank</p>
<p>Avg.</p>	 <p>Site : 03CH07-HY Condition : AVG_BE_54 3m HF-ANT_130829 VERTICAL Detector : Peak Project : 672834 Mode : 16</p>	<p>Left blank</p>

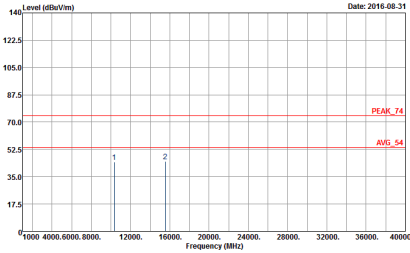
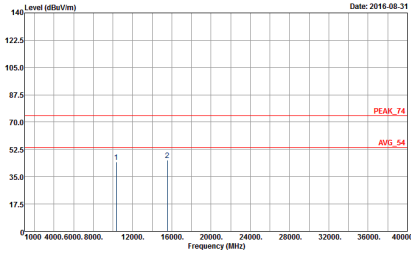

Band 1 - 5150~5250MHz
WIFI 802.11a (Harmonic @ 3m)

WIFI	Band 1 5150~5250MHz Harmonic @ 3m	
ANT	802.11a CH36 5180MHz	
2	Horizontal	Vertical
Peak Avg.	 <p>Site : 03CH07.HY Condition : PEAK_74 3m SHF-EHF_131029 HORIZONTAL Detector : Peak Project : 672834 Mode : 14 Setting : 66</p>	 <p>Site : 03CH07.HY Condition : PEAK_74 3m SHF-EHF_131029 VERTICAL Detector : Peak Project : 672834 Mode : 14 Setting : 66</p>



WIFI	Band 1 5150~5250MHz Harmonic @ 3m	
ANT	802.11a CH44 5220MHz	
2	Horizontal	Vertical
Peak Avg.	<p>Site : 03CH07.HY Condition : PEAK_74 3m SHF-EHF_131029 HORIZONTAL Detector : Peak Project : 672834 Mode : 15</p>	<p>Site : 03CH07.HY Condition : PEAK_74 3m SHF-EHF_131029 VERTICAL Detector : Peak Project : 672834 Mode : 15</p>

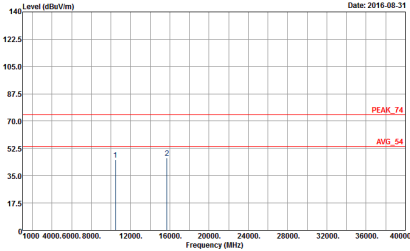
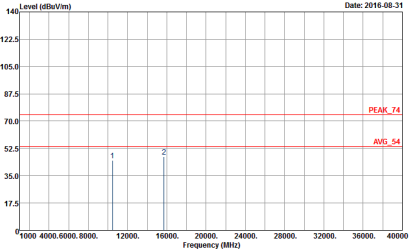

WIFI	Band 1 5150~5250MHz Harmonic @ 3m	
ANT	802.11a CH48 5240MHz	
2	Horizontal	Vertical
Peak Avg.	 <p data-bbox="347 748 579 801"> Site : 03CH07.HY Condition : PEAK_74 3m SHF-EHF_131029 HORIZONTAL Detector : Peak Project : 672834 Mode : 16 </p>	 <p data-bbox="946 748 1177 801"> Site : 03CH07.HY Condition : PEAK_74 3m SHF-EHF_131029 VERTICAL Detector : Peak Project : 672834 Mode : 16 </p>



Band 2 - 5250~5350MHz
WIFI 802.11a (Band Edge @ 3m)

WIFI	Band 2 5250~5350MHz Band Edge @ 3m	
ANT	802.11a CH52 5260MHz - L	
2	Horizontal	Fundamental
Peak	<p>Site : 03CH07-HY Condition : PEAK_BE_74 3m HF-ANT_130829 HORIZONTAL RBW:1000.000kHz VSW:3000.000kHz SWT:Auto Detector : Peak Project : 672834 Mode : 17</p>	<p>Site : 03CH07-HY Condition : PEAK_74 3m HF-ANT_130829 HORIZONTAL RBW:1000.000kHz VSW:3000.000kHz SWT:Auto Detector : Peak Project : 672834 Mode : 17</p>
Avg.	<p>Site : 03CH07-HY Condition : AVG_BE_54 3m HF-ANT_130829 HORIZONTAL RBW:1000.000kHz VSW:1.000kHz SWT:Auto Detector : Peak Project : 672834 Mode : 17</p>	Left blank

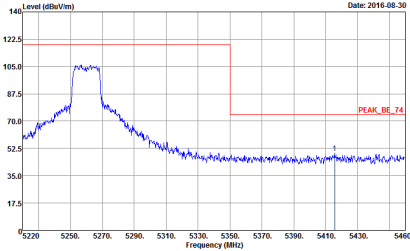
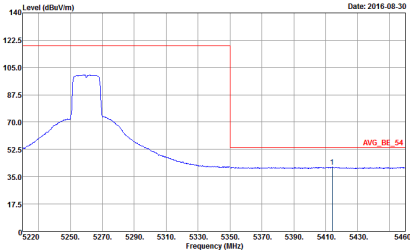

WIFI	Band 2 5250~5350MHz Band Edge @ 3m	
ANT	802.11a CH52 5260MHz - R	
2	Horizontal	Fundamental
Peak	 <p> Date: 2016-08-30 Site : 03CH07-FY Condition : PEAK_BE_74 3m HF-ANT_130829 HORIZONTAL Detector : Peak Project : 672834 Mode : 17 </p>	Left blank
Avg.	 <p> Date: 2016-08-30 Site : 03CH07-FY Condition : AVG_BE_54 3m HF-ANT_130829 HORIZONTAL Detector : Peak Project : 672834 Mode : 17 </p>	Left blank

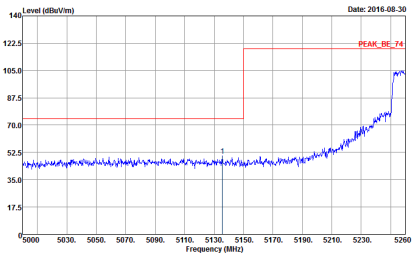
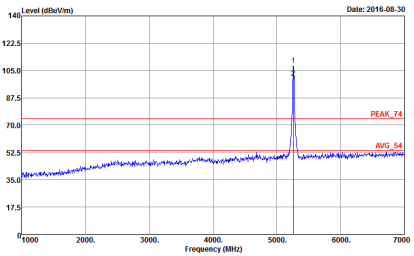
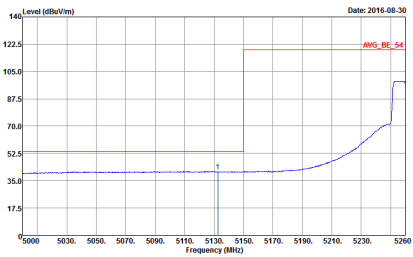

WIFI	Band 2 5250~5350MHz Band Edge @ 3m	
ANT	802.11a CH52 5260MHz - L	
2	Vertical	Fundamental
<p>Peak</p>	 <p>Site : 03CH07-HY Condition : PEAK_BE_74 3m HF-ANT_130829 VERTICAL Detector : Peak Project : 672834 Mode : 17</p>	 <p>Site : 03CH07-HY Condition : PEAK_74 3m HF-ANT_130829 VERTICAL Detector : Peak Project : 672834 Mode : 17</p>
<p>Avg.</p>	 <p>Site : 03CH07-HY Condition : AVG_BE_54 3m HF-ANT_130829 VERTICAL Detector : Peak Project : 672834 Mode : 17</p>	<p>Left blank</p>



WIFI	Band 2 5250~5350MHz Band Edge @ 3m	
ANT	802.11a CH52 5260MHz - R	
2	Vertical	Fundamental
Peak	<p>Site : 03CH07-HY Condition : PEAK_BE_74 3m HF-ANT_130829 VERTICAL Detector : Peak Project : 672834 Mode : 17</p>	Left blank
Avg.	<p>Site : 03CH07-HY Condition : AVG_BE_54 3m HF-ANT_130829 VERTICAL Detector : Peak Project : 672834 Mode : 17</p>	Left blank