

#01_GSM850_GPRS (4 Tx slots)_Right Cheek_Ch251

Communication System: GSM850; Frequency: 848.8 MHz; Duty Cycle: 1:2.08

Medium: HSL_850_160910 Medium parameters used: $f = 849$ MHz; $\sigma = 0.91$ S/m; $\epsilon_r = 42.362$; $\rho = 1000$ kg/m³

Ambient Temperature : 23.6 °C; Liquid Temperature : 22.6 °C

DASY5 Configuration:

- Probe: ES3DV3 - SN3270; ConvF(6.03, 6.03, 6.03); Calibrated: 2016/8/26;
- Sensor-Surface: 3mm (Mechanical Surface Detection)
- Electronics: DAE4 Sn1399; Calibrated: 2015/11/23
- Phantom: SAM-Right; Type: SAM; Serial: 1795
- Measurement SW: DASY52, Version 52.8 (8); SEMCAD X Version 14.6.10 (7373)

Area Scan (71x131x1): Interpolated grid: dx=1.500 mm, dy=1.500 mm

Maximum value of SAR (interpolated) = 0.900 W/kg

Zoom Scan (5x5x7)/Cube 0: Measurement grid: dx=8mm, dy=8mm, dz=5mm

Reference Value = 29.05 V/m; Power Drift = 0.12 dB

Peak SAR (extrapolated) = 1.62 W/kg

SAR(1 g) = 0.785 W/kg; SAR(10 g) = 0.599 W/kg

Maximum value of SAR (measured) = 0.980 W/kg

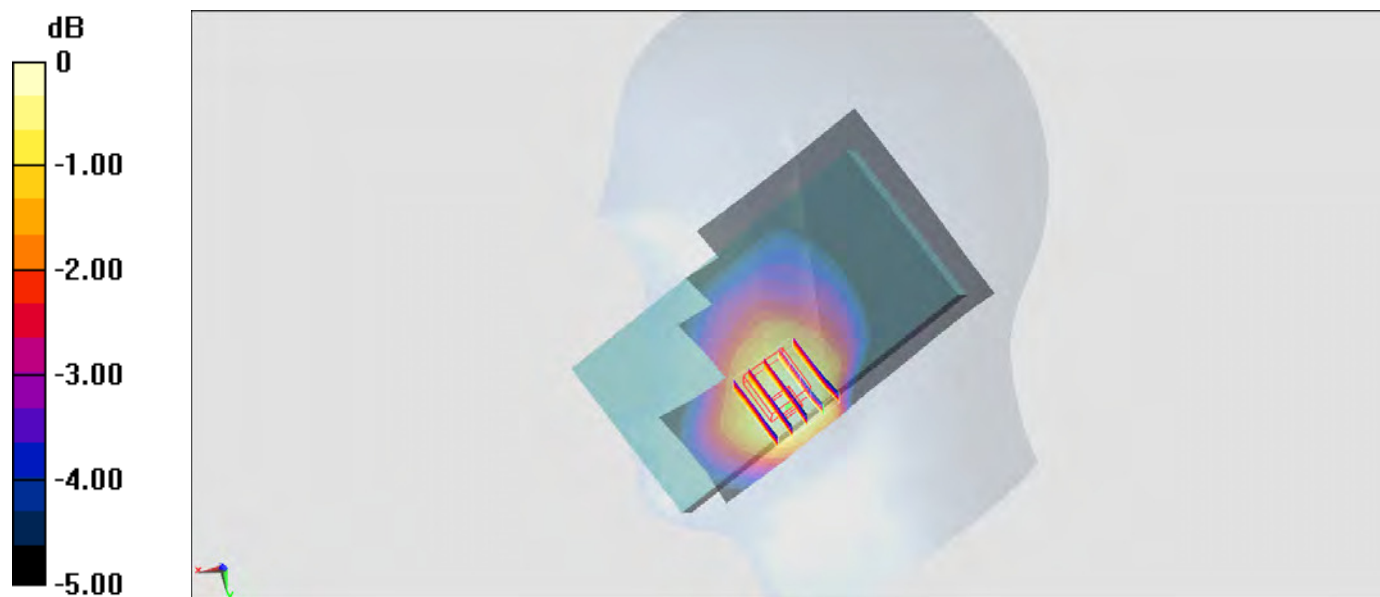

0 dB = 0.900 W/kg = -0.46 dBW/kg

#02_GSM1900_GPRS (3 Tx slots)_Left Cheek_Ch810

Communication System: PCS; Frequency: 1909.8 MHz; Duty Cycle: 1:2.77

Medium: HSL_1900_160911 Medium parameters used: $f = 1910$ MHz; $\sigma = 1.406$ S/m; $\epsilon_r = 40.513$; $\rho = 1000$ kg/m³

Ambient Temperature : 23.2 °C; Liquid Temperature : 22.2 °C

DASY5 Configuration:

- Probe: ES3DV3 - SN3270; ConvF(5.08, 5.08, 5.08); Calibrated: 2016/8/26;
- Sensor-Surface: 3mm (Mechanical Surface Detection)
- Electronics: DAE4 Sn1399; Calibrated: 2015/11/23
- Phantom: SAM_Left; Type: QD000P40CD; Serial: TP:1644
- Measurement SW: DASY52, Version 52.8 (8); SEMCAD X Version 14.6.10 (7373)

Area Scan (71x121x1): Interpolated grid: dx=1.500 mm, dy=1.500 mm

Maximum value of SAR (interpolated) = 0.246 W/kg

Zoom Scan (5x5x7)/Cube 0: Measurement grid: dx=8mm, dy=8mm, dz=5mm

Reference Value = 13.00 V/m; Power Drift = -0.01 dB

Peak SAR (extrapolated) = 0.319 W/kg

SAR(1 g) = 0.206 W/kg; SAR(10 g) = 0.131 W/kg

Maximum value of SAR (measured) = 0.246 W/kg

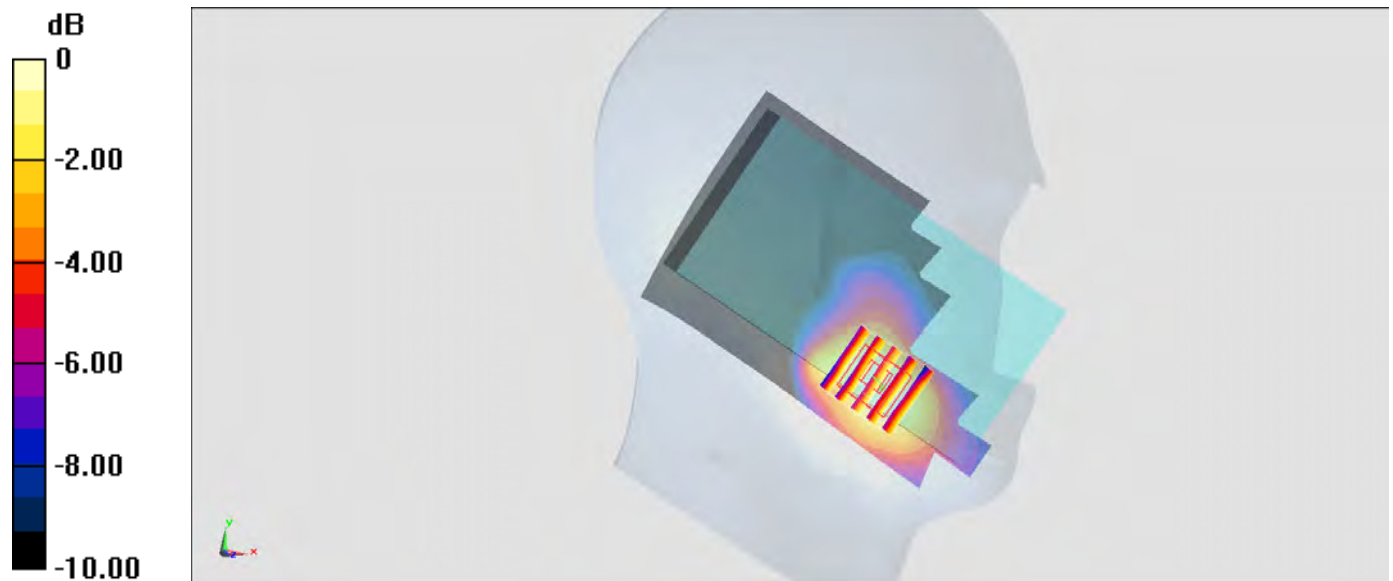

0 dB = 0.246 W/kg = -6.09 dBW/kg

#03_WCDMA II_RMC 12.2Kbps_Left Cheek_Ch9538

Communication System: WCDMA ; Frequency: 1907.6 MHz;Duty Cycle: 1:1

Medium: HSL_1900_160911 Medium parameters used: $f = 1908$ MHz; $\sigma = 1.404$ S/m; $\epsilon_r = 40.52$; $\rho = 1000$ kg/m³

Ambient Temperature : 23.2 °C; Liquid Temperature : 22.2 °C

DASY5 Configuration:

- Probe: ES3DV3 - SN3270; ConvF(5.08, 5.08, 5.08); Calibrated: 2016/8/26;
- Sensor-Surface: 3mm (Mechanical Surface Detection)
- Electronics: DAE4 Sn1399; Calibrated: 2015/11/23
- Phantom: SAM_Left; Type: QD000P40CD; Serial: TP:1644
- Measurement SW: DASY52, Version 52.8 (8);SEMCAD X Version 14.6.10 (7373)

Area Scan (71x121x1): Interpolated grid: dx=1.500 mm, dy=1.500 mm

Maximum value of SAR (interpolated) = 0.211 W/kg

Zoom Scan (5x5x7)/Cube 0: Measurement grid: dx=8mm, dy=8mm, dz=5mm

Reference Value = 11.70 V/m; Power Drift = 0.10 dB

Peak SAR (extrapolated) = 0.304 W/kg

SAR(1 g) = 0.191 W/kg; SAR(10 g) = 0.117 W/kg

Maximum value of SAR (measured) = 0.218 W/kg

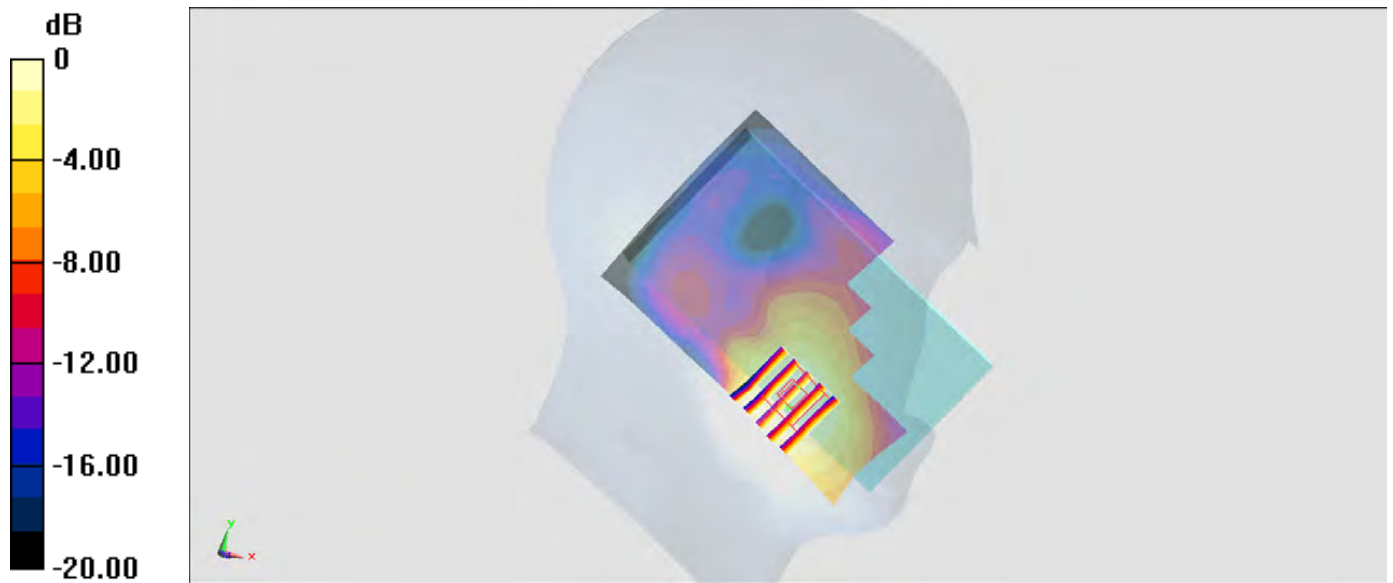

0 dB = 0.211 W/kg = -6.76 dBW/kg

#04_WCDMA IV_RMC 12.2Kbps_Left Cheek_Ch1513

Communication System: WCDMA ; Frequency: 1752.6 MHz;Duty Cycle: 1:1

Medium: HSL_1750_160911 Medium parameters used: $f = 1753$ MHz; $\sigma = 1.374$ S/m; $\epsilon_r = 39.993$; $\rho = 1000$ kg/m³

Ambient Temperature : 23.2 °C; Liquid Temperature : 22.2 °C

DASY5 Configuration:

- Probe: ES3DV3 - SN3270; ConvF(5.21, 5.21, 5.21); Calibrated: 2016/8/26;
- Sensor-Surface: 3mm (Mechanical Surface Detection)
- Electronics: DAE4 Sn1399; Calibrated: 2015/11/23
- Phantom: SAM_Left; Type: QD000P40CD; Serial: TP:1644
- Measurement SW: DASY52, Version 52.8 (8);SEMCAD X Version 14.6.10 (7373)

Area Scan (71x121x1): Interpolated grid: dx=1.500 mm, dy=1.500 mm

Maximum value of SAR (interpolated) = 0.212 W/kg

Zoom Scan (5x5x7)/Cube 0: Measurement grid: dx=8mm, dy=8mm, dz=5mm

Reference Value = 11.95 V/m; Power Drift = 0.06 dB

Peak SAR (extrapolated) = 0.342 W/kg

SAR(1 g) = 0.203 W/kg; SAR(10 g) = 0.130 W/kg

Maximum value of SAR (measured) = 0.241 W/kg

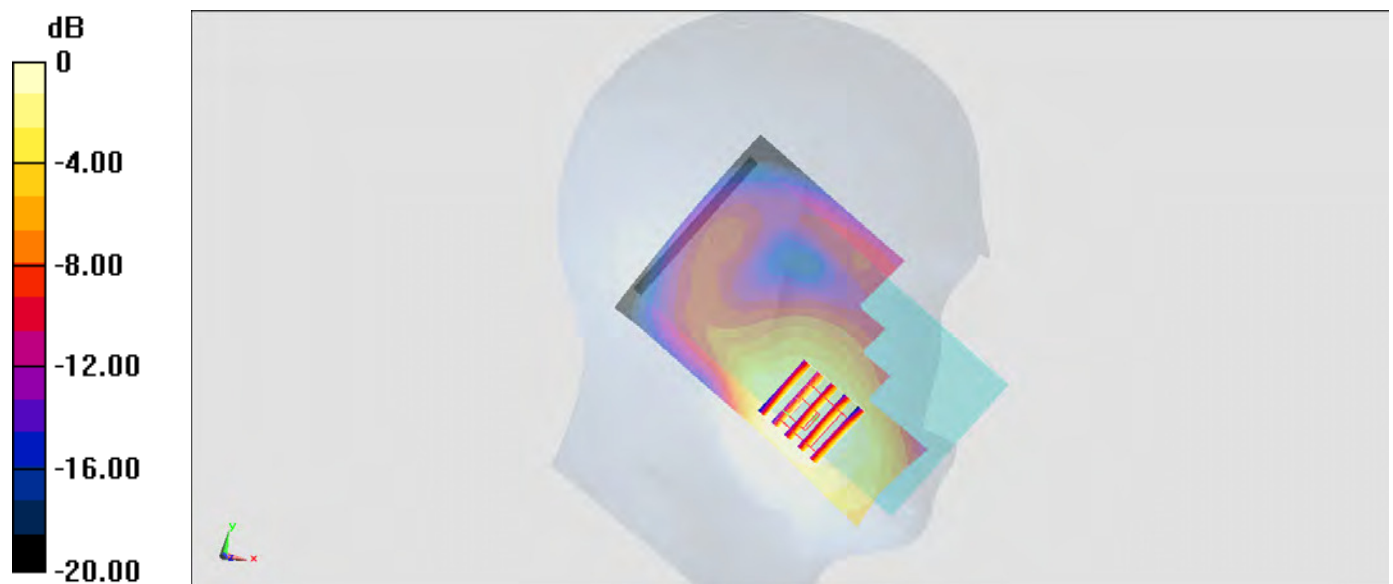

0 dB = 0.212 W/kg = -6.74 dBW/kg

#05_WCDMA V_RMC 12.2Kbps_Right Cheek_Ch4233

Communication System: WCDMA ; Frequency: 846.6 MHz; Duty Cycle: 1:1

Medium: HSL_850_160910 Medium parameters used: $f = 847 \text{ MHz}$; $\sigma = 0.908 \text{ S/m}$; $\epsilon_r = 42.387$; $\rho = 1000 \text{ kg/m}^3$

Ambient Temperature : $23.6 \text{ }^\circ\text{C}$; Liquid Temperature : $22.6 \text{ }^\circ\text{C}$

DASY5 Configuration:

- Probe: ES3DV3 - SN3270; ConvF(6.03, 6.03, 6.03); Calibrated: 2016/8/26;
- Sensor-Surface: 3mm (Mechanical Surface Detection)
- Electronics: DAE4 Sn1399; Calibrated: 2015/11/23
- Phantom: SAM-Right; Type: SAM; Serial: 1795
- Measurement SW: DASY52, Version 52.8 (8); SEMCAD X Version 14.6.10 (7373)

Area Scan (71x121x1): Interpolated grid: $dx=1.500 \text{ mm}$, $dy=1.500 \text{ mm}$

Maximum value of SAR (interpolated) = 0.366 W/kg

Zoom Scan (5x5x7)/Cube 0: Measurement grid: $dx=8\text{mm}$, $dy=8\text{mm}$, $dz=5\text{mm}$

Reference Value = 18.93 V/m ; Power Drift = -0.10 dB

Peak SAR (extrapolated) = 0.624 W/kg

SAR(1 g) = 0.303 W/kg ; SAR(10 g) = 0.228 W/kg

Maximum value of SAR (measured) = 0.360 W/kg

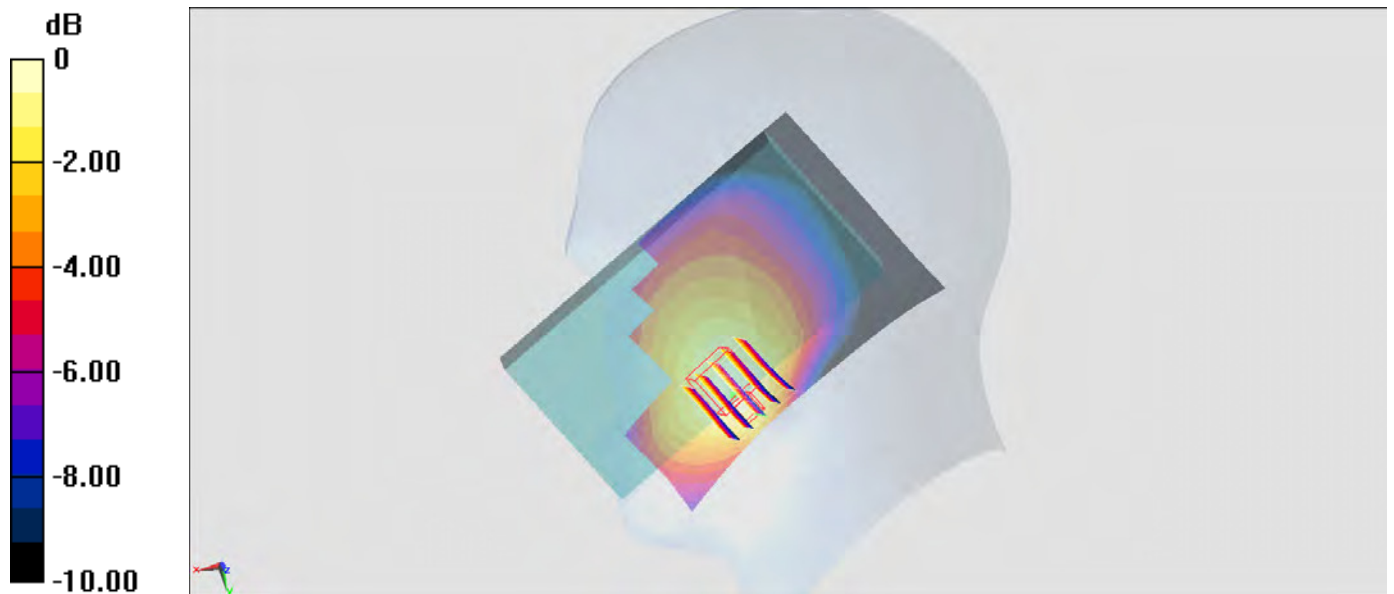

0 dB = $0.366 \text{ W/kg} = -4.37 \text{ dBW/kg}$

#06_CDMA BC0_1xRTT RC1 SO55_Right Cheek_Ch777

Communication System: CDMA ; Frequency: 848.31 MHz;Duty Cycle: 1:1

Medium: HSL_850_160910 Medium parameters used: $f = 848.31$ MHz; $\sigma = 0.909$ S/m; $\epsilon_r = 42.37$; $\rho = 1000$ kg/m³

Ambient Temperature : 23.6 °C ; Liquid Temperature : 22.6 °C

DASY5 Configuration:

- Probe: ES3DV3 - SN3270; ConvF(6.03, 6.03, 6.03); Calibrated: 2016/8/26;
- Sensor-Surface: 3mm (Mechanical Surface Detection)
- Electronics: DAE4 Sn1399; Calibrated: 2015/11/23
- Phantom: SAM-Right; Type: SAM; Serial: 1795
- Measurement SW: DASY52, Version 52.8 (8);SEMCAD X Version 14.6.10 (7373)

Area Scan (71x121x1): Interpolated grid: dx=1.500 mm, dy=1.500 mm

Maximum value of SAR (interpolated) = 0.392 W/kg

Zoom Scan (6x6x7)/Cube 0: Measurement grid: dx=8mm, dy=8mm, dz=5mm

Reference Value = 19.35 V/m; Power Drift = 0.08 dB

Peak SAR (extrapolated) = 0.600 W/kg

SAR(1 g) = 0.333 W/kg; SAR(10 g) = 0.252 W/kg

Maximum value of SAR (measured) = 0.403 W/kg

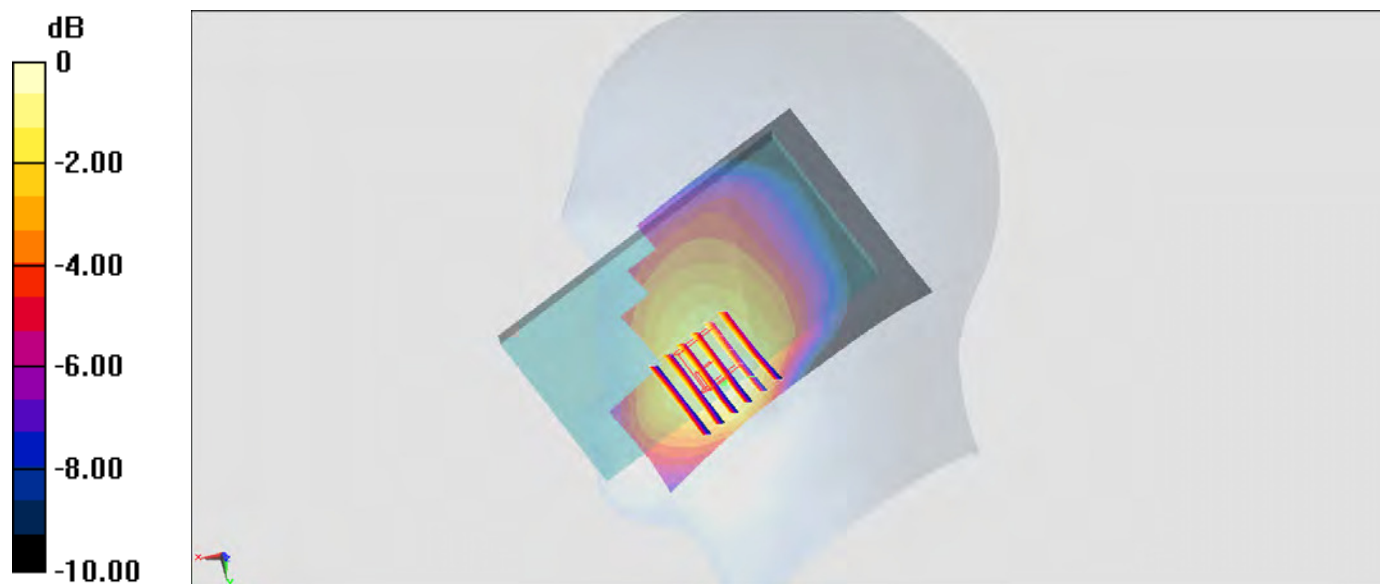

0 dB = 0.392 W/kg = -4.07 dBW/kg

#07_CDMA BC1_1xRTT RC1 SO55_Left Cheek_Ch1175

Communication System: CDMA ; Frequency: 1908.75 MHz;Duty Cycle: 1:1

Medium: HSL_1900_160911 Medium parameters used: $f = 1909$ MHz; $\sigma = 1.405$ S/m; $\epsilon_r = 40.516$; $\rho = 1000$ kg/m³

Ambient Temperature : 23.2 °C; Liquid Temperature : 22.2 °C

DASY5 Configuration:

- Probe: ES3DV3 - SN3270; ConvF(5.08, 5.08, 5.08); Calibrated: 2016/8/26;
- Sensor-Surface: 3mm (Mechanical Surface Detection)
- Electronics: DAE4 Sn1399; Calibrated: 2015/11/23
- Phantom: SAM_Left; Type: QD000P40CD; Serial: TP:1644
- Measurement SW: DASY52, Version 52.8 (8);SEMCAD X Version 14.6.10 (7373)

Area Scan (71x121x1): Interpolated grid: dx=1.500 mm, dy=1.500 mm

Maximum value of SAR (interpolated) = 0.211 W/kg

Zoom Scan (6x5x7)/Cube 0: Measurement grid: dx=8mm, dy=8mm, dz=5mm

Reference Value = 11.72 V/m; Power Drift = 0.15 dB

Peak SAR (extrapolated) = 0.299 W/kg

SAR(1 g) = 0.190 W/kg; SAR(10 g) = 0.115 W/kg

Maximum value of SAR (measured) = 0.223 W/kg

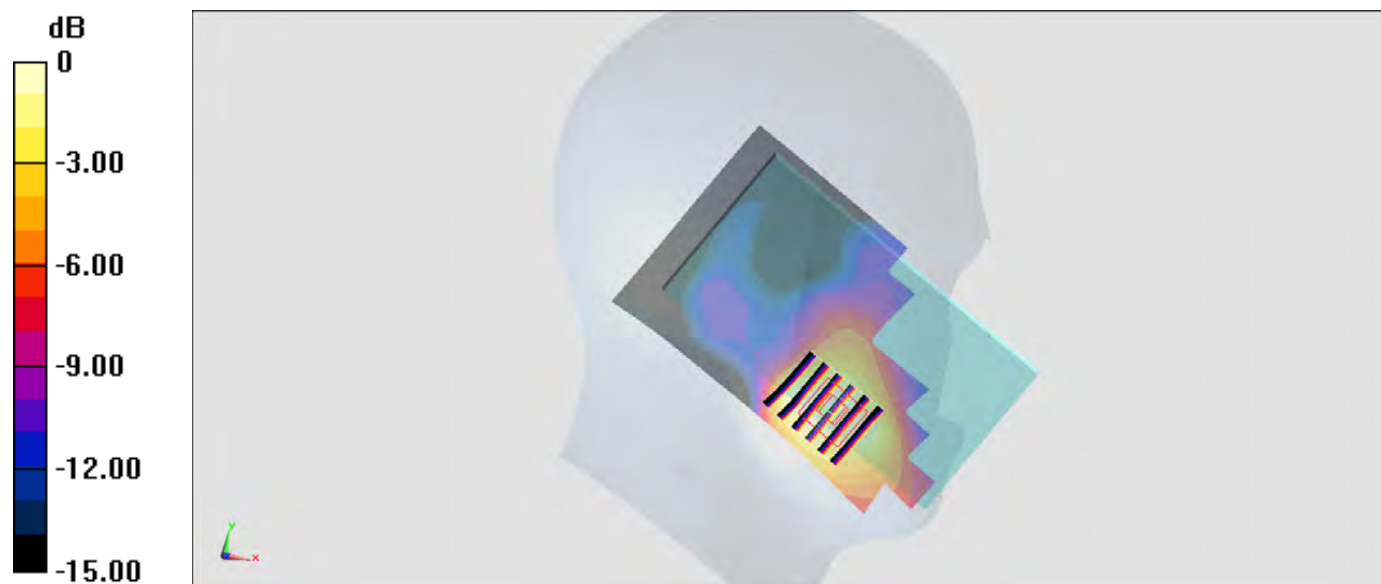

0 dB = 0.211 W/kg = -6.76 dBW/kg

#08_CDMA BC10_1xRTT RC1 SO55_Right Cheek_Ch684

Communication System: CDMA ; Frequency: 823.1 MHz; Duty Cycle: 1:1

Medium: HSL_850_160910 Medium parameters used: $f = 823.1$ MHz; $\sigma = 0.884$ S/m; $\epsilon_r = 42.699$; $\rho = 1000$ kg/m³

Ambient Temperature : 23.6 °C ; Liquid Temperature : 22.6 °C

DASY5 Configuration:

- Probe: ES3DV3 - SN3270; ConvF(6.03, 6.03, 6.03); Calibrated: 2016/8/26;
- Sensor-Surface: 3mm (Mechanical Surface Detection)
- Electronics: DAE4 Sn1399; Calibrated: 2015/11/23
- Phantom: SAM-Right; Type: SAM; Serial: 1795
- Measurement SW: DASY52, Version 52.8 (8); SEMCAD X Version 14.6.10 (7373)

Area Scan (71x121x1): Interpolated grid: dx=1.500 mm, dy=1.500 mm

Maximum value of SAR (interpolated) = 0.310 W/kg

Zoom Scan (6x6x7)/Cube 0: Measurement grid: dx=8mm, dy=8mm, dz=5mm

Reference Value = 17.18 V/m; Power Drift = 0.10 dB

Peak SAR (extrapolated) = 0.424 W/kg

SAR(1 g) = 0.269 W/kg; SAR(10 g) = 0.208 W/kg

Maximum value of SAR (measured) = 0.301 W/kg

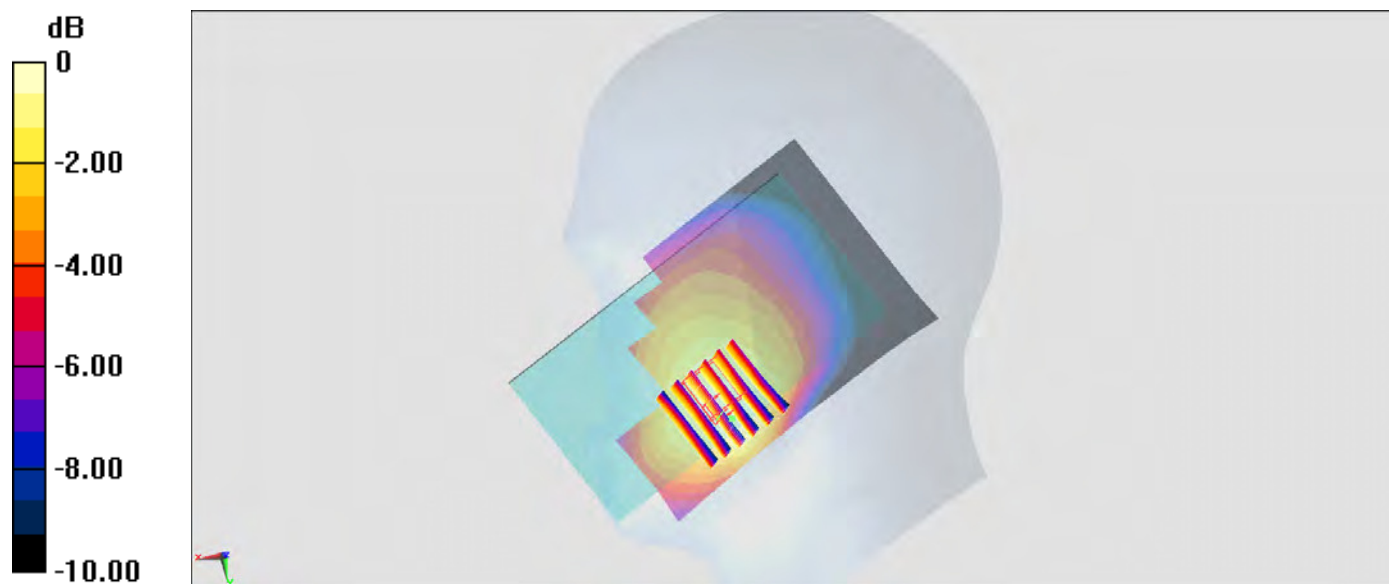

0 dB = 0.310 W/kg = -5.09 dBW/kg

#09_LTE Band 4_20M_QPSK_1_0_Left Cheek_Ch20175

Communication System: LTE; Frequency: 1732.5 MHz; Duty Cycle: 1:1

Medium: HSL_1750_160911 Medium parameters used : $f = 1732.5$ MHz; $\sigma = 1.355$ S/m; $\epsilon_r = 40.077$;

$\rho = 1000$ kg/m³

Ambient Temperature : 23.2 °C; Liquid Temperature : 22.2 °C

DASY5 Configuration:

- Probe: ES3DV3 - SN3270; ConvF(5.21, 5.21, 5.21); Calibrated: 2016/8/26;
- Sensor-Surface: 3mm (Mechanical Surface Detection)
- Electronics: DAE4 Sn1399; Calibrated: 2015/11/23
- Phantom: SAM_Left; Type: QD000P40CD; Serial: TP:1644
- Measurement SW: DASY52, Version 52.8 (8); SEMCAD X Version 14.6.10 (7373)

Area Scan (71x121x1): Interpolated grid: dx=1.500 mm, dy=1.500 mm

Maximum value of SAR (interpolated) = 0.188 W/kg

Zoom Scan (5x5x7)/Cube 0: Measurement grid: dx=8mm, dy=8mm, dz=5mm

Reference Value = 12.29 V/m; Power Drift = -0.05 dB

Peak SAR (extrapolated) = 0.267 W/kg

SAR(1 g) = 0.173 W/kg; SAR(10 g) = 0.114 W/kg

Maximum value of SAR (measured) = 0.204 W/kg

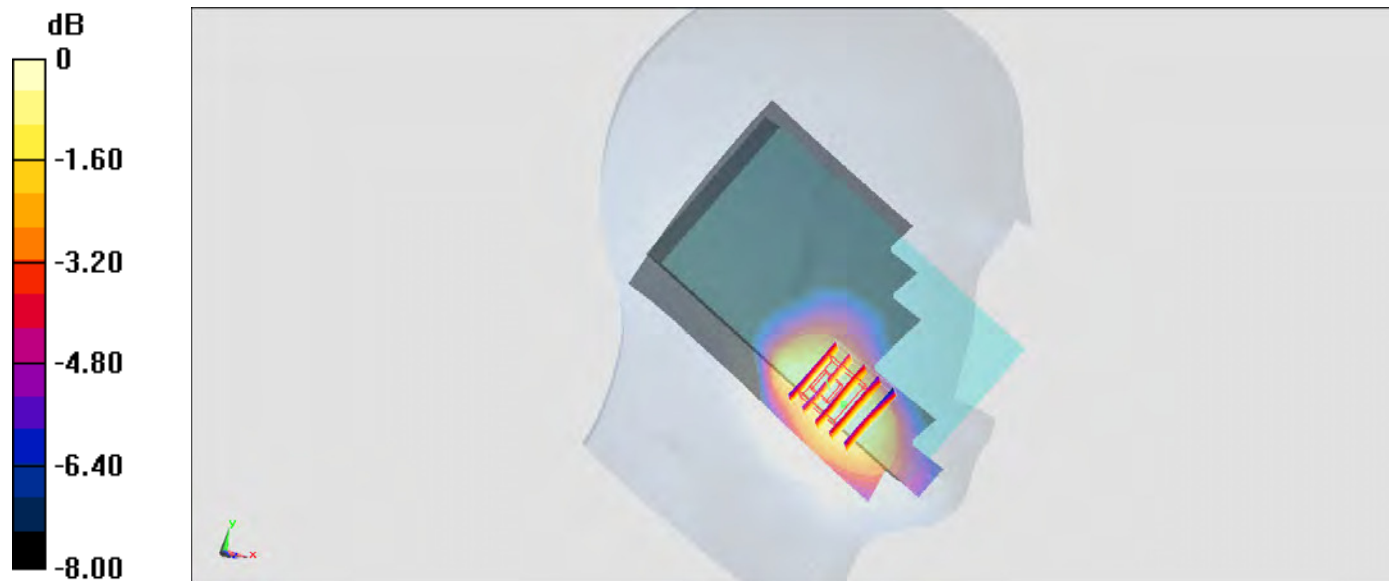

0 dB = 0.188 W/kg = -7.26 dBW/kg

#10_LTE Band 12_10M_QPSK_1_0_Right Cheek_Ch23095

Communication System: LTE; Frequency: 707.5 MHz; Duty Cycle: 1:1

Medium: HSL_750_160909 Medium parameters used : $f = 707.5$ MHz; $\sigma = 0.86$ S/m; $\epsilon_r = 44.111$; $\rho = 1000$ kg/m³

Ambient Temperature : 23.5 °C; Liquid Temperature : 22.5 °C

DASY5 Configuration:

- Probe: ES3DV3 - SN3270; ConvF(6.19, 6.19, 6.19); Calibrated: 2016/8/26;
- Sensor-Surface: 3mm (Mechanical Surface Detection)
- Electronics: DAE4 Sn1399; Calibrated: 2015/11/23
- Phantom: SAM-Right; Type: SAM; Serial: 1795
- Measurement SW: DASY52, Version 52.8 (8); SEMCAD X Version 14.6.10 (7373)

Area Scan (71x131x1): Interpolated grid: dx=1.500 mm, dy=1.500 mm

Maximum value of SAR (interpolated) = 0.262 W/kg

Zoom Scan (5x5x7)/Cube 0: Measurement grid: dx=8mm, dy=8mm, dz=5mm

Reference Value = 16.74 V/m; Power Drift = -0.05 dB

Peak SAR (extrapolated) = 0.322 W/kg

SAR(1 g) = 0.235 W/kg; SAR(10 g) = 0.187 W/kg

Maximum value of SAR (measured) = 0.252 W/kg

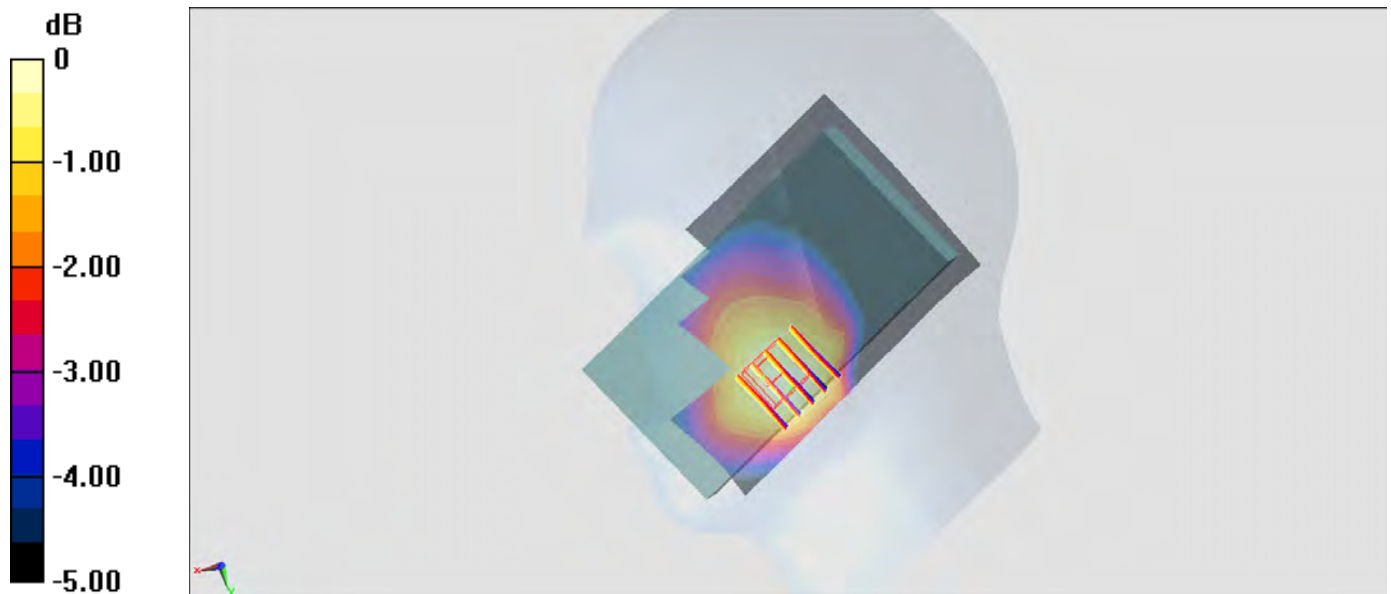

0 dB = 0.262 W/kg = -5.82 dBW/kg

#11_LTE Band 13_10M_QPSK_1_25_Right Cheek_Ch23230

Communication System: LTE; Frequency: 782 MHz; Duty Cycle: 1:1

Medium: HSL_750_160909 Medium parameters used: $f = 782$ MHz; $\sigma = 0.931$ S/m; $\epsilon_r = 43.103$; $\rho = 1000$ kg/m³

Ambient Temperature : 23.5 °C; Liquid Temperature : 22.5 °C

DASY5 Configuration:

- Probe: ES3DV3 - SN3270; ConvF(6.19, 6.19, 6.19); Calibrated: 2016/8/26;
- Sensor-Surface: 3mm (Mechanical Surface Detection)
- Electronics: DAE4 Sn1399; Calibrated: 2015/11/23
- Phantom: SAM-Right; Type: SAM; Serial: 1795
- Measurement SW: DASY52, Version 52.8 (8); SEMCAD X Version 14.6.10 (7373)

Area Scan (71x131x1): Interpolated grid: dx=1.500 mm, dy=1.500 mm

Maximum value of SAR (interpolated) = 0.267 W/kg

Zoom Scan (5x5x7)/Cube 0: Measurement grid: dx=8mm, dy=8mm, dz=5mm

Reference Value = 15.13 V/m; Power Drift = 0.01 dB

Peak SAR (extrapolated) = 0.320 W/kg

SAR(1 g) = 0.225 W/kg; SAR(10 g) = 0.171 W/kg

Maximum value of SAR (measured) = 0.250 W/kg

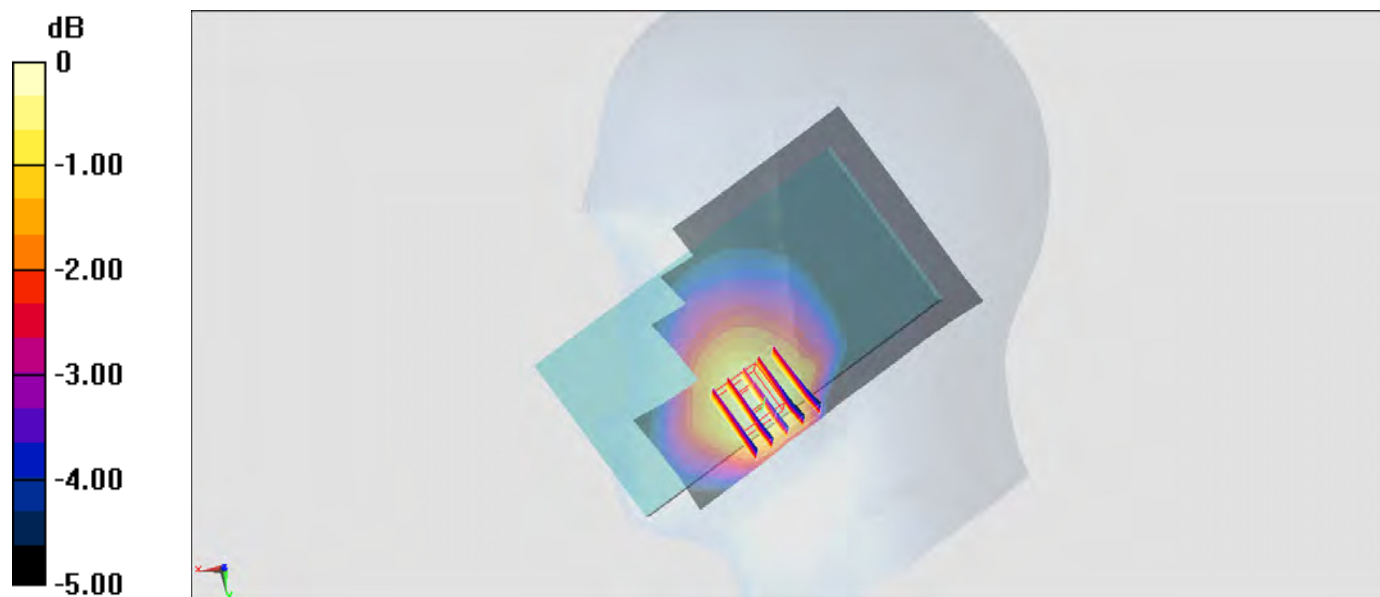

0 dB = 0.267 W/kg = -5.73 dBW/kg

#12_LTE Band 25_20M_QPSK_1_49_Left Cheek_Ch26140

Communication System: LTE; Frequency: 1860 MHz; Duty Cycle: 1:1

Medium: HSL_1900_160911 Medium parameters used: $f = 1860$ MHz; $\sigma = 1.355$ S/m; $\epsilon_r = 40.708$; $\rho = 1000$ kg/m³

Ambient Temperature : 23.2 °C; Liquid Temperature : 22.2 °C

DASY5 Configuration:

- Probe: ES3DV3 - SN3270; ConvF(5.08, 5.08, 5.08); Calibrated: 2016/8/26;
- Sensor-Surface: 3mm (Mechanical Surface Detection)
- Electronics: DAE4 Sn1399; Calibrated: 2015/11/23
- Phantom: SAM_Left; Type: QD000P40CD; Serial: TP:1644
- Measurement SW: DASY52, Version 52.8 (8); SEMCAD X Version 14.6.10 (7373)

Area Scan (71x121x1): Interpolated grid: dx=1.500 mm, dy=1.500 mm

Maximum value of SAR (interpolated) = 0.225 W/kg

Zoom Scan (5x5x7)/Cube 0: Measurement grid: dx=8mm, dy=8mm, dz=5mm

Reference Value = 12.76 V/m; Power Drift = -0.04 dB

Peak SAR (extrapolated) = 0.284 W/kg

SAR(1 g) = 0.184 W/kg; SAR(10 g) = 0.117 W/kg

Maximum value of SAR (measured) = 0.221 W/kg

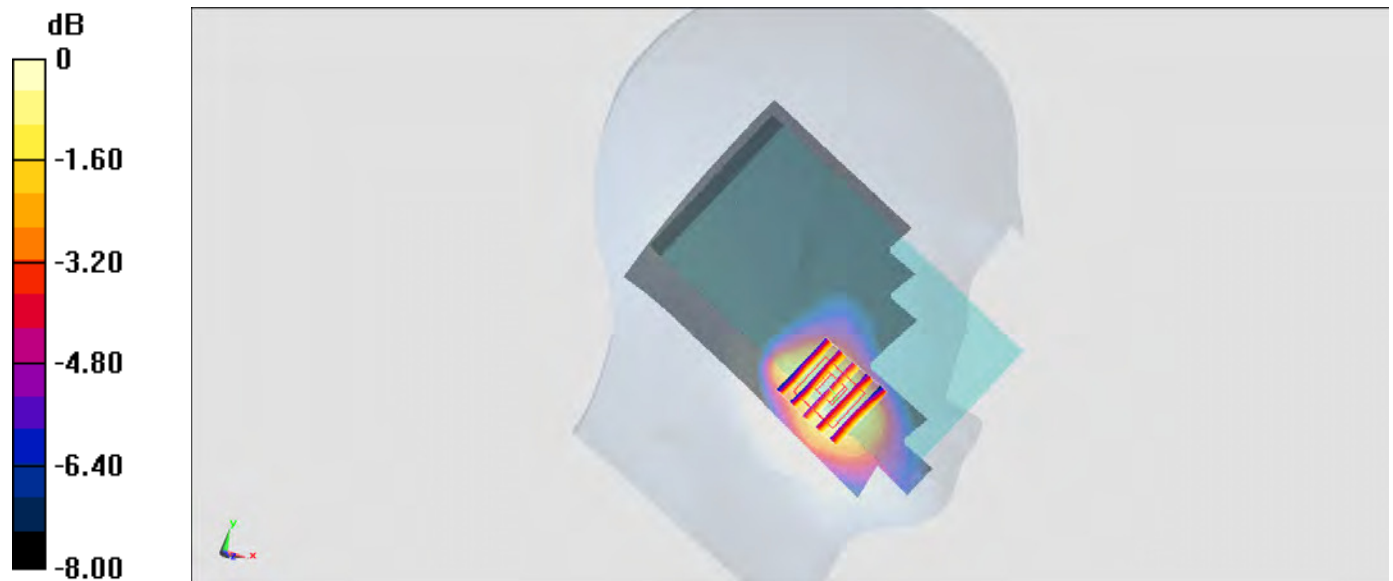

0 dB = 0.225 W/kg = -6.48 dBW/kg

#13_LTE Band 26_15M_QPSK_1_37_Right Cheek_Ch26865

Communication System: LTE ; Frequency: 831.5 MHz;Duty Cycle: 1:1

Medium: HSL_850_160910 Medium parameters used: $f = 831.5$ MHz; $\sigma = 0.892$ S/m; $\epsilon_r = 42.593$; $\rho = 1000$ kg/m³

Ambient Temperature : 23.6 °C ; Liquid Temperature : 22.6 °C

DASY5 Configuration:

- Probe: ES3DV3 - SN3270; ConvF(6.03, 6.03, 6.03); Calibrated: 2016/8/26;
- Sensor-Surface: 3mm (Mechanical Surface Detection)
- Electronics: DAE4 Sn1399; Calibrated: 2015/11/23
- Phantom: SAM-Right; Type: SAM; Serial: 1795
- Measurement SW: DASY52, Version 52.8 (8);SEMCAD X Version 14.6.10 (7373)

Area Scan (71x121x1): Interpolated grid: dx=1.500 mm, dy=1.500 mm

Maximum value of SAR (interpolated) = 0.324 W/kg

Zoom Scan (6x6x7)/Cube 0: Measurement grid: dx=8mm, dy=8mm, dz=5mm

Reference Value = 17.89 V/m; Power Drift = -0.11 dB

Peak SAR (extrapolated) = 0.447 W/kg

SAR(1 g) = 0.264 W/kg; SAR(10 g) = 0.201 W/kg

Maximum value of SAR (measured) = 0.314 W/kg

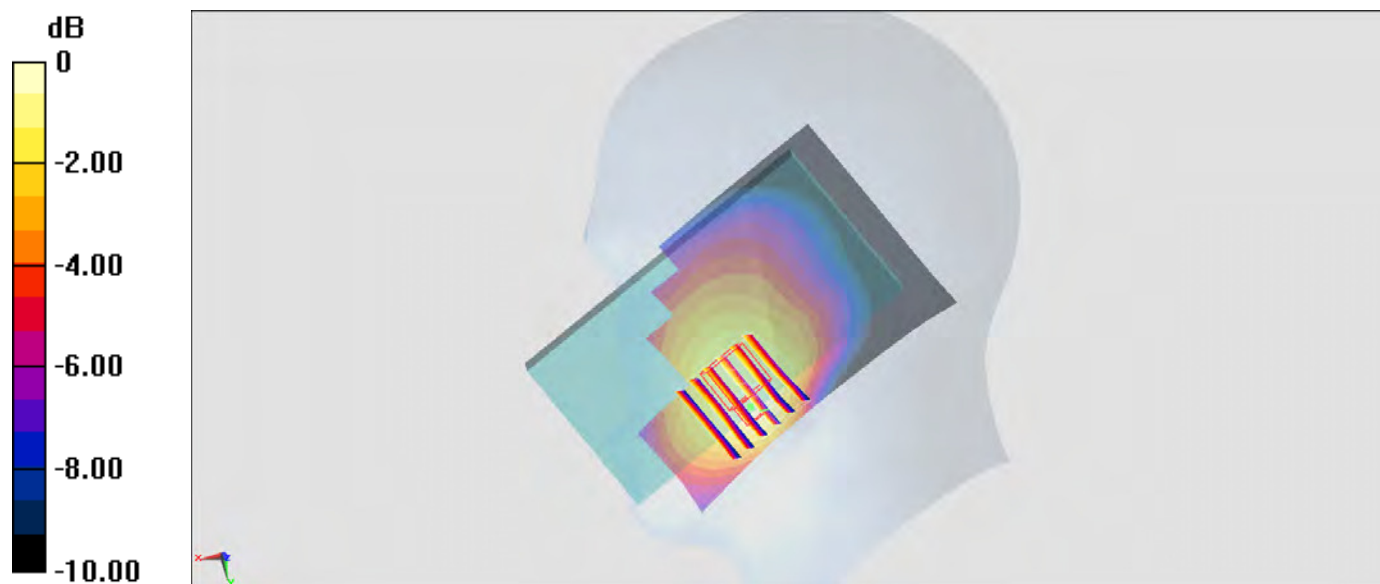

#14_WLAN2.4GHz_802.11b 1Mbps_Left Cheek_Ch11;Ant 2

Communication System: 802.11b ; Frequency: 2462 MHz;Duty Cycle: 1:1.014

Medium: HSL_2450_160908 Medium parameters used: $f = 2462$ MHz; $\sigma = 1.776$ S/m; $\epsilon_r = 40.724$; $\rho = 1000$ kg/m³

Ambient Temperature : 23.6 °C ; Liquid Temperature : 22.6 °C

DASY5 Configuration:

- Probe: EX3DV4 - SN3697; ConvF(6.75, 6.75, 6.75); Calibrated: 2015/9/28;
- Sensor-Surface: 1.4mm (Mechanical Surface Detection)
- Electronics: DAE4 Sn1388; Calibrated: 2015/9/25
- Phantom: SAM_Right; Type: QD000P40CD; Serial: TP:1383
- Measurement SW: DASY52, Version 52.8 (8);SEMCAD X Version 14.6.10 (7331)

Area Scan (81x151x1): Interpolated grid: dx=1.200 mm, dy=1.200 mm

Maximum value of SAR (interpolated) = 0.380 W/kg

Zoom Scan (7x7x7)/Cube 0: Measurement grid: dx=5mm, dy=5mm, dz=5mm

Reference Value = 7.415 V/m; Power Drift = 0.14 dB

Peak SAR (extrapolated) = 0.458 W/kg

SAR(1 g) = 0.246 W/kg; SAR(10 g) = 0.136 W/kg

Maximum value of SAR (measured) = 0.380 W/kg

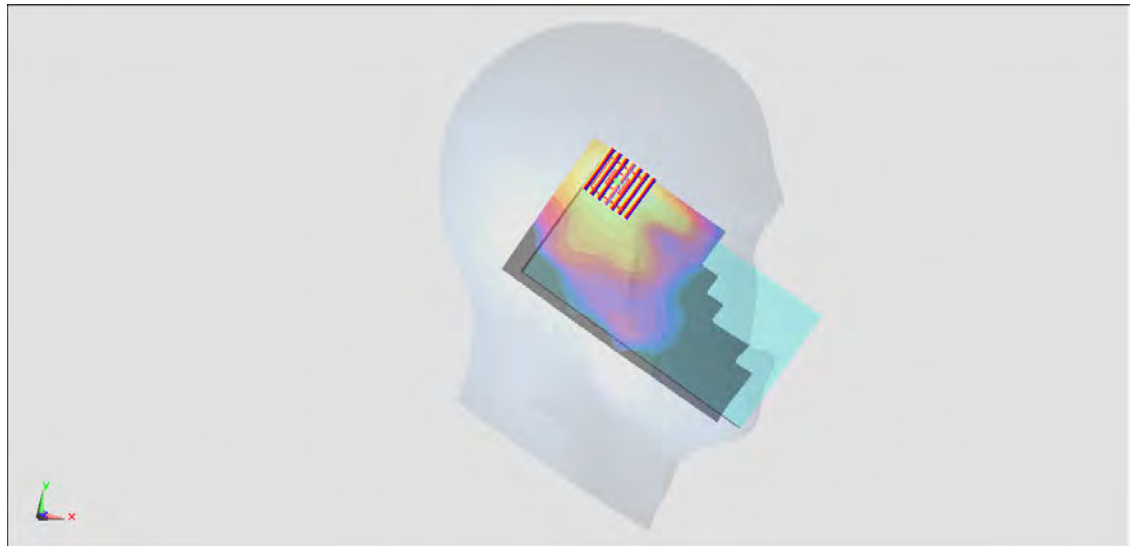
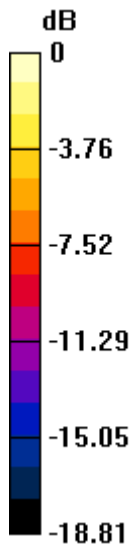

0 dB = 0.380 W/kg = -4.20 dBW/kg

#15_WLAN5GHz_802.11a 6Mbps_Left Cheek_Ch60;Ant 2

Communication System: 802.11a ; Frequency: 5300 MHz;Duty Cycle: 1:1.077

Medium: HSL_5G_160908 Medium parameters used: $f = 5300$ MHz; $\sigma = 4.597$ S/m; $\epsilon_r = 36.154$; $\rho = 1000$ kg/m³

Ambient Temperature : 23.6 °C ; Liquid Temperature : 22.6 °C

DASY5 Configuration:

- Probe: EX3DV4 - SN3925; ConvF(5.15, 5.15, 5.15); Calibrated: 2016/5/26;
- Sensor-Surface: 1.4mm (Mechanical Surface Detection)
- Electronics: DAE3 Sn495; Calibrated: 2016/5/27
- Phantom: SAM_Left; Type: QD 000 P40 CB; Serial: TP-1478
- Measurement SW: DASY52, Version 52.8 (8);SEMCAD X Version 14.6.10 (7331)

Area Scan (101x191x1): Interpolated grid: dx=1.000 mm, dy=1.000 mm

Maximum value of SAR (interpolated) = 0.213 W/kg

Zoom Scan (8x8x7)/Cube 0: Measurement grid: dx=4mm, dy=4mm, dz=1.4mm

Reference Value = 2.004 V/m; Power Drift = -0.12 dB

Peak SAR (extrapolated) = 0.394 W/kg

SAR(1 g) = 0.095 W/kg; SAR(10 g) = 0.039 W/kg

Maximum value of SAR (measured) = 0.214 W/kg

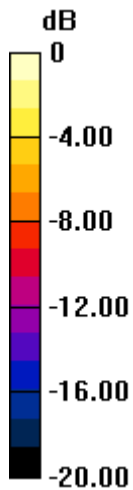

0 dB = 0.214 W/kg = -6.70 dBW/kg

#16_WLAN5GHz_802.11a 6Mbps_Left Cheek_Ch144;Ant 2

Communication System: 802.11a ; Frequency: 5720 MHz;Duty Cycle: 1:1.077

Medium: HSL_5G_160908 Medium parameters used: $f = 5720$ MHz; $\sigma = 5.012$ S/m; $\epsilon_r = 35.599$; $\rho = 1000$ kg/m³

Ambient Temperature : 23.6 °C ; Liquid Temperature : 22.6 °C

DASY5 Configuration:

- Probe: EX3DV4 - SN3925; ConvF(4.51, 4.51, 4.51); Calibrated: 2016/5/26;
- Sensor-Surface: 1.4mm (Mechanical Surface Detection)
- Electronics: DAE3 Sn495; Calibrated: 2016/5/27
- Phantom: SAM_Left; Type: QD 000 P40 CB; Serial: TP-1478
- Measurement SW: DASY52, Version 52.8 (8);SEMCAD X Version 14.6.10 (7331)

Area Scan (111x201x1): Interpolated grid: dx=1.000 mm, dy=1.000 mm

Maximum value of SAR (interpolated) = 0.202 W/kg

Zoom Scan (8x8x7)/Cube 0: Measurement grid: dx=4mm, dy=4mm, dz=1.4mm

Reference Value = 7.238 V/m; Power Drift = -0.13 dB

Peak SAR (extrapolated) = 0.309 W/kg

SAR(1 g) = 0.087 W/kg; SAR(10 g) = 0.036 W/kg

Maximum value of SAR (measured) = 0.198 W/kg

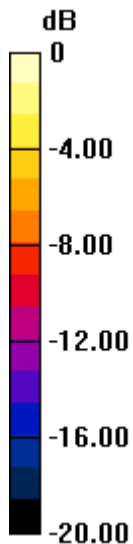

0 dB = 0.198 W/kg = -7.03 dBW/kg

#17_WLAN5GHz_802.11a 6Mbps_Right Cheek_Ch165;Ant 1

Communication System: 802.11a; Frequency: 5825 MHz; Duty Cycle: 1:1.077

Medium: HSL_5G_160911 Medium parameters used: $f = 5825$ MHz; $\sigma = 5.069$ S/m; $\epsilon_r = 34.838$; $\rho = 1000$ kg/m³

Ambient Temperature : 23.5 °C; Liquid Temperature : 22.5 °C

DASY5 Configuration:

- Probe: EX3DV4 - SN3925; ConvF(4.51, 4.51, 4.51); Calibrated: 2016/5/26;
- Sensor-Surface: 1.4mm (Mechanical Surface Detection)
- Electronics: DAE3 Sn495; Calibrated: 2016/5/27
- Phantom: SAM-Right; Type: SAM; Serial: 1795
- Measurement SW: DASY52, Version 52.8 (8); SEMCAD X Version 14.6.10 (7373)

Area Scan (121x201x1): Interpolated grid: dx=1.000 mm, dy=1.000 mm

Maximum value of SAR (interpolated) = 0.430 W/kg

Zoom Scan (8x8x7)/Cube 0: Measurement grid: dx=4mm, dy=4mm, dz=1.4mm

Reference Value = 7.250 V/m; Power Drift = 0.09 dB

Peak SAR (extrapolated) = 0.414 W/kg

SAR(1 g) = 0.103 W/kg; SAR(10 g) = 0.036 W/kg

Maximum value of SAR (measured) = 0.266 W/kg

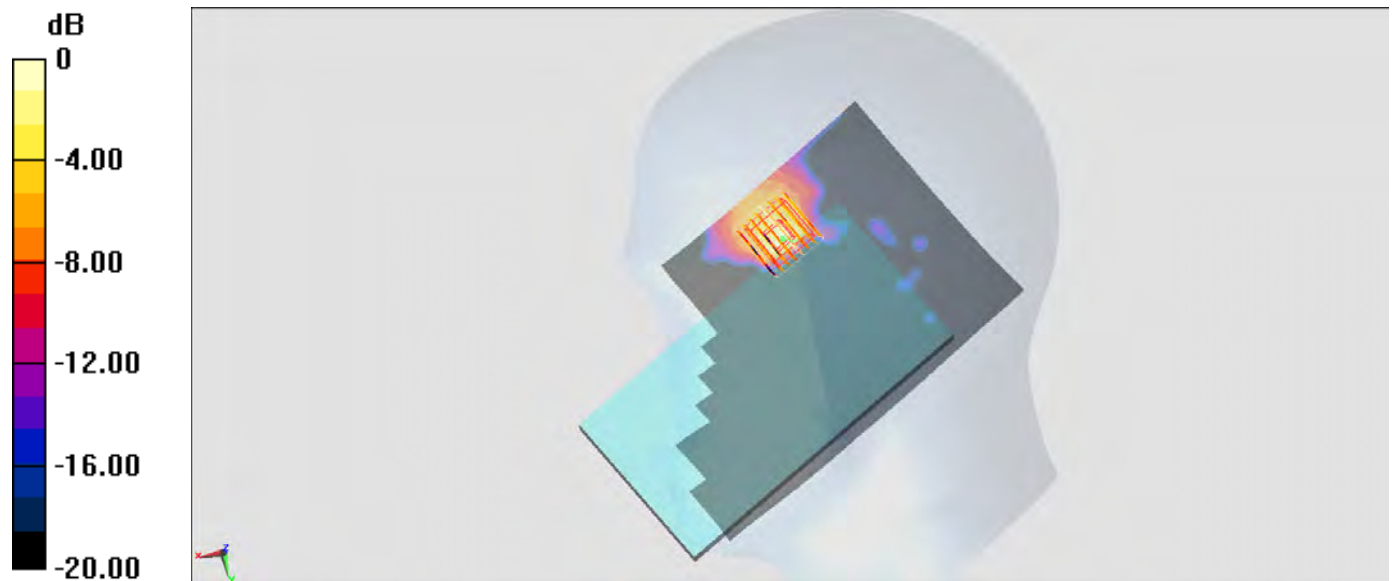

0 dB = 0.430 W/kg = -3.67 dBW/kg

#18_GSM850_GPRS (4 Tx slots)_Right Side_10mm_Ch251

Communication System: GSM850 ; Frequency: 848.8 MHz; Duty Cycle: 1:2.08

Medium: MSL_850_160908 Medium parameters used: $f = 849$ MHz; $\sigma = 0.976$ S/m; $\epsilon_r = 56.929$; $\rho = 1000$ kg/m³

Ambient Temperature : 23.5 °C ; Liquid Temperature : 22.5 °C

DASY5 Configuration:

- Probe: EX3DV4 - SN3955; ConvF(10.08, 10.08, 10.08); Calibrated: 2015/11/24;
- Sensor-Surface: 1.4mm (Mechanical Surface Detection)
- Electronics: DAE4 Sn778; Calibrated: 2016/5/12
- Phantom: SAM_Left; Type: QD000P40CD; Serial: TP:1644
- Measurement SW: DASY52, Version 52.8 (8); SEMCAD X Version 14.6.10 (7373)

Area Scan (41x121x1): Interpolated grid: dx=1.500 mm, dy=1.500 mm

Maximum value of SAR (interpolated) = 1.38 W/kg

Zoom Scan (5x5x7)/Cube 0: Measurement grid: dx=8mm, dy=8mm, dz=5mm

Reference Value = 36.99 V/m; Power Drift = -0.05 dB

Peak SAR (extrapolated) = 1.47 W/kg

SAR(1 g) = 1.06 W/kg; SAR(10 g) = 0.750 W/kg

Maximum value of SAR (measured) = 1.33 W/kg

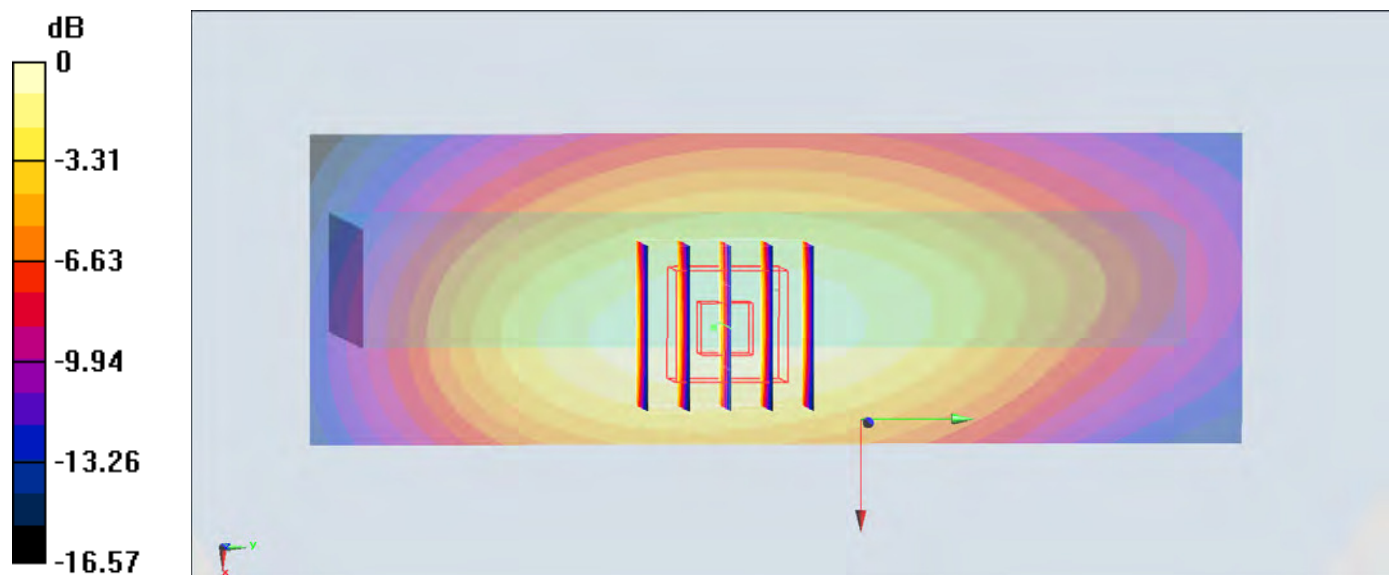

0 dB = 1.38 W/kg = 1.40 dBW/kg

#19_GSM1900_GPRS (4 Tx slots)_Bottom Side_10mm_Ch810

Communication System: PCS; Frequency: 1909.8 MHz; Duty Cycle: 1:2.08

Medium: MSL_1900_160905 Medium parameters used: $f = 1910$ MHz; $\sigma = 1.565$ S/m; $\epsilon_r = 55.731$; $\rho = 1000$ kg/m³

Ambient Temperature : 23.7 °C ; Liquid Temperature : 22.7 °C

DASY5 Configuration:

- Probe: EX3DV4 - SN3955; ConvF(7.89, 7.89, 7.89); Calibrated: 2015/11/24;
- Sensor-Surface: 1.4mm (Mechanical Surface Detection)
- Electronics: DAE4 Sn778; Calibrated: 2016/5/12
- Phantom: SAM_Left; Type: QD000P40CD; Serial: TP:1644
- Measurement SW: DASY52, Version 52.8 (8); SEMCAD X Version 14.6.10 (7373)

Area Scan (41x71x1): Interpolated grid: dx=1.500 mm, dy=1.500 mm

Maximum value of SAR (interpolated) = 1.65 W/kg

Zoom Scan (5x5x7)/Cube 0: Measurement grid: dx=8mm, dy=8mm, dz=5mm

Reference Value = 24.57 V/m; Power Drift = -0.06 dB

Peak SAR (extrapolated) = 1.68 W/kg

SAR(1 g) = 1.02 W/kg; SAR(10 g) = 0.573 W/kg

Maximum value of SAR (measured) = 1.42 W/kg

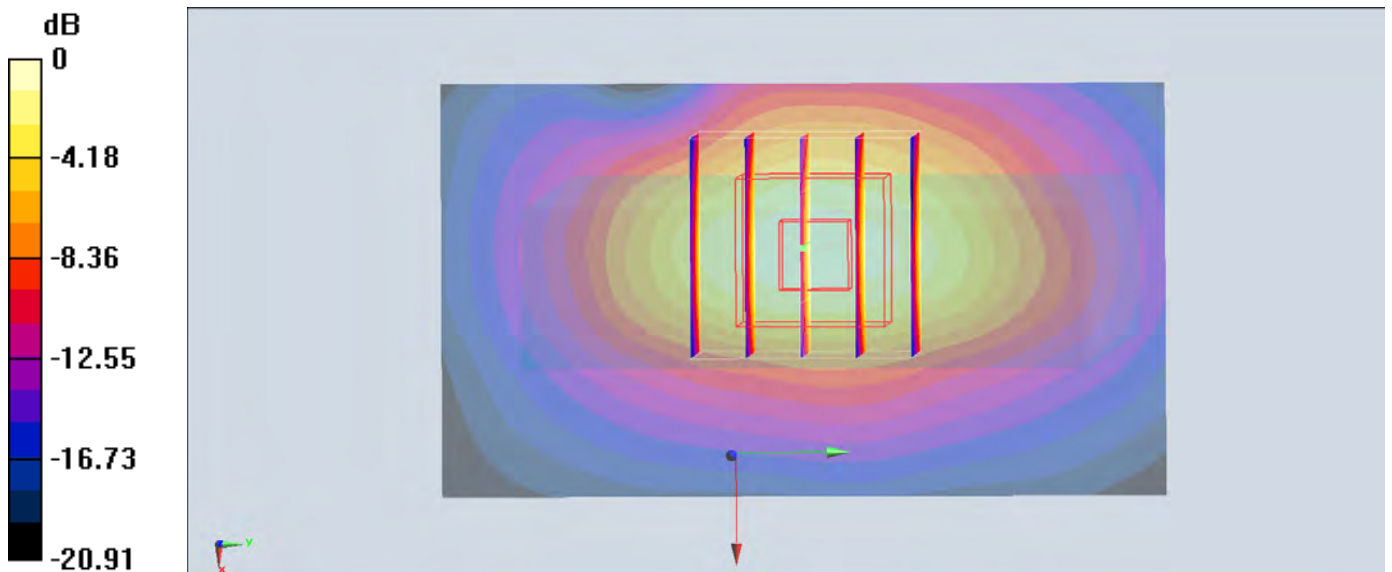

0 dB = 1.65 W/kg = 2.17 dBW/kg

#20_WCDMA II_RMC 12.2Kbps_Bottom Side_10mm_Ch9262

Communication System: WCDMA; Frequency: 1852.4 MHz; Duty Cycle: 1:1

Medium: MSL_1900_160905 Medium parameters used: $f = 1852.4$ MHz; $\sigma = 1.495$ S/m; $\epsilon_r = 55.904$;

$\rho = 1000$ kg/m³

Ambient Temperature : 23.7 °C ; Liquid Temperature : 22.7 °C

DASY5 Configuration:

- Probe: EX3DV4 - SN3955; ConvF(7.89, 7.89, 7.89); Calibrated: 2015/11/24;
- Sensor-Surface: 1.4mm (Mechanical Surface Detection)
- Electronics: DAE4 Sn778; Calibrated: 2016/5/12
- Phantom: SAM_Left; Type: QD000P40CD; Serial: TP:1644
- Measurement SW: DASY52, Version 52.8 (8); SEMCAD X Version 14.6.10 (7373)

Area Scan (41x71x1): Interpolated grid: dx=1.500 mm, dy=1.500 mm

Maximum value of SAR (interpolated) = 1.52 W/kg

Zoom Scan (5x5x7)/Cube 0: Measurement grid: dx=8mm, dy=8mm, dz=5mm

Reference Value = 22.69 V/m; Power Drift = 0.07 dB

Peak SAR (extrapolated) = 1.58 W/kg

SAR(1 g) = 0.965 W/kg; SAR(10 g) = 0.543 W/kg

Maximum value of SAR (measured) = 1.36 W/kg

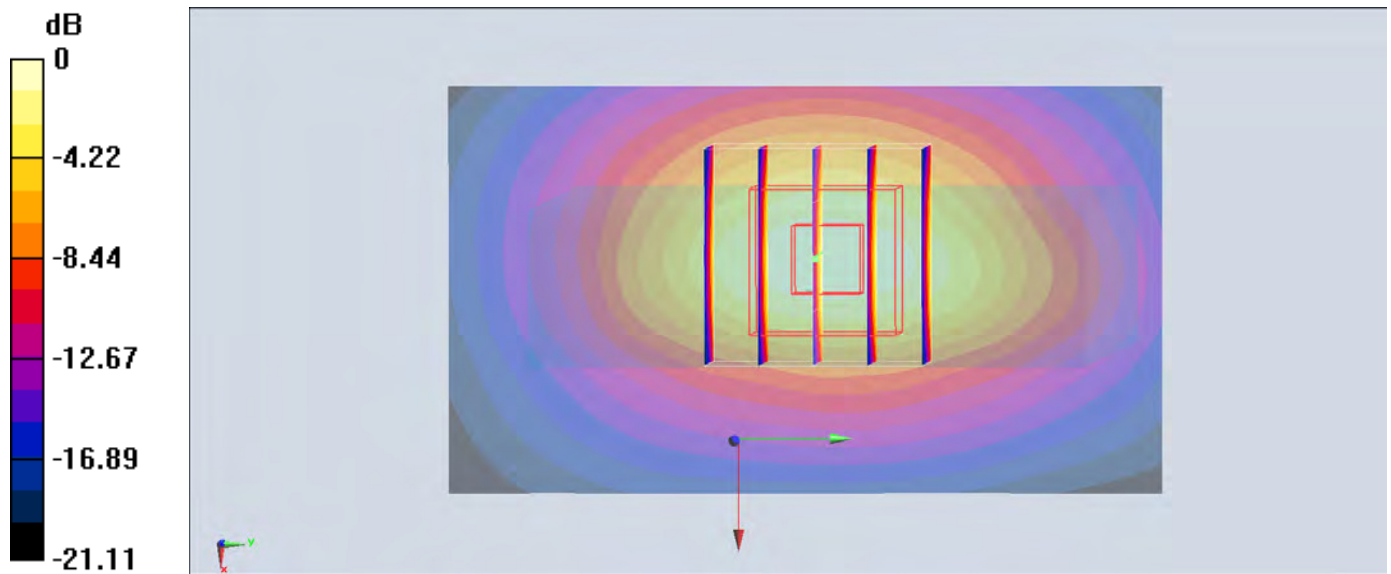

0 dB = 1.52 W/kg = 1.82 dBW/kg

#21_WCDMA IV_RMC 12.2Kbps_Bottom Side_10mm_Ch1312

Communication System: WCDMA ; Frequency: 1752.6 MHz; Duty Cycle: 1:1

Medium: MSL_1750_160906 Medium parameters used: $f = 1753$ MHz; $\sigma = 1.512$ S/m; $\epsilon_r = 55.926$; $\rho = 1000$ kg/m³

Ambient Temperature : 23.7 °C ; Liquid Temperature : 22.7 °C

DASY5 Configuration:

- Probe: EX3DV4 - SN3955; ConvF(8.25, 8.25, 8.25); Calibrated: 2015/11/24;
- Sensor-Surface: 1.4mm (Mechanical Surface Detection)
- Electronics: DAE4 Sn778; Calibrated: 2016/5/12
- Phantom: SAM_Left; Type: QD000P40CD; Serial: TP:1644
- Measurement SW: DASY52, Version 52.8 (8); SEMCAD X Version 14.6.10 (7373)

Area Scan (41x71x1): Interpolated grid: dx=1.500 mm, dy=1.500 mm

Maximum value of SAR (interpolated) = 1.28 W/kg

Zoom Scan (5x5x7)/Cube 0: Measurement grid: dx=8mm, dy=8mm, dz=5mm

Reference Value = 21.08 V/m; Power Drift = -0.13 dB

Peak SAR (extrapolated) = 1.23 W/kg

SAR(1 g) = 0.770 W/kg; SAR(10 g) = 0.443 W/kg

Maximum value of SAR (measured) = 1.07 W/kg

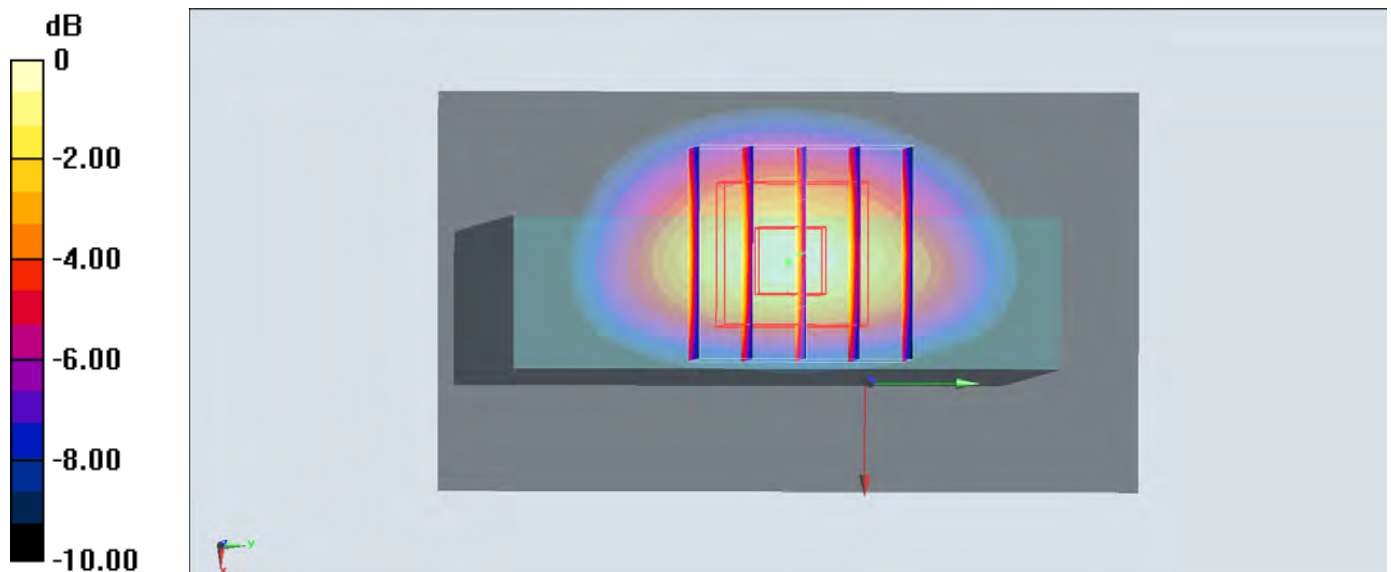

0 dB = 1.28 W/kg = 1.07 dBW/kg

#22_WCDMA V_RMC 12.2Kbps_Right Side_10mm_Ch4132

Communication System: WCDMA; Frequency: 826.4 MHz; Duty Cycle: 1:1

Medium: MSL_850_160908 Medium parameters used : $f = 826.4$ MHz; $\sigma = 0.955$ S/m; $\epsilon_r = 57.118$; $\rho = 1000$ kg/m³

Ambient Temperature : 23.5 °C ; Liquid Temperature : 22.5 °C

DASY5 Configuration:

- Probe: EX3DV4 - SN3955; ConvF(10.08, 10.08, 10.08); Calibrated: 2015/11/24;
- Sensor-Surface: 1.4mm (Mechanical Surface Detection)
- Electronics: DAE4 Sn778; Calibrated: 2016/5/12
- Phantom: SAM_Left; Type: QD000P40CD; Serial: TP:1644
- Measurement SW: DASY52, Version 52.8 (8); SEMCAD X Version 14.6.10 (7373)

Area Scan (41x131x1): Interpolated grid: dx=1.500 mm, dy=1.500 mm

Maximum value of SAR (interpolated) = 0.551 W/kg

Zoom Scan (5x5x7)/Cube 0: Measurement grid: dx=8mm, dy=8mm, dz=5mm

Reference Value = 23.21 V/m; Power Drift = -0.01 dB

Peak SAR (extrapolated) = 0.621 W/kg

SAR(1 g) = 0.440 W/kg; SAR(10 g) = 0.313 W/kg

Maximum value of SAR (measured) = 0.559 W/kg

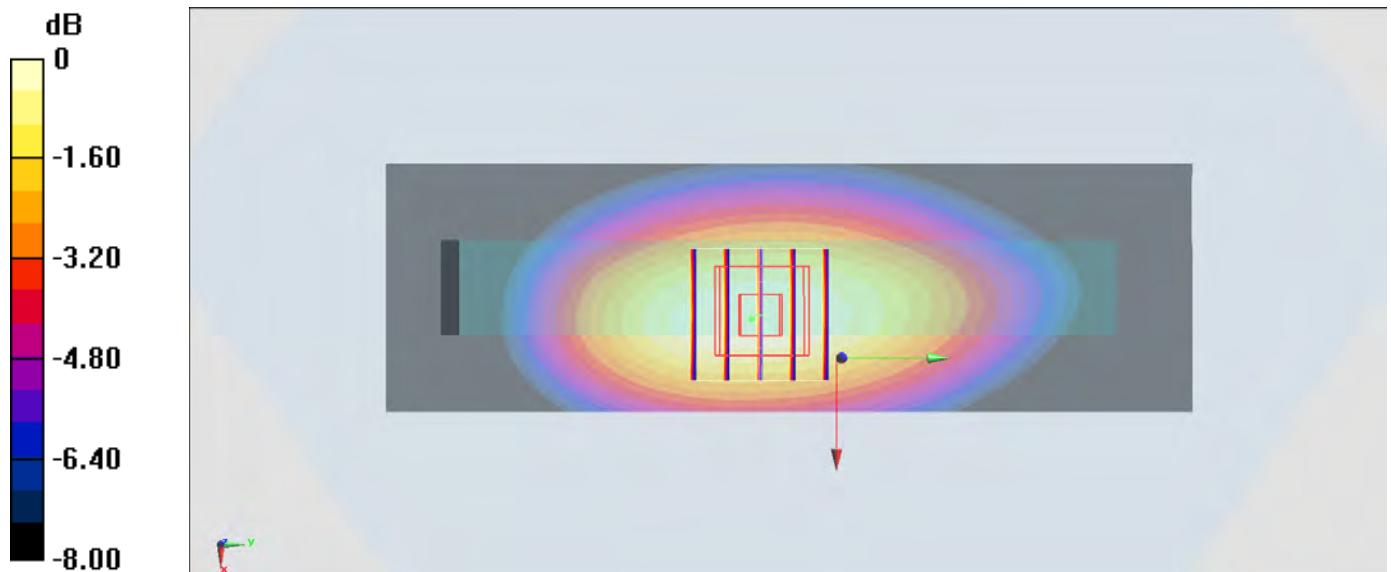

0 dB = 0.551 W/kg = -2.59 dBW/kg

#23_CDMA BC0_RTAP 153.6Kbps_Right Side_10mm_Ch777

Communication System: CDMA; Frequency: 848.31 MHz; Duty Cycle: 1:1

Medium: MSL_850_160908 Medium parameters used: $f = 848.31$ MHz; $\sigma = 0.975$ S/m; $\epsilon_r = 56.935$;

$\rho = 1000$ kg/m³

Ambient Temperature : 23.5 °C ; Liquid Temperature : 22.5 °C

DASY5 Configuration:

- Probe: ES3DV3 - SN3270; ConvF(6.01, 6.01, 6.01); Calibrated: 2016/8/26;
- Sensor-Surface: 3mm (Mechanical Surface Detection)
- Electronics: DAE4 Sn1399; Calibrated: 2015/11/23
- Phantom: SAM_Left; Type: QD000P40CD; Serial: TP:1644
- Measurement SW: DASY52, Version 52.8 (8); SEMCAD X Version 14.6.10 (7373)

Area Scan (51x121x1): Interpolated grid: dx=1.500 mm, dy=1.500 mm

Maximum value of SAR (interpolated) = 0.539 W/kg

Zoom Scan (5x5x7)/Cube 0: Measurement grid: dx=8mm, dy=8mm, dz=5mm

Reference Value = 23.61 V/m; Power Drift = 0.07 dB

Peak SAR (extrapolated) = 0.658 W/kg

SAR(1 g) = 0.477 W/kg; SAR(10 g) = 0.336 W/kg

Maximum value of SAR (measured) = 0.544 W/kg

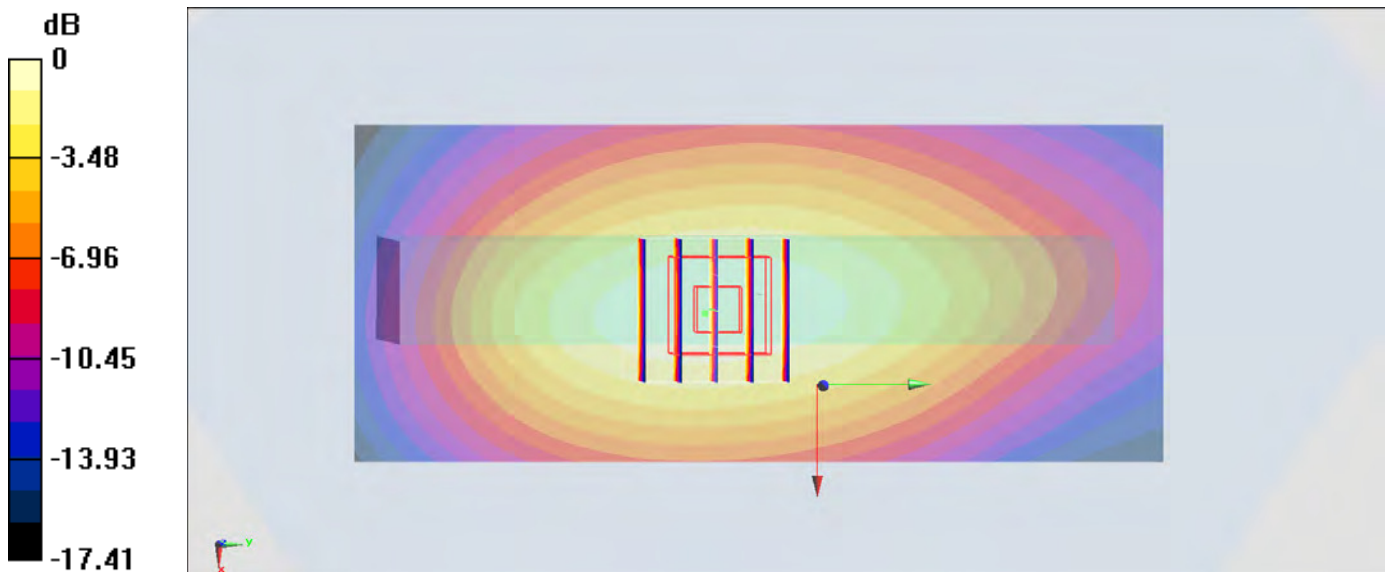

0 dB = 0.539 W/kg = -2.68 dBW/kg

#24_CDMA BC1_RTAP 153.6Kbps_Bottom Side_10mm_Ch600

Communication System: CDMA; Frequency: 1880 MHz; Duty Cycle: 1:1

Medium: MSL_1900_160905 Medium parameters used: $f = 1880$ MHz; $\sigma = 1.527$ S/m; $\epsilon_r = 55.846$; $\rho = 1000$ kg/m³

Ambient Temperature : 23.7 °C ; Liquid Temperature : 22.7 °C

DASY5 Configuration:

- Probe: EX3DV4 - SN3955; ConvF(7.89, 7.89, 7.89); Calibrated: 2015/11/24;
- Sensor-Surface: 1.4mm (Mechanical Surface Detection)
- Electronics: DAE4 Sn778; Calibrated: 2016/5/12
- Phantom: SAM_Left; Type: QD000P40CD; Serial: TP:1644
- Measurement SW: DASY52, Version 52.8 (8); SEMCAD X Version 14.6.10 (7373)

Area Scan (41x71x1): Interpolated grid: dx=1.500 mm, dy=1.500 mm

Maximum value of SAR (interpolated) = 1.56 W/kg

Zoom Scan (5x5x7)/Cube 0: Measurement grid: dx=8mm, dy=8mm, dz=5mm

Reference Value = 23.81 V/m; Power Drift = 0.01 dB

Peak SAR (extrapolated) = 1.59 W/kg

SAR(1 g) = 0.966 W/kg; SAR(10 g) = 0.543 W/kg

Maximum value of SAR (measured) = 1.38 W/kg

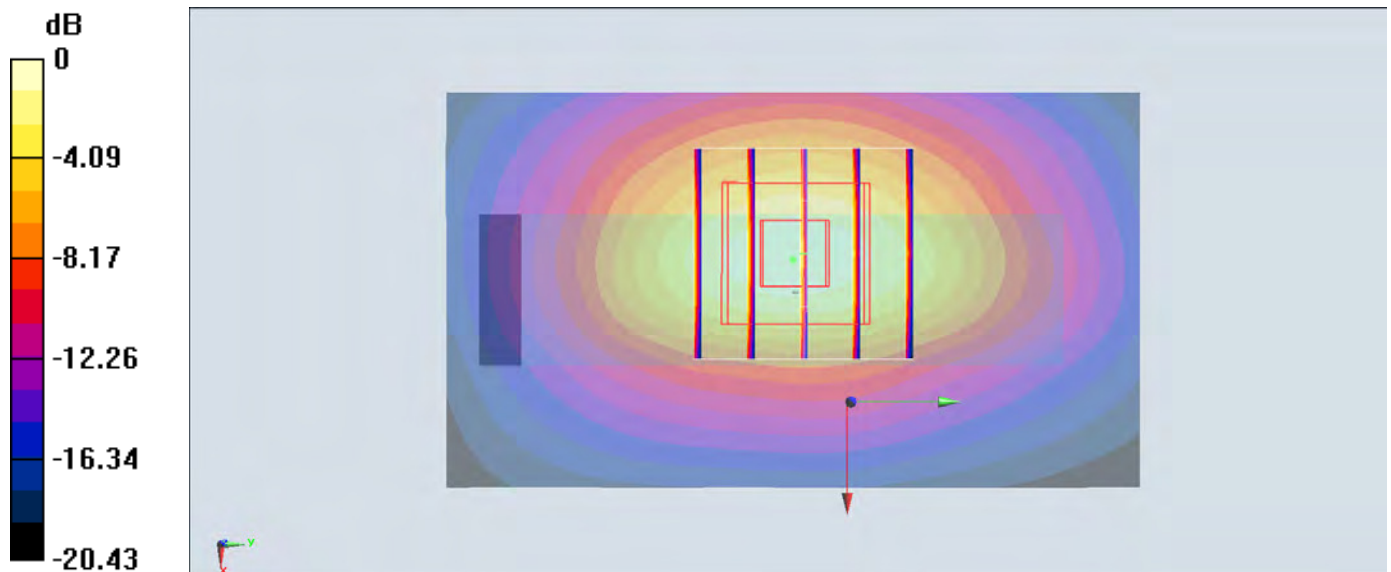

0 dB = 1.56 W/kg = 1.93 dBW/kg

#25_CDMA BC10_RTAP 153.6Kbps_Right Side_10mm_Ch580

Communication System: CDMA; Frequency: 820.5 MHz; Duty Cycle: 1:1

Medium: MSL_850_160908 Medium parameters used: $f = 820.5$ MHz; $\sigma = 0.949$ S/m; $\epsilon_r = 57.168$; $\rho = 1000$ kg/m³

Ambient Temperature : 23.5 °C ; Liquid Temperature : 22.5 °C

DASY5 Configuration:

- Probe: ES3DV3 - SN3270; ConvF(6.01, 6.01, 6.01); Calibrated: 2016/8/26;
- Sensor-Surface: 3mm (Mechanical Surface Detection)
- Electronics: DAE4 Sn1399; Calibrated: 2015/11/23
- Phantom: SAM_Left; Type: QD000P40CD; Serial: TP:1644
- Measurement SW: DASY52, Version 52.8 (8); SEMCAD X Version 14.6.10 (7373)

Area Scan (51x121x1): Interpolated grid: dx=1.500 mm, dy=1.500 mm

Maximum value of SAR (interpolated) = 0.477 W/kg

Zoom Scan (5x5x7)/Cube 0: Measurement grid: dx=8mm, dy=8mm, dz=5mm

Reference Value = 22.38 V/m; Power Drift = -0.02 dB

Peak SAR (extrapolated) = 0.573 W/kg

SAR(1 g) = 0.418 W/kg; SAR(10 g) = 0.297 W/kg

Maximum value of SAR (measured) = 0.473 W/kg

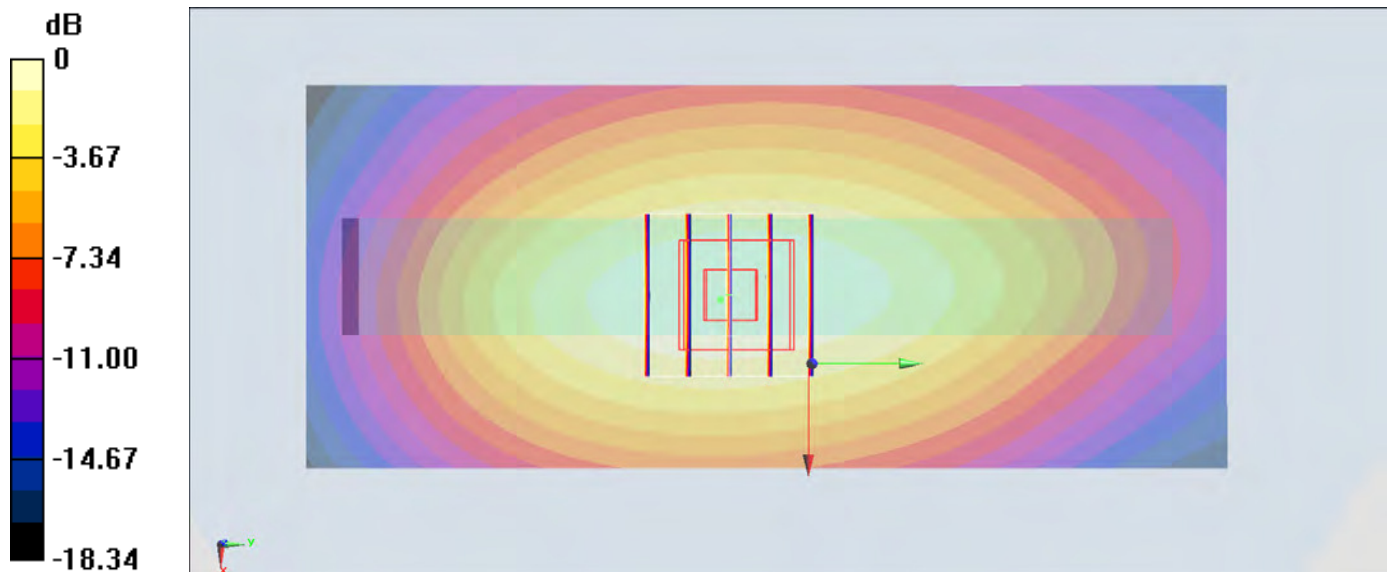

0 dB = 0.477 W/kg = -3.21 dBW/kg

#26_LTE Band 4_20M_QPSK_1_49_Bottom Side_10mm_Ch20175

Communication System: LTE; Frequency: 1732.5 MHz; Duty Cycle: 1:1

Medium: MSL_1750_160906 Medium parameters used: $f = 1732.5$ MHz; $\sigma = 1.491$ S/m; $\epsilon_r = 55.989$;

$\rho = 1000$ kg/m³

Ambient Temperature : 23.7 °C ; Liquid Temperature : 22.7 °C

DASY5 Configuration:

- Probe: EX3DV4 - SN3955; ConvF(8.25, 8.25, 8.25); Calibrated: 2015/11/24;
- Sensor-Surface: 1.4mm (Mechanical Surface Detection)
- Electronics: DAE4 Sn778; Calibrated: 2016/5/12
- Phantom: SAM_Left; Type: QD000P40CD; Serial: TP:1644
- Measurement SW: DASY52, Version 52.8 (8); SEMCAD X Version 14.6.10 (7373)

Area Scan (41x71x1): Interpolated grid: dx=1.500 mm, dy=1.500 mm

Maximum value of SAR (interpolated) = 1.67 W/kg

Zoom Scan (5x5x7)/Cube 0: Measurement grid: dx=8mm, dy=8mm, dz=5mm

Reference Value = 25.59 V/m; Power Drift = 0.09 dB

Peak SAR (extrapolated) = 1.65 W/kg

SAR(1 g) = 1.04 W/kg; SAR(10 g) = 0.602 W/kg

Maximum value of SAR (measured) = 1.44 W/kg

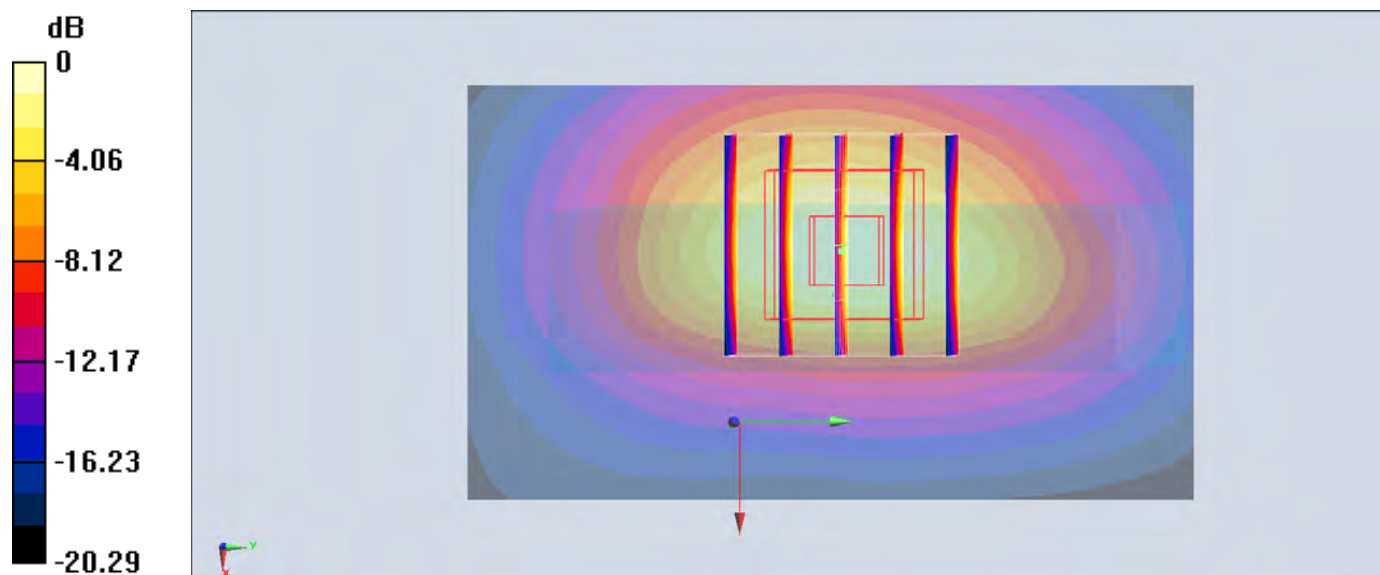

0 dB = 1.67 W/kg = 2.23 dBW/kg

#27_LTE Band 12_10M_QPSK_1_0_Right Side_10mm_Ch23095

Communication System: LTE; Frequency: 707.5 MHz; Duty Cycle: 1:1

Medium: MSL_750_160909 Medium parameters used: $f = 707.5$ MHz; $\sigma = 0.914$ S/m; $\epsilon_r = 56.151$; $\rho = 1000$ kg/m³

Ambient Temperature : 23.5 °C ; Liquid Temperature : 22.5 °C

DASY5 Configuration:

- Probe: ES3DV3 - SN3270; ConvF(6.09, 6.09, 6.09); Calibrated: 2016/8/26;
- Sensor-Surface: 3mm (Mechanical Surface Detection)
- Electronics: DAE4 Sn1399; Calibrated: 2015/11/23
- Phantom: SAM_Left; Type: QD000P40CD; Serial: TP:1644
- Measurement SW: DASY52, Version 52.8 (8); SEMCAD X Version 14.6.10 (7373)

Area Scan (51x131x1): Interpolated grid: dx=1.500 mm, dy=1.500 mm

Maximum value of SAR (interpolated) = 0.444 W/kg

Zoom Scan (5x5x7)/Cube 0: Measurement grid: dx=8mm, dy=8mm, dz=5mm

Reference Value = 22.04 V/m; Power Drift = -0.02 dB

Peak SAR (extrapolated) = 0.526 W/kg

SAR(1 g) = 0.381 W/kg; SAR(10 g) = 0.273 W/kg

Maximum value of SAR (measured) = 0.430 W/kg

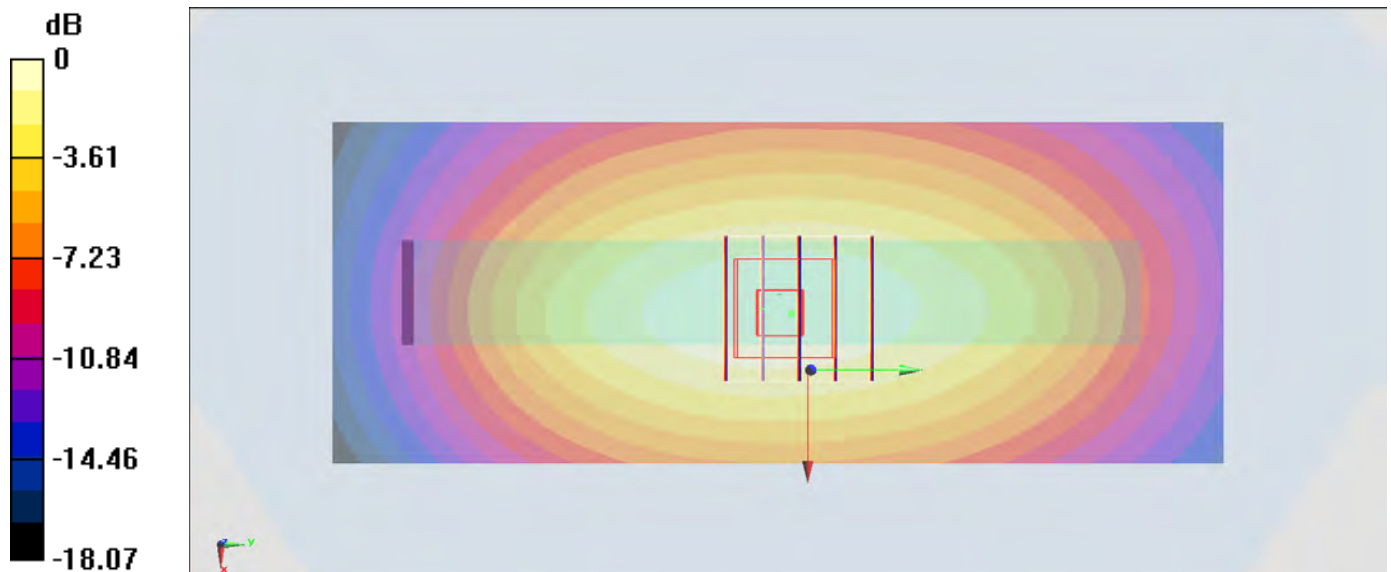

0 dB = 0.444 W/kg = -3.53 dBW/kg

#28_LTE Band 13_10M_QPSK_1_25_Right Side_10mm_Ch23230

Communication System: LTE; Frequency: 782 MHz; Duty Cycle: 1:1

Medium: MSL_750_160909 Medium parameters used: $f = 782 \text{ MHz}$; $\sigma = 0.983 \text{ S/m}$; $\epsilon_r = 55.502$; $\rho = 1000 \text{ kg/m}^3$

Ambient Temperature : $23.5 \text{ }^\circ\text{C}$; Liquid Temperature : $22.5 \text{ }^\circ\text{C}$

DASY5 Configuration:

- Probe: EX3DV4 - SN3955; ConvF(10.36, 10.36, 10.36); Calibrated: 2015/11/24;
- Sensor-Surface: 1.4mm (Mechanical Surface Detection)
- Electronics: DAE4 Sn778; Calibrated: 2016/5/12
- Phantom: SAM_Left; Type: QD000P40CD; Serial: TP:1644
- Measurement SW: DASY52, Version 52.8 (8); SEMCAD X Version 14.6.10 (7373)

Area Scan (51x131x1): Interpolated grid: $dx=1.500 \text{ mm}$, $dy=1.500 \text{ mm}$

Maximum value of SAR (interpolated) = 0.500 W/kg

Zoom Scan (5x5x7)/Cube 0: Measurement grid: $dx=8\text{mm}$, $dy=8\text{mm}$, $dz=5\text{mm}$

Reference Value = 22.72 V/m ; Power Drift = -0.13 dB

Peak SAR (extrapolated) = 0.558 W/kg

SAR(1 g) = 0.387 W/kg ; SAR(10 g) = 0.272 W/kg

Maximum value of SAR (measured) = 0.497 W/kg

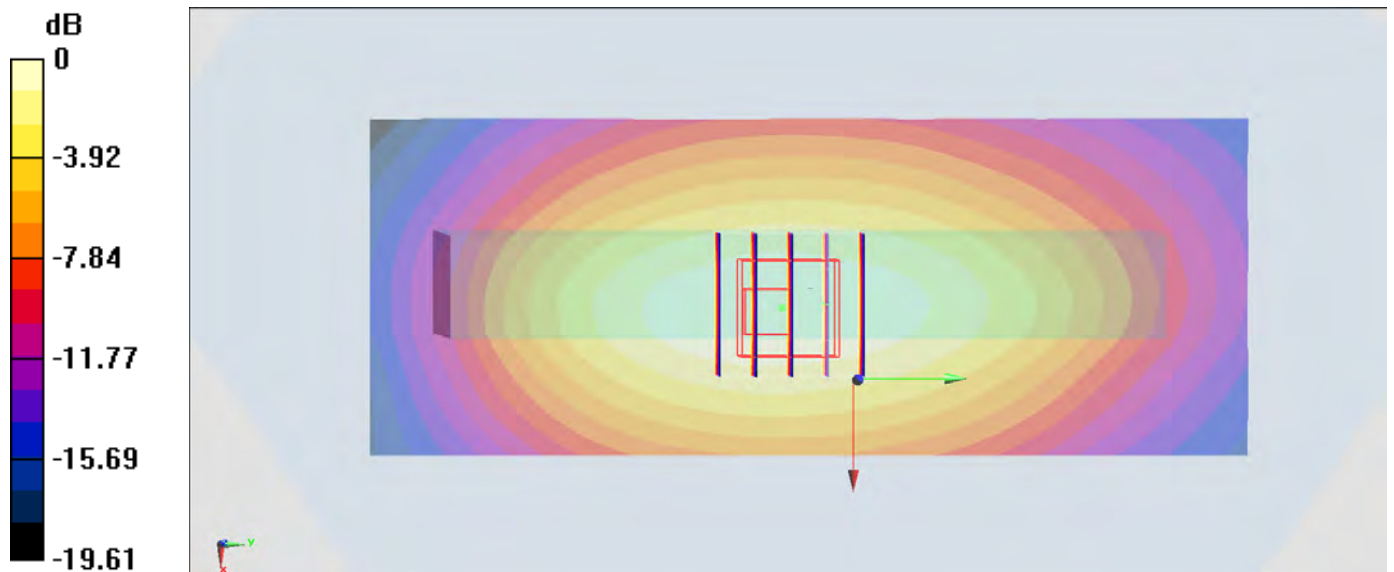

0 dB = 0.500 W/kg = -3.01 dBW/kg

#29_LTE Band 25_20M_QPSK_1_49_Bottom Side_10mm_Ch26340

Communication System: LTE; Frequency: 1880 MHz; Duty Cycle: 1:1

Medium: MSL_1900_160905 Medium parameters used: $f = 1880$ MHz; $\sigma = 1.527$ S/m; $\epsilon_r = 55.846$; $\rho = 1000$ kg/m³

Ambient Temperature : 23.7 °C ; Liquid Temperature : 22.7 °C

DASY5 Configuration:

- Probe: EX3DV4 - SN3955; ConvF(7.89, 7.89, 7.89); Calibrated: 2015/11/24;
- Sensor-Surface: 1.4mm (Mechanical Surface Detection)
- Electronics: DAE4 Sn778; Calibrated: 2016/5/12
- Phantom: SAM_Left; Type: QD000P40CD; Serial: TP:1644
- Measurement SW: DASY52, Version 52.8 (8); SEMCAD X Version 14.6.10 (7373)

Area Scan (41x71x1): Interpolated grid: dx=1.500 mm, dy=1.500 mm

Maximum value of SAR (interpolated) = 1.40 W/kg

Zoom Scan (5x5x7)/Cube 0: Measurement grid: dx=8mm, dy=8mm, dz=5mm

Reference Value = 22.83 V/m; Power Drift = -0.02 dB

Peak SAR (extrapolated) = 1.43 W/kg

SAR(1 g) = 0.867 W/kg; SAR(10 g) = 0.488 W/kg

Maximum value of SAR (measured) = 1.23 W/kg

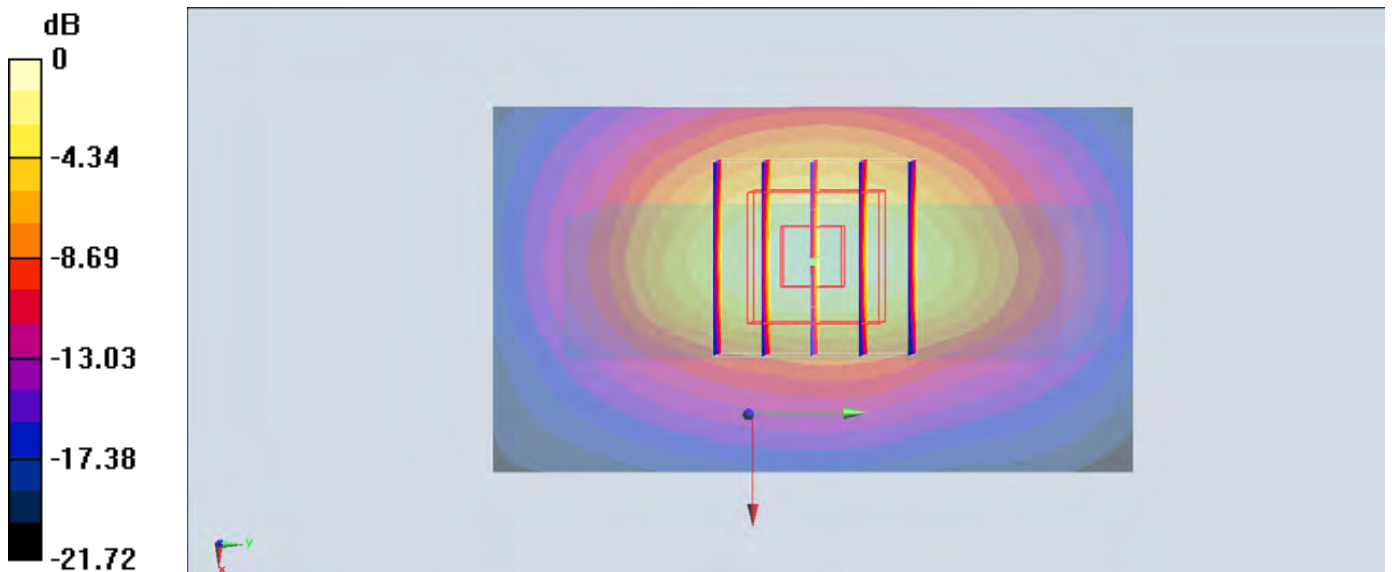

0 dB = 1.40 W/kg = 1.46 dBW/kg

#30_LTE Band 26_15M_QPSK_1_37_Right Side_10mm_Ch26865

Communication System: LTE ; Frequency: 831.5 MHz;Duty Cycle: 1:1

Medium: MSL_850_160907 Medium parameters used : $f = 831.5$ MHz; $\sigma = 0.965$ S/m; $\epsilon_r = 57.187$; $\rho = 1000$ kg/m³

Ambient Temperature : 23.4 °C ; Liquid Temperature : 22.4 °C

DASY5 Configuration:

- Probe: EX3DV4 - SN3955; ConvF(10.08, 10.08, 10.08); Calibrated: 2015/11/24;
- Sensor-Surface: 1.4mm (Mechanical Surface Detection)
- Electronics: DAE4 Sn778; Calibrated: 2016/5/12
- Phantom: SAM_Left; Type: QD000P40CD; Serial: TP:1644
- Measurement SW: DASY52, Version 52.8 (8);SEMCAD X Version 14.6.10 (7373)

Area Scan (41x131x1): Interpolated grid: dx=1.500 mm, dy=1.500 mm

Maximum value of SAR (interpolated) = 0.482 W/kg

Zoom Scan (5x5x7)/Cube 0: Measurement grid: dx=8mm, dy=8mm, dz=5mm

Reference Value = 23.07 V/m; Power Drift = -0.09 dB

Peak SAR (extrapolated) = 0.542 W/kg

SAR(1 g) = 0.382 W/kg; SAR(10 g) = 0.274 W/kg

Maximum value of SAR (measured) = 0.484 W/kg

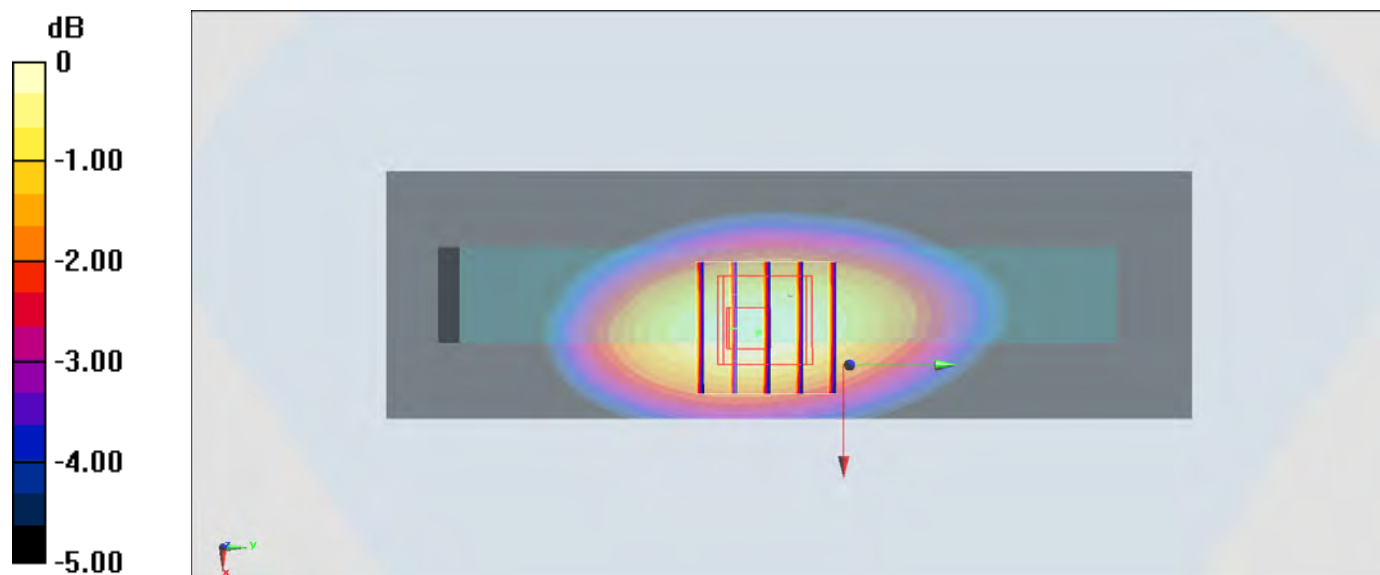

0 dB = 0.482 W/kg = -3.17 dBW/kg

#31_WLAN2.4GHz_802.11b 1Mbps_Right Side_10mm_Ch6;Ant 2

Communication System: 802.11b ; Frequency: 2437 MHz;Duty Cycle: 1:1.014

Medium: MSL_2450_160908 Medium parameters used: $f = 2437$ MHz; $\sigma = 1.965$ S/m; $\epsilon_r = 52.622$; $\rho = 1000$ kg/m³

Ambient Temperature : 23.6 °C ; Liquid Temperature : 22.6 °C

DASY5 Configuration:

- Probe: EX3DV4 - SN3697; ConvF(6.9, 6.9, 6.9); Calibrated: 2015/9/28;
- Sensor-Surface: 1.4mm (Mechanical Surface Detection)
- Electronics: DAE4 Sn1388; Calibrated: 2015/9/25
- Phantom: SAM_Right; Type: QD000P40CD; Serial: TP:1383
- Measurement SW: DASY52, Version 52.8 (8);SEMCAD X Version 14.6.10 (7331)

Area Scan (51x151x1): Interpolated grid: dx=1.200 mm, dy=1.200 mm

Maximum value of SAR (interpolated) = 0.434 W/kg

Zoom Scan (7x7x7)/Cube 0: Measurement grid: dx=5mm, dy=5mm, dz=5mm

Reference Value = 6.590 V/m; Power Drift = -0.11 dB

Peak SAR (extrapolated) = 0.547 W/kg

SAR(1 g) = 0.297 W/kg; SAR(10 g) = 0.162 W/kg

Maximum value of SAR (measured) = 0.453 W/kg

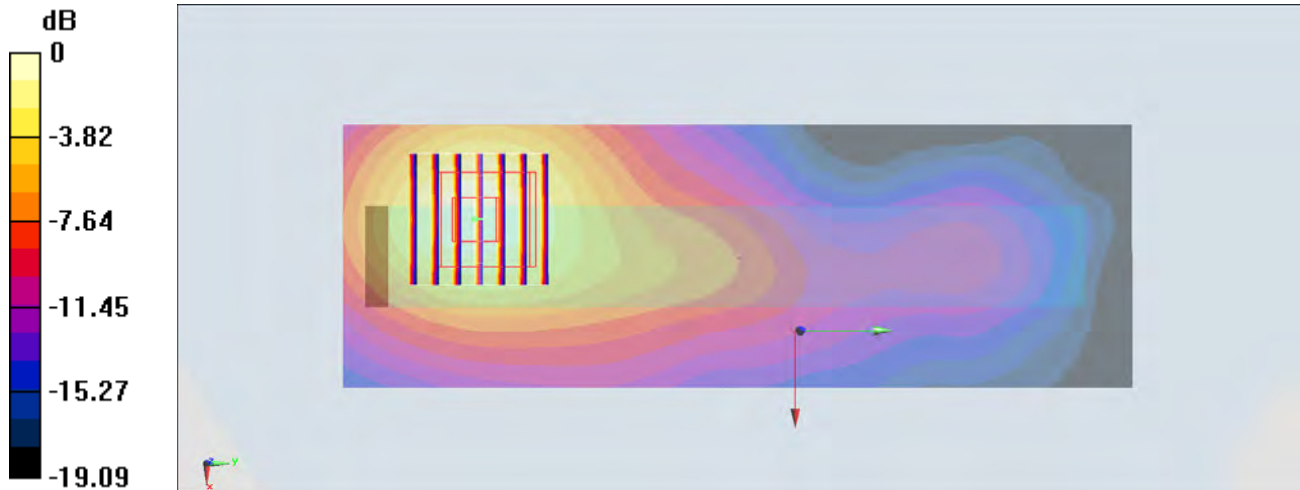

0 dB = 0.453 W/kg = -3.44 dBW/kg

#32_WLAN5GHz_802.11a 6Mbps_Back_10mm_Ch44;Ant 2

Communication System: 802.11a; Frequency: 5220 MHz; Duty Cycle: 1:1.077

Medium: MSL_5G_160913 Medium parameters used: $f = 5220 \text{ MHz}$; $\sigma = 5.43 \text{ mho/m}$; $\epsilon_r = 46.8$; $\rho = 1000 \text{ kg/m}^3$

Ambient Temperature : $23.5 \text{ }^\circ\text{C}$; Liquid Temperature : $22.5 \text{ }^\circ\text{C}$

DASY4 Configuration:

- Probe: EX3DV4 - SN3931; ConvF(4.48, 4.48, 4.48); Calibrated: 2015/10/1
- Sensor-Surface: 1.4mm (Mechanical Surface Detection)
- Electronics: DAE3 Sn577; Calibrated: 2015/9/24
- Phantom: SAM_Right; Type: QD000P40CD; Serial: TP:1383
- ;Postprocessing SW: SEMCAD, V1.8 Build 159

Area Scan (121x101x1): Measurement grid: $dx=10\text{mm}$, $dy=10\text{mm}$

Maximum value of SAR (interpolated) = 0.900 mW/g

Zoom Scan (7x7x7)/Cube 0: Measurement grid: $dx=4\text{mm}$, $dy=4\text{mm}$, $dz=1.4\text{mm}$

Reference Value = 7.96 V/m ; Power Drift = -0.031 dB

Peak SAR (extrapolated) = 1.37 W/kg

SAR(1 g) = 0.429 mW/g ; SAR(10 g) = 0.178 mW/g

Maximum value of SAR (measured) = 0.895 mW/g

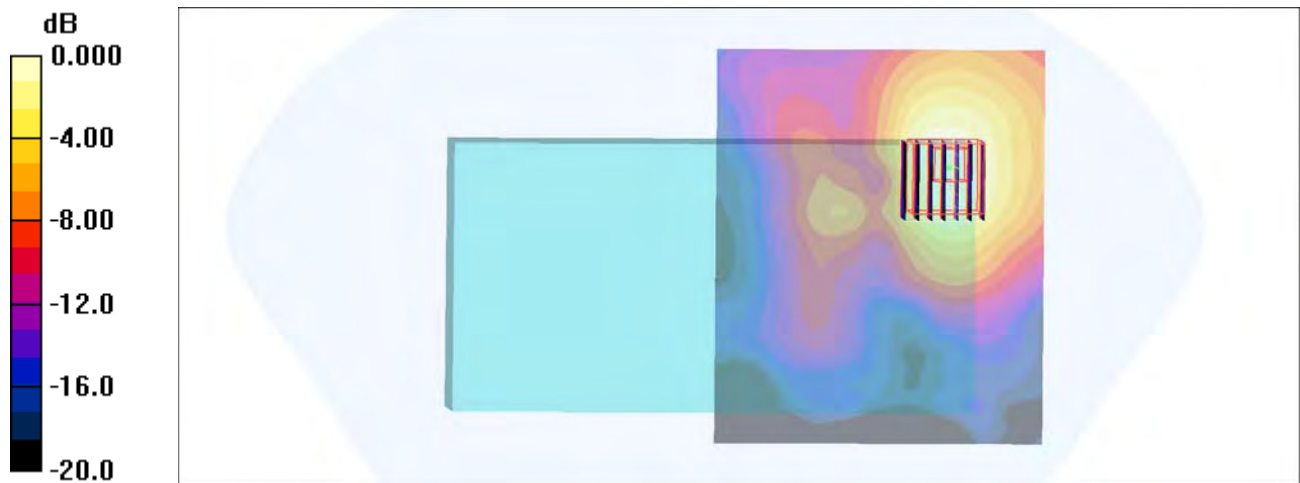

0 dB = 0.895mW/g

#33_WLAN5GHz_802.11a 6Mbps_Back_10mm_Ch165;Ant 2

Communication System: 802.11a; Frequency: 5825 MHz; Duty Cycle: 1:1.077

Medium: MSL_5G_160912 Medium parameters used: $f = 5825$ MHz; $\sigma = 6.23$ S/m; $\epsilon_r = 45.864$; $\rho = 1000$ kg/m³

Ambient Temperature : 23.5 °C ; Liquid Temperature : 22.5 °C

DASY5 Configuration:

- Probe: EX3DV4 - SN3931; ConvF(3.98, 3.98, 3.98); Calibrated: 2015/10/1;
- Sensor-Surface: 1.4mm (Mechanical Surface Detection)
- Electronics: DAE3 Sn577; Calibrated: 2015/9/24
- Phantom: SAM-Right; Type: SAM; Serial: 1795
- Measurement SW: DASY52, Version 52.8 (8); SEMCAD X Version 14.6.10 (7373)

Area Scan (111x101x1): Interpolated grid: dx=1.000 mm, dy=1.000 mm

Maximum value of SAR (interpolated) = 1.10 W/kg

Zoom Scan (7x7x7)/Cube 0: Measurement grid: dx=4mm, dy=4mm, dz=1.4mm

Reference Value = 13.68 V/m; Power Drift = -0.12 dB

Peak SAR (extrapolated) = 1.82 W/kg

SAR(1 g) = 0.485 W/kg; SAR(10 g) = 0.191 W/kg

Maximum value of SAR (measured) = 1.11 W/kg

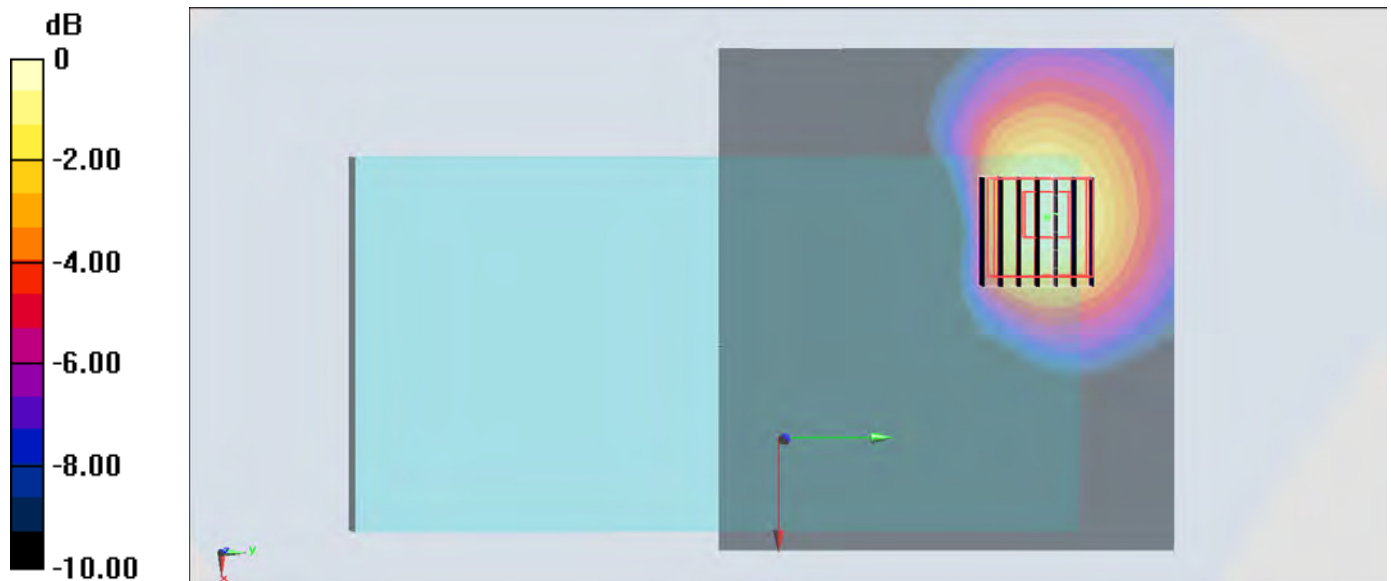

0 dB = 1.10 W/kg = 0.41 dBW/kg

#34_GSM850_GPRS (4 Tx slots)_Front_0mm_Ch189;Soft Holster

Communication System: GSM850; Frequency: 836.4 MHz; Duty Cycle: 1:2.08

Medium: MSL_850_160908 Medium parameters used: $f = 836.4$ MHz; $\sigma = 0.963$ S/m; $\epsilon_r = 57.048$; $\rho = 1000$ kg/m³

Ambient Temperature : 23.5 °C; Liquid Temperature : 22.5 °C

DASY5 Configuration:

- Probe: EX3DV4 - SN3955; ConvF(10.08, 10.08, 10.08); Calibrated: 2015/11/24;
- Sensor-Surface: 1.4mm (Mechanical Surface Detection)
- Electronics: DAE4 Sn778; Calibrated: 2016/5/12
- Phantom: SAM_Left; Type: QD000P40CD; Serial: TP:1644
- Measurement SW: DASY52, Version 52.8 (8); SEMCAD X Version 14.6.10 (7373)

Area Scan (71x71x1): Interpolated grid: dx=1.500 mm, dy=1.500 mm

Maximum value of SAR (interpolated) = 1.36 W/kg

Zoom Scan (5x5x7)/Cube 0: Measurement grid: dx=8mm, dy=8mm, dz=5mm

Reference Value = 39.25 V/m; Power Drift = -0.10 dB

Peak SAR (extrapolated) = 1.70 W/kg

SAR(1 g) = 1.02 W/kg; SAR(10 g) = 0.619 W/kg

Maximum value of SAR (measured) = 1.34 W/kg

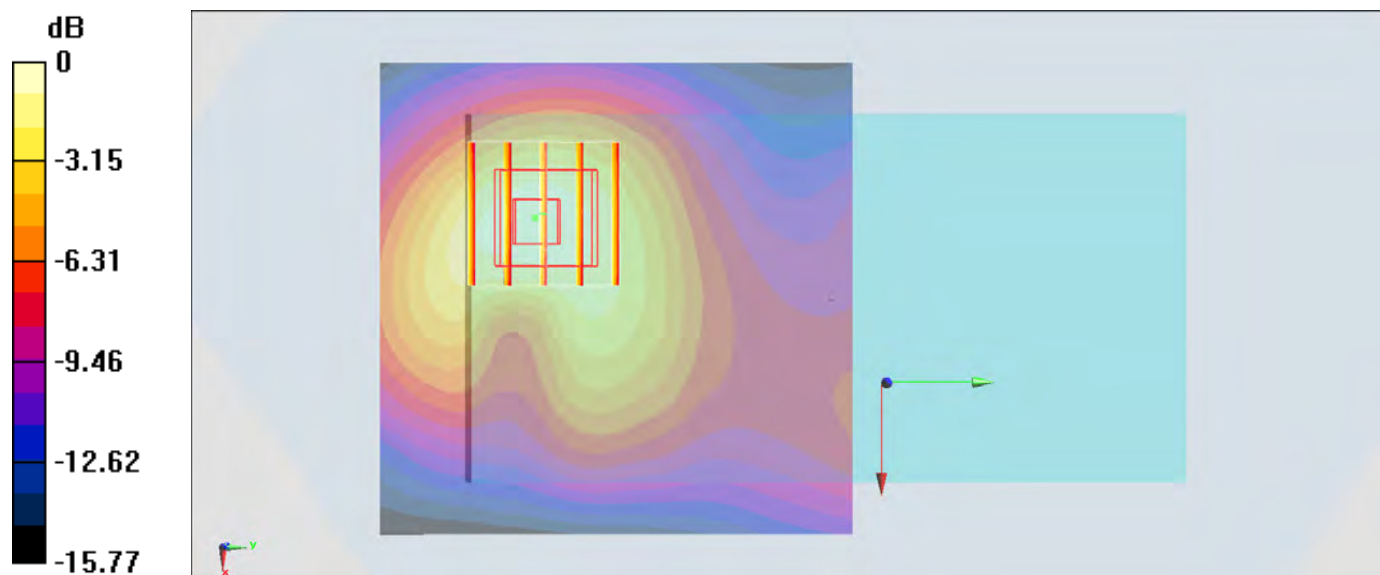

0 dB = 1.36 W/kg = 1.34 dBW/kg

#35_GSM1900_GPRS (3 Tx slots)_Back_15mm_Ch512

Communication System: PCS; Frequency: 1850.2 MHz; Duty Cycle: 1:2.77

Medium: MSL_1900_160905 Medium parameters used : $f = 1850.2$ MHz; $\sigma = 1.492$ S/m; $\epsilon_r = 55.907$; $\rho = 1000$ kg/m³

Ambient Temperature : 23.7 °C; Liquid Temperature : 22.7 °C

DASY5 Configuration:

- Probe: EX3DV4 - SN3955; ConvF(7.89, 7.89, 7.89); Calibrated: 2015/11/24;
- Sensor-Surface: 1.4mm (Mechanical Surface Detection)
- Electronics: DAE4 Sn778; Calibrated: 2016/5/12
- Phantom: SAM_Left; Type: QD000P40CD; Serial: TP:1644
- Measurement SW: DASY52, Version 52.8 (8); SEMCAD X Version 14.6.10 (7373)

Area Scan (71x131x1): Interpolated grid: dx=1.500 mm, dy=1.500 mm

Maximum value of SAR (interpolated) = 1.56 W/kg

Zoom Scan (5x5x7)/Cube 0: Measurement grid: dx=8mm, dy=8mm, dz=5mm

Reference Value = 21.40 V/m; Power Drift = -0.04 dB

Peak SAR (extrapolated) = 1.70 W/kg

SAR(1 g) = 1.1 W/kg; SAR(10 g) = 0.668 W/kg

Maximum value of SAR (measured) = 1.48 W/kg

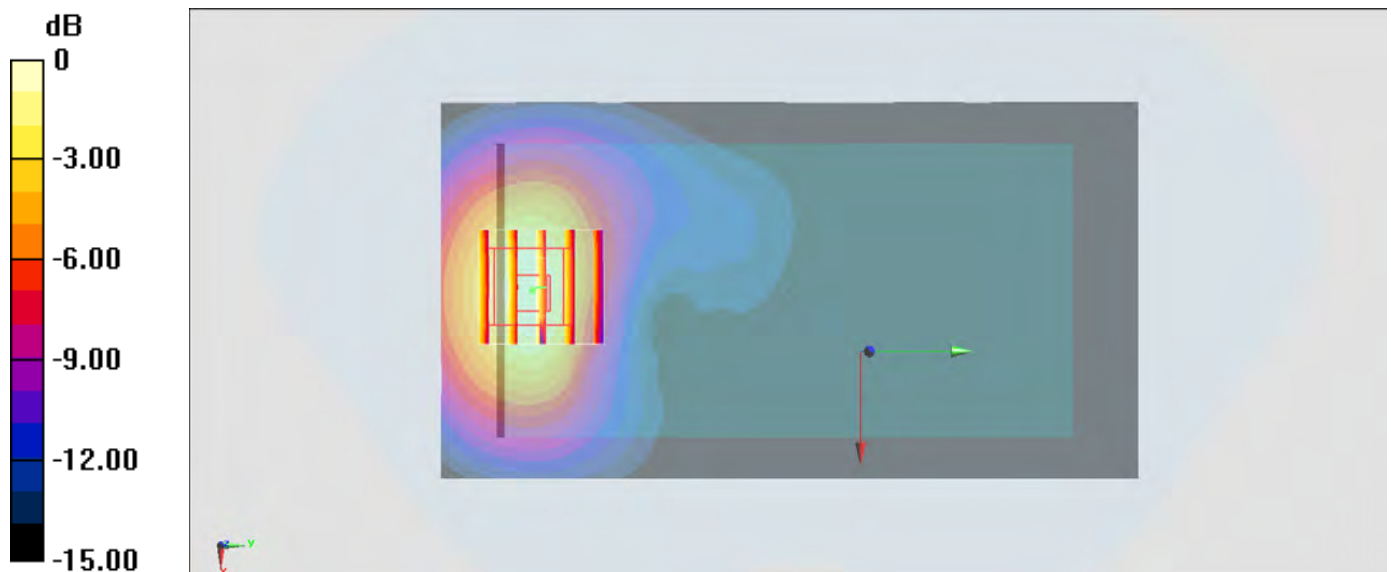

0 dB = 1.56 W/kg = 1.93 dBW/kg

#36_WCDMA II_RMC 12.2Kbps_Back_15mm_Ch9400

Communication System: WCDMA ; Frequency: 1880 MHz; Duty Cycle: 1:1

Medium: MSL_1900_160907 Medium parameters used: $f = 1880$ MHz; $\sigma = 1.52$ S/m; $\epsilon_r = 55.812$; $\rho = 1000$ kg/m³

Ambient Temperature : 23.4 °C ; Liquid Temperature : 22.4 °C

DASY5 Configuration:

- Probe: EX3DV4 - SN3955; ConvF(7.89, 7.89, 7.89); Calibrated: 2015/11/24;
- Sensor-Surface: 1.4mm (Mechanical Surface Detection)
- Electronics: DAE4 Sn778; Calibrated: 2016/5/12
- Phantom: SAM_Left; Type: QD000P40CD; Serial: TP:1644
- Measurement SW: DASY52, Version 52.8 (8); SEMCAD X Version 14.6.10 (7373)

Area Scan (71x71x1): Interpolated grid: dx=1.500 mm, dy=1.500 mm

Maximum value of SAR (interpolated) = 1.29 W/kg

Zoom Scan (5x5x7)/Cube 0: Measurement grid: dx=8mm, dy=8mm, dz=5mm

Reference Value = 24.44 V/m; Power Drift = -0.03 dB

Peak SAR (extrapolated) = 1.41 W/kg

SAR(1 g) = **0.895 W/kg**; SAR(10 g) = **0.539 W/kg**

Maximum value of SAR (measured) = 1.23 W/kg

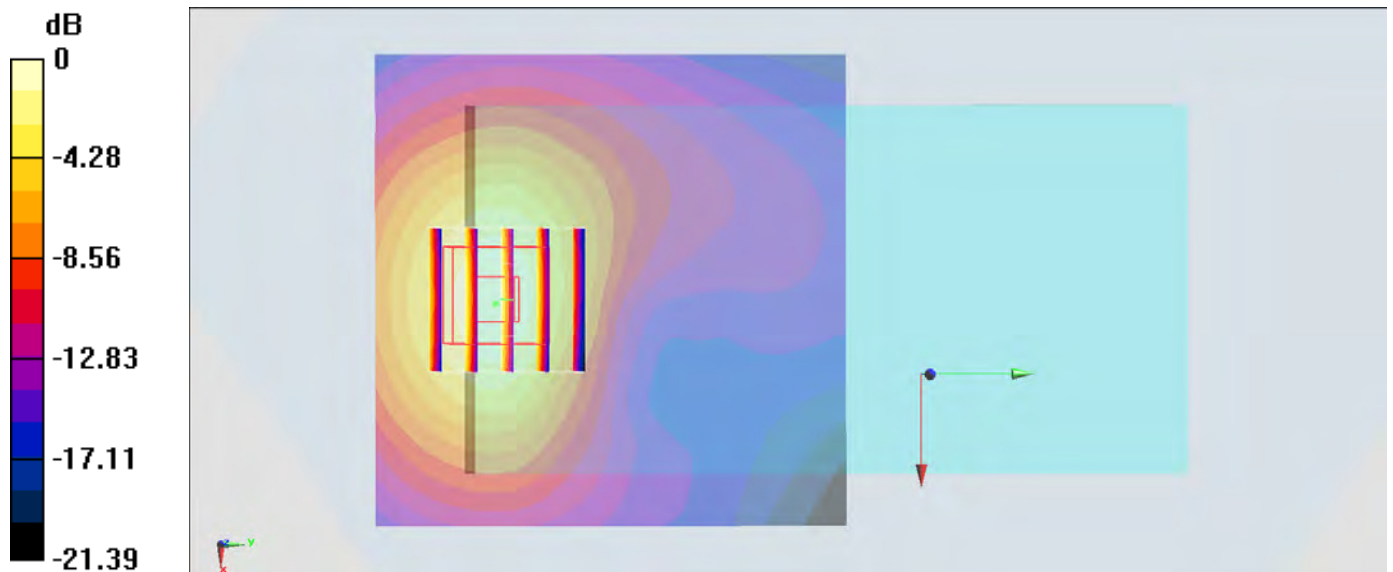

0 dB = 1.29 W/kg = 1.11 dBW/kg

#37_WCDMA IV_RMC 12.2Kbps_Back_15mm_Ch1413

Communication System: WCDMA ; Frequency: 1732.6 MHz; Duty Cycle: 1:1

Medium: MSL_1750_160906 Medium parameters used: $f = 1733 \text{ MHz}$; $\sigma = 1.492 \text{ S/m}$; $\epsilon_r = 55.987$; $\rho = 1000 \text{ kg/m}^3$

Ambient Temperature : $23.7 \text{ }^\circ\text{C}$; Liquid Temperature : $22.7 \text{ }^\circ\text{C}$

DASY5 Configuration:

- Probe: EX3DV4 - SN3955; ConvF(8.25, 8.25, 8.25); Calibrated: 2015/11/24;
- Sensor-Surface: 1.4mm (Mechanical Surface Detection)
- Electronics: DAE4 Sn778; Calibrated: 2016/5/12
- Phantom: SAM_Left; Type: QD000P40CD; Serial: TP:1644
- Measurement SW: DASY52, Version 52.8 (8); SEMCAD X Version 14.6.10 (7373)

Area Scan (71x71x1): Interpolated grid: $dx=1.500 \text{ mm}$, $dy=1.500 \text{ mm}$

Maximum value of SAR (interpolated) = 1.31 W/kg

Zoom Scan (5x5x7)/Cube 0: Measurement grid: $dx=8\text{mm}$, $dy=8\text{mm}$, $dz=5\text{mm}$

Reference Value = 24.59 V/m ; Power Drift = -0.06 dB

Peak SAR (extrapolated) = 1.39 W/kg

SAR(1 g) = 0.926 W/kg ; SAR(10 g) = 0.568 W/kg

Maximum value of SAR (measured) = 1.23 W/kg

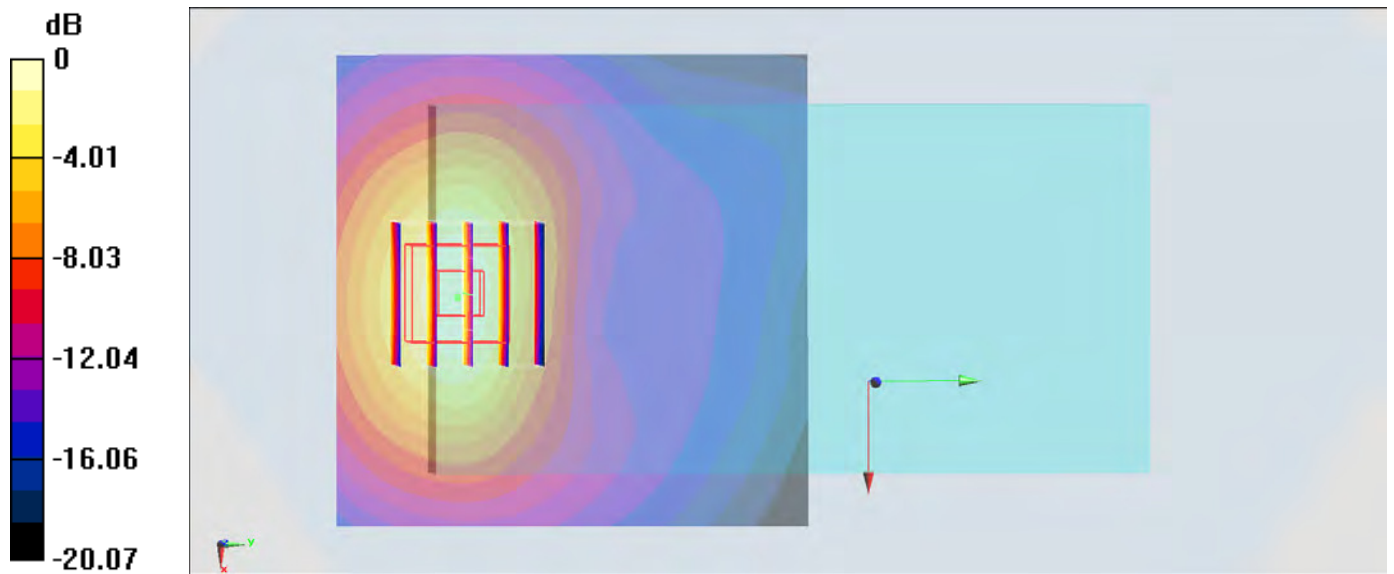

0 dB = $1.31 \text{ W/kg} = 1.17 \text{ dBW/kg}$

#38_WCDMA V_RMC 12.2Kbps_Front_0mm_Ch4233;Soft Holster

Communication System: WCDMA; Frequency: 846.6 MHz; Duty Cycle: 1:1

Medium: MSL_850_160908 Medium parameters used: $f = 847$ MHz; $\sigma = 0.974$ S/m; $\epsilon_r = 56.946$; $\rho = 1000$ kg/m³

Ambient Temperature : 23.5 °C; Liquid Temperature : 22.5 °C

DASY5 Configuration:

- Probe: EX3DV4 - SN3955; ConvF(10.08, 10.08, 10.08); Calibrated: 2015/11/24;
- Sensor-Surface: 1.4mm (Mechanical Surface Detection)
- Electronics: DAE4 Sn778; Calibrated: 2016/5/12
- Phantom: SAM_Left; Type: QD000P40CD; Serial: TP:1644
- Measurement SW: DASY52, Version 52.8 (8); SEMCAD X Version 14.6.10 (7373)

Area Scan (71x121x1): Interpolated grid: dx=1.500 mm, dy=1.500 mm

Maximum value of SAR (interpolated) = 0.465 W/kg

Zoom Scan (5x5x7)/Cube 0: Measurement grid: dx=8mm, dy=8mm, dz=5mm

Reference Value = 19.97 V/m; Power Drift = -0.11 dB

Peak SAR (extrapolated) = 0.530 W/kg

SAR(1 g) = 0.335 W/kg; SAR(10 g) = 0.214 W/kg

Maximum value of SAR (measured) = 0.460 W/kg

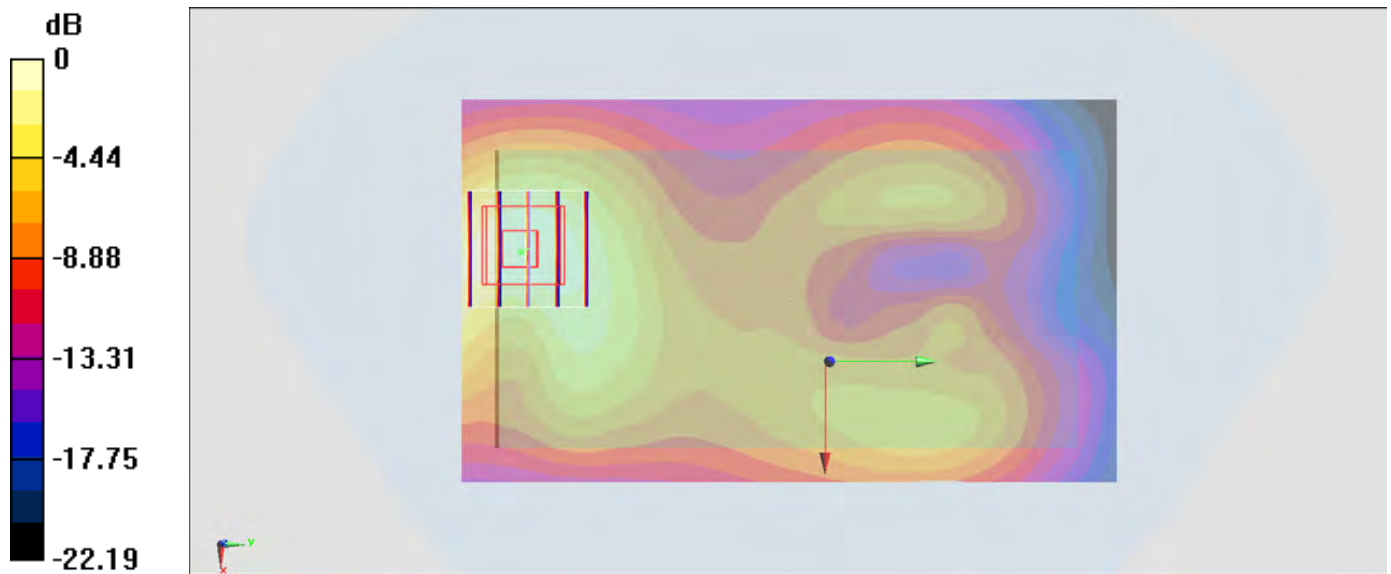

0 dB = 0.465 W/kg = -3.33 dBW/kg

#39_CDMA BC0_1xRTT RC3 SO32_Front_0mm_Ch777;Soft Holster

Communication System: CDMA ; Frequency: 848.31 MHz;Duty Cycle: 1:1

Medium: MSL_850_160908 Medium parameters used : $f = 848.31$ MHz; $\sigma = 0.975$ S/m; $\epsilon_r = 56.935$;

$\rho = 1000$ kg/m³

Ambient Temperature : 23.5 °C ; Liquid Temperature : 22.5 °C

DASY5 Configuration:

- Probe: ES3DV3 - SN3270; ConvF(6.01, 6.01, 6.01); Calibrated: 2016/8/26;
- Sensor-Surface: 3mm (Mechanical Surface Detection)
- Electronics: DAE4 Sn1399; Calibrated: 2015/11/23
- Phantom: SAM_Left; Type: QD000P40CD; Serial: TP:1644
- Measurement SW: DASY52, Version 52.8 (8);SEMCAD X Version 14.6.10 (7373)

Area Scan (71x121x1): Interpolated grid: dx=1.500 mm, dy=1.500 mm

Maximum value of SAR (interpolated) = 0.529 W/kg

Zoom Scan (5x5x7)/Cube 0: Measurement grid: dx=8mm, dy=8mm, dz=5mm

Reference Value = 24.20 V/m; Power Drift = -0.15 dB

Peak SAR (extrapolated) = 0.682 W/kg

SAR(1 g) = 0.436 W/kg; SAR(10 g) = 0.275 W/kg

Maximum value of SAR (measured) = 0.511 W/kg

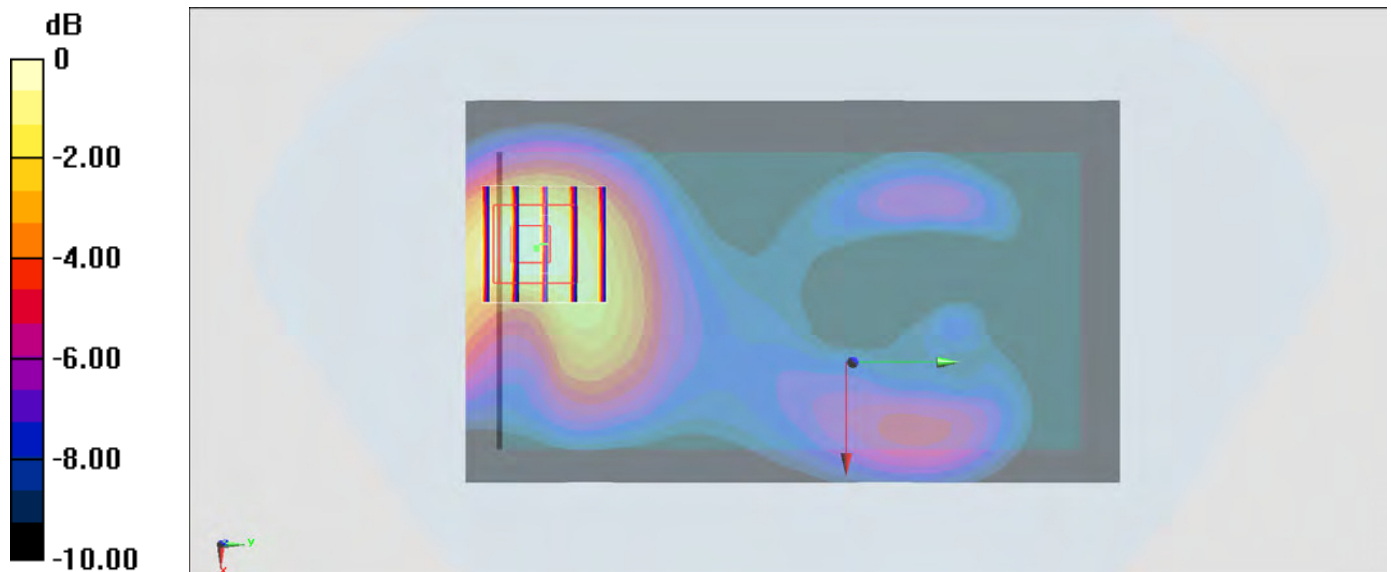

0 dB = 0.529 W/kg = -2.77 dBW/kg

#40_CDMA BC1_1xRTT RC3 SO32_Back_15mm_Ch600

Communication System: CDMA; Frequency: 1880 MHz; Duty Cycle: 1:1

Medium: MSL_1900_160905 Medium parameters used: $f = 1880$ MHz; $\sigma = 1.527$ S/m; $\epsilon_r = 55.846$; $\rho = 1000$ kg/m³

Ambient Temperature : 23.7 °C; Liquid Temperature : 22.7 °C

DASY5 Configuration:

- Probe: EX3DV4 - SN3955; ConvF(7.89, 7.89, 7.89); Calibrated: 2015/11/24;
- Sensor-Surface: 1.4mm (Mechanical Surface Detection)
- Electronics: DAE4 Sn778; Calibrated: 2016/5/12
- Phantom: SAM_Left; Type: QD000P40CD; Serial: TP:1644
- Measurement SW: DASY52, Version 52.8 (8); SEMCAD X Version 14.6.10 (7373)

Area Scan (71x71x1): Interpolated grid: dx=1.500 mm, dy=1.500 mm

Maximum value of SAR (interpolated) = 1.16 W/kg

Zoom Scan (5x5x7)/Cube 0: Measurement grid: dx=8mm, dy=8mm, dz=5mm

Reference Value = 22.15 V/m; Power Drift = -0.13 dB

Peak SAR (extrapolated) = 1.23 W/kg

SAR(1 g) = 0.797 W/kg; SAR(10 g) = 0.485 W/kg

Maximum value of SAR (measured) = 1.07 W/kg

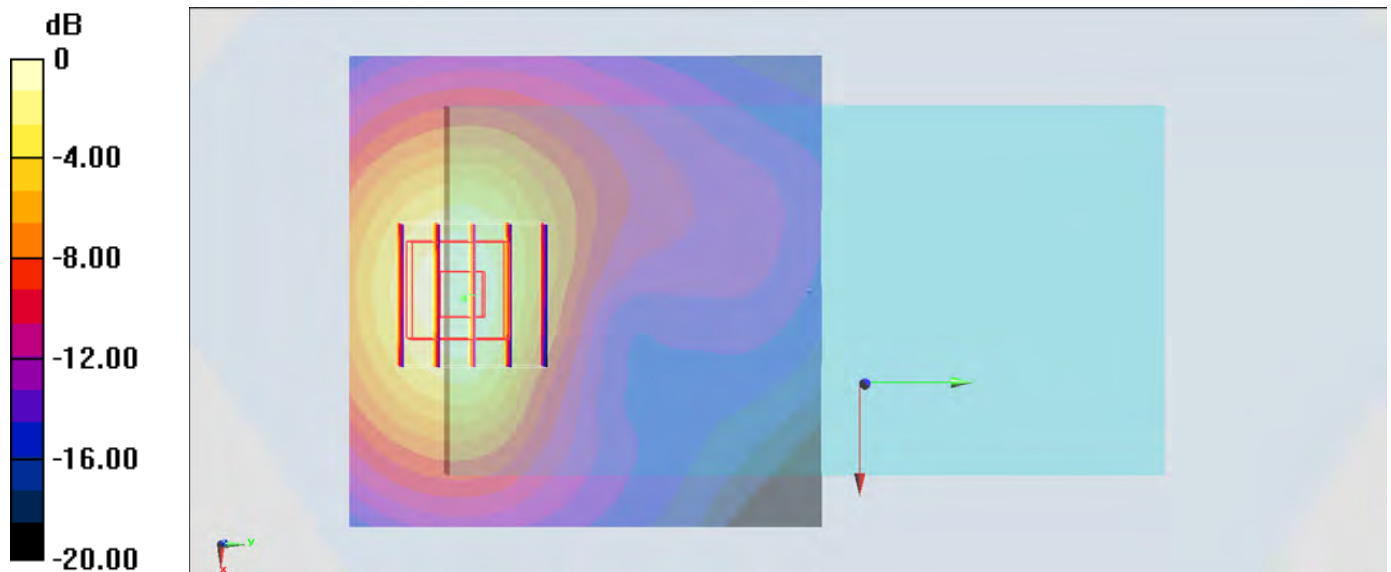

0 dB = 1.16 W/kg = 0.64 dBW/kg

#41_CDMA BC10_1xRTT RC3 SO32_Front_0mm_Ch684;Soft Holster

Communication System: CDMA; Frequency: 823.1 MHz; Duty Cycle: 1:1

Medium: MSL_850_160908 Medium parameters used : $f = 823.1$ MHz; $\sigma = 0.952$ S/m; $\epsilon_r = 57.144$; $\rho = 1000$ kg/m³

Ambient Temperature : 23.5 °C; Liquid Temperature : 22.5 °C

DASY5 Configuration:

- Probe: ES3DV3 - SN3270; ConvF(6.01, 6.01, 6.01); Calibrated: 2016/8/26;
- Sensor-Surface: 3mm (Mechanical Surface Detection)
- Electronics: DAE4 Sn1399; Calibrated: 2015/11/23
- Phantom: SAM_Left; Type: QD000P40CD; Serial: TP:1644
- Measurement SW: DASY52, Version 52.8 (8); SEMCAD X Version 14.6.10 (7373)

Area Scan (71x121x1): Interpolated grid: dx=1.500 mm, dy=1.500 mm

Maximum value of SAR (interpolated) = 0.394 W/kg

Zoom Scan (5x5x7)/Cube 0: Measurement grid: dx=8mm, dy=8mm, dz=5mm

Reference Value = 21.23 V/m; Power Drift = 0.01 dB

Peak SAR (extrapolated) = 0.539 W/kg

SAR(1 g) = 0.340 W/kg; SAR(10 g) = 0.213 W/kg

Maximum value of SAR (measured) = 0.394 W/kg

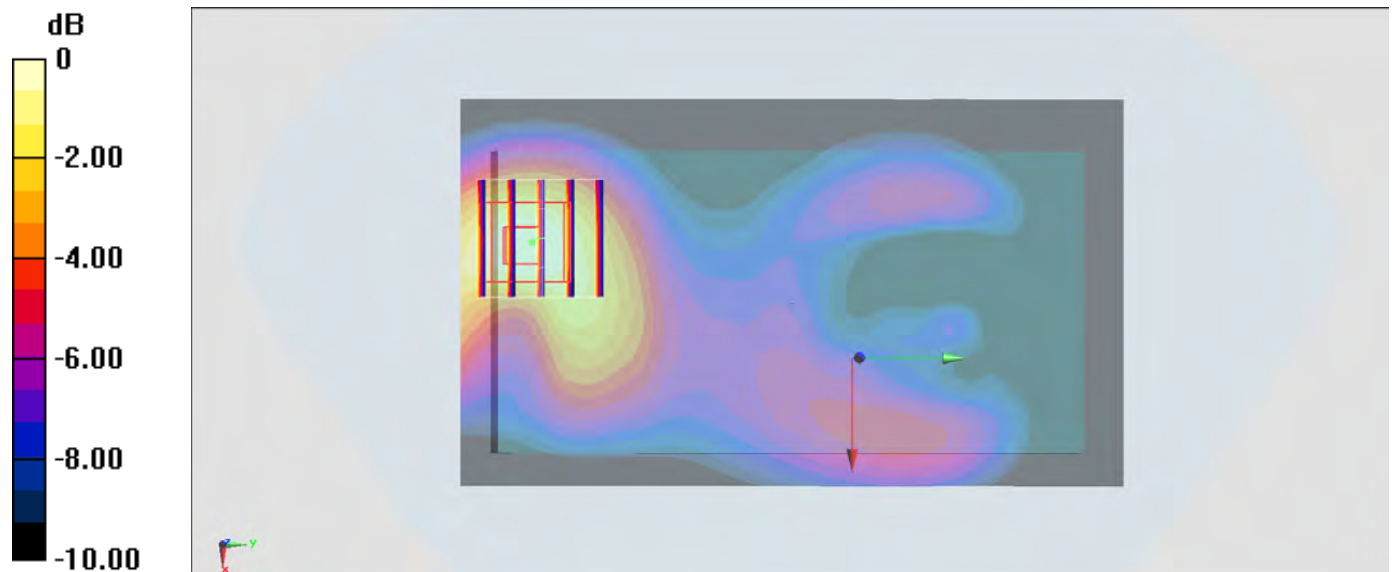

#42_LTE Band 4_20M_QPSK_1_0_Back_15mm_Ch20175

Communication System: LTE; Frequency: 1732.5 MHz; Duty Cycle: 1:1
 Medium: MSL_1750_160906 Medium parameters used: $f = 1732.5$ MHz; $\sigma = 1.491$ S/m; $\epsilon_r = 55.989$;
 $\rho = 1000$ kg/m³
 Ambient Temperature : 23.7 °C; Liquid Temperature : 22.7 °C

DASY5 Configuration:

- Probe: EX3DV4 - SN3955; ConvF(8.25, 8.25, 8.25); Calibrated: 2015/11/24;
- Sensor-Surface: 1.4mm (Mechanical Surface Detection)
- Electronics: DAE4 Sn778; Calibrated: 2016/5/12
- Phantom: SAM_Left; Type: QD000P40CD; Serial: TP:1644
- Measurement SW: DASY52, Version 52.8 (8); SEMCAD X Version 14.6.10 (7373)

Area Scan (71x71x1): Interpolated grid: dx=1.500 mm, dy=1.500 mm
 Maximum value of SAR (interpolated) = 1.00 W/kg

Zoom Scan (5x5x7)/Cube 0: Measurement grid: dx=8mm, dy=8mm, dz=5mm
 Reference Value = 24.45 V/m; Power Drift = -0.09 dB
 Peak SAR (extrapolated) = 1.13 W/kg
 SAR(1 g) = 0.739 W/kg; SAR(10 g) = 0.453 W/kg
 Maximum value of SAR (measured) = 1.00 W/kg

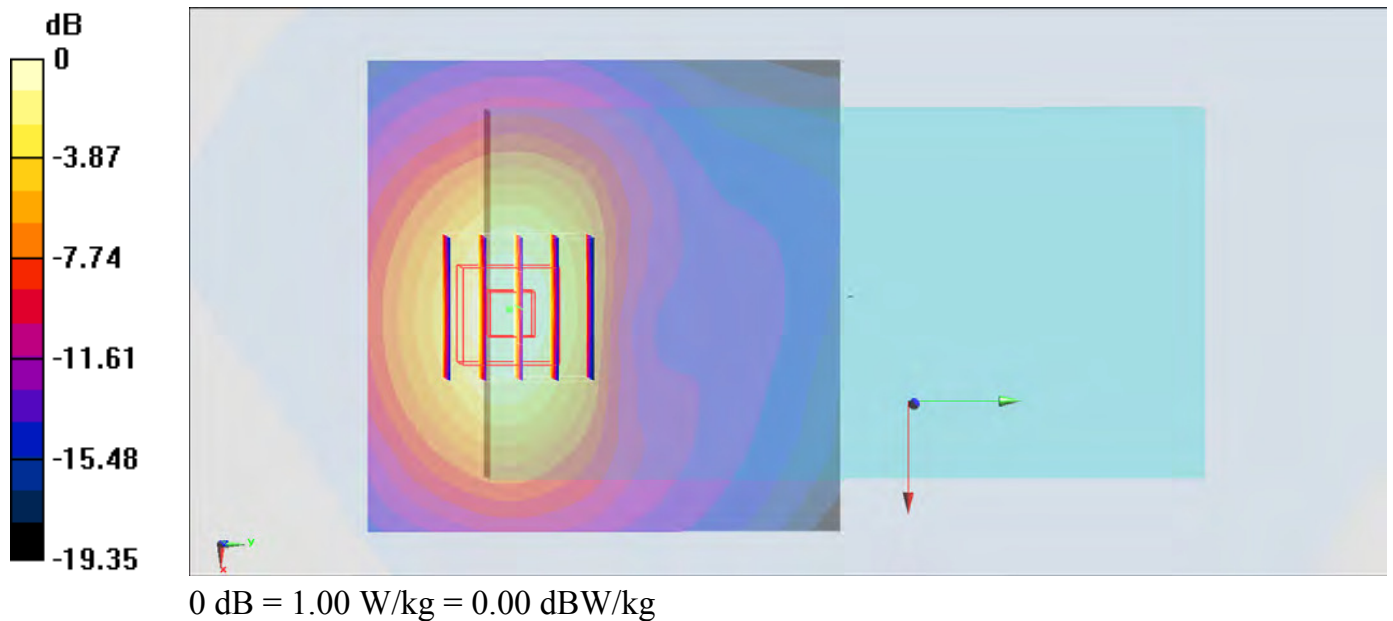

#43_LTE Band 12_10M_QPSK_1_0_Back_15mm_Ch23095

Communication System: LTE; Frequency: 707.5 MHz; Duty Cycle: 1:1

Medium: MSL_750_160909 Medium parameters used: $f = 707.5$ MHz; $\sigma = 0.914$ S/m; $\epsilon_r = 56.151$; $\rho = 1000$ kg/m³

Ambient Temperature : 23.5 °C; Liquid Temperature : 22.5 °C

DASY5 Configuration:

- Probe: EX3DV4 - SN3955; ConvF(10.36, 10.36, 10.36); Calibrated: 2015/11/24;
- Sensor-Surface: 1.4mm (Mechanical Surface Detection)
- Electronics: DAE4 Sn778; Calibrated: 2016/5/12
- Phantom: SAM_Left; Type: QD000P40CD; Serial: TP:1644
- Measurement SW: DASY52, Version 52.8 (8); SEMCAD X Version 14.6.10 (7373)

Area Scan (71x131x1): Interpolated grid: dx=1.500 mm, dy=1.500 mm

Maximum value of SAR (interpolated) = 0.363 W/kg

Zoom Scan (5x5x7)/Cube 0: Measurement grid: dx=8mm, dy=8mm, dz=5mm

Reference Value = 19.50 V/m; Power Drift = -0.01 dB

Peak SAR (extrapolated) = 0.385 W/kg

SAR(1 g) = 0.299 W/kg; SAR(10 g) = 0.234 W/kg

Maximum value of SAR (measured) = 0.354 W/kg

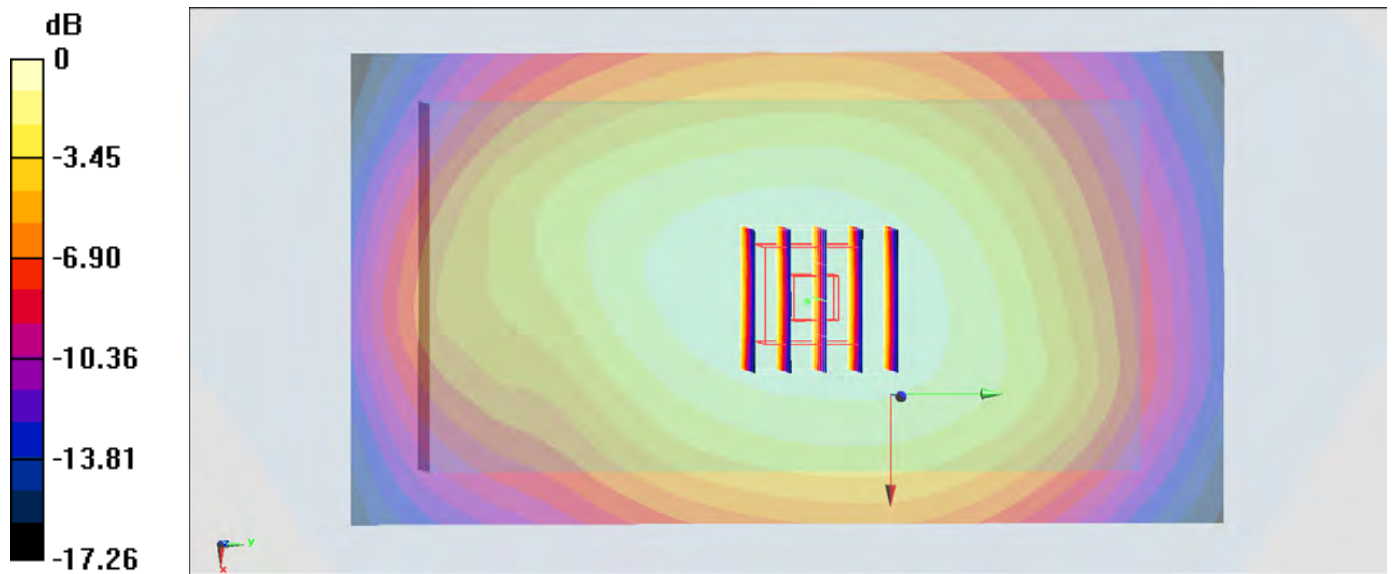

0 dB = 0.363 W/kg = -4.40 dBW/kg

#44_LTE Band 13_10M_QPSK_1_25_Back_15mm_Ch23230

Communication System: LTE ; Frequency: 782 MHz;Duty Cycle: 1:1

Medium: MSL_750_160909 Medium parameters used: $f = 782$ MHz; $\sigma = 0.983$ S/m; $\epsilon_r = 55.502$; $\rho = 1000$ kg/m³

Ambient Temperature : 23.5 °C ; Liquid Temperature : 22.5 °C

DASY5 Configuration:

- Probe: EX3DV4 - SN3955; ConvF(10.36, 10.36, 10.36); Calibrated: 2015/11/24;
- Sensor-Surface: 1.4mm (Mechanical Surface Detection)
- Electronics: DAE4 Sn778; Calibrated: 2016/5/12
- Phantom: SAM_Left; Type: QD000P40CD; Serial: TP:1644
- Measurement SW: DASY52, Version 52.8 (8);SEMCAD X Version 14.6.10 (7373)

Area Scan (71x131x1): Interpolated grid: dx=1.500 mm, dy=1.500 mm

Maximum value of SAR (interpolated) = 0.327 W/kg

Zoom Scan (5x5x7)/Cube 0: Measurement grid: dx=8mm, dy=8mm, dz=5mm

Reference Value = 17.95 V/m; Power Drift = 0.04 dB

Peak SAR (extrapolated) = 0.352 W/kg

SAR(1 g) = 0.268 W/kg; SAR(10 g) = 0.203 W/kg

Maximum value of SAR (measured) = 0.324 W/kg

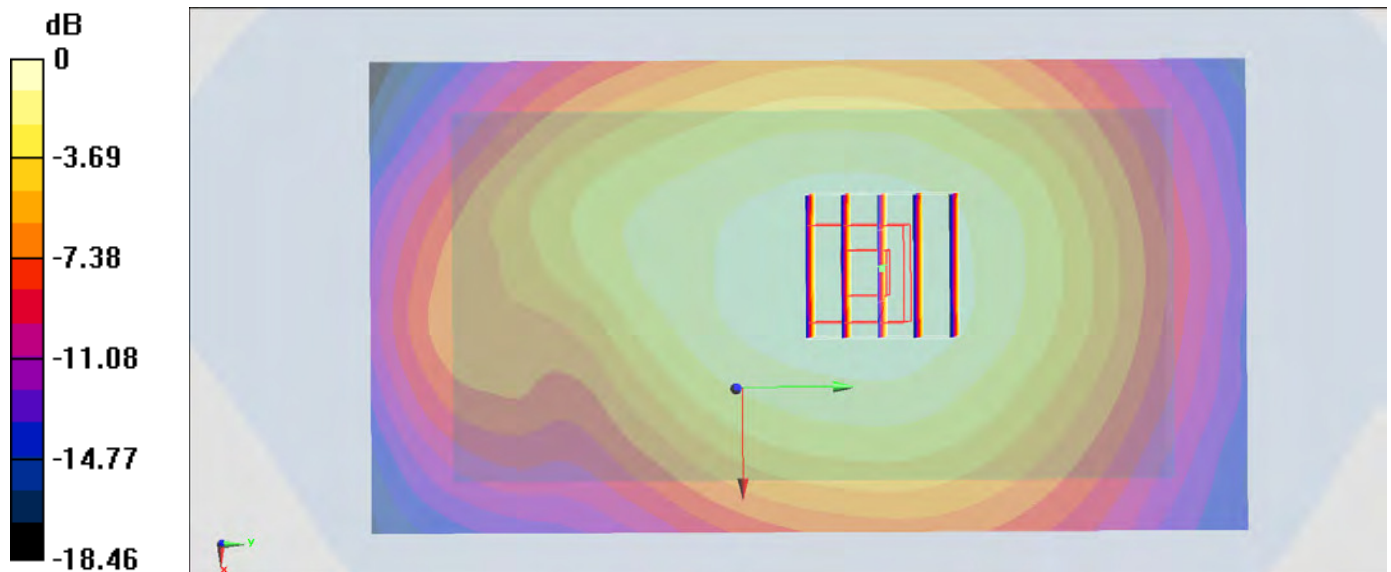

0 dB = 0.327 W/kg = -4.85 dBW/kg

#45_LTE Band 25_20M_QPSK_1_49_Back_15mm_Ch26340

Communication System: LTE; Frequency: 1880 MHz; Duty Cycle: 1:1

Medium: MSL_1900_160907 Medium parameters used: $f = 1880$ MHz; $\sigma = 1.52$ S/m; $\epsilon_r = 55.812$; $\rho = 1000$ kg/m³

Ambient Temperature : 23.4 °C; Liquid Temperature : 22.4 °C

DASY5 Configuration:

- Probe: EX3DV4 - SN3955; ConvF(7.89, 7.89, 7.89); Calibrated: 2015/11/24;
- Sensor-Surface: 1.4mm (Mechanical Surface Detection)
- Electronics: DAE4 Sn778; Calibrated: 2016/5/12
- Phantom: SAM_Left; Type: QD000P40CD; Serial: TP:1644
- Measurement SW: DASY52, Version 52.8 (8); SEMCAD X Version 14.6.10 (7373)

Area Scan (71x71x1): Interpolated grid: dx=1.500 mm, dy=1.500 mm

Maximum value of SAR (interpolated) = 1.05 W/kg

Zoom Scan (5x5x7)/Cube 0: Measurement grid: dx=8mm, dy=8mm, dz=5mm

Reference Value = 22.27 V/m; Power Drift = 0.06 dB

Peak SAR (extrapolated) = 1.13 W/kg

SAR(1 g) = 0.729 W/kg; SAR(10 g) = 0.442 W/kg

Maximum value of SAR (measured) = 0.993 W/kg

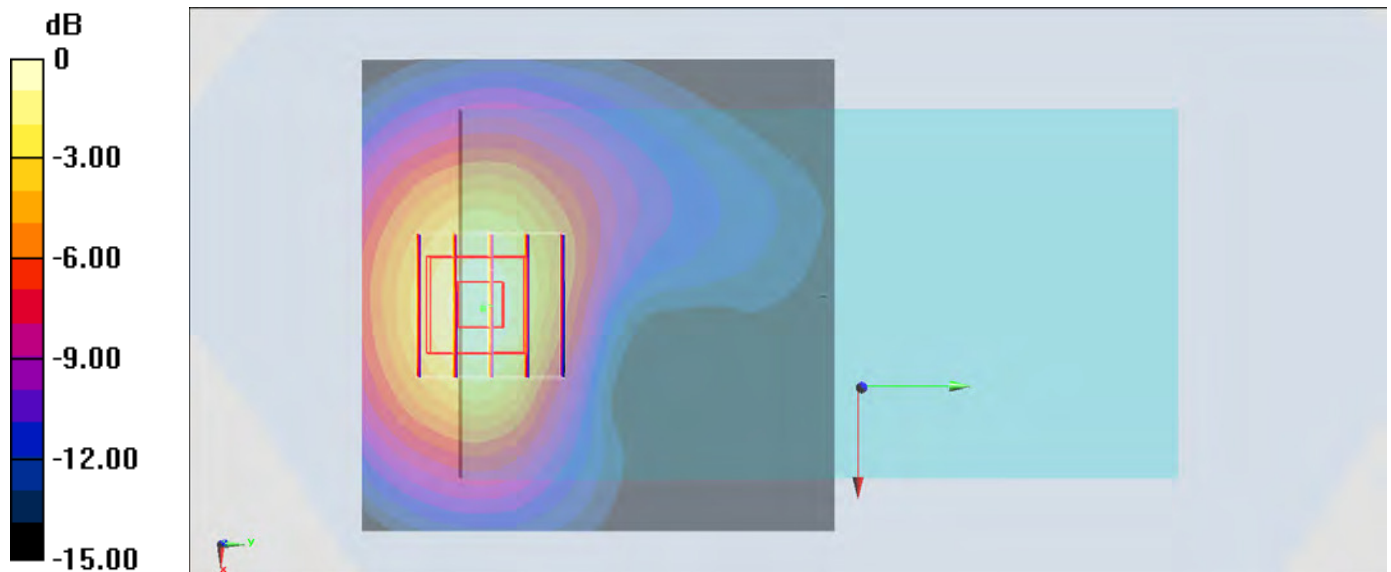

0 dB = 1.05 W/kg = 0.21 dBW/kg

#46_LTE Band 26_15M_QPSK_1_37_Front_0mm_Ch26865;Soft Holster

Communication System: LTE ; Frequency: 831.5 MHz;Duty Cycle: 1:1

Medium: MSL_850_160907 Medium parameters used : $f = 831.5$ MHz; $\sigma = 0.965$ S/m; $\epsilon_r = 57.187$; $\rho = 1000$ kg/m³

Ambient Temperature : 23.4 °C ; Liquid Temperature : 22.4 °C

DASY5 Configuration:

- Probe: EX3DV4 - SN3955; ConvF(10.08, 10.08, 10.08); Calibrated: 2015/11/24;
- Sensor-Surface: 1.4mm (Mechanical Surface Detection)
- Electronics: DAE4 Sn778; Calibrated: 2016/5/12
- Phantom: SAM_Left; Type: QD000P40CD; Serial: TP:1644
- Measurement SW: DASY52, Version 52.8 (8);SEMCAD X Version 14.6.10 (7373)

Area Scan (71x121x1): Interpolated grid: dx=1.500 mm, dy=1.500 mm

Maximum value of SAR (interpolated) = 0.493 W/kg

Zoom Scan (5x5x7)/Cube 0: Measurement grid: dx=8mm, dy=8mm, dz=5mm

Reference Value = 20.04 V/m; Power Drift = 0.15 dB

Peak SAR (extrapolated) = 0.585 W/kg

SAR(1 g) = 0.364 W/kg; SAR(10 g) = 0.229 W/kg

Maximum value of SAR (measured) = 0.498 W/kg

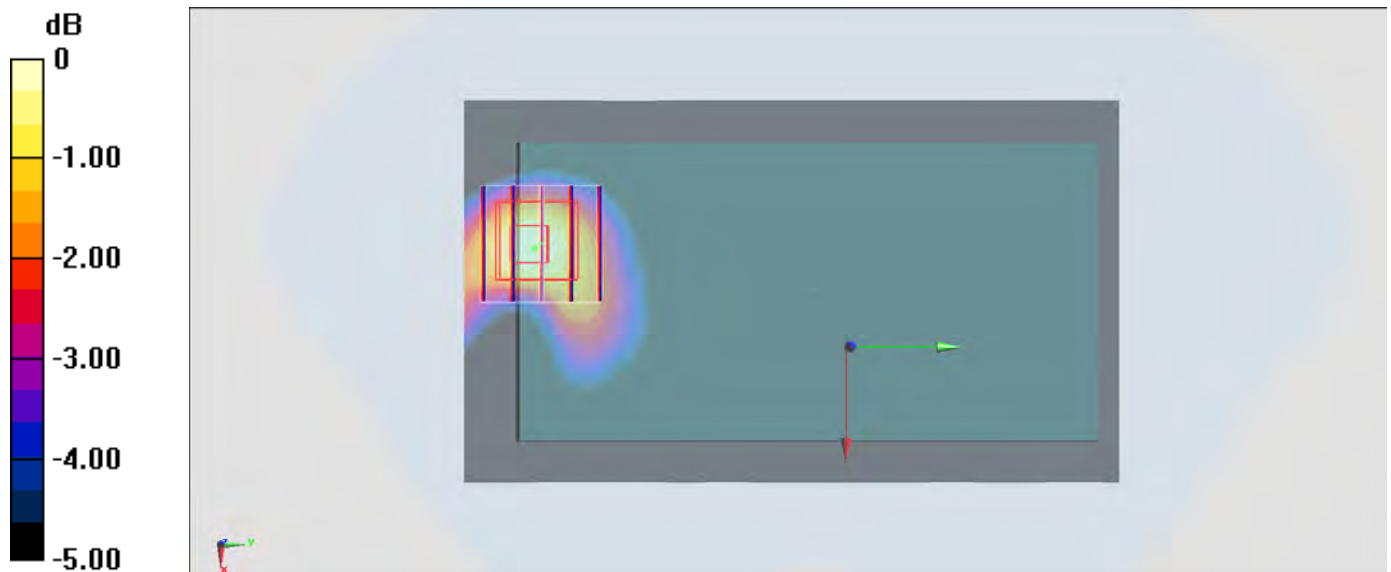

0 dB = 0.493 W/kg = -3.07 dBW/kg

#47_WLAN2.4GHz_802.11b 1Mbps_Back_15mm_Ch6;Ant 1

Communication System: 802.11b; Frequency: 2437 MHz; Duty Cycle: 1:1.014

Medium: MSL_2450_160908 Medium parameters used: $f = 2437$ MHz; $\sigma = 1.965$ S/m; $\epsilon_r = 52.622$; $\rho = 1000$ kg/m³

Ambient Temperature : 23.6 °C ; Liquid Temperature : 22.6 °C

DASY5 Configuration:

- Probe: EX3DV4 - SN3697; ConvF(6.9, 6.9, 6.9); Calibrated: 2015/9/28;
- Sensor-Surface: 1.4mm (Mechanical Surface Detection)
- Electronics: DAE4 Sn1388; Calibrated: 2015/9/25
- Phantom: SAM_Right; Type: QD000P40CD; Serial: TP:1383
- Measurement SW: DASY52, Version 52.8 (8); SEMCAD X Version 14.6.10 (7331)

Area Scan (81x151x1): Interpolated grid: dx=1.200 mm, dy=1.200 mm

Maximum value of SAR (interpolated) = 0.212 W/kg

Zoom Scan (7x7x7)/Cube 0: Measurement grid: dx=5mm, dy=5mm, dz=5mm

Reference Value = 5.616 V/m; Power Drift = -0.18 dB

Peak SAR (extrapolated) = 0.254 W/kg

SAR(1 g) = 0.143 W/kg; SAR(10 g) = 0.080 W/kg

Maximum value of SAR (measured) = 0.211 W/kg

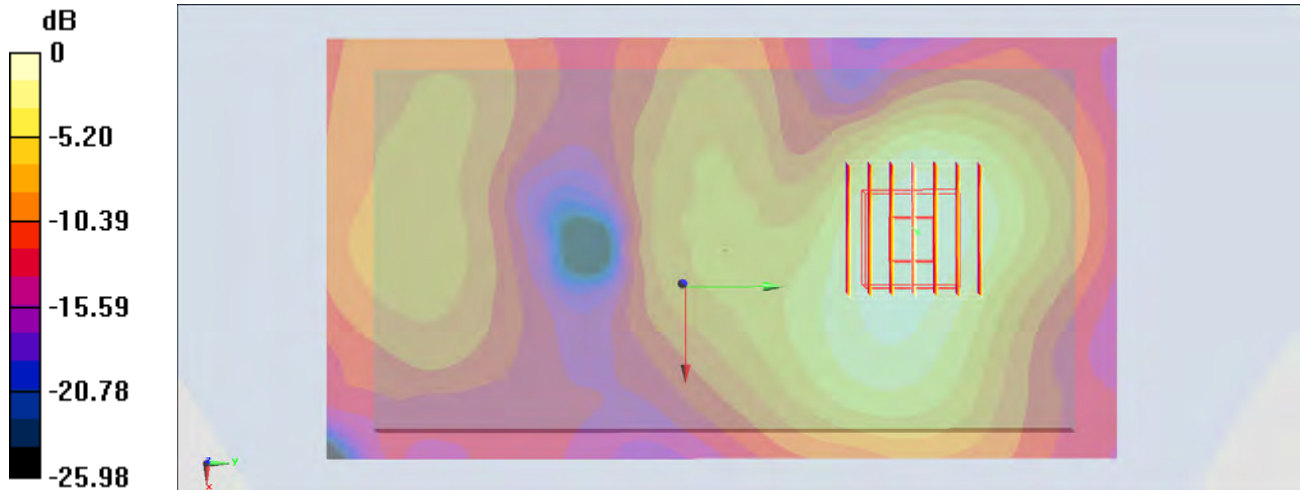

0 dB = 0.211 W/kg = -6.76 dBW/kg

#48_WLAN5GHz_802.11a 6Mbps_Back_15mm_Ch52;Ant 2

Communication System: 802.11a ; Frequency: 5260 MHz;Duty Cycle: 1:1.077

Medium: MSL_5G_160909 Medium parameters used: $f = 5260$ MHz; $\sigma = 5.483$ S/m; $\epsilon_r = 46.873$; $\rho = 1000$ kg/m³

Ambient Temperature : 23.9 °C ; Liquid Temperature : 22.9 °C

DASY5 Configuration:

- Probe: EX3DV4 - SN3931; ConvF(4.48, 4.48, 4.48); Calibrated: 2015/10/1;
- Sensor-Surface: 1.4mm (Mechanical Surface Detection)
- Electronics: DAE3 Sn577; Calibrated: 2015/9/24
- Phantom: SAM_Right; Type: QD000P40CD; Serial: TP:1383
- Measurement SW: DASY52, Version 52.8 (8);SEMCAD X Version 14.6.10 (7331)

Area Scan (121x101x1): Interpolated grid: dx=1.000 mm, dy=1.000 mm

Maximum value of SAR (interpolated) = 0.586 W/kg

Zoom Scan (7x7x7)/Cube 0: Measurement grid: dx=4mm, dy=4mm, dz=1.4mm

Reference Value = 0.7770 V/m; Power Drift = 0.17 dB

Peak SAR (extrapolated) = 0.998 W/kg

SAR(1 g) = 0.317 W/kg; SAR(10 g) = 0.137 W/kg

Maximum value of SAR (measured) = 0.647 W/kg

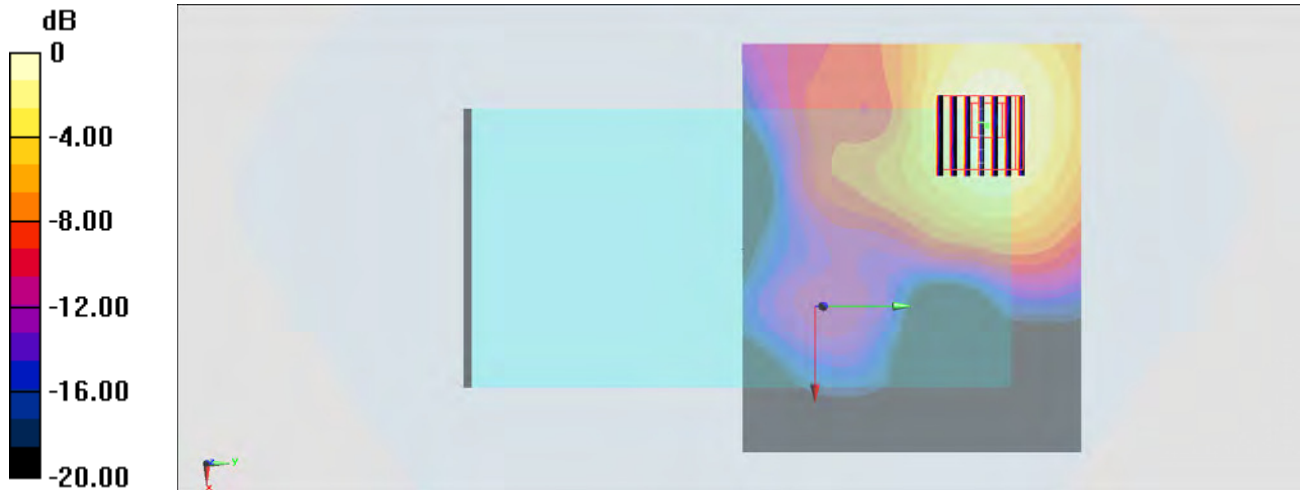

0 dB = 0.647 W/kg = -1.89 dBW/kg

#49_WLAN5GHz_802.11a 6Mbps_Back_15mm_Ch116;Ant 2

Communication System: 802.11a; Frequency: 5580 MHz; Duty Cycle: 1:1.077

Medium: MSL_5G_160912 Medium parameters used: $f = 5580$ MHz; $\sigma = 5.901$ S/m; $\epsilon_r = 46.262$; $\rho = 1000$ kg/m³

Ambient Temperature : 23.5 °C ; Liquid Temperature : 22.5 °C

DASY5 Configuration:

- Probe: EX3DV4 - SN3931; ConvF(3.84, 3.84, 3.84); Calibrated: 2015/10/1;
- Sensor-Surface: 1.4mm (Mechanical Surface Detection)
- Electronics: DAE3 Sn577; Calibrated: 2015/9/24
- Phantom: SAM-Right; Type: SAM; Serial: 1795
- Measurement SW: DASY52, Version 52.8 (8); SEMCAD X Version 14.6.10 (7373)

Area Scan (121x101x1): Interpolated grid: dx=1.000 mm, dy=1.000 mm

Maximum value of SAR (interpolated) = 0.697 W/kg

Zoom Scan (7x7x7)/Cube 0: Measurement grid: dx=4mm, dy=4mm, dz=1.4mm

Reference Value = 12.61 V/m; Power Drift = -0.08 dB

Peak SAR (extrapolated) = 1.07 W/kg

SAR(1 g) = 0.321 W/kg; SAR(10 g) = 0.134 W/kg

Maximum value of SAR (measured) = 0.693 W/kg

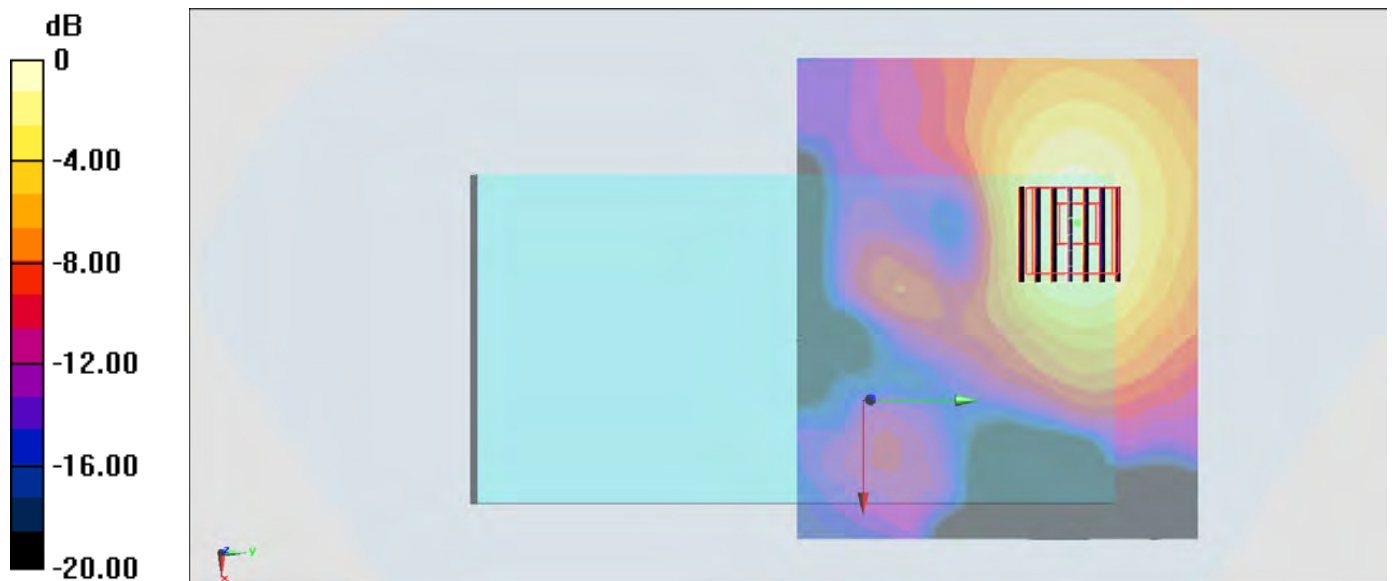

0 dB = 0.697 W/kg = -1.57 dBW/kg

#50_WLAN5GHz_802.11a 6Mbps_Back_15mm_Ch165;Ant 2

Communication System: 802.11a; Frequency: 5825 MHz; Duty Cycle: 1:1.077

Medium: MSL_5G_160912 Medium parameters used: $f = 5825$ MHz; $\sigma = 6.23$ S/m; $\epsilon_r = 45.864$; $\rho = 1000$ kg/m³

Ambient Temperature : 23.5 °C; Liquid Temperature : 22.5 °C

DASY5 Configuration:

- Probe: EX3DV4 - SN3931; ConvF(3.98, 3.98, 3.98); Calibrated: 2015/10/1;
- Sensor-Surface: 1.4mm (Mechanical Surface Detection)
- Electronics: DAE3 Sn577; Calibrated: 2015/9/24
- Phantom: SAM-Right; Type: SAM; Serial: 1795
- Measurement SW: DASY52, Version 52.8 (8); SEMCAD X Version 14.6.10 (7373)

Area Scan (121x101x1): Interpolated grid: dx=1.000 mm, dy=1.000 mm

Maximum value of SAR (interpolated) = 0.693 W/kg

Zoom Scan (7x7x7)/Cube 0: Measurement grid: dx=4mm, dy=4mm, dz=1.4mm

Reference Value = 11.90 V/m; Power Drift = -0.16 dB

Peak SAR (extrapolated) = 1.13 W/kg

SAR(1 g) = 0.313 W/kg; SAR(10 g) = 0.127 W/kg

Maximum value of SAR (measured) = 0.699 W/kg

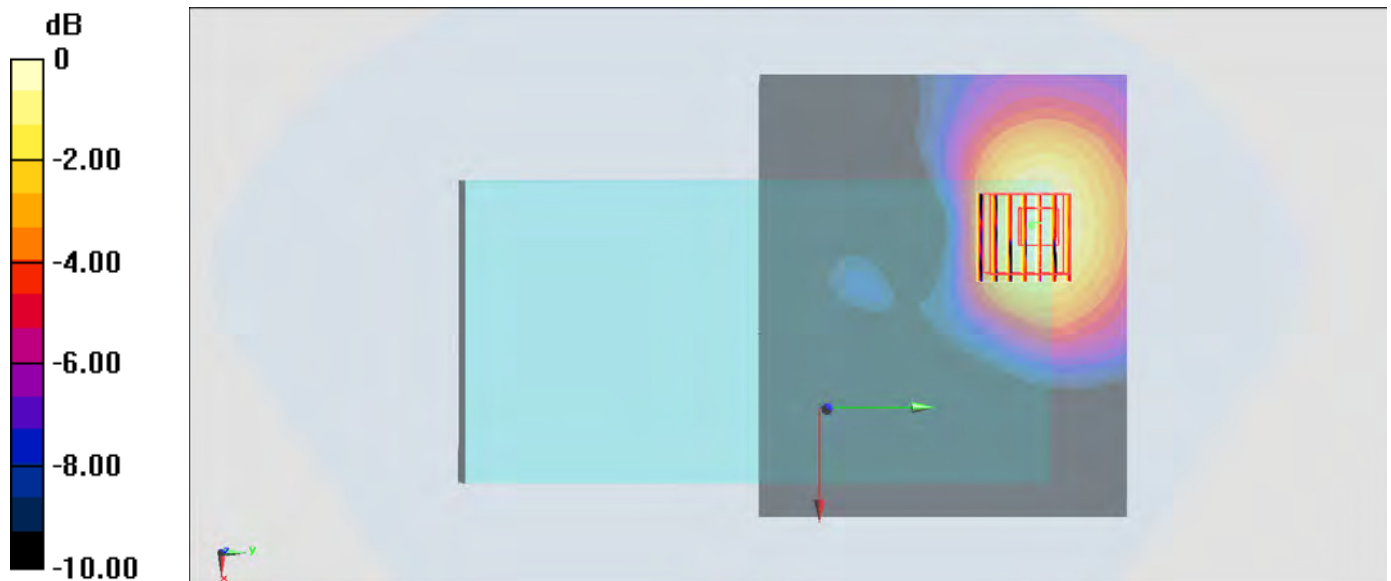

0 dB = 0.693 W/kg = -1.59 dBW/kg

#51_Bluetooth_GFSK_Back_15mm_Ch39

Communication System: Bluetooth ; Frequency: 2480 MHz;Duty Cycle: 1:1.20

Medium: MSL_2450_160921 Medium parameters used: $f = 2480$ MHz; $\sigma = 2.001$ S/m; $\epsilon_r = 52.18$; $\rho = 1000$ kg/m³

Ambient Temperature : 23.4 °C ; Liquid Temperature : 22.4 °C

DASY5 Configuration:

- Probe: EX3DV4 - SN3925; ConvF(7.64, 7.64, 7.64); Calibrated: 2016/5/26;
- Sensor-Surface: 1.4mm (Mechanical Surface Detection)
- Electronics: DAE3 Sn495; Calibrated: 2016/5/27
- Phantom: SAM-Right; Type: SAM; Serial: 1795
- Measurement SW: DASY52, Version 52.8 (8);SEMCAD X Version 14.6.10 (7331)

Area Scan (81x151x1): Interpolated grid: dx=1.200 mm, dy=1.200 mm

Maximum value of SAR (interpolated) = 0.000984 W/kg

Zoom Scan (7x7x7)/Cube 0: Measurement grid: dx=5mm, dy=5mm, dz=5mm

Reference Value = 0.4440 V/m; Power Drift = 0.10 dB

Peak SAR (extrapolated) = 0.00125 W/kg

SAR(1 g) = 6.91e-006 W/kg; SAR(10 g) = 1.14e-006 W/kg

Maximum value of SAR (measured) = 0.00236 W/kg

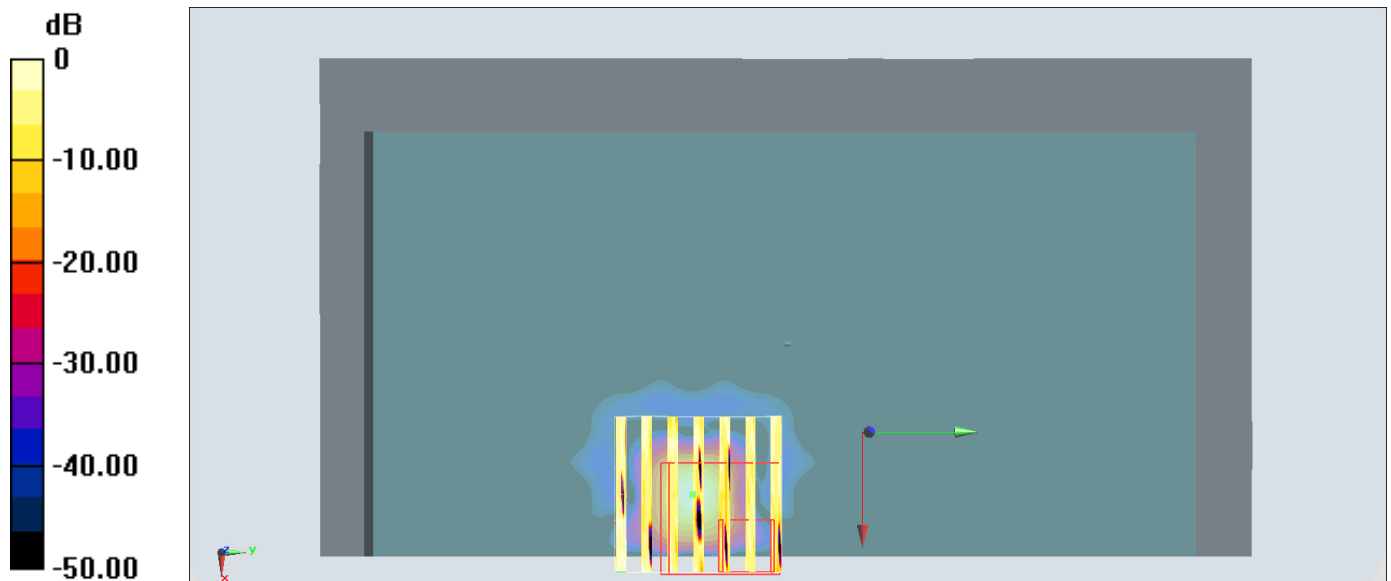

0 dB = 0.000984 W/kg = -30.07 dBW/kg