



FCC RADIO TEST REPORT

FCC ID : UZ7TC7301
Equipment : Touch Computer
Brand Name : Zebra
Model Name : TC7301
Applicant : Zebra Technologies Corporation
1 Zebra Plaza, Holtsville, NY 11742
Manufacturer : Zebra Technologies Corporation
1 Zebra Plaza, Holtsville, NY 11742
Standard : FCC Part 15 Subpart E §15.407

The product was received on Jul. 15. 2022 and testing was performed from Aug. 08, 2022 to Oct. 20, 2022. We, Sporton International Inc. Wensan Laboratory, would like to declare that the tested sample has been evaluated in accordance with the test procedures and has been in compliance with the applicable technical standards.

The test results in this report apply exclusively to the tested model / sample. Without written approval from Sporton International Inc. Wensan Laboratory, the test report shall not be reproduced except in full.

Approved by: Louis Wu

Sporton International Inc. Wensan Laboratory

No.58, Aly. 75, Ln. 564, Wenhua 3rd, Rd., Guishan Dist., Taoyuan City 333010, Taiwan (R.O.C.)



Table of Contents

History of this test report.....	3
Summary of Test Result.....	4
1 General Description	5
1.1 Product Feature of Equipment Under Test.....	5
1.2 Product Specification of Equipment Under Test.....	6
1.3 Modification of EUT	16
1.4 Testing Location	17
1.5 Applicable Standards.....	17
2 Test Configuration of Equipment Under Test	18
2.1 Carrier Frequency and Channel	18
2.2 Test Mode.....	21
2.3 Connection Diagram of Test System.....	26
2.4 Support Unit used in test configuration and system	27
2.5 EUT Operation Test Setup	28
2.6 Measurement Results Explanation Example.....	28
3 Test Result	29
3.1 26dB & 99% Occupied Bandwidth Measurement	29
3.2 Fundamental Maximum EIRP Measurement	35
3.3 Fundamental Power Spectral Density Measurement.....	37
3.4 In-Band Emissions (Channel Mask)	58
3.5 Contention Based Protocol.....	180
3.6 Unwanted Emissions Measurement.....	203
3.7 AC Conducted Emission Measurement.....	208
3.8 Antenna Requirements.....	210
4 List of Measuring Equipment.....	211
5 Uncertainty of Evaluation	213
Appendix A. Conducted Test Results	
A.1-1 SDM Mode (Indoor Client)	
A.1-2 SDM Mode (Standard Client)	
A.2-1 CDD Mode (Indoor Client)	
A.2-2 CDD Mode (Standard Client)	
A.3-1 Beamforming Mode (Indoor Client)	
A.3-2 Beamforming Mode (Standard Client)	
Appendix B. AC Conducted Emission Test Result	
Appendix C. Radiated Spurious Emission	
Appendix D. Radiated Spurious Emission Plots	
Appendix E. Duty Cycle Plots	
Appendix F. Setup Photographs	



History of this test report

Report No.	Version	Description	Issue Date
FR271537G	01	Initial issue of report	Nov. 09, 2022



Summary of Test Result

Report Clause	Ref Std. Clause	Test Items	Result (PASS/FAIL)	Remark
3.1	15.407(a)(10)	26dB Emission Bandwidth	Pass	-
3.1	2.1049	99% Occupied Bandwidth	Reporting only	-
3.2	15.407(a)(8)	Fundamental Maximum EIRP	Pass	-
3.3	15.407(a)(8)	Fundamental Power Spectral Density	Pass	-
3.4	15.407(b)(6)	In-Band Emissions (Channel Mask)	Pass	-
3.5	15.407(d)(6)	Contention Based Protocol	Pass	-
3.6	15.407(b)	Unwanted Emissions	Pass	0.10 dB under the limit at 7115.000 MHz
3.7	15.207	AC Conducted Emission	Pass	15.36 dB under the limit at 0.184 MHz
3.8	15.203	Antenna Requirement	Pass	-

Declaration of Conformity:

1. The test results (PASS/FAIL) with all measurement uncertainty excluded are presented in accordance with the regulation limits or requirements declared by manufacturers. It's means measurement values may risk exceeding the limit of regulation standards, if measurement uncertainty is include in test results.
2. The measurement uncertainty please refer to report "Uncertainty of Evaluation".

Comments and Explanations:

The product specifications of the EUT presented in the report are declared by the manufacturer who shall take full responsibility for the authenticity.

Reviewed by: Wei Chen

Report Producer: Lucy Wu



1 General Description

1.1 Product Feature of Equipment Under Test

Product Feature	
Equipment	Touch Computer
Brand Name	Zebra
Model Name	TC7301
FCC ID	UZ7TC7301
Sample 1	Lowell + Premium config
Sample 2	SE4720 + Base config
Sample 3	Lowell + Base config
EUT supports Radios application	NFC WLAN 11a/b/g/n HT20/HT40 WLAN 11ac VHT20/VHT40/VHT80/VHT160 WLAN 11ax HE20/HE40/HE80/HE160 Bluetooth BR/EDR/LE
HW Version	EV2
SW Version	11-11-28.00-RG-U00-PRD-ATH-04 356 test-keys
FW Version	FUSION_QA_4_1.2.0.001_R
MFD	10Jun22
EUT Stage	Identical Prototype

Remark: The above EUT's information was declared by manufacturer.

Specification of Accessories				
Adapter	Brand Name	Zebra	Part Number	PWR-WUA5V12W0US
Battery 1X	Brand Name	Zebra	Part Number	BT-000442-0020
Battery 1.5X	Brand Name	Zebra	Part Number	BT-000442-0820
Wireless Battery	Brand Name	Zebra	Part Number	BT-000442-002A
USB TYPE A to TYPE C cable	Brand Name	Zebra	Part Number	CBL-TC5X-USBC2A-01
USB TYPE C to 3.5mm audio connector	Brand Name	Zebra	Part Number	ADP-USBC-35MM1-01
3.5mm Earphone	Brand Name	Zebra	Part Number	HDST-35MM-PTVP-01
USB TYPE C Earphone	Brand Name	Zebra	Part Number	HPST-USBC-PTT1-01
Trigger Handle	Brand Name	Zebra	Part Number	TRG-NGTC5-ELEC-01
Soft Holster	Brand Name	Zebra	Part Number	SG-NGTC5TC7-HLSTR-01
TC53/TC58 RUGGED BOOT	Brand Name	Zebra	Part Number	SG-NGTC5EXO1-01



1.2 Product Specification of Equipment Under Test

Product Specification is subject to this standard	
Tx/Rx Frequency Range	5925 MHz ~ 6425 MHz 6425 MHz ~ 6525 MHz 6525 MHz ~ 6875 MHz 6875 MHz ~ 7125 MHz
Maximum Output Power to Antenna <SDM Mode>	<p><Indoor Client> MIMO <Ant. 9+8> <UNII-5> 802.11n HT20: 10.32 dBm / 0.0108 W 802.11n HT40: 13.17 dBm / 0.0207 W 802.11ac VHT20: 10.42 dBm / 0.0110 W 802.11ac VHT40: 13.27 dBm / 0.0212 W 802.11ac VHT80: 15.92 dBm / 0.0391 W 802.11ac VHT160: 17.11 dBm / 0.0514 W 802.11ax HE20: 10.52 dBm / 0.0113 W 802.11ax HE40: 13.37 dBm / 0.0217 W 802.11ax HE80: 16.02 dBm / 0.0400 W 802.11ax HE160: 17.21 dBm / 0.0526 W</p> <p><UNII-6> 802.11n HT20: 10.36 dBm / 0.0109 W 802.11n HT40: 13.11 dBm / 0.0205 W 802.11ac VHT20: 10.46 dBm / 0.0111 W 802.11ac VHT40: 13.21 dBm / 0.0209 W 802.11ac VHT80: 16.01 dBm / 0.0399 W 802.11ac VHT160: 16.41 dBm / 0.0438 W 802.11ax HE20: 10.56 dBm / 0.0114W 802.11ax HE40: 13.31 dBm / 0.0214 W 802.11ax HE80: 16.11 dBm / 0.0408 W 802.11ax HE160:16.51 dBm / 0.0448 W</p> <p><UNII-7> 802.11n HT20: 10.84 dBm / 0.0121 W 802.11n HT40: 13.87 dBm / 0.0244 W 802.11ac VHT20: 10.94 dBm / 0.0124 W 802.11ac VHT40: 13.97 dBm / 0.0249 W 802.11ac VHT80: 15.61 dBm / 0.0364 W 802.11ac VHT160: 15.41 dBm / 0.0348 W 802.11ax HE20: 11.04 dBm / 0.0127 W 802.11ax HE40: 14.07 dBm / 0.0255 W 802.11ax HE80: 15.71 dBm / 0.0372 W 802.11ax HE160: 15.51 dBm / 0.0356 W</p>



Product Specification is subject to this standard	
Maximum Output Power to Antenna <SDM Mode>	<UNII-8>
	802.11n HT20: 11.24 dBm / 0.0133 W
	802.11n HT40: 14.31 dBm / 0.0270 W
	802.11ac VHT20: 11.34 dBm / 0.0136 W
	802.11ac VHT40: 14.41 dBm / 0.0276 W
	802.11ac VHT80: 15.36 dBm / 0.0344 W
	802.11ac VHT160: 15.41 dBm / 0.0348 W
	802.11ax HE20: 11.44 dBm / 0.0139 W
	802.11ax HE40: 14.51 dBm / 0.0282 W
	802.11ax HE80: 15.46 dBm / 0.0352 W
	802.11ax HE160: 15.51 dBm / 0.0356 W
	<Standard Client>
	MIMO <Ant. 9+8>
	<UNII-5>
	802.11n HT20: 17.02 dBm / 0.0504 W
	802.11n HT40: 16.97 dBm / 0.0598 W
	802.11ac VHT20: 17.12 dBm / 0.0515 W
	802.11ac VHT40: 17.07 dBm / 0.0509 W
	802.11ac VHT80: 17.23 dBm / 0.0528 W
	802.11ac VHT160: 17.17 dBm / 0.0521 W
	802.11ax HE20: 17.22 dBm / 0.0527 W
	802.11ax HE40: 17.17 dBm / 0.0521 W
	802.11ax HE80: 17.22 dBm / 0.0527 W
	802.11ax HE160: 17.27 dBm / 0.0533 W
	<UNII-7>
	802.11n HT20: 15.53 dBm / 0.0357 W
	802.11n HT40: 15.62 dBm / 0.0365 W
	802.11ac VHT20: 15.63 dBm / 0.0366 W
	802.11ac VHT40: 15.72 dBm / 0.0373 W
	802.11ac VHT80: 15.61 dBm / 0.0364 W
	802.11ac VHT160: 15.61 dBm / 0.0364 W
	802.11ax HE20: 15.73 dBm / 0.0374 W
	802.11ax HE40: 15.82 dBm / 0.0382 W
802.11ax HE80: 15.71 dBm / 0.0372 W	
802.11ax HE160: 15.71 dBm / 0.0372 W	



Product Specification is subject to this standard	
<p>Maximum Output Power to Antenna <CDD Mode></p>	<p><Indoor Client> MIMO <Ant. 9+8> <UNII-5> 802.11a: 7.11 dBm / 0.0051 W 802.11n HT20: 7.01 dBm / 0.0050 W 802.11n HT40: 9.83 dBm / 0.0096 W 802.11ac VHT20: 7.11 dBm / 0.0051 W 802.11ac VHT40: 9.93 dBm / 0.0098 W 802.11ac VHT80: 12.57 dBm / 0.0181 W 802.11ac VHT160: 13.86 dBm / 0.0243 W 802.11ax HE20: 7.21 dBm / 0.0053 W 802.11ax HE40: 10.03 dBm / 0.0101 W 802.11ax HE80: 12.67 dBm / 0.0185 W 802.11ax HE160: 13.96 dBm / 0.0249 W <UNII-6> 802.11a: 7.41 dBm / 0.0055 W 802.11n HT20: 7.11 dBm / 0.0051 W 802.11n HT40: 9.71 dBm / 0.0094 W 802.11ac VHT20: 7.21 dBm / 0.0053 W 802.11ac VHT40: 9.81 dBm / 0.0097 W 802.11ac VHT80: 12.71 dBm / 0.0187 W 802.11ac VHT160: 13.16 dBm / 0.0207 W 802.11ax HE20: 7.31 dBm / 0.0054 W 802.11ax HE40: 9.91 dBm / 0.0098 W 802.11ax HE80: 12.81 dBm / 0.0191 W 802.11ax HE160: 13.26 dBm / 0.0212 W <UNII-7> 802.11a: 8.01 dBm / 0.0063 W 802.11n HT20: 7.58 dBm / 0.0057 W 802.11n HT40: 10.57 dBm / 0.0114 W 802.11ac VHT20: 7.68 dBm / 0.0059 W 802.11ac VHT40: 10.67 dBm / 0.0117 W 802.11ac VHT80: 12.54 dBm / 0.0179 W 802.11ac VHT160: 12.16 dBm / 0.0164 W 802.11ax HE20: 7.78 dBm / 0.0060 W 802.11ax HE40: 10.77 dBm / 0.0119 W 802.11ax HE80: 12.64 dBm / 0.0184 W 802.11ax HE160: 12.26 dBm / 0.0168 W <UNII-8> 802.11a: 8.66 dBm / 0.0073 W 802.11n HT20: 7.94 dBm / 0.0062 W 802.11n HT40: 11.01 dBm / 0.0126 W 802.11ac VHT20: 8.04 dBm / 0.0063 W 802.11ac VHT40: 11.11 dBm / 0.0129 W 802.11ac VHT80: 11.96 dBm / 0.0157 W 802.11ac VHT160: 12.11 dBm / 0.0163 W 802.11ax HE20: 8.14 dBm / 0.0065 W 802.11ax HE40: 11.21 dBm / 0.0132 W 802.11ax HE80: 12.06 dBm / 0.0161 W 802.11ax HE160: 12.21 dBm / 0.0166 W</p>



Product Specification is subject to this standard	
Maximum Output Power to Antenna <CDD Mode>	<Standard Client> MIMO <Ant. 9+8> <UNII-5> 802.11a: 17.42 dBm / 0.0552 W 802.11n HT20: 13.67 dBm / 0.0233 W 802.11n HT40: 13.67 dBm / 0.0233 W 802.11ac VHT20: 13.77 dBm / 0.0238 W 802.11ac VHT40: 13.77 dBm / 0.0238 W 802.11ac VHT80: 13.82 dBm / 0.0241 W 802.11ac VHT160: 13.87 dBm / 0.0244 W 802.11ax HE20: 13.87 dBm / 0.0244 W 802.11ax HE40: 13.87 dBm / 0.0244 W 802.11ax HE80: 13.92 dBm / 0.0247 W 802.11ax HE160: 13.97 dBm / 0.0249 W <UNII-7> 802.11a: 15.51 dBm / 0.0356 W 802.11n HT20: 12.21 dBm / 0.0166 W 802.11n HT40: 12.37 dBm / 0.0173 W 802.11ac VHT20: 12.31 dBm / 0.0170 W 802.11ac VHT40: 12.47 dBm / 0.0177 W 802.11ac VHT80: 12.58 dBm / 0.0181 W 802.11ac VHT160: 12.46 dBm / 0.0176 W 802.11ax HE20: 12.41 dBm / 0.0174 W 802.11ax HE40: 12.57 dBm / 0.0181 W 802.11ax HE80: 12.68 dBm / 0.0185 W 802.11ax HE160: 12.56 dBm / 0.0180 W



Product Specification is subject to this standard	
Maximum Output Power to Antenna <TXBF Mode>	<Indoor Client>
	MIMO <Ant. 9+8>
	<UNII-5>
	802.11n HT20: 5.44 dBm / 0.0035 W
	802.11n HT40: 9.07 dBm / 0.0081 W
	802.11ac VHT20: 5.54 dBm / 0.0036 W
	802.11ac VHT40: 9.17 dBm / 0.0083 W
	802.11ac VHT80: 12.32 dBm / 0.0171 W
	802.11ac VHT160: 13.87 dBm / 0.0244 W
	802.11ax HE20: 5.64 dBm / 0.0037 W
	802.11ax HE40: 9.27 dBm / 0.0085 W
	802.11ax HE80: 12.42 dBm / 0.0175 W
	802.11ax HE160: 13.97 dBm / 0.0249 W
	<UNII-6>
	802.11n HT20: 6.67 dBm / 0.0046 W
	802.11n HT40: 9.53 dBm / 0.0090 W
	802.11ac VHT20: 6.77 dBm / 0.0048 W
	802.11ac VHT40: 9.63 dBm / 0.0092 W
	802.11ac VHT80: 12.37 dBm / 0.0173 W
	802.11ac VHT160: 12.71 dBm / 0.0187 W
	802.11ax HE20: 6.87 dBm / 0.0049 W
	802.11ax HE40: 9.73 dBm / 0.0094 W
	802.11ax HE80: 12.47 dBm / 0.0177 W
	802.11ax HE160: 12.81 dBm / 0.0191 W
	<UNII-7>
	802.11n HT20: 6.84 dBm / 0.0048 W
	802.11n HT40: 10.21 dBm / 0.0105 W
	802.11ac VHT20: 6.94 dBm / 0.0049 W
	802.11ac VHT40: 10.31 dBm / 0.0107 W
	802.11ac VHT80: 12.56 dBm / 0.0480 W
	802.11ac VHT160: 12.11 dBm / 0.0163 W
	802.11ax HE20: 7.04 dBm / 0.0051 W
	802.11ax HE40: 10.41 dBm / 0.0110 W
	802.11ax HE80: 12.66 dBm / 0.0185 W
	802.11ax HE160: 12.21 dBm / 0.0166 W
	<UNII-8>
	802.11n HT20: 6.41 dBm / 0.0044 W
	802.11n HT40: 10.42 dBm / 0.0110 W
	802.11ac VHT20: 6.51 dBm / 0.0045 W
	802.11ac VHT40: 10.52 dBm / 0.0113 W
802.11ac VHT80: 12.07 dBm / 0.0161 W	
802.11ac VHT160: 11.71 dBm / 0.0148 W	
802.11ax HE20: 6.61 dBm / 0.0046 W	
802.11ax HE40: 10.62 dBm / 0.0115 W	
802.11ax HE80: 12.17 dBm / 0.0165 W	
802.11ax HE160: 11.81 dBm / 0.0152 W	



Product Specification is subject to this standard	
<p>Maximum Output Power to Antenna <TXBF Mode></p>	<p><Standard Client> MIMO <Ant. 9+8> <UNII-5> 802.11n HT20: 13.57 dBm / 0.0228 W 802.11n HT40: 13.47 dBm / 0.0222 W 802.11ac VHT20: 13.67 dBm / 0.0233 W 802.11ac VHT40: 13.57. dBm / 0.0228 W 802.11ac VHT80: 13.96 dBm / 0.0249 W 802.11ac VHT160: 14.02 dBm / 0.0252 W 802.11ax HE20: 13.77 dBm / 0.0238 W 802.11ax HE40: 13.67 dBm / 0.0233 W 802.11ax HE80: 14.06 dBm / 0.0255 W 802.11ax HE160: 14.12 dBm / 0.0258 W <UNII-7> 802.11n HT20: 11.96 dBm / 0.0157 W 802.11n HT40: 12.37 dBm / 0.0173 W 802.11ac VHT20: 12.06 dBm / 0.0161 W 802.11ac VHT40: 12.47 dBm / 0.0177 W 802.11ac VHT80: 12.32 dBm / 0.0171 W 802.11ac VHT160: 12.11 dBm / 0.0163 W 802.11ax HE20: 12.16 dBm / 0.0164 W 802.11ax HE40: 12.57 dBm / 0.0181 W 802.11ax HE80: 12.42 dBm / 0.0175 W 802.11ax HE160: 12.31 dBm / 0.0170 W</p>
<p>99% Occupied Bandwidth <SDM Mode></p>	<p><Indoor Client> MIMO <Ant. 9> 802.11ax HE20: 19.38 MHz 802.11ax HE40: 38.06 MHz 802.11ax HE80: 77.32 MHz 802.11ax HE160: 156.32 MHz MIMO <Ant. 8> 802.11ax HE20: 19.43 MHz 802.11ax HE40: 38.06 MHz 802.11ax HE80: 77.44 MHz 802.11ax HE160: 157.28 MHz</p> <p><Standard Client> MIMO <Ant. 9> 802.11ax HE20: 19.33 MHz 802.11ax HE40: 38.36 MHz 802.11ax HE80: 77.56 MHz 802.11ax HE160: 156.56 MHz MIMO <Ant. 8> 802.11ax HE20: 19.68 MHz 802.11ax HE40: 39.06 MHz 802.11ax HE80: 77.92 MHz 802.11ax HE160: 157.04 MHz</p>



Product Specification is subject to this standard	
99% Occupied Bandwidth <CDD Mode>	<Indoor Client> MIMO <Ant. 9> 802.11a: 16.58 MHz MIMO <Ant. 8> 802.11a: 16.48 MHz
	<Standard Client> MIMO <Ant. 9> 802.11a: 16.48 MHz MIMO <Ant. 8> 802.11a: 16.83 MHz
Antenna Type	<UNII-5> <Ant. 9> : PIFA Antenna <Ant. 8> : PIFA Antenna <UNII-6> <Ant. 9> : PIFA Antenna <Ant. 8> : PIFA Antenna <UNII-7> <Ant. 9> : PIFA Antenna <Ant. 8> : PIFA Antenna <UNII-8> <Ant. 9> : PIFA Antenna <Ant. 8> : PIFA Antenna
Antenna Gain	TX Beamforming Gain (Y) : 0 dBi <UNII-5> <Ant. 9> : Max: 1.02 dBi Min: 0.02 dBi <Ant. 8> : Max: 1.65 dBi Min: 1.03 dBi <UNII-6> <Ant. 9> : Max: 1.02 dBi Min: 0.59 dBi <Ant. 8> : Max: 1.03 dBi Min: 0.73 dBi <UNII-7> <Ant. 9> : Max: 0.59 dBi Min: -1.19 dBi <Ant. 8> : Max: 0.73 dBi Min: 0.50 dBi <UNII-8> <Ant. 9> : Max: 0.45 dBi Min: -1.19 dBi <Ant. 8> : Max: 0.50 dBi Min: -0.35 dBi



Product Specification is subject to this standard			
Type of Modulation	802.11a/n: OFDM (BPSK/QPSK/16QAM/64QAM)		
	802.11ac: OFDM (BPSK/QPSK/16QAM/64QAM/256QAM)		
Antenna Function Description	802.11ax: OFDMA		
	(BPSK/QPSK/16QAM/64QAM/256QAM/1024QAM)		
		Ant. 9	Ant. 8
	802.11 n/ac/ax SDM	V	V
	802.11 a/n/ac/ax CDD	V	V
	802.11 n/ac/ax TXBF	V	V

Remark:

1. MIMO Ant. 9+8 Directional Gain is a calculated result from MIMO Ant. 9 and MIMO Ant. 8. The formula used in calculation is documented in section 1.2.1.
2. Power of MIMO Ant. 9 + Ant. 8 is a calculated result from sum of the power MIMO Ant. 9 and MIMO Ant. 8.

Antenna Information				
Antenna 9	Brand Name	Amphenol corp.	Model Name	WT5907-16-002-C
Antenna 8	Brand Name	Amphenol corp.	Model Name	WT5907-16-002-C

Remark: The EUT's information above is declared by manufacturer. Please refer to Comments and Explanations in report summary.

1.2.1 Antenna Gain

<For CDD Mode>

Follows FCC KDB 662911 D01 Multiple Transmitter Output v02r01 F2)f)ii)

Directional gain = G_{ANT} + Array Gain, where Array Gain is as follows:

For power measurements on IEEE 802.11 devices,

Array Gain = 0 dB (i.e., no array gain) for $N_{ANT} \leq 4$.

G_{ANT} is set equal to the gain of the antenna having the highest gain.

For PSD measurements, the directional gain calculation.

$$DirectionalGain = 10 \cdot \log \left[\frac{\sum_{j=1}^{N_{SS}} \left\{ \sum_{k=1}^{N_{ANT}} g_{j,k} \right\}^2}{N_{ANT}} \right]$$

where

Each antenna is driven by no more than one spatial stream;

N_{SS} = the number of independent spatial streams of data;

N_{ANT} = the total number of antennas

$g_{j,k} = 10^{G_k / 20}$ if the k th antenna is being fed by spatial stream j , or zero if it is not;
 G_k is the gain in dBi of the k th antenna.

As minimum $N_{SS}=1$ is supported by EUT, the formula can be simplified as:

$$Directional\ gain = 10 \cdot \log \left[\left(10^{G_1 / 20} + 10^{G_2 / 20} + \dots + 10^{G_N / 20} \right)^2 / N_{ANT} \right] \text{ dBi}$$

Where G_1, G_2, \dots, G_N denote single antenna gain.

The directional gain "DG" is calculated as following table.

	Ant 9 (dBi)	Ant 8 (dBi)	DG for Power (dBi)	DG for PSD (dBi)
5925 MHz ~ 6425 MHz	1.02	1.65	1.65	4.35
6425 MHz ~ 6525 MHz	1.02	1.03	1.03	4.04
6525 MHz ~ 6875 MHz	0.59	0.73	0.73	3.67
6875 MHz ~ 7125 MHz	0.45	0.50	0.50	3.49

Calculation example:

If a device has two antenna, $G_{ANT1}= 1.02\text{dBi}$; $G_{ANT2}=1.65\text{dBi}$

Directional gain of power measurement = $\max(1.02, 1.65) + 0 = 1.65 \text{ dBi}$

Directional gain of PSD derived from formula which is

$$10 \times \log \left\{ \left[\left(10^{(1.02 \text{ dBi} / 20)} + 10^{(1.65 \text{ dBi} / 20)} \right)^2 \right] / 2 \right\}$$

= 4.35 dBi



<For SDM Mode>

SDM mode all transmit signals are completely uncorrelated, then

Follows FCC KDB 662911 D01 Multiple Transmitter Output v02r01 F)2)d)ii)

The Directional gain = $10 \cdot \log[(10^{G1/10} + 10^{G2/10} + \dots + 10^{GN/10}) / N_{ANT}]$ dBi

Where G1, G2....GN denote single antenna gain.

The directional gain "DG" is calculated as following table.

				DG for Power (dBi)	DG for PSD (dBi)
		Ant 9 (dBi)	Ant 8 (dBi)		
5925 MHz ~ 6425 MHz		1.02	1.65	1.35	1.35
6425 MHz ~ 6525 MHz		1.02	1.03	1.03	1.03
6525 MHz ~ 6875 MHz		0.59	0.73	0.66	0.66
6875 MHz ~ 7125 MHz		0.45	0.50	0.48	0.48

Calculation example:

If a device has two antenna, $G_{ANT1}= 1.02\text{dBi}$; $G_{ANT2}=1.65\text{dBi}$

Directional gain is derived from formula which is

$$10 \times \log \left\{ \left[10^{(1.02 \text{ dBi} / 10)} + 10^{(1.65 \text{ dBi} / 10)} \right] / 2 \right\}$$

$$= 1.35 \text{ dBi}$$

<For TXBF Modes>

The EUT supports beamforming modes then

Follows FCC KDB 662911 D01 Multiple Transmitter Output v02r01 F)2)e)ii)

$$DirectionalGain = 10 \cdot \log \left[\frac{\sum_{j=1}^{N_{SS}} \left\{ \sum_{k=1}^{N_{ANT}} g_{j,k} \right\}^2}{N_{ANT}} \right]$$

where

Each antenna is driven by no more than one spatial stream;

N_{SS} = the number of independent spatial streams of data;

N_{ANT} = the total number of antennas

$g_{j,k} = 10^{G_k / 20}$ if the k th antenna is being fed by spatial stream j , or zero if it is not;
 G_k is the gain in dBi of the k th antenna.

The directional gain “DG” is calculated as following table.

				DG	DG
				for	for
		Ant 9	Ant 8	Power	PSD
		(dBi)	(dBi)	(dBi)	(dBi)
5925 MHz ~ 6425 MHz	1.02	1.65	4.35	4.35	
6425 MHz ~ 6525 MHz	1.02	1.03	4.04	4.04	
6525 MHz ~ 6875 MHz	0.59	0.73	3.67	3.67	
6875 MHz ~ 7125 MHz	0.45	0.50	3.49	3.49	

Calculation example:

Directional gain is derived from formula which is

$$10 \times \log \left\{ \left[10^{(1.02 \text{ dBi} / 20)} + 10^{(1.65 \text{ dBi} / 20)} \right]^2 / 2 \right\} = 4.35 \text{ dBi}$$

1.3 Modification of EUT

No modifications made to the EUT during the testing.



1.4 Testing Location

Test Site	Sporton International Inc. EMC & Wireless Communications Laboratory
Test Site Location	No.52, Huaya 1st Rd., Guishan Dist., Taoyuan City 333, Taiwan (R.O.C.) TEL: +886-3-327-3456 FAX: +886-3-328-4978
Test Site No.	Sporton Site No. CO05-HY, DF02-HY (TAF Code: 1190)
Remark	The Conducted Emission and Contention Based Protocol test items subcontracted to Sporton International Inc. EMC & Wireless Communications Laboratory

Note: The test site complies with ANSI C63.4 2014 requirement.

Test Site	Sporton International Inc. Wensan Laboratory
Test Site Location	No.58, Aly. 75, Ln. 564, Wenhua 3rd, Rd., Guishan Dist., Taoyuan City 333010, Taiwan (R.O.C.) TEL: +886-3-327-0868 FAX: +886-3-327-0855
Test Site No.	Sporton Site No. TH05-HY, 03CH15-HY

Note: The test site complies with ANSI C63.4 2014 requirement.

FCC designation No.: TW1190 and TW3786

1.5 Applicable Standards

According to the specifications declared by the manufacturer, the EUT must comply with the requirements of the following standards:

- ♦ FCC Part 15 Subpart E
- ♦ FCC KDB 789033 D02 General UNII Test Procedures New Rules v02r01.
- ♦ FCC KDB 987594 D02 U-NII 6 GHz EMC Measurement v01r01
- ♦ FCC KDB 414788 D01 Radiated Test Site v01r01.
- ♦ FCC KDB 662911 D01 Multiple Transmitter Output v02r01.
- ♦ ANSI C63.10-2013

Remark:

1. All the test items were validated and recorded in accordance with the standards without any modification during the testing.
2. The TAF code is not including all the FCC KDB listed without accreditation.
3. This EUT has also been tested and complied with the requirements of FCC Part 15, Subpart B, recorded in a separate test report.



2 Test Configuration of Equipment Under Test

- a. The EUT has been associated with peripherals and configuration operated in a manner tended to maximize its emission characteristics in a typical application. Frequency range investigated: conduction emission (150 kHz to 30 MHz), radiation emission (9 kHz to the 10th harmonic of the highest fundamental frequency or to 40 GHz, whichever is lower). For radiated measurement, , the measured emission level of the EUT was maximized by rotating the EUT on a turntable, adjusting the orientation of the EUT and EUT antenna in three orthogonal axis (X: flat, Y: portrait, Z: landscape), and adjusting the measurement antenna orientation, following C63.10 exploratory test procedures and only the worst case emissions were reported in this report.
- b. AC power line Conducted Emission was tested under maximum output power.

2.1 Carrier Frequency and Channel

BW 20M	Channel	1	5	9	13	17	21	25	29
	Freq. (MHz)	5955	5975	5995	6015	6035	6055	6075	6095
BW 40M	Channel	3		11		19		27	
	Freq. (MHz)	5965		6005		6045		6085	
BW 80M	Channel	7				23			
	Freq. (MHz)	5985				6065			
BW 160M	Channel	15							
	Freq. (MHz)	6025							

BW 20M	Channel	33	37	41	45	49	53	57	61
	Freq. (MHz)	6115	6135	6155	6175	6195	6215	6235	6255
BW 40M	Channel	35		43		51		59	
	Freq. (MHz)	6125		6165		6205		6245	
BW 80M	Channel	39				55			
	Freq. (MHz)	6145				6225			
BW 160M	Channel	47							
	Freq. (MHz)	6185							



BW 20M	Channel	65	69	73	77	81	85	89	93
	Freq. (MHz)	6275	6295	6315	6335	6355	6375	6395	6415
BW 40M	Channel	67		75		83		91	
	Freq. (MHz)	6285		6325		6365		6405	
BW 80M	Channel	71				87			
	Freq. (MHz)	6305				6385			
BW 160M	Channel	79							
	Freq. (MHz)	6345							

BW 20M	Channel	97	101	105	109	113	117	121	125
	Freq. (MHz)	6435	6455	6475	6495	6515	6535	6555	6575
BW 40M	Channel	99		107		115		123	
	Freq. (MHz)	6445		6485		6525		6565	
BW 80M	Channel	103				119			
	Freq. (MHz)	6465				6545			
BW 160M	Channel	111							
	Freq. (MHz)	6505							

BW 20M	Channel	129	133	137	141	145	149	153	157
	Freq. (MHz)	6595	6615	6635	6655	6675	6695	6715	6735
BW 40M	Channel	131		139		147		155	
	Freq. (MHz)	6605		6645		6685		6725	
BW 80M	Channel	135				151			
	Freq. (MHz)	6625				6705			
BW 160M	Channel	143							
	Freq. (MHz)	6665							

BW 20M	Channel	161	165	169	173	177	181	185	189
	Freq. (MHz)	6755	6775	6795	6815	6835	6855	6875	6895
BW 40M	Channel	163		171		179		187	
	Freq. (MHz)	6765		6805		6845		6885	
BW 80M	Channel	167				183			
	Freq. (MHz)	6785				6865			
BW 160M	Channel	175							
	Freq. (MHz)	6825							



BW 20M	Channel	193	197	201	205	209	213	217	221
	Freq. (MHz)	6915	6935	6955	6975	6995	7015	7035	7055
BW 40M	Channel	195		203		211		219	
	Freq. (MHz)	6925		6965		7005		7045	
BW 80M	Channel	199				215			
	Freq. (MHz)	6945				7025			
BW 160M	Channel	207							
	Freq. (MHz)	6985							
BW 20M	Channel	225				229			
	Freq. (MHz)	7075				7095			
BW 40M	Channel	227							
	Freq. (MHz)	7085							
BW 20M	Channel	233							
	Freq. (MHz)	7115							



2.2 Test Mode

This device support 26/52/106/242/484/996-tone RU but does not support 2x996-tone RU on 160MHz channel.

The PSD of partial RU is reduced to be smaller than full RU according to TCB workshop interim guidance Oct. 2018.

The 802.11ax mode is investigated among different tones, full resource units (RU), partial resource units. The partial RU has no higher power than full RU's, thus the full RU is chosen as main test configuration.

The 242-tone RU is covered by 20MHz channel, 484-tone RU is covered by 40MHz channel and 996-tone RU is covered by 80MHz channel.

The SISO mode conducted power is covered by MIMO mode per chain, so only the MIMO mode is tested.

The conducted power and PSD for indoor client mode is smaller than standard client mode, so all other conducted and radiated test is covered by standard client mode.

The power for 802.11n and 802.11ac mode is smaller than 802.11ax mode, so all other conducted and radiated test is covered by 802.11ax mode.

The SISO mode conducted power is covered by MIMO mode per chain, so only the MIMO mode is tested.

The SDM mode is chosen as main configuration for all MIMO test cases due to SDM EIRP is higher than CDD and TXBF modes.

The radiated spurious emission is tested under SDM because the conducted power for SDM mode is 3dB higher than TXBF mode and CDD modes. The high power condition dominants the result of unwanted spurious emissions.

The final test modes include the worst data rates for each modulation shown in the table below.



<SDM Mode>

<Indoor Client>

Modulation	Data Rate
802.11n HT20 (Covered by HE20)	MCS0
802.11n HT40 (Covered by HE40)	MCS0
802.11ac VHT20 (Covered by HE20)	MCS0
802.11ac VHT40 (Covered by HE40)	MCS0
802.11ac VHT80 (Covered by HE80)	MCS0
802.11ac VHT160 (Covered by HE160)	MCS0
802.11ax HE20	MCS0
802.11ax HE40	MCS0
802.11ax HE80	MCS0
802.11ax HE160	MCS0

<Standard Client>

Modulation	Data Rate
802.11n HT20 (Covered by HE20)	MCS0
802.11n HT40 (Covered by HE40)	MCS0
802.11ac VHT20 (Covered by HE20)	MCS0
802.11ac VHT40 (Covered by HE40)	MCS0
802.11ac VHT80 (Covered by HE80)	MCS0
802.11ac VHT160 (Covered by HE160)	MCS0
802.11ax HE20	MCS0
802.11ax HE40	MCS0
802.11ax HE80	MCS0
802.11ax HE160	MCS0



<CDD Mode>

<Indoor Client>

Modulation	Data Rate
802.11a	6 Mbps
802.11n HT20 (Covered by HE20)	MCS0
802.11n HT40 (Covered by HE40)	MCS0
802.11ac VHT20 (Covered by HE20)	MCS0
802.11ac VHT40 (Covered by HE40)	MCS0
802.11ac VHT80 (Covered by HE80)	MCS0
802.11ac VHT160 (Covered by HE160)	MCS0
802.11ax HE20	MCS0
802.11ax HE40	MCS0
802.11ax HE80	MCS0
802.11ax HE160	MCS0

<Standard Client>

Modulation	Data Rate
802.11a	6 Mbps
802.11n HT20 (Covered by HE20)	MCS0
802.11n HT40 (Covered by HE40)	MCS0
802.11ac VHT20 (Covered by HE20)	MCS0
802.11ac VHT40 (Covered by HE40)	MCS0
802.11ac VHT80 (Covered by HE80)	MCS0
802.11ac VHT160 (Covered by HE160)	MCS0
802.11ax HE20	MCS0
802.11ax HE40	MCS0
802.11ax HE80	MCS0
802.11ax HE160	MCS0



<TXBF Mode>

<Indoor Client>

Modulation	Data Rate
802.11n HT20 (Covered by HE20)	MCS0
802.11n HT40 (Covered by HE40)	MCS0
802.11ac VHT20 (Covered by HE20)	MCS0
802.11ac VHT40 (Covered by HE40)	MCS0
802.11ac VHT80 (Covered by HE80)	MCS0
802.11ac VHT160 (Covered by HE160)	MCS0
802.11ax HE20	MCS0
802.11ax HE40	MCS0
802.11ax HE80	MCS0
802.11ax HE160	MCS0

<Standard Client>

Modulation	Data Rate
802.11n HT20 (Covered by HE20)	MCS0
802.11n HT40 (Covered by HE40)	MCS0
802.11ac VHT20 (Covered by HE20)	MCS0
802.11ac VHT40 (Covered by HE40)	MCS0
802.11ac VHT80 (Covered by HE80)	MCS0
802.11ac VHT160 (Covered by HE160)	MCS0
802.11ax HE20	MCS0
802.11ax HE40	MCS0
802.11ax HE80	MCS0
802.11ax HE160	MCS0

Remark: The conducted power level of each chain in MIMO mode is equal or higher than SISO mode.

Test Cases	
AC Conducted Emission	Mode 1 : WLAN (5GHz) Link + Bluetooth Link + NFC On + USB TYPE A to TYPE C cable (Charging with Adapter) + Battery 1X for Sample 1
Remark: For Radiated Test Cases, the tests were performed with Battery 1X.	



Ch. #		UNII-5 (5925-6425 MHz)	UNII-6 (6425-6525 MHz)	UNII-7 (6525-6875 MHz)	UNII-8 (6875-7125 MHz)
		802.11a	802.11a	802.11a	802.11a
L	Low	001	097	117	189
M	Middle	049	105	149	209
					-
H	High	093	113	-	233
Straddle		-	-	185	-

Ch. #		UNII-5 (5925-6425 MHz)	UNII-6 (6425-6525 MHz)	UNII-7 (6525-6875 MHz)	UNII-8 (6875-7125 MHz)
		802.11ax HE20	802.11ax HE20	802.11ax HE20	802.11ax HE20
L	Low	001	097	117	189
M	Middle	049	105	149	209
H	High	093	113	-	233
Straddle		-	-	185	-

Ch. #		UNII-5 (5925-6425 MHz)	UNII-6 (6425-6525 MHz)	UNII-7 (6525-6875 MHz)	UNII-8 (6875-7125 MHz)
		802.11ax HE40	802.11ax HE40	802.11ax HE40	802.11ax HE40
L	Low	003	099	123	195
M	Middle	051	-	147	211
H	High	091	107	-	227
Straddle		-	115	187	-

Ch. #		UNII-5 (5925-6425 MHz)	UNII-6 (6425-6525 MHz)	UNII-7 (6525-6875 MHz)	UNII-8 (6875-7125 MHz)
		802.11ax HE80	802.11ax HE80	802.11ax HE80	802.11ax HE80
L	Low	007	103	135	199
M	Middle	055		151	-
H	High	087		-	215
Straddle		-	119	183	-

Ch. #		UNII-5 (5925-6425 MHz)	UNII-6 (6425-6525 MHz)	UNII-7 (6525-6875 MHz)	UNII-8 (6875-7125 MHz)
		802.11ax HE160	802.11ax HE160	802.11ax HE160	802.11ax HE160
L	Low	015	-	143	207
M	Middle	047			
H	High	079			
Straddle		-	111	175	-

Remark: Based on ANSI C63.10 clause 5.6.2.2, b) Spurious emissions, measure the mode with the highest output power and the mode with highest output power spectral density for each modulation family.

2.3 Connection Diagram of Test System

<AC Conducted Emission Mode>

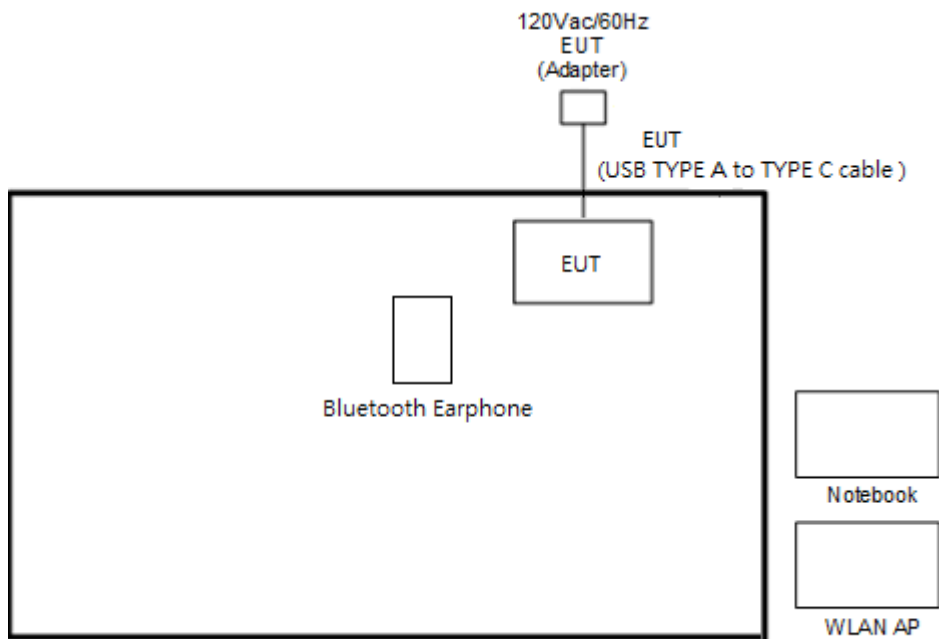

<WLAN Tx Mode>

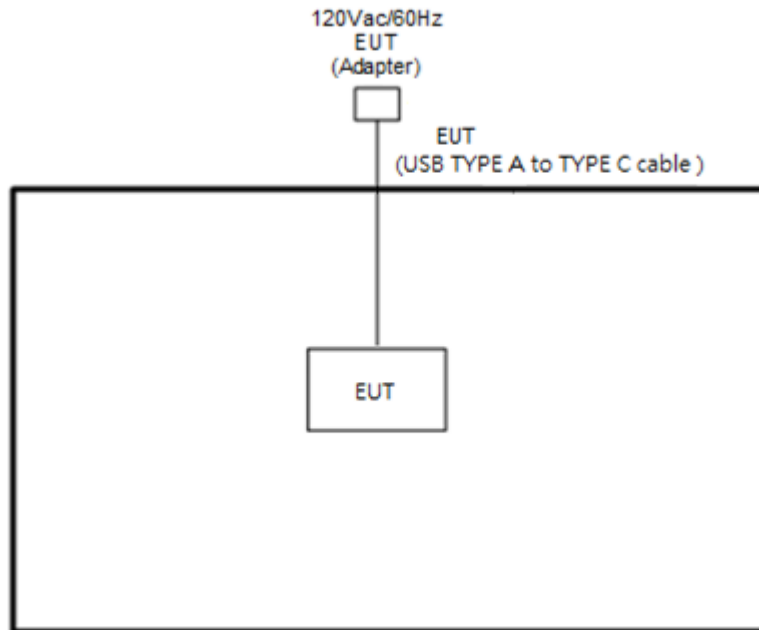

2.4 Support Unit used in test configuration and system

Item	Equipment	Brand Name	Model Name	FCC ID	Data Cable	Power Cord
1.	Bluetooth Earphone	Sony Ericsson	MW600	PY700A2029	N/A	N/A
2.	WLAN AP	ASUS	RT-AC66U	MSQ-RTAC66U	N/A	Unshielded, 1.8m
3.	Notebook	Dell	Latitude 3400	FCC DoC	N/A	AC I/P: Unshielded, 1.2 m DC O/P: Shielded, 1.8 m
4.	SD Card	SanDisk	MicroSD HC	FCC DoC	N/A	N/A



2.5 EUT Operation Test Setup

The RF test items, utility “QRCT v4.0.00194.0” was installed in Notebook which was programmed in order to make the EUT get into the engineering modes to provide channel selection, power level, data rate and the application type and for continuous transmitting signals.

For TXBF mode, the modulation modes and data rates manipulated by the command lines in the engineering program made the EUT link to another EUT by power under the normal operation. The “QRCT v4.0.00194.0” software tool was used to enable the EUT to transmit signals continuously.

2.6 Measurement Results Explanation Example

For all conducted test items:

The offset level is set in the spectrum analyzer to compensate the RF cable loss and attenuator factor between EUT conducted output port and spectrum analyzer. With the offset compensation, the spectrum analyzer reading level is exactly the EUT RF output level.

Example :

The spectrum analyzer offset is derived from RF cable loss and attenuator factor.

Offset = RF cable loss + attenuator factor.

Following shows an offset computation example with cable loss 4.2 dB and 10dB attenuator.

$$\begin{aligned} \text{Offset(dB)} &= \text{RF cable loss(dB)} + \text{attenuator factor(dB)}. \\ &= 4.2 + 10 = 14.2 \text{ (dB)} \end{aligned}$$

3 Test Result

3.1 26dB & 99% Occupied Bandwidth Measurement

3.1.1 Limit of 26dB & 99% Occupied Bandwidth

<FCC 14-30 CFR 15.407>

(a)(10) The maximum transmitter channel bandwidth for U-NII devices in the 5.925-7.125 GHz band is 320 megahertz.

3.1.2 Measuring Instruments

Please refer to the measuring equipment list in this test report.

3.1.3 Test Procedures

1. The testing follows FCC KDB 789033 D02 General UNII Test Procedures New Rules v02r01. Section C) Emission bandwidth
2. Set RBW = approximately 1% of the emission bandwidth.
3. Set the VBW > RBW.
4. Detector = Peak.
5. Trace mode = max hold
6. Measure the maximum width of the emission that is 26 dB down from the peak of the emission. Compare this with the RBW setting of the analyzer. Readjust RBW and repeat measurement as needed until the RBW/EBW ratio is approximately 1%.
7. For 99% Bandwidth Measurement, the spectrum analyzer's resolution bandwidth (RBW) is set 1-5% of the emission bandwidth and set the Video bandwidth (VBW) $\geq 3 * RBW$.
8. Measure and record the results in the test report.

3.1.4 Test Setup

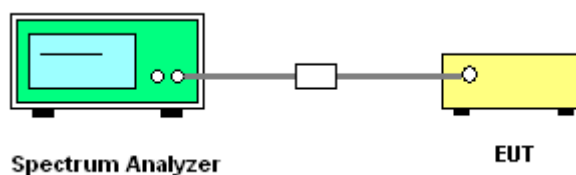

3.1.5 Test Result of 26dB & 99% Occupied Bandwidth

Please refer to Appendix A.



MIMO <Ant. 9+8>

<SDM Mode>

<Indoor Client>

<802.11ax HE20>

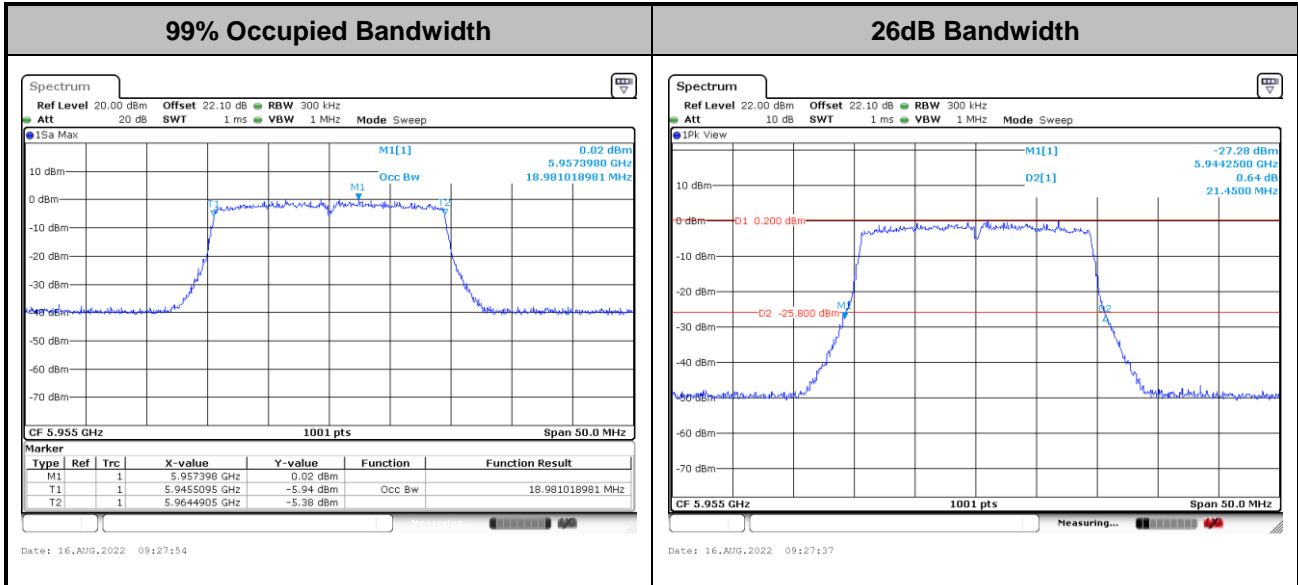

Note: The occupied channel bandwidth is maintained within the band of operation for all of the modulations.

<802.11ax HE40>

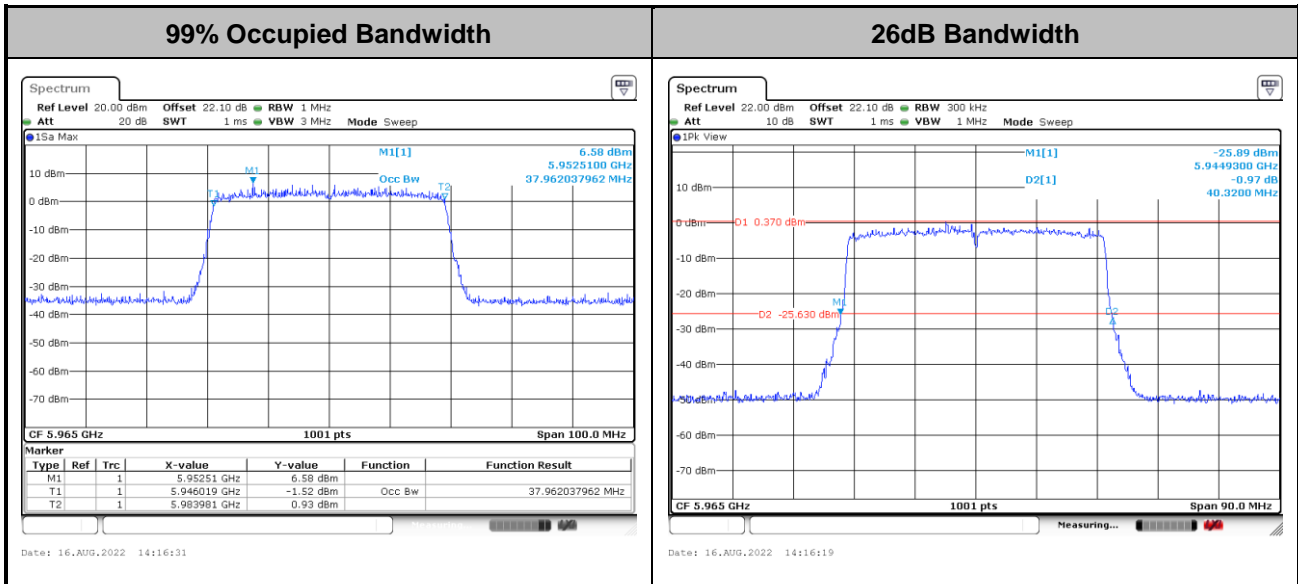

Note: The occupied channel bandwidth is maintained within the band of operation for all of the modulations.



<802.11ax HE80>

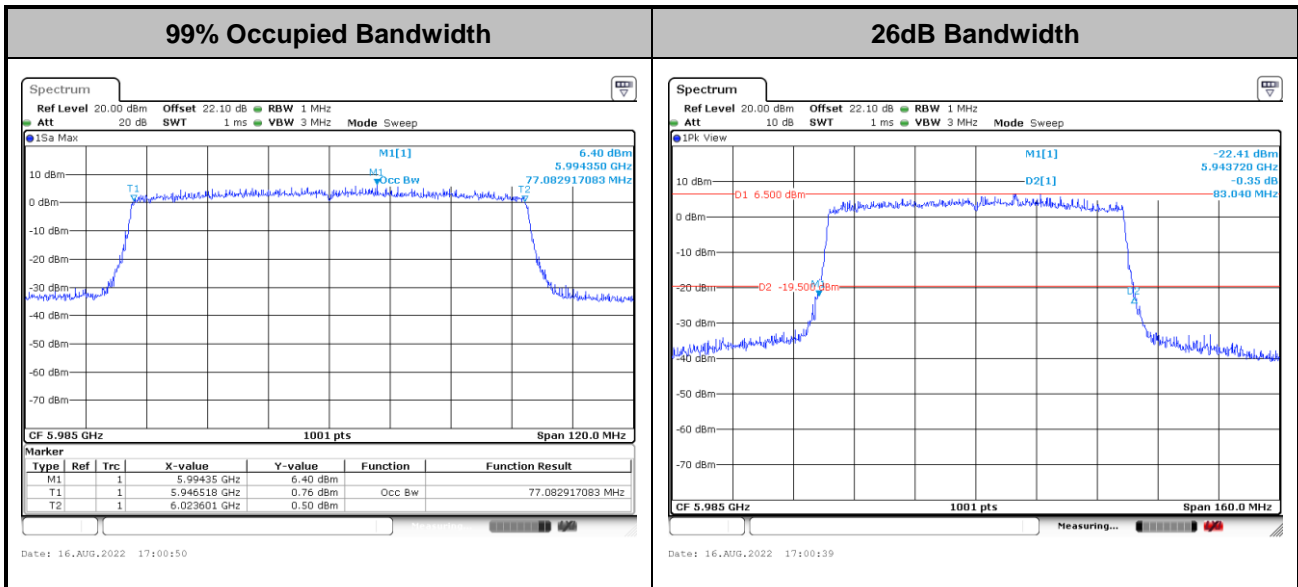

Note: The occupied channel bandwidth is maintained within the band of operation for all of the modulations.

<802.11ax HE160>

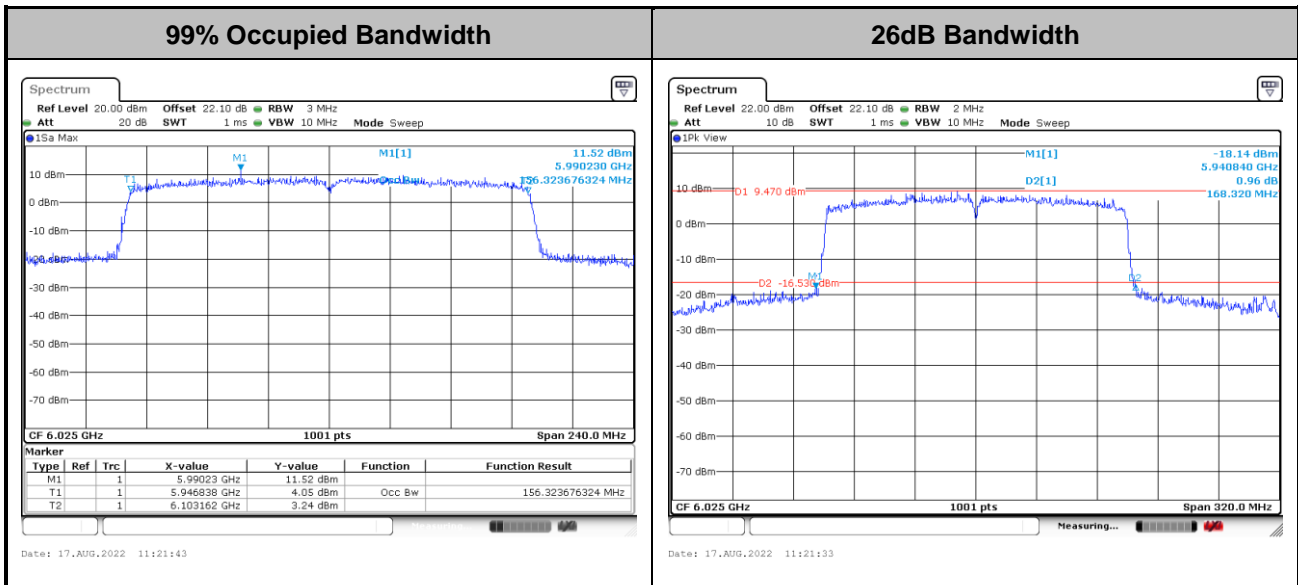

Note: The occupied channel bandwidth is maintained within the band of operation for all of the modulations.



<Standard Client>

<802.11ax HE20>

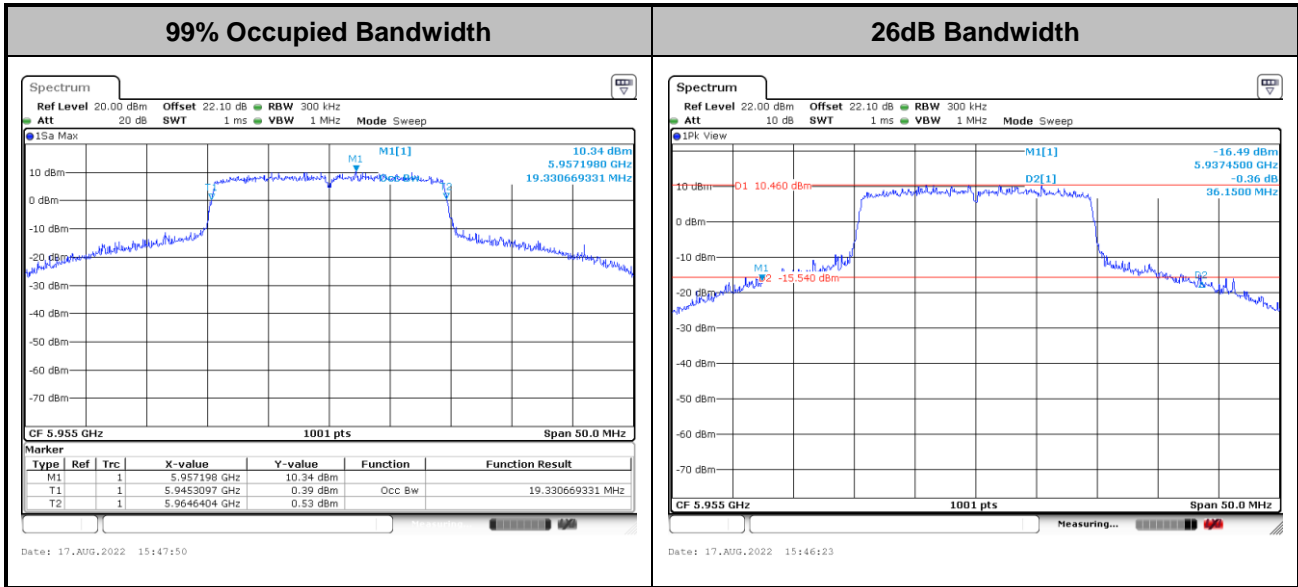

Note: The occupied channel bandwidth is maintained within the band of operation for all of the modulations.

<802.11ax HE40>

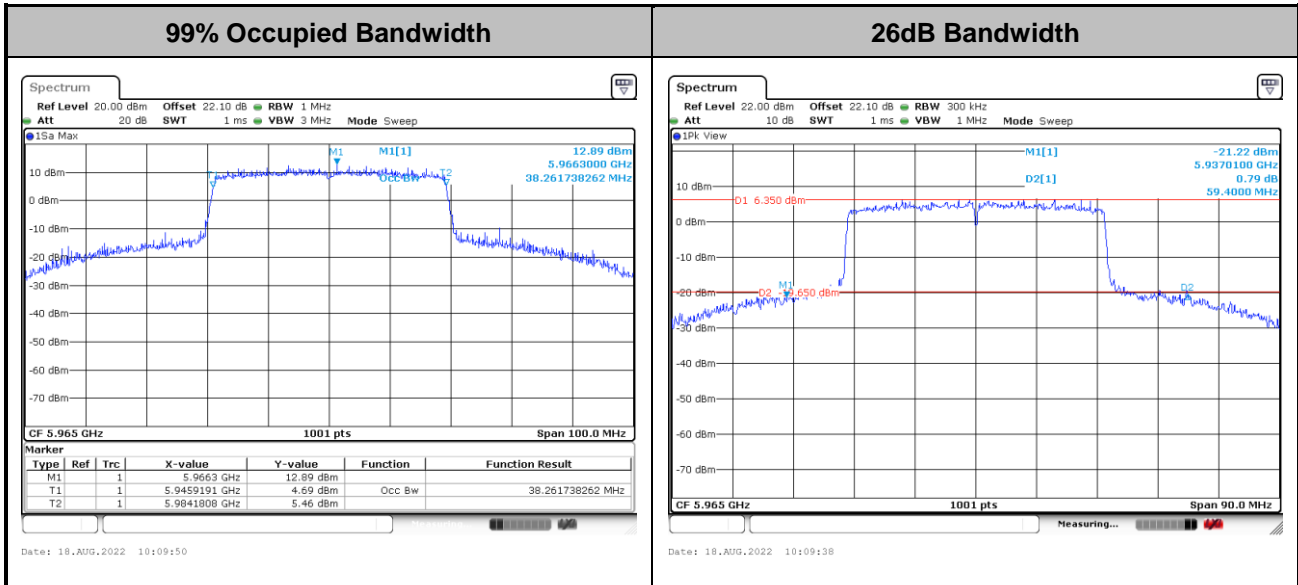

Note: The occupied channel bandwidth is maintained within the band of operation for all of the modulations.



<802.11ax HE80>

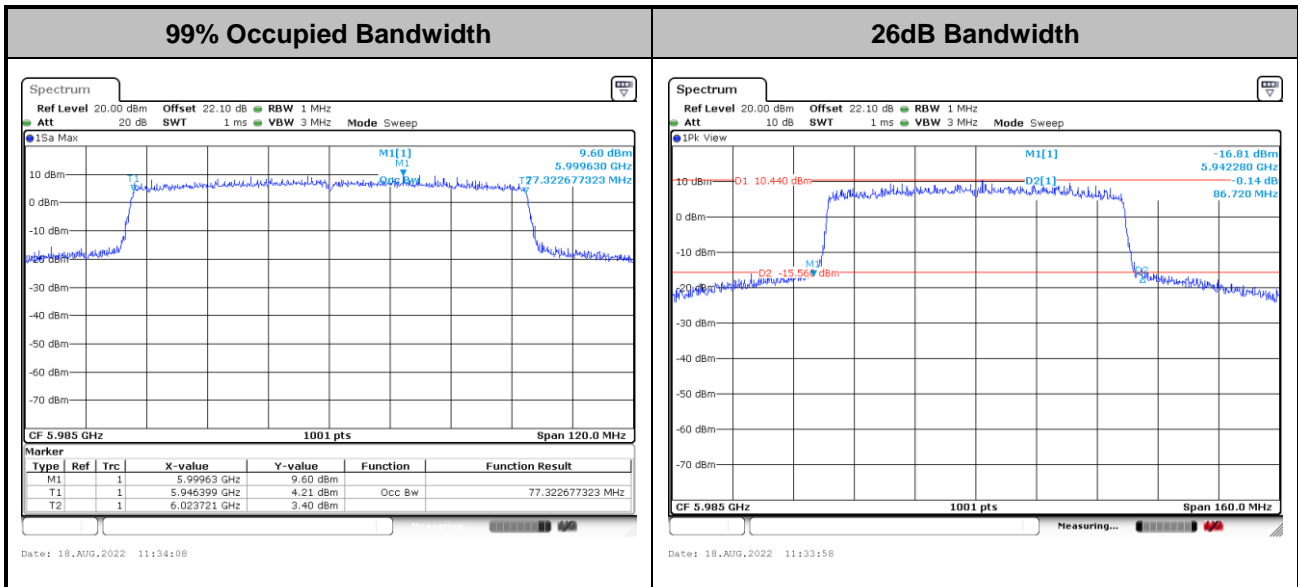

Note: The occupied channel bandwidth is maintained within the band of operation for all of the modulations.

<802.11ax HE160>

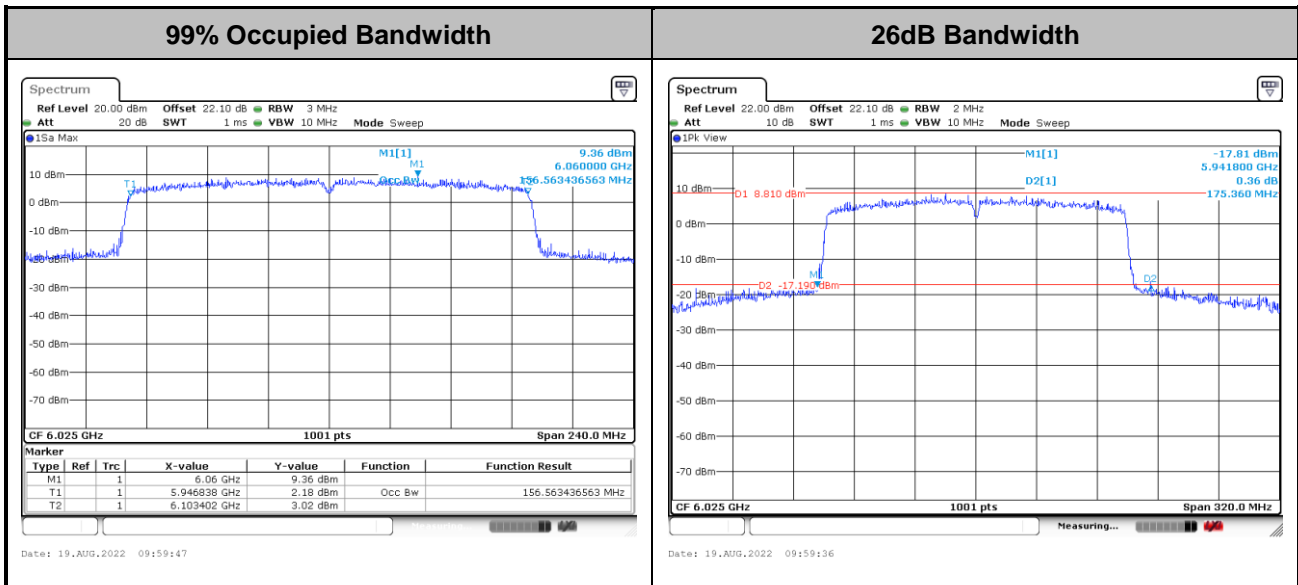

Note: The occupied channel bandwidth is maintained within the band of operation for all of the modulations.



<CDD Mode>

<Indoor Client>

<802.11a>

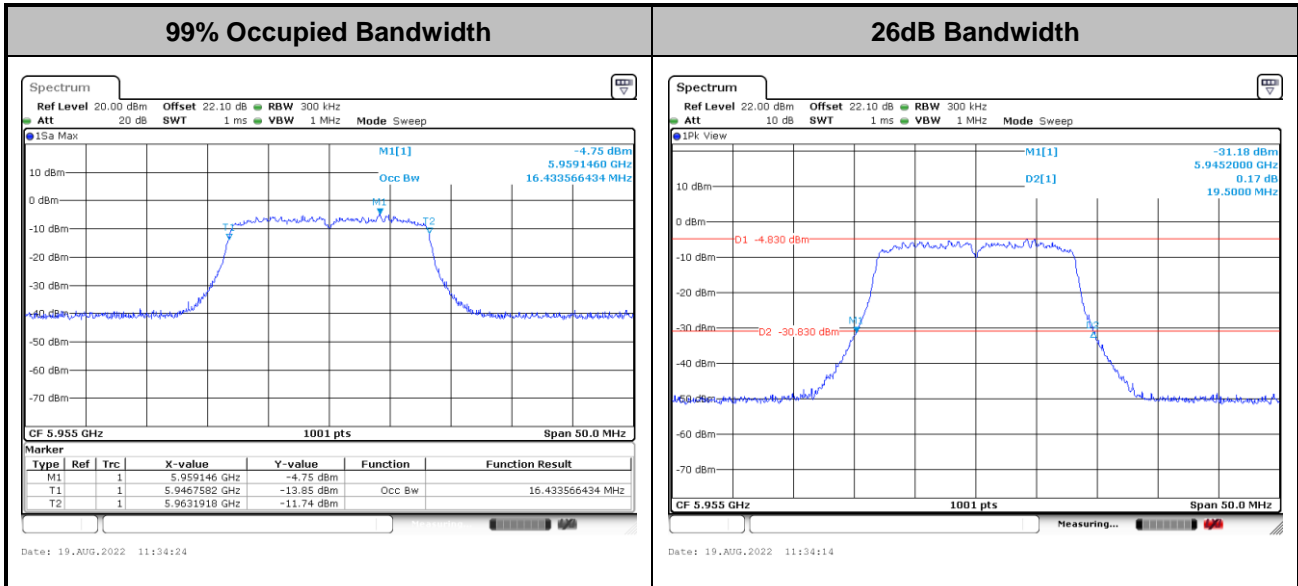

Note: The occupied channel bandwidth is maintained within the band of operation for all of the modulations.

<Standard Client>

<802.11a>

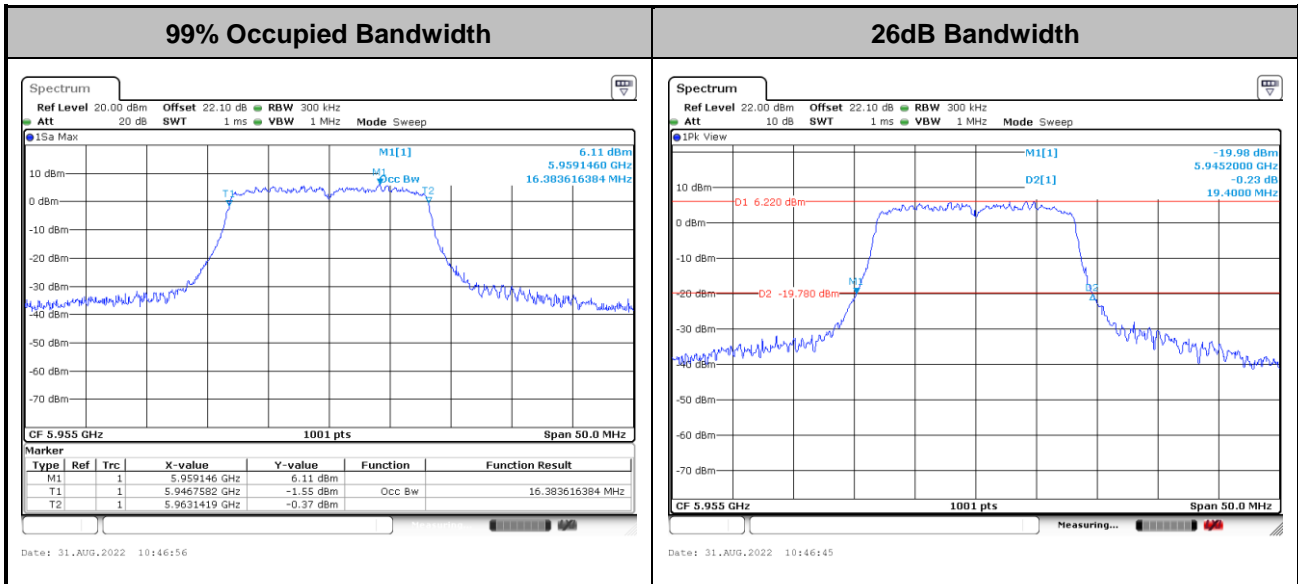

Note: The occupied channel bandwidth is maintained within the band of operation for all of the modulations.



3.2 Fundamental Maximum EIRP Measurement

3.2.1 Limit of Fundamental Maximum EIRP

<FCC 14-30 CFR 15.407>

(a)(7) For client devices, except for fixed client devices as defined in this subpart, operating under the control of a standard power access

point in 5.925-6.425 GHz and 6.525-6.875 GHz bands, the maximum power spectral density must not exceed 17 dBm e.i.r.p. in any 1-megahertz band, and the maximum e.i.r.p. over the frequency band of operation must not exceed 30 dBm and the device must limit its power to no more than 6 dB below its associated standard power access point's authorized transmit power.

(a)(8) For client devices operating under the control of an indoor access point in the 5.925-7.125 GHz bands, the maximum e.i.r.p. over the frequency band of operation must not exceed 24 dBm.

3.2.2 Measuring Instruments

Please refer to the measuring equipment list in this test report.

3.2.3 Test Procedures

<CDD and SDM Modes>

The testing follows Method PM-G of FCC KDB 789033 D02 General UNII Test Procedures New Rules v02r01.

Method PM-G (Measurement using a gated RF average power meter):

1. Measurement is performed using a wideband RF power meter.
2. The EUT is configured to transmit at its maximum power control level.
3. Measure the average power of the transmitter.
4. Since the measurement is made only during the ON time of the transmitter, no duty cycle correction factor is required.
5. For MIMO mode, calculation method follows FCC KDB 662911 D01 Multiple Transmitter Output v02r01.

<TXBF Modes>

The testing follows Method PM-G of FCC KDB 789033 D02 General UNII Test Procedures New Rules v02r01.

Method PM-G (Measurement using a gated RF average power meter):

1. Measurement is performed using a wideband RF power meter.
2. The EUT is configured to transmit at its maximum power control level.
3. Measure the average power of the transmitter
4. Since the measurement is made only during the ON time of the transmitter, no duty cycle correction factor is required.
5. For MIMO mode, calculation method follows FCC KDB 662911 D01 Multiple Transmitter Output v02r01.

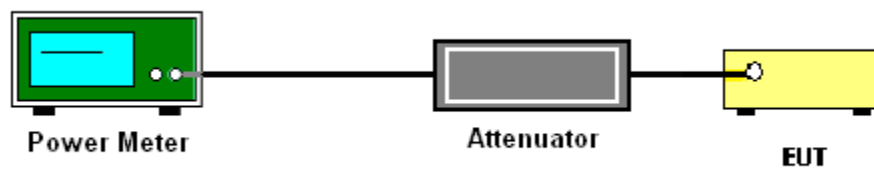
3.2.4 Test Setup**3.2.5 Test Result of Fundamental Maximum EIRP**

Please refer to Appendix A.



3.3 Fundamental Power Spectral Density Measurement

3.3.1 Limit of Fundamental Power Spectral Density

<FCC 14-30 CFR 15.407>

(a)(8) For client devices operating under the control of an indoor access point in the 5.925-7.125 GHz bands, the maximum power spectral density must not exceed -1 dBm e.i.r.p. in any 1-megahertz band.

(a)(7) For client devices, except for fixed client devices as defined in this subpart, operating under the control of a standard power access point in 5.925-6.425 GHz and 6.525-6.875 GHz bands, the maximum power spectral density must not exceed 17 dBm e.i.r.p. in any 1-megahertz band.

3.3.2 Measuring Instruments

Please refer to the measuring equipment list in this test report.



3.3.3 Test Procedures

The testing follows FCC KDB 789033 D02 General UNII Test Procedures New Rules v02r01.
Section F) Maximum power spectral density.

<CDD and SDM Modes>

Method SA-2

(trace averaging across on and off times of the EUT transmissions, followed by duty cycle correction).

- Measure the duty cycle.
- Set span to encompass the entire emission bandwidth (EBW) of the signal.
- Set RBW = 1 MHz.
- Set VBW \geq 3 MHz.
- Number of points in sweep \geq 2 Span / RBW.
- Sweep time = auto.
- Detector = RMS
- Trace average at least 100 traces in power averaging mode.
- Add $10 \log(1/x)$, where x is the duty cycle, to the measured power in order to compute the average power during the actual transmission times. For example, add $10 \log(1/0.25) = 6$ dB if the duty cycle is 25 percent.

<TXBF Modes>

Method SA-3

(power averaging (rms) detection with max hold):

- Set span to encompass the entire emission bandwidth (EBW) of the signal.
- Set RBW = 1 MHz.
- Set VBW \geq 3 MHz.
- Number of points in sweep \geq 2 Span / RBW.
- Sweep time \leq (number of points in sweep) \times T, when duty cycle is less than 98 percent where T is the minimum transmission duration over which the transmitter is on and is transmitting at its maximum power control level for the tested mode of operation.
- Detector = power averaging (rms).
- Trace mode = max hold.
- Allow max hold to run for at least 60 seconds, or longer as needed to allow the trace to stabilize.

1. The RF output of EUT was connected to the spectrum analyzer by a low loss cable.
2. Each plot has already offset with cable loss, and attenuator loss. Measure the PPSD and record it.
3. For MIMO mode, calculation method follows FCC KDB 662911 D01 Multiple Transmitter Output v02r01.

Method (a): Measure and sum the spectra across the outputs.

The total final Power Spectral Density is from a device with 2 transmitter outputs. The spectrum measurements of the individual outputs are all performed with the same span and number of points; the spectrum value in the first spectral bin of output 1 is summed with that in the first spectral bin of output 2 to obtain the value for the first frequency bin of the summed spectrum.

3.3.4 Test Setup

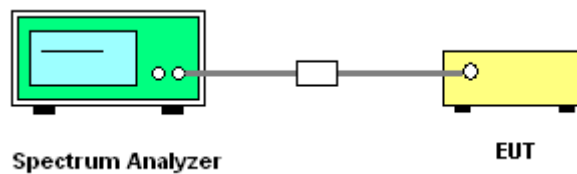

3.3.5 Test Result of Power Spectral Density

Please refer to Appendix A.



<SDM Mode>

<Indoor Client>

<802.11ax HE20>

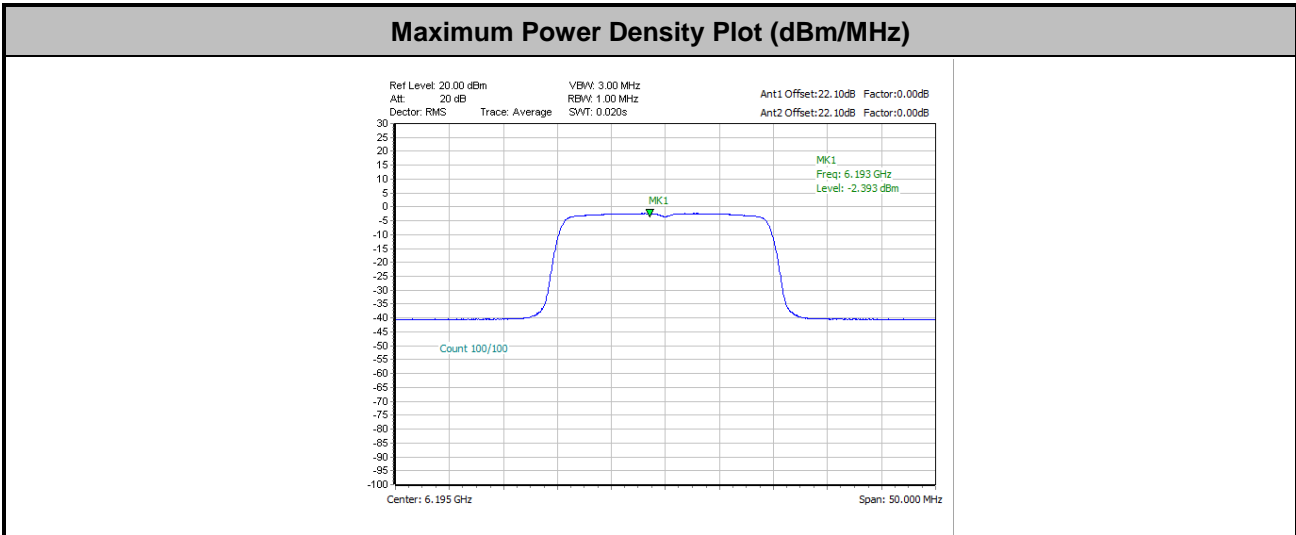

Note:

1. EIRP Power Density (dBm/MHz) = Measured value+ Duty Factor + Directional Gain
2. The test plot is showing a bin by bin combined result mathematically adds two traces.

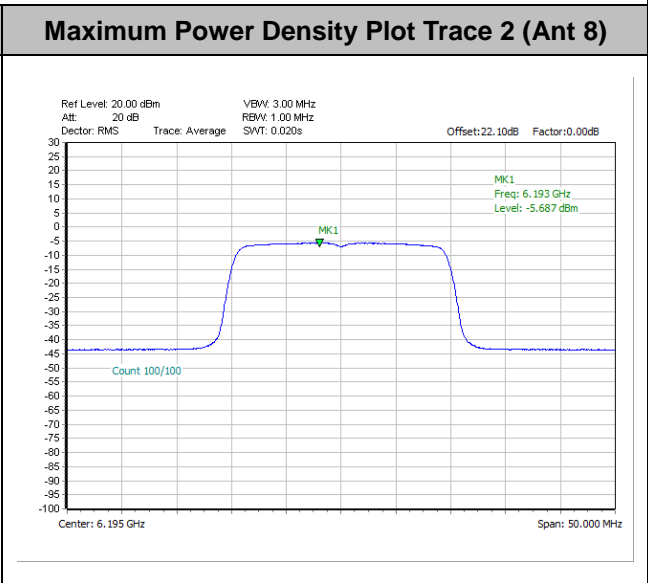
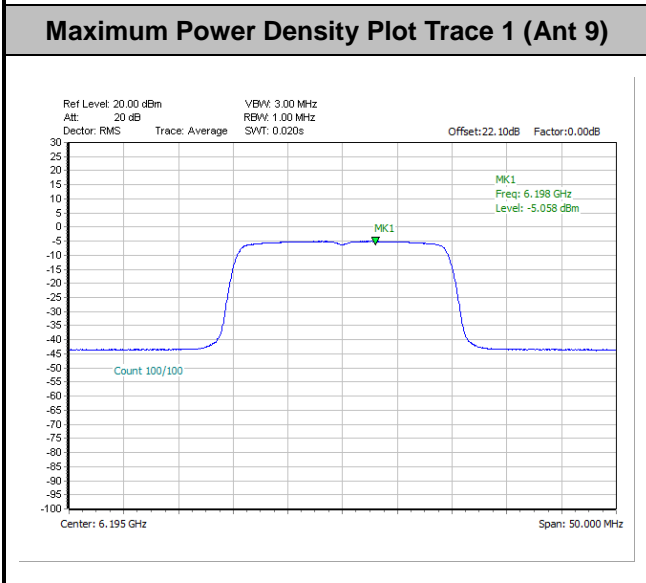



<802.11ax HE40>

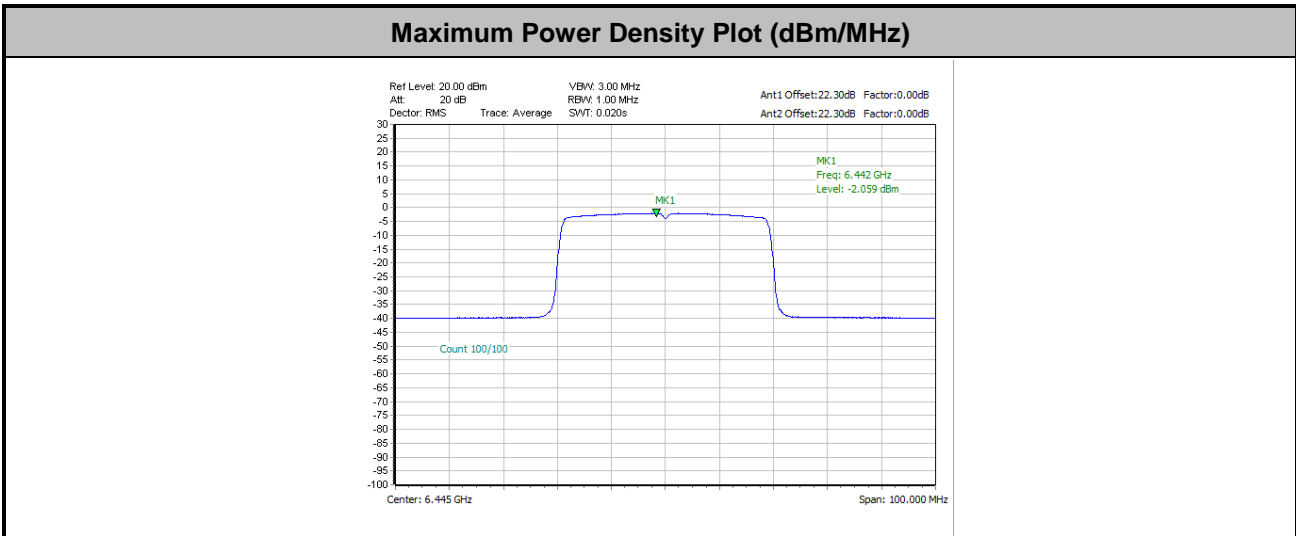

Note:

1. EIRP Power Density (dBm/MHz) = Measured value+ Duty Factor + Directional Gain
2. The test plot is showing a bin by bin combined result mathematically adds two traces.

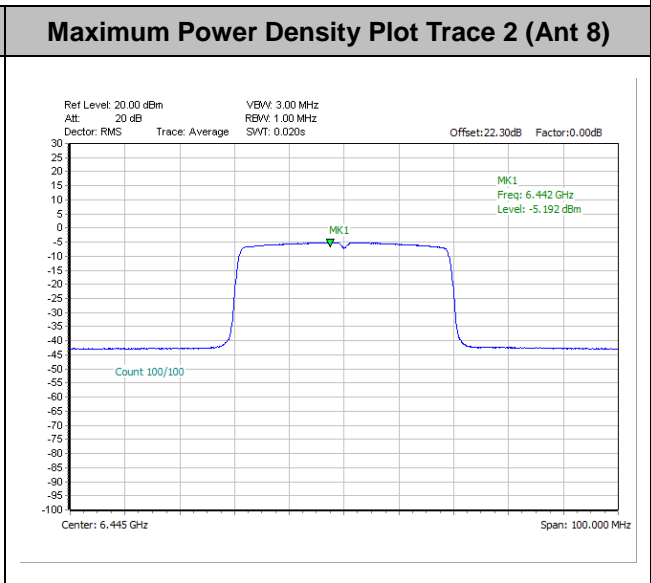
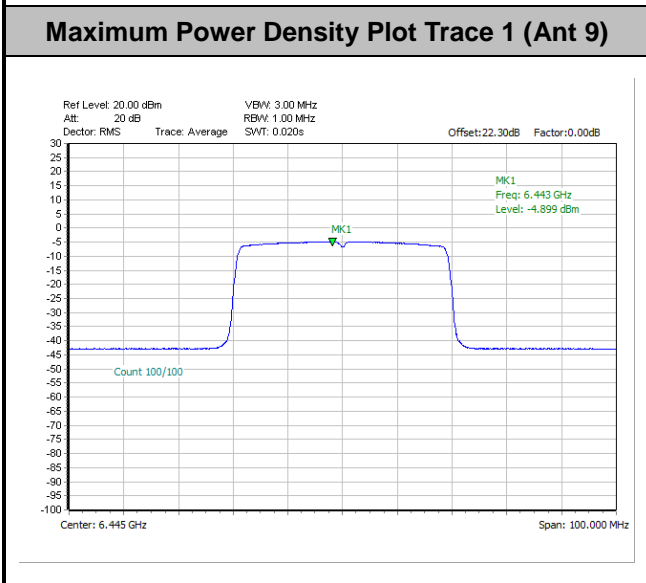



<802.11ax HE80>

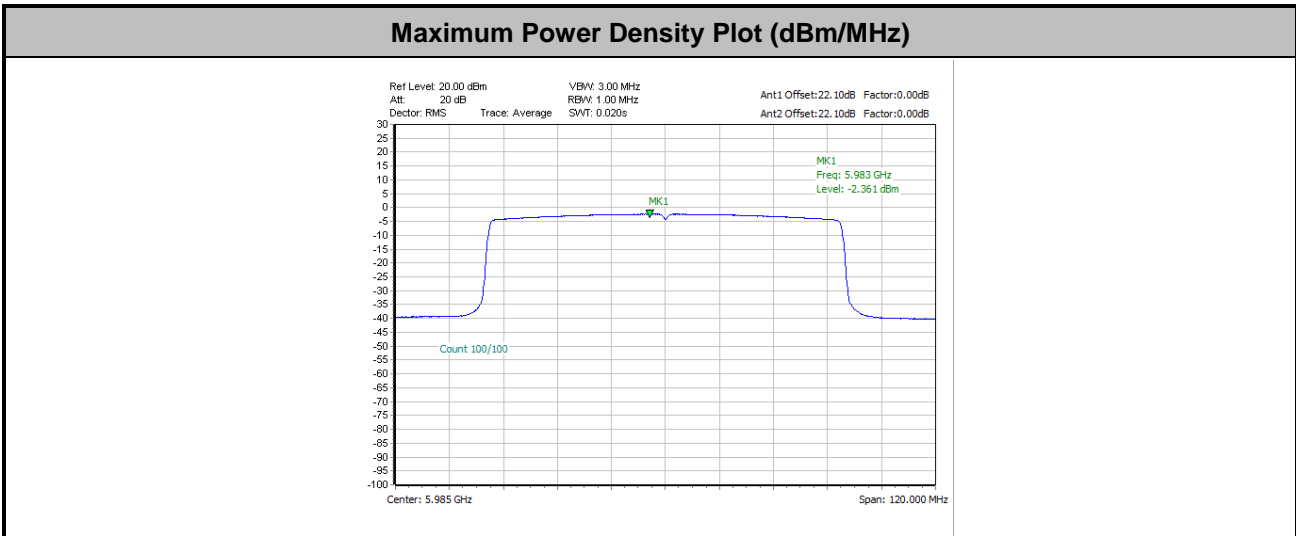

Note:

1. EIRP Power Density (dBm/MHz) = Measured value+ Duty Factor + Directional Gain
2. The test plot is showing a bin by bin combined result mathematically adds two traces.

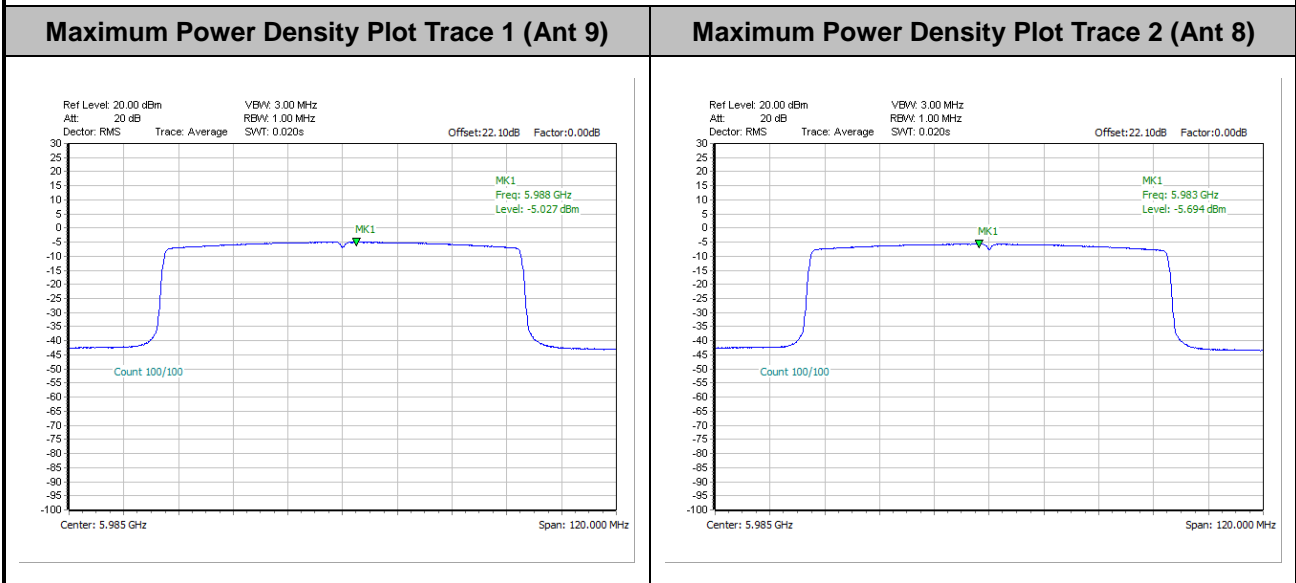



<802.11ax HE160>

Maximum Power Density Plot (dBm/MHz)

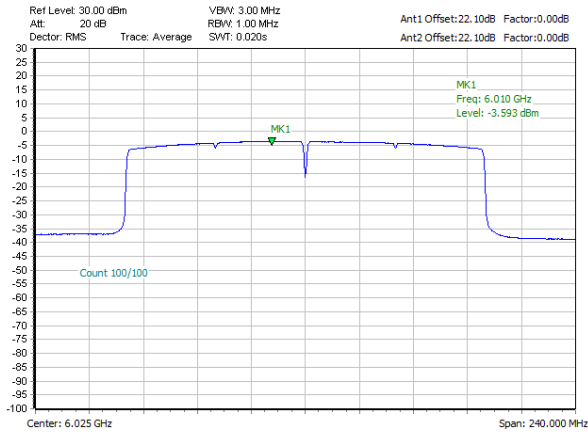

Note:

1. EIRP Power Density (dBm/MHz) = Measured value+ Duty Factor + Directional Gain
2. The test plot is showing a bin by bin combined result mathematically adds two traces.

Maximum Power Density Plot Trace 1 (Ant 9)

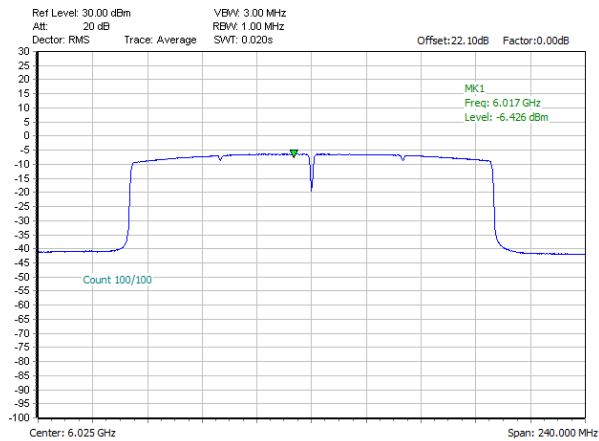

Maximum Power Density Plot Trace 2 (Ant 8)

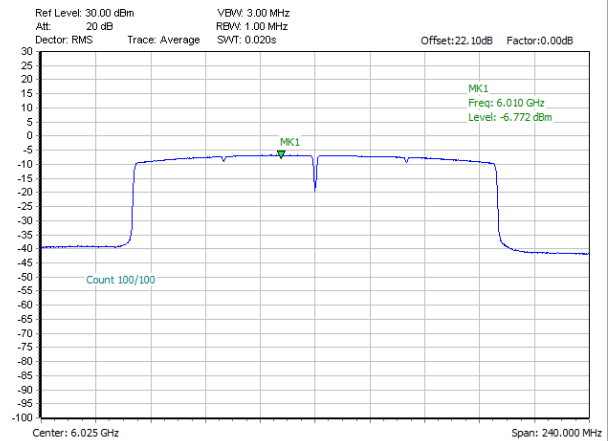



<SDM Mode>

<Standard Client>

<802.11ax HE20>

Maximum Power Density Plot (dBm/MHz)

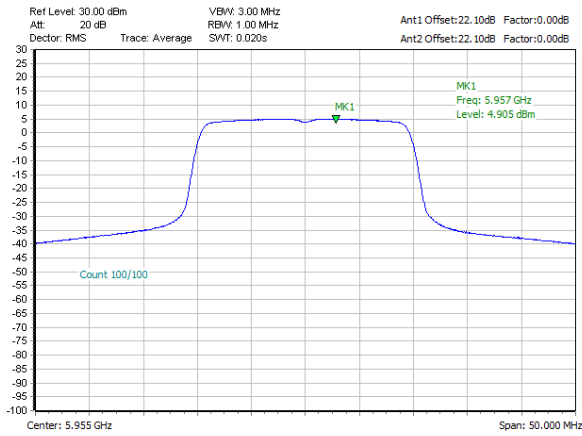

Note:

1. EIRP Power Density (dBm/MHz) = Measured value+ Duty Factor + Directional Gain
2. The test plot is showing a bin by bin combined result mathematically adds two traces.

Maximum Power Density Plot Trace 1 (Ant 9)

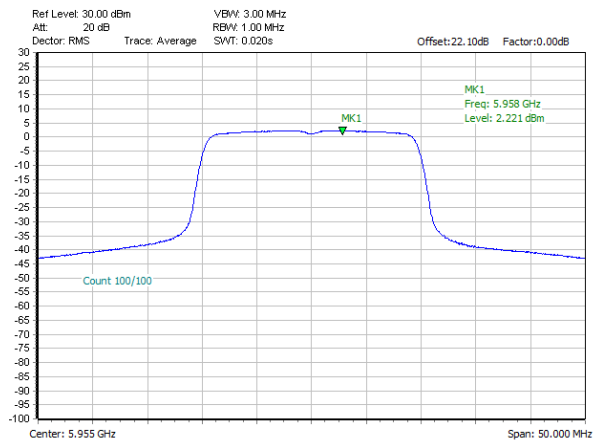

Maximum Power Density Plot Trace 2 (Ant 8)

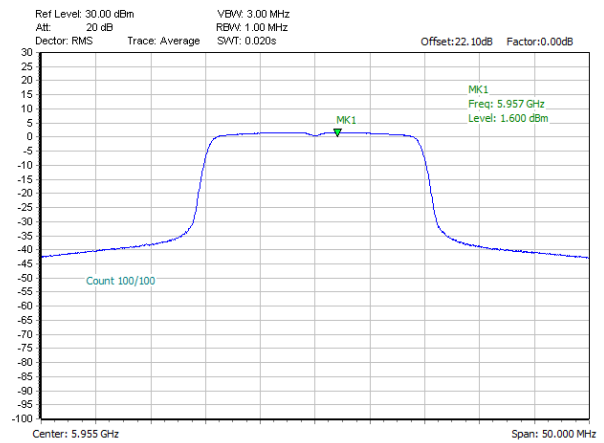



<802.11ax HE40>

Maximum Power Density Plot (dBm/MHz)

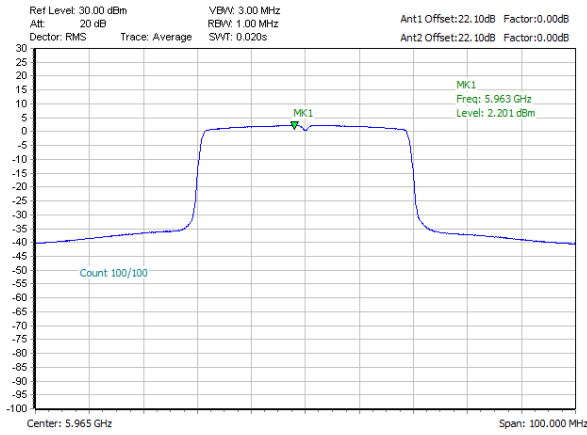

Note:

1. EIRP Power Density (dBm/MHz) = Measured value+ Duty Factor + Directional Gain
2. The test plot is showing a bin by bin combined result mathematically adds two traces.

Maximum Power Density Plot Trace 1 (Ant 9)

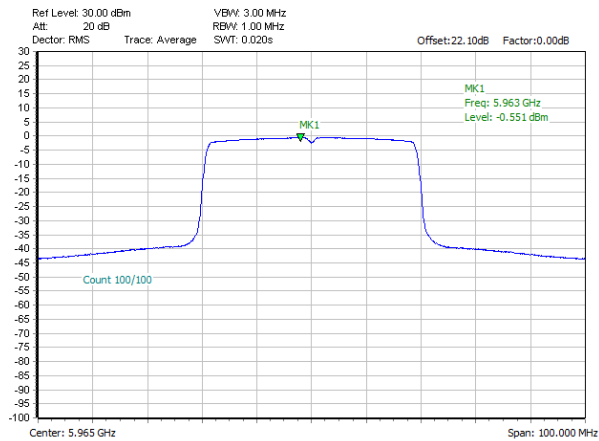

Maximum Power Density Plot Trace 2 (Ant 8)

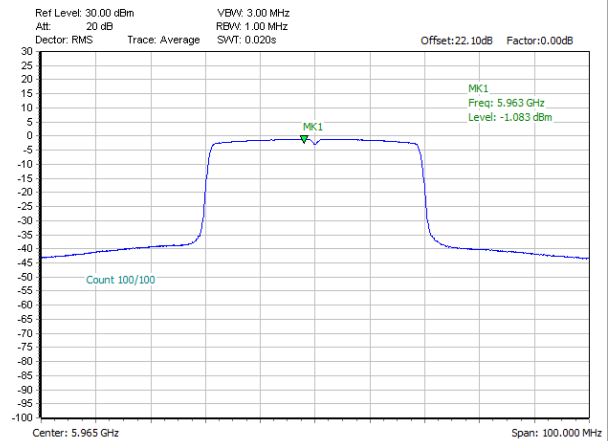



<802.11ax HE80>

Maximum Power Density Plot (dBm/MHz)

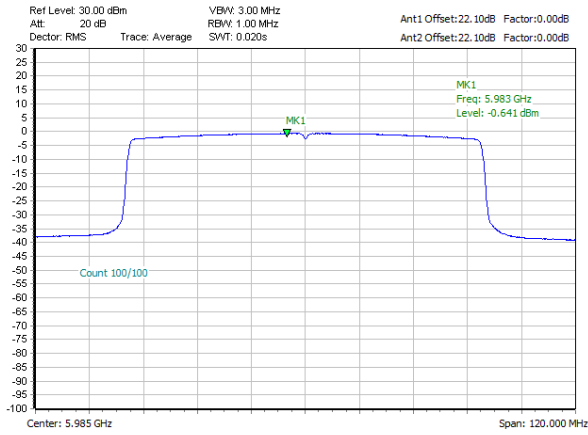

Note:

1. EIRP Power Density (dBm/MHz) = Measured value+ Duty Factor + Directional Gain
2. The test plot is showing a bin by bin combined result mathematically adds two traces.

Maximum Power Density Plot Trace 1 (Ant 9)

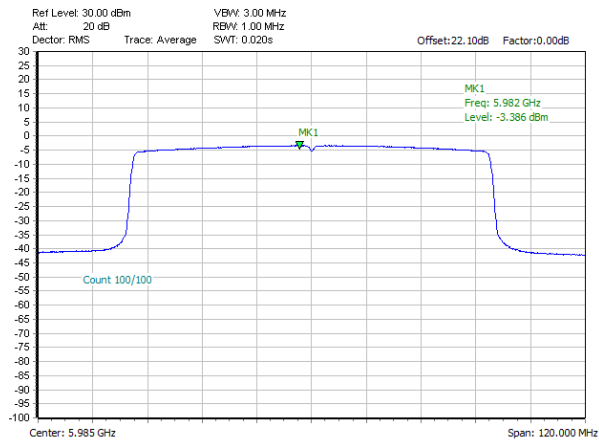

Maximum Power Density Plot Trace 2 (Ant 8)

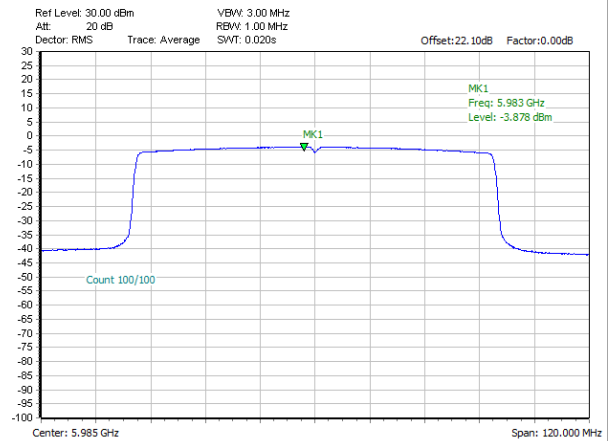



<802.11ax HE160>

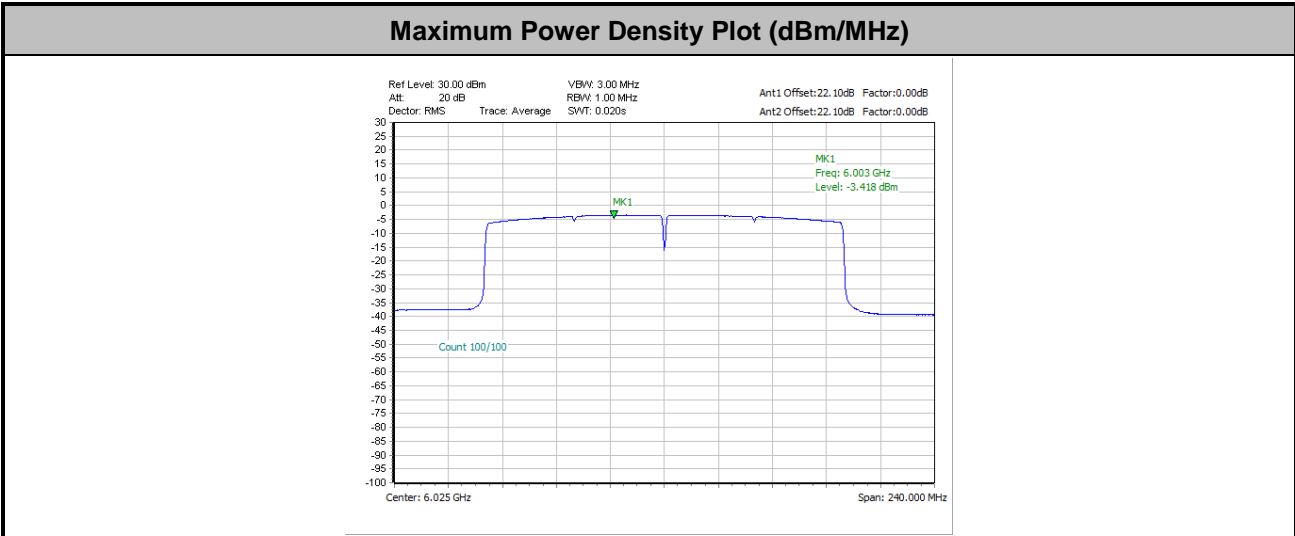

Note:

1. EIRP Power Density (dBm/MHz) = Measured value+ Duty Factor + Directional Gain
2. The test plot is showing a bin by bin combined result mathematically adds two traces.

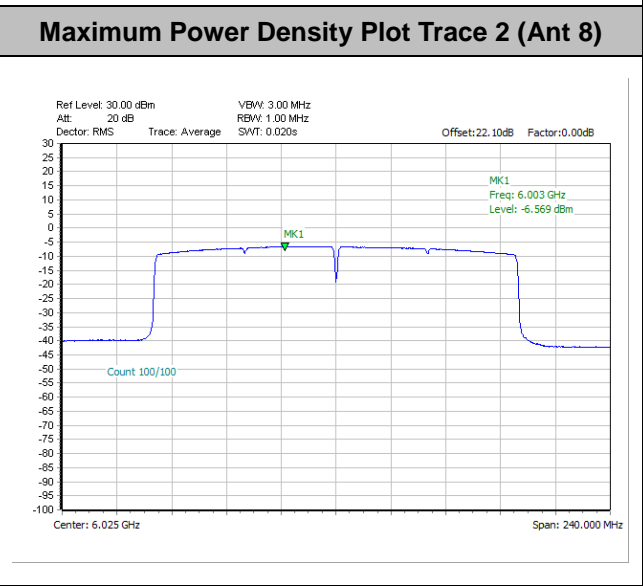
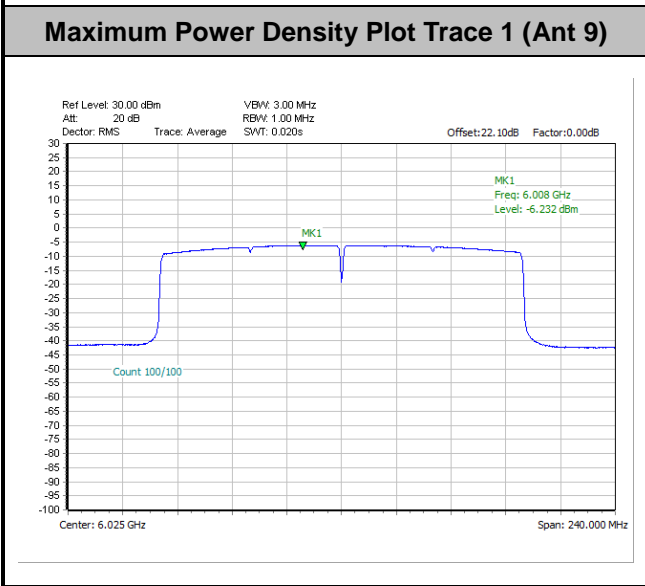



<CDD Mode>

<Indoor Client>

<802.11a>

Maximum Power Density Plot (dBm/MHz)

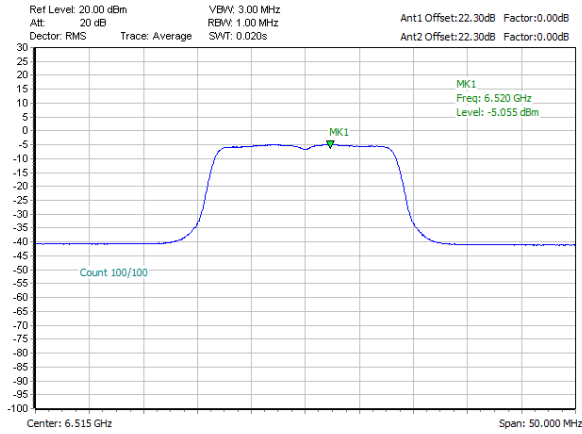

Note:

1. EIRP Power Density (dBm/MHz) = Measured value+ Duty Factor + Directional Gain
2. The test plot is showing a bin by bin combined result mathematically adds two traces.

Maximum Power Density Plot Trace 1 (Ant 9)

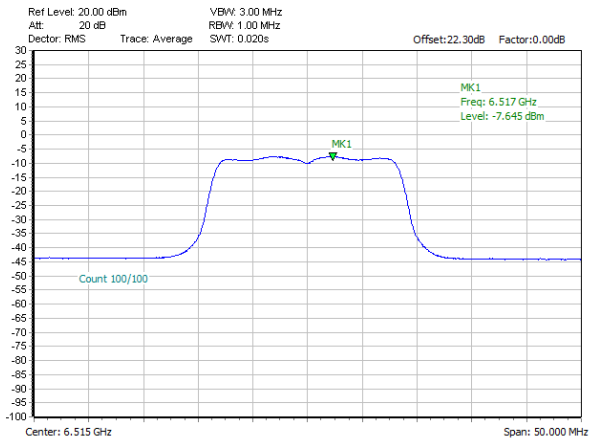

Maximum Power Density Plot Trace 2 (Ant 8)

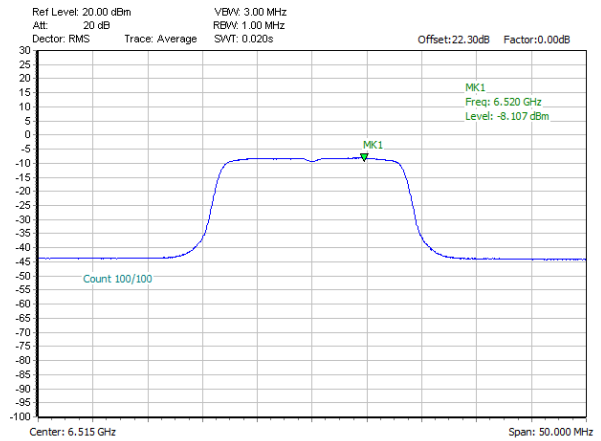



<CDD Mode>

<Standard Client>

<802.11a>

Maximum Power Density Plot (dBm/MHz)

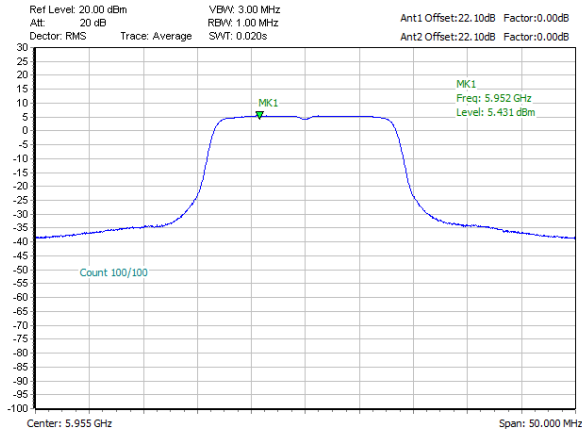

Note:

1. EIRP Power Density (dBm/MHz) = Measured value+ Duty Factor + Directional Gain
2. The test plot is showing a bin by bin combined result mathematically adds two traces.

Maximum Power Density Plot Trace 1 (Ant 9)

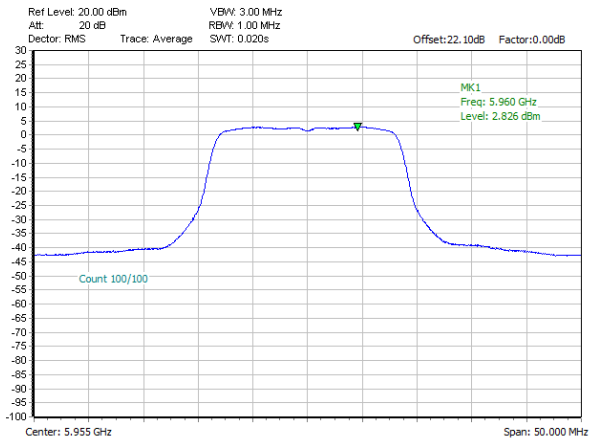

Maximum Power Density Plot Trace 2 (Ant 8)

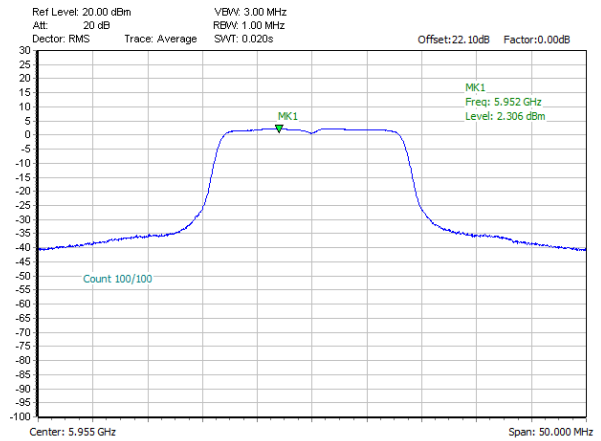



<TXBF Modes>

<Indoor Client>

<802.11ax HE20>

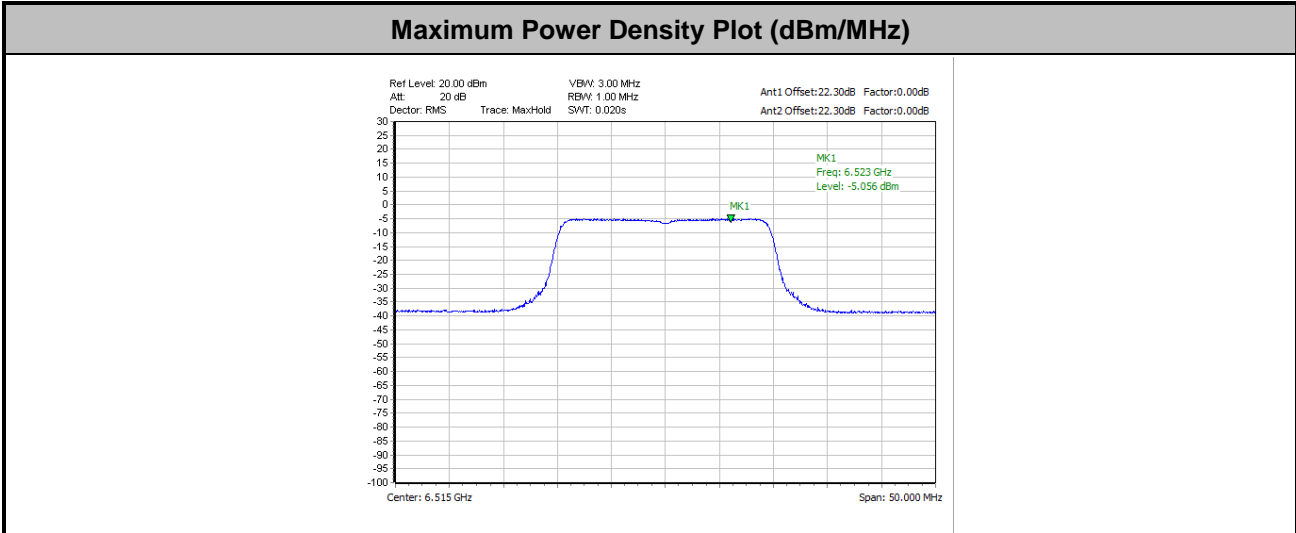

Note:

1. EIRP Power Density (dBm/MHz) = Measured value+ Duty Factor + Directional Gain
2. The test plot is showing a bin by bin combined result mathematically adds two traces.

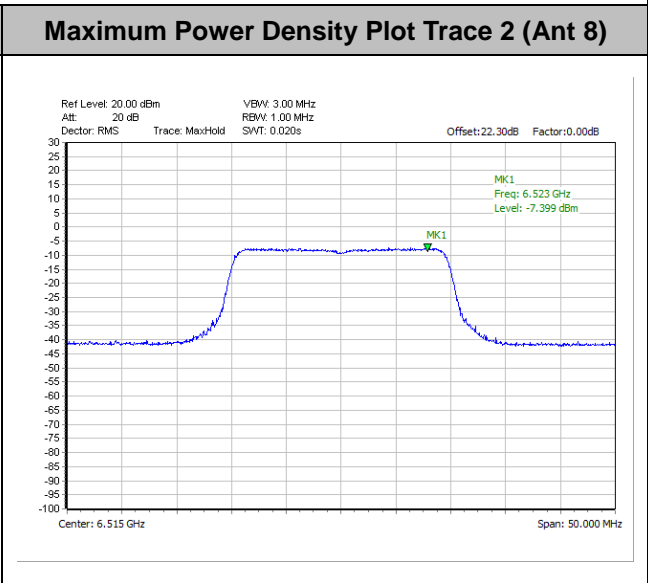
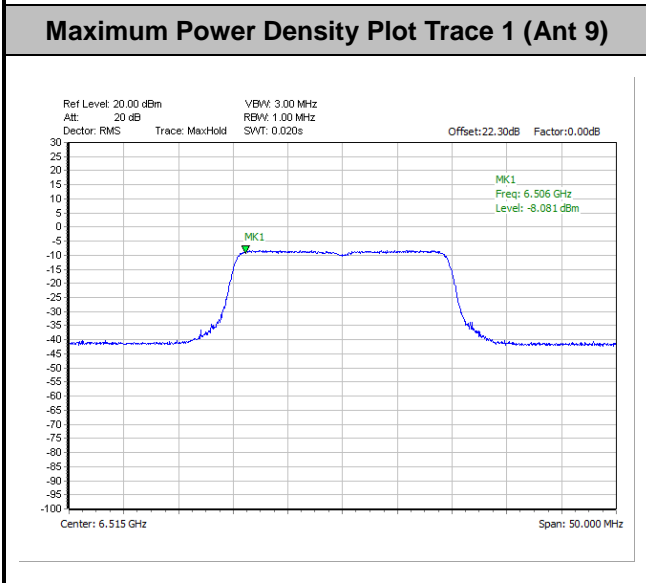



<802.11ax HE40>

Maximum Power Density Plot (dBm/MHz)

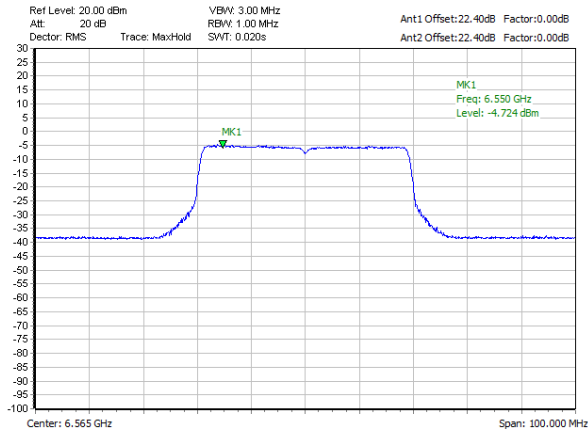

Note:

1. EIRP Power Density (dBm/MHz) = Measured value+ Duty Factor + Directional Gain
2. The test plot is showing a bin by bin combined result mathematically adds two traces.

Maximum Power Density Plot Trace 1 (Ant 9)

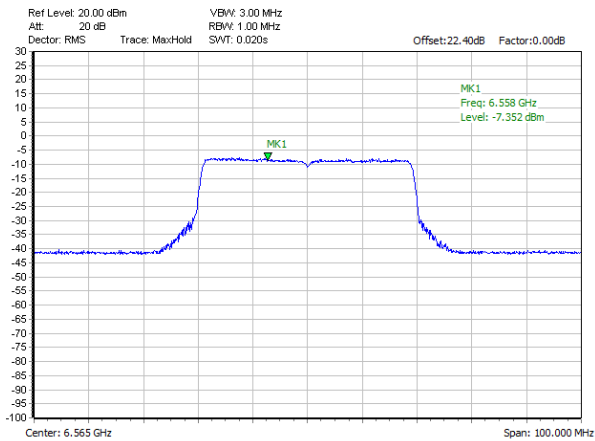

Maximum Power Density Plot Trace 2 (Ant 8)

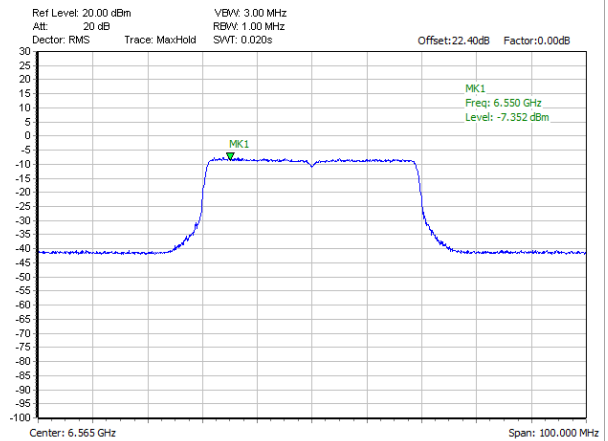



<802.11ax HE80>

Maximum Power Density Plot (dBm/MHz)

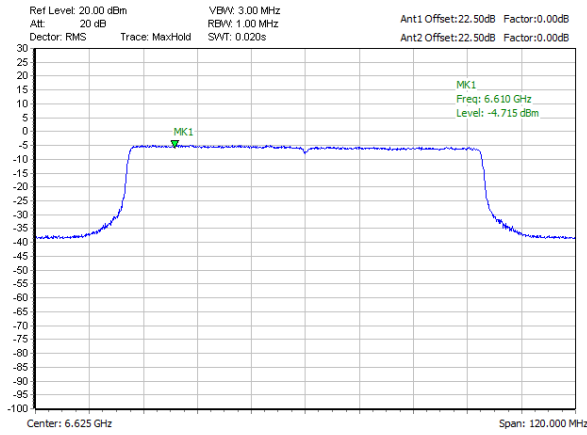

Note:

1. EIRP Power Density (dBm/MHz) = Measured value+ Duty Factor + Directional Gain
2. The test plot is showing a bin by bin combined result mathematically adds two traces.

Maximum Power Density Plot Trace 1 (Ant 9)

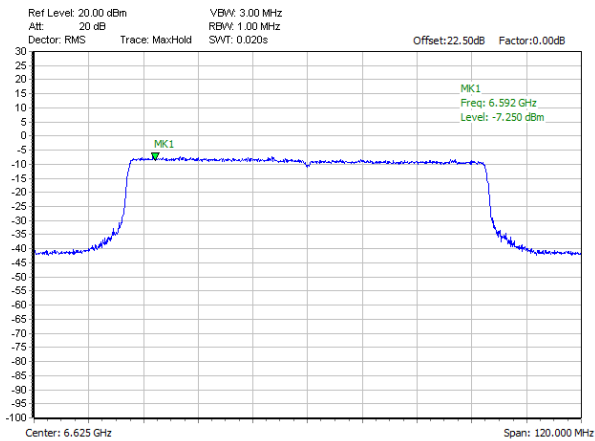

Maximum Power Density Plot Trace 2 (Ant 8)

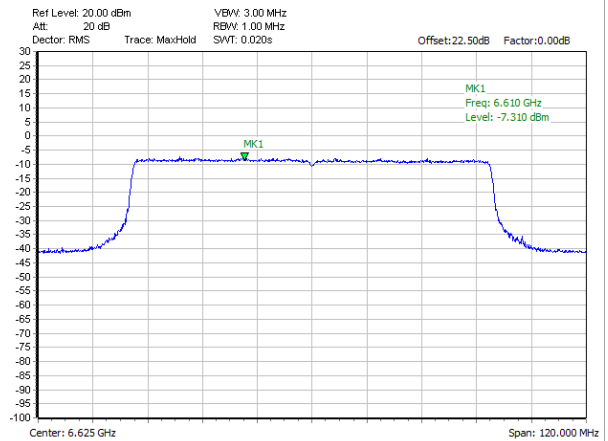



<802.11ax HE160>

Maximum Power Density Plot (dBm/MHz)

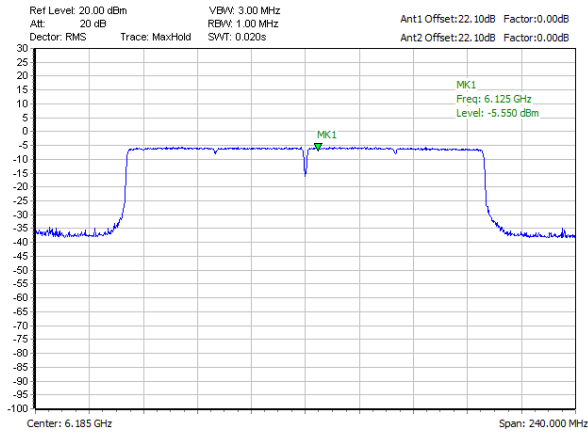

Note:

1. EIRP Power Density (dBm/MHz) = Measured value+ Duty Factor + Directional Gain
2. The test plot is showing a bin by bin combined result mathematically adds two traces.

Maximum Power Density Plot Trace 1 (Ant 9)

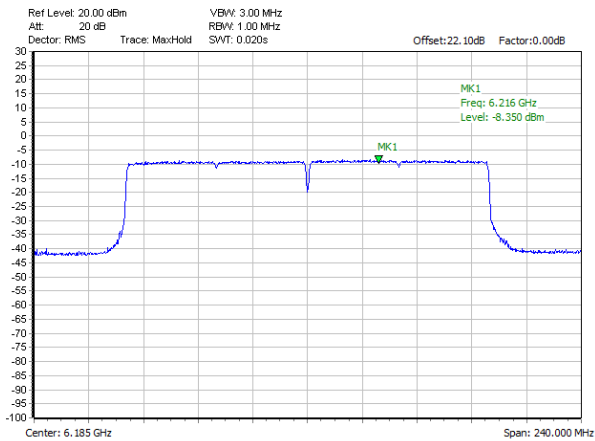

Maximum Power Density Plot Trace 2 (Ant 8)

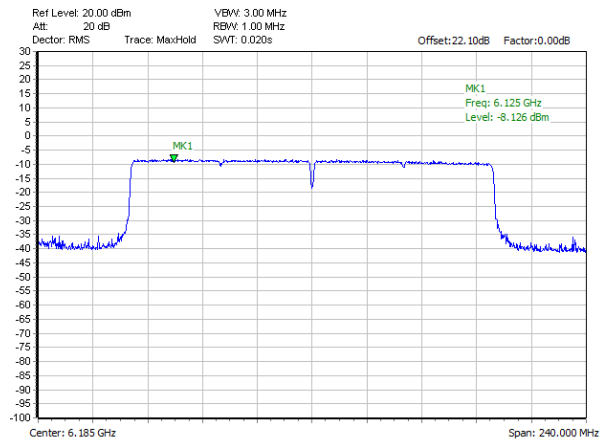



<TXBF Mode>
<Standard Client>
<802.11ax HE20>

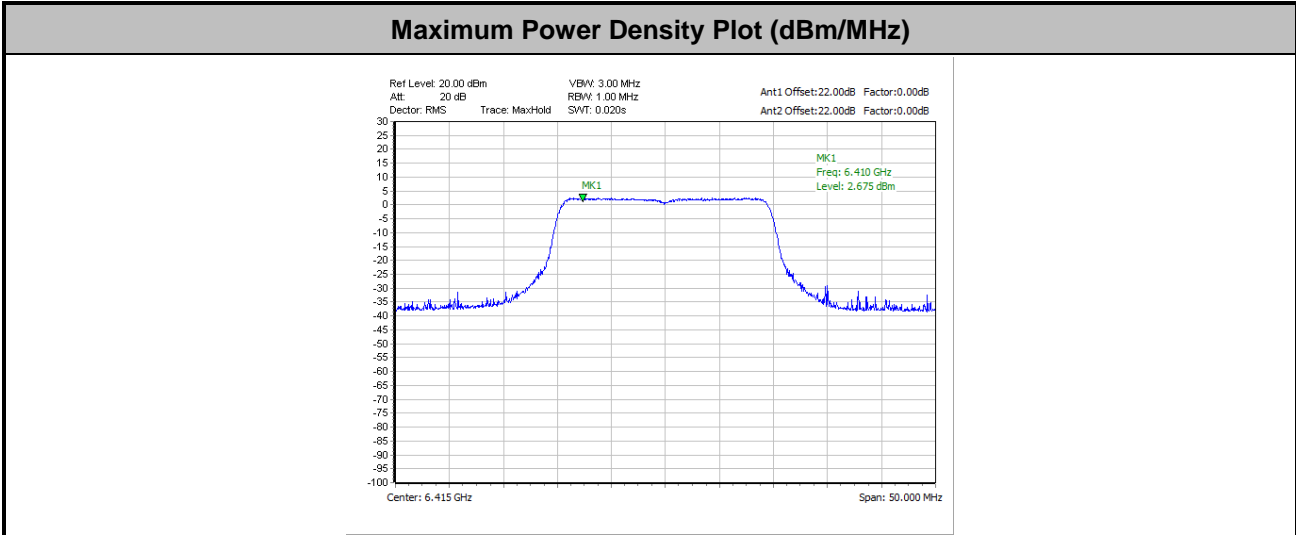

Note:

1. EIRP Power Density (dBm/MHz) = Measured value+ Duty Factor + Directional Gain
2. The test plot is showing a bin by bin combined result mathematically adds two traces.

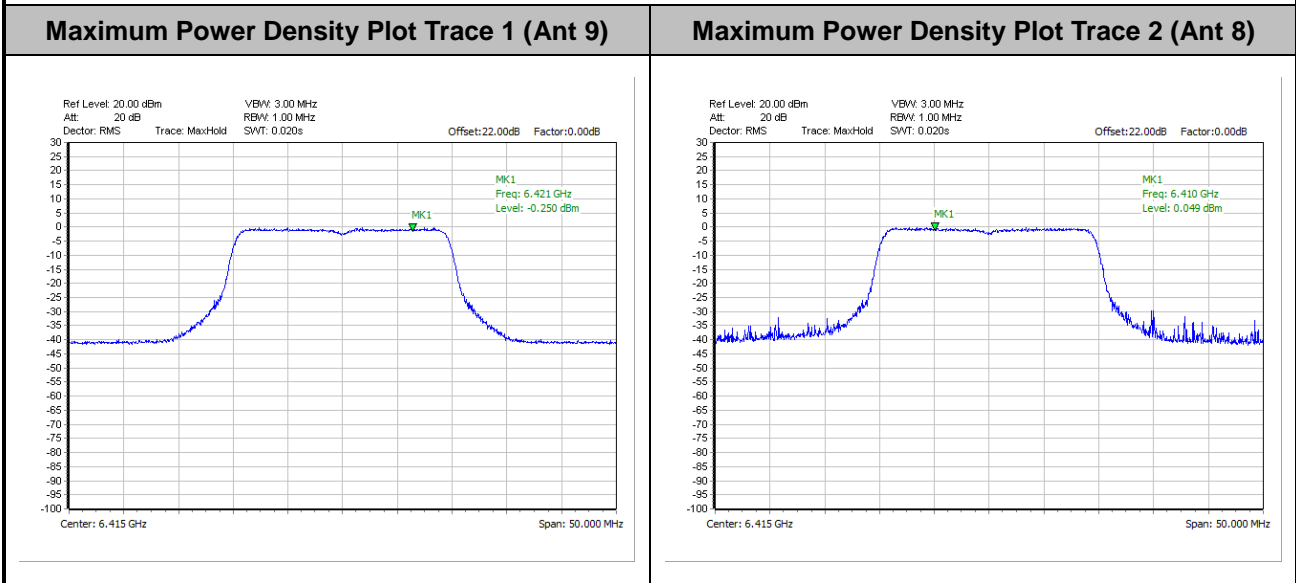



<802.11ax HE40>

Maximum Power Density Plot (dBm/MHz)

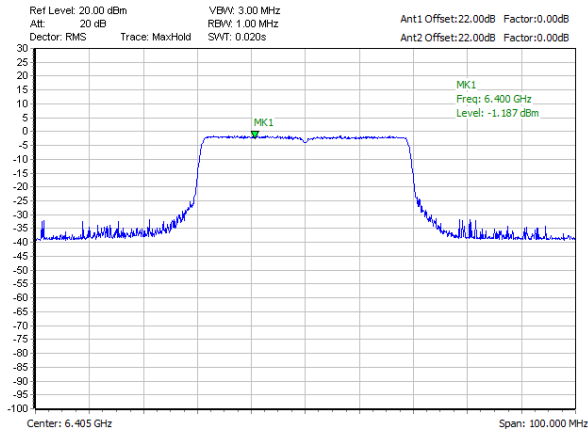

Note:

1. EIRP Power Density (dBm/MHz) = Measured value+ Duty Factor + Directional Gain
2. The test plot is showing a bin by bin combined result mathematically adds two traces.

Maximum Power Density Plot Trace 1 (Ant 9)

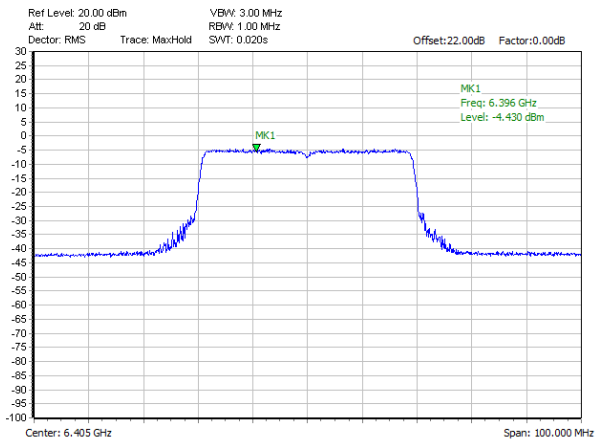

Maximum Power Density Plot Trace 2 (Ant 8)

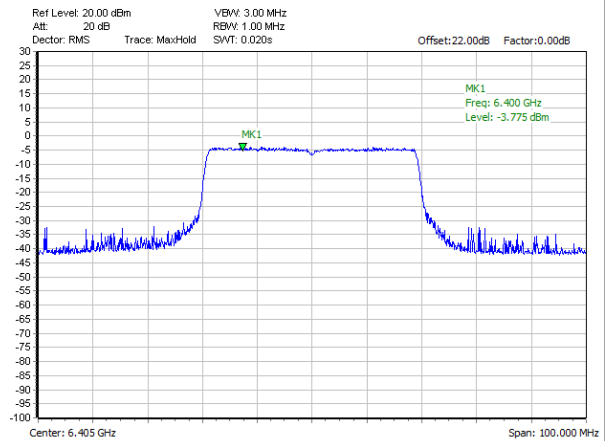



<802.11ax HE80>

Maximum Power Density Plot (dBm/MHz)

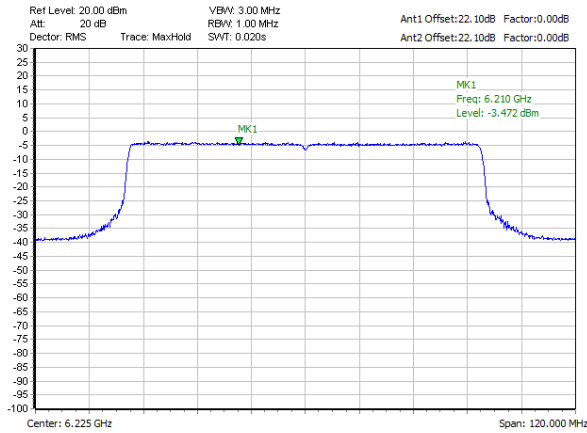

Note:

1. EIRP Power Density (dBm/MHz) = Measured value+ Duty Factor + Directional Gain
2. The test plot is showing a bin by bin combined result mathematically adds two traces.

Maximum Power Density Plot Trace 1 (Ant 9)

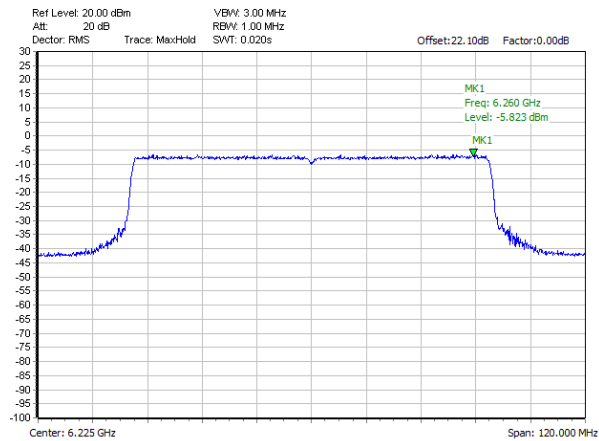

Maximum Power Density Plot Trace 2 (Ant 8)

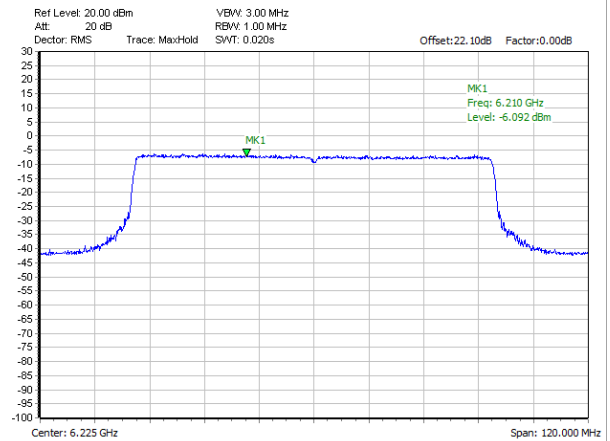



<802.11ax HE160>

Maximum Power Density Plot (dBm/MHz)

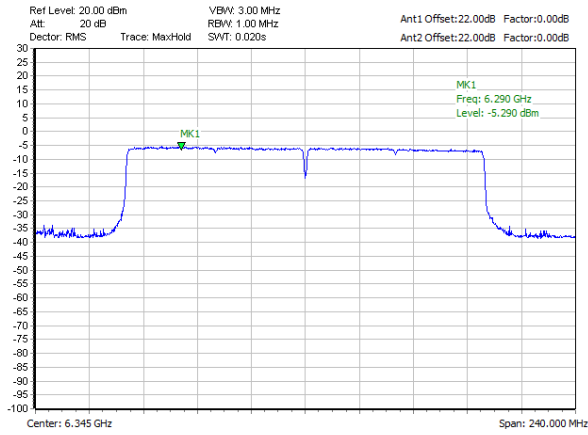

Note:

1. EIRP Power Density (dBm/MHz) = Measured value+ Duty Factor + Directional Gain
2. The test plot is showing a bin by bin combined result mathematically adds two traces.

Maximum Power Density Plot Trace 1 (Ant 9)

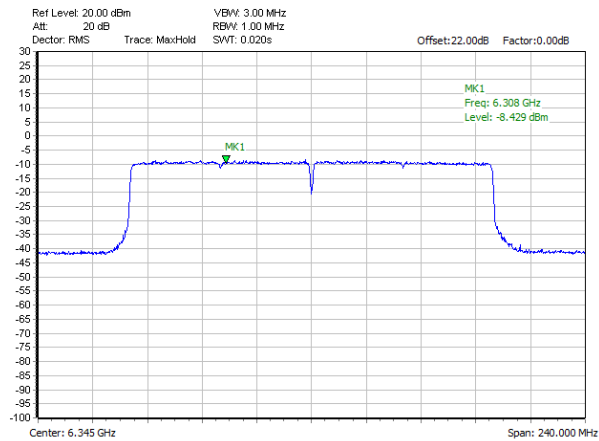

Maximum Power Density Plot Trace 2 (Ant 8)

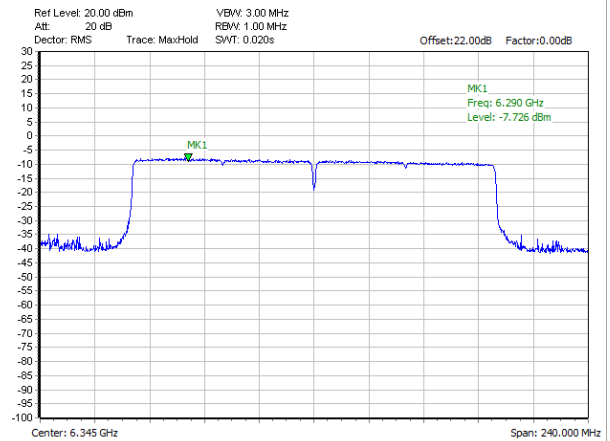



3.4 In-Band Emissions (Channel Mask)

3.4.1 Limit of Unwanted Emissions

<FCC 14-30 CFR 15.407>

(a)(6) For transmitters operating within the 5.925-7.125 GHz bands: Power spectral density must be suppressed by 20 dB at 1 MHz outside of channel edge, by 28 dB at one channel bandwidth from the channel center, and by 40 dB at one- and one-half times the channel bandwidth away from channel center. At frequencies between one megahertz outside an unlicensed device's channel edge and one channel bandwidth from the center of the channel, the limits must be linearly interpolated between 20 dB and 28 dB suppression, and at frequencies between one and one- and one-half times an unlicensed device's channel bandwidth, the limits must be linearly interpolated between 28 dB and 40 dB suppression. Emissions removed from the channel center by more than one- and one-half times the channel bandwidth must be suppressed by at least 40 dB.

3.4.2 Measuring Instruments

Please refer to the measuring equipment list in this test report.

3.4.3 Test Procedures

The testing follows FCC KDB 987594 D02 U-NII 6GHz EMC Measurement v01.

Section J) In-Band Emissions.

1. Take nominal bandwidth as reference channel bandwidth provided that 26 dB emission bandwidth is always larger than nominal bandwidth
2. Measure the power spectral density (which will be used for emissions mask reference) using the following procedure:
 - a) Set the span to encompass the entire 26 dB EBW of the signal.
 - b) Set RBW = same RBW used for 26 dB EBW measurement.
 - c) Set VBW $\geq 3 \times$ RBW
 - d) Number of points in sweep $\geq [2 \times \text{span} / \text{RBW}]$.
 - e) Sweep time = auto.
 - f) Detector = RMS (i.e., power averaging)
 - g) Trace average at least 100 traces in power averaging (rms) mode.
 - h) Use the peak search function on the instrument to find the peak of the spectrum.
3. Using the measuring equipment limit line function, develop the emissions mask based on the following requirements. The emissions power spectral density must be reduced below the peak power spectral density (in dB) as follows:
 - a. Suppressed by 20 dB at 1 MHz outside of the channel edge.
 - b. Suppressed by 28 dB at one channel bandwidth from the channel center.
 - c. Suppressed by 40 dB at one- and one-half times the channel bandwidth from the channel center.
4. Adjust the span to encompass the entire mask as necessary.
5. Clear trace.
6. Trace average at least 100 traces in power averaging (rms) mode.
7. Adjust the reference level as necessary so that the crest of the channel touches the top of the emission mask.

3.4.4 Test Setup

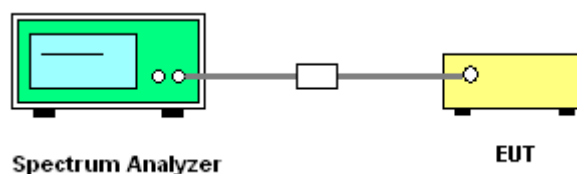



3.4.5 Test Result

<SDM Mode>

<Indoor Client>

MIMO <Ant. 9+8(9)>

EUT Mode :	802.11ax HE20 Full RU
------------	-----------------------

Plot on Channel 5955MHz

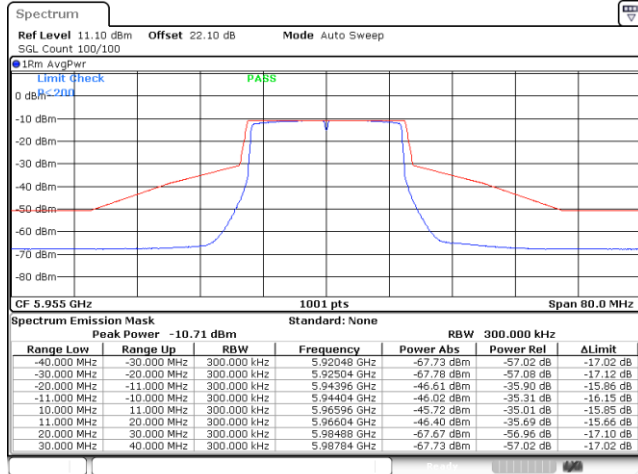

Date: 16.AUG.2022 09:20:41

Plot on Channel 6195MHz

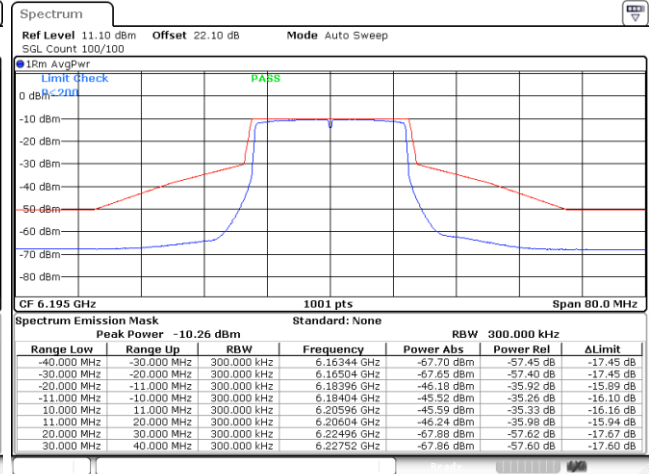

Date: 16.AUG.2022 09:13:26

Plot on Channel 6415MHz

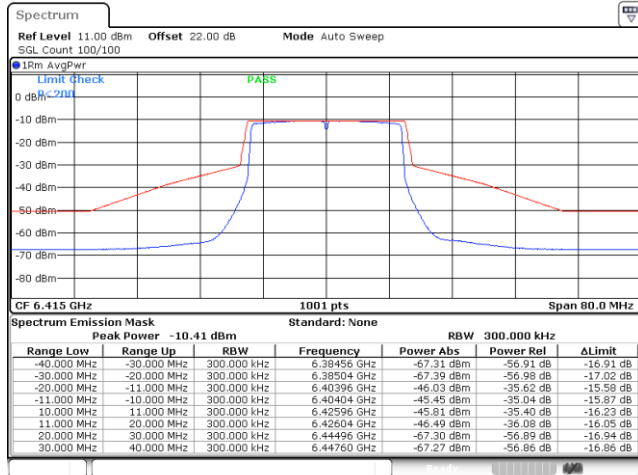

Date: 16.AUG.2022 10:20:33

Plot on Channel 6435MHz

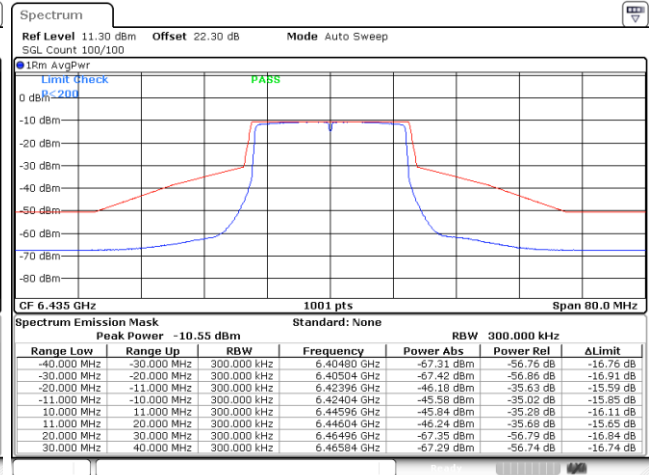

Date: 16.AUG.2022 10:26:21



Plot on Channel 6475MHz

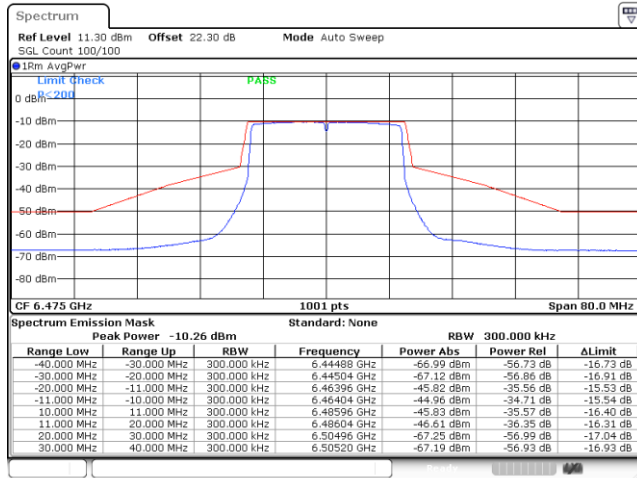

Date: 16.AUG.2022 10:32:04

Plot on Channel 6515MHz

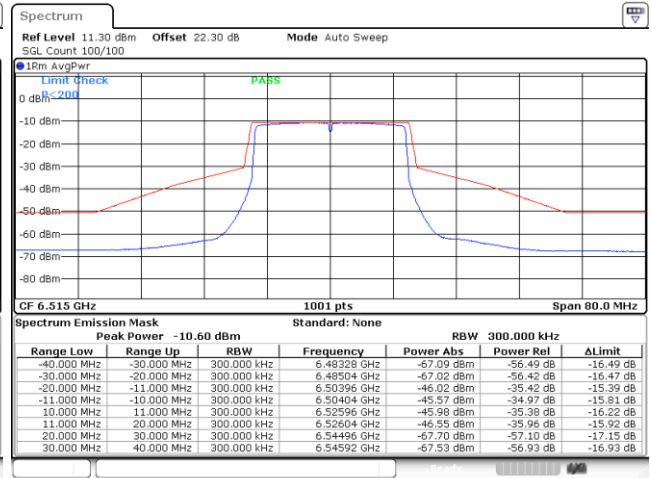

Date: 16.AUG.2022 11:26:12

Plot on Channel 6535MHz

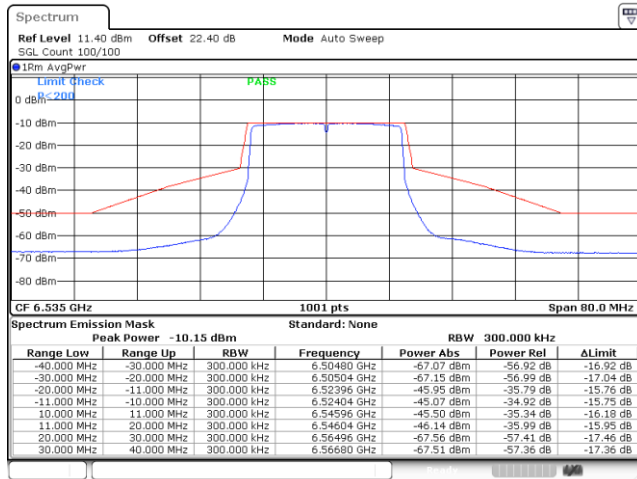

Date: 16.AUG.2022 11:32:41

Plot on Channel 6695MHz

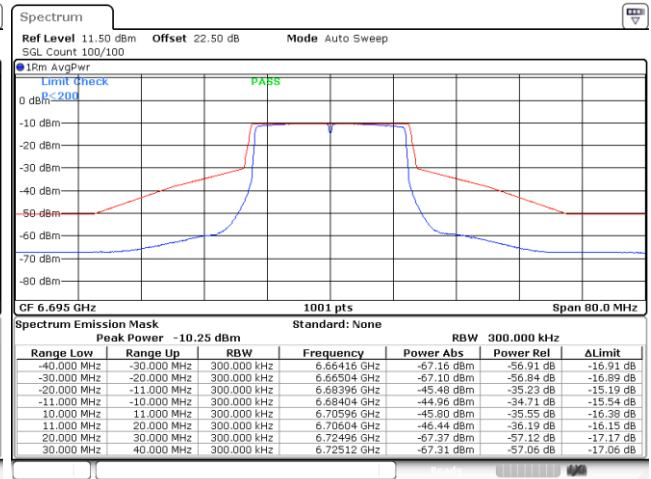

Date: 16.AUG.2022 11:38:53

Plot on Channel 6855MHz

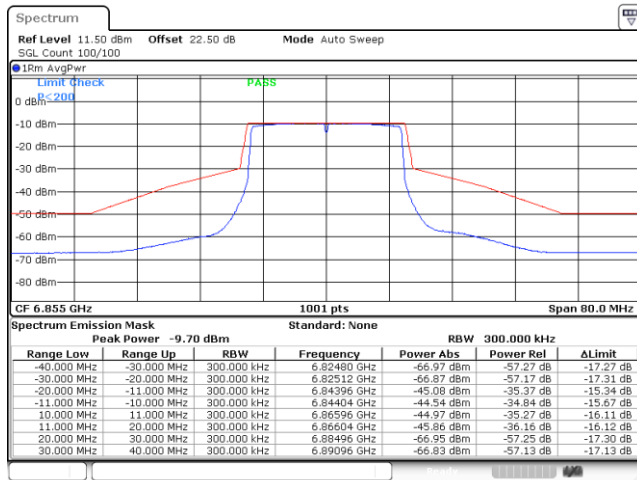

Date: 16.AUG.2022 11:43:30

Plot on Channel 6875MHz

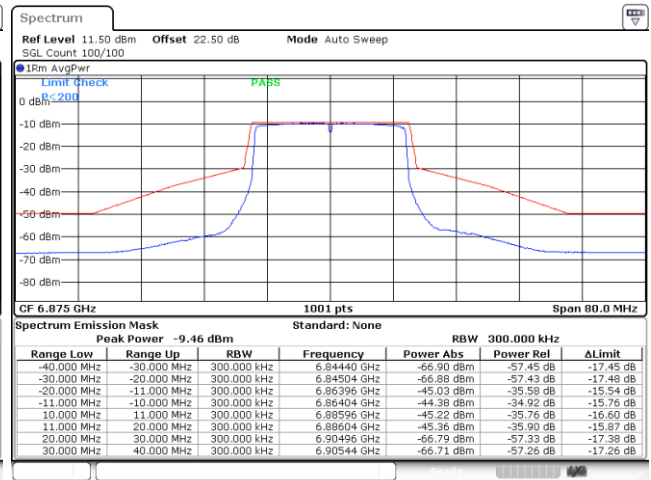

Date: 16.AUG.2022 11:48:04



Plot on Channel 6895MHz

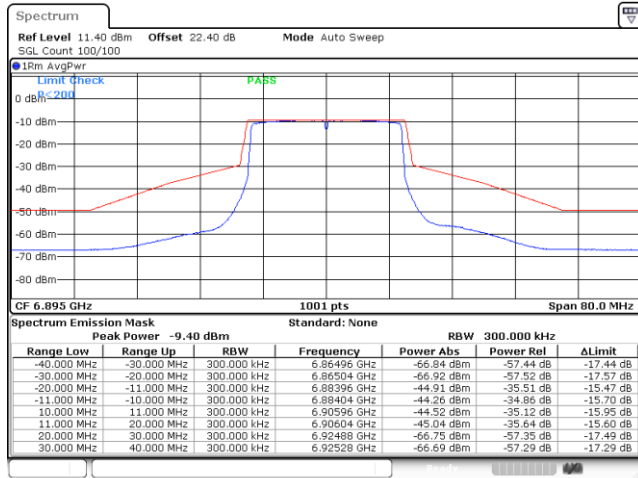

Date: 16.AUG.2022 11:53:55

Plot on Channel 6995MHz

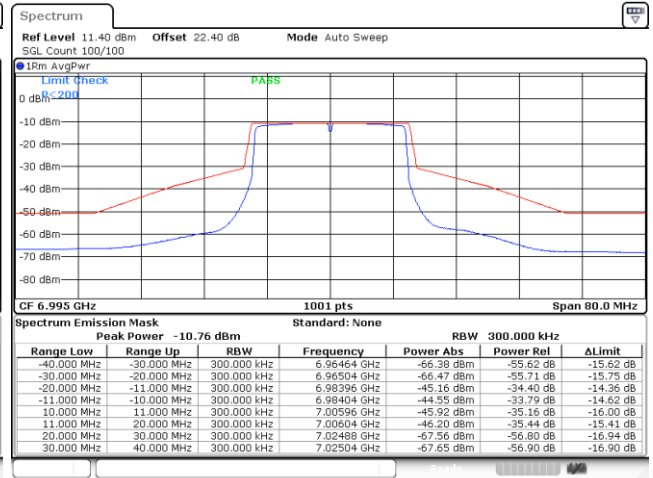

Date: 16.AUG.2022 12:01:54

Plot on Channel 7115MHz

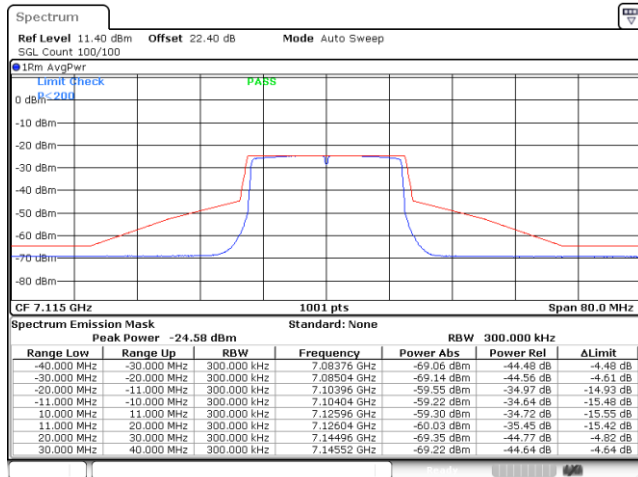

Date: 16.AUG.2022 13:51:09



EUT Mode : 802.11ax HE20 26 RU

Plot on Channel 5955MHz

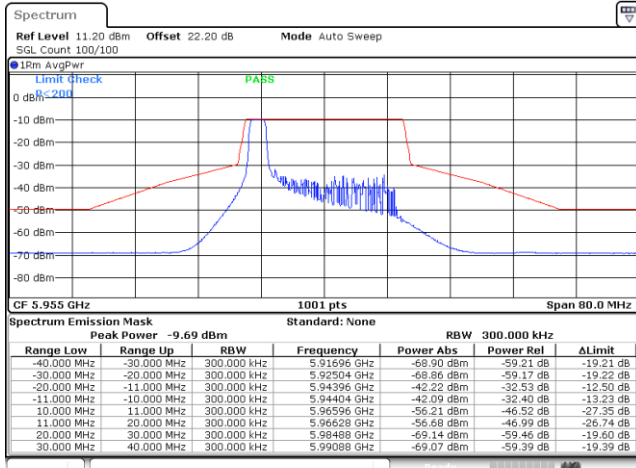

Date: 13.OCT.2022 14:24:30

Plot on Channel 6195MHz

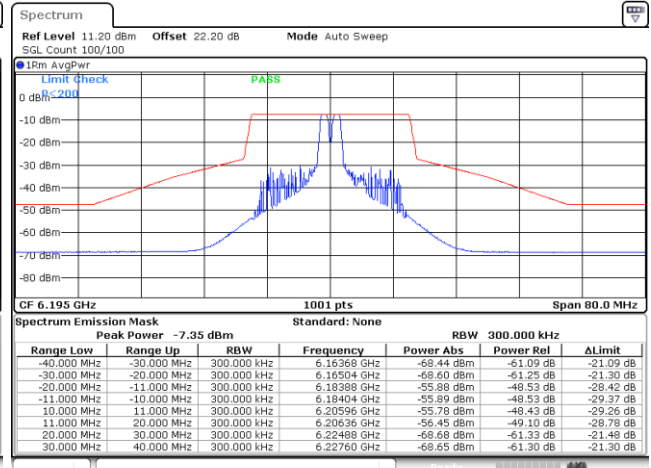

Date: 13.OCT.2022 14:33:24

Plot on Channel 6415MHz

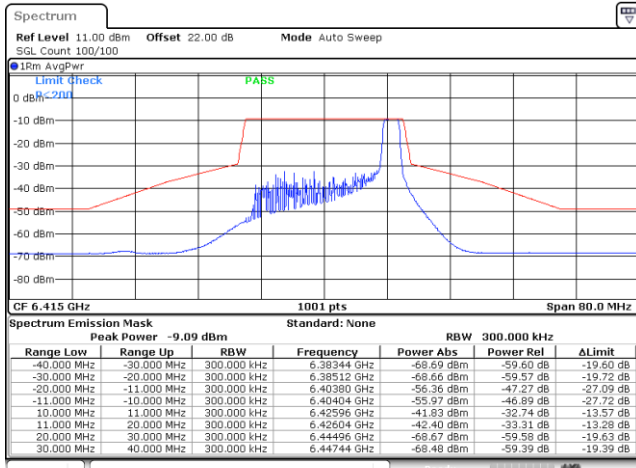

Date: 13.OCT.2022 14:39:20

Plot on Channel 6435MHz

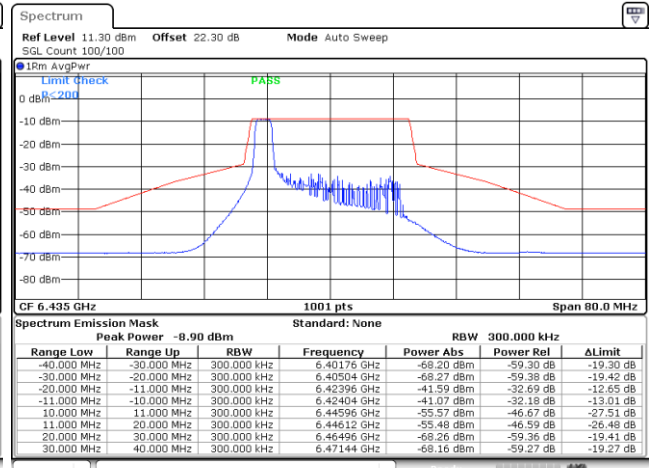

Date: 13.OCT.2022 14:44:25



Plot on Channel 6475MHz

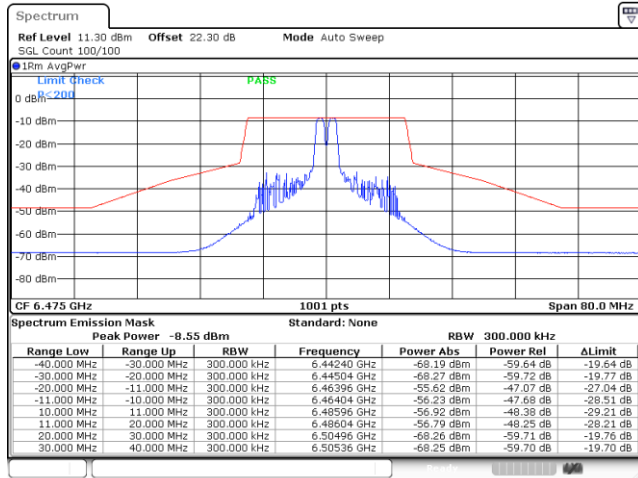

Date: 13.OCT.2022 14:50:50

Plot on Channel 6515MHz

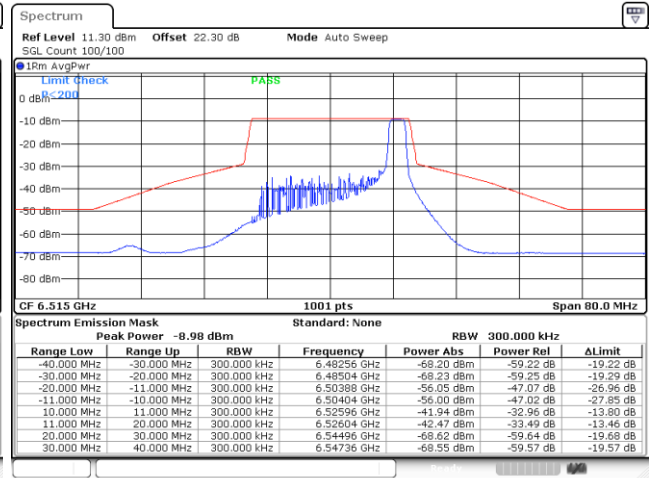

Date: 13.OCT.2022 15:18:35

Plot on Channel 6535MHz

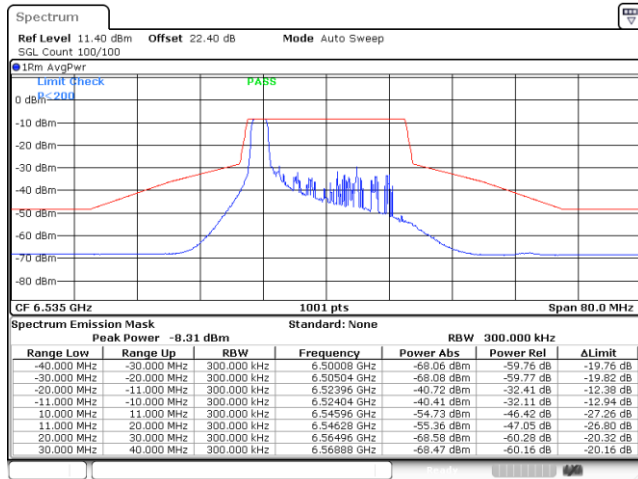

Date: 13.OCT.2022 15:23:39

Plot on Channel 6695MHz

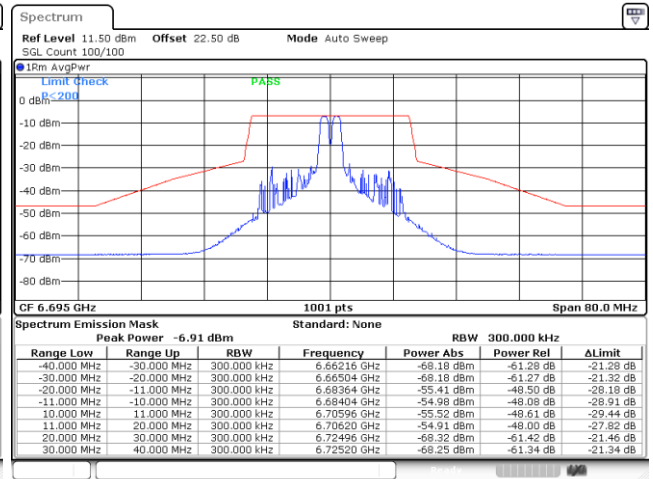

Date: 13.OCT.2022 15:30:17

Plot on Channel 6855MHz

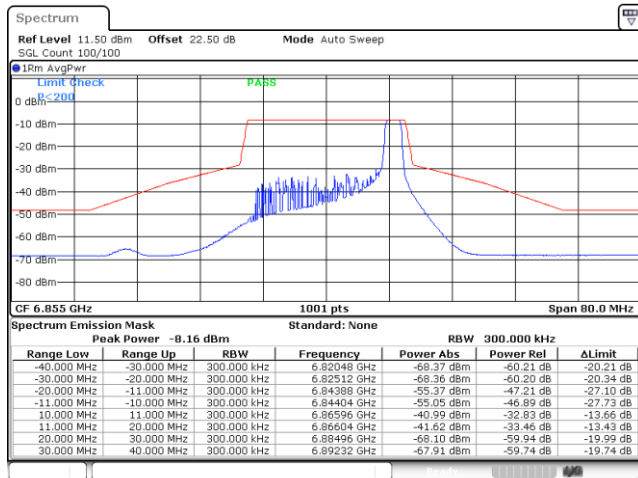

Date: 13.OCT.2022 15:35:14

Plot on Channel 6875MHz

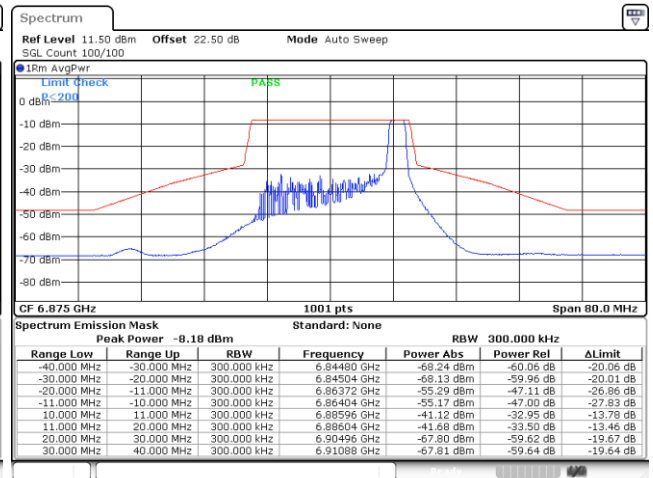

Date: 13.OCT.2022 15:40:11



Plot on Channel 6895MHz

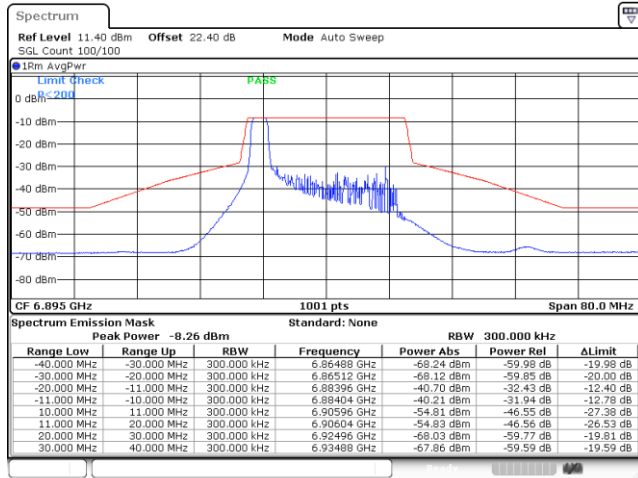

Date: 13.OCT.2022 15:45:38

Plot on Channel 6995MHz

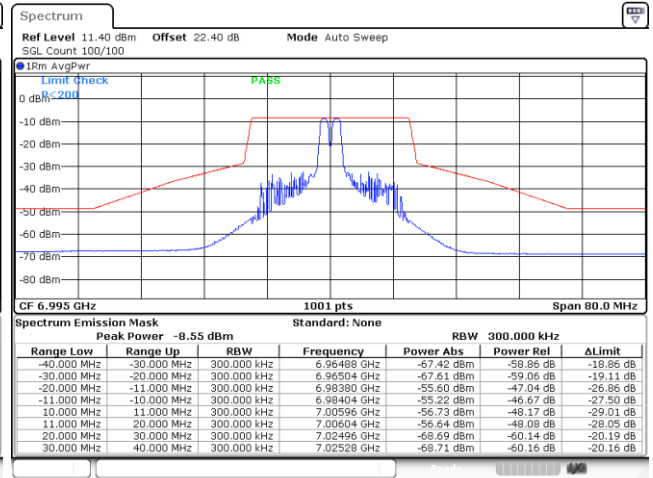

Date: 13.OCT.2022 15:59:07

Plot on Channel 7115MHz

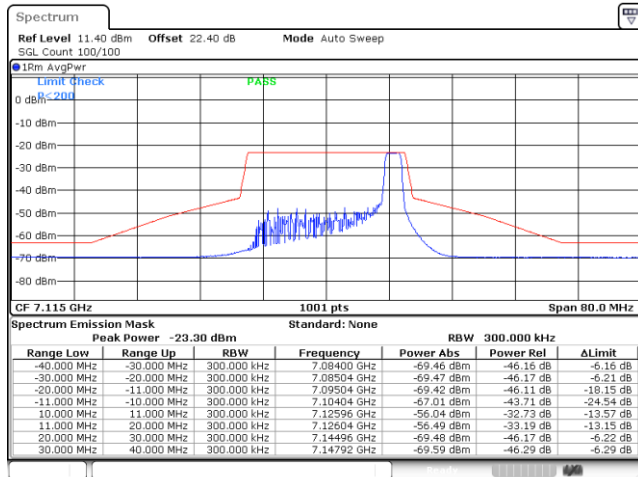

Date: 13.OCT.2022 16:04:35



EUT Mode : 802.11ax HE20 52 RU

Plot on Channel 5955MHz

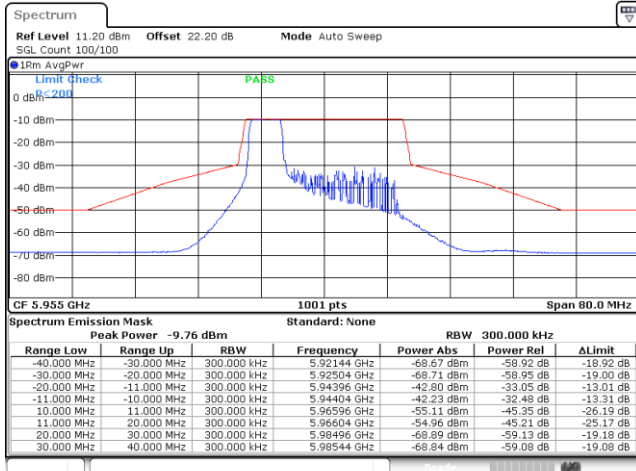

Date: 13.OCT.2022 14:28:11

Plot on Channel 6195MHz

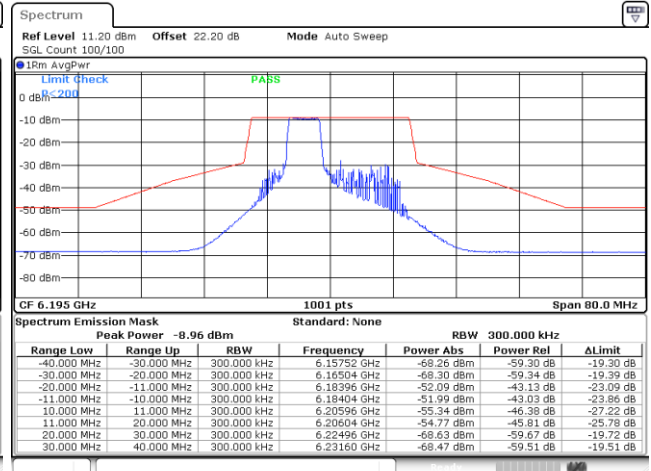

Date: 13.OCT.2022 14:35:05

Plot on Channel 6415MHz

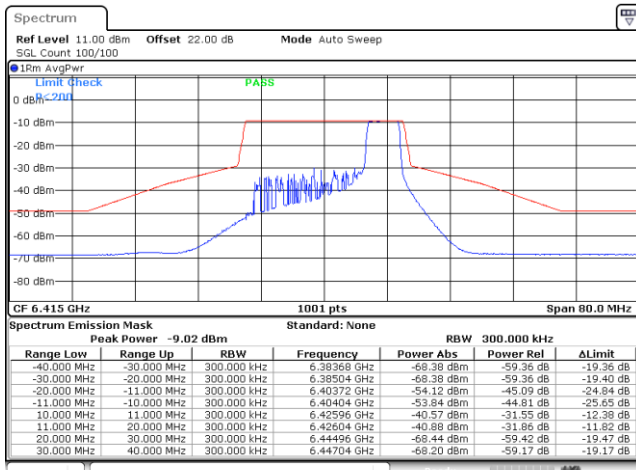

Date: 13.OCT.2022 14:41:02

Plot on Channel 6435MHz

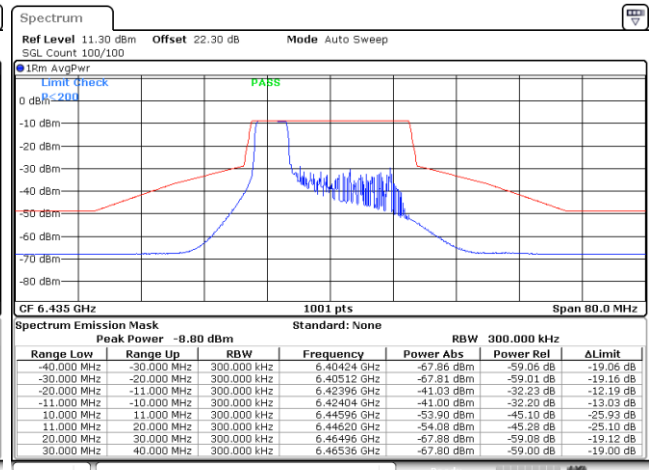

Date: 13.OCT.2022 14:46:52



Plot on Channel 6475MHz

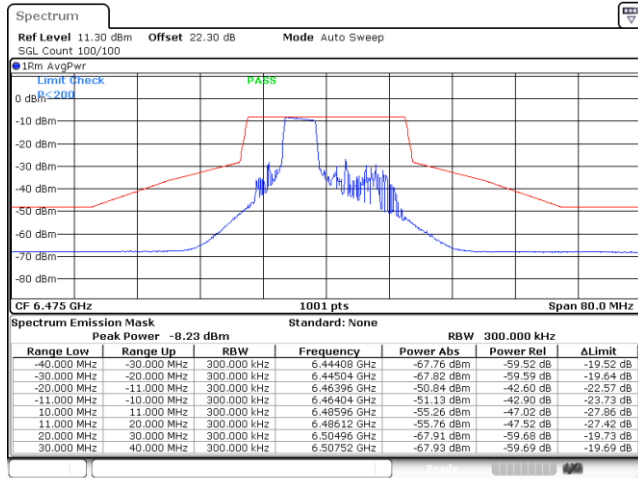

Date: 13.OCT.2022 15:15:10

Plot on Channel 6515MHz

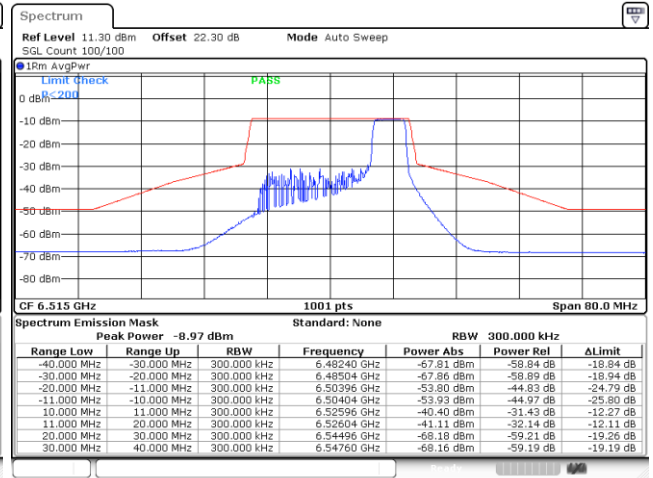

Date: 13.OCT.2022 15:20:20

Plot on Channel 6535MHz

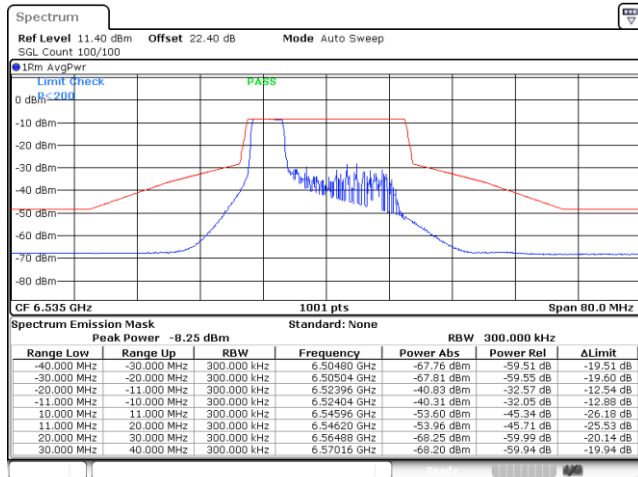

Date: 13.OCT.2022 15:25:11

Plot on Channel 6695MHz

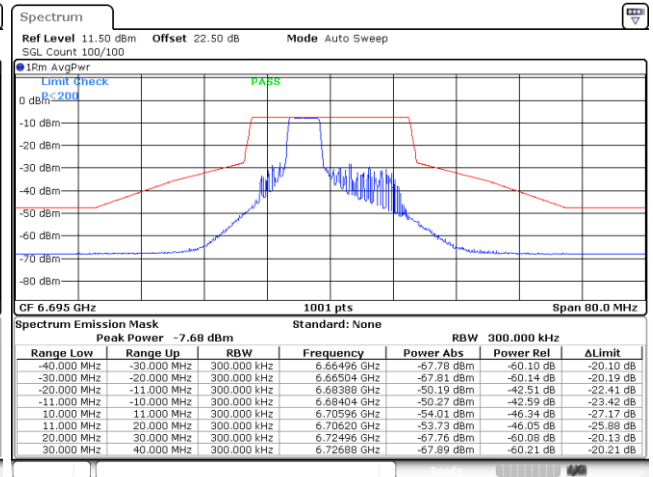

Date: 13.OCT.2022 15:31:51

Plot on Channel 6855MHz

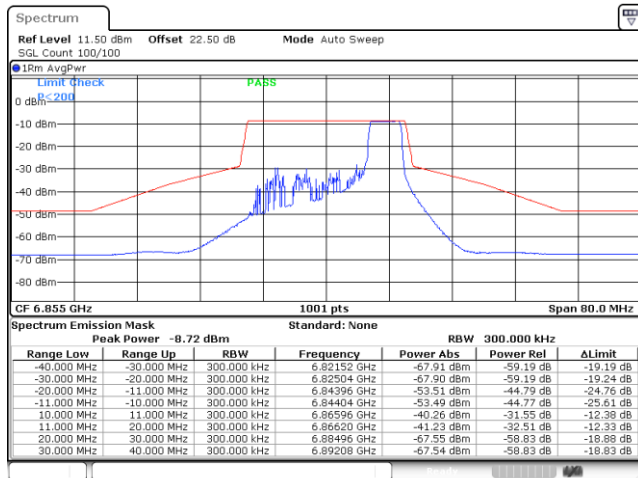

Date: 13.OCT.2022 15:36:40

Plot on Channel 6875MHz

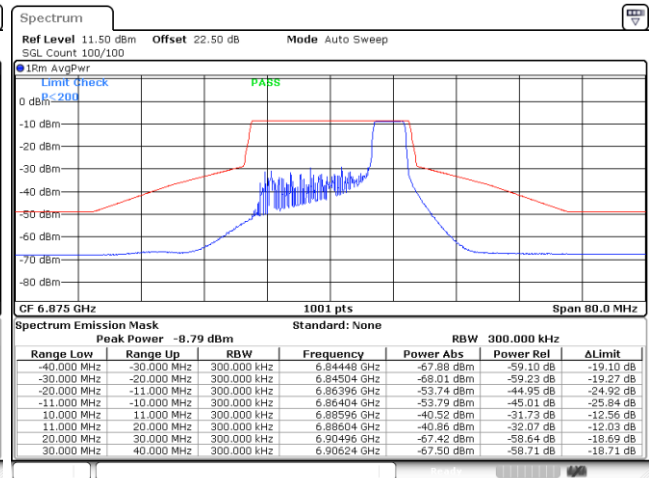

Date: 13.OCT.2022 15:41:47



Plot on Channel 6895MHz

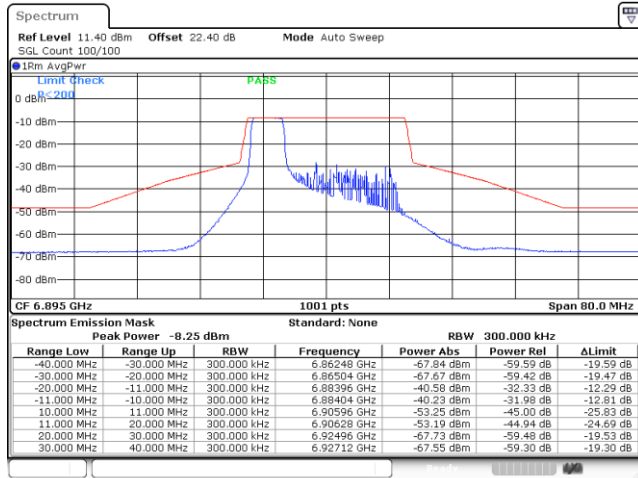

Date: 13.OCT.2022 15:47:08

Plot on Channel 6995MHz

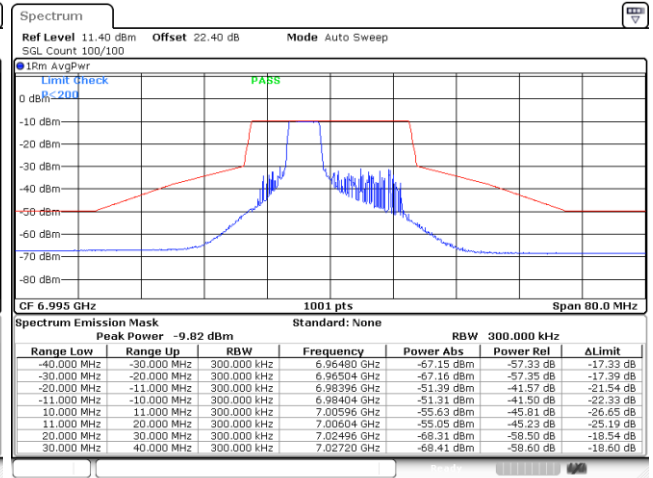

Date: 13.OCT.2022 16:00:39

Plot on Channel 7115MHz

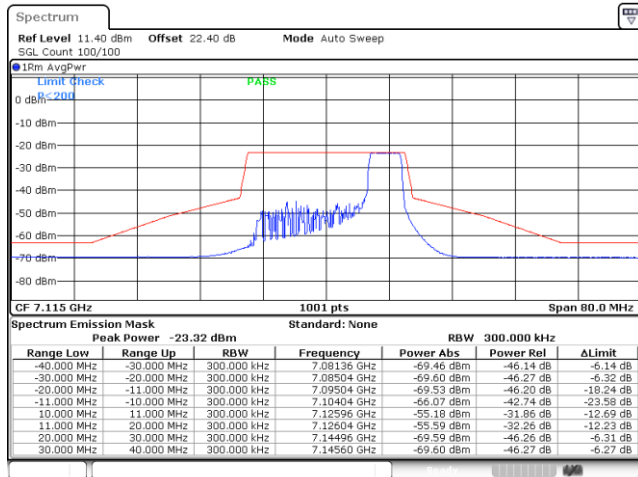

Date: 13.OCT.2022 16:06:22



EUT Mode : 802.11ax HE20 106 RU

Plot on Channel 5955MHz

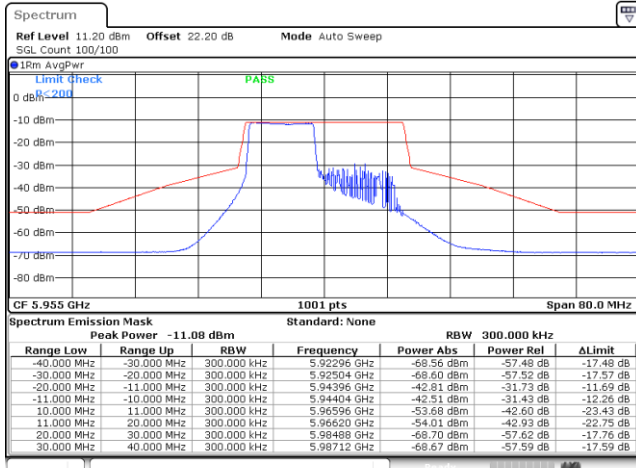

Date: 13.OCT.2022 14:29:56

Plot on Channel 6195MHz

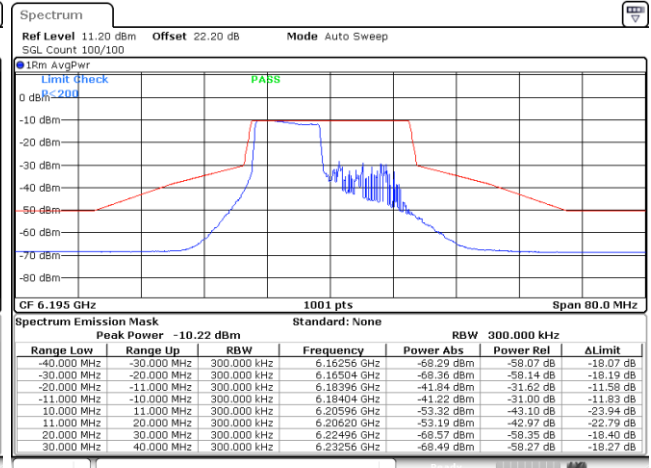

Date: 13.OCT.2022 14:37:10

Plot on Channel 6415MHz

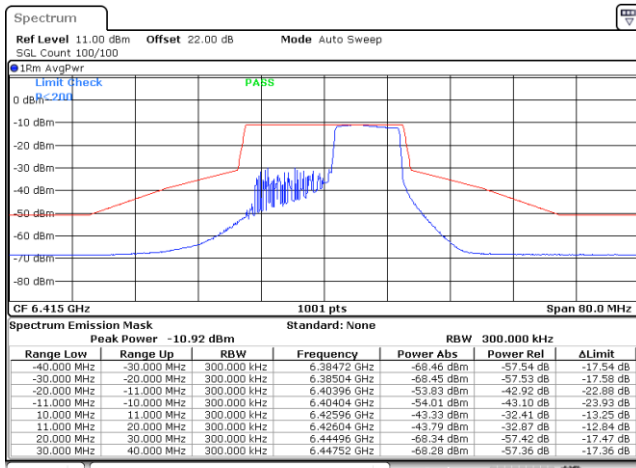

Date: 13.OCT.2022 14:42:42

Plot on Channel 6435MHz

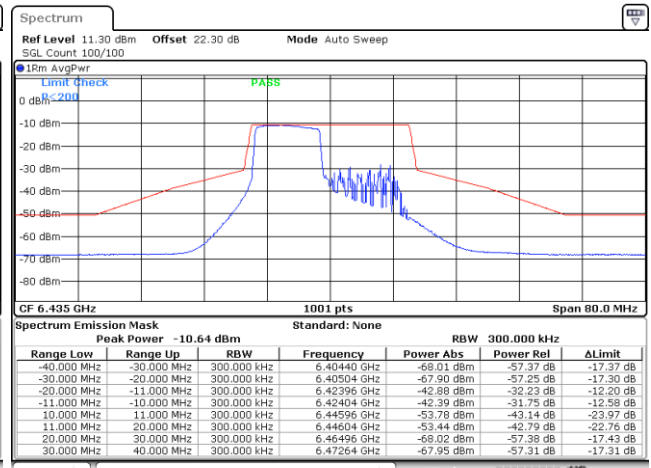

Date: 13.OCT.2022 14:48:36



Plot on Channel 6475MHz

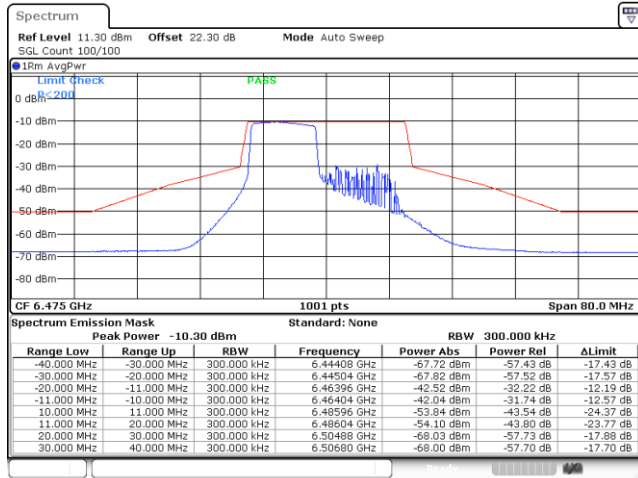

Date: 13.OCT.2022 15:17:16

Plot on Channel 6515MHz

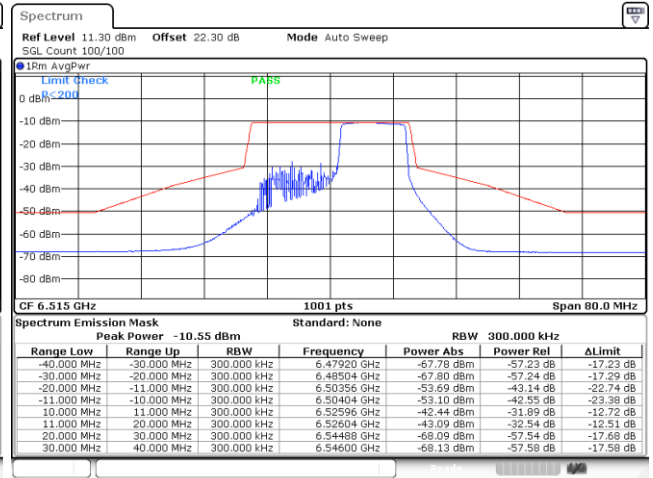

Date: 13.OCT.2022 15:22:00

Plot on Channel 6535MHz

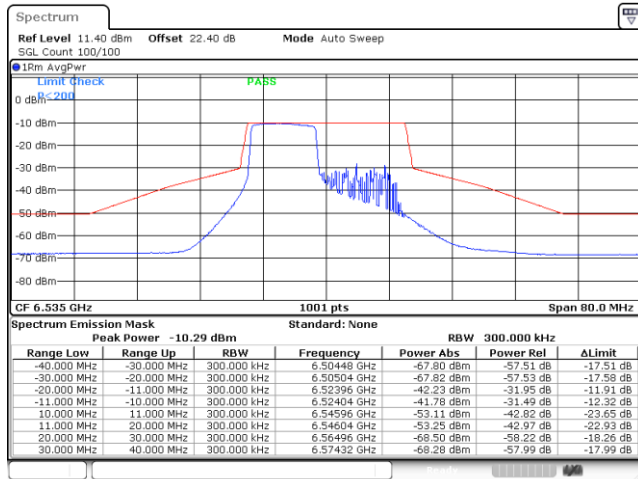

Date: 13.OCT.2022 15:26:41

Plot on Channel 6695MHz

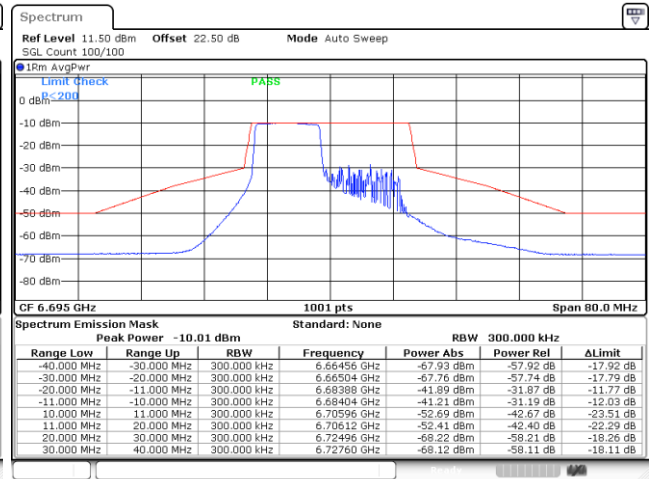

Date: 13.OCT.2022 15:33:12

Plot on Channel 6855MHz

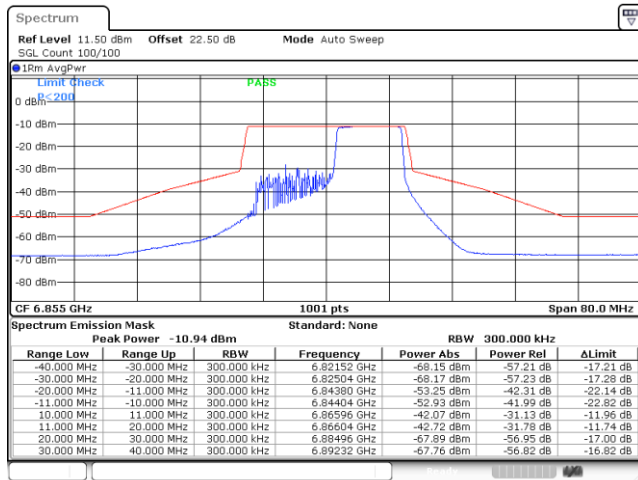

Date: 13.OCT.2022 15:38:10

Plot on Channel 6875MHz

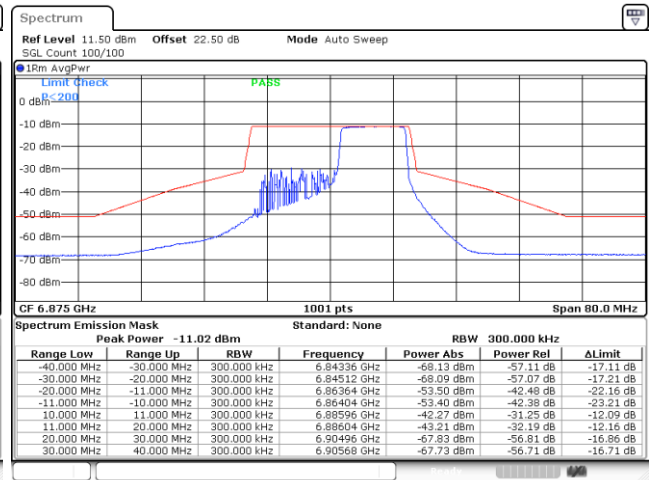

Date: 13.OCT.2022 15:43:48



Plot on Channel 6895MHz

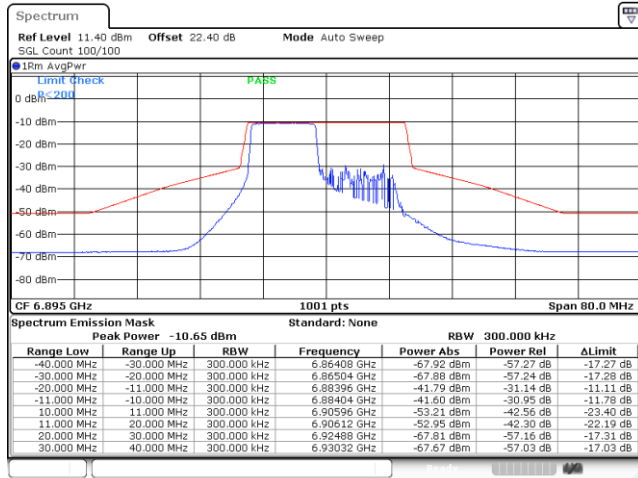

Date: 13.OCT.2022 15:51:08

Plot on Channel 6995MHz

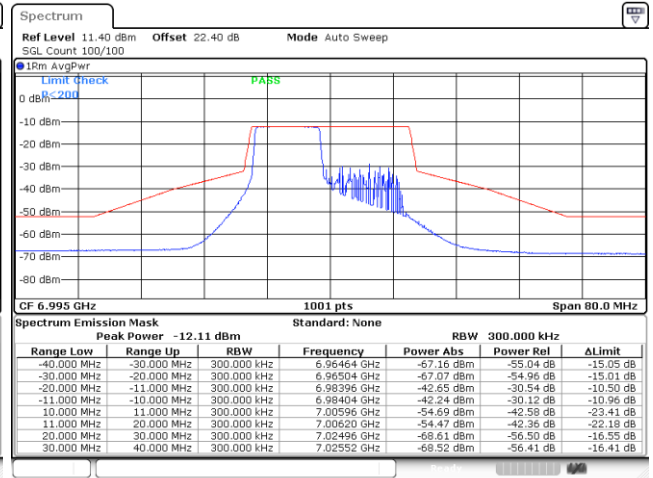

Date: 13.OCT.2022 16:02:17

Plot on Channel 7115MHz

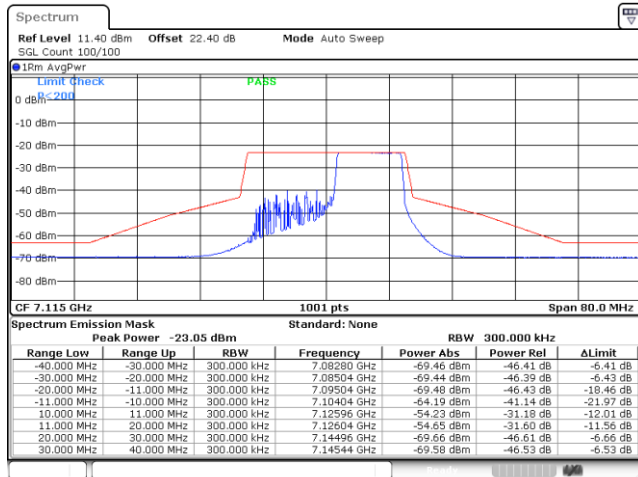

Date: 13.OCT.2022 16:08:09



EUT Mode : 802.11ax HE40 Full RU

Plot on Channel 5965MHz

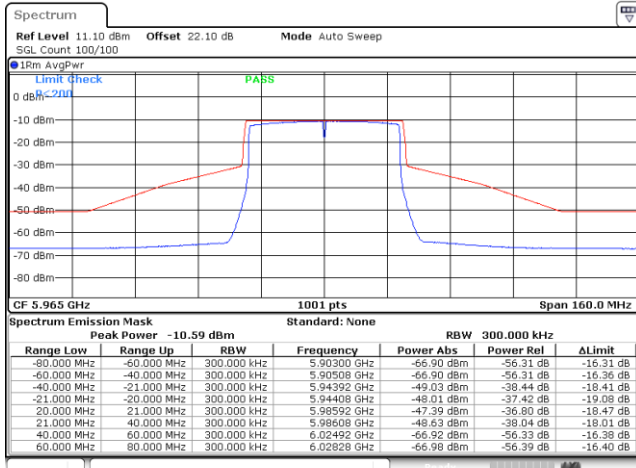

Date: 16.AUG.2022 14:17:07

Plot on Channel 6205MHz

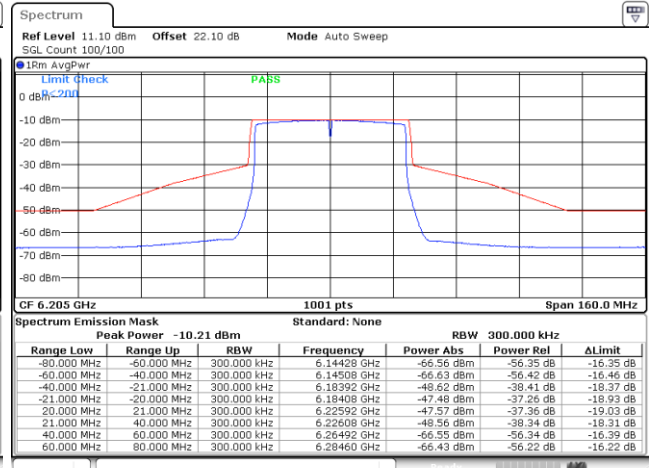

Date: 16.AUG.2022 14:23:52

Plot on Channel 6405MHz

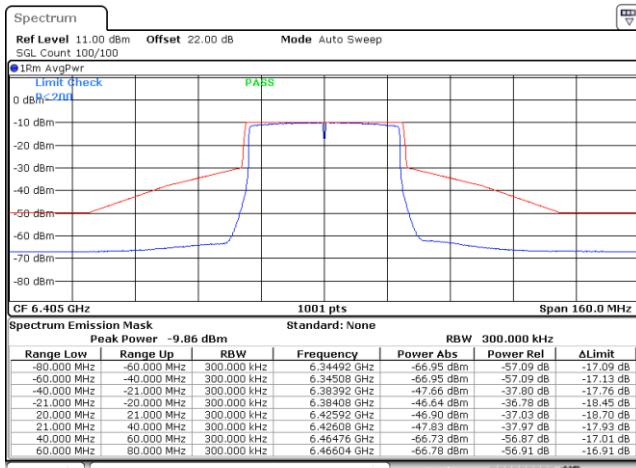

Date: 16.AUG.2022 14:31:32

Plot on Channel 6445MHz

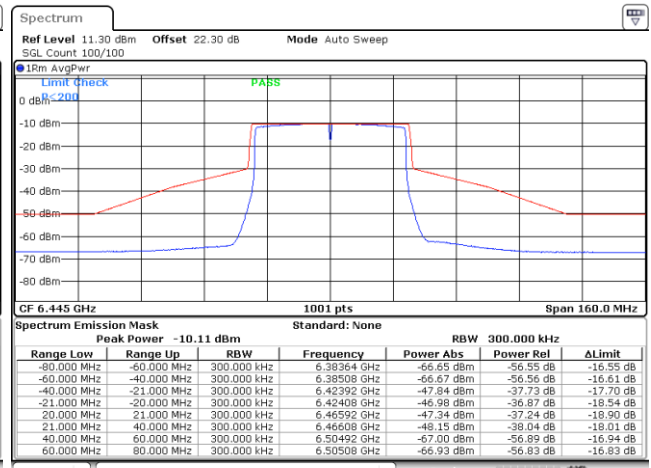

Date: 16.AUG.2022 14:40:20