



FCC RADIO TEST REPORT

FCC ID : UZ7TC77HL
Equipment : Touch computer
Brand Name : Zebra
Model Name : TC77HL
Applicant : Zebra Technologies Corporation
1 Zebra Plaza Holtsville, NY 11742
Manufacturer : Zebra Technologies Corporation
1 Zebra Plaza Holtsville, NY 11742
Standard : FCC Part 15 Subpart C §15.225

The product was received on Jul. 25, 2018 and testing was started from Aug. 06, 2018 and completed on Aug. 17, 2018. We, SPORTON INTERNATIONAL INC., would like to declare that the tested sample has been evaluated in accordance with the test procedures and has been in compliance with the applicable technical standards.

The report must not be used by the client to claim product certification, approval, or endorsement by TAF or any agency of government.

The test results in this report apply exclusively to the tested model / sample. Without written approval of SPORTON INTERNATIONAL INC. EMC & Wireless Communications Laboratory, the test report shall not be reproduced except in full.

Approved by: Joseph Lin

SPORTON INTERNATIONAL INC. EMC & Wireless Communications Laboratory
No. 52, Huaya 1st Rd., Guishan Dist., Taoyuan City, Taiwan (R.O.C.)



Table of Contents

History of this test report	3
Summary of Test Result	4
1. General Description	5
1.1 Product Feature of Equipment Under Test	5
1.2 Product Specification of Equipment Under Test	6
1.3 Modification of EUT	6
1.4 Testing Location	6
1.5 Applicable Standards.....	6
2. Test Configuration of Equipment Under Test	7
2.1 Descriptions of Test Mode	7
2.2 Connection Diagram of Test System	8
2.3 Table for Supporting Units	9
2.4 EUT Operation Test Setup	9
3. Test Results	10
3.1 AC Power Line Conducted Emissions Measurement	10
3.2 20dB and 99% OBW Spectrum Bandwidth Measurement.....	12
3.3 Frequency Stability Measurement	13
3.4 Field Strength of Fundamental Emissions and Mask Measurement.....	14
3.5 Radiated Emissions Measurement	16
3.6 Antenna Requirements.....	19
4. List of Measuring Equipment	20
5. Uncertainty of Evaluation	21
Appendix A. Test Results of Conducted Emission Test	
Appendix B. Test Results of Conducted Test Items	
B1. Test Result of 20dB Spectrum Bandwidth	
B2. Test Result of Frequency Stability	
Appendix C. Test Results of Radiated Test Items	
C1. Test Result of Field Strength of Fundamental Emissions	
C2. Results of Radiated Emissions (9 kHz~30MHz)	
C4. Results of Radiated Emissions (30MHz~1GHz)	
Appendix D. Setup Photographs	



History of this test report

Report No.	Version	Description	Issued Date
FR872506D	01	Initial issue of report	Sep. 19, 2018



Summary of Test Result

Report Clause	Ref Std. Clause	Test Items	Result (PASS/FAIL)	Remark
3.1	15.207	AC Power Line Conducted Emissions	Pass	Under limit 12.05 dB at 0.771MHz
3.2	15.215(c)	20dB Spectrum Bandwidth	Pass	-
	2.1049	99% OBW Spectrum Bandwidth	Reporting only	-
3.3	15.225(e)	Frequency Stability	Pass	-
3.4	15.225(a)(b)(c)	Field Strength of Fundamental Emissions	Pass	Max level 64.81 dB μ V/m at 13.560 MHz
3.5	15.225(d) 15.209	Radiated Spurious Emissions	Pass	Under limit 6.87 dB at 40.800MHz
3.6	15.203	Antenna Requirements	Pass	-

Reviewed by: Wii Chang

Report Producer: Polly Tsai



1. General Description

1.1 Product Feature of Equipment Under Test

Product Feature	
Equipment	Touch computer
Brand Name	Zebra
Model Name	TC77HL
FCC ID	UZ7TC77HL
EUT supports Radios application	GSM/EGPRS/WCDMA/HSPA/LTE/NFC/GNSS WLAN 11a/b/g/n HT20/HT40 WLAN 11ac VHT20/VHT40/VHT80 Bluetooth BR/EDR/LE
HW Version	DV
SW Version	Android version 8.1.0
FW Version	91-09-14.00-OG-U00-STD
MFD	06JUL18
EUT Stage	Engineering Sample

Remark: The above EUT's information was declared by manufacturer.

Specification of Accessories				
AC Adapter	Brand Name	Zebra	Part Number	PWR-BUA5V16W0WW
4 PIN DC power cable	Brand Name	Zebra	Part Number	CBL-DC-383A1-01
AC Power cable	Brand Name	Zebra	Part Number	50-16000-182R
Snap-On USB/Charge Cable	Brand Name	Zebra	Part Number	CBL-TC7X-USB1-01
Snap-On Charging Cable Cup	Brand Name	Zebra	Part Number	CHG-TC7X-CBL1-01
Battery 1	Brand Name	Zebra	Part Number	BT-000318-01
Battery 2 (Falcon 1S3P Battery Pack)	Brand Name	Zebra	Part Number	BT-000318-51
Battery 3	Brand Name	Symbol	Part Number	82-171249-02
Earphone 1	Brand Name	Zebra	Part Number	HDST-35MM-PTVP-01
Earphone 2	Brand Name	Zebra	Part Number	HS2100-OTH
Snap-on 3.5MM Audio Jack Adapter	Brand Name	Symbol	Part Number	ADP-TC7X-AUD35-01
3.5mm Jack 43"(1.1m) Standard Cable	Brand Name	Zebra	Part Number	CBL-HS2100-3MS1-01
Holster	Brand Name	Zebra	Part Number	SG-TC7X-HLSTR1-02
Rigid Holster	Brand Name	Zebra	Part Number	SG-TC7X-RHLSTR1-01



1.2 Product Specification of Equipment Under Test

Standards-related Product Specification	
Tx/Rx Frequency Range	13.553 ~ 13.567MHz
Channel Number	1
20dBW	2.64 KHz
99%OBW	2.26 KHz
Antenna Type	Loop Antenna
Type of Modulation	ASK

Remark: The above EUT's information was declared by manufacturer.

1.3 Modification of EUT

No modifications are made to the EUT during all test items.

1.4 Testing Location

Sporton Lab is accredited to ISO 17025 by Taiwan Accreditation Foundation (TAF code : 1190) and the FCC designation No. TW1190 under the FCC 2.948(e) by Mutual Recognition Agreement (MRA) in FCC Test.

Test Site	SPORTON INTERNATIONAL INC.		
Test Site Location	No.52, Huaya 1st Rd., Guishan Dist., Taoyuan City, Taiwan (R.O.C.) TEL: +886-3-327-3456 FAX: +886-3-328-4978		
Test Site No.	Sporton Site No.		
	TH03-HY	CO05-HY	03CH07-HY
Test Engineer	George Chen	Jimmy Chang	Stan Hsieh
Temperature	22~24°C	25~27°C	23~24°C
Relative Humidity	53~55%	50~52%	51~53%

Note: The test site complies with ANSI C63.4 2014 requirement.

1.5 Applicable Standards

According to the specifications of the manufacturer, the EUT must comply with the requirements of the following standards:

- ♦ FCC Part 15 Subpart C §15.225
- ♦ ANSI C63.10-2013



2. Test Configuration of Equipment Under Test

2.1 Descriptions of Test Mode

Investigation has been done on all the possible configurations.

The following table is a list of the test modes shown in this test report.

Test Items	
AC Power Line Conducted Emissions	Field Strength of Fundamental Emissions
20dB Spectrum Bandwidth	Frequency Stability
Radiated Emissions 9kHz~30MHz	Radiated Emissions 30MHz~1GHz

The EUT pre-scanned in four NFC type, A, B, F, V. The worst type (type F) was recorded in this report. Pre-scanned tests, X, Y, Z in three orthogonal panels to determine the final configuration (Y plane as worst plane) from all possible combinations.

Test Cases	
AC Conducted Emission	Mode 1 : NFC Link + WLAN (2.4GHz) Link + Bluetooth Link + Snap-On Charging Cable Cup + AC Adapter + Earphone 1 with Audio Adapter Connect to EUT + Battery 1
Remark: For Radiated Test Cases, the tests were performed with Earphone 1, and Battery 1, 2 or 3.	

2.2 Connection Diagram of Test System

<Radiated Emission Mode>

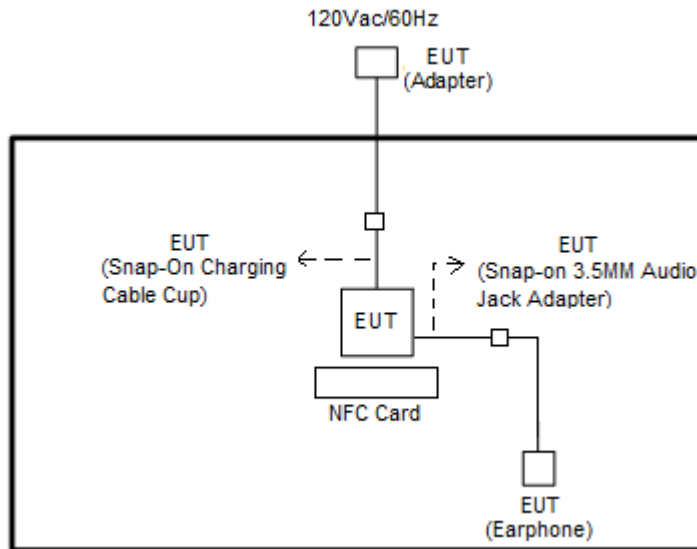

<AC Conducted Emission Mode>

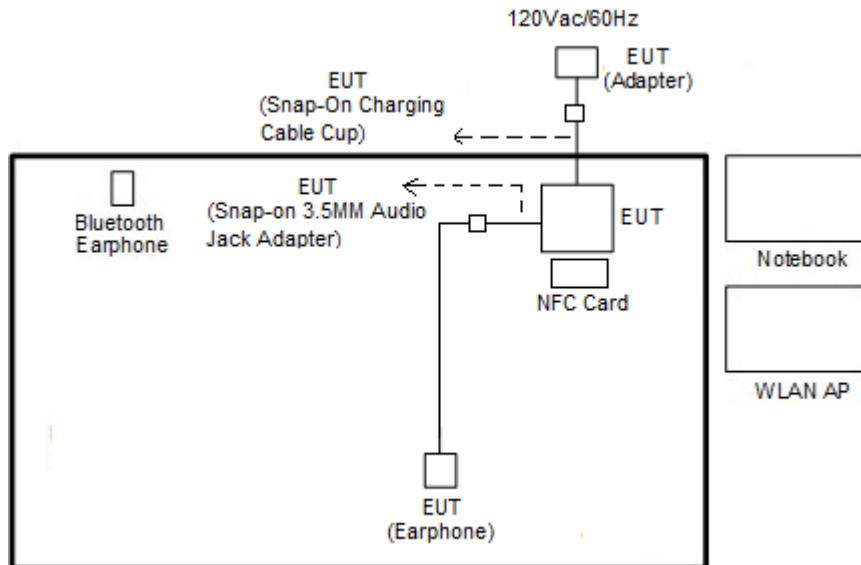



2.3 Table for Supporting Units

Item	Equipment	Trade Name	Model Name	FCC ID	Data Cable	Power Cord
1.	WLAN AP	ASUS	RT-AC66U	MSQ-RTAC66U	N/A	Unshielded, 1.8 m
2.	Bluetooth Earphone	Sony Ericsson	MW600	PY7DDA-2029	N/A	N/A
3.	Notebook	DELL	Latitude E6320	FCC DoC/ Contains FCC ID: QDS-BRCM1054	N/A	AC I/P: Unshielded, 1.2 m DC O/P: Shielded, 1.8 m
4.	SD Card	SanDisk	MicroSD HC	FCC DoC	N/A	N/A
5.	NFC Card	N/A	N/A	N/A	N/A	N/A

2.4 EUT Operation Test Setup

The EUT was programmed to be in continuously transmitting mode.

The ancillary equipment, NFC card, is used to make the EUT (NFC) continuously transmit at 13.56MHz and is placed around 0 cm gap to the EUT.



3. Test Results

3.1 AC Power Line Conducted Emissions Measurement

3.1.1 Limit of AC Conducted Emission

For equipment that is designed to be connected to the public utility (AC) power line, the radio frequency voltage that is conducted back onto the AC power line on any frequency or frequencies within the band 150 kHz to 30 MHz shall not exceed the limits in the following table.

Frequency of Emission (MHz)	Conducted Limit (dBµV)	
	Quasi-Peak	Average
0.15-0.5	66 to 56*	56 to 46*
0.5-5	56	46
5-30	60	50

*Decreases with the logarithm of the frequency.

For terminal test result, the testing follows FCC KDB 174176.

3.1.2 Measuring Instruments

See list of measuring equipment of this test report.

3.1.3 Test Procedures

1. The EUT was placed 0.4 meter from the conducting wall of the shielding room, and it was kept at least 80 centimeters from any other grounded conducting surface.
2. Connect EUT to the power mains through a line impedance stabilization network (LISN).
3. All the support units are connecting to the other LISN.
4. The LISN provides 50 ohm coupling impedance for the measuring instrument.
5. The FCC states that a 50 ohm, 50 microhenry LISN should be used.
6. Both sides of AC line were checked for maximum conducted interference.
7. The frequency range from 150 kHz to 30 MHz was searched.
8. Set the test-receiver system to Peak Detect Function and specified bandwidth (IF Bandwidth = 9kHz) with Maximum Hold Mode. Then measurement is also conducted by Average Detector and Quasi-Peak Detector Function respectively.

3.1.4 Test setup

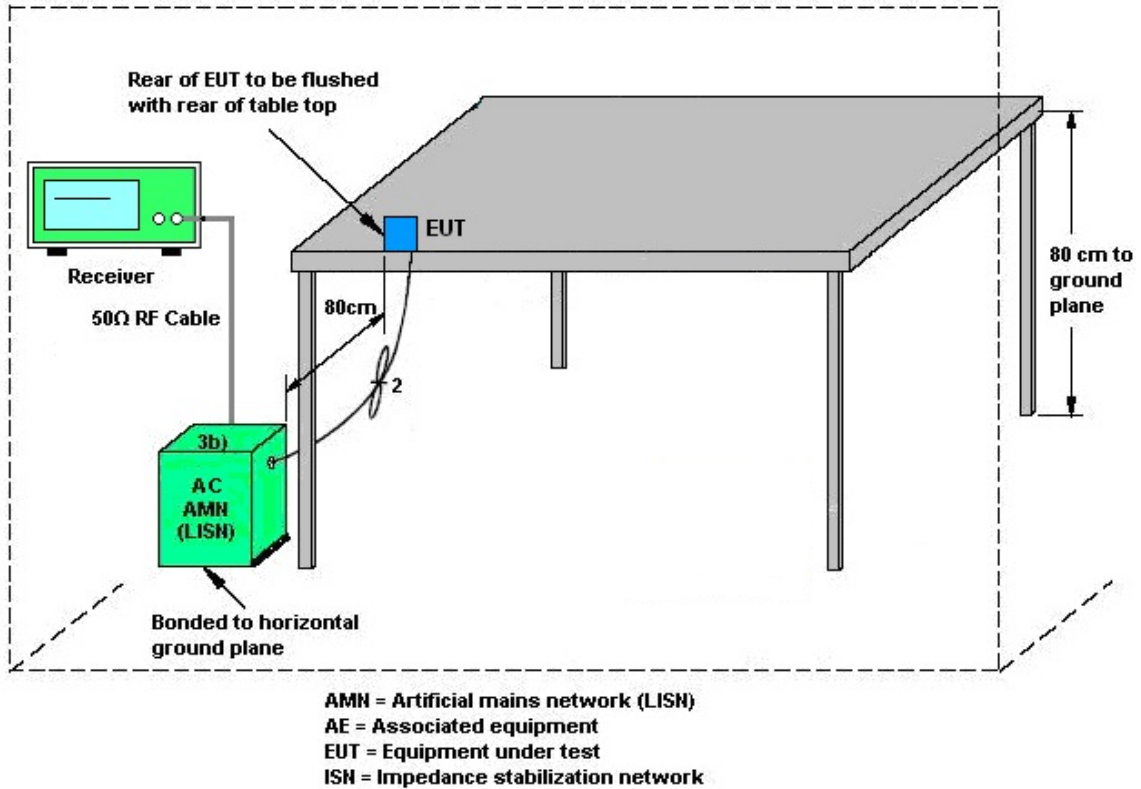

3.1.5 Test Result of AC Conducted Emission

Please refer to Appendix A.

Note:

(1) with antenna

Remark: 13.560MHz is the NFC RF fundamental signal.

(2) with dummy load

Remark: Only the fundamental NFC signal needs to be retested per C63.4.

3.2 20dB and 99% OBW Spectrum Bandwidth Measurement

3.2.1 Limit

Intentional radiators must be designed to ensure that the 20dB and 99% emission bandwidth in the specific band 13.553~13.567MHz.

3.2.2 Measuring Instruments

See list of measuring instruments of this test report.

3.2.3 Test Procedures

1. The spectrum analyzer connected via a receive antenna placed near the EUT in peak Max hold mode.
2. The resolution bandwidth of 1 kHz and the video bandwidth of 3 kHz were used.
3. Measured the spectrum width with power higher than 20dB below carrier.
4. Measured the 99% OBW.

3.2.4 Test Setup



3.2.5 Test Result of Conducted Test Items

Please refer to Appendix B.

3.3 Frequency Stability Measurement

3.3.1 Limit

The frequency tolerance of the carrier signal shall be maintained within +/- 0.01% (100ppm) of the operating frequency over a temperature variation of -20 degrees to +50 degrees C at normal supply voltage, and for a variation in the primary supply voltage from 85% to 115% of the rated supply voltage at a temperature of 20 degrees C. For battery operated equipment, the equipment tests shall be performed using a new battery.

3.3.2 Measuring Instruments

See list of measuring instruments of this test report.

3.3.3 Test Procedures

1. The spectrum analyzer connected via a receive antenna placed near the EUT.
2. EUT have transmitted signal and fixed channelize.
3. Set the spectrum analyzer span to view the entire emissions bandwidth.
4. Set RBW = 1 kHz, VBW = 3 kHz with peak detector and maxhold settings.
5. The f_c is declaring of channel frequency. Then the frequency error formula is $(f_c - f) / f_c \times 10^6$ ppm and the limit is less than ± 100 ppm.
6. Extreme temperature rule is -20°C~50°C.

3.3.4 Test Setup



3.3.5 Test Result of Conducted Test Items

Please refer to Appendix B.



3.4 Field Strength of Fundamental Emissions and Mask Measurement

3.4.1 Limit

Rules and specifications	FCC CFR 47 Part 15 section 15.225			
Description	Compliance with the spectrum mask is tested with RBW set to 9kHz.			
Freq. of Emission (MHz)	Field Strength ($\mu\text{V/m}$) at 30m	Field Strength ($\text{dB}\mu\text{V/m}$) at 30m	Field Strength ($\text{dB}\mu\text{V/m}$) at 10m	Field Strength ($\text{dB}\mu\text{V/m}$) at 3m
1.705~13.110	30	29.5	48.58	69.5
13.110~13.410	106	40.5	59.58	80.5
13.410~13.553	334	50.5	69.58	90.5
13.553~13.567	15848	84.0	103.08	124.0
13.567~13.710	334	50.5	69.58	90.5
13.710~14.010	106	40.5	59.58	80.5
14.010~30.000	30	29.5	48.58	69.5

3.4.2 Measuring Instruments

See list of measuring instruments of this test report.

3.4.3 Test Procedures

1. Configure the EUT according to ANSI C63.10. The EUT was placed on the top of the turntable 0.8 meter above ground. The phase center of the loop receiving antenna mounted antenna tower was placed 3 meters far away from the turntable.
2. Power on the EUT and all the supporting units. The turntable was rotated by 360 degrees to determine the position of the highest radiation.
3. The height of the receiving antenna was fixed at one meter above ground to find the maximum emissions field strength.
4. For Fundamental emissions, use the receiver to measure QP reading.
5. When the radiated emissions limits are expressed in terms of the average value of the emissions, and pulsed operation is employed, the measurement field strength shall be determined by averaging over one complete pulse train, including blanking intervals, as long as the pulse train does not exceed 0.1 seconds. As an alternative (provided the transmitter operates for longer than 0.1 seconds) or in cases where the pulse train exceeds 0.1 seconds, the measured field strength shall be determined from the average absolute voltage during a 0.1 second interval during which the field strength is at its maximum value.
6. Compliance with the spectrum mask is tested with RBW set to 9kHz.
Note: Emission level (dB μ V/m) = 20 log Emission level (μ V/m).

3.4.4 Test Setup

For radiated emissions below 30MHz



3.4.5 Test Result of Field Strength of Fundamental Emissions and Mask

Please refer to Appendix C.



3.5 Radiated Emissions Measurement

3.5.1 Limit

The field strength of any emissions which appear outside of 13.110 ~14.010MHz band shall not exceed the general radiated emissions limits.

Frequencies (MHz)	Field Strength (µV/m)	Measurement Distance (meters)
0.009~0.490	2400/F(kHz)	300
0.490~1.705	24000/F(kHz)	30
1.705~30.0	30	30
30~88	100	3
88~216	150	3
216~960	200	3
Above 960	500	3

3.5.2 Measuring Instruments

See list of measuring instruments of this test report.

3.5.3 Measuring Instrument Setting

The following table is the setting of receiver:

Receiver Parameter	Setting
Attenuation	Auto
Frequency Range: 9kHz~150kHz	RBW 200Hz for QP
Frequency Range: 150kHz~30MHz	RBW 9kHz for QP
Frequency Range: 30MHz~1000MHz	RBW 120kHz for Peak

Note: The emission limits shown in the above table are based on measurements employing a CISPR quasi-peak detector except for the frequency bands 9-90 kHz and 110-490 kHz. Radiated emission limits in these two bands are based on measurements employing an average detector.



3.5.4 Test Procedures

1. Configure the EUT according to ANSI C63.10. The EUT was placed on the top of the turntable 0.8 meter above ground. The phase center of the receiving antenna mounted on the top of a height-variable antenna tower was placed 3 meters far away from the turntable.
2. Power on the EUT and all the supporting units. The turntable was rotated by 360 degrees to determine the position of the highest radiation.
3. The height of the broadband receiving antenna was varied between one meter and four meters above ground to find the maximum emissions field strength of both horizontal and vertical polarization.
4. For each suspected emissions, the antenna tower was scan (from 1 M to 4 M) and then the turntable was rotated (from 0 degree to 360 degrees) to find the maximum reading.
5. Set the test-receiver system to Peak or CISPR quasi-peak Detect Function with specified bandwidth under Maximum Hold Mode.
6. When the radiated emissions limits are expressed in terms of the average value of the emissions, and pulsed operation is employed, the measurement field strength shall be determined by averaging over one complete pulse train, including blanking intervals, as long as the pulse train does not exceed 0.1 seconds. As an alternative (provided the transmitter operates for longer than 0.1 seconds) or in cases where the pulse train exceeds 0.1 seconds, the measured field strength shall be determined from the average absolute voltage during a 0.1 second interval during which the field strength is at its maximum value.
7. In case the emission is lower than 30MHz, loop antenna has to be used for measurement and the recorded data should be QP measured by receiver.

3.5.5 Test Setup

For radiated emissions below 30MHz

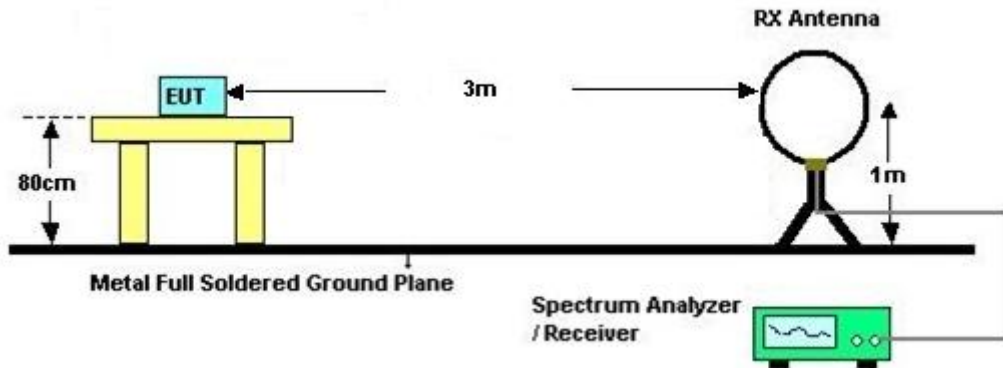

For radiated emissions above 30MHz

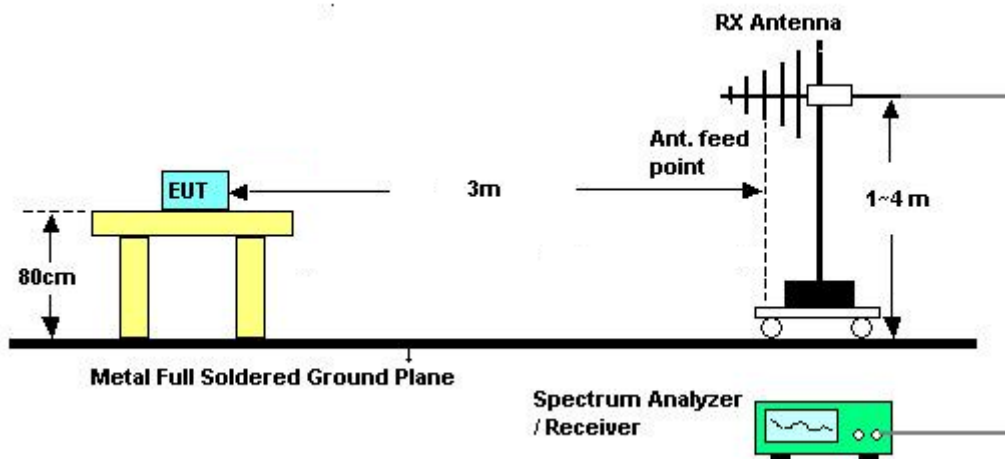

3.5.6 Test Result of Radiated Emissions Measurement

Please refer to Appendix C.

Remark: There is a comparison data of both open-field test site and semi-Anechoic chamber, and the result came out very similar.



3.6 Antenna Requirements

3.6.1 Standard Applicable

Except for special regulations, the Low-power Radio-frequency Devices must not be equipped with any jacket for installing an antenna with extension cable. An intentional radiator shall be designed to ensure that no antenna other than that furnished by the responsible party shall be used with the device. The use of a permanently attached antenna or of an antenna that uses a unique coupling to the intentional radiator shall be considered sufficient to comply with the provisions of this Section. The manufacturer may design the unit so that the user can replace a broken antenna, but the use of a standard antenna jack or electrical connector is prohibited.

The use of a permanently attached antenna or of an antenna that uses a unique coupling to the intentional radiator shall be considered sufficient to comply with the rule.

3.6.2 Antenna Anti-Replacement Construction

An embedded-in antenna design is used.



4. List of Measuring Equipment

Instrument	Manufacturer	Model No.	Serial No.	Characteristics	Calibration Date	Test Date	Due Date	Remark
AC Power Source	AC POWER	AFC-500W	F104070011	50Hz~60Hz	Mar. 21, 2018	Aug. 17, 2018	Mar. 20, 2019	Conducted (TH03-HY)
Spectrum Analyzer	Rohde & Schwarz	FSP30	101329	9kHz~30GHz	Jun. 25, 2018	Aug. 17, 2018	Jun. 24, 2019	Conducted (TH03-HY)
Temperature Chamber	ESPEC	SU-641	92013721	-30°C ~70°C	Dec. 06, 2017	Aug. 17, 2018	Dec. 05, 2019	Conducted (TH03-HY)
AC Power Source	ChainTek	APC-1000W	N/A	N/A	N/A	Aug. 06, 2018~ Aug. 11, 2018	N/A	Conduction (CO05-HY)
EMI Test Receiver	Rohde & Schwarz	ESR3	102388	9KHz~3.6GHz	Dec. 08, 2017	Aug. 06, 2018~ Aug. 11, 2018	Dec. 07, 2018	Conduction (CO05-HY)
LISN	Rohde & Schwarz	ENV216	100080	9kHz~30MHz	Nov. 30, 2017	Aug. 06, 2018~ Aug. 11, 2018	Nov. 29, 2018	Conduction (CO05-HY)
LISN	Rohde & Schwarz	ENV216	100081	9kHz~30MHz	Dec. 08, 2017	Aug. 06, 2018~ Aug. 11, 2018	Dec. 07, 2018	Conduction (CO05-HY)
Software	Rohde & Schwarz	EMC32 V10.30	N/A	N/A	N/A	Aug. 06, 2018~ Aug. 11, 2018	N/A	Conduction (CO05-HY)
LF Cable	HUBER + SUHNER	RG-214/U	LF01	N/A	Jan. 03, 2018	Aug. 06, 2018~ Aug. 11, 2018	Jan. 02, 2019	Conduction (CO05-HY)
Pulse Limiter	Rohde & Schwarz	ESH3-Z2	100851	N/A	Jan. 03, 2018	Aug. 06, 2018~ Aug. 11, 2018	Jan. 02, 2019	Conduction (CO05-HY)
Bilog Antenna	TESEQ	CBL 6111D&0080 0N1D01N-0 6	35419&03	30MHz to 1GHz	Dec. 18, 2017	Aug. 06, 2018~ Aug. 07, 2018	Dec. 17, 2018	Radiation (03CH07-HY)
Double Ridge Horn Antenna	ESCO	3117	00075962	1GHz ~ 18GHz	Aug. 23, 2017	Aug. 06, 2018~ Aug. 07, 2018	Aug. 22, 2018	Radiation (03CH07-HY)
Loop Antenna	Rohde & Schwarz	HFH2-Z2	100315	9 kHz~30 MHz	Nov. 10, 2017	Aug. 06, 2018~ Aug. 07, 2018	Nov. 09, 2018	Radiation (03CH07-HY)
Preamplifier	COM-POWER	PA-103A	161241	10MHz-1GHz	May 21, 2018	Aug. 06, 2018~ Aug. 07, 2018	May 20, 2019	Radiation (03CH07-HY)
Filter	Wainwright	WHK20/100 0C7/40SS	SN3	20M High Pass	Nov. 21, 2017	Aug. 06, 2018~ Aug. 07, 2018	Nov. 20, 2018	Radiation (03CH07-HY)
RF Cable	HUBER + SUHNER	SUCOFLEX 104	MY24971/4, MY28655/4	9KHz~30MHz	Jan. 02, 2018	Aug. 06, 2018~ Aug. 07, 2018	Jan. 01, 2019	Radiation (03CH07-HY)
RF Cable	HUBER + SUHNER	SUCOFLEX 104	MY28655/4, MY24971/4, MY15682/4	30MHz~1GHz	Feb. 27, 2018	Aug. 06, 2018~ Aug. 07, 2018	Feb. 26, 2019	Radiation (03CH07-HY)
Software	Audix	E3 6.2009-8 -24	8050400465 6H	N/A	N/A	Aug. 06, 2018~ Aug. 07, 2018	N/A	Radiation (03CH07-HY)
Antenna Mast	Max-Full	MFA520BS	N/A	1m~4m	N/A	Aug. 06, 2018~ Aug. 07, 2018	N/A	Radiation (03CH07-HY)
Turn Table	ChainTek	Chaintek 3000	N/A	0~360 Degree	N/A	Aug. 06, 2018~ Aug. 07, 2018	N/A	Radiation (03CH07-HY)
EMI Test Receiver	Agilent	N9038A (MXE)	MY5329005 3	20Hz to 26.5GHz	Jan. 16, 2018	Aug. 06, 2018~ Aug. 07, 2018	Jan. 15, 2019	Radiation (03CH07-HY)



5. Uncertainty of Evaluation

Uncertainty of Conducted Emission Measurement (150 kHz ~ 30 MHz)

Measuring Uncertainty for a Level of Confidence of 95% ($U = 2Uc(y)$)	2.7
---	-----

Uncertainty of Radiated Emission Measurement (9 kHz ~ 30 MHz)

Measuring Uncertainty for a Level of Confidence of 95% ($U = 2Uc(y)$)	3.4
---	-----

Uncertainty of Radiated Emission Measurement (30 MHz ~ 1000 MHz)

Measuring Uncertainty for a Level of Confidence of 95% ($U = 2Uc(y)$)	5.7
---	-----



Appendix A. Test Results of Conducted Emission Test

<Original Test Result>

Test Engineer :	Jimmy Chang	Temperature :	25~27°C
		Relative Humidity :	50~52%
Test Voltage :	120Vac / 60Hz	Phase :	Line

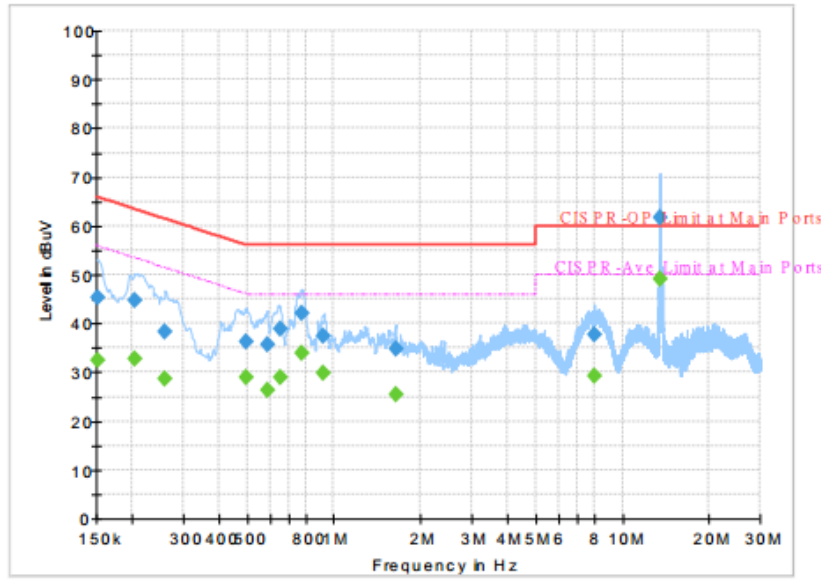

Frequency (MHz)	QuasiPeak (dBuV)	CAverage (dBuV)	Limit (dBuV)	Margin (dB)	Line	Filter	Corr. (dB)
0.152250	---	32.41	55.88	23.47	L1	OFF	19.5
0.152250	45.41	---	65.88	20.47	L1	OFF	19.5
0.204000	---	32.72	53.45	20.73	L1	OFF	19.5
0.204000	44.62	---	63.45	18.83	L1	OFF	19.5
0.260250	---	28.62	51.42	22.80	L1	OFF	19.5
0.260250	38.30	---	61.42	23.12	L1	OFF	19.5
0.498750	---	28.81	46.02	17.21	L1	OFF	19.5
0.498750	36.13	---	56.02	19.89	L1	OFF	19.5
0.586500	---	26.38	46.00	19.62	L1	OFF	19.5
0.586500	35.72	---	56.00	20.28	L1	OFF	19.5
0.651750	---	28.96	46.00	17.04	L1	OFF	19.5
0.651750	38.78	---	56.00	17.22	L1	OFF	19.5
0.771000	---	33.95	46.00	12.05	L1	OFF	19.5
0.771000	42.04	---	56.00	13.96	L1	OFF	19.5
0.921750	---	29.94	46.00	16.06	L1	OFF	19.5
0.921750	37.31	---	56.00	18.69	L1	OFF	19.5
1.635000	---	25.41	46.00	20.59	L1	OFF	19.6
1.635000	34.76	---	56.00	21.24	L1	OFF	19.6
7.962000	---	29.21	50.00	20.79	L1	OFF	19.7
7.962000	37.65	---	60.00	22.35	L1	OFF	19.7
13.560000	---	49.15	50.00	0.85	L1	OFF	19.7
13.560000	61.68	---	60.00	-1.68	L1	OFF	19.7



Test Engineer :	Jimmy Chang	Temperature :	25~27°C
		Relative Humidity :	50~52%
Test Voltage :	120Vac / 60Hz	Phase :	Neutral

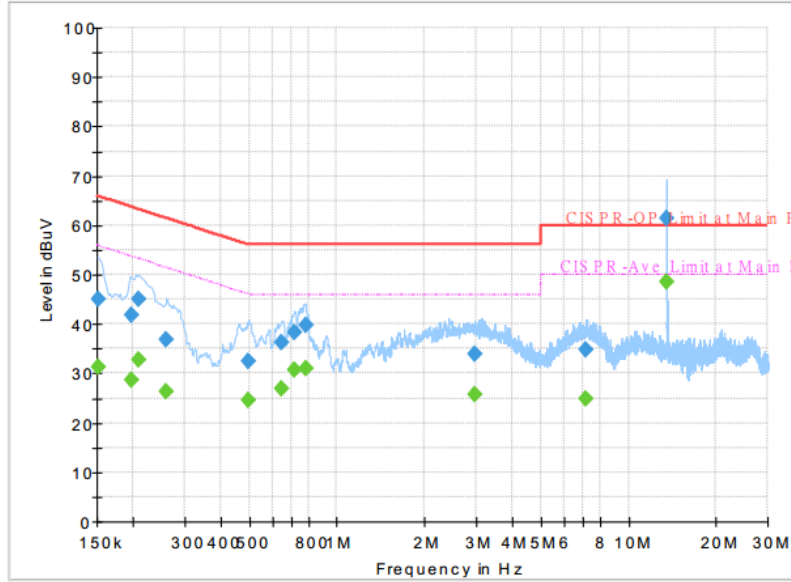

Frequency (MHz)	QuasiPeak (dBuV)	CAverage (dBuV)	Limit (dBuV)	Margin (dB)	Line	Filter	Corr. (dB)
0.152250	---	31.31	55.88	24.57	N	OFF	19.5
0.152250	44.95	---	65.88	20.93	N	OFF	19.5
0.197250	---	28.64	53.73	25.09	N	OFF	19.5
0.197250	41.95	---	63.73	21.78	N	OFF	19.5
0.208500	---	32.76	53.27	20.51	N	OFF	19.5
0.208500	45.11	---	63.27	18.16	N	OFF	19.5
0.260250	---	26.24	51.42	25.18	N	OFF	19.5
0.260250	36.93	---	61.42	24.49	N	OFF	19.5
0.498750	---	24.48	46.02	21.54	N	OFF	19.5
0.498750	32.47	---	56.02	23.55	N	OFF	19.5
0.647250	---	26.76	46.00	19.24	N	OFF	19.5
0.647250	36.15	---	56.00	19.85	N	OFF	19.5
0.712500	---	30.56	46.00	15.44	N	OFF	19.5
0.712500	38.43	---	56.00	17.57	N	OFF	19.5
0.780000	---	31.10	46.00	14.90	N	OFF	19.5
0.780000	39.83	---	56.00	16.17	N	OFF	19.5
2.960250	---	25.84	46.00	20.16	N	OFF	19.6
2.960250	33.94	---	56.00	22.06	N	OFF	19.6
7.176750	---	24.79	50.00	25.21	N	OFF	19.7
7.176750	34.90	---	60.00	25.10	N	OFF	19.7
13.560000	---	48.60	50.00	1.40	N	OFF	19.8
13.560000	61.42	---	60.00	-1.42	N	OFF	19.8



<Terminal Test Result>

Test Engineer :	Jimmy Chang	Temperature :	25~27°C
		Relative Humidity :	50~52%
Test Voltage :	120Vac / 60Hz	Phase :	Line

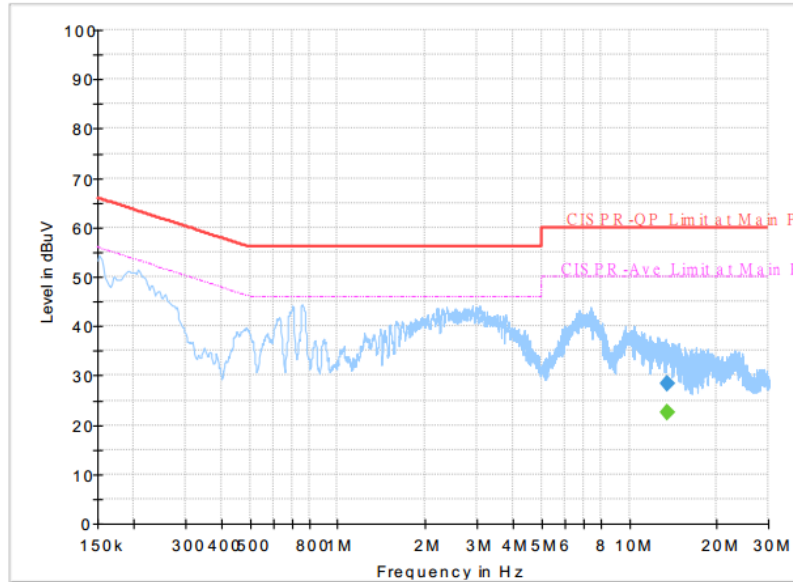

Frequency (MHz)	QuasiPeak (dBuV)	CAverage (dBuV)	Limit (dBuV)	Margin (dB)	Line	Filter	Corr. (dB)
13.560000	---	22.43	50.00	27.57	L1	OFF	19.7
13.560000	28.24	---	60.00	31.76	L1	OFF	19.7



Test Engineer :	Jimmy Chang	Temperature :	25~27°C
		Relative Humidity :	50~52%
Test Voltage :	120Vac / 60Hz	Phase :	Neutral

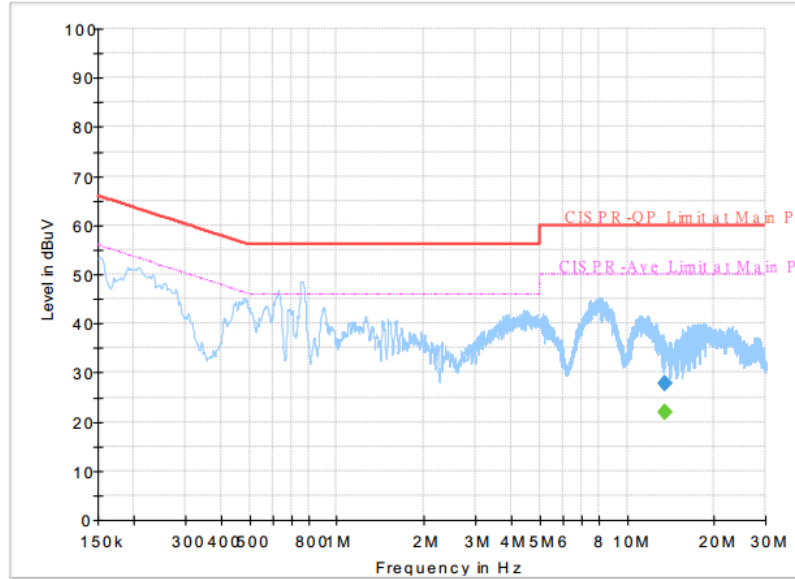

Frequency (MHz)	QuasiPeak (dBuV)	CAverage (dBuV)	Limit (dBuV)	Margin (dB)	Line	Filter	Corr. (dB)
13.560000	---	21.96	50.00	28.04	N	OFF	19.8
13.560000	27.84	---	60.00	32.16	N	OFF	19.8



Appendix B. Test Results of Conducted Test Items

B1. Test Result of 20dB Spectrum Bandwidth

Test mode	NFC Tx	Test Frequency (MHz)	13.56
Date: 17.AUG.2018 13:48:18		Date: 17.AUG.2018 16:22:18	
20dB Bandwidth (kHz)	2.640	99% OccupiedBW(kHz)	2.260
Frequency range (MHz)	$f_L > 13.553$	13.55886	Test Result
	$f_H < 13.567$	13.56150	Complies

Remark: Because the measured signal is CW adjusting the RBW per C63.10 would not be practical since measured bandwidth will always follow the RBW and the result will be approximately twice the RBW.



B2. Test Result of Frequency Stability

B3. Voltage vs. Frequency Stability		Temperature vs. Frequency Stability		
Voltage (Vac)	Measurement Frequency (MHz)	Temperature (°C)	Time	Measurement Frequency (MHz)
120	13.560180	-20	0	13.560200
			2	13.560200
			5	13.560220
			10	13.560220
		-10	0	13.560240
			2	13.560230
			5	13.560240
			10	13.560240
		0	0	13.560240
			2	13.560240
			5	13.560240
			10	13.560230
		10	0	13.560230
			2	13.560220
			5	13.560220
			10	13.560220
		20	0	13.560180
			2	13.560180
			5	13.560180
			10	13.560180
		30	0	13.560200
			2	13.560200
			5	13.560200
			10	13.560200
		40	0	13.560170
			2	13.560160
			5	13.560170
			10	13.560160



Voltage vs. Frequency Stability		Temperature vs. Frequency Stability		
Voltage (Vac)	Measurement Frequency (MHz)	Temperature (°C)	Time	Measurement Frequency (MHz)
		50	0	13.560150
			2	13.560150
			5	13.560150
			10	13.560150
Max.Deviation (MHz)	0.000180	Max.Deviation (MHz)		0.000240
Max.Deviation (ppm)	13.2743	Max.Deviation (ppm)		17.6991
Limit	FS < ±100 ppm	Limit		FS < ±100 ppm
Test Result	PASS	Test Result		PASS



Appendix C. Test Results of Radiated Test Items

C1. Test Result of Field Strength of Fundamental Emissions

Test Mode :	NFC Tx + Battery 1	Test Frequency (MHz)	13.56																																																																																																											
<p>Site : 03CH07-HY Condition : 15.225 3m LOOP_ANT(H)_100315 HORIZONTAL : RBW:9.000KHz VBW:9.000KHz SWT:Auto Project : 872506 Mode : 1</p>																																																																																																														
<table border="1"> <thead> <tr> <th>1</th> <th>13.56</th> <th>64.80</th> <th>-59.20</th> <th>124.00</th> <th>44.46</th> <th>19.91</th> <th>0.43</th> <th>100</th> <th>356</th> <th>QP</th> </tr> </thead> <tbody> <tr> <th>Site</th> <td colspan="11">: 03CH07-HY</td> </tr> <tr> <th>Condition</th> <td colspan="11">: 15.225 3m LOOP_ANT(H)_100315 HORIZONTAL</td> </tr> <tr> <th>Project</th> <td colspan="11">: 872506</td> </tr> <tr> <th>Mode</th> <td colspan="11">: 1</td> </tr> <tr> <th>Site</th> <td colspan="11">: 03CH07-HY</td> </tr> <tr> <th>Condition</th> <td colspan="11">: 15.225 3m LOOP_ANT(V)_100315 VERTICAL</td> </tr> <tr> <th>Project</th> <td colspan="11">: 872506</td> </tr> <tr> <th>Mode</th> <td colspan="11">: 1</td> </tr> </tbody> </table>				1	13.56	64.80	-59.20	124.00	44.46	19.91	0.43	100	356	QP	Site	: 03CH07-HY											Condition	: 15.225 3m LOOP_ANT(H)_100315 HORIZONTAL											Project	: 872506											Mode	: 1											Site	: 03CH07-HY											Condition	: 15.225 3m LOOP_ANT(V)_100315 VERTICAL											Project	: 872506											Mode	: 1										
1	13.56	64.80	-59.20	124.00	44.46	19.91	0.43	100	356	QP																																																																																																				
Site	: 03CH07-HY																																																																																																													
Condition	: 15.225 3m LOOP_ANT(H)_100315 HORIZONTAL																																																																																																													
Project	: 872506																																																																																																													
Mode	: 1																																																																																																													
Site	: 03CH07-HY																																																																																																													
Condition	: 15.225 3m LOOP_ANT(V)_100315 VERTICAL																																																																																																													
Project	: 872506																																																																																																													
Mode	: 1																																																																																																													
<p>Site : 03CH07-HY Condition : 15.225 3m LOOP_ANT(V)_100315 VERTICAL : RBW:9.000KHz VBW:9.000KHz SWT:Auto Project : 872506 Mode : 1</p>																																																																																																														
<table border="1"> <thead> <tr> <th>1</th> <th>13.56</th> <th>62.88</th> <th>-61.12</th> <th>124.00</th> <th>42.54</th> <th>19.91</th> <th>0.43</th> <th>100</th> <th>72</th> <th>QP</th> </tr> </thead> <tbody> <tr> <th>Site</th> <td colspan="11">: 03CH07-HY</td> </tr> <tr> <th>Condition</th> <td colspan="11">: 15.225 3m LOOP_ANT(V)_100315 VERTICAL</td> </tr> <tr> <th>Project</th> <td colspan="11">: 872506</td> </tr> <tr> <th>Mode</th> <td colspan="11">: 1</td> </tr> </tbody> </table>				1	13.56	62.88	-61.12	124.00	42.54	19.91	0.43	100	72	QP	Site	: 03CH07-HY											Condition	: 15.225 3m LOOP_ANT(V)_100315 VERTICAL											Project	: 872506											Mode	: 1																																																										
1	13.56	62.88	-61.12	124.00	42.54	19.91	0.43	100	72	QP																																																																																																				
Site	: 03CH07-HY																																																																																																													
Condition	: 15.225 3m LOOP_ANT(V)_100315 VERTICAL																																																																																																													
Project	: 872506																																																																																																													
Mode	: 1																																																																																																													



Test Mode :	NFC Tx + Battery 2	Test Frequency (MHz)	13.56
-------------	--------------------	----------------------	-------

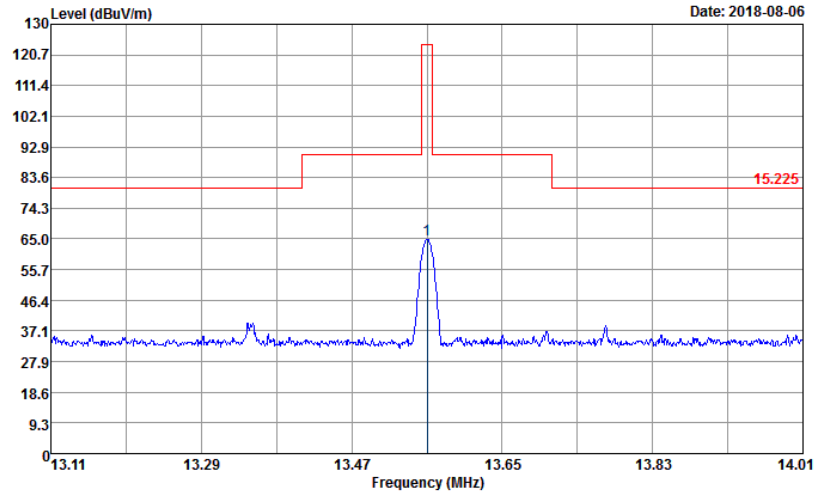

Site : 03CH07-HY
 Condition : 15.225 3m LOOP_ANT(H)_100315 HORIZONTAL
 : RBW:9.000KHz VBW:9.000KHz SWT:Auto
 Project : 872506
 Mode : 2

1	13.56	64.81	-59.19	124.00	44.47	19.91	0.43	100	0	QP
---	-------	-------	--------	--------	-------	-------	------	-----	---	----

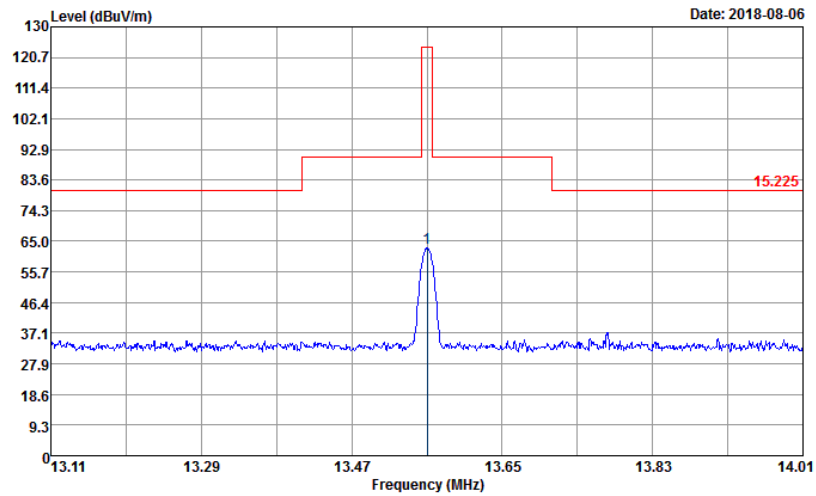

Site : 03CH07-HY
 Condition : 15.225 3m LOOP_ANT(V)_100315 VERTICAL
 : RBW:9.000KHz VBW:9.000KHz SWT:Auto
 Project : 872506
 Mode : 2

1	13.56	62.93	-61.07	124.00	42.59	19.91	0.43	100	96	QP
---	-------	-------	--------	--------	-------	-------	------	-----	----	----



Test Mode :	NFC Tx + Battery 3	Test Frequency (MHz)	13.56
-------------	--------------------	----------------------	-------

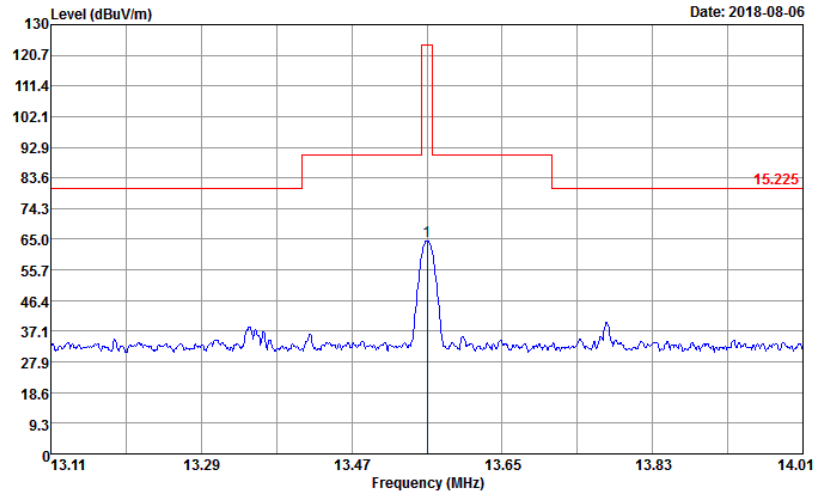

Site : 03CH07-HY
 Condition : 15.225 3m LOOP_ANT(H)_100315 HORIZONTAL
 : RBW:9.000KHz VBW:9.000KHz SWT:Auto
 Project : 872506
 Mode : 3

1	13.56	64.59	-59.41	124.00	44.25	19.91	0.43	100	0	QP
---	-------	-------	--------	--------	-------	-------	------	-----	---	----

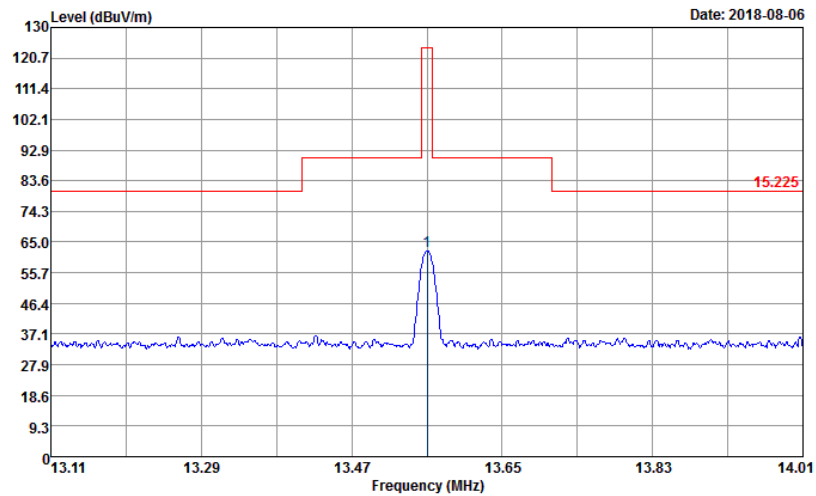

Site : 03CH07-HY
 Condition : 15.225 3m LOOP_ANT(V)_100315 VERTICAL
 : RBW:9.000KHz VBW:9.000KHz SWT:Auto
 Project : 872506
 Mode : 3

1	13.56	62.41	-61.59	124.00	42.07	19.91	0.43	100	101	QP
---	-------	-------	--------	--------	-------	-------	------	-----	-----	----



C2. Results of Radiated Spurious Emissions (9 kHz~30MHz)

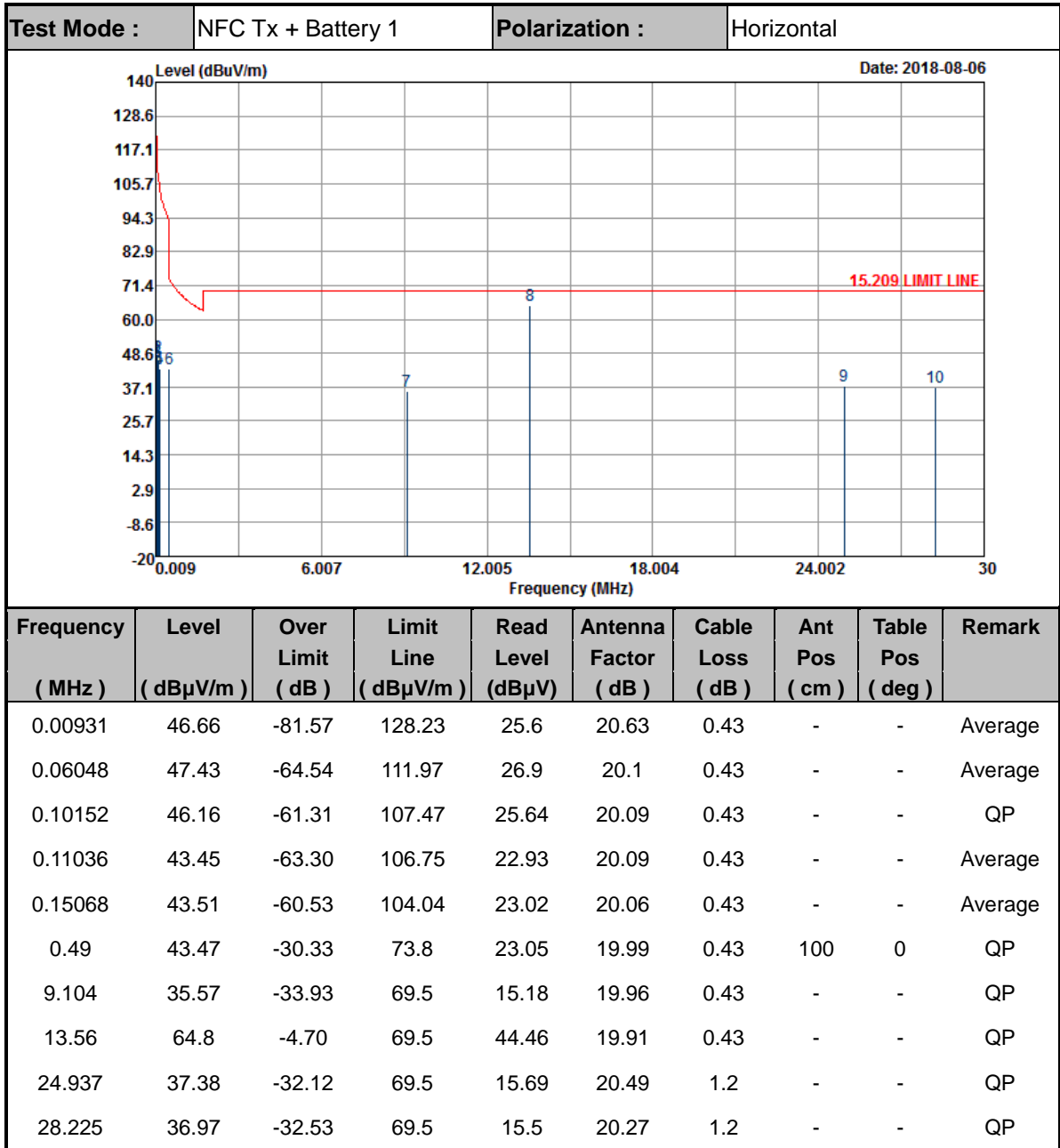

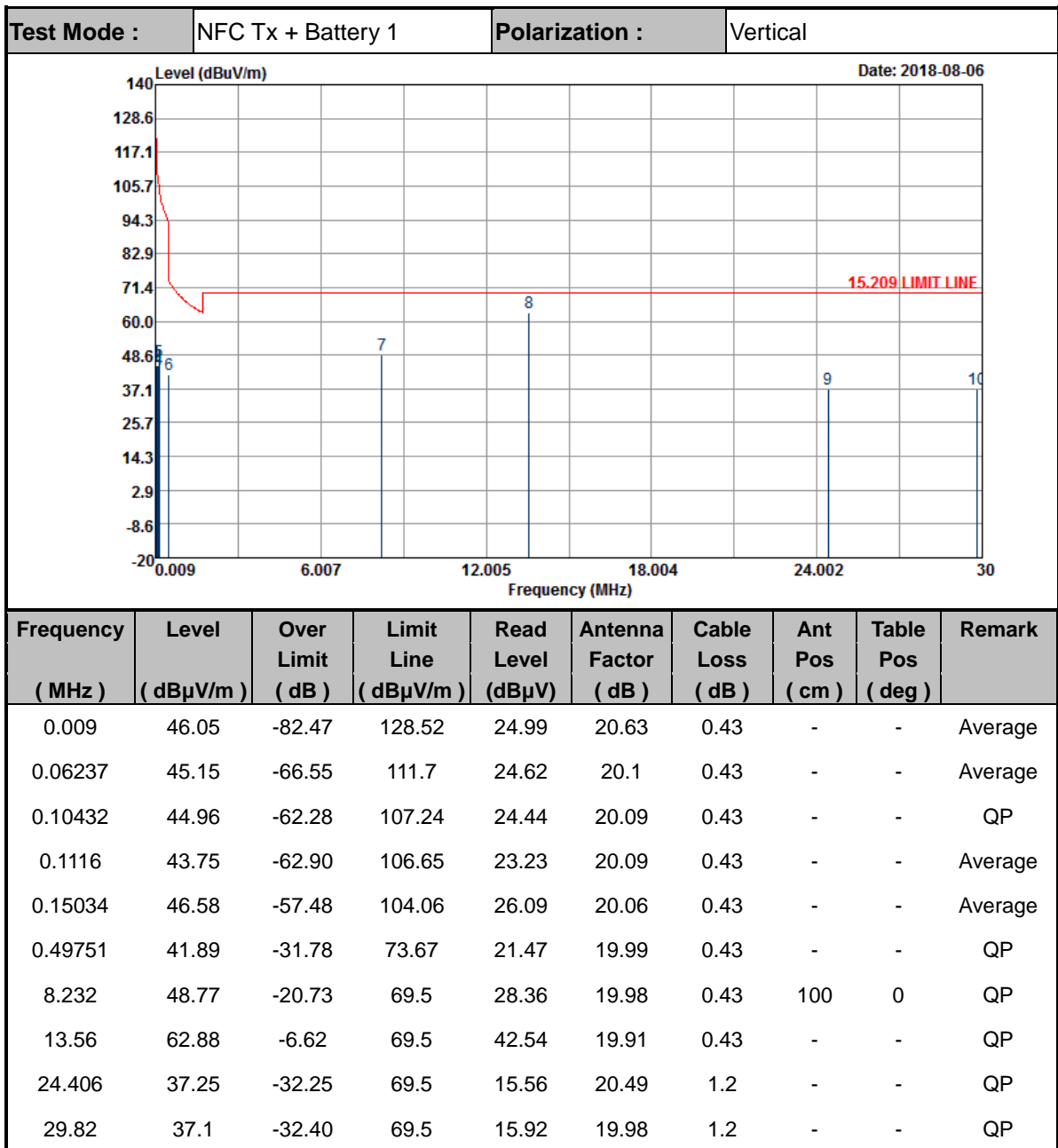

Note:

1. 13.56 MHz is fundamental signal which can be ignored.
2. The amplitude of spurious emissions which are attenuated by more than 20dB below the permissible value has no need to be reported.
3. Distance extrapolation factor = 40 log (specific distance / test distance) (dB);
4. Limit line = specific limits (dBuV) + distance extrapolation factor.

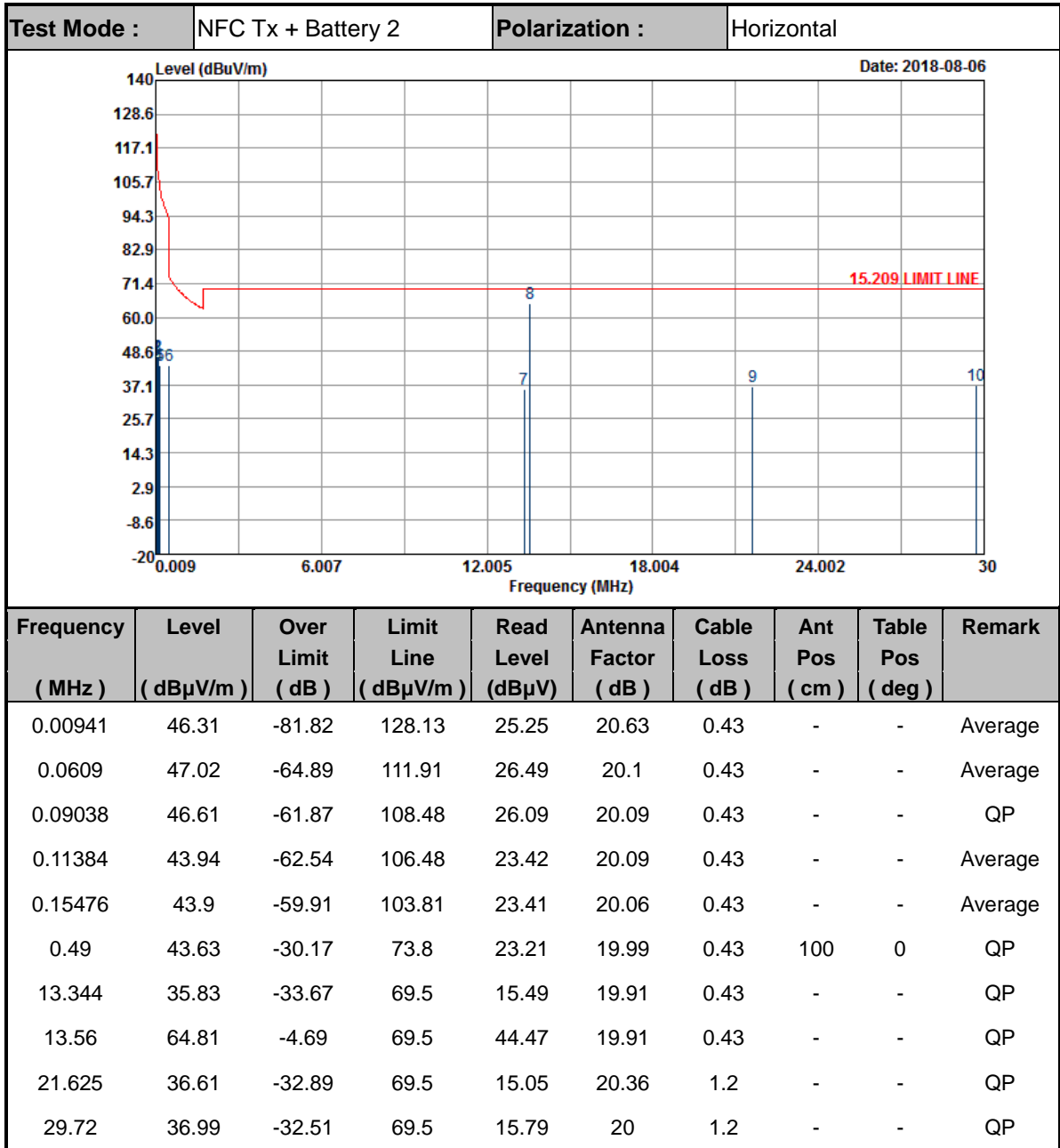

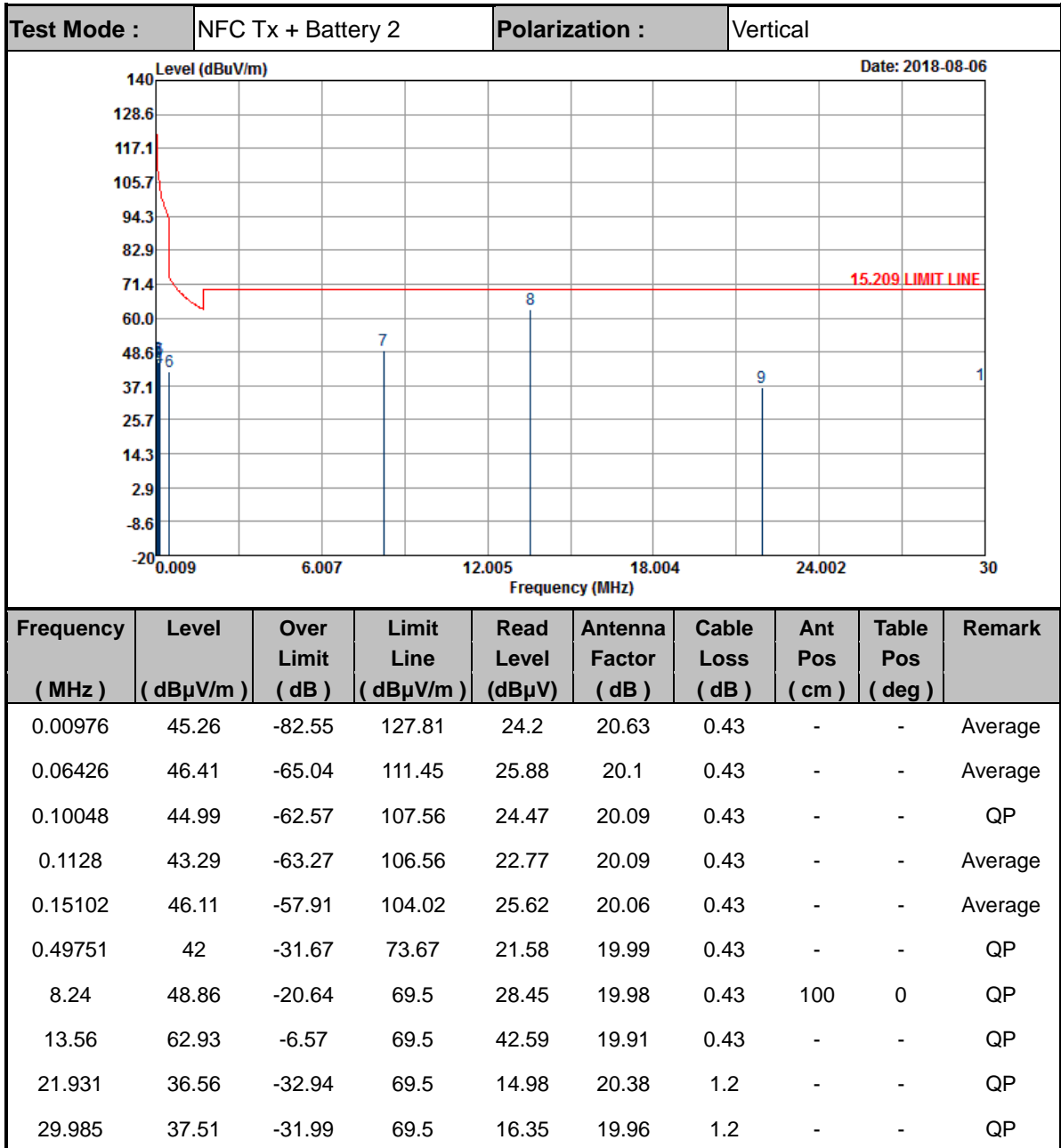

Note:

5. 13.56 MHz is fundamental signal which can be ignored.
6. The amplitude of spurious emissions which are attenuated by more than 20dB below the permissible value has no need to be reported.
7. Distance extrapolation factor = 40 log (specific distance / test distance) (dB);
8. Limit line = specific limits (dBμV) + distance extrapolation factor.



Test Mode :	NFC Tx + Battery 3	Polarization :	Horizontal
-------------	--------------------	----------------	------------

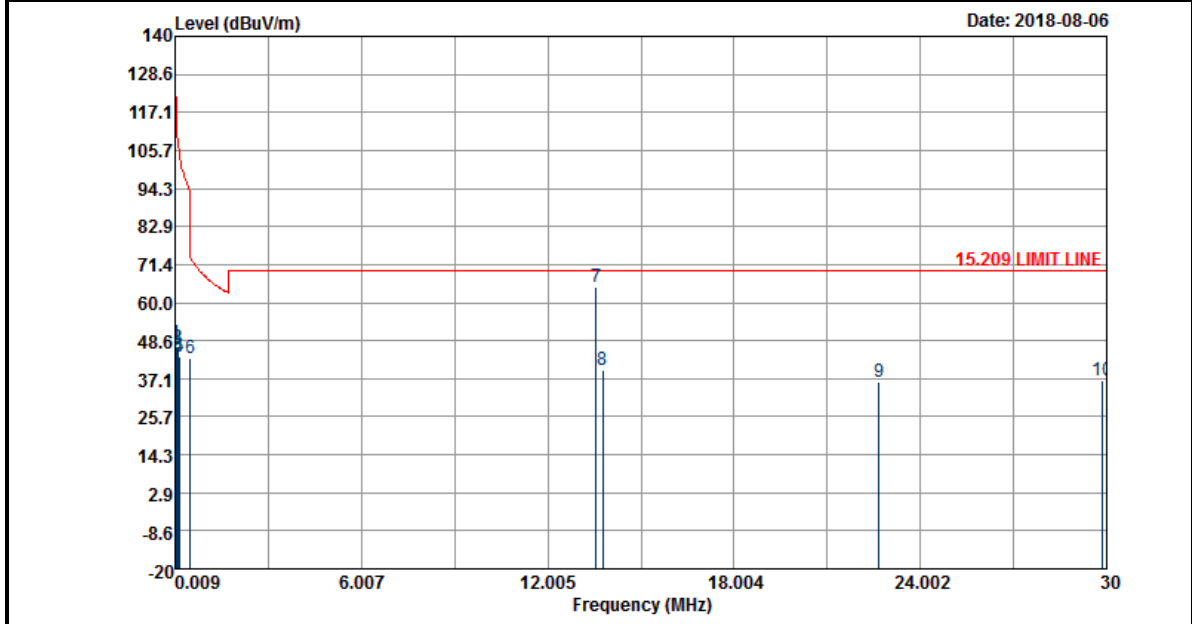

Frequency (MHz)	Level (dBμV/m)	Over Limit (dB)	Limit Line (dBμV/m)	Read Level (dBμV)	Antenna Factor (dB)	Cable Loss (dB)	Ant Pos (cm)	Table Pos (deg)	Remark
0.01114	47.89	-78.78	126.67	26.83	20.63	0.43	-	-	Average
0.06072	46.55	-65.39	111.94	26.02	20.1	0.43	-	-	Average
0.09032	46.53	-61.96	108.49	26.01	20.09	0.43	-	-	QP
0.12384	43.65	-62.10	105.75	23.15	20.07	0.43	-	-	Average
0.15136	43.62	-60.38	104	23.13	20.06	0.43	-	-	Average
0.49	43.36	-30.44	73.8	22.94	19.99	0.43	-	-	QP
13.56	64.59	-4.91	69.5	44.25	19.91	0.43	-	-	QP
13.776	39.81	-29.69	69.5	19.47	19.91	0.43	100	0	QP
22.678	36.36	-33.14	69.5	14.73	20.43	1.2	-	-	QP
29.835	36.62	-32.88	69.5	15.44	19.98	1.2	-	-	QP

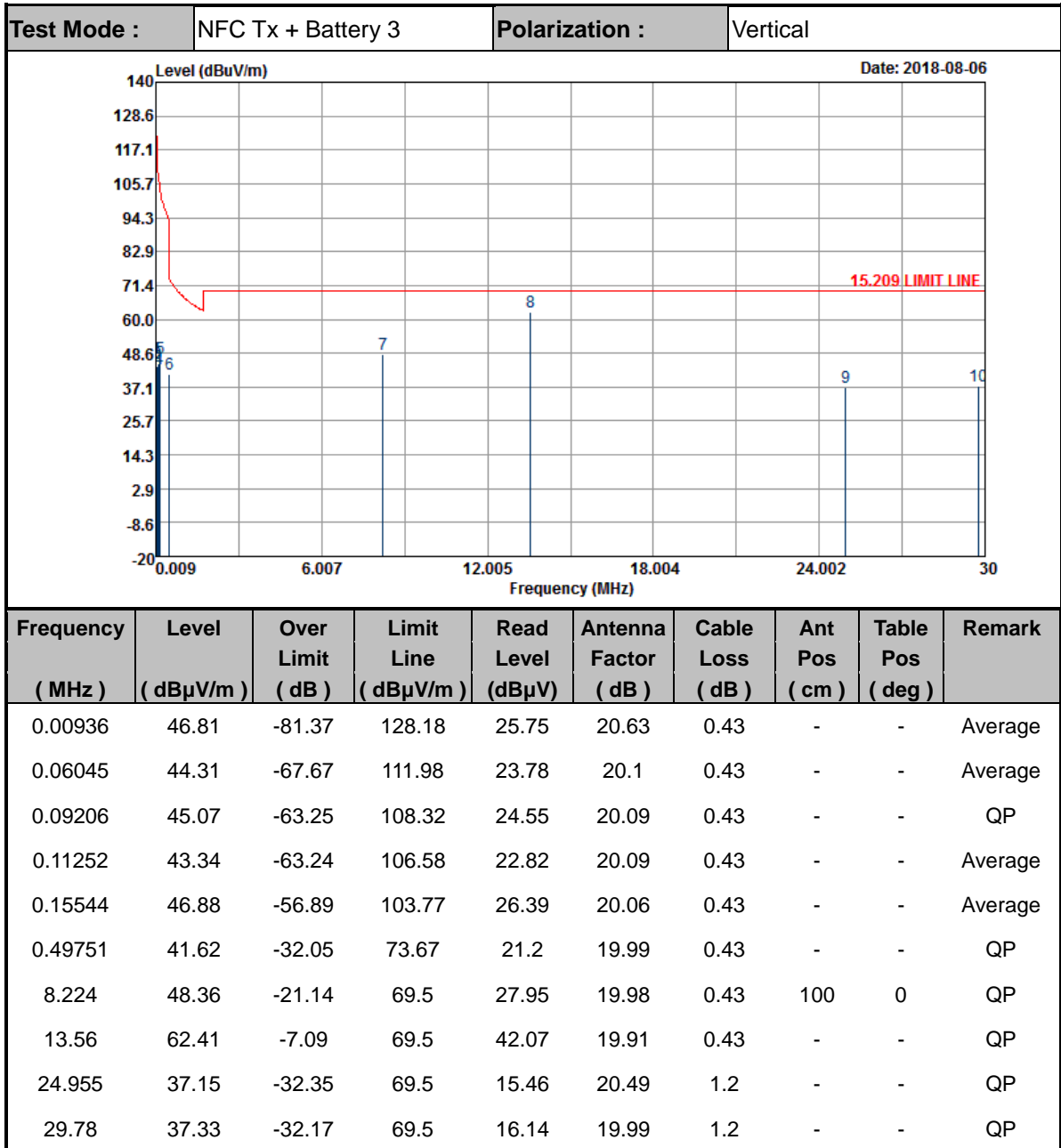

Note:

- 9. 13.56 MHz is fundamental signal which can be ignored.
- 10. The amplitude of spurious emissions which are attenuated by more than 20dB below the permissible value has no need to be reported.
- 11. Distance extrapolation factor = 40 log (specific distance / test distance) (dB);
- 12. Limit line = specific limits (dBμV) + distance extrapolation factor.



C4. Results of Radiated Spurious Emissions (30MHz~1GHz)

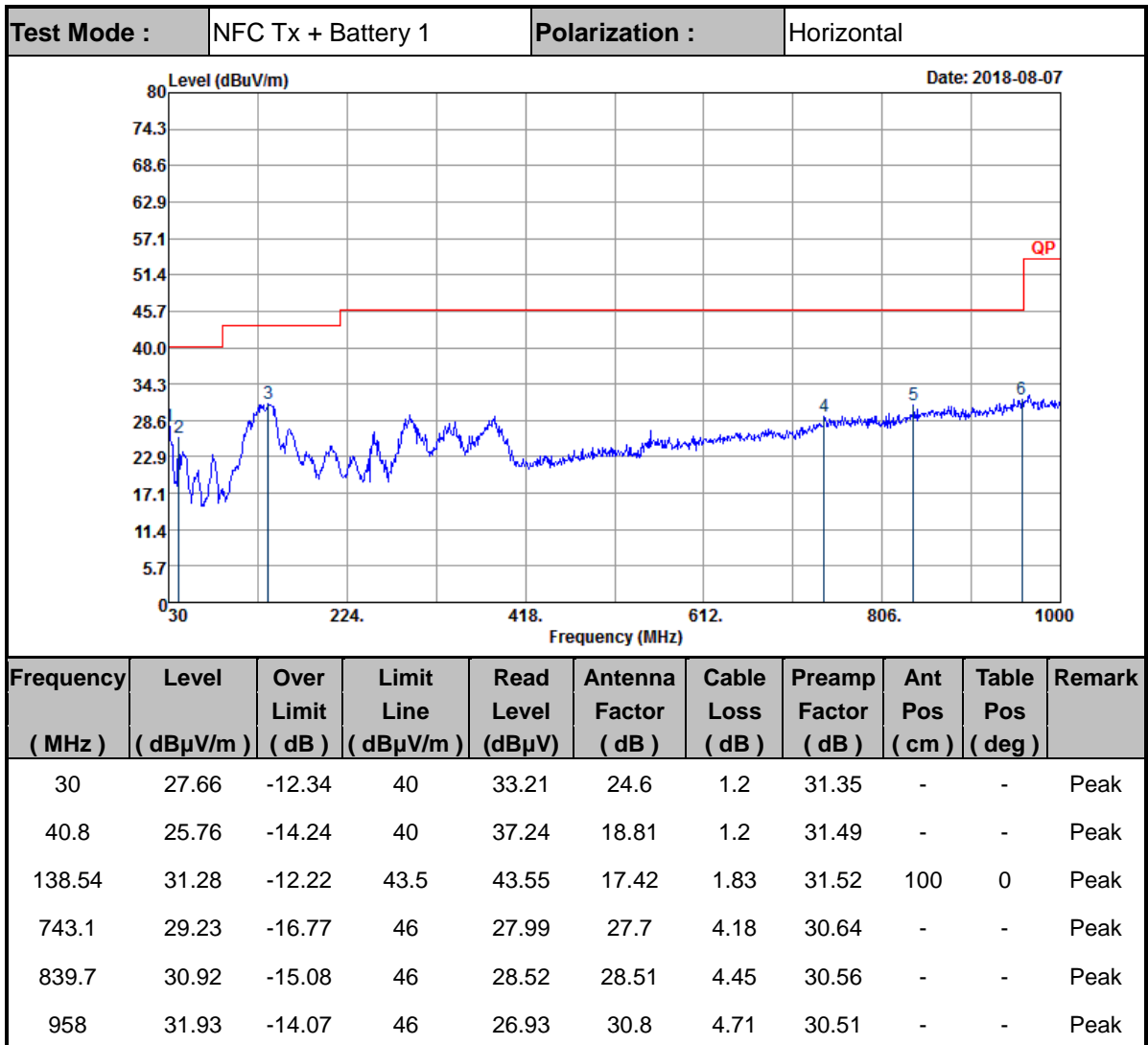

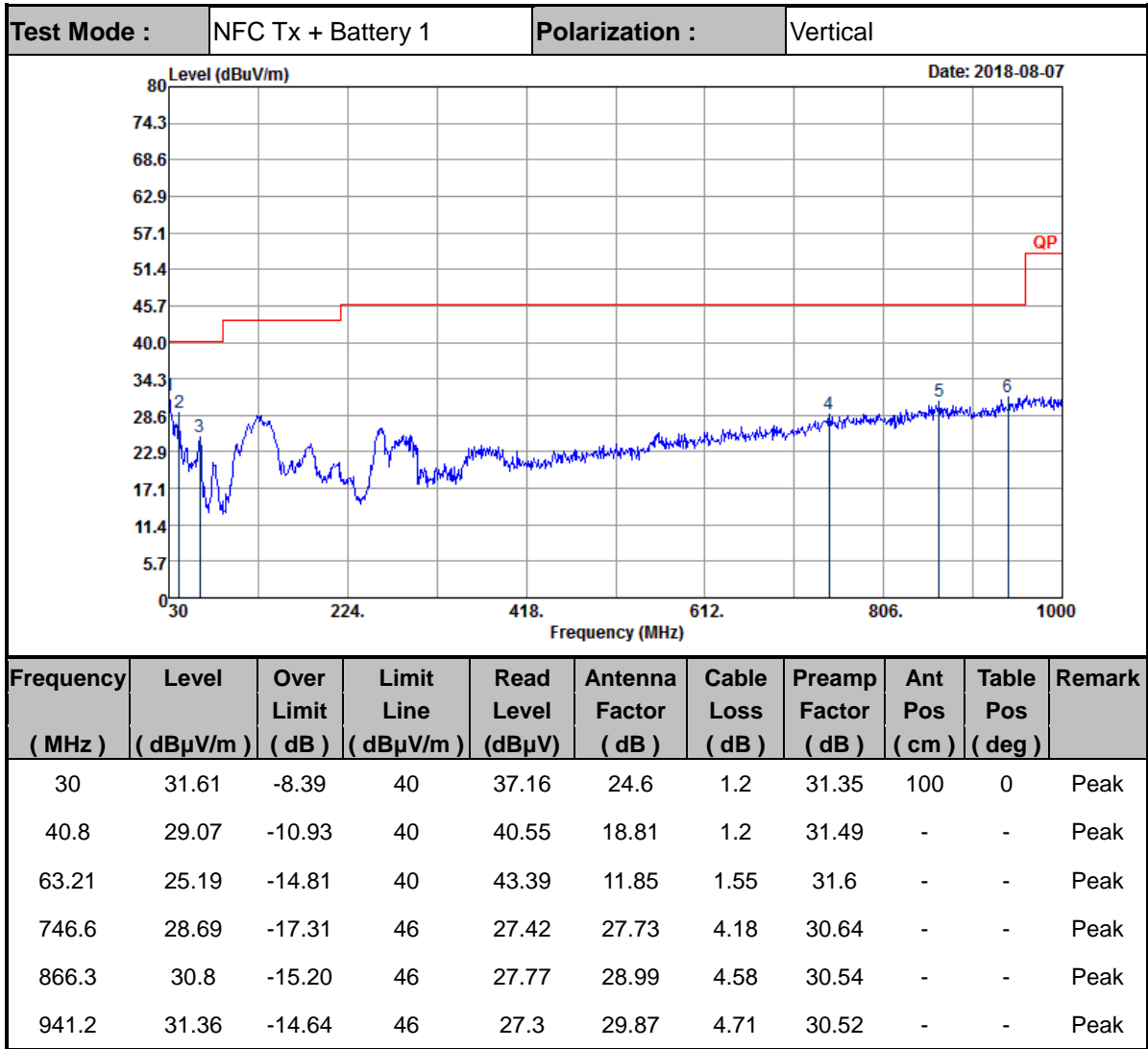

Note:

1. The amplitude of spurious emissions which are attenuated by more than 20dB below the permissible value has no need to be reported.
2. Emission level (dBμV/m) = 20 log Emission level (μV/m).
3. Corrected Reading: Antenna Factor + Cable Loss + Read Level - Preamp Factor= Level.

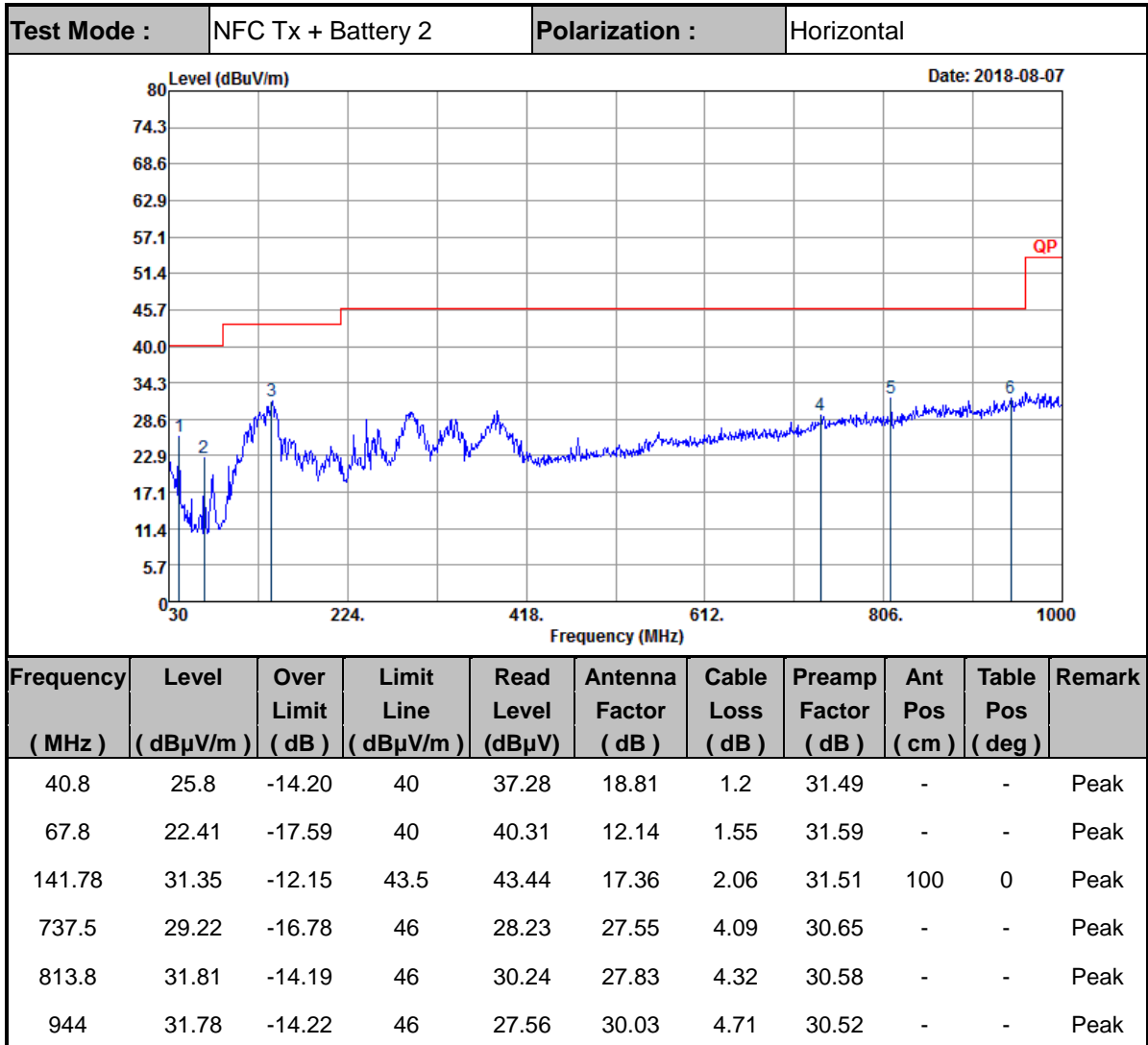

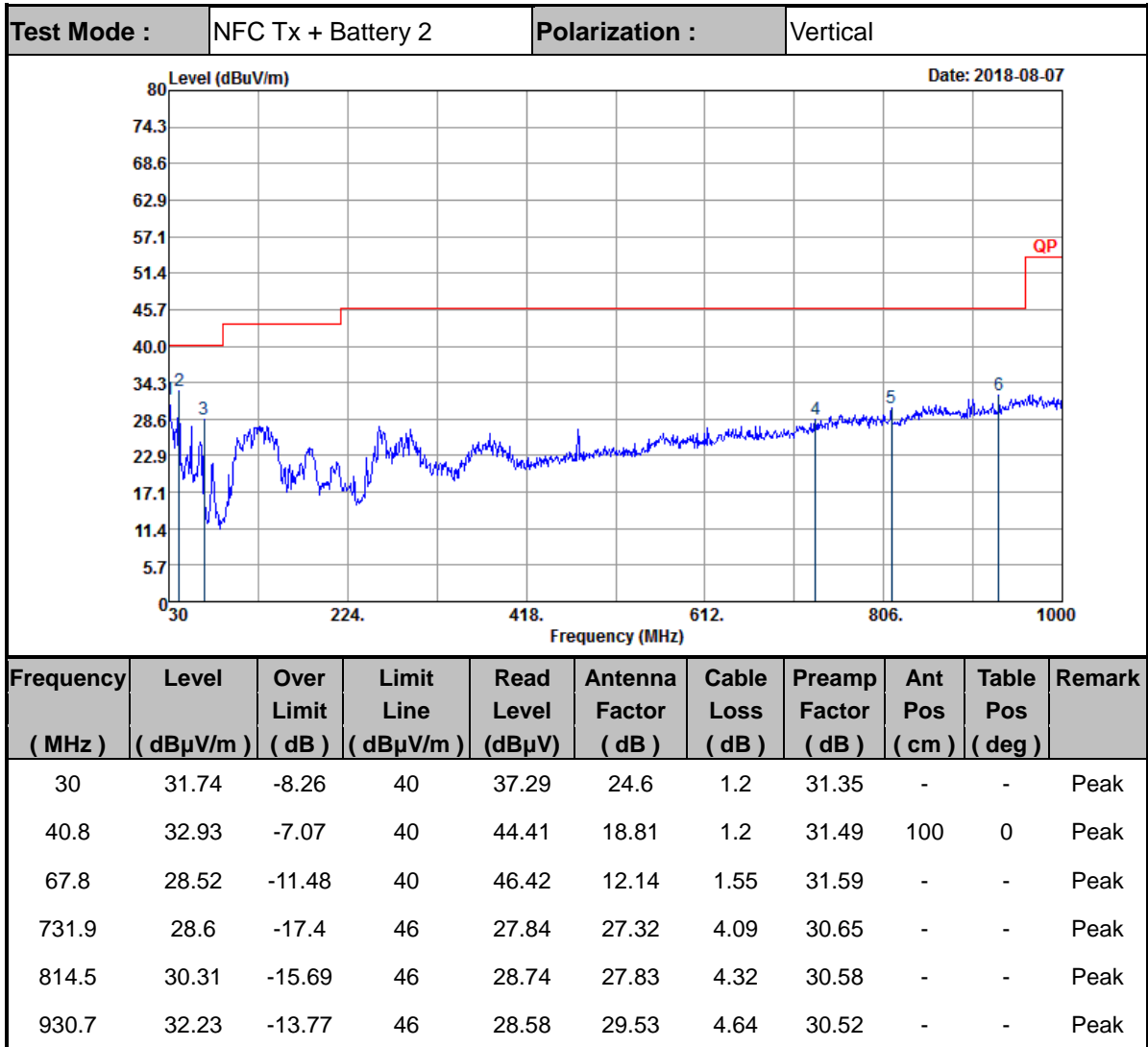

Note:

4. The amplitude of spurious emissions which are attenuated by more than 20dB below the permissible value has no need to be reported.
5. Emission level (dBμV/m) = 20 log Emission level (μV/m).
6. Corrected Reading: Antenna Factor + Cable Loss + Read Level - Preamp Factor= Level.

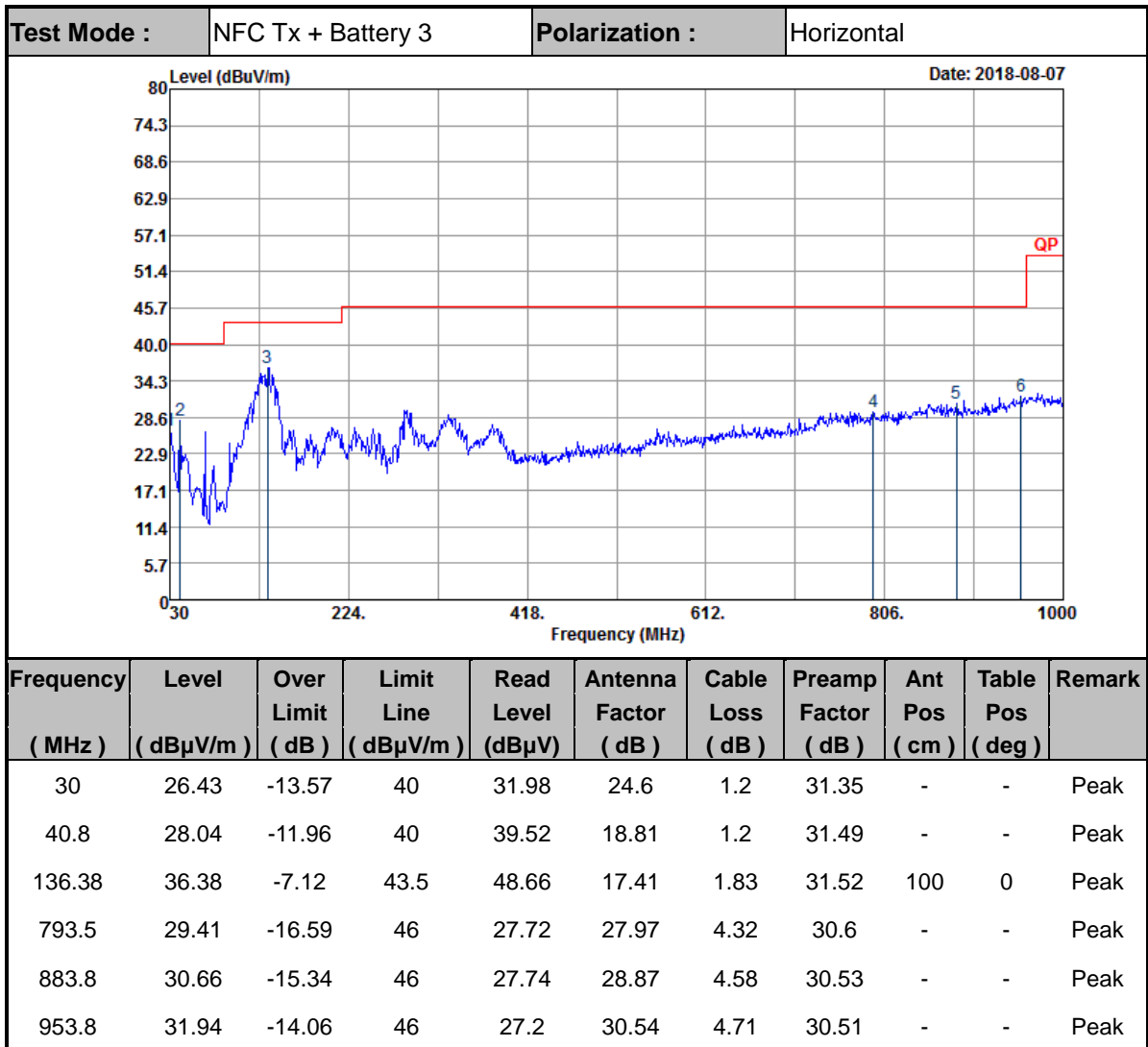

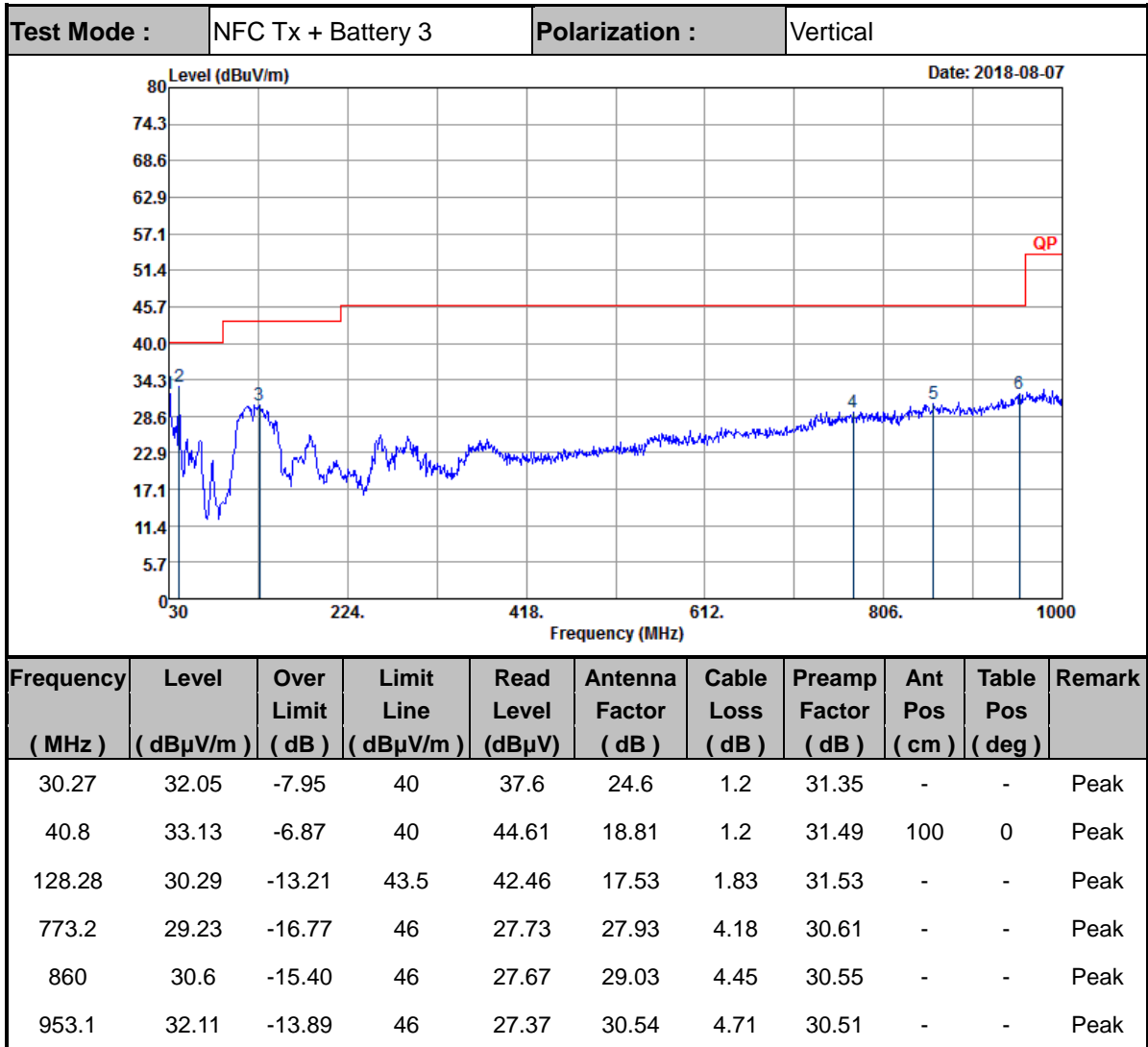

Note:

7. The amplitude of spurious emissions which are attenuated by more than 20dB below the permissible value has no need to be reported.
8. Emission level (dBμV/m) = 20 log Emission level (μV/m).
9. Corrected Reading: Antenna Factor + Cable Loss + Read Level - Preamp Factor= Level.