



FCC RF CO-LOCATION TEST REPORT

FCC ID : UZ7TC720L
Equipment : Touch computer
Brand Name : Zebra
Model Name : TC720L
Applicant : Zebra Technologies Corporation
1 Zebra Plaza Holtsville, NY 11742
Manufacturer : Zebra Technologies Corporation
1 Zebra Plaza Holtsville, NY 11742
Standard : FCC Part 15 Subpart E §15.407

The product was received on Jul. 25, 2018 and testing was started from Aug. 22, 2018 and completed on Sep. 13, 2018. We, SPORTON INTERNATIONAL INC., would like to declare that the tested sample has been evaluated in accordance with the test procedures and has been in compliance with the applicable technical standards.

The report must not be used by the client to claim product certification, approval, or endorsement by TAF or any agency of government.

The test results in this report apply exclusively to the tested model / sample. Without written approval of SPORTON INTERNATIONAL INC. EMC & Wireless Communications Laboratory, the test report shall not be reproduced except in full.

Approved by: Joseph Lin

SPORTON INTERNATIONAL INC. EMC & Wireless Communications Laboratory
No. 52, Huaya 1st Rd., Guishan Dist., Taoyuan City, Taiwan (R.O.C.)



Table of Contents

History of this test report..... 3

Summary of Test Result..... 4

1 General Description 5

 1.1 Product Feature of Equipment Under Test..... 5

 1.2 Product Specification of Equipment Under Test..... 5

 1.3 Modification of EUT 6

 1.4 Testing Location 6

 1.5 Applicable Standards..... 6

2 Test Configuration of Equipment Under Test 7

 2.1 Carrier Frequency and Channel 7

 2.2 Test Mode..... 7

 2.3 Connection Diagram of Test System..... 8

 2.4 Support Unit used in test configuration and system 8

 2.5 EUT Operation Test Setup 8

3 Test Result 9

 3.1 Unwanted Emissions Measurement..... 9

 3.2 Antenna Requirements 13

4 List of Measuring Equipment..... 14

5 Uncertainty of Evaluation 15

Appendix A. Radiated Spurious Emission

Appendix B. Radiated Spurious Emission Plots

Appendix C. Duty Cycle Plots

Appendix D. Setup Photographs



Summary of Test Result

Report Clause	Ref Std. Clause	Test Items	Result (PASS/FAIL)	Remark
3.1	15.407(b)	Unwanted Emissions	Pass	Under limit 8.00 dB at 134.760 MHz
3.2	15.203 15.407(a)	Antenna Requirement	Pass	-

Reviewed by: **Wii Chang**

Report Producer: **Maggie Chiang**



1 General Description

1.1 Product Feature of Equipment Under Test

Product Feature	
Equipment	Touch computer
Brand Name	Zebra
Model Name	TC720L
FCC ID	UZ7TC720L
EUT supports Radios application	NFC WLAN 11a/b/g/n HT20/HT40 WLAN 11ac VHT20/VHT40/VHT80 Bluetooth BR/EDR/LE
HW Version	DV
SW Version	Android version 8.1.0
FW Version	91-09-14.00-OG-U00-STD
MFD	03JUL18
EUT Stage	Engineering Sample

Remark: The above EUT's information was declared by manufacturer.

Specification of Accessories				
AC Adapter	Brand Name	Zebra	Part Number	PWR-BUA5V16W0WW
4 PIN DC power cable	Brand Name	Zebra	Part Number	CBL-DC-383A1-01
AC Power cable	Brand Name	Zebra	Part Number	50-16000-182R
Snap-On USB/Charge Cable	Brand Name	Zebra	Part Number	CBL-TC7X-USB1-01
Snap-On Charging Cable Cup	Brand Name	Zebra	Part Number	CHG-TC7X-CBL1-01
Battery 1	Brand Name	Zebra	Part Number	BT-000318-01
Battery 2 (Falcon 1S3P Battery Pack)	Brand Name	Zebra	Part Number	BT-000318-51
Battery 3	Brand Name	Symbol	Part Number	82-171249-02
Earphone 1	Brand Name	Zebra	Part Number	HDST-35MM-PTVP-01
Earphone 2	Brand Name	Zebra	Part Number	HS2100-OTH
Snap-on 3.5MM Audio Jack Adapter	Brand Name	Symbol	Part Number	ADP-TC7X-AUD35-01
3.5mm Jack 43"(1.1m) Standard Cable	Brand Name	Zebra	Part Number	CBL-HS2100-3MS1-01
Holster	Brand Name	Zebra	Part Number	SG-TC7X-HLSTR1-02
Rigid Holster	Brand Name	Zebra	Part Number	SG-TC7X-RHLSTR1-01

1.2 Product Specification of Equipment Under Test

Standards-related Product Specification	
Tx/Rx Frequency Range	2400 MHz ~ 2483.5 MHz 5260 MHz ~ 5320 MHz
Antenna Type / Gain	<2400 MHz ~ 2483.5 MHz> Ant. 1 : PIFA Antenna with gain 2.00 dBi Ant. 2 : PIFA Antenna with gain 3.40 dBi <5260 MHz ~ 5320 MHz> Ant. 1 : PIFA Antenna with gain 2.00 dBi Ant. 2 : PIFA Antenna with gain 2.40 dBi
Type of Modulation	802.11ac : OFDM (BPSK/QPSK/16QAM/64QAM/256QAM)



1.3 Modification of EUT

No modifications are made to the EUT during all test items.

1.4 Testing Location

Sporton Lab is accredited to ISO 17025 by Taiwan Accreditation Foundation (TAF code : 1190) and the FCC designation No. TW1190 under the FCC 2.948(e) by Mutual Recognition Agreement (MRA) in FCC Test.

Test Site	SPORTON INTERNATIONAL INC.
Test Site Location	No.52, Huaya 1st Rd., Guishan Dist., Taoyuan City, Taiwan (R.O.C.) TEL: +886-3-327-3456 FAX: +886-3-328-4978
Test Site No.	Sporton Site No.
	03CH07-HY

Note: The test site complies with ANSI C63.4 2014 requirement.

1.5 Applicable Standards

According to the specifications of the manufacturer, the EUT must comply with the requirements of the following standards:

- ♦ FCC Part 15 Subpart E
- ♦ FCC KDB 789033 D02 General UNII Test Procedures New Rules v02r01.
- ♦ FCC KDB 414788 D01 Radiated Test Site v01r01.
- ♦ FCC KDB 662911 D01 Multiple Transmitter Output v02r01.
- ♦ ANSI C63.10-2013

Remark: All test items were verified and recorded according to the standards and without any deviation during the test.



2 Test Configuration of Equipment Under Test

The EUT has been associated with peripherals and configuration operated in a manner tended to maximize its emission characteristics in a typical application. Frequency range investigated: radiation emission (9 kHz to the 10th harmonic of the highest fundamental frequency or to 40 GHz, whichever is lower). For radiated measurement, pre-scanned in three orthogonal panels, X, Y, Z. The worst cases (Z plane) were recorded in this report.

2.1 Carrier Frequency and Channel

2400-2483.5 MHz 802.11ac VHT40		5250-5350 MHz 802.11ac VHT80	
Channel	Channel	Channel	Freq. (MHz)
09	2452	58	5290

2.2 Test Mode

Final test modes are considering the modulation and worse data rates as below table.

<Co-Location>

Modulation	Data Rate
802.11ac VHT40 for Ant. 1 + 802.11ac VHT80 for Ant. 2	MCS0 + MCS0

2.3 Connection Diagram of Test System

<Co-location Mode>

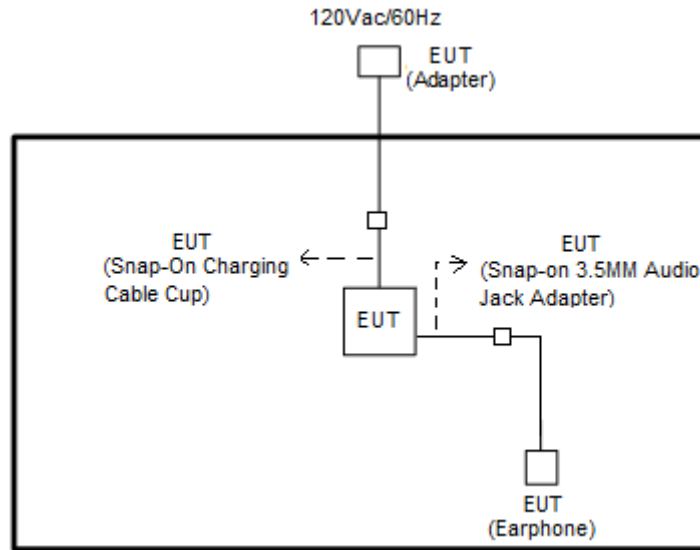

2.4 Support Unit used in test configuration and system

Item	Equipment	Trade Name	Model Name	FCC ID	Data Cable	Power Cord
1.	Notebook	DELL	Latitude E3340	FCC DoC/ Contains FCC ID: PD97260NGU	N/A	AC I/P: Unshielded, 1.2 m DC O/P: Shielded, 1.8 m
2.	Notebook	DELL	P79G	FCC DoC	N/A	AC I/P: Unshielded, 1.2 m DC O/P: Shielded, 1.8 m

2.5 EUT Operation Test Setup

The RF test items, utility “QRCT” was installed in Notebook which was programmed in order to make the EUT get into the engineering modes to provide channel selection, power level, data rate and the application type and for continuous transmitting signals.



3 Test Result

3.1 Unwanted Emissions Measurement

3.1.1 Limit of Unwanted Emissions

(1) Unwanted spurious emissions fallen in restricted bands shall comply with the general field strength limits as below table,

Frequency (MHz)	Field Strength (microvolts/meter)	Measurement Distance (meters)
0.009 – 0.490	2400/F(kHz)	300
0.490 – 1.705	24000/F(kHz)	30
1.705 – 30.0	30	30
30 – 88	100	3
88 – 216	150	3
216 - 960	200	3
Above 960	500	3

Note: The following formula is used to convert the EIRP to field strength.

$$E = \frac{1000000\sqrt{30P}}{3} \text{ } \mu\text{V/m, where P is the eirp (Watts)}$$

EIRP (dBm)	Field Strength at 3m (dBμV/m)
- 27	68.3

(2) KDB789033 D02 v02r01 G)2)c)

- (i) Section 15.407(b)(1) to (b)(3) specify the unwanted emission limits for the U-NII-1 and U-NII-2 bands. As specified, emissions above 1000 MHz that are outside of the restricted bands are subject to a peak emission limit of -27 dBm/MHz.³
- (ii) Section 15.407(b)(4) specifies the unwanted emission limit for the U-NII-3 band. A band emissions mask is specified in Section 15.407(b)(4)(i). The emission limits are in terms of a Peak detector. An alternative to the band emissions mask is specified in Section 15.407(b)(4)(ii). The alternative limits are based on the highest antenna gain specified in the filing. There are also marketing and importation restrictions for the devices using the alternative limit.⁴

Note 3: An out-of-band emission that complies with both the average and peak limits of Section 15.209 is not required to satisfy the -27 dBm/MHz peak emission limit.

Note 4: Only devices with antenna gains of 10 dBi or less may be approved using the emission limits specified in Section 15.247(d) till March 2, 2018; all other devices operating in this band must use the mask specified in Section 15.407(b)(4)(i).

3.1.2 Measuring Instruments

See list of measuring equipment of this test report.



3.1.3 Test Procedures

1. The testing follows FCC KDB 789033 D02 General UNII Test Procedures New Rules v02r01. Section G) Unwanted emissions measurement.
 - (1) Procedure for Unwanted Emissions Measurements Below 1000MHz
 - RBW = 120 kHz
 - VBW = 300 kHz
 - Detector = Peak
 - Trace mode = max hold
 - (2) Procedure for Peak Unwanted Emissions Measurements Above 1000 MHz
 - RBW = 1 MHz
 - VBW \geq 3 MHz
 - Detector = Peak
 - Sweep time = auto
 - Trace mode = max hold
 - (3) Procedures for Average Unwanted Emissions Measurements Above 1000MHz
 - RBW = 1 MHz
 - VBW = 10 Hz, when duty cycle is no less than 98 percent.
 - VBW \geq 1/T, when duty cycle is less than 98 percent where T is the minimum transmission duration over which the transmitter is on and is transmitting at its maximum power control level for the tested mode of operation.
2. The EUT was placed on a turntable with 0.8 meter for frequency below 1GHz and 1.5 meter for frequency above 1GHz respectively above ground.
3. The EUT was set 3 meters from the interference receiving antenna which was mounted on the top of a variable height antenna tower.
4. The antenna is a broadband antenna and its height is adjusted between one meter and four meters above ground to find the maximum value of the field strength for both horizontal polarization and vertical polarization of the antenna.
5. For each suspected emission, the EUT was arranged to its worst case and then adjust the antenna tower (from 1 m to 4 m) and turntable (from 0 degree to 360 degrees) to find the maximum reading.
6. For testing below 1GHz, if the emission level of the EUT in peak mode was 3 dB lower than the limit specified, then peak values of EUT will be reported, otherwise, the emissions will be repeated one by one using the CISPR quasi-peak method and reported.
7. For testing above 1GHz, the emission level of the EUT in peak mode was 20dB lower than average limit (that means the emission level in average mode also complies with the limit in average mode), then peak values of EUT will be reported, otherwise, the emissions will be measured in average mode again and reported.

3.1.4 Test Setup

For radiated emissions below 30MHz

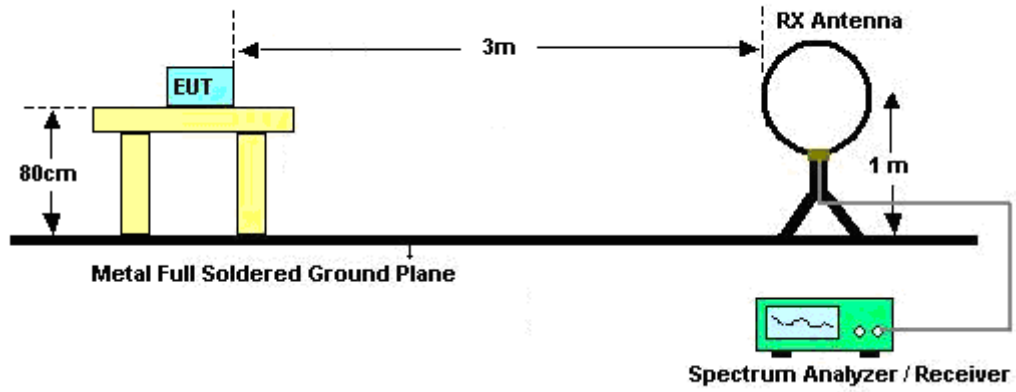

For radiated emissions from 30MHz to 1GHz

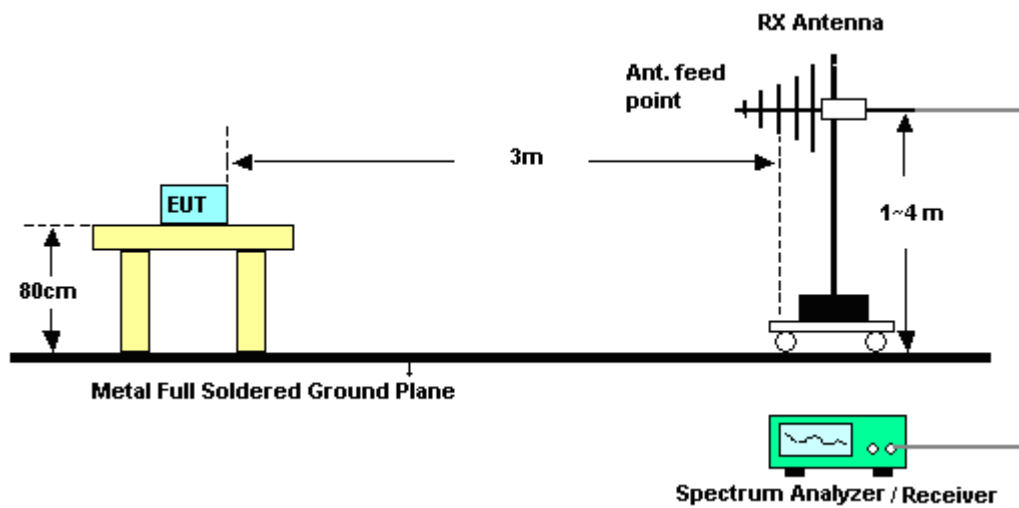

For radiated emissions above 1GHz

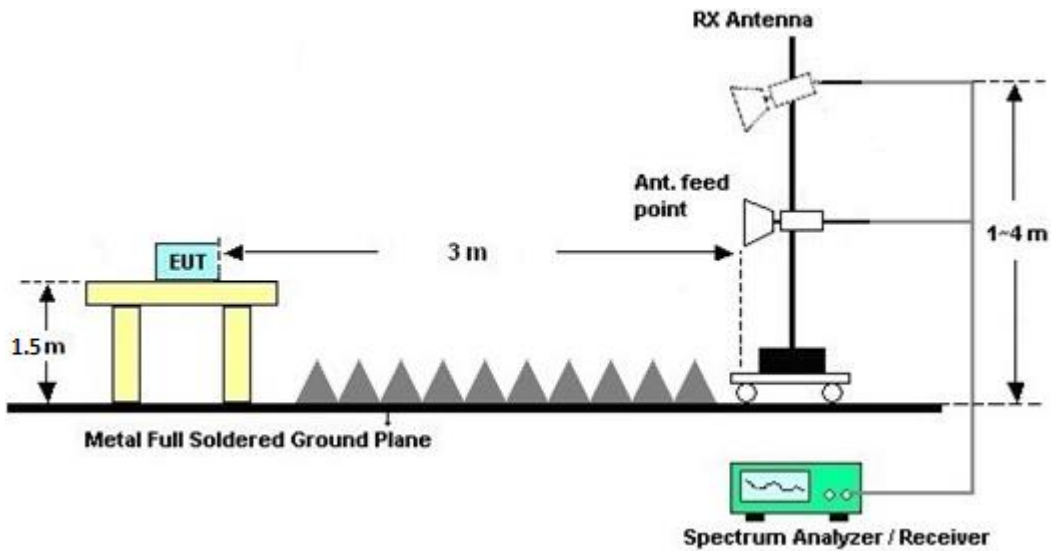

3.1.5 Test Results of Radiated Spurious Emissions (9 kHz ~ 30 MHz)

The low frequency, which started from 9 kHz to 30MHz, was pre-scanned and the result which was 20dB lower than the limit line was not reported.

There is a comparison data of both open-field test site and alternative test site - semi-Anechoic chamber according to 414788 D01 Radiated Test Site v01r01, and the result came out very similar.

3.1.6 Test Result of Radiated Spurious at Band Edges

Please refer to Appendix A and B.

3.1.7 Duty Cycle

Please refer to Appendix C.

3.1.8 Test Result of Radiated Spurious Emissions (30MHz ~ 10th Harmonic)

Please refer to Appendix A and B.



3.2 Antenna Requirements

3.2.1 Standard Applicable

If transmitting antenna directional gain is greater than 6 dBi, both the peak transmit power and the peak power spectral density shall be reduced by the amount in dB that the directional gain of the antenna exceeds 6 dBi.

3.2.2 Antenna Anti-Replacement Construction

An embedded-in antenna design is used.

3.2.3 Antenna Gain

The antenna peak gain of EUT is less than 6 dBi. Therefore, it is not necessary to reduce maximum peak output power limit.



4 List of Measuring Equipment

Instrument	Manufacturer	Model No.	Serial No.	Characteristics	Calibration Date	Test Date	Due Date	Remark
Bilog Antenna	TESEQ	CBL 6111D&00800 N1D01N-06	35419&03	30MHz to 1GHz	Dec. 18, 2017	Aug. 22, 2018~ Sep. 13, 2018	Dec. 17, 2018	Radiation (03CH07-HY)
Double Ridge Horn Antenna	EMCO	3117	00066583	1GHz~18GHz	Aug. 06, 2018	Aug. 22, 2018~ Sep. 13, 2018	Aug. 05, 2019	Radiation (03CH07-HY)
Loop Antenna	Rohde & Schwarz	HFH2-Z2	100315	9 kHz~30 MHz	Nov. 10, 2017	Aug. 22, 2018~ Sep. 13, 2018	Nov. 09, 2018	Radiation (03CH07-HY)
Preamplifier	MITEQ	AMF-7D-0010 1800-30-10P	1590075	1GHz ~ 18GHz	Apr. 25, 2018	Aug. 22, 2018~ Sep. 13, 2018	Apr. 24, 2019	Radiation (03CH07-HY)
Preamplifier	COM-POWER	PA-103A	161241	10MHz-1GHz	May 21, 2018	Aug. 22, 2018~ Sep. 13, 2018	May 20, 2019	Radiation (03CH07-HY)
Preamplifier	Agilent	8449B	3008A02362	1GHz~ 26.5GHz	Oct. 30, 2017	Aug. 22, 2018~ Sep. 13, 2018	Oct. 29, 2018	Radiation (03CH07-HY)
Spectrum Analyzer	Agilent	N9010A	MY53470118	10Hz~44GHz	Apr. 17, 2018	Aug. 22, 2018~ Sep. 13, 2018	Apr. 16, 2019	Radiation (03CH07-HY)
Filter	Microwave	H1G013G1	SN477215	1.0G High Pass	Dec. 07, 2017	Aug. 22, 2018~ Sep. 13, 2018	Dec. 06, 2018	Radiation (03CH07-HY)
Filter	Wainwright	WLKS1200- 8SS	SN3	1.2G Low Pass	Nov. 21, 2017	Aug. 22, 2018~ Sep. 13, 2018	Nov. 20, 2018	Radiation (03CH07-HY)
Filter	Microwave	H3G018G1	SN477220	3.0G High Pass	Nov. 21, 2017	Aug. 22, 2018~ Sep. 13, 2018	Nov. 20, 2018	Radiation (03CH07-HY)
Filter	Microwave	WHKX7.0/26.5 G-6SS	SN4	7G High Pass	Nov. 21, 2017	Aug. 22, 2018~ Sep. 13, 2018	Nov. 20, 2018	Radiation (03CH07-HY)
RF Cable	HUBER + SUHNER	SUCOFLEX 104	MY24971/4,M Y28655/4	9KHz~30MHz	Jan. 02, 2018	Aug. 22, 2018~ Sep. 13, 2018	Jan. 01, 2019	Radiation (03CH07-HY)
RF Cable	HUBER + SUHNER	SUCOFLEX 104	MY28655/4, MY24971/4, MY15682/4	30MHz~1GHz	Feb. 27, 2018	Aug. 22, 2018~ Sep. 13, 2018	Feb. 26, 2019	Radiation (03CH07-HY)
RF Cable	HUBER + SUHNER	SUCOFLEX 104	MY28655/4, MY24971/4, MY15682/4	1GHz~18GHz	Feb. 27, 2018	Aug. 22, 2018~ Sep. 13, 2018	Feb. 26, 2019	Radiation (03CH07-HY)
RF Cable	HUBER + SUHNER	SUCOFLEX 102	MY2858/2	18GHz~40GHz	Feb. 27, 2018	Aug. 22, 2018~ Sep. 13, 2018	Feb. 26, 2019	Radiation (03CH07-HY)
Antenna Mast	Max-Full	MFA520BS	N/A	1m~4m	N/A	Aug. 22, 2018~ Sep. 13, 2018	N/A	Radiation (03CH07-HY)
Turn Table	ChainTek	Chaintek 3000	N/A	0~360 Degree	N/A	Aug. 22, 2018~ Sep. 13, 2018	N/A	Radiation (03CH07-HY)
Amplifier	MITEQ	TTA1840-35-H G	1871923	18GHz~40GHz, VSWR : 2.5:1 max	Jul. 16, 2018	Aug. 22, 2018~ Sep. 13, 2018	Jul. 15, 2019	Radiation (03CH07-HY)
SHF-EHF Horn Antenna	SCHWARZBE CK	BBHA 9170	BBHA9170251	18GHz- 40GHz	Nov. 10, 2017	Aug. 22, 2018~ Sep. 13, 2018	Nov. 09, 2018	Radiation (03CH07-HY)
EMI Test Receiver	Agilent	N9038A(MXE)	MY53290053	20Hz to 26.5GHz	Jan. 16, 2018	Aug. 22, 2018~ Sep. 13, 2018	Jan. 15, 2019	Radiation (03CH07-HY)
Software	Audix	E3 6.2009-8-24	80504004656 H	N/A	N/A	Aug. 22, 2018~ Sep. 13, 2018	N/A	Radiation (03CH07-HY)



5 Uncertainty of Evaluation

Uncertainty of Radiated Emission Measurement (30 MHz ~ 1000 MHz)

Measuring Uncertainty for a Level of Confidence of 95% ($U = 2Uc(y)$)	5.7
---	-----

Uncertainty of Radiated Emission Measurement (1000 MHz ~ 18000 MHz)

Measuring Uncertainty for a Level of Confidence of 95% ($U = 2Uc(y)$)	5.5
---	-----

Uncertainty of Radiated Emission Measurement (18000 MHz ~ 40000 MHz)

Measuring Uncertainty for a Level of Confidence of 95% ($U = 2Uc(y)$)	5.2
---	-----



Appendix A. Radiated Spurious Emission

Test Engineer :	Jesse Wang, Stan Hsieh, and Nick Yu	Temperature :	24~26°C
		Relative Humidity :	51~53%

Co-location Mode

802.11ac VHT40 and 802.11ac VHT80 (Harmonic @ 3m)

WIFI	Note	Frequency	Level	Over	Limit	Read	Antenna	Path	Preamp	Ant	Table	Peak	Pol.	
Ant.				Limit	Line	Level	Factor	Loss	Factor	Pos	Pos	Avg.		
Simultaneously		(MHz)	(dBμV/m)	(dB)	(dBμV/m)	(dBμV)	(dB/m)	(dB)	(dB)	(cm)	(deg)	(P/A)	(H/V)	
802.11ac VHT40 CH 09 2452MHz + 802.11ac VHT80 CH 58 5290MHz		4904	48.83	-25.17	74	38.86	34.03	11.09	35.15	100	0	P	H	
		7356	44.13	-29.87	74	52.69	35.7	13.95	58.21	100	0	P	H	
		10580	48.03	-20.17	68.2	52.28	37.57	17.26	59.08	100	0	P	H	
		15870	49.71	-24.29	74	45.21	40.34	20.68	56.52	100	0	P	H	
													H	
													H	
													H	
													H	
			4904	48.48	-25.52	74	38.51	34.03	11.09	35.15	100	0	P	V
			7356	44.3	-29.7	74	52.86	35.7	13.95	58.21	100	0	P	V
			10580	47.53	-20.67	68.2	51.78	37.57	17.26	59.08	100	0	P	V
			15870	49.73	-24.27	74	45.23	40.34	20.68	56.52	100	0	P	V
													V	
													V	
												V		
												V		
Remark	1. No other spurious found. 2. All results are PASS against Peak and Average limit line.													



Emission below 1GHz
802.11ac VHT40 and 802.11ac VHT80 (LF @ 3m)

WIFI Ant. Simultaneously	Note	Frequency (MHz)	Level (dBμV/m)	Over Limit (dB)	Limit Line (dBμV/m)	Read Level (dBμV)	Antenna Factor (dB/m)	Path Loss (dB)	Preamp Factor (dB)	Ant Pos (cm)	Table Pos (deg)	Peak Avg. (P/A)	Pol. (H/V)	
802.11ac VHT40 CH 09 2452MHz + 802.11ac VHT80 CH 58 5290MHz		95.07	22.98	-20.52	43.5	37.59	15.21	1.74	31.56	-	-	P	H	
		134.76	35.5	-8	43.5	47.61	17.4	2.01	31.52	100	0	P	H	
		292.17	28.38	-17.62	46	37.84	18.99	2.86	31.31	-	-	P	H	
		561.1	26.97	-19.03	46	28.21	25.84	3.81	30.89	-	-	P	H	
		786.5	29.56	-16.44	46	27.59	27.97	4.6	30.6	-	-	P	H	
		950.3	32.27	-13.73	46	27.34	30.39	5.05	30.51	-	-	P	H	
														H
														H
														H
														H
														H
														H
														H
														H
			30	31.03	-8.97	40	36.45	24.6	1.33	31.35	100	0	P	V
			95.34	33.89	-9.61	43.5	48.5	15.21	1.74	31.56	-	-	P	V
			191.46	25.6	-17.9	43.5	39.91	14.77	2.38	31.46	-	-	P	V
			568.1	25.91	-20.09	46	27.3	25.68	3.81	30.88	-	-	P	V
			715.1	29.14	-16.86	46	28.84	26.61	4.36	30.67	-	-	P	V
			972	32.48	-21.52	54	27.08	30.85	5.06	30.51	-	-	P	V
													V	
													V	
													V	
													V	
													V	
													V	
Remark	1. No other spurious found. 2. All results are PASS against limit line.													



Note symbol

*	Fundamental Frequency which can be ignored. However, the level of any unwanted emissions shall not exceed the level of the fundamental frequency.
!	Test result is over limit line.
P/A	Peak or Average
H/V	Horizontal or Vertical



A calculation example for radiated spurious emission is shown as below:

WIFI	Note	Frequency	Level	Over	Limit	Read	Antenna	Path	Preamp	Ant	Table	Peak	Pol.
Ant.				Limit	Line	Level	Factor	Loss	Factor	Pos	Pos	Avg.	
0		(MHz)	(dBμV/m)	(dB)	(dBμV/m)	(dBμV)	(dB/m)	(dB)	(dB)	(cm)	(deg)	(P/A)	(H/V)
802.11b		2390	55.45	-18.55	74	54.51	32.22	4.58	35.86	103	308	P	H
CH 01													
2412MHz		2390	43.54	-10.46	54	42.6	32.22	4.58	35.86	103	308	A	H

1. Path Loss(dB) = Cable loss(dB) + Filter loss(dB) + Attenuator loss(dB)
2. Level(dBμV/m) =
Antenna Factor(dB/m) + Path Loss(dB) + Read Level(dBμV) - Preamp Factor(dB)
3. Over Limit(dB) = Level(dBμV/m) – Limit Line(dBμV/m)

For Peak Limit @ 2390MHz:

1. Level(dBμV/m)
= Antenna Factor(dB/m) + Path Loss(dB) + Read Level(dBμV) - Preamp Factor(dB)
= 32.22(dB/m) + 4.58(dB) + 54.51(dBμV) – 35.86 (dB)
= 55.45 (dBμV/m)
2. Over Limit(dB)
= Level(dBμV/m) – Limit Line(dBμV/m)
= 55.45(dBμV/m) – 74(dBμV/m)
= -18.55(dB)

For Average Limit @ 2390MHz:

1. Level(dBμV/m)
= Antenna Factor(dB/m) + Path Loss(dB) + Read Level(dBμV) - Preamp Factor(dB)
= 32.22(dB/m) + 4.58(dB) + 42.6(dBμV) – 35.86 (dB)
= 43.54 (dBμV/m)
2. Over Limit(dB)
= Level(dBμV/m) – Limit Line(dBμV/m)
= 43.54(dBμV/m) – 54(dBμV/m)
= -10.46(dB)

Both peak and average measured complies with the limit line, so test result is “PASS”.



Appendix B. Radiated Spurious Emission Plots

Test Engineer :	Jesse Wang, Stan Hsieh, and Nick Yu	Temperature :	24~26°C
		Relative Humidity :	51~53%

Note symbol

-L	Low channel location
-R	High channel location

Co-location Mode

802.11ac VHT40 and 802.11ac VHT80 (Harmonic @ 3m)

Ant.	802.11ac VHT40_Tx_Ch09 + 802.11ac VHT80_Tx_Ch58	
	Horizontal	Vertical
Peak Avg.	<p>Site : 03CH07-HY Condition : PEAK(UNII) 3m SHF-EHF_131829 HORIZONTAL Detector : Peak Project : 872508 Mode : 78</p>	<p>Site : 03CH07-HY Condition : PEAK(UNII) 3m SHF-EHF_131829 VERTICAL Detector : Peak Project : 872508 Mode : 78</p>

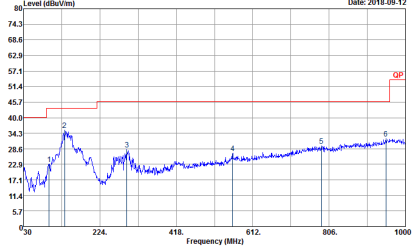
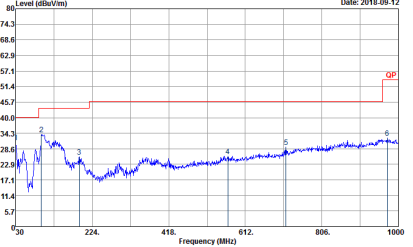

Emission below 1GHz
802.11ac VHT40 and 802.11ac VHT80 (LF)

Ant.	802.11ac VHT40_Tx_Ch09 + 802.11ac VHT80_Tx_Ch58	
Simultaneously	Horizontal	Vertical
<p>QP / Peak</p>	 <p>Site : 03CH07-HY Condition : QP 3m LF-ANT-35419(6) HORIZONTAL Detector : Peak Project : 872508 Mode : 78</p>	 <p>Site : 03CH07-HY Condition : QP 3m LF-ANT-35419(6) VERTICAL Detector : Peak Project : 872508 Mode : 78</p>



Appendix C. Duty Cycle Plots

Antenna	Band	Duty Cycle(%)	T(us)	1/T(kHz)	VBW Setting	Duty Factor(dB)
1	2.4GHz 802.11ac VHT40	91.54	952.00	1.05	3kHz	0.38
2	5GHz 802.11ac VHT80	87.72	600.00	1.67	3kHz	0.57

<Ant. 1>

802.11ac VHT40

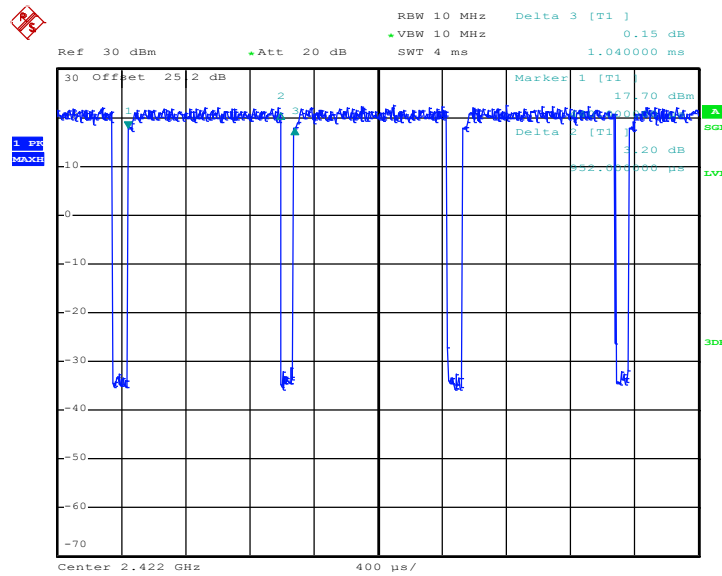

Date: 22.AUG.2018 00:19:30



<Ant. 2>

802.11ac VHT80

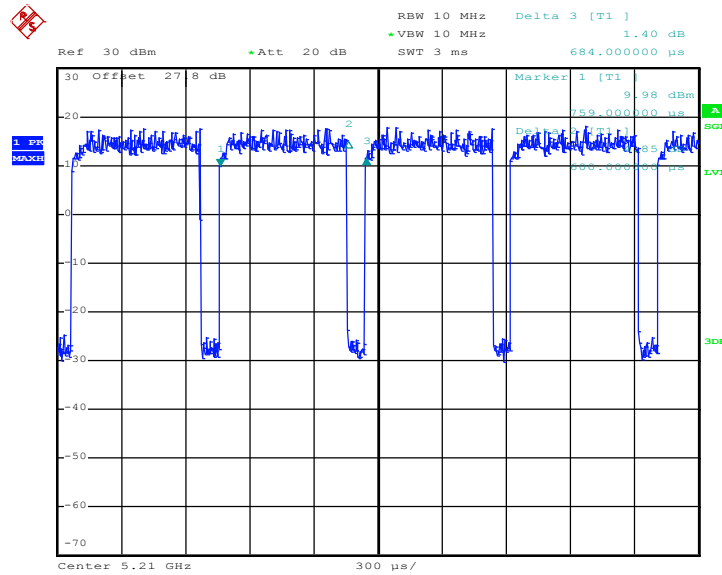

Date: 15.AUG.2018 23:48:43