



FCC RADIO TEST REPORT

FCC ID : UZ7TC720L
Equipment : Touch computer
Brand Name : Zebra
Model name : TC720L
Applicant : Zebra Technologies Corporation
1 Zebra Plaza Holtsville, NY 11742
Manufacturer : Zebra Technologies Corporation
1 Zebra Plaza Holtsville, NY 11742
Standard : FCC Part 15 Subpart E §15.407

The product was received on Jul. 25, 2018 and testing was started from Aug. 15, 2018 and completed on Sep. 14, 2018. We, SPORTON INTERNATIONAL INC., would like to declare that the tested sample has been evaluated in accordance with the test procedures and has been in compliance with the applicable technical standards.

The report must not be used by the client to claim product certification, approval, or endorsement by TAF or any agency of government.

The test results in this report apply exclusively to the tested model / sample. Without written approval of SPORTON INTERNATIONAL INC. EMC & Wireless Communications Laboratory, the test report shall not be reproduced except in full.

Approved by: Joseph Lin

SPORTON INTERNATIONAL INC. EMC & Wireless Communications Laboratory
No. 52, Huaya 1st Rd., Guishan Dist., Taoyuan City, Taiwan (R.O.C.)



Table of Contents

History of this test report.....	3
Summary of Test Result.....	4
1 General Description	5
1.1 Product Feature of Equipment Under Test.....	5
1.2 Product Specification of Equipment Under Test.....	6
1.3 Modification of EUT	7
1.4 Testing Location	8
1.5 Applicable Standards.....	8
2 Test Configuration of Equipment Under Test	9
2.1 Carrier Frequency and Channel	9
2.2 Test Mode.....	10
2.3 Connection Diagram of Test System.....	19
2.4 Support Unit used in test configuration and system	20
2.5 EUT Operation Test Setup	21
2.6 Measurement Results Explanation Example.....	21
3 Test Result	22
3.1 6dB and 26dB and 99% Occupied Bandwidth Measurement	22
3.2 Maximum Conducted Output Power Measurement	28
3.3 Power Spectral Density Measurement	32
3.4 Unwanted Emissions Measurement.....	38
3.5 AC Conducted Emission Measurement.....	44
3.6 Automatically Discontinue Transmission	46
3.7 Antenna Requirements	47
4 List of Measuring Equipment.....	49
5 Uncertainty of Evaluation.....	51
Appendix A. AC Conducted Emission Test Result	
Appendix B. Radiated Spurious Emission	
Appendix C. Radiated Spurious Emission Plots	
Appendix D. Duty Cycle Plots	
Appendix E. Setup Photographs	



History of this test report

Report No.	Version	Description	Issued Date
FR872508F	01	Initial issue of report	Sep. 21, 2018



Summary of Test Result

Report Clause	Ref Std. Clause	Test Items	Result (PASS/FAIL)	Remark
3.1	15.403 (i)	6dB & 26dB Bandwidth	Pass	-
3.1	2.1049	99% Occupied Bandwidth	Reporting only	-
3.2	15.407 (a)	Maximum Conducted Output Power	Pass	-
3.3	15.407 (a)	Power Spectral Density	Pass	-
3.4	15.407(b)	Unwanted Emissions	Pass	Under limit 5.18 dB at 5642.200 MHz
3.5	15.207	AC Conducted Emission	Pass	Under limit 5.65 dB at 13.560 MHz
3.6	15.407 (c)	Automatically Discontinue Transmission	Pass	-
3.7	15.203 & 15.407 (a)	Antenna Requirement	Pass	-

Reviewed by: Wii Chang

Report Producer: Natasha Hsieh



1 General Description

1.1 Product Feature of Equipment Under Test

Product Feature	
Equipment	Touch computer
Brand Name	Zebra
Model Name	TC720L
FCC ID	UZ7TC720L
EUT supports Radios application	NFC WLAN 11a/b/g/n HT20/HT40 WLAN 11ac VHT20/VHT40/VHT80 Bluetooth BR/EDR/LE
HW Version	DV
SW Version	Android version 8.1.0
FW Version	91-09-14.00-OG-U00-STD
MFD	03JUL18
EUT Stage	Engineering Sample

Remark: The above EUT's information was declared by manufacturer.

Specification of Accessories				
AC Adapter	Brand Name	Zebra	Part Number	PWR-BUA5V16W0WWW
4 PIN DC power cable	Brand Name	Zebra	Part Number	CBL-DC-383A1-01
AC Power cable	Brand Name	Zebra	Part Number	50-16000-182R
Snap-On USB/Charge Cable	Brand Name	Zebra	Part Number	CBL-TC7X-USB1-01
Snap-On Charging Cable Cup	Brand Name	Zebra	Part Number	CHG-TC7X-CBL1-01
Battery 1	Brand Name	Zebra	Part Number	BT-000318-01
Battery 2 (Falcon 1S3P Battery Pack)	Brand Name	Zebra	Part Number	BT-000318-51
Battery 3	Brand Name	Symbol	Part Number	82-171249-02
Earphone 1	Brand Name	Zebra	Part Number	HDST-35MM-PTVP-01
Earphone 2	Brand Name	Zebra	Part Number	HS2100-OTH
Snap-on 3.5MM Audio Jack Adapter	Brand Name	Symbol	Part Number	ADP-TC7X-AUD35-01
3.5mm Jack 43"(1.1m) Standard Cable	Brand Name	Zebra	Part Number	CBL-HS2100-3MS1-01
Holster	Brand Name	Zebra	Part Number	SG-TC7X-HLSTR1-02
Rigid Holster	Brand Name	Zebra	Part Number	SG-TC7X-RHLSTR1-01

1.2 Product Specification of Equipment Under Test

Standards-related Product Specification	
Tx/Rx Channel Frequency Range	5745 MHz ~ 5825 MHz
Maximum Output Power to Antenna <CDD Modes>	<p><5745 MHz ~ 5825 MHz></p> <p><Ant. 1></p> <p>802.11a : 20.42 dBm / 0.1102 W 802.11n HT20 : 20.22 dBm / 0.1052 W 802.11n HT40 : 20.47 dBm / 0.1114 W 802.11ac VHT20: 20.34 dBm / 0.1081 W 802.11ac VHT40: 20.49 dBm / 0.1119 W 802.11ac VHT80: 20.28 dBm / 0.1067 W</p> <p><Ant. 2></p> <p>802.11a : 19.43 dBm / 0.0877 W 802.11n HT20 : 19.30 dBm / 0.0851 W 802.11n HT40 : 19.43 dBm / 0.0877 W 802.11ac VHT20: 19.36 dBm / 0.0863 W 802.11ac VHT40: 19.49 dBm / 0.0889 W 802.11ac VHT80: 19.21 dBm / 0.0834 W</p> <p>MIMO <Ant. 1 + 2></p> <p>802.11a : 23.48 dBm / 0.2228 W 802.11n HT20 : 23.40 dBm / 0.2188 W 802.11n HT40 : 23.42 dBm / 0.2198 W 802.11ac VHT20: 23.43 dBm / 0.2203 W 802.11ac VHT40: 23.49 dBm / 0.2234 W 802.11ac VHT80: 23.23 dBm / 0.2104 W</p>
Maximum Output Power <TXBF Modes>	<p><5745 MHz ~ 5825 MHz></p> <p>MIMO <Ant. 1 + 2></p> <p>802.11ac VHT20: 22.91 dBm / 0.1954 W 802.11ac VHT40: 23.16 dBm / 0.2070 W 802.11ac VHT80: 23.11 dBm / 0.2046 W</p>

Standards-related Product Specification													
99% Occupied Bandwidth <CDD Modes>	<Ant. 1> 802.11a : 18.33 MHz 802.11ac VHT20 : 19.03 MHz 802.11ac VHT40 : 37.06 MHz 802.11ac VHT80 : 76.72 MHz <Ant. 2> 802.11a : 17.33 MHz 802.11ac VHT20 : 18.43 MHz 802.11ac VHT40 : 36.86 MHz 802.11ac VHT80 : 76.72 MHz MIMO <Ant. 1> 802.11a : 20.08 MHz 802.11ac VHT20 : 19.43 MHz 802.11ac VHT40 : 37.46 MHz 802.11ac VHT80 : 76.84 MHz MIMO <Ant. 2> 802.11a : 20.78 MHz 802.11ac VHT20 : 20.63 MHz 802.11ac VHT40 : 38.26 MHz 802.11ac VHT80 : 77.20 MHz												
99% Occupied Bandwidth <TXBF Modes>	MIMO <Ant. 1> 802.11ac VHT20 : 18.05 MHz 802.11ac VHT40 : 36.80 MHz 802.11ac VHT80 : 77.04 MHz MIMO <Ant. 2> 802.11ac VHT20 : 18.20 MHz 802.11ac VHT40 : 37.00 MHz 802.11ac VHT80 : 77.40 MHz												
Antenna Gain / Gain	<Ant. 1> : PIFA Antenna with gain 1.8 dBi <Ant. 2> : PIFA Antenna with gain 3.4 dBi												
Type of Modulation	802.11a/n : OFDM (BPSK / QPSK / 16QAM / 64QAM) 802.11ac : OFDM (BPSK / QPSK / 16QAM / 64QAM / 256QAM)												
Antenna Function Description	<table border="1"> <thead> <tr> <th></th> <th>Ant. 1</th> <th>Ant. 2</th> </tr> </thead> <tbody> <tr> <td>802.11 a/n/ac</td> <td>V</td> <td>V</td> </tr> <tr> <td>802.11 a/n/ac MIMO</td> <td>V</td> <td>V</td> </tr> <tr> <td>802.11ac TXBF</td> <td>V</td> <td>V</td> </tr> </tbody> </table>		Ant. 1	Ant. 2	802.11 a/n/ac	V	V	802.11 a/n/ac MIMO	V	V	802.11ac TXBF	V	V
	Ant. 1	Ant. 2											
802.11 a/n/ac	V	V											
802.11 a/n/ac MIMO	V	V											
802.11ac TXBF	V	V											

Note: MIMO Ant. 1+2 is a calculated result from sum of the power MIMO Ant. 1 and MIMO Ant. 2.

1.3 Modification of EUT

No modifications are made to the EUT during all test items.



1.4 Testing Location

Sporton Lab is accredited to ISO 17025 by Taiwan Accreditation Foundation (TAF code : 1190) and the FCC designation No. TW1190 under the FCC 2.948(e) by Mutual Recognition Agreement (MRA) in FCC Test.

Test Site	SPORTON INTERNATIONAL INC.		
Test Site Location	No.52, Huaya 1st Rd., Guishan Dist., Taoyuan City, Taiwan (R.O.C.) TEL: +886-3-327-3456 FAX: +886-3-328-4978		
Test Site No.	Sporton Site No.		
	TH05-HY	CO05-HY	03CH07-HY

Note: The test site complies with ANSI C63.4 2014 requirement.

1.5 Applicable Standards

According to the specifications of the manufacturer, the EUT must comply with the requirements of the following standards:

- ♦ FCC Part 15 Subpart E
- ♦ FCC KDB 789033 D02 General UNII Test Procedures New Rules v02r01.
- ♦ FCC KDB 414788 D01 Radiated Test Site v01r01.
- ♦ FCC KDB 662911 D01 Multiple Transmitter Output v02r01.
- ♦ ANSI C63.10-2013

Remark:

1. All test items were verified and recorded according to the standards and without any deviation during the test.
2. This EUT has also been tested and complied with the requirements of FCC Part 15, Subpart B, recorded in a separate test report.



2 Test Configuration of Equipment Under Test

- a. The EUT has been associated with peripherals and configuration operated in a manner tended to maximize its emission characteristics in a typical application. Frequency range investigated: conduction emission (150 kHz to 30 MHz), radiation emission (9 kHz to the 10th harmonic of the highest fundamental frequency or to 40 GHz, whichever is lower). For radiated measurement, pre-scanned in three orthogonal panels, X, Y, Z. The worst cases (X plane for CDD Mode Ant. 1 and Ant. 2, Z plane for TXBF Mode) were recorded in this report.

- b. AC power line Conducted Emission was tested under maximum output power.

2.1 Carrier Frequency and Channel

Frequency Band	Channel	Freq. (MHz)	Channel	Freq. (MHz)
5725-5850 MHz Band 4 (U-NII-3)	149	5745	157	5785
	151*	5755	159*	5795
	153	5765	161	5805
	155 [#]	5775	165	5825

Note:

- 1. The above Frequency and Channel in "*" were 802.11n HT40 and 802.11ac VHT40.
- 2. The above Frequency and Channel in "[#]" were 802.11ac VHT80.



2.2 Test Mode

Final test modes are considering the modulation and worse data rates as below table.

Single Mode

Modulation	Data Rate
802.11a	6 Mbps
802.11n HT20 (Covered by VHT20)	MCS0
802.11n HT40 (Covered by VHT40)	MCS0
802.11ac VHT20	MCS0
802.11ac VHT40	MCS0
802.11ac VHT80	MCS0

MIMO Mode

Modulation	Data Rate
802.11a	6 Mbps
802.11n HT20 (Covered by VHT20)	MCS0
802.11n HT40 (Covered by VHT40)	MCS0
802.11ac VHT20	MCS0
802.11ac VHT40	MCS0
802.11ac VHT80	MCS0

TXBF Mode

Modulation	Data Rate
802.11ac VHT20	MCS0
802.11ac VHT40	MCS0
802.11ac VHT80	MCS0



Test Cases	
AC Conducted Emission	Mode 1 :NFC Link + WLAN (5GHz) Link + Bluetooth Link + Snap on USB Cable Data Link with Notebook + Copy Data from Notebook to EDA (eMMC) + AC Adapter

Ch. #		Band IV : 5725-5850 MHz			
		802.11a	802.11ac VHT20	802.11ac VHT40	802.11ac VHT80
L	Low	149	149	151	-
M	Middle	157	157	-	155
H	High	165	165	159	-



<CDD Mode>

<Ant. 1>

802.11a RF Output Power (dBm)										
Power vs. Channel			Power vs Data Rate							
Channel	Frequency (MHz)	Data Rate (bps)	channel	Data Rate (bps)						
		6M		9M	12M	18M	24M	36M	48M	54M
Duty Cycle (%)		95.37		93.88	92.92	88.61	81.98	77.53	77.53	73.49
CH 149	5745	20.36	CH 157							
CH 157	5785	20.42		20.13	20.07	20.38	20.41	20.26	20.04	20.12
CH 165	5825	20.41								

802.11n HT20 RF Output Power (dBm)										
Power vs. Channel			Power vs Data Rate							
Channel	Frequency (MHz)	MCS Index	channel	MCS Index						
		MCS0		MCS1	MCS2	MCS3	MCS4	MCS5	MCS6	MCS7
Duty Cycle (%)		95.05		90.74	88.16	86.35	80.56	77.27	75.61	74.03
CH 149	5745	20.18	CH 157							
CH 157	5785	20.22		20.18	20.05	20.04	19.83	19.91	19.77	19.79
CH 165	5825	20.20								

802.11n HT40 RF Output Power (dBm)										
Power vs. Channel			Power vs Data Rate							
Channel	Frequency (MHz)	MCS Index	channel	MCS Index						
		MCS0		MCS1	MCS2	MCS3	MCS4	MCS5	MCS6	MCS7
Duty Cycle (%)		91.86		86.01	80.95	76.74	68.66	65.52	63.64	60.78
CH 151	5755	20.47	CH 151							
CH 159	5795	20.40		20.22	20.12	20.29	20.28	20.04	20.21	20.39



802.11ac VHT20 RF Output Power (dBm)											
Power vs. Channel			Power vs Data Rate								
Channel	Frequency (MHz)	MCS Index	channel	MCS Index							
		MCS0		MCS1	MCS2	MCS3	MCS4	MCS5	MCS6	MCS7	MCS8
Duty Cycle (%)		95.10		91.67	88.16	84.77	81.57	76.09	75.90	74.36	68.06
CH 149	5745	20.23									
CH 157	5785	20.34	CH 157	20.34	20.25	20.32	19.97	20.18	19.96	19.97	20.22
CH 165	5825	20.32									

802.11ac VHT40 RF Output Power (dBm)												
Power vs. Channel			Power vs Data Rate									
Channel	Frequency (MHz)	MCS Index	channel	MCS Index								
		MCS0		MCS1	MCS2	MCS3	MCS4	MCS5	MCS6	MCS7	MCS8	MCS9
Duty Cycle (%)		91.95		86.11	78.34	77.91	71.64	62.90	63.64	62.26	58.33	59.57
CH 151	5755	20.49										
CH 159	5795	20.46	CH 151	20.42	20.46	20.42	20.30	20.41	20.41	20.49	20.44	20.35

802.11ac VHT80 RF Output Power (dBm)												
Power vs. Channel			Power vs Data Rate									
Channel	Frequency (MHz)	MCS Index	channel	MCS Index								
		MCS0		MCS1	MCS2	MCS3	MCS4	MCS5	MCS6	MCS7	MCS8	MCS9
Duty Cycle (%)		87.72		79.90	74.03	70.31	62.96	59.14	55.56	54.55	52.38	50.00
CH155	5775	20.28	CH155	20.25	20.21	20.09	20.06	19.93	20.09	20.01	20.04	20.04



<Ant. 2>

802.11a RF Output Power (dBm)										
Power vs. Channel			Power vs Data Rate							
Channel	Frequency (MHz)	Data Rate (bps)	channel	Data Rate (bps)						
		6M		9M	12M	18M	24M	36M	48M	54M
Duty Cycle (%)		95.37		95.83	93.24	92.08	89.74	84.84	81.82	77.67
CH 149	5745	19.29	CH 157							
CH 157	5785	19.43		19.38	19.31	19.36	19.32	19.20	19.20	19.26
CH 165	5825	19.32								

802.11n HT20 RF Output Power (dBm)										
Power vs. Channel			Power vs Data Rate							
Channel	Frequency (MHz)	MCS Index	channel	MCS Index						
		MCS0		MCS1	MCS2	MCS3	MCS4	MCS5	MCS6	MCS7
Duty Cycle (%)		95.05		93.48	90.67	86.84	85.07	80.56	79.80	78.02
CH 149	5745	19.09	CH 157							
CH 157	5785	19.30		19.04	19.13	19.21	19.14	19.07	19.14	19.03
CH 165	5825	19.15								

802.11n HT40 RF Output Power (dBm)										
Power vs. Channel			Power vs Data Rate							
Channel	Frequency (MHz)	MCS Index	channel	MCS Index						
		MCS0		MCS1	MCS2	MCS3	MCS4	MCS5	MCS6	MCS7
Duty Cycle (%)		91.86		86.49	83.85	80.77	73.75	68.66	65.62	66.10
CH 151	5755	19.43	CH 151							
CH 159	5795	19.39		19.33	19.21	19.17	19.11	19.18	19.32	19.15



802.11ac VHT20 RF Output Power (dBm)											
Power vs. Channel			Power vs Data Rate								
Channel	Frequency (MHz)	MCS Index	channel	MCS Index							
		MCS0		MCS1	MCS2	MCS3	MCS4	MCS5	MCS6	MCS7	MCS8
Duty Cycle (%)		95.05		93.53	91.67	86.84	85.07	81.65	78.43	78.38	76.83
CH 149	5745	19.17									
CH 157	5785	19.36	CH 157	19.07	19.15	19.23	19.24	19.11	19.32	19.11	19.06
CH 165	5825	19.19									

802.11ac VHT40 RF Output Power (dBm)												
Power vs. Channel			Power vs Data Rate									
Channel	Frequency (MHz)	MCS Index	channel	MCS Index								
		MCS0		MCS1	MCS2	MCS3	MCS4	MCS5	MCS6	MCS7	MCS8	MCS9
Duty Cycle (%)		91.86		87.67	82.71	80.19	75.31	70.59	67.69	66.94	62.50	61.54
CH 151	5755	19.49										
CH 159	5795	19.47	CH 151	19.47	19.47	19.40	19.22	19.26	19.38	19.29	19.34	19.26

802.11ac VHT80 RF Output Power (dBm)												
Power vs. Channel			Power vs Data Rate									
Channel	Frequency (MHz)	MCS Index	channel	MCS Index								
		MCS0		MCS1	MCS2	MCS3	MCS4	MCS5	MCS6	MCS7	MCS8	MCS9
Duty Cycle (%)		87.72		80.00	73.68	70.31	60.00	56.25	55.56	53.49	51.22	50.00
CH155	5775	19.21	CH155	19.02	19.07	18.88	19.16	19.00	18.91	18.97	19.02	19.00



MIMO <Ant. 1+2>

802.11a RF Output Power (dBm)										
Power vs. Channel			Power vs Data Rate							
Channel	Frequency (MHz)	Data Rate (bps)	channel	Data Rate (bps)						
		6M		9M	12M	18M	24M	36M	48M	54M
Duty Cycle (%)										
CH 149	5745	23.35	CH 157							
CH 157	5785	23.48		23.31	23.24	23.45	23.38	23.09	23.22	23.18
CH 165	5825	23.36								

802.11n HT20 RF Output Power (dBm)										
Power vs. Channel			Power vs Data Rate							
Channel	Frequency (MHz)	MCS Index	channel	MCS Index						
		MCS0		MCS1	MCS2	MCS3	MCS4	MCS5	MCS6	MCS7
Duty Cycle (%)										
CH 149	5745	23.21	CH 157							
CH 157	5785	23.40		23.21	23.16	23.27	23.23	23.24	23.18	23.24
CH 165	5825	23.25								

802.11n HT40 RF Output Power (dBm)										
Power vs. Channel			Power vs Data Rate							
Channel	Frequency (MHz)	MCS Index	channel	MCS Index						
		MCS0		MCS1	MCS2	MCS3	MCS4	MCS5	MCS6	MCS7
Duty Cycle (%)										
CH 151	5755	23.42	CH 151							
CH 159	5795	23.39		23.26	23.16	23.28	23.20	23.05	23.12	23.13



802.11ac VHT20 RF Output Power (dBm)												
Power vs. Channel			Power vs Data Rate									
Channel	Frequency (MHz)	MCS Index	channel	MCS Index								
		MCS0		MCS1	MCS2	MCS3	MCS4	MCS5	MCS6	MCS7	MCS8	
Duty Cycle (%)												
CH 149	5745	23.29										
CH 157	5785	23.43	CH 157	23.37	23.41	23.39	23.42	23.38	23.39	23.37	23.39	
CH 165	5825	23.34										

802.11ac VHT40 RF Output Power (dBm)												
Power vs. Channel			Power vs Data Rate									
Channel	Frequency (MHz)	MCS Index	channel	MCS Index								
		MCS0		MCS1	MCS2	MCS3	MCS4	MCS5	MCS6	MCS7	MCS8	MCS9
Duty Cycle (%)												
CH 151	5755	23.49										
CH 159	5795	23.48	CH 151	23.47	23.35	23.46	23.33	23.31	23.34	23.29	23.36	23.26

802.11ac VHT80 RF Output Power (dBm)												
Power vs. Channel			Power vs Data Rate									
Channel	Frequency (MHz)	MCS Index	channel	MCS Index								
		MCS0		MCS1	MCS2	MCS3	MCS4	MCS5	MCS6	MCS7	MCS8	MCS9
Duty Cycle (%)												
CH155	5775	23.23	CH155	23.08	23.12	23.02	22.99	23.02	22.96	22.95	22.88	23.06



<TXBF Mode>

MIMO <Ant. 1+2>

802.11ac VHT20 RF Output Power (dBm)											
Power vs. Channel			Power vs Data Rate								
Channel	Frequency (MHz)	MCS Index	channel	MCS Index							
		MCS0		MCS1	MCS2	MCS3	MCS4	MCS5	MCS6	MCS7	MCS8
Duty Cycle (%)											
CH 149	5745	22.81									
CH 157	5785	22.91	CH 157	22.86	22.86	22.81	22.81	22.76	22.76	22.76	22.71
CH 165	5825	22.71									

802.11ac VHT40 RF Output Power (dBm)												
Power vs. Channel			Power vs Data Rate									
Channel	Frequency (MHz)	MCS Index	channel	MCS Index								
		MCS0		MCS1	MCS2	MCS3	MCS4	MCS5	MCS6	MCS7	MCS8	MCS9
Duty Cycle (%)												
CH 151	5755	23.16										
CH 159	5795	23.11	CH 151	23.11	23.11	23.11	23.06	23.06	23.06	23.06	23.06	23.06

802.11ac VHT80 RF Output Power (dBm)												
Power vs. Channel			Power vs Data Rate									
Channel	Frequency (MHz)	MCS Index	channel	MCS Index								
		MCS0		MCS1	MCS2	MCS3	MCS4	MCS5	MCS6	MCS7	MCS8	MCS9
Duty Cycle (%)												
CH155	5775	23.11	CH155	23.06	23.06	23.01	23.01	23.01	23.01	23.01	23.01	23.06

2.3 Connection Diagram of Test System

<Radiated Emission Mode>
 <CDD Mode with Earphone 1>

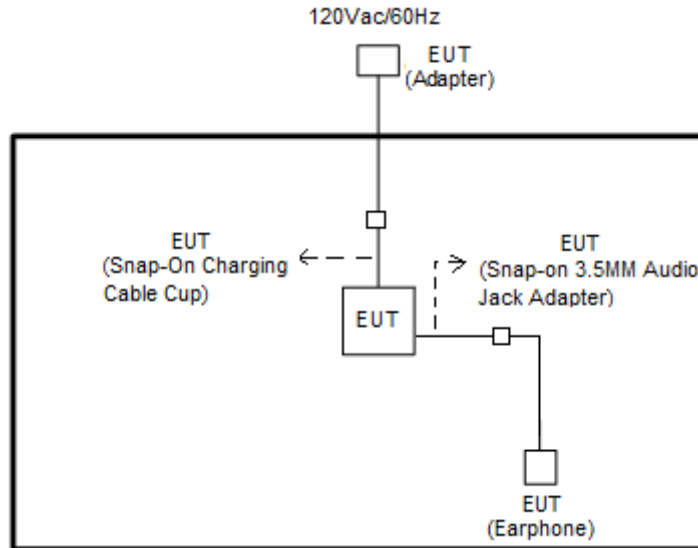

<TXBF Mode>

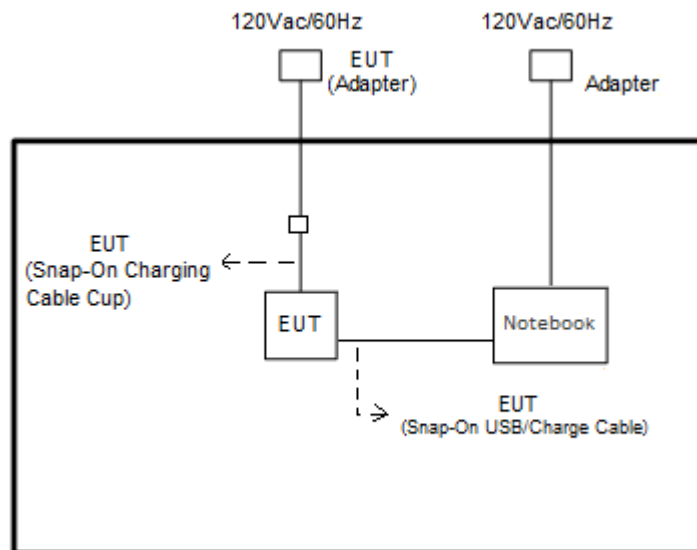

<AC Conducted Emission for data link mode>

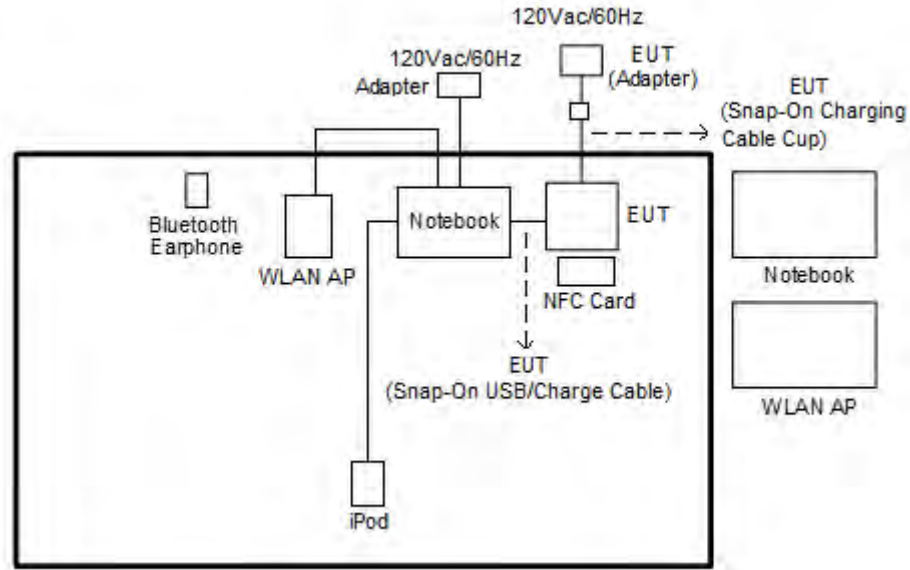

2.4 Support Unit used in test configuration and system

Item	Equipment	Trade Name	Model Name	FCC ID	Data Cable	Power Cord
1.	Bluetooth Earphone	Sony Ericsson	MW600	PY7DDA-2029	N/A	N/A
2.	WLAN AP	ASUS	RT-AC66U	MSQ-RTAC66U	N/A	Unshielded, 1.8 m
3.	iPod	Apple	A1285	FCC DoC	Shielded, 1.0 m	N/A
4.	Notebook	DELL	Latitude E6320	FCC DoC/ Contains FCC ID: QDS-BRCM1054	N/A	AC I/P: Unshielded, 1.2 m DC O/P: Shielded, 1.8 m
5.	Notebook	DELL	Latitude E3340	FCC DoC/ Contains FCC ID: PD97260NGU	N/A	AC I/P: Unshielded, 1.2 m DC O/P: Shielded, 1.8 m
6.	SD Card	SanDisk	MicroSD HC	FCC DoC	N/A	N/A
7.	NFC Card	Metro Taipei	Easy Card	N/A	N/A	N/A



2.5 EUT Operation Test Setup

The RF test items, utility “QRCT” was installed in Notebook which was programmed in order to make the EUT get into the engineering modes to provide channel selection, power level, data rate and the application type and for continuous transmitting signals.

For TXBF mode, the modulation modes and data rates manipulated by the command lines in the engineering program made the EUT link to another EUT by power under the normal operation. The “ADB” software tool was used to enable the EUT to transmit signals continuously.

2.6 Measurement Results Explanation Example

For all conducted test items:

The offset level is set in the spectrum analyzer to compensate the RF cable loss and attenuator factor between EUT conducted output port and spectrum analyzer. With the offset compensation, the spectrum analyzer reading level is exactly the EUT RF output level.

Example :

The spectrum analyzer offset is derived from RF cable loss and attenuator factor.

Offset = RF cable loss + attenuator factor.

Following shows an offset computation example with cable loss 4.2 dB and 10dB attenuator.

$$\begin{aligned} \text{Offset(dB)} &= \text{RF cable loss(dB)} + \text{attenuator factor(dB)}. \\ &= 4.2 + 10 = 14.2 \text{ (dB)} \end{aligned}$$

3 Test Result

3.1 6dB and 26dB and 99% Occupied Bandwidth Measurement

3.1.1 Description of 6dB and 26dB and 99% Occupied Bandwidth

The minimum 6 dB bandwidth shall be at least 500 kHz.

26dB and 99% Occupied bandwidth are reporting only.

3.1.2 Measuring Instruments

See list of measuring equipment of this test report.

3.1.3 Test Procedures

1. The testing follows FCC KDB 789033 D02 General UNII Test Procedures New Rules v02r01. Section C) Emission bandwidth for the band 5.725-5.85GHz
2. Set RBW = 100kHz.
3. Set the VBW $\geq 3 \times$ RBW.
4. Detector = Peak.
5. Trace mode = max hold
6. Measure the maximum width of the emission that is 6 dB down from the peak of the emission.
7. Measure and record the results in the test report.

3.1.4 Test Setup

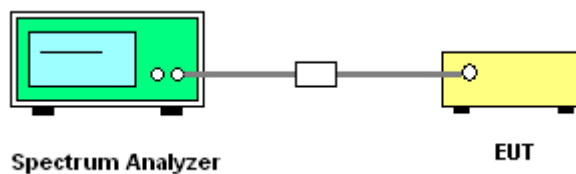



3.1.5 Test Result of 6dB Bandwidth

Test Engineer :	Shiming Liu and Allen Lin	Temperature :	21~25°C
		Relative Humidity :	51~54%

<CDD Mode>

Band IV												
Mod.	Data Rate	NTX	CH.	Freq. (MHz)	99% Bandwidth (MHz)		26dB Bandwidth (MHz)		6 dB Bandwidth (MHz)		6 dB Bandwidth Min. Limit (MHz)	Pass/Fail
					Ant 1	Ant 2	Ant 1	Ant 2	Ant 1	Ant 2		
11a	6Mbps	1	149	5745	17.63	17.33	32.55	30.24	15.63	15.48	0.5	Pass
11a	6Mbps	1	157	5785	17.78	17.18	31.47	30.44	15.48	15.48	0.5	Pass
11a	6Mbps	1	165	5825	18.33	17.18	32.55	29.10	15.68	15.63	0.5	Pass
VHT20	MCS0	1	149	5745	19.03	18.43	34.56	31.38	16.78	16.53	0.5	Pass
VHT20	MCS0	1	157	5785	18.33	18.33	30.86	31.39	16.48	16.48	0.5	Pass
VHT20	MCS0	1	165	5825	18.23	18.18	30.27	30.48	16.53	16.48	0.5	Pass
VHT40	MCS0	1	151	5755	37.06	36.86	62.13	51.25	35.42	35.34	0.5	Pass
VHT40	MCS0	1	159	5795	36.96	36.76	61.86	49.54	35.87	35.42	0.5	Pass
VHT80	MCS0	1	155	5775	76.72	76.72	132.83	118.44	75.12	75.12	0.5	Pass
11a	6Mbps	2	149	5745	18.68	20.78	32.94	34.07	15.93	16.33	0.5	Pass
11a	6Mbps	2	157	5785	19.68	20.08	33.40	34.50	15.13	16.28	0.5	Pass
11a	6Mbps	2	165	5825	20.08	19.38	35.72	34.20	15.13	15.63	0.5	Pass
VHT20	MCS0	2	149	5745	18.73	20.63	32.85	36.61	16.48	17.13	0.5	Pass
VHT20	MCS0	2	157	5785	19.23	20.23	34.66	35.77	16.13	17.13	0.5	Pass
VHT20	MCS0	2	165	5825	19.43	19.83	35.55	36.03	16.53	16.73	0.5	Pass
VHT40	MCS0	2	151	5755	37.16	37.96	61.68	77.32	35.16	35.96	0.5	Pass
VHT40	MCS0	2	159	5795	37.46	38.26	65.81	75.17	35.96	35.51	0.5	Pass
VHT80	MCS0	2	155	5775	76.84	77.20	134.99	166.71	74.97	75.12	0.5	Pass

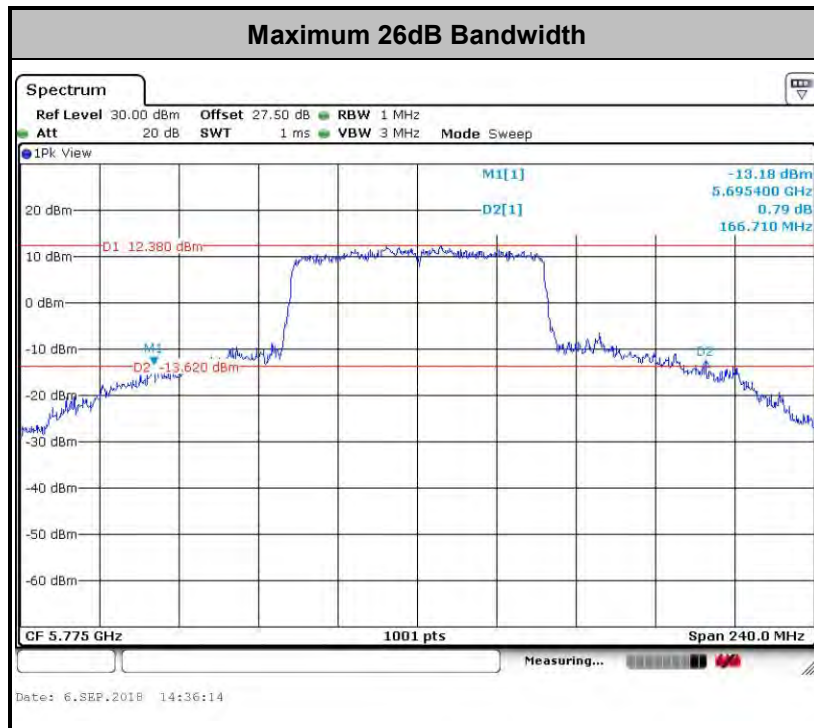
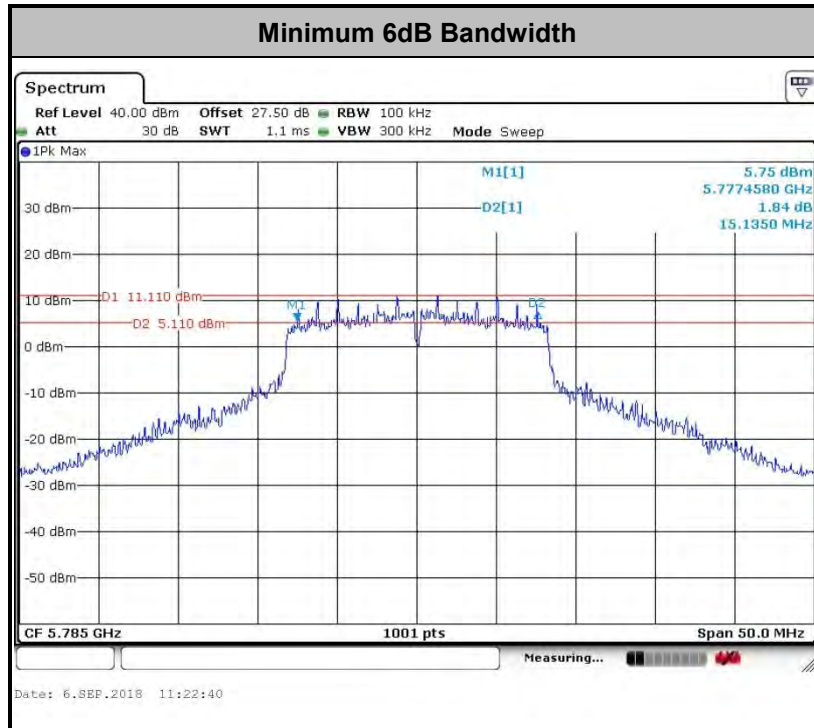

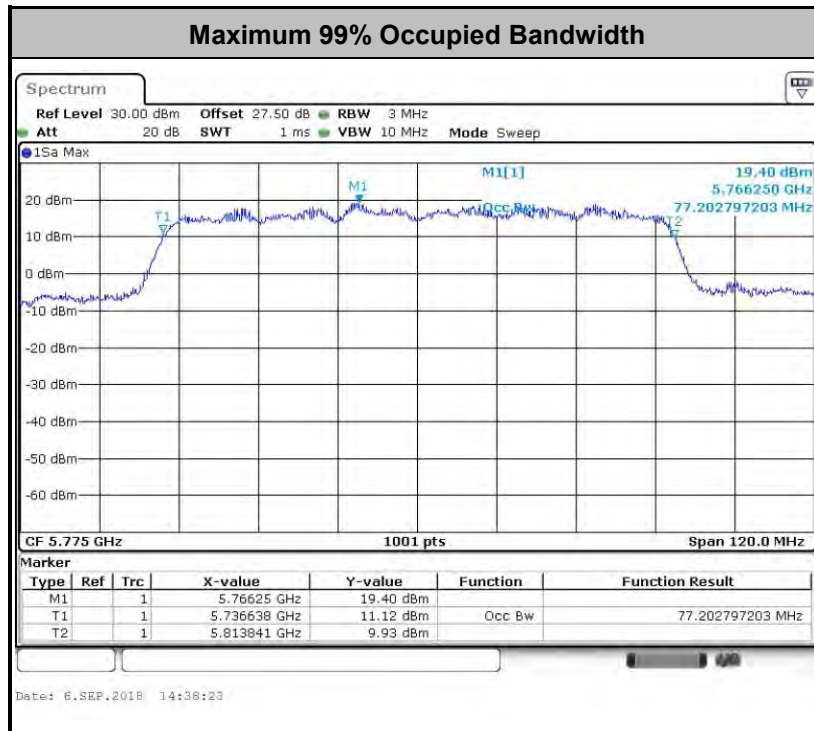

Note: The occupied channel bandwidth is maintained within the band of operation for all of the modulations.



<TXBF Modes>

Band IV												
Mod.	Data Rate	NTX	CH.	Freq. (MHz)	99% Bandwidth (MHz)		26dB Bandwidth (MHz)		6 dB Bandwidth (MHz)		6 dB Bandwidth Min. Limit (MHz)	Pass/Fail
					Ant 1	Ant 2	Ant 1	Ant 2	Ant 1	Ant 2		
VHT20	MCS0	2	149	5745	18.05	18.10	27.75	27.85	15.30	16.25	0.5	Pass
VHT20	MCS0	2	157	5785	18.05	18.20	28.00	28.15	16.80	16.55	0.5	Pass
VHT20	MCS0	2	165	5825	18.05	18.20	26.70	27.60	15.00	16.90	0.5	Pass
VHT40	MCS0	2	151	5755	36.70	37.00	68.83	72.57	35.64	35.64	0.5	Pass
VHT40	MCS0	2	159	5795	36.80	36.90	70.69	71.03	35.64	36.36	0.5	Pass
VHT80	MCS0	2	155	5775	77.04	77.40	84.88	104.84	74.88	74.88	0.5	Pass

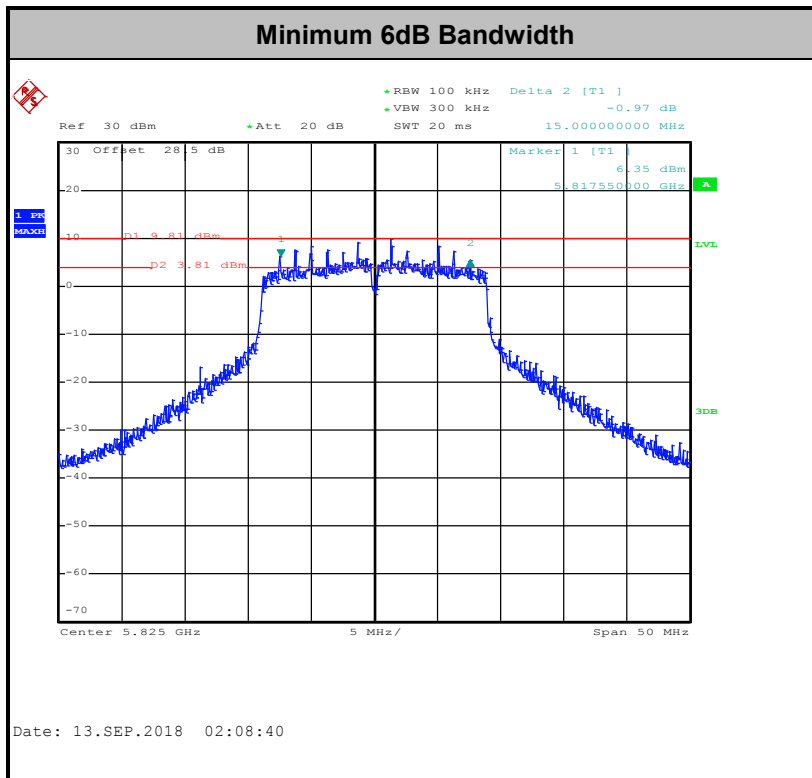

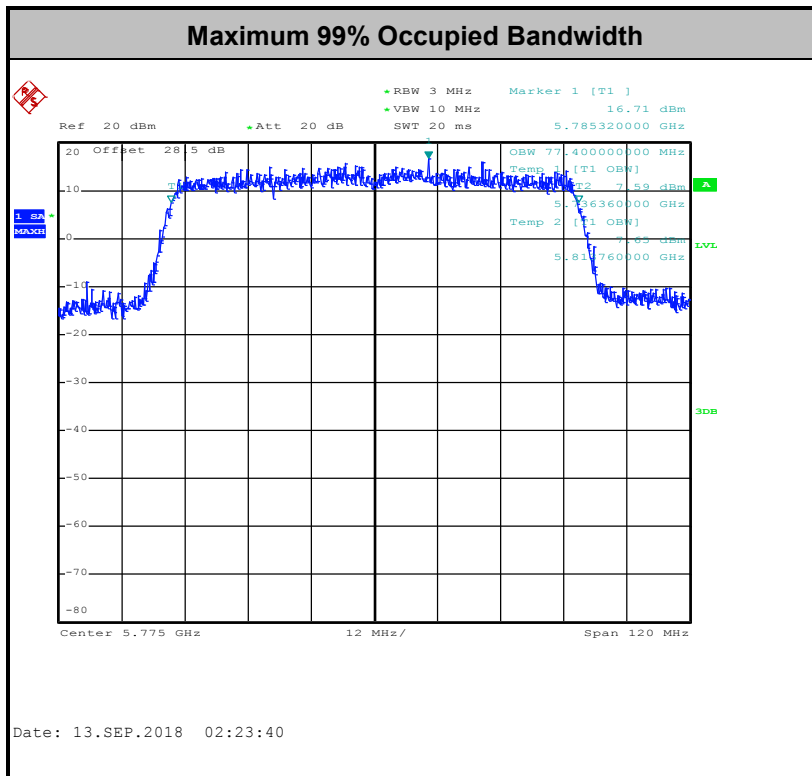
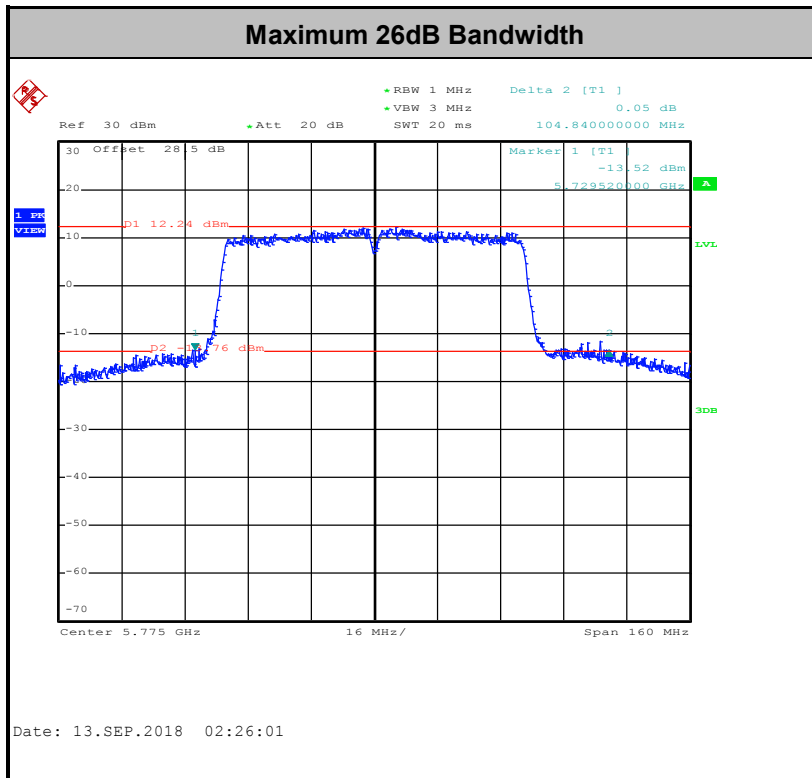

Note: The occupied channel bandwidth is maintained within the band of operation for all of the modulations.



3.2 Maximum Conducted Output Power Measurement

3.2.1 Limit of Maximum Conducted Output Power

For the band 5.725–5.85 GHz, the maximum conducted output power over the frequency band of operation shall not exceed 1 W.

If transmitting antennas of directional gain greater than 6 dBi are used, the peak output power shall be reduced by the amount in dB that the directional gain of the antenna exceeds 6 dBi.

3.2.2 Measuring Instruments

See list of measuring equipment of this test report.

3.2.3 Test Procedures

<CDD Modes>

The testing follows Method PM of FCC KDB 789033 D02 General UNII Test Procedures New Rules v02r01.

Method PM (Measurement using an RF average power meter):

1. Measurement is performed using a wideband RF power meter.
2. The EUT is configured to transmit continuously with a consistent duty cycle at its maximum power control level.
3. Measure the average power of the transmitter, and the average power is corrected with duty factor, $10 \log(1/x)$, where x is the duty cycle.

<TXBF Modes>

The testing follows Method PM-G of FCC KDB 789033 D02 General UNII Test Procedures New Rules v02r01 for TXBF modes.

Method PM-G (Measurement using a gated RF average power meter):

1. Measurement is performed using a wideband RF power meter.
2. The EUT is configured to transmit at its maximum power control level.
3. Measure the average power of the transmitter
4. Since the measurement is made only during the ON time of the transmitter, no duty cycle correction factor is required.

3.2.4 Test Setup

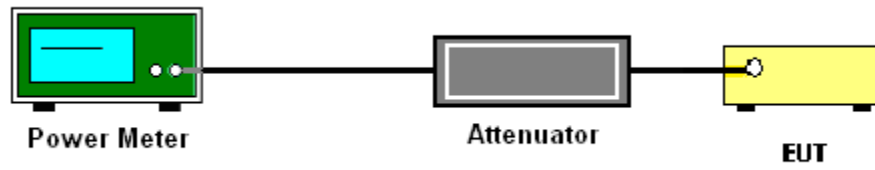



3.2.5 Test Result of Maximum Conducted Output Power

<CDD Mode>

Mod.	Data Rate	N _{TX}	CH.	Freq. (MHz)	Duty Factor (dB)		Average Conducted Power (dBm)			FCC Conducted Power Limit (dBm)		DG (dBi)		Pass/Fail
					Ant 1	Ant 2	Ant 1	Ant 2	SUM	Ant 1	Ant 2	Ant 1	Ant 2	
11a	6Mbps	1	149	5745	0.21	0.21	20.36	19.29		30.00	30.00	1.80	3.40	Pass
11a	6Mbps	1	157	5785	0.21	0.21	20.42	19.43		30.00	30.00	1.80	3.40	Pass
11a	6Mbps	1	165	5825	0.21	0.21	20.41	19.32		30.00	30.00	1.80	3.40	Pass
HT20	MCS0	1	149	5745	0.22	0.22	20.18	19.09		30.00	30.00	1.80	3.40	Pass
HT20	MCS0	1	157	5785	0.22	0.22	20.22	19.30		30.00	30.00	1.80	3.40	Pass
HT20	MCS0	1	165	5825	0.22	0.22	20.20	19.15		30.00	30.00	1.80	3.40	Pass
HT40	MCS0	1	151	5755	0.37	0.37	20.47	19.43		30.00	30.00	1.80	3.40	Pass
HT40	MCS0	1	159	5795	0.37	0.37	20.40	19.39		30.00	30.00	1.80	3.40	Pass
VHT20	MCS0	1	149	5745	0.22	0.22	20.23	19.17		30.00	30.00	1.80	3.40	Pass
VHT20	MCS0	1	157	5785	0.22	0.22	20.34	19.36		30.00	30.00	1.80	3.40	Pass
VHT20	MCS0	1	165	5825	0.22	0.22	20.32	19.19		30.00	30.00	1.80	3.40	Pass
VHT40	MCS0	1	151	5755	0.36	0.37	20.49	19.49		30.00	30.00	1.80	3.40	Pass
VHT40	MCS0	1	159	5795	0.36	0.37	20.46	19.47		30.00	30.00	1.80	3.40	Pass
VHT80	MCS0	1	155	5775	0.57	0.57	20.28	19.21		30.00	30.00	1.80	3.40	Pass
11a	6Mbps	2	149	5745	0.21	0.21	20.38	20.31	23.35	30.00		3.40		Pass
11a	6Mbps	2	157	5785	0.21	0.21	20.49	20.45	23.48	30.00		3.40		Pass
11a	6Mbps	2	165	5825	0.21	0.21	20.41	20.30	23.36	30.00		3.40		Pass
HT20	MCS0	2	149	5745	0.22	0.22	20.24	20.15	23.21	30.00		3.40		Pass
HT20	MCS0	2	157	5785	0.22	0.22	20.45	20.32	23.40	30.00		3.40		Pass
HT20	MCS0	2	165	5825	0.22	0.22	20.31	20.17	23.25	30.00		3.40		Pass
HT40	MCS0	2	151	5755	0.37	0.42	20.40	20.42	23.42	30.00		3.40		Pass
HT40	MCS0	2	159	5795	0.37	0.42	20.37	20.39	23.39	30.00		3.40		Pass
VHT20	MCS0	2	149	5745	0.22	0.22	20.34	20.22	23.29	30.00		3.40		Pass
VHT20	MCS0	2	157	5785	0.22	0.22	20.47	20.37	23.43	30.00		3.40		Pass
VHT20	MCS0	2	165	5825	0.22	0.22	20.42	20.23	23.34	30.00		3.40		Pass
VHT40	MCS0	2	151	5755	0.41	0.42	20.49	20.47	23.49	30.00		3.40		Pass
VHT40	MCS0	2	159	5795	0.41	0.42	20.48	20.45	23.48	30.00		3.40		Pass
VHT80	MCS0	2	155	5775	0.59	0.57	20.29	20.14	23.23	30.00		3.40		Pass



<TXBF Mode>

Mod.	Data Rate	NTX	CH.	Freq. (MHz)	Duty Factor (dB)		Average Conducted Power (dBm)			FCC Conducted Power Limit (dBm)		DG (dBi)		Pass/Fail
					Ant 1	Ant 2	Ant 1	Ant 2	SUM	Ant 1	Ant 2	Ant 1	Ant 2	
VHT20	MCS0	2	149	5745	0.00	0.00	19.80	19.80	22.81	30.00	5.65	Pass		
VHT20	MCS0	2	157	5785	0.00	0.00	19.90	19.90	22.91	30.00	5.65	Pass		
VHT20	MCS0	2	165	5825	0.00	0.00	19.70	19.70	22.71	30.00	5.65	Pass		
VHT40	MCS0	2	151	5755	0.00	0.00	20.10	20.20	23.16	30.00	5.65	Pass		
VHT40	MCS0	2	159	5795	0.00	0.00	20.10	20.10	23.11	30.00	5.65	Pass		
VHT80	MCS0	2	155	5775	0.00	0.00	20.10	20.10	23.11	30.00	5.65	Pass		



3.3 Power Spectral Density Measurement

3.3.1 Limit of Power Spectral Density

For the band 5.725–5.85 GHz, the maximum power spectral density shall not exceed 30 dBm in any 500-kHz band.

If transmitting antennas of directional gain greater than 6 dBi are used, the peak output power shall be reduced by the amount in dB that the directional gain of the antenna exceeds 6 dBi.

3.3.2 Measuring Instruments

See list of measuring equipment of this test report.

3.3.3 Test Procedures

The testing follows FCC KDB 789033 D02 General UNII Test Procedures New Rules v02r01. Section F) Maximum power spectral density.

<CDD Modes>

Method SA-2

(trace averaging across on and off times of the EUT transmissions, followed by duty cycle correction).

- Measure the duty cycle.
- Set span to encompass the entire emission bandwidth (EBW) of the signal.
- Set RBW = 300 kHz.
- Set VBW \geq 1 MHz.
- Number of points in sweep \geq 2 Span / RBW.
- Sweep time = auto.
- Detector = RMS
- Trace average at least 100 traces in power averaging mode.
- Add $10 \log(500\text{kHz}/\text{RBW})$ to the test result.
- Add $10 \log(1/x)$, where x is the duty cycle, to the measured power in order to compute the average power during the actual transmission times. For example, add $10 \log(1/0.25) = 6$ dB if the duty cycle is 25 percent.

<TXBF Modes>**# Method SA-3 #**

(power averaging (rms) detection with max hold):

- Set span to encompass the entire emission bandwidth (EBW) of the signal.
 - Set RBW = 300 kHz.
 - Set VBW \geq 1 MHz.
 - Number of points in sweep \geq 2 Span / RBW.
 - Sweep time \leq (number of points in sweep) \times T, when duty cycle is less than 98 percent where T is the minimum transmission duration over which the transmitter is on and is transmitting at its maximum power control level for the tested mode of operation.
 - Detector = power averaging (rms).
 - Trace mode = max hold.
 - Allow max hold to run for at least 60 seconds, or longer as needed to allow the trace to stabilize.
1. The RF output of EUT was connected to the spectrum analyzer by a low loss cable.
 2. Each plot has already offset with cable loss, and attenuator loss. Measure the PPSD and record it.
 3. For MIMO mode, calculation method follows FCC KDB 662911 D01 Multiple Transmitter Output v02r01.

Method (c): Measure and add $10 \log(N_{ANT})$ dB.

With this technique, spectrum measurements are performed at each output of the device, but rather than summing the spectra or the spectral peaks across the outputs, the quantity $10 \log(N_{ANT})$ dB is added to each spectrum value before comparing to the emission limit. The addition of $10 \log(N_{ANT})$ dB serves to apportion the emission limit among the N_{ANT} outputs so that each output is permitted to contribute no more than $1/N_{ANT}^{th}$ of the PSD limit.

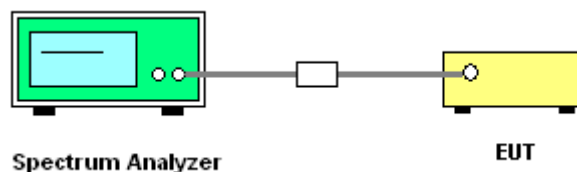
3.3.4 Test Setup



3.3.5 Test Result of Power Spectral Density

Test Engineer :	Shiming Liu and Allen Lin	Temperature :	21~25°C
		Relative Humidity :	51~54%

<CDD Modes>

Mod.	Data Rate	NTX	CH.	Freq. (MHz)	Duty Factor (dB)		10log (500kHz /RBW) Factor (dB)		Average Power Density (dBm/500kHz)			Average PSD Limit (dBm/500kHz)		DG (dBi)		Pass /Fail
					Ant 1	Ant 2	Ant 1	Ant 2	Ant 1	Ant 2	SUM	Ant 1	Ant 2	Ant 1	Ant 2	
11a	6Mbps	1	149	5745	0.21	0.21	2.22	2.22	7.44	6.83		30.00	30.00	1.80	3.40	Pass
11a	6Mbps	1	157	5785	0.21	0.21	2.22	2.22	7.77	6.52		30.00	30.00	1.80	3.40	Pass
11a	6Mbps	1	165	5825	0.21	0.21	2.22	2.22	7.48	6.97		30.00	30.00	1.80	3.40	Pass
VHT20	MCS0	1	149	5745	0.22	0.22	2.22	2.22	7.09	6.16		30.00	30.00	1.80	3.40	Pass
VHT20	MCS0	1	157	5785	0.22	0.22	2.22	2.22	6.32	6.07		30.00	30.00	1.80	3.40	Pass
VHT20	MCS0	1	165	5825	0.22	0.22	2.22	2.22	6.27	6.16		30.00	30.00	1.80	3.40	Pass
VHT40	MCS0	1	151	5755	0.36	0.37	2.22	2.22	4.34	3.54		30.00	30.00	1.80	3.40	Pass
VHT40	MCS0	1	159	5795	0.36	0.37	2.22	2.22	4.42	3.48		30.00	30.00	1.80	3.40	Pass
VHT80	MCS0	1	155	5775	0.57	0.57	2.22	2.22	1.44	0.01		30.00	30.00	1.80	3.40	Pass
11a	6Mbps	2	149	5745	0.21	0.21	2.22		7.25	8.04	11.05	30.00		5.65		Pass
11a	6Mbps	2	157	5785	0.21	0.21	2.22		7.99	7.37	11.00	30.00		5.65		Pass
11a	6Mbps	2	165	5825	0.21	0.21	2.22		7.78	7.97	10.98	30.00		5.65		Pass
VHT20	MCS0	2	149	5745	0.22	0.22	2.22		7.41	7.27	10.42	30.00		5.65		Pass
VHT20	MCS0	2	157	5785	0.22	0.22	2.22		7.62	7.25	10.63	30.00		5.65		Pass
VHT20	MCS0	2	165	5825	0.22	0.22	2.22		7.76	7.61	10.77	30.00		5.65		Pass
VHT40	MCS0	2	151	5755	0.41	0.42	2.22		4.83	4.43	7.84	30.00		5.65		Pass
VHT40	MCS0	2	159	5795	0.41	0.42	2.22		4.80	4.67	7.81	30.00		5.65		Pass
VHT80	MCS0	2	155	5775	0.59	0.57	2.22		1.52	1.23	4.53	30.00		5.65		Pass



Worst Case Power Density (dBm/MHz) for MIMO Ant. 1



Worst Case Power Density (dBm/MHz) for MIMO Ant. 2





<TXBF Modes>

Mod.	Data Rate	NTX	CH.	Freq. (MHz)	Duty Factor (dB)		10log (500kHz /RBW) Factor (dB)		Average Power Density (dBm/500kHz)			Average PSD Limit (dBm/500kHz)		DG (dBi)		Pass /Fail
					Ant 1	Ant 2	Ant 1	Ant 2	Ant 1	Ant 2	SUM	Ant 1	Ant 2	Ant 1	Ant 2	
VHT20	MCS0	2	149	5745	0.00	0.00	2.22	9.72	9.55	12.73	30.00	5.65	Pass			
VHT20	MCS0	2	157	5785	0.00	0.00	2.22	9.82	9.62	12.83	30.00	5.65	Pass			
VHT20	MCS0	2	165	5825	0.00	0.00	2.22	9.52	9.28	12.53	30.00	5.65	Pass			
VHT40	MCS0	2	151	5755	0.00	0.00	2.22	6.07	6.12	9.13	30.00	5.65	Pass			
VHT40	MCS0	2	159	5795	0.00	0.00	2.22	5.91	5.96	8.97	30.00	5.65	Pass			
VHT80	MCS0	2	155	5775	0.00	0.00	2.22	3.70	3.71	6.72	30.00	5.65	Pass			



Worst Case Power Density (dBm/MHz) for MIMO Ant. 1

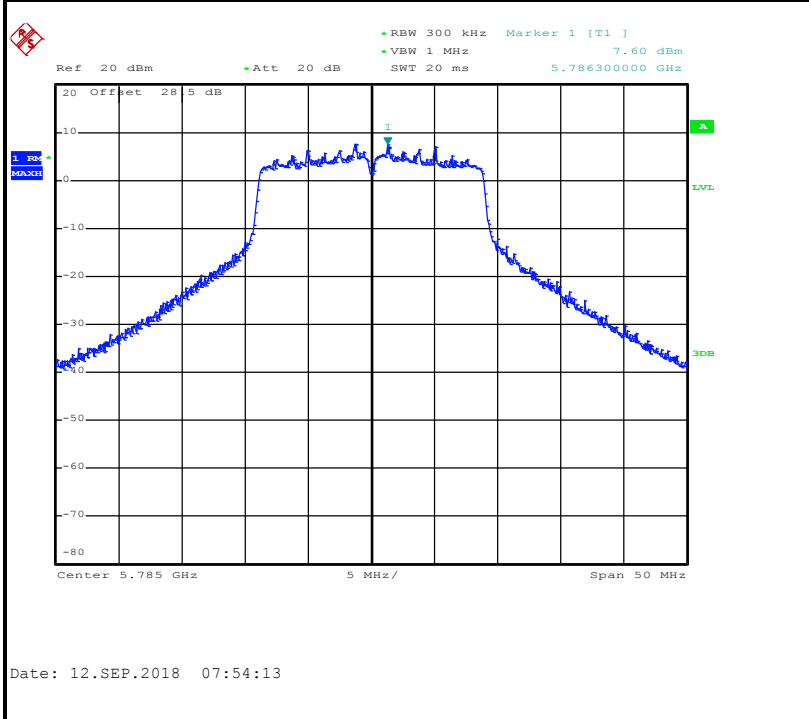

Worst Case Power Density (dBm/MHz) for MIMO Ant. 2

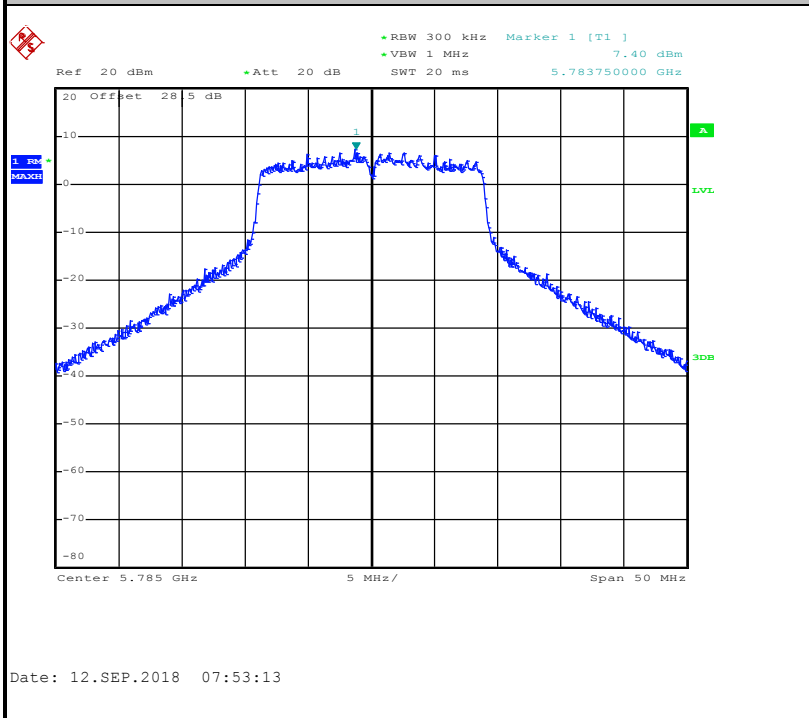



3.4 Unwanted Emissions Measurement

This section is to measure unwanted emissions through radiated measurement for band edge spurious emissions and out of band emissions measurement.

3.4.1 Limit of Unwanted Emissions

- (1) For transmitters operating in the 5.725-5.85 GHz band:
 15.407(b)(4)(i) All emissions shall be limited to a level of -27 dBm/MHz at 75 MHz or more above or below the band edge increasing linearly to 10 dBm/MHz at 25 MHz above or below the band edge, and from 25 MHz above or below the band edge increasing linearly to a level of 15.6 dBm/MHz at 5 MHz above or below the band edge, and from 5 MHz above or below the band edge increasing linearly to a level of 27 dBm/MHz at the band edge.
- (2) Unwanted spurious emissions fallen in restricted bands shall comply with the general field strength limits as below table,

Frequency (MHz)	Field Strength (microvolts/meter)	Measurement Distance (meters)
0.009 – 0.490	2400/F(kHz)	300
0.490 – 1.705	24000/F(kHz)	30
1.705 – 30.0	30	30
30 – 88	100	3
88 – 216	150	3
216 - 960	200	3
Above 960	500	3

Note: The following formula is used to convert the EIRP to field strength.

$$E = \frac{1000000\sqrt{30P}}{3} \mu\text{V/m, where P is the eirp (Watts)}$$

EIRP (dBm)	Field Strength at 3m (dBµV/m)
- 27	68.3



(3) KDB789033 D02 v02r01 G)2)c)

- (i) Section 15.407(b)(1) to (b)(3) specify the unwanted emission limits for the U-NII-1 and U-NII-2 bands. As specified, emissions above 1000 MHz that are outside of the restricted bands are subject to a peak emission limit of -27 dBm/MHz.³
- (ii) Section 15.407(b)(4) specifies the unwanted emission limit for the U-NII-3 band. A band emissions mask is specified in Section 15.407(b)(4)(i). The emission limits are in terms of a Peak detector. An alternative to the band emissions mask is specified in Section 15.407(b)(4)(ii). The alternative limits are based on the highest antenna gain specified in the filing. There are also marketing and importation restrictions for the devices using the alternative limit.⁴

Note 3: An out-of-band emission that complies with both the average and peak limits of Section 15.209 is not required to satisfy the -27 dBm/MHz peak emission limit.

Note 4: Only devices with antenna gains of 10 dBi or less may be approved using the emission limits specified in Section 15.247(d) till March 2, 2018; all other devices operating in this band must use the mask specified in Section 15.407(b)(4)(i).

3.4.2 Measuring Instruments

See list of measuring equipment of this test report.

3.4.3 Test Procedures

1. The testing follows FCC KDB 789033 D02 General UNII Test Procedures New Rules v02r01. Section G) Unwanted emissions measurement.

(1) Procedure for Unwanted Emissions Measurements Below 1000MHz

- RBW = 120 kHz
- VBW = 300 kHz
- Detector = Peak
- Trace mode = max hold

(2) Procedure for Peak Unwanted Emissions Measurements Above 1000 MHz

- RBW = 1 MHz
- VBW ≥ 3 MHz
- Detector = Peak
- Sweep time = auto
- Trace mode = max hold

(3) Procedures for Average Unwanted Emissions Measurements Above 1000MHz

- RBW = 1 MHz
- VBW = 10 Hz, when duty cycle is no less than 98 percent.
- VBW ≥ 1/T, when duty cycle is less than 98 percent where T is the minimum transmission duration over which the transmitter is on and is transmitting at its maximum power control level for the tested mode of operation.



2. The EUT was placed on a turntable with 0.8 meter for frequency below 1GHz and 1.5 meter for frequency above 1GHz respectively above ground.
3. The EUT was set 3 meters from the interference receiving antenna which was mounted on the top of a variable height antenna tower.
4. The antenna is a broadband antenna and its height is adjusted between one meter and four meters above ground to find the maximum value of the field strength for both horizontal polarization and vertical polarization of the antenna.
5. For each suspected emission, the EUT was arranged to its worst case and then adjust the antenna tower (from 1 m to 4 m) and turntable (from 0 degree to 360 degrees) to find the maximum reading.
6. For testing below 1GHz, if the emission level of the EUT in peak mode was 3 dB lower than the limit specified, then peak values of EUT will be reported, otherwise, the emissions will be repeated one by one using the CISPR quasi-peak method and reported.
7. For testing above 1GHz, the emission level of the EUT in peak mode was 20dB lower than average limit (that means the emission level in average mode also complies with the limit in average mode), then peak values of EUT will be reported, otherwise, the emissions will be measured in average mode again and reported.

3.4.4 Test Setup

For radiated emissions below 30MHz

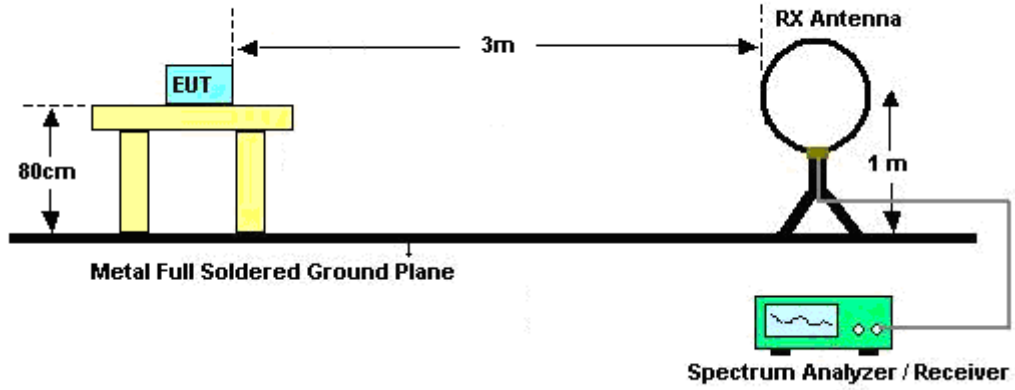

For radiated emissions from 30MHz to 1GHz

<CDD Mode>

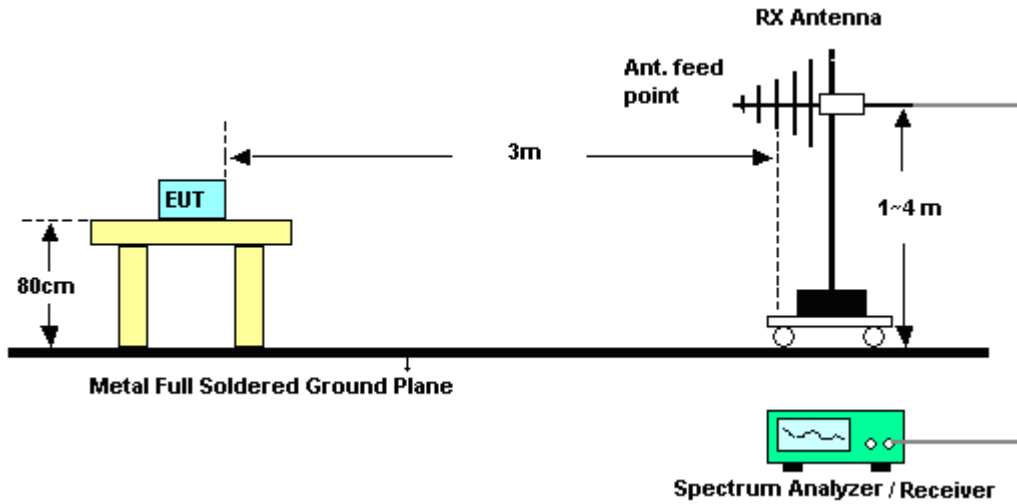

<TXBF Modes>

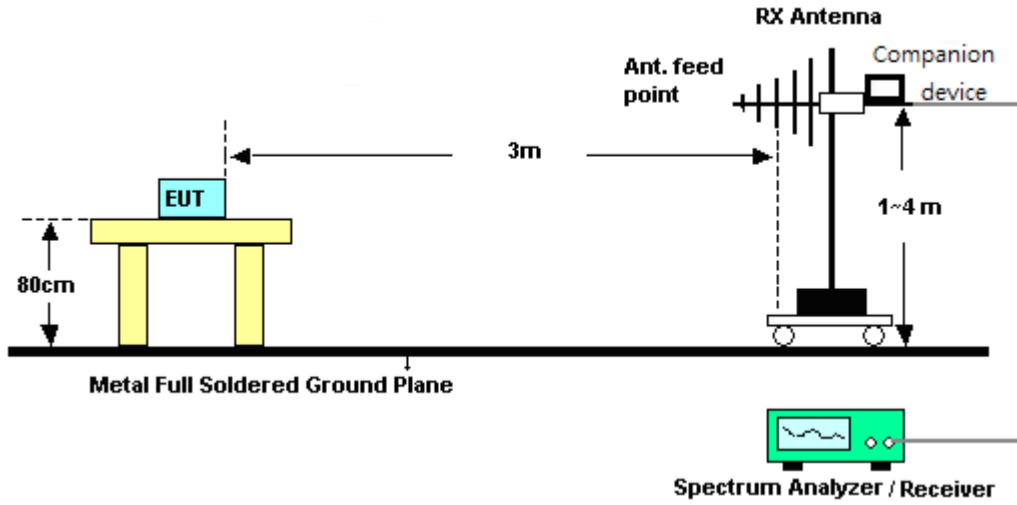

For radiated emissions above 1GHz

<CDD Mode>

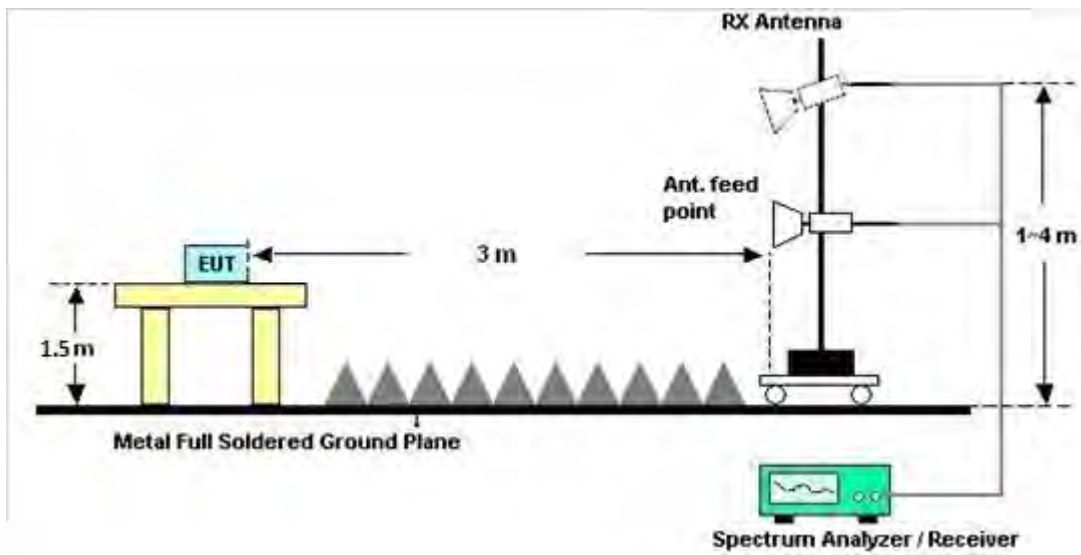

<TXBF Modes>

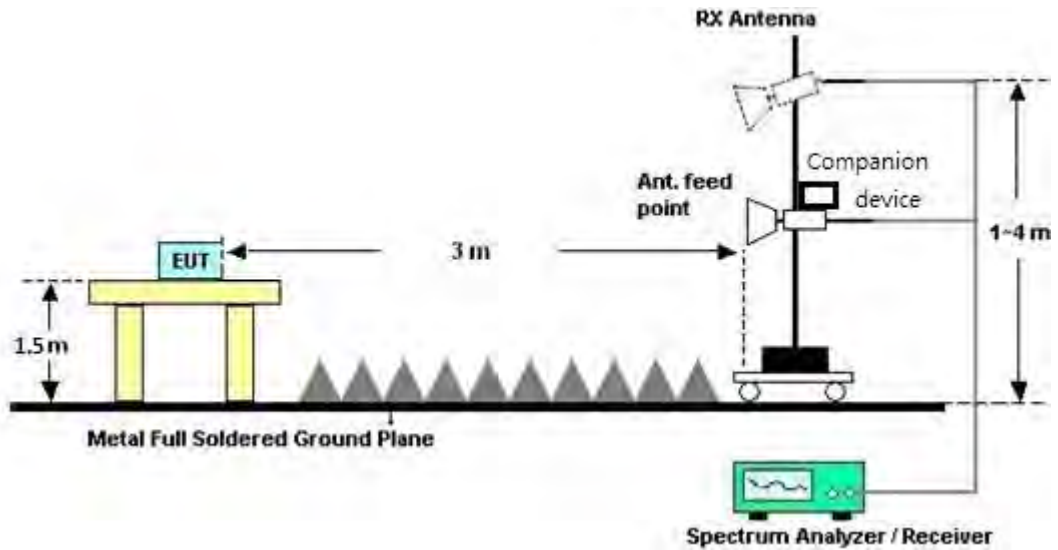

3.4.5 Test Results of Radiated Emissions (9 kHz ~ 30 MHz)

The low frequency, which started from 9 kHz to 30MHz, was pre-scanned and the result which was 20dB lower than the limit line was not reported.

There is a comparison data of both open-field test site and alternative test site - semi-Anechoic chamber according to 414788 D01 Radiated Test Site v01r01, and the result came out very similar.

3.4.6 Test Result of Radiated Band Edges

Please refer to Appendix B and C..

3.4.7 Duty Cycle

Please refer to Appendix D.

3.4.8 Test Result of Unwanted Radiated Emission (30MHz ~ 10th Harmonic)

Please refer to Appendix B and C.



3.5 AC Conducted Emission Measurement

3.5.1 Limit of AC Conducted Emission

For equipment that is designed to be connected to the public utility (AC) power line, the radio frequency voltage that is conducted back onto the AC power line on any frequency or frequencies within the band 150 kHz to 30 MHz shall not exceed the limits in the following table.

Frequency of emission (MHz)	Conducted limit (dB μ V)	
	Quasi-peak	Average
0.15-0.5	66 to 56*	56 to 46*
0.5-5	56	46
5-30	60	50

*Decreases with the logarithm of the frequency.

3.5.2 Measuring Instruments

See list of measuring equipment of this test report.

3.5.3 Test Procedures

1. The EUT was placed 0.4 meter from the conducting wall of the shielding room was kept at least 80 centimeters from any other grounded conducting surface.
2. Connect EUT to the power mains through a line impedance stabilization network (LISN).
3. All the support units are connecting to the other LISN.
4. The LISN provides 50 ohm coupling impedance for the measuring instrument.
5. The FCC states that a 50 ohm, 50 microhenry LISN should be used.
6. Both sides of AC line were checked for maximum conducted interference.
7. The frequency range from 150 kHz to 30 MHz was searched.
8. Set the test-receiver system to Peak Detect Function and specified bandwidth with Maximum Hold Mode.

3.5.4 Test Setup

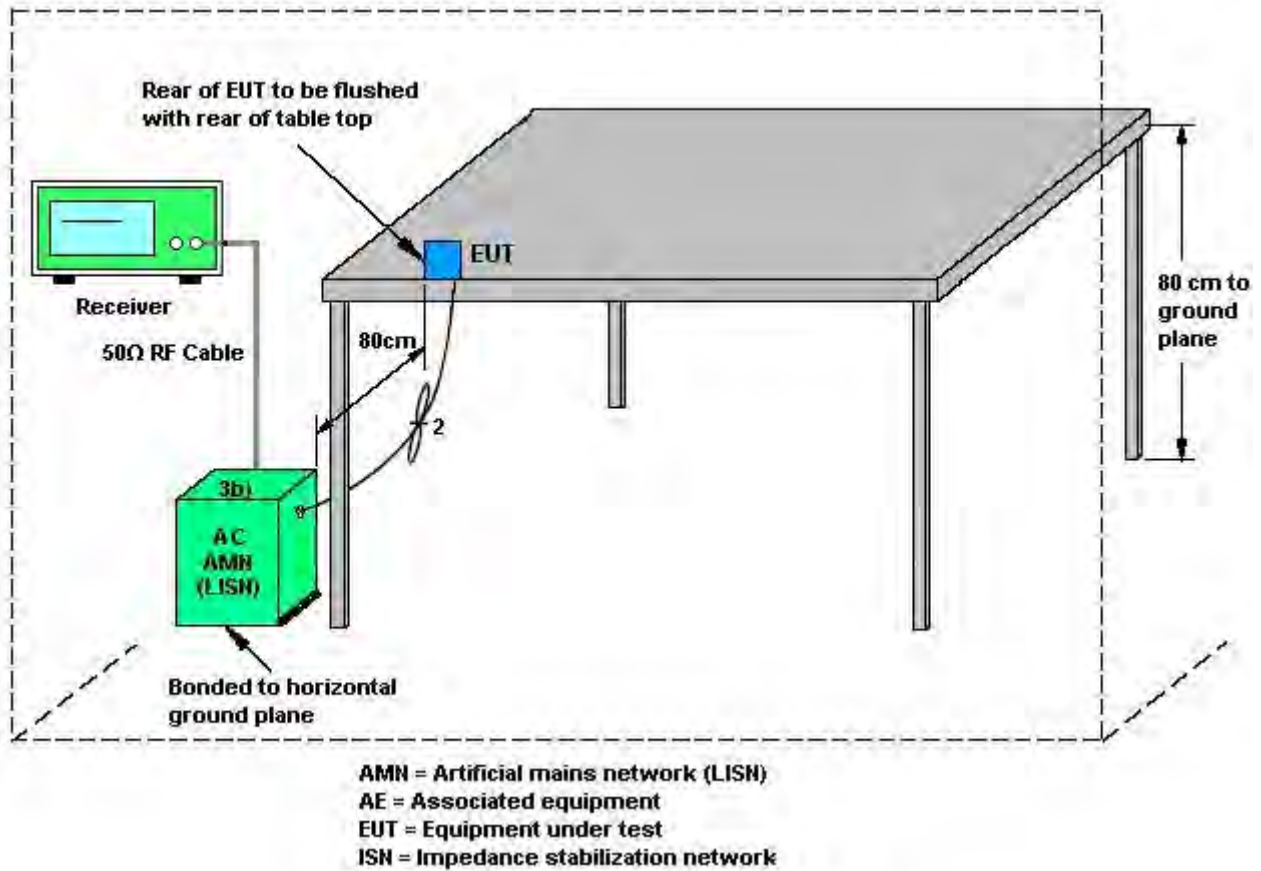

3.5.5 Test Result of AC Conducted Emission

Please refer to Appendix A.



3.6 Automatically Discontinue Transmission

3.6.1 Limit of Automatically Discontinue Transmission

The device shall automatically discontinue transmission in case of either absence of information to transmit or operational failure. These provisions are not intended to preclude the transmission of control or signaling information or the use of repetitive codes used by certain digital technologies to complete frame or burst intervals. Applicants shall include in their application for equipment authorization to describe how this requirement is met.

3.6.2 Measuring Instruments

See list of measuring equipment of this test report.

3.6.3 Test Result of Automatically Discontinue Transmission

While the EUT is not transmitting any information, the EUT can automatically discontinue transmission and become standby mode for power saving. The EUT can detect the controlling signal of ACK message transmitting from remote device and verify whether it shall resend or discontinue transmission.



3.7 Antenna Requirements

3.7.1 Standard Applicable

If transmitting antenna directional gain is greater than 6 dBi, both the peak transmit power and the peak power spectral density shall be reduced by the amount in dB that the directional gain of the antenna exceeds 6 dBi.

3.7.2 Antenna Anti-Replacement Construction

An embedded-in antenna design is used.

3.7.3 Antenna Gain

<CDD Modes >

FCC KDB 662911 D01 Multiple Transmitter Output v02r01

For CDD transmissions, directional gain is calculated as

Directional gain = GANT + Array Gain, where Array Gain is as follows.

For power spectral density (PSD) measurements on all devices,

Array Gain = 10 log(NANT/NSS=1) dB.

For power measurements on IEEE 802.11 devices,

Array Gain = 0 dB (i.e., no array gain) for NANT ≤ 4.

Directional gain may be calculated by using the formulas applicable to equal gain antennas with GANT set equal to the gain of the antenna having the highest gain;

The EUT supports CDD mode.

For power, the directional gain GANT is set equal to the antenna having the highest gain, i.e., F)2)f)i).

For PSD, the directional gain calculation is following F)2)f)ii) of KDB 662911 D01 v02r01.

The power and PSD limit should be modified if the directional gain of EUT is over 6 dBi,

The directional gain "DG" is calculated as following table.

<CDD Modes>						
			DG	DG	Power	PSD
			for	for	Limit	Limit
	Ant. 1	Ant. 2	Power	PSD	Reduction	Reduction
	(dBi)	(dBi)	(dBi)	(dBi)	(dB)	(dB)
Band IV	1.80	3.40	3.40	5.65	0.00	0.00

Power Limit Reduction = DG(Power) – 6dBi, (min = 0)

PSD Limit Reduction = DG(PSD) – 6dBi, (min = 0)

TXBF modes

FCC KDB 662911 D01 Multiple Transmitter Output v02r01

For CDD transmissions, directional gain is calculated as

$$DirectionalGain = 10 \cdot \log \left[\frac{\sum_{j=1}^{N_{SS}} \left\{ \sum_{k=1}^{N_{ANT}} g_{j,k} \right\}^2}{N_{ANT}} \right]$$

where

Each antenna is driven by no more than one spatial stream;

N_{SS} = the number of independent spatial streams of data;

N_{ANT} = the total number of antennas

$g_{j,k} = 10^{G_k / 20}$ if the k th antenna is being fed by spatial stream j , or zero if it is not;
 G_k is the gain in dBi of the k th antenna.

The EUT supports beamforming for 802.11ac modes.

The directional gain calculation is following F)2)e)ii) of KDB 662911 D01 v02r01.

The power and PSD limit should be modified if the directional gain of EUT is over 6 dBi,

The directional gain “DG” is calculated as following table.

			DG	DG	Power	PSD
			for	for	Limit	Limit
	Ant 1	Ant 2	Power	PSD	Reduction	Reduction
	(dBi)	(dBi)	(dBi)	(dBi)	(dB)	(dB)
Band IV	1.80	3.40	5.65	5.65	0.00	0.00

$Power\ Limit\ Reduction = DG(Power) - 6dBi, (min = 0)$

$PSD\ Limit\ Reduction = DG(PSD) - 6dBi, (min = 0)$



4 List of Measuring Equipment

Instrument	Manufacturer	Model No.	Serial No.	Characteristics	Calibration Date	Test Date	Due Date	Remark
Power Meter	Anritsu	ML2495A	1132003	N/A	Aug. 16, 2018	Aug. 15, 2018~ Sep. 14, 2018	Aug. 15, 2019	Conducted (TH05-HY)
Power Sensor	Anritsu	MA2411B	1126017	300MHz~40GHz	Aug. 16, 2018	Aug. 15, 2018~ Sep. 14, 2018	Aug. 15, 2019	Conducted (TH05-HY)
Spectrum Analyzer	Rohde & Schwarz	FSP40	100057	9kHz-40GHz	Nov. 21, 2017	Aug. 15, 2018~ Sep. 14, 2018	Nov. 20, 2018	Conducted (TH05-HY)
Signal Analyzer	Rohde & Schwarz	FSV40	101397	10Hz~40GHz	Nov. 07, 2017	Aug. 15, 2018~ Sep. 14, 2018	Nov. 06, 2018	Conducted (TH05-HY)
Switch Box & RF Cable	Burgeon	ETF-058	EC1300484	N/A	Mar. 01, 2018	Aug. 15, 2018~ Sep. 14, 2018	Feb. 28, 2019	Conducted (TH05-HY)
Power Sensor	DARE	RPR3006W	15100041SN O10	10MHz~6GHz	May 07, 2018	Aug. 15, 2018~ Sep. 14, 2018	May 06, 2019	Conducted (TH05-HY)
AC Power Source	ChainTek	APC-1000W	N/A	N/A	N/A	Aug. 23, 2018	N/A	Conduction (CO05-HY)
EMI Test Receiver	Rohde & Schwarz	ESR3	102388	9KHz~3.6GHz	Dec. 08, 2017	Aug. 23, 2018	Dec. 07, 2018	Conduction (CO05-HY)
LISN	Rohde & Schwarz	ENV216	100080	9kHz~30MHz	Nov. 30, 2017	Aug. 23, 2018	Nov. 29, 2018	Conduction (CO05-HY)
LISN	Rohde & Schwarz	ENV216	100081	9kHz~30MHz	Dec. 08, 2017	Aug. 23, 2018	Dec. 07, 2018	Conduction (CO05-HY)
Software	Rohde & Schwarz	EMC32 V10.30	N/A	N/A	N/A	Aug. 23, 2018	N/A	Conduction (CO05-HY)
LF Cable	HUBER + SUHNER	RG-214/U	LF01	N/A	Jan. 03, 2018	Aug. 23, 2018	Jan. 02, 2019	Conduction (CO05-HY)
Pulse Limiter	Rohde & Schwarz	ESH3-Z2	100851	N/A	Jan. 03, 2018	Aug. 23, 2018	Jan. 02, 2019	Conduction (CO05-HY)
Bilog Antenna	TESEQ	CBL 6111D&0080 0N1D01N-06	35419&03	30MHz to 1GHz	Dec. 18, 2017	Aug. 22, 2018 ~ Sep. 13, 2018	Dec. 17, 2018	Radiation (03CH07-HY)
Horn Antenna	ESCO	3117	00211469	1GHz~18GHz	Aug. 06, 2018	Aug. 22, 2018 ~ Sep. 13, 2018	Aug. 05, 2019	Radiation (03CH07-HY)
Double Ridge Horn Antenna	EMCO	3117	00066583	1GHz~18GHz	Aug. 06, 2018	Aug. 22, 2018 ~ Sep. 13, 2018	Aug. 05, 2019	Radiation (03CH07-HY)
Loop Antenna	Rohde & Schwarz	HFH2-Z2	100315	9 kHz~30 MHz	Nov. 10, 2017	Aug. 22, 2018 ~ Sep. 13, 2018	Nov. 09, 2018	Radiation (03CH07-HY)
Preamplifier	MITEQ	AMF-7D-001 01800-30-10 P	1590075	1GHz ~ 18GHz	Apr. 25, 2018	Aug. 22, 2018 ~ Sep. 13, 2018	Apr. 24, 2019	Radiation (03CH07-HY)
Preamplifier	COM-POWER	PA-103A	161241	10MHz-1GHz	May 21, 2018	Aug. 22, 2018 ~ Sep. 13, 2018	May 20, 2019	Radiation (03CH07-HY)
Preamplifier	Agilent	8449B	3008A02362	1GHz~ 26.5GHz	Oct. 30, 2017	Aug. 22, 2018 ~ Sep. 13, 2018	Oct. 29, 2018	Radiation (03CH07-HY)
Spectrum Analyzer	Agilent	N9010A	MY5347011 8	10Hz~44GHz	Apr. 17, 2018	Aug. 22, 2018 ~ Sep. 13, 2018	Apr. 16, 2019	Radiation (03CH07-HY)



Instrument	Manufacturer	Model No.	Serial No.	Characteristics	Calibration Date	Test Date	Due Date	Remark
Filter	Microwave	H1G013G1	SN477215	1.0G High Pass	Dec. 07, 2017	Aug. 22, 2018 ~ Sep. 13, 2018	Dec. 06, 2018	Radiation (03CH07-HY)
Filter	Wainwright	WLKS1200-8SS	SN3	1.2G Low Pass	Nov. 21, 2017	Aug. 22, 2018 ~ Sep. 13, 2018	Nov. 20, 2018	Radiation (03CH07-HY)
Filter	Microwave	H3G018G1	SN477220	3.0G High Pass	Nov. 21, 2017	Aug. 22, 2018 ~ Sep. 13, 2018	Nov. 20, 2018	Radiation (03CH07-HY)
Filter	Microwave	WHKX7.0/26 .5G-6SS	SN4	7G High Pass	Nov. 21, 2017	Aug. 22, 2018 ~ Sep. 13, 2018	Nov. 20, 2018	Radiation (03CH07-HY)
RF Cable	HUBER + SUHNER	SUCOFLEX 104	MY24971/4, MY28655/4	9KHz~30MHz	Jan. 02, 2018	Aug. 22, 2018 ~ Sep. 13, 2018	Jan. 01, 2019	Radiation (03CH07-HY)
RF Cable	HUBER + SUHNER	SUCOFLEX 104	MY28655/4, MY24971/4, MY15682/4	30MHz~1GHz	Feb. 27, 2018	Aug. 22, 2018 ~ Sep. 13, 2018	Feb. 26, 2019	Radiation (03CH07-HY)
RF Cable	HUBER + SUHNER	SUCOFLEX 104	MY28655/4, MY24971/4, MY15682/4	1GHz~18GHz	Feb. 27, 2018	Aug. 22, 2018 ~ Sep. 13, 2018	Feb. 26, 2019	Radiation (03CH07-HY)
RF Cable	HUBER + SUHNER	SUCOFLEX 102	MY2858/2	18GHz~40GHz	Feb. 27, 2018	Aug. 22, 2018 ~ Sep. 13, 2018	Feb. 26, 2019	Radiation (03CH07-HY)
Antenna Mast	Max-Full	MFA520BS	N/A	1m~4m	N/A	Aug. 22, 2018 ~ Sep. 13, 2018	N/A	Radiation (03CH07-HY)
Turn Table	ChainTek	Chaintek 3000	N/A	0~360 Degree	N/A	Aug. 22, 2018 ~ Sep. 13, 2018	N/A	Radiation (03CH07-HY)
Amplifier	MITEQ	TTA1840-35- HG	1871923	18GHz~40GHz, VSWR : 2.5:1 max	Jul. 16, 2018	Aug. 22, 2018 ~ Sep. 13, 2018	Jul. 15, 2019	Radiation (03CH07-HY)
SHF-EHF Horn Antenna	SCHWARZBE CK	BBHA 9170	BBHA91702 51	18GHz- 40GHz	Nov. 10, 2017	Aug. 22, 2018 ~ Sep. 13, 2018	Nov. 09, 2018	Radiation (03CH07-HY)
EMI Test Receiver	Agilent	N9038A(MX E)	MY5329005 3	20Hz to 26.5GHz	Jan. 16, 2018	Aug. 22, 2018 ~ Sep. 13, 2018	Jan. 15, 2019	Radiation (03CH07-HY)
Software	Audix	E3 6.2009-8 -24	8050400465 6H	N/A	N/A	Aug. 22, 2018 ~ Sep. 13, 2018	N/A	Radiation (03CH07-HY)



5 Uncertainty of Evaluation

Uncertainty of Conducted Emission Measurement (150kHz ~ 30MHz)

Measuring Uncertainty for a Level of Confidence of 95% ($U = 2Uc(y)$)	2.70
---	------

Uncertainty of Radiated Emission Measurement (30 MHz ~ 1000 MHz)

Measuring Uncertainty for a Level of Confidence of 95% ($U = 2Uc(y)$)	5.70
---	------

Uncertainty of Radiated Emission Measurement (1000 MHz ~ 18000 MHz)

Measuring Uncertainty for a Level of Confidence of 95% ($U = 2Uc(y)$)	5.50
---	------

Uncertainty of Radiated Emission Measurement (18000 MHz ~ 40000 MHz)

Measuring Uncertainty for a Level of Confidence of 95% ($U = 2Uc(y)$)	5.20
---	------



Appendix A. AC Conducted Emission Test Results

Test Engineer :	Jimmy Chang	Temperature :	25~27°C
		Relative Humidity :	50~52%
Test Voltage :	120Vac / 60Hz	Phase :	Line

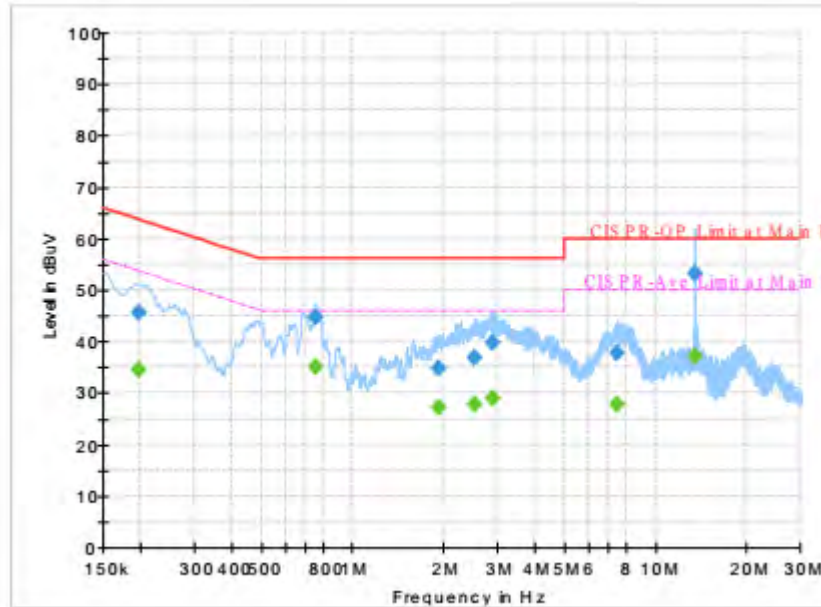

Final Result

Frequency (MHz)	QuasiPeak (dBuV)	CAverage (dBuV)	Limit (dBuV)	Margin (dB)	Line	Filter	Corr. (dB)
0.197250	45.69	---	63.73	18.04	L1	OFF	19.5
0.197250	---	34.61	53.73	19.12	L1	OFF	19.5
0.759750	44.66	---	56.00	11.34	L1	OFF	19.5
0.759750	---	35.20	46.00	10.80	L1	OFF	19.5
1.920750	34.76	---	56.00	21.24	L1	OFF	19.6
1.920750	---	27.19	46.00	18.81	L1	OFF	19.6
2.523750	36.92	---	56.00	19.08	L1	OFF	19.5
2.523750	---	27.92	46.00	18.08	L1	OFF	19.5
2.901750	39.67	---	56.00	16.33	L1	OFF	19.6
2.901750	---	28.84	46.00	17.16	L1	OFF	19.6
7.500750	37.59	---	60.00	22.41	L1	OFF	19.7
7.500750	---	27.87	50.00	22.13	L1	OFF	19.7
13.560000	53.08	---	60.00	6.92	L1	OFF	19.7
13.560000	---	37.15	50.00	12.85	L1	OFF	19.7



Test Engineer :	Jimmy Chang	Temperature :	25~27°C
		Relative Humidity :	50~52%
Test Voltage :	120Vac / 60Hz	Phase :	Neutral

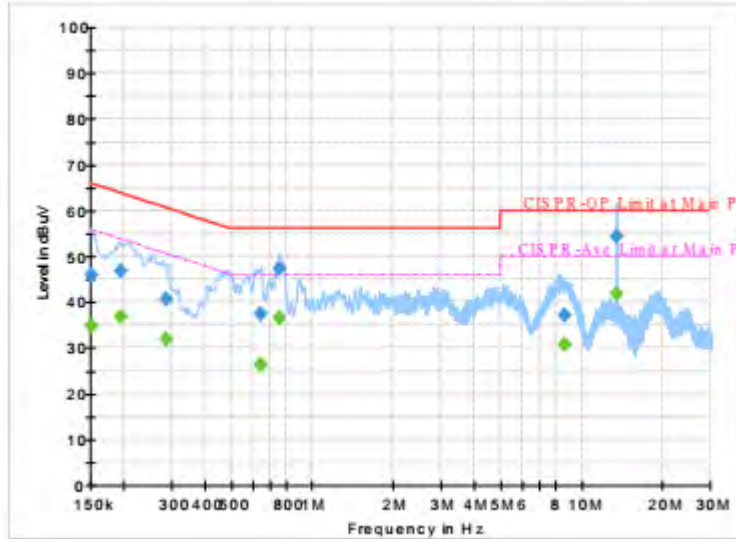

Final Result

Frequency (MHz)	QuasiPeak (dBuV)	CAverage (dBuV)	Limit (dBuV)	Margin (dB)	Line	Filter	Corr. (dB)
0.152250	---	34.75	55.88	21.13	N	OFF	19.5
0.152250	46.01	---	65.88	19.87	N	OFF	19.5
0.195000	---	36.72	53.82	17.10	N	OFF	19.5
0.195000	46.93	---	63.82	16.89	N	OFF	19.5
0.287250	---	32.00	50.60	18.60	N	OFF	19.5
0.287250	40.56	---	60.60	20.04	N	OFF	19.5
0.647250	---	26.43	46.00	19.57	N	OFF	19.5
0.647250	37.37	---	56.00	18.63	N	OFF	19.5
0.753000	---	36.53	46.00	9.47	N	OFF	19.5
0.753000	47.37	---	56.00	8.63	N	OFF	19.5
8.673000	---	30.59	50.00	19.41	N	OFF	19.7
8.673000	37.03	---	60.00	22.97	N	OFF	19.7
13.560000	---	41.92	50.00	8.08	N	OFF	19.8
13.560000	54.35	---	60.00	5.65	N	OFF	19.8



Appendix B. Radiated Spurious Emission

Test Engineer :	Jesse Wang, Stan Hsieh, and Nick Yu	Temperature :	24~26°C
		Relative Humidity :	51~53%

<CDD Mode>
<For Earphone 1>

Band 4 - 5725~5850MHz

WIFI 802.11a (Band Edge @ 3m)

WIFI Ant.	Note	Frequency (MHz)	Level (dBμV/m)	Over Limit (dB)	Limit Line (dBμV/m)	Read Level (dBμV)	Antenna Factor (dB/m)	Path Loss (dB)	Preamp Factor (dB)	Ant Pos (cm)	Table Pos (deg)	Peak Avg. (P/A)	Pol. (H/V)	
802.11a CH 149 5745MHz		5628	50.8	-17.4	68.2	39.45	35.1	11.43	35.18	100	325	P	H	
		5694.2	61.86	-39.06	100.92	50.45	35.15	11.46	35.2	100	325	P	H	
		5720	71.01	-39.79	110.8	59.53	35.18	11.5	35.2	100	325	P	H	
		5724.2	81.29	-39.09	120.38	69.81	35.18	11.5	35.2	100	325	P	H	
	*	5745	113.92	-	-	102.41	35.19	11.53	35.21	100	325	P	H	
	*	5745	106.87	-	-	95.36	35.19	11.53	35.21	100	325	A	H	
														H
														H
			5612.2	49.97	-18.23	68.2	38.67	35.08	11.4	35.18	100	248	P	V
			5694.8	60.07	-41.3	101.37	48.66	35.15	11.46	35.2	100	248	P	V
			5720	70.15	-40.65	110.8	58.67	35.18	11.5	35.2	100	248	P	V
			5724.8	80.13	-41.61	121.74	68.65	35.18	11.5	35.2	100	248	P	V
		*	5745	112.49	-	-	100.98	35.19	11.53	35.21	100	248	P	V
		*	5745	105.1	-	-	93.59	35.19	11.53	35.21	100	248	A	V
														V
													V	



WIFI Ant. 1	Note	Frequency (MHz)	Level (dBμV/m)	Over Limit (dB)	Limit Line (dBμV/m)	Read Level (dBμV)	Antenna Factor (dB/m)	Path Loss (dB)	Preamp Factor (dB)	Ant Pos (cm)	Table Pos (deg)	Peak Avg. (P/A)	Pol. (H/V)
		5623.8	50.62	-17.58	68.2	39.27	35.1	11.43	35.18	100	325	P	H
		5682.6	51.79	-40.57	92.36	40.39	35.14	11.46	35.2	100	325	P	H
		5718.4	59.23	-51.12	110.35	47.75	35.18	11.5	35.2	100	325	P	H
		5722.2	53.22	-62.6	115.82	41.74	35.18	11.5	35.2	100	325	P	H
	*	5785	114.59	-	-	103.03	35.22	11.56	35.22	100	325	P	H
	*	5785	107.21	-	-	95.65	35.22	11.56	35.22	100	325	A	H
		5854.6	58.47	-53.24	111.71	46.81	35.29	11.6	35.23	100	325	P	H
		5862.4	58.09	-50.64	108.73	46.39	35.29	11.65	35.24	100	325	P	H
		5880.8	54.61	-46.28	100.89	42.9	35.3	11.65	35.24	100	325	P	H
		5928.6	50.46	-17.74	68.2	38.67	35.34	11.69	35.24	100	325	P	H
													H
													H
802.11a													
CH 157													
5785MHz		5649.6	50.36	-17.84	68.2	39	35.12	11.43	35.19	100	248	P	V
		5690.6	52.1	-46.17	98.27	40.69	35.15	11.46	35.2	100	248	P	V
		5715.2	56.61	-52.85	109.46	45.14	35.17	11.5	35.2	100	248	P	V
		5724	57.73	-62.19	119.92	46.25	35.18	11.5	35.2	100	248	P	V
	*	5785	113.08	-	-	101.52	35.22	11.56	35.22	100	248	P	V
	*	5785	105.51	-	-	93.95	35.22	11.56	35.22	100	248	A	V
		5851	59.87	-60.05	119.92	48.22	35.28	11.6	35.23	100	248	P	V
		5861	56.88	-52.24	109.12	45.18	35.29	11.65	35.24	100	248	P	V
		5879.8	52.46	-49.17	101.63	40.75	35.3	11.65	35.24	100	248	P	V
		5932.8	49	-19.2	68.2	37.21	35.34	11.69	35.24	100	248	P	V
													V
													V



WiFi Ant. 1	Note	Frequency (MHz)	Level (dBµV/m)	Over Limit (dB)	Limit Line (dBµV/m)	Read Level (dBµV)	Antenna Factor (dB/m)	Path Loss (dB)	Preamp Factor (dB)	Ant Pos (cm)	Table Pos (deg)	Peak Avg. (P/A)	Pol. (H/V)	
802.11a CH 165 5825MHz	*	5825	114.56	-	-	102.92	35.26	11.6	35.22	105	325	P	H	
	*	5825	106.67	-	-	95.03	35.26	11.6	35.22	105	325	A	H	
		5850	68.66	-53.54	122.2	57.01	35.28	11.6	35.23	105	325	P	H	
		5861.2	66.79	-42.27	109.06	55.09	35.29	11.65	35.24	105	325	P	H	
		5878	64	-38.97	102.97	52.29	35.3	11.65	35.24	105	325	P	H	
		5932.2	53.54	-14.66	68.2	41.75	35.34	11.69	35.24	105	325	P	H	
														H
														H
	*	5825	113.3	-	-	101.66	35.26	11.6	35.22	100	241	P	V	
	*	5825	105.16	-	-	93.52	35.26	11.6	35.22	100	241	A	V	
		5850	67.86	-54.34	122.2	56.21	35.28	11.6	35.23	100	241	P	V	
		5861	66.97	-42.15	109.12	55.27	35.29	11.65	35.24	100	241	P	V	
		5881.6	61.41	-38.89	100.3	49.7	35.3	11.65	35.24	100	241	P	V	
		5927	52.79	-15.41	68.2	41	35.34	11.69	35.24	100	241	P	V	
														V
														V
													V	
Remark	<ol style="list-style-type: none"> No other spurious found. All results are PASS against Peak and Average limit line. 													



Band 4 5725~5850MHz

WIFI 802.11a (Harmonic @ 3m)

WIFI Ant. 1	Note	Frequency (MHz)	Level (dBμV/m)	Over Limit (dB)	Limit Line (dBμV/m)	Read Level (dBμV)	Antenna Factor (dB/m)	Path Loss (dB)	Preamp Factor (dB)	Ant Pos (cm)	Table Pos (deg)	Peak Avg. (P/A)	Pol. (H/V)
802.11a CH 149 5745MHz		11490	47.68	-26.32	74	48.6	37.98	18.44	57.34	100	0	P	H
		17235	51.21	-16.99	68.2	44.16	41	21.8	55.75	100	0	P	H
													H
													H
		11490	47.45	-26.55	74	48.37	37.98	18.44	57.34	100	0	P	V
		17235	51.97	-16.23	68.2	44.92	41	21.8	55.75	100	0	P	V
													V
													V
802.11a CH 157 5785MHz		11570	47.75	-26.25	74	48.34	38.07	18.54	57.2	100	0	P	H
		17355	51.89	-16.31	68.2	44.81	40.9	21.91	55.73	100	0	P	H
													H
													H
		11570	46.91	-27.09	74	47.5	38.07	18.54	57.2	100	0	P	V
		17355	52.64	-15.56	68.2	45.56	40.9	21.91	55.73	100	0	P	V
													V
													V
802.11a CH 165 5825MHz		11650	49.2	-24.8	74	49.49	38.18	18.64	57.11	100	0	P	H
		17475	52.14	-16.06	68.2	45.17	40.67	22.01	55.71	100	0	P	H
													H
													H
		11650	49.07	-24.93	74	49.36	38.18	18.64	57.11	100	0	P	V
		17475	51.69	-16.51	68.2	44.72	40.67	22.01	55.71	100	0	P	V
													V
													V
Remark	1. No other spurious found. 2. All results are PASS against Peak and Average limit line.												



Band 4 5725~5850MHz

WIFI 802.11ac VHT20 (Band Edge @ 3m)

WIFI Ant. 1	Note	Frequency (MHz)	Level (dBμV/m)	Over Limit (dB)	Limit Line (dBμV/m)	Read Level (dBμV)	Antenna Factor (dB/m)	Path Loss (dB)	Preamp Factor (dB)	Ant Pos (cm)	Table Pos (deg)	Peak Avg. (P/A)	Pol. (H/V)	
802.11ac VHT20 CH 149 5745MHz		5648.2	52.19	-16.01	68.2	40.84	35.11	11.43	35.19	100	326	P	H	
		5698	62.59	-41.14	103.73	51.18	35.15	11.46	35.2	100	326	P	H	
		5719.8	74.84	-35.9	110.74	63.36	35.18	11.5	35.2	100	326	P	H	
		5723.6	82.92	-36.09	119.01	71.44	35.18	11.5	35.2	100	326	P	H	
	*	5745	114.32	-	-	102.81	35.19	11.53	35.21	100	326	P	H	
	*	5745	106.78	-	-	95.27	35.19	11.53	35.21	100	326	A	H	
														H
														H
			5612.6	51.47	-16.73	68.2	40.17	35.08	11.4	35.18	100	248	P	V
			5694	59.7	-41.08	100.78	48.29	35.15	11.46	35.2	100	248	P	V
			5720	74.27	-36.53	110.8	62.79	35.18	11.5	35.2	100	248	P	V
			5723.4	80.57	-37.98	118.55	69.09	35.18	11.5	35.2	100	248	P	V
	*		5745	112.41	-	-	100.9	35.19	11.53	35.21	100	248	P	V
	*		5745	104.74	-	-	93.23	35.19	11.53	35.21	100	248	A	V
														V
													V	



WIFI Ant. 1	Note	Frequency (MHz)	Level (dBμV/m)	Over Limit (dB)	Limit Line (dBμV/m)	Read Level (dBμV)	Antenna Factor (dB/m)	Path Loss (dB)	Preamp Factor (dB)	Ant Pos (cm)	Table Pos (deg)	Peak Avg. (P/A)	Pol. (H/V)
		5645.4	50.76	-17.44	68.2	39.41	35.11	11.43	35.19	100	325	P	H
		5695.2	54.01	-47.65	101.66	42.6	35.15	11.46	35.2	100	325	P	H
		5717	57.68	-52.28	109.96	46.21	35.17	11.5	35.2	100	325	P	H
		5720.2	57.79	-53.47	111.26	46.31	35.18	11.5	35.2	100	325	P	H
	*	5785	114.26	-	-	102.7	35.22	11.56	35.22	100	325	P	H
	*	5785	106.52	-	-	94.96	35.22	11.56	35.22	100	325	A	H
		5853.8	52.79	-60.75	113.54	41.13	35.29	11.6	35.23	100	325	P	H
		5865	57.5	-50.5	108	45.8	35.29	11.65	35.24	100	325	P	H
		5876	57.55	-46.91	104.46	45.84	35.3	11.65	35.24	100	325	P	H
		5944.6	49.94	-18.26	68.2	38.09	35.36	11.74	35.25	100	325	P	H
802.11ac													H
VHT20													H
CH 157		5618.6	50.19	-18.01	68.2	38.87	35.1	11.4	35.18	100	248	P	V
5785MHz		5696.2	51.65	-50.75	102.4	40.24	35.15	11.46	35.2	100	248	P	V
		5712.8	55.21	-53.58	108.79	43.74	35.17	11.5	35.2	100	248	P	V
		5722.8	57.43	-59.75	117.18	45.95	35.18	11.5	35.2	100	248	P	V
	*	5785	112.67	-	-	101.11	35.22	11.56	35.22	100	248	P	V
	*	5785	104.89	-	-	93.33	35.22	11.56	35.22	100	248	A	V
		5852.6	52.58	-63.69	116.27	40.93	35.28	11.6	35.23	100	248	P	V
		5860	56.7	-52.7	109.4	45.05	35.29	11.6	35.24	100	248	P	V
		5877.2	54.69	-48.88	103.57	42.98	35.3	11.65	35.24	100	248	P	V
		5943.8	50.16	-18.04	68.2	38.31	35.36	11.74	35.25	100	248	P	V
													V
													V



WiFi Ant. 1	Note	Frequency (MHz)	Level (dBμV/m)	Over Limit (dB)	Limit Line (dBμV/m)	Read Level (dBμV)	Antenna Factor (dB/m)	Path Loss (dB)	Preamp Factor (dB)	Ant Pos (cm)	Table Pos (deg)	Peak Avg. (P/A)	Pol. (H/V)	
802.11ac VHT20 CH 165 5825MHz	*	5825	113.92	-	-	102.28	35.26	11.6	35.22	102	324	P	H	
	*	5825	106.23	-	-	94.59	35.26	11.6	35.22	102	324	A	H	
		5850	74.07	-48.13	122.2	62.42	35.28	11.6	35.23	102	324	P	H	
		5855.4	67.61	-43.08	110.69	55.95	35.29	11.6	35.23	102	324	P	H	
		5876.6	64.59	-39.42	104.01	52.88	35.3	11.65	35.24	102	324	P	H	
		5927.8	53.56	-14.64	68.2	41.77	35.34	11.69	35.24	102	324	P	H	
														H
														H
	*	5825	112.65	-	-	101.01	35.26	11.6	35.22	101	247	247	P	V
	*	5825	104.78	-	-	93.14	35.26	11.6	35.22	101	247	247	A	V
		5850	72.6	-49.6	122.2	60.95	35.28	11.6	35.23	101	247	247	P	V
		5856.2	66.09	-44.37	110.46	54.43	35.29	11.6	35.23	101	247	247	P	V
		5877	63.18	-40.53	103.71	51.47	35.3	11.65	35.24	101	247	247	P	V
		5925.8	54.8	-13.4	68.2	43.01	35.34	11.69	35.24	101	247	247	P	V
														V
													V	
Remark	1. No other spurious found. 2. All results are PASS against Peak and Average limit line.													



Band 4 5725~5850MHz

WIFI 802.11ac VHT20 (Harmonic @ 3m)

WIFI Ant. 1	Note	Frequency (MHz)	Level (dBμV/m)	Over Limit (dB)	Limit Line (dBμV/m)	Read Level (dBμV)	Antenna Factor (dB/m)	Path Loss (dB)	Preamp Factor (dB)	Ant Pos (cm)	Table Pos (deg)	Peak Avg. (P/A)	Pol. (H/V)	
802.11ac VHT20 CH 149 5745MHz		11490	48.12	-25.88	74	49.04	37.98	18.44	57.34	100	0	P	H	
		17235	51.4	-16.8	68.2	44.35	41	21.8	55.75	100	0	P	H	
													H	
													H	
			11490	47.77	-26.23	74	48.69	37.98	18.44	57.34	100	0	P	V
			17235	51.68	-16.52	68.2	44.63	41	21.8	55.75	100	0	P	V
														V
802.11ac VHT20 CH 157 5785MHz		11570	47.71	-26.29	74	48.3	38.07	18.54	57.2	100	0	P	H	
		17355	52.62	-15.58	68.2	45.54	40.9	21.91	55.73	100	0	P	H	
													H	
													H	
			11570	47.38	-26.62	74	47.97	38.07	18.54	57.2	100	0	P	V
			17355	51.9	-16.3	68.2	44.82	40.9	21.91	55.73	100	0	P	V
														V
802.11ac VHT20 CH 165 5825MHz		11650	49	-25	74	49.29	38.18	18.64	57.11	100	0	P	H	
		17475	51.72	-16.48	68.2	44.75	40.67	22.01	55.71	100	0	P	H	
													H	
													H	
			11650	48.78	-25.22	74	49.07	38.18	18.64	57.11	100	0	P	V
			17475	52.7	-15.5	68.2	45.73	40.67	22.01	55.71	100	0	P	V
														V
Remark	1. No other spurious found.													
	2. All results are PASS against Peak and Average limit line.													



Band 4 5725~5850MHz

WIFI 802.11ac VHT40 (Band Edge @ 3m)

WIFI Ant. 1	Note	Frequency (MHz)	Level (dBμV/m)	Over Limit (dB)	Limit Line (dBμV/m)	Read Level (dBμV)	Antenna Factor (dB/m)	Path Loss (dB)	Preamp Factor (dB)	Ant Pos (cm)	Table Pos (deg)	Peak Avg. (P/A)	Pol. (H/V)
		5650	54.94	-13.26	68.2	43.58	35.12	11.43	35.19	100	325	P	H
		5699	68.44	-36.02	104.46	57.03	35.15	11.46	35.2	100	325	P	H
		5718.8	83.28	-27.18	110.46	71.8	35.18	11.5	35.2	100	325	P	H
		5723.8	84.56	-34.9	119.46	73.08	35.18	11.5	35.2	100	325	P	H
	*	5755	112.26	-	-	100.73	35.21	11.53	35.21	100	325	P	H
	*	5755	104.46	-	-	92.93	35.21	11.53	35.21	100	325	A	H
		5853	56.3	-59.06	115.36	44.65	35.28	11.6	35.23	100	325	P	H
		5855.4	56.74	-53.95	110.69	45.08	35.29	11.6	35.23	100	325	P	H
		5889	54.4	-40.41	94.81	42.67	35.32	11.65	35.24	100	325	P	H
		5934	49.35	-18.85	68.2	37.56	35.34	11.69	35.24	100	325	P	H
802.11ac													H
VHT40													H
CH 151		5647.4	51.58	-16.62	68.2	40.23	35.11	11.43	35.19	100	249	P	V
5755MHz		5699.8	64.38	-40.67	105.05	52.97	35.15	11.46	35.2	100	249	P	V
		5719.2	81.69	-28.89	110.58	70.21	35.18	11.5	35.2	100	249	P	V
		5723.8	83.23	-36.23	119.46	71.75	35.18	11.5	35.2	100	249	P	V
	*	5755	110.33	-	-	98.8	35.21	11.53	35.21	100	249	P	V
	*	5755	102.63	-	-	91.1	35.21	11.53	35.21	100	249	A	V
		5853.4	54.8	-59.65	114.45	43.15	35.28	11.6	35.23	100	249	P	V
		5863.4	54.33	-54.12	108.45	42.63	35.29	11.65	35.24	100	249	P	V
		5876.8	52.54	-51.32	103.86	40.83	35.3	11.65	35.24	100	249	P	V
		5933.2	50.59	-17.61	68.2	38.8	35.34	11.69	35.24	100	249	P	V
													V
													V



WIFI Ant. 1	Note	Frequency (MHz)	Level (dBμV/m)	Over Limit (dB)	Limit Line (dBμV/m)	Read Level (dBμV)	Antenna Factor (dB/m)	Path Loss (dB)	Preamp Factor (dB)	Ant Pos (cm)	Table Pos (deg)	Peak Avg. (P/A)	Pol. (H/V)
		5630.6	51.32	-16.88	68.2	39.98	35.1	11.43	35.19	100	325	P	H
		5698.6	55.91	-48.26	104.17	44.5	35.15	11.46	35.2	100	325	P	H
		5715.4	60.06	-49.45	109.51	48.59	35.17	11.5	35.2	100	325	P	H
		5724.4	62.43	-58.4	120.83	50.95	35.18	11.5	35.2	100	325	P	H
	*	5795	111.4	-	-	99.83	35.23	11.56	35.22	100	325	P	H
	*	5795	103.86	-	-	92.29	35.23	11.56	35.22	100	325	A	H
		5850	62.31	-59.89	122.2	50.66	35.28	11.6	35.23	100	325	P	H
		5861.6	63.81	-45.14	108.95	52.11	35.29	11.65	35.24	100	325	P	H
		5878.4	61.19	-41.48	102.67	49.48	35.3	11.65	35.24	100	325	P	H
		5927.8	52.26	-15.94	68.2	40.47	35.34	11.69	35.24	100	325	P	H
802.11ac													H
VHT40													H
CH 159		5641.2	50.16	-18.04	68.2	38.81	35.11	11.43	35.19	104	249	P	V
5795MHz		5697.6	54.05	-49.38	103.43	42.64	35.15	11.46	35.2	104	249	P	V
		5716.4	57.83	-51.96	109.79	46.36	35.17	11.5	35.2	104	249	P	V
		5723.8	59.61	-59.85	119.46	48.13	35.18	11.5	35.2	104	249	P	V
	*	5795	110.55	-	-	98.98	35.23	11.56	35.22	104	249	P	V
	*	5795	102.79	-	-	91.22	35.23	11.56	35.22	104	249	A	V
		5852	63.96	-53.68	117.64	52.31	35.28	11.6	35.23	104	249	P	V
		5855.4	63.53	-47.16	110.69	51.87	35.29	11.6	35.23	104	249	P	V
		5886.4	58.45	-38.29	96.74	46.74	35.3	11.65	35.24	104	249	P	V
		5946	51.83	-16.37	68.2	39.98	35.36	11.74	35.25	104	249	P	V
													V
													V
Remark	1. No other spurious found. 2. All results are PASS against Peak and Average limit line.												



Band 4 5725~5850MHz

WIFI 802.11ac VHT40 (Harmonic @ 3m)

WIFI Ant. 1	Note	Frequency (MHz)	Level (dBμV/m)	Over Limit (dB)	Limit Line (dBμV/m)	Read Level (dBμV)	Antenna Factor (dB/m)	Path Loss (dB)	Preamp Factor (dB)	Ant Pos (cm)	Table Pos (deg)	Peak Avg. (P/A)	Pol. (H/V)
802.11ac VHT40 CH 151 5755MHz		11510	48.01	-25.99	74	48.82	38	18.49	57.3	100	0	P	H
		17265	52.07	-16.13	68.2	44.99	41	21.83	55.75	100	0	P	H
													H
													H
		11510	48.69	-25.31	74	49.5	38	18.49	57.3	100	0	P	V
		17265	51.91	-16.29	68.2	44.83	41	21.83	55.75	100	0	P	V
													V
													V
802.11ac VHT40 CH 159 5795MHz		11590	47.21	-26.79	74	47.72	38.08	18.59	57.18	100	0	P	H
		17385	51.72	-16.48	68.2	44.67	40.83	21.94	55.72	100	0	P	H
													H
													H
		11590	47.65	-26.35	74	48.16	38.08	18.59	57.18	100	0	P	V
		17385	52.7	-15.5	68.2	45.65	40.83	21.94	55.72	100	0	P	V
													V
													V
Remark	1. No other spurious found. 2. All results are PASS against Peak and Average limit line.												



Band 4 5725~5850MHz

WIFI 802.11ac VHT80 (Band Edge @ 3m)

WIFI Ant. 1	Note	Frequency (MHz)	Level (dBμV/m)	Over Limit (dB)	Limit Line (dBμV/m)	Read Level (dBμV)	Antenna Factor (dB/m)	Path Loss (dB)	Preamp Factor (dB)	Ant Pos (cm)	Table Pos (deg)	Peak Avg. (P/A)	Pol. (H/V)
		5645.8	57.94	-10.26	68.2	46.59	35.11	11.43	35.19	100	326	P	H
		5695.8	78.2	-23.9	102.1	66.79	35.15	11.46	35.2	100	326	P	H
		5719	84.29	-26.23	110.52	72.81	35.18	11.5	35.2	100	326	P	H
		5722.8	81.6	-35.58	117.18	70.12	35.18	11.5	35.2	100	326	P	H
	*	5775	108.54	-	-	97.01	35.22	11.53	35.22	100	326	P	H
	*	5775	101.16	-	-	89.63	35.22	11.53	35.22	100	326	A	H
		5853.6	79.25	-34.74	113.99	67.59	35.29	11.6	35.23	100	326	P	H
		5860.6	78.82	-30.41	109.23	67.12	35.29	11.65	35.24	100	326	P	H
		5879.2	73.49	-28.59	102.08	61.78	35.3	11.65	35.24	100	326	P	H
		5931.4	55.38	-12.82	68.2	43.59	35.34	11.69	35.24	100	326	P	H
802.11ac													H
VHT80													H
CH 155		5644	55.04	-13.16	68.2	43.69	35.11	11.43	35.19	100	248	P	V
5775MHz		5699.2	76.03	-28.58	104.61	64.62	35.15	11.46	35.2	100	248	P	V
		5718.8	82.16	-28.3	110.46	70.68	35.18	11.5	35.2	100	248	P	V
		5720.4	81.21	-30.5	111.71	69.73	35.18	11.5	35.2	100	248	P	V
	*	5775	107	-	-	95.47	35.22	11.53	35.22	100	248	P	V
	*	5775	99.52	-	-	87.99	35.22	11.53	35.22	100	248	A	V
		5851.2	79.09	-40.37	119.46	67.44	35.28	11.6	35.23	100	248	P	V
		5855.2	77.12	-33.62	110.74	65.46	35.29	11.6	35.23	100	248	P	V
		5875.6	71.55	-33.2	104.75	59.84	35.3	11.65	35.24	100	248	P	V
		5930	54.15	-14.05	68.2	42.36	35.34	11.69	35.24	100	248	P	V
													V
													V
Remark	1. No other spurious found. 2. All results are PASS against Peak and Average limit line.												



Band 4 5725~5850MHz

WIFI 802.11ac VHT80 (Harmonic @ 3m)

WIFI Ant. 1	Note	Frequency (MHz)	Level (dBμV/m)	Over Limit (dB)	Limit Line (dBμV/m)	Read Level (dBμV)	Antenna Factor (dB/m)	Path Loss (dB)	Preamp Factor (dB)	Ant Pos (cm)	Table Pos (deg)	Peak Avg. (P/A)	Pol. (H/V)	
802.11ac VHT80 CH 155 5775MHz		11550	47.46	-26.54	74	48.1	38.05	18.54	57.23	100	0	P	H	
		17325	51.28	-16.92	68.2	44.17	40.97	21.88	55.74	100	0	P	H	
													H	
													H	
			11550	47.6	-26.4	74	48.24	38.05	18.54	57.23	100	0	P	V
			17325	52.73	-15.47	68.2	45.62	40.97	21.88	55.74	100	0	P	V
														V
Remark	1. No other spurious found. 2. All results are PASS against Peak and Average limit line.													



Emission below 1GHz

5GHz WIFI 802.11ac VHT80 (LF @ 3m)

WIFI	Note	Frequency	Level	Over	Limit	Read	Antenna	Path	Preamp	Ant	Table	Peak	Pol.	
Ant.				Limit	Line	Level	Factor	Loss	Factor	Pos	Pos	Avg.		
1		(MHz)	(dBμV/m)	(dB)	(dBμV/m)	(dBμV)	(dB/m)	(dB)	(dB)	(cm)	(deg)	(P/A)	(H/V)	
5GHz 802.11ac VHT80 LF		30.27	21.22	-18.78	40	26.64	24.6	1.33	31.35			P	H	
		68.34	20.21	-19.79	40	37.86	12.24	1.7	31.59			P	H	
		137.19	35.06	-8.44	43.5	47.15	17.42	2.01	31.52	100	0	P	H	
		905.5	30.88	-15.12	46	27.59	28.85	4.96	30.52			P	H	
		934.9	31.22	-14.78	46	27.11	29.66	4.97	30.52			P	H	
		951	32.34	-13.66	46	27.41	30.39	5.05	30.51			P	H	
														H
														H
														H
														H
														H
														H
														H
														H
														H
			30	30.68	-9.32	40	36.1	24.6	1.33	31.35	100	0	P	V
			49.44	27.99	-12.01	40	43.6	14.66	1.34	31.61			P	V
			96.42	33.93	-9.57	43.5	48.42	15.33	1.74	31.56			P	V
			906.2	30.92	-15.08	46	27.63	28.85	4.96	30.52			P	V
			926.5	31.2	-14.8	46	27.39	29.36	4.97	30.52			P	V
		958	32.29	-13.71	46	26.95	30.8	5.05	30.51			P	V	
													V	
													V	
													V	
													V	
													V	
													V	
Remark	1. No other spurious found. 2. All results are PASS against limit line.													



Band 4 - 5725~5850MHz

WIFI 802.11a (Band Edge @ 3m)

WIFI	Note	Frequency	Level	Over	Limit	Read	Antenna	Path	Preamp	Ant	Table	Peak	Pol.	
Ant.				Limit	Line	Level	Factor	Loss	Factor	Pos	Pos	Avg.		
2		(MHz)	(dBμV/m)	(dB)	(dBμV/m)	(dBμV)	(dB/m)	(dB)	(dB)	(cm)	(deg)	(P/A)	(H/V)	
802.11a CH 149 5745MHz		5649.4	50.8	-17.4	68.2	39.45	35.11	11.43	35.19	100	162	P	H	
		5698.4	58.85	-45.17	104.02	47.44	35.15	11.46	35.2	100	162	P	H	
		5708.6	61.25	-46.36	107.61	49.78	35.17	11.5	35.2	100	162	P	H	
		5725	73.04	-49.16	122.2	61.56	35.18	11.5	35.2	100	162	P	H	
	*	5745	108.67	-	-	97.16	35.19	11.53	35.21	100	162	P	H	
	*	5745	101.41	-	-	89.9	35.19	11.53	35.21	100	162	A	H	
														H
														H
			5636.8	51.34	-16.86	68.2	39.99	35.11	11.43	35.19	100	282	P	V
			5678.6	57.86	-31.54	89.4	46.45	35.14	11.46	35.19	100	282	P	V
			5720	66.53	-44.27	110.8	55.05	35.18	11.5	35.2	100	282	P	V
			5725	79.51	-42.69	122.2	68.03	35.18	11.5	35.2	100	282	P	V
	*		5745	114.84	-	-	103.33	35.19	11.53	35.21	100	282	P	V
	*		5745	107.78	-	-	96.27	35.19	11.53	35.21	100	282	A	V
														V
														V



WIFI Ant. 2	Note	Frequency (MHz)	Level (dBμV/m)	Over Limit (dB)	Limit Line (dBμV/m)	Read Level (dBμV)	Antenna Factor (dB/m)	Path Loss (dB)	Preamp Factor (dB)	Ant Pos (cm)	Table Pos (deg)	Peak Avg. (P/A)	Pol. (H/V)
		5602.2	50.16	-18.04	68.2	38.86	35.08	11.4	35.18	100	160	P	H
		5658	50.67	-23.47	74.14	39.31	35.12	11.43	35.19	100	160	P	H
		5707.6	51.76	-55.57	107.33	40.29	35.17	11.5	35.2	100	160	P	H
		5721.8	52.97	-61.93	114.9	41.49	35.18	11.5	35.2	100	160	P	H
	*	5785	107.85	-	-	96.29	35.22	11.56	35.22	100	160	P	H
	*	5785	100.58	-	-	89.02	35.22	11.56	35.22	100	160	A	H
		5850.2	51.57	-70.17	121.74	39.92	35.28	11.6	35.23	100	160	P	H
		5860	52.76	-56.64	109.4	41.11	35.29	11.6	35.24	100	160	P	H
		5886.8	48.83	-47.61	96.44	37.12	35.3	11.65	35.24	100	160	P	H
		5940.8	49.55	-18.65	68.2	37.7	35.36	11.74	35.25	100	160	P	H
													H
													H
802.11a													
CH 157													
5785MHz		5609.6	50.37	-17.83	68.2	39.07	35.08	11.4	35.18	100	284	P	V
		5686.2	53.33	-41.69	95.02	41.92	35.15	11.46	35.2	100	284	P	V
		5715	58.75	-50.65	109.4	47.28	35.17	11.5	35.2	100	284	P	V
		5720.6	53.13	-59.04	112.17	41.65	35.18	11.5	35.2	100	284	P	V
	*	5785	114.81	-	-	103.25	35.22	11.56	35.22	100	284	P	V
	*	5785	107.46	-	-	95.9	35.22	11.56	35.22	100	284	A	V
		5852.8	52.53	-63.29	115.82	40.88	35.28	11.6	35.23	100	284	P	V
		5859.2	58.5	-51.12	109.62	46.85	35.29	11.6	35.24	100	284	P	V
		5884.6	55.35	-42.72	98.07	43.64	35.3	11.65	35.24	100	284	P	V
		5949.2	49.83	-18.37	68.2	37.98	35.36	11.74	35.25	100	284	P	V
													V
													V



WiFi Ant. 2	Note	Frequency (MHz)	Level (dBµV/m)	Over Limit (dB)	Limit Line (dBµV/m)	Read Level (dBµV)	Antenna Factor (dB/m)	Path Loss (dB)	Preamp Factor (dB)	Ant Pos (cm)	Table Pos (deg)	Peak Avg. (P/A)	Pol. (H/V)	
802.11a CH 165 5825MHz	*	5825	107.51	-	-	95.87	35.26	11.6	35.22	100	159	P	H	
	*	5825	100.15	-	-	88.51	35.26	11.6	35.22	100	159	A	H	
		5850.2	61.29	-60.45	121.74	49.64	35.28	11.6	35.23	100	159	P	H	
		5860.4	60.13	-49.16	109.29	48.43	35.29	11.65	35.24	100	159	P	H	
		5877	55.64	-48.07	103.71	43.93	35.3	11.65	35.24	100	159	P	H	
		5932.4	49.48	-18.72	68.2	37.69	35.34	11.69	35.24	100	159	P	H	
														H
														H
	*	5825	114.75	-	-	103.11	35.26	11.6	35.22	100	280	280	P	V
	*	5825	107.16	-	-	95.52	35.26	11.6	35.22	100	280	280	A	V
		5850.2	67.35	-54.39	121.74	55.7	35.28	11.6	35.23	100	280	280	P	V
		5858.8	65.95	-43.78	109.73	54.3	35.29	11.6	35.24	100	280	280	P	V
		5875.2	64.08	-40.97	105.05	52.37	35.3	11.65	35.24	100	280	280	P	V
		5926	52.03	-16.17	68.2	40.24	35.34	11.69	35.24	100	280	280	P	V
														V
														V
													V	
Remark	1. No other spurious found. 2. All results are PASS against Peak and Average limit line.													



Band 4 5725~5850MHz

WIFI 802.11a (Harmonic @ 3m)

WIFI Ant. 2	Note	Frequency (MHz)	Level (dBμV/m)	Over Limit (dB)	Limit Line (dBμV/m)	Read Level (dBμV)	Antenna Factor (dB/m)	Path Loss (dB)	Preamp Factor (dB)	Ant Pos (cm)	Table Pos (deg)	Peak Avg. (P/A)	Pol. (H/V)
802.11a CH 149 5745MHz		11490	47.78	-26.22	74	48.7	37.98	18.44	57.34	100	0	P	H
		17235	51.35	-16.85	68.2	44.3	41	21.8	55.75	100	0	P	H
													H
													H
		11490	47.85	-26.15	74	48.77	37.98	18.44	57.34	100	0	P	V
		17235	51.45	-16.75	68.2	44.4	41	21.8	55.75	100	0	P	V
													V
													V
802.11a CH 157 5785MHz		11570	47.02	-26.98	74	47.61	38.07	18.54	57.2	100	0	P	H
		17350	52.6	-15.6	68.2	45.52	40.9	21.91	55.73	100	0	P	H
													H
													H
		11570	46.93	-27.07	74	47.52	38.07	18.54	57.2	100	0	P	V
		17350	53.05	-15.15	68.2	45.97	40.9	21.91	55.73	100	0	P	V
													V
													V
802.11a CH 165 5825MHz		11650	47.69	-26.31	74	47.98	38.18	18.64	57.11	100	0	P	H
		17475	51.73	-16.47	68.2	44.76	40.67	22.01	55.71	100	0	P	H
													H
													H
		11650	47.89	-26.11	74	48.18	38.18	18.64	57.11	100	0	P	V
		17475	51.94	-16.26	68.2	44.97	40.67	22.01	55.71	100	0	P	V
													V
													V
Remark	1. No other spurious found. 2. All results are PASS against Peak and Average limit line.												



Band 4 5725~5850MHz

WIFI 802.11ac VHT20 (Band Edge @ 3m)

WIFI Ant. 2	Note	Frequency (MHz)	Level (dBμV/m)	Over Limit (dB)	Limit Line (dBμV/m)	Read Level (dBμV)	Antenna Factor (dB/m)	Path Loss (dB)	Preamp Factor (dB)	Ant Pos (cm)	Table Pos (deg)	Peak Avg. (P/A)	Pol. (H/V)	
802.11ac VHT20 CH 149 5745MHz		5629.6	50.31	-17.89	68.2	38.97	35.1	11.43	35.19	100	161	P	H	
		5697.2	56.71	-46.43	103.14	45.3	35.15	11.46	35.2	100	161	P	H	
		5719.4	63.74	-46.89	110.63	52.26	35.18	11.5	35.2	100	161	P	H	
		5725	73.32	-48.88	122.2	61.84	35.18	11.5	35.2	100	161	P	H	
	*	5745	108.26	-	-	96.75	35.19	11.53	35.21	100	161	P	H	
	*	5745	100.94	-	-	89.43	35.19	11.53	35.21	100	161	A	H	
														H
														H
			5641	50.44	-17.76	68.2	39.09	35.11	11.43	35.19	100	283	P	V
			5694.2	63.33	-37.59	100.92	51.92	35.15	11.46	35.2	100	283	P	V
			5720	70.32	-40.48	110.8	58.84	35.18	11.5	35.2	100	283	P	V
			5724.2	78.82	-41.56	120.38	67.34	35.18	11.5	35.2	100	283	P	V
	*		5745	114.67	-	-	103.16	35.19	11.53	35.21	100	283	P	V
	*		5745	107.21	-	-	95.7	35.19	11.53	35.21	100	283	A	V
														V
													V	



WIFI Ant. 2	Note	Frequency (MHz)	Level (dBμV/m)	Over Limit (dB)	Limit Line (dBμV/m)	Read Level (dBμV)	Antenna Factor (dB/m)	Path Loss (dB)	Preamp Factor (dB)	Ant Pos (cm)	Table Pos (deg)	Peak Avg. (P/A)	Pol. (H/V)
		5616.8	50.32	-17.88	68.2	39	35.1	11.4	35.18	100	160	P	H
		5685.2	50.02	-44.26	94.28	38.61	35.15	11.46	35.2	100	160	P	H
		5708.6	50.84	-56.77	107.61	39.37	35.17	11.5	35.2	100	160	P	H
		5723.2	55.86	-62.24	118.1	44.38	35.18	11.5	35.2	100	160	P	H
	*	5785	107.81	-	-	96.25	35.22	11.56	35.22	100	160	P	H
	*	5785	100.15	-	-	88.59	35.22	11.56	35.22	100	160	A	H
		5853.4	52.64	-61.81	114.45	40.99	35.28	11.6	35.23	100	160	P	H
		5855.6	49.49	-61.14	110.63	37.83	35.29	11.6	35.23	100	160	P	H
		5914.6	49.19	-26.68	75.87	37.41	35.33	11.69	35.24	100	160	P	H
		5925.8	49.08	-19.12	68.2	37.29	35.34	11.69	35.24	100	160	P	H
802.11ac													H
VHT20													H
CH 157		5609.8	50.55	-17.65	68.2	39.25	35.08	11.4	35.18	107	282	P	V
5785MHz		5688.4	52.98	-43.66	96.64	41.57	35.15	11.46	35.2	107	282	P	V
		5708.4	56.58	-50.97	107.55	45.11	35.17	11.5	35.2	107	282	P	V
		5723	59.9	-57.74	117.64	48.42	35.18	11.5	35.2	107	282	P	V
	*	5785	114.97	-	-	103.41	35.22	11.56	35.22	107	282	P	V
	*	5785	107.26	-	-	95.7	35.22	11.56	35.22	107	282	A	V
		5852.4	59.77	-56.96	116.73	48.12	35.28	11.6	35.23	107	282	P	V
		5865.6	57.29	-50.54	107.83	45.59	35.29	11.65	35.24	107	282	P	V
		5894.6	53.54	-37.12	90.66	41.81	35.32	11.65	35.24	107	282	P	V
		5939	50.31	-17.89	68.2	38.51	35.36	11.69	35.25	107	282	P	V
													V
													V



WiFi Ant. 2	Note	Frequency (MHz)	Level (dBμV/m)	Over Limit (dB)	Limit Line (dBμV/m)	Read Level (dBμV)	Antenna Factor (dB/m)	Path Loss (dB)	Preamp Factor (dB)	Ant Pos (cm)	Table Pos (deg)	Peak Avg. (P/A)	Pol. (H/V)	
802.11ac VHT20 CH 165 5825MHz	*	5825	107.19	-	-	95.55	35.26	11.6	35.22	100	160	P	H	
	*	5825	99.56	-	-	87.92	35.26	11.6	35.22	100	160	A	H	
		5850	63.25	-58.95	122.2	51.6	35.28	11.6	35.23	100	160	P	H	
		5857	57.87	-52.37	110.24	46.21	35.29	11.6	35.23	100	160	P	H	
		5889	54.6	-40.21	94.81	42.87	35.32	11.65	35.24	100	160	P	H	
		5935.2	50.33	-17.87	68.2	38.55	35.34	11.69	35.25	100	160	P	H	
														H
														H
	*	5825	114.39	-	-	102.75	35.26	11.6	35.22	100	280	280	P	V
	*	5825	106.73	-	-	95.09	35.26	11.6	35.22	100	280	280	A	V
		5850.2	73.81	-47.93	121.74	62.16	35.28	11.6	35.23	100	280	280	P	V
		5857	67.18	-43.06	110.24	55.52	35.29	11.6	35.23	100	280	280	P	V
		5875.6	62.54	-42.21	104.75	50.83	35.3	11.65	35.24	100	280	280	P	V
		5931	51.15	-17.05	68.2	39.36	35.34	11.69	35.24	100	280	280	P	V
														V
													V	
Remark	1. No other spurious found. 2. All results are PASS against Peak and Average limit line.													



Band 4 5725~5850MHz

WIFI 802.11ac VHT20 (Harmonic @ 3m)

WIFI Ant. 2	Note	Frequency (MHz)	Level (dBµV/m)	Over Limit (dB)	Limit Line (dBµV/m)	Read Level (dBµV)	Antenna Factor (dB/m)	Path Loss (dB)	Preamp Factor (dB)	Ant Pos (cm)	Table Pos (deg)	Peak Avg. (P/A)	Pol. (H/V)	
802.11ac VHT20 CH 149 5745MHz		11490	48.88	-25.12	74	49.8	37.98	18.44	57.34	100	0	P	H	
		17235	51.06	-17.14	68.2	44.01	41	21.8	55.75	100	0	P	H	
													H	
													H	
			11490	48.26	-25.74	74	49.18	37.98	18.44	57.34	100	0	P	V
			17235	51.01	-17.19	68.2	43.96	41	21.8	55.75	100	0	P	V
														V
802.11ac VHT20 CH 157 5785MHz		11570	46.99	-27.01	74	47.58	38.07	18.54	57.2	100	0	P	H	
		17355	52.57	-15.63	68.2	45.49	40.9	21.91	55.73	100	0	P	H	
													H	
													H	
			11570	47.91	-26.09	74	48.5	38.07	18.54	57.2	100	0	P	V
			17355	52.14	-16.06	68.2	45.06	40.9	21.91	55.73	100	0	P	V
														V
802.11ac VHT20 CH 165 5825MHz		11650	48.24	-25.76	74	48.53	38.18	18.64	57.11	100	0	P	H	
		17475	51.81	-16.39	68.2	44.84	40.67	22.01	55.71	100	0	P	H	
													H	
													H	
			11650	47.66	-26.34	74	47.95	38.18	18.64	57.11	100	0	P	V
			17475	52.38	-15.82	68.2	45.41	40.67	22.01	55.71	100	0	P	V
														V
Remark	1. No other spurious found.													
	2. All results are PASS against Peak and Average limit line.													



Band 4 5725~5850MHz

WIFI 802.11ac VHT40 (Band Edge @ 3m)

WIFI Ant. 2	Note	Frequency (MHz)	Level (dBμV/m)	Over Limit (dB)	Limit Line (dBμV/m)	Read Level (dBμV)	Antenna Factor (dB/m)	Path Loss (dB)	Preamp Factor (dB)	Ant Pos (cm)	Table Pos (deg)	Peak Avg. (P/A)	Pol. (H/V)
		5645	50.91	-17.29	68.2	39.56	35.11	11.43	35.19	100	160	P	H
		5695.8	60.25	-41.85	102.1	48.84	35.15	11.46	35.2	100	160	P	H
		5718.8	74.75	-35.71	110.46	63.27	35.18	11.5	35.2	100	160	P	H
		5725	77.4	-44.8	122.2	65.92	35.18	11.5	35.2	100	160	P	H
	*	5755	106.23	-	-	94.7	35.21	11.53	35.21	100	160	P	H
	*	5755	98.27	-	-	86.74	35.21	11.53	35.21	100	160	A	H
		5853	51.42	-63.94	115.36	39.77	35.28	11.6	35.23	100	160	P	H
		5874	49.94	-55.54	105.48	38.23	35.3	11.65	35.24	100	160	P	H
		5877.6	50.39	-52.88	103.27	38.68	35.3	11.65	35.24	100	160	P	H
		5944.6	49.28	-18.92	68.2	37.43	35.36	11.74	35.25	100	160	P	H
802.11ac													H
VHT40													H
CH 151		5647.6	51.96	-16.24	68.2	40.61	35.11	11.43	35.19	102	284	P	V
5755MHz		5699	64.13	-40.33	104.46	52.72	35.15	11.46	35.2	102	284	P	V
		5717.2	80.33	-29.69	110.02	68.86	35.17	11.5	35.2	102	284	P	V
		5722	83.3	-32.06	115.36	71.82	35.18	11.5	35.2	102	284	P	V
	*	5755	112.71	-	-	101.18	35.21	11.53	35.21	102	284	P	V
	*	5755	104.84	-	-	93.31	35.21	11.53	35.21	102	284	A	V
		5854.4	51.85	-60.32	112.17	40.19	35.29	11.6	35.23	102	284	P	V
		5860.8	56.93	-52.24	109.17	45.23	35.29	11.65	35.24	102	284	P	V
		5875.2	54.28	-50.77	105.05	42.57	35.3	11.65	35.24	102	284	P	V
		5927.8	49.77	-18.43	68.2	37.98	35.34	11.69	35.24	102	284	P	V
													V
													V



WIFI Ant. 2	Note	Frequency (MHz)	Level (dBμV/m)	Over Limit (dB)	Limit Line (dBμV/m)	Read Level (dBμV)	Antenna Factor (dB/m)	Path Loss (dB)	Preamp Factor (dB)	Ant Pos (cm)	Table Pos (deg)	Peak Avg. (P/A)	Pol. (H/V)
		5636.4	49.63	-18.57	68.2	38.28	35.11	11.43	35.19	100	177	P	H
		5698.6	50.9	-53.27	104.17	39.49	35.15	11.46	35.2	100	177	P	H
		5716.4	55.26	-54.53	109.79	43.79	35.17	11.5	35.2	100	177	P	H
		5721.4	54.78	-59.21	113.99	43.3	35.18	11.5	35.2	100	177	P	H
	*	5795	105.91	-	-	94.34	35.23	11.56	35.22	100	177	P	H
	*	5795	98.09	-	-	86.52	35.23	11.56	35.22	100	177	A	H
		5850	57.24	-64.96	122.2	45.59	35.28	11.6	35.23	100	177	P	H
		5857.6	57.25	-52.82	110.07	45.59	35.29	11.6	35.23	100	177	P	H
		5879.4	52.44	-49.49	101.93	40.73	35.3	11.65	35.24	100	177	P	H
		5928	49.71	-18.49	68.2	37.92	35.34	11.69	35.24	100	177	P	H
802.11ac													H
VHT40													H
CH 159		5609.8	50.48	-17.72	68.2	39.18	35.08	11.4	35.18	100	280	P	V
5795MHz		5681.2	54.21	-37.12	91.33	42.81	35.14	11.46	35.2	100	280	P	V
		5714	59.94	-49.18	109.12	48.47	35.17	11.5	35.2	100	280	P	V
		5722.6	59.56	-57.17	116.73	48.08	35.18	11.5	35.2	100	280	P	V
	*	5795	113.29	-	-	101.72	35.23	11.56	35.22	100	280	P	V
	*	5795	104.85	-	-	93.28	35.23	11.56	35.22	100	280	A	V
		5851.6	65.38	-53.17	118.55	53.73	35.28	11.6	35.23	100	280	P	V
		5856.8	66.02	-44.28	110.3	54.36	35.29	11.6	35.23	100	280	P	V
		5876.6	60.59	-43.42	104.01	48.88	35.3	11.65	35.24	100	280	P	V
		5927	50.46	-17.74	68.2	38.67	35.34	11.69	35.24	100	280	P	V
													V
													V
Remark	1. No other spurious found. 2. All results are PASS against Peak and Average limit line.												



Band 4 5725~5850MHz

WIFI 802.11ac VHT40 (Harmonic @ 3m)

WIFI Ant. 2	Note	Frequency (MHz)	Level (dBµV/m)	Over Limit (dB)	Limit Line (dBµV/m)	Read Level (dBµV)	Antenna Factor (dB/m)	Path Loss (dB)	Preamp Factor (dB)	Ant Pos (cm)	Table Pos (deg)	Peak Avg. (P/A)	Pol. (H/V)	
802.11ac VHT40 CH 151 5755MHz		11510	48.11	-25.89	74	48.92	38	18.49	57.3	100	0	P	H	
		17265	51.47	-16.73	68.2	44.39	41	21.83	55.75	100	0	P	H	
													H	
													H	
			11510	48.63	-25.37	74	49.44	38	18.49	57.3	100	0	P	V
			17265	51.35	-16.85	68.2	44.27	41	21.83	55.75	100	0	P	V
														V
														V
802.11ac VHT40 CH 159 5795MHz		11590	47.07	-26.93	74	47.58	38.08	18.59	57.18	100	0	P	H	
		17385	52.47	-15.73	68.2	45.42	40.83	21.94	55.72	100	0	P	H	
													H	
													H	
			11590	46.55	-27.45	74	47.06	38.08	18.59	57.18	100	0	P	V
			17385	52.71	-15.49	68.2	45.66	40.83	21.94	55.72	100	0	P	V
														V
														V
Remark	1. No other spurious found. 2. All results are PASS against Peak and Average limit line.													



Band 4 5725~5850MHz

WIFI 802.11ac VHT80 (Band Edge @ 3m)

WIFI Ant. 2	Note	Frequency (MHz)	Level (dBμV/m)	Over Limit (dB)	Limit Line (dBμV/m)	Read Level (dBμV)	Antenna Factor (dB/m)	Path Loss (dB)	Preamp Factor (dB)	Ant Pos (cm)	Table Pos (deg)	Peak Avg. (P/A)	Pol. (H/V)
		5637.4	50.87	-17.33	68.2	39.52	35.11	11.43	35.19	100	160	P	H
		5698.6	69.74	-34.43	104.17	58.33	35.15	11.46	35.2	100	160	P	H
		5718.6	75.02	-35.39	110.41	63.54	35.18	11.5	35.2	100	160	P	H
		5723.8	73.61	-45.85	119.46	62.13	35.18	11.5	35.2	100	160	P	H
	*	5775	102.54	-	-	91.01	35.22	11.53	35.22	100	160	P	H
	*	5775	95.01	-	-	83.48	35.22	11.53	35.22	100	160	A	H
		5851.2	72.04	-47.42	119.46	60.39	35.28	11.6	35.23	100	160	P	H
		5860.6	70.36	-38.87	109.23	58.66	35.29	11.65	35.24	100	160	P	H
		5877.2	65	-38.57	103.57	53.29	35.3	11.65	35.24	100	160	P	H
		5927	49.96	-18.24	68.2	38.17	35.34	11.69	35.24	100	160	P	H
802.11ac													H
VHT80													H
CH 155		5639.8	54.18	-14.02	68.2	42.83	35.11	11.43	35.19	100	283	P	V
5775MHz		5699	75.72	-28.74	104.46	64.31	35.15	11.46	35.2	100	283	P	V
		5720	81.48	-29.32	110.8	70	35.18	11.5	35.2	100	283	P	V
		5720.2	82.06	-29.2	111.26	70.58	35.18	11.5	35.2	100	283	P	V
	*	5775	109.03	-	-	97.5	35.22	11.53	35.22	100	283	P	V
	*	5775	101.69	-	-	90.16	35.22	11.53	35.22	100	283	A	V
		5852.2	78.3	-38.88	117.18	66.65	35.28	11.6	35.23	100	283	P	V
		5856.2	77.06	-33.4	110.46	65.4	35.29	11.6	35.23	100	283	P	V
		5875.8	70.21	-34.4	104.61	58.5	35.3	11.65	35.24	100	283	P	V
		5927.4	54.02	-14.18	68.2	42.23	35.34	11.69	35.24	100	283	P	V
													V
													V
Remark	1. No other spurious found. 2. All results are PASS against Peak and Average limit line.												



Band 4 5725~5850MHz

WIFI 802.11ac VHT80 (Harmonic @ 3m)

WIFI Ant. 2	Note	Frequency (MHz)	Level (dBμV/m)	Over Limit (dB)	Limit Line (dBμV/m)	Read Level (dBμV)	Antenna Factor (dB/m)	Path Loss (dB)	Preamp Factor (dB)	Ant Pos (cm)	Table Pos (deg)	Peak Avg. (P/A)	Pol. (H/V)	
802.11ac VHT80 CH 155 5775MHz		11550	46.91	-27.09	74	47.55	38.05	18.54	57.23	100	0	P	H	
		17325	51.86	-16.34	68.2	44.75	40.97	21.88	55.74	100	0	P	H	
													H	
													H	
			11550	47.59	-26.41	74	48.23	38.05	18.54	57.23	100	0	P	V
			17325	52.11	-16.09	68.2	45	40.97	21.88	55.74	100	0	P	V
														V
Remark	1. No other spurious found. 2. All results are PASS against Peak and Average limit line.													



Emission below 1GHz

5GHz WIFI 802.11ac VHT80 (LF @ 3m)

WIFI	Note	Frequency	Level	Over	Limit	Read	Antenna	Path	Preamp	Ant	Table	Peak	Pol.	
Ant.				Limit	Line	Level	Factor	Loss	Factor	Pos	Pos	Avg.		
2		(MHz)	(dBμV/m)	(dB)	(dBμV/m)	(dBμV)	(dB/m)	(dB)	(dB)	(cm)	(deg)	(P/A)	(H/V)	
5GHz 802.11ac VHT80 LF		30.27	22.14	-17.86	40	27.56	24.6	1.33	31.35	-	-	P	H	
		140.7	34.9	-8.6	43.5	46.78	17.4	2.24	31.52	100	0	P	H	
		290.82	28.61	-17.39	46	38.09	18.97	2.86	31.31	-	-	P	H	
		848.8	31.38	-14.62	46	28.47	28.73	4.74	30.56	-	-	P	H	
		930.7	31.37	-14.63	46	27.39	29.53	4.97	30.52	-	-	P	H	
		953.1	32.42	-13.58	46	27.34	30.54	5.05	30.51	-	-	P	H	
														H
														H
														H
														H
														H
														H
														H
														H
														H
			30	31.2	-8.8	40	36.62	24.6	1.33	31.35	100	0	P	V
			80.76	28.5	-11.5	40	45.08	13.28	1.72	31.58	-	-	P	V
			97.23	33.85	-9.65	43.5	48.22	15.45	1.74	31.56	-	-	P	V
		855.1	30.85	-15.15	46	27.75	28.91	4.74	30.55	-	-	P	V	
		890.8	30.7	-15.3	46	27.53	28.81	4.89	30.53	-	-	P	V	
		947.5	31.73	-14.27	46	26.97	30.23	5.05	30.52	-	-	P	V	
													V	
													V	
													V	
													V	
													V	
													V	
Remark	1. No other spurious found. 2. All results are PASS against limit line.													



Band 4 - 5725~5850MHz

WIFI 802.11a (Band Edge @ 3m)

WIFI Ant. 1+2	Note	Frequency (MHz)	Level (dBμV/m)	Over Limit (dB)	Limit Line (dBμV/m)	Read Level (dBμV)	Antenna Factor (dB/m)	Path Loss (dB)	Preamp Factor (dB)	Ant Pos (cm)	Table Pos (deg)	Peak Avg. (P/A)	Pol. (H/V)	
802.11a CH 149 5745MHz		5649.6	53.88	-14.32	68.2	42.52	35.12	11.43	35.19	100	307	P	H	
		5697.2	64.08	-39.06	103.14	52.67	35.15	11.46	35.2	100	307	P	H	
		5719.6	75.15	-35.54	110.69	63.67	35.18	11.5	35.2	100	307	P	H	
		5723.6	86.61	-32.4	119.01	75.13	35.18	11.5	35.2	100	307	P	H	
	*	5745	119.14	-	-	107.63	35.19	11.53	35.21	100	307	P	H	
	*	5745	111.45	-	-	99.94	35.19	11.53	35.21	100	307	A	H	
														H
														H
			5637.2	50.03	-18.17	68.2	38.68	35.11	11.43	35.19	100	54	P	V
			5693.8	61.96	-38.67	100.63	50.55	35.15	11.46	35.2	100	54	P	V
			5720	72.27	-38.53	110.8	60.79	35.18	11.5	35.2	100	54	P	V
			5725	83.57	-38.63	122.2	72.09	35.18	11.5	35.2	100	54	P	V
	*		5745	114.72	-	-	103.21	35.19	11.53	35.21	100	54	P	V
	*		5745	107.81	-	-	96.3	35.19	11.53	35.21	100	54	A	V
														V
														V



WIFI Ant. 1+2	Note	Frequency (MHz)	Level (dBμV/m)	Over Limit (dB)	Limit Line (dBμV/m)	Read Level (dBμV)	Antenna Factor (dB/m)	Path Loss (dB)	Preamp Factor (dB)	Ant Pos (cm)	Table Pos (deg)	Peak Avg. (P/A)	Pol. (H/V)	
802.11a CH 157 5785MHz		5649.4	51.16	-17.04	68.2	39.81	35.11	11.43	35.19	100	298	P	H	
		5698.8	55.05	-49.27	104.32	43.64	35.15	11.46	35.2	100	298	P	H	
		5719.8	61.38	-49.36	110.74	49.9	35.18	11.5	35.2	100	298	P	H	
		5723.8	60.74	-58.72	119.46	49.26	35.18	11.5	35.2	100	298	P	H	
	*	5785	119.66	-	-	108.1	35.22	11.56	35.22	100	298	P	H	
	*	5785	112.44	-	-	100.88	35.22	11.56	35.22	100	298	A	H	
		5850.2	62.07	-59.67	121.74	50.42	35.28	11.6	35.23	100	298	P	H	
		5857.2	60.62	-49.56	110.18	48.96	35.29	11.6	35.23	100	298	P	H	
		5877.8	54.54	-48.58	103.12	42.83	35.3	11.65	35.24	100	298	P	H	
		5939.4	51.53	-16.67	68.2	39.73	35.36	11.69	35.25	100	298	P	H	
														H
														H
			5628.2	50.43	-17.77	68.2	39.08	35.1	11.43	35.18	100	57	P	V
			5699.2	54.39	-50.22	104.61	42.98	35.15	11.46	35.2	100	57	P	V
			5714.2	57.99	-51.19	109.18	46.52	35.17	11.5	35.2	100	57	P	V
			5725	59.84	-62.36	122.2	48.36	35.18	11.5	35.2	100	57	P	V
	*		5785	116.18	-	-	104.62	35.22	11.56	35.22	100	57	P	V
	*		5785	109.22	-	-	97.66	35.22	11.56	35.22	100	57	A	V
			5850.4	52.84	-68.45	121.29	41.19	35.28	11.6	35.23	100	57	P	V
			5864	58.69	-49.59	108.28	46.99	35.29	11.65	35.24	100	57	P	V
		5885.8	54.71	-42.47	97.18	43	35.3	11.65	35.24	100	57	P	V	
		5947.4	49.28	-18.92	68.2	37.43	35.36	11.74	35.25	100	57	P	V	
													V	
													V	



WiFi Ant. 1+2	Note	Frequency (MHz)	Level (dBµV/m)	Over Limit (dB)	Limit Line (dBµV/m)	Read Level (dBµV)	Antenna Factor (dB/m)	Path Loss (dB)	Preamp Factor (dB)	Ant Pos (cm)	Table Pos (deg)	Peak Avg. (P/A)	Pol. (H/V)	
802.11a CH 165 5825MHz	*	5825	118.67	-	-	107.03	35.26	11.6	35.22	100	300	P	H	
	*	5825	111.41	-	-	99.77	35.26	11.6	35.22	100	300	A	H	
		5850	78.38	-43.82	122.2	66.73	35.28	11.6	35.23	100	300	P	H	
		5855	65.46	-45.34	110.8	53.8	35.29	11.6	35.23	100	300	P	H	
		5876.6	62.76	-41.25	104.01	51.05	35.3	11.65	35.24	100	300	P	H	
		5931.2	51.86	-16.34	68.2	40.07	35.34	11.69	35.24	100	300	P	H	
														H
														H
	*	5825	115.76	-	-	104.12	35.26	11.6	35.22	100	54	54	P	V
	*	5825	108.6	-	-	96.96	35.26	11.6	35.22	100	54	54	A	V
		5850.6	73.22	-47.61	120.83	61.57	35.28	11.6	35.23	100	54	54	P	V
		5860.4	67.43	-41.86	109.29	55.73	35.29	11.65	35.24	100	54	54	P	V
		5887.2	61.76	-34.38	96.14	50.05	35.3	11.65	35.24	100	54	54	P	V
		5928.8	52.15	-16.05	68.2	40.36	35.34	11.69	35.24	100	54	54	P	V
														V
														V
													V	
Remark	1. No other spurious found. 2. All results are PASS against Peak and Average limit line.													



Band 4 5725~5850MHz

WIFI 802.11a (Harmonic @ 3m)

WIFI Ant. 1+2	Note	Frequency (MHz)	Level (dBμV/m)	Over Limit (dB)	Limit Line (dBμV/m)	Read Level (dBμV)	Antenna Factor (dB/m)	Path Loss (dB)	Preamp Factor (dB)	Ant Pos (cm)	Table Pos (deg)	Peak Avg. (P/A)	Pol. (H/V)
802.11a CH 149 5745MHz		11490	47.16	-26.84	74	48.08	37.98	18.44	57.34	100	0	P	H
		17235	49.68	-18.52	68.2	42.63	41	21.8	55.75	100	0	P	H
													H
													H
		11490	47.79	-26.21	74	48.71	37.98	18.44	57.34	100	0	P	V
		17235	50.51	-17.69	68.2	43.46	41	21.8	55.75	100	0	P	V
													V
													V
802.11a CH 157 5785MHz		11570	46.64	-27.36	74	47.23	38.07	18.54	57.2	100	0	P	H
		17355	51.02	-17.18	68.2	43.94	40.9	21.91	55.73	100	0	P	H
													H
													H
		11570	49.85	-24.15	74	50.44	38.07	18.54	57.2	100	0	P	V
		17355	50.91	-17.29	68.2	43.83	40.9	21.91	55.73	100	0	P	V
													V
													V
802.11a CH 165 5825MHz		11650	47.99	-26.01	74	48.28	38.18	18.64	57.11	100	0	P	H
		17475	50.9	-17.3	68.2	43.93	40.67	22.01	55.71	100	0	P	H
													H
													H
		11650	49.35	-24.65	74	49.64	38.18	18.64	57.11	100	0	P	V
		17475	51.4	-16.8	68.2	44.43	40.67	22.01	55.71	100	0	P	V
													V
													V
Remark	1. No other spurious found. 2. All results are PASS against Peak and Average limit line.												



Band 4 5725~5850MHz

WIFI 802.11ac VHT20 (Band Edge @ 3m)

WIFI Ant. 1+2	Note	Frequency (MHz)	Level (dBμV/m)	Over Limit (dB)	Limit Line (dBμV/m)	Read Level (dBμV)	Antenna Factor (dB/m)	Path Loss (dB)	Preamp Factor (dB)	Ant Pos (cm)	Table Pos (deg)	Peak Avg. (P/A)	Pol. (H/V)	
802.11ac VHT20 CH 149 5745MHz		5642.2	50.71	-17.49	68.2	39.36	35.11	11.43	35.19	100	306	P	H	
		5699.6	62.9	-42.01	104.91	51.49	35.15	11.46	35.2	100	306	P	H	
		5714	72.72	-36.4	109.12	61.25	35.17	11.5	35.2	100	306	P	H	
		5725	83.55	-38.65	122.2	72.07	35.18	11.5	35.2	100	306	P	H	
	*	5745	118.53	-	-	107.02	35.19	11.53	35.21	100	306	P	H	
	*	5745	110.68	-	-	99.17	35.19	11.53	35.21	100	306	A	H	
														H
														H
			5619.4	50.62	-17.58	68.2	39.3	35.1	11.4	35.18	100	58	P	V
			5699.8	58.57	-46.48	105.05	47.16	35.15	11.46	35.2	100	58	P	V
			5719.6	77.18	-33.51	110.69	65.7	35.18	11.5	35.2	100	58	P	V
			5721.2	81.81	-31.73	113.54	70.33	35.18	11.5	35.2	100	58	P	V
	*		5745	114.41	-	-	102.9	35.19	11.53	35.21	100	58	P	V
	*		5745	106.65	-	-	95.14	35.19	11.53	35.21	100	58	A	V
													V	
													V	



WIFI Ant. 1+2	Note	Frequency (MHz)	Level (dBμV/m)	Over Limit (dB)	Limit Line (dBμV/m)	Read Level (dBμV)	Antenna Factor (dB/m)	Path Loss (dB)	Preamp Factor (dB)	Ant Pos (cm)	Table Pos (deg)	Peak Avg. (P/A)	Pol. (H/V)
		5645	50.51	-17.69	68.2	39.16	35.11	11.43	35.19	100	298	P	H
		5695.8	55.98	-46.12	102.1	44.57	35.15	11.46	35.2	100	298	P	H
		5718.8	59.91	-50.55	110.46	48.43	35.18	11.5	35.2	100	298	P	H
		5720.6	59.91	-52.26	112.17	48.43	35.18	11.5	35.2	100	298	P	H
	*	5785	119.03	-	-	107.47	35.22	11.56	35.22	100	298	P	H
	*	5785	111.39	-	-	99.83	35.22	11.56	35.22	100	298	A	H
		5850.4	61.58	-59.71	121.29	49.93	35.28	11.6	35.23	100	298	P	H
		5857.2	59.53	-50.65	110.18	47.87	35.29	11.6	35.23	100	298	P	H
		5876	55.86	-48.6	104.46	44.15	35.3	11.65	35.24	100	298	P	H
		5931.6	50.04	-18.16	68.2	38.25	35.34	11.69	35.24	100	298	P	H
802.11ac													H
VHT20													H
CH 157		5610	50.59	-17.61	68.2	39.29	35.08	11.4	35.18	100	54	P	V
5785MHz		5696.2	55.35	-47.05	102.4	43.94	35.15	11.46	35.2	100	54	P	V
		5719.2	59.35	-51.23	110.58	47.87	35.18	11.5	35.2	100	54	P	V
		5724.2	60.22	-60.16	120.38	48.74	35.18	11.5	35.2	100	54	P	V
	*	5785	116.19	-	-	104.63	35.22	11.56	35.22	100	54	P	V
	*	5785	109.05	-	-	97.49	35.22	11.56	35.22	100	54	A	V
		5850	52.08	-70.12	122.2	40.43	35.28	11.6	35.23	100	54	P	V
		5855.6	61.06	-49.57	110.63	49.4	35.29	11.6	35.23	100	54	P	V
		5880.2	54.94	-46.4	101.34	43.23	35.3	11.65	35.24	100	54	P	V
		5937.6	49.89	-18.31	68.2	38.11	35.34	11.69	35.25	100	54	P	V
													V
													V



WiFi Ant. 1+2	Note	Frequency (MHz)	Level (dBμV/m)	Over Limit (dB)	Limit Line (dBμV/m)	Read Level (dBμV)	Antenna Factor (dB/m)	Path Loss (dB)	Preamp Factor (dB)	Ant Pos (cm)	Table Pos (deg)	Peak Avg. (P/A)	Pol. (H/V)	
802.11ac VHT20 CH 165 5825MHz	*	5825	118.37	-	-	106.73	35.26	11.6	35.22	100	326	P	H	
	*	5825	110.85	-	-	99.21	35.26	11.6	35.22	100	326	A	H	
		5850	79.31	-42.89	122.2	67.66	35.28	11.6	35.23	100	326	P	H	
		5857	68.62	-41.62	110.24	56.96	35.29	11.6	35.23	100	326	P	H	
		5876.2	65.29	-39.02	104.31	53.58	35.3	11.65	35.24	100	326	P	H	
		5939.2	51	-17.2	68.2	39.2	35.36	11.69	35.25	100	326	P	H	
														H
														H
	*	5825	115.92	-	-	104.28	35.26	11.6	35.22	100	52	52	P	V
	*	5825	108.31	-	-	96.67	35.26	11.6	35.22	100	52	52	A	V
		5850	77.02	-45.18	122.2	65.37	35.28	11.6	35.23	100	52	52	P	V
		5861	68.33	-40.79	109.12	56.63	35.29	11.65	35.24	100	52	52	P	V
		5877.8	63.82	-39.3	103.12	52.11	35.3	11.65	35.24	100	52	52	P	V
		5935.2	51.6	-16.6	68.2	39.82	35.34	11.69	35.25	100	52	52	P	V
														V
													V	
Remark	1. No other spurious found. 2. All results are PASS against Peak and Average limit line.													



Band 4 5725~5850MHz

WIFI 802.11ac VHT20 (Harmonic @ 3m)

WIFI Ant. 1+2	Note	Frequency (MHz)	Level (dBμV/m)	Over Limit (dB)	Limit Line (dBμV/m)	Read Level (dBμV)	Antenna Factor (dB/m)	Path Loss (dB)	Preamp Factor (dB)	Ant Pos (cm)	Table Pos (deg)	Peak Avg. (P/A)	Pol. (H/V)	
802.11ac VHT20 CH 149 5745MHz		11490	48.54	-25.46	74	49.46	37.98	18.44	57.34	100	0	P	H	
		17235	51.55	-16.65	68.2	44.5	41	21.8	55.75	100	0	P	H	
													H	
													H	
			11490	49.26	-24.74	74	50.18	37.98	18.44	57.34	100	0	P	V
			17235	51.61	-16.59	68.2	44.56	41	21.8	55.75	100	0	P	V
														V
802.11ac VHT20 CH 157 5785MHz		11570	48.54	-25.46	74	49.13	38.07	18.54	57.2	100	0	P	H	
		17355	52.76	-15.44	68.2	45.68	40.9	21.91	55.73	100	0	P	H	
													H	
													H	
			11570	49.95	-24.05	74	50.54	38.07	18.54	57.2	100	0	P	V
			17355	53.37	-14.83	68.2	46.29	40.9	21.91	55.73	100	0	P	V
														V
802.11ac VHT20 CH 165 5825MHz		11650	49.29	-24.71	74	49.58	38.18	18.64	57.11	100	0	P	H	
		17355	53.41	-14.79	68.2	46.33	40.9	21.91	55.73	100	0	P	H	
													H	
													H	
			11650	49.62	-24.38	74	49.91	38.18	18.64	57.11	100	0	P	V
			17355	53.15	-15.05	68.2	46.07	40.9	21.91	55.73	100	0	P	V
														V
Remark	1. No other spurious found.													
	2. All results are PASS against Peak and Average limit line.													



Band 4 5725~5850MHz

WIFI 802.11ac VHT40 (Band Edge @ 3m)

WIFI Ant. 1+2	Note	Frequency (MHz)	Level (dBµV/m)	Over Limit (dB)	Limit Line (dBµV/m)	Read Level (dBµV)	Antenna Factor (dB/m)	Path Loss (dB)	Preamp Factor (dB)	Ant Pos (cm)	Table Pos (deg)	Peak Avg. (P/A)	Pol. (H/V)
		5647.8	53.81	-14.39	68.2	42.46	35.11	11.43	35.19	100	299	P	H
		5699.8	73.71	-31.34	105.05	62.3	35.15	11.46	35.2	100	299	P	H
		5719.2	89.3	-21.28	110.58	77.82	35.18	11.5	35.2	100	299	P	H
		5724.4	90.4	-30.43	120.83	78.92	35.18	11.5	35.2	100	299	P	H
	*	5755	117.5	-	-	105.97	35.21	11.53	35.21	100	299	P	H
	*	5755	109.55	-	-	98.02	35.21	11.53	35.21	100	299	A	H
		5850.6	60.2	-60.63	120.83	48.55	35.28	11.6	35.23	100	299	P	H
		5857.4	56.15	-53.98	110.13	44.49	35.29	11.6	35.23	100	299	P	H
		5880.8	52.63	-48.26	100.89	40.92	35.3	11.65	35.24	100	299	P	H
		5937.2	49.94	-18.26	68.2	38.16	35.34	11.69	35.25	100	299	P	H
802.11ac													H
VHT40													H
CH 151		5625.6	53.54	-14.66	68.2	42.19	35.1	11.43	35.18	101	58	P	V
5755MHz		5699.2	68.34	-36.27	104.61	56.93	35.15	11.46	35.2	101	58	P	V
		5718.8	82.92	-27.54	110.46	71.44	35.18	11.5	35.2	101	58	P	V
		5725	87.09	-35.11	122.2	75.61	35.18	11.5	35.2	101	58	P	V
	*	5755	112.76	-	-	101.23	35.21	11.53	35.21	101	58	P	V
	*	5755	105.23	-	-	93.7	35.21	11.53	35.21	101	58	A	V
		5850	54.76	-67.44	122.2	43.11	35.28	11.6	35.23	101	58	P	V
		5857.6	52.46	-57.61	110.07	40.8	35.29	11.6	35.23	101	58	P	V
		5907.8	49.86	-31.03	80.89	38.08	35.33	11.69	35.24	101	58	P	V
		5932.8	50.62	-17.58	68.2	38.83	35.34	11.69	35.24	101	58	P	V
													V
													V



WIFI Ant. 1+2	Note	Frequency (MHz)	Level (dBμV/m)	Over Limit (dB)	Limit Line (dBμV/m)	Read Level (dBμV)	Antenna Factor (dB/m)	Path Loss (dB)	Preamp Factor (dB)	Ant Pos (cm)	Table Pos (deg)	Peak Avg. (P/A)	Pol. (H/V)
		5641.2	50.62	-17.58	68.2	39.27	35.11	11.43	35.19	100	299	P	H
		5694.2	56.11	-44.81	100.92	44.7	35.15	11.46	35.2	100	299	P	H
		5718.8	59.22	-51.24	110.46	47.74	35.18	11.5	35.2	100	299	P	H
		5724.2	60.28	-60.1	120.38	48.8	35.18	11.5	35.2	100	299	P	H
	*	5795	116.36	-	-	104.79	35.23	11.56	35.22	100	299	P	H
	*	5795	108.97	-	-	97.4	35.23	11.56	35.22	100	299	A	H
		5852.6	68.23	-48.04	116.27	56.58	35.28	11.6	35.23	100	299	P	H
		5855.4	62.32	-48.37	110.69	50.66	35.29	11.6	35.23	100	299	P	H
		5877.4	59.24	-44.18	103.42	47.53	35.3	11.65	35.24	100	299	P	H
		5928.8	51.67	-16.53	68.2	39.88	35.34	11.69	35.24	100	299	P	H
802.11ac													H
VHT40													H
CH 159		5624.8	50.54	-17.66	68.2	39.19	35.1	11.43	35.18	100	58	P	V
5795MHz		5696.8	53.61	-49.23	102.84	42.2	35.15	11.46	35.2	100	58	P	V
		5718.2	57.45	-52.85	110.3	45.97	35.18	11.5	35.2	100	58	P	V
		5724	59.17	-60.75	119.92	47.69	35.18	11.5	35.2	100	58	P	V
	*	5795	113.29	-	-	101.72	35.23	11.56	35.22	100	58	P	V
	*	5795	105.6	-	-	94.03	35.23	11.56	35.22	100	58	A	V
		5854.6	65.68	-46.03	111.71	54.02	35.29	11.6	35.23	100	58	P	V
		5855.2	63.84	-46.9	110.74	52.18	35.29	11.6	35.23	100	58	P	V
		5875.2	59.48	-45.57	105.05	47.77	35.3	11.65	35.24	100	58	P	V
		5925.4	52.03	-16.17	68.2	40.24	35.34	11.69	35.24	100	58	P	V
													V
													V
Remark	1. No other spurious found. 2. All results are PASS against Peak and Average limit line.												



Band 4 5725~5850MHz

WIFI 802.11ac VHT40 (Harmonic @ 3m)

WIFI Ant. 1+2	Note	Frequency (MHz)	Level (dBμV/m)	Over Limit (dB)	Limit Line (dBμV/m)	Read Level (dBμV)	Antenna Factor (dB/m)	Path Loss (dB)	Preamp Factor (dB)	Ant Pos (cm)	Table Pos (deg)	Peak Avg. (P/A)	Pol. (H/V)	
802.11ac VHT40 CH 151 5755MHz		11510	48.16	-25.84	74	48.97	38	18.49	57.3	100	0	P	H	
		17265	52.23	-15.97	68.2	45.15	41	21.83	55.75	100	0	P	H	
													H	
													H	
			11510	49.22	-24.78	74	50.03	38	18.49	57.3	100	0	P	V
			17265	51.37	-16.83	68.2	44.29	41	21.83	55.75	100	0	P	V
														V
														V
802.11ac VHT40 CH 159 5795MHz		11590	46.98	-27.02	74	47.49	38.08	18.59	57.18	100	0	P	H	
		17385	52.83	-15.37	68.2	45.78	40.83	21.94	55.72	100	0	P	H	
													H	
													H	
			11590	47.37	-26.63	74	47.88	38.08	18.59	57.18	100	0	P	V
			17385	52.74	-15.46	68.2	45.69	40.83	21.94	55.72	100	0	P	V
														V
														V
Remark	<ol style="list-style-type: none"> No other spurious found. All results are PASS against Peak and Average limit line. 													



Band 4 5725~5850MHz

WIFI 802.11ac VHT80 (Band Edge @ 3m)

WIFI Ant. 1+2	Note	Frequency (MHz)	Level (dBμV/m)	Over Limit (dB)	Limit Line (dBμV/m)	Read Level (dBμV)	Antenna Factor (dB/m)	Path Loss (dB)	Preamp Factor (dB)	Ant Pos (cm)	Table Pos (deg)	Peak Avg. (P/A)	Pol. (H/V)
		5642.2	63.02	-5.18	68.2	51.67	35.11	11.43	35.19	100	298	P	H
		5699.6	83.4	-21.51	104.91	71.99	35.15	11.46	35.2	100	298	P	H
		5720	88.72	-22.08	110.8	77.24	35.18	11.5	35.2	100	298	P	H
		5720.8	89.89	-22.73	112.62	78.41	35.18	11.5	35.2	100	298	P	H
	*	5775	113.76	-	-	102.23	35.22	11.53	35.22	100	298	P	H
	*	5775	106.47	-	-	94.94	35.22	11.53	35.22	100	298	A	H
		5851	84.71	-35.21	119.92	73.06	35.28	11.6	35.23	100	298	P	H
		5859.4	83.96	-25.61	109.57	72.31	35.29	11.6	35.24	100	298	P	H
		5879.4	77.69	-24.24	101.93	65.98	35.3	11.65	35.24	100	298	P	H
		5930.8	61.01	-7.19	68.2	49.22	35.34	11.69	35.24	100	298	P	H
802.11ac													H
VHT80													H
CH 155		5649.8	61.55	-6.65	68.2	50.19	35.12	11.43	35.19	100	54	P	V
5775MHz		5689.4	78.04	-19.34	97.38	66.63	35.15	11.46	35.2	100	54	P	V
		5717	82.94	-27.02	109.96	71.47	35.17	11.5	35.2	100	54	P	V
		5723	85.37	-32.27	117.64	73.89	35.18	11.5	35.2	100	54	P	V
	*	5775	109.52	-	-	97.99	35.22	11.53	35.22	100	54	P	V
	*	5775	102.03	-	-	90.5	35.22	11.53	35.22	100	54	A	V
		5850	83.22	-38.98	122.2	71.57	35.28	11.6	35.23	100	54	P	V
		5870.6	80.45	-25.98	106.43	68.74	35.3	11.65	35.24	100	54	P	V
		5885.4	72.11	-25.37	97.48	60.4	35.3	11.65	35.24	100	54	P	V
		5928	59.7	-8.5	68.2	47.91	35.34	11.69	35.24	100	54	P	V
													V
													V
Remark	1. No other spurious found. 2. All results are PASS against Peak and Average limit line.												



Band 4 5725~5850MHz

WIFI 802.11ac VHT80 (Harmonic @ 3m)

WIFI Ant. 1+2	Note	Frequency (MHz)	Level (dBμV/m)	Over Limit (dB)	Limit Line (dBμV/m)	Read Level (dBμV)	Antenna Factor (dB/m)	Path Loss (dB)	Preamp Factor (dB)	Ant Pos (cm)	Table Pos (deg)	Peak Avg. (P/A)	Pol. (H/V)	
802.11ac VHT80 CH 155 5775MHz		11550	48	-26	74	48.64	38.05	18.54	57.23	100	0	P	H	
		17325	52.53	-15.67	68.2	45.42	40.97	21.88	55.74	100	0	P	H	
													H	
													H	
			11550	48.46	-25.54	74	49.1	38.05	18.54	57.23	100	0	P	V
			17325	52.49	-15.71	68.2	45.38	40.97	21.88	55.74	100	0	P	V
														V
														V
Remark	1. No other spurious found. 2. All results are PASS against Peak and Average limit line.													



Emission below 1GHz

5GHz WIFI 802.11ac VHT80 (LF @ 3m)

WIFI	Note	Frequency	Level	Over	Limit	Read	Antenna	Path	Preamp	Ant	Table	Peak	Pol.	
Ant.				Limit	Line	Level	Factor	Loss	Factor	Pos	Pos	Avg.		
1+2		(MHz)	(dBμV/m)	(dB)	(dBμV/m)	(dBμV)	(dB/m)	(dB)	(dB)	(cm)	(deg)	(P/A)	(H/V)	
5GHz 802.11ac VHT80 LF		30	27.58	-12.42	40	33	24.6	1.33	31.35	100	0	P	H	
		48.36	24.47	-15.53	40	39.66	15.07	1.34	31.6	-	-	P	H	
		68.07	26.73	-13.27	40	44.48	12.14	1.7	31.59	-	-	P	H	
		371.4	29.32	-16.68	46	36.63	20.81	3.06	31.18	-	-	P	H	
		855.8	30.52	-15.48	46	27.42	28.91	4.74	30.55	-	-	P	H	
		957.3	32.31	-13.69	46	27.02	30.75	5.05	30.51	-	-	P	H	
														H
														H
														H
														H
														H
														H
														H
														H
														H
			30	32.69	-7.31	40	38.11	24.6	1.33	31.35	100	0	P	V
			37.02	28.98	-11.02	40	38.12	20.97	1.33	31.44	-	-	P	V
			48.63	28.35	-11.65	40	43.54	15.07	1.34	31.6	-	-	P	V
		751.5	29.36	-16.64	46	27.76	27.77	4.46	30.63	-	-	P	V	
		844.6	30.8	-15.2	46	27.99	28.63	4.74	30.56	-	-	P	V	
		948.2	32.61	-13.39	46	27.8	30.28	5.05	30.52	-	-	P	V	
													V	
													V	
													V	
													V	
													V	
													V	
Remark	1. No other spurious found. 2. All results are PASS against limit line.													



<TXBF Mode>

Band 4 - 5725~5850MHz

WIFI 802.11ac VHT20 (Band Edge @ 3m)

WIFI Ant. 1+2	Note	Frequency (MHz)	Level (dBμV/m)	Over Limit (dB)	Limit Line (dBμV/m)	Read Level (dBμV)	Antenna Factor (dB/m)	Path Loss (dB)	Preamp Factor (dB)	Ant Pos (cm)	Table Pos (deg)	Peak Avg. (P/A)	Pol. (H/V)	
802.11ac VHT20 CH 149 5745MHz		5632.2	51.72	-16.48	68.2	40.38	35.1	11.43	35.19	100	327	P	H	
		5681.4	60.94	-30.53	91.47	49.54	35.14	11.46	35.2	100	327	P	H	
		5720	75.55	-35.25	110.8	64.07	35.18	11.5	35.2	100	327	P	H	
		5724.6	81.67	-39.62	121.29	70.19	35.18	11.5	35.2	100	327	P	H	
	*	5745	117.81	-	-	106.3	35.19	11.53	35.21	100	327	P	H	
	*	5745	109.19	-	-	97.68	35.19	11.53	35.21	100	327	A	H	
														H
														H
			5637	51.93	-16.27	68.2	40.58	35.11	11.43	35.19	192	2	P	V
			5699.2	58.44	-46.17	104.61	47.03	35.15	11.46	35.2	192	2	P	V
			5719.6	63.94	-46.75	110.69	52.46	35.18	11.5	35.2	192	2	P	V
			5724.6	72.8	-48.49	121.29	61.32	35.18	11.5	35.2	192	2	P	V
		*	5745	113.58	-	-	102.07	35.19	11.53	35.21	192	2	P	V
		*	5745	104.93	-	-	93.42	35.19	11.53	35.21	192	2	A	V
													V	
													V	



WIFI Ant. 1+2	Note	Frequency (MHz)	Level (dBμV/m)	Over Limit (dB)	Limit Line (dBμV/m)	Read Level (dBμV)	Antenna Factor (dB/m)	Path Loss (dB)	Preamp Factor (dB)	Ant Pos (cm)	Table Pos (deg)	Peak Avg. (P/A)	Pol. (H/V)
		5640	51.21	-16.99	68.2	39.86	35.11	11.43	35.19	100	327	P	H
		5678.8	53.83	-35.72	89.55	42.42	35.14	11.46	35.19	100	327	P	H
		5719.6	60.54	-50.15	110.69	49.06	35.18	11.5	35.2	100	327	P	H
		5720.4	54.15	-57.56	111.71	42.67	35.18	11.5	35.2	100	327	P	H
	*	5785	117.93	-	-	106.37	35.22	11.56	35.22	100	327	P	H
	*	5785	109.33	-	-	97.77	35.22	11.56	35.22	100	327	A	H
		5850.6	61.61	-59.22	120.83	49.96	35.28	11.6	35.23	100	327	P	H
		5856.4	59.42	-50.99	110.41	47.76	35.29	11.6	35.23	100	327	P	H
		5875.8	56.82	-47.79	104.61	45.11	35.3	11.65	35.24	100	327	P	H
		5947.8	49.7	-18.5	68.2	37.85	35.36	11.74	35.25	100	327	P	H
802.11ac													H
VHT20													H
CH 157		5647.6	51.15	-17.05	68.2	39.8	35.11	11.43	35.19	197	2	P	V
5785MHz		5698.4	52.64	-51.38	104.02	41.23	35.15	11.46	35.2	197	2	P	V
		5716.2	56.95	-52.79	109.74	45.48	35.17	11.5	35.2	197	2	P	V
		5724	59.89	-60.03	119.92	48.41	35.18	11.5	35.2	197	2	P	V
	*	5785	112.3	-	-	100.74	35.22	11.56	35.22	197	2	P	V
	*	5785	104.33	-	-	92.77	35.22	11.56	35.22	197	2	A	V
		5852.2	59.85	-57.33	117.18	48.2	35.28	11.6	35.23	197	2	P	V
		5870.4	54.8	-51.69	106.49	43.1	35.29	11.65	35.24	197	2	P	V
		5879.2	50.52	-51.56	102.08	38.81	35.3	11.65	35.24	197	2	P	V
		5926.4	49.1	-19.1	68.2	37.31	35.34	11.69	35.24	197	2	P	V
													V
													V



WiFi Ant. 1+2	Note	Frequency (MHz)	Level (dBμV/m)	Over Limit (dB)	Limit Line (dBμV/m)	Read Level (dBμV)	Antenna Factor (dB/m)	Path Loss (dB)	Preamp Factor (dB)	Ant Pos (cm)	Table Pos (deg)	Peak Avg. (P/A)	Pol. (H/V)	
802.11ac VHT20 CH 165 5825MHz	*	5825	117.97	-	-	106.33	35.26	11.6	35.22	102	327	P	H	
	*	5825	108.97	-	-	97.33	35.26	11.6	35.22	102	327	A	H	
		5851	71.92	-48	119.92	60.27	35.28	11.6	35.23	102	327	P	H	
		5857.8	67.24	-42.77	110.01	55.59	35.29	11.6	35.24	102	327	P	H	
		5881.6	61.72	-38.58	100.3	50.01	35.3	11.65	35.24	102	327	P	H	
		5942.2	50.63	-17.57	68.2	38.78	35.36	11.74	35.25	102	327	P	H	
														H
														H
	*	5825	112.31	-	-	100.67	35.26	11.6	35.22	178	2	P	V	
	*	5825	104.19	-	-	92.55	35.26	11.6	35.22	178	2	A	V	
		5852.6	64.82	-51.45	116.27	53.17	35.28	11.6	35.23	178	2	P	V	
		5866	63.14	-44.58	107.72	51.44	35.29	11.65	35.24	178	2	P	V	
		5875.2	60.96	-44.09	105.05	49.25	35.3	11.65	35.24	178	2	P	V	
		5928.6	53.84	-14.36	68.2	42.05	35.34	11.69	35.24	178	2	P	V	
														V
													V	
Remark	1. No other spurious found. 2. All results are PASS against Peak and Average limit line.													



Band 4 5725~5850MHz

WIFI 802.11ac VHT20 (Harmonic @ 3m)

WIFI Ant. 1+2	Note	Frequency (MHz)	Level (dBµV/m)	Over Limit (dB)	Limit Line (dBµV/m)	Read Level (dBµV)	Antenna Factor (dB/m)	Path Loss (dB)	Preamp Factor (dB)	Ant Pos (cm)	Table Pos (deg)	Peak Avg. (P/A)	Pol. (H/V)	
802.11ac VHT20 CH 149 5745MHz		11490	47.55	-26.45	74	48.47	37.98	18.44	57.34	100	0	P	H	
		17235	52.27	-15.93	68.2	45.22	41	21.8	55.75	100	0	P	H	
													H	
													H	
			11490	48.35	-25.65	74	49.27	37.98	18.44	57.34	100	0	P	V
			17235	52.5	-15.7	68.2	45.45	41	21.8	55.75	100	0	P	V
														V
802.11ac VHT20 CH 157 5785MHz		11570	47.86	-26.14	74	48.45	38.07	18.54	57.2	100	0	P	H	
		17355	53.02	-15.18	68.2	45.94	40.9	21.91	55.73	100	0	P	H	
													H	
													H	
			11570	47.18	-26.82	74	47.77	38.07	18.54	57.2	100	0	P	V
			17355	51.81	-16.39	68.2	44.73	40.9	21.91	55.73	100	0	P	V
														V
802.11ac VHT20 CH 165 5825MHz		11650	48.72	-25.28	74	49.01	38.18	18.64	57.11	100	0	P	H	
		17475	51.74	-16.46	68.2	44.77	40.67	22.01	55.71	100	0	P	H	
													H	
													H	
			11650	48.87	-25.13	74	49.16	38.18	18.64	57.11	100	0	P	V
			17475	52.03	-16.17	68.2	45.06	40.67	22.01	55.71	100	0	P	V
														V
Remark	1. No other spurious found.													
	2. All results are PASS against Peak and Average limit line.													



Band 4 5725~5850MHz

WIFI 802.11ac VHT40 (Band Edge @ 3m)

WIFI Ant. 1+2	Note	Frequency (MHz)	Level (dBμV/m)	Over Limit (dB)	Limit Line (dBμV/m)	Read Level (dBμV)	Antenna Factor (dB/m)	Path Loss (dB)	Preamp Factor (dB)	Ant Pos (cm)	Table Pos (deg)	Peak Avg. (P/A)	Pol. (H/V)	
		5644.8	56.04	-12.16	68.2	44.69	35.11	11.43	35.19	100	329	P	H	
		5693	63.95	-36.09	100.04	52.54	35.15	11.46	35.2	100	329	P	H	
		5715.4	82.79	-26.72	109.51	71.32	35.17	11.5	35.2	100	329	P	H	
		5725	84.51	-37.69	122.2	73.03	35.18	11.5	35.2	100	329	P	H	
	*	5755	115.49	-	-	103.96	35.21	11.53	35.21	100	329	P	H	
	*	5755	107.12	-	-	95.59	35.21	11.53	35.21	100	329	A	H	
		5851	56.4	-63.52	119.92	44.75	35.28	11.6	35.23	100	329	P	H	
		5856	54.63	-55.89	110.52	42.97	35.29	11.6	35.23	100	329	P	H	
		5881.2	52.45	-48.14	100.59	40.74	35.3	11.65	35.24	100	329	P	H	
		5937.6	49.38	-18.82	68.2	37.6	35.34	11.69	35.25	100	329	P	H	
802.11ac VHT40 CH 151 5755MHz													H	
													H	
			5613.6	51.16	-17.04	68.2	39.86	35.08	11.4	35.18	185	2	P	V
			5697	60.39	-42.6	102.99	48.98	35.15	11.46	35.2	185	2	P	V
			5718.8	80.72	-29.74	110.46	69.24	35.18	11.5	35.2	185	2	P	V
			5724.8	79.53	-42.21	121.74	68.05	35.18	11.5	35.2	185	2	P	V
		*	5755	110.62	-	-	99.09	35.21	11.53	35.21	185	2	P	V
		*	5755	101.97	-	-	90.44	35.21	11.53	35.21	185	2	A	V
			5850	51.36	-70.84	122.2	39.71	35.28	11.6	35.23	185	2	P	V
			5860.4	55.95	-53.34	109.29	44.25	35.29	11.65	35.24	185	2	P	V
			5881.6	50.43	-49.87	100.3	38.72	35.3	11.65	35.24	185	2	P	V
			5936.6	49.84	-18.36	68.2	38.06	35.34	11.69	35.25	185	2	P	V
														V
														V



WIFI Ant. 1+2	Note	Frequency (MHz)	Level (dBµV/m)	Over Limit (dB)	Limit Line (dBµV/m)	Read Level (dBµV)	Antenna Factor (dB/m)	Path Loss (dB)	Preamp Factor (dB)	Ant Pos (cm)	Table Pos (deg)	Peak Avg. (P/A)	Pol. (H/V)
		5639.8	51.79	-16.41	68.2	40.44	35.11	11.43	35.19	100	326	P	H
		5695	54.97	-46.54	101.51	43.56	35.15	11.46	35.2	100	326	P	H
		5702.8	58.79	-47.2	105.99	47.32	35.17	11.5	35.2	100	326	P	H
		5725	59.13	-63.07	122.2	47.65	35.18	11.5	35.2	100	326	P	H
	*	5795	115.9	-	-	104.33	35.23	11.56	35.22	100	326	P	H
	*	5795	107.46	-	-	95.89	35.23	11.56	35.22	100	326	A	H
		5850	64.55	-57.65	122.2	52.9	35.28	11.6	35.23	100	326	P	H
		5862.2	63.88	-44.9	108.78	52.18	35.29	11.65	35.24	100	326	P	H
		5877	58.77	-44.94	103.71	47.06	35.3	11.65	35.24	100	326	P	H
		5931.2	51.84	-16.36	68.2	40.05	35.34	11.69	35.24	100	326	P	H
802.11ac													H
VHT40													H
CH 159		5626	51.42	-16.78	68.2	40.07	35.1	11.43	35.18	190	2	P	V
5795MHz		5695.8	52.46	-49.64	102.1	41.05	35.15	11.46	35.2	190	2	P	V
		5719.8	53.23	-57.51	110.74	41.75	35.18	11.5	35.2	190	2	P	V
		5720	53.04	-57.76	110.8	41.56	35.18	11.5	35.2	190	2	P	V
	*	5795	110.05	-	-	98.48	35.23	11.56	35.22	190	2	P	V
	*	5795	101.82	-	-	90.25	35.23	11.56	35.22	190	2	A	V
		5850	62.19	-60.01	122.2	50.54	35.28	11.6	35.23	190	2	P	V
		5856.4	61.85	-48.56	110.41	50.19	35.29	11.6	35.23	190	2	P	V
		5880.4	57.05	-44.14	101.19	45.34	35.3	11.65	35.24	190	2	P	V
		5947	51.16	-17.04	68.2	39.31	35.36	11.74	35.25	190	2	P	V
													V
													V
Remark	1. No other spurious found. 2. All results are PASS against Peak and Average limit line.												



Band 4 5725~5850MHz

WIFI 802.11ac VHT40 (Harmonic @ 3m)

WIFI Ant. 1+2	Note	Frequency (MHz)	Level (dBμV/m)	Over Limit (dB)	Limit Line (dBμV/m)	Read Level (dBμV)	Antenna Factor (dB/m)	Path Loss (dB)	Preamp Factor (dB)	Ant Pos (cm)	Table Pos (deg)	Peak Avg. (P/A)	Pol. (H/V)	
802.11ac VHT40 CH 151 5755MHz		11510	48.4	-25.6	74	49.21	38	18.49	57.3	100	0	P	H	
		17265	52.68	-15.52	68.2	45.6	41	21.83	55.75	100	0	P	H	
													H	
													H	
			11510	47.64	-26.36	74	48.45	38	18.49	57.3	100	0	P	V
			17265	52.07	-16.13	68.2	44.99	41	21.83	55.75	100	0	P	V
														V
														V
802.11ac VHT40 CH 159 5795MHz		11590	48.22	-25.78	74	48.73	38.08	18.59	57.18	100	0	P	H	
		17385	51.8	-16.4	68.2	44.75	40.83	21.94	55.72	100	0	P	H	
													H	
													H	
			11590	47.13	-26.87	74	47.64	38.08	18.59	57.18	100	0	P	V
			17385	52.71	-15.49	68.2	45.66	40.83	21.94	55.72	100	0	P	V
														V
														V
Remark	1. No other spurious found. 2. All results are PASS against Peak and Average limit line.													



Band 4 5725~5850MHz

WIFI 802.11ac VHT80 (Band Edge @ 3m)

WIFI Ant. 1+2	Note	Frequency (MHz)	Level (dBμV/m)	Over Limit (dB)	Limit Line (dBμV/m)	Read Level (dBμV)	Antenna Factor (dB/m)	Path Loss (dB)	Preamp Factor (dB)	Ant Pos (cm)	Table Pos (deg)	Peak Avg. (P/A)	Pol. (H/V)
		5649.2	57.04	-11.16	68.2	45.69	35.11	11.43	35.19	100	326	P	H
		5692	79.28	-20.02	99.3	67.87	35.15	11.46	35.2	100	326	P	H
		5717.8	82.3	-27.88	110.18	70.82	35.18	11.5	35.2	100	326	P	H
		5721.4	83.95	-30.04	113.99	72.47	35.18	11.5	35.2	100	326	P	H
	*	5775	111.12	-	-	99.59	35.22	11.53	35.22	100	326	P	H
	*	5775	104.64	-	-	93.11	35.22	11.53	35.22	100	326	A	H
		5850.2	78.41	-43.33	121.74	66.76	35.28	11.6	35.23	100	326	P	H
		5855.2	77.37	-33.37	110.74	65.71	35.29	11.6	35.23	100	326	P	H
		5877.2	69.27	-34.3	103.57	57.56	35.3	11.65	35.24	100	326	P	H
		5927.8	54.18	-14.02	68.2	42.39	35.34	11.69	35.24	100	326	P	H
802.11ac													H
VHT80													H
CH 155		5647	53.88	-14.32	68.2	42.53	35.11	11.43	35.19	190	2	P	V
5775MHz		5697.4	69.82	-33.46	103.28	58.41	35.15	11.46	35.2	190	2	P	V
		5718.8	76.47	-33.99	110.46	64.99	35.18	11.5	35.2	190	2	P	V
		5722.2	74.01	-41.81	115.82	62.53	35.18	11.5	35.2	190	2	P	V
	*	5775	106.36	-	-	94.83	35.22	11.53	35.22	190	2	P	V
	*	5775	98.84	-	-	87.31	35.22	11.53	35.22	190	2	A	V
		5853	72.16	-43.2	115.36	60.51	35.28	11.6	35.23	190	2	P	V
		5856.2	71	-39.46	110.46	59.34	35.29	11.6	35.23	190	2	P	V
		5875	63.79	-41.41	105.2	52.08	35.3	11.65	35.24	190	2	P	V
		5944	51.13	-17.07	68.2	39.28	35.36	11.74	35.25	190	2	P	V
													V
													V
Remark	1. No other spurious found. 2. All results are PASS against Peak and Average limit line.												



Band 4 5725~5850MHz

WIFI 802.11ac VHT80 (Harmonic @ 3m)

WIFI Ant. 1+2	Note	Frequency (MHz)	Level (dBμV/m)	Over Limit (dB)	Limit Line (dBμV/m)	Read Level (dBμV)	Antenna Factor (dB/m)	Path Loss (dB)	Preamp Factor (dB)	Ant Pos (cm)	Table Pos (deg)	Peak Avg. (P/A)	Pol. (H/V)	
802.11ac VHT80 CH 155 5775MHz		11550	47.5	-26.5	74	48.14	38.05	18.54	57.23	100	0	P	H	
		17325	52.05	-16.15	68.2	44.94	40.97	21.88	55.74	100	0	P	H	
													H	
													H	
			11550	47.73	-26.27	74	48.37	38.05	18.54	57.23	100	0	P	V
			17325	51.81	-16.39	68.2	44.7	40.97	21.88	55.74	100	0	P	V
														V
Remark	1. No other spurious found. 2. All results are PASS against Peak and Average limit line.													



Emission below 1GHz

5GHz WIFI 802.11ac VHT80 (LF @ 3m)

WIFI	Note	Frequency	Level	Over	Limit	Read	Antenna	Path	Preamp	Ant	Table	Peak	Pol.	
Ant.				Limit	Line	Level	Factor	Loss	Factor	Pos	Pos	Avg.		
1+2		(MHz)	(dBμV/m)	(dB)	(dBμV/m)	(dBμV)	(dB/m)	(dB)	(dB)	(cm)	(deg)	(P/A)	(H/V)	
5GHz 802.11ac VHT80 LF		30.27	27.8	-12.2	40	33.22	24.6	1.33	31.35	100	0	P	H	
		68.61	26.66	-13.34	40	44.31	12.24	1.7	31.59	-	-	P	H	
		103.98	28.35	-15.15	43.5	41.49	16.39	2.03	31.56	-	-	P	H	
		379.8	29.31	-16.69	46	36.47	20.94	3.06	31.16	-	-	P	H	
		864.2	30.69	-15.31	46	27.35	29	4.88	30.54	-	-	P	H	
		951.7	31.83	-14.17	46	26.85	30.44	5.05	30.51	-	-	P	H	
														H
														H
														H
														H
														H
														H
														H
														H
														H
			30.27	32.15	-7.85	40	37.57	24.6	1.33	31.35	100	0	P	V
			37.29	29.85	-10.15	40	39.55	20.42	1.33	31.45	-	-	P	V
			110.46	31.12	-12.38	43.5	43.74	16.91	2.02	31.55	-	-	P	V
		787.2	29.66	-16.34	46	27.69	27.97	4.6	30.6	-	-	P	V	
		857.2	30.25	-15.75	46	27.1	28.96	4.74	30.55	-	-	P	V	
		957.3	32.81	-13.19	46	27.52	30.75	5.05	30.51	-	-	P	V	
													V	
													V	
													V	
													V	
													V	
													V	
Remark	1. No other spurious found. 2. All results are PASS against limit line.													



Note symbol

*	Fundamental Frequency which can be ignored. However, the level of any unwanted emissions shall not exceed the level of the fundamental frequency.
!	Test result is over limit line.
P/A	Peak or Average
H/V	Horizontal or Vertical



A calculation example for radiated spurious emission is shown as below:

WIFI	Note	Frequency	Level	Over	Limit	Read	Antenna	Path	Preamp	Ant	Table	Peak	Pol.
Ant.				Limit	Line	Level	Factor	Loss	Factor	Pos	Pos	Avg.	
1		(MHz)	(dBμV/m)	(dB)	(dBμV/m)	(dBμV)	(dB/m)	(dB)	(dB)	(cm)	(deg)	(P/A)	(H/V)
802.11b		2390	55.45	-18.55	74	54.51	32.22	4.58	35.86	103	308	P	H
CH 01		2390	43.54	-10.46	54	42.6	32.22	4.58	35.86	103	308	A	H
2412MHz													

1. Path Loss(dB) = Cable loss(dB) + Filter loss(dB) + Attenuator loss(dB)
2. Level(dBμV/m) = Antenna Factor(dB/m) + Path Loss(dB) + Read Level(dBμV) - Preamp Factor(dB)
3. Over Limit(dB) = Level(dBμV/m) – Limit Line(dBμV/m)

For Peak Limit @ 2390MHz:

1. Level(dBμV/m)
= Antenna Factor(dB/m) + Path Loss(dB) + Read Level(dBμV) - Preamp Factor(dB)
= 32.22(dB/m) + 4.58(dB) + 54.51(dBμV) – 35.86 (dB)
= 55.45 (dBμV/m)
2. Over Limit(dB)
= Level(dBμV/m) – Limit Line(dBμV/m)
= 55.45(dBμV/m) – 74(dBμV/m)
= -18.55(dB)

For Average Limit @ 2390MHz:

1. Level(dBμV/m)
= Antenna Factor(dB/m) + Path Loss(dB) + Read Level(dBμV) - Preamp Factor(dB)
= 32.22(dB/m) + 4.58(dB) + 42.6(dBμV) – 35.86 (dB)
= 43.54 (dBμV/m)
2. Over Limit(dB) = Level(dBμV/m) – Limit Line(dBμV/m)
= 43.54(dBμV/m) – 54(dBμV/m)
= -10.46(dB)

Both peak and average measured complies with the limit line, so test result is “PASS”.



Appendix C. Radiated Spurious Emission Plots

Test Engineer :	Jesse Wang, Stan Hsieh, and Nick Yu	Temperature :	24~26°C
		Relative Humidity :	51~53%

Note symbol

-L	Low channel location
-R	High channel location



<CDD Mode>
<For Earphone 1>

Band 4 - 5725~5850MHz
WIFI 802.11a (Band Edge @ 3m)

WIFI	Band 4 5725~5850MHz Band Edge @ 3m	
ANT	802.11a CH149 5745MHz	
1	Horizontal	Fundamental
Peak	<p>Site : 03CH07-HY Condition : PEAK_HF(04)_16-24 3e HF_ANT_00066583 HORIZONTAL FRM: 1000.000kHz VSM: 3000.000kHz SMT: Auto Detector : Peak Project : #72508 Mode : 14</p>	<p>Site : 03CH07-HY Condition : PEAK(FR11) 3e HF_ANT_00066583 HORIZONTAL FRM: 1000.000kHz VSM: 3000.000kHz SMT: Auto Detector : Peak Project : #72508 Mode : 14</p>



WIFI	Band 4 5725~5850MHz Band Edge @ 3m	
ANT	802.11a CH149 5745MHz	
1	Vertical	Fundamental
Peak	<p>Site : 03CN07-HY Condition : PEAK_04(04)_16-24 3m HF_ANT_00066583 VERTICAL Detector : Peak Project : 872508 Mode : 14</p>	<p>Site : 03CN07-HY Condition : PEAK(04) 3m HF_ANT_00066583 VERTICAL Detector : Peak Project : 872508 Mode : 14</p>



WIFI	Band 4 5725~5850MHz Band Edge @ 3m	
ANT	802.11a CH157 5785MHz	
1	Horizontal	Fundamental
Peak	<p>Site : 03CN07-HY Condition : PEAK_B6(04)_16-24 3e HF_ANT_00066583 HORIZONTAL Detector : Peak Project : #72508 Mode : 35</p>	<p>Site : 03CN07-HY Condition : PEAK((011)) 3e HF_ANT_00066583 HORIZONTAL Detector : Peak Project : #72508 Mode : 35</p>
Peak	<p>Site : 03CN07-HY Condition : PEAK_B6(04)_16-24 3e HF_ANT_00066583 HORIZONTAL Detector : Peak Project : #72508 Mode : 35</p>	Left blank

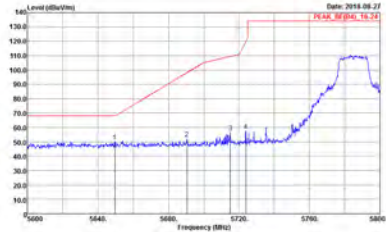
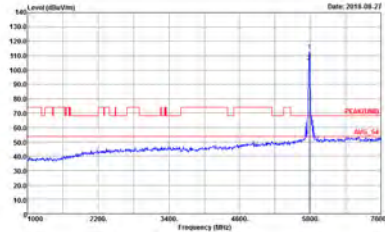
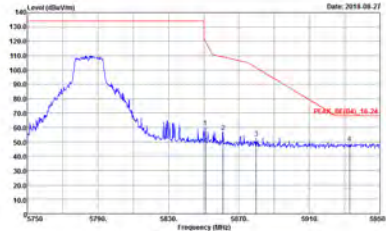

WIFI	Band 4 5725~5850MHz Band Edge @ 3m	
ANT	802.11a CH157 5785MHz	
1	Vertical	Fundamental
Peak	 <p>Site : 03CN07-HY Condition : PEAK_B4(04)_16-24 3e HF_ANT_00066583 VERTICAL Detector : Peak Project : 872508 Mode : 3S</p>	 <p>Site : 03CN07-HY Condition : PEAK(FUN1) 3e HF_ANT_00066583 VERTICAL Detector : Peak Project : 872508 Mode : 3S</p>
Peak	 <p>Site : 03CN07-HY Condition : PEAK_B4(04)_16-24 3e HF_ANT_00066583 VERTICAL Detector : Peak Project : 872508 Mode : 3S</p>	Left blank

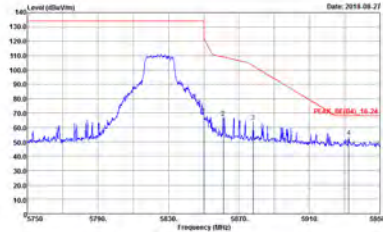
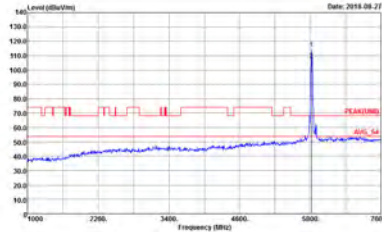

WIFI	Band 4 5725~5850MHz Band Edge @ 3m	
ANT	802.11a CH165 5825MHz	
1	Horizontal	Fundamental
Peak	 <p>Site : 03CN07-HY Condition : PEAK_04(04)_16-24 3m HF_ANT_00066583 HORIZONTAL Detector : Peak Project : 872508 Mode : 16</p>	 <p>Site : 03CN07-HY Condition : PEAK((011)) 3m HF_ANT_00066583 HORIZONTAL Detector : Peak Project : 872508 Mode : 16</p>



WIFI	Band 4 5725~5850MHz Band Edge @ 3m	
ANT	802.11a CH165 5825MHz	
1	Vertical	Fundamental
Peak	<p>Site : 03C307-HY Condition : PEAK_04(04)_16-24 3m HF_ANT_00066583 VERTICAL Deflection : Peak Project : 872508 Mode : 16</p>	<p>Site : 03C307-HY Condition : PEAK((04)) 3m HF_ANT_00066583 VERTICAL Deflection : Peak Project : 872508 Mode : 16</p>



Band 4 5725~5850MHz
WIFI 802.11ac VHT20 (Band Edge @ 3m)

Table with 2 columns: WIFI, ANT. Row 1: 1, Horizontal, Fundamental. Contains two spectral plots and their respective metadata.



WIFI	Band 4 5725~5850MHz Band Edge @ 3m	
ANT	802.11ac VHT20 CH149 5745MHz	
1	Vertical	Fundamental
Peak Avg.	<p>Site : 03CN07-HY Condition : PEAK_04(04)_16-24 @ HF_ANT_00066583 VERTICAL RBW: 1000.000kHz VBW: 3000.000kHz SMT: Auto Detector : Peak Project : 872508 Mode : 17</p>	<p>Site : 03CN07-HY Condition : PEAK(01) @ HF_ANT_00066583 VERTICAL RBW: 1000.000kHz VBW: 3000.000kHz SMT: Auto Detector : Peak Project : 872508 Mode : 17</p>



WIFI	Band 4 5725~5850MHz Band Edge @ 3m	
ANT	802.11ac VHT20 CH157 5785MHz	
1	Horizontal	Fundamental
Peak	<p>Site : 03CN07-HY Condition : PEAK_B4(04)_16-24 3e HF_ANT_00066583 HORIZONTAL Detector : Peak Project : R22508 Mode : IS</p>	<p>Site : 03CN07-HY Condition : PEAK(FUN1) 3e HF_ANT_00066583 HORIZONTAL Detector : Peak Project : R22508 Mode : IS</p>
Peak	<p>Site : 03CN07-HY Condition : PEAK_B4(04)_16-24 3e HF_ANT_00066583 HORIZONTAL Detector : Peak Project : R22508 Mode : IS</p>	Left blank



WIFI	Band 4 5725~5850MHz Band Edge @ 3m	
ANT	802.11ac VHT20 CH157 5785MHz	
1	Vertical	Fundamental
Peak	<p>Site : 03CN07-HY Condition : PEAK_B4(04)_16-24 3e HF_ANT_00066583 VERTICAL Detector : Peak Project : R22508 Mode : IS</p>	<p>Site : 03CN07-HY Condition : PEAK(UNL) 3e HF_ANT_00066583 VERTICAL Detector : Peak Project : R22508 Mode : IS</p>
Peak	<p>Site : 03CN07-HY Condition : PEAK_B4(04)_16-24 3e HF_ANT_00066583 VERTICAL Detector : Peak Project : R22508 Mode : IS</p>	Left blank

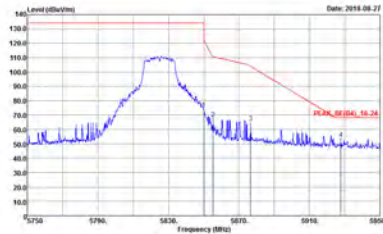
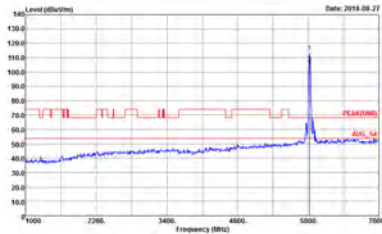

WIFI	Band 4 5725~5850MHz Band Edge @ 3m	
ANT	802.11ac VHT20 CH165 5825MHz	
1	Horizontal	Fundamental
Peak	 <p>Site : 03C807-HY Condition : PEAK_04(04)_16-24 3m HF_ANT_00066583 HORIZONTAL Deflection : Peak Project : 872508 Mode : 19</p>	 <p>Site : 03C807-HY Condition : PEAK((011)) 3m HF_ANT_00066583 HORIZONTAL Deflection : Peak Project : 872508 Mode : 19</p>



WIFI	Band 4 5725~5850MHz Band Edge @ 3m	
ANT	802.11ac VHT20 CH165 5825MHz	
1	Vertical	Fundamental
Peak Avg.	<p>Site : 03CN07-HY Condition : PEAK_04(04)_16-24 3m HE_ANT_00066583 VERTICAL FDM:1000.0000Hz VBM:3000.0000Hz SMT:Auto Detector : Peak Project : 872508 Mode : 19</p>	<p>Site : 03CN07-HY Condition : PEAK((011)) 3m HE_ANT_00066583 VERTICAL FDM:1000.0000Hz VBM:3000.0000Hz SMT:Auto Detector : Peak Project : 872508 Mode : 19</p>



Band 4 5725~5850MHz
WIFI 802.11ac VHT40 (Band Edge @ 3m)

WIFI	Band 4 5725~5850MHz Band Edge @ 3m	
ANT	802.11ac VHT40 CH151 5755MHz	
1	Horizontal	Fundamental
Peak	<p>Site : 01CH07-HY Condition : PEAK_BE(04)_16-24 3m HE_ANT_00066583 HORIZONTAL Detector : Peak Project : 872508 Mode : 4B</p>	<p>Site : 01CH07-HY Condition : PEAK(UNIT) 3m HE_ANT_00066583 HORIZONTAL Detector : Peak Project : 872508 Mode : 4B</p>
Peak	<p>Site : 01CH07-HY Condition : PEAK_BE(04)_16-24 3m HE_ANT_00066583 HORIZONTAL Detector : Peak Project : 872508 Mode : 4B</p>	Left blank



WIFI	Band 4 5725~5850MHz Band Edge @ 3m	
ANT	802.11ac VHT40 CH151 5755MHz	
1	Vertical	Fundamental
Peak	<p>Site : 03CN07-HY Condition : PEAK_B4(04)_16-24 3e HF_ANT_00066583 VERTICAL Detector : Peak Project : 872508 Mode : 40</p>	<p>Site : 03CN07-HY Condition : PEAK(FUN1)_3e HF_ANT_00066583 VERTICAL Detector : Peak Project : 872508 Mode : 40</p>
Peak	<p>Site : 03CN07-HY Condition : PEAK_B4(04)_16-24 3e HF_ANT_00066583 VERTICAL Detector : Peak Project : 872508 Mode : 40</p>	Left blank



WIFI	Band 4 5725~5850MHz Band Edge @ 3m	
ANT	802.11ac VHT40 CH159 5795MHz	
1	Horizontal	Fundamental
Peak		
Peak		Left blank



WIFI	Band 4 5725~5850MHz Band Edge @ 3m	
ANT	802.11ac VHT40 CH159 5795MHz	
1	Vertical	Fundamental
Peak	<p>Site : 03CN07-HY Condition : PEAK_B4(04)_16-24 3m HF_ANT_00066583 VERTICAL Detector : Peak Project : R22508 Mode : 41</p>	<p>Site : 03CN07-HY Condition : PEAK(FUN1)_3m HF_ANT_00066583 VERTICAL Detector : Peak Project : R22508 Mode : 41</p>
Peak	<p>Site : 03CN07-HY Condition : PEAK_B4(04)_16-24 3m HF_ANT_00066583 VERTICAL Detector : Peak Project : R22508 Mode : 41</p>	Left blank



Band 4 5725~5850MHz
WIFI 802.11ac VHT80 (Band Edge @ 3m)

WIFI	Band 4 5725~5850MHz Band Edge @ 3m	
ANT	802.11ac VHT80 CH155 5775MHz	
1	Horizontal	Fundamental
Peak	<p>Site : 01CH07-HY Condition : PEAK_BE(04)_16-24 3m HE_ANT_00066583 HORIZONTAL FIM: 1000.000kHz VSM: 3000.000kHz SMT: Auto Detector : Peak Project : 872508 Mode : 42</p>	<p>Site : 01CH07-HY Condition : PEAK(001) 3m HE_ANT_00066583 HORIZONTAL FIM: 1000.000kHz VSM: 3000.000kHz SMT: Auto Detector : Peak Project : 872508 Mode : 42</p>
Peak	<p>Site : 01CH07-HY Condition : PEAK_BE(04)_16-24 3m HE_ANT_00066583 HORIZONTAL FIM: 1000.000kHz VSM: 3000.000kHz SMT: Auto Detector : Peak Project : 872508 Mode : 42</p>	Left blank



WIFI	Band 4 5725~5850MHz Band Edge @ 3m	
ANT	802.11ac VHT80 CH155 5775MHz	
1	Vertical	Fundamental
Peak	<p>Site : 03CN07-HY Condition : PEAK_B4(04)_16-24 3e HF_ANT_00066583 VERTICAL Detector : Peak Project : #72508 Mode : 42</p>	<p>Site : 03CN07-HY Condition : PEAK(FUN1)_3e HF_ANT_00066583 VERTICAL Detector : Peak Project : #72508 Mode : 42</p>
Peak	<p>Site : 03CN07-HY Condition : PEAK_B4(04)_16-24 3e HF_ANT_00066583 VERTICAL Detector : Peak Project : #72508 Mode : 42</p>	Left blank



Band 4 - 5725~5850MHz
WIFI 802.11a (Harmonic @ 3m)

WIFI	Band 4 5725~5850MHz Harmonic @ 3m	
ANT	802.11a CH149 5745MHz	
1	Horizontal	Vertical
Peak Avg.	<p>Site : 03CM07-HY Condition : PEAK(RN11) 3m SHF-EHE_131829 HORIZONTAL Detector : Peak Project : 872508 Mode : 34</p>	<p>Site : 03CM07-HY Condition : PEAK(RN11) 3m SHF-EHE_131829 VERTICAL Detector : Peak Project : 872508 Mode : 34</p>

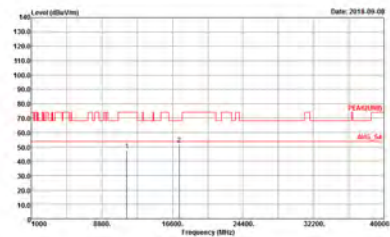
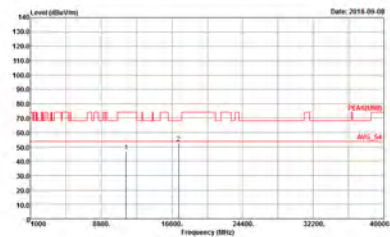

WIFI	Band 4 5725~5850MHz Harmonic @ 3m	
ANT	802.11a CH157 5785MHz	
1	Horizontal	Vertical
Peak Avg.	 <p>Site : 03C807-HY Condition : PEAK(0N11) 3m SHF-EHE_131829 HORIZONTAL Detector : Peak Project : 872508 Mode : 35</p>	 <p>Site : 03C807-HY Condition : PEAK(0N11) 3m SHF-EHE_131829 VERTICAL Detector : Peak Project : 872508 Mode : 35</p>

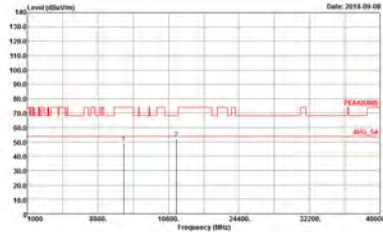
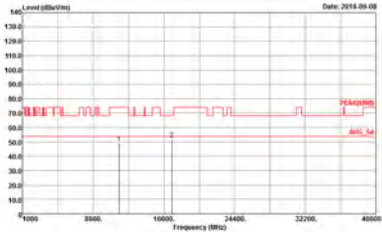

WIFI	Band 4 5725~5850MHz Harmonic @ 3m	
ANT	802.11a CH165 5825MHz	
1	Horizontal	Vertical
Peak Avg.	 <p>Site : 03C807-HY Condition : PEAK(0N11) 3m SHF-EHE_131829 HORIZONTAL Detector : Peak Project : 872508 Mode : 36</p>	 <p>Site : 03C807-HY Condition : PEAK(0N11) 3m SHF-EHE_131829 VERTICAL Detector : Peak Project : 872508 Mode : 36</p>



Band 4 5725~5850MHz
WIFI 802.11ac VHT20 (Harmonic @ 3m)

WIFI	Band 4 5725~5850MHz Harmonic @ 3m	
ANT	802.11ac VHT20 CH149 5745MHz	
1	Horizontal	Vertical
Peak Avg.	<p>Site : 01CH07-HY Condition : PEAK (UNIT) 3m SHF-EHE_131029 HORIZONTAL Detection : Peak Project : 872508 Mode : 37</p>	<p>Site : 01CH07-HY Condition : PEAK (UNIT) 3m SHF-EHE_131029 VERTICAL Detection : Peak Project : 872508 Mode : 37</p>



WIFI	Band 4 5725~5850MHz Harmonic @ 3m	
ANT	802.11ac VHT20 CH157 5785MHz	
1	Horizontal	Vertical
Peak Avg.	<p>Site : 03C807-HY Condition : PEAK(0N11) 3m SHF-EHE_131829 HORIZONTAL Detector : Peak Project : 872508 Mode : 18</p>	<p>Site : 03C807-HY Condition : PEAK(0N11) 3m SHF-EHE_131829 VERTICAL Detector : Peak Project : 872508 Mode : 18</p>

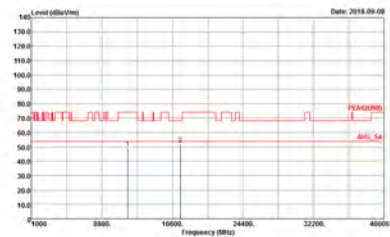
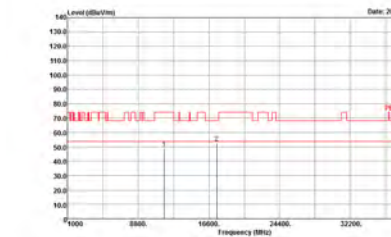

WIFI	Band 4 5725~5850MHz Harmonic @ 3m	
ANT	802.11ac VHT20 CH165 5825MHz	
1	Horizontal	Vertical
Peak Avg.	<div style="display: flex; justify-content: space-around;"> <div style="width: 45%;">  </div> <div style="width: 45%;">  </div> </div>	



**Band 4 5725~5850MHz
WIFI 802.11ac VHT40 (Harmonic @ 3m)**

WIFI	Band 4 5725~5850MHz Harmonic @ 3m	
ANT	802.11ac VHT40 CH151 5755MHz	
1	Horizontal	Vertical
<p>Peak</p> <p>Avg.</p>	<p>Site : 01CH07-HY Condition : PEAK (UNIT) 3m SHF-EHE_131029 HORIZONTAL Detection : Peak Project : 872508 Mode : 40</p>	<p>Site : 01CH07-HY Condition : PEAK (UNIT) 3m SHF-EHE_131029 VERTICAL Detection : Peak Project : 872508 Mode : 40</p>

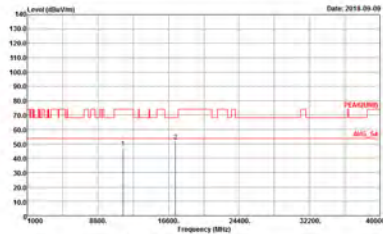
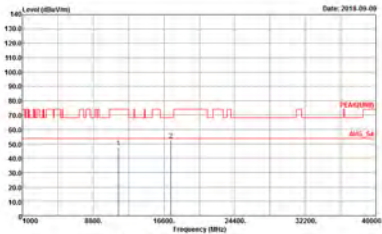

WIFI	Band 4 5725~5850MHz Harmonic @ 3m	
ANT	802.11ac VHT40 CH159 5795MHz	
1	Horizontal	Vertical
Peak Avg.	 <p>Site : 03C807-HY Condition : PEAK(0N11) 3m SHF-EHE_131829 HORIZONTAL Detector : Peak Project : 872508 Mode : 41</p>	 <p>Site : 03C807-HY Condition : PEAK(0N11) 3m SHF-EHE_131829 VERTICAL Detector : Peak Project : 872508 Mode : 41</p>



**Band 4 5725~5850MHz
WIFI 802.11ac VHT80 (Harmonic @ 3m)**

WIFI	Band 4 5725~5850MHz Harmonic @ 3m	
ANT	802.11ac VHT80 CH155 5775MHz	
1	Horizontal	Vertical
<p>Peak</p> <p>Avg.</p>	<p>Site : 01CH07-HY Condition : PEAK (UNIT) 3m SHF-EHE_131029 HORIZONTAL Detection : Peak Project : 872508 Mode : 42</p>	<p>Site : 01CH07-HY Condition : PEAK (UNIT) 3m SHF-EHE_131029 VERTICAL Detection : Peak Project : 872508 Mode : 42</p>



Emission below 1GHz
5GHz WIFI 802.11ac VHT80 (LF)

Table with 3 columns: WIFI (5GHz 5725~5850MHz), ANT (802.11ac VHT80 LF), and 1 (Horizontal/Vertical). It contains two spectral plots: Horizontal and Vertical. Each plot shows Level (dBuV/m) vs Frequency (MHz) with a peak labeled 'QP'. Metadata includes Site: 03CH07-HY, Condition: QP, Detector: Peak, Project: 872508, and Mode: 159.



Band 4 - 5725~5850MHz
WIFI 802.11a (Band Edge @ 3m)

WIFI	Band 4 5725~5850MHz Band Edge @ 3m	
ANT	802.11a CH149 5745MHz	
2	Horizontal	Fundamental
Peak	<p>Site : 03CH07-HY Condition : PEAK_RF(0.5) 16-24 3m HE_ANT_00066583 HORIZONTAL Detector : Peak Project : 872508 Mode : 75</p>	<p>Site : 03CH07-HY Condition : PEAK(0.1) 3m HE_ANT_00066583 HORIZONTAL Detector : Peak Project : 872508 Mode : 75</p>



WIFI	Band 4 5725~5850MHz Band Edge @ 3m	
ANT	802.11a CH149 5745MHz	
2	Vertical	Fundamental
Peak	<p>Site : 03CN07-HY Condition : PEAK_04(04)_16-24 @ HF_ANT_00066583 VERTICAL FDM: 1000.0000Hz VBM: 3000.0000Hz SMT: Auto Detector : Peak Project : 872508 Mode : 75</p>	<p>Site : 03CN07-HY Condition : PEAK_04(04)_16-24 @ HF_ANT_00066583 VERTICAL FDM: 1000.0000Hz VBM: 3000.0000Hz SMT: Auto Detector : Peak Project : 872508 Mode : 75</p>



WIFI	Band 4 5725~5850MHz Band Edge @ 3m	
ANT	802.11a CH157 5785MHz	
2	Horizontal	Fundamental
Peak	<p>Site : 03CN07-HY Condition : PEAK_B4(04)_16-24 3e HF_ANT_00066583 HORIZONTAL Detector : Peak Project : #72508 Mode : 77</p>	<p>Site : 03CN07-HY Condition : PEAK(FUN1) 3e HF_ANT_00066583 HORIZONTAL Detector : Peak Project : #72508 Mode : 77</p>
Peak	<p>Site : 03CN07-HY Condition : PEAK_B4(04)_16-24 3e HF_ANT_00066583 HORIZONTAL Detector : Peak Project : #72508 Mode : 77</p>	Left blank



WIFI	Band 4 5725~5850MHz Band Edge @ 3m	
ANT	802.11a CH157 5785MHz	
2	Vertical	Fundamental
Peak	<p>Site : 03CN07-HY Condition : PEAK_B4(04)_16-24 3e HF_ANT_00066583 VERTICAL Detector : Peak Project : #72508 Mode : 77</p>	<p>Site : 03CN07-HY Condition : PEAK(FUN1) 3e HF_ANT_00066583 VERTICAL Detector : Peak Project : #72508 Mode : 77</p>
Peak	<p>Site : 03CN07-HY Condition : PEAK_B4(04)_16-24 3e HF_ANT_00066583 VERTICAL Detector : Peak Project : #72508 Mode : 77</p>	Left blank



WIFI	Band 4 5725~5850MHz Band Edge @ 3m	
ANT	802.11a CH165 5825MHz	
2	Horizontal	Fundamental
Peak	<p>Site : 03CN07-HY Condition : PEAK_04(04)_16-24 3m HF_ANT_00066583 HORIZONTAL FDM:1000.000kHz VBM:3000.000kHz SMT:Auto Detector : Peak Project : 872508 Mode : 7E</p>	<p>Site : 03CN07-HY Condition : PEAK((011)) 3m HF_ANT_00066583 HORIZONTAL FDM:1000.000kHz VBM:3000.000kHz SMT:Auto Detector : Peak Project : 872508 Mode : 7E</p>



WIFI	Band 4 5725~5850MHz Band Edge @ 3m	
ANT	802.11a CH165 5825MHz	
2	Vertical	Fundamental
Peak	<p>Site : 03CN07-HY Condition : PEAK_04(04)_16-24 3m HF_ANT_00066583 VERTICAL Detector : Peak Project : 872508 Mode : 7E</p>	<p>Site : 03CN07-HY Condition : PEAK(011) 3m HF_ANT_00066583 VERTICAL Detector : Peak Project : 872508 Mode : 7E</p>



Band 4 5725~5850MHz
WIFI 802.11ac VHT20 (Band Edge @ 3m)

WIFI	Band 4 5725~5850MHz Band Edge @ 3m	
ANT	802.11ac VHT20 CH149 5745MHz	
2	Horizontal	Fundamental
Peak	<p>Site : 01CH07-HY Condition : PEAK_BI(04)_16-24 3e HF_ANT_00066583 HORIZONTAL : #f0e:1000.0000Hz VSW:3000.0000Hz SWT:Auto Detector : Peak Project : R22508 Mode : 79</p>	<p>Site : 01CH07-HY Condition : PEAK(UNI) 3e HF_ANT_00066583 HORIZONTAL : #f0e:1000.0000Hz VSW:3000.0000Hz SWT:Auto Detector : Peak Project : R22508 Mode : 79</p>



WIFI	Band 4 5725~5850MHz Band Edge @ 3m	
ANT	802.11ac VHT20 CH149 5745MHz	
2	Vertical	Fundamental
Peak Avg.	<p>Site : 03C807-HY Condition : PEAK_04(04)_16-24 3m HF_ANT_00066583 VERTICAL Deflection : Peak Project : 872508 Mode : 79</p>	<p>Site : 03C807-HY Condition : PEAK(011) 3m HF_ANT_00066583 VERTICAL Deflection : Peak Project : 872508 Mode : 79</p>



WIFI	Band 4 5725~5850MHz Band Edge @ 3m	
ANT	802.11ac VHT20 CH157 5785MHz	
2	Horizontal	Fundamental
Peak		
Peak		Left blank



WIFI	Band 4 5725~5850MHz Band Edge @ 3m	
ANT	802.11ac VHT20 CH157 5785MHz	
2	Vertical	Fundamental
Peak	<p>Site : 03CN07-HY Condition : PEAK_B4(04)_16-24 3e HF_ANT_00066583 VERTICAL Detector : Peak Project : 872508 Mode : BB</p>	<p>Site : 03CN07-HY Condition : PEAK(FUN1) 3e HF_ANT_00066583 VERTICAL Detector : Peak Project : 872508 Mode : BB</p>
Peak	<p>Site : 03CN07-HY Condition : PEAK_B4(04)_16-24 3e HF_ANT_00066583 VERTICAL Detector : Peak Project : 872508 Mode : BB</p>	Left blank



WIFI	Band 4 5725~5850MHz Band Edge @ 3m	
ANT	802.11ac VHT20 CH165 5825MHz	
2	Horizontal	Fundamental
Peak	<p>Site : 03CN07-HY Condition : PEAK_04(04)_16-24 3m HF_ANT_00066583 HORIZONTAL Deflection : Peak Project : 872508 Mode : 01</p>	<p>Site : 03CN07-HY Condition : PEAK((011)) 3m HF_ANT_00066583 HORIZONTAL Deflection : Peak Project : 872508 Mode : 01</p>



WIFI	Band 4 5725~5850MHz Band Edge @ 3m	
ANT	802.11ac VHT20 CH165 5825MHz	
2	Vertical	Fundamental
Peak Avg.	<p>Site : 03CN07-HY Condition : PEAK_04(04)_16-24 3m HE_ANT_00066583 VERTICAL Defector : Peak Project : 872508 Mode : 01</p>	<p>Site : 03CN07-HY Condition : PEAK(0011) 3m HE_ANT_00066583 VERTICAL Defector : Peak Project : 872508 Mode : 01</p>



Band 4 5725~5850MHz
WIFI 802.11ac VHT40 (Band Edge @ 3m)

WIFI	Band 4 5725~5850MHz Band Edge @ 3m	
ANT	802.11ac VHT40 CH151 5755MHz	
2	Horizontal	Fundamental
Peak	<p>Site : 01CH07-HY Condition : PEAK_BE(04)_16-24 3m HE_ANT_00066583 HORIZONTAL Detector : Peak Project : 872508 Mode : E2</p>	<p>Site : 01CH07-HY Condition : PEAK(UNIT) 3m HE_ANT_00066583 HORIZONTAL Detector : Peak Project : 872508 Mode : E2</p>
Peak	<p>Site : 01CH07-HY Condition : PEAK_BE(04)_16-24 3m HE_ANT_00066583 HORIZONTAL Detector : Peak Project : 872508 Mode : E2</p>	Left blank



WIFI	Band 4 5725~5850MHz Band Edge @ 3m	
ANT	802.11ac VHT40 CH151 5755MHz	
2	Vertical	Fundamental
Peak	<p>Site : 03CN07-HY Condition : PEAK_B4(04)_16-24 3e HF_ANT_00066583 VERTICAL Detector : Peak Project : 872508 Mode : E2</p>	<p>Site : 03CN07-HY Condition : PEAK(FUN1) 3e HF_ANT_00066583 VERTICAL Detector : Peak Project : 872508 Mode : E2</p>
Peak	<p>Site : 03CN07-HY Condition : PEAK_B4(04)_16-24 3e HF_ANT_00066583 VERTICAL Detector : Peak Project : 872508 Mode : E2</p>	Left blank



WIFI	Band 4 5725~5850MHz Band Edge @ 3m	
ANT	802.11ac VHT40 CH159 5795MHz	
2	Horizontal	Fundamental
Peak	<p>Site : 03CN07-HY Condition : PEAK_B4(04)_16-24 3m HF_ANT_00066583 HORIZONTAL FDM:1000.000kHz VBM:3000.000kHz SMT:Auto Detector : Peak Project : #72508 Mode : BT</p>	<p>Site : 03CN07-HY Condition : PEAK(FUN1)_3m HF_ANT_00066583 HORIZONTAL FDM:1000.000kHz VBM:3000.000kHz SMT:Auto Detector : Peak Project : #72508 Mode : BT</p>
Peak	<p>Site : 03CN07-HY Condition : PEAK_B4(04)_16-24 3m HF_ANT_00066583 HORIZONTAL FDM:1000.000kHz VBM:3000.000kHz SMT:Auto Detector : Peak Project : #72508 Mode : BT</p>	Left blank



WIFI	Band 4 5725~5850MHz Band Edge @ 3m	
ANT	802.11ac VHT40 CH159 5795MHz	
2	Vertical	Fundamental
Peak	<p>Site : 03CN07-HY Condition : PEAK_B4(04)_16-24 3e HF_ANT_00066583 VERTICAL Detector : Peak Project : #72508 Mode : BT</p>	<p>Site : 03CN07-HY Condition : PEAK(FUN1)_3e HF_ANT_00066583 VERTICAL Detector : Peak Project : #72508 Mode : BT</p>
Peak	<p>Site : 03CN07-HY Condition : PEAK_B4(04)_16-24 3e HF_ANT_00066583 VERTICAL Detector : Peak Project : #72508 Mode : BT</p>	Left blank



Band 4 5725~5850MHz
WIFI 802.11ac VHT80 (Band Edge @ 3m)

WIFI	Band 4 5725~5850MHz Band Edge @ 3m	
ANT	802.11ac VHT80 CH155 5775MHz	
2	Horizontal	Fundamental
Peak	<p>Site : 01CH07-HY Condition : PEAK_02(04)_16-24 3m HE_ANT_00066583 HORIZONTAL FIM: 1000.000kHz VSM: 3000.000kHz SMT: Auto Detector : Peak Project : R22508 Mode : E4</p>	<p>Site : 01CH07-HY Condition : PEAK(000) 3m HE_ANT_00066583 HORIZONTAL FIM: 1000.000kHz VSM: 3000.000kHz SMT: Auto Detector : Peak Project : R22508 Mode : E4</p>
Peak	<p>Site : 01CH07-HY Condition : PEAK_02(04)_16-24 3m HE_ANT_00066583 HORIZONTAL FIM: 1000.000kHz VSM: 3000.000kHz SMT: Auto Detector : Peak Project : R22508 Mode : E4</p>	Left blank



WIFI	Band 4 5725~5850MHz Band Edge @ 3m	
ANT	802.11ac VHT80 CH155 5775MHz	
2	Vertical	Fundamental
Peak	<p>Site : 03CN07-HY Condition : PEAK_B4(04)_16-24 3e HE_ANT_00066583 VERTICAL Detector : Peak Project : #22508 Mode : E4</p>	<p>Site : 03CN07-HY Condition : PEAK(FUN1) 3e HE_ANT_00066583 VERTICAL Detector : Peak Project : #22508 Mode : E4</p>
Peak	<p>Site : 03CN07-HY Condition : PEAK_B4(04)_16-24 3e HE_ANT_00066583 VERTICAL Detector : Peak Project : #22508 Mode : E4</p>	Left blank



Band 4 - 5725~5850MHz
WIFI 802.11a (Harmonic @ 3m)

Table with 2 columns: Horizontal and Vertical. Each column contains a spectrum plot showing Level (dBuV/m) vs Frequency (MHz) with a peak at 5745 MHz. Includes metadata like Site, Condition, Detector, Project, and Mode.

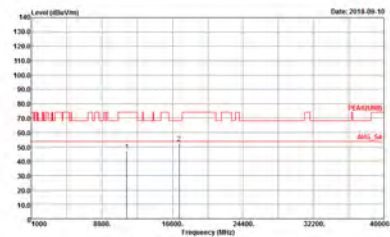
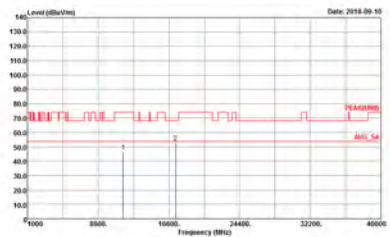

WIFI	Band 4 5725~5850MHz Harmonic @ 3m	
ANT	802.11a CH157 5785MHz	
2	Horizontal	Vertical
Peak Avg.	 <p>Site : 03C807-HY Condition : PEAK(0N11) 3m SHF-EHE_131829 HORIZONTAL Detector : Peak Project : 872508 Mode : 77</p>	 <p>Site : 03C807-HY Condition : PEAK(0N11) 3m SHF-EHE_131829 VERTICAL Detector : Peak Project : 872508 Mode : 77</p>

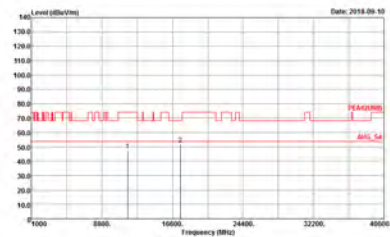
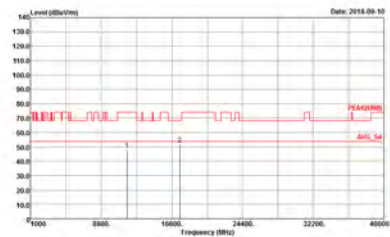

WIFI	Band 4 5725~5850MHz Harmonic @ 3m	
ANT	802.11a CH165 5825MHz	
2	Horizontal	Vertical
Peak Avg.	 <p>Site : 03C807-HY Condition : PEAK(0N11) 3m SHF-EHF_131829 HORIZONTAL Detector : Peak Project : 872508 Mode : FS</p>	 <p>Site : 03C807-HY Condition : PEAK(0N11) 3m SHF-EHF_131829 VERTICAL Detector : Peak Project : 872508 Mode : FS</p>



**Band 4 5725~5850MHz
WIFI 802.11ac VHT20 (Harmonic @ 3m)**

WIFI	Band 4 5725~5850MHz Harmonic @ 3m	
ANT	802.11ac VHT20 CH149 5745MHz	
2	Horizontal	Vertical
Peak Avg.	<p>Site : 01CH07-HY Condition : PEAK (UNIT) 3m SHF-EHE_131029 HORIZONTAL Detection : Peak Project : 872508 Mode : 79</p>	<p>Site : 01CH07-HY Condition : PEAK (UNIT) 3m SHF-EHE_131029 VERTICAL Detection : Peak Project : 872508 Mode : 79</p>

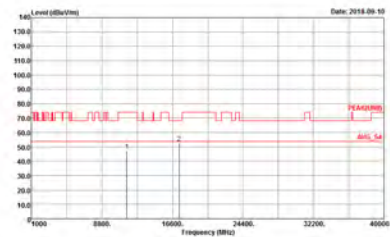
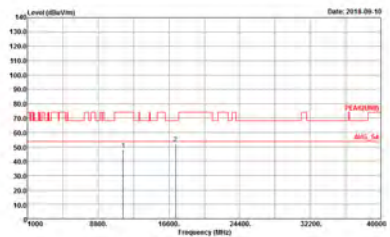

WIFI	Band 4 5725~5850MHz Harmonic @ 3m	
ANT	802.11ac VHT20 CH157 5785MHz	
2	Horizontal	Vertical
Peak Avg.	 <p>Site : 03C807-HY Condition : PEAK(0N11) 3m SHF-EHE_131829 HORIZONTAL Detector : Peak Project : 872508 Mode : 80</p>	 <p>Site : 03C807-HY Condition : PEAK(0N11) 3m SHF-EHE_131829 VERTICAL Detector : Peak Project : 872508 Mode : 80</p>

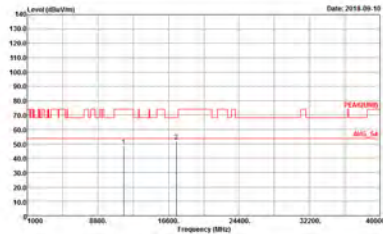
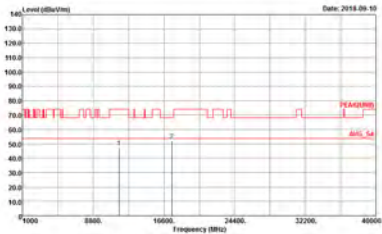

WIFI	Band 4 5725~5850MHz Harmonic @ 3m	
ANT	802.11ac VHT20 CH165 5825MHz	
2	Horizontal	Vertical
Peak Avg.	 <p>Site : 03C807-HY Condition : PEAK(0N11) 3m SHF-EHF_131829 HORIZONTAL Detector : Peak Project : 872508 Mode : #1</p>	 <p>Site : 03C807-HY Condition : PEAK(0N11) 3m SHF-EHF_131829 VERTICAL Detector : Peak Project : 872508 Mode : #1</p>



**Band 4 5725~5850MHz
WIFI 802.11ac VHT40 (Harmonic @ 3m)**

WIFI	Band 4 5725~5850MHz Harmonic @ 3m	
ANT	802.11ac VHT40 CH151 5755MHz	
2	Horizontal	Vertical
Peak Avg.	<p>Site : 01CH07-HY Condition : PEAK (UNIT) 3m SHF-EHE_131029 HORIZONTAL Detection : Peak Project : 072508 Mode : R2</p>	<p>Site : 01CH07-HY Condition : PEAK (UNIT) 3m SHF-EHE_131029 VERTICAL Detection : Peak Project : 072508 Mode : R2</p>

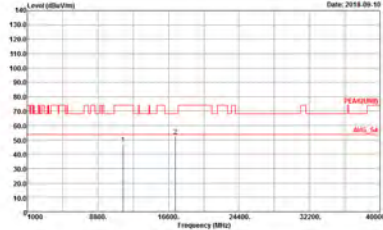
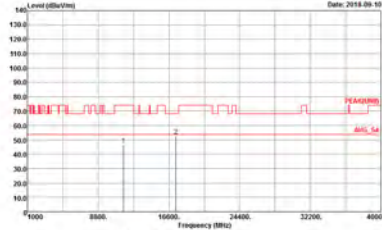

WIFI	Band 4 5725~5850MHz Harmonic @ 3m	
ANT	802.11ac VHT40 CH159 5795MHz	
2	Horizontal	Vertical
Peak Avg.	 <p>Site : 03C807-HY Condition : PEAK(0N11) 3m SHF-EHE_131829 HORIZONTAL Detector : Peak Project : 872508 Mode : #3</p>	 <p>Site : 03C807-HY Condition : PEAK(0N11) 3m SHF-EHE_131829 VERTICAL Detector : Peak Project : 872508 Mode : #3</p>



**Band 4 5725~5850MHz
WIFI 802.11ac VHT80 (Harmonic @ 3m)**

WIFI	Band 4 5725~5850MHz Harmonic @ 3m	
ANT	802.11ac VHT80 CH155 5775MHz	
2	Horizontal	Vertical
Peak Avg.	<p>Site : 01CH07-HY Condition : PEAK (UNIT) 3m SHF-EHE_131029 HORIZONTAL Detection : Peak Project : 872508 Mode : 84</p>	<p>Site : 01CH07-HY Condition : PEAK (UNIT) 3m SHF-EHE_131029 VERTICAL Detection : Peak Project : 872508 Mode : 84</p>



Emission below 1GHz
5GHz WIFI 802.11ac VHT80 (LF)

WIFI	5GHz 5725~5850MHz	
ANT	802.11ac VHT80 LF	
2	Horizontal	Vertical
QP / Peak	<p>Site : 03SCH07-HY Condition : QP Detector : Peak Project : 872508 Mode : 101</p>	<p>Site : 03SCH07-HY Condition : QP Detector : Peak Project : 872508 Mode : 101</p>



Band 4 - 5725~5850MHz
WIFI 802.11a (Band Edge @ 3m)

WIFI	Band 4 5725~5850MHz Band Edge @ 3m	
ANT	802.11a CH149 5745MHz	
1+2	Horizontal	Fundamental
Peak	<p>Site : 03CM07-HY Condition : PEAK_01 (04) 16-24 3m HE_ANT_00066583 HORIZONTAL Detector : Peak Project : 872508 Mode : 147</p>	<p>Site : 03CM07-HY Condition : PEAK(011) 3m HE_ANT_00066583 HORIZONTAL Detector : Peak Project : 872508 Mode : 147</p>



WIFI	Band 4 5725~5850MHz Band Edge @ 3m	
ANT	802.11a CH149 5745MHz	
1+2	Vertical	Fundamental
Peak	<p>Site : 03CN07-HY Condition : PEAK_04(04)_16-24 3m HF_ANT_00066583 VERTICAL Defector : Peak Project : 872508 Mode : 147</p>	<p>Site : 03CN07-HY Condition : PEAK(0411) 3m HF_ANT_00066583 VERTICAL Defector : Peak Project : 872508 Mode : 147</p>



WIFI	Band 4 5725~5850MHz Band Edge @ 3m	
ANT	802.11a CH157 5785MHz	
1+2	Horizontal	Fundamental
Peak	<p>Site : 03CN07-HY Condition : PEAK_B0(04)_16-24 3m HF_ANT_00066583 HORIZONTAL Detector : Peak Project : #72508 Mode : 147</p>	<p>Site : 03CN07-HY Condition : PEAK(0111) 3m HF_ANT_00066583 HORIZONTAL Detector : Peak Project : #72508 Mode : 147</p>
Peak	<p>Site : 03CN07-HY Condition : PEAK_B0(04)_16-24 3m HF_ANT_00066583 HORIZONTAL Detector : Peak Project : #72508 Mode : 147</p>	Left blank



WIFI	Band 4 5725~5850MHz Band Edge @ 3m	
ANT	802.11a CH157 5785MHz	
1+2	Vertical	Fundamental
Peak	<p>Site : 03CN07-HY Condition : PEAK_B4(04)_16-24 3e HF_ANT_00066583 VERTICAL Detector : Peak Project : #72508 Mode : 147</p>	<p>Site : 03CN07-HY Condition : PEAK(FUN1) 3e HF_ANT_00066583 VERTICAL Detector : Peak Project : #72508 Mode : 147</p>
Peak	<p>Site : 03CN07-HY Condition : PEAK_B4(04)_16-24 3e HF_ANT_00066583 VERTICAL Detector : Peak Project : #72508 Mode : 147</p>	Left blank

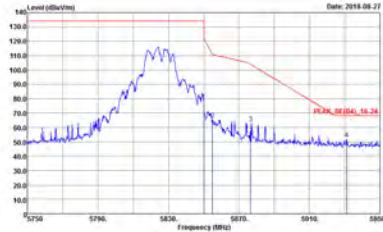
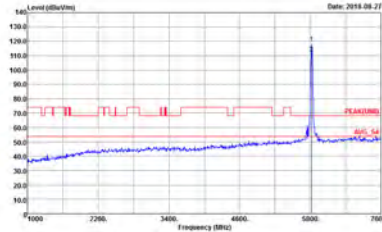

WIFI	Band 4 5725~5850MHz Band Edge @ 3m	
ANT	802.11a CH165 5825MHz	
1+2	Horizontal	Fundamental
Peak	 <p>Site : 03CN07-HY Condition : PEAK_B4(04)_16-24 3m HE_ANT_00066583 HORIZONTAL FDM:1000.000kHz VBM:3000.000kHz SMT:Auto Detector : Peak Project : 872508 Mode : 149</p>	 <p>Site : 03CN07-HY Condition : PEAK((H1)) 3m HE_ANT_00066583 HORIZONTAL FDM:1000.000kHz VBM:3000.000kHz SMT:Auto Detector : Peak Project : 872508 Mode : 149</p>



WIFI	Band 4 5725~5850MHz Band Edge @ 3m	
ANT	802.11a CH165 5825MHz	
1+2	Vertical	Fundamental
Peak	<p>Site : 03CN07-HY Condition : PEAK_04(04)_16-24 3m HF_ANT_00066583 VERTICAL Deflection : Peak Project : 872508 Mode : 149</p>	<p>Site : 03CN07-HY Condition : PEAK(011) 3m HF_ANT_00066583 VERTICAL Deflection : Peak Project : 872508 Mode : 149</p>



Band 4 5725~5850MHz
WIFI 802.11ac VHT20 (Band Edge @ 3m)

Table with 2 columns: WIFI, ANT. Row 1: Band 4 5725~5850MHz Band Edge @ 3m. Row 2: 802.11ac VHT20 CH149 5745MHz. Row 3: 1+2, Horizontal, Fundamental. Row 4: Peak, [Graphs and Metadata]



WIFI	Band 4 5725~5850MHz Band Edge @ 3m	
ANT	802.11ac VHT20 CH149 5745MHz	
1+2	Vertical	Fundamental
Peak Avg.	<p>Site : 03C807-HY Condition : PEAK_04(04)_16-24 3m HF_ANT_00066583 VERTICAL FDM:1000.0000Hz VBM:3000.0000Hz SMT:Auto Detector : Peak Project : 872508 Mode : E5B</p>	<p>Site : 03C807-HY Condition : PEAK(0011) 3m HF_ANT_00066583 VERTICAL FDM:1000.0000Hz VBM:3000.0000Hz SMT:Auto Detector : Peak Project : 872508 Mode : E5B</p>



WIFI	Band 4 5725~5850MHz Band Edge @ 3m	
ANT	802.11ac VHT20 CH157 5785MHz	
1+2	Horizontal	Fundamental
Peak	<p>Site : 03CN07-HY Condition : PEAK_B4(04)_16-24 3e HF_ANT_00066583 HORIZONTAL Detector : Peak Project : 872508 Mode : IS1</p>	<p>Site : 03CN07-HY Condition : PEAK(FUN1)_3e HF_ANT_00066583 HORIZONTAL Detector : Peak Project : 872508 Mode : IS1</p>
Peak	<p>Site : 03CN07-HY Condition : PEAK_B4(04)_16-24 3e HF_ANT_00066583 HORIZONTAL Detector : Peak Project : 872508 Mode : IS1</p>	Left blank



WIFI	Band 4 5725~5850MHz Band Edge @ 3m	
ANT	802.11ac VHT20 CH157 5785MHz	
1+2	Vertical	Fundamental
Peak	<p>Site : 03CN07-HY Condition : PEAK_B4(04)_16-24 3e HF_ANT_00066583 VERTICAL Detector : Peak Project : 872508 Mode : IS1</p>	<p>Site : 03CN07-HY Condition : PEAK(FUN1) 3e HF_ANT_00066583 VERTICAL Detector : Peak Project : 872508 Mode : IS1</p>
Peak	<p>Site : 03CN07-HY Condition : PEAK_B4(04)_16-24 3e HF_ANT_00066583 VERTICAL Detector : Peak Project : 872508 Mode : IS1</p>	Left blank



WIFI	Band 4 5725~5850MHz Band Edge @ 3m	
ANT	802.11ac VHT20 CH165 5825MHz	
1+2	Horizontal	Fundamental
Peak	<p>Site : 03C807-HY Condition : PEAK_B6(04)_16-24 3m HF_ANT_00066583 HORIZONTAL FDM:1000.000kHz VBM:3000.000kHz SMT:Auto Defector : Peak Project : 872508 Mode : 152</p>	<p>Site : 03C807-HY Condition : PEAK((011)) 3m HF_ANT_00066583 HORIZONTAL FDM:1000.000kHz VBM:3000.000kHz SMT:Auto Defector : Peak Project : 872508 Mode : 152</p>



WIFI	Band 4 5725~5850MHz Band Edge @ 3m	
ANT	802.11ac VHT20 CH165 5825MHz	
1+2	Vertical	Fundamental
Peak Avg.	<p>Site : 03CN07-HY Condition : PEAK_04(04)_16-24 3m HF_ANT_00066583 VERTICAL Deflection : Peak Project : 872508 Mode : 152</p>	<p>Site : 03CN07-HY Condition : PEAK(0011) 3m HF_ANT_00066583 VERTICAL Deflection : Peak Project : 872508 Mode : 152</p>



Band 4 5725~5850MHz
WIFI 802.11ac VHT40 (Band Edge @ 3m)

WIFI	Band 4 5725~5850MHz Band Edge @ 3m	
ANT	802.11ac VHT40 CH151 5755MHz	
1+2	Horizontal	Fundamental
Peak	<p>Site : 01CH07-HY Condition : PEAK_BE(04)_16-24 3m HE_ANT_00066583 HORIZONTAL Detector : Peak Project : R72508 Mode : IS3</p>	<p>Site : 01CH07-HY Condition : PEAK((011)) 3m HE_ANT_00066583 HORIZONTAL Detector : Peak Project : R72508 Mode : IS3</p>
Peak	<p>Site : 01CH07-HY Condition : PEAK_BE(04)_16-24 3m HE_ANT_00066583 HORIZONTAL Detector : Peak Project : R72508 Mode : IS3</p>	Left blank



WIFI	Band 4 5725~5850MHz Band Edge @ 3m	
ANT	802.11ac VHT40 CH151 5755MHz	
1+2	Vertical	Fundamental
Peak	<p>Site : 03CN07-HY Condition : PEAK_B4(04)_16-24 3e HF_ANT_00066583 VERTICAL FBM:1000.0000Hz VBM:3000.0000Hz SMT:Auto Detector : Peak Project : 872508 Mode : 153</p>	<p>Site : 03CN07-HY Condition : PEAK(0011) 3e HF_ANT_00066583 VERTICAL FBM:1000.0000Hz VBM:3000.0000Hz SMT:Auto Detector : Peak Project : 872508 Mode : 153</p>
Peak	<p>Site : 03CN07-HY Condition : PEAK_B4(04)_16-24 3e HF_ANT_00066583 VERTICAL FBM:1000.0000Hz VBM:3000.0000Hz SMT:Auto Detector : Peak Project : 872508 Mode : 153</p>	Left blank



WIFI	Band 4 5725~5850MHz Band Edge @ 3m	
ANT	802.11ac VHT40 CH159 5795MHz	
1+2	Horizontal	Fundamental
Peak	<p>Site : 03CN07-HY Condition : PEAK_B4(04)_16-24 3e HF_ANT_00066583 HORIZONTAL Detector : Peak Project : #72508 Mode : 154</p>	<p>Site : 03CN07-HY Condition : PEAK(FUN1) 3e HF_ANT_00066583 HORIZONTAL Detector : Peak Project : #72508 Mode : 154</p>
Peak	<p>Site : 03CN07-HY Condition : PEAK_B4(04)_16-24 3e HF_ANT_00066583 HORIZONTAL Detector : Peak Project : #72508 Mode : 154</p>	Left blank



WIFI	Band 4 5725~5850MHz Band Edge @ 3m	
ANT	802.11ac VHT40 CH159 5795MHz	
1+2	Vertical	Fundamental
Peak	<p>Site : 03CN07-HY Condition : PEAK_B4(04)_16-24 3m HF_ANT_00066583 VERTICAL FREQ: 1000.0000Hz VSW: 3000.0000Hz SMT: Auto Detector : Peak Project : #72508 Mode : 154</p>	<p>Site : 03CN07-HY Condition : PEAK(FUN1) 3m HF_ANT_00066583 VERTICAL FREQ: 1000.0000Hz VSW: 3000.0000Hz SMT: Auto Detector : Peak Project : #72508 Mode : 154</p>
Peak	<p>Site : 03CN07-HY Condition : PEAK_B4(04)_16-24 3m HF_ANT_00066583 VERTICAL FREQ: 1000.0000Hz VSW: 3000.0000Hz SMT: Auto Detector : Peak Project : #72508 Mode : 154</p>	Left blank



Band 4 5725~5850MHz
WIFI 802.11ac VHT80 (Band Edge @ 3m)

WIFI	Band 4 5725~5850MHz Band Edge @ 3m	
ANT	802.11ac VHT80 CH155 5775MHz	
1+2	Horizontal	Fundamental
Peak	<p>Site : 01CH07-HY Condition : PEAK_BE(04)_16-24 3m HE_ANT_00066583 HORIZONTAL Detector : Peak Project : R72508 Mode : ISS</p>	<p>Site : 01CH07-HY Condition : PEAK(UNIT) 3m HE_ANT_00066583 HORIZONTAL Detector : Peak Project : R72508 Mode : ISS</p>
Peak	<p>Site : 01CH07-HY Condition : PEAK_BE(04)_16-24 3m HE_ANT_00066583 HORIZONTAL Detector : Peak Project : R72508 Mode : ISS</p>	Left blank



WIFI	Band 4 5725~5850MHz Band Edge @ 3m	
ANT	802.11ac VHT80 CH155 5775MHz	
1+2	Vertical	Fundamental
Peak	<p>Site : 03CN07-HY Condition : PEAK_B0(04)_16-24 3m HF_ANT_00066583 VERTICAL Detector : Peak Project : 872508 Mode : 155</p>	<p>Site : 03CN07-HY Condition : PEAK(0011) 3m HF_ANT_00066583 VERTICAL Detector : Peak Project : 872508 Mode : 155</p>
Peak	<p>Site : 03CN07-HY Condition : PEAK_B0(04)_16-24 3m HF_ANT_00066583 VERTICAL Detector : Peak Project : 872508 Mode : 155</p>	Left blank



Band 4 - 5725~5850MHz
WIFI 802.11a (Harmonic @ 3m)

Table with 3 columns: WIFI, ANT, and 1+2. The 1+2 column is split into Horizontal and Vertical sub-columns. Each sub-column contains a spectral plot showing Level (dBuV/m) vs Frequency (MHz) with a peak at 5745 MHz. Metadata includes Site: 03CM07-HY, Condition: PEAK(RN11) 3m SHF-EHF_131029, Detector: Peak, Project: 872508, and Mode: 1A7.



WIFI	Band 4 5725~5850MHz Harmonic @ 3m	
ANT	802.11a CH157 5785MHz	
1+2	Horizontal	Vertical
Peak Avg.	<p>Site : 03C807-HY Condition : PEAK(0N11) 3m SHF-EHF_131829 HORIZONTAL Detector : Peak Project : 872508 Mode : S4B</p>	<p>Site : 03C807-HY Condition : PEAK(0N11) 3m SHF-EHF_131829 VERTICAL Detector : Peak Project : 872508 Mode : S4B</p>

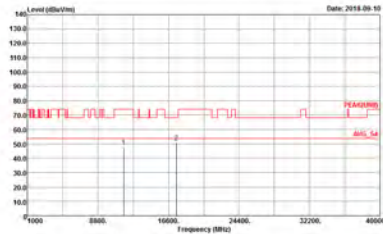
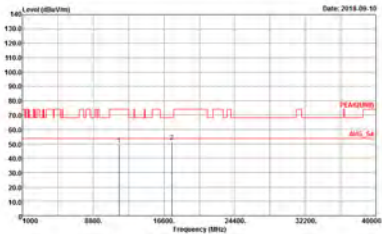

WIFI	Band 4 5725~5850MHz Harmonic @ 3m	
ANT	802.11a CH165 5825MHz	
1+2	Horizontal	Vertical
Peak Avg.	 <p>Site : 03C807-HY Condition : PEAK(0N11) 3m SHF-EHF_131829 HORIZONTAL Detector : Peak Project : 872508 Mode : 149</p>	 <p>Site : 03C807-HY Condition : PEAK(0N11) 3m SHF-EHF_131829 VERTICAL Detector : Peak Project : 872508 Mode : 149</p>



**Band 4 5725~5850MHz
WIFI 802.11ac VHT20 (Harmonic @ 3m)**

WIFI	Band 4 5725~5850MHz Harmonic @ 3m	
ANT	802.11ac VHT20 CH149 5745MHz	
1+2	Horizontal	Vertical
Peak Avg.	<p>Site : 03CH07-HY Condition : PEAK (UNIT) 3m SHF-EHE_131029 HORIZONTAL Detector : Peak Project : 072508 Mode : 150</p>	<p>Site : 03CH07-HY Condition : PEAK (UNIT) 3m SHF-EHE_131029 VERTICAL Detector : Peak Project : 072508 Mode : 150</p>

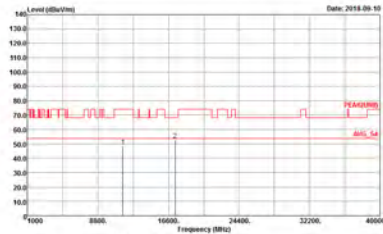
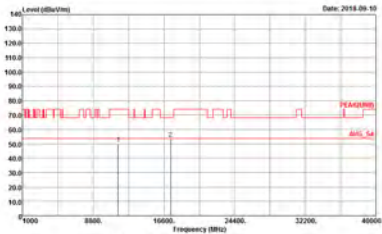

WIFI	Band 4 5725~5850MHz Harmonic @ 3m	
ANT	802.11ac VHT20 CH157 5785MHz	
1+2	Horizontal	Vertical
Peak Avg.	 <p>Site : 03CM07-HY Condition : PEAK(0N11) 3m SHF-EHE_131029 HORIZONTAL Detector : Peak Project : 872508 Mode : 151</p>	 <p>Site : 03CM07-HY Condition : PEAK(0N11) 3m SHF-EHE_131029 VERTICAL Detector : Peak Project : 872508 Mode : 151</p>

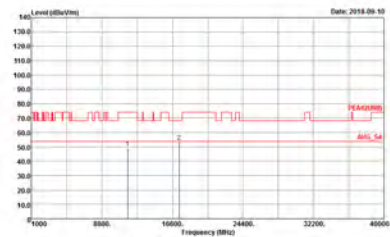
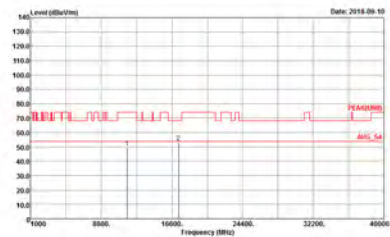

WIFI	Band 4 5725~5850MHz Harmonic @ 3m	
ANT	802.11ac VHT20 CH165 5825MHz	
1+2	Horizontal	Vertical
<p>Peak</p> <p>Avg.</p>	 <p>Site : 03CM07-HY Condition : PEAK(0N11) 3m SHF-EHE_131029 HORIZONTAL Detector : Peak Project : 872508 Mode : 152</p>	 <p>Site : 03CM07-HY Condition : PEAK(0N11) 3m SHF-EHE_131029 VERTICAL Detector : Peak Project : 872508 Mode : 152</p>

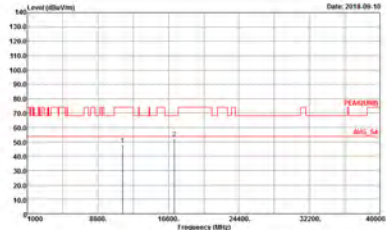
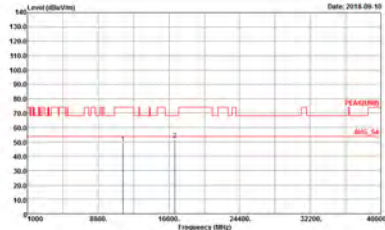

**Band 4 5725~5850MHz
WIFI 802.11ac VHT40 (Harmonic @ 3m)**

WIFI	Band 4 5725~5850MHz Harmonic @ 3m	
ANT	802.11ac VHT40 CH151 5755MHz	
1+2	Horizontal	Vertical
<p>Peak Avg.</p>	 <p>Site : 03CH07-HY Condition : PEAK (UNIT) 3m SHF-EHE_131029 HORIZONTAL Detection : Peak Project : 072508 Mode : 15.1</p>	 <p>Site : 03CH07-HY Condition : PEAK (UNIT) 3m SHF-EHE_131029 VERTICAL Detection : Peak Project : 072508 Mode : 15.1</p>

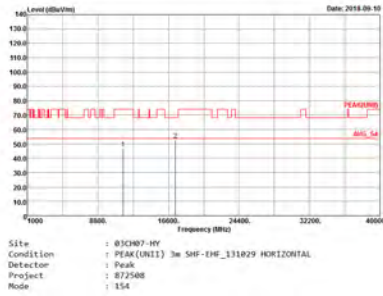
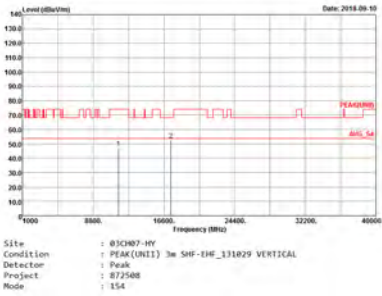

WIFI	Band 4 5725~5850MHz Harmonic @ 3m	
ANT	802.11ac VHT40 CH159 5795MHz	
1+2	Horizontal	Vertical
Peak Avg.		

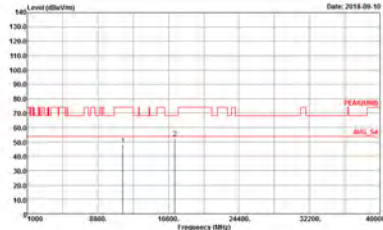
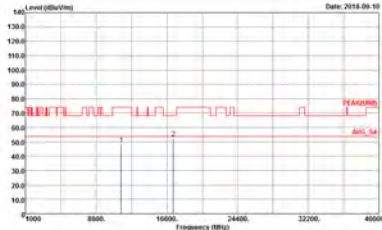

**Band 4 5725~5850MHz
WIFI 802.11ac VHT80 (Harmonic @ 3m)**

WIFI	Band 4 5725~5850MHz Harmonic @ 3m	
ANT	802.11ac VHT80 CH155 5775MHz	
1+2	Horizontal	Vertical
<p>Peak Avg.</p>	 <p>Site : 01CH07-HY Condition : PEAK (UNIT) 3m SHF-EHE_131029 HORIZONTAL Detection : Peak Project : 072508 Mode : 155</p>	 <p>Site : 01CH07-HY Condition : PEAK (UNIT) 3m SHF-EHE_131029 VERTICAL Detection : Peak Project : 072508 Mode : 155</p>



Emission below 1GHz
5GHz WIFI 802.11ac VHT80 (LF)

WIFI	5GHz 5725~5850MHz	
ANT	802.11ac VHT80 LF	
1+2	Horizontal	Vertical
QP / Peak		



<TXBF Mode>

Band 4 - 5725~5850MHz
WIFI 802.11ac VHT20 (Band Edge @ 3m)

WIFI	Band 4 5725~5850MHz Band Edge @ 3m	
ANT	802.11ac VHT20 CH149 5745MHz	
1+2	Horizontal	Fundamental
Peak	<p>Site : 03CH07-HY Condition : PEAK_RF (0.5) 16-24 3m HF_ANT_00066583 HORIZONTAL FBM: 1000.000kHz VSM: 3000.000kHz SMT: Auto Detector : Peak Project : 872508 Mode : 10S</p>	<p>Site : 03CH07-HY Condition : PEAK (0.5) 3m HF_ANT_00066583 HORIZONTAL FBM: 1000.000kHz VSM: 3000.000kHz SMT: Auto Detector : Peak Project : 872508 Mode : 10S</p>

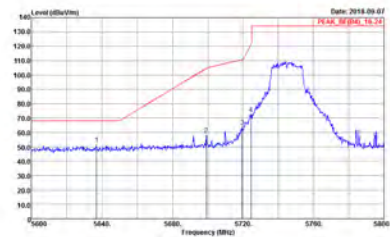
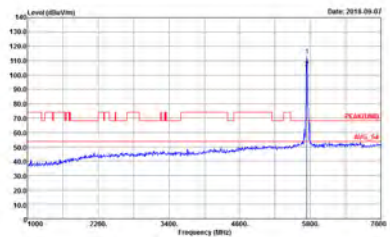

WIFI	Band 4 5725~5850MHz Band Edge @ 3m	
ANT	802.11ac VHT20 CH149 5745MHz	
1+2	Vertical	Fundamental
Peak Avg.	 <p>Site : 03C807-HY Condition : PEAK_04(04)_16-24 3m HF_ANT_00066583 VERTICAL FDM: 1000.0000Hz VBM: 3000.0000Hz SMT: Auto Detector : Peak Project : 872508 Mode : 10B</p>	 <p>Site : 03C807-HY Condition : PEAK(011) 3m HF_ANT_00066583 VERTICAL FDM: 1000.0000Hz VBM: 3000.0000Hz SMT: Auto Detector : Peak Project : 872508 Mode : 10B</p>



WIFI	Band 4 5725~5850MHz Band Edge @ 3m	
ANT	802.11ac VHT20 CH157 5785MHz	
1+2	Horizontal	Fundamental
Peak	<p>Site : 03CN07-HY Condition : PEAK_B4(04)_16-24 3e HE_ANT_00066583 HORIZONTAL Detector : Peak Project : 872508 Mode : 109</p>	<p>Site : 03CN07-HY Condition : PEAK(FUN1) 3e HE_ANT_00066583 HORIZONTAL Detector : Peak Project : 872508 Mode : 109</p>
Peak	<p>Site : 03CN07-HY Condition : PEAK_B4(04)_16-24 3e HE_ANT_00066583 HORIZONTAL Detector : Peak Project : 872508 Mode : 109</p>	Left blank



WIFI	Band 4 5725~5850MHz Band Edge @ 3m	
ANT	802.11ac VHT20 CH157 5785MHz	
1+2	Vertical	Fundamental
<p>Peak</p>	<p>Site : 03CN07-HY Condition : PEAK_B4(04)_16-24 3e HF_ANT_00066583 VERTICAL Detector : Peak Project : 872508 Mode : 109</p>	<p>Site : 03CN07-HY Condition : PEAK(FUN1) 3e HF_ANT_00066583 VERTICAL Detector : Peak Project : 872508 Mode : 109</p>
<p>Peak</p>	<p>Site : 03CN07-HY Condition : PEAK_B4(04)_16-24 3e HF_ANT_00066583 VERTICAL Detector : Peak Project : 872508 Mode : 109</p>	<p>Left blank</p>

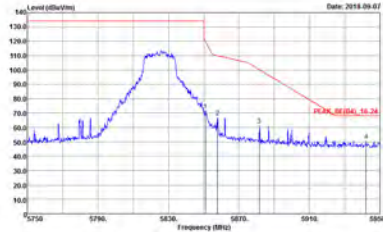
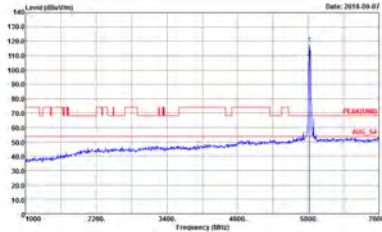

WIFI	Band 4 5725~5850MHz Band Edge @ 3m	
ANT	802.11ac VHT20 CH165 5825MHz	
1+2	Horizontal	Fundamental
Peak	 <p>Site : 03CN07-HY Condition : PEAK_04(04)_16-24 3m HF_ANT_00066583 HORIZONTAL Detector : Peak Project : 872508 Mode : 110</p>	 <p>Site : 03CN07-HY Condition : PEAK(0111) 3m HF_ANT_00066583 HORIZONTAL Detector : Peak Project : 872508 Mode : 110</p>



WIFI	Band 4 5725~5850MHz Band Edge @ 3m	
ANT	802.11ac VHT20 CH165 5825MHz	
1+2	Vertical	Fundamental
Peak Avg.	<div style="display: flex; justify-content: space-around;"> <div style="width: 45%;"> <p>Site : 03C007-HY Condition : PEAK_04(04)_16-24 3m HF_ANT_00066583 VERTICAL FDM:1000.0000Hz VSM:3000.0000Hz SMT:Auto Detector : Peak Project : 872508 Mode : 110</p> </div> <div style="width: 45%;"> <p>Site : 03C007-HY Condition : PEAK(0011) 3m HF_ANT_00066583 VERTICAL FDM:1000.0000Hz VSM:3000.0000Hz SMT:Auto Detector : Peak Project : 872508 Mode : 110</p> </div> </div>	



Band 4 5725~5850MHz
WIFI 802.11ac VHT40 (Band Edge @ 3m)

WIFI	Band 4 5725~5850MHz Band Edge @ 3m	
ANT	802.11ac VHT40 CH151 5755MHz	
1+2	Horizontal	Fundamental
Peak	<p>Site : 01CH07-HY Condition : PEAK_BE(04)_16-24 3m HF_ANT_00066583 HORIZONTAL Detector : Peak Project : 872508 Mode : III</p>	<p>Site : 01CH07-HY Condition : PEAK(UNIT) 3m HF_ANT_00066583 HORIZONTAL Detector : Peak Project : 872508 Mode : III</p>
Peak	<p>Site : 01CH07-HY Condition : PEAK_BE(04)_16-24 3m HF_ANT_00066583 HORIZONTAL Detector : Peak Project : 872508 Mode : III</p>	Left blank



WIFI	Band 4 5725~5850MHz Band Edge @ 3m	
ANT	802.11ac VHT40 CH151 5755MHz	
1+2	Vertical	Fundamental
<p>Peak</p>	<p>Site : 03CN07-HY Condition : PEAK_B(04)_16-24 3e HF_ANT_00066583 VERTICAL FDM:1000.0000Hz VBM:3000.0000Hz SMT:Auto Detector : Peak Project : 872508 Mode : III</p>	<p>Site : 03CN07-HY Condition : PEAK(U011) 3e HF_ANT_00066583 VERTICAL FDM:1000.0000Hz VBM:3000.0000Hz SMT:Auto Detector : Peak Project : 872508 Mode : III</p>
<p>Peak</p>	<p>Site : 03CN07-HY Condition : PEAK_B(04)_16-24 3e HF_ANT_00066583 VERTICAL FDM:1000.0000Hz VBM:3000.0000Hz SMT:Auto Detector : Peak Project : 872508 Mode : III</p>	<p>Left blank</p>



WIFI	Band 4 5725~5850MHz Band Edge @ 3m	
ANT	802.11ac VHT40 CH159 5795MHz	
1+2	Horizontal	Fundamental
Peak	<p>Site : 03CN07-HY Condition : PEAK_B4(04)_16-24 3e HF_ANT_00066583 HORIZONTAL Detector : Peak Project : #72508 Mode : 112</p>	<p>Site : 03CN07-HY Condition : PEAK(FUN1) 3e HF_ANT_00066583 HORIZONTAL Detector : Peak Project : #72508 Mode : 112</p>
Peak	<p>Site : 03CN07-HY Condition : PEAK_B4(04)_16-24 3e HF_ANT_00066583 HORIZONTAL Detector : Peak Project : #72508 Mode : 112</p>	Left blank



WIFI	Band 4 5725~5850MHz Band Edge @ 3m	
ANT	802.11ac VHT40 CH159 5795MHz	
1+2	Vertical	Fundamental
<p>Peak</p>	<p>Site : 03CN07-HY Condition : PEAK_B4(04)_16-24 3e HF_ANT_00066583 VERTICAL Detector : Peak Project : #72508 Mode : 112</p>	<p>Site : 03CN07-HY Condition : PEAK(FUN1) 3e HF_ANT_00066583 VERTICAL Detector : Peak Project : #72508 Mode : 112</p>
<p>Peak</p>	<p>Site : 03CN07-HY Condition : PEAK_B4(04)_16-24 3e HF_ANT_00066583 VERTICAL Detector : Peak Project : #72508 Mode : 112</p>	<p>Left blank</p>



Band 4 5725~5850MHz
WIFI 802.11ac VHT80 (Band Edge @ 3m)

WIFI	Band 4 5725~5850MHz Band Edge @ 3m	
ANT	802.11ac VHT80 CH155 5775MHz	
1+2	Horizontal	Fundamental
Peak	<p>Site : 01CH07-HY Condition : PEAK_BE(04)_16-24 3m HE_ANT_00066583 HORIZONTAL Detector : Peak Project : 872508 Mode : 113</p>	<p>Site : 01CH07-HY Condition : PEAK(UNIT) 3m HE_ANT_00066583 HORIZONTAL Detector : Peak Project : 872508 Mode : 113</p>
Peak	<p>Site : 01CH07-HY Condition : PEAK_BE(04)_16-24 3m HE_ANT_00066583 HORIZONTAL Detector : Peak Project : 872508 Mode : 113</p>	Left blank

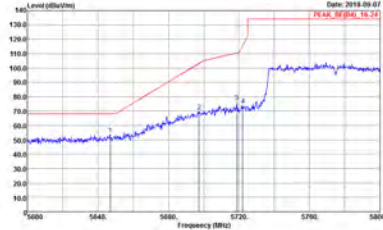
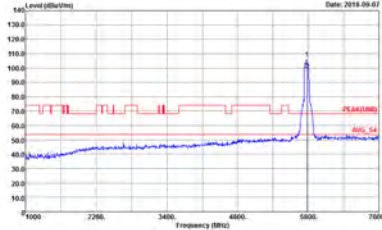
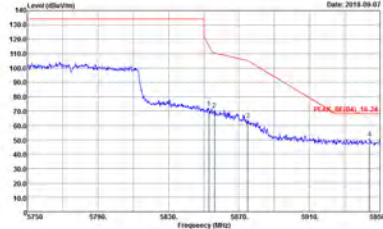

WIFI	Band 4 5725~5850MHz Band Edge @ 3m	
ANT	802.11ac VHT80 CH155 5775MHz	
1+2	Vertical	Fundamental
Peak	 <p>Site : 03CN07-HY Condition : PEAK_BI(04)_16-24 3m HF_ANT_00066583 VERTICAL Detector : Peak Project : #72508 Mode : 113</p>	 <p>Site : 03CN07-HY Condition : PEAK(011) 3m HF_ANT_00066583 VERTICAL Detector : Peak Project : #72508 Mode : 113</p>
Peak	 <p>Site : 03CN07-HY Condition : PEAK_BI(04)_16-24 3m HF_ANT_00066583 VERTICAL Detector : Peak Project : #72508 Mode : 113</p>	Left blank



Band 4 - 5725~5850MHz
WIFI 802.11ac VHT20 (Harmonic @ 3m)

WIFI	Band 4 5725~5850MHz Harmonic @ 3m	
ANT	802.11ac VHT20 CH149 5745MHz	
1+2	Horizontal	Vertical
Peak Avg.	<p>Site : 03CM07-HY Condition : PEAK(RN11) 3m SHF-EHE_131829 HORIZONTAL Detector : Peak Project : 872508 Mode : 100</p>	<p>Site : 03CM07-HY Condition : PEAK(RN11) 3m SHF-EHE_131829 VERTICAL Detector : Peak Project : 872508 Mode : 100</p>



WIFI	Band 4 5725~5850MHz Harmonic @ 3m	
ANT	802.11ac VHT20 CH157 5785MHz	
1+2	Horizontal	Vertical
Peak Avg.		

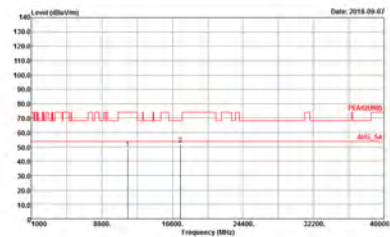
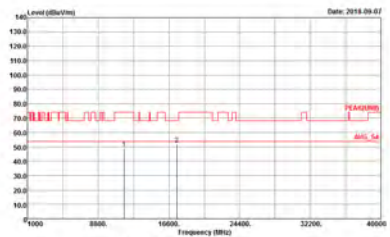

WIFI	Band 4 5725~5850MHz Harmonic @ 3m	
ANT	802.11ac VHT20 CH165 5825MHz	
1+2	Horizontal	Vertical
Peak Avg.	 <p>Site : 03CM07-HY Condition : PEAK(0N11) 3m SHF-EHE_131029 HORIZONTAL Detector : Peak Project : 872508 Mode : 110</p>	 <p>Site : 03CM07-HY Condition : PEAK(0N11) 3m SHF-EHE_131029 VERTICAL Detector : Peak Project : 872508 Mode : 110</p>



Band 4 5725~5850MHz
WIFI 802.11ac VHT40 (Harmonic @ 3m)

Table with 3 columns: WIFI, ANT, and 1+2. The 1+2 column contains two graphs: Horizontal and Vertical. Each graph shows Level (dBm) vs Frequency (MHz) with Peak and Avg. markers. Metadata includes Site: 03CH07-HY, Condition: PEAK (UNIT) 3m SHF-EHE_131029 HORIZONTAL, and Project: 072508.



WIFI	Band 4 5725~5850MHz Harmonic @ 3m	
ANT	802.11ac VHT40 CH159 5795MHz	
1+2	Horizontal	Vertical
Peak Avg.	<p>Site : 03CM07-HY Condition : PEAK(0N11) 3m SHF-EHE_131829 HORIZONTAL Detector : Peak Project : 872508 Mode : 112</p>	<p>Site : 03CM07-HY Condition : PEAK(0N11) 3m SHF-EHE_131829 VERTICAL Detector : Peak Project : 872508 Mode : 112</p>

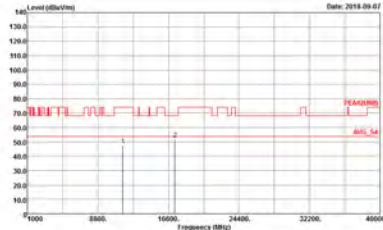
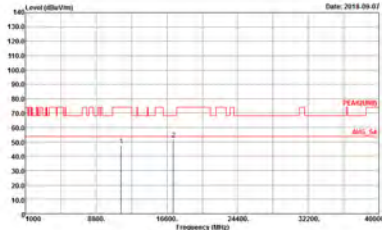

**Band 4 5725~5850MHz
WIFI 802.11ac VHT80 (Harmonic @ 3m)**

WIFI	Band 4 5725~5850MHz Harmonic @ 3m	
ANT	802.11ac VHT80 CH155 5775MHz	
1+2	Horizontal	Vertical
<p>Peak Avg.</p>	 <p>Site : 01CH07-HY Condition : PEAK (UNIT) 3m SHF-EHE_131029 HORIZONTAL Detection : Peak Project : 072508 Mode : 113</p>	 <p>Site : 01CH07-HY Condition : PEAK (UNIT) 3m SHF-EHE_131029 VERTICAL Detection : Peak Project : 072508 Mode : 113</p>



Emission below 1GHz
5GHz WIFI 802.11ac VHT80 (LF)

Table with 3 columns: WIFI (5GHz 5725~5850MHz), ANT (802.11ac VHT80 LF), and 1+2 (Horizontal/Vertical). It contains two spectral plots and a 'QP / Peak' label.

**Appendix D. Duty Cycle Plots**

Antenna	Band	Duty Cycle(%)	T(us)	1/T(kHz)	VBW Setting	Duty Factor(dB)
1	802.11a	95.37	2060.00	0.49	1kHz	95.37
2	802.11a	95.37	2060.00	0.49	1kHz	95.37
1+2	802.11a for Ant. 1	95.37	2060.00	0.49	1kHz	95.37
1+2	802.11a for Ant. 2	95.37	2060.00	0.49	1kHz	95.37
1	5GHz 802.11n HT20	95.05	1920.00	0.52	1kHz	95.05
2	5GHz 802.11n HT20	95.05	1920.00	0.52	1kHz	95.05
1+2	5GHz 802.11n HT20 for Ant. 1	95.05	1920.00	0.52	1kHz	95.05
1+2	5GHz 802.11n HT20 for Ant. 2	95.05	1920.00	0.52	1kHz	95.05
1	5GHz 802.11n HT40	91.86	948.00	1.05	3kHz	91.86
2	5GHz 802.11n HT40	91.86	948.00	1.05	3kHz	91.86
1+2	5GHz 802.11n HT40 for Ant. 1	91.86	948.00	1.05	3kHz	91.86
1+2	5GHz 802.11n HT40 for Ant. 2	90.80	948.00	1.05	3kHz	90.80
1	5GHz 802.11ac VHT20	95.10	1940.00	0.52	1kHz	95.10
2	5GHz 802.11ac VHT20	95.05	1920.00	0.52	1kHz	95.05
1+2	5GHz 802.11ac VHT20 for Ant. 1	95.10	1940.00	0.52	1kHz	95.10
1+2	5GHz 802.11ac VHT20 for Ant. 2	95.05	1920.00	0.52	1kHz	95.05
1	5GHz 802.11ac VHT40	91.95	960.00	1.04	3kHz	91.95
2	5GHz 802.11ac VHT40	91.86	948.00	1.05	3kHz	91.86
1+2	5GHz 802.11ac VHT40 for Ant. 1	90.91	960.00	1.04	3kHz	90.91
1+2	5GHz 802.11ac VHT40 for Ant. 2	90.80	948.00	1.05	3kHz	90.80
1	5GHz 802.11ac VHT80	87.72	600.00	1.67	3kHz	87.72
2	5GHz 802.11ac VHT80	87.72	600.00	1.67	3kHz	87.72
1+2	5GHz 802.11ac VHT80 for Ant. 1	87.34	600.00	1.67	3kHz	87.34
1+2	5GHz 802.11ac VHT80 for Ant. 2	87.61	594.00	1.68	3kHz	87.61



<Ant. 1>

802.11a

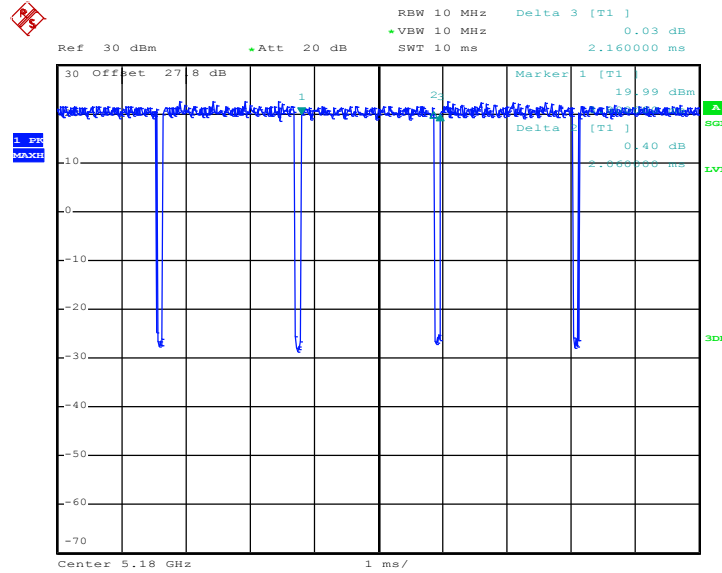

Date: 15.AUG.2018 23:09:50

802.11n HT20

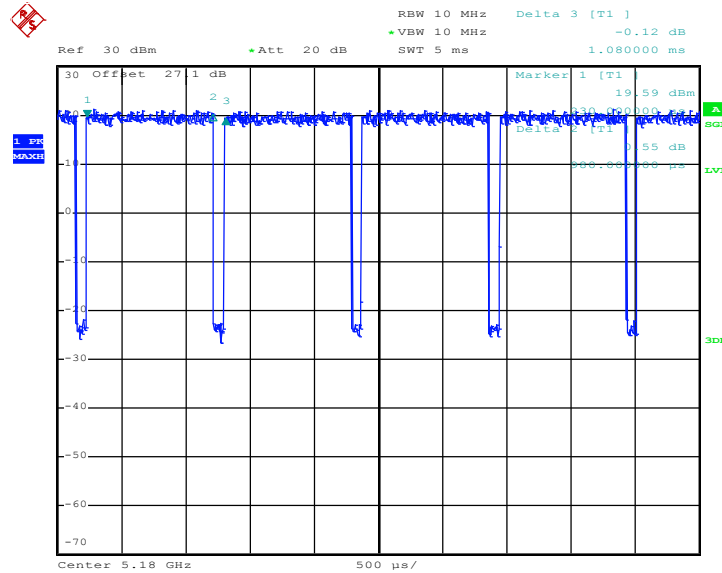

Date: 9.SEP.2018 22:03:43



802.11n HT40

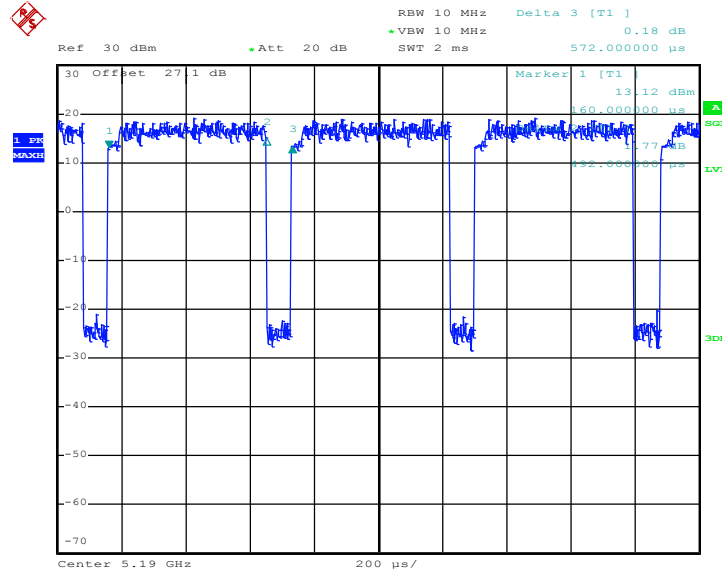

Date: 9.SEP.2018 22:17:53

802.11ac VHT20

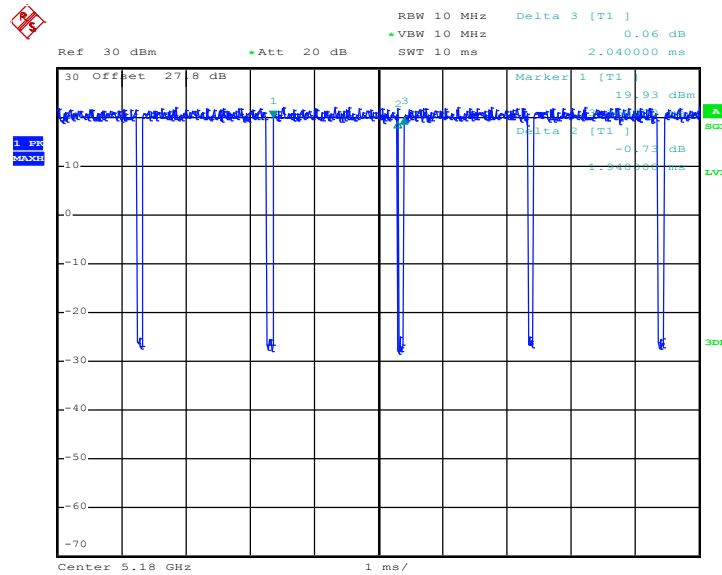

Date: 15.AUG.2018 23:29:50



802.11ac VHT40

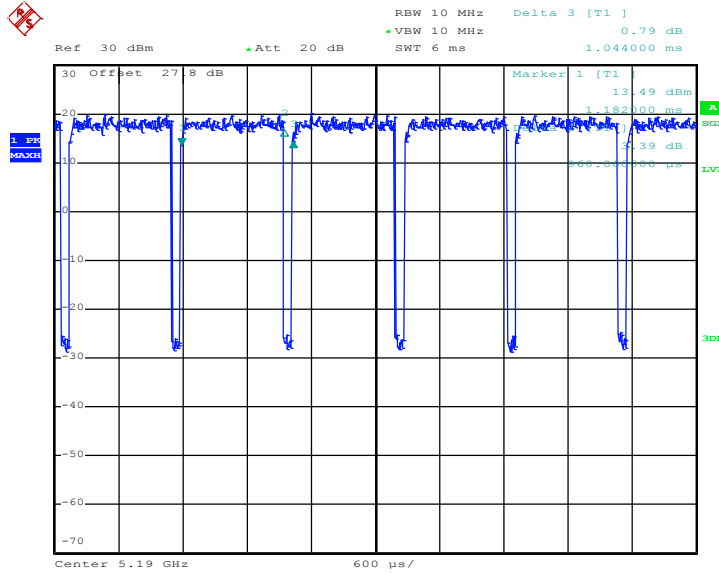

Date: 15.AUG.2018 23:35:27

802.11ac VHT80

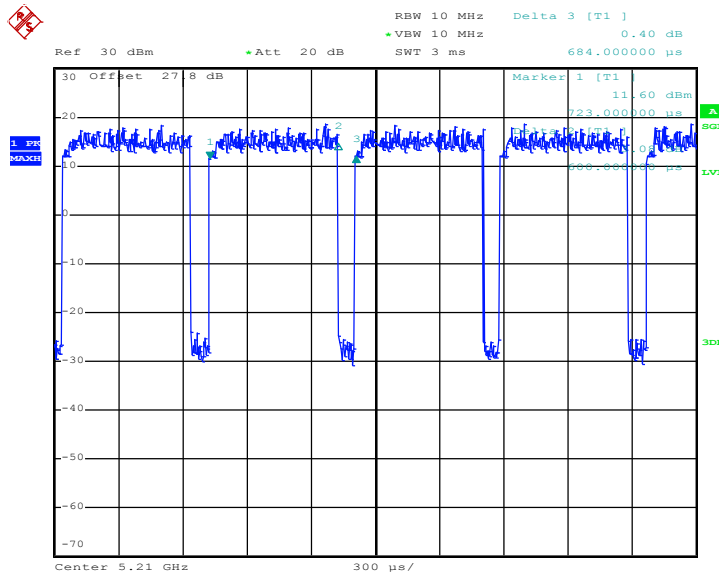

Date: 15.AUG.2018 23:41:04



<Ant. 2>

802.11a

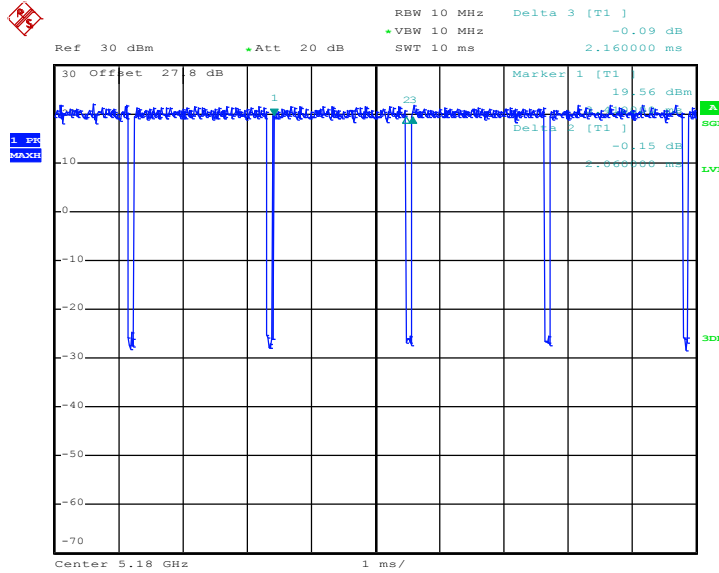

Date: 15.AUG.2018 23:10:56

802.11n HT20

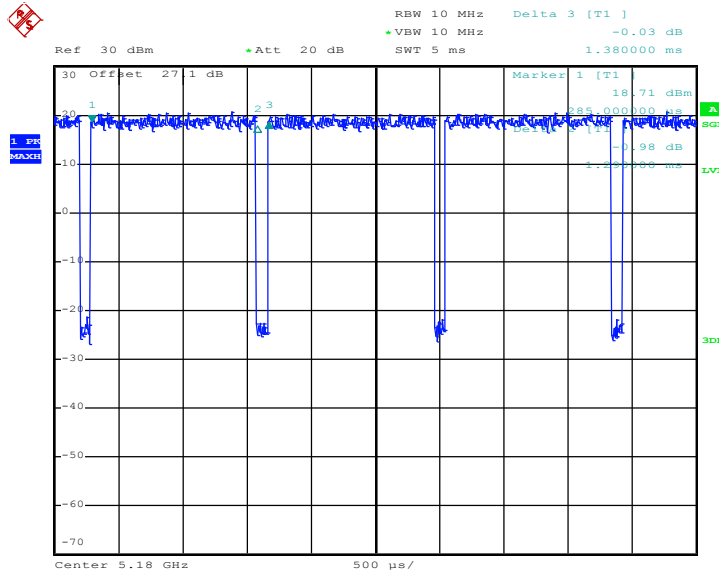

Date: 9.SEP.2018 22:44:25



802.11n HT40

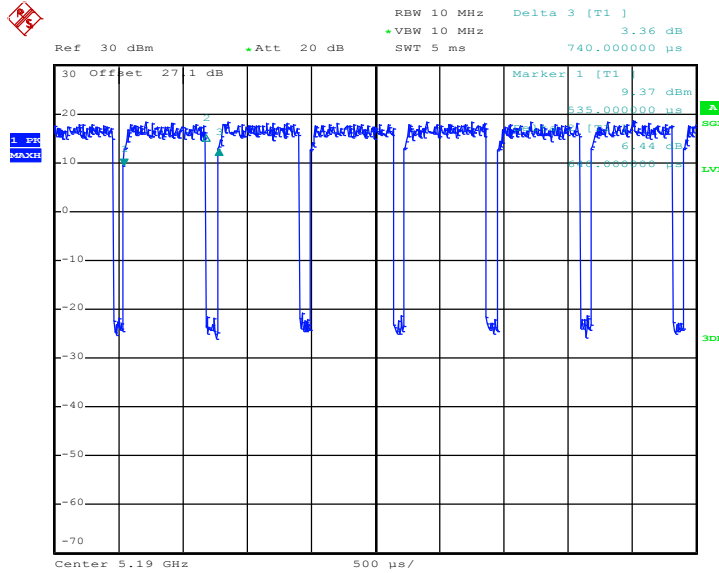

Date: 9.SEP.2018 22:54:29

802.11ac VHT20

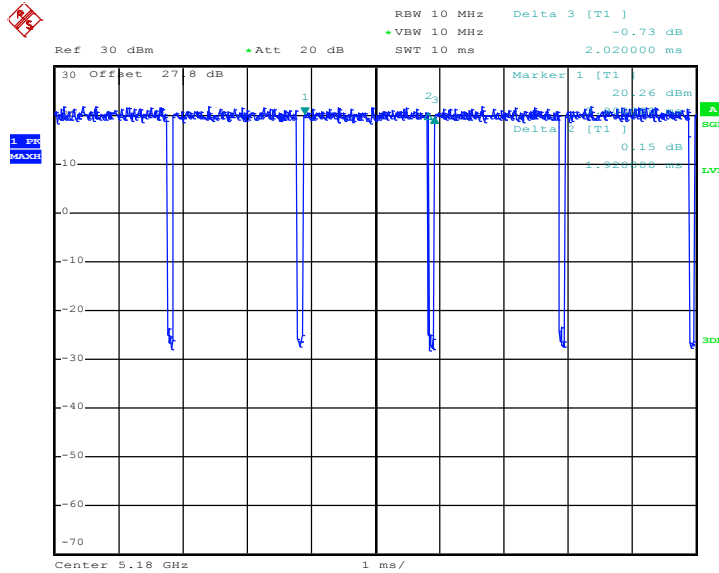

Date: 15.AUG.2018 23:30:32



802.11ac VHT40

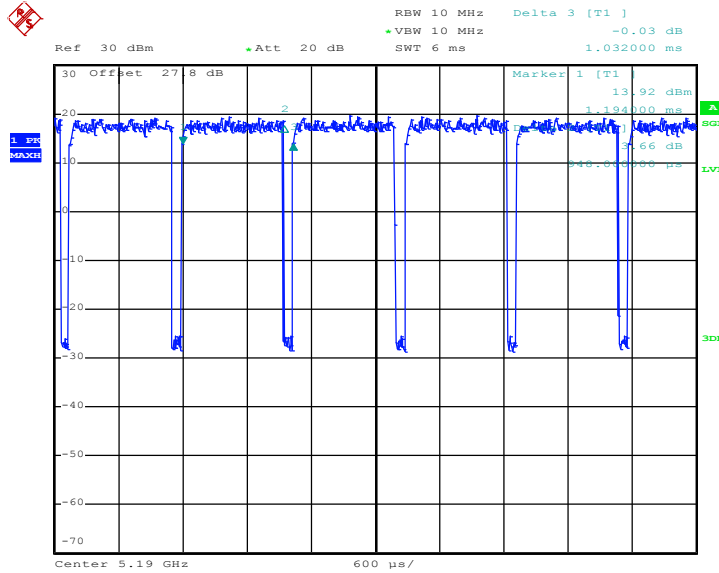

Date: 15.AUG.2018 23:36:23

802.11ac VHT80

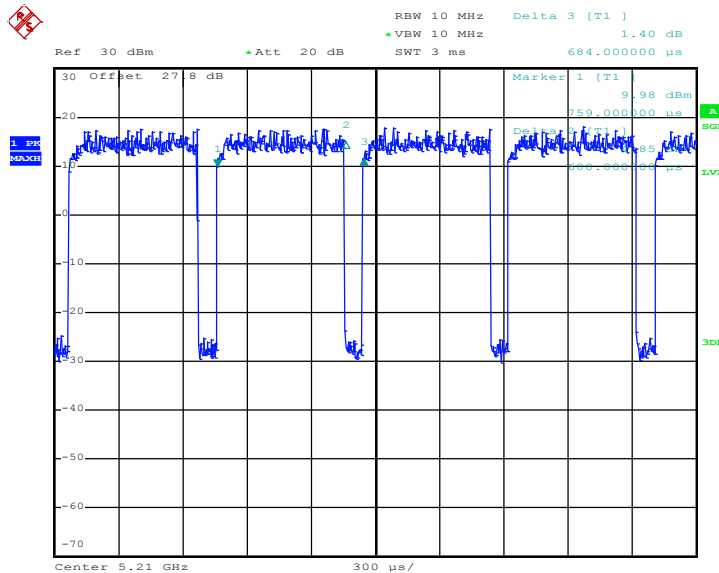

Date: 15.AUG.2018 23:48:43



MIMO <Ant. 1>

802.11a

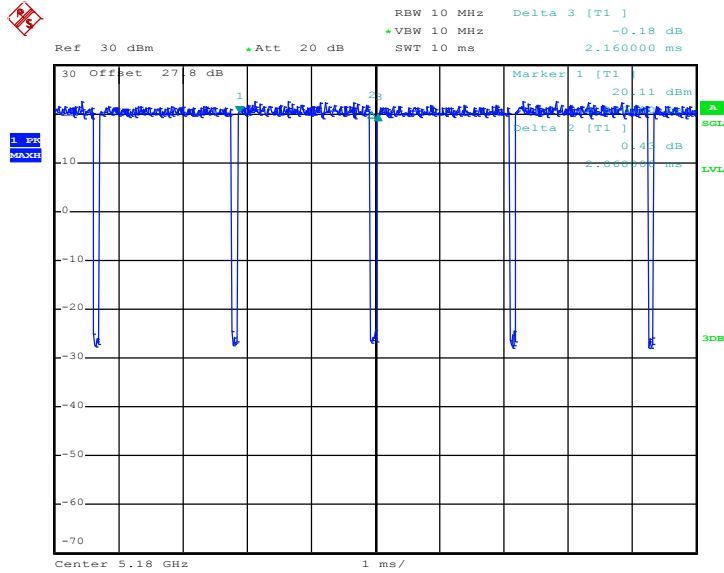

Date: 15.AUG.2018 23:12:22

802.11n HT20

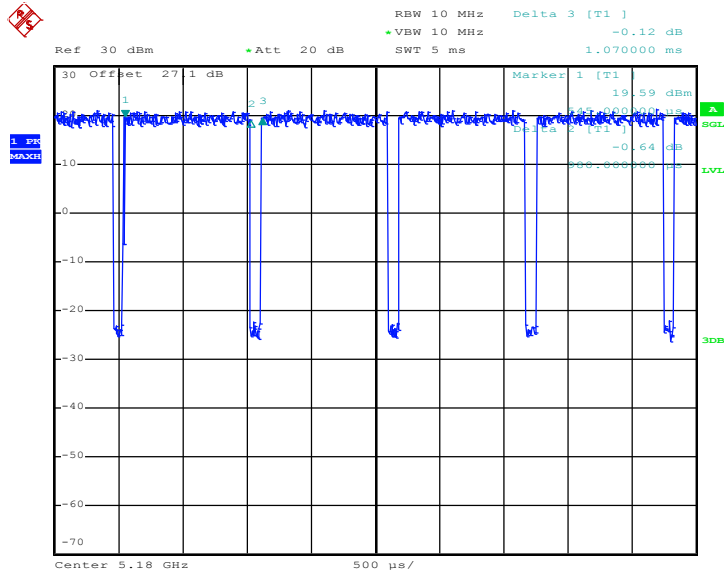

Date: 9.SEP.2018 23:30:38



802.11n HT40

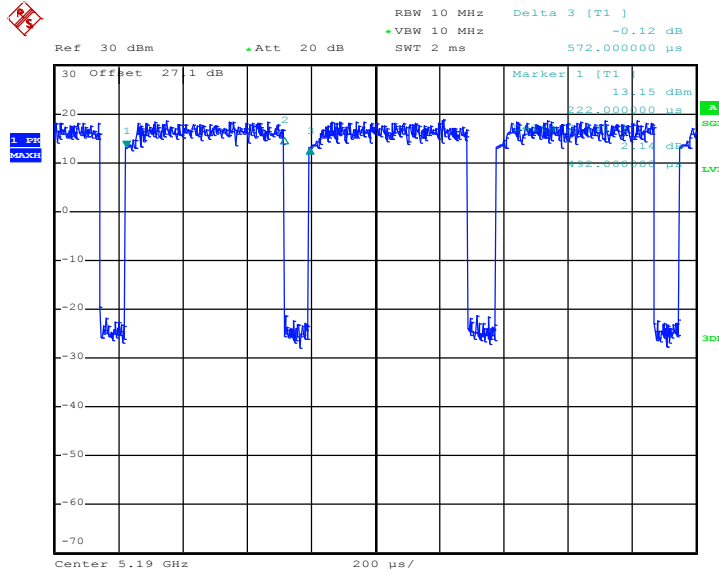

Date: 9.SEP.2018 23:46:48

802.11ac VHT20

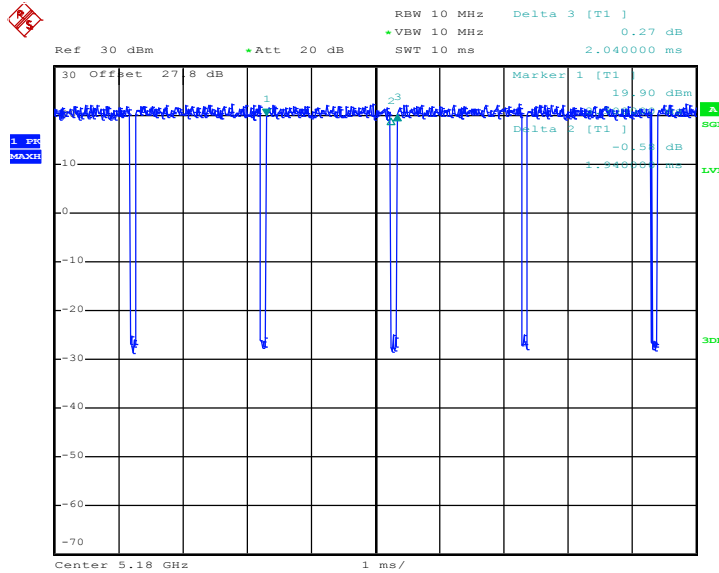

Date: 15.AUG.2018 23:33:39



802.11ac VHT40

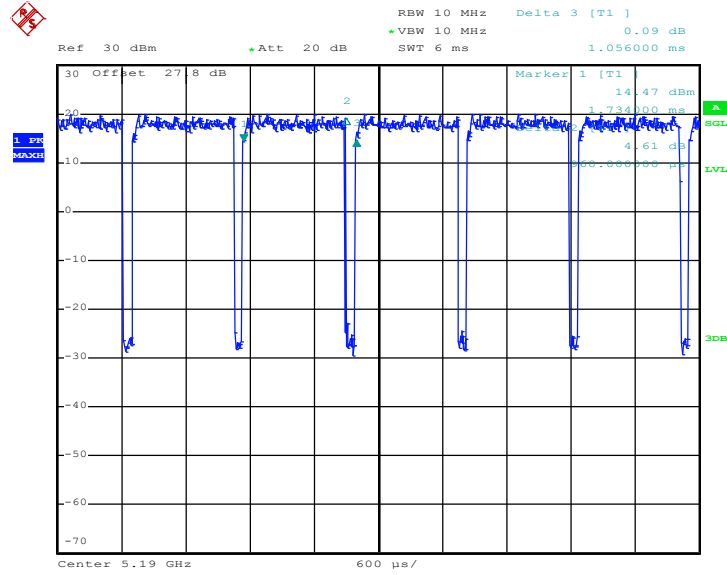

Date: 15.AUG.2018 23:37:23

802.11ac VHT80

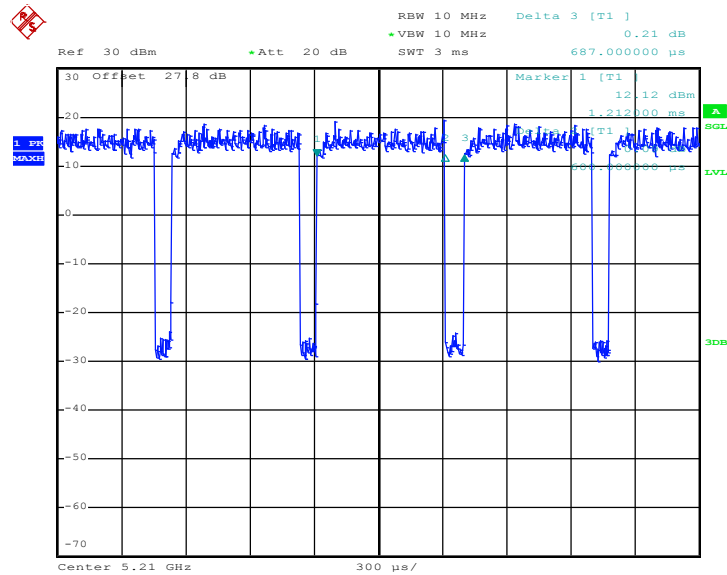

Date: 15.AUG.2018 23:53:59



MIMO <Ant. 2>

802.11a

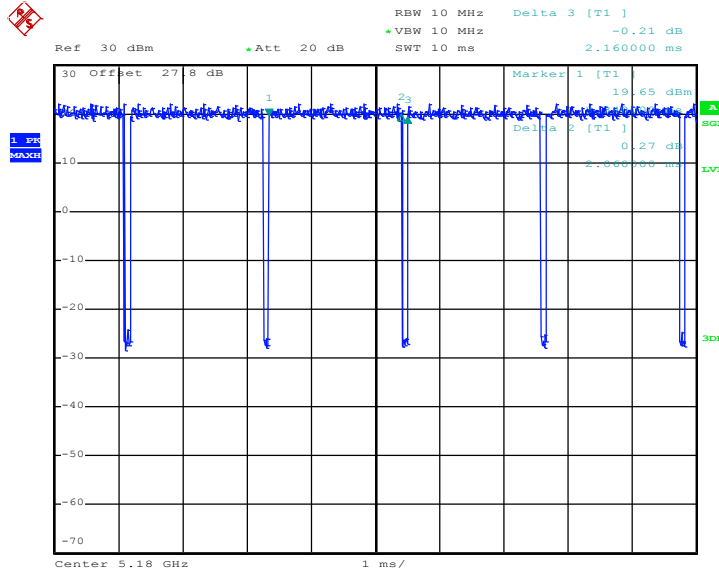

Date: 15.AUG.2018 23:13:18

802.11n HT20

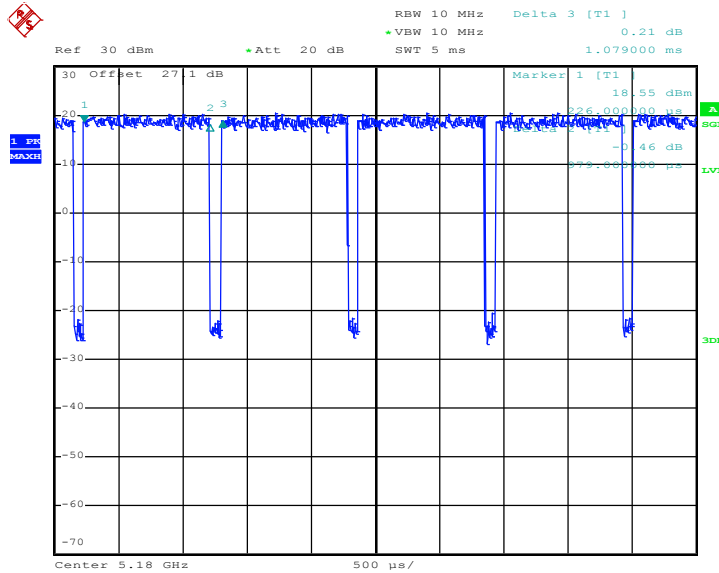

Date: 9.SEP.2018 23:38:03



802.11n HT40

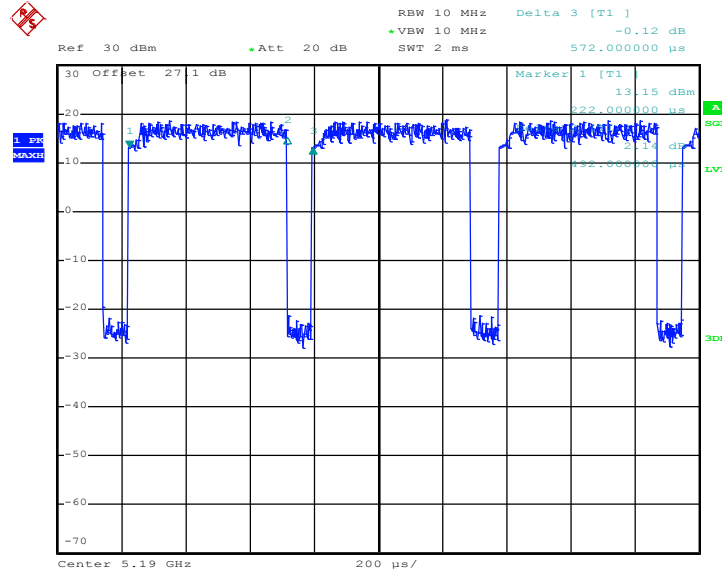

Date: 9.SEP.2018 23:46:48

802.11ac VHT20

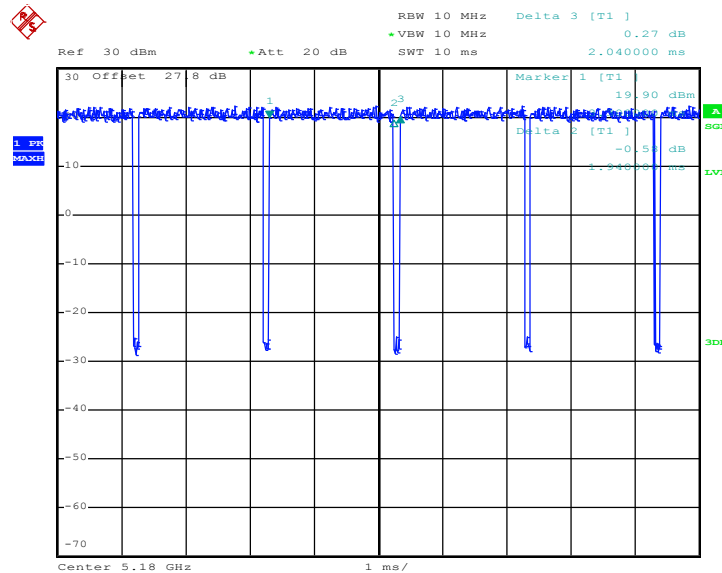

Date: 15.AUG.2018 23:33:39



802.11ac VHT40

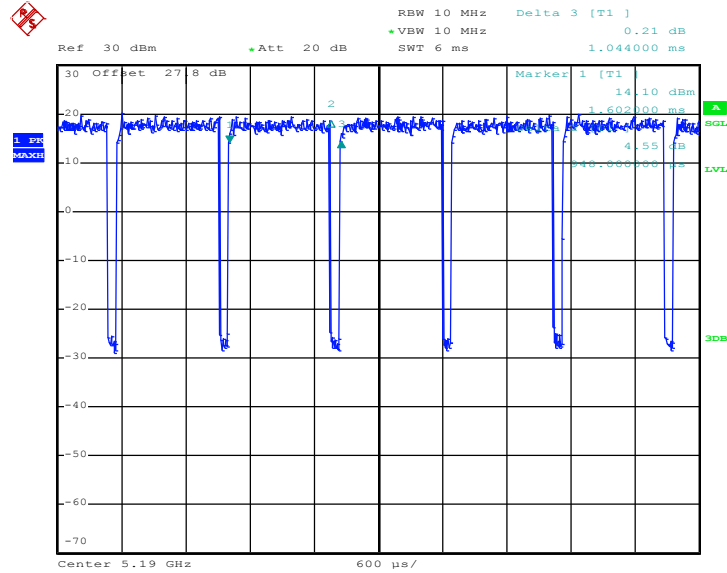

Date: 15.AUG.2018 23:38:09

802.11ac VHT80

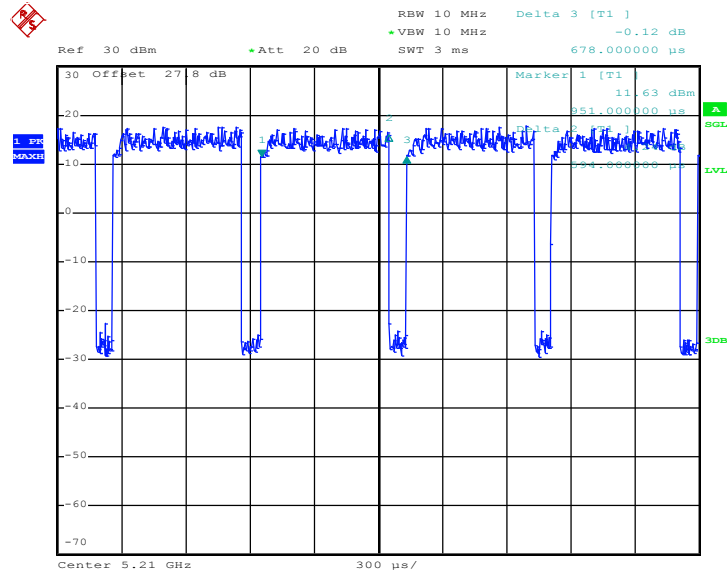

Date: 15.AUG.2018 23:51:14